



A D T

# FCC TEST REPORT (15.247)

**REPORT NO.:** RF980724L11

**MODEL NO.:** EUB9801 (Refer to item 3.1 for the more details)

**RECEIVED:** Jul. 27, 2009

**TESTED:** Jul. 30 ~ Aug. 11, 2009

**ISSUED:** Aug. 14, 2009

**APPLICANT:** Senao Networks Inc.

**ADDRESS:** 3F, No. 529, Chung Cheng Rd., Hsintien, Taipei,  
Taiwan, R.O.C.

**ISSUED BY:** Bureau Veritas Consumer Products Services  
(H.K.) Ltd., Taoyuan Branch

**LAB ADDRESS:** No. 47, 14th Ling, Chia Pau Tsuen, Lin Kou  
Hsiang, Taipei Hsien 244, Taiwan, R.O.C.

**TEST LOCATION:** No. 19, Hwa Ya 2nd Rd, Wen Hwa Tsuen, Kwei  
Shan Hsiang, Taoyuan Hsien 333, Taiwan,  
R.O.C.

This test report consists of 210 pages in total. It may be duplicated completely for legal use with the approval of the applicant. It should not be reproduced except in full, without the written approval of our laboratory. The client should not use it to claim product endorsement by TAF or any government agencies. The test results in the report only apply to the tested sample.





A D T

# TABLE OF CONTENTS

1.	CERTIFICATION.....	5
2.	SUMMARY OF TEST RESULTS .....	6
2.1	MEASUREMENT UNCERTAINTY.....	6
3.	GENERAL INFORMATION.....	7
3.1	GENERAL DESCRIPTION OF EUT .....	7
3.2	DESCRIPTION OF TEST MODES.....	9
3.2.1	CONFIGURATION OF SYSTEM UNDER TEST .....	10
3.2.2	TEST MODE APPLICABILITY AND TESTED CHANNEL DETAIL .....	11
3.3	GENERAL DESCRIPTION OF APPLIED STANDARDS .....	15
3.4	DESCRIPTION OF SUPPORT UNITS .....	15
4.	TEST TYPES AND RESULTS (FOR 2.4GHz BAND).....	16
4.1	RADIATED EMISSION MEASUREMENT .....	16
4.1.1	LIMITS OF RADIATED EMISSION MEASUREMENT.....	16
4.1.2	TEST INSTRUMENTS.....	17
4.1.3	TEST PROCEDURES .....	18
4.1.4	DEVIATION FROM TEST STANDARD.....	18
4.1.5	TEST SETUP.....	19
4.1.6	EUT OPERATING CONDITIONS .....	19
4.1.7	TEST RESULTS .....	20
4.2	CONDUCTED EMISSION MEASUREMENT .....	33
4.2.1	LIMITS OF CONDUCTED EMISSION MEASUREMENT.....	33
4.2.2	TEST INSTRUMENTS.....	33
4.2.3	TEST PROCEDURES .....	34
4.2.4	DEVIATION FROM TEST STANDARD.....	34
4.2.5	TEST SETUP.....	35
4.2.6	EUT OPERATING CONDITIONS .....	35
4.2.7	TEST RESULTS .....	36
4.3	6dB BANDWIDTH MEASUREMENT.....	38
4.3.1	LIMITS OF 6dB BANDWIDTH MEASUREMENT .....	38
4.3.2	TEST INSTRUMENTS.....	38
4.3.3	TEST PROCEDURE.....	38
4.3.4	DEVIATION FROM TEST STANDARD.....	38
4.3.5	TEST SETUP.....	39
4.3.6	EUT OPERATING CONDITIONS .....	39
4.3.7	TEST RESULTS .....	40
4.4	MAXIMUM PEAK OUTPUT POWER.....	56
4.4.1	LIMITS OF MAXIMUM PEAK OUTPUT POWER MEASUREMENT .....	56
4.4.2	INSTRUMENTS.....	56
4.4.3	TEST PROCEDURE.....	56
4.4.4	DEVIATION FROM TEST STANDARD.....	57
4.4.5	TEST SETUP.....	57
4.4.6	EUT OPERATING CONDITIONS .....	57
4.4.7	TEST RESULTS .....	58
4.5	POWER SPECTRAL DENSITY MEASUREMENT.....	90
4.5.1	LIMITS OF POWER SPECTRAL DENSITY MEASUREMENT .....	90
4.5.2	TEST INSTRUMENTS.....	90
4.5.3	TEST PROCEDURE.....	90
4.5.4	DEVIATION FROM TEST STANDARD.....	91
4.5.5	TEST SETUP.....	91



A D T

4.5.6	EUT OPERATING CONDITION.....	91
4.5.7	TEST RESULTS .....	92
4.6	BAND EDGES MEASUREMENT .....	108
4.6.1	LIMITS OF BAND EDGES MEASUREMENT .....	108
4.6.2	TEST INSTRUMENTS.....	108
4.6.3	TEST PROCEDURE.....	109
4.6.4	DEVIATION FROM TEST STANDARD.....	109
4.6.5	EUT OPERATING CONDITION.....	109
4.6.6	TEST RESULTS .....	110
4.7	ANTENNA REQUIREMENT .....	126
4.7.1	STANDARD APPLICABLE .....	126
4.7.2	ANTENNA CONNECTED CONSTRUCTION .....	126
5.	TEST TYPES AND RESULTS (FOR 5.0GHz BAND).....	127
5.1	RADIATED EMISSION MEASUREMENT .....	127
5.1.1	LIMITS OF RADIATED EMISSION MEASUREMENT .....	127
5.1.2	TEST INSTRUMENTS.....	128
5.1.3	TEST PROCEDURES .....	129
5.1.4	DEVIATION FROM TEST STANDARD.....	129
5.1.5	TEST SETUP .....	130
5.1.6	EUT OPERATING CONDITIONS .....	130
5.1.7	TEST RESULTS .....	131
5.2	CONDUCTED EMISSION MEASUREMENT .....	140
5.2.1	LIMITS OF CONDUCTED EMISSION MEASUREMENT .....	140
5.2.2	TEST INSTRUMENTS.....	140
5.2.3	TEST PROCEDURES .....	141
5.2.4	DEVIATION FROM TEST STANDARD.....	141
5.2.5	TEST SETUP .....	142
5.2.6	EUT OPERATING CONDITIONS .....	142
5.2.7	TEST RESULTS .....	143
5.3	6dB BANDWIDTH MEASUREMENT.....	145
5.3.1	LIMITS OF 6dB BANDWIDTH MEASUREMENT .....	145
5.3.2	TEST INSTRUMENTS.....	145
5.3.3	TEST PROCEDURE.....	145
5.3.4	DEVIATION FROM TEST STANDARD.....	146
5.3.5	TEST SETUP.....	146
5.3.6	EUT OPERATING CONDITIONS .....	146
5.3.7	TEST RESULTS .....	147
5.4	MAXIMUM PEAK OUTPUT POWER.....	158
5.4.1	LIMITS OF MAXIMUM PEAK OUTPUT POWER MEASUREMENT .....	158
5.4.2	INSTRUMENTS.....	158
5.4.3	TEST PROCEDURE.....	158
5.4.4	DEVIATION FROM TEST STANDARD.....	159
5.4.5	TEST SETUP.....	159
5.4.6	EUT OPERATING CONDITIONS .....	159
5.4.7	TEST RESULTS .....	160
5.5	POWER SPECTRAL DENSITY MEASUREMENT .....	182
5.5.1	LIMITS OF POWER SPECTRAL DENSITY MEASUREMENT .....	182
5.5.2	TEST INSTRUMENTS.....	182
5.5.3	TEST PROCEDURE.....	182
5.5.4	DEVIATION FROM TEST STANDARD.....	183
5.5.5	TEST SETUP .....	183



**A D T**

5.5.6	EUT OPERATING CONDITION.....	183
5.5.7	TEST RESULTS .....	184
5.6	BAND EDGES MEASUREMENT .....	195
5.6.1	LIMITS OF BAND EDGES MEASUREMENT .....	195
5.6.2	TEST INSTRUMENTS.....	195
5.6.3	TEST PROCEDURE.....	196
5.6.4	DEVIATION FROM TEST STANDARD.....	197
5.6.5	EUT OPERATING CONDITION.....	197
5.6.6	TEST RESULTS .....	197
5.7	ANTENNA REQUIREMENT .....	207
5.7.1	STANDARD APPLICABLE .....	207
5.7.2	ANTENNA CONNECTED CONSTRUCTION .....	207
6.	PHOTOGRAPHS OF THE TEST CONFIGURATION.....	208
7.	INFORMATION ON THE TESTING LABORATORIES .....	209
8.	APPENDIX A - MODIFICATIONS RECORDERS FOR ENGINEERING CHANGES TO THE EUT BY THE LAB.....	210



A D T

## 1. CERTIFICATION

**PRODUCT:** Wireless Dual Band 802.11 a/b/g/n USB adapter

**MODEL:** EUB9801 (Refer to item 3.1 for the more details)

**BRAND:** EnGenius (Refer to item 3.1 for the more details)

**APPLICANT:** Senao Networks Inc.

**TEST SAMPLE:** ENGINEERING SAMPLE

**TESTED:** Jul. 30 ~ Aug. 11, 2009

**STANDARDS:** FCC Part 15, Subpart C (Section 15.247)

ANSI C63.4-2003

The above equipment (Model: EUB9801) has been tested by **Bureau Veritas Consumer Products Services (H.K.) Ltd., Taoyuan Branch**, and found compliance with the requirement of the above standards. The test record, data evaluation & Equipment Under Test (EUT) configurations represented herein are true and accurate accounts of the measurements of the sample's EMC characteristics under the conditions specified in this report.

**PREPARED BY** : *Polly Chien* , **DATE** : Aug. 14, 2009  
Polly Chien / Specialist

**TECHNICAL ACCEPTANCE** : *Long Chen* , **DATE** : Aug. 14, 2009  
Responsible for RF Long Chen / Senior Engineer

**APPROVED BY** : *Gary Chang* , **DATE** : Aug. 14, 2009  
Gary Chang / Assistant Manager

## 2. SUMMARY OF TEST RESULTS

The EUT has been tested according to the following specifications:

APPLIED STANDARD: FCC PART 15, SUBPART C (SECTION 15.247)			
STANDARD SECTION	TEST TYPE AND LIMIT	RESULT	REMARK
15.207	AC Power Conducted Emission	PASS	Meet the requirement of limit. Minimum passing margin is -13.36dB at 22.570MHz.
15.247(a)(2)	Spectrum Bandwidth of a Direct Sequence Spread Spectrum System Limit: min. 500kHz	PASS	Meet the requirement of limit.
15.247(b)	Maximum Peak Output Power Limit: max. 30dBm	PASS	Meet the requirement of limit.
15.247(d)	Radiated Emissions Limit: Table 15.209	PASS	Meet the requirement of limit. Minimum passing margin is -3.49dB at 47.40MHz.
15.247(e)	Power Spectral Density Limit: max. 8dBm	PASS	Meet the requirement of limit.
15.247(d)	Band Edge Measurement Limit: 20dB less than the peak value of fundamental frequency	PASS	Meet the requirement of limit.

### 2.1 MEASUREMENT UNCERTAINTY

Where relevant, the following measurement uncertainty levels have been estimated for tests performed on the EUT as specified in CISPR 16-4-2:

MEASUREMENT	FREQUENCY	UNCERTAINTY
Conducted emissions	150kHz~30MHz	2.44 dB
Radiated emissions	30MHz ~ 200MHz	3.34 dB
	200MHz ~1000MHz	3.35 dB
	1GHz ~ 18GHz	2.26 dB
	18GHz ~ 40GHz	1.94 dB

This uncertainty represents an expanded uncertainty expressed at approximately the 95% confidence level using a coverage factor of  $k = 2$ .



### 3. GENERAL INFORMATION

#### 3.1 GENERAL DESCRIPTION OF EUT

<b>EUT</b>	Wireless Dual Band 802.11 a/b/g/n USB adapter
<b>MODEL NO.</b>	EUB9801 (Refer to Note 1 for the more details)
<b>FCC ID</b>	U2M-UB9801
<b>POWER SUPPLY</b>	5Vdc from host equipment
<b>MODULATION TYPE</b>	CCK, DQPSK, DBPSK for DSSS 64QAM, 16QAM, QPSK, BPSK for OFDM
<b>MODULATION TECHNOLOGY</b>	DSSS, OFDM
<b>TRANSFER RATE</b>	802.11b:11.0/ 5.5/ 2.0/ 1.0Mbps 802.11g: 54.0/ 48.0/ 36.0/ 24.0/ 18.0/ 12.0/ 9.0/ 6.0Mbps 802.11a: 54.0/ 48.0/ 36.0/ 24.0/ 18.0/ 12.0/ 9.0/ 6.0Mbps Draft 802.11n: up to 300.0Mbps
<b>OPERATING FREQUENCY</b>	2.4GHz: 2412 ~ 2462MHz 5.0GHz: 5745 ~ 5825MHz
<b>NUMBER OF CHANNEL</b>	2.4GHz: 11 for 802.11b, 802.11g, draft 802.11n (20MHz) 7 for draft 802.11n (40MHz) 5.0GHz: 5 for 802.11a, draft 802.11n (20MHz) 2 for draft 802.11n (40MHz)
<b>OUTPUT POWER</b>	19.91mW for 2412 ~ 2462MHz 29.24mW for 5745 ~ 5825MHz
<b>ANTENNA TYPE</b>	Printed antenna with -3dBi gain
<b>I/O PORTS</b>	NA
<b>DATA CABLE</b>	USB
<b>ACCESSORY DEVICES</b>	NA

**NOTE:**

- The following models are electrically identical, different model names and brands are for marketing purpose.

BRAND	MODEL	DIFFERENCE
EnGenius	EUB9801	Marketing different
Rosewill	RNX-N1-Dual	
Sitecom	WL-329	

- The EUT is a Wireless Dual Band 802.11 a/b/g/n USB adapter. The functions of EUT listed as below:

	TEST STANDARD	REFERENCE REPORT
WLAN 802.11b/g, draft 802.11n	FCC Part 15, Subpart C (Section 15.247)	RF980724L11
WLAN 802.11a, draft 802.11n (5745~5825 MHz)		
WLAN 802.11a, draft 802.11n (5180~ 5240MHz)	FCC Part 15, Subpart E (Section 15.407)	RF980724L11-1



A D T

3. The frequency bands used in this EUT are listed as follows:

Frequency Band (MHz)	2412~2462	5180~5240	5745~5825
802.11b	√		
802.11g	√		
802.11a		√	√
Draft 802.11n (20MHz)	√	√	√
Draft 802.11n (40MHz)	√	√	√

4. The EUT incorporates a MIMO function. Physically, the EUT provides two completed transmitters and two receivers.

MODULATION MODE	TX FUNCTION
802.11b	2TX
802.11g	2TX
802.11a	2TX
Draft 802.11n (20MHz)	2TX
Draft 802.11n (40MHz)	2TX

5. The above EUT information was declared by manufacturer and for more detailed features description, please refer to the manufacturer's specifications or user's manual.



### 3.2 DESCRIPTION OF TEST MODES

#### FOR 2.4GHz:

11 channels are provided for 802.11b, 802.11g and draft 802.11n (20MHz):

CHANNEL	FREQUENCY	CHANNEL	FREQUENCY
1	2412MHz	7	2442MHz
2	2417MHz	8	2447MHz
3	2422MHz	9	2452MHz
4	2427MHz	10	2457MHz
5	2432MHz	11	2462MHz
6	2437MHz		

7 channels are provided for draft 802.11n (40MHz):

CHANNEL	FREQUENCY	CHANNEL	FREQUENCY
1	2422MHz	5	2442MHz
2	2427MHz	6	2447MHz
3	2432MHz	7	2452MHz
4	2437MHz		

#### FOR 5.0GHz (5745 ~ 5825MHz):

5 channels are provided for 802.11a, draft 802.11n (20MHz):

CHANNEL	FREQUENCY	CHANNEL	FREQUENCY
149	5745MHz	161	5805MHz
153	5765MHz	165	5825MHz
157	5785MHz		

2 channels are provided for draft 802.11n (40MHz):

CHANNEL	FREQUENCY	CHANNEL	FREQUENCY
151	5755MHz	159	5795MHz

### 3.2.1 CONFIGURATION OF SYSTEM UNDER TEST

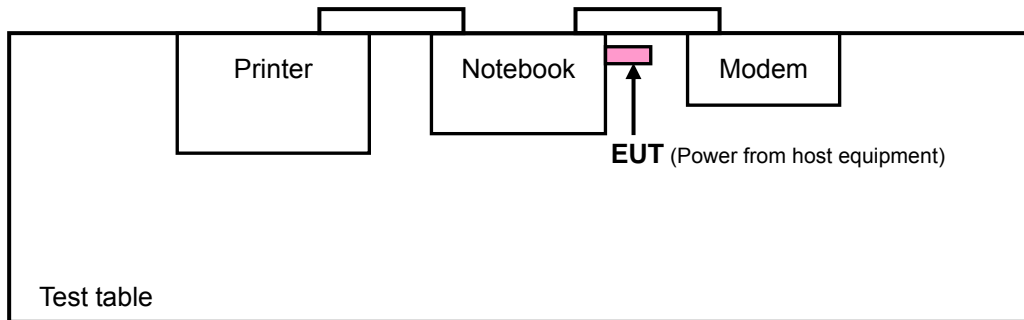



### 3.2.2 TEST MODE APPLICABILITY AND TESTED CHANNEL DETAIL FOR 2.4GHz:

EUT CONFIGURE MODE	APPLICABLE TO				DESCRIPTION
	RE≥1G	RE<1G	PLC	APCM	
-	√	√	√	√	-

Where **RE≥1G**: Radiated Emission above 1GHz  
**RE<1G**: Radiated Emission below 1GHz  
**PLC**: Power Line Conducted Emission  
**APCM**: Antenna Port Conducted Measurement

#### **RADIATED EMISSION TEST (ABOVE 1GHz):**

- Pre-Scan has been conducted to determine the worst-case mode from all possible combinations between available modulations, data rates and antenna ports (if EUT with antenna diversity architecture).
- Following channel(s) was (were) selected for the final test as listed below.

EUT CONFIGURE MODE	MODE	AVAILABLE CHANNEL	TESTED CHANNEL	MODULATION TECHNOLOGY	MODULATION TYPE	DATA RATE (Mbps)
-	802.11b	1 to 11	1, 6, 11	DSSS	DBPSK	1.0
-	802.11g	1 to 11	1, 6, 11	OFDM	BPSK	6.0
-	Draft 802.11n (20MHz)	1 to 11	1, 6, 11	OFDM	BPSK	7.2
-	Draft 802.11n (40MHz)	1 to 7	1, 4, 7	OFDM	BPSK	15.0

#### **RADIATED EMISSION TEST (BELOW 1GHz):**

- Pre-Scan has been conducted to determine the worst-case mode from all possible combinations between available modulations, data rates and antenna ports (if EUT with antenna diversity architecture).
- Following channel(s) was (were) selected for the final test as listed below.

EUT CONFIGURE MODE	MODE	AVAILABLE CHANNEL	TESTED CHANNEL	MODULATION TECHNOLOGY	MODULATION TYPE	DATA RATE (Mbps)
-	802.11b	1 to 11	6	DSSS	DBPSK	1.0

#### **POWER LINE CONDUCTED EMISSION TEST:**

- Pre-Scan has been conducted to determine the worst-case mode from all possible combinations between available modulations, data rates and antenna ports (if EUT with antenna diversity architecture).
- Following channel(s) was (were) selected for the final test as listed below.

EUT CONFIGURE MODE	MODE	AVAILABLE CHANNEL	TESTED CHANNEL	MODULATION TECHNOLOGY	MODULATION TYPE	DATA RATE (Mbps)
-	802.11b	1 to 11	6	DSSS	DBPSK	1.0

**BANDEDGE MEASUREMENT:**

- Pre-Scan has been conducted to determine the worst-case mode from all possible combinations between available modulations, data rates and antenna ports (if EUT with antenna diversity architecture).
- Following channel(s) was (were) selected for the final test as listed below.

EUT CONFIGURE MODE	MODE	AVAILABLE CHANNEL	TESTED CHANNEL	MODULATION TECHNOLOGY	MODULATION TYPE	DATA RATE (Mbps)
-	802.11b	1 to 11	1, 11	DSSS	DBPSK	1.0
-	802.11g	1 to 11	1, 11	OFDM	BPSK	6.0
-	Draft 802.11n (20MHz)	1 to 11	1, 11	OFDM	BPSK	7.2
-	Draft 802.11n (40MHz)	1 to 7	1, 7	OFDM	BPSK	15.0

**ANTENNA PORT CONDUCTED MEASUREMENT:**

- Pre-Scan has been conducted to determine the worst-case mode from all possible combinations between available modulations, data rates and antenna ports (if EUT with antenna diversity architecture).
- Following channel(s) was (were) selected for the final test as listed below.

EUT CONFIGURE MODE	MODE	AVAILABLE CHANNEL	TESTED CHANNEL	MODULATION TECHNOLOGY	MODULATION TYPE	DATA RATE (Mbps)
-	802.11b	1 to 11	1, 6, 11	DSSS	DBPSK	1.0
-	802.11g	1 to 11	1, 6, 11	OFDM	BPSK	6.0
-	Draft 802.11n (20MHz)	1 to 11	1, 6, 11	OFDM	BPSK	7.2
-	Draft 802.11n (40MHz)	1 to 7	1, 4, 7	OFDM	BPSK	15.0



**FOR 5.745 ~ 5.825GHz:**

EUT CONFIGURE MODE	APPLICABLE TO				DESCRIPTION
	RE≥1G	RE<1G	PLC	APCM	
-	√	√	√	√	-

Where **RE≥1G:** Radiated Emission above 1GHz **RE<1G:** Radiated Emission below 1GHz  
**PLC:** Power Line Conducted Emission **APCM:** Antenna Port Conducted Measurement

**RADIATED EMISSION TEST (ABOVE 1GHz):**

- Pre-Scan has been conducted to determine the worst-case mode from all possible combinations between available modulations and antenna ports (if EUT with antenna diversity architecture).
- Following channel(s) was (were) selected for the final test as listed below.

EUT CONFIGURE MODE	MODE	AVAILABLE CHANNEL	TESTED CHANNEL	MODULATION TECHNOLOGY	MODULATION TYPE	DATA RATE (Mbps)
-	802.11a	149 to 165	149, 157, 165	OFDM	BPSK	6.0
-	Draft 802.11n (20MHz)	149 to 165	149, 157, 165	OFDM	BPSK	7.2
-	Draft 802.11n (40MHz)	151 to 159	151, 159	OFDM	BPSK	15.0

**RADIATED EMISSION TEST (BELOW 1GHz):**

- Pre-Scan has been conducted to determine the worst-case mode from all possible combinations between available modulations and antenna ports (if EUT with antenna diversity architecture).
- Following channel(s) was (were) selected for the final test as listed below.

EUT CONFIGURE MODE	MODE	AVAILABLE CHANNEL	TESTED CHANNEL	MODULATION TECHNOLOGY	MODULATION TYPE	DATA RATE (Mbps)
-	Draft 802.11n (20MHz)	149 to 165	157	OFDM	BPSK	7.2

**POWER LINE CONDUCTED EMISSION TEST:**

- Pre-Scan has been conducted to determine the worst-case mode from all possible combinations between available modulations, data rates and antenna ports (if EUT with antenna diversity architecture).
- Following channel(s) was (were) selected for the final test as listed below.

EUT CONFIGURE MODE	MODE	AVAILABLE CHANNEL	TESTED CHANNEL	MODULATION TECHNOLOGY	MODULATION TYPE	DATA RATE (Mbps)
-	Draft 802.11n (20MHz)	149 to 165	157	OFDM	BPSK	7.2



**BANDEDGE MEASUREMENT:**

- Pre-Scan has been conducted to determine the worst-case mode from all possible combinations between available modulations, data rates and antenna ports (if EUT with antenna diversity architecture).
- Following channel(s) was (were) selected for the final test as listed below.

EUT CONFIGURE MODE	MODE	AVAILABLE CHANNEL	TESTED CHANNEL	MODULATION TECHNOLOGY	MODULATION TYPE	DATA RATE (Mbps)
-	802.11a	149 to 165	149, 165	OFDM	BPSK	6.0
-	Draft 802.11n (20MHz)	149 to 165	149, 165	OFDM	BPSK	7.2
-	Draft 802.11n (40MHz)	151 to 159	151, 159	OFDM	BPSK	15.0

**ANTENNA PORT CONDUCTED MEASUREMENT:**

- Pre-Scan has been conducted to determine the worst-case mode from all possible combinations between available modulations, data rates and antenna ports (if EUT with antenna diversity architecture).
- Following channel(s) was (were) selected for the final test as listed below.

EUT CONFIGURE MODE	MODE	AVAILABLE CHANNEL	TESTED CHANNEL	MODULATION TECHNOLOGY	MODULATION TYPE	DATA RATE (Mbps)
-	802.11a	149 to 165	149, 157, 165	OFDM	BPSK	6.0
-	Draft 802.11n (20MHz)	149 to 165	149, 157, 165	OFDM	BPSK	7.2
-	Draft 802.11n (40MHz)	151 to 159	151, 159	OFDM	BPSK	15.0



### 3.3 GENERAL DESCRIPTION OF APPLIED STANDARDS

The EUT is a RF Product. According to the specifications of the manufacturer, it must comply with the requirements of the following standards:

#### FCC Part 15, Subpart C (15.247)

#### ANSI C63.4-2003

All test items have been performed and recorded as per the above standards.

**NOTE:** The EUT is also considered as a kind of computer peripheral, because the connection to computer is necessary for typical use. It has been verified to comply with the requirements of FCC Part 15, Subpart B, Class B (DoC). The test report has been issued separately.

### 3.4 DESCRIPTION OF SUPPORT UNITS

The EUT has been tested as an independent unit together with other necessary accessories or support units. The following support units or accessories were used to form a representative test configuration during the tests.

NO.	PRODUCT	BRAND	MODEL NO.	SERIAL NO.	FCC ID
1	NOTEBOOK	DELL	D531	CN-0XM006-48643 -81U-2786	QDS-BRCM1020
2	PRINTER	HP	1300	CNBJC66727	FCC DoC Approved
3	MODEM	ACEEX	1414V/3	0401008260	IFAXDM1414

NO.	SIGNAL CABLE DESCRIPTION OF THE ABOVE SUPPORT UNITS
1	NA
2	1.8m braid shielded wire, DB25 connector, w/o core.
3	1.2m braid shielded wire, DB25 & DB9 connector, w/o core.

**NOTE:** All power cords of the above support units are non shielded (1.8m).



## 4. TEST TYPES AND RESULTS (FOR 2.4GHz BAND)

### 4.1 RADIATED EMISSION MEASUREMENT

#### 4.1.1 LIMITS OF RADIATED EMISSION MEASUREMENT

Emissions radiated outside of the specified bands, shall be according to the general radiated limits in 15.209 as following:

FREQUENCIES (MHz)	FIELD STRENGTH (microvolts/meter)	MEASUREMENT DISTANCE (meters)
0.009 ~ 0.490	2400/F(kHz)	300
0.490 ~ 1.705	24000/F(kHz)	30
1.705 ~ 30.0	30	30
30 ~ 88	100	3
88 ~ 216	150	3
216 ~ 960	200	3
Above 960	500	3

**NOTE:**

1. The lower limit shall apply at the transition frequencies.
2. Emission level (dBuV/m) = 20 log Emission level (uV/m).
3. As shown in 15.35(b), for frequencies above 1000MHz, the field strength limits are based on average detector, however, the peak field strength of any emission shall not exceed the maximum permitted average limits, specified above by more than 20dB under any condition of modulation.





### 4.1.2 TEST INSTRUMENTS

DESCRIPTION & MANUFACTURER	MODEL NO.	SERIAL NO.	DATE OF CALIBRATION	DUE DATE OF CALIBRATION
Test Receiver ROHDE & SCHWARZ	ESI7	100033	Jul. 06, 2009	Jul. 05, 2010
Spectrum Analyzer ROHDE & SCHWARZ	FSP40	100076	May. 26, 2009	May. 25, 2010
BILOG Antenna SCHWARZBECK	VULB9168	9168-160	Apr. 27, 2009	Apr. 26, 2010
HORN Antenna SCHWARZBECK	9120D	9120D-209	Jul. 01, 2009	Jun. 30, 2010
HORN Antenna SCHWARZBECK	BBHA 9170	BBHA9170243	Dec. 25, 2008	Dec. 24, 2009
Preamplifier Agilent	8447D	2944A10633	Nov. 03, 2008	Nov. 02, 2009
Preamplifier Agilent	8449B	3008A01964	Oct. 23, 2008	Oct. 22, 2009
RF signal cable HUBER+SUHNNER	SUCOFLEX 104	238141/4	May 13, 2009	May 12, 2010
RF signal cable HUBER+SUHNNER	SUCOFLEX 104	12738/6	May 13, 2009	May 12, 2010
Software ADT.	ADT_Radiated_ V7.6.15.9.2	NA	NA	NA
Antenna Tower inn-co GmbH	MA 4000	013303	NA	NA
Antenna Tower Controller inn-co GmbH	CO2000	017303	NA	NA
Turn Table ADT.	TT100.	TT93021703	NA	NA
Turn Table Controller ADT.	SC100.	SC93021703	NA	NA

- NOTE:**
1. The calibration interval of the above test instruments is 12 months and the calibrations are traceable to NML/ROC and NIST/USA.
  2. The test was performed in HwaYa Chamber 3.
  3. The horn antenna and HP preamplifier (model: 8449B) are used only for the measurement of emission frequency above 1GHz if tested.
  4. The FCC Site Registration No. is 988962.
  5. The IC Site Registration No. is IC 7450F-3.



A D T

#### 4.1.3 TEST PROCEDURES

- a. The EUT was placed on the top of a rotating table 0.8 meters above the ground at a 3 meters semi-anechoic chamber. The table was rotated 360 degrees to determine the position of the highest radiation.
- b. The EUT was set 3 meters away from the interference-receiving antenna, which was mounted on the top of a variable-height antenna tower.
- c. The antenna is a broadband antenna, and its height is varied from one meter to four meters above the ground to determine the maximum value of the field strength. Both horizontal and vertical polarizations of the antenna are set to make the measurement.
- d. For each suspected emission, the EUT was arranged to its worst case and then the antenna was tuned to heights from 1 meter to 4 meters and the rotatable table was turned from 0 degrees to 360 degrees to find the maximum reading.
- e. The test-receiver system was set to Peak Detect Function and Specified Bandwidth with Maximum Hold Mode.
- f. If the emission level of the EUT in peak mode was lower than the limit specified, then testing could be stopped and the peak values of the EUT would be reported. Otherwise the emissions would be re-tested one by one using peak, quasi-peak or average method as specified and then reported in a data sheet.

**NOTE:**

1. The resolution bandwidth and video bandwidth of test receiver/spectrum analyzer is 120kHz for Quasi-peak detection at frequency below 1GHz.
2. The resolution bandwidth of test receiver/spectrum analyzer is 1MHz and video bandwidth is 3MHz for Peak detection at frequency above 1GHz.
3. The resolution bandwidth of test receiver/spectrum analyzer is 1MHz and the video bandwidth is 10Hz for Average detection (AV) at frequency above 1GHz.
4. All modes of operation were investigated and the worst-case emissions are reported.

#### 4.1.4 DEVIATION FROM TEST STANDARD

No deviation.

#### 4.1.5 TEST SETUP

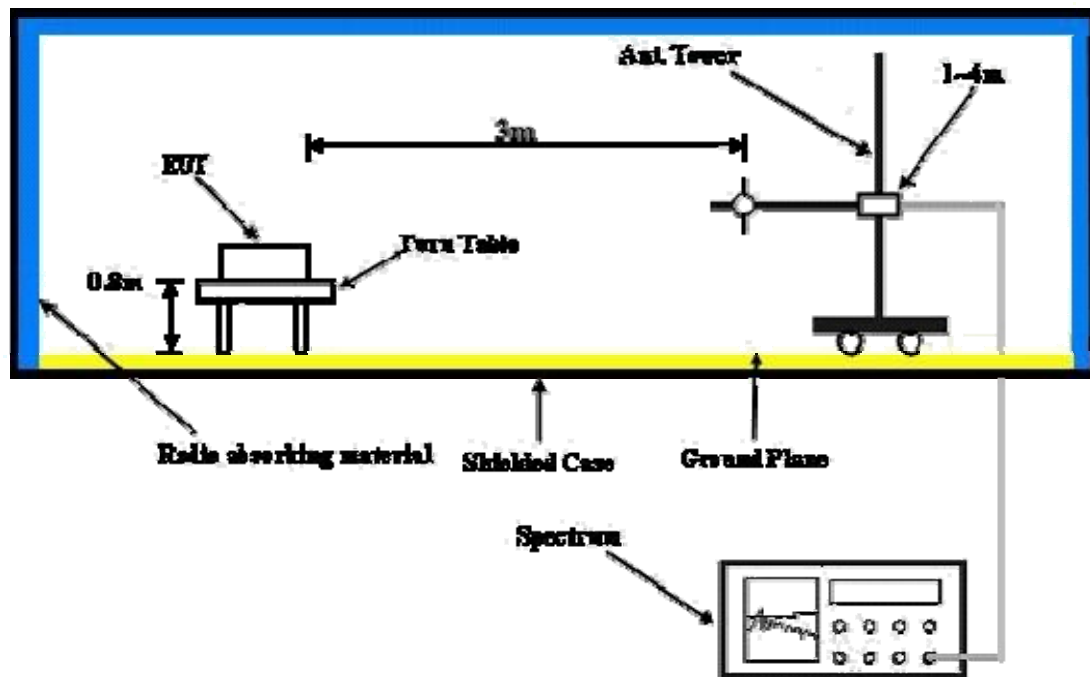

For the actual test configuration, please refer to the attached file (Test Setup Photo).

#### 4.1.6 EUT OPERATING CONDITIONS

- a. Plugged the EUT into a notebook system and placed on a testing table.
- b. The notebook system ran a test program (provided by manufacturer) to enable EUT under transmission condition continuously at specific channel frequency.
- c. The necessary accessories enable the system in full functions.



A D T

### 4.1.7 TEST RESULTS

#### 802.11b DSSS MODULATION

EUT TEST CONDITION		MEASUREMENT DETAIL	
CHANNEL	Channel 1	FREQUENCY RANGE	1 ~ 25GHz
INPUT POWER (SYSTEM)	120Vac, 60 Hz	DETECTOR FUNCTION	Peak (PK) Average (AV)
ENVIRONMENTAL CONDITIONS	24deg. C, 64%RH 1000 hPa	TESTED BY	Sun Lin

ANTENNA POLARITY & TEST DISTANCE: HORIZONTAL AT 3 M								
NO.	FREQ. (MHz)	EMISSION LEVEL (dBuV/m)	LIMIT (dBuV/m)	MARGIN (dB)	ANTENNA HEIGHT (m)	TABLE ANGLE (Degree)	RAW VALUE (dBuV)	CORRECTION FACTOR (dB/m)
1	2390.00	57.88 PK	74.00	-16.12	1.03 H	117	27.23	30.65
2	2390.00	48.19 AV	54.00	-5.81	1.03 H	117	17.54	30.65
3	*2412.00	101.01 PK			1.05 H	7	70.28	30.73
4	*2412.00	96.48 AV			1.05 H	7	65.75	30.73
5	4824.00	47.39 PK	74.00	-26.61	1.29 H	181	10.97	36.42
6	4824.00	34.77 AV	54.00	-19.23	1.29 H	181	-1.65	36.42
ANTENNA POLARITY & TEST DISTANCE: VERTICAL AT 3 M								
NO.	FREQ. (MHz)	EMISSION LEVEL (dBuV/m)	LIMIT (dBuV/m)	MARGIN (dB)	ANTENNA HEIGHT (m)	TABLE ANGLE (Degree)	RAW VALUE (dBuV)	CORRECTION FACTOR (dB/m)
1	2390.00	55.00 PK	74.00	-19.00	1.02 V	350	24.35	30.65
2	2390.00	46.48 AV	54.00	-7.52	1.02 V	350	15.83	30.65
3	*2412.00	98.30 PK			1.80 V	83	67.57	30.73
4	*2412.00	93.52 AV			1.80 V	83	62.79	30.73
5	4824.00	46.97 PK	74.00	-27.03	1.30 V	48	10.55	36.42
6	4824.00	33.76 AV	54.00	-20.24	1.30 V	48	-2.66	36.42

- REMARKS:**
1. Emission level (dBuV/m) = Raw Value (dBuV) + Correction Factor (dB/m).
  2. Correction Factor (dB/m) = Antenna Factor (dB/m) + Cable Factor (dB).
  3. The other emission levels were very low against the limit.
  4. Margin value = Emission level – Limit value.
  5. “ \* “: Fundamental frequency.



A D T

EUT TEST CONDITION		MEASUREMENT DETAIL	
CHANNEL	Channel 6	FREQUENCY RANGE	1 ~ 25GHz
INPUT POWER (SYSTEM)	120Vac, 60 Hz	DETECTOR FUNCTION	Peak (PK) Average (AV)
ENVIRONMENTAL CONDITIONS	24deg. C, 64%RH 1000 hPa	TESTED BY	Sun Lin

ANTENNA POLARITY & TEST DISTANCE: HORIZONTAL AT 3 M								
NO.	FREQ. (MHz)	EMISSION LEVEL (dBuV/m)	LIMIT (dBuV/m)	MARGIN (dB)	ANTENNA HEIGHT (m)	TABLE ANGLE (Degree)	RAW VALUE (dBuV)	CORRECTION FACTOR (dB/m)
1	*2437.00	101.18 PK			1.04 H	3	70.37	30.81
2	*2437.00	96.39 AV			1.04 H	3	65.58	30.81
3	4874.00	47.89 PK	74.00	-26.11	1.02 H	218	11.42	36.47
4	4874.00	34.81 AV	54.00	-19.19	1.02 H	218	-1.66	36.47

ANTENNA POLARITY & TEST DISTANCE: VERTICAL AT 3 M								
NO.	FREQ. (MHz)	EMISSION LEVEL (dBuV/m)	LIMIT (dBuV/m)	MARGIN (dB)	ANTENNA HEIGHT (m)	TABLE ANGLE (Degree)	RAW VALUE (dBuV)	CORRECTION FACTOR (dB/m)
1	*2437.00	98.17 PK			1.77 V	83	67.36	30.81
2	*2437.00	93.47 AV			1.77 V	83	62.66	30.81
3	4874.00	46.55 PK	74.00	-27.45	1.25 V	30	10.08	36.47
4	4874.00	33.22 AV	54.00	-20.78	1.25 V	30	-3.25	36.47

- REMARKS:**
1. Emission level (dBuV/m) = Raw Value (dBuV) + Correction Factor (dB/m).
  2. Correction Factor (dB/m) = Antenna Factor (dB/m) + Cable Factor (dB).
  3. The other emission levels were very low against the limit.
  4. Margin value = Emission level – Limit value.
  5. “ \* “: Fundamental frequency.



A D T

EUT TEST CONDITION		MEASUREMENT DETAIL	
CHANNEL	Channel 11	FREQUENCY RANGE	1 ~ 25GHz
INPUT POWER (SYSTEM)	120Vac, 60 Hz	DETECTOR FUNCTION	Peak (PK) Average (AV)
ENVIRONMENTAL CONDITIONS	24deg. C, 64%RH 1000 hPa	TESTED BY	Sun Lin

ANTENNA POLARITY & TEST DISTANCE: HORIZONTAL AT 3 M								
NO.	FREQ. (MHz)	EMISSION LEVEL (dBuV/m)	LIMIT (dBuV/m)	MARGIN (dB)	ANTENNA HEIGHT (m)	TABLE ANGLE (Degree)	RAW VALUE (dBuV)	CORRECTION FACTOR (dB/m)
1	*2462.00	100.94 PK			1.02 H	8	70.05	30.89
2	*2462.00	96.31 AV			1.02 H	8	65.42	30.89
3	2483.50	57.28 PK	74.00	-16.72	1.11 H	201	26.32	30.96
4	2483.50	48.49 AV	54.00	-5.51	1.11 H	201	17.53	30.96
5	4924.00	48.77 PK	74.00	-25.23	1.12 H	231	12.19	36.58
6	4924.00	35.52 AV	54.00	-18.48	1.12 H	231	-1.06	36.58
ANTENNA POLARITY & TEST DISTANCE: VERTICAL AT 3 M								
NO.	FREQ. (MHz)	EMISSION LEVEL (dBuV/m)	LIMIT (dBuV/m)	MARGIN (dB)	ANTENNA HEIGHT (m)	TABLE ANGLE (Degree)	RAW VALUE (dBuV)	CORRECTION FACTOR (dB/m)
1	*2462.00	98.15 PK			1.00 V	84	67.26	30.89
2	*2462.00	93.35 AV			1.00 V	84	62.46	30.89
3	2483.50	55.50 PK	74.00	-18.50	1.02 V	77	24.54	30.96
4	2483.50	46.08 AV	54.00	-7.92	1.02 V	77	15.12	30.96
5	4924.00	46.95 PK	74.00	-27.05	1.07 V	305	10.37	36.58
6	4924.00	34.30 AV	54.00	-19.70	1.07 V	305	-2.28	36.58

- REMARKS:**
1. Emission level (dBuV/m) = Raw Value (dBuV) + Correction Factor (dB/m).
  2. Correction Factor (dB/m) = Antenna Factor (dB/m) + Cable Factor (dB).
  3. The other emission levels were very low against the limit.
  4. Margin value = Emission level – Limit value.
  5. “ \* “: Fundamental frequency.



A D T

### 802.11g OFDM MODULATION

EUT TEST CONDITION		MEASUREMENT DETAIL	
CHANNEL	Channel 1	FREQUENCY RANGE	1 ~ 25GHz
INPUT POWER (SYSTEM)	120Vac, 60 Hz	DETECTOR FUNCTION	Peak (PK) Average (AV)
ENVIRONMENTAL CONDITIONS	24deg. C, 64%RH 1000 hPa	TESTED BY	Sun Lin

ANTENNA POLARITY & TEST DISTANCE: HORIZONTAL AT 3 M								
NO.	FREQ. (MHz)	EMISSION LEVEL (dBuV/m)	LIMIT (dBuV/m)	MARGIN (dB)	ANTENNA HEIGHT (m)	TABLE ANGLE (Degree)	RAW VALUE (dBuV)	CORRECTION FACTOR (dB/m)
1	2390.00	55.97 PK	74.00	-18.03	1.53 H	201	25.32	30.65
2	2390.00	48.49 AV	54.00	-5.51	1.53 H	201	17.84	30.65
3	*2412.00	99.91 PK			1.00 H	106	69.18	30.73
4	*2412.00	89.06 AV			1.00 H	106	58.33	30.73
5	4824.00	49.52 PK	74.00	-24.48	1.30 H	322	13.10	36.42
6	4824.00	34.78 AV	54.00	-19.22	1.30 H	322	-1.64	36.42
ANTENNA POLARITY & TEST DISTANCE: VERTICAL AT 3 M								
NO.	FREQ. (MHz)	EMISSION LEVEL (dBuV/m)	LIMIT (dBuV/m)	MARGIN (dB)	ANTENNA HEIGHT (m)	TABLE ANGLE (Degree)	RAW VALUE (dBuV)	CORRECTION FACTOR (dB/m)
1	2390.00	55.79 PK	74.00	-18.21	1.14 V	9	25.14	30.65
2	2390.00	48.50 AV	54.00	-5.50	1.14 V	9	17.85	30.65
3	*2412.00	97.63 PK			1.00 V	83	66.90	30.73
4	*2412.00	87.29 AV			1.00 V	83	56.56	30.73
5	4824.00	48.40 PK	74.00	-25.60	1.23 V	30	11.98	36.42
6	4824.00	33.96 AV	54.00	-20.04	1.23 V	30	-2.46	36.42

- REMARKS:**
1. Emission level (dBuV/m) = Raw Value (dBuV) + Correction Factor (dB/m).
  2. Correction Factor (dB/m) = Antenna Factor (dB/m) + Cable Factor (dB).
  3. The other emission levels were very low against the limit.
  4. Margin value = Emission level – Limit value.
  5. “ \* “: Fundamental frequency.



A D T

EUT TEST CONDITION		MEASUREMENT DETAIL	
CHANNEL	Channel 6	FREQUENCY RANGE	1 ~ 25GHz
INPUT POWER (SYSTEM)	120Vac, 60 Hz	DETECTOR FUNCTION	Peak (PK) Average (AV)
ENVIRONMENTAL CONDITIONS	24deg. C, 64%RH 1000 hPa	TESTED BY	Sun Lin

ANTENNA POLARITY & TEST DISTANCE: HORIZONTAL AT 3 M								
NO.	FREQ. (MHz)	EMISSION LEVEL (dBuV/m)	LIMIT (dBuV/m)	MARGIN (dB)	ANTENNA HEIGHT (m)	TABLE ANGLE (Degree)	RAW VALUE (dBuV)	CORRECTION FACTOR (dB/m)
1	*2437.00	99.90 PK			1.04 H	6	69.09	30.81
2	*2437.00	89.09 AV			1.04 H	6	58.28	30.81
3	4874.00	49.35 PK	74.00	-24.65	1.02 H	163	12.88	36.47
4	4874.00	34.97 AV	54.00	-19.03	1.02 H	163	-1.50	36.47
ANTENNA POLARITY & TEST DISTANCE: VERTICAL AT 3 M								
NO.	FREQ. (MHz)	EMISSION LEVEL (dBuV/m)	LIMIT (dBuV/m)	MARGIN (dB)	ANTENNA HEIGHT (m)	TABLE ANGLE (Degree)	RAW VALUE (dBuV)	CORRECTION FACTOR (dB/m)
1	*2437.00	97.60 PK			1.00 V	83	66.79	30.81
2	*2437.00	87.57 AV			1.00 V	83	56.76	30.81
3	4874.00	47.80 PK	74.00	-26.20	1.09 V	350	11.33	36.47
4	4874.00	32.18 AV	54.00	-21.82	1.09 V	350	-4.29	36.47

- REMARKS:**
1. Emission level (dBuV/m) = Raw Value (dBuV) + Correction Factor (dB/m).
  2. Correction Factor (dB/m) = Antenna Factor (dB/m) + Cable Factor (dB).
  3. The other emission levels were very low against the limit.
  4. Margin value = Emission level – Limit value.
  5. “ \* “: Fundamental frequency.





A D T

EUT TEST CONDITION		MEASUREMENT DETAIL	
CHANNEL	Channel 11	FREQUENCY RANGE	1 ~ 25GHz
INPUT POWER (SYSTEM)	120Vac, 60 Hz	DETECTOR FUNCTION	Peak (PK) Average (AV)
ENVIRONMENTAL CONDITIONS	24deg. C, 64%RH 1000 hPa	TESTED BY	Sun Lin

ANTENNA POLARITY & TEST DISTANCE: HORIZONTAL AT 3 M								
NO.	FREQ. (MHz)	EMISSION LEVEL (dBuV/m)	LIMIT (dBuV/m)	MARGIN (dB)	ANTENNA HEIGHT (m)	TABLE ANGLE (Degree)	RAW VALUE (dBuV)	CORRECTION FACTOR (dB/m)
1	*2462.00	99.98 PK			1.05 H	7	69.09	30.89
2	*2462.00	89.22 AV			1.05 H	7	58.33	30.89
3	2483.50	56.77 PK	74.00	-17.23	1.15 H	230	25.81	30.96
4	2483.50	48.59 AV	54.00	-5.41	1.15 H	230	17.63	30.96
5	4924.00	49.91 PK	74.00	-24.09	1.43 H	306	13.33	36.58
6	4924.00	35.45 AV	54.00	-18.55	1.43 H	306	-1.13	36.58

ANTENNA POLARITY & TEST DISTANCE: VERTICAL AT 3 M								
NO.	FREQ. (MHz)	EMISSION LEVEL (dBuV/m)	LIMIT (dBuV/m)	MARGIN (dB)	ANTENNA HEIGHT (m)	TABLE ANGLE (Degree)	RAW VALUE (dBuV)	CORRECTION FACTOR (dB/m)
1	*2462.00	97.92 PK			1.02 V	84	67.03	30.89
2	*2462.00	87.25 AV			1.02 V	84	56.36	30.89
3	2483.50	42.84 PK	74.00	-31.16	1.08 V	325	11.88	30.96
4	2483.50	28.99 AV	54.00	-25.01	1.08 V	325	-1.97	30.96
5	4924.00	47.40 PK	74.00	-26.60	1.18 V	164	10.82	36.58
6	4924.00	33.96 AV	54.00	-20.04	1.18 V	164	-2.62	36.58

- REMARKS:**
1. Emission level (dBuV/m) = Raw Value (dBuV) + Correction Factor (dB/m).
  2. Correction Factor (dB/m) = Antenna Factor (dB/m) + Cable Factor (dB).
  3. The other emission levels were very low against the limit.
  4. Margin value = Emission level – Limit value.
  5. “ \* “: Fundamental frequency.



A D T

**DRAFT 802.11n (20MHz) OFDM MODULATION**

EUT TEST CONDITION		MEASUREMENT DETAIL	
CHANNEL	Channel 1	FREQUENCY RANGE	1 ~ 25GHz
INPUT POWER (SYSTEM)	120Vac, 60 Hz	DETECTOR FUNCTION	Peak (PK) Average (AV)
ENVIRONMENTAL CONDITIONS	24deg. C, 64%RH 1000 hPa	TESTED BY	Sun Lin

ANTENNA POLARITY & TEST DISTANCE: HORIZONTAL AT 3 M								
NO.	FREQ. (MHz)	EMISSION LEVEL (dBuV/m)	LIMIT (dBuV/m)	MARGIN (dB)	ANTENNA HEIGHT (m)	TABLE ANGLE (Degree)	RAW VALUE (dBuV)	CORRECTION FACTOR (dB/m)
1	2390.00	57.02 PK	74.00	-16.98	1.18 H	232	26.37	30.65
2	2390.00	48.51 AV	54.00	-5.49	1.18 H	232	17.86	30.65
3	*2412.00	99.03 PK			1.05 H	7	68.30	30.73
4	*2412.00	89.25 AV			1.05 H	7	58.52	30.73
5	4824.00	48.32 PK	74.00	-25.68	1.02 H	171	11.90	36.42
6	4824.00	34.55 AV	54.00	-19.45	1.02 H	171	-1.87	36.42
ANTENNA POLARITY & TEST DISTANCE: VERTICAL AT 3 M								
NO.	FREQ. (MHz)	EMISSION LEVEL (dBuV/m)	LIMIT (dBuV/m)	MARGIN (dB)	ANTENNA HEIGHT (m)	TABLE ANGLE (Degree)	RAW VALUE (dBuV)	CORRECTION FACTOR (dB/m)
1	2390.00	55.87 PK	74.00	-18.13	1.34 V	57	25.22	30.65
2	2390.00	47.29 AV	54.00	-6.71	1.34 V	57	16.64	30.65
3	*2412.00	97.11 PK			1.01 V	83	66.38	30.73
4	*2412.00	87.33 AV			1.01 V	83	56.60	30.73
5	4824.00	47.04 PK	74.00	-26.96	1.12 V	25	10.62	36.42
6	4824.00	32.50 AV	54.00	-21.50	1.12 V	25	-3.92	36.42

- REMARKS:**
1. Emission level (dBuV/m) = Raw Value (dBuV) + Correction Factor (dB/m).
  2. Correction Factor (dB/m) = Antenna Factor (dB/m) + Cable Factor (dB).
  3. The other emission levels were very low against the limit.
  4. Margin value = Emission level – Limit value.
  5. “ \* “: Fundamental frequency.



A D T

EUT TEST CONDITION		MEASUREMENT DETAIL	
CHANNEL	Channel 6	FREQUENCY RANGE	1 ~ 25GHz
INPUT POWER (SYSTEM)	120Vac, 60 Hz	DETECTOR FUNCTION	Peak (PK) Average (AV)
ENVIRONMENTAL CONDITIONS	24deg. C, 64%RH 1000 hPa	TESTED BY	Sun Lin

ANTENNA POLARITY & TEST DISTANCE: HORIZONTAL AT 3 M								
NO.	FREQ. (MHz)	EMISSION LEVEL (dBuV/m)	LIMIT (dBuV/m)	MARGIN (dB)	ANTENNA HEIGHT (m)	TABLE ANGLE (Degree)	RAW VALUE (dBuV)	CORRECTION FACTOR (dB/m)
1	*2437.00	99.86 PK			1.03 H	7	69.05	30.81
2	*2437.00	89.21 AV			1.03 H	7	58.40	30.81
3	4874.00	48.60 PK	74.00	-25.40	1.17 H	5	12.13	36.47
4	4874.00	35.00 AV	54.00	-19.00	1.17 H	5	-1.47	36.47

ANTENNA POLARITY & TEST DISTANCE: VERTICAL AT 3 M								
NO.	FREQ. (MHz)	EMISSION LEVEL (dBuV/m)	LIMIT (dBuV/m)	MARGIN (dB)	ANTENNA HEIGHT (m)	TABLE ANGLE (Degree)	RAW VALUE (dBuV)	CORRECTION FACTOR (dB/m)
1	*2437.00	97.56 PK			1.77 V	83	66.75	30.81
2	*2437.00	87.64 AV			1.77 V	83	56.83	30.81
3	4874.00	46.07 PK	74.00	-27.93	1.53 V	30	9.60	36.47
4	4874.00	33.48 AV	54.00	-20.52	1.53 V	30	-2.99	36.47

- REMARKS:**
1. Emission level (dBuV/m) = Raw Value (dBuV) + Correction Factor (dB/m).
  2. Correction Factor (dB/m) = Antenna Factor (dB/m) + Cable Factor (dB).
  3. The other emission levels were very low against the limit.
  4. Margin value = Emission level – Limit value.
  5. “ \* “: Fundamental frequency.



A D T

EUT TEST CONDITION		MEASUREMENT DETAIL	
CHANNEL	Channel 11	FREQUENCY RANGE	1 ~ 25GHz
INPUT POWER (SYSTEM)	120Vac, 60 Hz	DETECTOR FUNCTION	Peak (PK) Average (AV)
ENVIRONMENTAL CONDITIONS	24deg. C, 64%RH 1000 hPa	TESTED BY	Sun Lin

ANTENNA POLARITY & TEST DISTANCE: HORIZONTAL AT 3 M								
NO.	FREQ. (MHz)	EMISSION LEVEL (dBuV/m)	LIMIT (dBuV/m)	MARGIN (dB)	ANTENNA HEIGHT (m)	TABLE ANGLE (Degree)	RAW VALUE (dBuV)	CORRECTION FACTOR (dB/m)
1	*2462.00	99.40 PK			1.03 H	7	68.51	30.89
2	*2462.00	89.48 AV			1.03 H	7	58.59	30.89
3	2483.50	57.79 PK	74.00	-16.21	1.20 H	171	26.83	30.96
4	2483.50	48.11 AV	54.00	-5.89	1.20 H	171	17.15	30.96
5	4924.00	49.59 PK	74.00	-24.41	1.05 H	53	13.01	36.58
6	4924.00	35.40 AV	54.00	-18.60	1.05 H	53	-1.18	36.58
ANTENNA POLARITY & TEST DISTANCE: VERTICAL AT 3 M								
NO.	FREQ. (MHz)	EMISSION LEVEL (dBuV/m)	LIMIT (dBuV/m)	MARGIN (dB)	ANTENNA HEIGHT (m)	TABLE ANGLE (Degree)	RAW VALUE (dBuV)	CORRECTION FACTOR (dB/m)
1	*2462.00	97.36 PK			1.75 V	82	66.47	30.89
2	*2462.00	87.47 AV			1.75 V	82	56.58	30.89
3	2483.50	56.04 PK	74.00	-17.96	1.02 V	33	25.08	30.96
4	2483.50	48.81 AV	54.00	-5.19	1.02 V	33	17.85	30.96
5	4924.00	48.47 PK	74.00	-25.53	1.21 V	335	11.89	36.58
6	4924.00	34.40 AV	54.00	-19.60	1.21 V	335	-2.18	36.58

- REMARKS:**
1. Emission level (dBuV/m) = Raw Value (dBuV) + Correction Factor (dB/m).
  2. Correction Factor (dB/m) = Antenna Factor (dB/m) + Cable Factor (dB).
  3. The other emission levels were very low against the limit.
  4. Margin value = Emission level – Limit value.
  5. “ \* “: Fundamental frequency.



A D T

**DRAFT 802.11n (40MHz) OFDM MODULATION**

EUT TEST CONDITION		MEASUREMENT DETAIL	
CHANNEL	Channel 1	FREQUENCY RANGE	1 ~ 25GHz
INPUT POWER (SYSTEM)	120Vac, 60 Hz	DETECTOR FUNCTION	Peak (PK) Average (AV)
ENVIRONMENTAL CONDITIONS	24deg. C, 64%RH 1000 hPa	TESTED BY	Sun Lin

ANTENNA POLARITY & TEST DISTANCE: HORIZONTAL AT 3 M								
NO.	FREQ. (MHz)	EMISSION LEVEL (dBuV/m)	LIMIT (dBuV/m)	MARGIN (dB)	ANTENNA HEIGHT (m)	TABLE ANGLE (Degree)	RAW VALUE (dBuV)	CORRECTION FACTOR (dB/m)
1	2390.00	55.98 PK	74.00	-18.02	1.31 H	107	25.33	30.65
2	2390.00	48.23 AV	54.00	-5.77	1.31 H	107	17.58	30.65
3	*2422.00	96.91 PK			1.02 H	83	66.15	30.76
4	*2422.00	86.03 AV			1.02 H	83	55.27	30.76
5	4844.00	47.85 PK	74.00	-26.15	1.03 H	89	11.41	36.44
6	4844.00	33.74 AV	54.00	-20.26	1.03 H	89	-2.70	36.44
ANTENNA POLARITY & TEST DISTANCE: VERTICAL AT 3 M								
NO.	FREQ. (MHz)	EMISSION LEVEL (dBuV/m)	LIMIT (dBuV/m)	MARGIN (dB)	ANTENNA HEIGHT (m)	TABLE ANGLE (Degree)	RAW VALUE (dBuV)	CORRECTION FACTOR (dB/m)
1	2390.00	54.68 PK	74.00	-19.32	1.12 V	307	24.03	30.65
2	2390.00	47.67 AV	54.00	-6.33	1.12 V	307	17.02	30.65
3	*2422.00	92.36 PK			1.18 V	347	61.60	30.76
4	*2422.00	82.03 AV			1.18 V	347	51.27	30.76
5	4844.00	46.13 PK	74.00	-27.87	1.14 V	345	9.69	36.44
6	4844.00	32.04 AV	54.00	-21.96	1.14 V	345	-4.40	36.44

- REMARKS:**
1. Emission level (dBuV/m) = Raw Value (dBuV) + Correction Factor (dB/m).
  2. Correction Factor (dB/m) = Antenna Factor (dB/m) + Cable Factor (dB).
  3. The other emission levels were very low against the limit.
  4. Margin value = Emission level – Limit value.
  5. “ \* “: Fundamental frequency.



A D T

EUT TEST CONDITION		MEASUREMENT DETAIL	
CHANNEL	Channel 4	FREQUENCY RANGE	1 ~ 25GHz
INPUT POWER (SYSTEM)	120Vac, 60 Hz	DETECTOR FUNCTION	Peak (PK) Average (AV)
ENVIRONMENTAL CONDITIONS	24deg. C, 64%RH 1000 hPa	TESTED BY	Sun Lin

ANTENNA POLARITY & TEST DISTANCE: HORIZONTAL AT 3 M								
NO.	FREQ. (MHz)	EMISSION LEVEL (dBuV/m)	LIMIT (dBuV/m)	MARGIN (dB)	ANTENNA HEIGHT (m)	TABLE ANGLE (Degree)	RAW VALUE (dBuV)	CORRECTION FACTOR (dB/m)
1	*2437.00	96.98 PK			1.05 H	5	66.17	30.81
2	*2437.00	86.29 AV			1.05 H	5	55.48	30.81
3	4874.00	49.75 PK	74.00	-24.25	1.04 H	22	13.28	36.47
4	4874.00	35.12 AV	54.00	-18.88	1.04 H	22	-1.35	36.47
ANTENNA POLARITY & TEST DISTANCE: VERTICAL AT 3 M								
NO.	FREQ. (MHz)	EMISSION LEVEL (dBuV/m)	LIMIT (dBuV/m)	MARGIN (dB)	ANTENNA HEIGHT (m)	TABLE ANGLE (Degree)	RAW VALUE (dBuV)	CORRECTION FACTOR (dB/m)
1	*2437.00	92.49 PK			1.01 V	84	61.68	30.81
2	*2437.00	82.08 AV			1.01 V	84	51.27	30.81
3	4874.00	48.00 PK	74.00	-26.00	1.08 V	200	11.53	36.47
4	4874.00	34.31 AV	54.00	-19.69	1.08 V	200	-2.16	36.47

- REMARKS:**
1. Emission level (dBuV/m) = Raw Value (dBuV) + Correction Factor (dB/m).
  2. Correction Factor (dB/m) = Antenna Factor (dB/m) + Cable Factor (dB).
  3. The other emission levels were very low against the limit.
  4. Margin value = Emission level – Limit value.
  5. “ \* “: Fundamental frequency.



A D T

EUT TEST CONDITION		MEASUREMENT DETAIL	
CHANNEL	Channel 7	FREQUENCY RANGE	1 ~ 25GHz
INPUT POWER (SYSTEM)	120Vac, 60 Hz	DETECTOR FUNCTION	Peak (PK) Average (AV)
ENVIRONMENTAL CONDITIONS	24deg. C, 64%RH 1000 hPa	TESTED BY	Sun Lin

ANTENNA POLARITY & TEST DISTANCE: HORIZONTAL AT 3 M								
NO.	FREQ. (MHz)	EMISSION LEVEL (dBuV/m)	LIMIT (dBuV/m)	MARGIN (dB)	ANTENNA HEIGHT (m)	TABLE ANGLE (Degree)	RAW VALUE (dBuV)	CORRECTION FACTOR (dB/m)
1	*2452.00	96.67 PK			1.04 H	5	65.81	30.86
2	*2452.00	86.12 AV			1.04 H	5	55.26	30.86
3	2483.50	57.21 PK	74.00	-16.79	1.18 H	253	26.25	30.96
4	2483.50	48.55 AV	54.00	-5.45	1.18 H	253	17.59	30.96
5	4904.00	49.59 PK	74.00	-24.41	1.21 H	303	13.08	36.51
6	4904.00	34.35 AV	54.00	-19.65	1.21 H	303	-2.16	36.51
ANTENNA POLARITY & TEST DISTANCE: VERTICAL AT 3 M								
NO.	FREQ. (MHz)	EMISSION LEVEL (dBuV/m)	LIMIT (dBuV/m)	MARGIN (dB)	ANTENNA HEIGHT (m)	TABLE ANGLE (Degree)	RAW VALUE (dBuV)	CORRECTION FACTOR (dB/m)
1	*2452.00	92.31 PK			1.75 V	85	61.45	30.86
2	*2452.00	82.13 AV			1.75 V	85	51.27	30.86
3	2483.50	55.89 PK	74.00	-18.11	1.35 V	259	24.93	30.96
4	2483.50	47.28 AV	54.00	-6.72	1.35 V	259	16.32	30.96
5	4904.00	47.33 PK	74.00	-26.67	1.12 V	23	10.82	36.51
6	4904.00	32.93 AV	54.00	-21.07	1.12 V	23	-3.58	36.51

- REMARKS:**
1. Emission level (dBuV/m) = Raw Value (dBuV) + Correction Factor (dB/m).
  2. Correction Factor (dB/m) = Antenna Factor (dB/m) + Cable Factor (dB).
  3. The other emission levels were very low against the limit.
  4. Margin value = Emission level – Limit value.
  5. “ \* “: Fundamental frequency.



A D T

### BELOW 1GHz WORST-CASE DATA : 802.11b DSSS MODULATION

EUT TEST CONDITION		MEASUREMENT DETAIL	
CHANNEL	Channel 6	FREQUENCY RANGE	Below 1000MHz
INPUT POWER (SYSTEM)	120Vac, 60 Hz	DETECTOR FUNCTION	Quasi-Peak
ENVIRONMENTAL CONDITIONS	25deg. C, 65%RH 999 hPa	TESTED BY	Brad Wu

ANTENNA POLARITY & TEST DISTANCE: HORIZONTAL AT 3 M								
NO.	FREQ. (MHz)	EMISSION LEVEL (dBuV/m)	LIMIT (dBuV/m)	MARGIN (dB)	ANTENNA HEIGHT (m)	TABLE ANGLE (Degree)	RAW VALUE (dBuV)	CORRECTION FACTOR (dB/m)
1	166.00	34.25 QP	43.50	-9.25	1.50 H	283	20.30	13.95
2	399.31	32.82 QP	46.00	-13.18	1.25 H	205	14.80	18.02
3	531.53	36.98 QP	46.00	-9.02	1.50 H	112	15.90	21.09
4	667.63	40.37 QP	46.00	-5.63	1.50 H	169	16.14	24.23
5	799.84	36.66 QP	46.00	-9.34	1.00 H	10	10.64	26.02
6	960.00	33.31 QP	46.00	-12.69	1.50 H	205	4.70	28.60

ANTENNA POLARITY & TEST DISTANCE: VERTICAL AT 3 M								
NO.	FREQ. (MHz)	EMISSION LEVEL (dBuV/m)	LIMIT (dBuV/m)	MARGIN (dB)	ANTENNA HEIGHT (m)	TABLE ANGLE (Degree)	RAW VALUE (dBuV)	CORRECTION FACTOR (dB/m)
1	47.40	36.51 QP	40.00	-3.49	2.00 V	28	22.78	13.74
2	164.06	38.48 QP	43.50	-5.02	1.00 V	10	24.41	14.07
3	399.31	42.05 QP	46.00	-3.95	1.00 V	19	24.03	18.02
4	533.47	37.40 QP	46.00	-8.60	1.00 V	286	16.27	21.13
5	667.63	41.45 QP	46.00	-4.55	1.00 V	85	17.22	24.23
6	961.21	37.06 QP	54.00	-16.94	1.50 V	127	8.45	28.61

- REMARKS:**
1. Emission level (dBuV/m) = Raw Value (dBuV) + Correction Factor (dB/m).
  2. Correction Factor (dB/m) = Antenna Factor (dB/m) + Cable Factor (dB).
  3. The other emission levels were very low against the limit.
  4. Margin value = Emission level – Limit value.





ADT

## 4.2 CONDUCTED EMISSION MEASUREMENT

### 4.2.1 LIMITS OF CONDUCTED EMISSION MEASUREMENT

FREQUENCY OF EMISSION (MHz)	CONDUCTED LIMIT (dB $\mu$ V)	
	Quasi-peak	Average
0.15 ~ 0.5	66 to 56	56 to 46
0.5 ~ 5	56	46
5 ~ 30	60	50

- NOTE:** 1. The lower limit shall apply at the transition frequencies.  
2. The limit decreases in line with the logarithm of the frequency in the range of 0.15 to 0.50MHz.  
3. All emanations from a class A/B digital device or system, including any network of conductors and apparatus connected thereto, shall not exceed the level of field strengths specified above.

### 4.2.2 TEST INSTRUMENTS

DESCRIPTION & MANUFACTURER	MODEL NO.	SERIAL NO.	DATE OF CALIBRATION	DUE DATE OF CALIBRATION
Test Receiver ROHDE & SCHWARZ	ESCS30	100291	Nov. 19, 2008	Nov. 18, 2009
RF signal cable Woken	5D-FB	Cable-HYC01-01	Dec. 31, 2008	Dec. 30, 2009
LISN SCHWARZBECK	NNBL 8226-2	8226-142	Jun. 03, 2009	Jun. 02, 2010
LISN ROHDE & SCHWARZ	ESH2-Z5	100104	Dec. 04, 2008	Dec. 03, 2009
Software ADT	ADT_Cond_ V7.3.7	NA	NA	NA

- NOTE:** 1. The calibration interval of the above test instruments is 12 months and the calibrations are traceable to NML/ROC and NIST/USA.  
2. The test was performed in HwaYa Shielded Room 1.  
3. The VCCI Site Registration No. is C-2040.



A D T

#### 4.2.3 TEST PROCEDURES

- a. The EUT was placed 0.4 meters from the conducting wall of the shielded room with EUT being connected to the power mains through a line impedance stabilization network (LISN). Other support units were connected to the power mains through another LISN. The two LISNs provide 50 ohm/ 50uH of coupling impedance for the measuring instrument.
- b. Both lines of the power mains connected to the EUT were checked for maximum conducted interference.
- c. The frequency range from 150kHz to 30MHz was searched. Emission levels under (Limit - 20dB) was not recorded.

**NOTE:** All modes of operation were investigated and the worst-case emissions are reported.

#### 4.2.4 DEVIATION FROM TEST STANDARD

No deviation.

#### 4.2.5 TEST SETUP

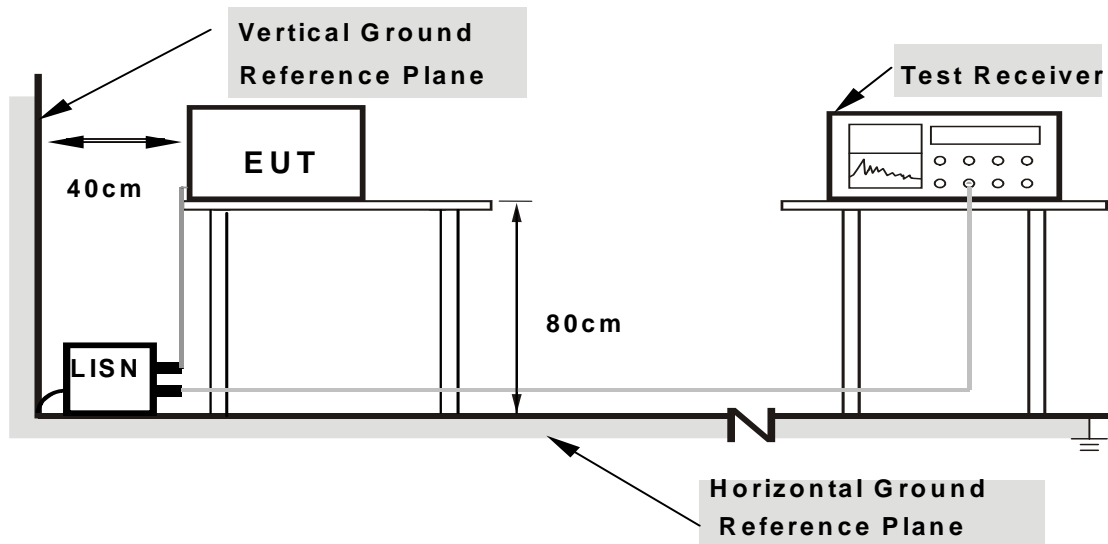

- Note:**
1. Support units were connected to second LISN.
  2. Both of LISNs (AMN) are 80 cm from EUT and at least 80 from other units and other metal planes

For the actual test configuration, please refer to the attached file (Test Setup Photo).

#### 4.2.6 EUT OPERATING CONDITIONS

Same as 4.1.6.

### 4.2.7 TEST RESULTS

#### CONDUCTED WORST-CASE DATA : 802.11b DSSS MODULATION

EUT TEST CONDITION		MEASUREMENT DETAIL	
CHANNEL	Channel 6	PHASE	Line 1
MODULATION TYPE	DBPSK	INPUT POWER	120Vac, 60Hz
TRANSFER RATE	1.0Mbps	6dB BANDWIDTH	9kHz
ENVIRONMENTAL CONDITIONS	20deg. C, 60%RH, 1021hPa	TESTED BY	Match Tsui

No	Freq. [MHz]	Corr. Factor (dB)	Reading Value [dB (uV)]		Emission Level [dB (uV)]		Limit [dB (uV)]		Margin (dB)	
			Q.P.	AV.	Q.P.	AV.	Q.P.	AV.	Q.P.	AV.
			1	0.150	0.13	44.89	-	45.02	-	66.00
2	0.341	0.14	36.30	-	36.44	-	59.17	49.17	-22.73	-
3	0.685	0.16	31.64	-	31.80	-	56.00	46.00	-24.20	-
4	2.297	0.25	30.30	-	30.55	-	56.00	46.00	-25.45	-
5	10.742	0.70	34.76	-	35.46	-	60.00	50.00	-24.54	-
6	22.570	1.19	44.92	-	46.11	-	60.00	50.00	-13.89	-

- REMARKS:**
1. Q.P. and AV. are abbreviations of quasi-peak and average individually.
  2. "-": The Quasi-peak reading value also meets average limit and measurement with the average detector is unnecessary.
  3. The emission levels of other frequencies were very low against the limit.
  4. Margin value = Emission level - Limit value
  5. Correction factor = Insertion loss + Cable loss
  6. Emission Level = Correction Factor + Reading Value.

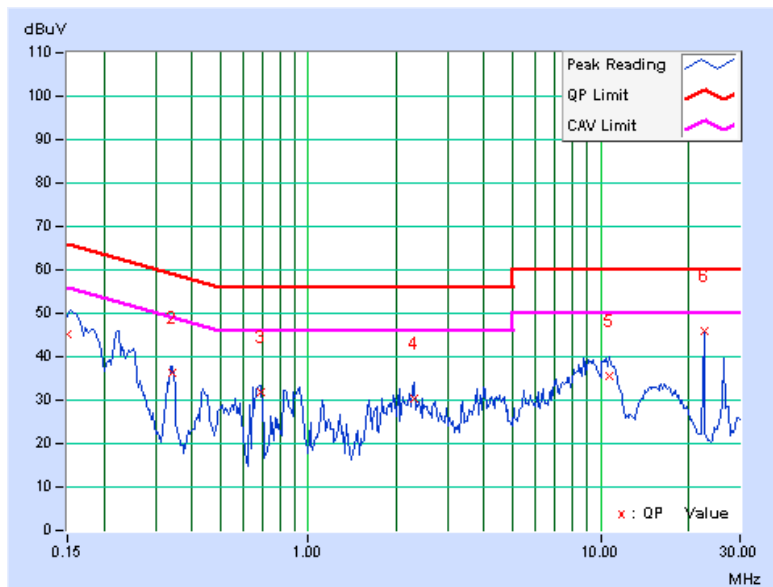

EUT TEST CONDITION		MEASUREMENT DETAIL	
CHANNEL	Channel 6	PHASE	Line 2
MODULATION TYPE	DBPSK	INPUT POWER	120Vac, 60Hz
TRANSFER RATE	1.0Mbps	6dB BANDWIDTH	9kHz
ENVIRONMENTAL CONDITIONS	20deg. C, 60%RH, 1021hPa	TESTED BY	Match Tsui

No	Freq. [MHz]	Corr. Factor (dB)	Reading Value [dB (uV)]		Emission Level [dB (uV)]		Limit [dB (uV)]		Margin (dB)	
			Q.P.	AV.	Q.P.	AV.	Q.P.	AV.	Q.P.	AV.
			1	0.150	0.14	44.38	-	44.52	-	66.00
2	0.341	0.16	36.06	-	36.22	-	59.17	49.17	-22.95	-
3	0.685	0.18	31.78	-	31.96	-	56.00	46.00	-24.04	-
4	2.291	0.27	30.61	-	30.88	-	56.00	46.00	-25.12	-
5	9.457	0.64	35.45	-	36.09	-	60.00	50.00	-23.91	-
6	22.570	0.92	45.72	-	46.64	-	60.00	50.00	-13.36	-

- REMARKS:**
1. Q.P. and AV. are abbreviations of quasi-peak and average individually.
  2. "-": The Quasi-peak reading value also meets average limit and measurement with the average detector is unnecessary.
  3. The emission levels of other frequencies were very low against the limit.
  4. Margin value = Emission level - Limit value
  5. Correction factor = Insertion loss + Cable loss
  6. Emission Level = Correction Factor + Reading Value.

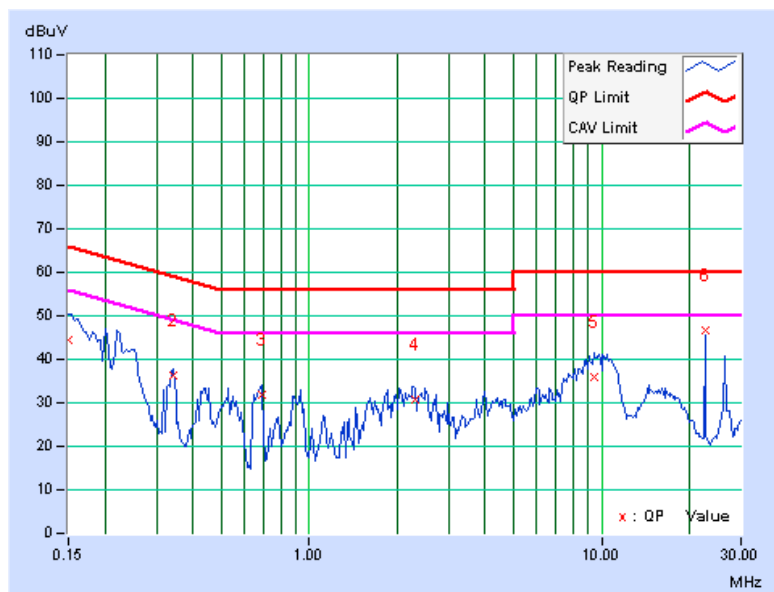



### 4.3 6dB BANDWIDTH MEASUREMENT

#### 4.3.1 LIMITS OF 6dB BANDWIDTH MEASUREMENT

The minimum of 6dB Bandwidth Measurement is 0.5 MHz.

#### 4.3.2 TEST INSTRUMENTS

DESCRIPTION & MANUFACTURER	MODEL NO.	SERIAL NO.	DATE OF CALIBRATION	CALIBRATED UNTIL
R&S SPECTRUM ANALYZER	FSP40	100040	Jul. 07, 2009	Jul. 06, 2010

**NOTE:** The calibration interval of the above test instruments is 12 months and the calibrations are traceable to NML/ROC and NIST/USA.

#### 4.3.3 TEST PROCEDURE

The transmitter output was connected to the spectrum analyzer through an attenuator. The bandwidth of the fundamental frequency was measured by spectrum analyzer with 100kHz RBW and 300kHz VBW. The 6dB bandwidth is defined as the total spectrum the power of which is higher than peak power minus 6dB.

#### 4.3.4 DEVIATION FROM TEST STANDARD

No deviation.

#### 4.3.5 TEST SETUP

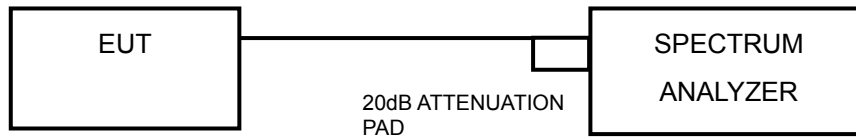

#### 4.3.6 EUT OPERATING CONDITIONS

The software provided by client to enable the EUT under transmission condition continuously at lowest, middle and highest channel frequencies individually.



A D T

### 4.3.7 TEST RESULTS

#### 802.11b DSSS MODULATION

<b>MODULATION TYPE</b>	DBPSK	<b>TRANSFER RATE</b>	1.0Mbps
<b>INPUT POWER</b>	120Vac, 60Hz	<b>ENVIRONMENTAL CONDITIONS</b>	24deg.C, 64%RH, 1021hPa
<b>TESTED BY</b>	Sun Lin		

CHANNEL	CHANNEL FREQUENCY (MHz)	6dB BANDWIDTH (MHz)		MINIMUM LIMIT (MHz)	PASS / FAIL
		CHAIN 0	CHAIN 1		
1	2412	11.19	10.19	0.5	PASS
6	2437	11.13	11.12	0.5	PASS
11	2462	10.19	11.16	0.5	PASS





A D T

### FOR CHAIN 0: CH 1

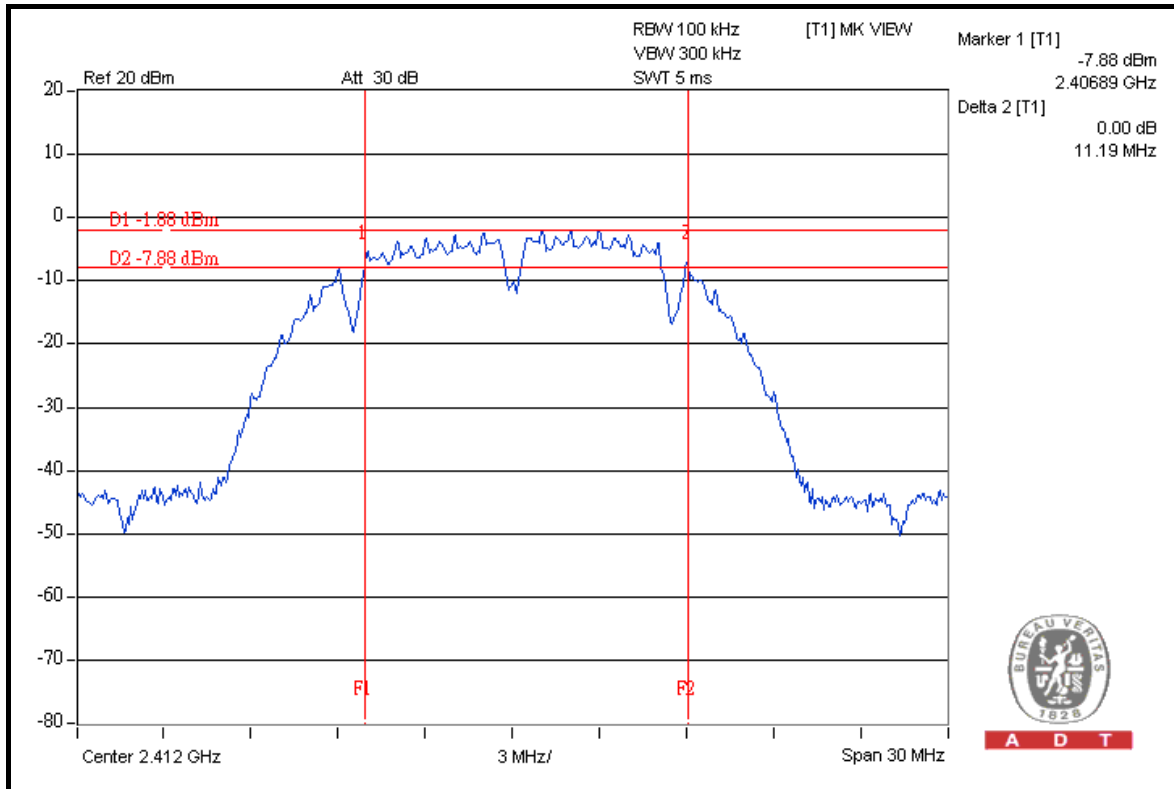

### CH 6

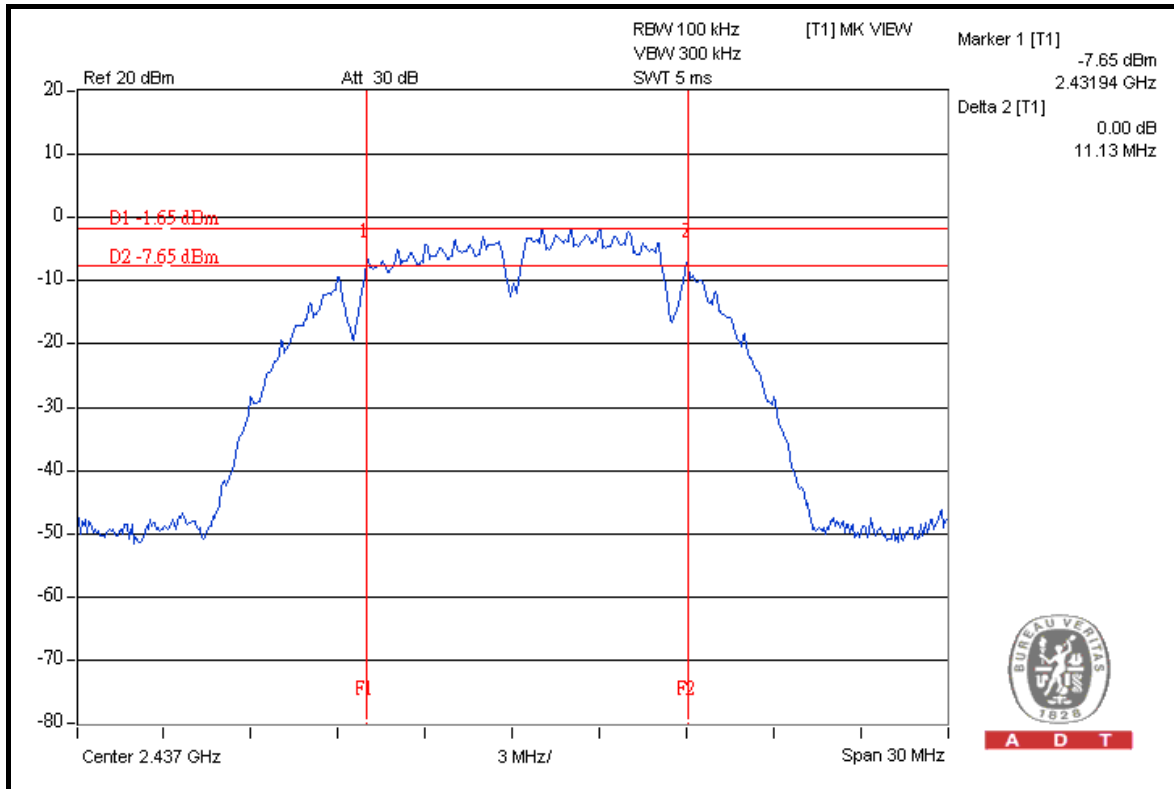



A D T

### CH 11

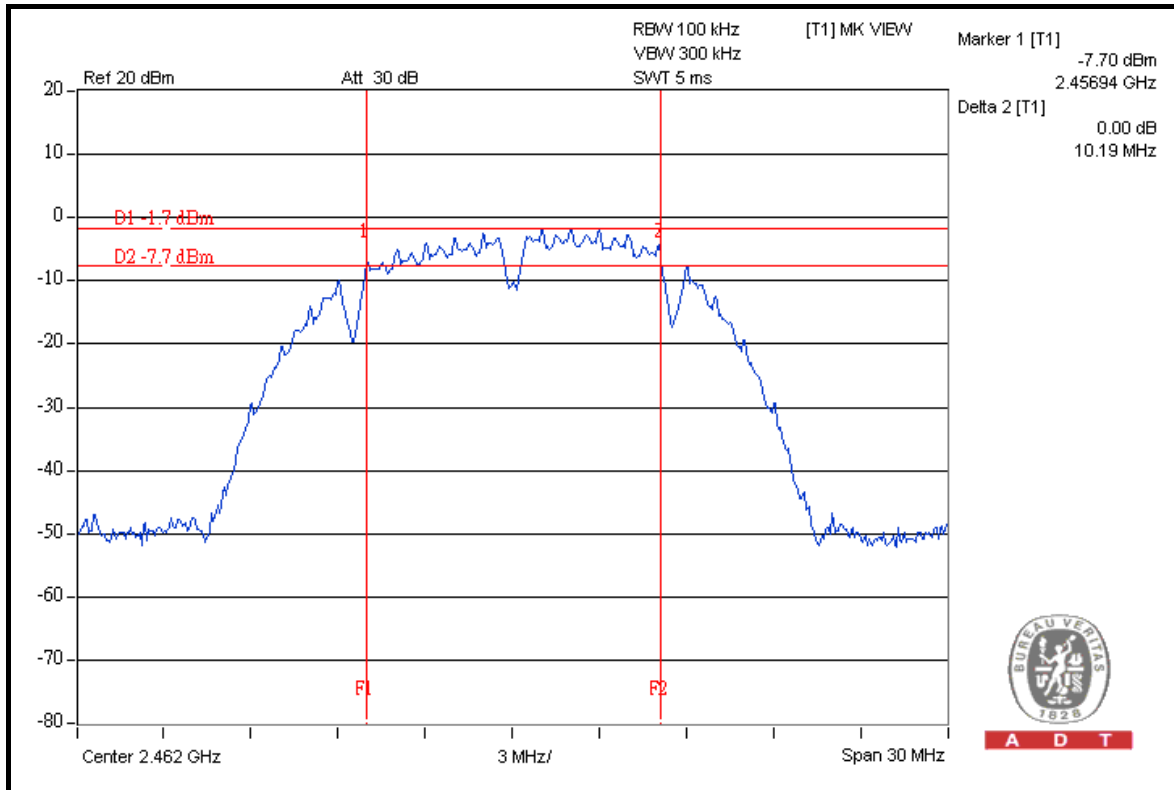

A D T

### FOR CHAIN 1: CH 1

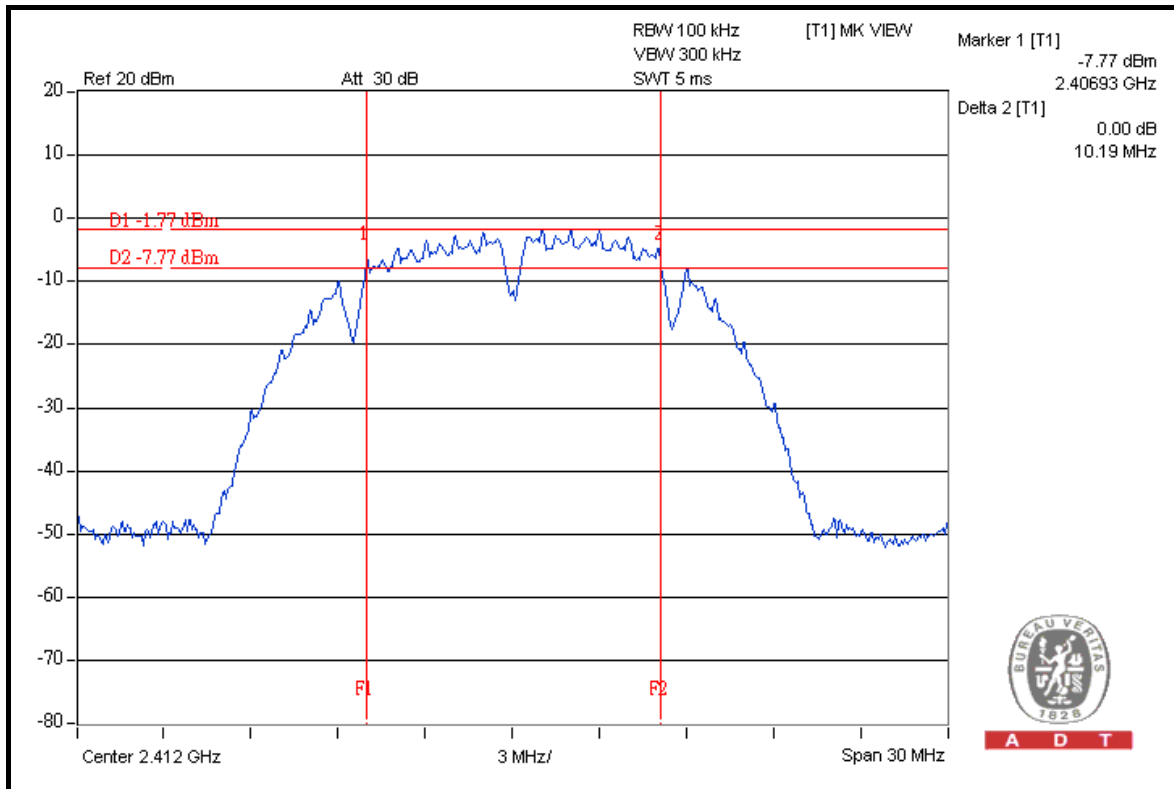

A D T



A D T

### CH 6

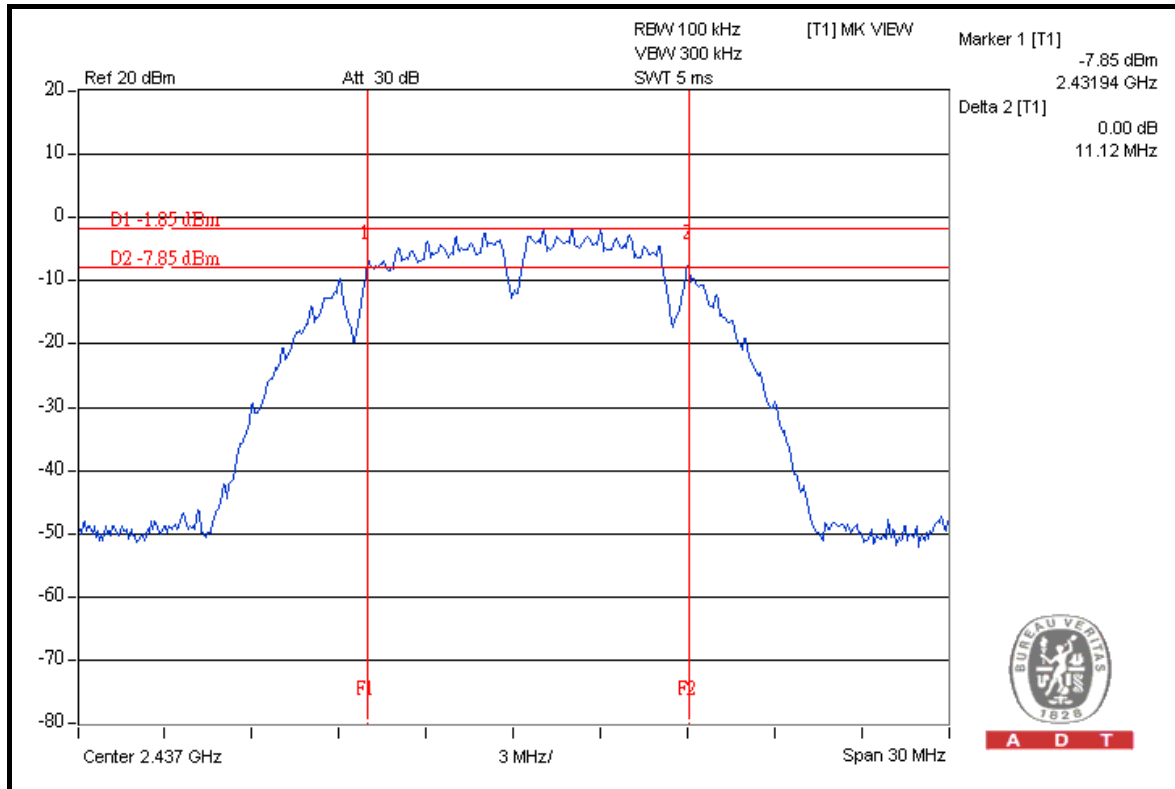

### CH 11

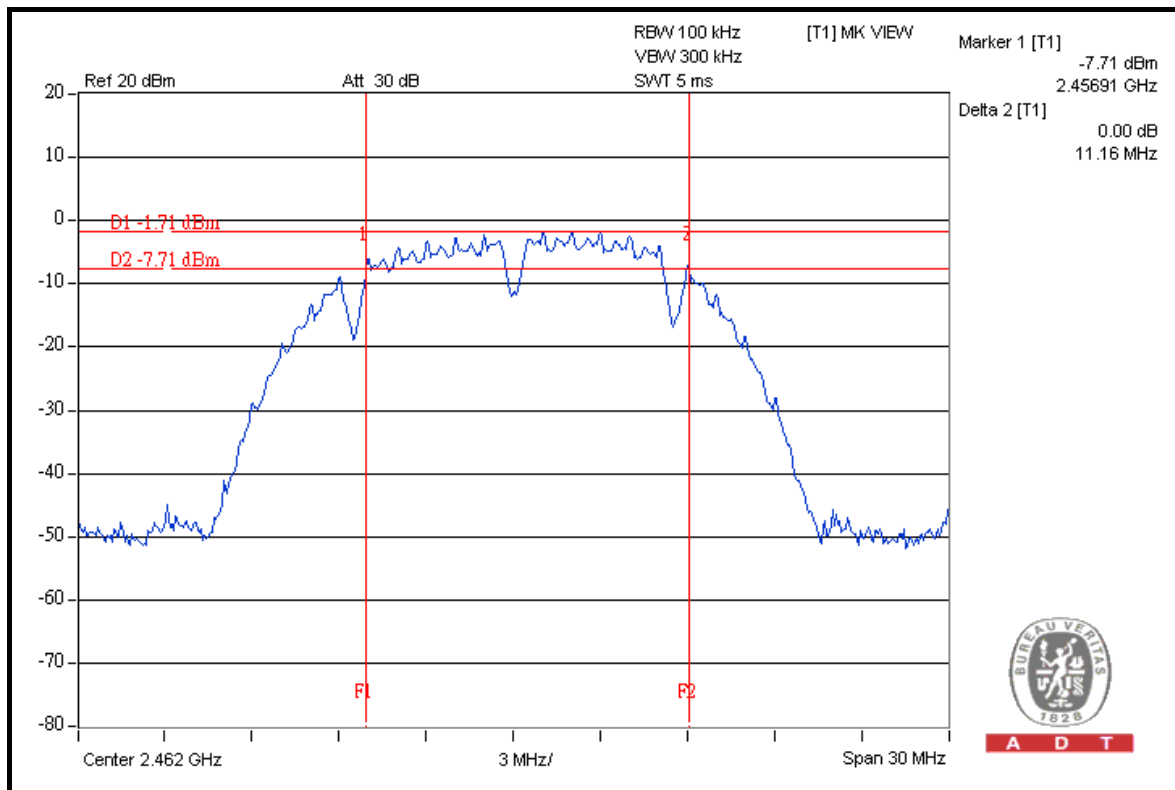



A D T

### 802.11g OFDM MODULATION

<b>MODULATION TYPE</b>	BPSK	<b>TRANSFER RATE</b>	6.0Mbps
<b>INPUT POWER</b>	120Vac, 60Hz	<b>ENVIRONMENTAL CONDITIONS</b>	24deg.C, 64%RH, 1021hPa
<b>TESTED BY</b>	Sun Lin		

CHANNEL	CHANNEL FREQUENCY (MHz)	6dB BANDWIDTH (MHz)		MINIMUM LIMIT (MHz)	PASS / FAIL
		CHAIN 0	CHAIN 1		
1	2412	16.57	16.46	0.5	PASS
6	2437	16.62	16.47	0.5	PASS
11	2462	16.58	16.50	10.5	PASS



A D T

### FOR CHAIN 0: CH 1

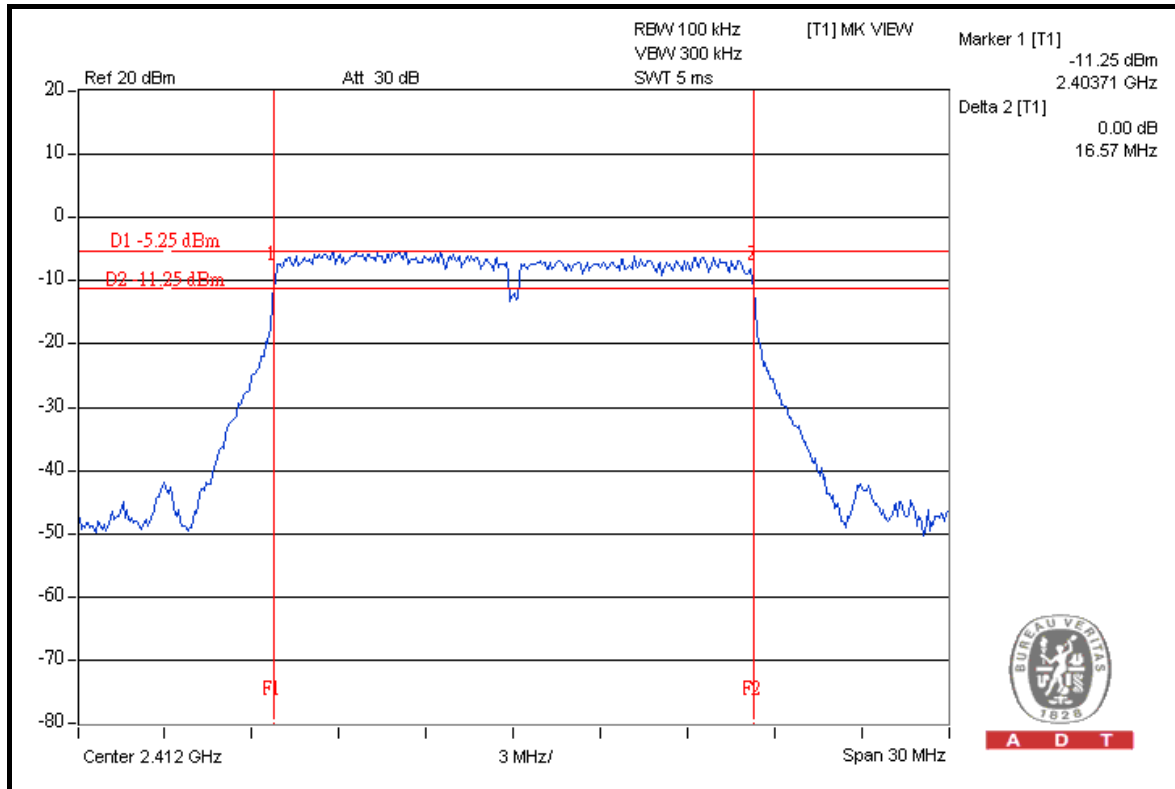

### CH 6

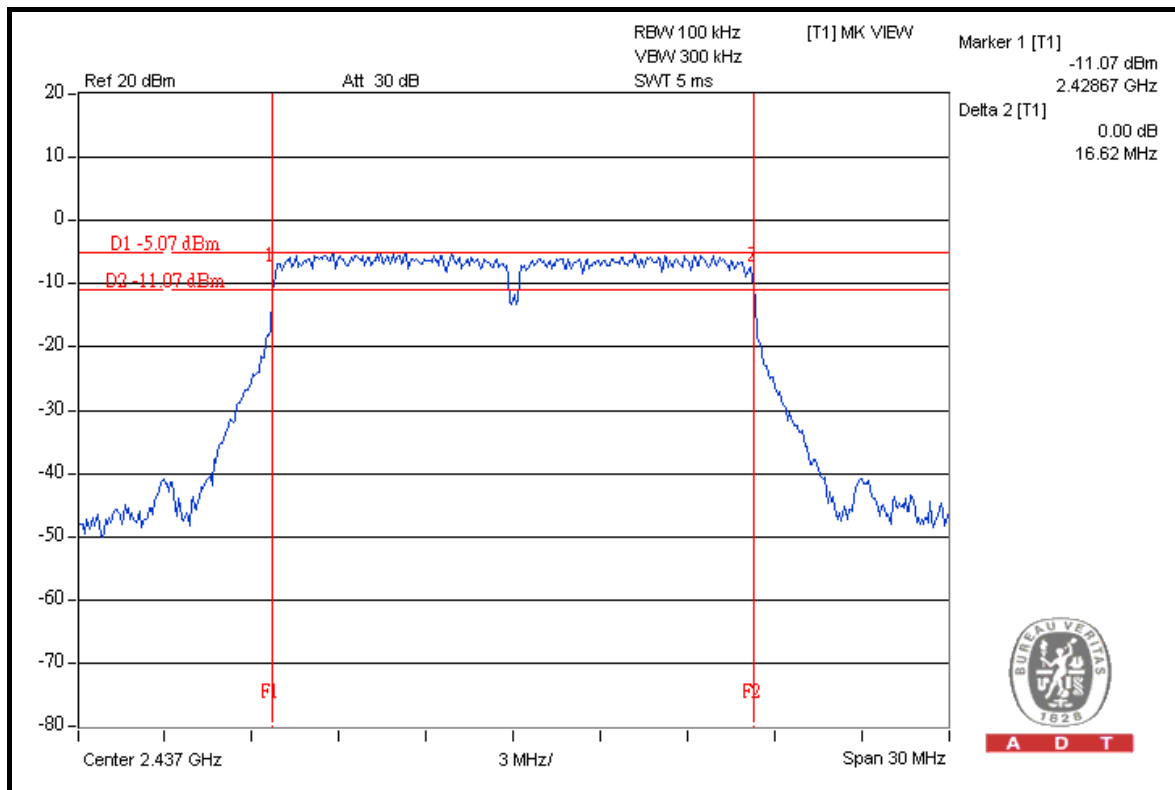



A D T

### CH 11

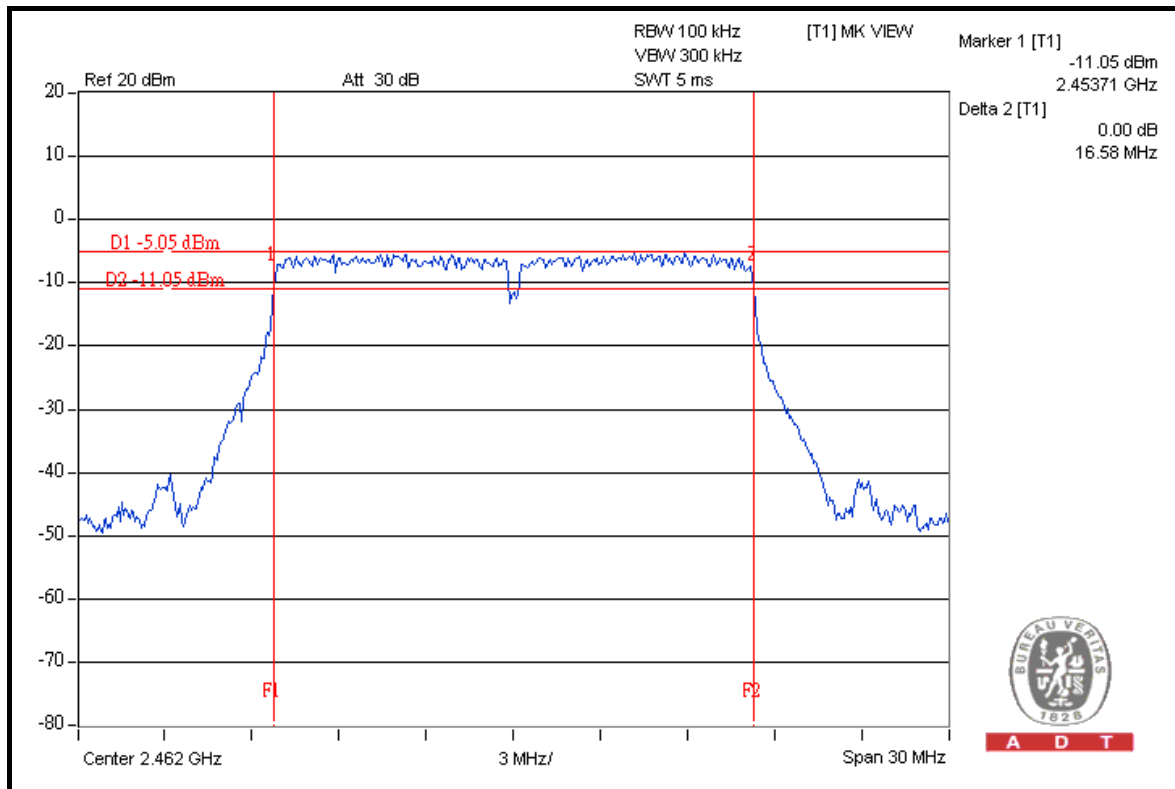

A D T

### FOR CHAIN 1: CH 1

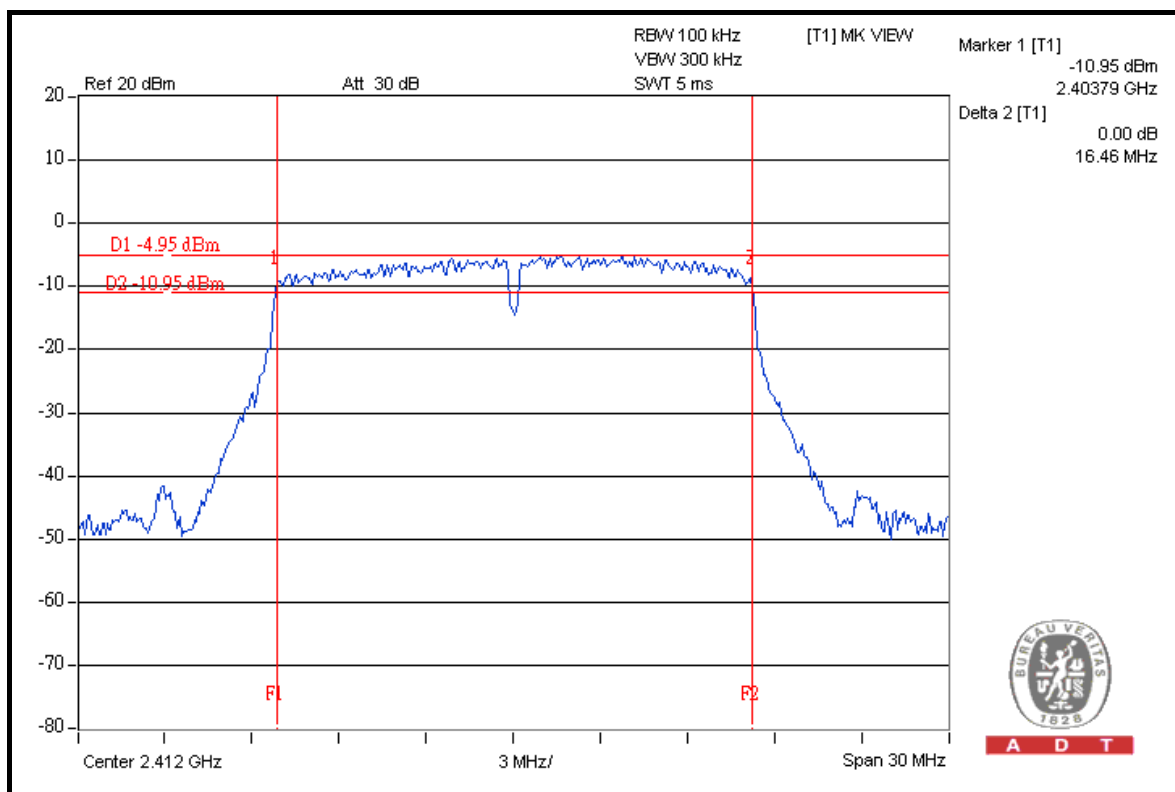

A D T



A D T

### CH 6

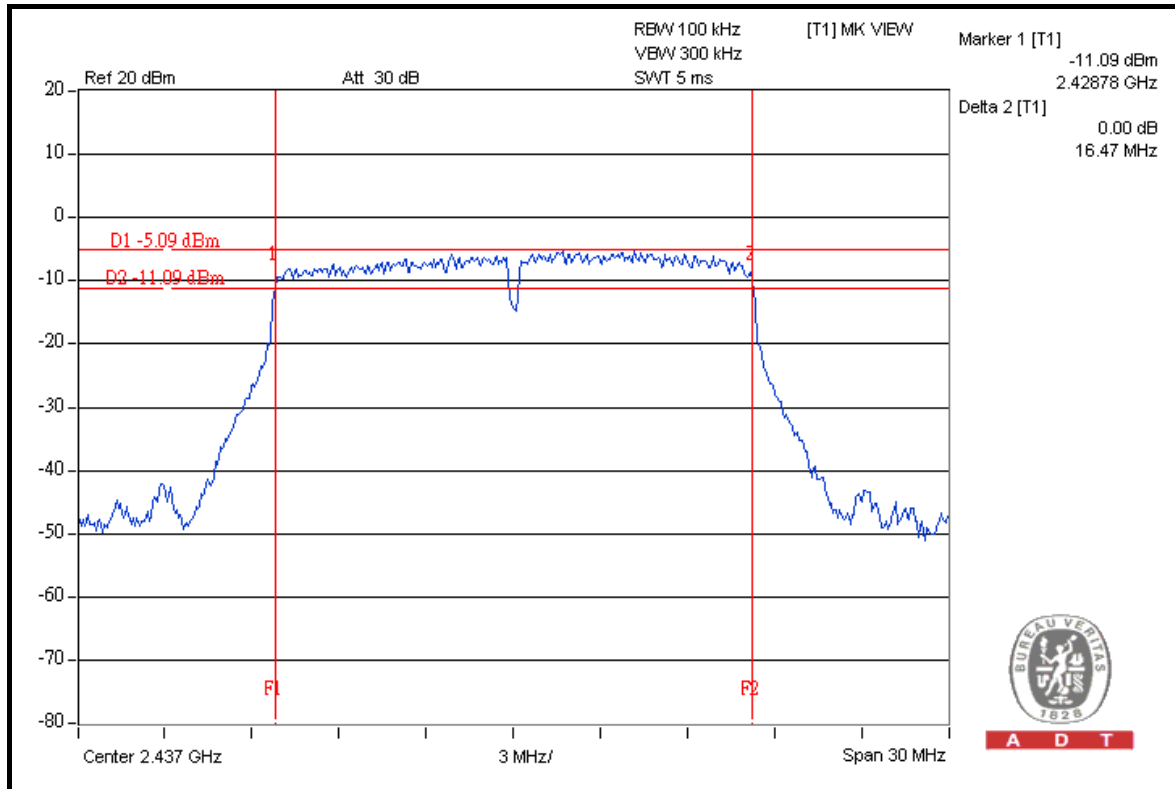

### CH 11

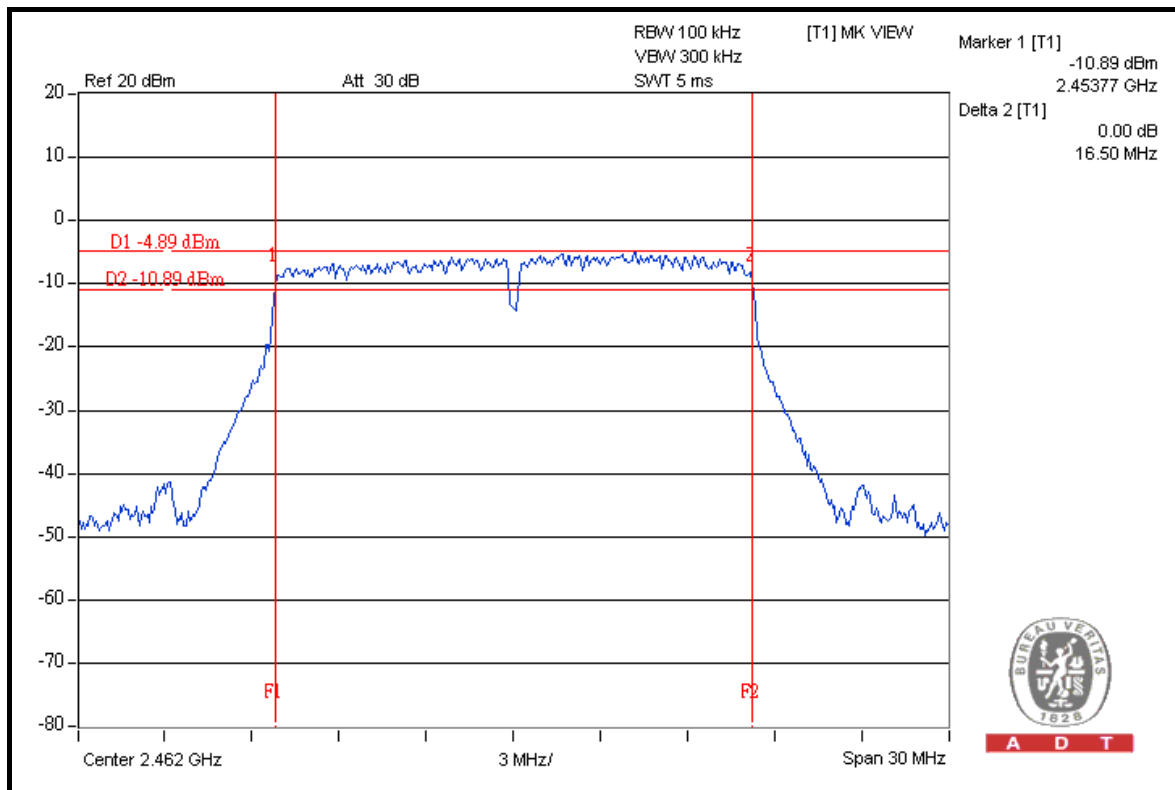



A D T

### DRAFT 802.11n (20MHz) OFDM MODULATION

<b>MODULATION TYPE</b>	BPSK	<b>TRANSFER RATE</b>	7.2Mbps
<b>INPUT POWER</b>	120Vac, 60Hz	<b>ENVIRONMENTAL CONDITIONS</b>	24deg.C, 64%RH, 1021hPa
<b>TESTED BY</b>	Sun Lin		

CHANNEL	CHANNEL FREQUENCY (MHz)	6dB BANDWIDTH (MHz)		MINIMUM LIMIT (MHz)	PASS / FAIL
		CHAIN 0	CHAIN 1		
1	2412	17.03	17.70	0.5	PASS
6	2437	17.02	17.70	0.5	PASS
11	2462	17.44	17.69	0.5	PASS





A D T

### FOR CHAIN 0: CH 1

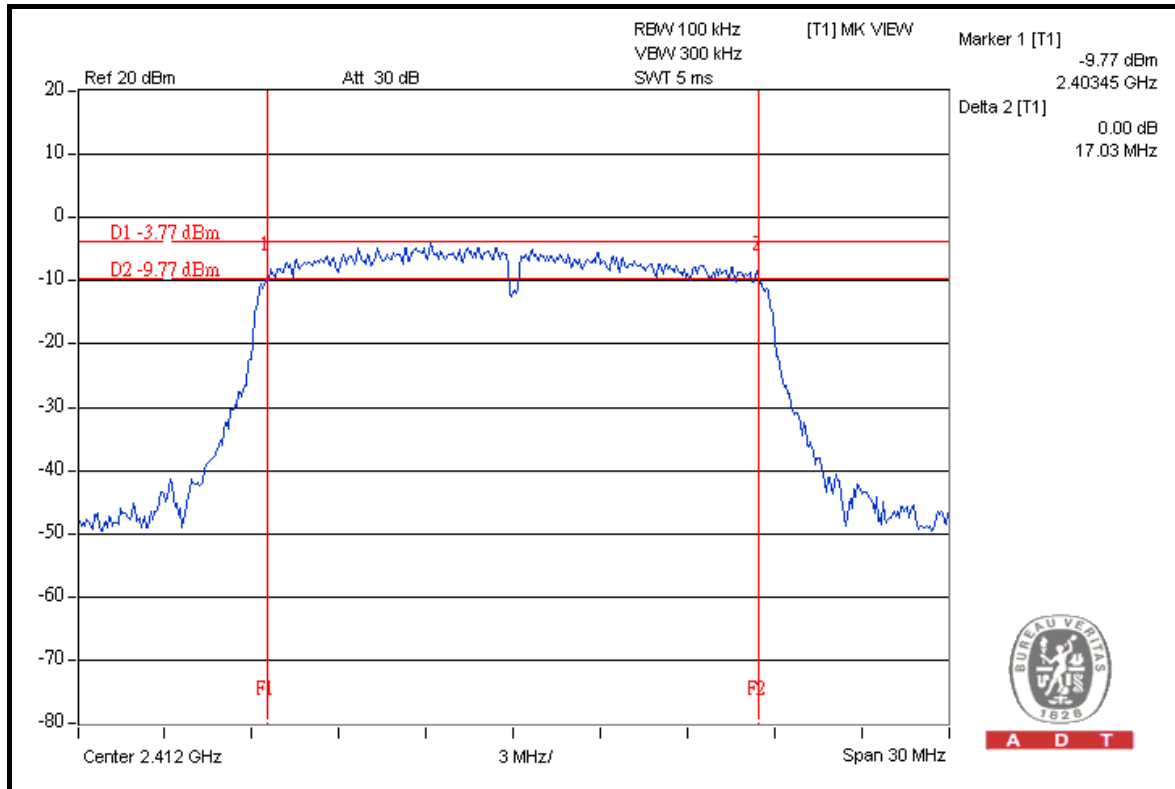

### CH 6

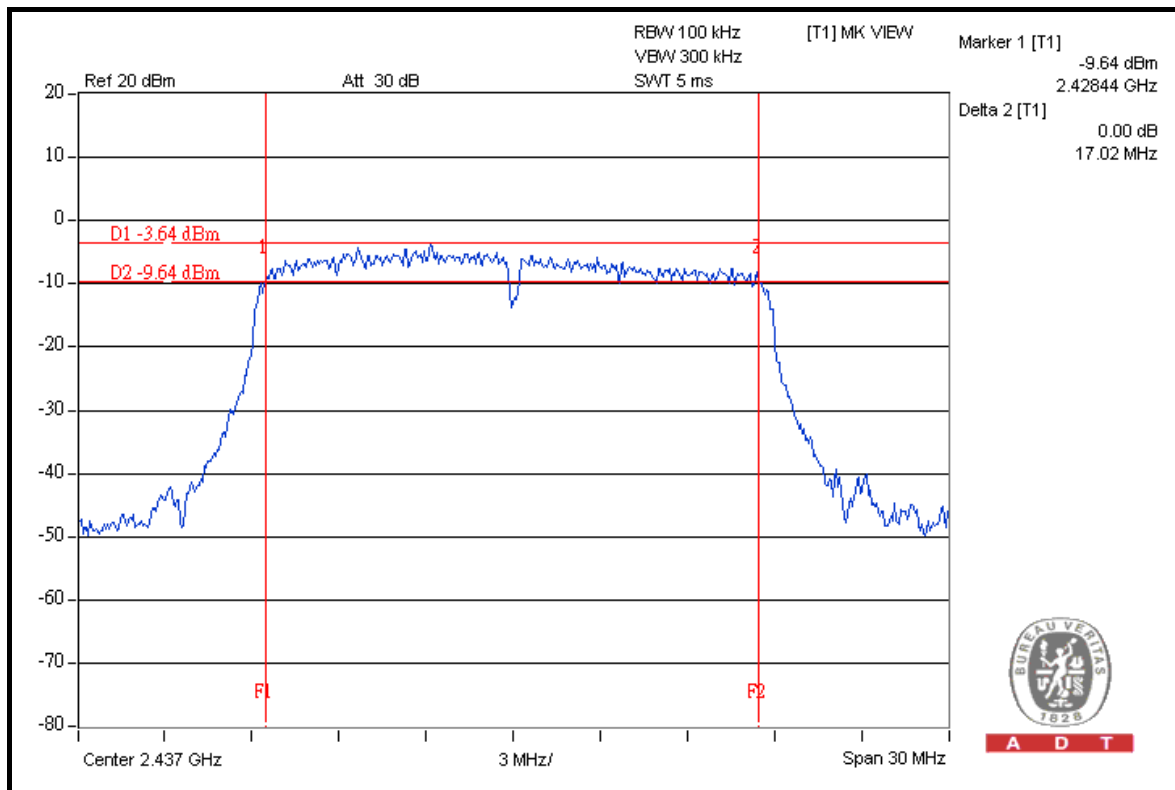



A D T

### CH 11

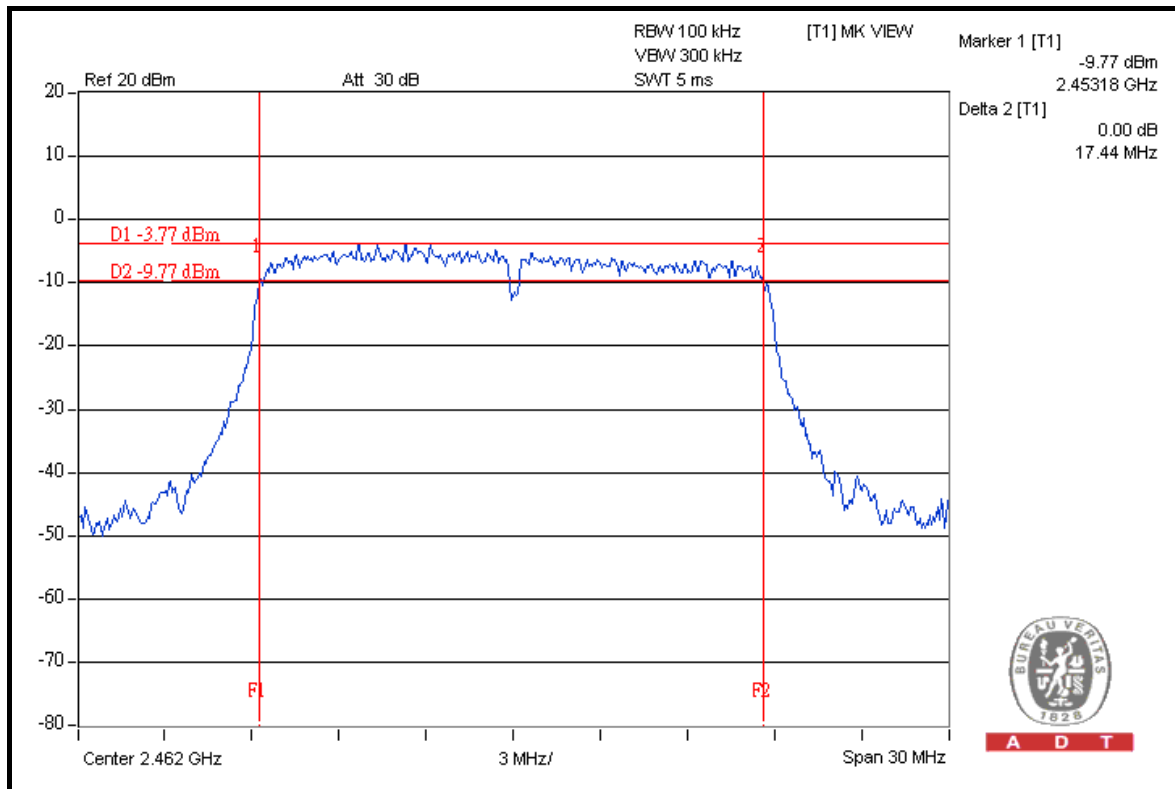

A D T

### FOR CHAIN 1: CH 1

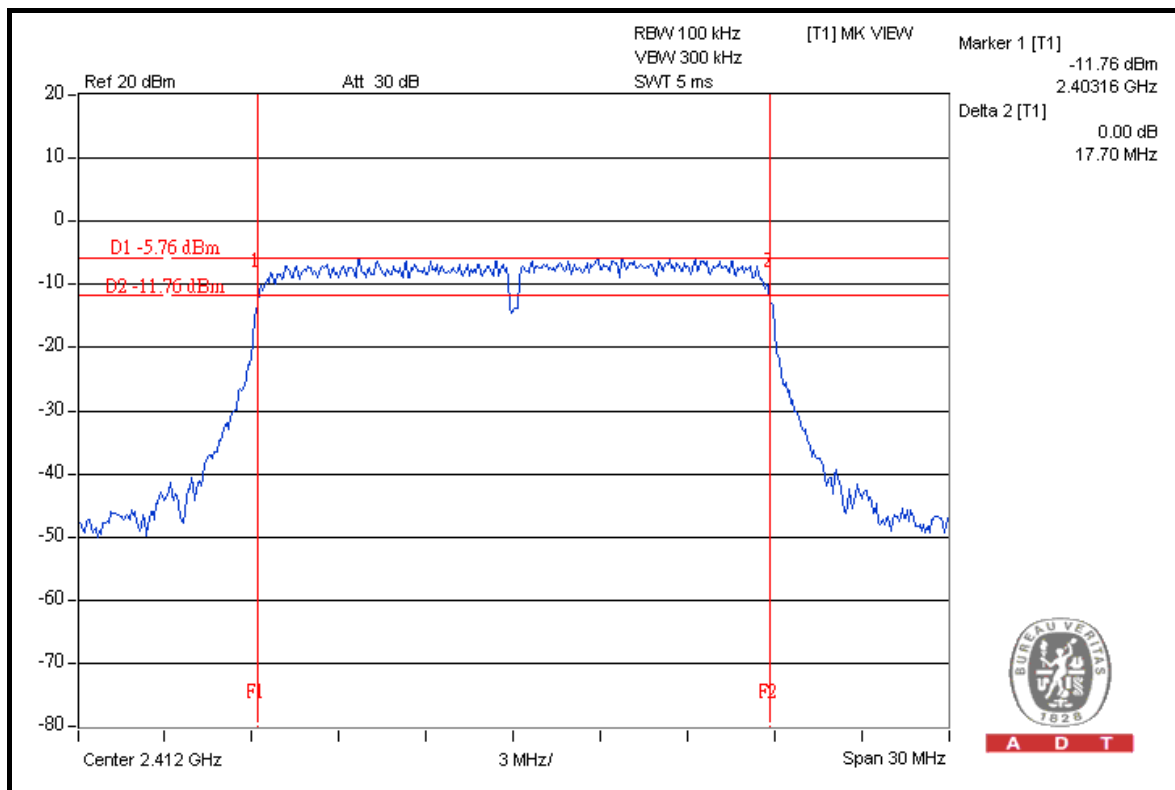

A D T



A D T

### CH 6

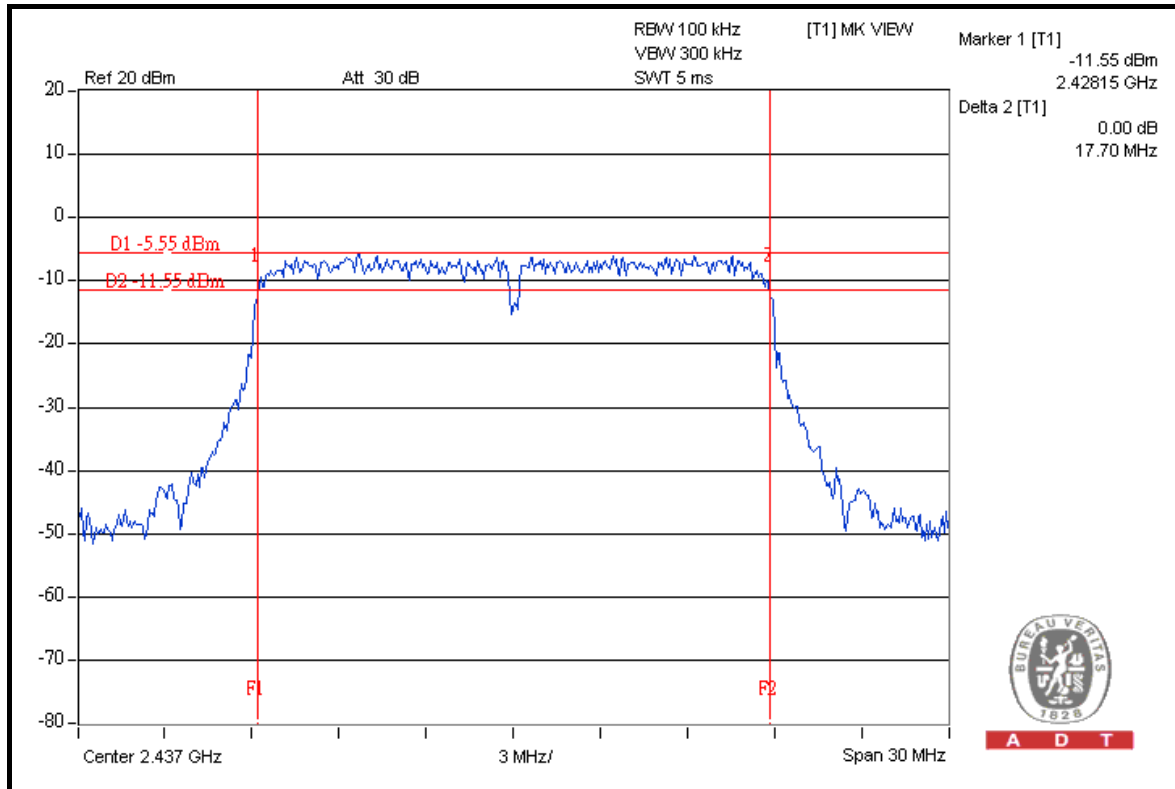

### CH 11

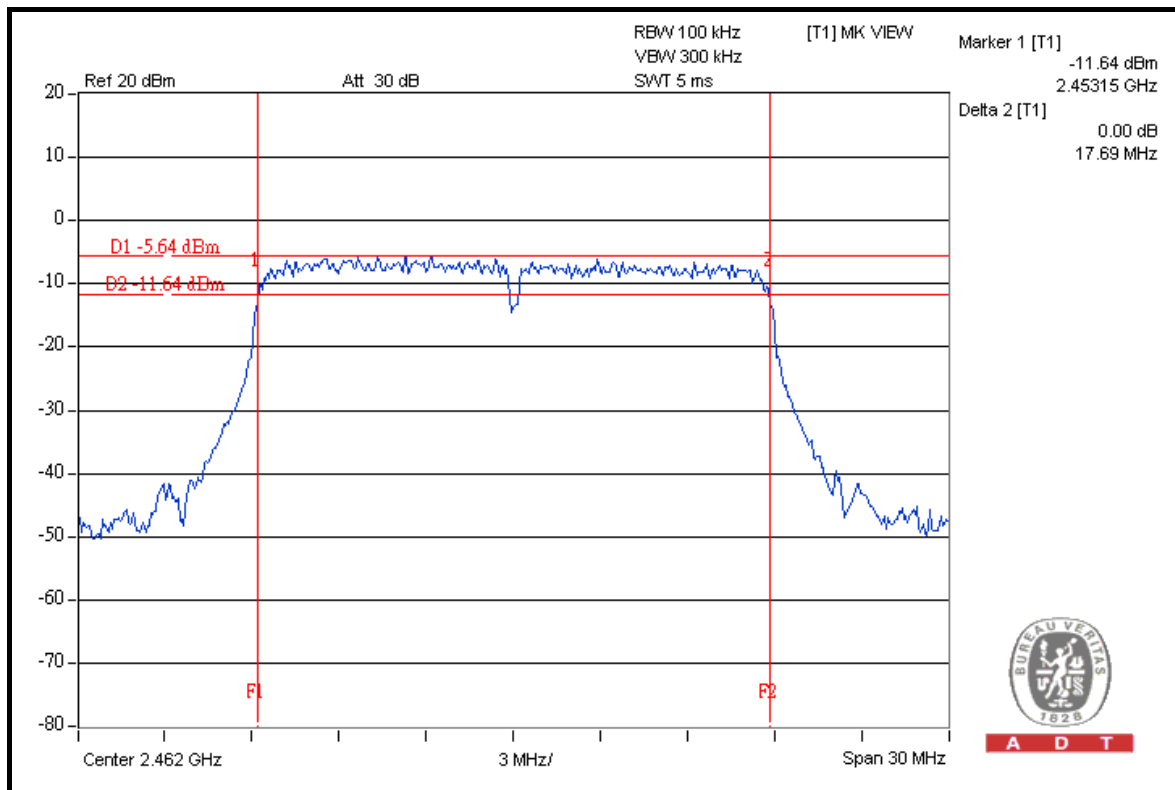



A D T

### DRAFT 802.11n (40MHz) OFDM MODULATION

<b>MODULATION TYPE</b>	BPSK	<b>TRANSFER RATE</b>	15.0Mbps
<b>INPUT POWER</b>	120Vac, 60Hz	<b>ENVIRONMENTAL CONDITIONS</b>	24deg.C, 64%RH, 1021hPa
<b>TESTED BY</b>	Sun Lin		

CHANNEL	CHANNEL FREQUENCY (MHz)	6dB BANDWIDTH (MHz)		MINIMUM LIMIT (MHz)	PASS / FAIL
		CHAIN 0	CHAIN 1		
1	2422	36.43	35.99	0.5	PASS
4	2437	36.26	36.18	0.5	PASS
7	2452	36.09	36.23	0.5	PASS



A D T

### FOR CHAIN 0: CH 1

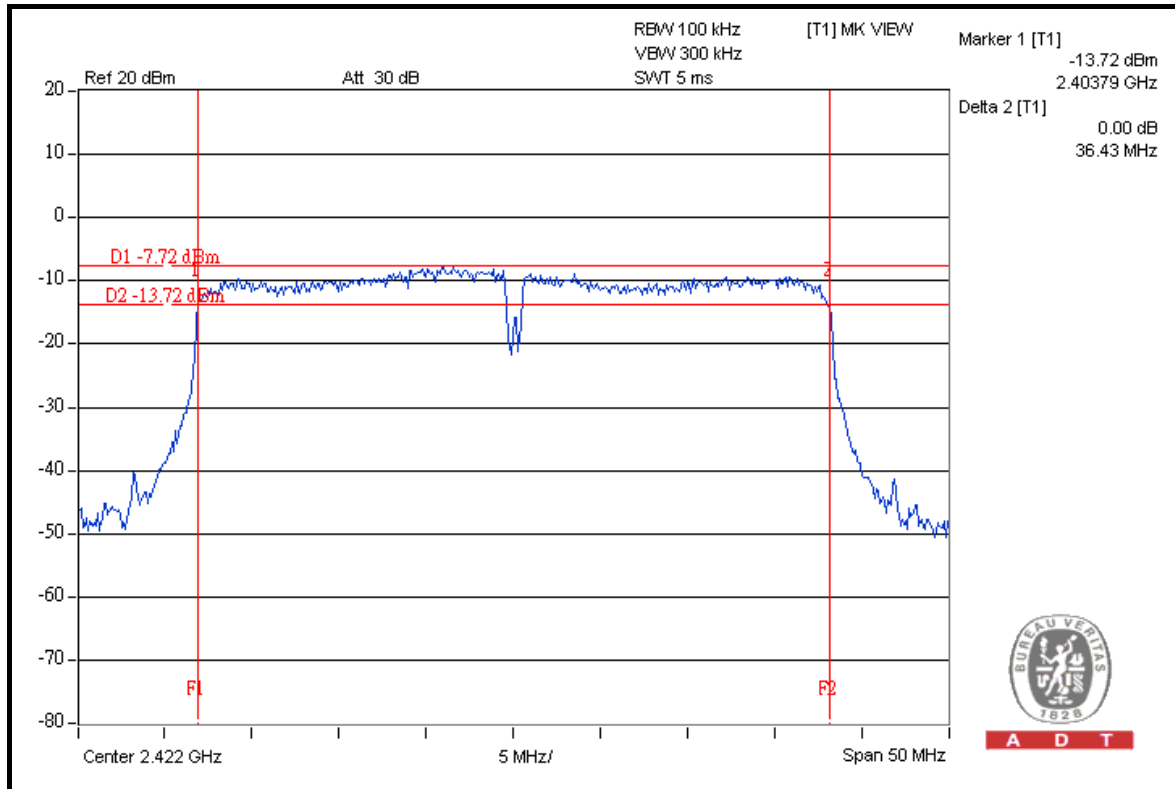

A D T

### CH 4

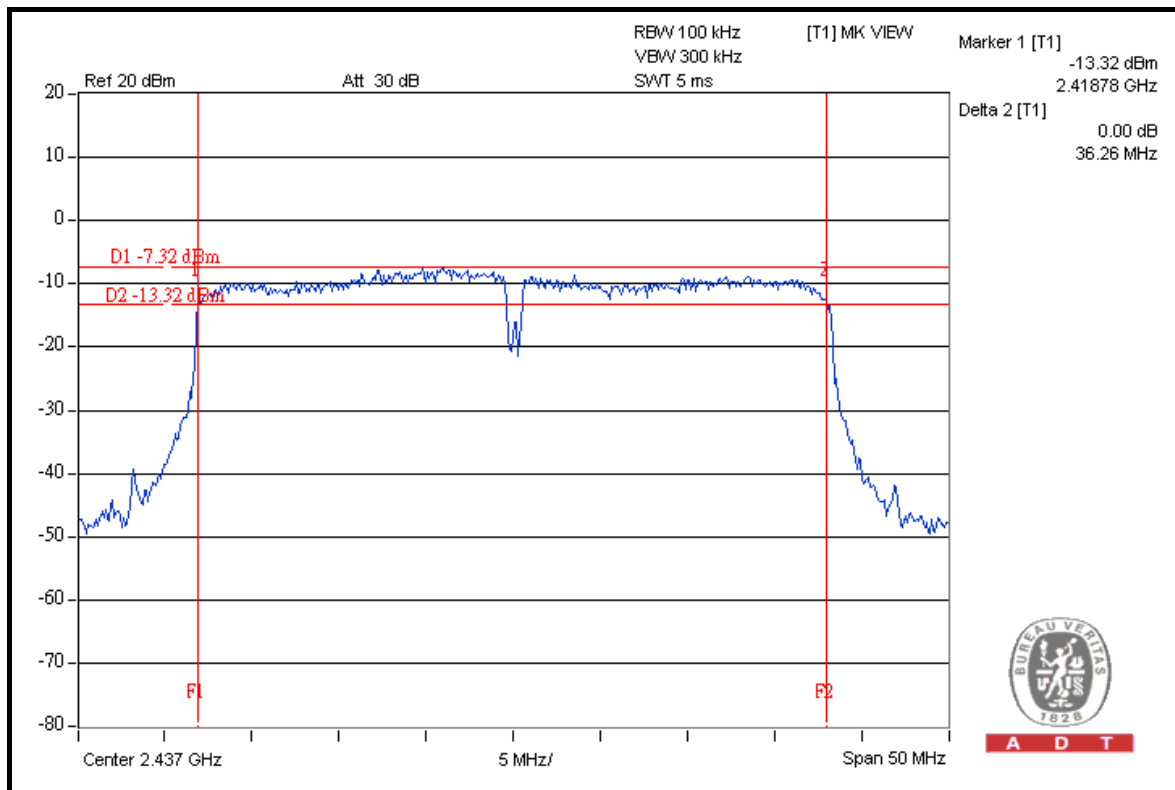

A D T



A D T

### CH 7

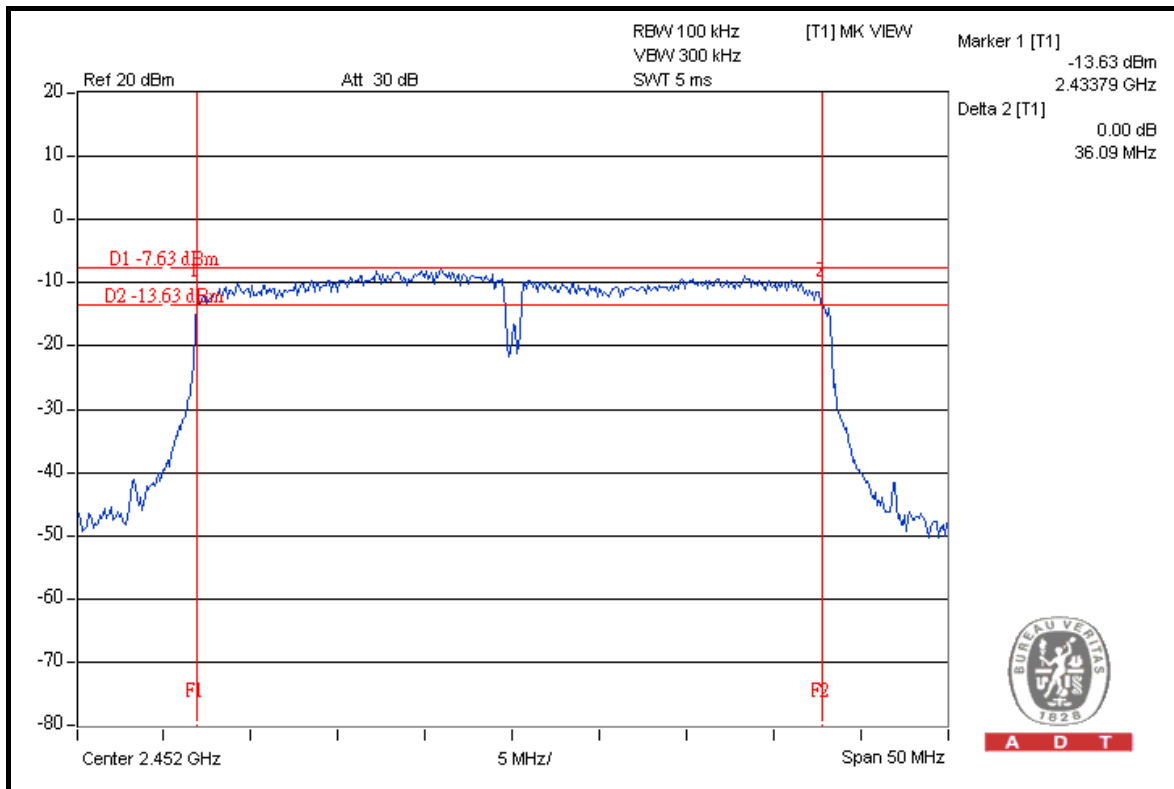

### FOR CHAIN 1: CH 1

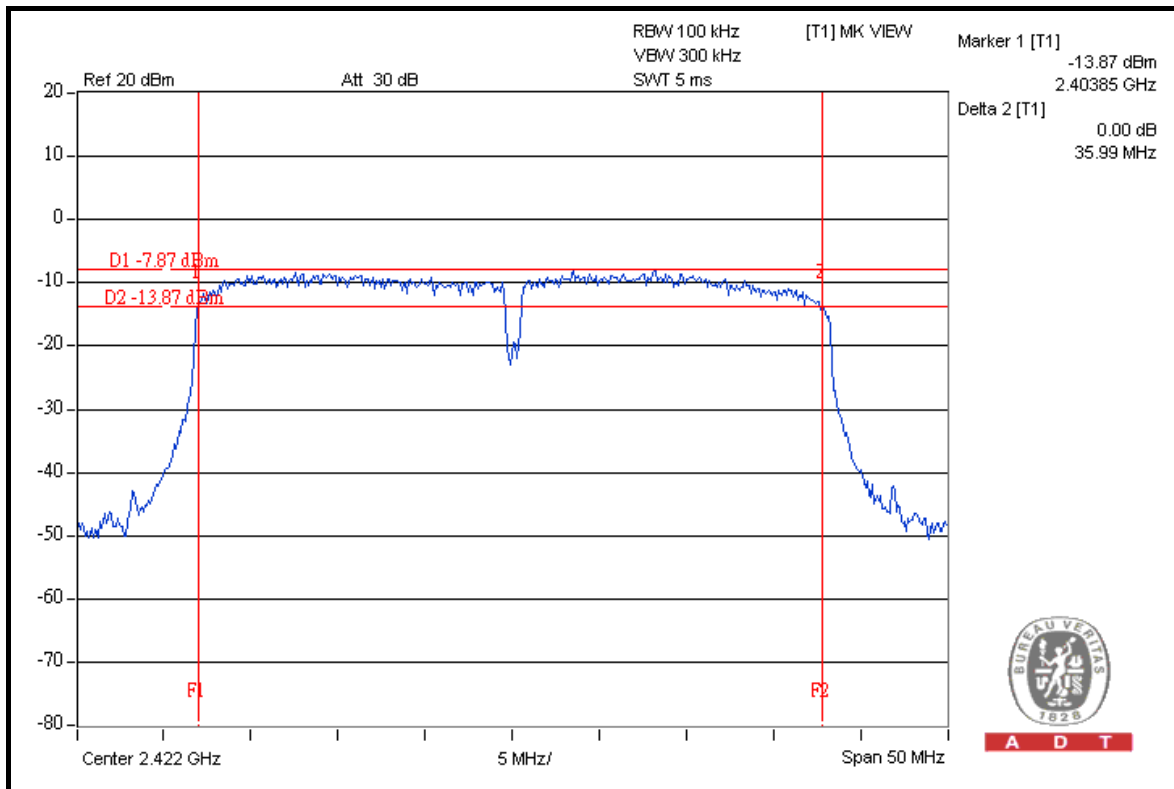



A D T

### CH 4

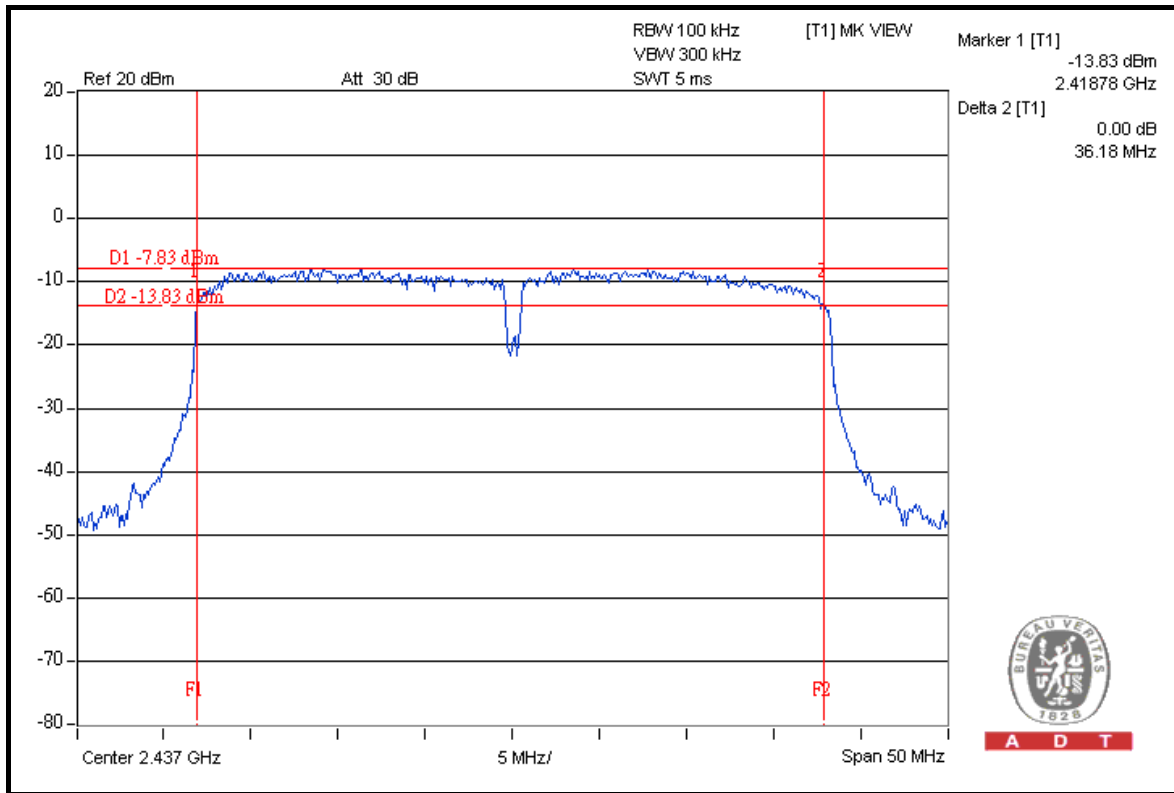

### CH 7

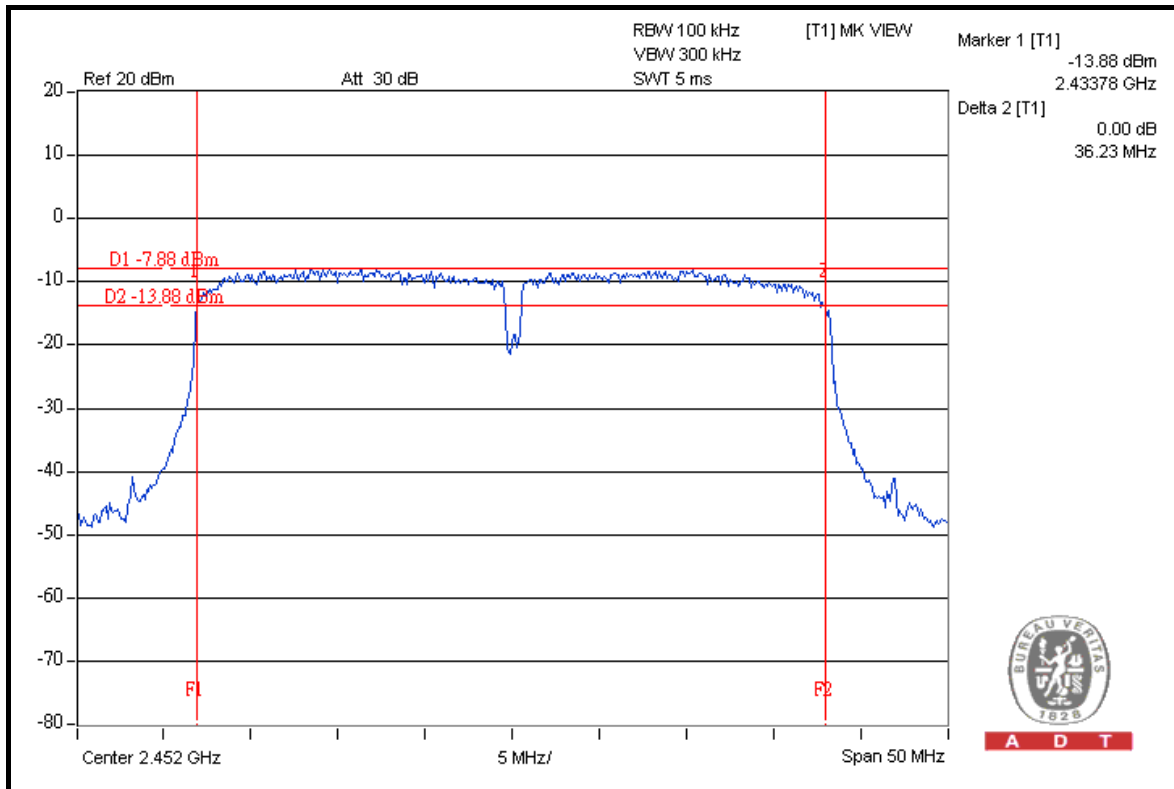



#### 4.4 MAXIMUM PEAK OUTPUT POWER

##### 4.4.1 LIMITS OF MAXIMUM PEAK OUTPUT POWER MEASUREMENT

The Maximum Peak Output Power Measurement is 30dBm.

##### 4.4.2 INSTRUMENTS

DESCRIPTION & MANUFACTURER	MODEL NO.	SERIAL NO.	DATE OF CALIBRATION	CALIBRATED UNTIL
PSA Seviess Spectrum Analyzer	E4446A	MY48250113	Nov. 26, 2008	Nov. 25, 2009

**NOTE:** The calibration interval of the above test instruments is 12 months and the calibrations are traceable to NML/ROC and NIST/USA.

##### 4.4.3 TEST PROCEDURE

1. Follow DTS measurement (Power Output Option 2), the transmitter output was connected to the spectrum analyzer through an attenuator, the bandwidth of the fundamental frequency was measured with the spectrum analyzer.
2. Set span to encompass the entire emission bandwidth (EBW) of the signal.
3. Set RBW = 1 MHz ;VBW  $\geq$  3 MHz.
4. Use sample detector mode and video trigger with the trigger level set to enable triggering only on full power pulses.
5. Trace average 100 traces in power averaging mode.
6. Compute power by integrating the spectrum across the 26 dB EBW of the signal.
7. Record the power level.



#### 4.4.4 DEVIATION FROM TEST STANDARD

No deviation.

#### 4.4.5 TEST SETUP

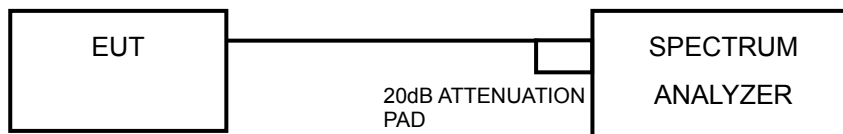

#### 4.4.6 EUT OPERATING CONDITIONS

Same as Item 4.3.6.



A D T

#### 4.4.7 TEST RESULTS

##### 802.11b DSSS MODULATION

<b>MODULATION TYPE</b>	DBPSK	<b>TRANSFER RATE</b>	1.0Mbps
<b>INPUT POWER</b>	120Vac, 60Hz	<b>ENVIRONMENTAL CONDITIONS</b>	24deg.C, 64%RH, 1021hPa
<b>TESTED BY</b>	Sun Lin		

CHAN.	CHAN. FREQ. (MHz)	PEAK POWER OUTPUT (dBm)		TOTAL PEAK POWER (mW)	TOTAL PEAK POWER (dBm)	PEAK POWER LIMIT (dBm)	PASS / FAIL
		CHAIN 0	CHAIN 1				
1	2412	9.94	9.92	19.68	12.94	30	PASS
6	2437	9.98	9.98	19.91	12.99	30	PASS
11	2462	9.89	9.89	19.50	12.90	30	PASS



A D T

### FOR CHAIN 0: CH 1

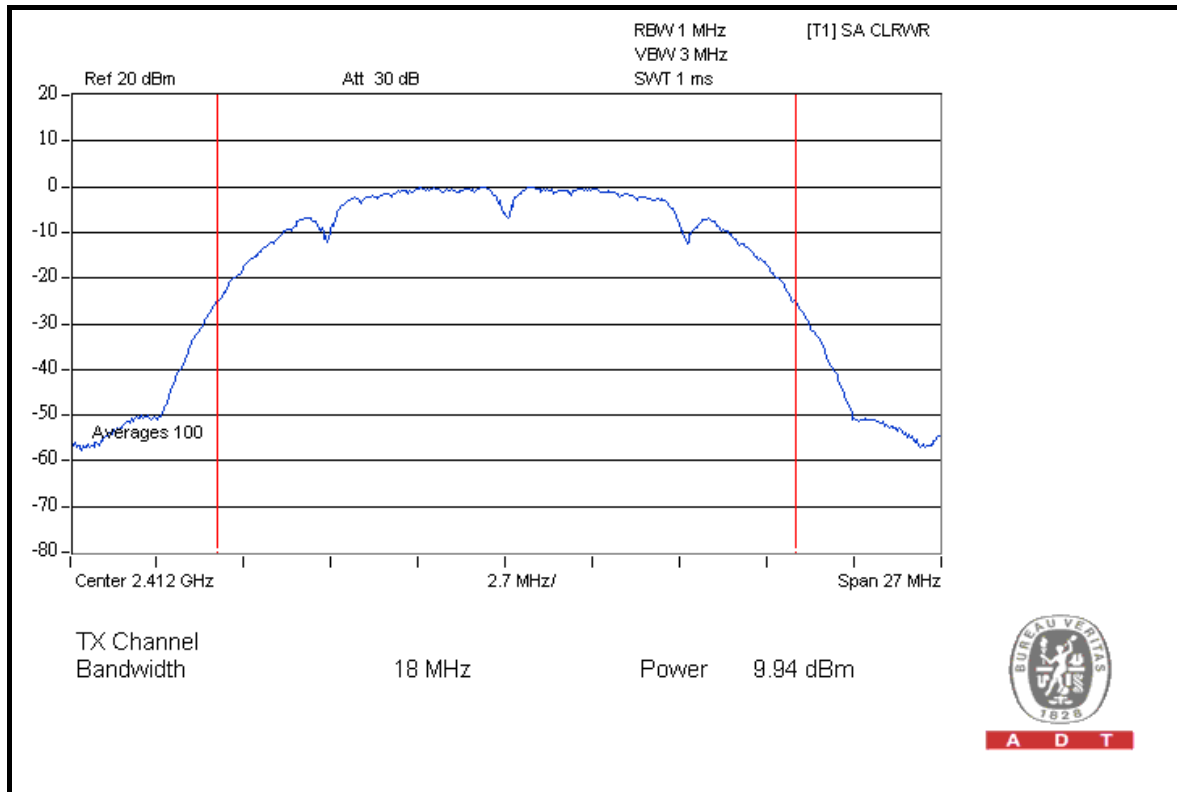

### CH 6

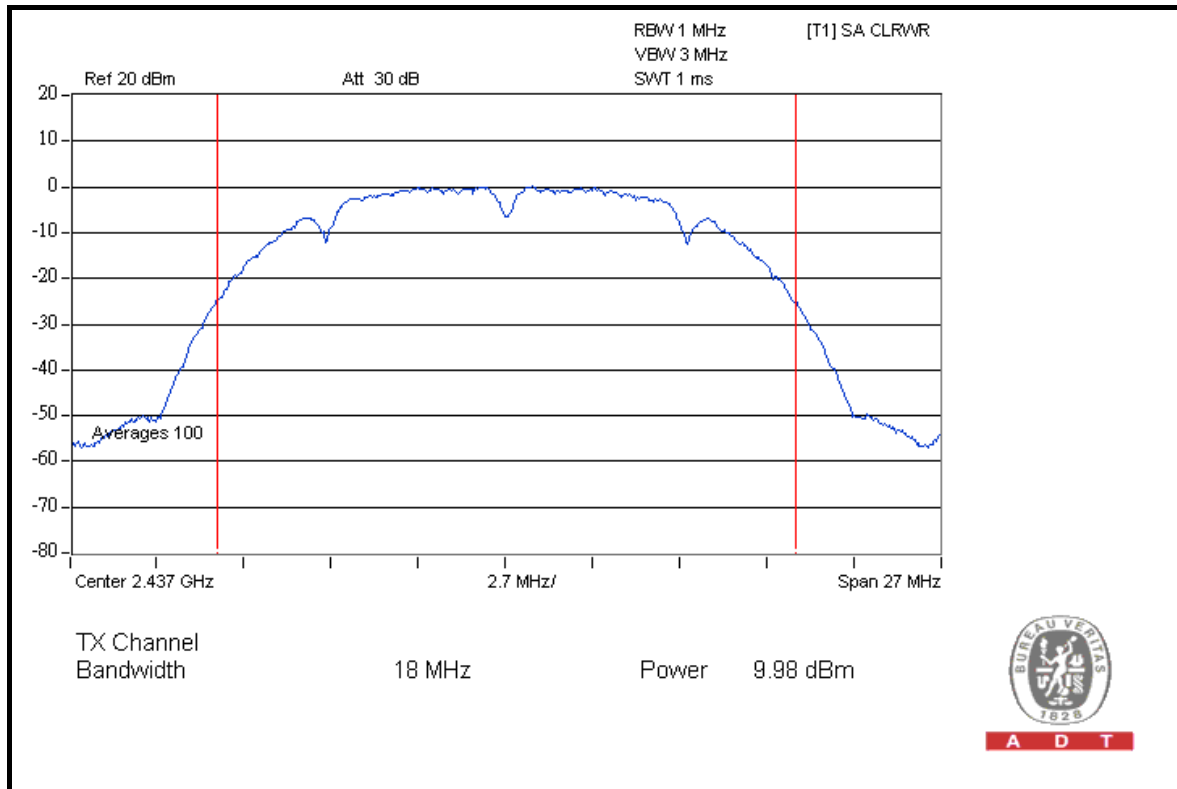



A D T

### CH 11

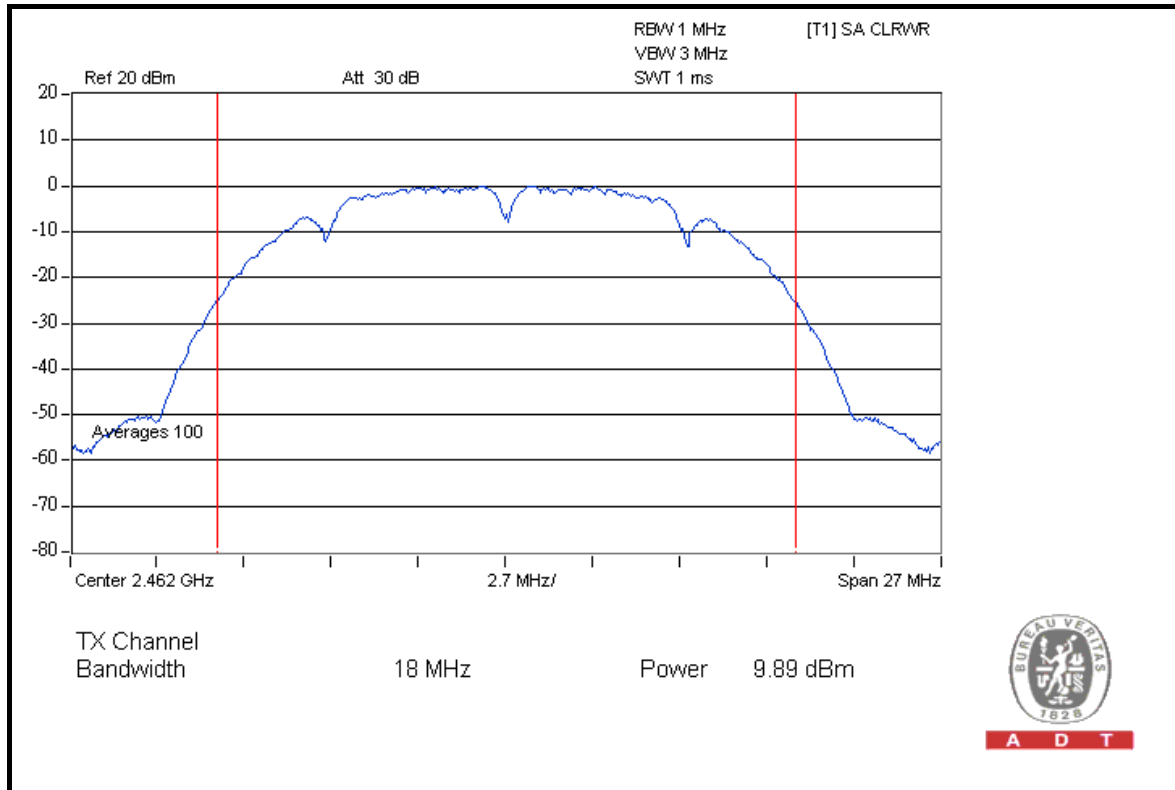

### FOR CHAIN 1: CH 1

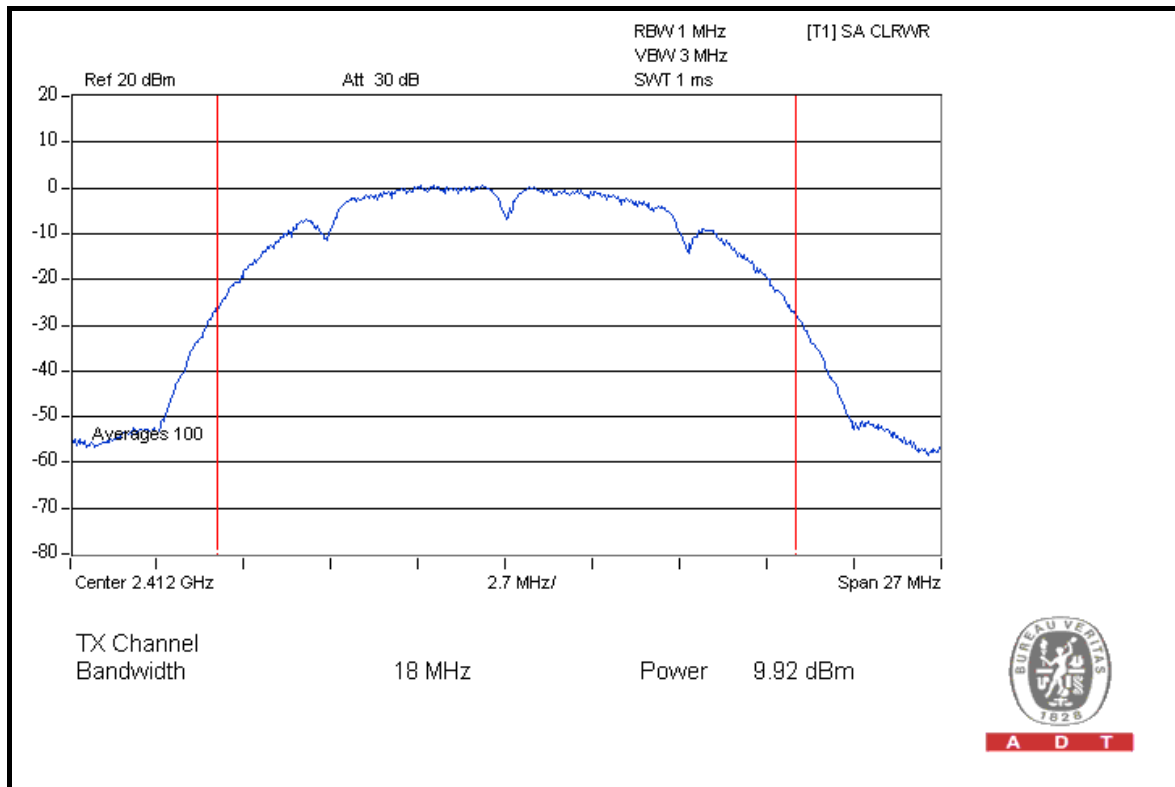



A D T

### CH 6

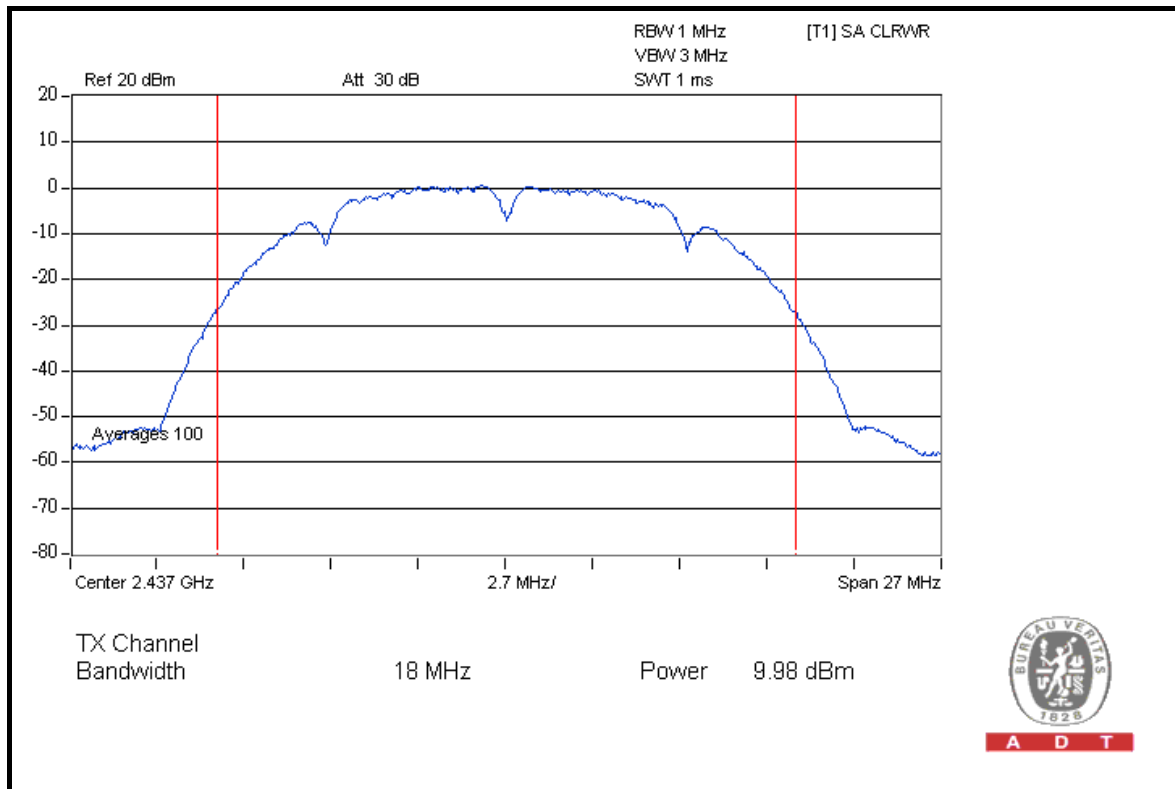

### CH 11

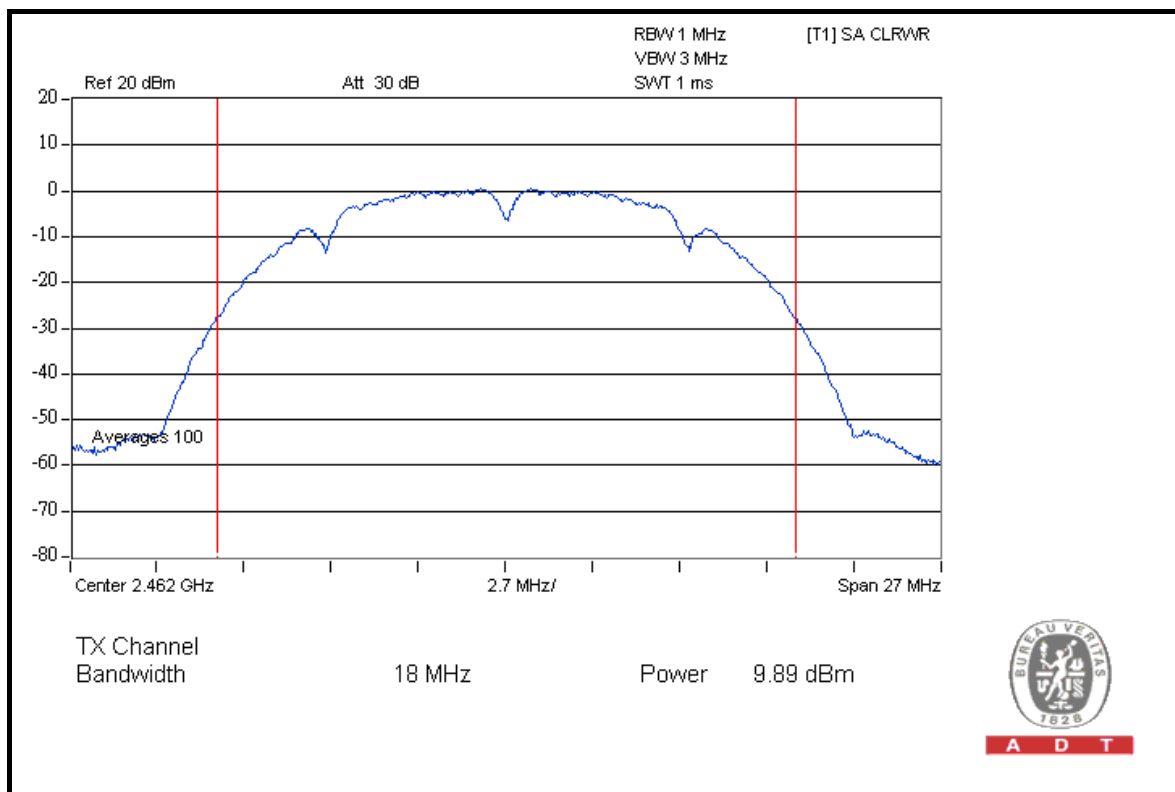



A D T

### 802.11g OFDM MODULATION

<b>MODULATION TYPE</b>	BPSK	<b>TRANSFER RATE</b>	6.0Mbps
<b>INPUT POWER</b>	120Vac, 60Hz	<b>ENVIRONMENTAL CONDITIONS</b>	24deg.C, 64%RH, 1021hPa
<b>TESTED BY</b>	Sun Lin		

CHAN.	CHAN. FREQ. (MHz)	PEAK POWER OUTPUT (dBm)		TOTAL PEAK POWER (mW)	TOTAL PEAK POWER (dBm)	PEAK POWER LIMIT (dBm)	PASS / FAIL
		CHAIN 0	CHAIN 1				
1	2412	9.89	9.93	19.59	12.92	30	PASS
6	2437	9.96	9.94	19.77	12.96	30	PASS
11	2462	9.98	9.90	19.73	12.95	30	PASS



A D T

### FOR CHAIN 0: CH 1

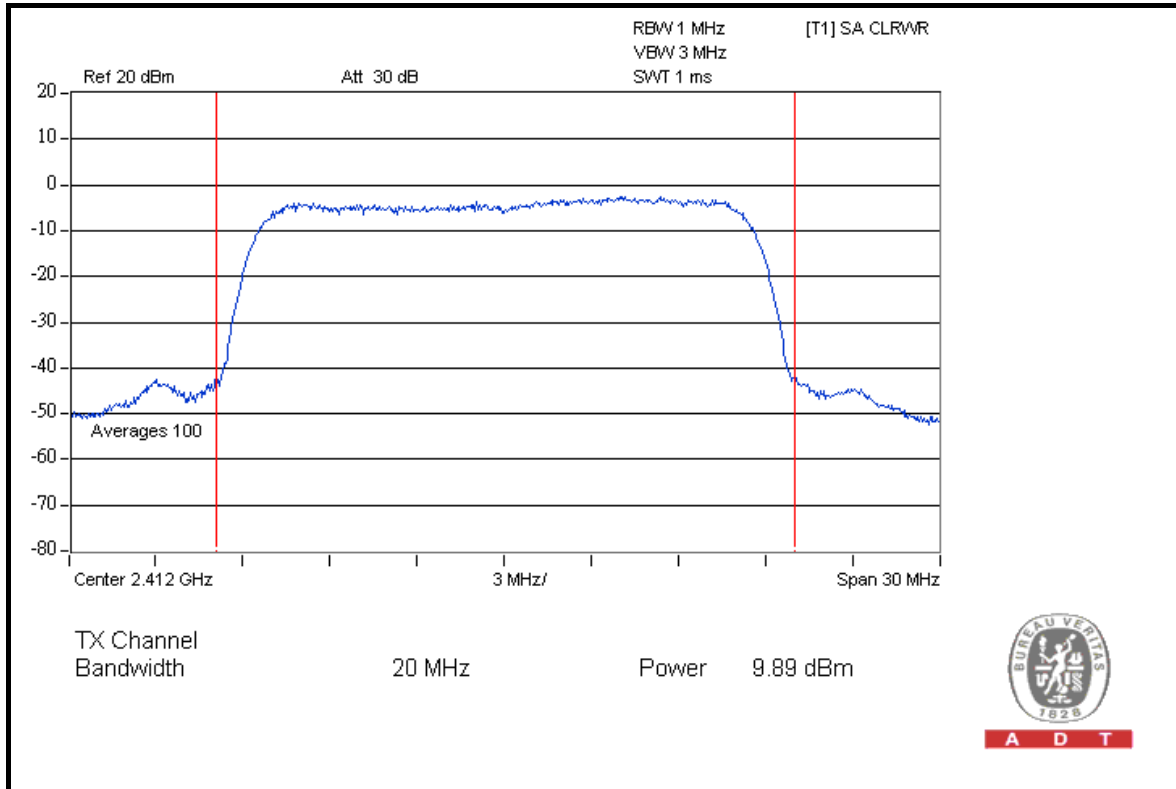

### CH 6

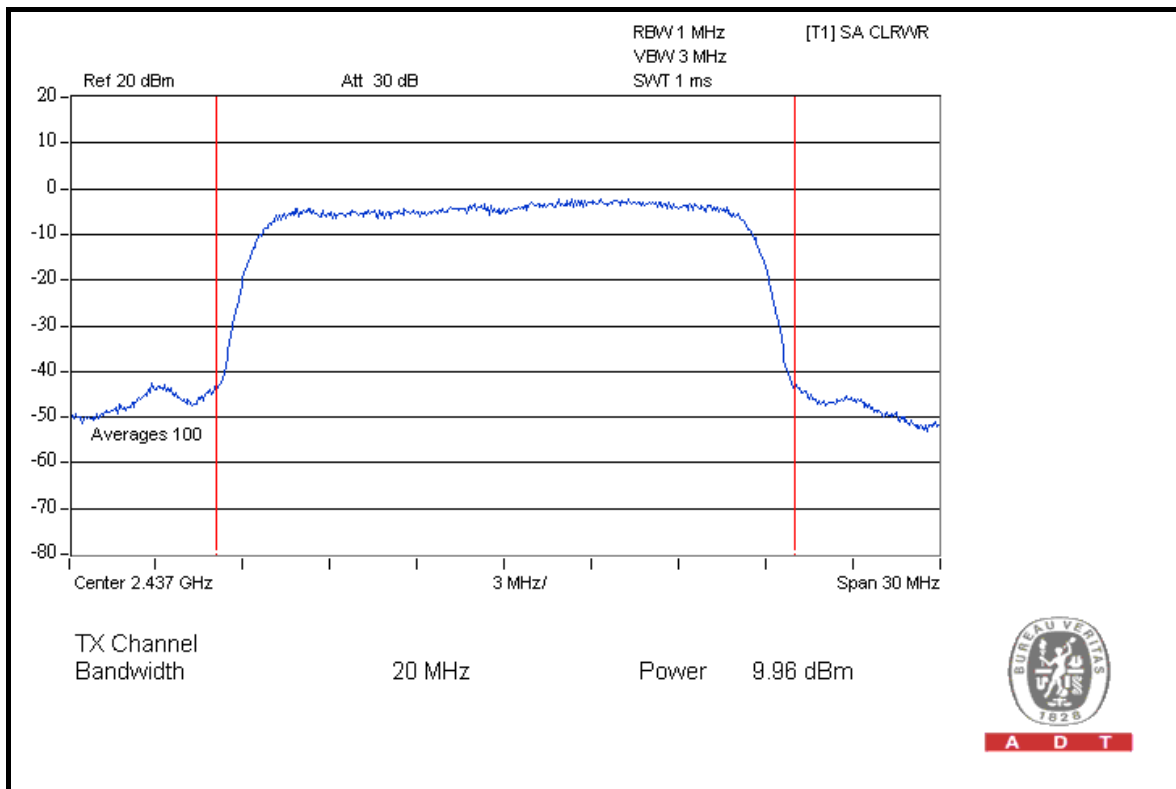



A D T

### CH 11

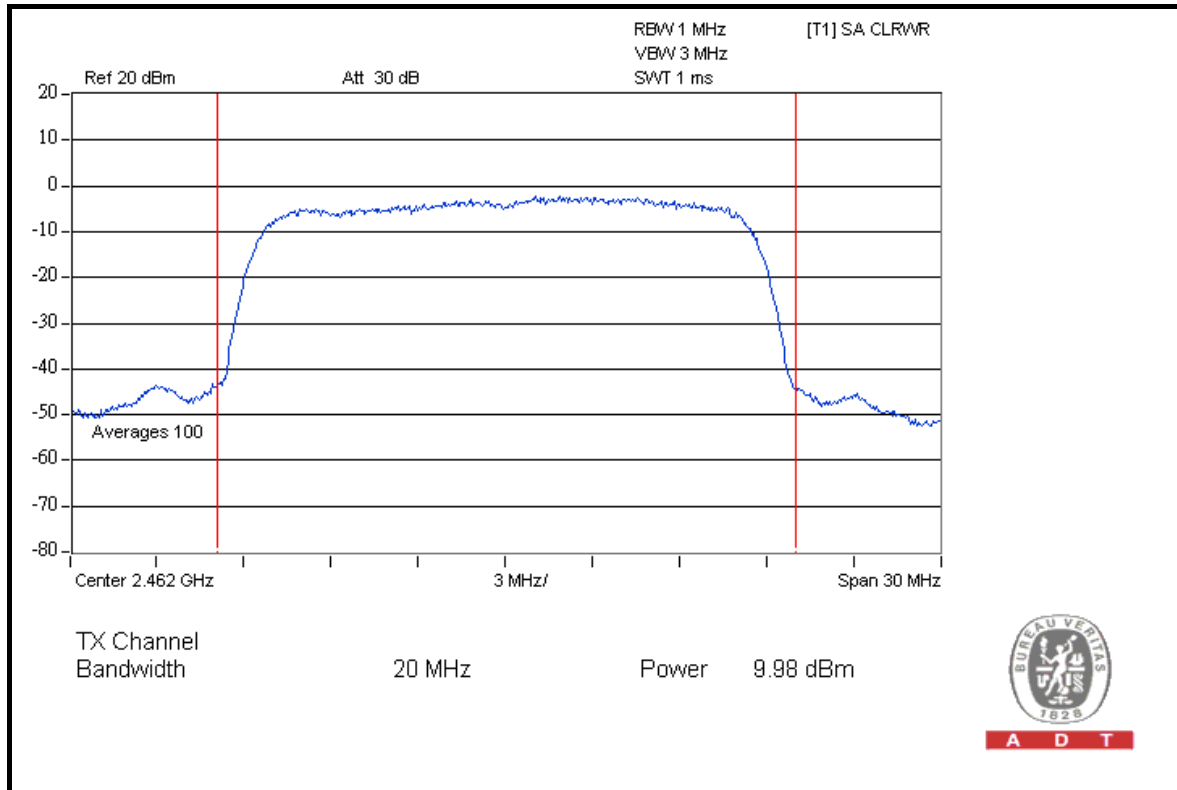

A D T

### FOR CHAIN 1: CH 1

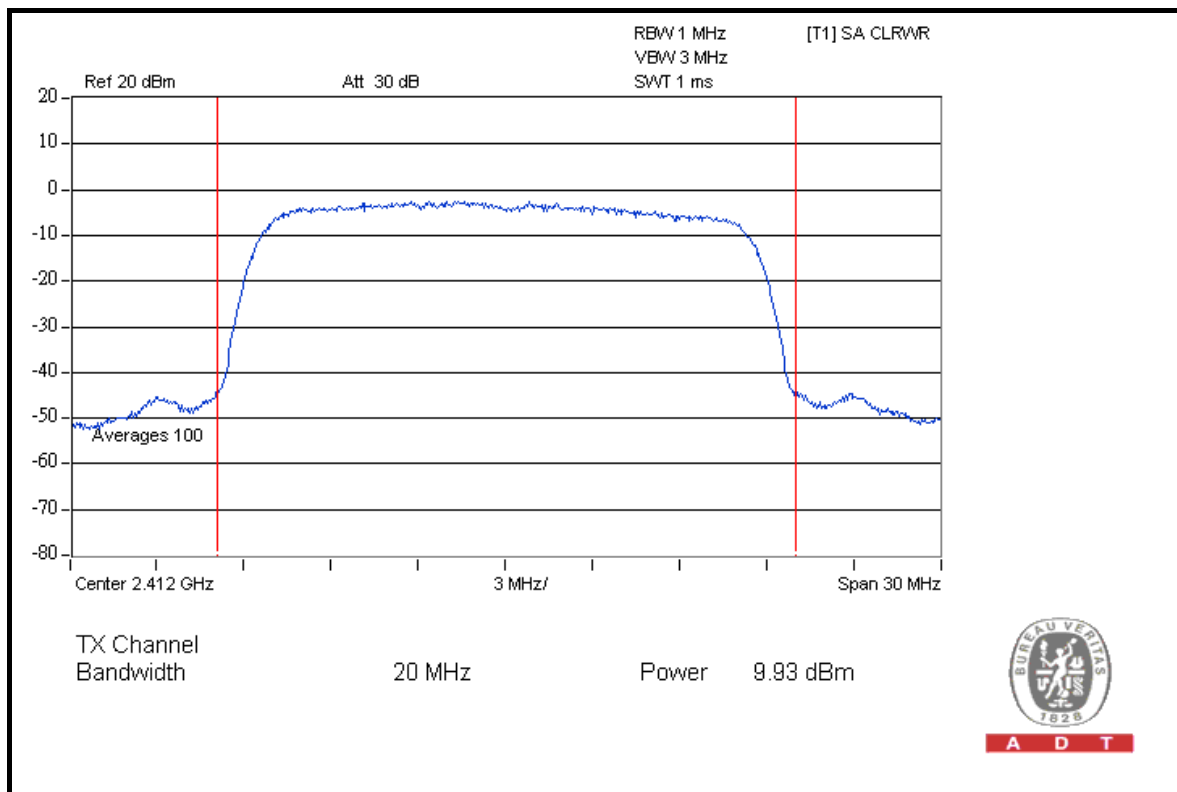

A D T





A D T

### CH 6

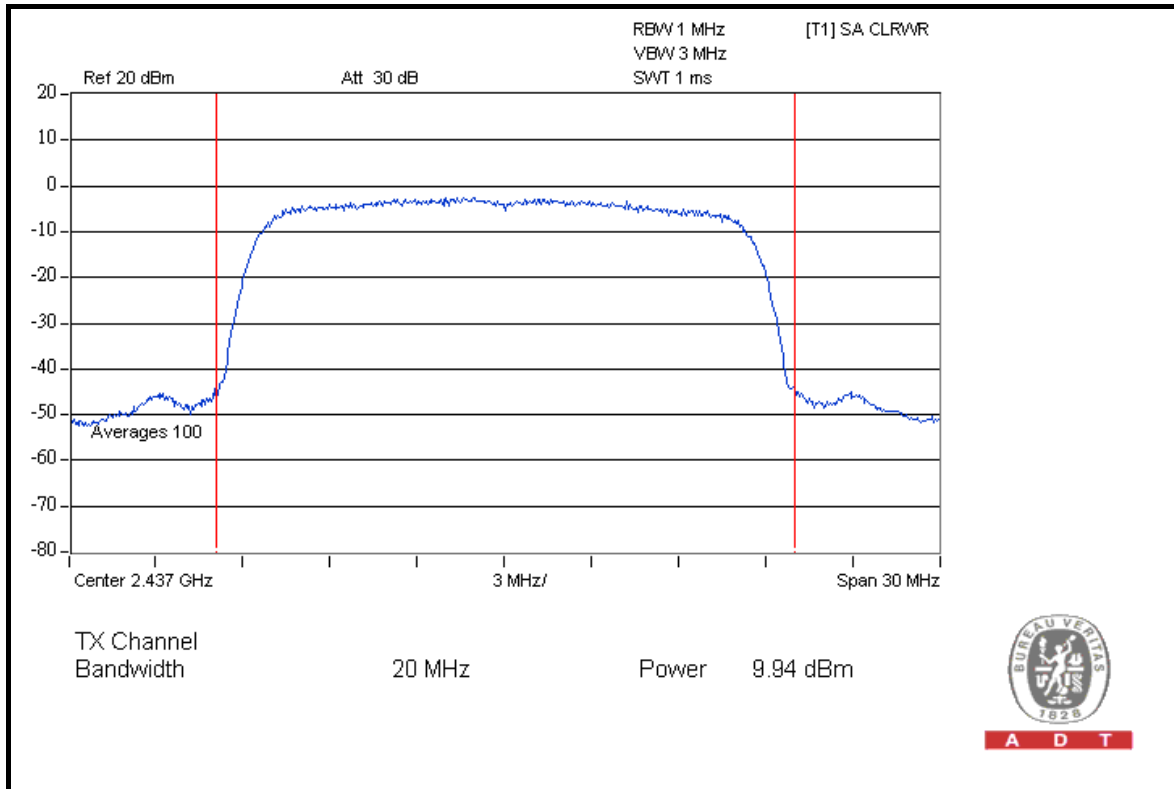

### CH 11

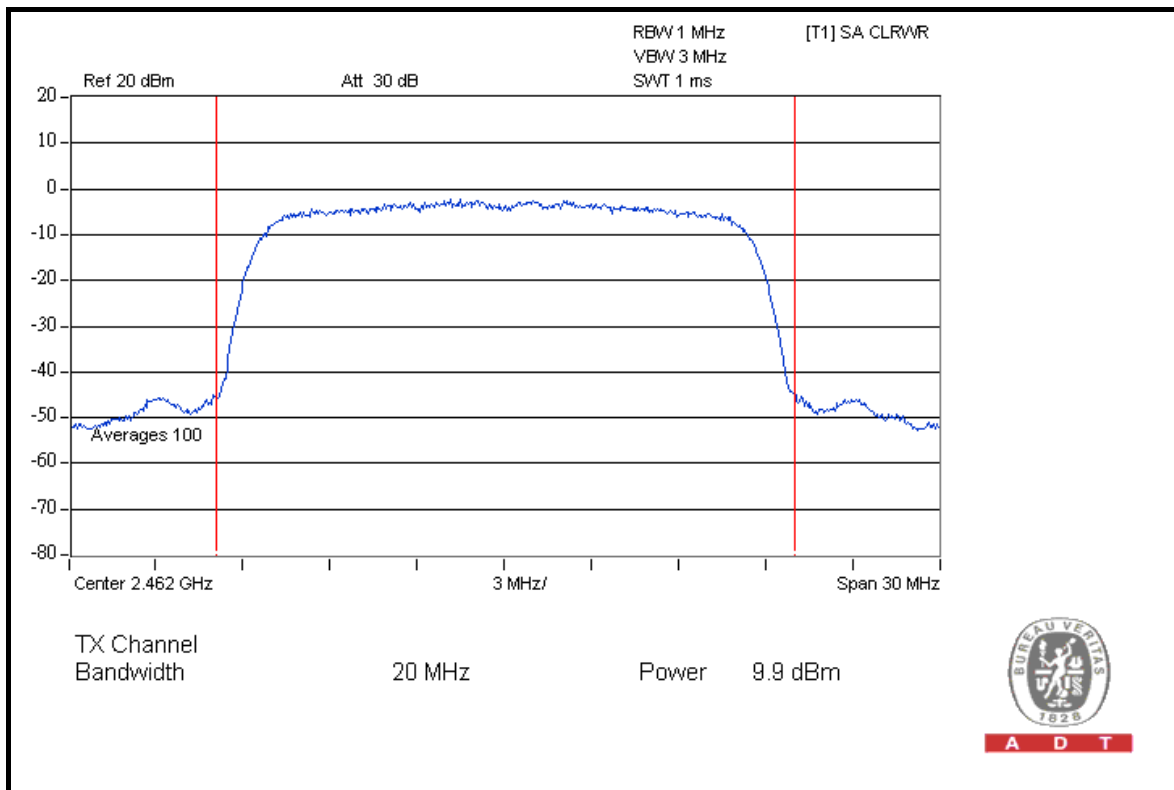



A D T

**DRAFT 802.11n (20MHz) OFDM MODULATION**

<b>MODULATION TYPE</b>	BPSK	<b>TRANSFER RATE</b>	7.2Mbps
<b>INPUT POWER</b>	120Vac, 60Hz	<b>ENVIRONMENTAL CONDITIONS</b>	24deg.C, 64%RH, 1021hPa
<b>TESTED BY</b>	Sun Lin		

CHAN.	CHAN. FREQ. (MHz)	PEAK POWER OUTPUT (dBm)		TOTAL PEAK POWER (mW)	TOTAL PEAK POWER (dBm)	PEAK POWER LIMIT (dBm)	PASS / FAIL
		CHAIN 0	CHAIN 1				
1	2412	9.96	9.97	19.84	12.98	30	PASS
6	2437	9.99	9.94	19.84	12.98	30	PASS
11	2462	9.68	9.85	18.95	12.78	30	PASS



A D T

### FOR CHAIN 0: CH 1

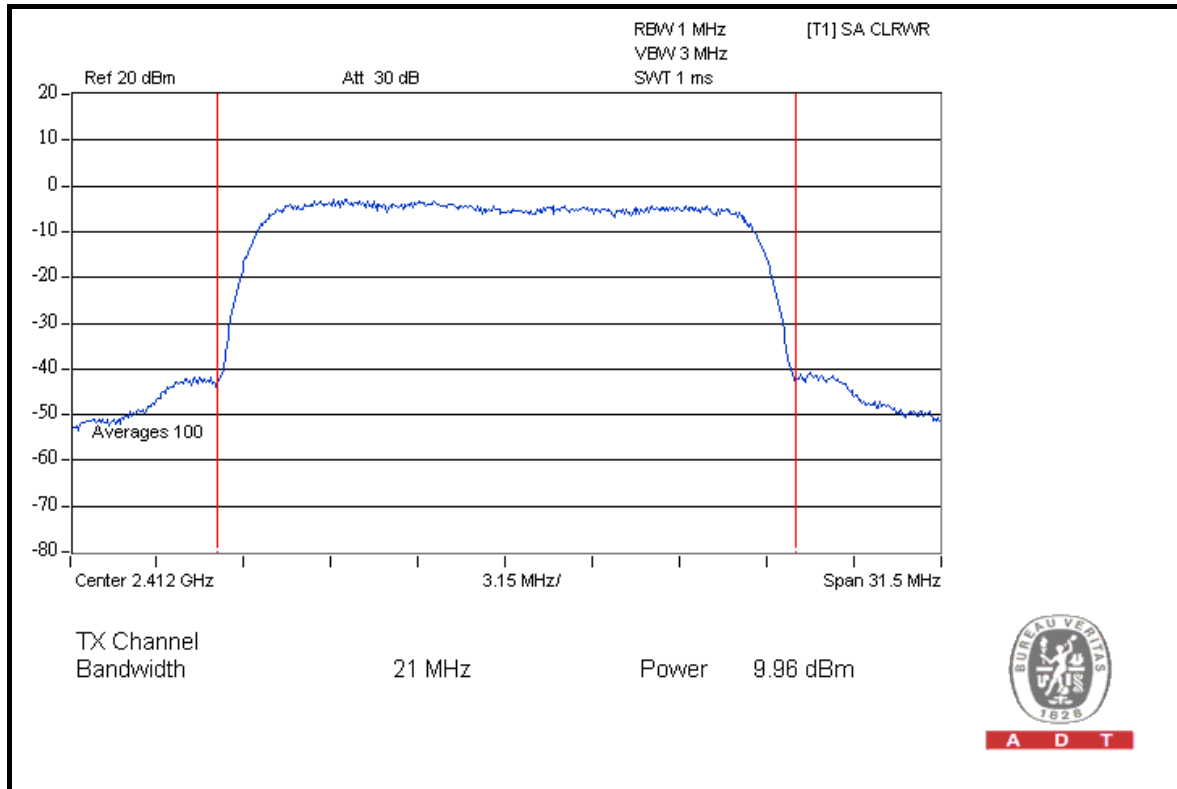

### CH 6

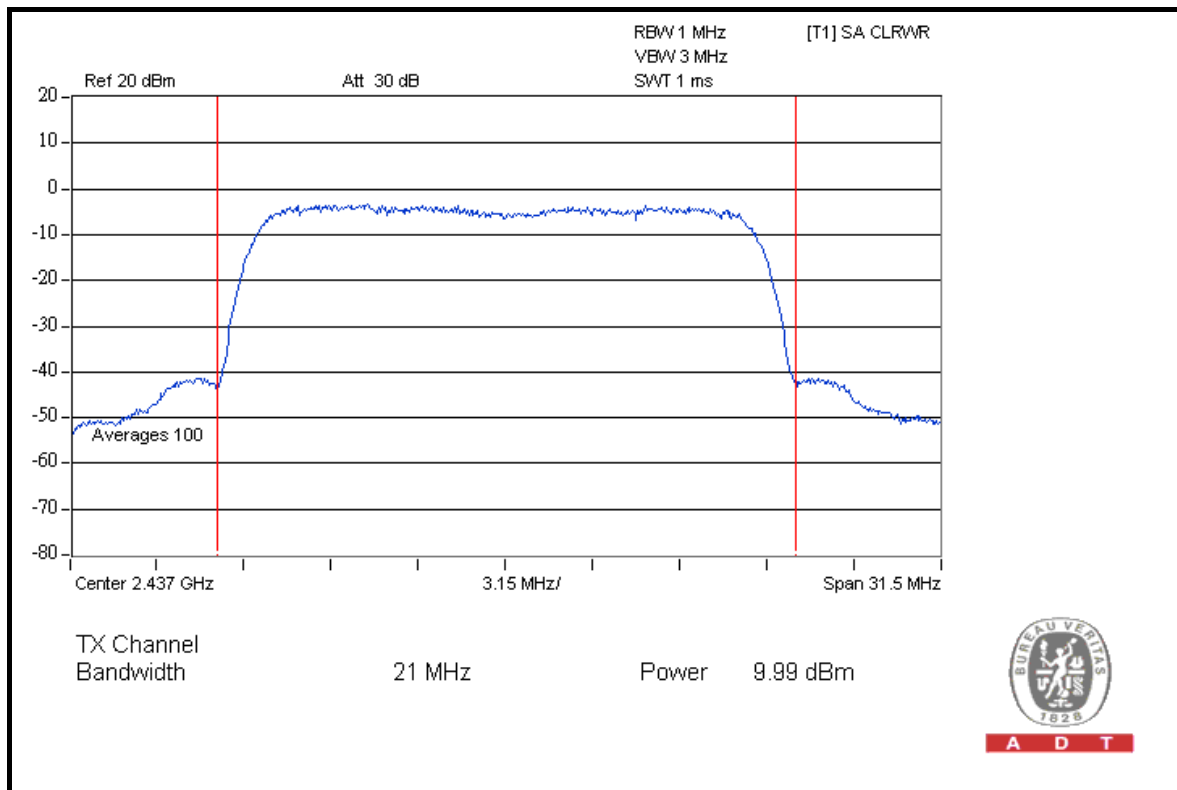



A D T

### CH 11

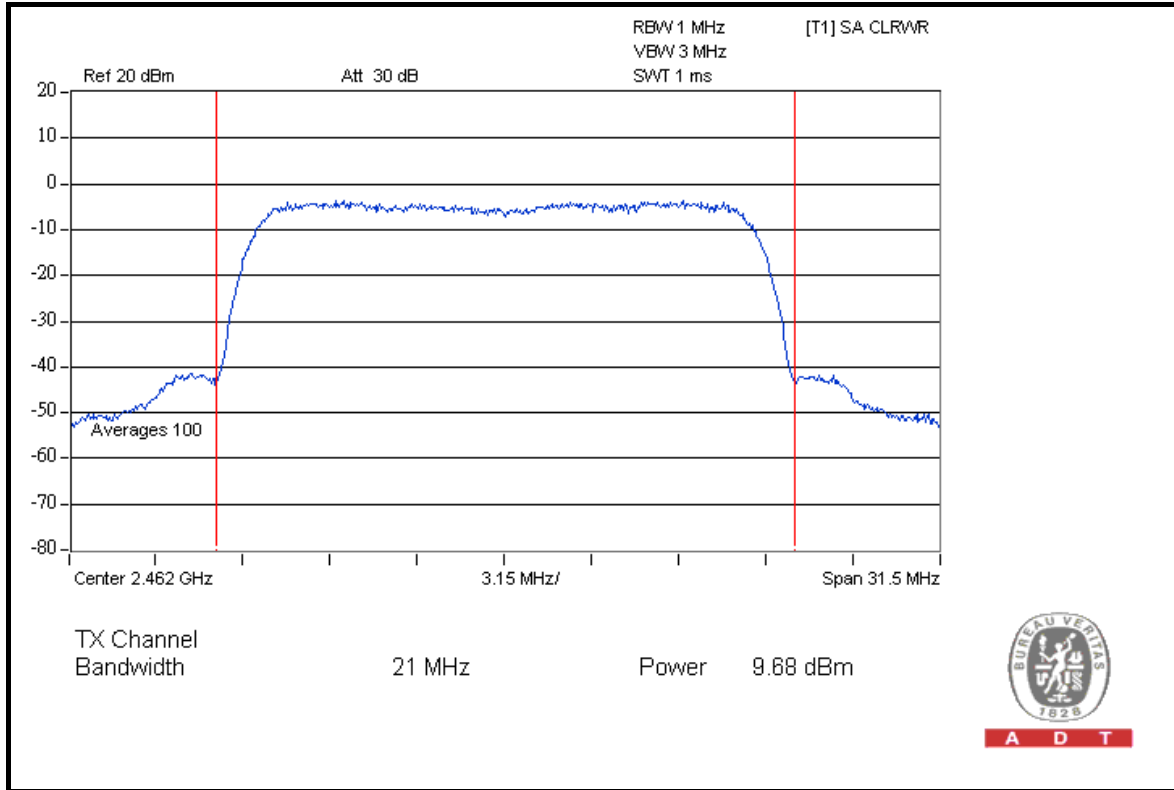

### FOR CHAIN 1: CH 1

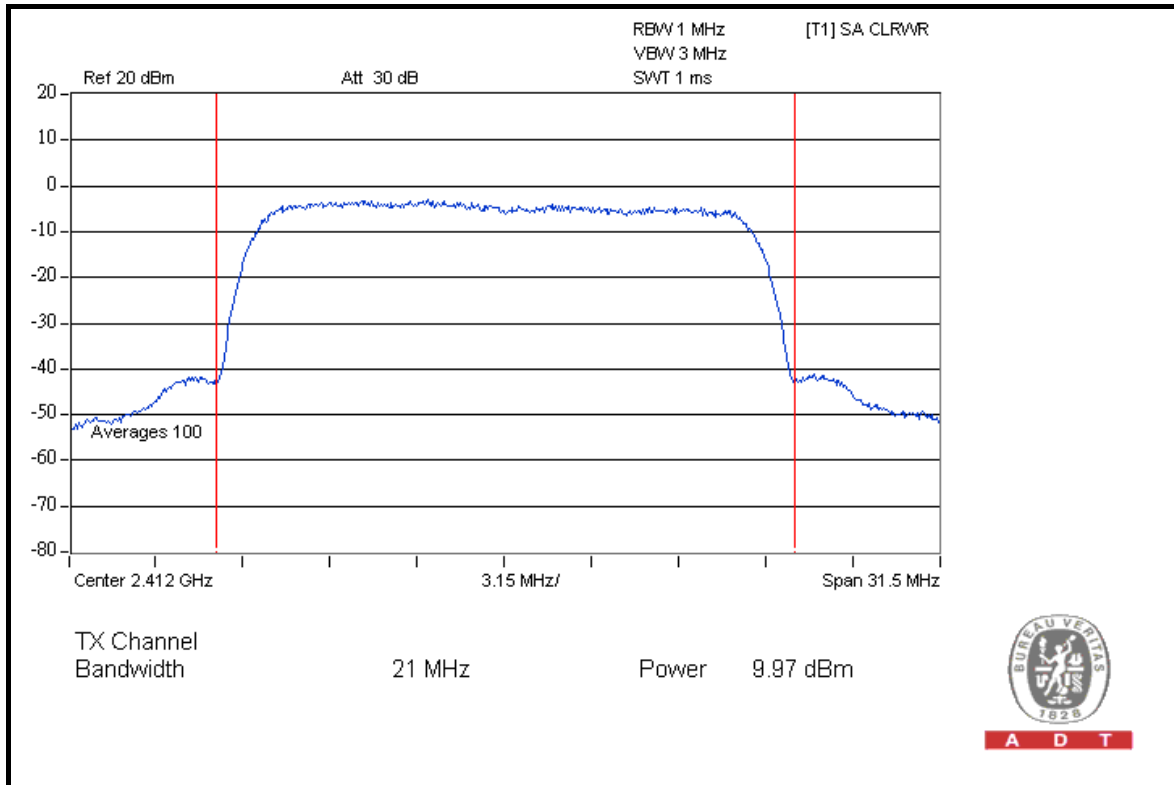



A D T

### CH 6

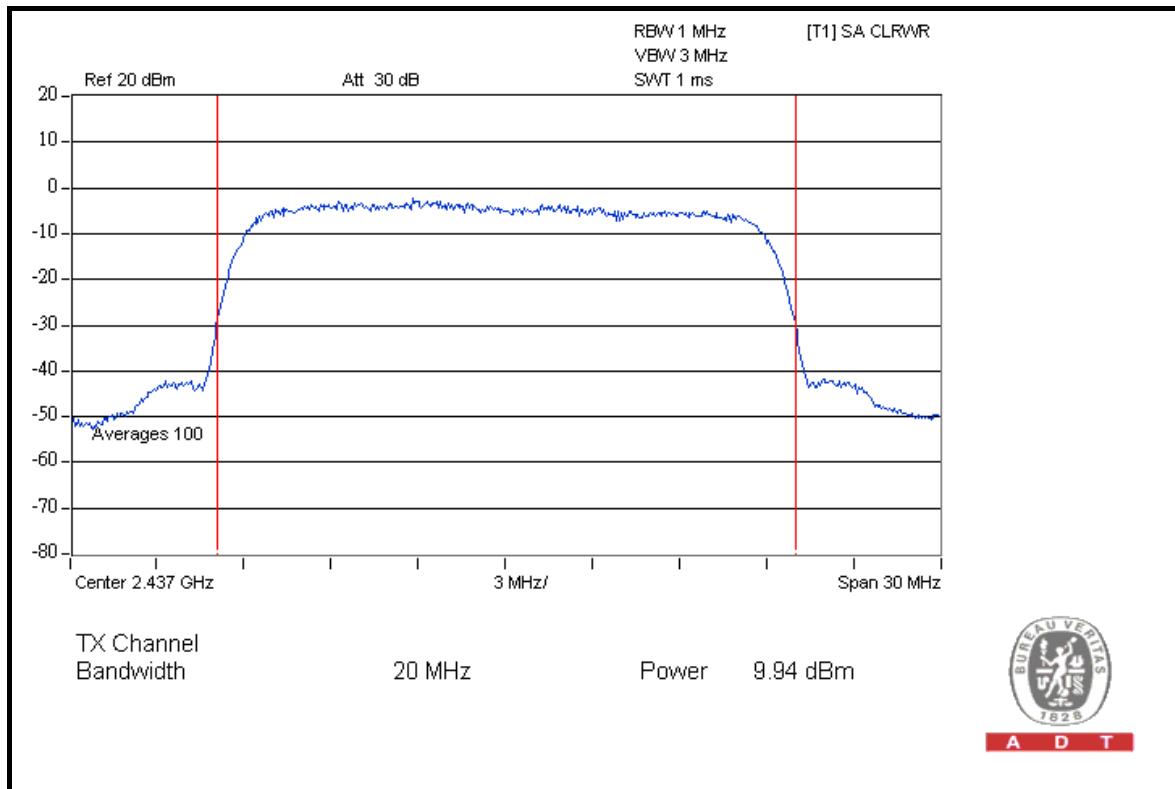

### CH 11

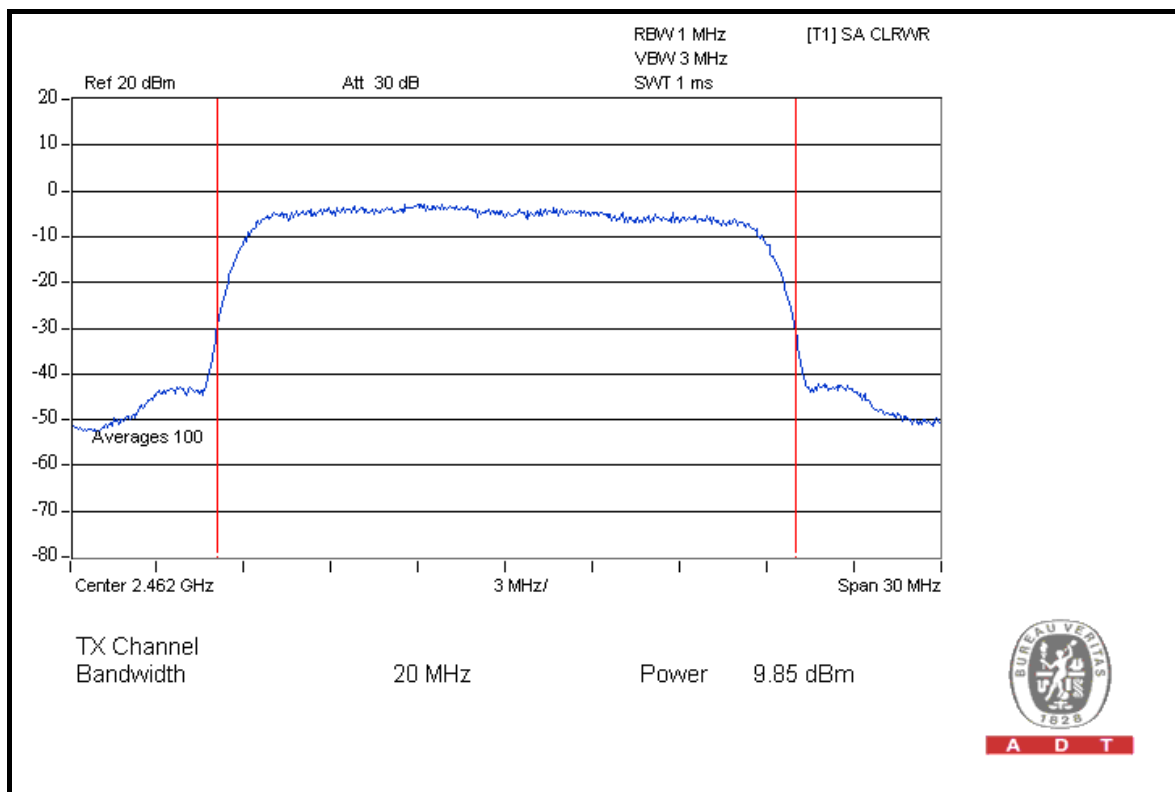



A D T

**DRAFT 802.11n (40MHz) OFDM MODULATION**

<b>MODULATION TYPE</b>	BPSK	<b>TRANSFER RATE</b>	15.0Mbps
<b>INPUT POWER</b>	120Vac, 60Hz	<b>ENVIRONMENTAL CONDITIONS</b>	24deg.C, 64%RH, 1021hPa
<b>TESTED BY</b>	Sun Lin		

CHAN.	CHAN. FREQ. (MHz)	PEAK POWER OUTPUT (dBm)		TOTAL PEAK POWER (mW)	TOTAL PEAK POWER (dBm)	PEAK POWER LIMIT (dBm)	PASS / FAIL
		CHAIN 0	CHAIN 1				
1	2422	9.58	9.92	18.90	12.76	30	PASS
4	2437	9.89	9.93	19.59	12.92	30	PASS
7	2452	9.64	9.88	18.93	12.77	30	PASS



A D T

### FOR CHAIN 0: CH 1

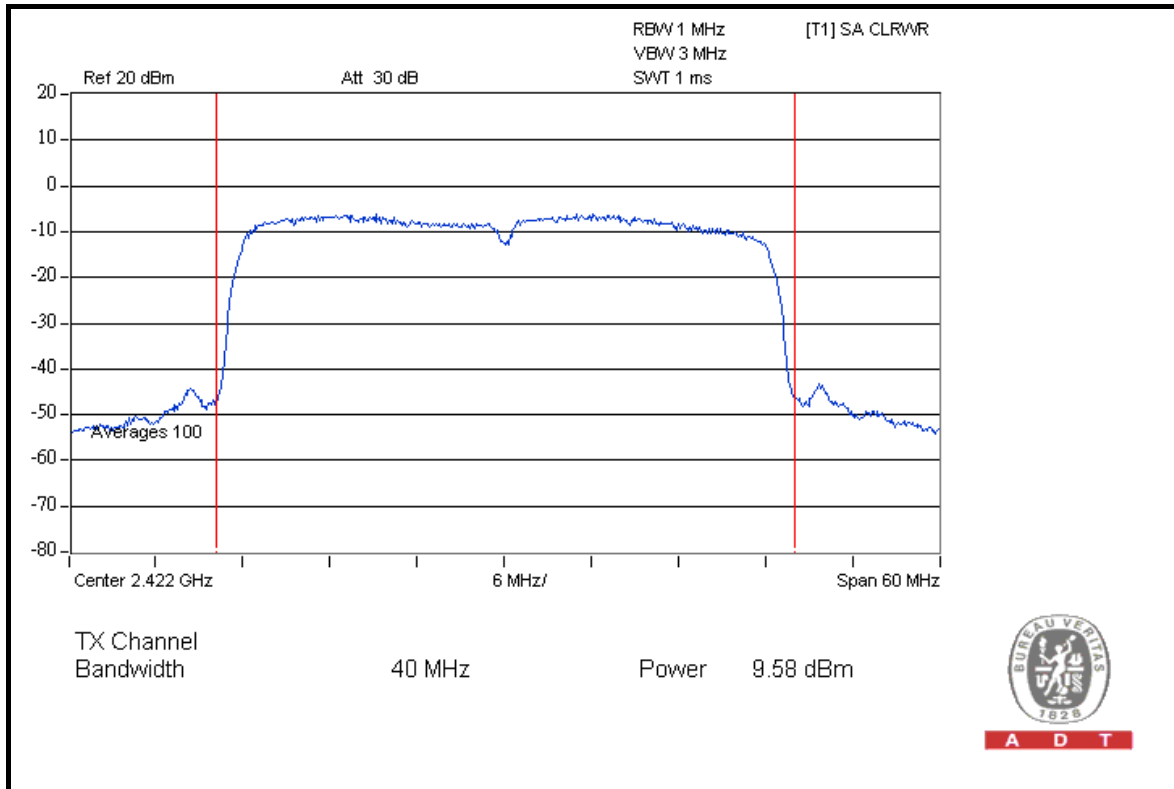

### CH 4

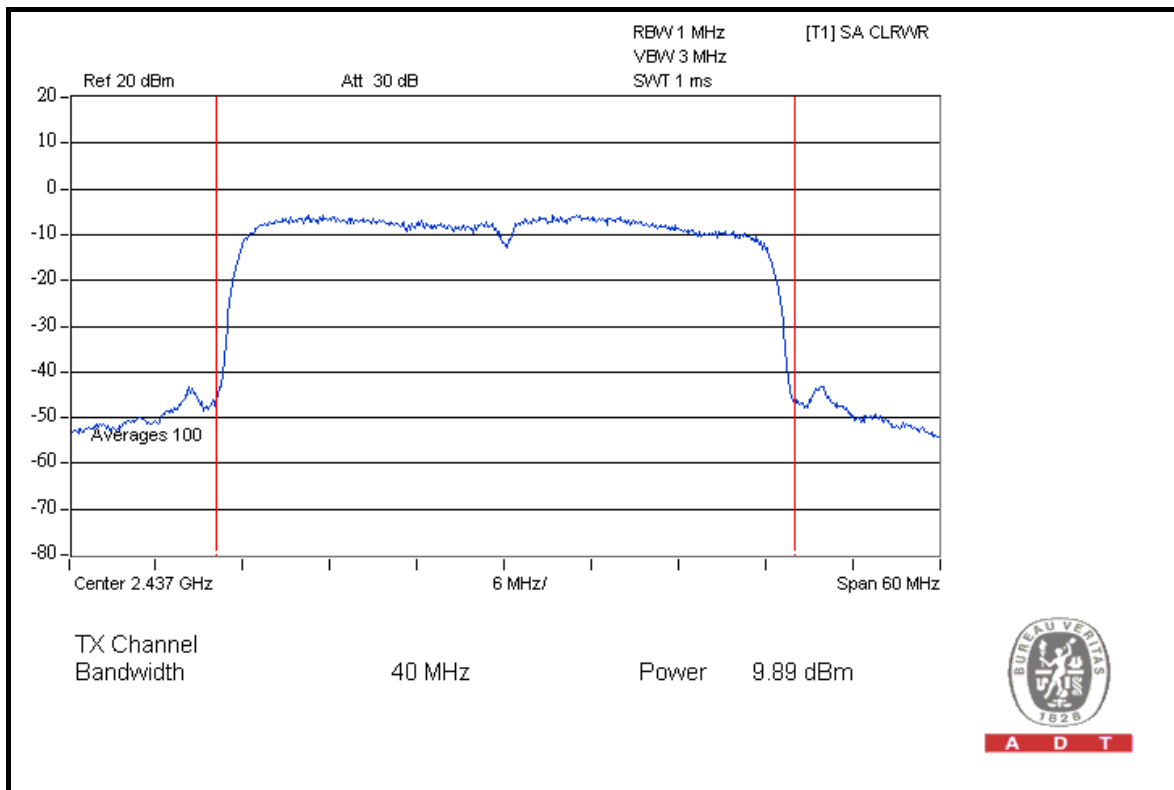



A D T

### CH 7

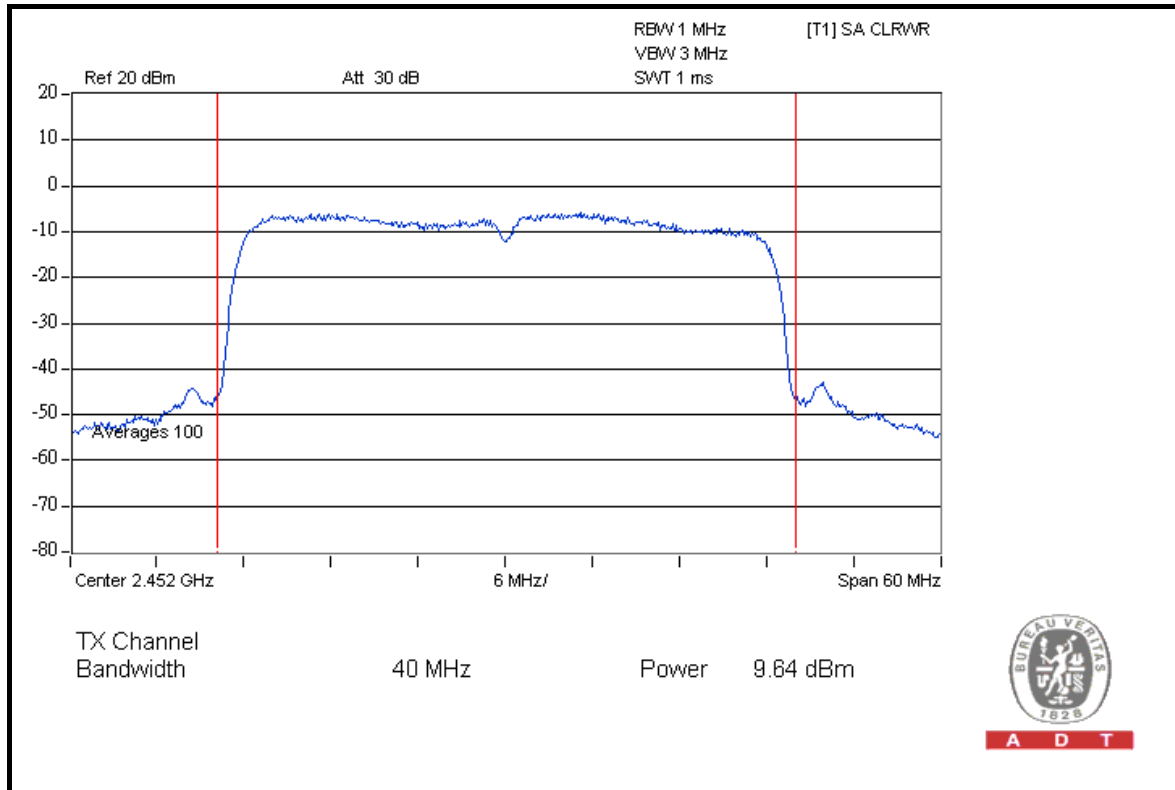

### FOR CHAIN 1: CH 1

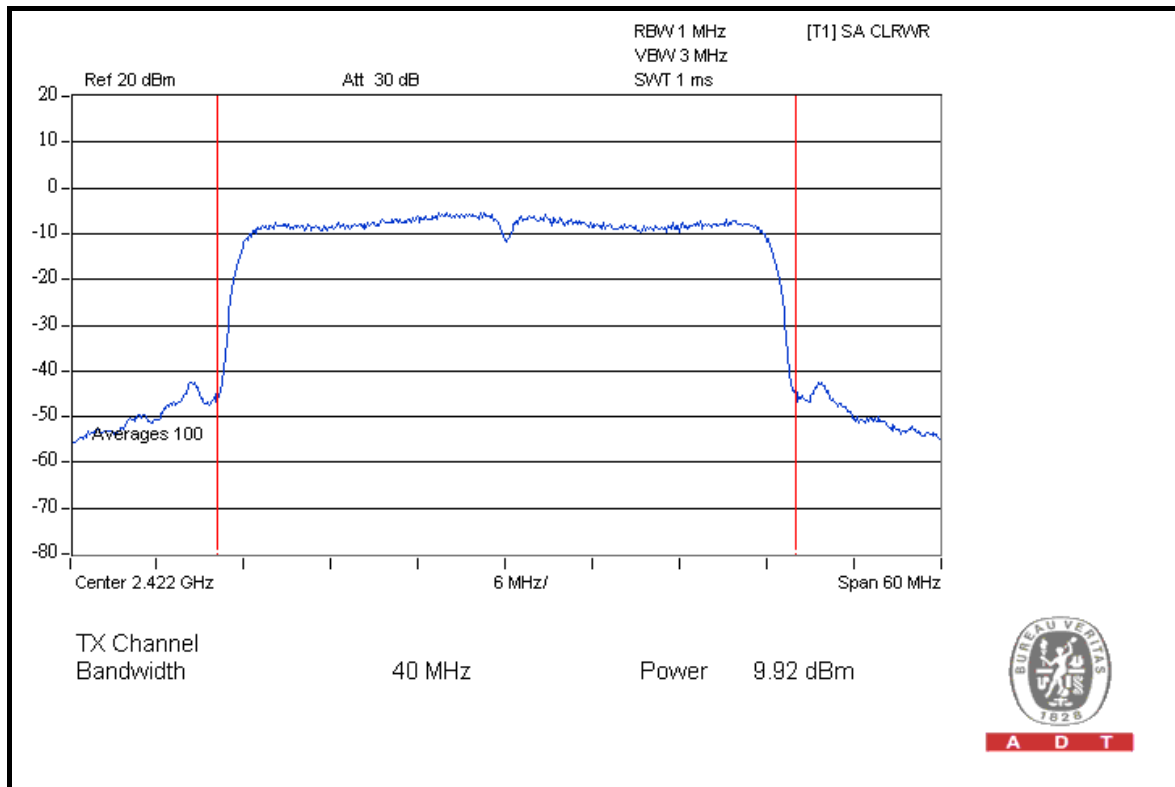





A D T

### CH 4

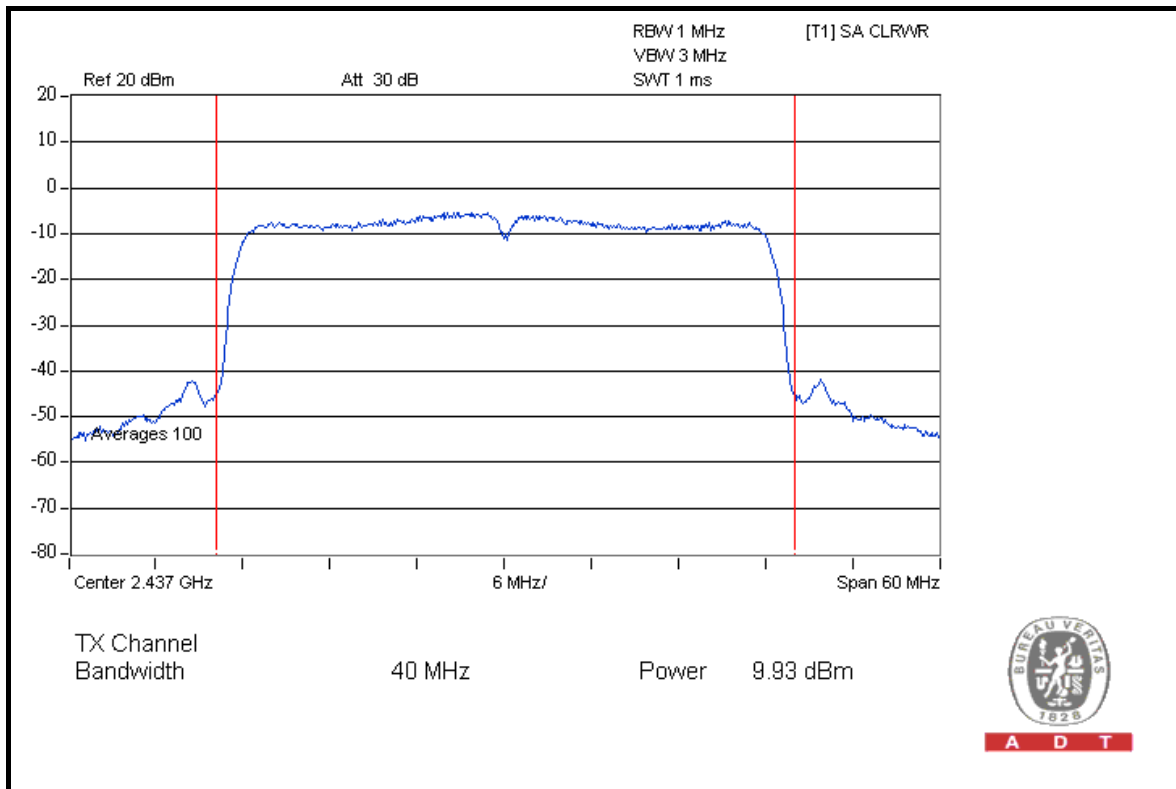

### CH 7

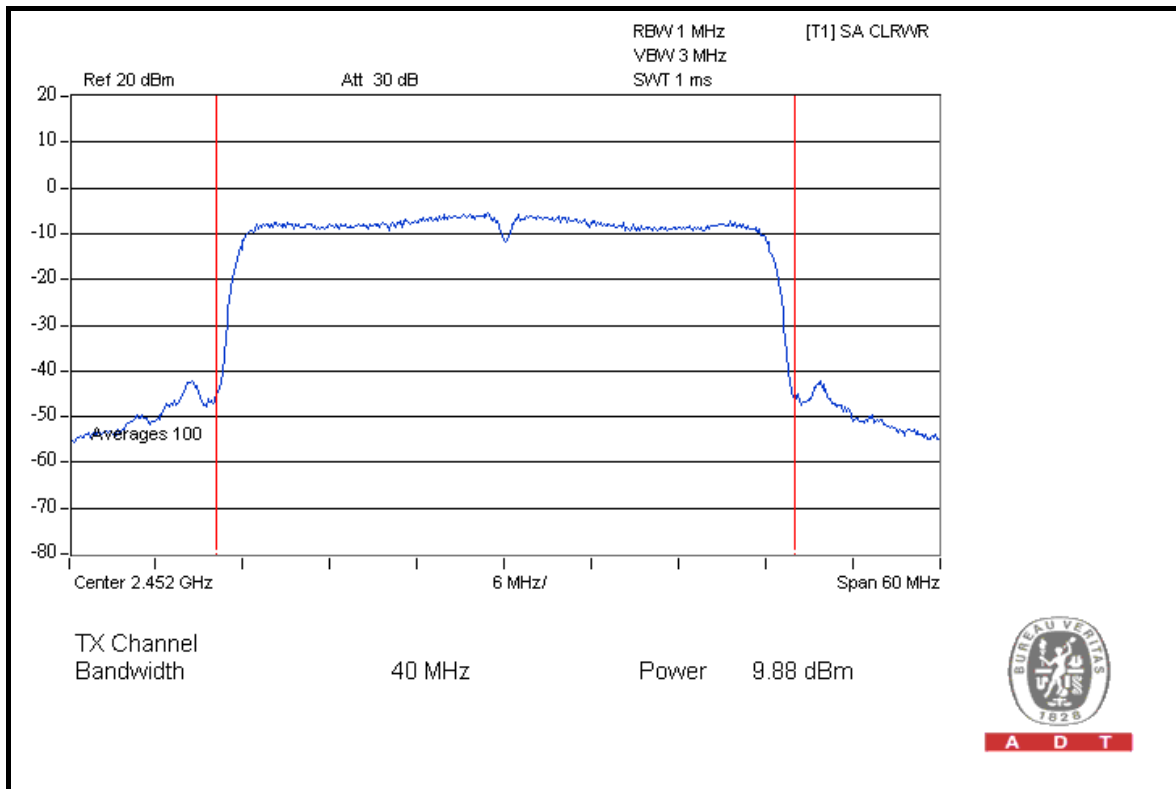



A D T

### 26dB OCCUPIED BANDWIDTH: 802.11b DSSS MODULATION

<b>MODULATION TYPE</b>	DSSS	<b>TRANSFER RATE</b>	1.0Mbps
<b>INPUT POWER (SYSTEM)</b>	120Vac, 60Hz	<b>ENVIRONMENTAL CONDITIONS</b>	24deg.C, 64%RH, 991hPa
<b>TESTED BY</b>	Sun Lin		

CHANNEL	CHANNEL FREQUENCY (MHz)	26dBc OCCUPIED BANDWIDTH (MHz)		PASS / FAIL
		CHAIN 0	CHAIN 1	
1	2412	17.50	17.34	PASS
6	2437	17.51	17.30	PASS
11	2462	17.50	17.28	PASS



A D T

### FOR CHAIN 0: CH 1

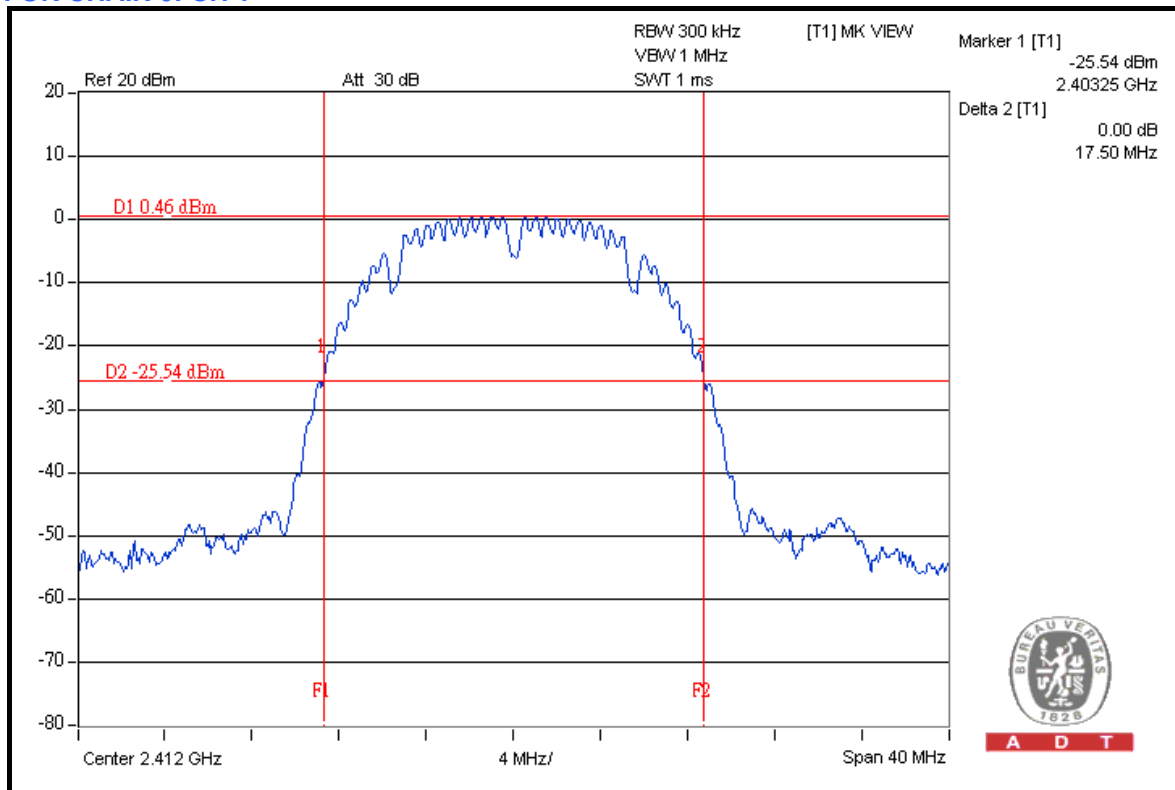

### CH 6

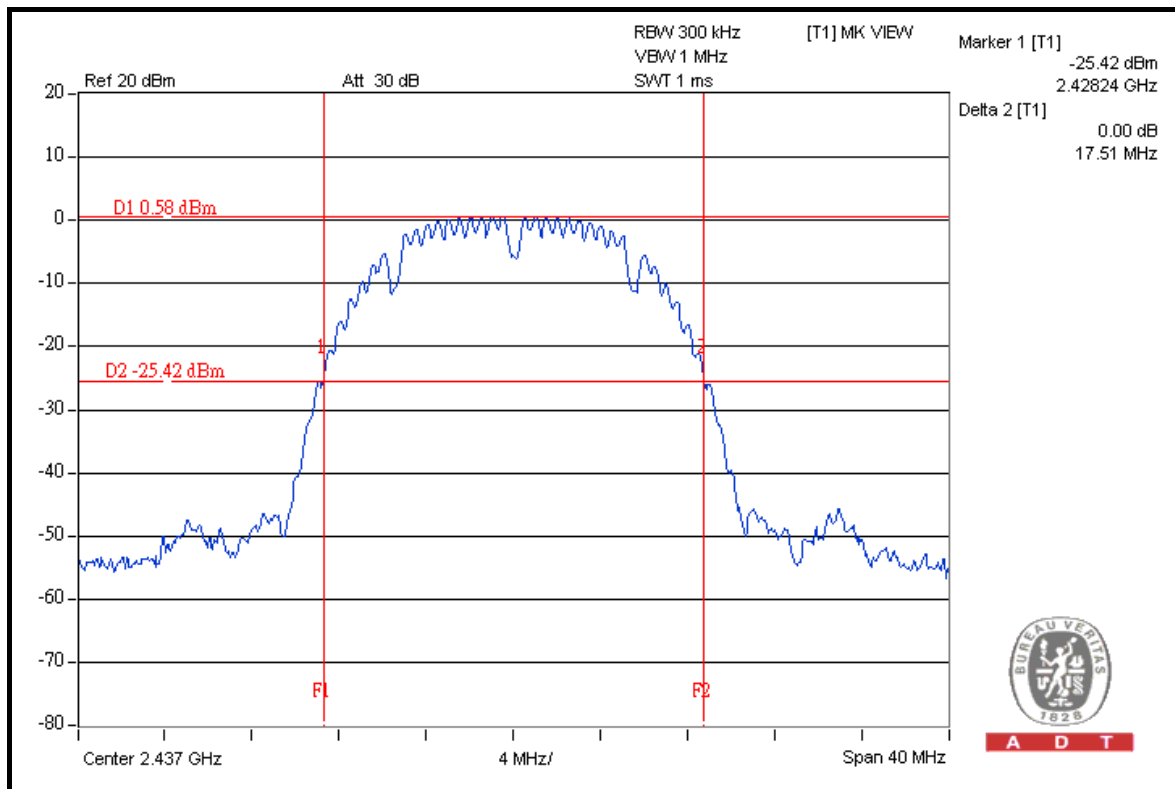



A D T

### CH 11

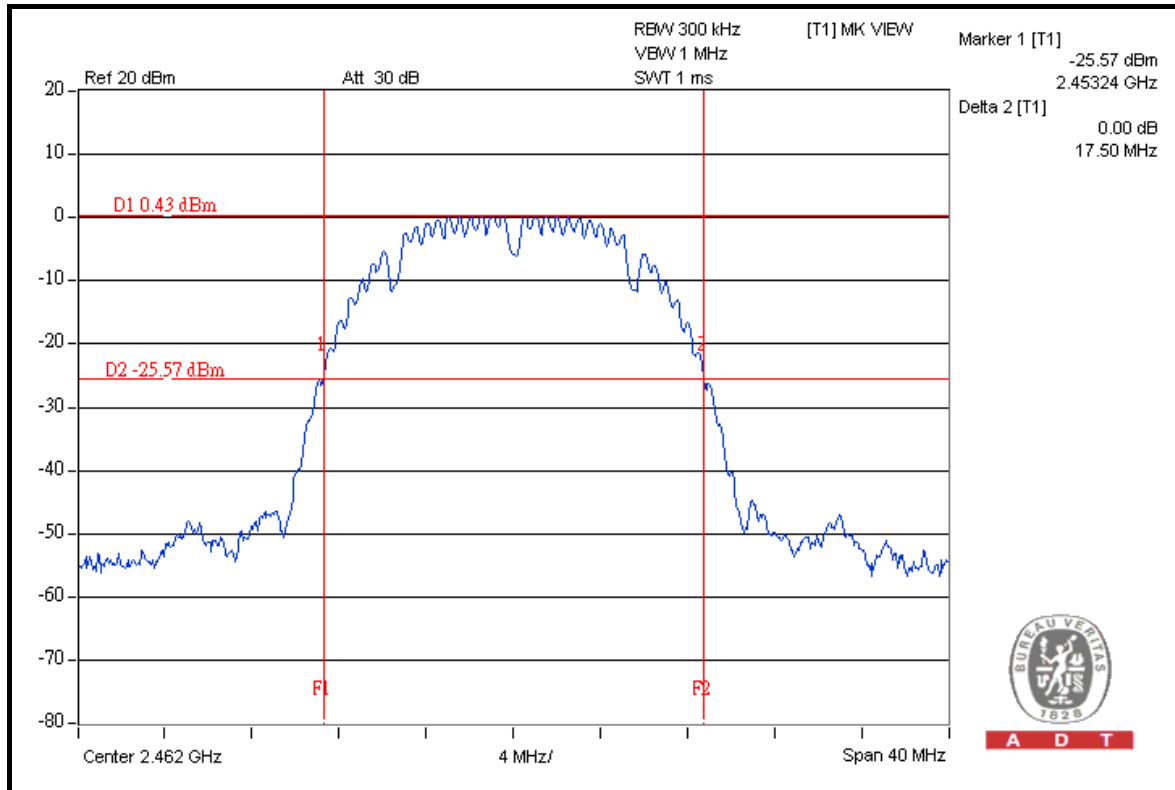

### FOR CHAIN 1: CH 1

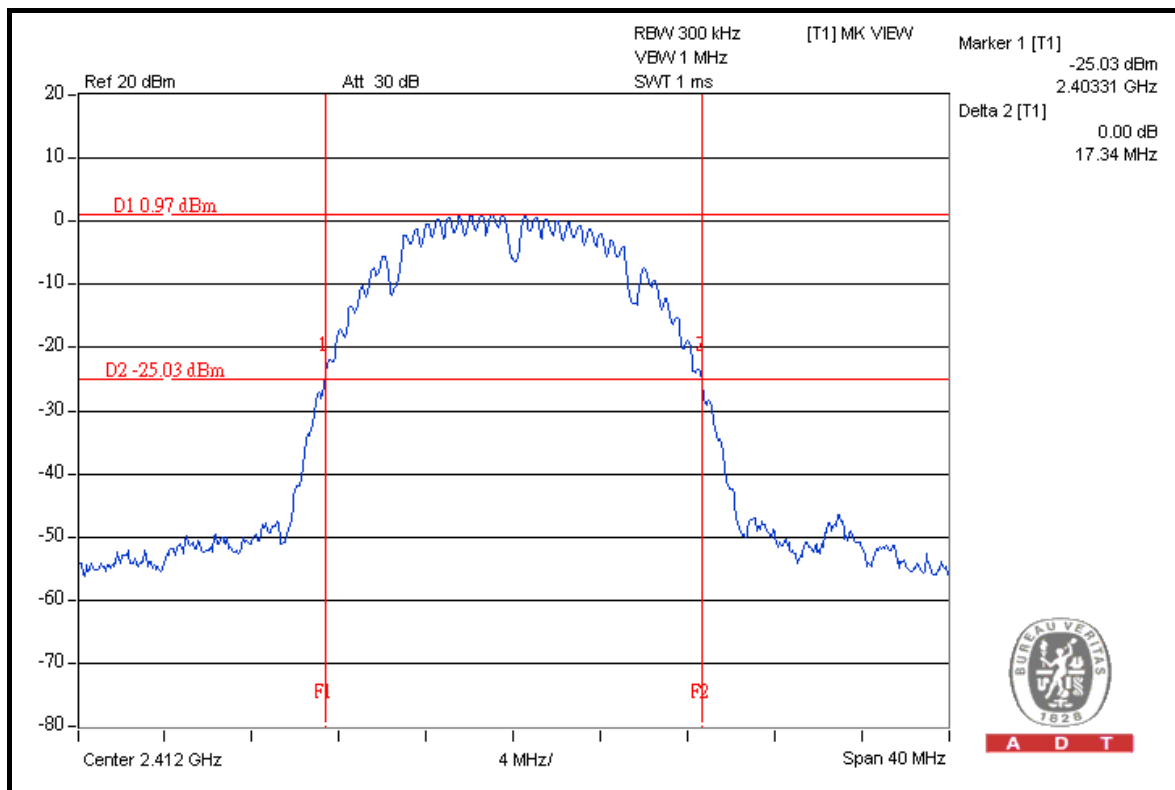



A D T

### CH 6

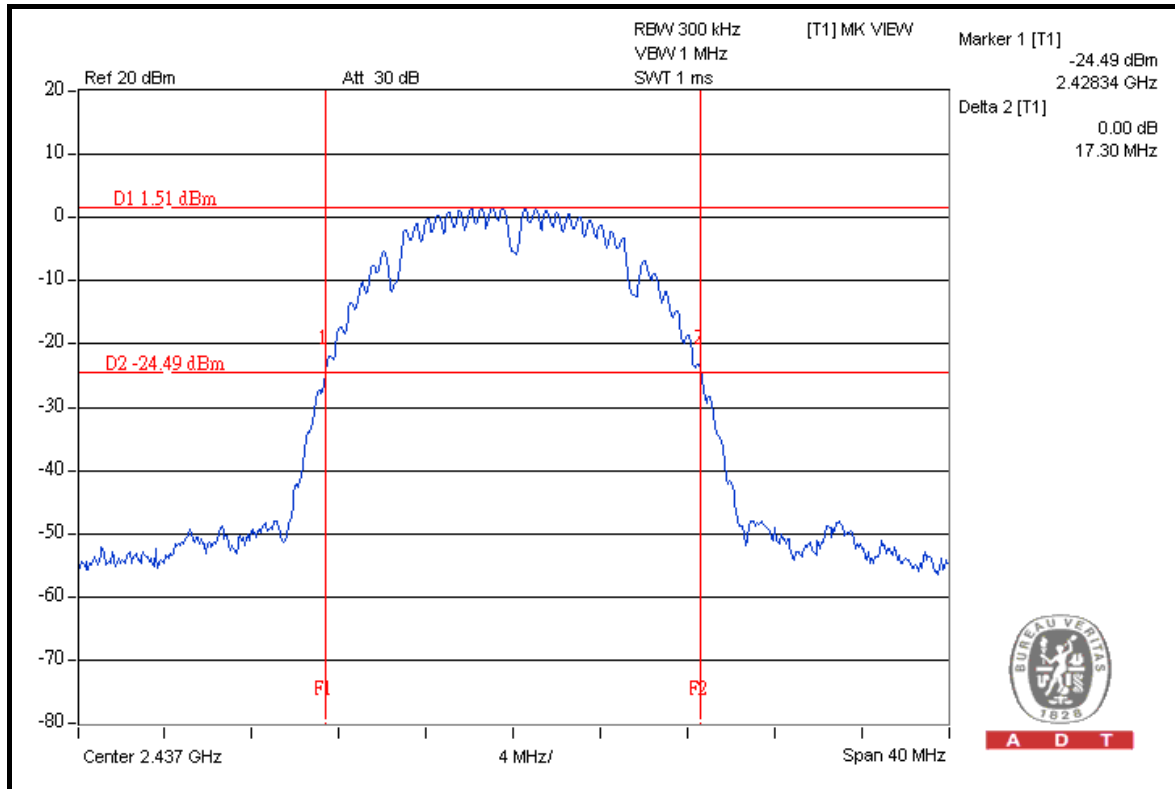

A D T

### CH 11

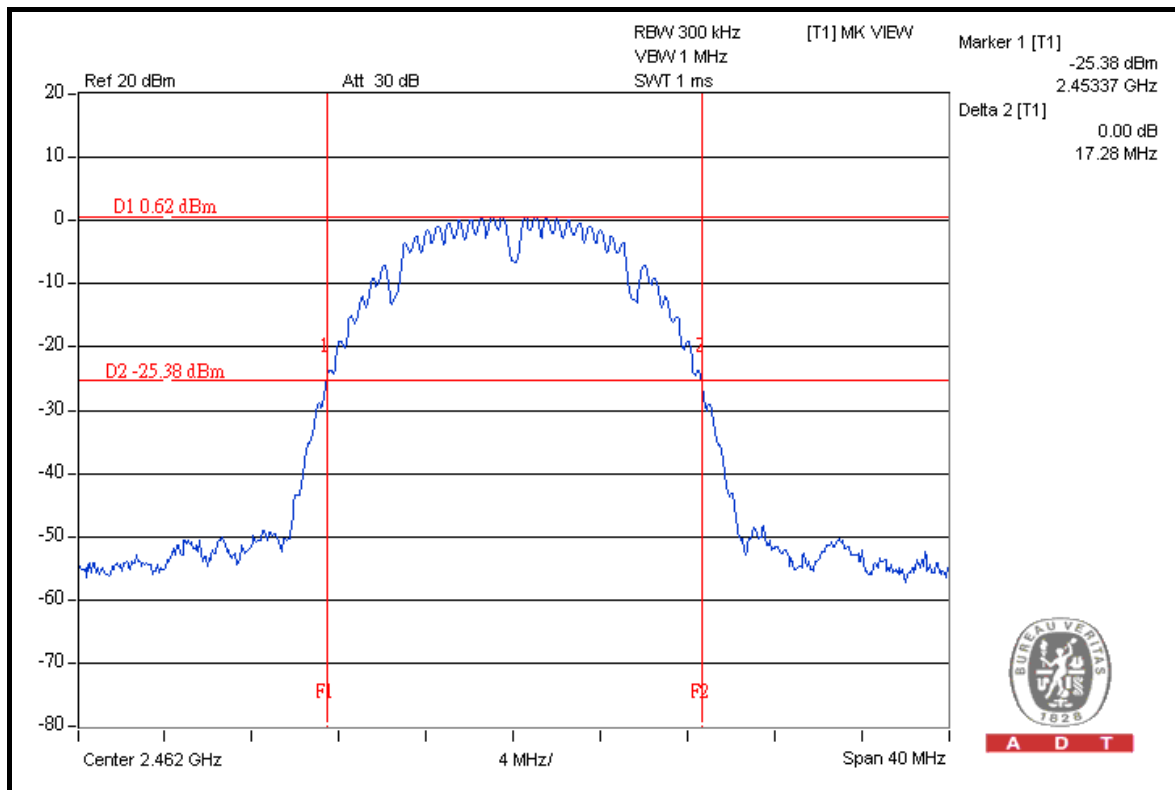

A D T



A D T

### 802.11g OFDM MODULATION

<b>MODULATION TYPE</b>	OFDM	<b>TRANSFER RATE</b>	6.0Mbps
<b>INPUT POWER (SYSTEM)</b>	120Vac, 60Hz	<b>ENVIRONMENTAL CONDITIONS</b>	24deg.C, 64%RH, 991hPa
<b>TESTED BY</b>	Sun Lin		

CHANNEL	CHANNEL FREQUENCY (MHz)	26dBc OCCUPIED BANDWIDTH (MHz)		PASS / FAIL
		CHAIN 0	CHAIN 1	
1	2412	19.73	19.36	PASS
6	2437	19.59	19.40	PASS
11	2462	19.41	19.34	PASS



A D T

### FOR CHAIN 0: CH 1

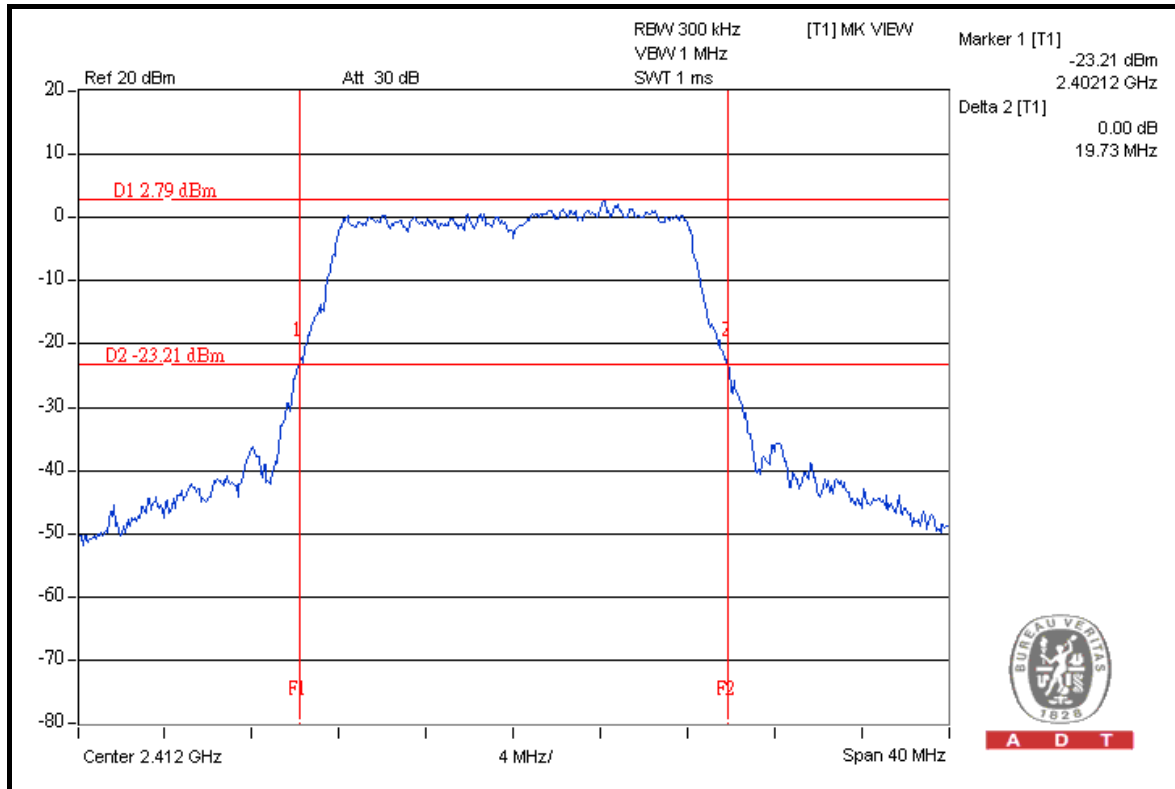

### CH 6

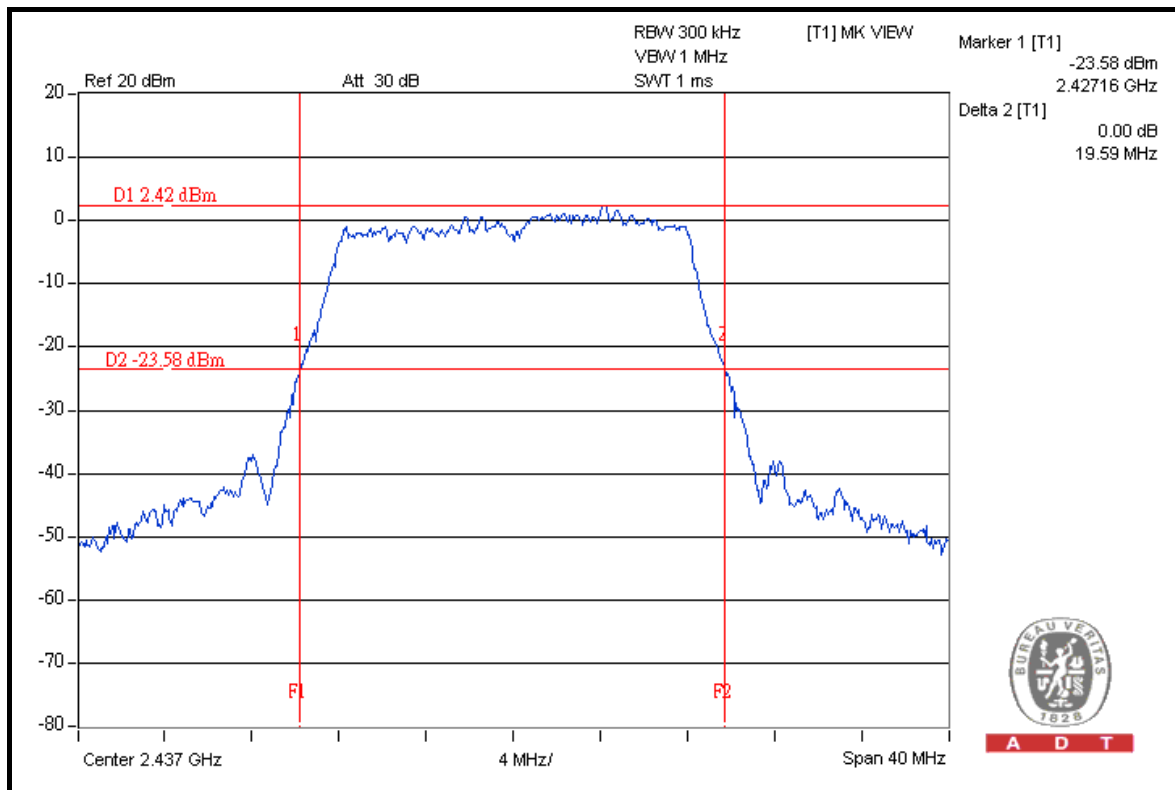



A D T

### CH 11

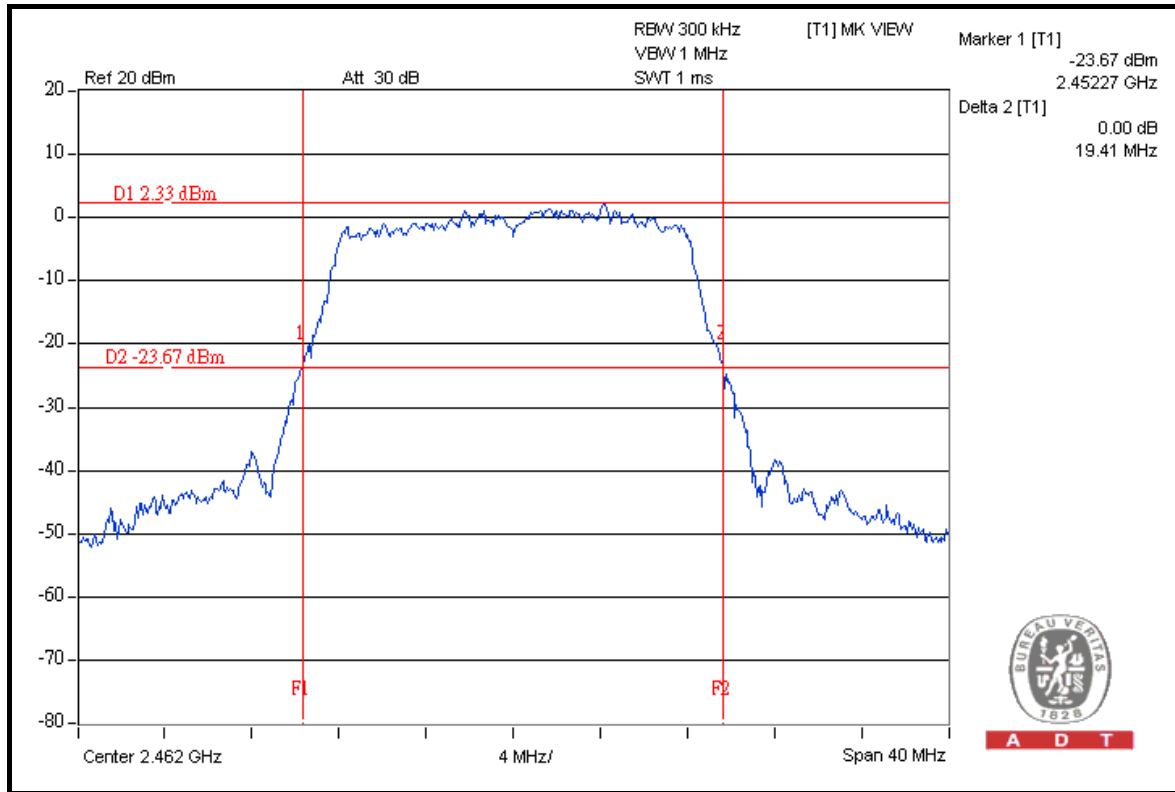

### FOR CHAIN 1: CH 1

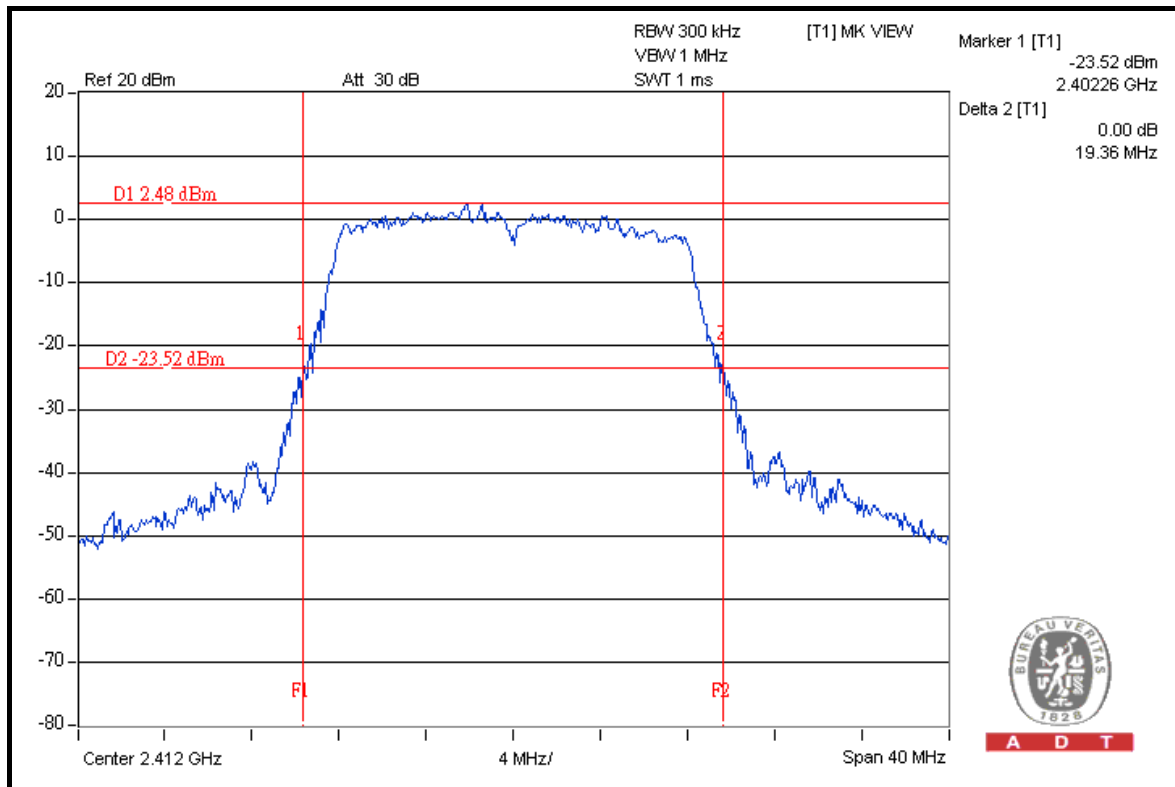





A D T

### CH 6

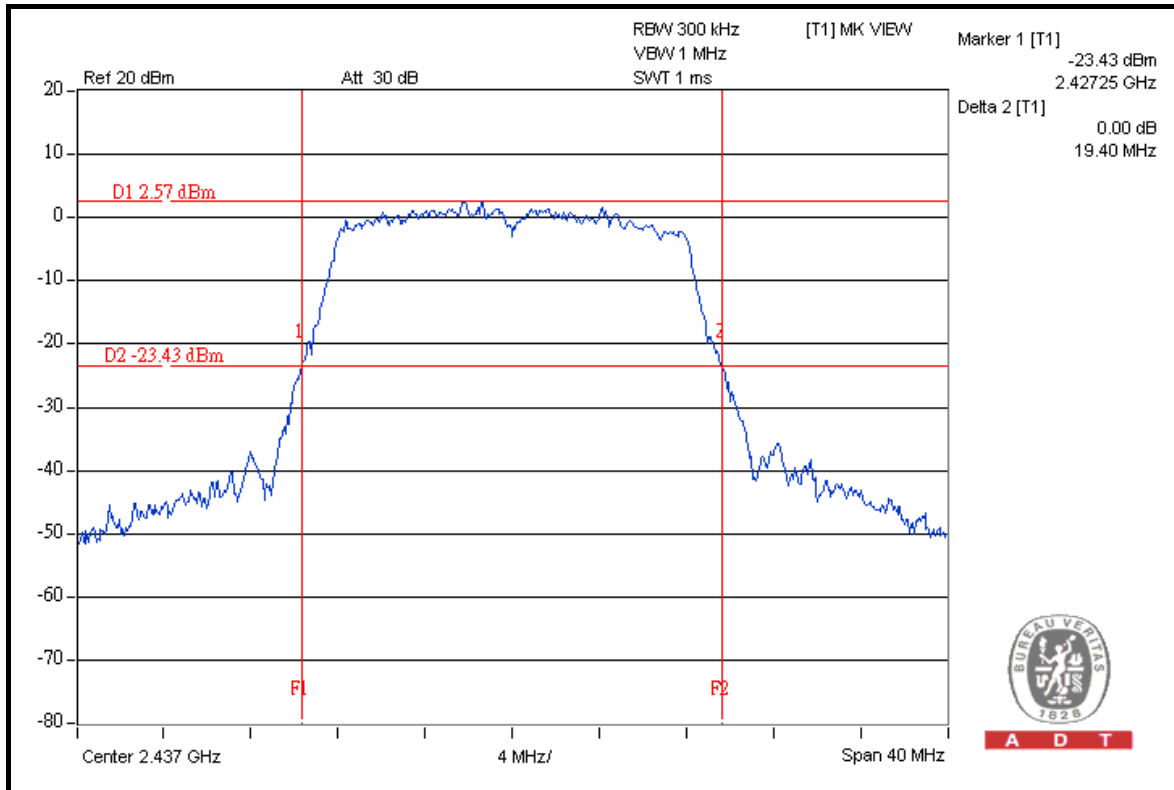

A D T

### CH 11

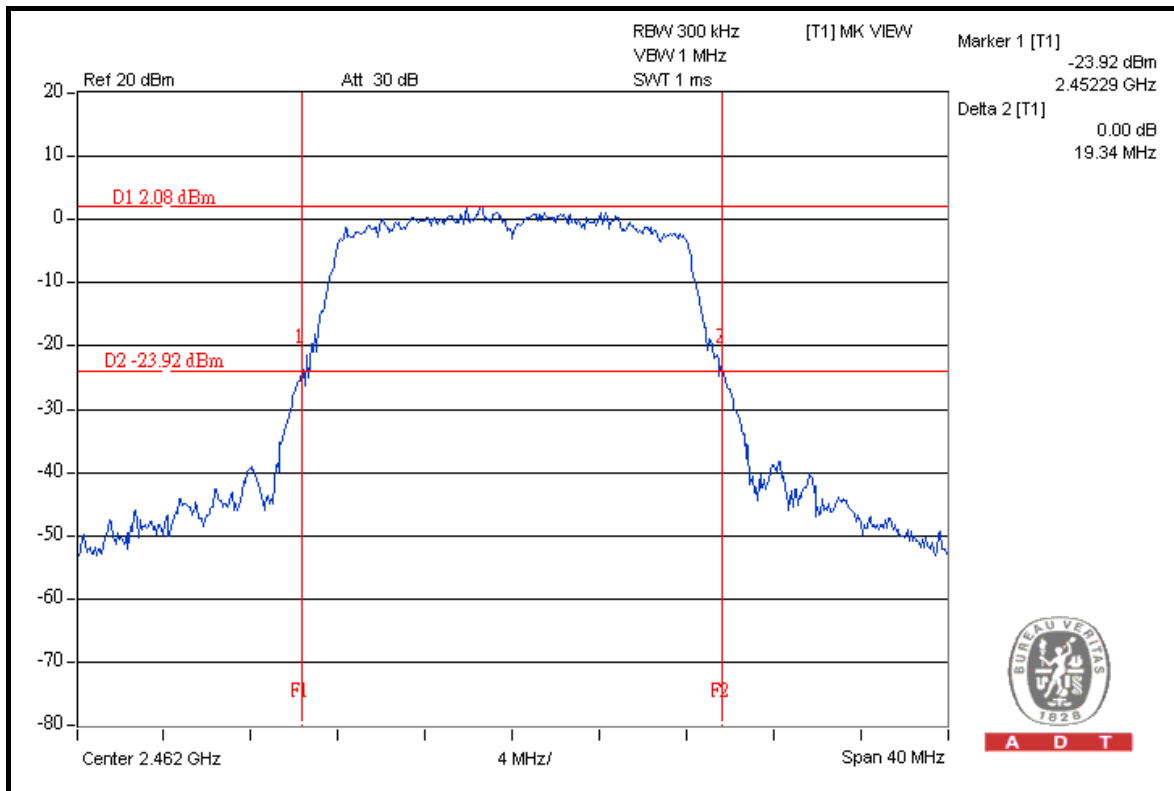

A D T



A D T

### DRAFT 802.11n (20MHz) OFDM MODULATION

<b>MODULATION TYPE</b>	OFDM	<b>TRANSFER RATE</b>	7.2Mbps
<b>INPUT POWER (SYSTEM)</b>	120Vac, 60Hz	<b>ENVIRONMENTAL CONDITIONS</b>	24deg.C, 64%RH, 991hPa
<b>TESTED BY</b>	Sun Lin		

CHANNEL	CHANNEL FREQUENCY (MHz)	26dBc OCCUPIED BANDWIDTH (MHz)		PASS / FAIL
		CHAIN 0	CHAIN 1	
1	2412	20.04	20.05	PASS
6	2437	20.18	19.87	PASS
11	2462	20.13	19.81	PASS



A D T

### FOR CHAIN 0: CH 1

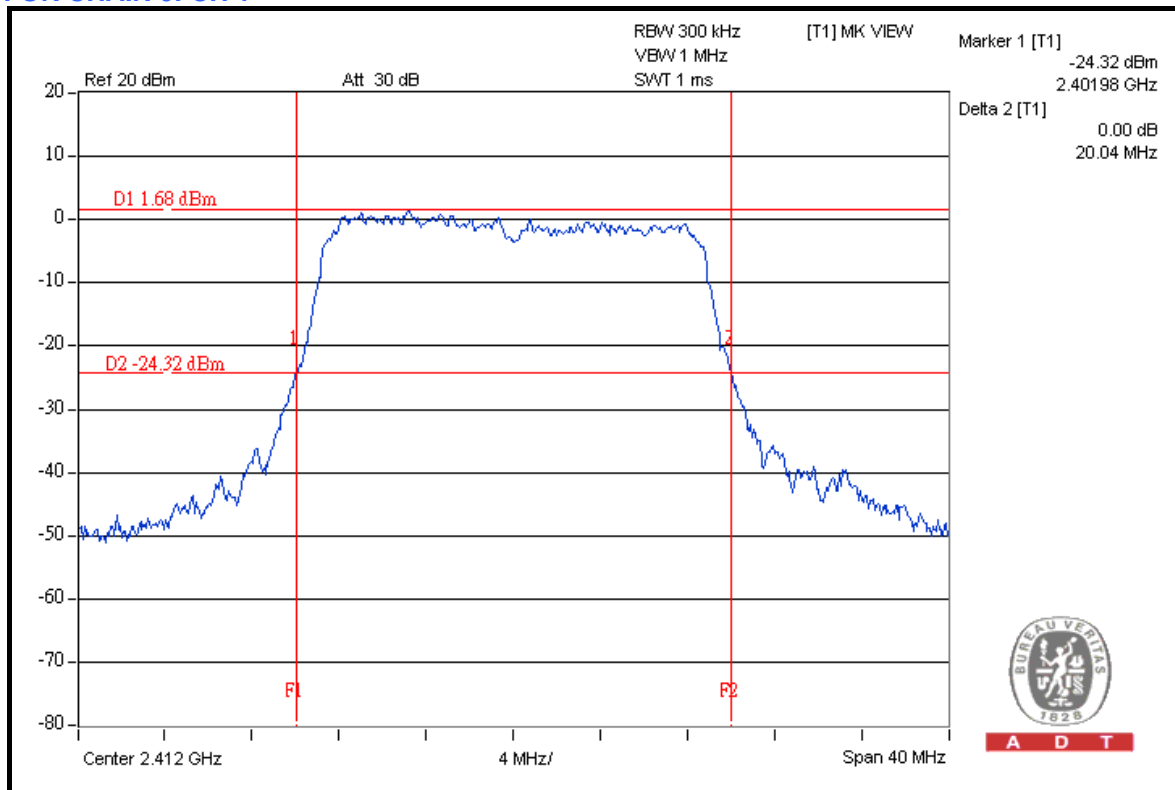

### CH 6

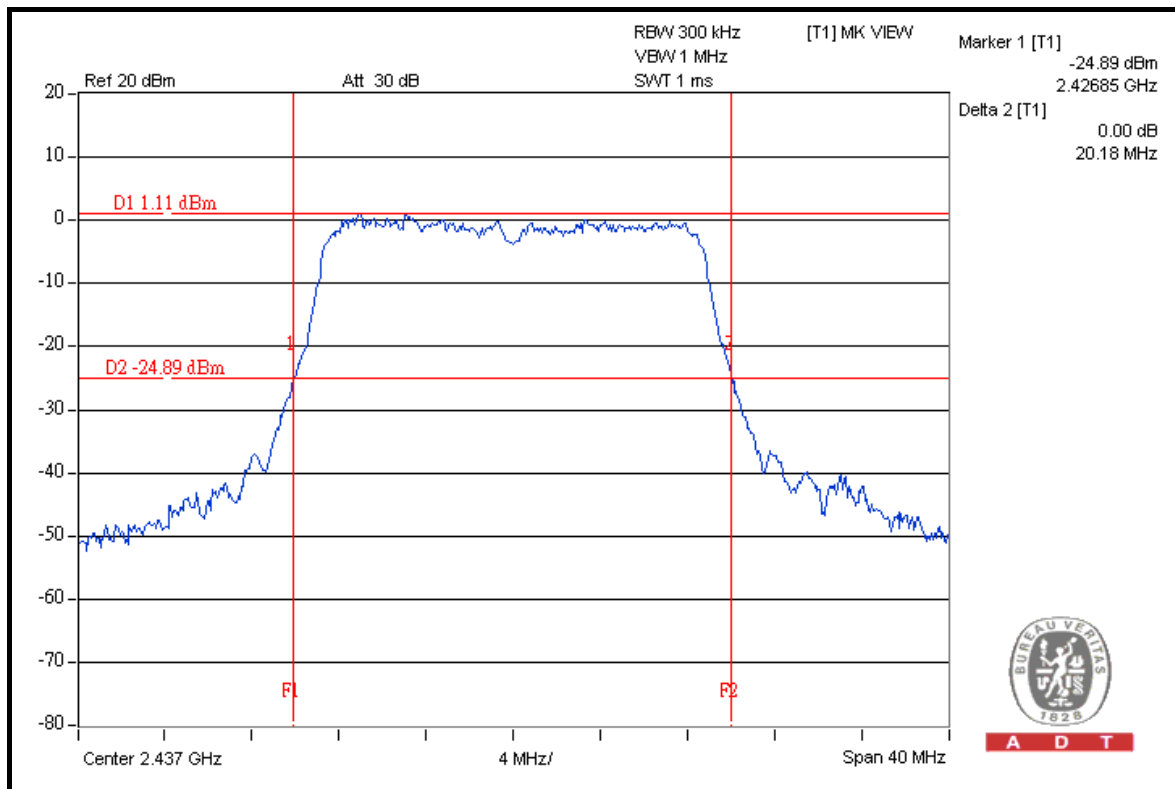



A D T

### CH 11

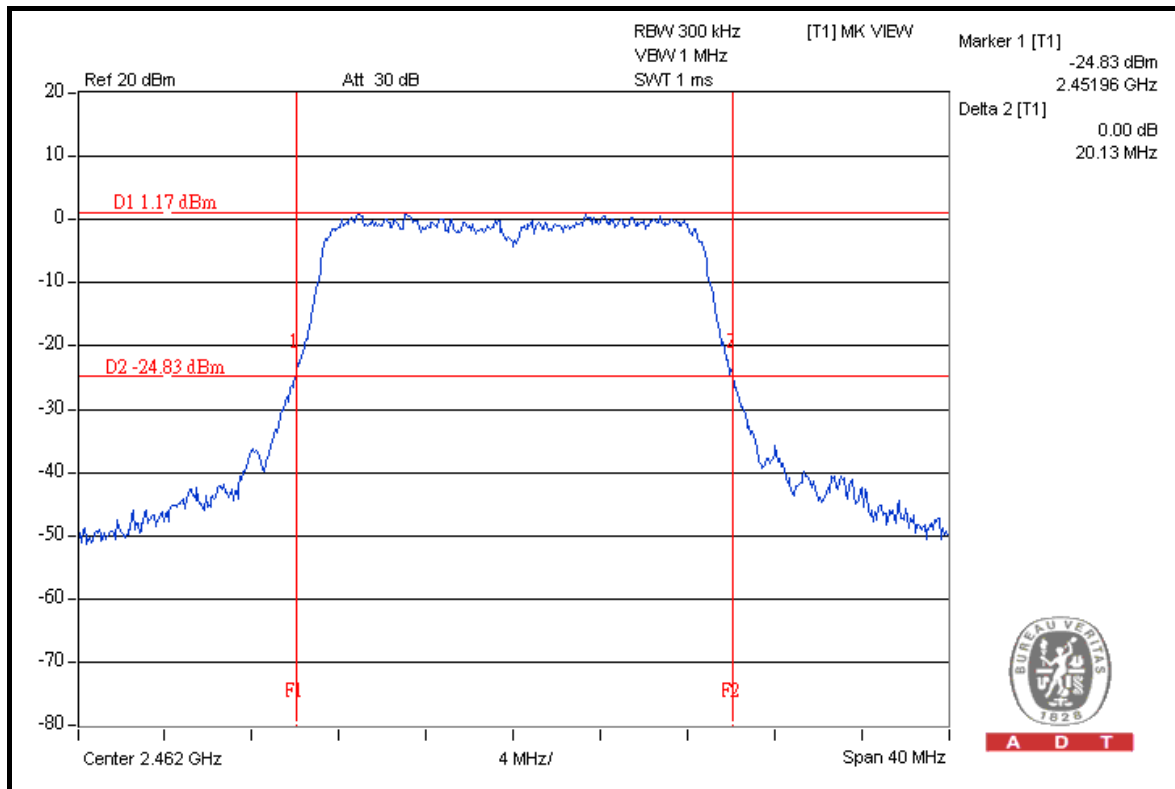

### FOR CHAIN 1: CH 1

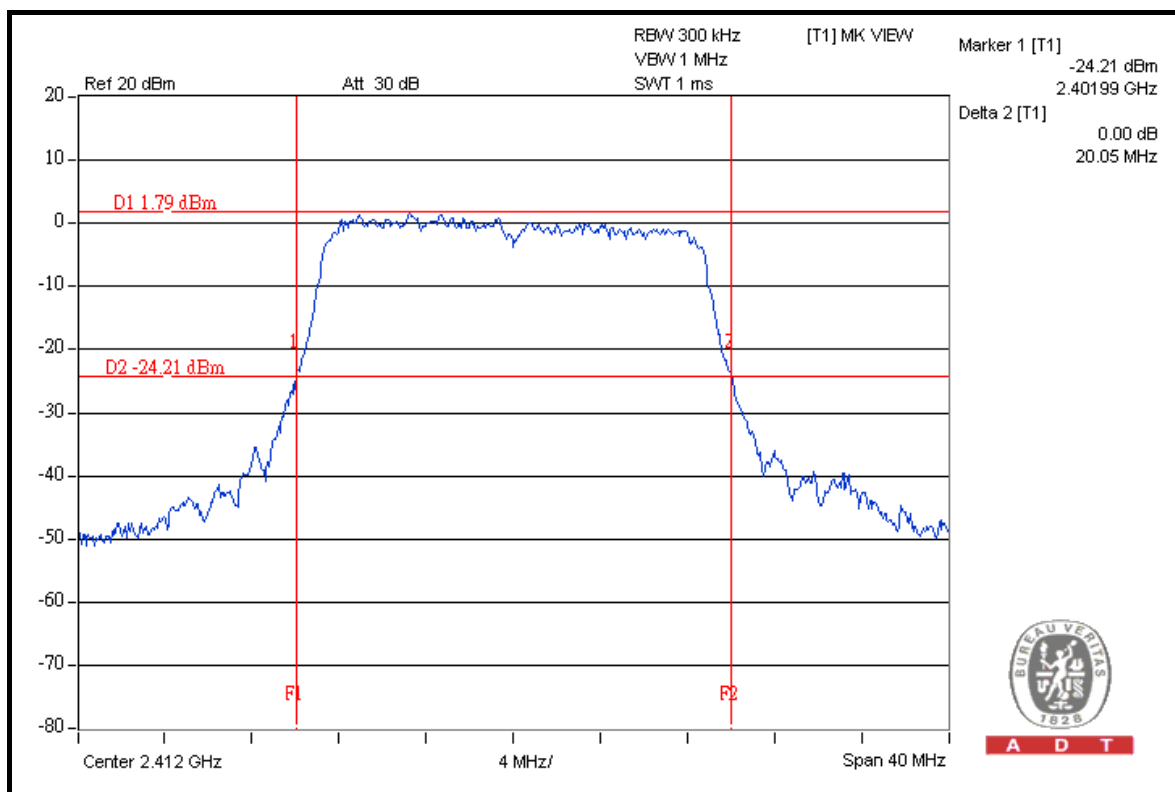



A D T

### CH 6

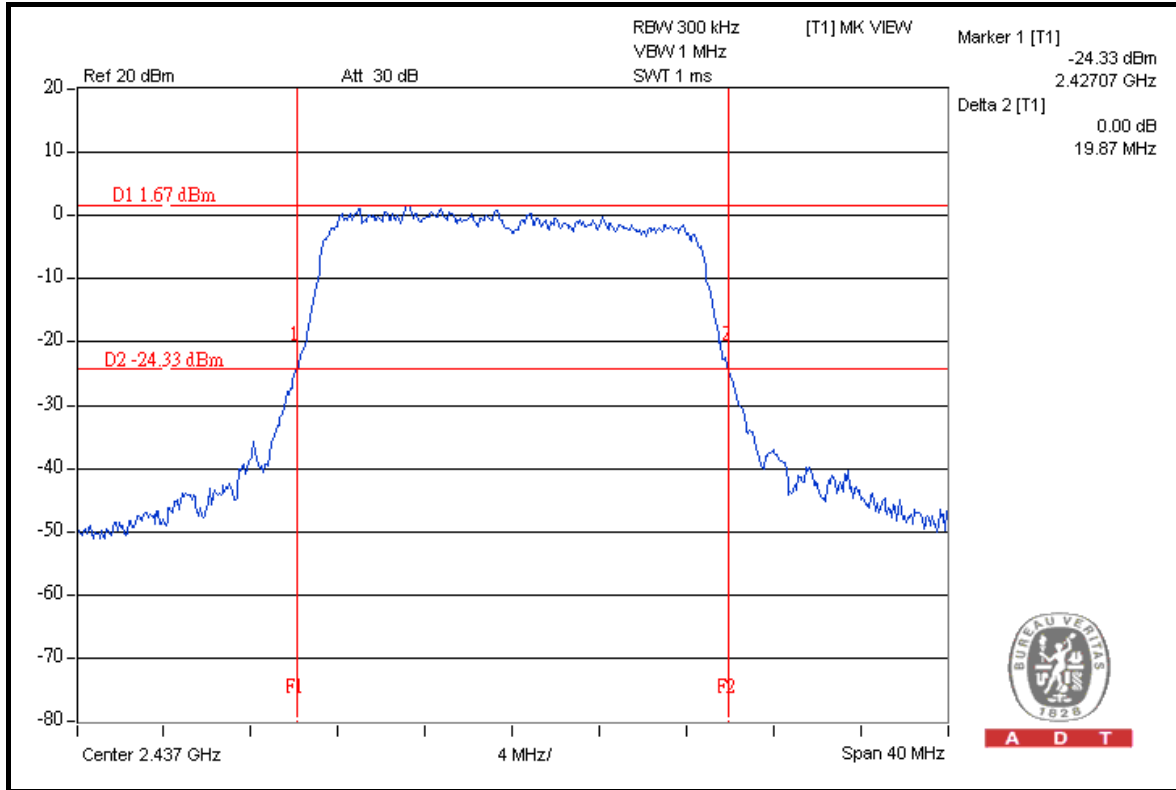

### CH 11

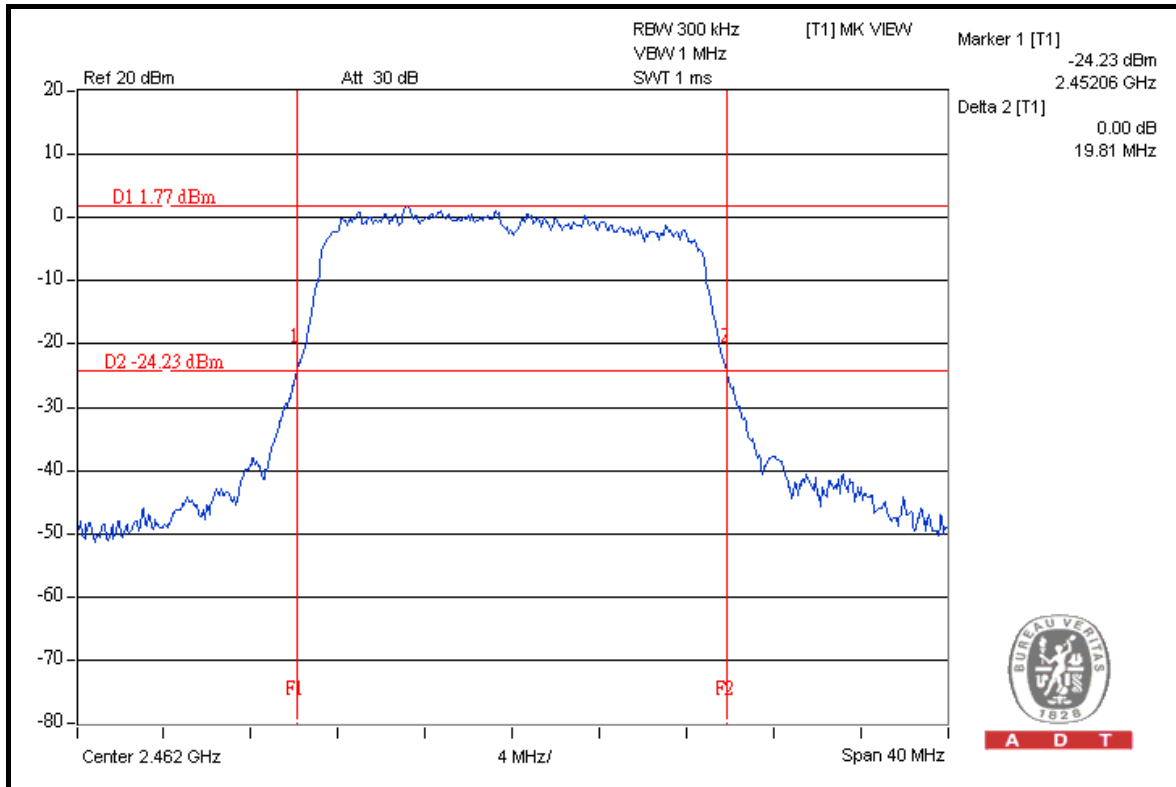



A D T

### DRAFT 802.11n (40MHz) OFDM MODULATION

<b>MODULATION TYPE</b>	OFDM	<b>TRANSFER RATE</b>	15.0Mbps
<b>INPUT POWER (SYSTEM)</b>	120Vac, 60Hz	<b>ENVIRONMENTAL CONDITIONS</b>	24deg.C, 64%RH, 991hPa
<b>TESTED BY</b>	Sun Lin		

CHANNEL	CHANNEL FREQUENCY (MHz)	26dBc OCCUPIED BANDWIDTH (MHz)		PASS / FAIL
		CHAIN 0	CHAIN 1	
1	2422	39.34	39.48	PASS
4	2437	39.37	39.53	PASS
7	2452	39.24	39.67	PASS



A D T

### FOR CHAIN 0: CH 1

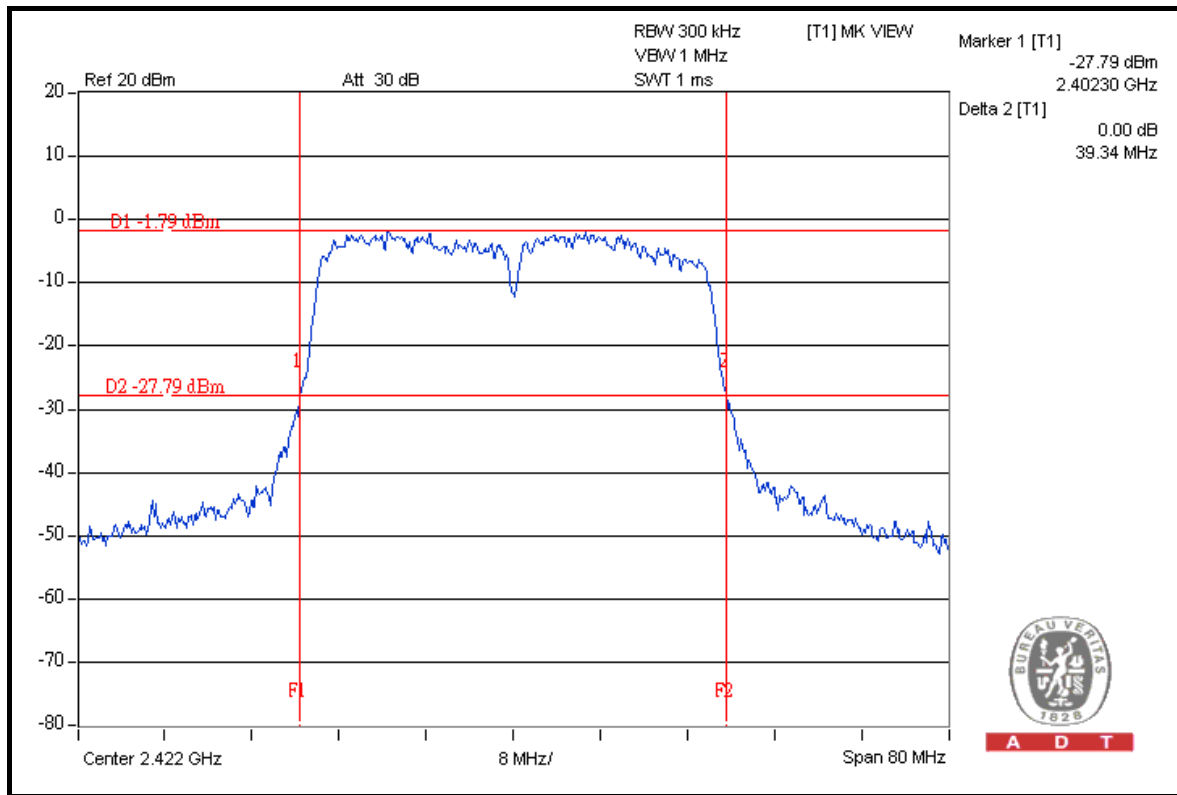

### CH 4

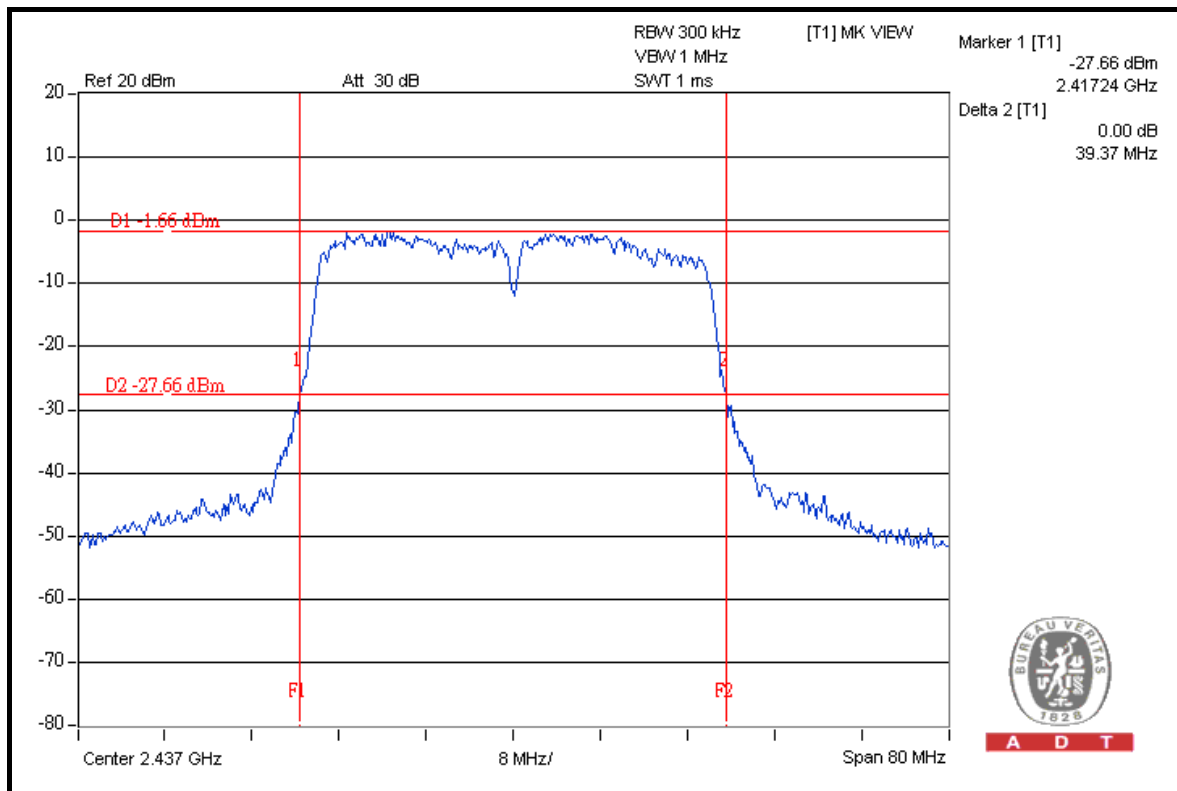



A D T

### CH 7

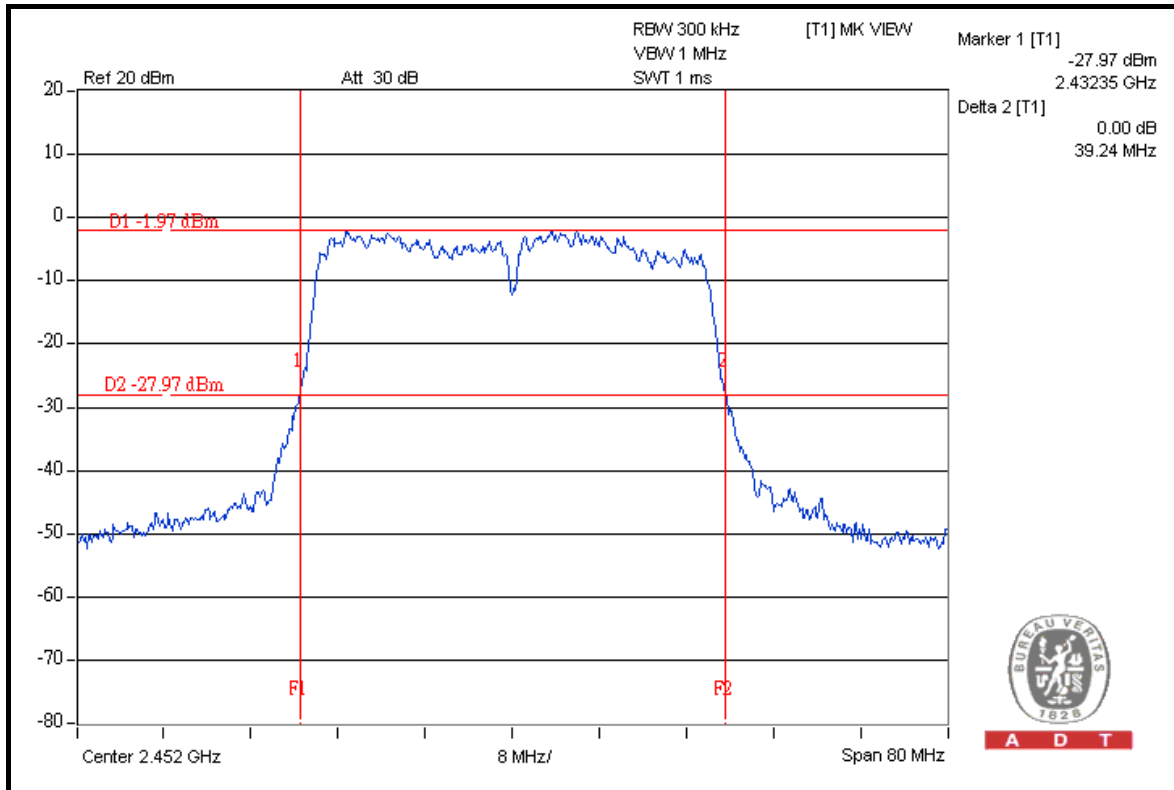

### FOR CHAIN 1: CH 1

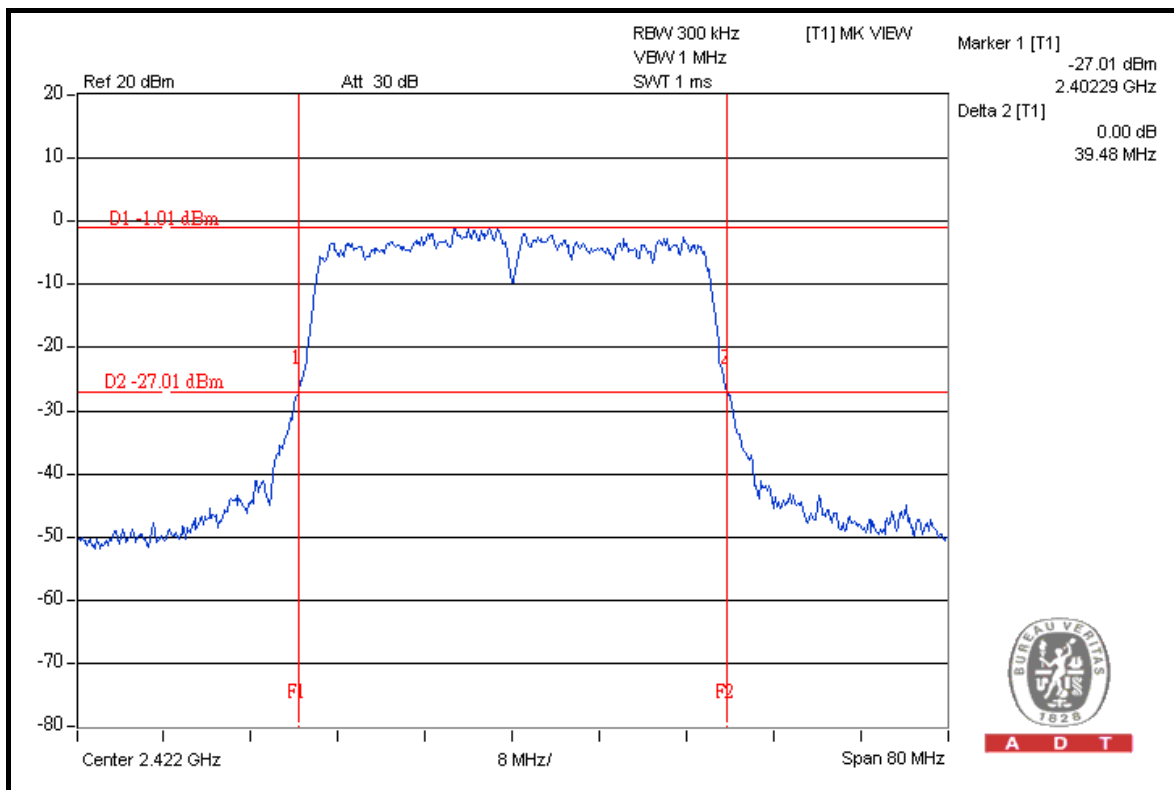





A D T

### CH 4

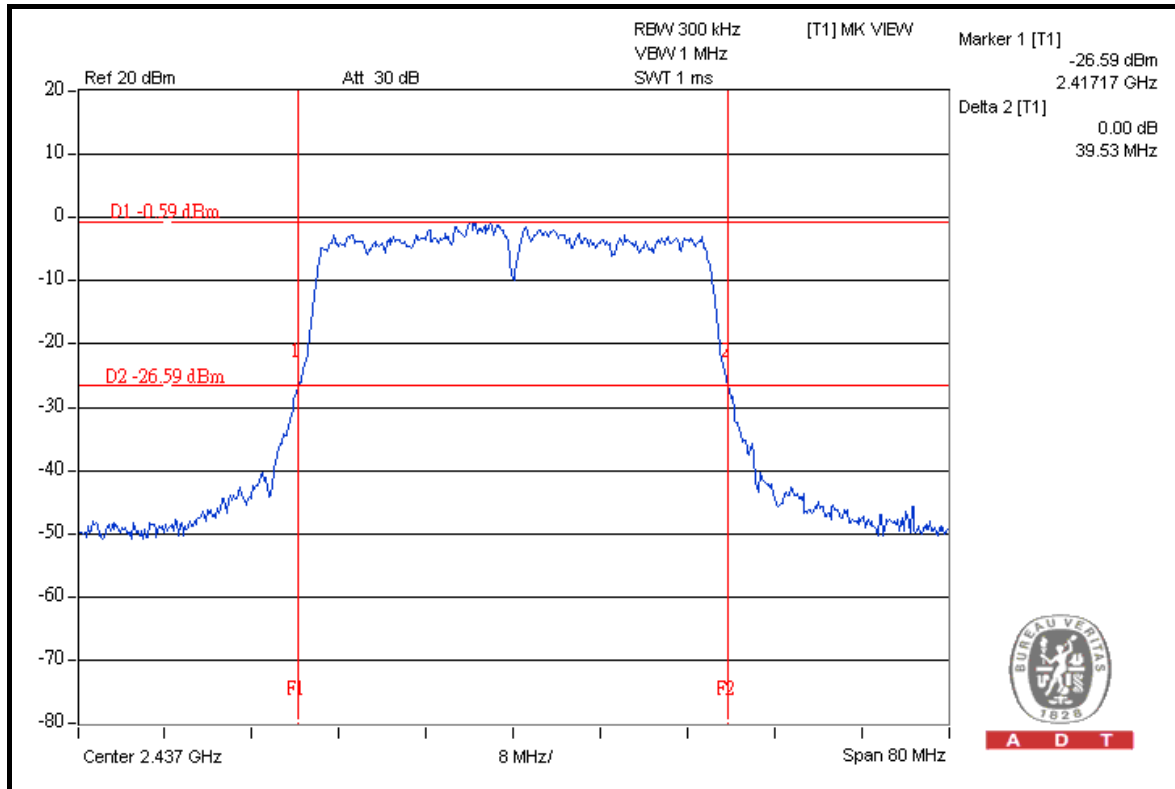

### CH 7

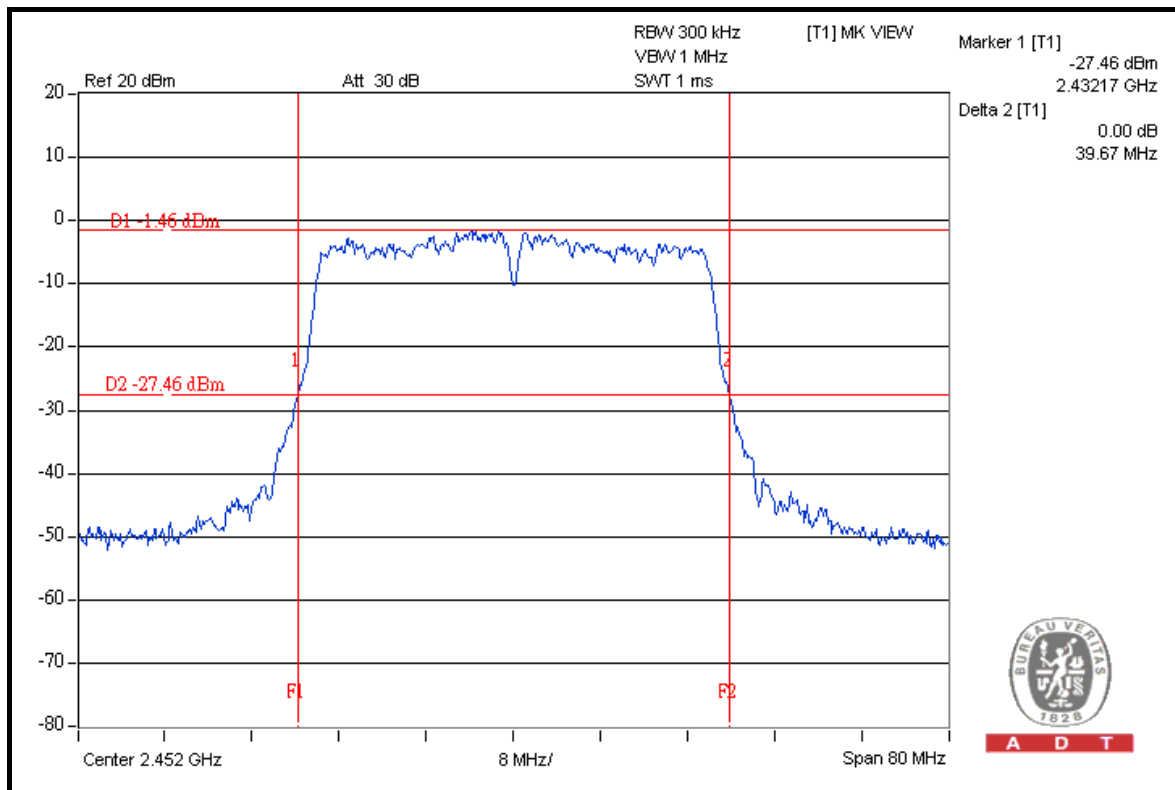



A D T

## 4.5 POWER SPECTRAL DENSITY MEASUREMENT

### 4.5.1 LIMITS OF POWER SPECTRAL DENSITY MEASUREMENT

The Maximum of Power Spectral Density Measurement is 8dBm.

### 4.5.2 TEST INSTRUMENTS

DESCRIPTION & MANUFACTURER	MODEL NO.	SERIAL NO.	DATE OF CALIBRATION	CALIBRATED UNTIL
R&S SPECTRUM ANALYZER	FSP40	100040	Jul. 07, 2009	Jul. 06, 2010

**NOTE:** The calibration interval of the above test instruments is 12 months and the calibrations are traceable to NML/ROC and NIST/USA.

### 4.5.3 TEST PROCEDURE

1. Follow DTS measurement (PSD Option 2), the transmitter output was connected to the spectrum analyzer through an attenuator, the bandwidth of the fundamental frequency was measured with the spectrum analyzer. Locate and zoom in on emission peak(s) within the pass band.
2. Set RBW = 3 kHz /VBW > 9 kHz and sweep time to Automatic.
3. Detector use peak mode and a video trigger with the trigger level set to enable triggering only on full power pulses.
4. Trace average 100 traces in power averaging mode. The power spectral density was measured and recorded.

#### 4.5.4 DEVIATION FROM TEST STANDARD

No deviation

#### 4.5.5 TEST SETUP

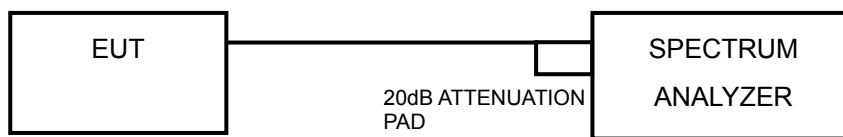

#### 4.5.6 EUT OPERATING CONDITION

Same as Item 4.3.6



A D T

#### 4.5.7 TEST RESULTS

##### 802.11b DSSS MODULATION

<b>MODULATION TYPE</b>	DBPSK	<b>TRANSFER RATE</b>	1.0Mbps
<b>INPUT POWER</b>	120Vac, 60Hz	<b>ENVIRONMENTAL CONDITIONS</b>	24deg.C, 64%RH, 1021hPa
<b>TESTED BY</b>	Sun Lin		

CHAN.	CHAN. FREQ. (MHz)	RF POWER LEVEL IN 3kHz BW (dBm)		TOTAL POWER DENSITY (mW)	TOTAL POWER DENSITY (dBm)	MAX. LIMIT (dBm)	PASS / FAIL
		CHAIN 0	CHAIN 1				
1	2412	-19.72	-19.96	0.02	-16.78	8	PASS
6	2437	-19.53	-20.13	0.02	-16.78	8	PASS
11	2462	-19.51	-19.71	0.02	-16.58	8	PASS



A D T

### FOR CHAIN 0: CH 1

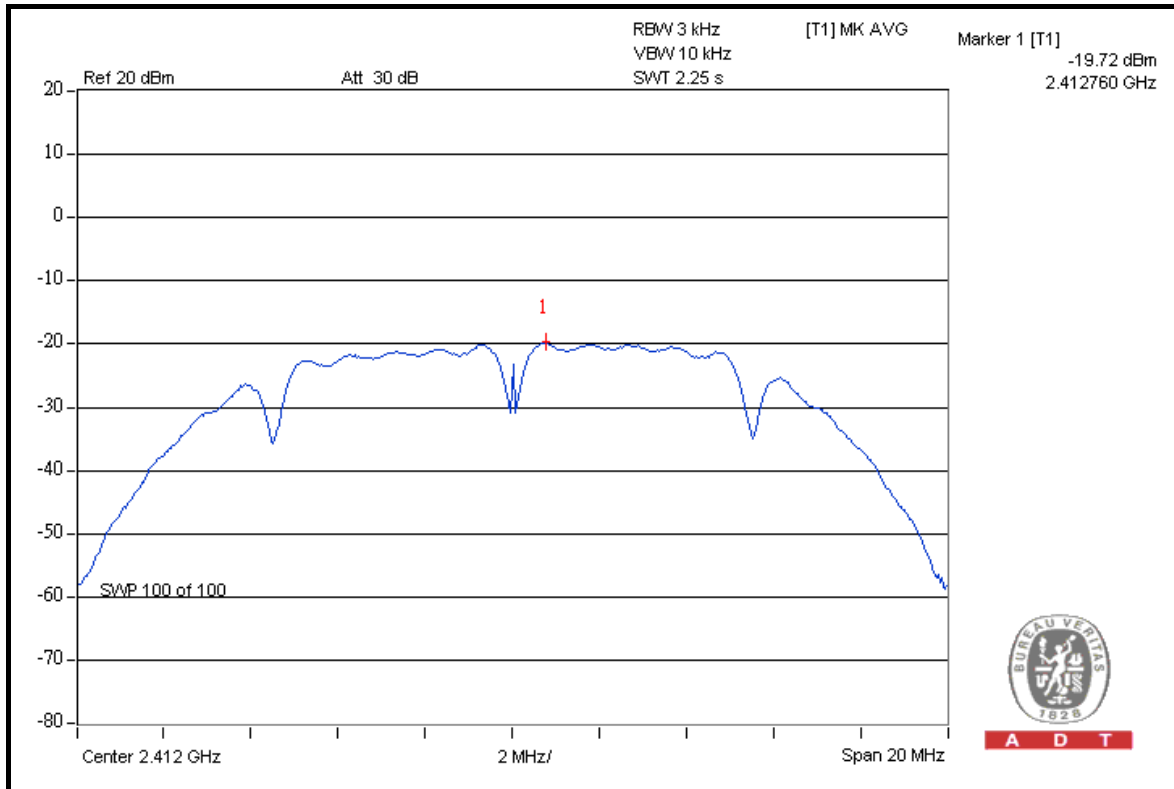

A D T

### CH 6

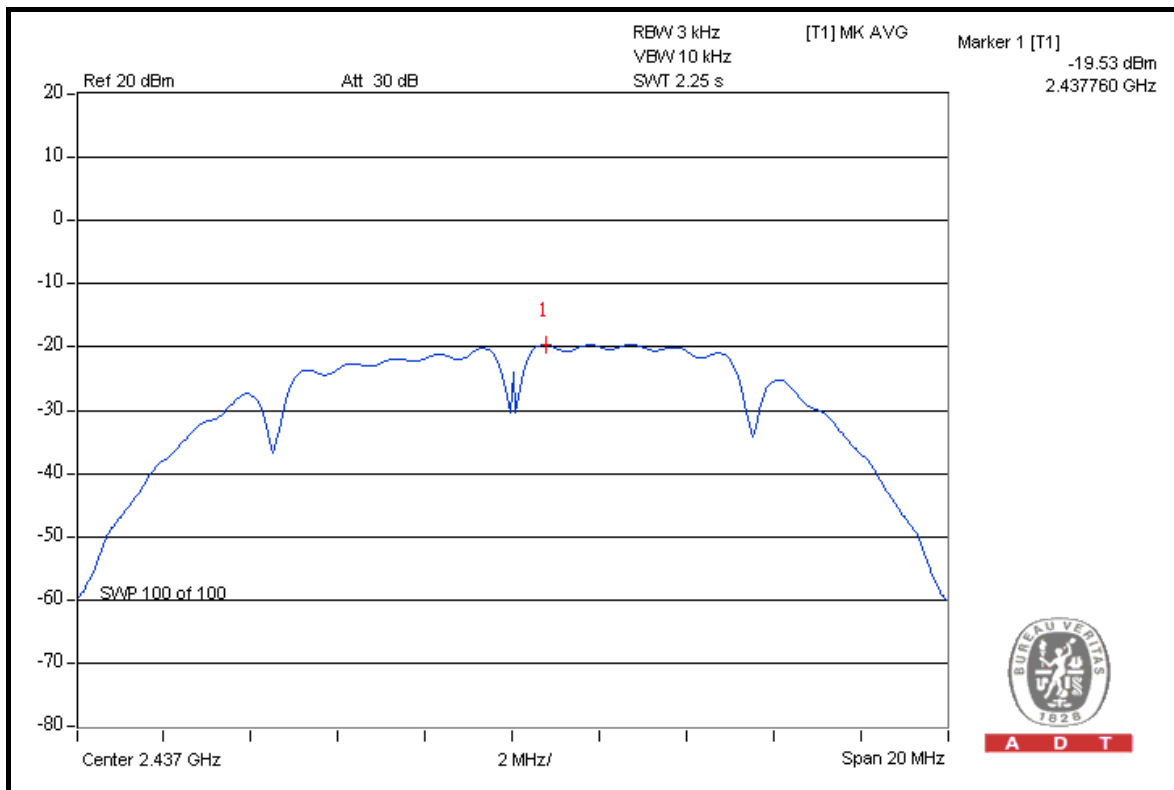

A D T



A D T

### CH 11

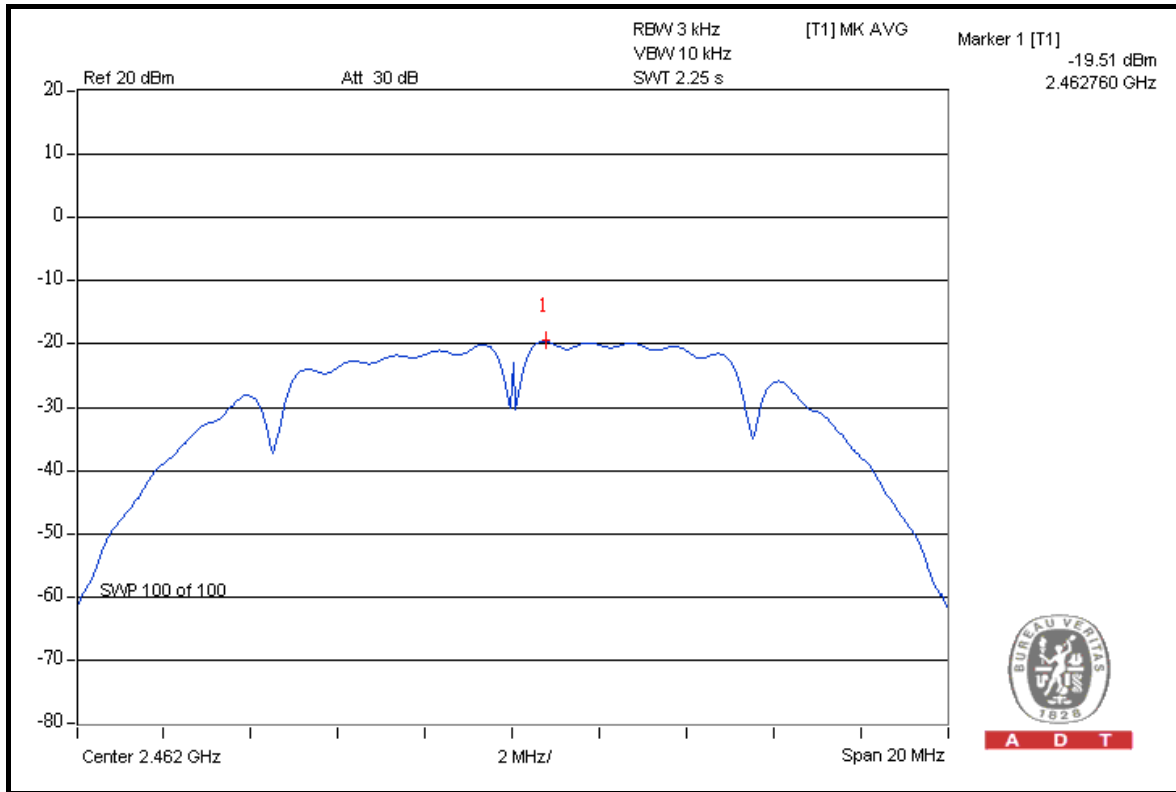

### FOR CHAIN 1: CH 1

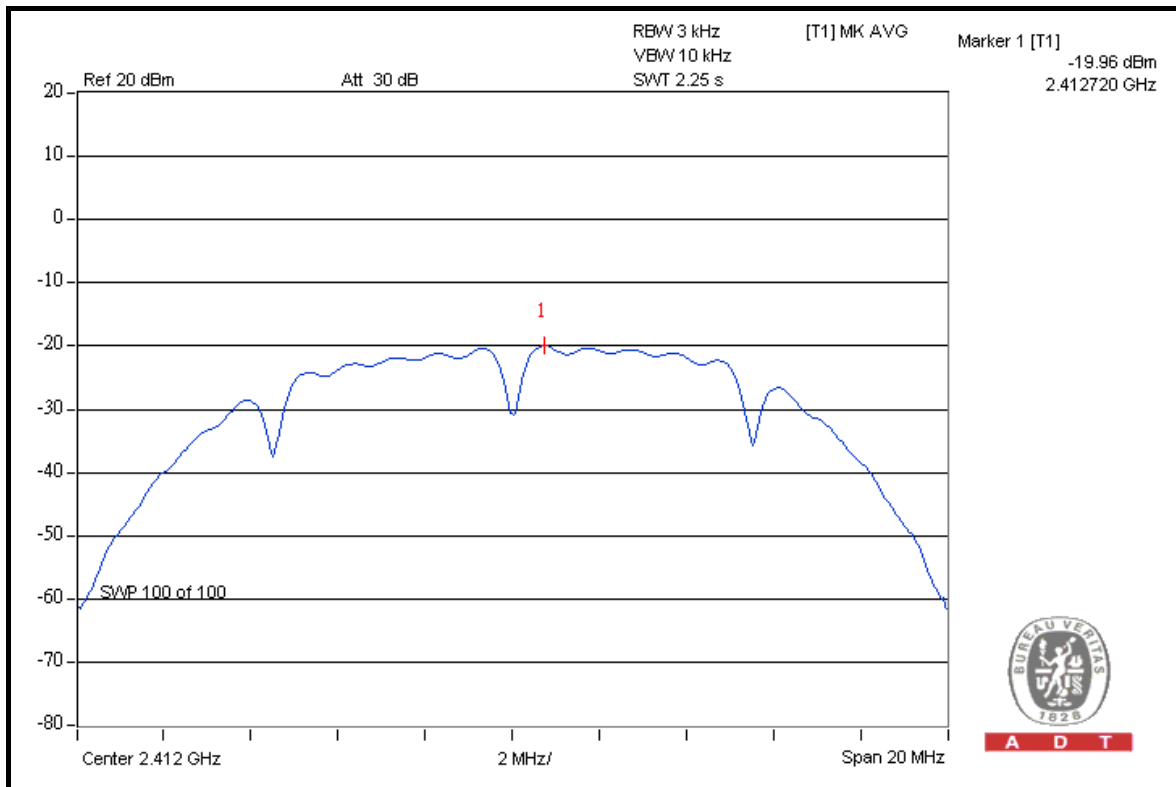



A D T

### CH 6

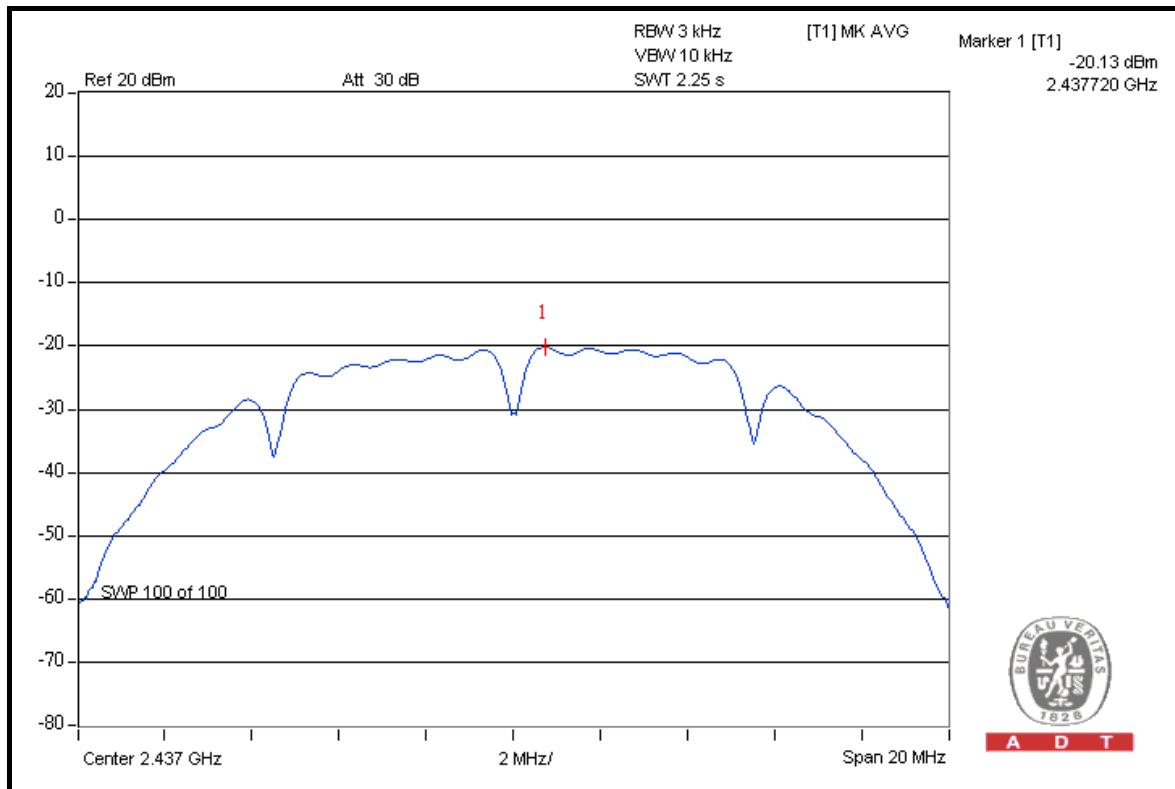

### CH 11

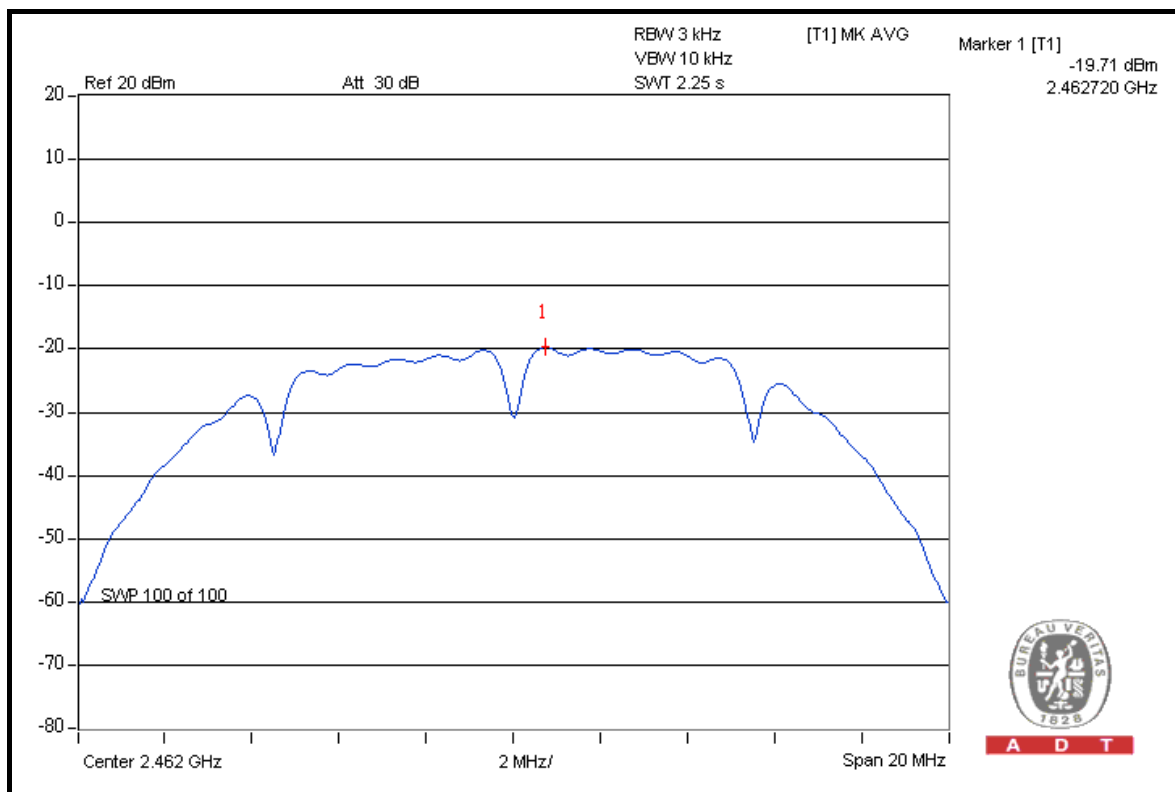



A D T

### 802.11g OFDM MODULATION

<b>MODULATION TYPE</b>	BPSK	<b>TRANSFER RATE</b>	6.0Mbps
<b>INPUT POWER</b>	120Vac, 60Hz	<b>ENVIRONMENTAL CONDITIONS</b>	24deg.C, 64%RH, 1021hPa
<b>TESTED BY</b>	Sun Lin		

CHAN.	CHAN. FREQ. (MHz)	RF POWER LEVEL IN 3kHz BW (dBm)		TOTAL POWER DENSITY (mW)	TOTAL POWER DENSITY (dBm)	MAX. LIMIT (dBm)	PASS / FAIL
		CHAIN 0	CHAIN 1				
1	2412	-19.46	-19.90	0.02	-16.58	8	PASS
6	2437	-19.27	-19.66	0.02	-16.38	8	PASS
11	2462	-19.27	-19.69	0.02	-16.38	8	PASS





A D T

### FOR CHAIN 0: CH 1

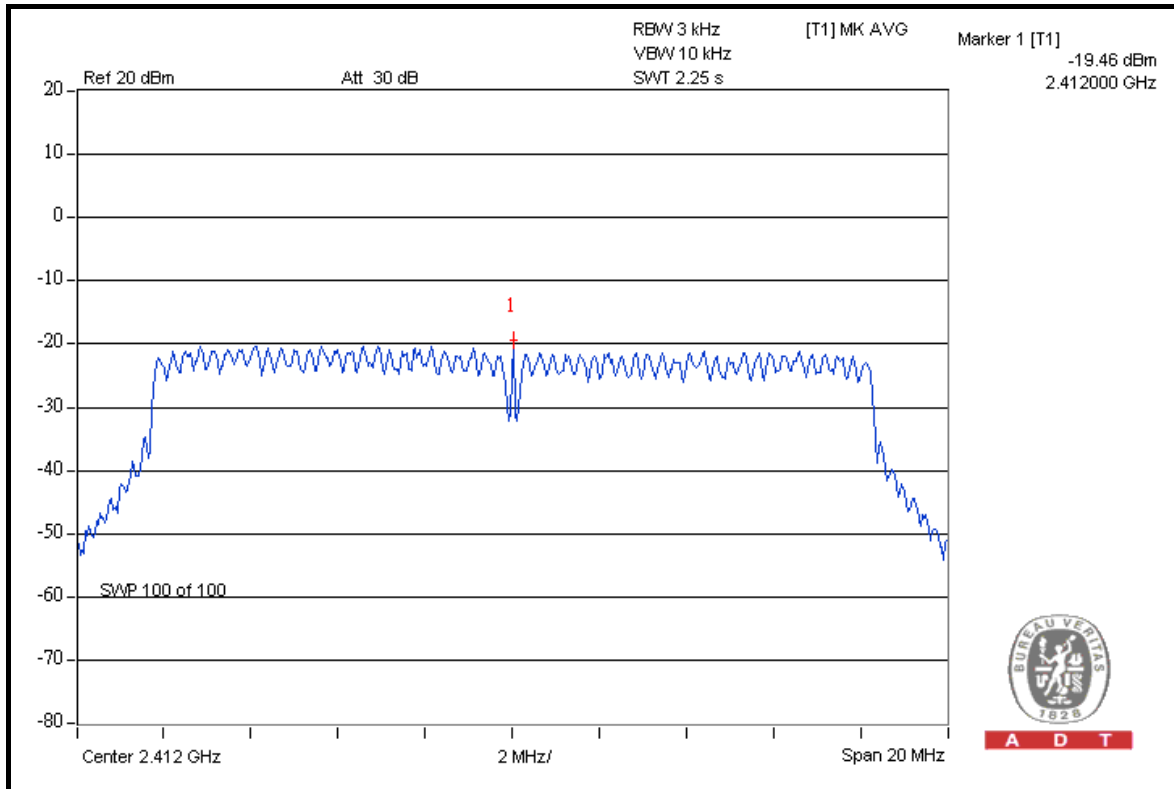

A D T

### CH 6

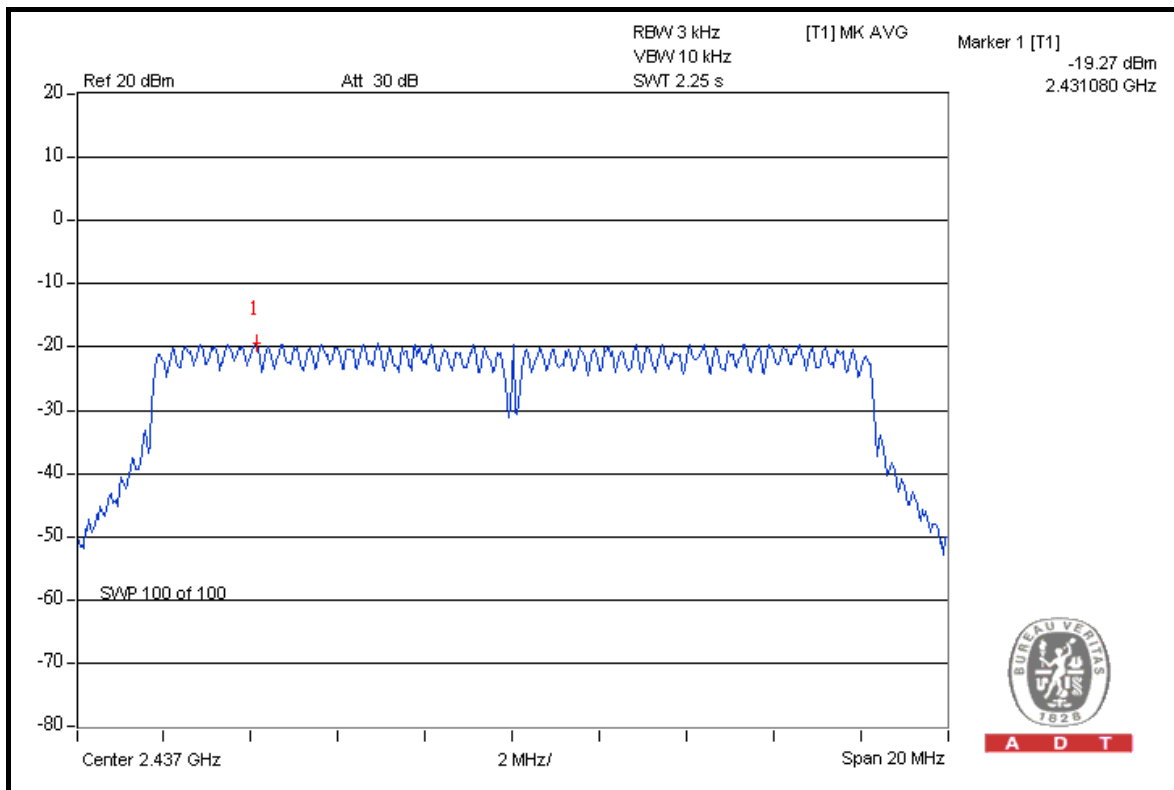

A D T



A D T

### CH 11

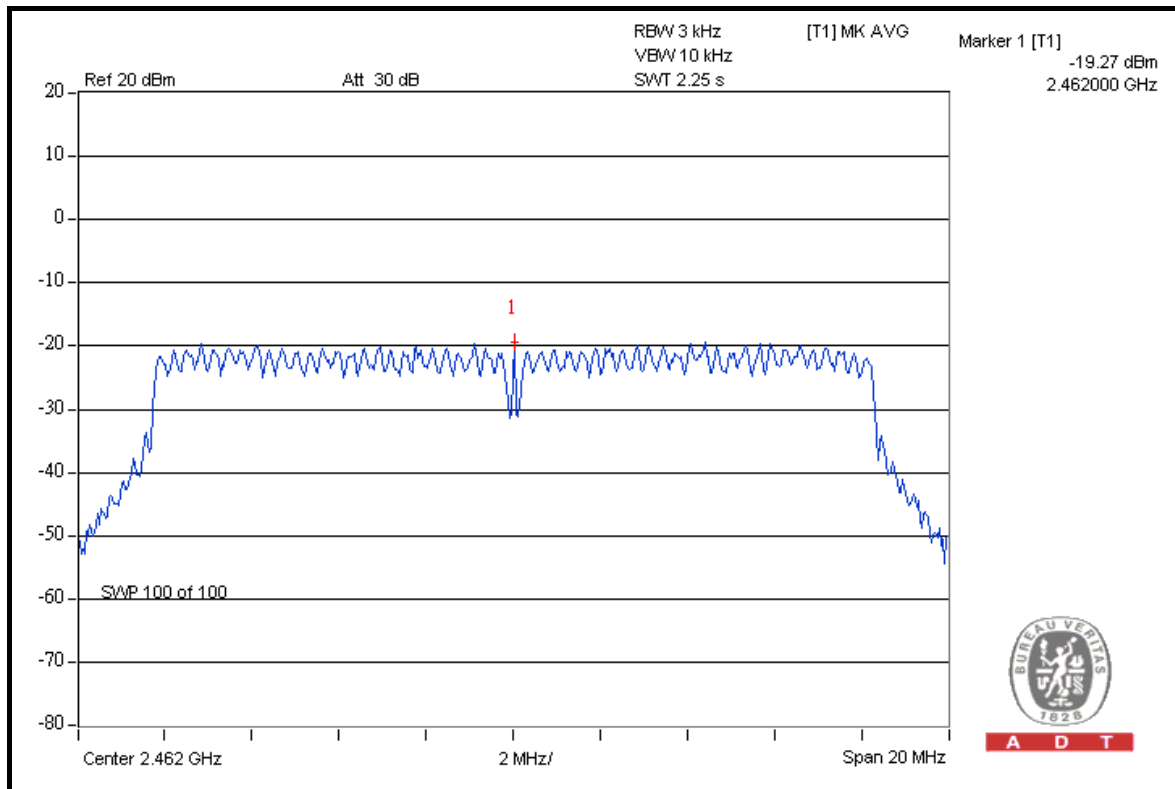

A D T

### FOR CHAIN 1: CH 1

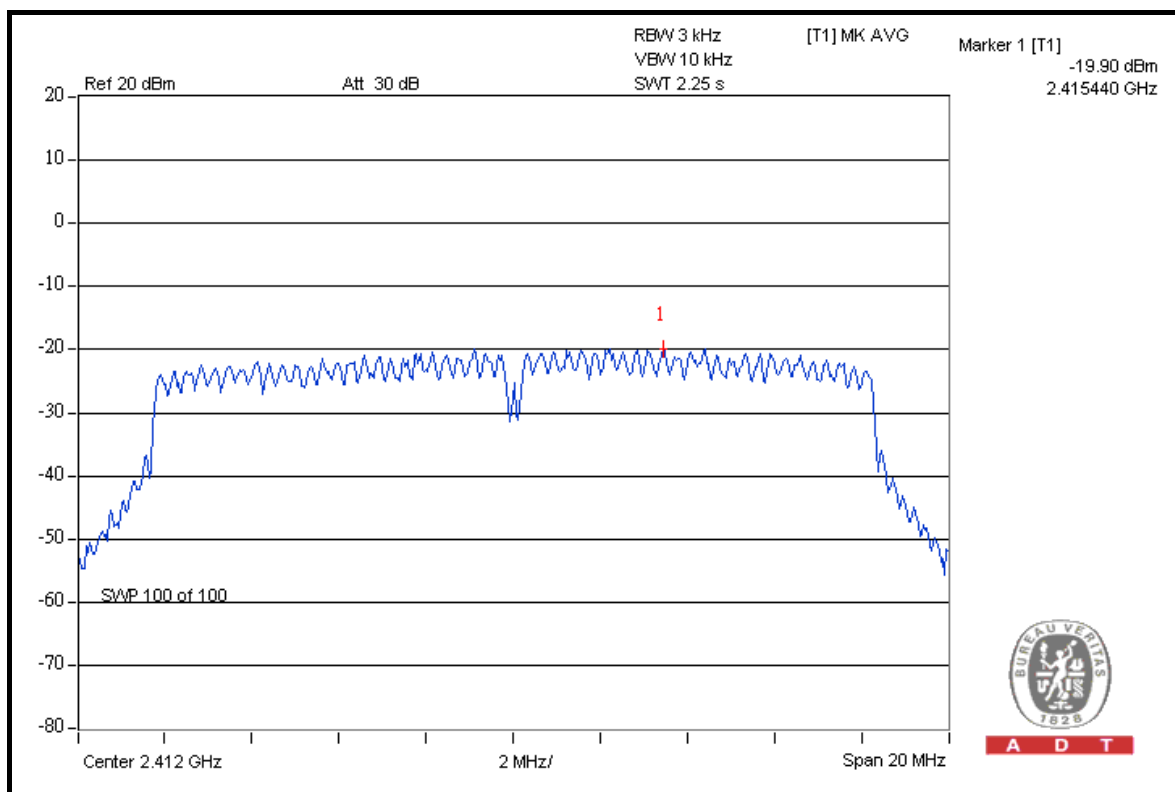

A D T



A D T

### CH 6

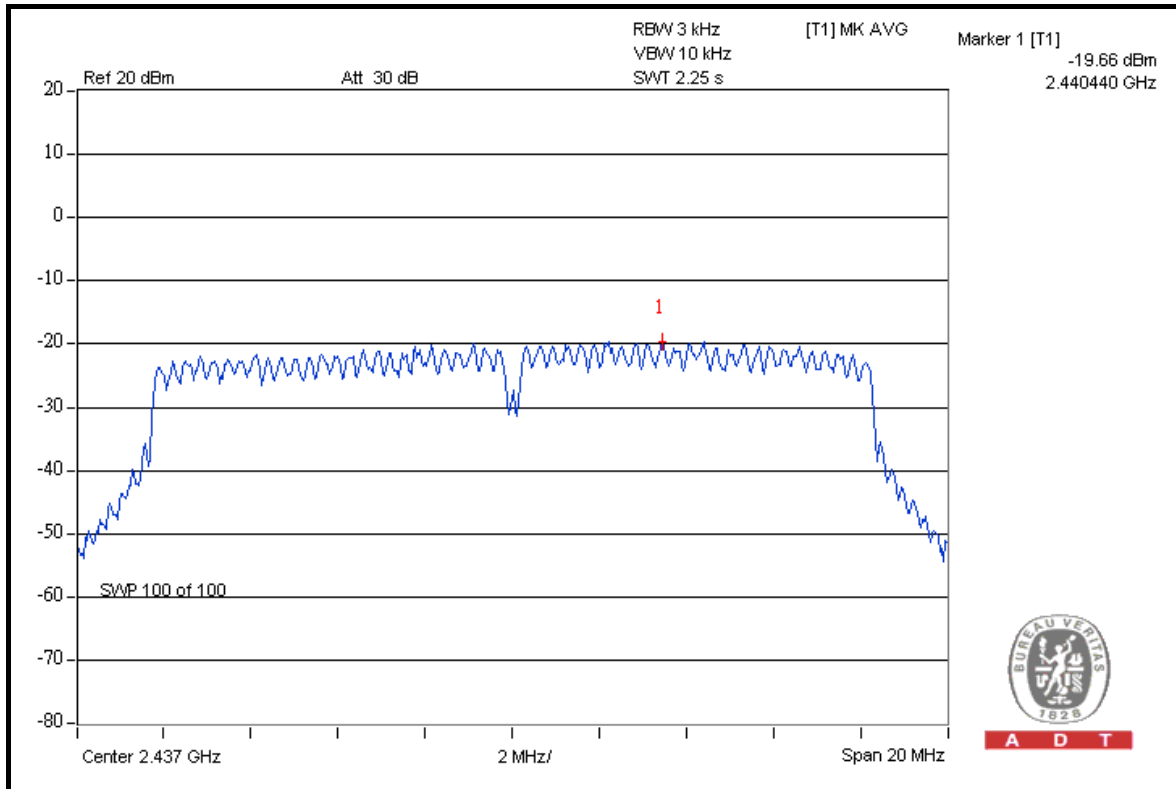

### CH 11

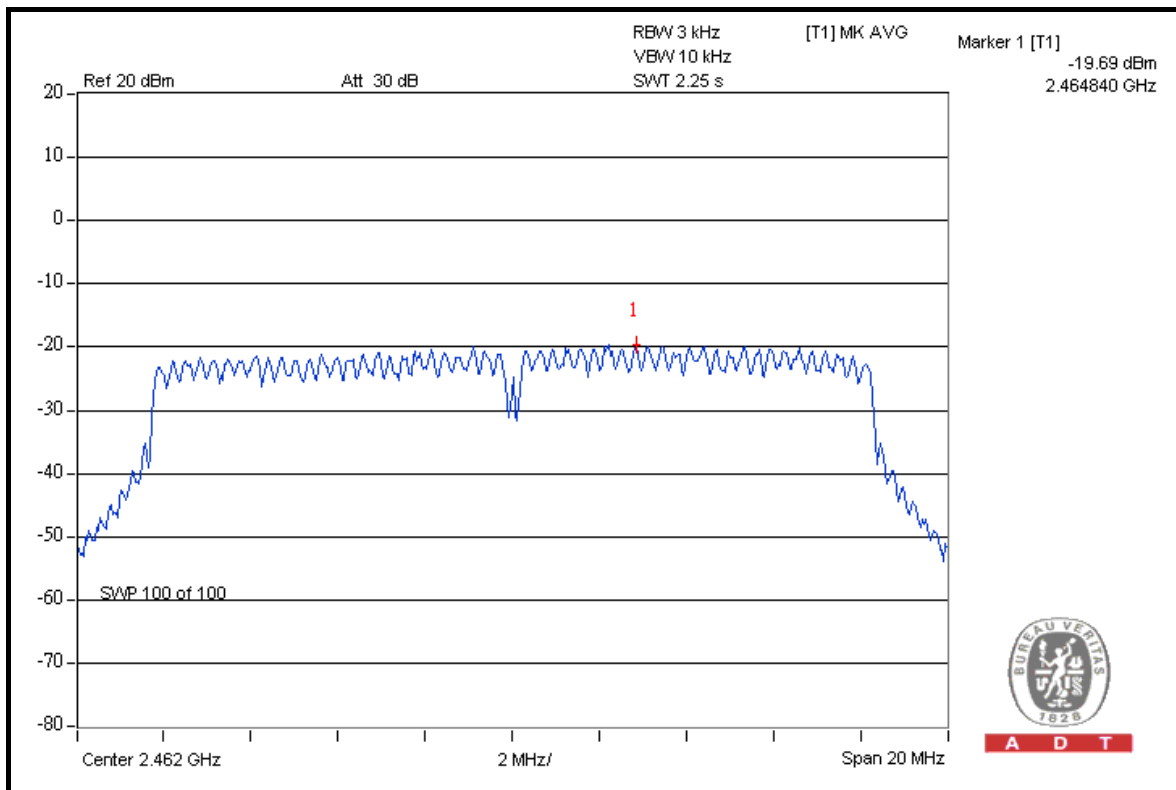



A D T

**DRAFT 802.11n (20MHz) OFDM MODULATION**

<b>MODULATION TYPE</b>	BPSK	<b>TRANSFER RATE</b>	7.2Mbps
<b>INPUT POWER</b>	120Vac, 60Hz	<b>ENVIRONMENTAL CONDITIONS</b>	24deg.C, 64%RH, 1021hPa
<b>TESTED BY</b>	Sun Lin		

CHAN.	CHAN. FREQ. (MHz)	RF POWER LEVEL IN 3kHz BW (dBm)		TOTAL POWER DENSITY (mW)	TOTAL POWER DENSITY (dBm)	MAX. LIMIT (dBm)	PASS / FAIL
		CHAIN 0	CHAIN 1				
1	2412	-18.74	-20.39	0.02	-16.48	8	PASS
6	2437	-18.47	-20.30	0.02	-16.28	8	PASS
11	2462	-18.80	-20.17	0.02	-16.42	8	PASS



A D T

### FOR CHAIN 0: CH 1

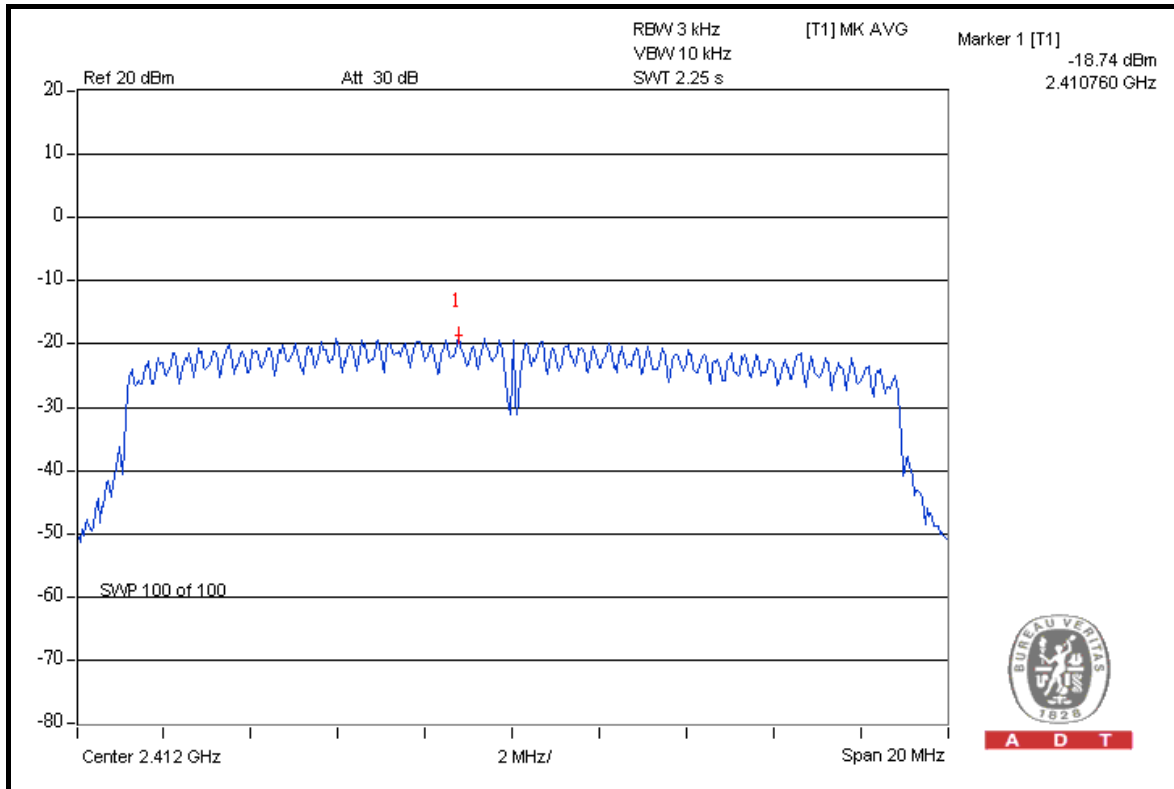

### CH 6

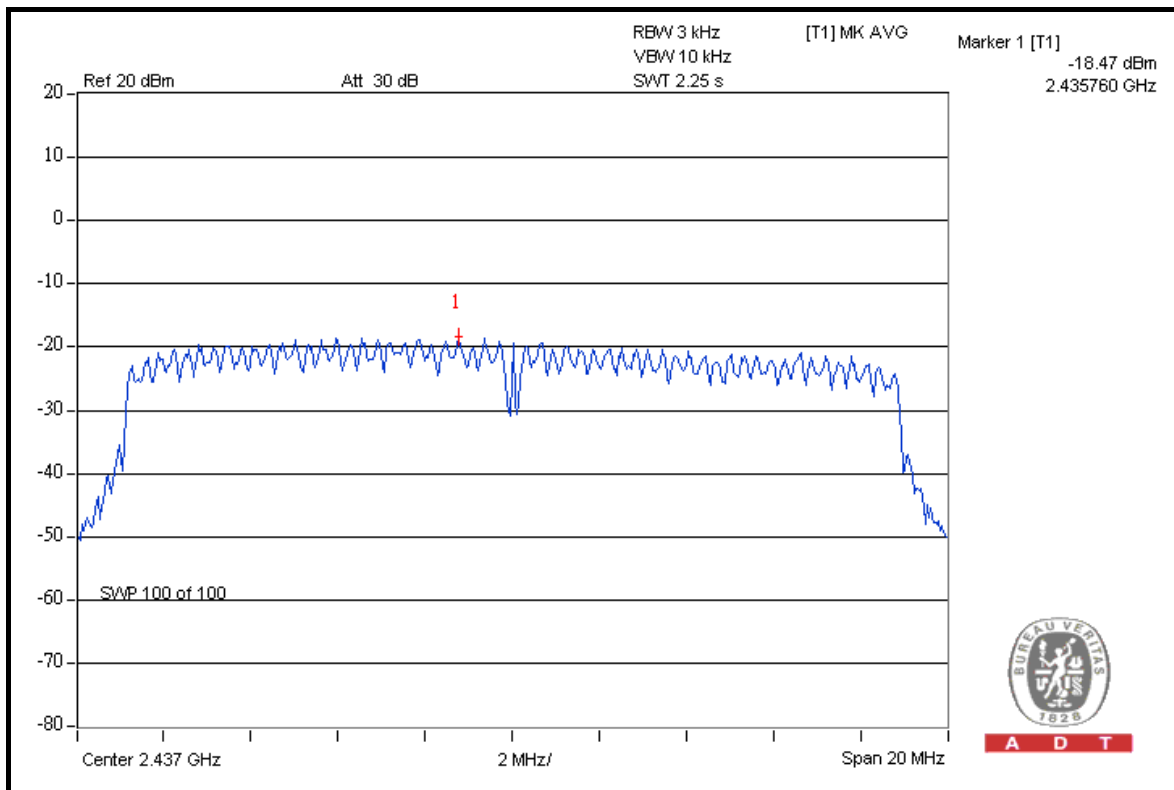



A D T

### CH 11

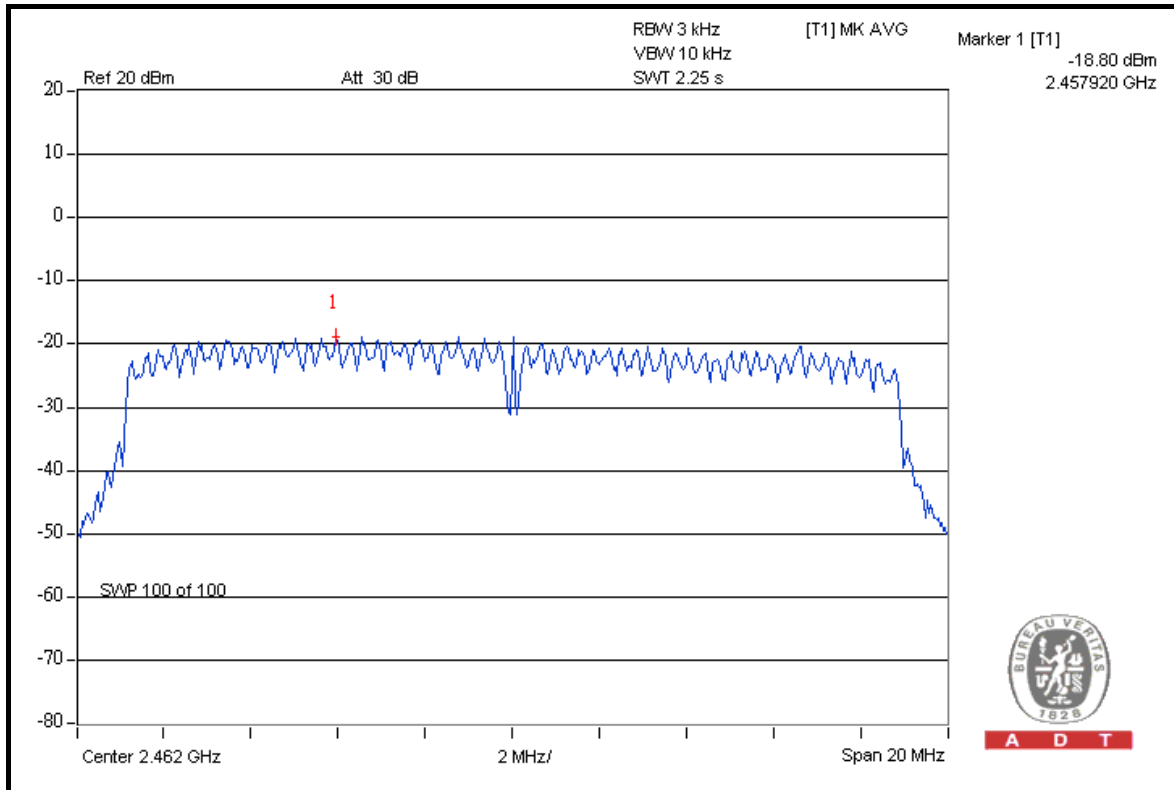

### FOR CHAIN 1: CH 1

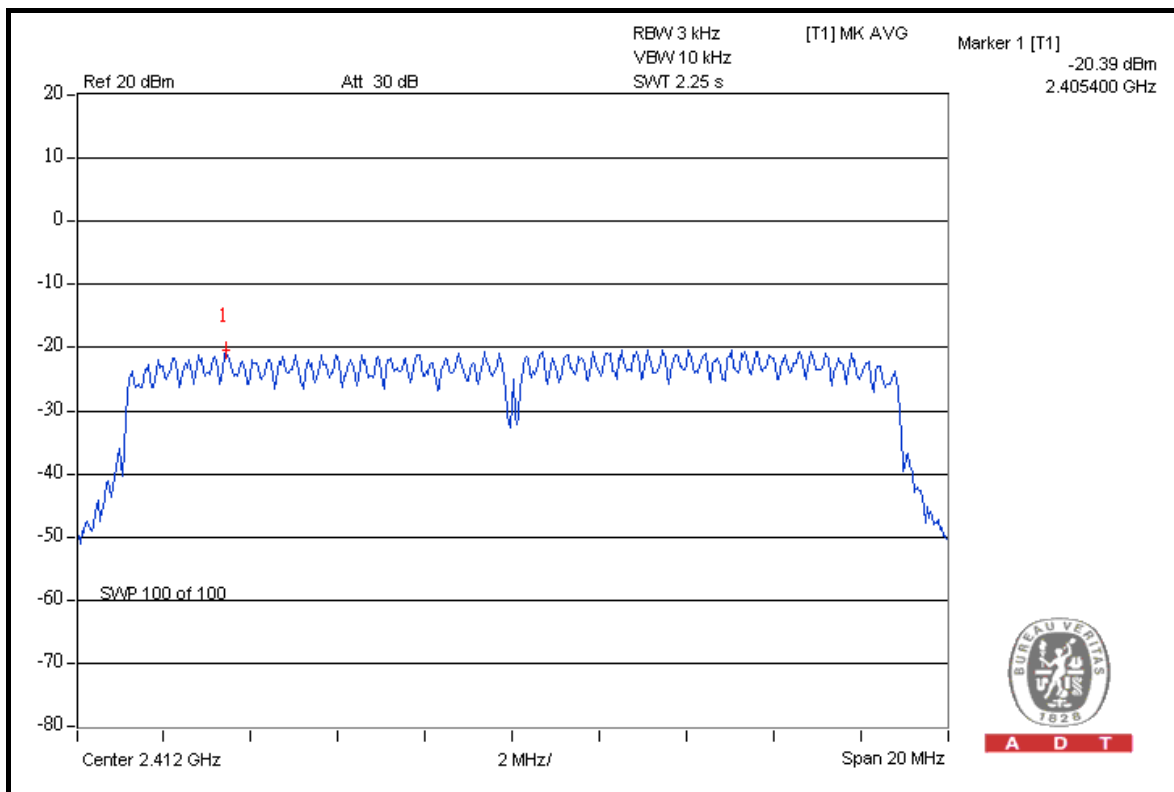



A D T

### CH 6

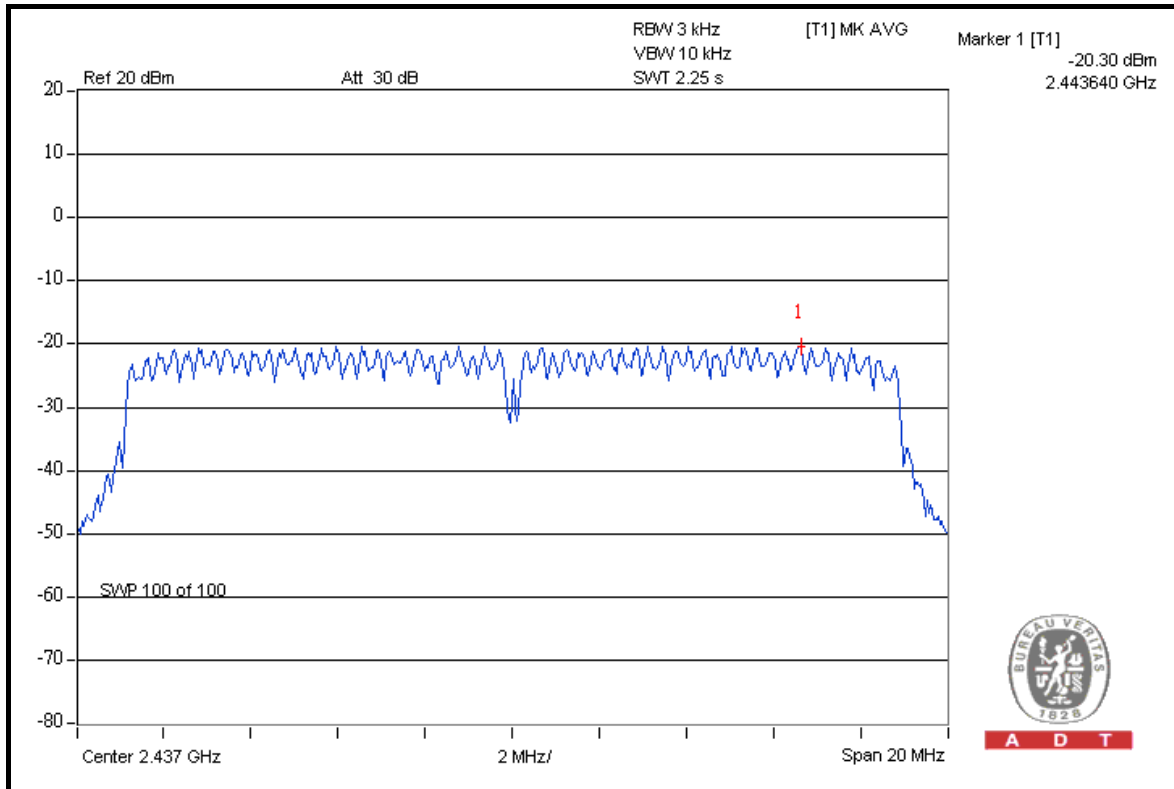

A D T

### CH 11

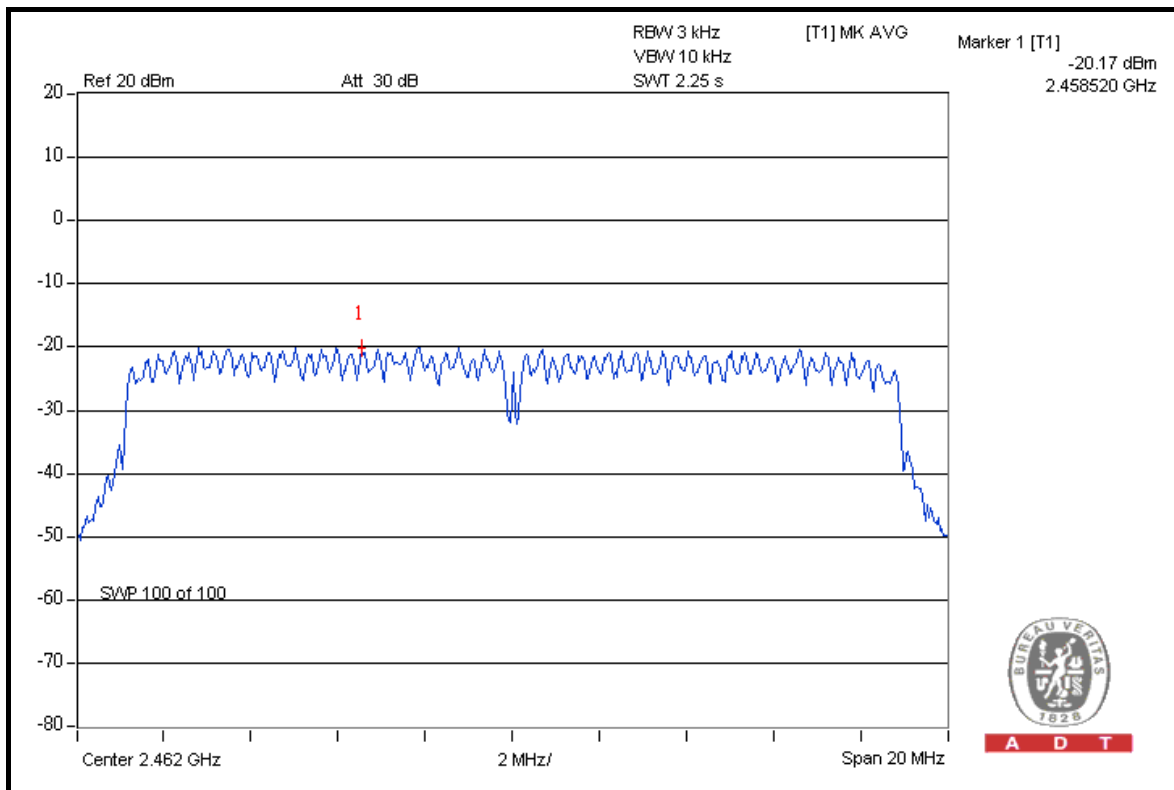

A D T



A D T

### DRAFT 802.11n (40MHz) OFDM MODULATION

<b>MODULATION TYPE</b>	BPSK	<b>TRANSFER RATE</b>	15.0Mbps
<b>INPUT POWER</b>	120Vac, 60Hz	<b>ENVIRONMENTAL CONDITIONS</b>	24deg.C, 64%RH, 1021hPa
<b>TESTED BY</b>	Sun Lin		

CHAN.	CHAN. FREQ. (MHz)	RF POWER LEVEL IN 3kHz BW (dBm)		TOTAL POWER DENSITY (mW)	TOTAL POWER DENSITY (dBm)	MAX. LIMIT (dBm)	PASS / FAIL
		CHAIN 0	CHAIN 1				
1	2422	-19.76	-22.31	0.02	-17.96	8	PASS
4	2437	-19.34	-22.08	0.02	-17.45	8	PASS
7	2452	-19.66	-22.24	0.02	-17.70	8	PASS





A D T

### FOR CHAIN 0: CH 1

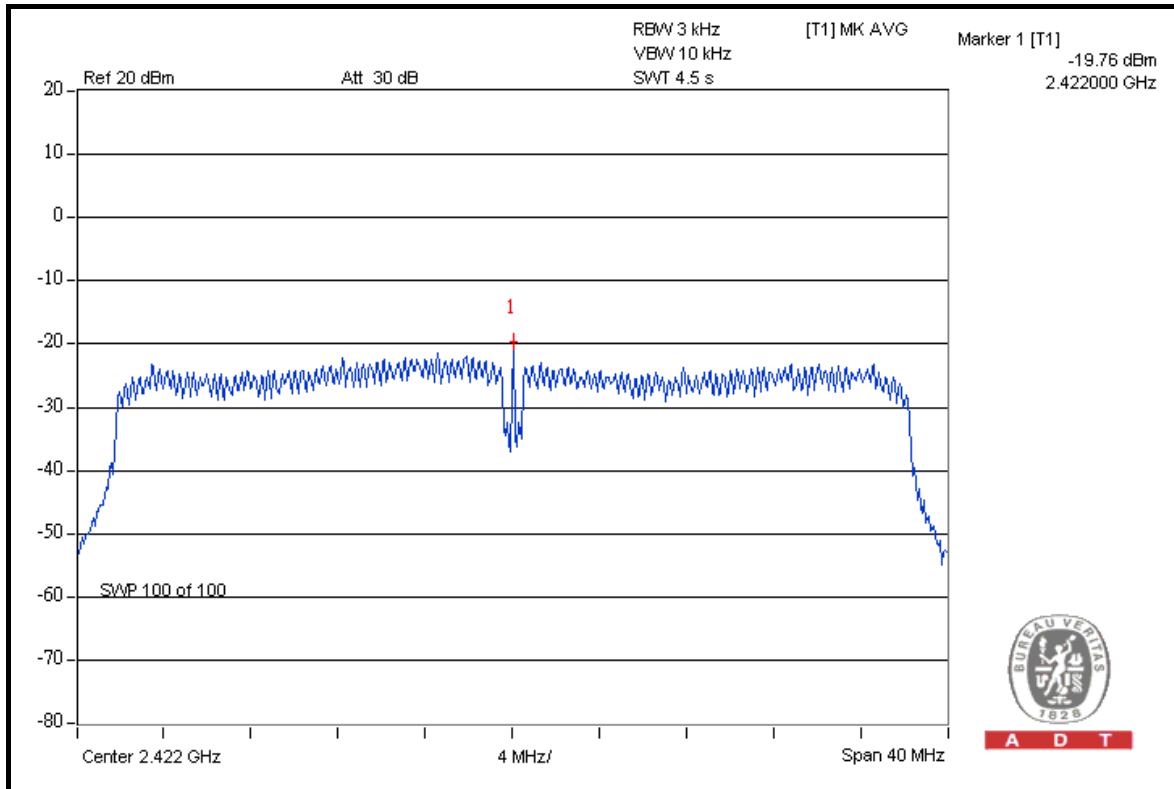

### CH 4

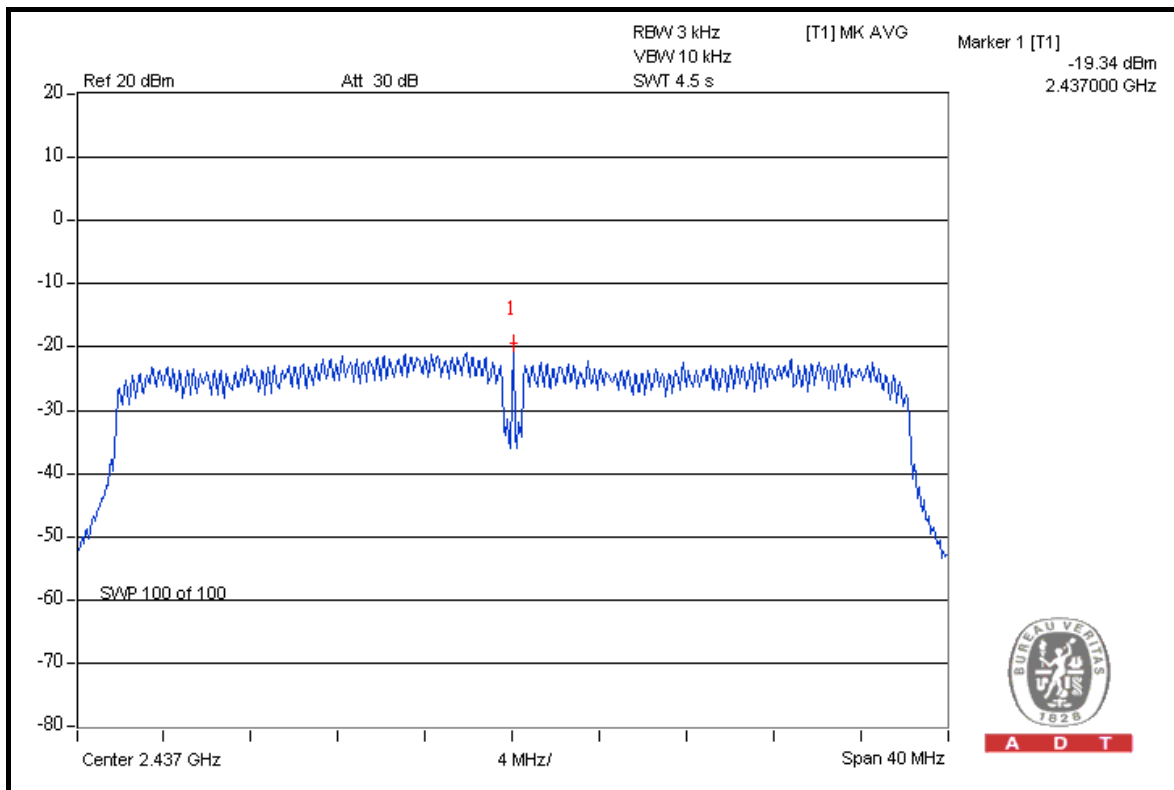



A D T

### CH 7

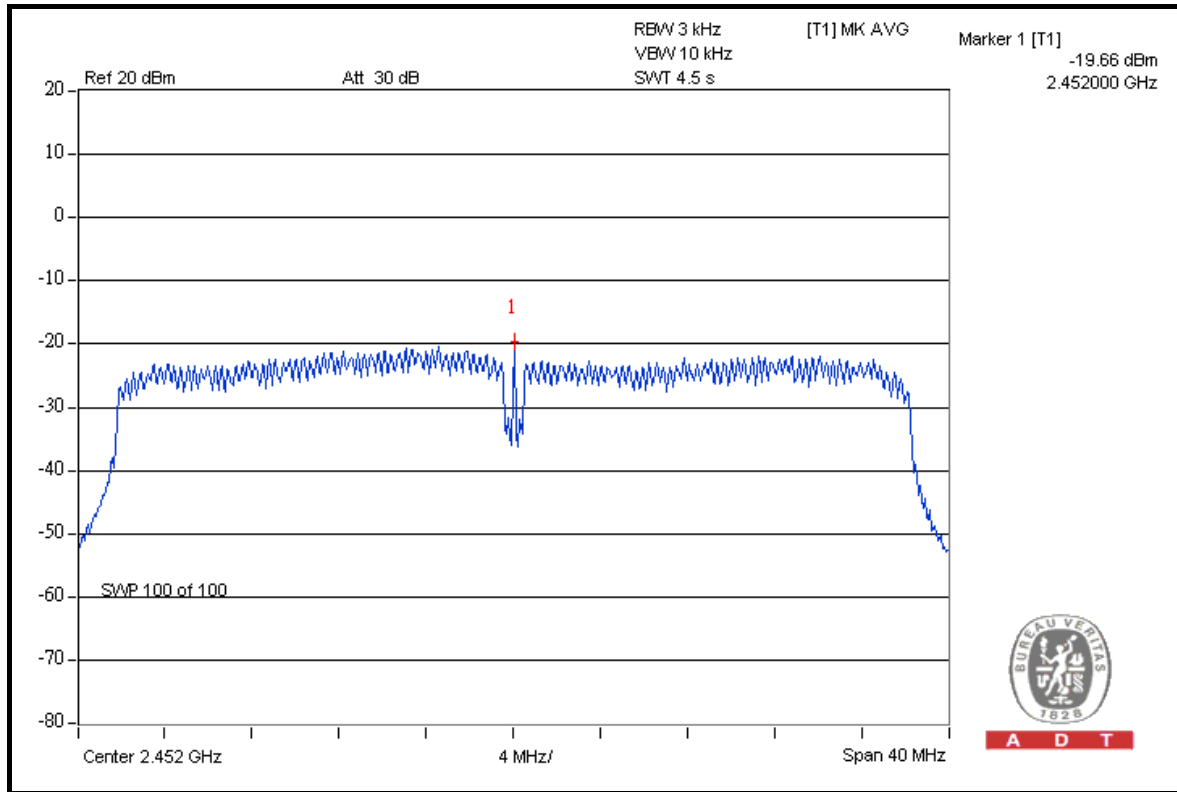

### FOR CHAIN 1: CH 1

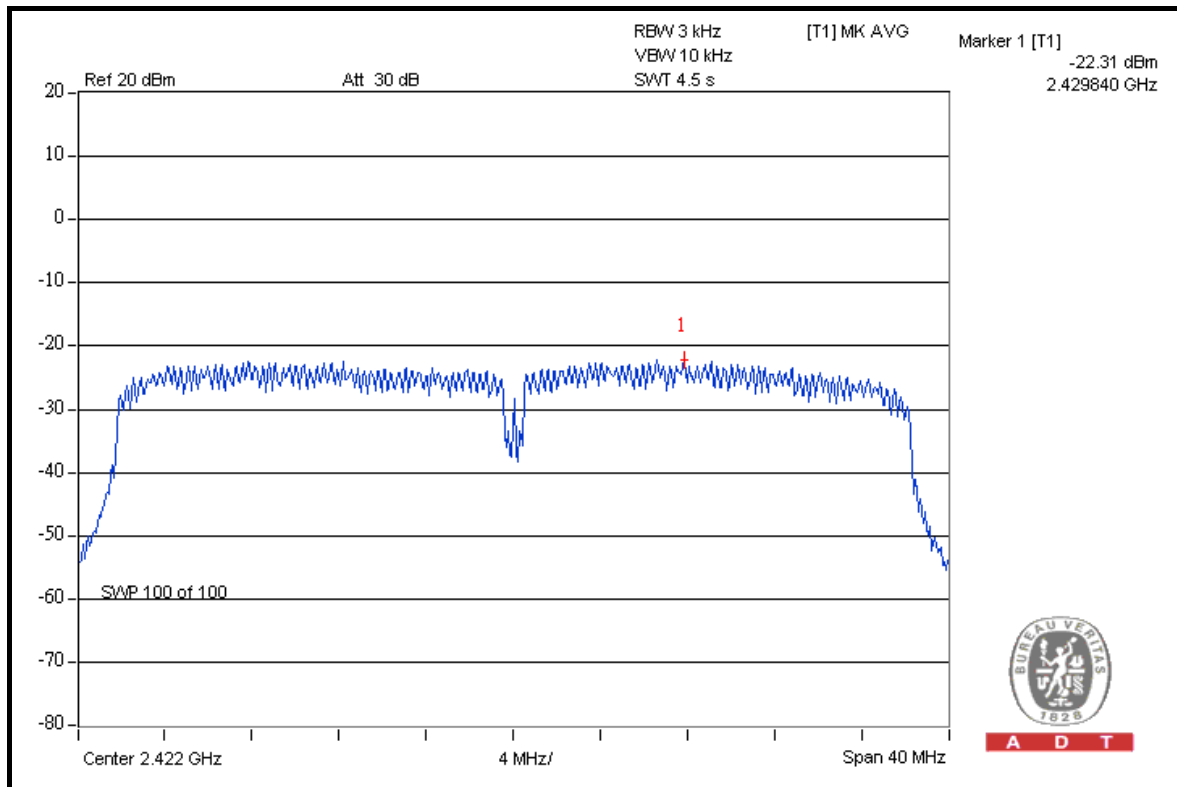



A D T

### CH 4

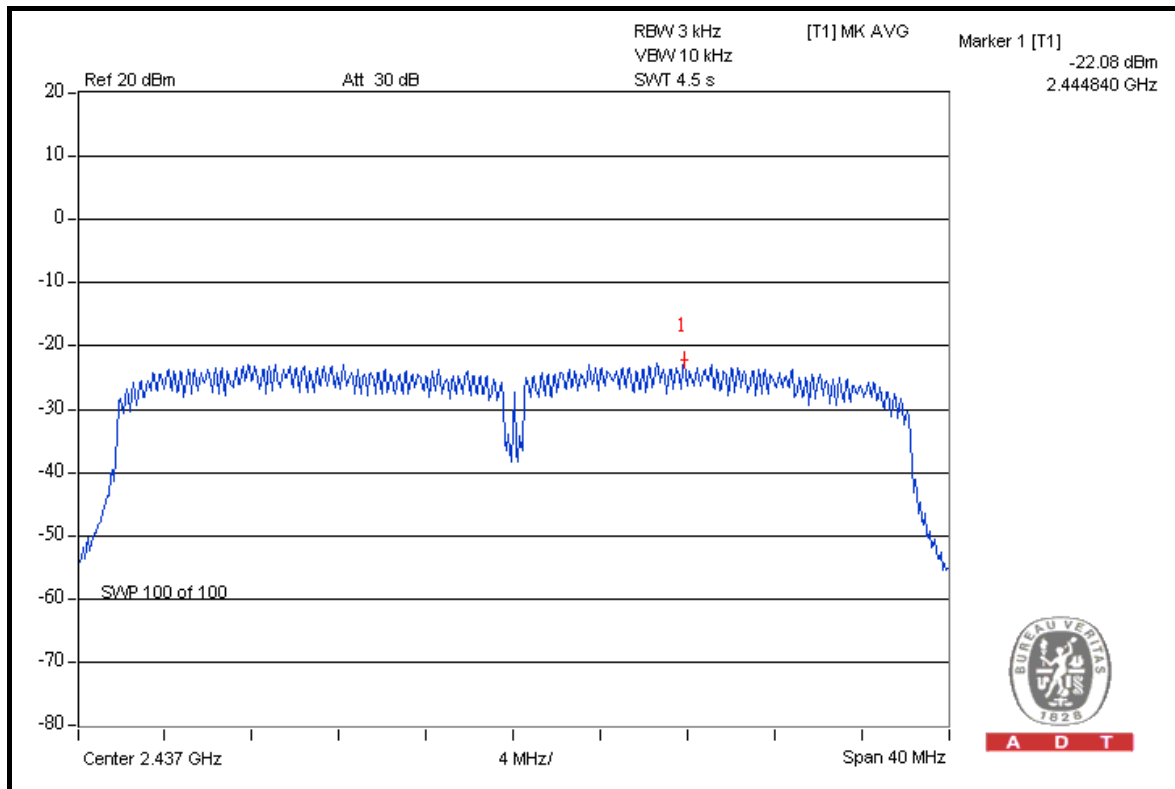

### CH 7

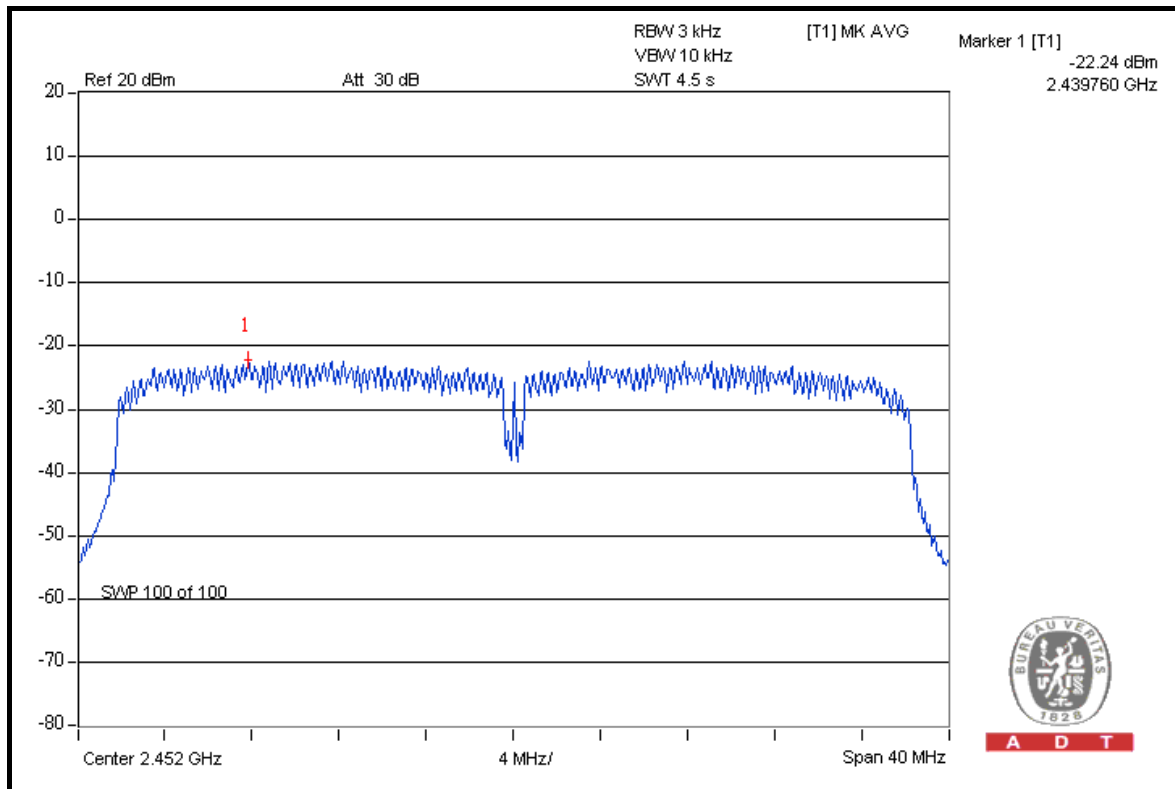



A D T

## 4.6 BAND EDGES MEASUREMENT

### 4.6.1 LIMITS OF BAND EDGES MEASUREMENT

Below -20dB of the highest emission level of operating band (in 100kHz Resolution Bandwidth).

**Note:** Follow DTS measurement, If the device complies with the use of power option 2 the attenuation under this paragraph shall be 30 dB instead of 20 dB.

### 4.6.2 TEST INSTRUMENTS

DESCRIPTION & MANUFACTURER	MODEL NO.	SERIAL NO.	DATE OF CALIBRATION	DUE DATE OF CALIBRATION
Test Receiver ROHDE & SCHWARZ	ESI7	100033	Jul. 06, 2009	Jul. 05, 2010
Spectrum Analyzer ROHDE & SCHWARZ	FSP40	100076	May. 26, 2009	May. 25, 2010
BILOG Antenna SCHWARZBECK	VULB9168	9168-160	Apr. 27, 2009	Apr. 26, 2010
HORN Antenna SCHWARZBECK	9120D	9120D-209	Jul. 01, 2009	Jun. 30, 2010
HORN Antenna SCHWARZBECK	BBHA 9170	BBHA9170243	Dec. 25, 2008	Dec. 24, 2009
Preamplifier Agilent	8447D	2944A10633	Nov. 03, 2008	Nov. 02, 2009
Preamplifier Agilent	8449B	3008A01964	Oct. 23, 2008	Oct. 22, 2009
RF signal cable HUBER+SUHNNER	SUCOFLEX 104	238141/4	May 13, 2009	May 12, 2010
RF signal cable HUBER+SUHNNER	SUCOFLEX 104	12738/6	May 13, 2009	May 12, 2010
Software ADT.	ADT_Radiated_ V7.6.15.9.2	NA	NA	NA
Antenna Tower inn-co GmbH	MA 4000	013303	NA	NA
Antenna Tower Controller inn-co GmbH	CO2000	017303	NA	NA
Turn Table ADT.	TT100.	TT93021703	NA	NA
Turn Table Controller ADT.	SC100.	SC93021703	NA	NA

**NOTE:** The calibration interval of the above test instruments is 12 months and the calibrations are traceable to NML/ROC and NIST/USA.



A D T

#### 4.6.3 TEST PROCEDURE

- a. The EUT was placed on the top of a rotating table 0.8 meters above the ground at a 3 meter semi-anechoic chamber. The table was rotated 360 degrees to determine the position of the highest radiation.
- b. The EUT was set 3 meters away from the interference-receiving antenna, which was mounted on the top of a variable-height antenna tower.
- c. The antenna is a broadband antenna, and its height is varied from one meter to four meters above the ground to determine the maximum value of the field strength. Both horizontal and vertical polarizations of the antenna are set to make the measurement.
- d. For each suspected emission, the EUT was arranged to its worst case and then the antenna was tuned to heights from 1 meter to 4 meters and the rotatable table was turned from 0 degrees to 360 degrees to find the maximum reading.
- e. Set both RBW and VBW of spectrum analyzer to 100kHz and 300kHz with suitable frequency span including 100MHz bandwidth from band edge. The band edges was measured and recorded.

The spectrum plots (Peak RBW = 100kHz, VBW = 300kHz) are attached on the following pages.

**NOTE:** The resolution bandwidth of test receiver/spectrum analyzer is 1MHz and the video bandwidth is 10Hz for Average detection (AV) at frequency above 1GHz.

#### 4.6.4 DEVIATION FROM TEST STANDARD

No deviation.

#### 4.6.5 EUT OPERATING CONDITION

Same as Item 4.3.6.

#### 4.6.6 TEST RESULTS

The spectrum plots are attached on the following pages. D1 line indicates the highest level, and D2 line indicates the 20dB offset below D1. It shows compliance with the requirement in part 15.247(d).

#### 802.11b DSSS MODULATION

**NOTE 1:** The band edge emission plot on the next page shows 45.51dBuV between carrier maximum power and local maximum emission in restrict band (2.32380GHz). The emission of carrier strength list in the test result of channel 1 at the item 4.1.7 is 101.01dBuV/m (Peak), so the maximum field strength in restrict band is  $101.01 - 45.51 = 55.50$ dBuV/m which is under 74dBuV/m limit.

The band edge emission plot of on the next page shows 58.80dBuV between carrier maximum power and local maximum emission in restrict band (2.33620GHz). The emission of carrier strength list in the test result of channel 1 at the item 4.1.7 is 96.48dBuV/m (Average), so the maximum field strength in restrict band is  $96.48 - 58.80 = 37.68$ dBuV/m which is under 54dBuV/m limit.

**NOTE 2:** The band edge emission plot on the next second page shows 44.90dBuV between carrier maximum power and local maximum emission in restrict band (2.49100GHz). The emission of carrier strength list in the test result of channel 11 at the item 4.1.7 is 100.94dBuV/m (Peak), so the maximum field strength in restrict band is  $100.94 - 44.90 = 56.04$ dBuV/m which is under 74dBuV/m limit.

The band edge emission plot on the next third page shows 59.15dBuV between carrier maximum power and local maximum emission in restrict band (2.48360GHz). The emission of carrier strength list in the test result of channel 11 at the item 4.1.7 is 96.31dBuV/m (Average), so the maximum field strength in restrict band is  $96.31 - 59.15 = 37.16$ dBuV/m which is under 54dBuV/m limit.



A D T

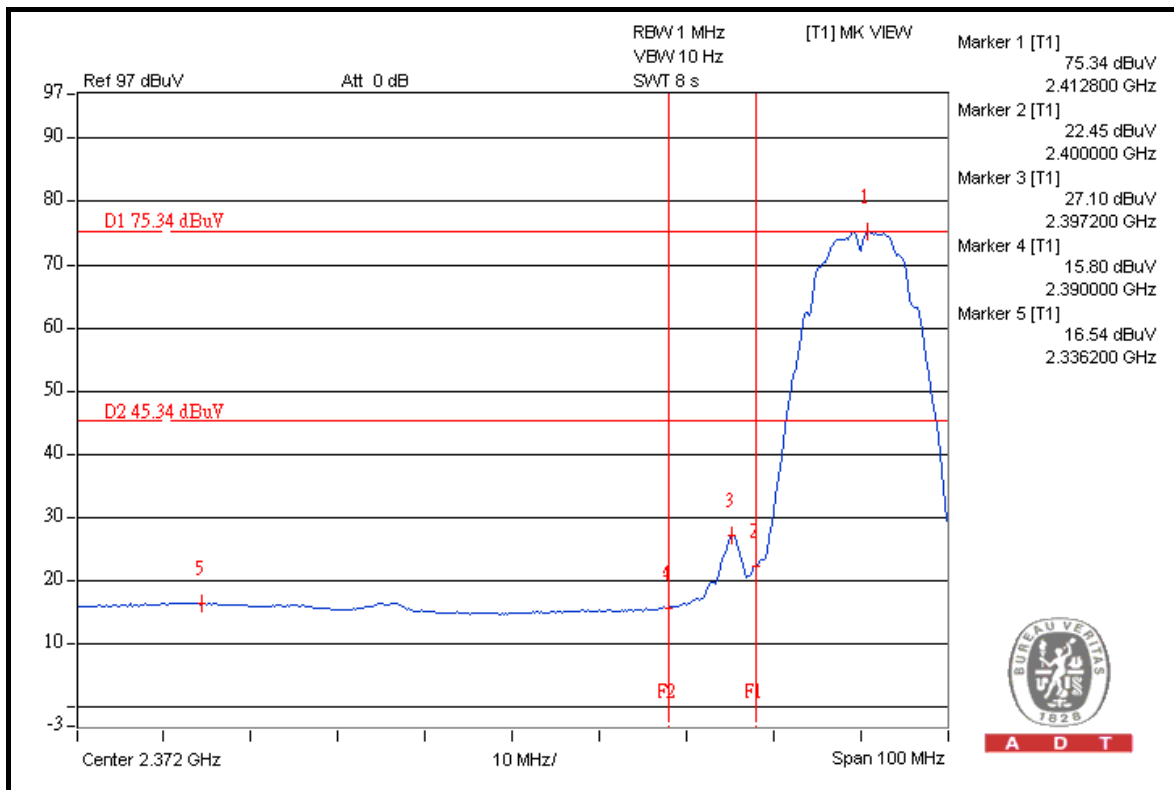
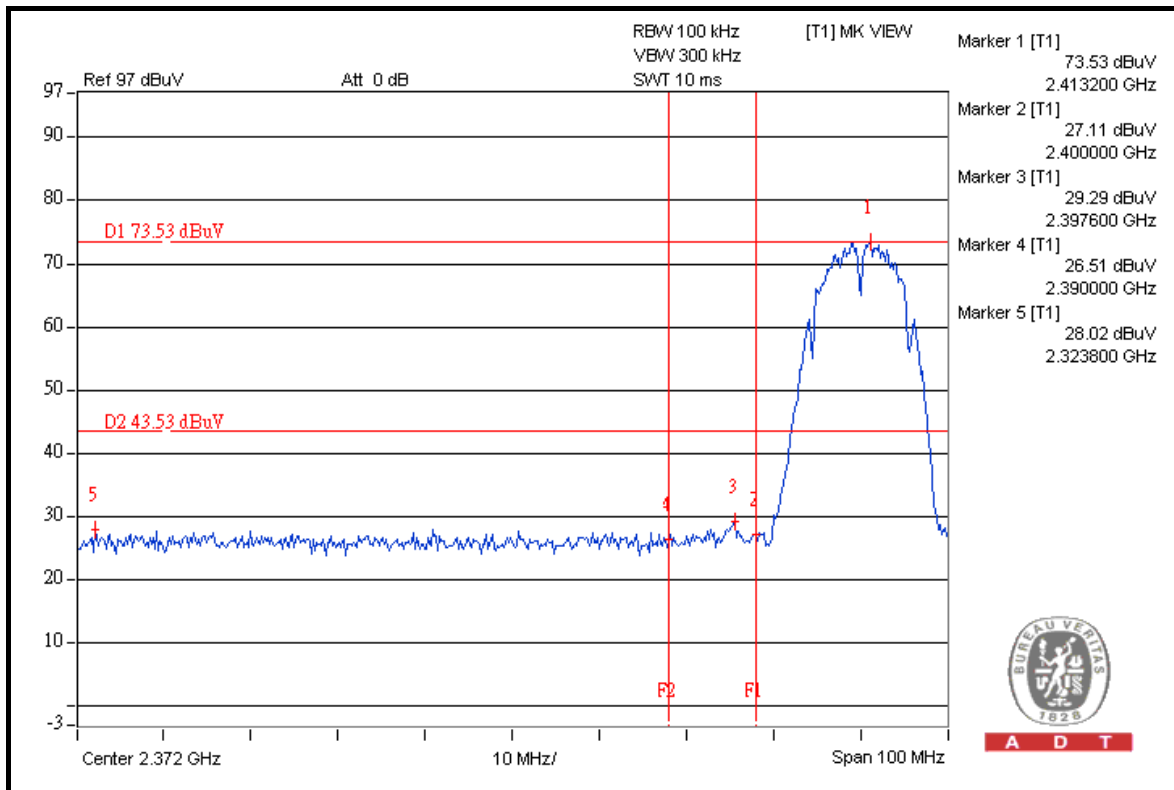



A D T

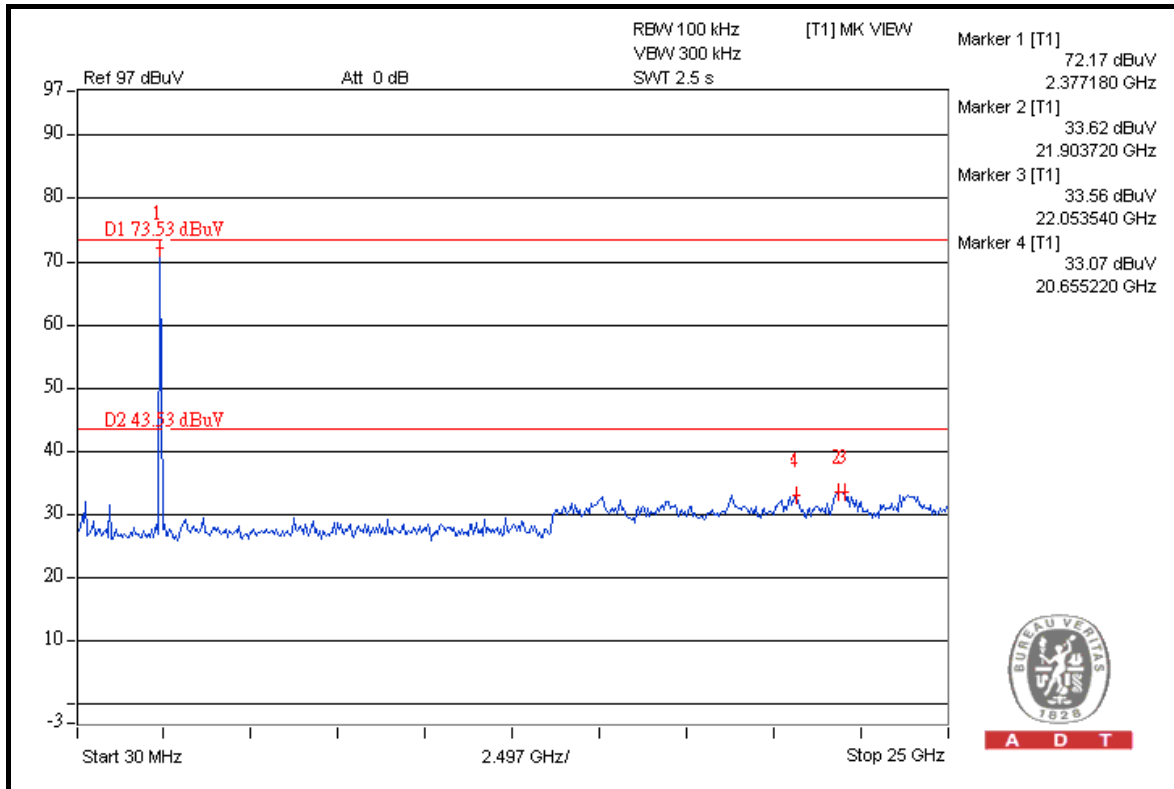

A D T

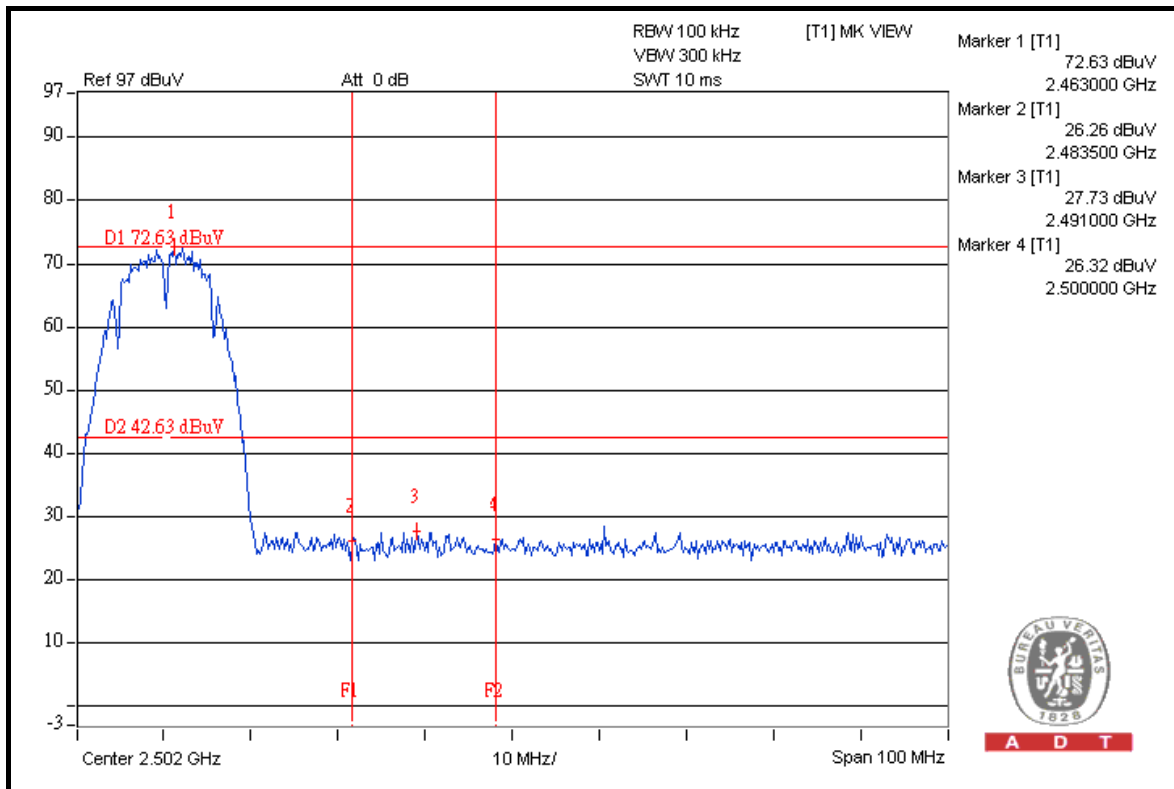

A D T





A D T

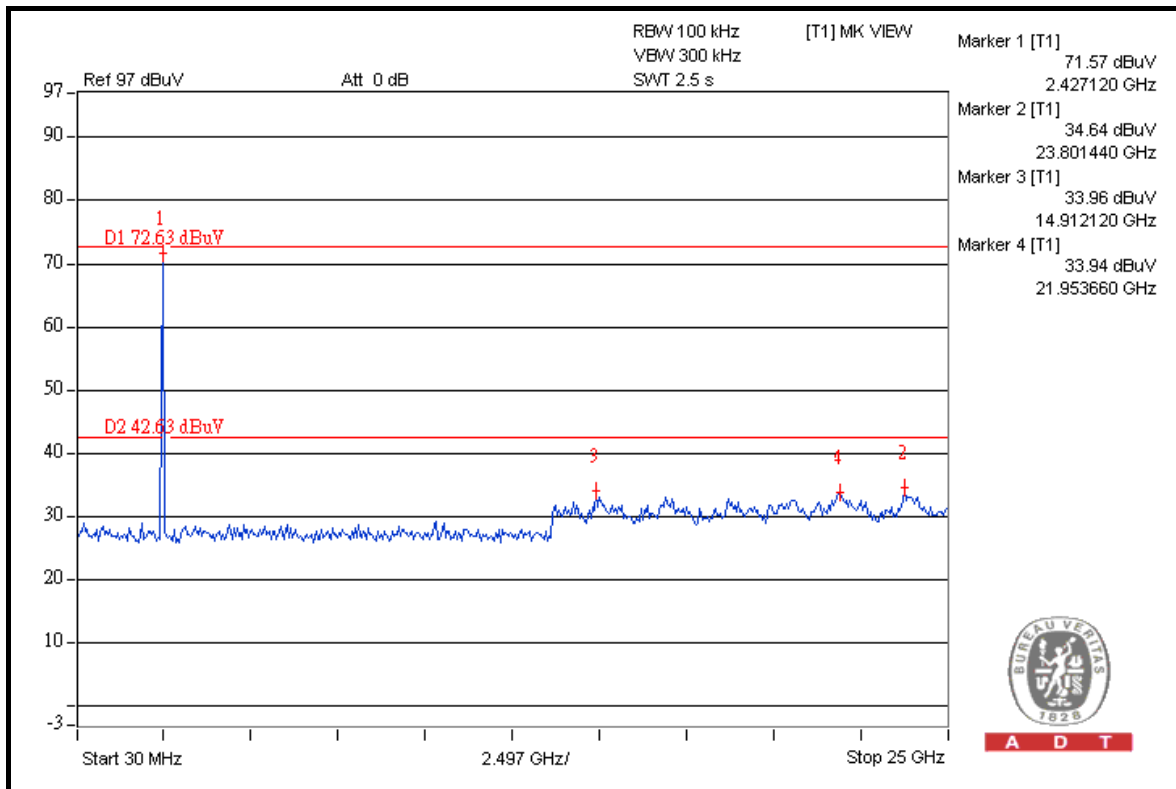
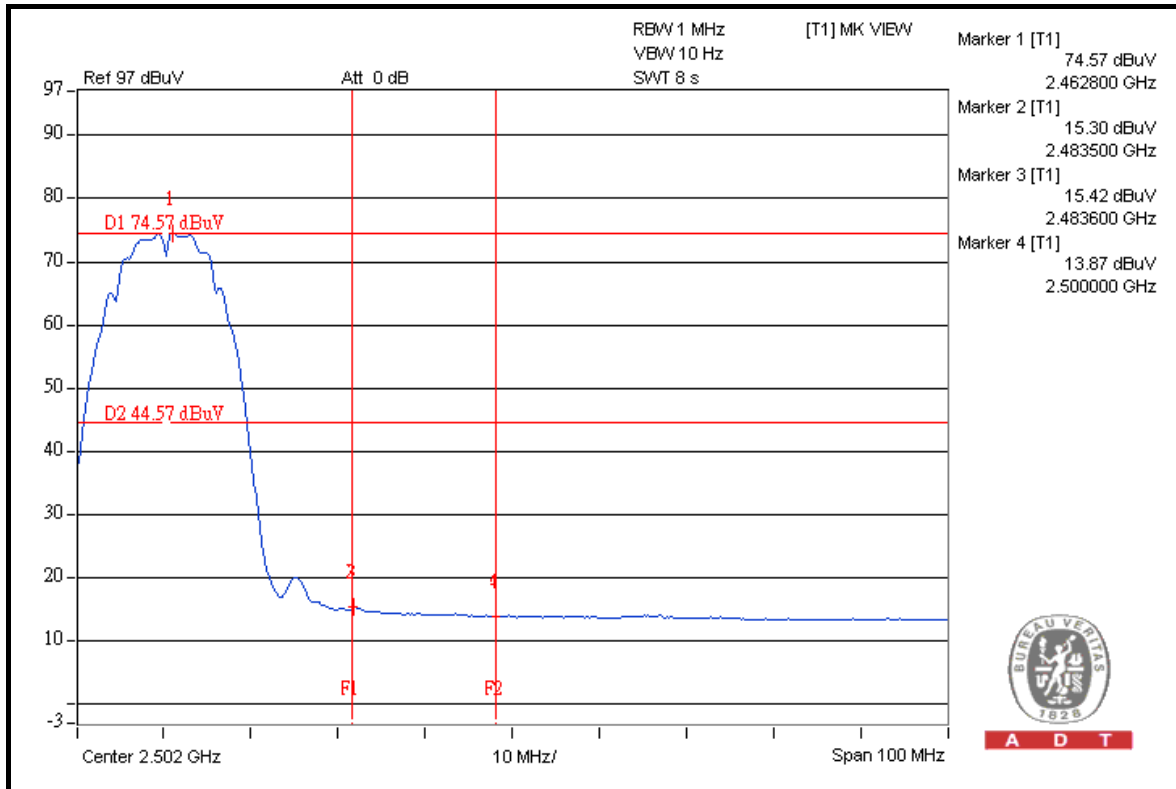



## 802.11g OFDM MODULATION

**NOTE 1:** The band edge emission plot on the next page shows 37.70dBuV between carrier maximum power and local maximum emission in restrict band (2.35120GHz). The emission of carrier strength list in the test result of channel 1 at the item 4.1.7 is 99.91dBuV/m (Peak), so the maximum field strength in restrict band is  $99.91 - 37.70 = 62.21$ dBuV/m which is under 74dBuV/m limit.

The band edge emission plot of on the next page shows 50.51dBuV between carrier maximum power and local maximum emission in restrict band (2.35960GHz). The emission of carrier strength list in the test result of channel 1 at the item 4.1.7 is 89.06dBuV/m (Average), so the maximum field strength in restrict band is  $89.06 - 50.51 = 38.55$ dBuV/m which is under 54dBuV/m limit.

**NOTE 2:** The band edge emission plot on the next second page shows 37.99dBuV between carrier maximum power and local maximum emission in restrict band (2.48520GHz). The emission of carrier strength list in the test result of channel 11 at the item 4.1.7 is 99.98dBuV/m (Peak), so the maximum field strength in restrict band is  $99.98 - 37.99 = 61.99$ dBuV/m which is under 74dBuV/m limit.

The band edge emission plot on the next third page shows 52.42dBuV between carrier maximum power and local maximum emission in restrict band (2.48350GHz). The emission of carrier strength list in the test result of channel 11 at the item 4.1.7 is 89.22dBuV/m (Average), so the maximum field strength in restrict band is  $89.22 - 52.42 = 36.80$ dBuV/m which is under 54dBuV/m limit.



A D T

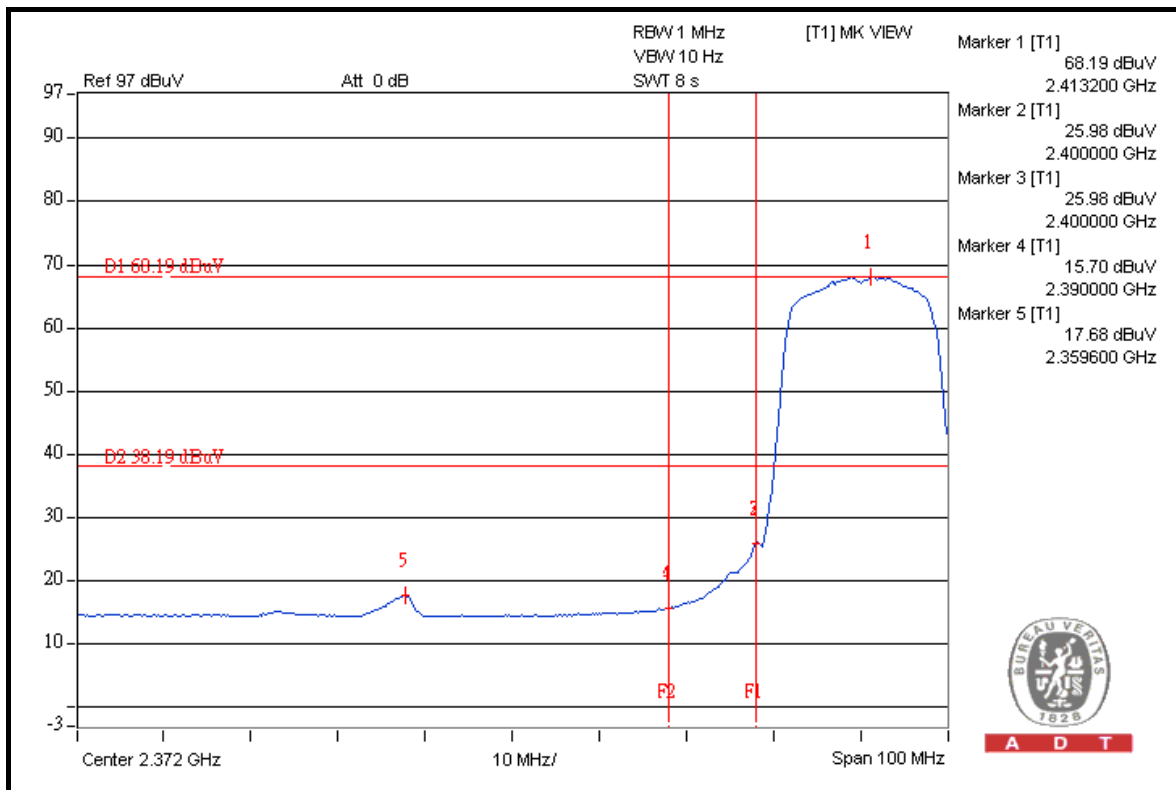
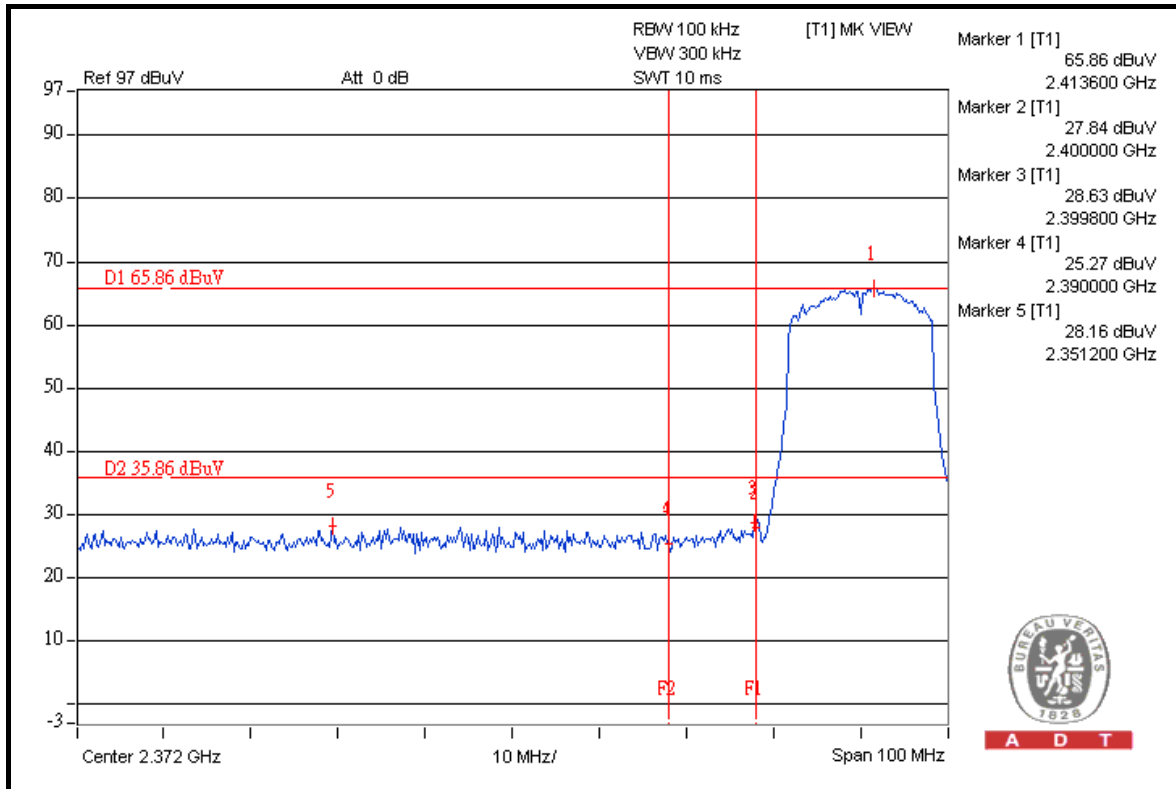



A D T

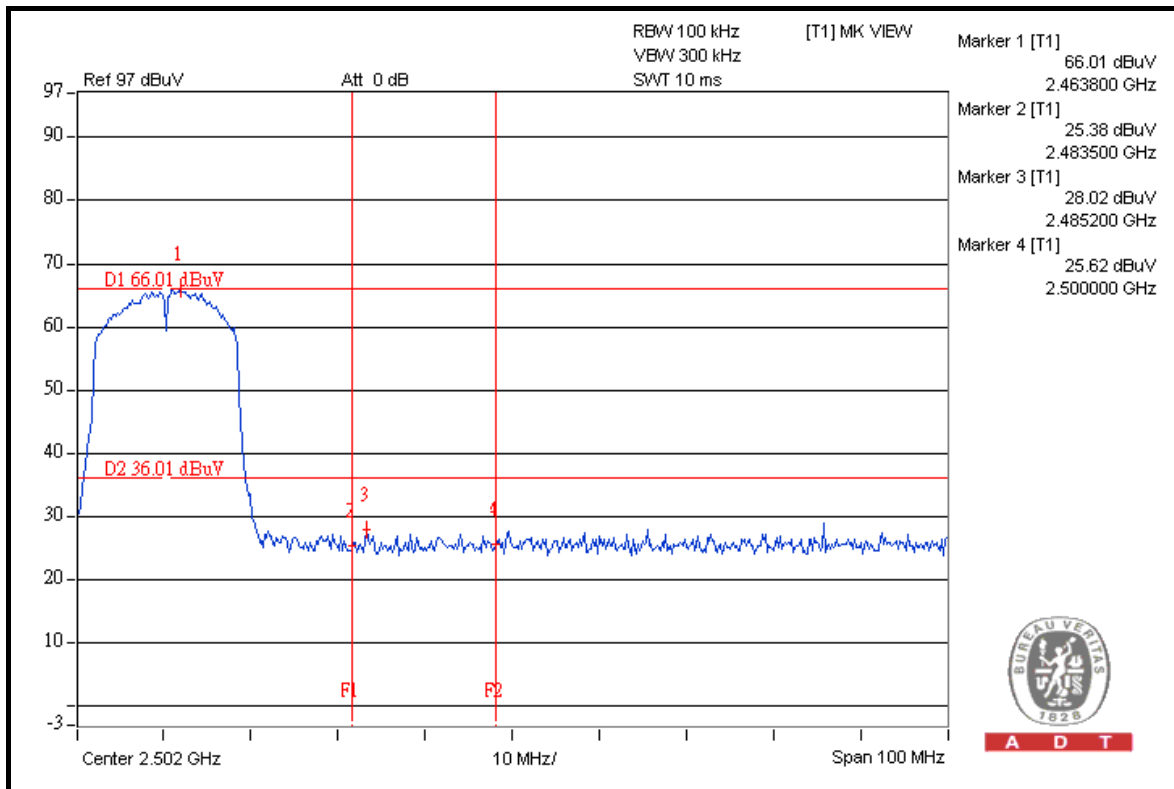
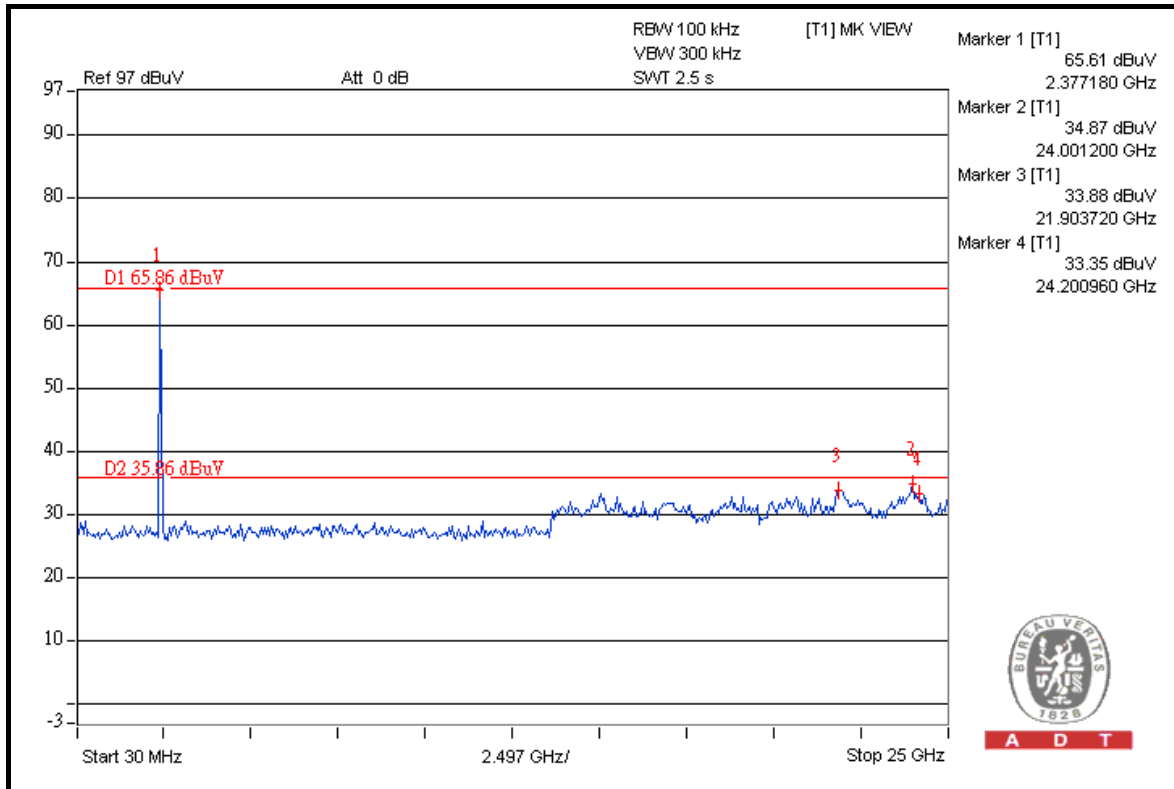



A D T

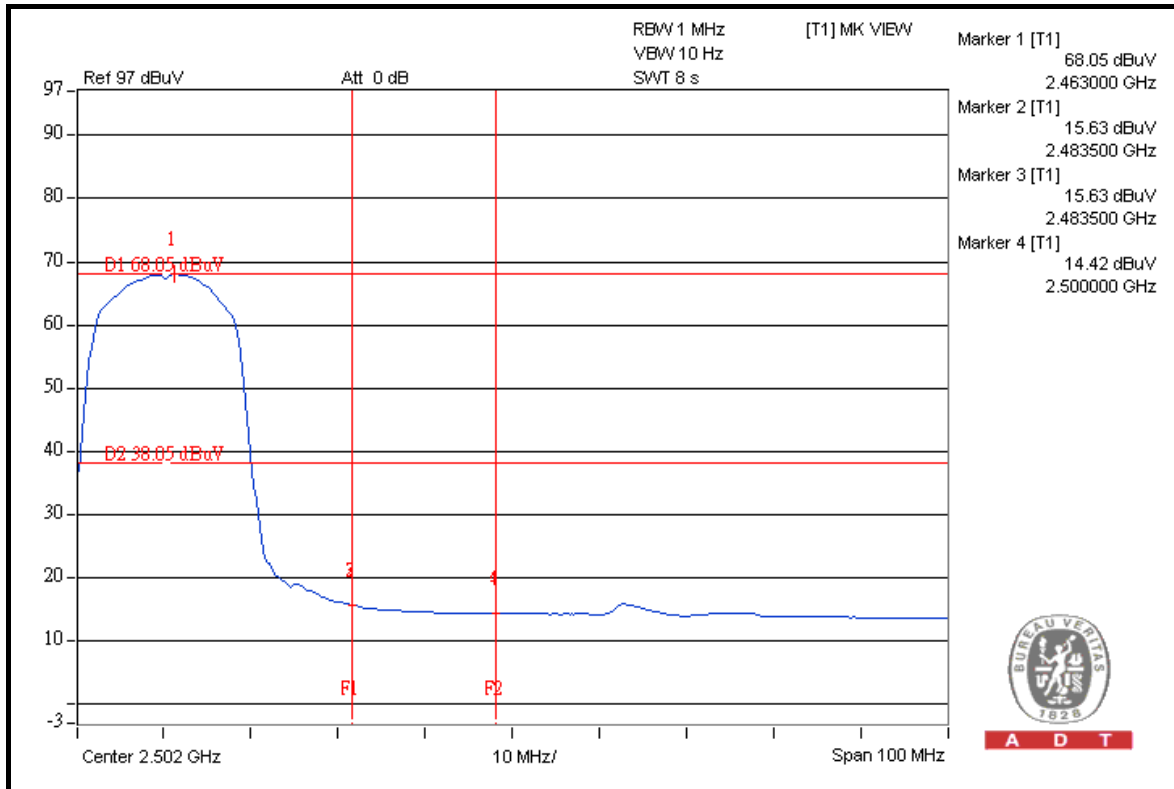

A D T

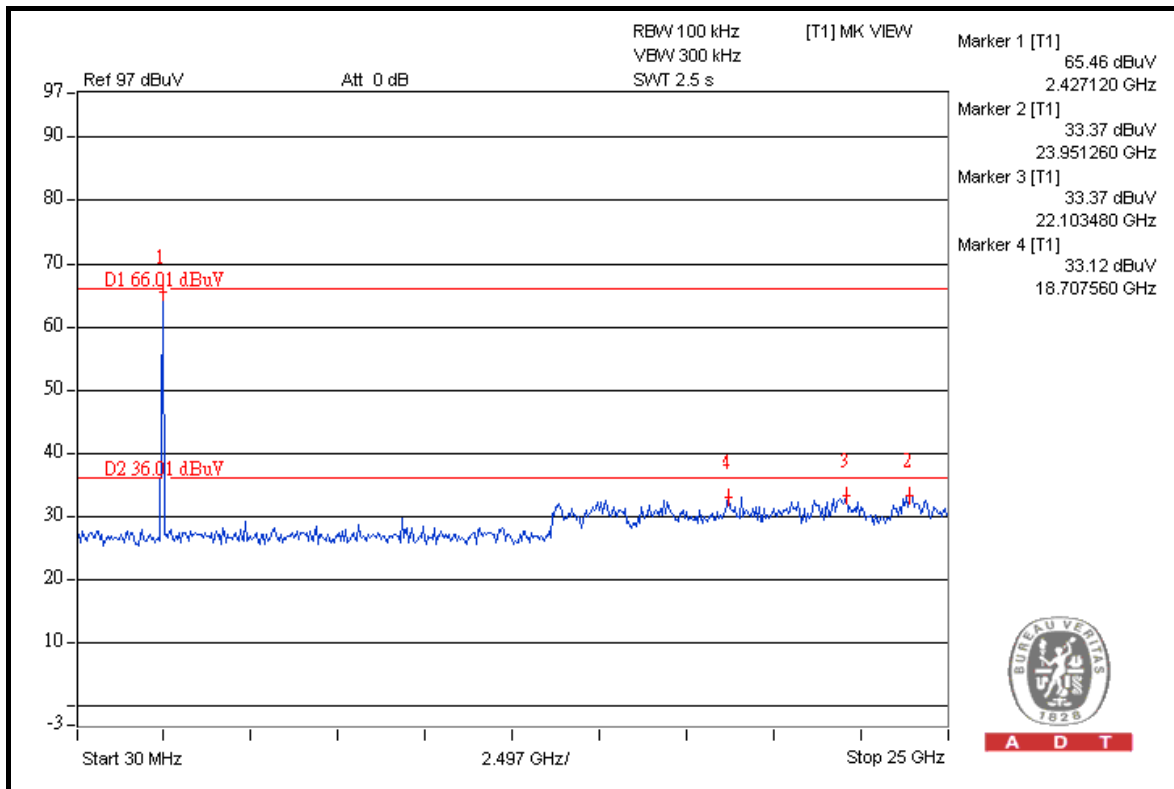

A D T



A D T

## DRAFT 802.11n (20MHz) OFDM MODULATION

**NOTE 1:** The band edge emission plot on the next page shows 37.96dBuV between carrier maximum power and local maximum emission in restrict band (2.34340GHz). The emission of carrier strength list in the test result of channel 1 at the item 4.1.7 is 99.03dBuV/m (Peak), so the maximum field strength in restrict band is  $99.03 - 37.96 = 61.07$ dBuV/m which is under 74dBuV/m limit.

The band edge emission plot of on the next page shows 49.75dBuV between carrier maximum power and local maximum emission in restrict band (2.36000GHz). The emission of carrier strength list in the test result of channel 1 at the item 4.1.7 is 89.25dBuV/m (Average), so the maximum field strength in restrict band is  $89.25 - 49.75 = 39.50$ dBuV/m which is under 54dBuV/m limit.

**NOTE 2:** The band edge emission plot on the next second page shows 37.81dBuV between carrier maximum power and local maximum emission in restrict band (2.49780GHz). The emission of carrier strength list in the test result of channel 11 at the item 4.1.7 is 99.40dBuV/m (Peak), so the maximum field strength in restrict band is  $99.40 - 37.81 = 61.59$ dBuV/m which is under 74dBuV/m limit.

The band edge emission plot on the next third page shows 53.27dBuV between carrier maximum power and local maximum emission in restrict band (2.48350GHz). The emission of carrier strength list in the test result of channel 11 at the item 4.1.7 is 89.48dBuV/m (Average), so the maximum field strength in restrict band is  $89.48 - 53.27 = 36.21$ dBuV/m which is under 54dBuV/m limit.



A D T

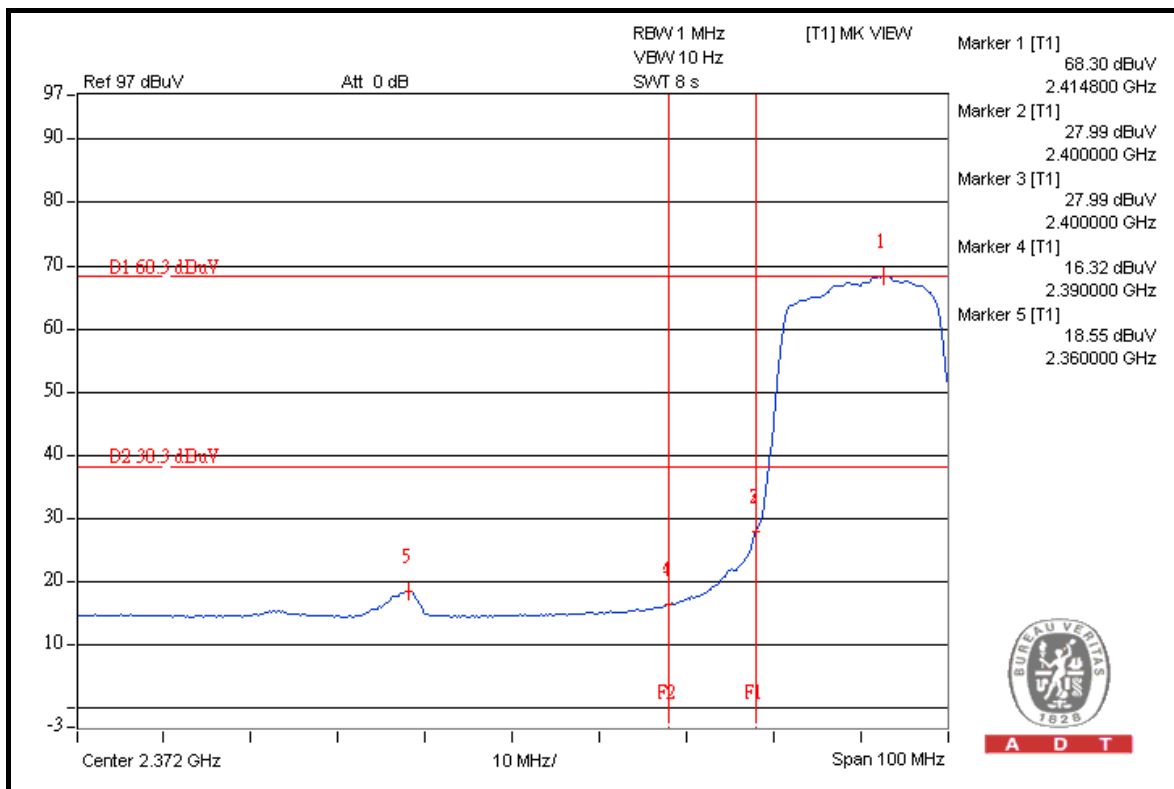
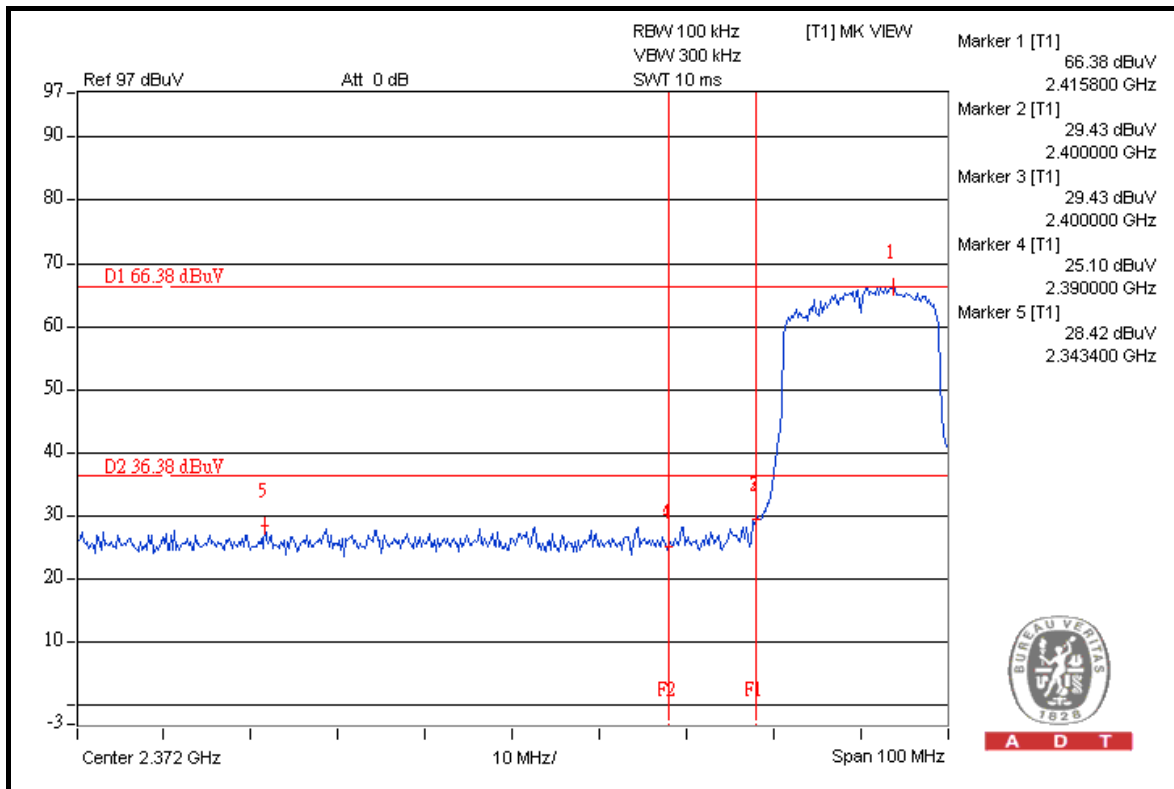



A D T

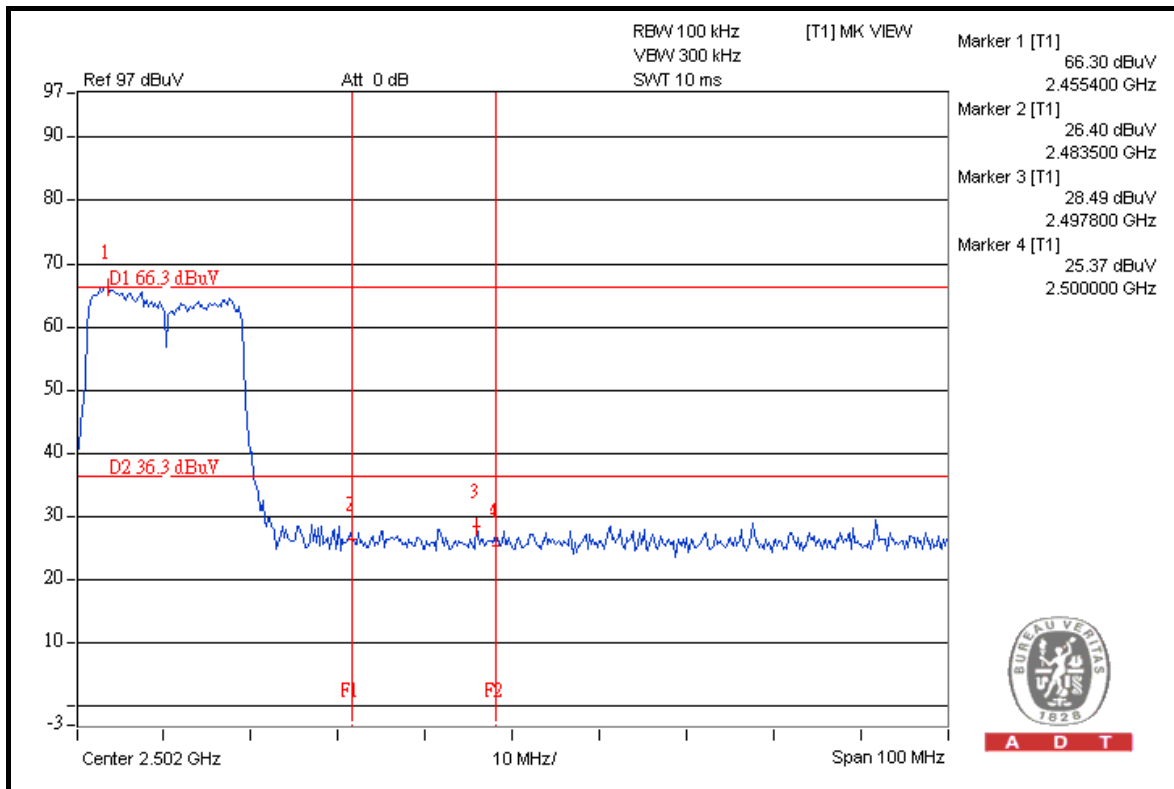
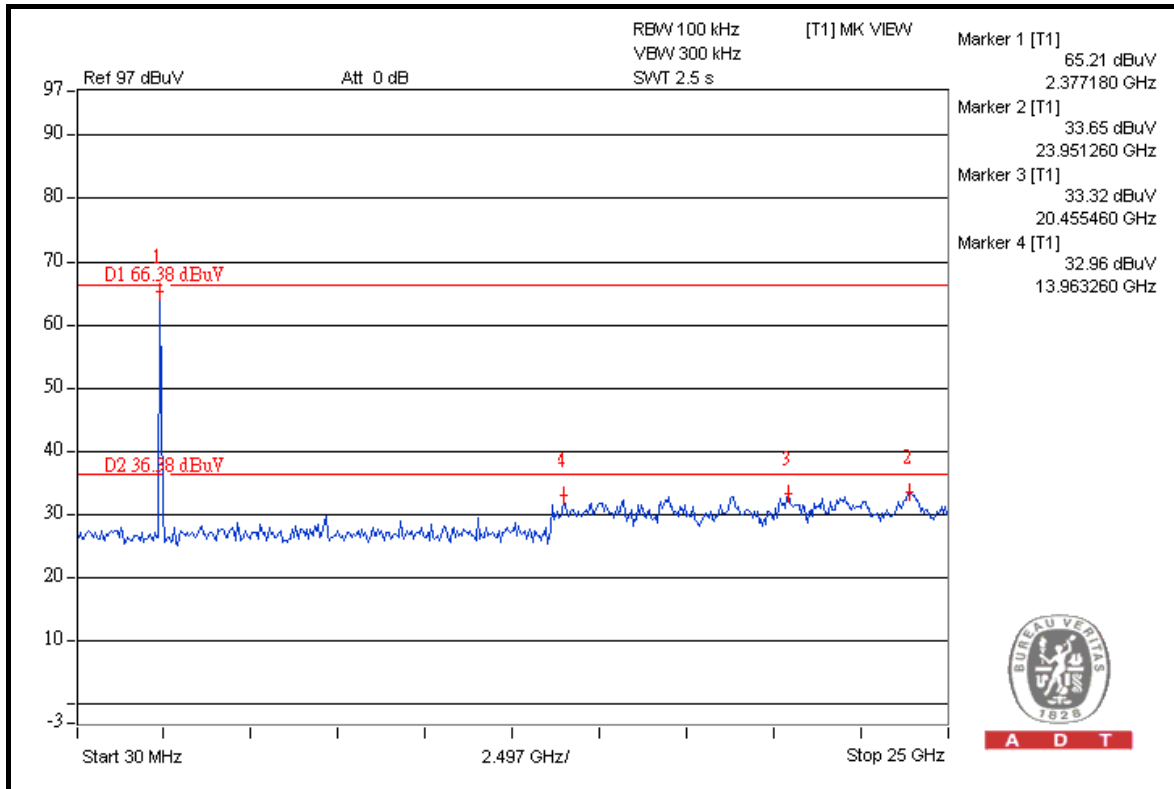





A D T

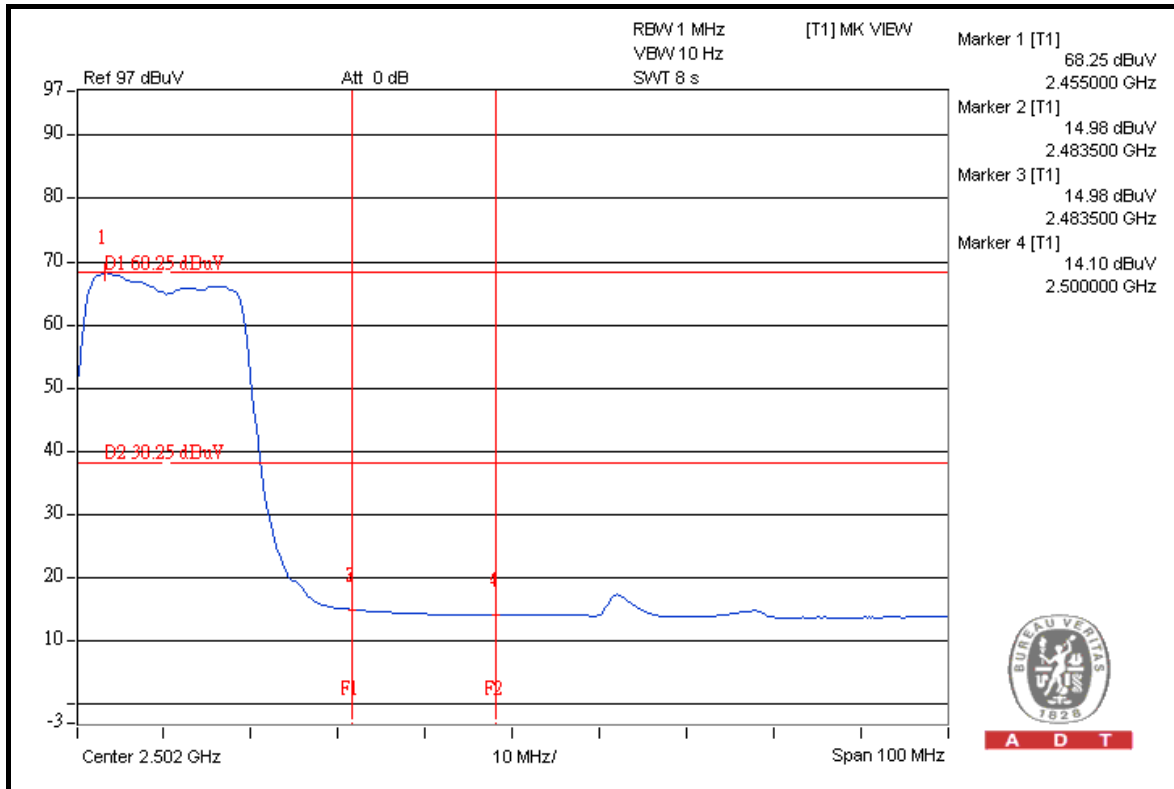

A D T

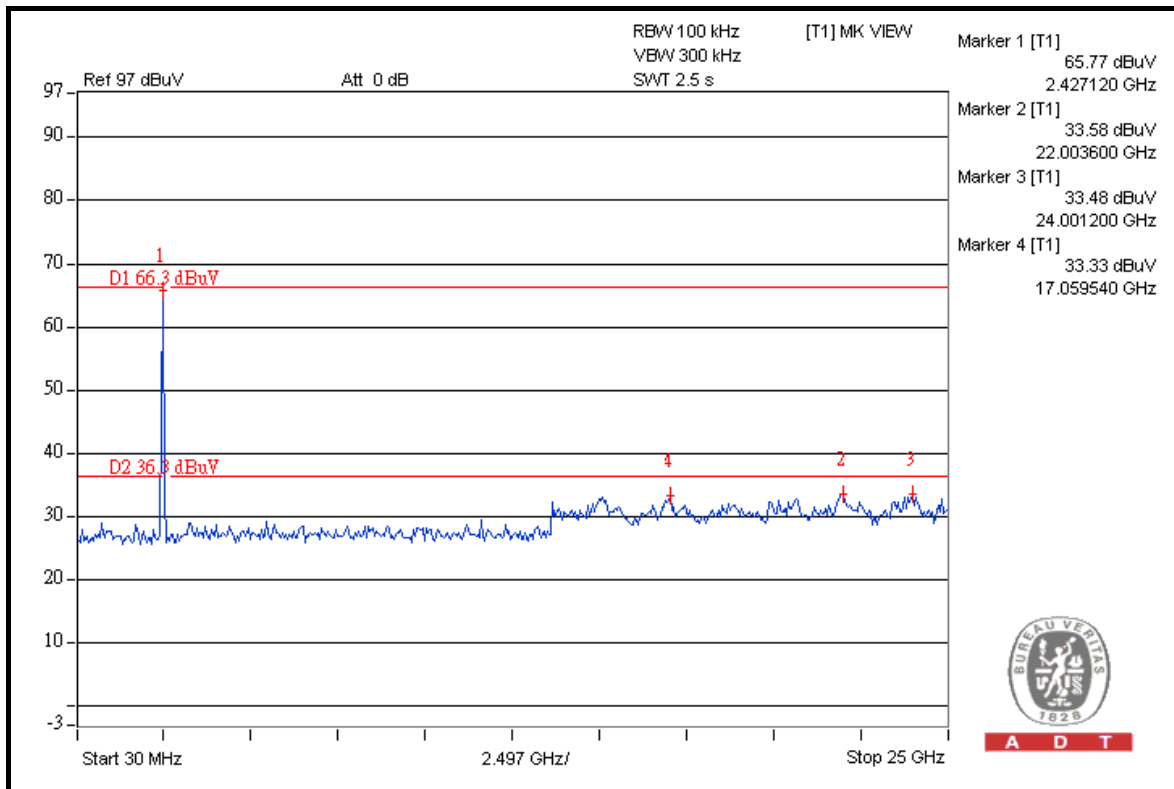

A D T



## DRAFT 802.11n (40MHz) OFDM MODULATION

**NOTE 1:** The band edge emission plot on the next page shows 34.63dBuV between carrier maximum power and local maximum emission in restrict band (2.31560GHz). The emission of carrier strength list in the test result of channel 1 at the item 4.1.7 is 96.91dBuV/m (Peak), so the maximum field strength in restrict band is  $96.91 - 34.63 = 62.28$ dBuV/m which is under 74dBuV/m limit.

The band edge emission plot of on the next page shows 46.76dBuV between carrier maximum power and local maximum emission in restrict band (2.39000GHz). The emission of carrier strength list in the test result of channel 1 at the item 4.1.7 is 86.03dBuV/m (Average), so the maximum field strength in restrict band is  $86.03 - 46.76 = 39.27$ dBuV/m which is under 54dBuV/m limit.

**NOTE 2:** The band edge emission plot on the next second page shows 35.07dBuV between carrier maximum power and local maximum emission in restrict band (2.49680GHz). The emission of carrier strength list in the test result of channel 7 at the item 4.1.7 is 96.67dBuV/m (Peak), so the maximum field strength in restrict band is  $96.67 - 35.07 = 61.60$ dBuV/m which is under 74dBuV/m limit.

The band edge emission plot on the next third page shows 49.43dBuV between carrier maximum power and local maximum emission in restrict band (2.48350GHz). The emission of carrier strength list in the test result of channel 7 at the item 4.1.7 is 86.12dBuV/m (Average), so the maximum field strength in restrict band is  $86.12 - 49.43 = 36.69$ dBuV/m which is under 54dBuV/m limit.



A D T

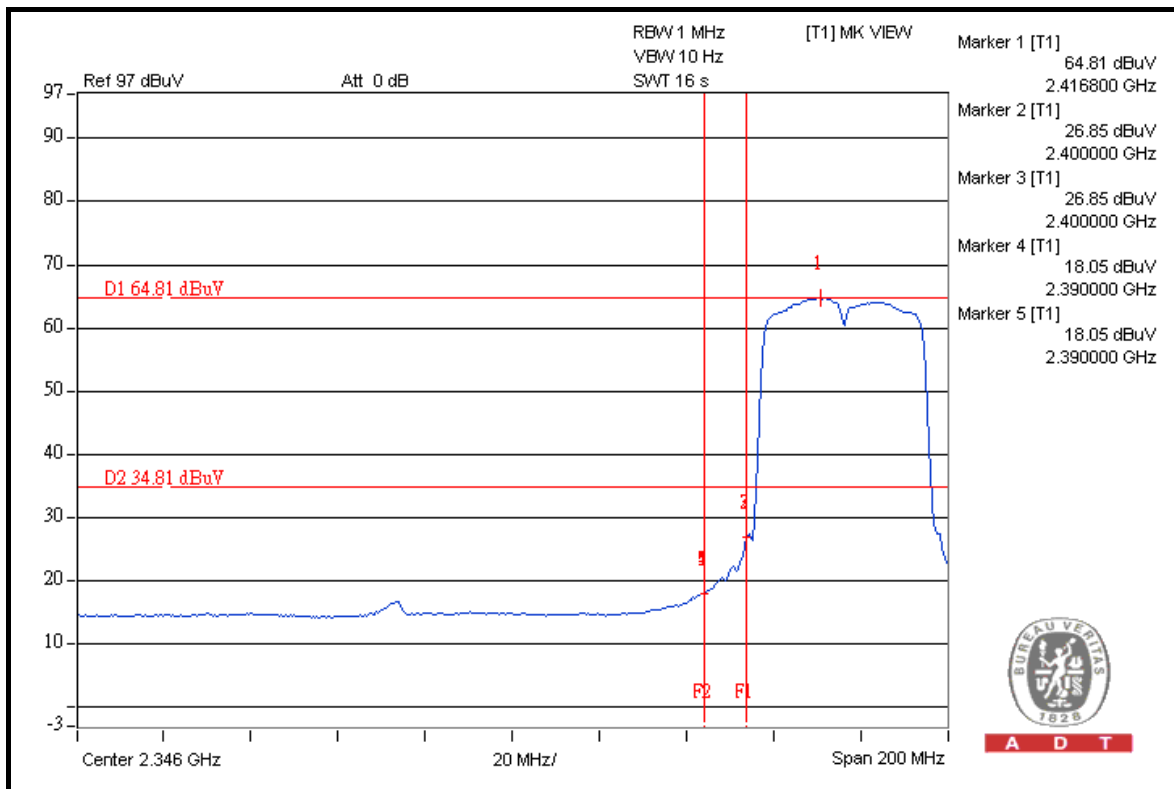
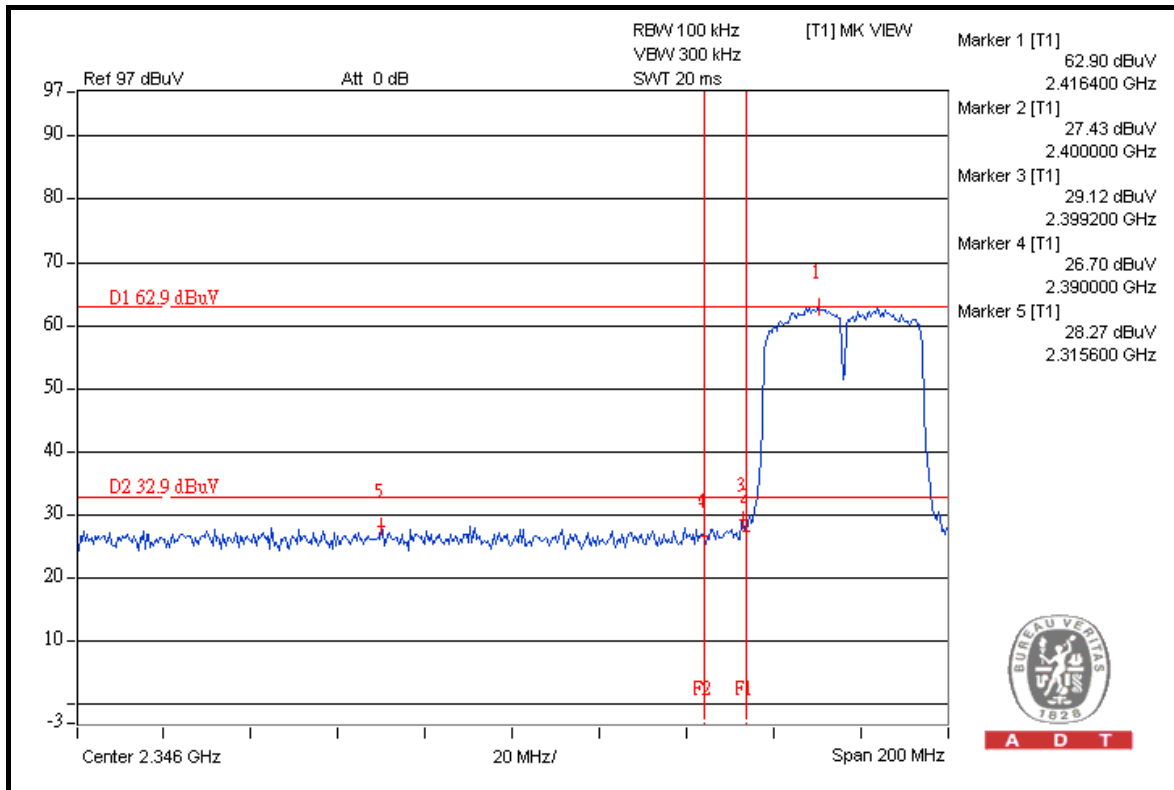



A D T

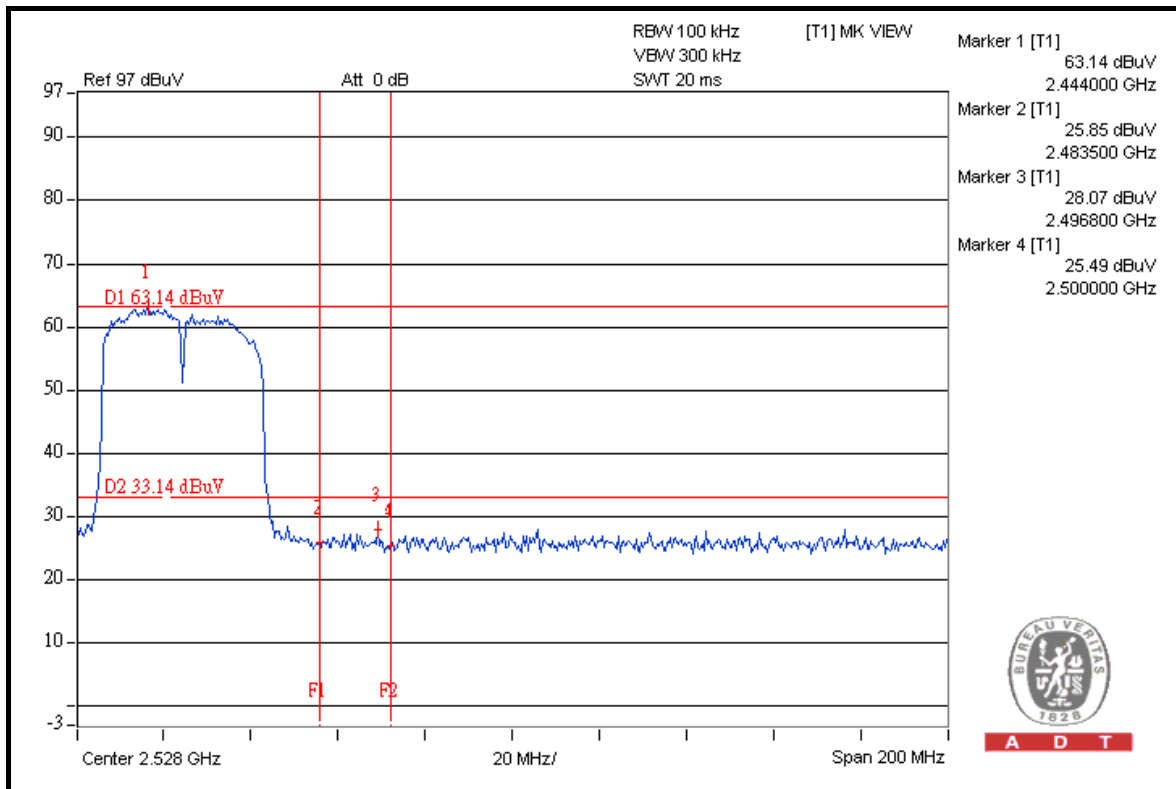
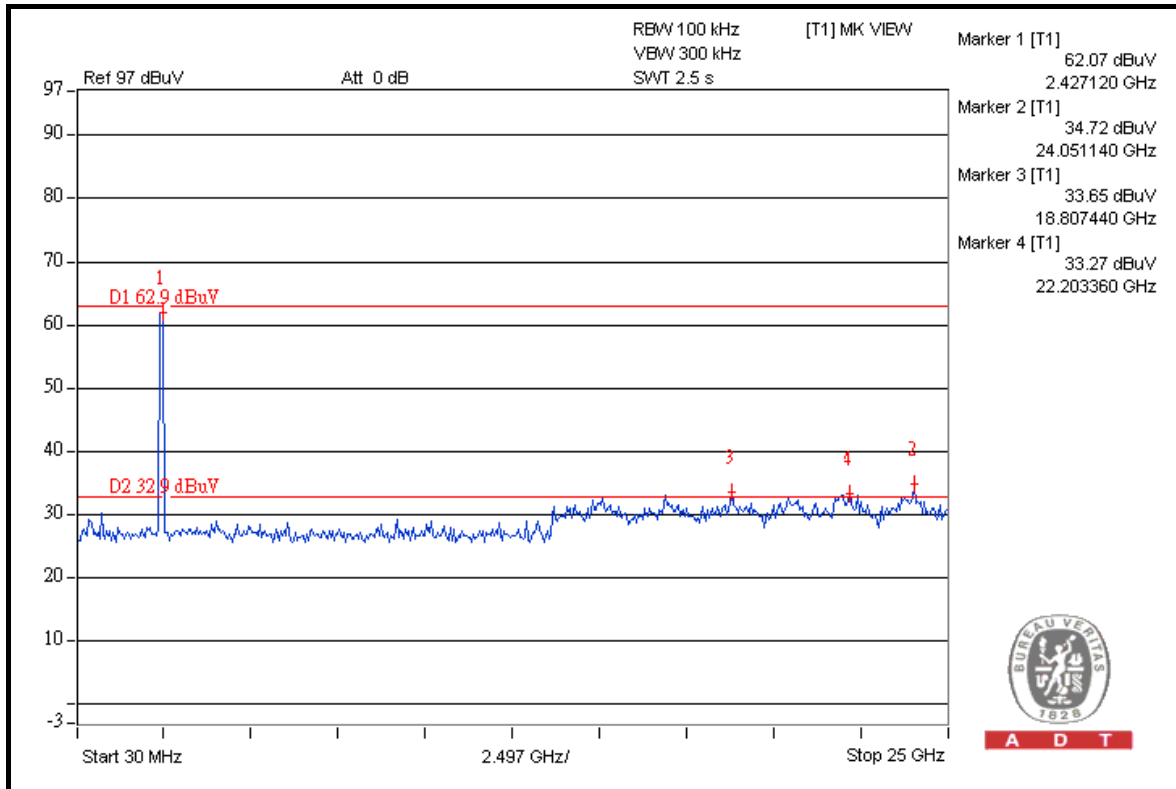



A D T

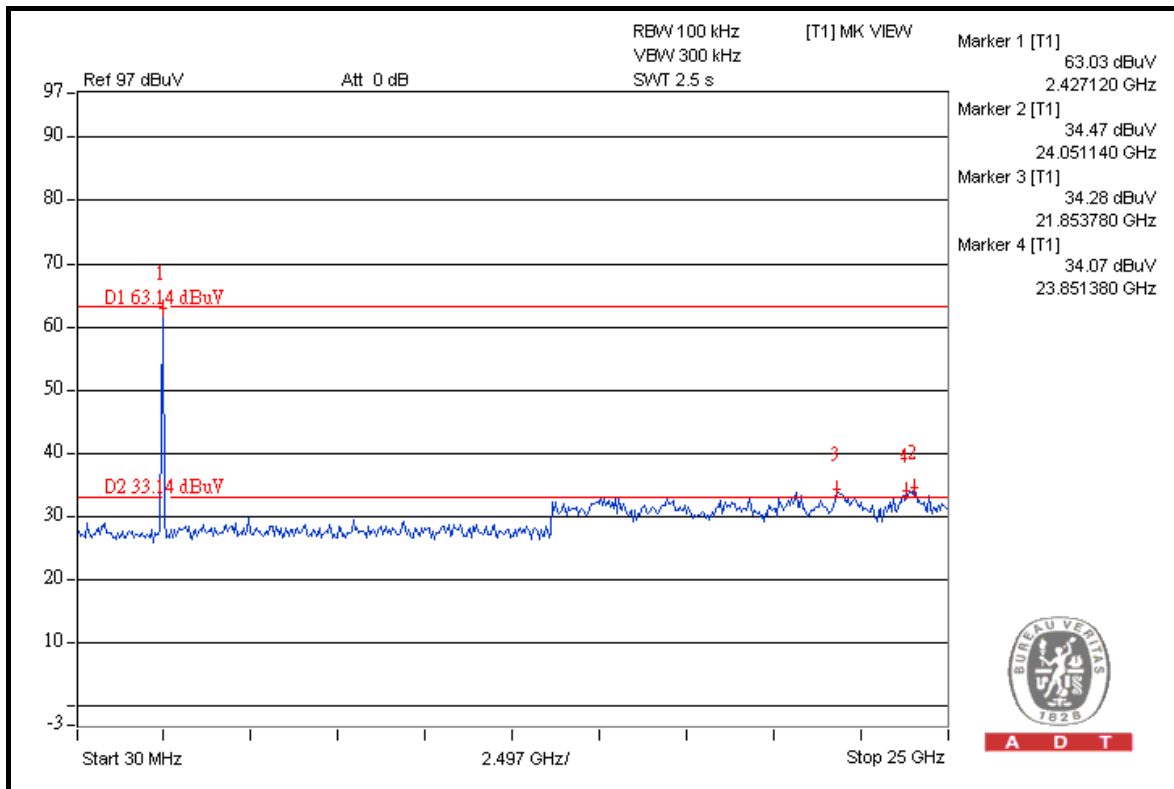
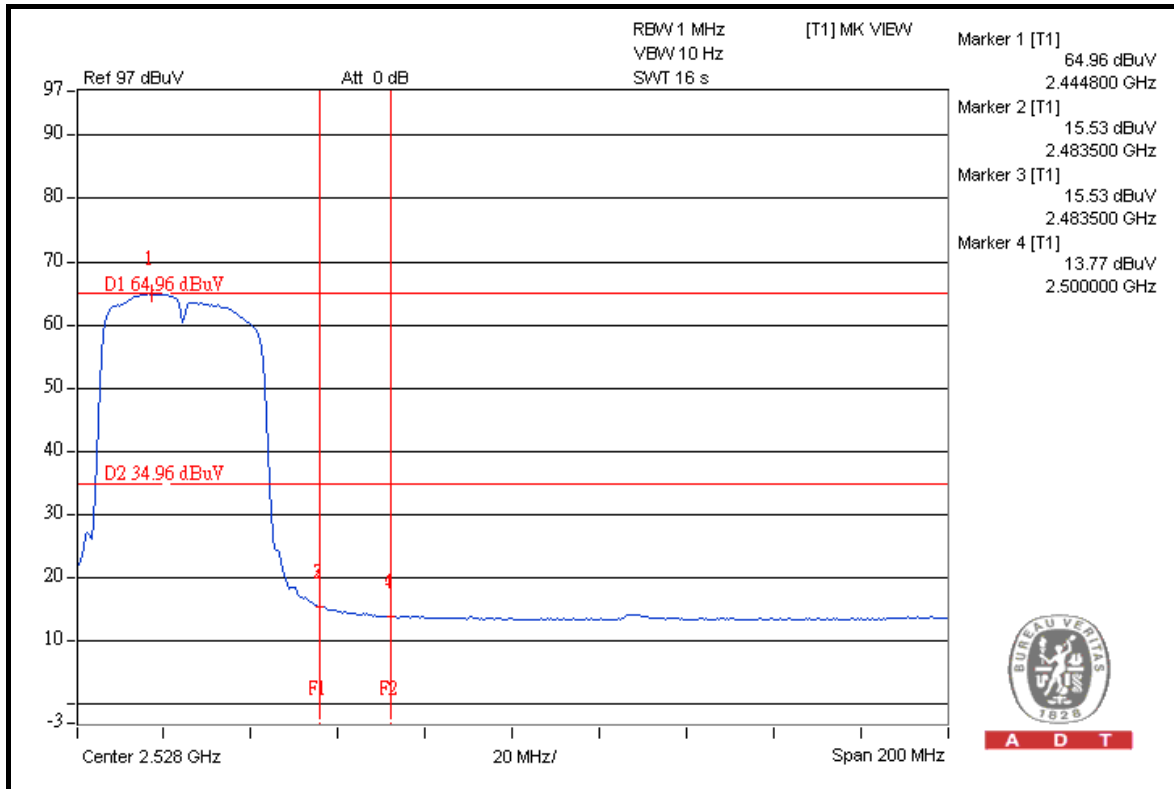



A D T

## 4.7 ANTENNA REQUIREMENT

### 4.7.1 STANDARD APPLICABLE

For intentional device, according to FCC 47 CFR Section 15.203, an intentional radiator shall be designed to ensure that no antenna other than that furnished by the responsible party shall be used with the device.

And according to FCC 47 CFR Section 15.247 (b), if transmitting antennas of directional gain greater than 6dBi are used, the power shall be reduced by the amount in dB that the directional gain of the antenna exceeds 6dBi.

### 4.7.2 ANTENNA CONNECTED CONSTRUCTION

The antenna used in this product is Printed antenna without connector. The maximum gain of the antenna is -3dBi.



## 5. TEST TYPES AND RESULTS (FOR 5.0GHz BAND)

### 5.1 RADIATED EMISSION MEASUREMENT

#### 5.1.1 LIMITS OF RADIATED EMISSION MEASUREMENT

Emissions radiated outside of the specified bands, shall be according to the general radiated limits in 15.209 as following:

FREQUENCIES (MHz)	FIELD STRENGTH (microvolts/meter)	MEASUREMENT DISTANCE (meters)
0.009 ~ 0.490	2400/F(kHz)	300
0.490 ~ 1.705	24000/F(kHz)	30
1.705 ~ 30.0	30	30
30 ~ 88	100	3
88 ~ 216	150	3
216 ~ 960	200	3
Above 960	500	3

**NOTE:**

1. The lower limit shall apply at the transition frequencies.
2. Emission level (dBuV/m) = 20 log Emission level (uV/m).
3. As shown in 15.35(b), for frequencies above 1000MHz, the field strength limits are based on average detector, however, the peak field strength of any emission shall not exceed the maximum permitted average limits, specified above by more than 20dB under any condition of modulation.



A D T

### 5.1.2 TEST INSTRUMENTS

DESCRIPTION & MANUFACTURER	MODEL NO.	SERIAL NO.	DATE OF CALIBRATION	DUE DATE OF CALIBRATION
Test Receiver ROHDE & SCHWARZ	ESI7	100033	Jul. 06, 2009	Jul. 05, 2010
Spectrum Analyzer ROHDE & SCHWARZ	FSP40	100076	May. 26, 2009	May. 25, 2010
BILOG Antenna SCHWARZBECK	VULB9168	9168-160	Apr. 27, 2009	Apr. 26, 2010
HORN Antenna SCHWARZBECK	9120D	9120D-209	Jul. 01, 2009	Jun. 30, 2010
HORN Antenna SCHWARZBECK	BBHA 9170	BBHA9170243	Dec. 25, 2008	Dec. 24, 2009
Preamplifier Agilent	8447D	2944A10633	Nov. 03, 2008	Nov. 02, 2009
Preamplifier Agilent	8449B	3008A01964	Oct. 23, 2008	Oct. 22, 2009
RF signal cable HUBER+SUHNNER	SUCOFLEX 104	238141/4	May 13, 2009	May 12, 2010
RF signal cable HUBER+SUHNNER	SUCOFLEX 104	12738/6	May 13, 2009	May 12, 2010
Software ADT.	ADT_Radiated_V7.6.15.9.2	NA	NA	NA
Antenna Tower inn-co GmbH	MA 4000	013303	NA	NA
Antenna Tower Controller inn-co GmbH	CO2000	017303	NA	NA
Turn Table ADT.	TT100.	TT93021703	NA	NA
Turn Table Controller ADT.	SC100.	SC93021703	NA	NA
26GHz ~ 40GHz Amplifier	EM26400	07026401	Aug. 27, 2008	Aug. 26, 2009

- NOTE:**
1. The calibration interval of the above test instruments is 12 months and the calibrations are traceable to NML/ROC and NIST/USA.
  2. The test was performed in HwaYa Chamber 3.
  3. The horn antenna and HP preamplifier (model: 8449B) are used only for the measurement of emission frequency above 1GHz if tested.
  4. The FCC Site Registration No. is 988962.
  5. The IC Site Registration No. is IC 7450F-3.





### 5.1.3 TEST PROCEDURES

- a. The EUT was placed on the top of a rotating table 0.8 meters above the ground at a 3 meters semi-anechoic chamber. The table was rotated 360 degrees to determine the position of the highest radiation.
- b. The EUT was set 3 meters away from the interference-receiving antenna, which was mounted on the top of a variable-height antenna tower.
- c. The antenna is a broadband antenna, and its height is varied from one meter to four meters above the ground to determine the maximum value of the field strength. Both horizontal and vertical polarizations of the antenna are set to make the measurement.
- d. For each suspected emission, the EUT was arranged to its worst case and then the antenna was tuned to heights from 1 meter to 4 meters and the rotatable table was turned from 0 degrees to 360 degrees to find the maximum reading.
- e. The test-receiver system was set to Peak Detect Function and Specified Bandwidth with Maximum Hold Mode.
- f. If the emission level of the EUT in peak mode was lower than the limit specified, then testing could be stopped and the peak values of the EUT would be reported. Otherwise the emissions would be re-tested one by one using peak, quasi-peak or average method as specified and then reported in a data sheet.

**NOTE:**

1. The resolution bandwidth and video bandwidth of test receiver/spectrum analyzer is 120kHz for Quasi-peak detection at frequency below 1GHz.
2. The resolution bandwidth of test receiver/spectrum analyzer is 1MHz and video bandwidth is 3MHz for Peak detection at frequency above 1GHz.
3. The resolution bandwidth of test receiver/spectrum analyzer is 1MHz and the video bandwidth is 10Hz for Average detection (AV) at frequency above 1GHz.
4. All modes of operation were investigated and the worst-case emissions are reported.

### 5.1.4 DEVIATION FROM TEST STANDARD

No deviation.

### 5.1.5 TEST SETUP

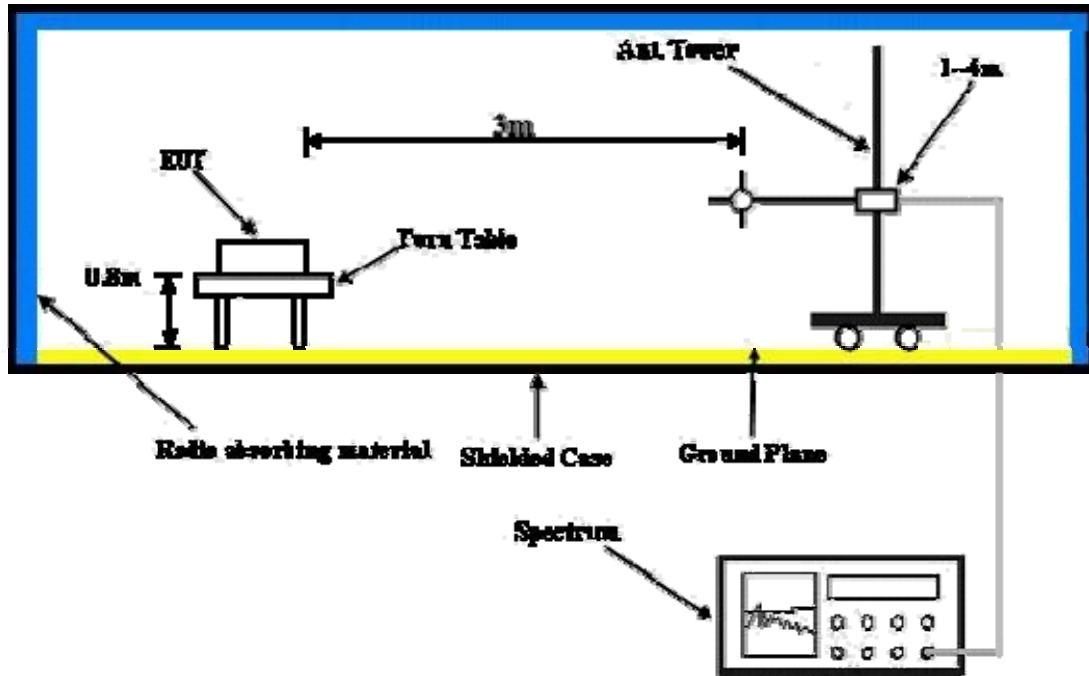

For the actual test configuration, please refer to the attached file (Test Setup Photo).

### 5.1.6 EUT OPERATING CONDITIONS

Same as 4.1.6.



A D T

### 5.1.7 TEST RESULTS

#### 802.11a OFDM MODULATION

EUT TEST CONDITION		MEASUREMENT DETAIL	
CHANNEL	Channel 149	FREQUENCY RANGE	1 ~ 40GHz
INPUT POWER (SYSTEM)	120Vac, 60 Hz	DETECTOR FUNCTION	Peak (PK) Average (AV)
ENVIRONMENTAL CONDITIONS	25deg. C, 65%RH 1000 hPa	TESTED BY	Brad Wu

ANTENNA POLARITY & TEST DISTANCE: HORIZONTAL AT 3 M								
NO.	FREQ. (MHz)	EMISSION LEVEL (dBuV/m)	LIMIT (dBuV/m)	MARGIN (dB)	ANTENNA HEIGHT (m)	TABLE ANGLE (Degree)	RAW VALUE (dBuV)	CORRECTION FACTOR (dB/m)
1	#5725.00	56.53 PK	73.60	-17.07	1.04 H	119	18.43	38.10
2	#5725.00	43.00 AV	63.39	-20.39	1.04 H	119	4.90	38.10
3	*5745.00	103.60 PK			1.04 H	119	65.47	38.13
4	*5745.00	93.39 AV			1.04 H	119	55.26	38.13
5	11490.00	59.18 PK	74.00	-14.82	1.00 H	24	10.75	48.43
6	11490.00	46.38 AV	54.00	-7.62	1.00 H	24	-2.05	48.43
ANTENNA POLARITY & TEST DISTANCE: VERTICAL AT 3 M								
NO.	FREQ. (MHz)	EMISSION LEVEL (dBuV/m)	LIMIT (dBuV/m)	MARGIN (dB)	ANTENNA HEIGHT (m)	TABLE ANGLE (Degree)	RAW VALUE (dBuV)	CORRECTION FACTOR (dB/m)
1	#5725.00	50.48 PK	66.21	-15.73	1.00 V	110	12.38	38.10
2	#5725.00	36.84 AV	55.73	-18.89	1.00 V	110	-1.26	38.10
3	*5745.00	96.21 PK			1.00 V	110	58.08	38.13
4	*5745.00	85.73 AV			1.00 V	110	47.60	38.13
5	11490.00	58.38 PK	74.00	-15.62	1.04 V	265	9.95	48.43
6	11490.00	45.52 AV	54.00	-8.48	1.04 V	265	-2.91	48.43

- REMARKS:**
1. Emission level (dBuV/m) = Raw Value (dBuV) + Correction Factor (dB/m).
  2. Correction Factor (dB/m) = Antenna Factor (dB/m) + Cable Factor (dB).
  3. The other emission levels were very low against the limit.
  4. Margin value = Emission level – Limit value.
  5. “ \* “: Fundamental frequency.
  6. The limit value is defined as per 15.247.
  7. "#":The radiated frequency is out the restricted band.



A D T

EUT TEST CONDITION		MEASUREMENT DETAIL	
CHANNEL	Channel 157	FREQUENCY RANGE	1 ~ 40GHz
INPUT POWER (SYSTEM)	120Vac, 60 Hz	DETECTOR FUNCTION	Peak (PK) Average (AV)
ENVIRONMENTAL CONDITIONS	25deg. C, 65%RH 1000 hPa	TESTED BY	Brad Wu

ANTENNA POLARITY & TEST DISTANCE: HORIZONTAL AT 3 M								
NO.	FREQ. (MHz)	EMISSION LEVEL (dBuV/m)	LIMIT (dBuV/m)	MARGIN (dB)	ANTENNA HEIGHT (m)	TABLE ANGLE (Degree)	RAW VALUE (dBuV)	CORRECTION FACTOR (dB/m)
1	*5785.00	104.01 PK			1.00 H	130	65.81	38.20
2	*5785.00	93.68 AV			1.00 H	130	55.48	38.20
3	11570.00	59.57 PK	74.00	-14.43	1.05 H	72	11.22	48.35
4	11570.00	46.85 AV	54.00	-7.15	1.05 H	72	-1.50	48.35

ANTENNA POLARITY & TEST DISTANCE: VERTICAL AT 3 M								
NO.	FREQ. (MHz)	EMISSION LEVEL (dBuV/m)	LIMIT (dBuV/m)	MARGIN (dB)	ANTENNA HEIGHT (m)	TABLE ANGLE (Degree)	RAW VALUE (dBuV)	CORRECTION FACTOR (dB/m)
1	*5785.00	96.65 PK			1.01 V	108	58.45	38.20
2	*5785.00	86.16 AV			1.01 V	108	47.96	38.20
3	11570.00	58.49 PK	74.00	-15.51	1.01 V	281	10.14	48.35
4	11570.00	45.65 AV	54.00	-8.35	1.01 V	281	-2.70	48.35

- REMARKS:**
1. Emission level (dBuV/m) = Raw Value (dBuV) + Correction Factor (dB/m).
  2. Correction Factor (dB/m) = Antenna Factor (dB/m) + Cable Factor (dB).
  3. The other emission levels were very low against the limit.
  4. Margin value = Emission level – Limit value.
  5. “ \* “: Fundamental frequency.
  6. The limit value is defined as per 15.247.



A D T

EUT TEST CONDITION		MEASUREMENT DETAIL	
CHANNEL	Channel 165	FREQUENCY RANGE	1 ~ 40GHz
INPUT POWER (SYSTEM)	120Vac, 60 Hz	DETECTOR FUNCTION	Peak (PK) Average (AV)
ENVIRONMENTAL CONDITIONS	25deg. C, 65%RH 1000 hPa	TESTED BY	Brad Wu

ANTENNA POLARITY & TEST DISTANCE: HORIZONTAL AT 3 M								
NO.	FREQ. (MHz)	EMISSION LEVEL (dBuV/m)	LIMIT (dBuV/m)	MARGIN (dB)	ANTENNA HEIGHT (m)	TABLE ANGLE (Degree)	RAW VALUE (dBuV)	CORRECTION FACTOR (dB/m)
1	*5825.00	104.13 PK			1.01 H	126	65.84	38.29
2	*5825.00	93.82 AV			1.01 H	126	55.53	38.29
3	#5850.00	58.87 PK	74.13	-15.26	1.01 H	126	20.52	38.35
4	#5850.00	48.19 AV	63.82	-15.63	1.01 H	126	9.84	38.35
5	11650.00	60.68 PK	74.00	-13.32	1.01 H	125	12.55	48.13
6	11650.00	48.02 AV	54.00	-5.98	1.01 H	125	-0.11	48.13
ANTENNA POLARITY & TEST DISTANCE: VERTICAL AT 3 M								
NO.	FREQ. (MHz)	EMISSION LEVEL (dBuV/m)	LIMIT (dBuV/m)	MARGIN (dB)	ANTENNA HEIGHT (m)	TABLE ANGLE (Degree)	RAW VALUE (dBuV)	CORRECTION FACTOR (dB/m)
1	*5825.00	96.84 PK			1.03 V	114	58.55	38.29
2	*5825.00	86.32 AV			1.03 V	114	48.03	38.29
3	#5850.00	51.61 PK	66.84	-15.23	1.03 V	114	13.26	38.35
4	#5850.00	40.89 AV	56.32	-15.43	1.03 V	114	2.54	38.35
5	11650.00	59.85 PK	74.00	-14.15	1.05 V	304	11.72	48.13
6	11650.00	46.98 AV	54.00	-7.02	1.05 V	304	-1.15	48.13

- REMARKS:**
1. Emission level (dBuV/m) = Raw Value (dBuV) + Correction Factor (dB/m).
  2. Correction Factor (dB/m) = Antenna Factor (dB/m) + Cable Factor (dB).
  3. The other emission levels were very low against the limit.
  4. Margin value = Emission level – Limit value.
  5. “ \* “: Fundamental frequency.
  6. The limit value is defined as per 15.247.
  7. "#":The radiated frequency is out the restricted band.



A D T

**DRAFT 802.11n (20MHz) OFDM MODULATION**

EUT TEST CONDITION		MEASUREMENT DETAIL	
CHANNEL	Channel 149	FREQUENCY RANGE	1 ~ 40GHz
INPUT POWER (SYSTEM)	120Vac, 60 Hz	DETECTOR FUNCTION	Peak (PK) Average (AV)
ENVIRONMENTAL CONDITIONS	25deg. C, 65%RH 1000 hPa	TESTED BY	Brad Wu

ANTENNA POLARITY & TEST DISTANCE: HORIZONTAL AT 3 M								
NO.	FREQ. (MHz)	EMISSION LEVEL (dBuV/m)	LIMIT (dBuV/m)	MARGIN (dB)	ANTENNA HEIGHT (m)	TABLE ANGLE (Degree)	RAW VALUE (dBuV)	CORRECTION FACTOR (dB/m)
1	#5725.00	55.41 PK	73.45	-18.04	1.05 H	121	17.31	38.10
2	#5725.00	41.86 AV	63.26	-21.40	1.05 H	121	3.76	38.10
3	*5745.00	103.45 PK			1.05 H	121	65.32	38.13
4	*5745.00	93.26 AV			1.05 H	121	55.13	38.13
5	11490.00	59.60 PK	74.00	-14.40	1.03 H	211	11.17	48.43
6	11490.00	46.45 AV	54.00	-7.55	1.03 H	211	-1.98	48.43
ANTENNA POLARITY & TEST DISTANCE: VERTICAL AT 3 M								
NO.	FREQ. (MHz)	EMISSION LEVEL (dBuV/m)	LIMIT (dBuV/m)	MARGIN (dB)	ANTENNA HEIGHT (m)	TABLE ANGLE (Degree)	RAW VALUE (dBuV)	CORRECTION FACTOR (dB/m)
1	#5725.00	50.35 PK	66.08	-15.73	1.02 V	108	12.25	38.10
2	#5725.00	36.72 AV	55.61	-18.89	1.02 V	108	-1.38	38.10
3	*5745.00	96.08 PK			1.02 V	108	57.95	38.13
4	*5745.00	85.61 AV			1.02 V	108	47.48	38.13
5	11490.00	58.46 PK	74.00	-15.54	1.06 V	283	10.03	48.43
6	11490.00	45.68 AV	54.00	-8.32	1.06 V	283	-2.75	48.43

- REMARKS:**
1. Emission level (dBuV/m) = Raw Value (dBuV) + Correction Factor (dB/m).
  2. Correction Factor (dB/m) = Antenna Factor (dB/m) + Cable Factor (dB).
  3. The other emission levels were very low against the limit.
  4. Margin value = Emission level – Limit value.
  5. “ \* “: Fundamental frequency.
  6. The limit value is defined as per 15.247.
  7. "#":The radiated frequency is out the restricted band.



A D T

EUT TEST CONDITION		MEASUREMENT DETAIL	
CHANNEL	Channel 157	FREQUENCY RANGE	1 ~ 40GHz
INPUT POWER (SYSTEM)	120Vac, 60 Hz	DETECTOR FUNCTION	Peak (PK) Average (AV)
ENVIRONMENTAL CONDITIONS	25deg. C, 65%RH 1000 hPa	TESTED BY	Brad Wu

ANTENNA POLARITY & TEST DISTANCE: HORIZONTAL AT 3 M								
NO.	FREQ. (MHz)	EMISSION LEVEL (dBuV/m)	LIMIT (dBuV/m)	MARGIN (dB)	ANTENNA HEIGHT (m)	TABLE ANGLE (Degree)	RAW VALUE (dBuV)	CORRECTION FACTOR (dB/m)
1	*5785.00	103.85 PK			1.01 H	128	65.65	38.20
2	*5785.00	93.52 AV			1.01 H	128	55.32	38.20
3	11570.00	59.74 PK	74.00	-14.26	1.02 H	86	11.39	48.35
4	11570.00	49.92 AV	54.00	-4.08	1.02 H	86	1.57	48.35

ANTENNA POLARITY & TEST DISTANCE: VERTICAL AT 3 M								
NO.	FREQ. (MHz)	EMISSION LEVEL (dBuV/m)	LIMIT (dBuV/m)	MARGIN (dB)	ANTENNA HEIGHT (m)	TABLE ANGLE (Degree)	RAW VALUE (dBuV)	CORRECTION FACTOR (dB/m)
1	*5785.00	96.53 PK			1.04 V	112	58.33	38.20
2	*5785.00	86.04 AV			1.04 V	112	47.84	38.20
3	11570.00	58.62 PK	74.00	-15.38	1.05 V	294	10.27	48.35
4	11570.00	47.83 AV	54.00	-6.17	1.05 V	294	-0.52	48.35

- REMARKS:**
1. Emission level (dBuV/m) = Raw Value (dBuV) + Correction Factor (dB/m).
  2. Correction Factor (dB/m) = Antenna Factor (dB/m) + Cable Factor (dB).
  3. The other emission levels were very low against the limit.
  4. Margin value = Emission level – Limit value.
  5. “ \* “: Fundamental frequency.
  6. The limit value is defined as per 15.247.



A D T

EUT TEST CONDITION		MEASUREMENT DETAIL	
CHANNEL	Channel 165	FREQUENCY RANGE	1 ~ 40GHz
INPUT POWER (SYSTEM)	120Vac, 60 Hz	DETECTOR FUNCTION	Peak (PK) Average (AV)
ENVIRONMENTAL CONDITIONS	25deg. C, 65%RH 1000 hPa	TESTED BY	Brad Wu

ANTENNA POLARITY & TEST DISTANCE: HORIZONTAL AT 3 M								
NO.	FREQ. (MHz)	EMISSION LEVEL (dBuV/m)	LIMIT (dBuV/m)	MARGIN (dB)	ANTENNA HEIGHT (m)	TABLE ANGLE (Degree)	RAW VALUE (dBuV)	CORRECTION FACTOR (dB/m)
1	*5825.00	104.05 PK			1.02 H	130	65.76	38.29
2	*5825.00	93.68 AV			1.02 H	130	55.40	38.29
3	#5850.00	58.62 PK	74.05	-15.43	1.02 H	130	20.27	38.35
4	#5850.00	48.03 AV	63.68	-15.65	1.02 H	130	9.68	38.35
5	11650.00	60.53 PK	74.00	-13.47	1.03 H	226	12.40	48.13
6	11650.00	47.94 AV	54.00	-6.06	1.03 H	226	-0.19	48.13
ANTENNA POLARITY & TEST DISTANCE: VERTICAL AT 3 M								
NO.	FREQ. (MHz)	EMISSION LEVEL (dBuV/m)	LIMIT (dBuV/m)	MARGIN (dB)	ANTENNA HEIGHT (m)	TABLE ANGLE (Degree)	RAW VALUE (dBuV)	CORRECTION FACTOR (dB/m)
1	*5825.00	96.67 PK			1.05 V	119	58.38	38.29
2	*5825.00	86.14 AV			1.05 V	119	47.85	38.29
3	#5850.00	51.42 PK	66.67	-15.25	1.05 V	119	13.07	38.35
4	#5850.00	40.65 AV	56.14	-15.49	1.05 V	119	2.30	38.35
5	11650.00	59.68 PK	74.00	-14.32	1.03 V	295	11.55	48.13
6	11650.00	46.84 AV	54.00	-7.16	1.03 V	295	-1.29	48.13

- REMARKS:**
1. Emission level (dBuV/m) = Raw Value (dBuV) + Correction Factor (dB/m).
  2. Correction Factor (dB/m) = Antenna Factor (dB/m) + Cable Factor (dB).
  3. The other emission levels were very low against the limit.
  4. Margin value = Emission level – Limit value.
  5. “ \* “: Fundamental frequency.
  6. The limit value is defined as per 15.247.
  7. "#":The radiated frequency is out the restricted band.





A D T

**DRAFT 802.11n (40MHz) OFDM MODULATION**

EUT TEST CONDITION		MEASUREMENT DETAIL	
CHANNEL	Channel 151	FREQUENCY RANGE	1 ~ 40GHz
INPUT POWER (SYSTEM)	120Vac, 60 Hz	DETECTOR FUNCTION	Peak (PK) Average (AV)
ENVIRONMENTAL CONDITIONS	25deg. C, 65%RH 1000 hPa	TESTED BY	Brad Wu

ANTENNA POLARITY & TEST DISTANCE: HORIZONTAL AT 3 M								
NO.	FREQ. (MHz)	EMISSION LEVEL (dBuV/m)	LIMIT (dBuV/m)	MARGIN (dB)	ANTENNA HEIGHT (m)	TABLE ANGLE (Degree)	RAW VALUE (dBuV)	CORRECTION FACTOR (dB/m)
1	#5725.00	57.97 PK	70.39	-12.42	1.01 H	131	19.87	38.10
2	#5725.00	43.76 AV	60.38	-16.62	1.01 H	131	5.66	38.10
3	*5755.00	100.39 PK			1.01 H	131	62.24	38.15
4	*5755.00	90.38 AV			1.01 H	131	52.23	38.15
5	11510.00	59.68 PK	74.00	-14.32	1.04 H	236	11.26	48.43
6	11510.00	46.69 AV	54.00	-7.31	1.04 H	236	-1.73	48.43
ANTENNA POLARITY & TEST DISTANCE: VERTICAL AT 3 M								
NO.	FREQ. (MHz)	EMISSION LEVEL (dBuV/m)	LIMIT (dBuV/m)	MARGIN (dB)	ANTENNA HEIGHT (m)	TABLE ANGLE (Degree)	RAW VALUE (dBuV)	CORRECTION FACTOR (dB/m)
1	#5725.00	51.84 PK	63.12	-11.28	1.02 V	108	13.74	38.10
2	#5725.00	38.02 AV	52.65	-14.63	1.02 V	108	-0.08	38.10
3	*5755.00	93.12 PK			1.02 V	108	54.97	38.15
4	*5755.00	82.65 AV			1.02 V	108	44.50	38.15
5	11510.00	58.81 PK	74.00	-15.19	1.04 V	212	10.38	48.43
6	11510.00	45.84 AV	54.00	-8.16	1.04 V	212	-2.59	48.43

- REMARKS:**
1. Emission level (dBuV/m) = Raw Value (dBuV) + Correction Factor (dB/m).
  2. Correction Factor (dB/m) = Antenna Factor (dB/m) + Cable Factor (dB).
  3. The other emission levels were very low against the limit.
  4. Margin value = Emission level – Limit value.
  5. “ \* “: Fundamental frequency.
  6. The limit value is defined as per 15.247.
  7. "#":The radiated frequency is out the restricted band.



A D T

EUT TEST CONDITION		MEASUREMENT DETAIL	
CHANNEL	Channel 159	FREQUENCY RANGE	1 ~ 40GHz
INPUT POWER (SYSTEM)	120Vac, 60 Hz	DETECTOR FUNCTION	Peak (PK) Average (AV)
ENVIRONMENTAL CONDITIONS	25deg. C, 65%RH 1000 hPa	TESTED BY	Brad Wu

ANTENNA POLARITY & TEST DISTANCE: HORIZONTAL AT 3 M								
NO.	FREQ. (MHz)	EMISSION LEVEL (dBuV/m)	LIMIT (dBuV/m)	MARGIN (dB)	ANTENNA HEIGHT (m)	TABLE ANGLE (Degree)	RAW VALUE (dBuV)	CORRECTION FACTOR (dB/m)
1	*5795.00	100.68 PK			1.02 H	129	62.47	38.21
2	*5795.00	90.81 AV			1.02 H	129	52.60	38.21
3	#5850.00	58.04 PK	70.68	-12.64	1.02 H	129	19.69	38.35
4	#5850.00	47.45 AV	60.81	-13.36	1.02 H	129	9.10	38.35
5	11590.00	60.52 PK	74.00	-13.48	1.03 H	252	12.20	48.32
6	11590.00	47.83 AV	54.00	-6.17	1.03 H	252	-0.49	48.32
ANTENNA POLARITY & TEST DISTANCE: VERTICAL AT 3 M								
NO.	FREQ. (MHz)	EMISSION LEVEL (dBuV/m)	LIMIT (dBuV/m)	MARGIN (dB)	ANTENNA HEIGHT (m)	TABLE ANGLE (Degree)	RAW VALUE (dBuV)	CORRECTION FACTOR (dB/m)
1	*5795.00	93.36 PK			1.03 V	109	55.15	38.21
2	*5795.00	82.75 AV			1.03 V	109	44.54	38.21
3	#5850.00	50.64 PK	63.36	-12.72	1.03 V	109	12.29	38.35
4	#5850.00	39.95 AV	52.75	-12.80	1.03 V	109	1.60	38.35
5	11590.00	59.98 PK	74.00	-14.02	1.01 V	223	11.66	48.32
6	11590.00	47.06 AV	54.00	-6.94	1.01 V	223	-1.26	48.32

- REMARKS:**
1. Emission level (dBuV/m) = Raw Value (dBuV) + Correction Factor (dB/m).
  2. Correction Factor (dB/m) = Antenna Factor (dB/m) + Cable Factor (dB).
  3. The other emission levels were very low against the limit.
  4. Margin value = Emission level – Limit value.
  5. “ \* “: Fundamental frequency.
  6. The limit value is defined as per 15.247.
  7. "#":The radiated frequency is out the restricted band.



A D T

### BELOW 1GHz WORST-CASE DATA : DRAFT 802.11n (20MHz) OFDM MODULATION

EUT TEST CONDITION		MEASUREMENT DETAIL	
CHANNEL	Channel 157	FREQUENCY RANGE	Below 1000MHz
INPUT POWER (SYSTEM)	120Vac, 60 Hz	DETECTOR FUNCTION	Quasi-Peak
ENVIRONMENTAL CONDITIONS	25deg. C, 65%RH 999 hPa	TESTED BY	Brad Wu

ANTENNA POLARITY & TEST DISTANCE: HORIZONTAL AT 3 M								
NO.	FREQ. (MHz)	EMISSION LEVEL (dBuV/m)	LIMIT (dBuV/m)	MARGIN (dB)	ANTENNA HEIGHT (m)	TABLE ANGLE (Degree)	RAW VALUE (dBuV)	CORRECTION FACTOR (dB/m)
1	162.11	33.68 QP	43.50	-9.82	1.50 H	289	19.49	14.19
2	465.42	32.10 QP	46.00	-13.90	2.00 H	262	12.45	19.65
3	531.53	34.86 QP	46.00	-11.14	1.50 H	355	13.78	21.09
4	667.63	32.27 QP	46.00	-13.73	1.25 H	163	8.03	24.23
5	733.73	30.27 QP	46.00	-15.73	1.00 H	292	4.92	25.35
6	961.21	41.05 QP	54.00	-12.95	1.25 H	235	12.45	28.61

ANTENNA POLARITY & TEST DISTANCE: VERTICAL AT 3 M								
NO.	FREQ. (MHz)	EMISSION LEVEL (dBuV/m)	LIMIT (dBuV/m)	MARGIN (dB)	ANTENNA HEIGHT (m)	TABLE ANGLE (Degree)	RAW VALUE (dBuV)	CORRECTION FACTOR (dB/m)
1	45.45	36.25 QP	40.00	-3.75	1.25 V	214	22.11	14.14
2	115.45	35.80 QP	43.50	-7.70	1.25 V	214	24.42	11.38
3	166.00	36.14 QP	43.50	-7.36	1.25 V	235	22.19	13.95
4	399.31	33.56 QP	46.00	-12.44	1.25 V	10	15.54	18.02
5	667.63	38.83 QP	46.00	-7.17	1.00 V	79	14.60	24.23
6	961.21	35.76 QP	54.00	-18.24	1.50 V	178	7.15	28.61

- REMARKS:**
1. Emission level (dBuV/m) = Raw Value (dBuV) + Correction Factor (dB/m).
  2. Correction Factor (dB/m) = Antenna Factor (dB/m) + Cable Factor (dB).
  3. The other emission levels were very low against the limit.
  4. Margin value = Emission level – Limit value.



A D T

## 5.2 CONDUCTED EMISSION MEASUREMENT

### 5.2.1 LIMITS OF CONDUCTED EMISSION MEASUREMENT

FREQUENCY OF EMISSION (MHz)	CONDUCTED LIMIT (dB $\mu$ V)	
	Quasi-peak	Average
0.15 ~ 0.5	66 to 56	56 to 46
0.5 ~ 5	56	46
5 ~ 30	60	50

- NOTE:** 1. The lower limit shall apply at the transition frequencies.  
2. The limit decreases in line with the logarithm of the frequency in the range of 0.15 to 0.50MHz.  
3. All emanations from a class A/B digital device or system, including any network of conductors and apparatus connected thereto, shall not exceed the level of field strengths specified above.

### 5.2.2 TEST INSTRUMENTS

DESCRIPTION & MANUFACTURER	MODEL NO.	SERIAL NO.	DATE OF CALIBRATION	DUE DATE OF CALIBRATION
Test Receiver ROHDE & SCHWARZ	ESCS30	100291	Nov. 19, 2008	Nov. 18, 2009
RF signal cable Woken	5D-FB	Cable-HYC01-01	Dec. 31, 2008	Dec. 30, 2009
LISN SCHWARZBECK	NNBL 8226-2	8226-142	Jun. 03, 2009	Jun. 02, 2010
LISN ROHDE & SCHWARZ	ESH2-Z5	100104	Dec. 04, 2008	Dec. 03, 2009
Software ADT	ADT_Cond_ V7.3.7	NA	NA	NA

- NOTE:** 1. The calibration interval of the above test instruments is 12 months and the calibrations are traceable to NML/ROC and NIST/USA.  
2. The test was performed in HwaYa Shielded Room 1.  
3. The VCCI Site Registration No. is C-2040.



A D T

### 5.2.3 TEST PROCEDURES

- a. The EUT was placed 0.4 meters from the conducting wall of the shielded room with EUT being connected to the power mains through a line impedance stabilization network (LISN). Other support units were connected to the power mains through another LISN. The two LISNs provide 50 ohm/ 50uH of coupling impedance for the measuring instrument.
- b. Both lines of the power mains connected to the EUT were checked for maximum conducted interference.
- c. The frequency range from 150kHz to 30MHz was searched. Emission levels under (Limit - 20dB) was not recorded.

### 5.2.4 DEVIATION FROM TEST STANDARD

No deviation.

### 5.2.5 TEST SETUP

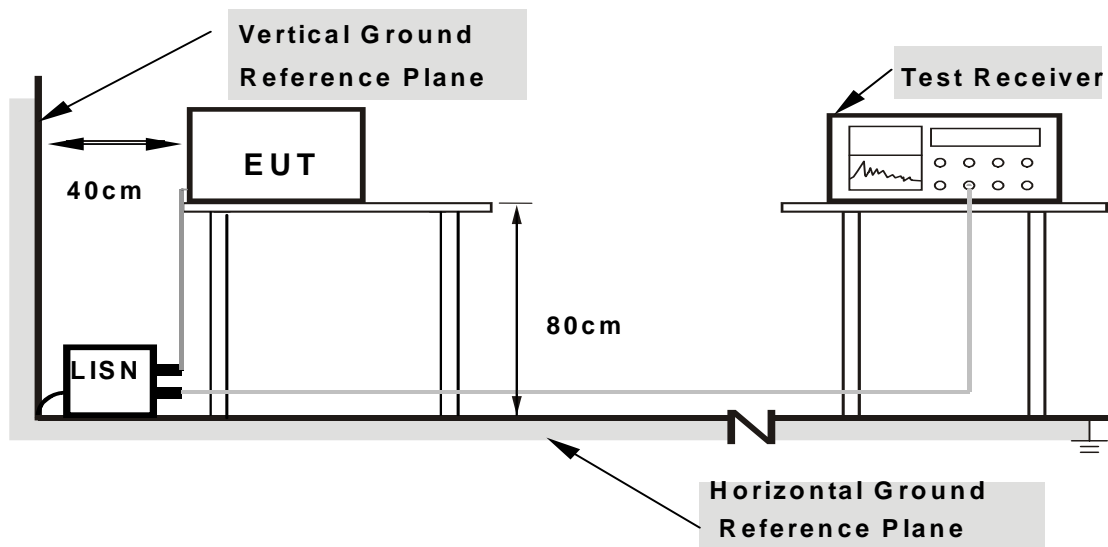

**Note: 1.Support units were connected to second LISN.**

**2.Both of LISNs (AMN) are 80 cm from EUT and at least 80 from other units and other metal planes**

For the actual test configuration, please refer to the attached file (Test Setup Photo).

### 5.2.6 EUT OPERATING CONDITIONS

Same as 4.1.6

### 5.2.7 TEST RESULTS

#### CONDUCTED WORST-CASE DATA : DRAFT 802.11n (20MHz) OFDM MODULATION

EUT TEST CONDITION		MEASUREMENT DETAIL	
CHANNEL	Channel 157	PHASE	Line 1
MODULATION TYPE	BPSK	INPUT POWER	120Vac, 60Hz
TRANSFER RATE	7.2Mbps	6dB BANDWIDTH	9kHz
ENVIRONMENTAL CONDITIONS	20deg. C, 60%RH, 1021hPa	TESTED BY	Match Tsui

No	Freq. [MHz]	Corr.	Reading Value		Emission Level		Limit		Margin	
		Factor	[dB (uV)]		[dB (uV)]		[dB (uV)]		(dB)	
		(dB)	Q.P.	AV.	Q.P.	AV.	Q.P.	AV.	Q.P.	AV.
1	0.150	0.13	45.31	-	45.44	-	66.00	56.00	-20.56	-
2	0.341	0.14	36.37	-	36.51	-	59.17	49.17	-22.66	-
3	0.681	0.16	31.66	-	31.82	-	56.00	46.00	-24.18	-
4	2.289	0.25	30.47	-	30.72	-	56.00	46.00	-25.28	-
5	11.012	0.71	33.19	-	33.90	-	60.00	50.00	-26.10	-
6	22.570	1.19	44.98	-	46.17	-	60.00	50.00	-13.83	-

- REMARKS:**
1. Q.P. and AV. are abbreviations of quasi-peak and average individually.
  2. "-": The Quasi-peak reading value also meets average limit and measurement with the average detector is unnecessary.
  3. The emission levels of other frequencies were very low against the limit.
  4. Margin value = Emission level - Limit value
  5. Correction factor = Insertion loss + Cable loss
  6. Emission Level = Correction Factor + Reading Value.

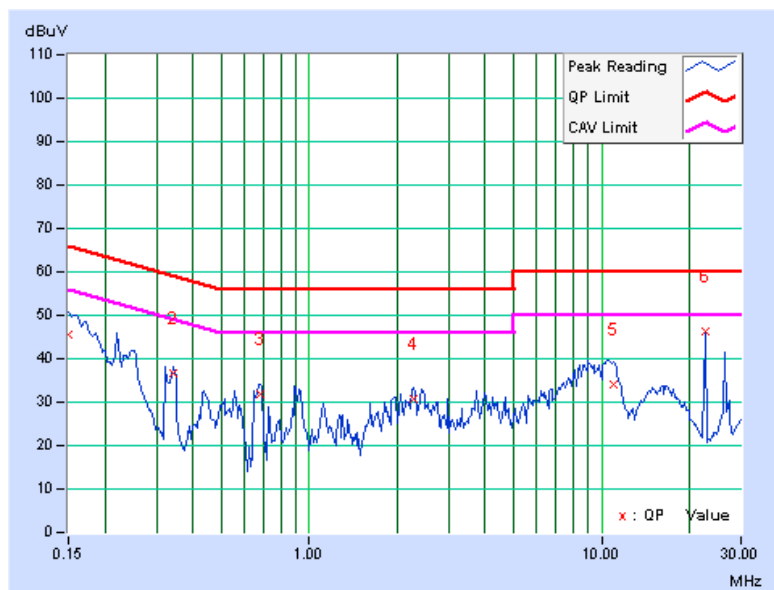

EUT TEST CONDITION		MEASUREMENT DETAIL	
CHANNEL	Channel 157	PHASE	Line 2
MODULATION TYPE	BPSK	INPUT POWER	120Vac, 60Hz
TRANSFER RATE	7.2Mbps	6dB BANDWIDTH	9kHz
ENVIRONMENTAL CONDITIONS	20deg. C, 60%RH, 1021hPa	TESTED BY	Match Tsui

No	Freq. [MHz]	Corr. Factor (dB)	Reading Value [dB (uV)]		Emission Level [dB (uV)]		Limit [dB (uV)]		Margin (dB)	
			Q.P.	AV.	Q.P.	AV.	Q.P.	AV.	Q.P.	AV.
			1	0.150	0.14	44.32	-	44.46	-	66.00
2	0.341	0.16	36.12	-	36.28	-	59.17	49.17	-22.89	-
3	0.681	0.18	31.68	-	31.86	-	56.00	46.00	-24.14	-
4	2.289	0.27	30.23	-	30.50	-	56.00	46.00	-25.50	-
5	9.504	0.64	34.61	-	35.25	-	60.00	50.00	-24.75	-
6	22.570	0.92	44.78	-	44.70	-	60.00	50.00	-15.30	-

- REMARKS:**
1. Q.P. and AV. are abbreviations of quasi-peak and average individually.
  2. "-": The Quasi-peak reading value also meets average limit and measurement with the average detector is unnecessary.
  3. The emission levels of other frequencies were very low against the limit.
  4. Margin value = Emission level - Limit value
  5. Correction factor = Insertion loss + Cable loss
  6. Emission Level = Correction Factor + Reading Value.

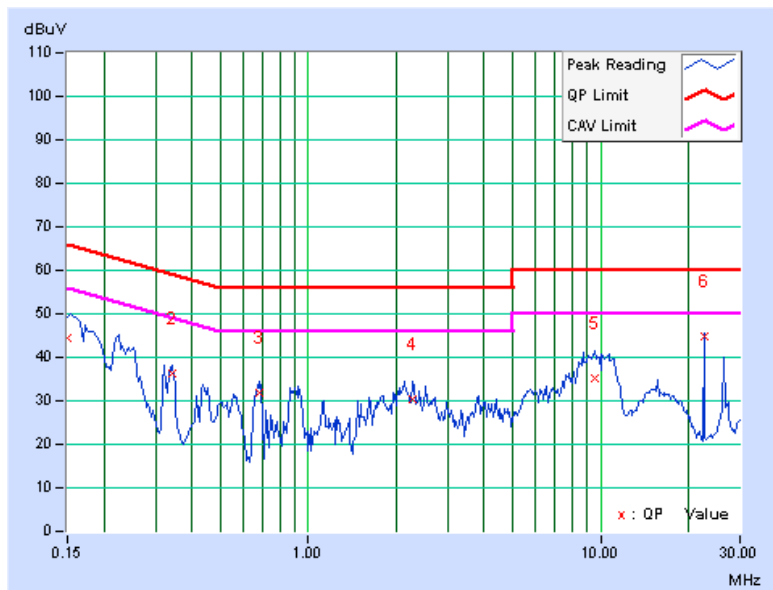





### 5.3 6dB BANDWIDTH MEASUREMENT

#### 5.3.1 LIMITS OF 6dB BANDWIDTH MEASUREMENT

The minimum of 6dB Bandwidth Measurement is 0.5MHz.

#### 5.3.2 TEST INSTRUMENTS

DESCRIPTION & MANUFACTURER	MODEL NO.	SERIAL NO.	DATE OF CALIBRATION	CALIBRATED UNTIL
R&S SPECTRUM ANALYZER	FSP40	100040	Jul. 07, 2009	Jul. 06, 2010

**NOTE:** The calibration interval of the above test instruments is 12 months and the calibrations are traceable to NML/ROC and NIST/USA.

#### 5.3.3 TEST PROCEDURE

The transmitter output was connected to the spectrum analyzer through an attenuator. The bandwidth of the fundamental frequency was measured by spectrum analyzer with 100kHz RBW and 300kHz VBW. The 6dB bandwidth is defined as the total spectrum the power of which is higher than peak power minus 6dB.

### 5.3.4 DEVIATION FROM TEST STANDARD

No deviation

### 5.3.5 TEST SETUP

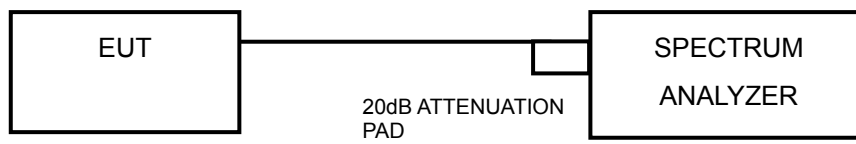

### 5.3.6 EUT OPERATING CONDITIONS

The software provided by client to enable the EUT under transmission condition continuously at lowest, middle and highest channel frequencies individually.



A D T

### 5.3.7 TEST RESULTS

#### 802.11a OFDM MODULATION

<b>MODULATION TYPE</b>	BPSK	<b>TRANSFER RATE</b>	6.0Mbps
<b>INPUT POWER</b>	120Vac, 60Hz	<b>ENVIRONMENTAL CONDITIONS</b>	24deg.C, 64%RH, 1021hPa
<b>TESTED BY</b>	Sun Lin		

CHANNEL	CHANNEL FREQUENCY (MHz)	6dB BANDWIDTH (MHz)		MINIMUM LIMIT (MHz)	PASS / FAIL
		CHAIN 0	CHAIN 1		
149	5745	16.49	16.47	0.5	PASS
157	5785	16.45	16.53	0.5	PASS
165	5825	16.47	16.47	0.5	PASS



A D T

### FOR CHAIN 0: CH 149

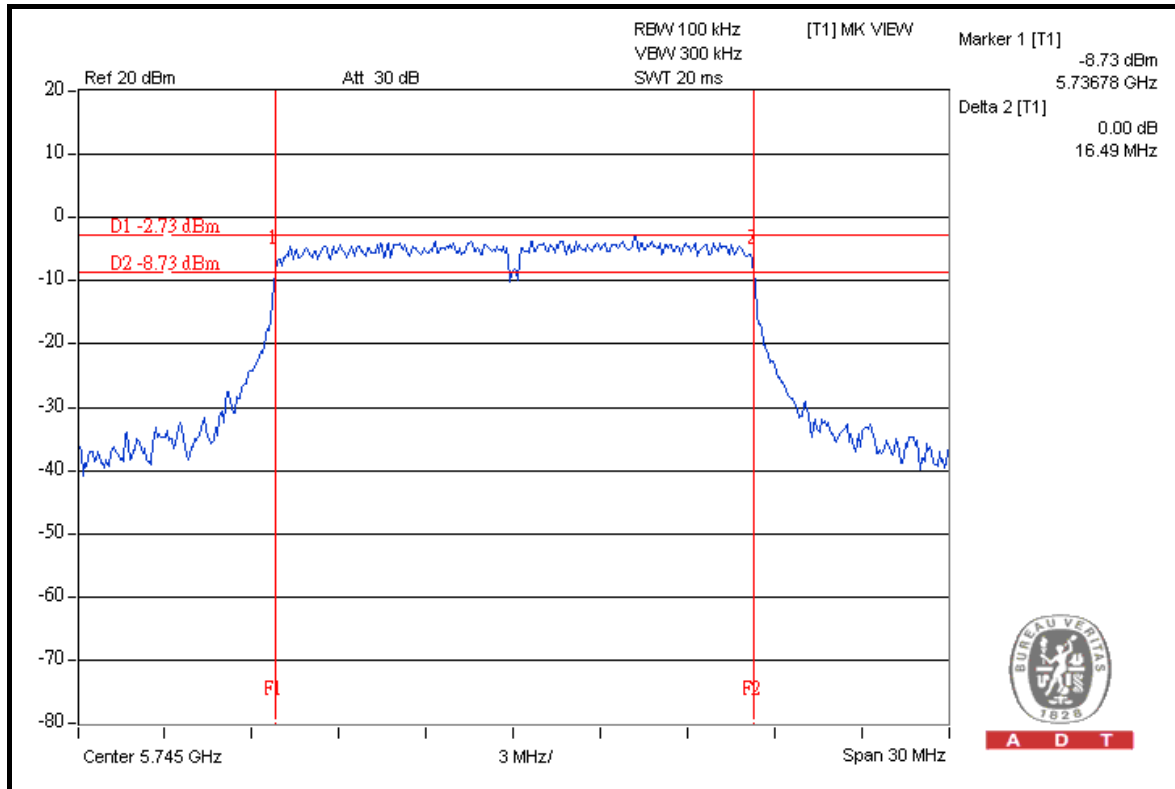

### CH 157

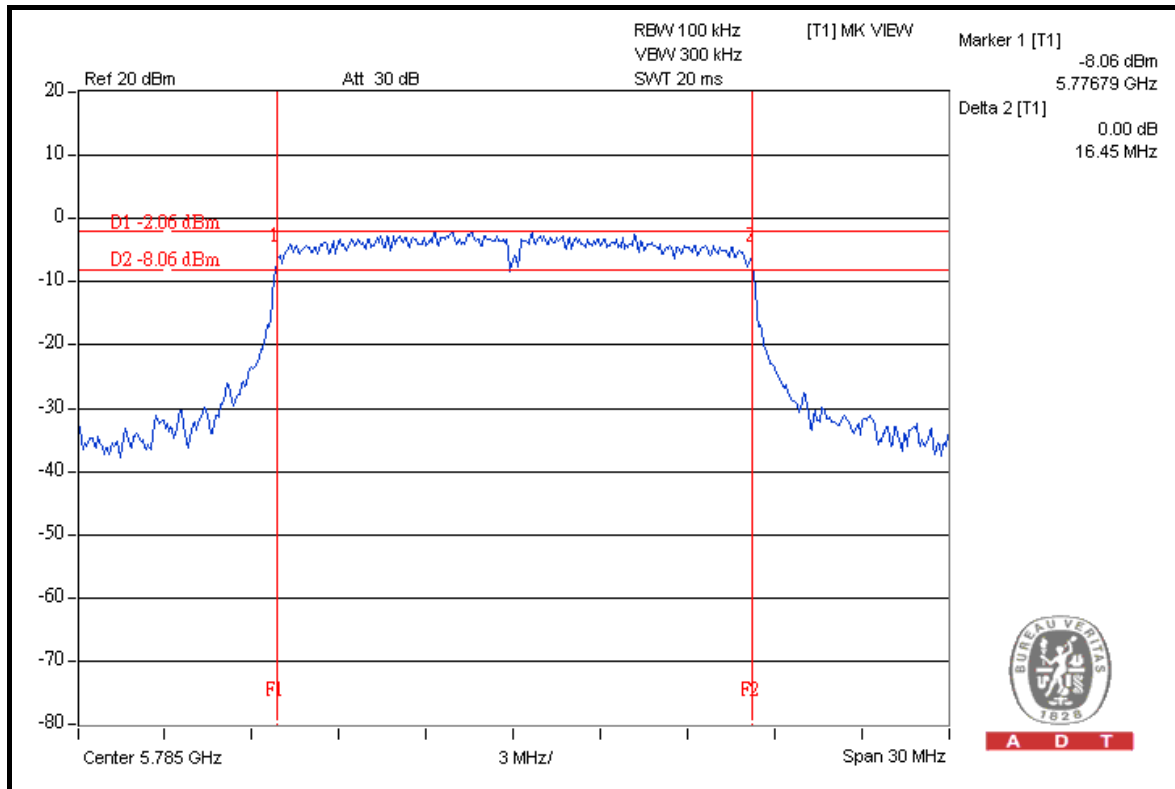



A D T

### CH 165

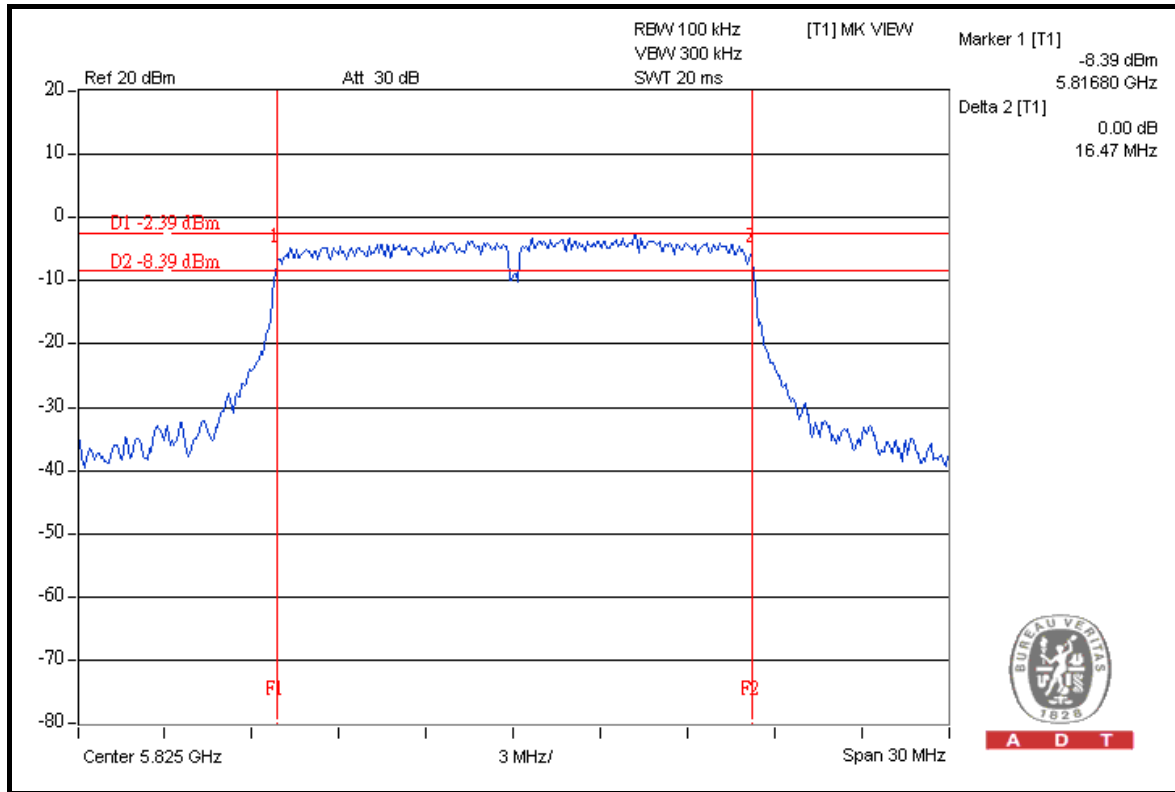

A D T

### FOR CHAIN 1: CH 149

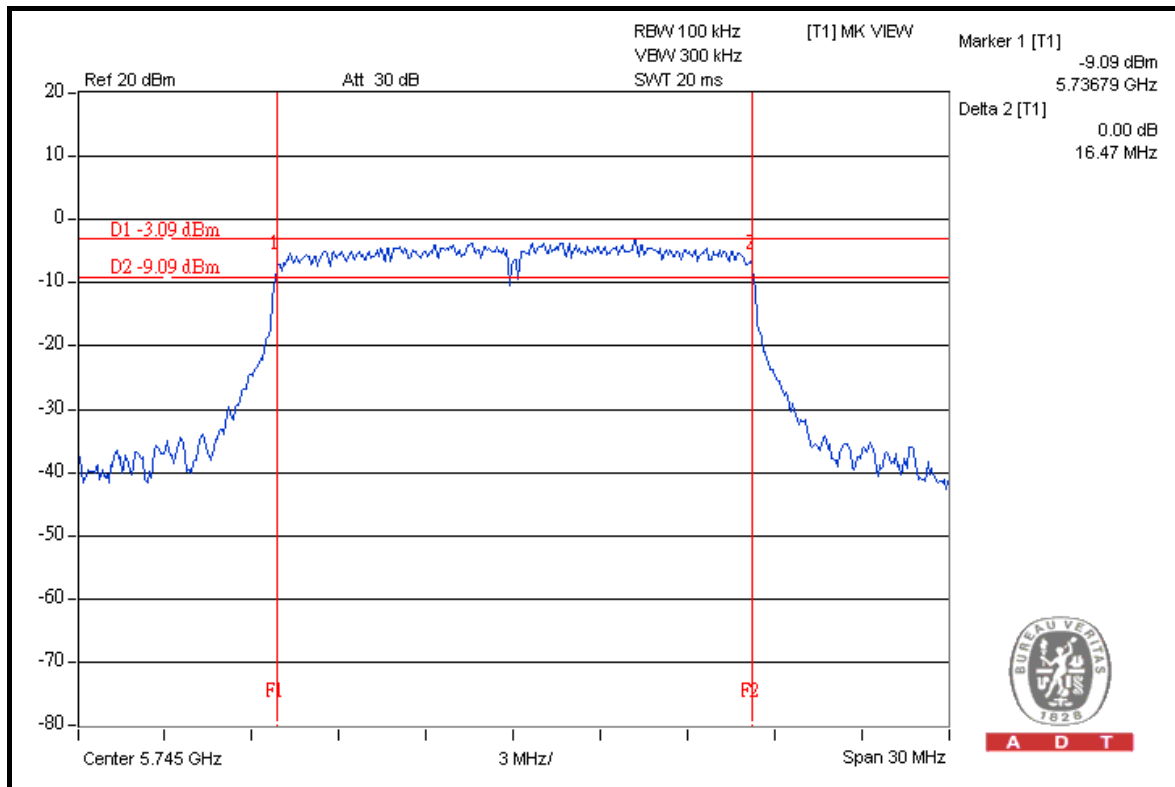

A D T



A D T

### CH 157

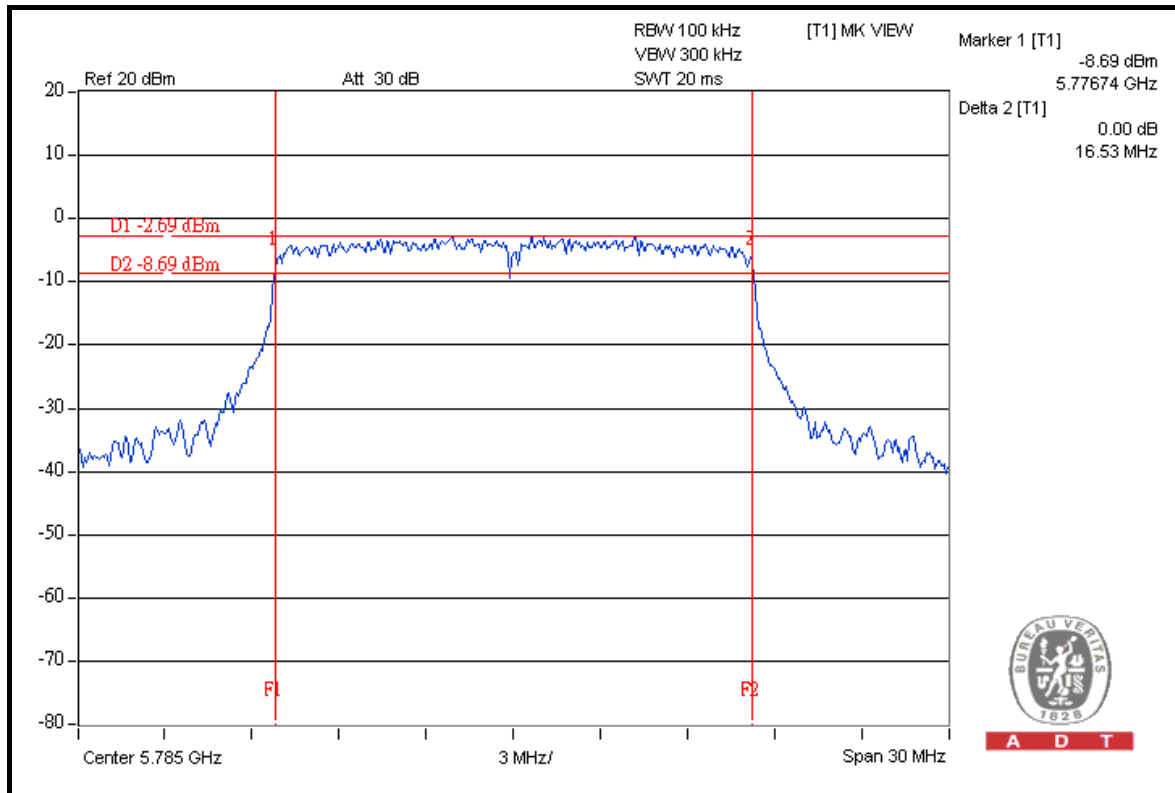

### CH 165

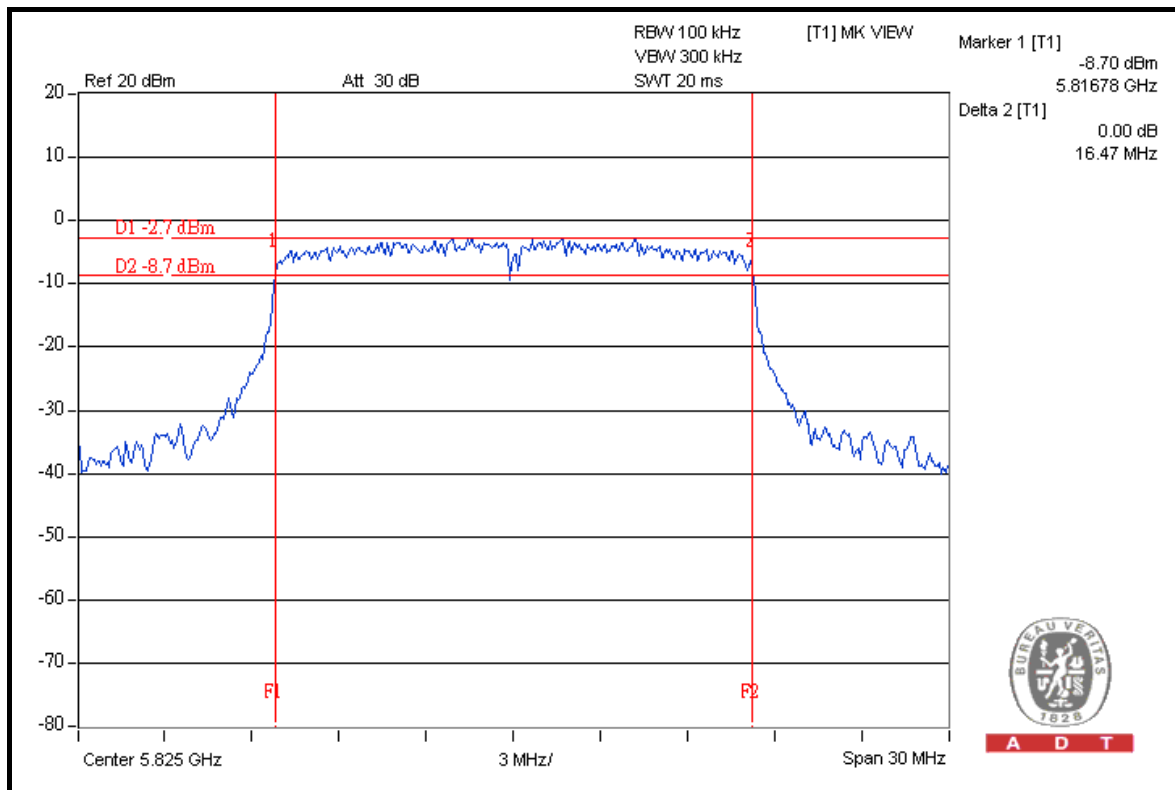



A D T

### DRAFT 802.11n (20MHz) OFDM MODULATION

<b>MODULATION TYPE</b>	BPSK	<b>TRANSFER RATE</b>	7.2Mbps
<b>INPUT POWER</b>	120Vac, 60Hz	<b>ENVIRONMENTAL CONDITIONS</b>	24deg.C, 64%RH, 1021hPa
<b>TESTED BY</b>	Sun Lin		

CHANNEL	CHANNEL FREQUENCY (MHz)	6dB BANDWIDTH (MHz)		MINIMUM LIMIT (MHz)	PASS / FAIL
		CHAIN 0	CHAIN 1		
149	5745	17.17	17.61	0.5	PASS
157	5785	17.63	17.60	0.5	PASS
165	5825	17.64	17.61	0.5	PASS



A D T

### FOR CHAIN 0: CH 149

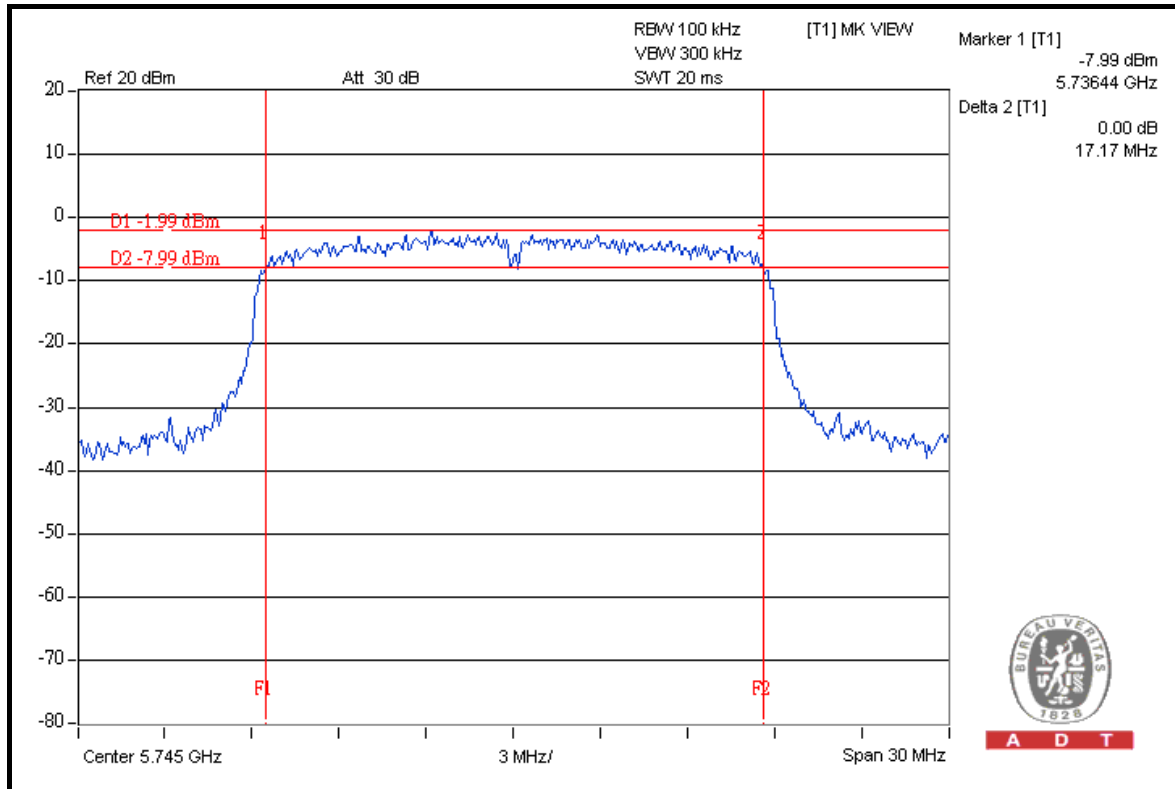

### CH 157

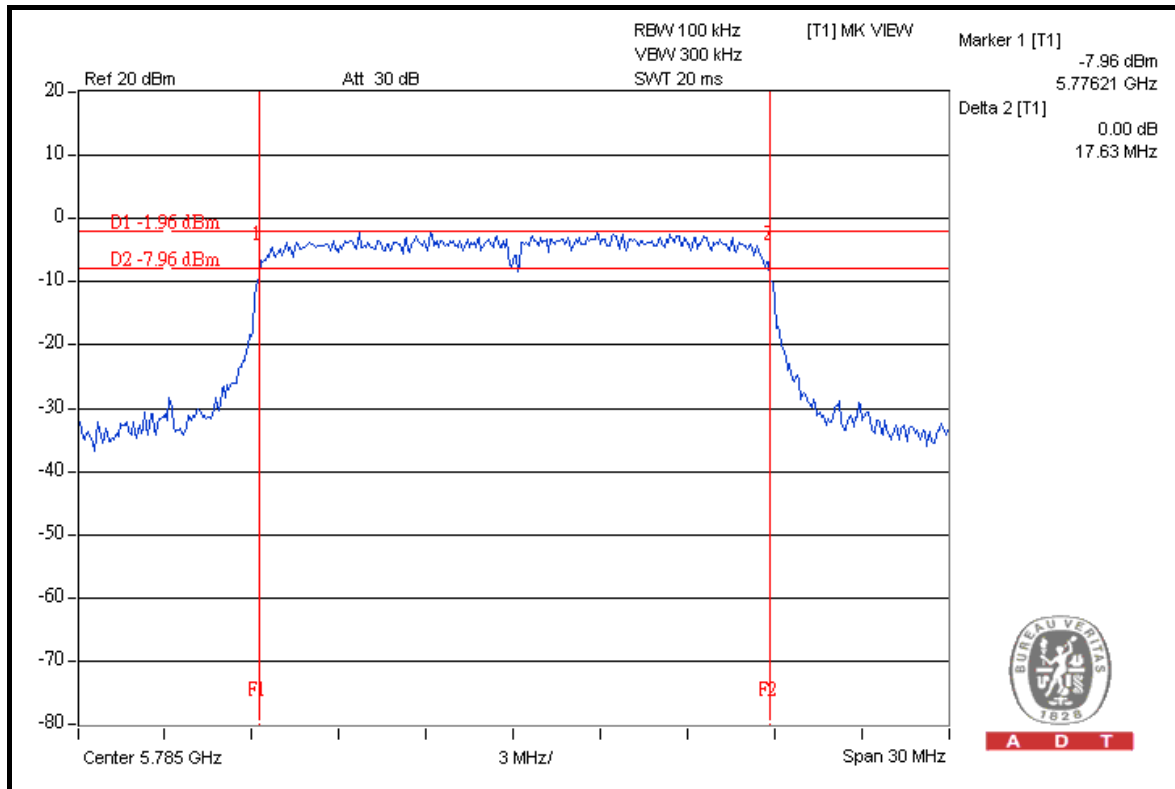





A D T

### CH 165

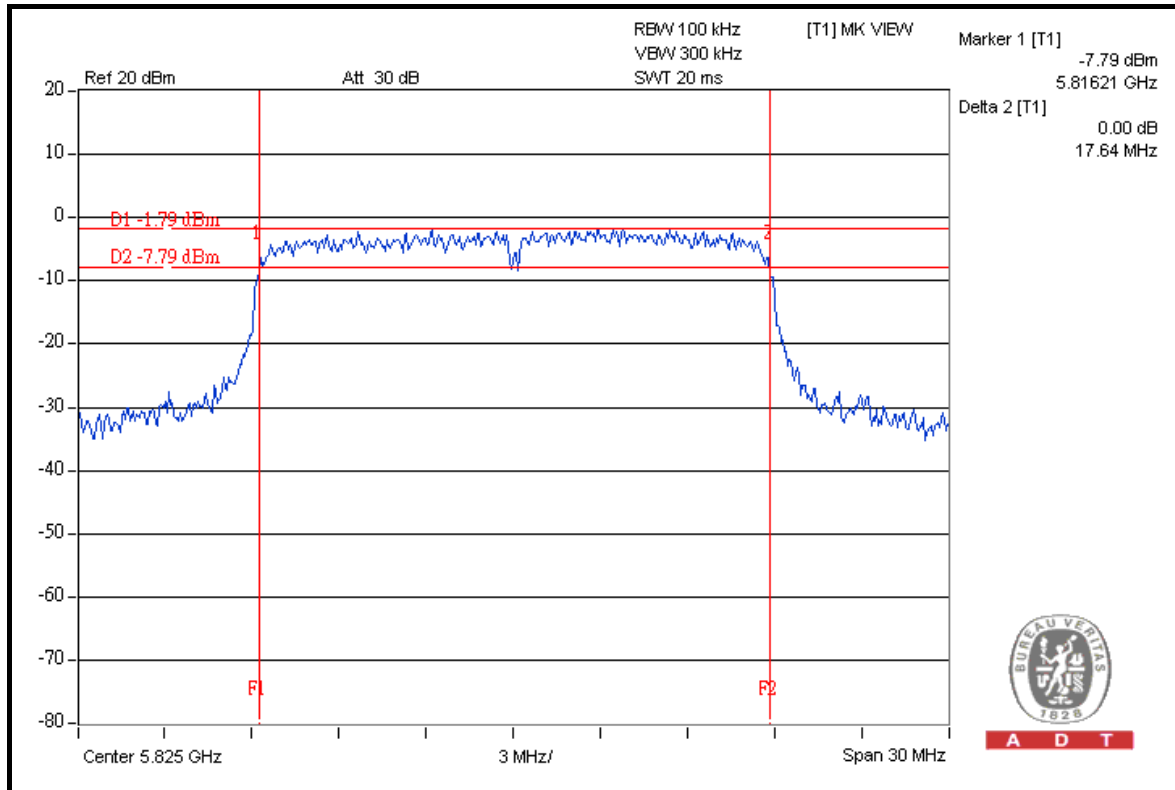

A D T

### FOR CHAIN 1: CH 149

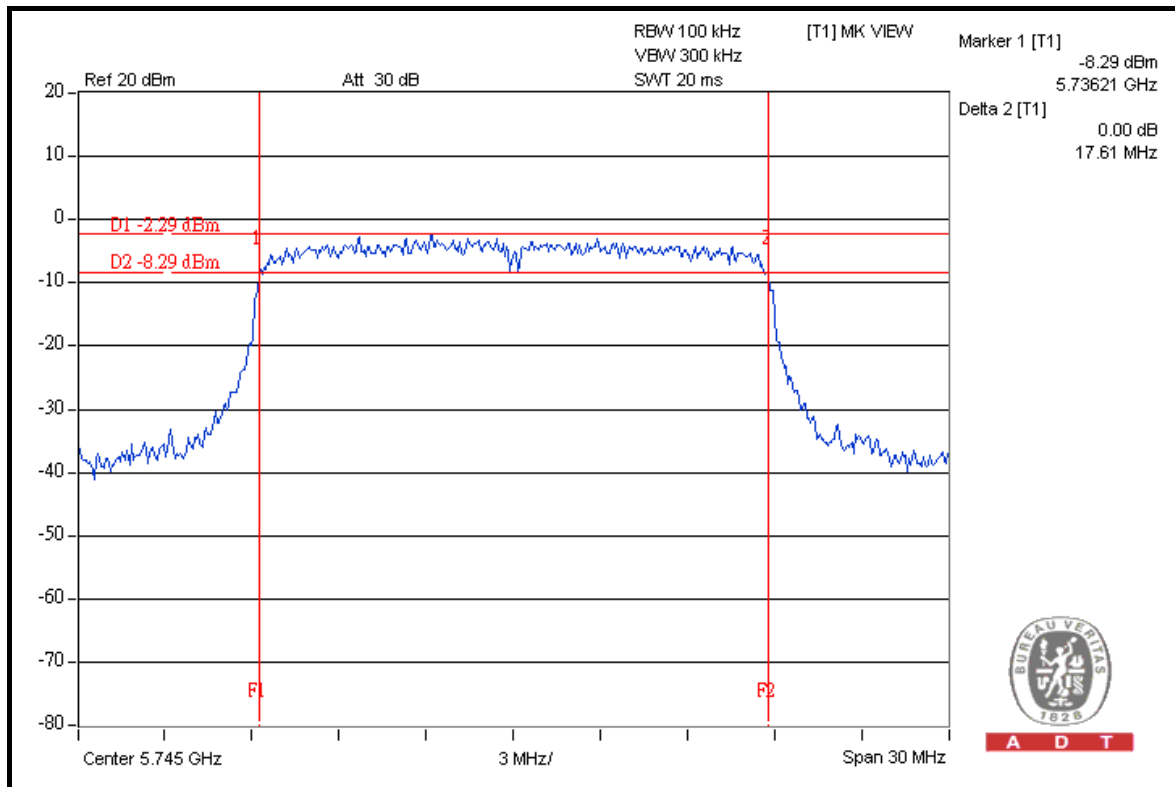

A D T



A D T

### CH 157

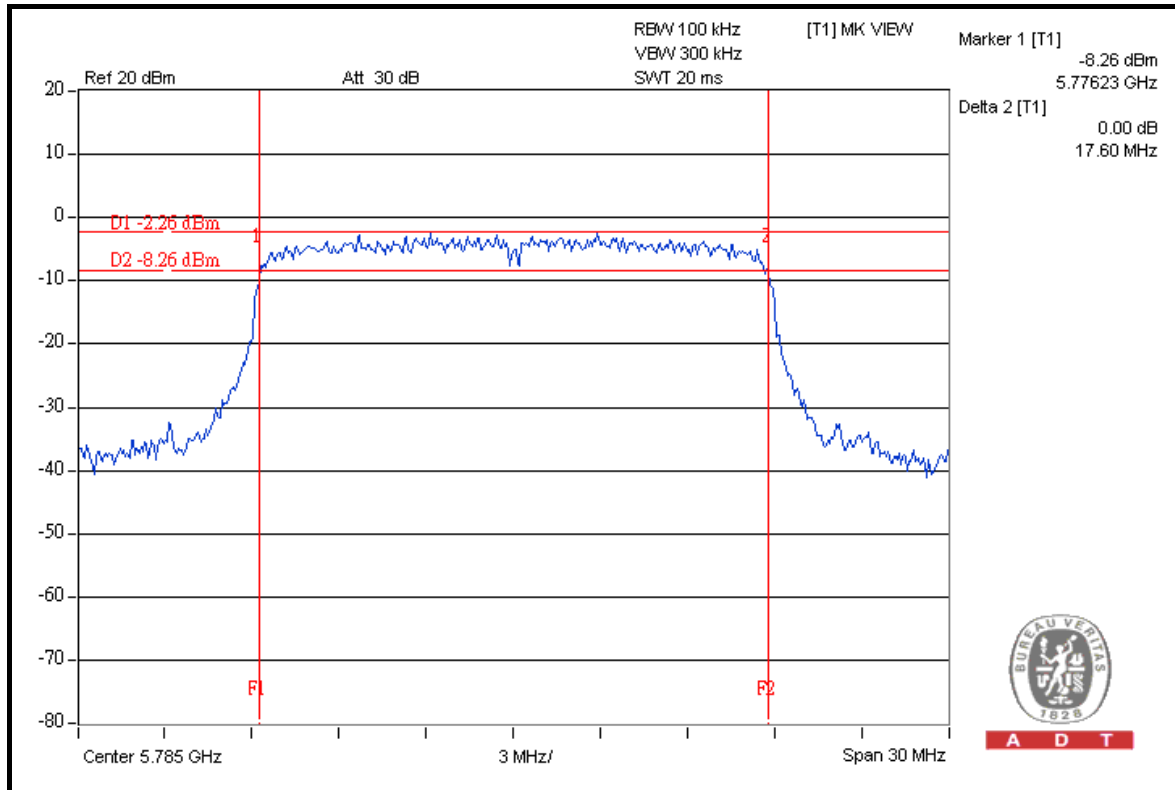

### CH 165

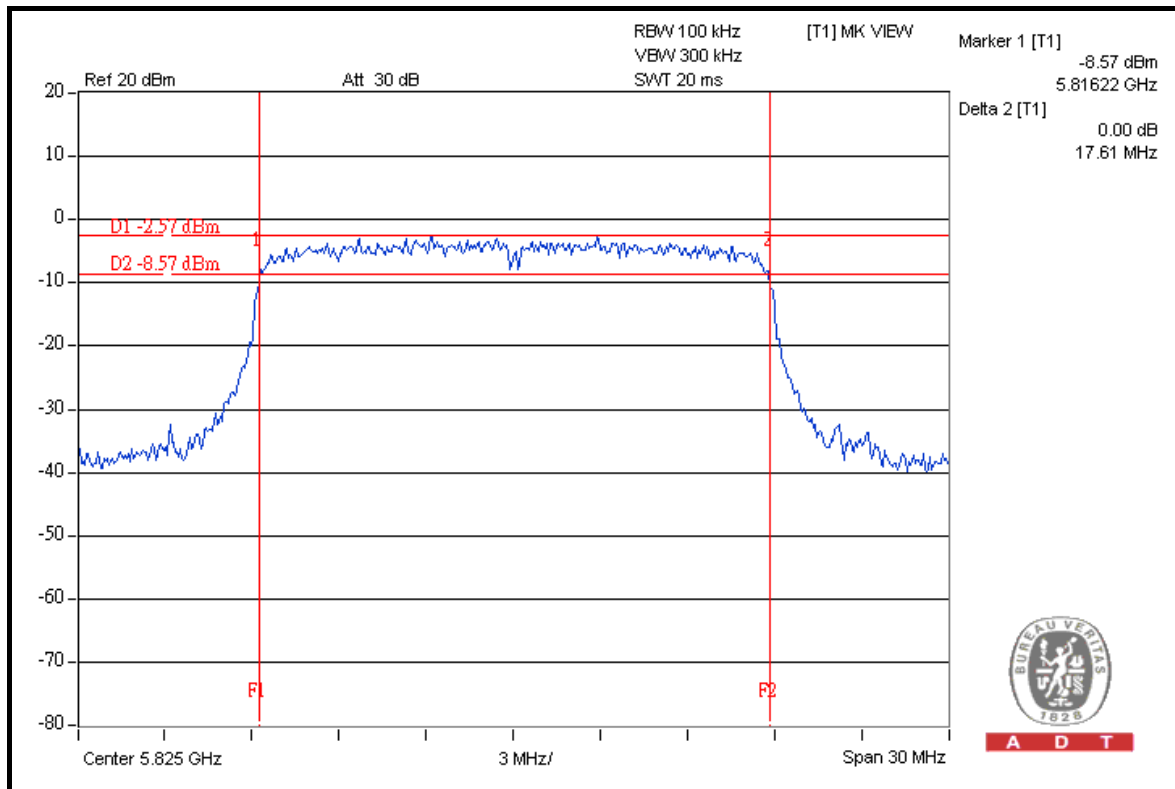



A D T

### DRAFT 802.11n (40MHz) OFDM MODULATION

<b>MODULATION TYPE</b>	BPSK	<b>TRANSFER RATE</b>	15.0Mbps
<b>INPUT POWER</b>	120Vac, 60Hz	<b>ENVIRONMENTAL CONDITIONS</b>	24deg.C, 64%RH, 1021hPa
<b>TESTED BY</b>	Sun Lin		

CHANNEL	CHANNEL FREQUENCY (MHz)	6dB BANDWIDTH (MHz)		MINIMUM LIMIT (MHz)	PASS / FAIL
		CHAIN 0	CHAIN 1		
151	5755	36.19	36.37	0.5	PASS
159	5795	36.46	36.44	0.5	PASS



A D T

### FOR CHAIN 0: CH 151

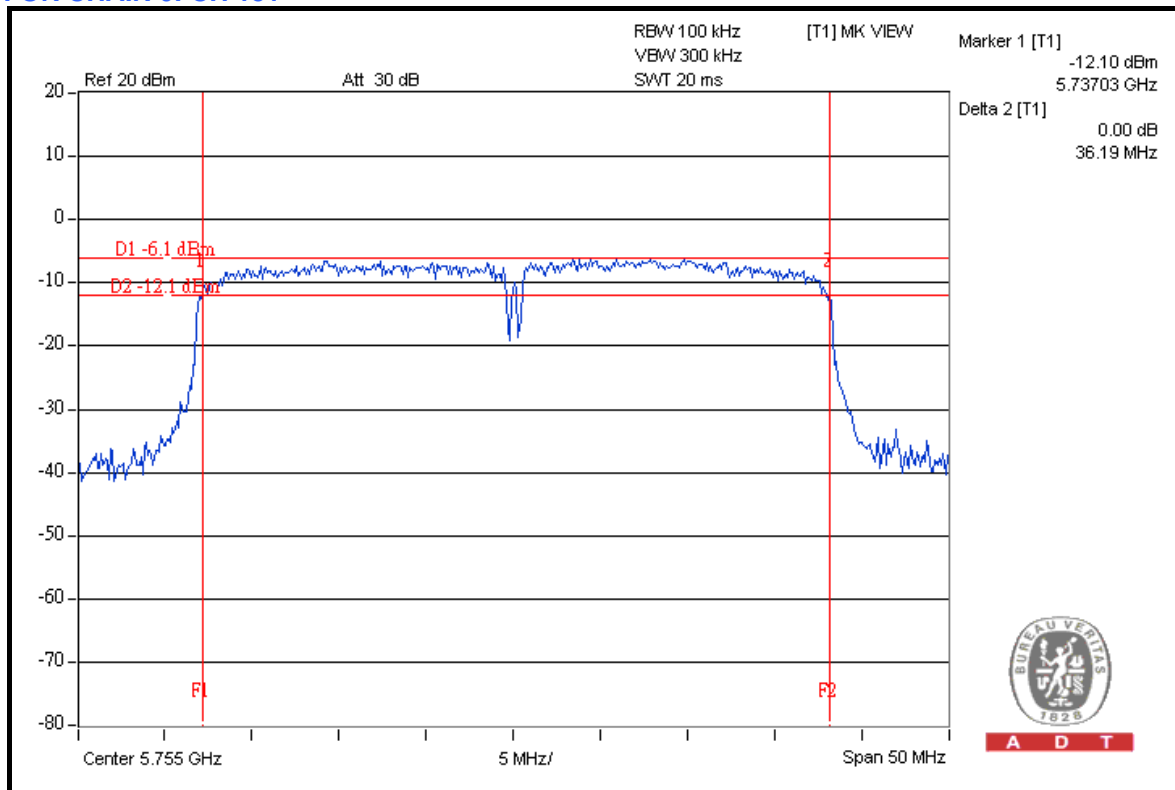

### CH 159

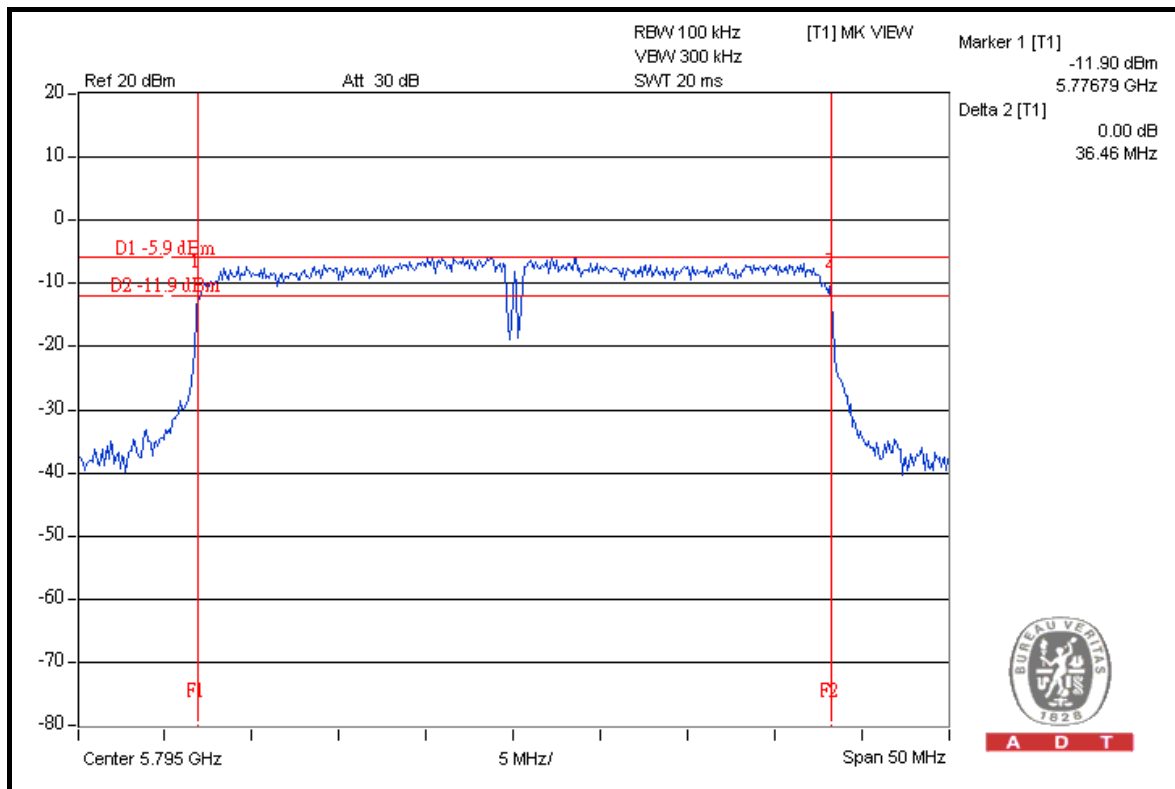



A D T

### FOR CHAIN 1: CH 151

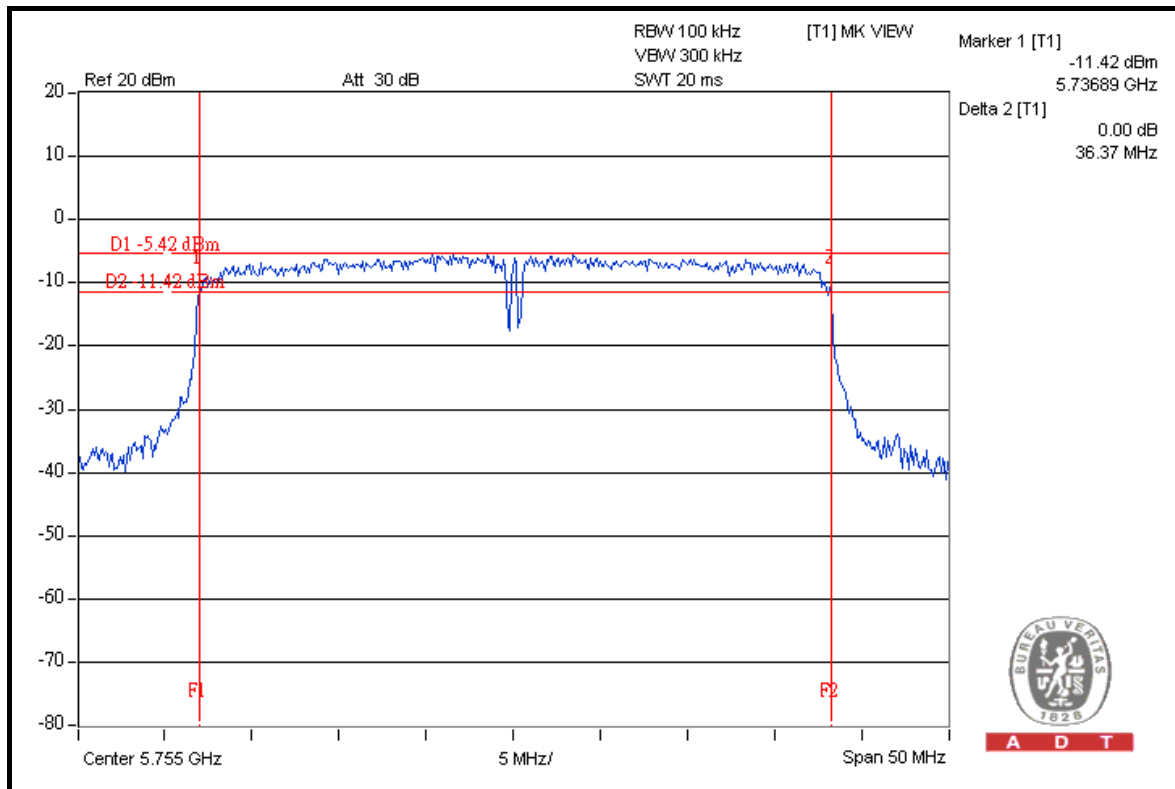

### CH 159

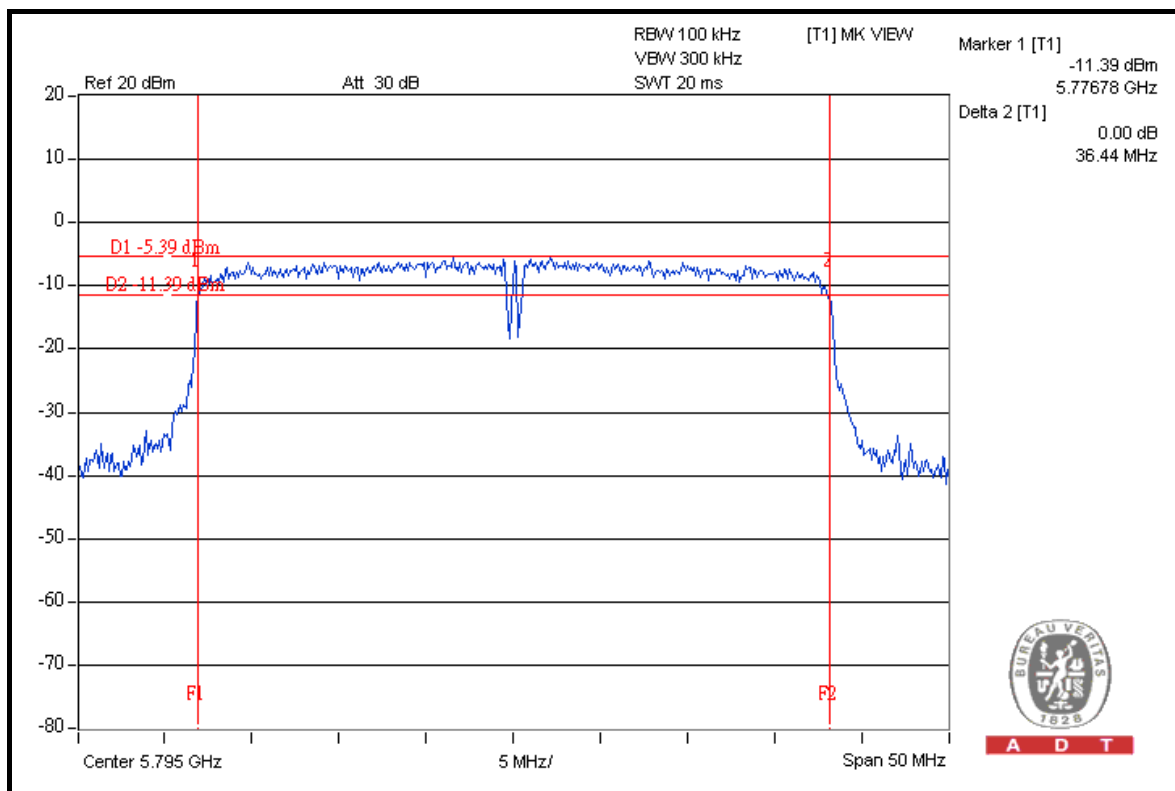

## 5.4 MAXIMUM PEAK OUTPUT POWER

### 5.4.1 LIMITS OF MAXIMUM PEAK OUTPUT POWER MEASUREMENT

The Maximum Peak Output Power Measurement is 30dBm.

### 5.4.2 INSTRUMENTS

DESCRIPTION & MANUFACTURER	MODEL NO.	SERIAL NO.	DATE OF CALIBRATION	CALIBRATED UNTIL
PSA Seviess Spectrum Analyzer	E4446A	MY48250113	Nov. 26, 2008	Nov. 25, 2009

**NOTE:** The calibration interval of the above test instruments is 12 months and the calibrations are traceable to NML/ROC and NIST/USA.

### 5.4.3 TEST PROCEDURE

1. Follow DTS measurement (Power Output Option 2), the transmitter output was connected to the spectrum analyzer through an attenuator, the bandwidth of the fundamental frequency was measured with the spectrum analyzer.
2. Set span to encompass the entire emission bandwidth (EBW) of the signal.
3. Set RBW = 1 MHz ; VBW  $\geq$  3 MHz.
4. Use sample detector mode and video trigger with the trigger level set to enable triggering only on full power pulses.
5. Trace average 100 traces in power averaging mode.
6. Compute power by integrating the spectrum across the 26 dB EBW of the signal.
7. Record the power level.

#### 5.4.4 DEVIATION FROM TEST STANDARD

No deviation.

#### 5.4.5 TEST SETUP

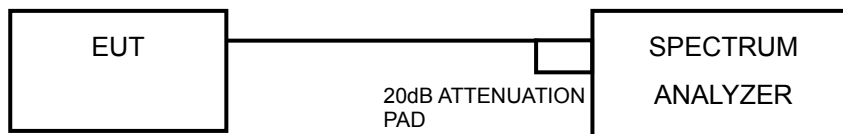

#### 5.4.6 EUT OPERATING CONDITIONS

Same as Item 5.3.6



A D T

### 5.4.7 TEST RESULTS

#### 802.11a OFDM MODULATION

<b>MODULATION TYPE</b>	BPSK	<b>TRANSFER RATE</b>	6.0Mbps
<b>INPUT POWER</b>	120Vac, 60Hz	<b>ENVIRONMENTAL CONDITIONS</b>	24deg.C, 64%RH, 1021hPa
<b>TESTED BY</b>	Sun Lin		

CHAN.	CHAN. FREQ. (MHz)	PEAK POWER OUTPUT (dBm)		TOTAL PEAK POWER (mW)	TOTAL PEAK POWER (dBm)	PEAK POWER LIMIT (dBm)	PASS / FAIL
		CHAIN 0	CHAIN 1				
149	5745	11.07	11.08	25.62	14.09	30	PASS
157	5785	11.66	11.64	29.24	14.66	30	PASS
165	5825	11.57	11.61	28.84	14.60	30	PASS





A D T

### FOR CHAIN 0: CH 149

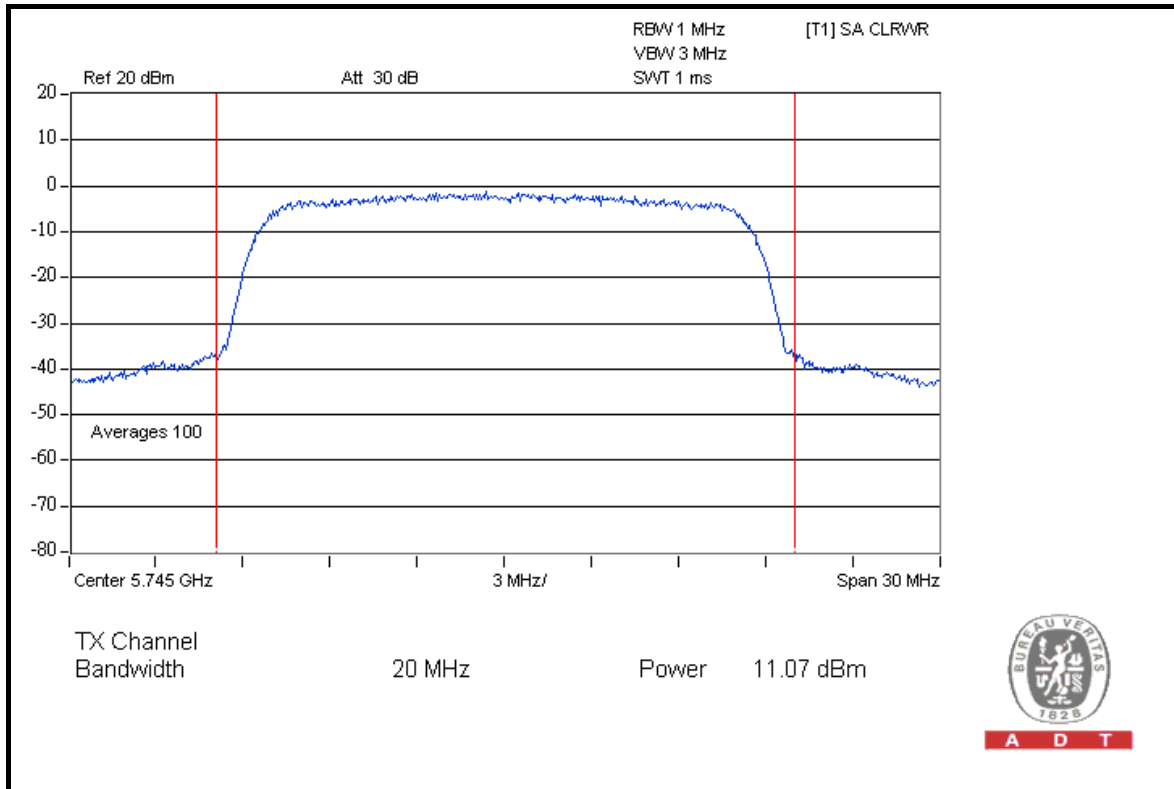

A D T

### CH 157

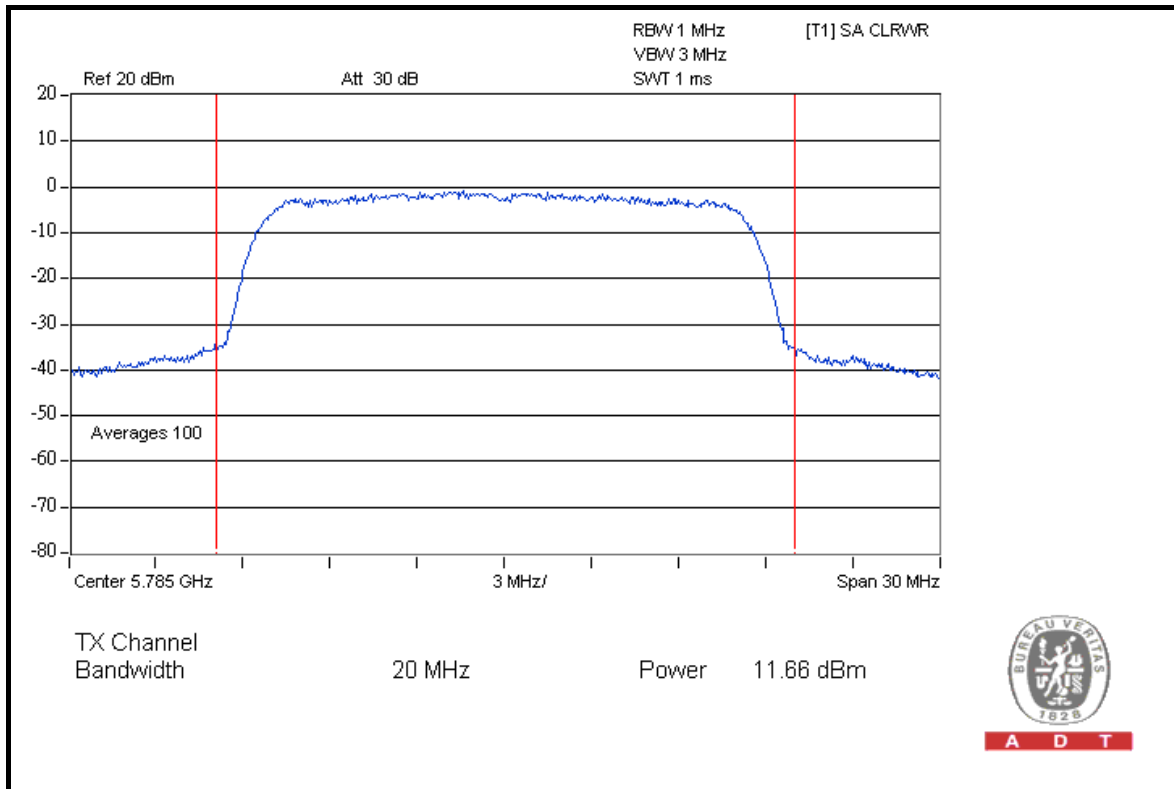

A D T



A D T

### CH 165

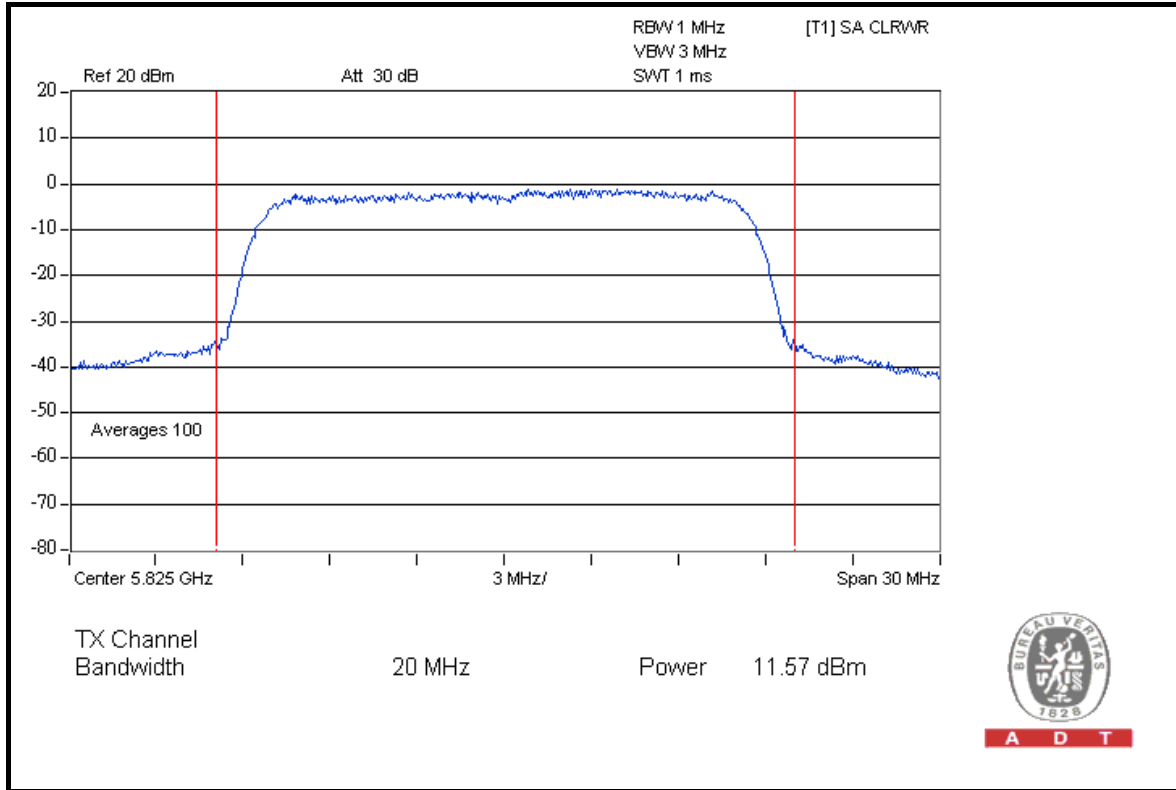

### FOR CHAIN 1: CH 149

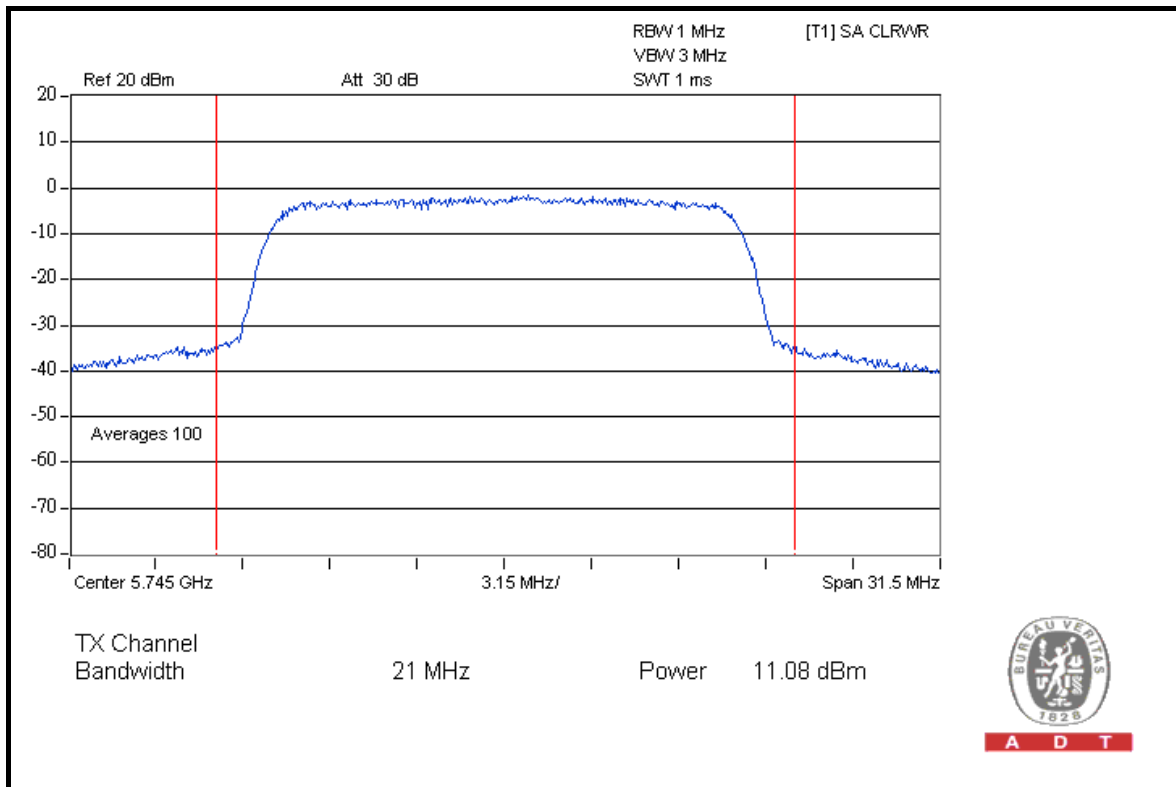



A D T

### CH 157

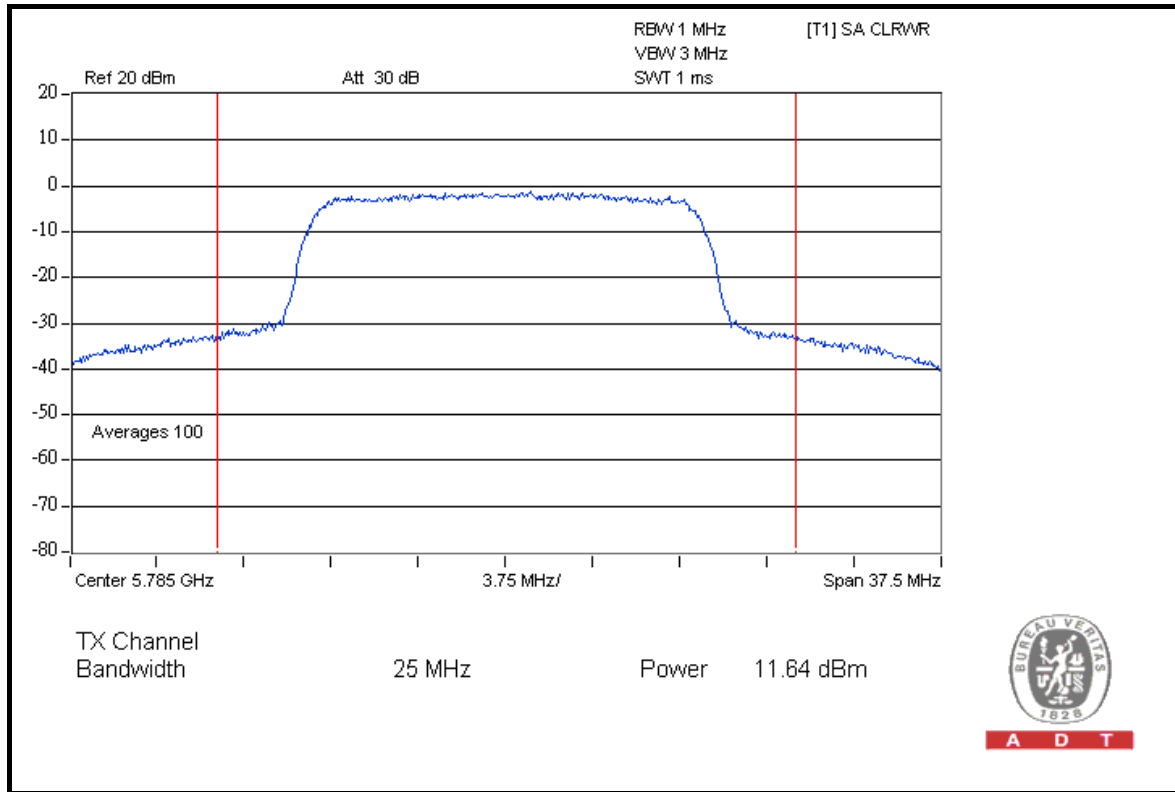

### CH 165

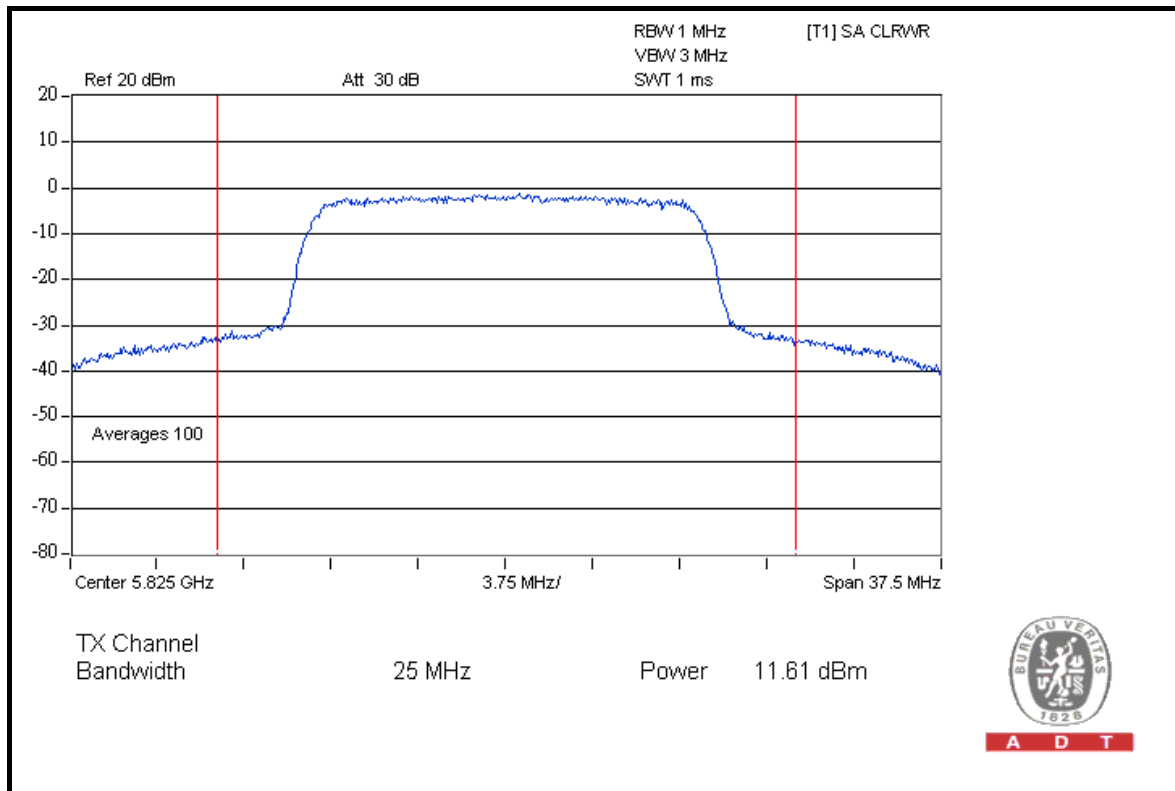



A D T

### DRAFT 802.11n (20MHz) OFDM MODULATION

<b>MODULATION TYPE</b>	BPSK	<b>TRANSFER RATE</b>	7.2Mbps
<b>INPUT POWER</b>	120Vac, 60Hz	<b>ENVIRONMENTAL CONDITIONS</b>	24deg.C, 64%RH, 1021hPa
<b>TESTED BY</b>	Sun Lin		

CHAN.	CHAN. FREQ. (MHz)	PEAK POWER OUTPUT (dBm)		TOTAL PEAK POWER (mW)	TOTAL PEAK POWER (dBm)	PEAK POWER LIMIT (dBm)	PASS / FAIL
		CHAIN 0	CHAIN 1				
149	5745	11.67	11.57	29.04	14.63	30	PASS
157	5785	11.67	11.63	29.24	14.66	30	PASS
165	5825	11.64	11.58	28.98	14.62	30	PASS



A D T

### FOR CHAIN 0: CH 149

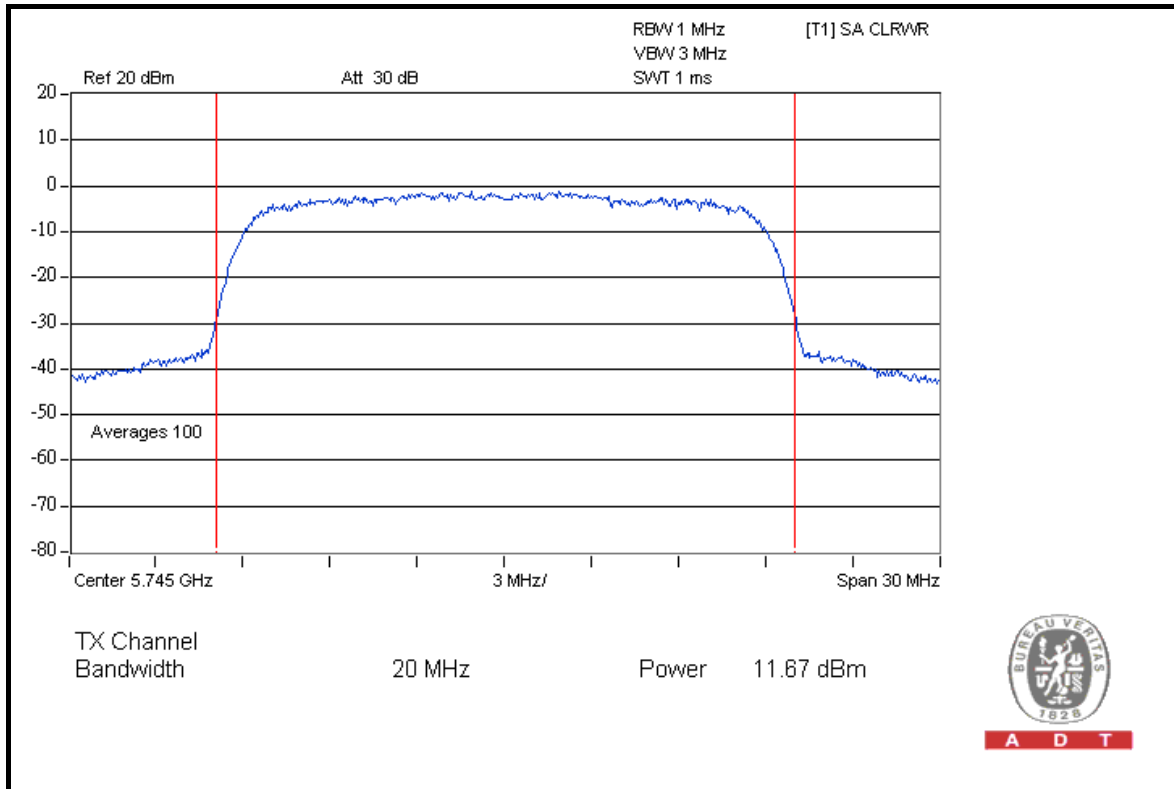

A D T

### CH 157

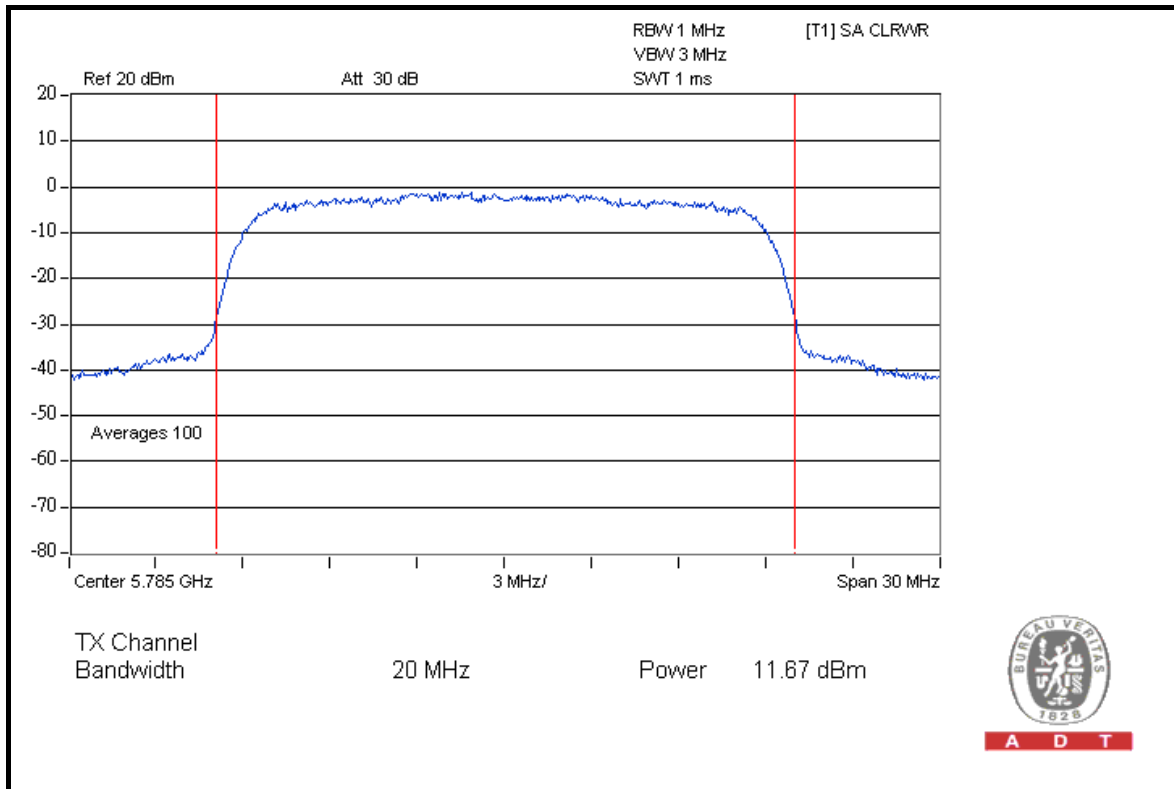

A D T



A D T

### CH 165

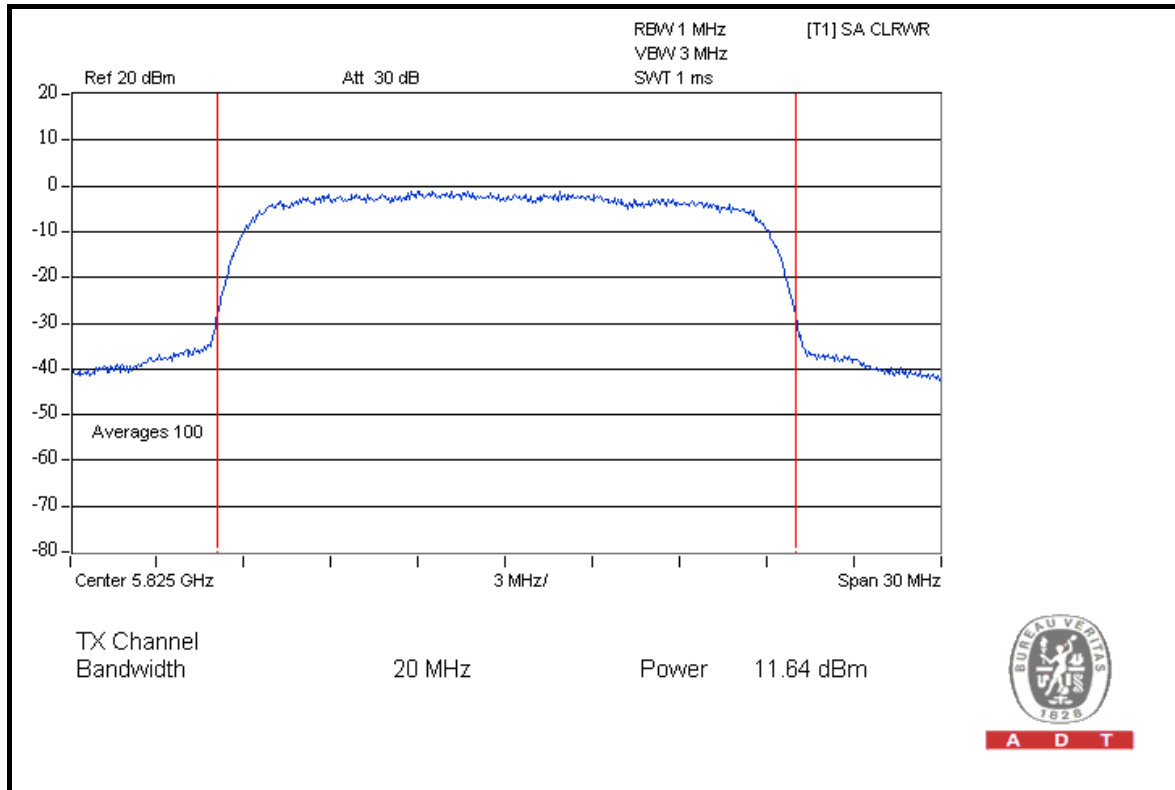

A D T

### FOR CHAIN 1: CH 149

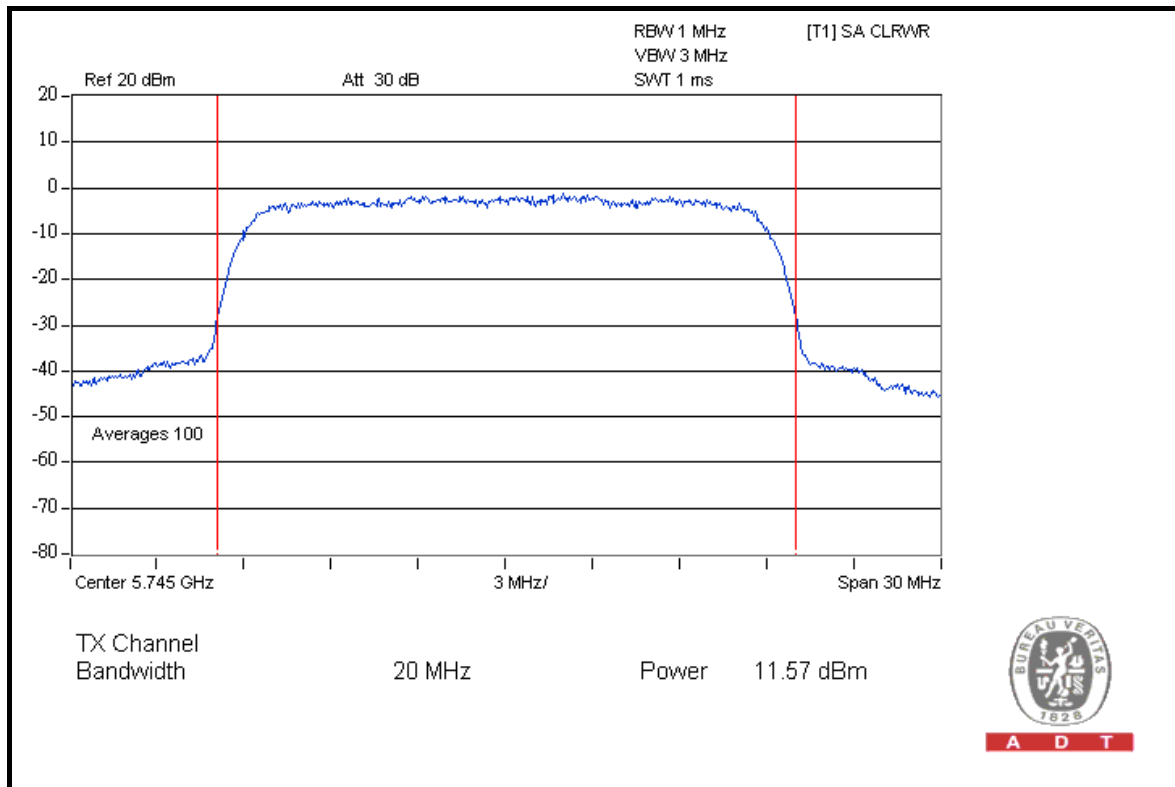

A D T



A D T

### CH 157

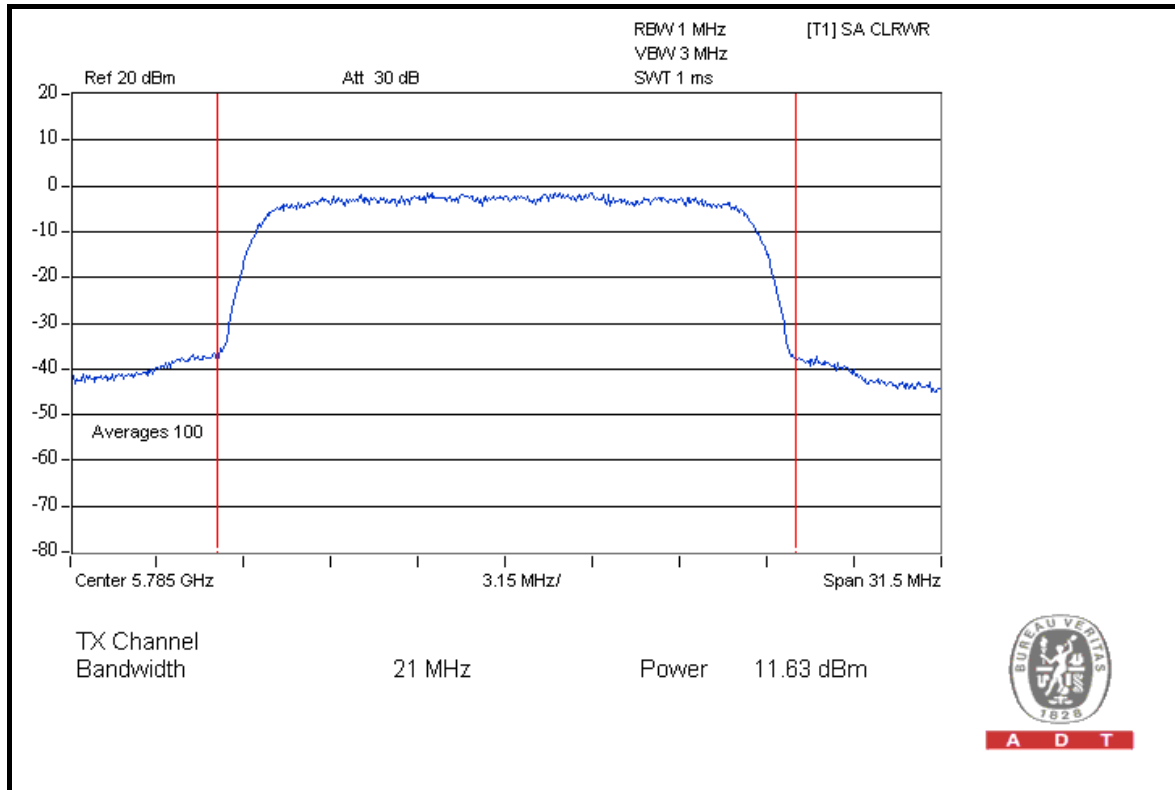

### CH 165

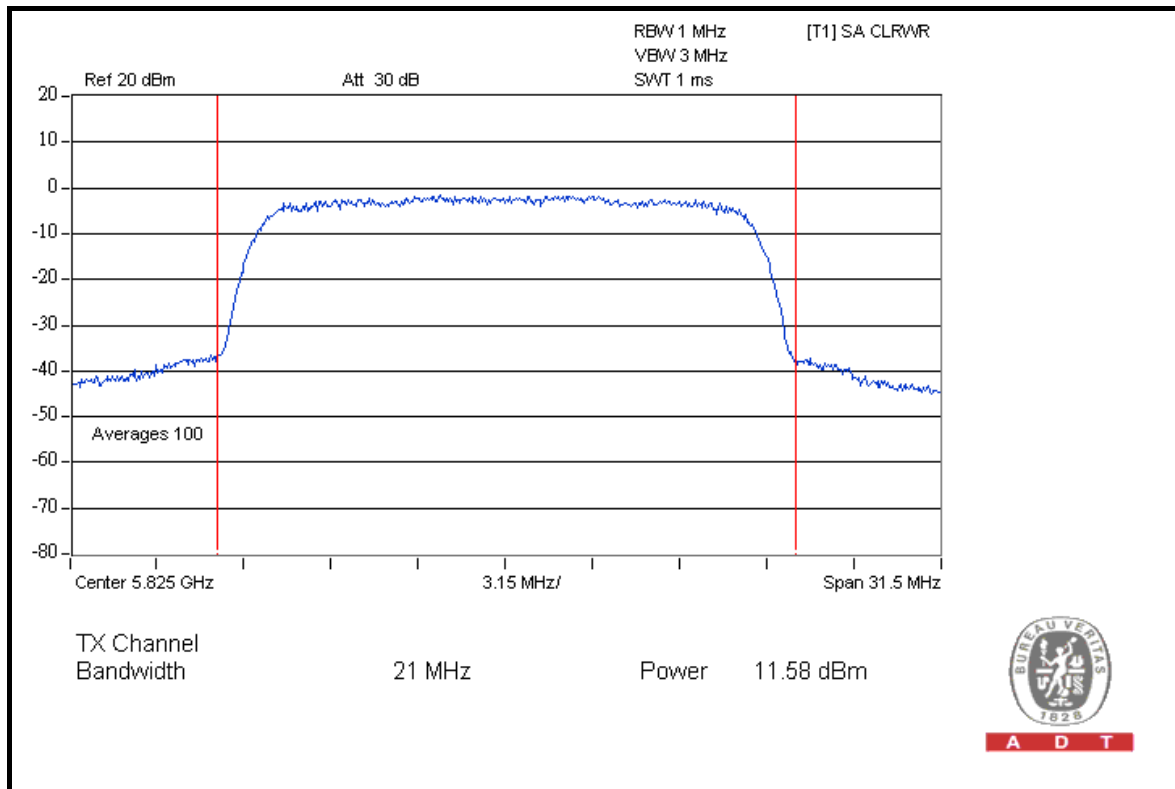



A D T

**DRAFT 802.11n (40MHz) OFDM MODULATION**

<b>MODULATION TYPE</b>	BPSK	<b>TRANSFER RATE</b>	15.0Mbps
<b>INPUT POWER</b>	120Vac, 60Hz	<b>ENVIRONMENTAL CONDITIONS</b>	24deg.C, 64%RH, 1021hPa
<b>TESTED BY</b>	Sun Lin		

CHAN.	CHAN. FREQ. (MHz)	PEAK POWER OUTPUT (dBm)		TOTAL PEAK POWER (mW)	TOTAL PEAK POWER (dBm)	PEAK POWER LIMIT (dBm)	PASS / FAIL
		CHAIN 0	CHAIN 1				
151	5755	11.15	11.12	25.97	14.15	30	PASS
159	5795	11.11	11.17	26.00	14.15	30	PASS





A D T

### FOR CHAIN 0: CH 151

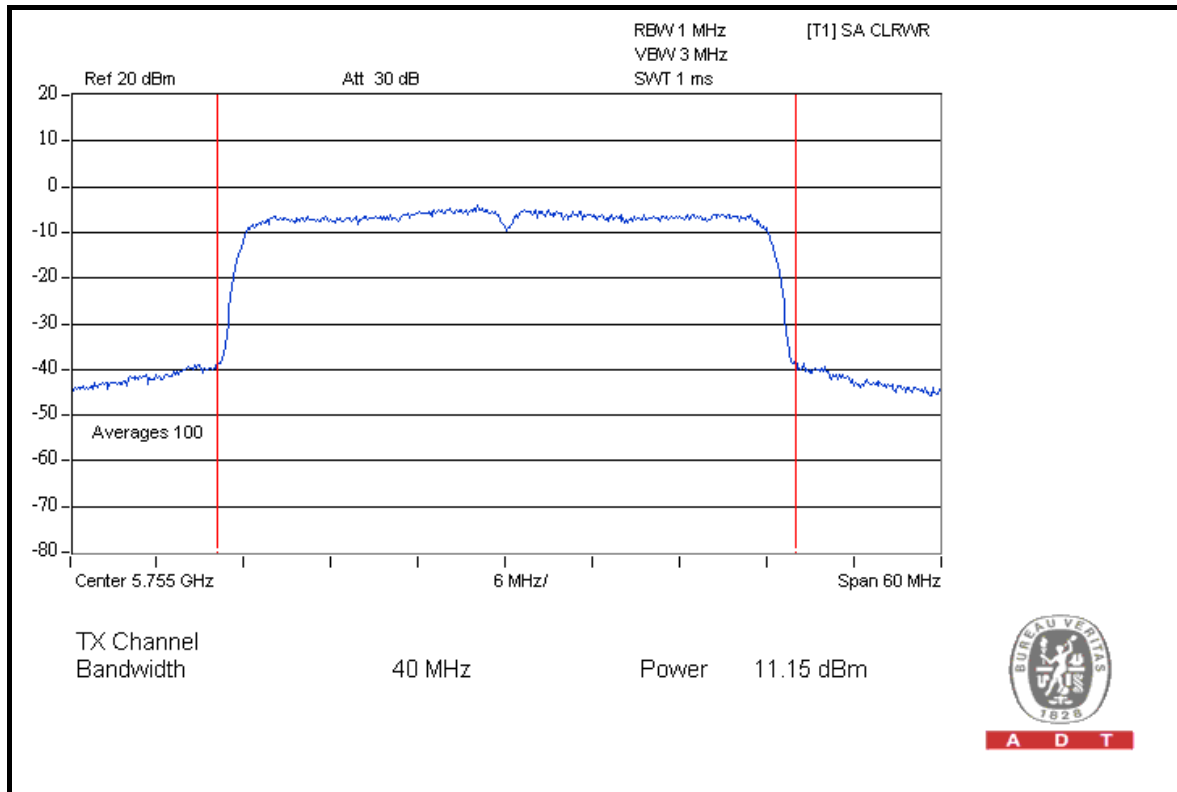

### CH 159

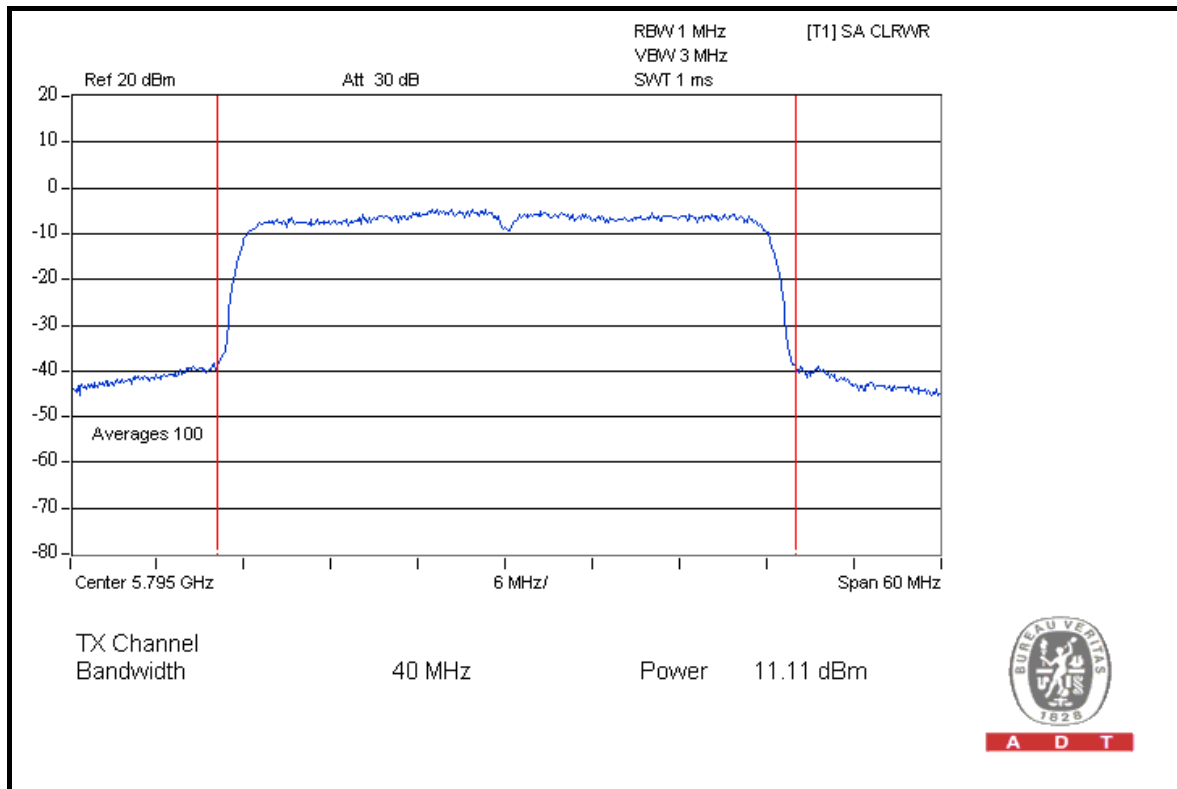



A D T

### FOR CHAIN 1: CH 151

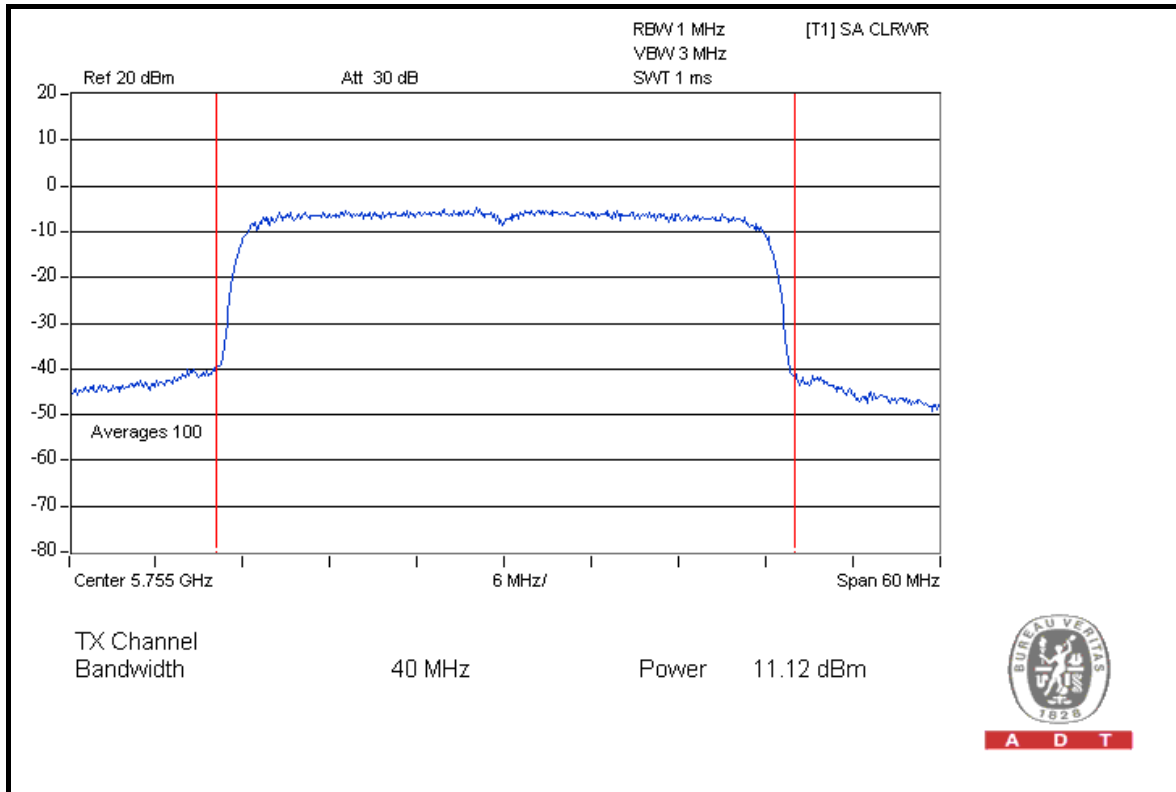

### CH 159

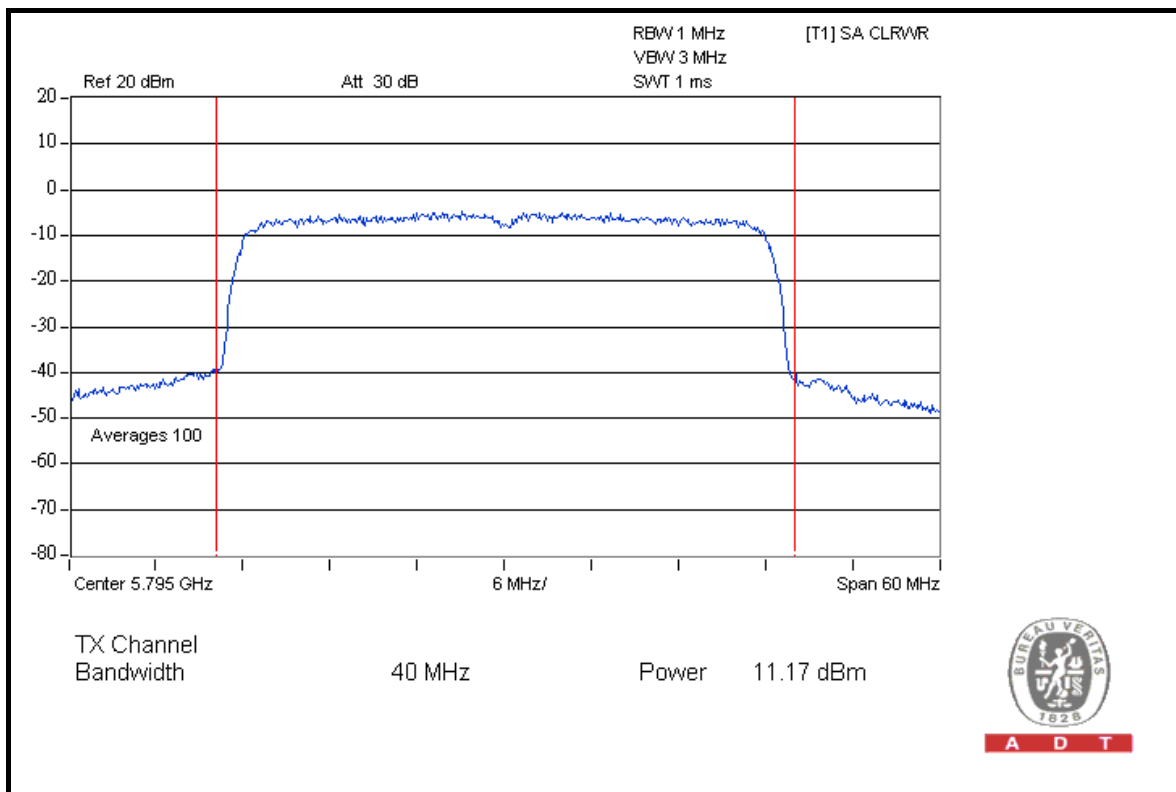



A D T

**26dB OCCUPIED BANDWIDTH: 802.11a OFDM MODULATION**

<b>MODULATION TYPE</b>	OFDM	<b>TRANSFER RATE</b>	6.0Mbps
<b>INPUT POWER (SYSTEM)</b>	120Vac, 60Hz	<b>ENVIRONMENTAL CONDITIONS</b>	24deg.C, 64%RH, 991hPa
<b>TESTED BY</b>	Sun Lin		

CHANNEL	CHANNEL FREQUENCY (MHz)	26dBc OCCUPIED BANDWIDTH (MHz)		PASS / FAIL
		CHAIN 0	CHAIN 1	
149	5745	19.47	20.21	PASS
157	5785	19.07	24.71	PASS
165	5825	19.18	24.55	PASS



A D T

### FOR CHAIN 0: CH 149

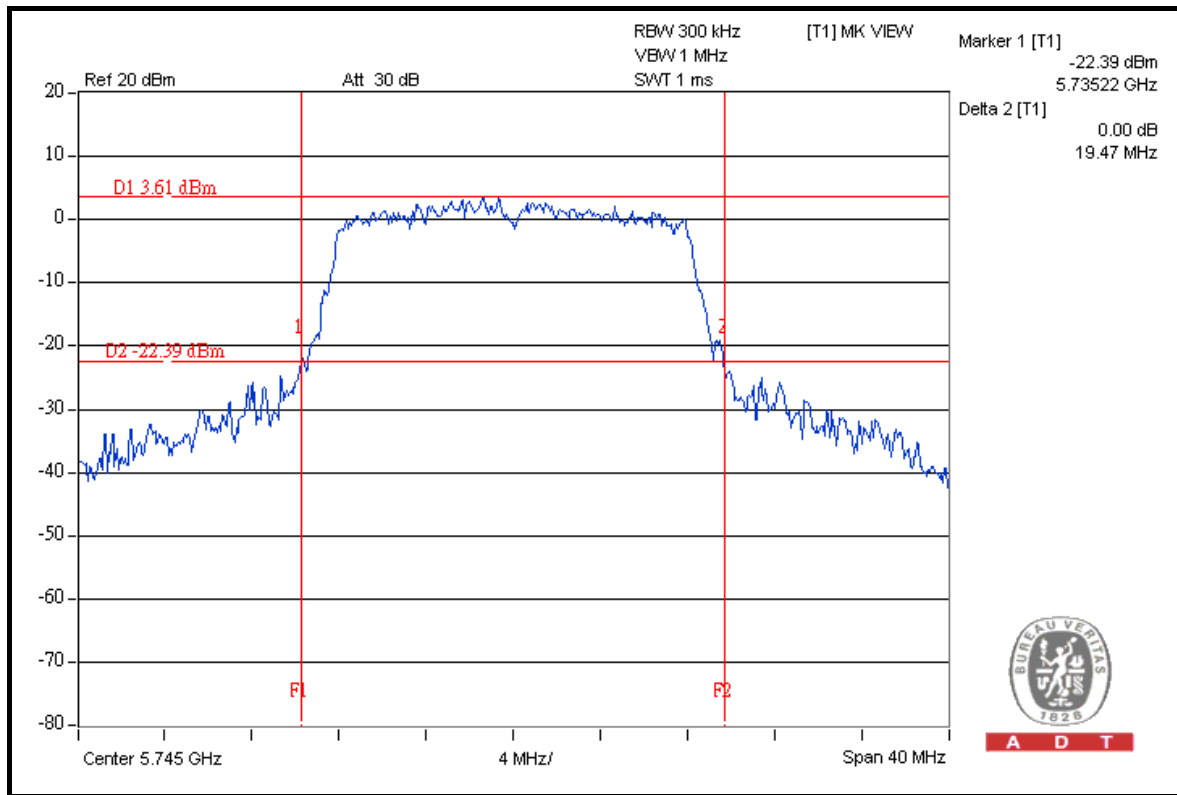

### CH 157

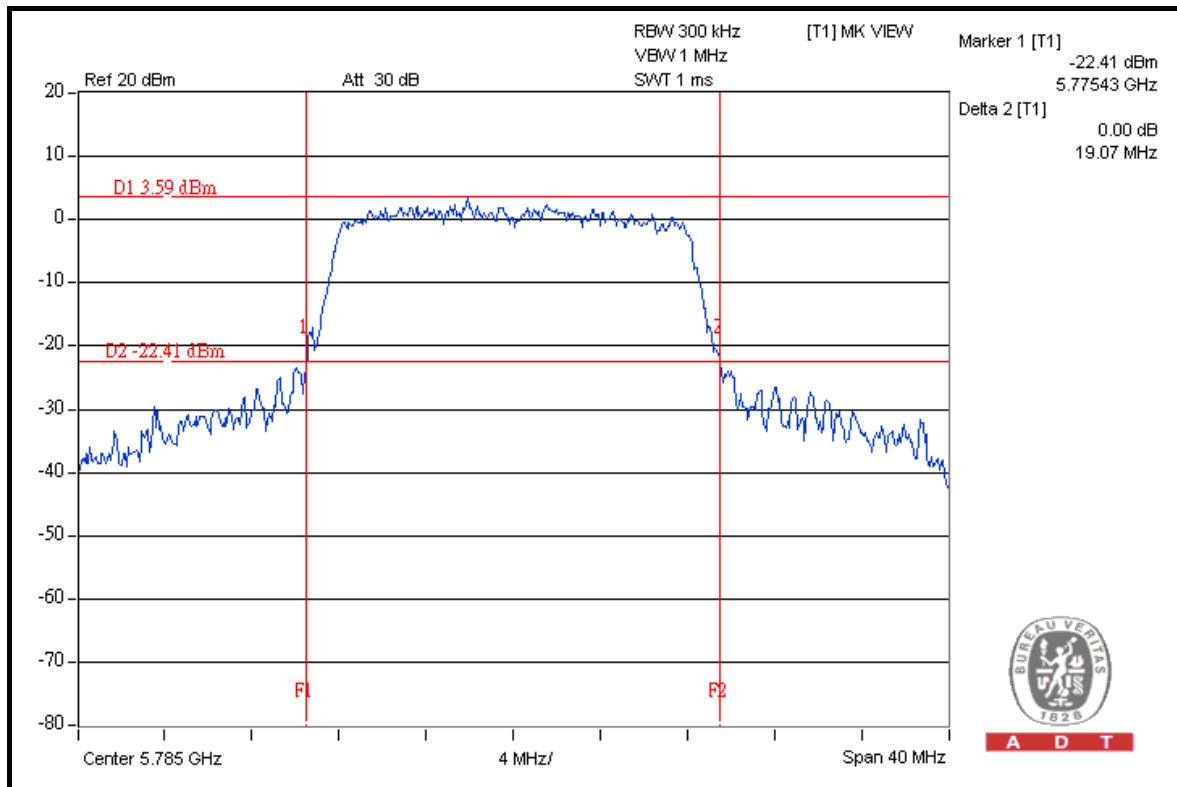



A D T

### CH 165

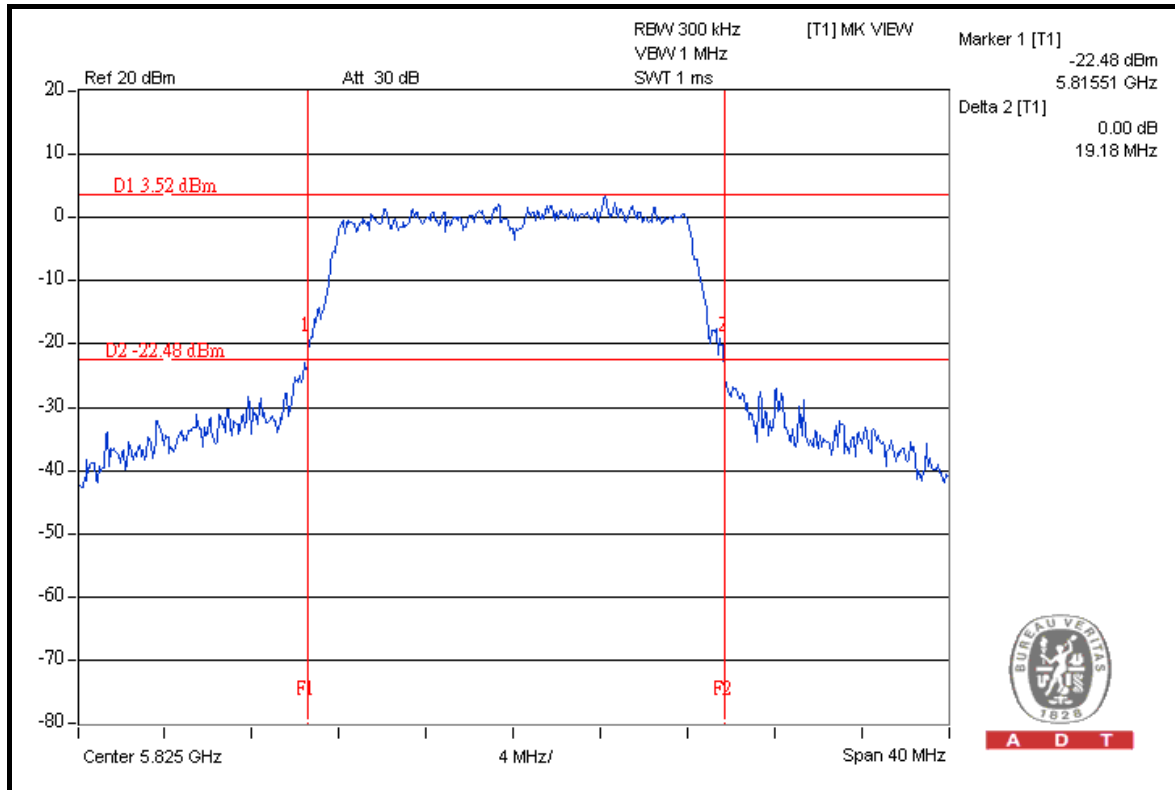

### FOR CHAIN 1: CH 149

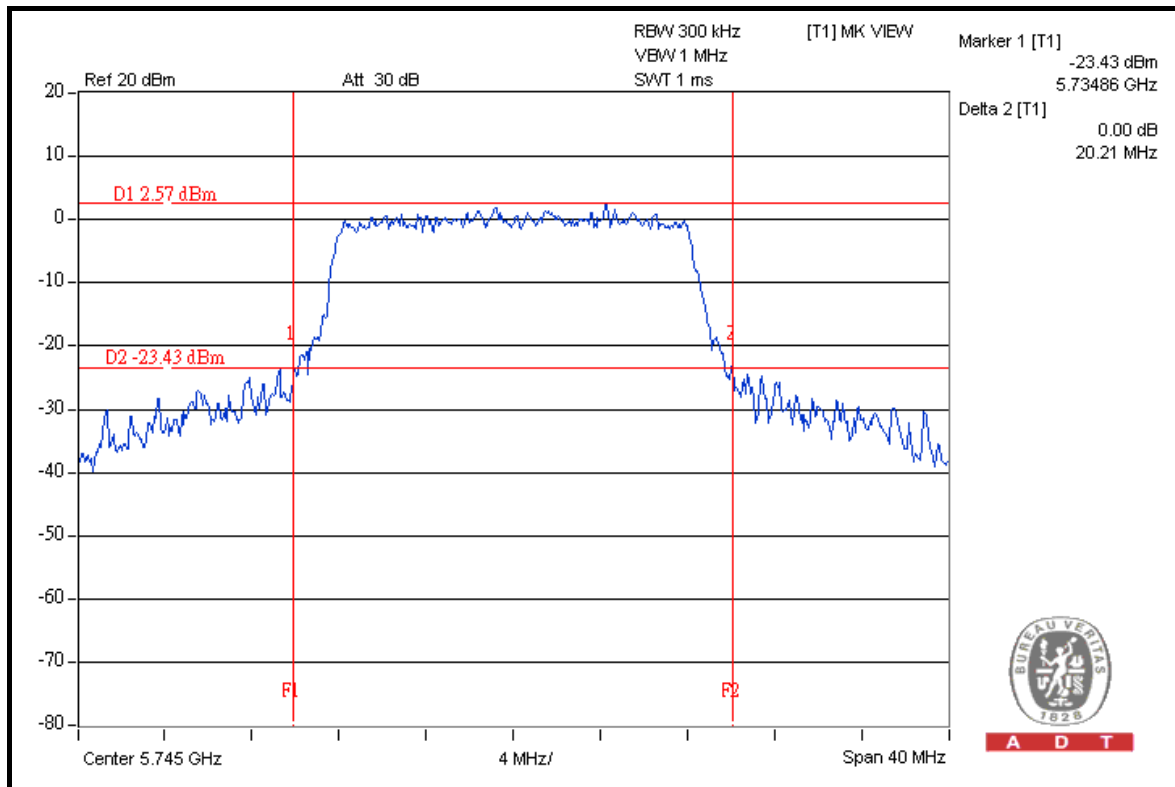



A D T

### CH 157

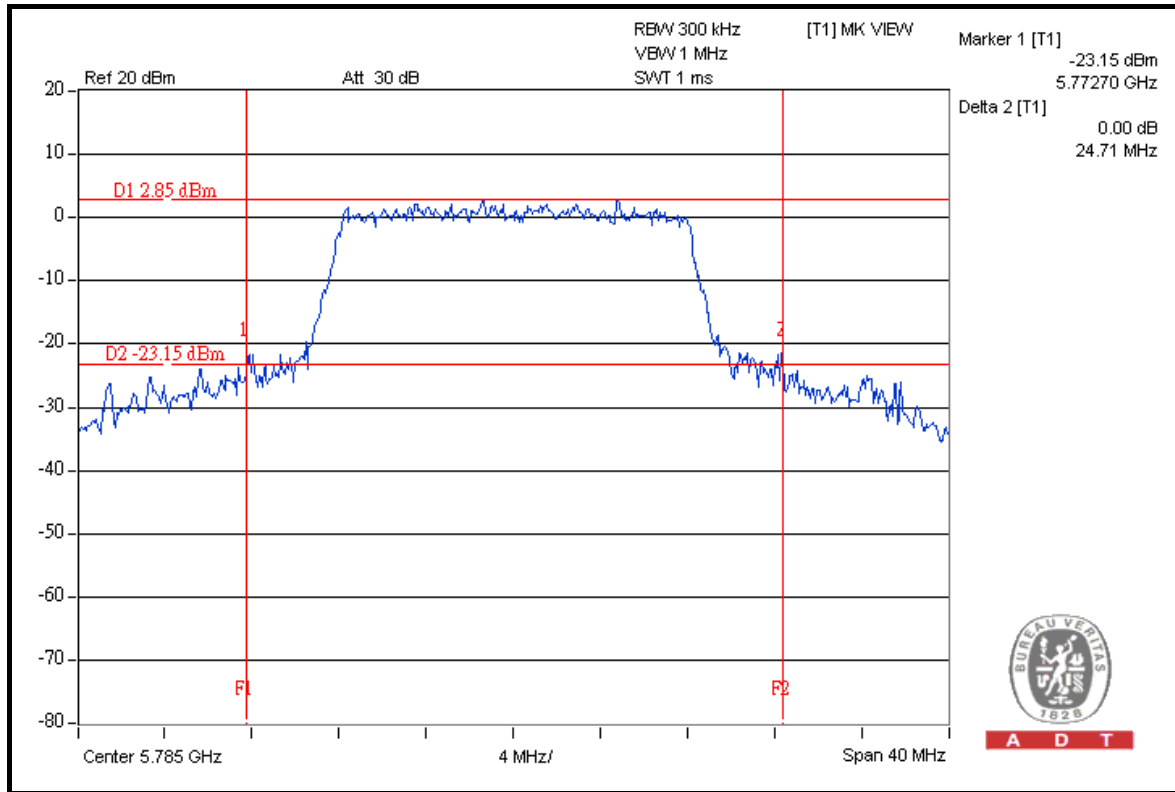

### CH 165

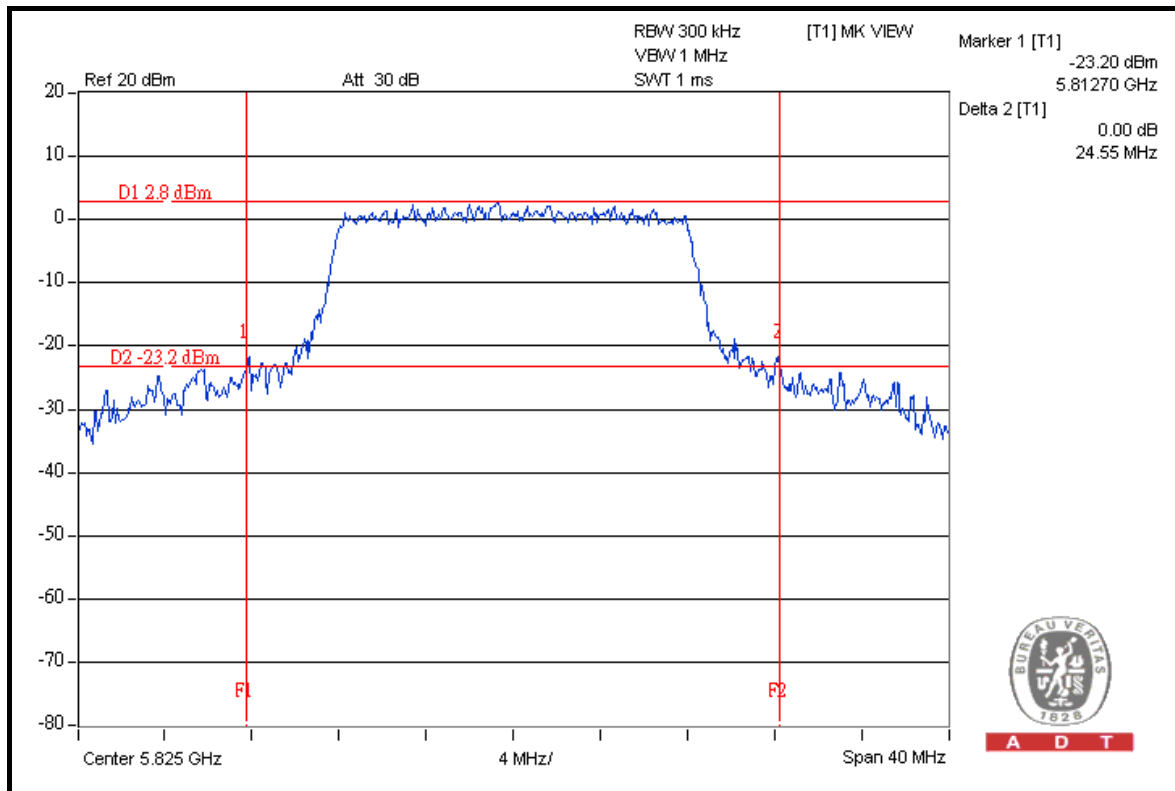



A D T

### DRAFT 802.11n (20MHz) OFDM MODULATION

<b>MODULATION TYPE</b>	OFDM	<b>TRANSFER RATE</b>	7.2Mbps
<b>INPUT POWER (SYSTEM)</b>	120Vac, 60Hz	<b>ENVIRONMENTAL CONDITIONS</b>	24deg.C, 64%RH, 991hPa
<b>TESTED BY</b>	Sun Lin		

CHANNEL	CHANNEL FREQUENCY (MHz)	26dBc OCCUPIED BANDWIDTH (MHz)		PASS / FAIL
		CHAIN 0	CHAIN 1	
149	5745	19.72	19.86	PASS
157	5785	19.67	20.39	PASS
165	5825	19.76	20.36	PASS



A D T

### FOR CHAIN 0: CH 149

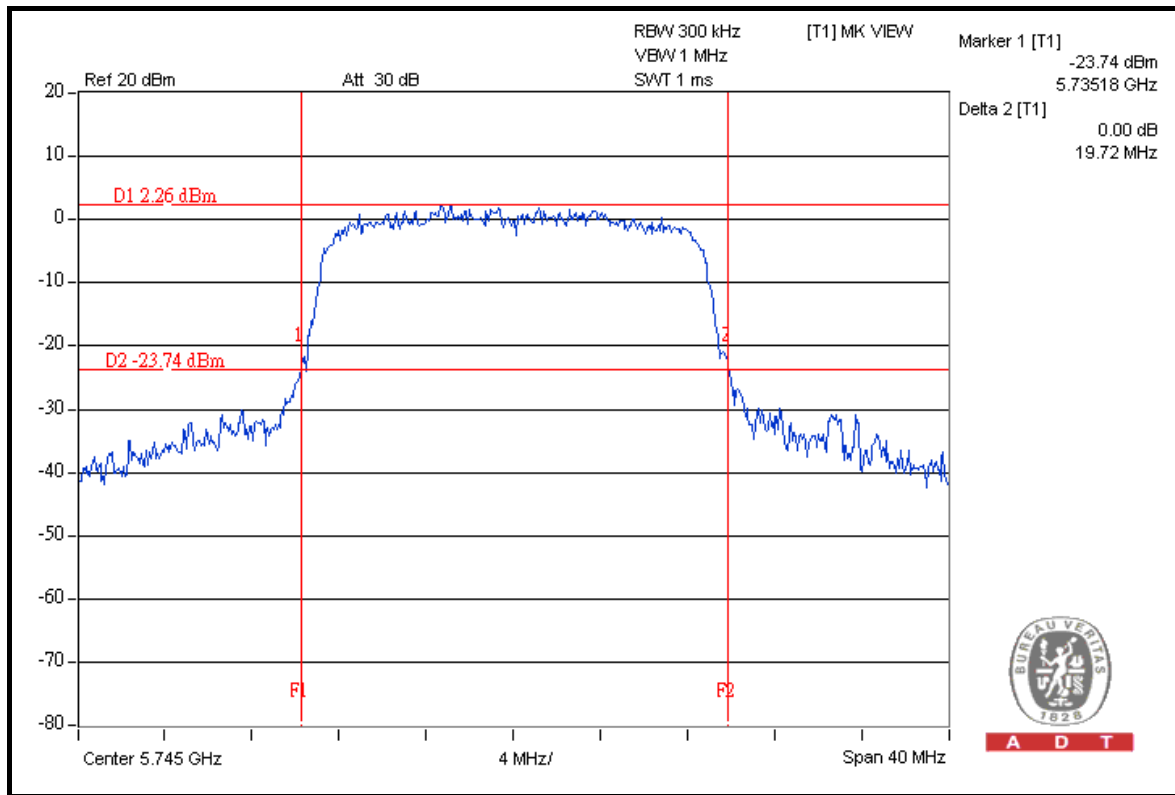

### CH 157

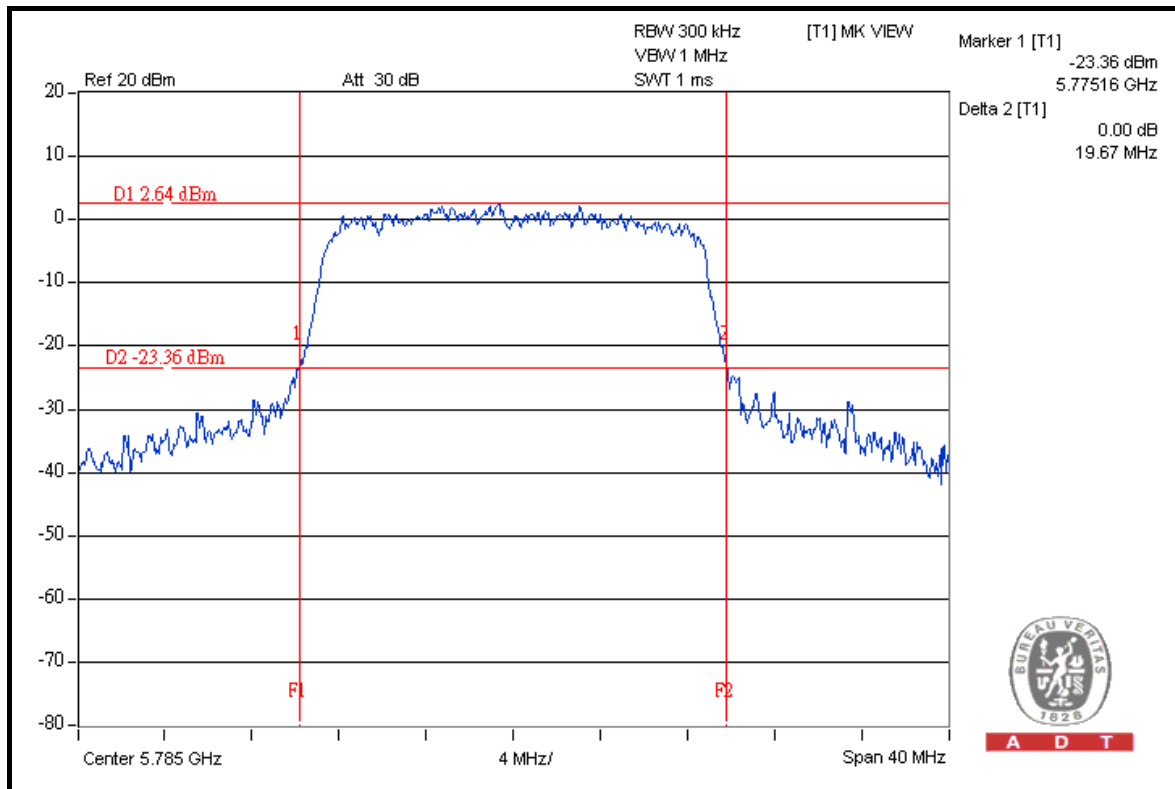





A D T

### CH 165

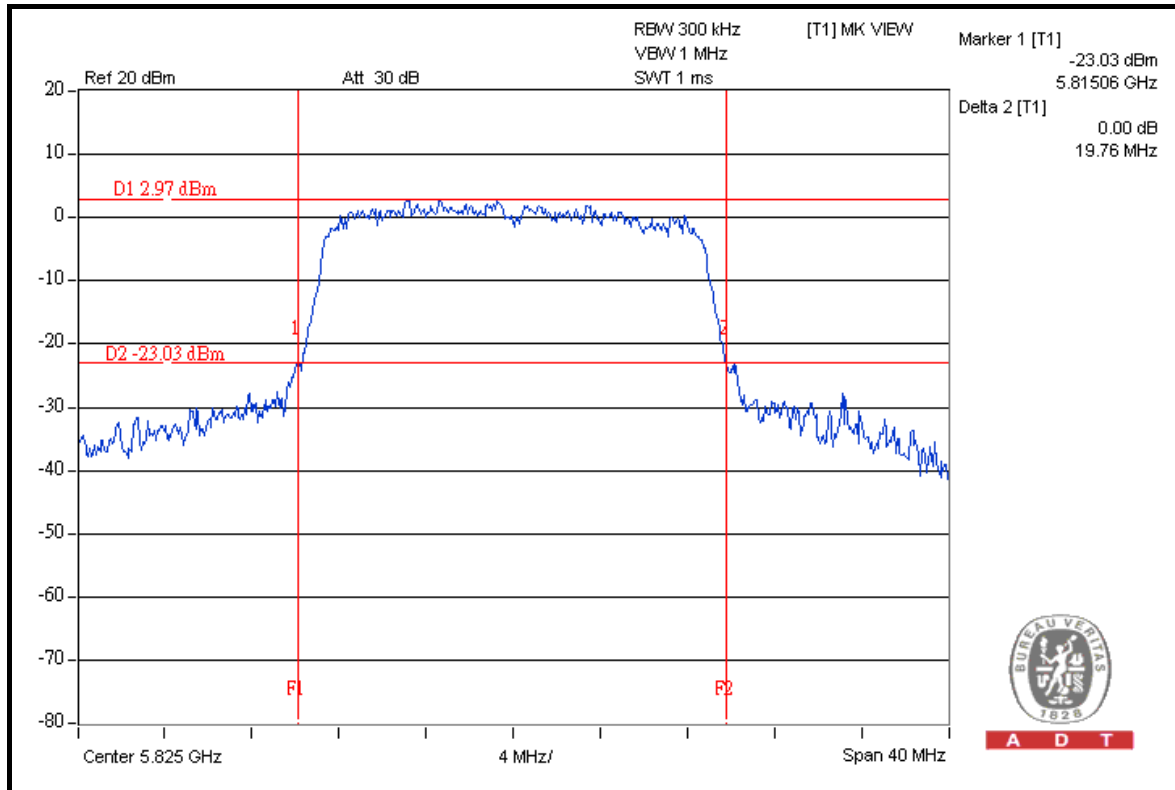

A D T

### FOR CHAIN 1: CH 149

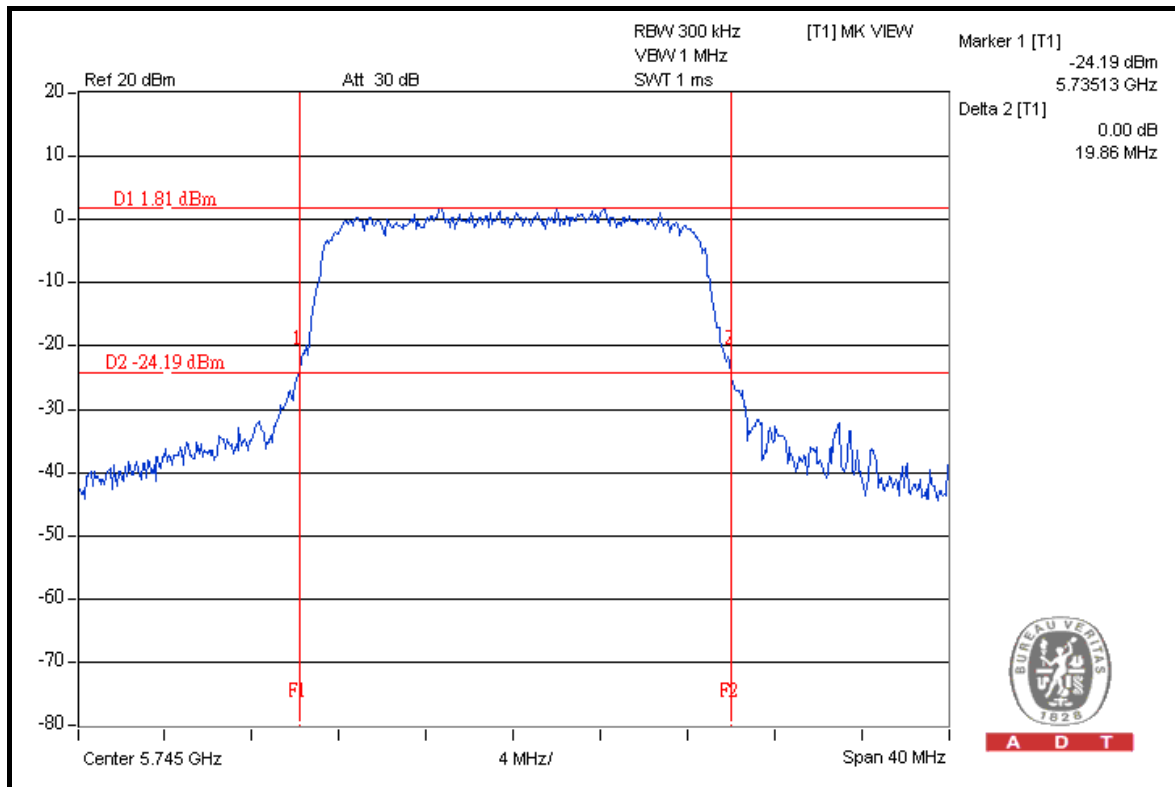

A D T



A D T

### CH 157

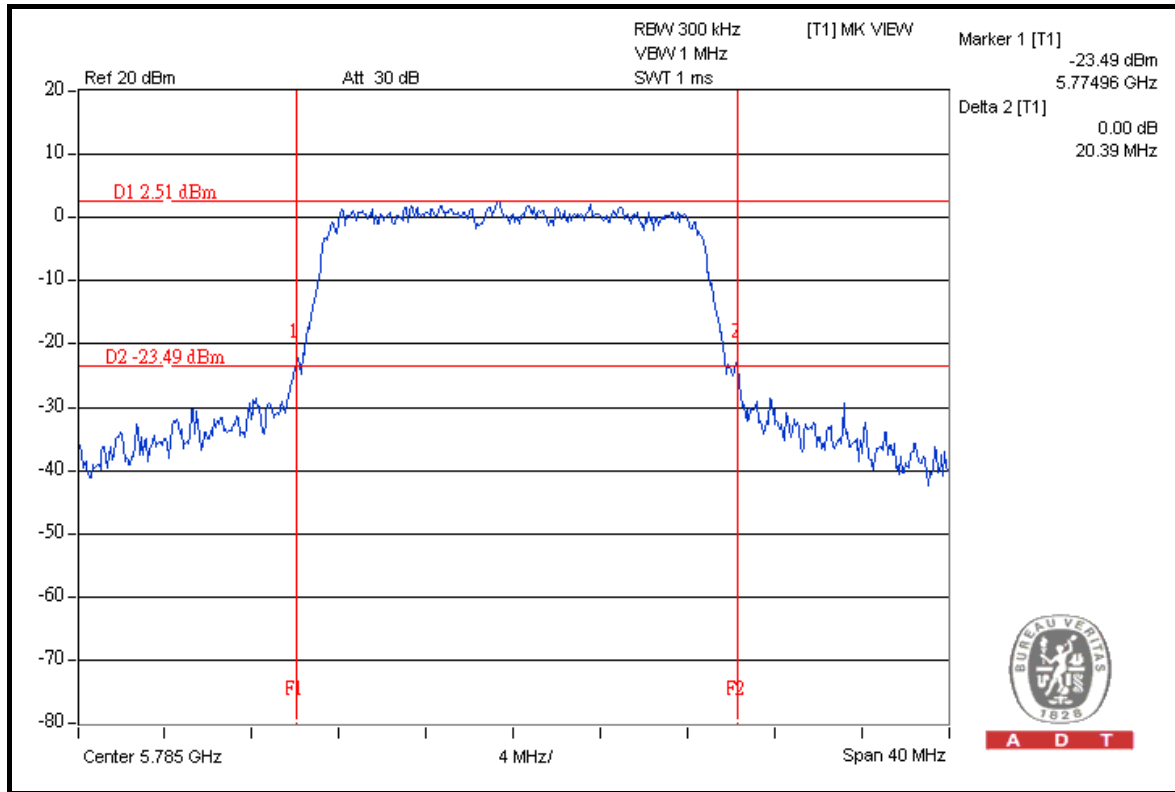

### CH 165

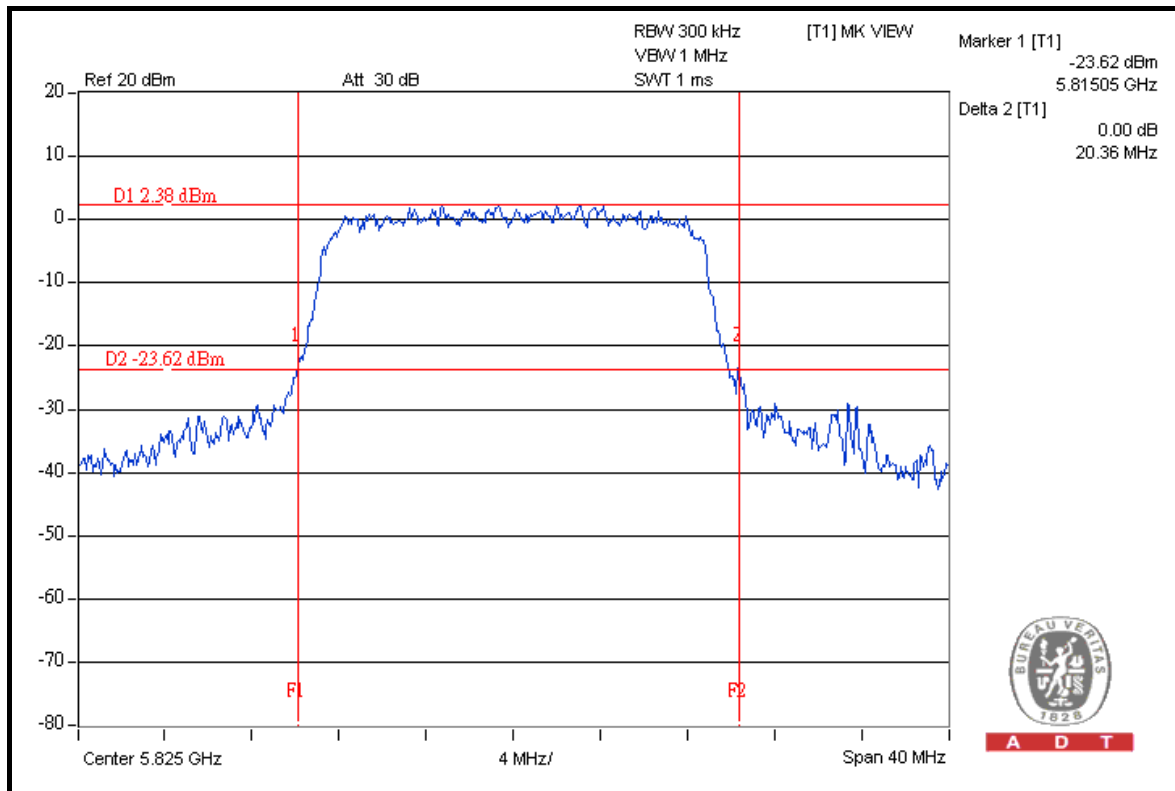



A D T

### DRAFT 802.11n (40MHz) OFDM MODULATION

<b>MODULATION TYPE</b>	OFDM	<b>TRANSFER RATE</b>	15.0Mbps
<b>INPUT POWER (SYSTEM)</b>	120Vac, 60Hz	<b>ENVIRONMENTAL CONDITIONS</b>	24deg.C, 64%RH, 991hPa
<b>TESTED BY</b>	Sun Lin		

CHANNEL	CHANNEL FREQUENCY (MHz)	26dBc OCCUPIED BANDWIDTH (MHz)		PASS / FAIL
		CHAIN 0	CHAIN 1	
151	5755	39.53	39.48	PASS
159	5795	39.14	39.03	PASS



A D T

### FOR CHAIN 0: CH 151

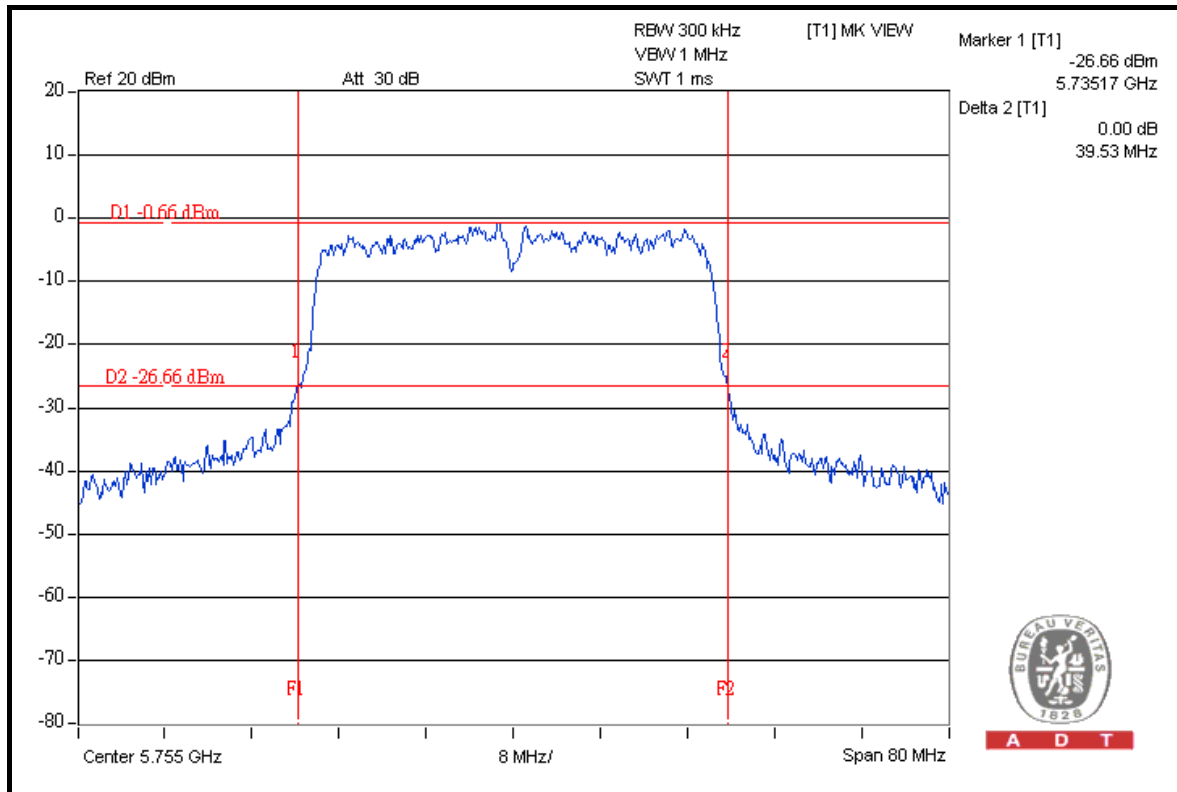

### CH 159

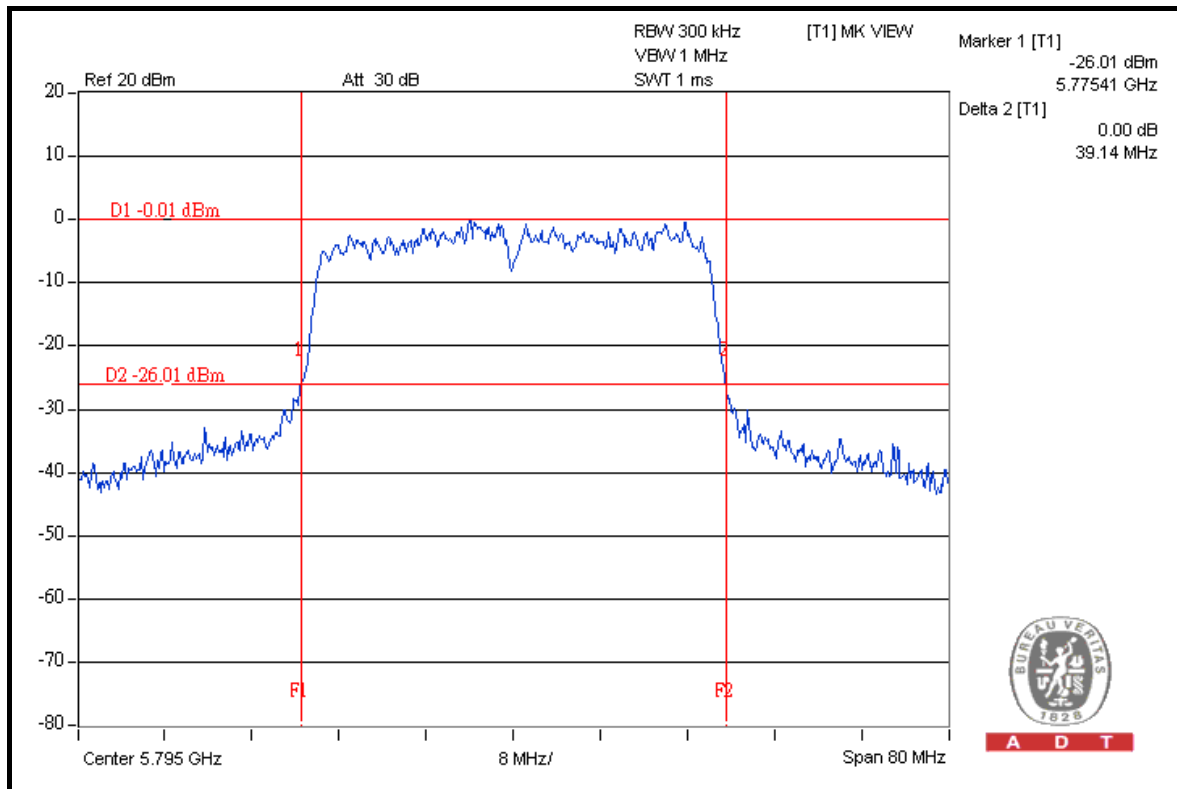



A D T

### FOR CHAIN 1: CH 151

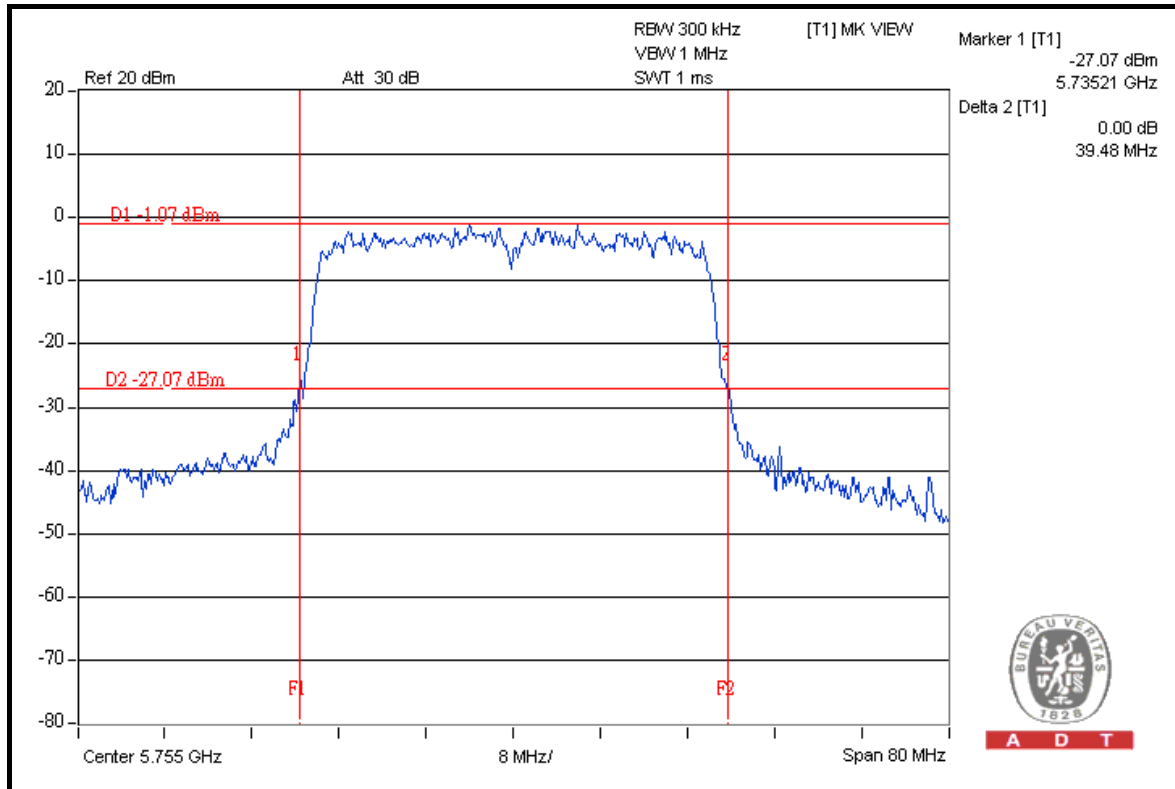

### CH 159

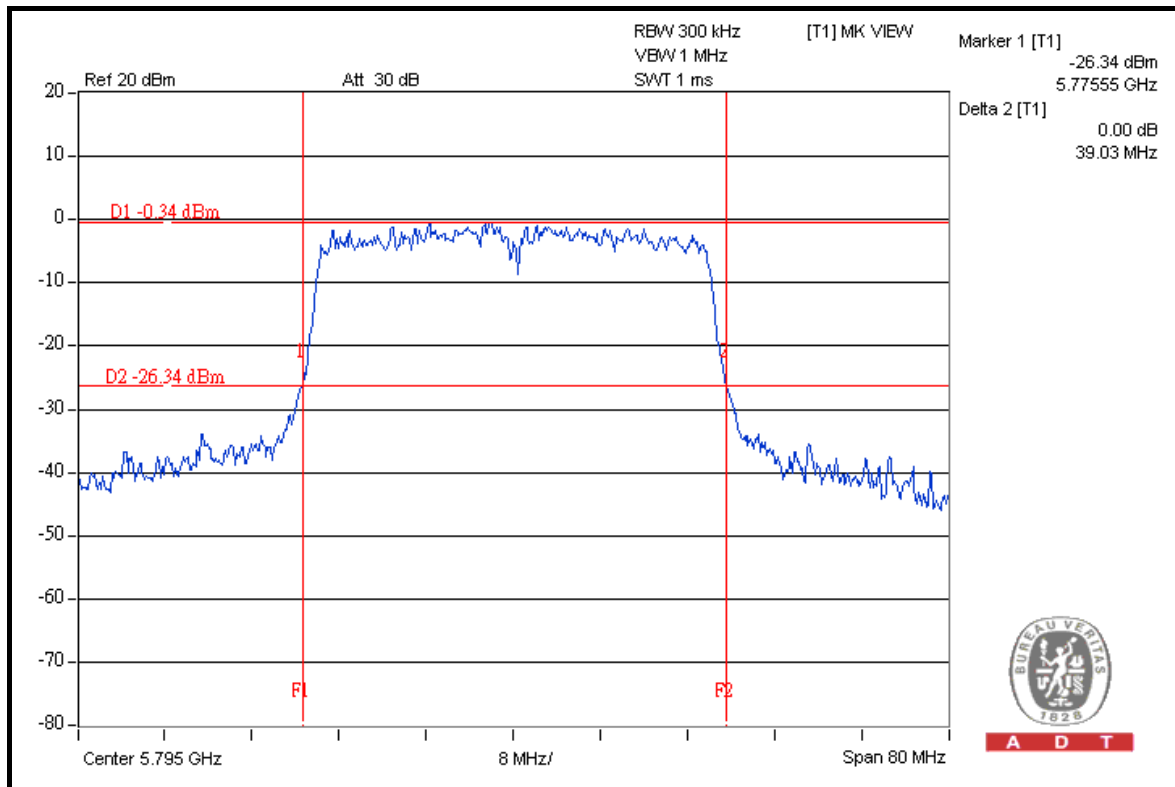



## 5.5 POWER SPECTRAL DENSITY MEASUREMENT

### 5.5.1 LIMITS OF POWER SPECTRAL DENSITY MEASUREMENT

The Maximum of Power Spectral Density Measurement is 8dBm.

### 5.5.2 TEST INSTRUMENTS

DESCRIPTION & MANUFACTURER	MODEL NO.	SERIAL NO.	DATE OF CALIBRATION	CALIBRATED UNTIL
R&S SPECTRUM ANALYZER	FSP40	100040	Jul. 07, 2009	Jul. 06, 2010

**NOTE:** The calibration interval of the above test instruments is 12 months and the calibrations are traceable to NML/ROC and NIST/USA.

### 5.5.3 TEST PROCEDURE

1. Follow DTS measurement (PSD Option 2), the transmitter output was connected to the spectrum analyzer through an attenuator, the bandwidth of the fundamental frequency was measured with the spectrum analyzer. Locate and zoom in on emission peak(s) within the pass band.
2. Set RBW = 3 kHz /VBW > 9 kHz and sweep time to Automatic.
3. Detector use peak mode and a video trigger with the trigger level set to enable triggering only on full power pulses.
4. Trace average 100 traces in power averaging mode. The power spectral density was measured and recorded.

#### 5.5.4 DEVIATION FROM TEST STANDARD

No deviation.

#### 5.5.5 TEST SETUP

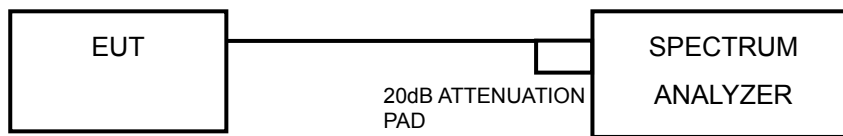

#### 5.5.6 EUT OPERATING CONDITION

Same as Item 5.3.6.



A D T

### 5.5.7 TEST RESULTS

#### 802.11a OFDM MODULATION

<b>MODULATION TYPE</b>	BPSK	<b>TRANSFER RATE</b>	6.0Mbps
<b>INPUT POWER</b>	120Vac, 60Hz	<b>ENVIRONMENTAL CONDITIONS</b>	24deg.C, 64%RH, 1021hPa
<b>TESTED BY</b>	Sun Lin		

CHAN.	CHAN. FREQ. (MHz)	RF POWER LEVEL IN 3kHz BW (dBm)		TOTAL POWER DENSITY (mW)	TOTAL POWER DENSITY (dBm)	MAX. LIMIT (dBm)	PASS / FAIL
		CHAIN 0	CHAIN 1				
149	5745	-12.05	-9.02	0.19	-7.26	8	PASS
157	5785	-11.42	-8.32	0.22	-6.60	8	PASS
165	5825	-11.45	-8.32	0.22	-6.60	8	PASS





A D T

### FOR CHAIN 0: CH 149

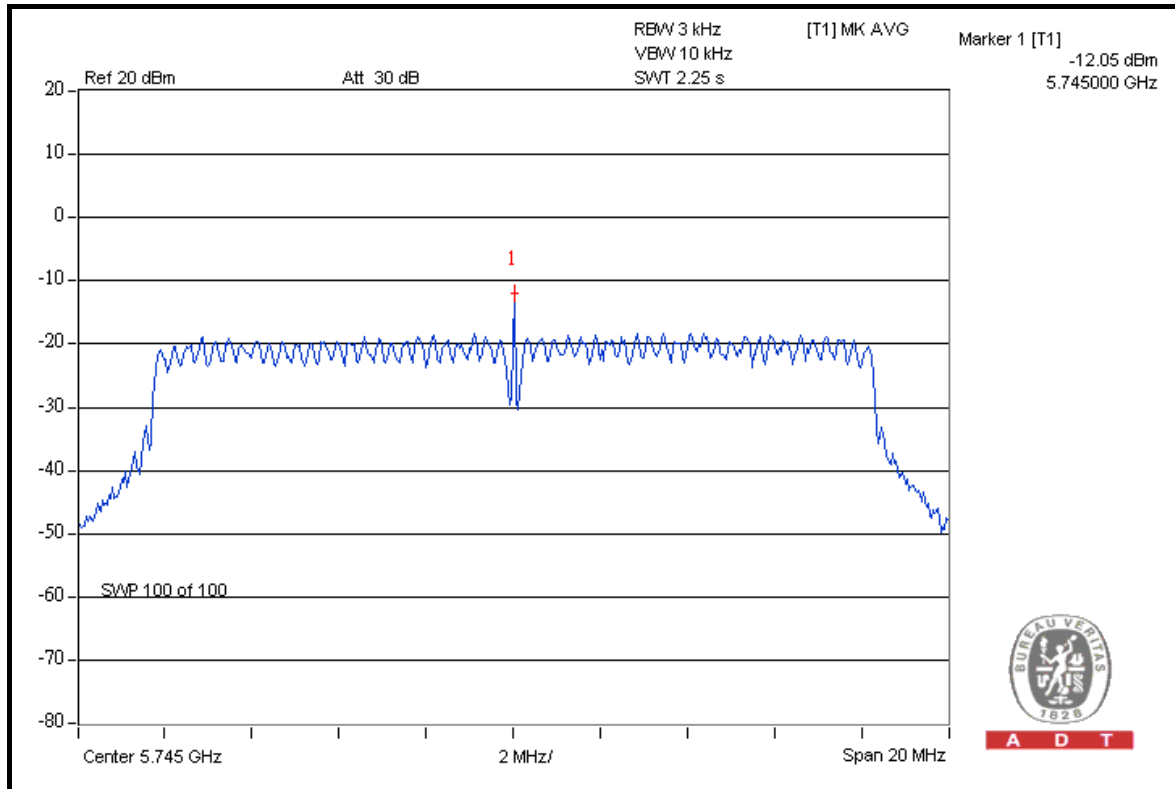

A D T

### CH 157

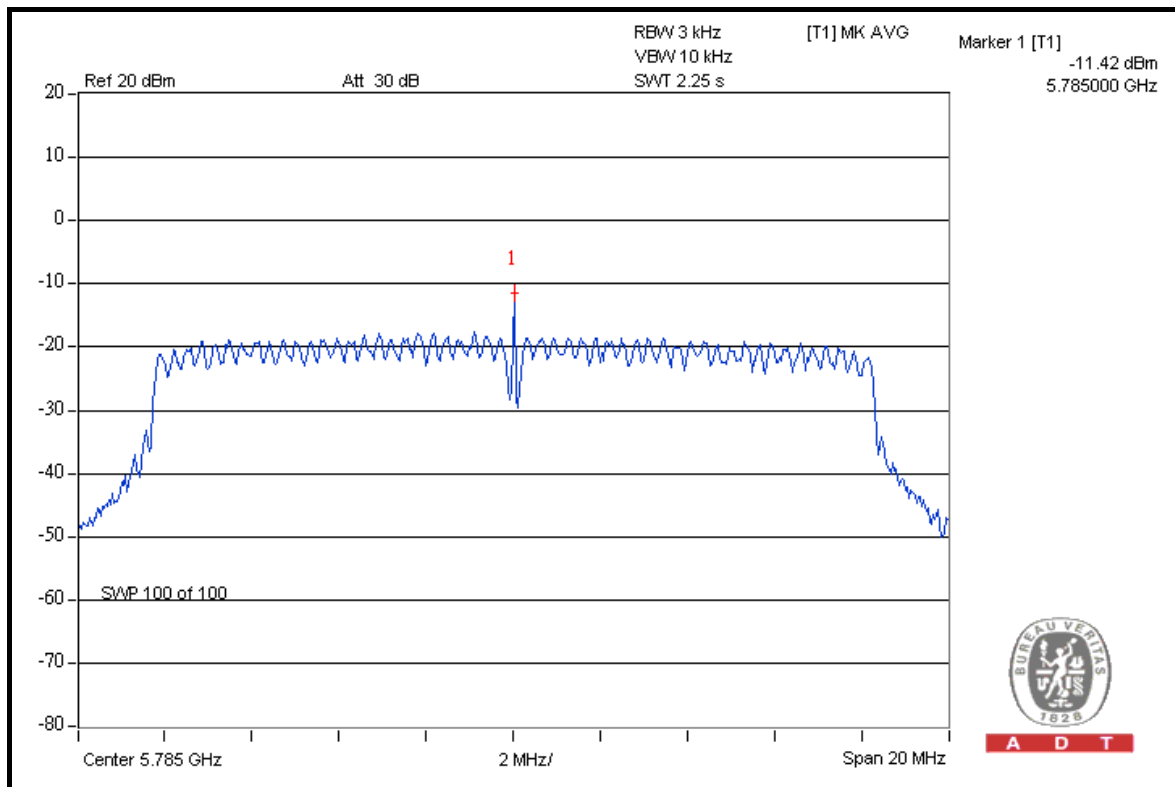

A D T



A D T

### CH 165

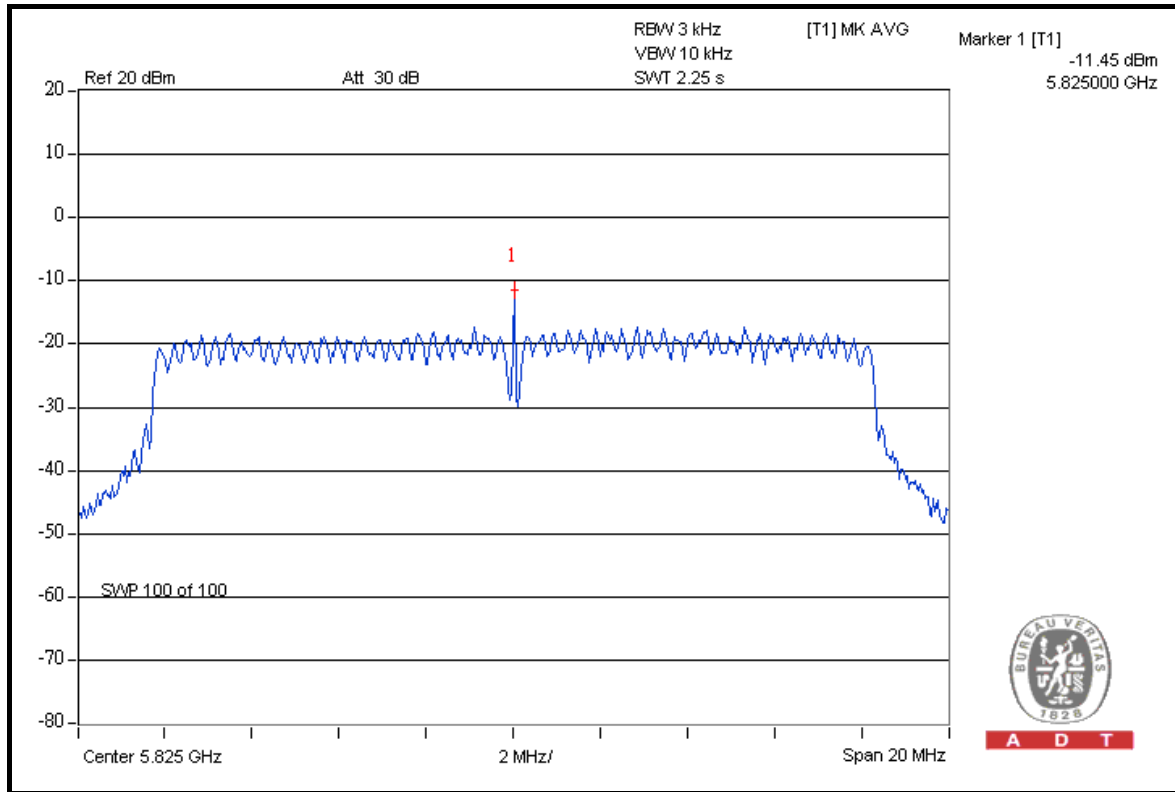

### FOR CHAIN 1: CH 149

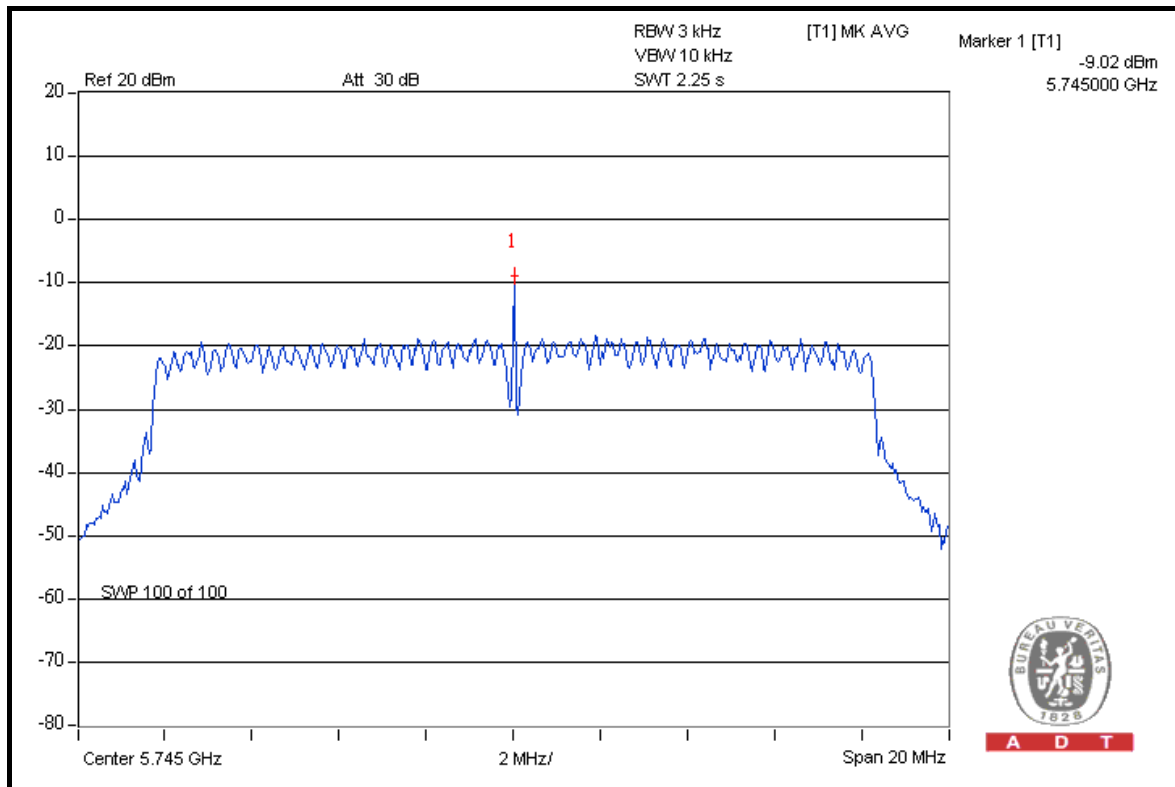



A D T

### CH 157

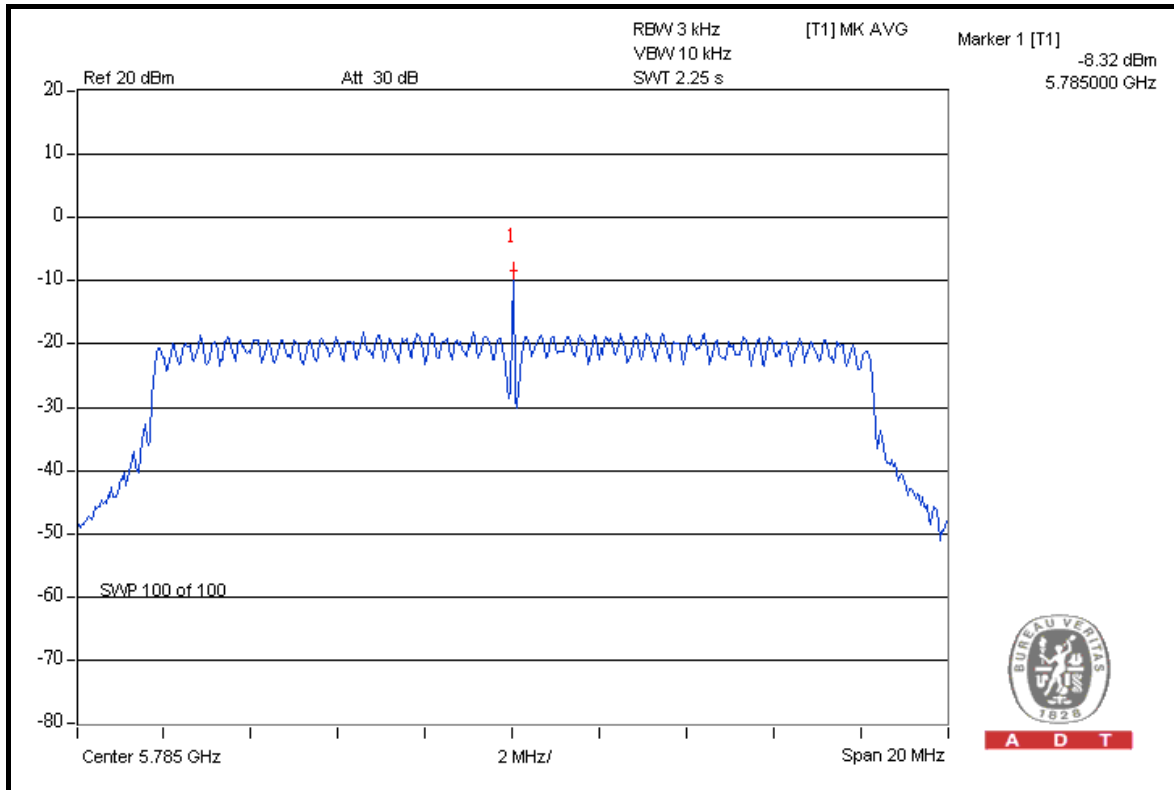

### CH 165

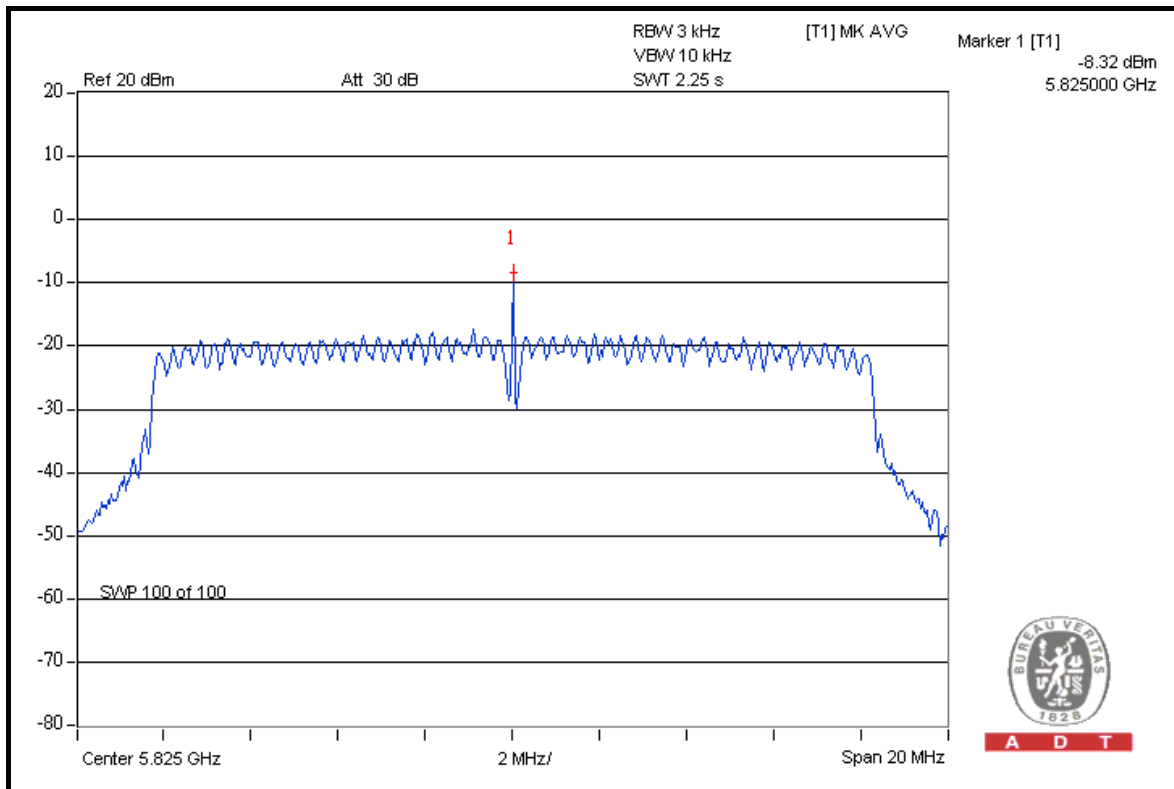



A D T

### DRAFT 802.11n (20MHz) OFDM MODULATION

<b>MODULATION TYPE</b>	BPSK	<b>TRANSFER RATE</b>	7.2Mbps
<b>INPUT POWER</b>	120Vac, 60Hz	<b>ENVIRONMENTAL CONDITIONS</b>	24deg.C, 64%RH, 991hPa
<b>TESTED BY</b>	Sun Lin		

CHAN.	CHAN. FREQ. (MHz)	RF POWER LEVEL IN 3kHz BW (dBm)		TOTAL POWER DENSITY (mW)	TOTAL POWER DENSITY (dBm)	MAX. LIMIT (dBm)	PASS / FAIL
		CHAIN 0	CHAIN 1				
149	5745	-10.53	-8.24	0.24	-6.23	8	PASS
157	5785	-10.35	-8.08	0.25	-6.06	8	PASS
165	5825	-10.35	-8.15	0.25	-6.11	8	PASS



A D T

### FOR CHAIN 0: CH 149

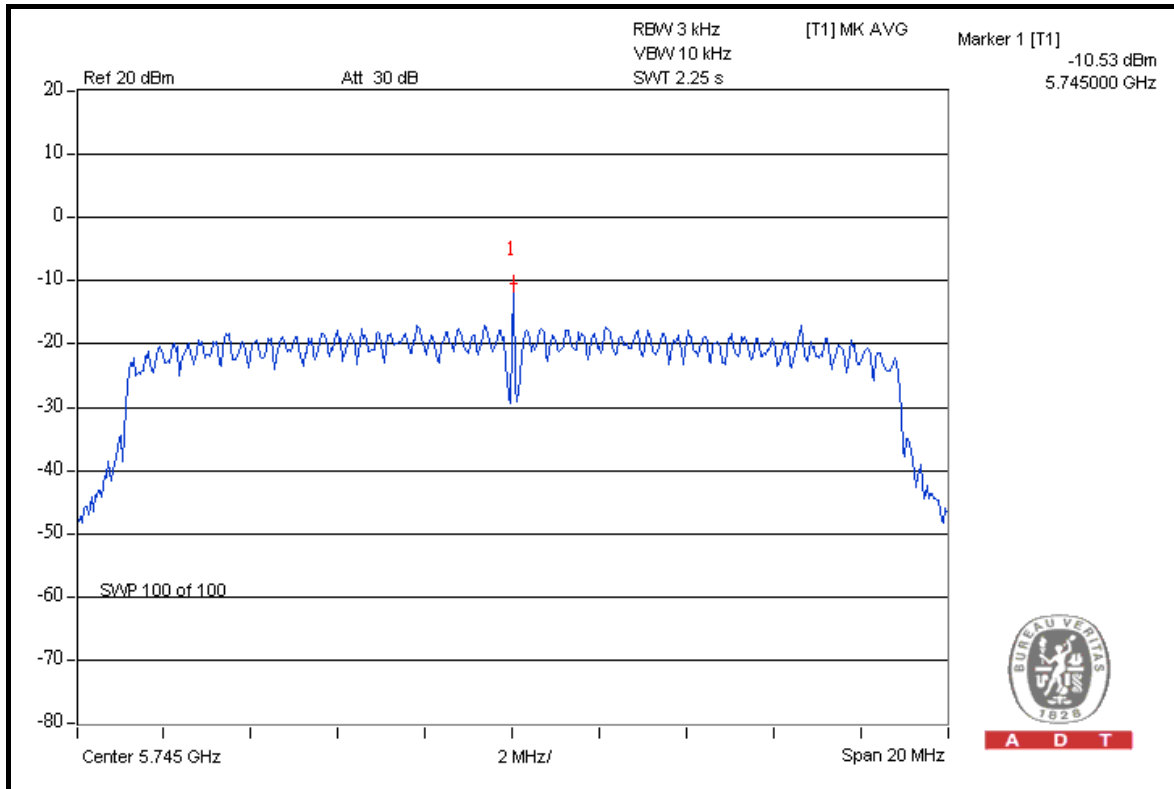

A D T

### CH 157

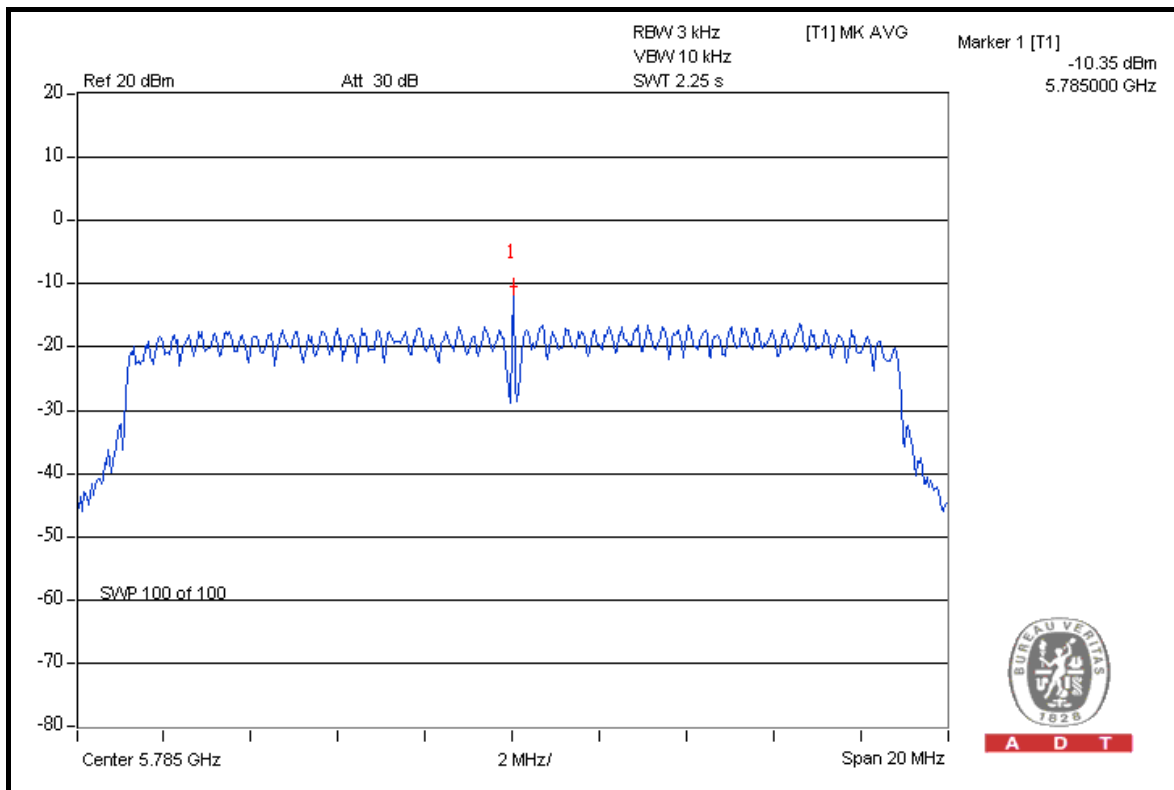

A D T



A D T

### CH 165

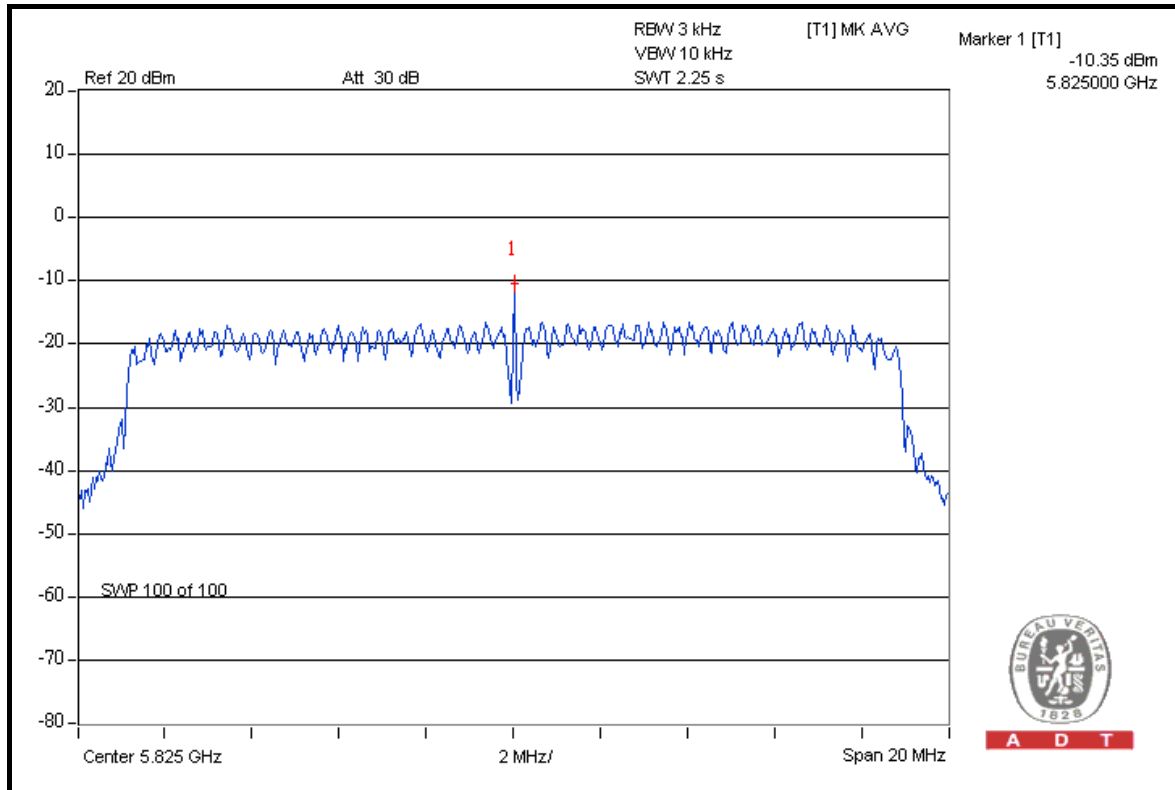

A D T

### FOR CHAIN 1: CH 149

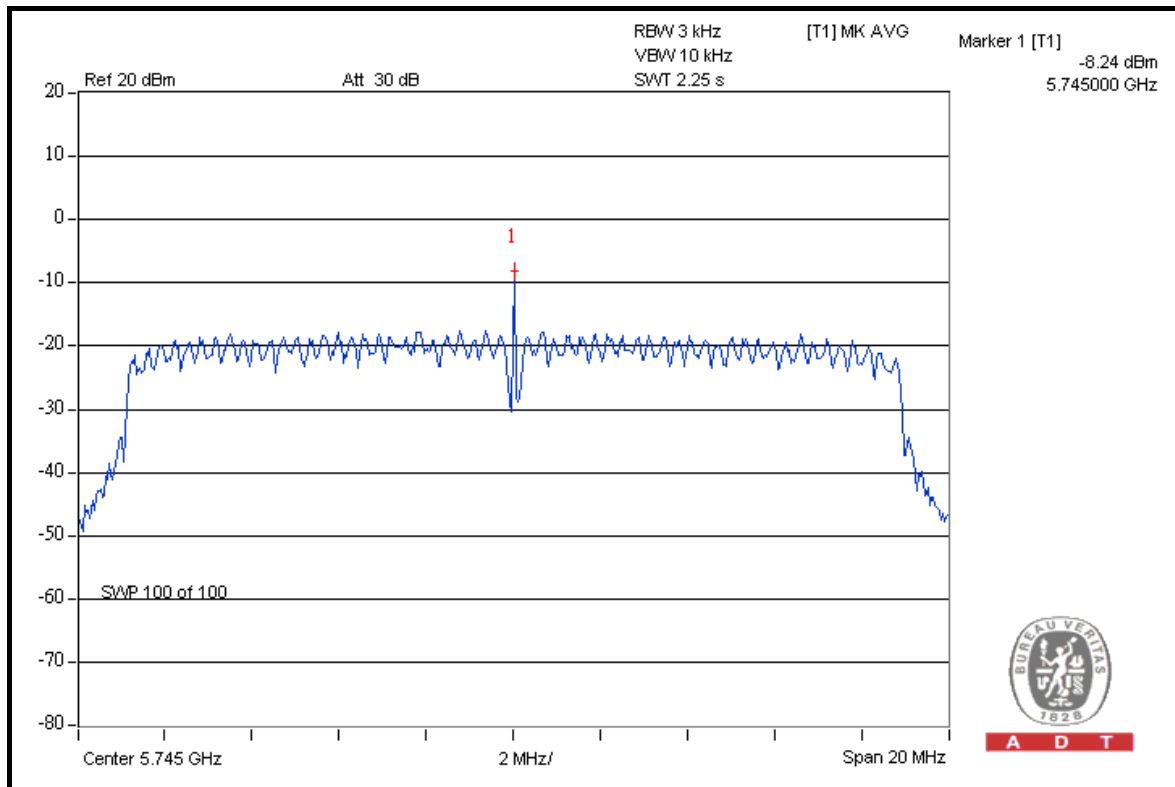

A D T



A D T

### CH 157

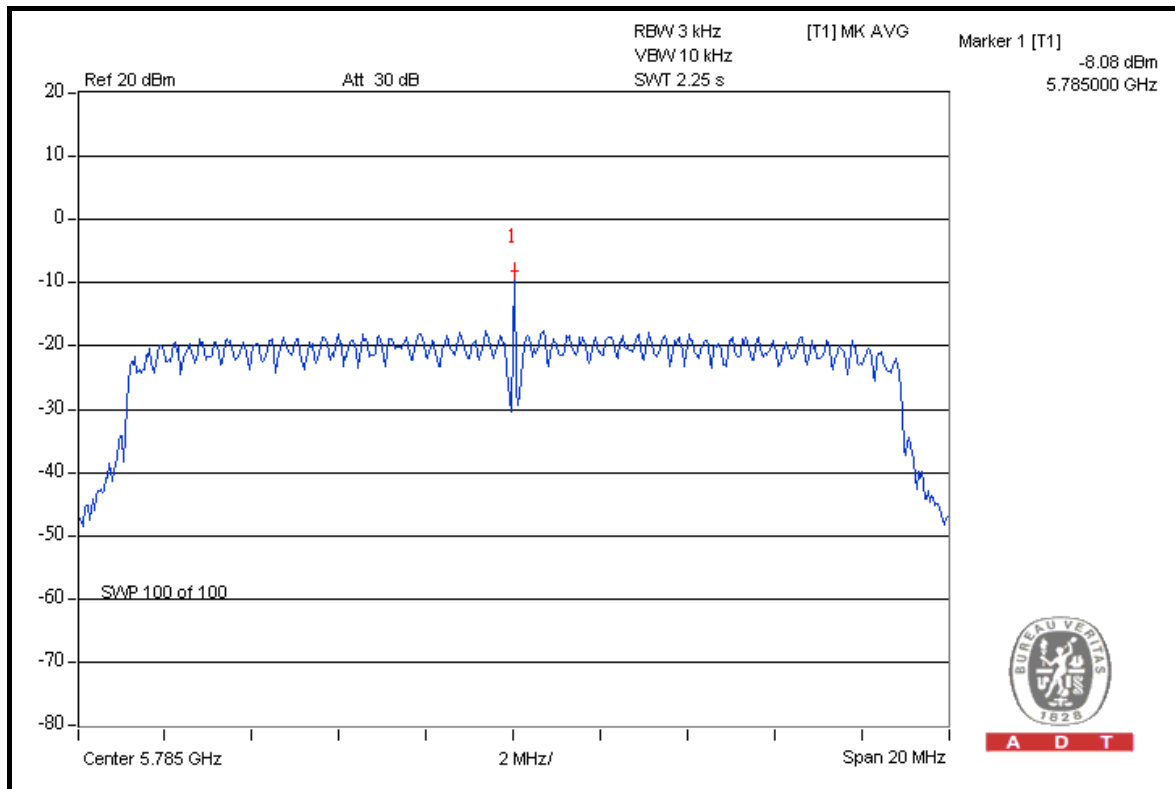

### CH 165

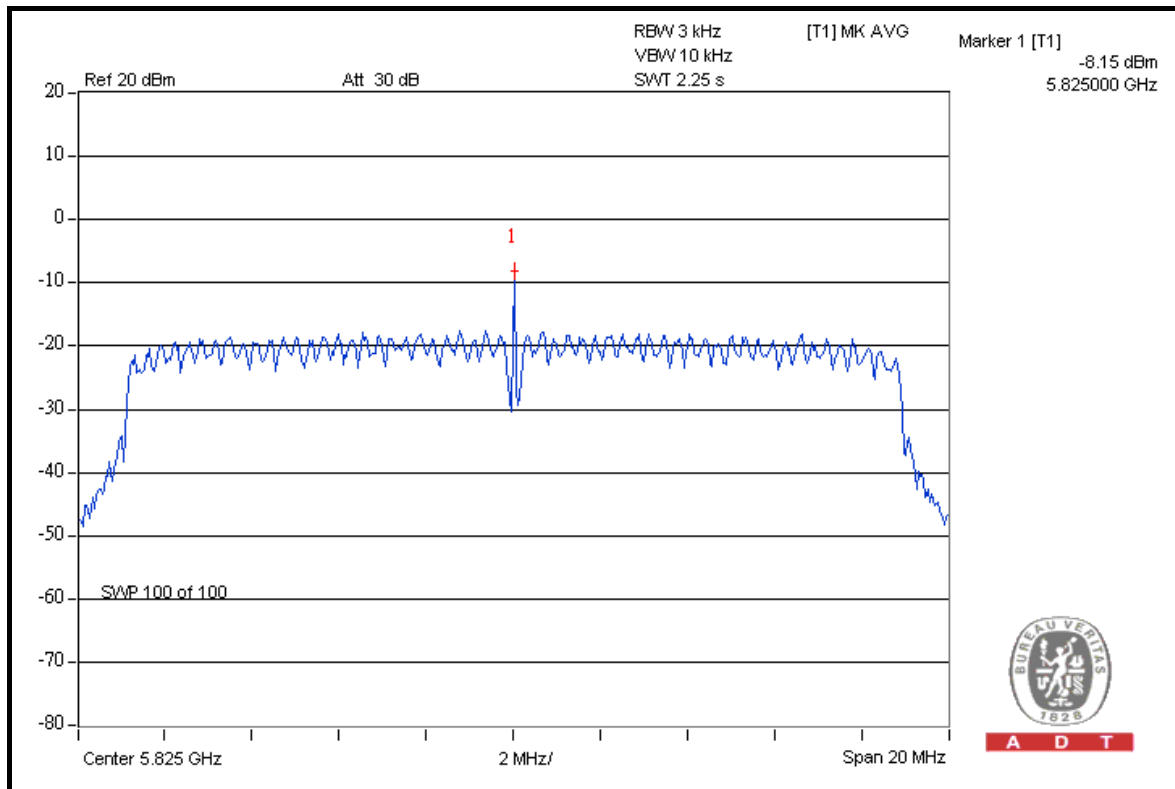



A D T

### DRAFT 802.11n (40MHz) OFDM MODULATION

<b>MODULATION TYPE</b>	BPSK	<b>TRANSFER RATE</b>	15.0Mbps
<b>INPUT POWER</b>	120Vac, 60Hz	<b>ENVIRONMENTAL CONDITIONS</b>	24deg.C, 64%RH, 1021hPa
<b>TESTED BY</b>	Sun Lin		

CHAN.	CHAN. FREQ. (MHz)	RF POWER LEVEL IN 3kHz BW (dBm)		TOTAL POWER DENSITY (mW)	TOTAL POWER DENSITY (dBm)	MAX. LIMIT (dBm)	PASS / FAIL
		CHAIN 0	CHAIN 1				
151	5755	-12.17	-7.66	0.23	-6.35	8	PASS
159	5795	-12.01	-7.74	0.23	-6.36	8	PASS





A D T

### FOR CHAIN 0: CH 151

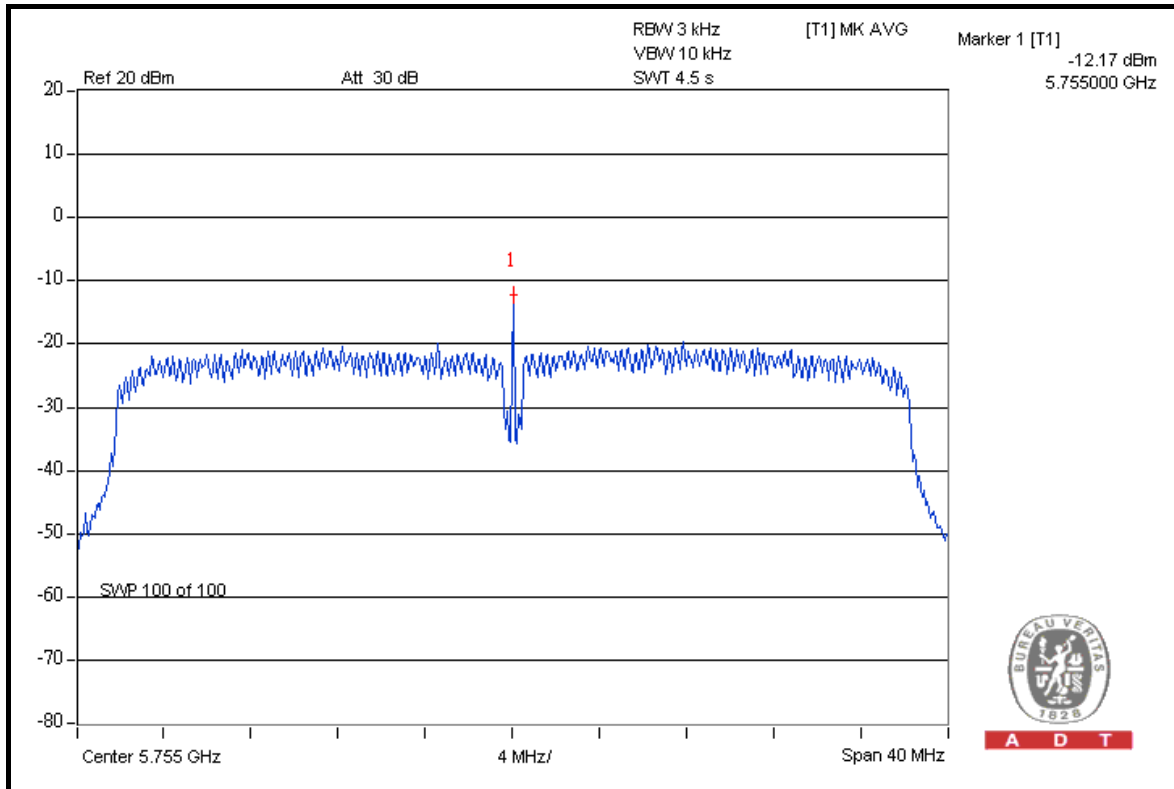

### CH 159

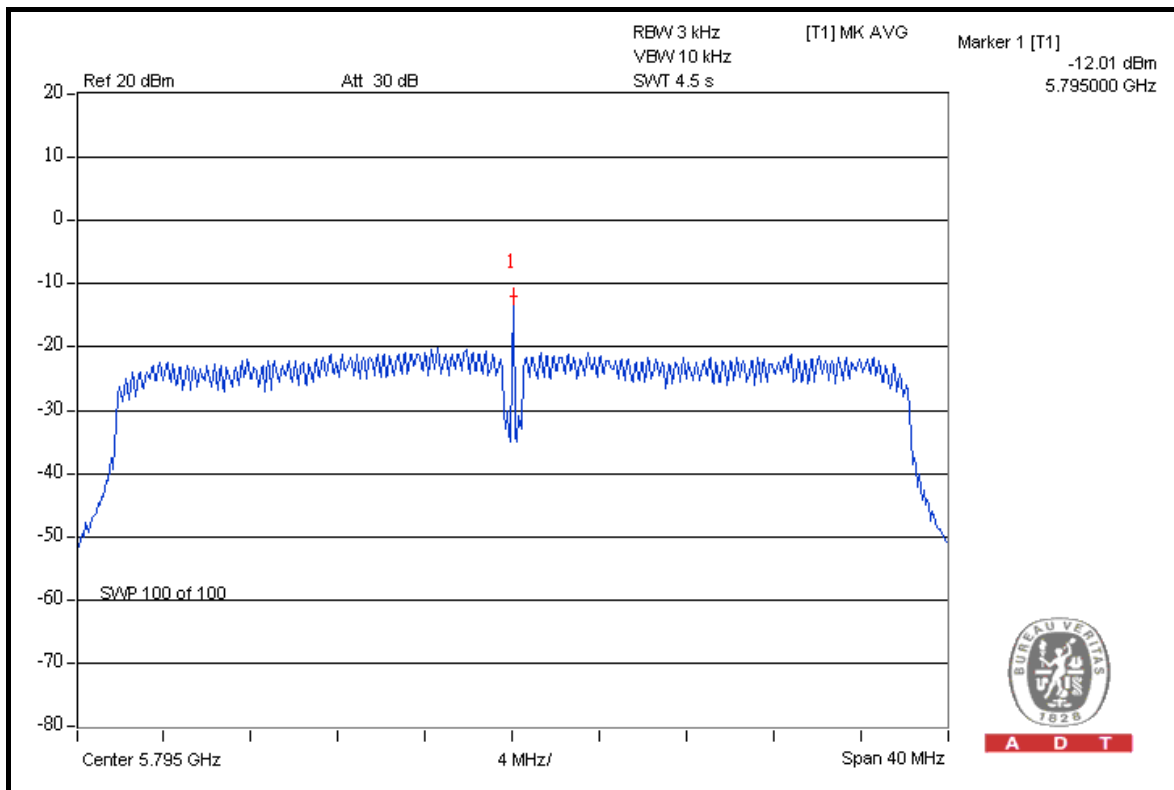



A D T

### FOR CHAIN 1: CH 151

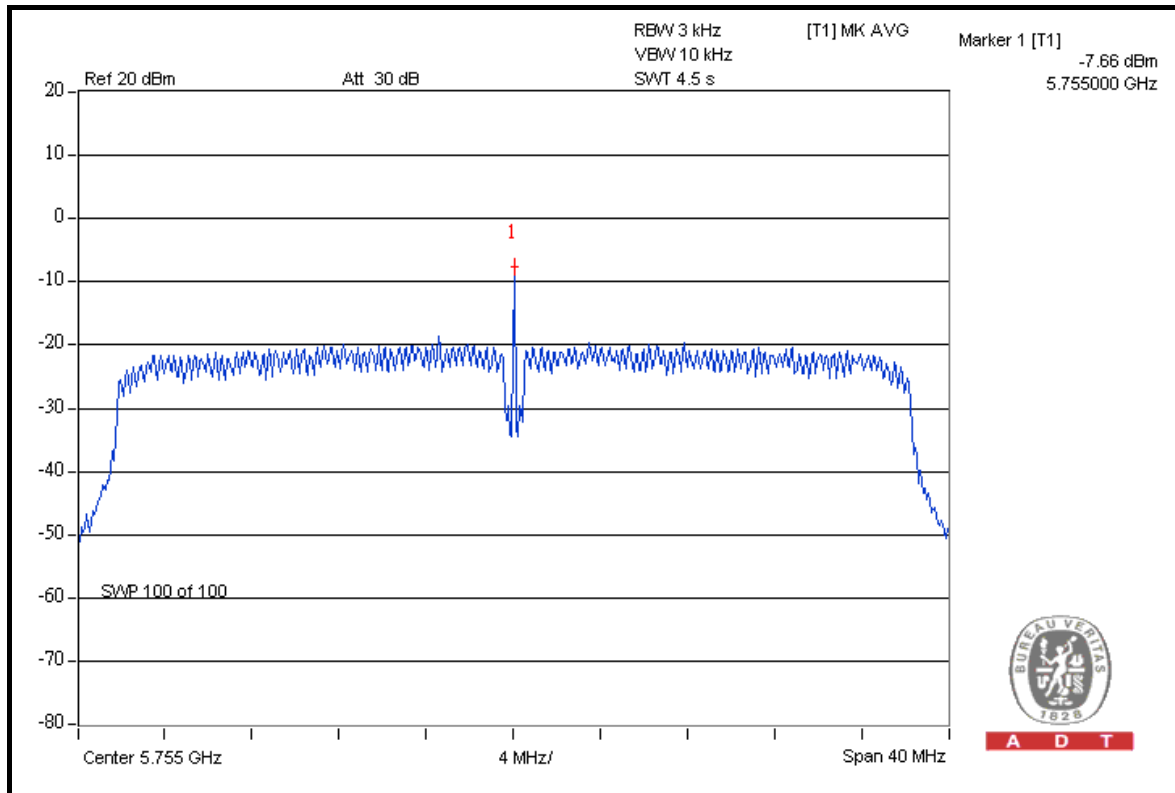

A D T

### CH 159

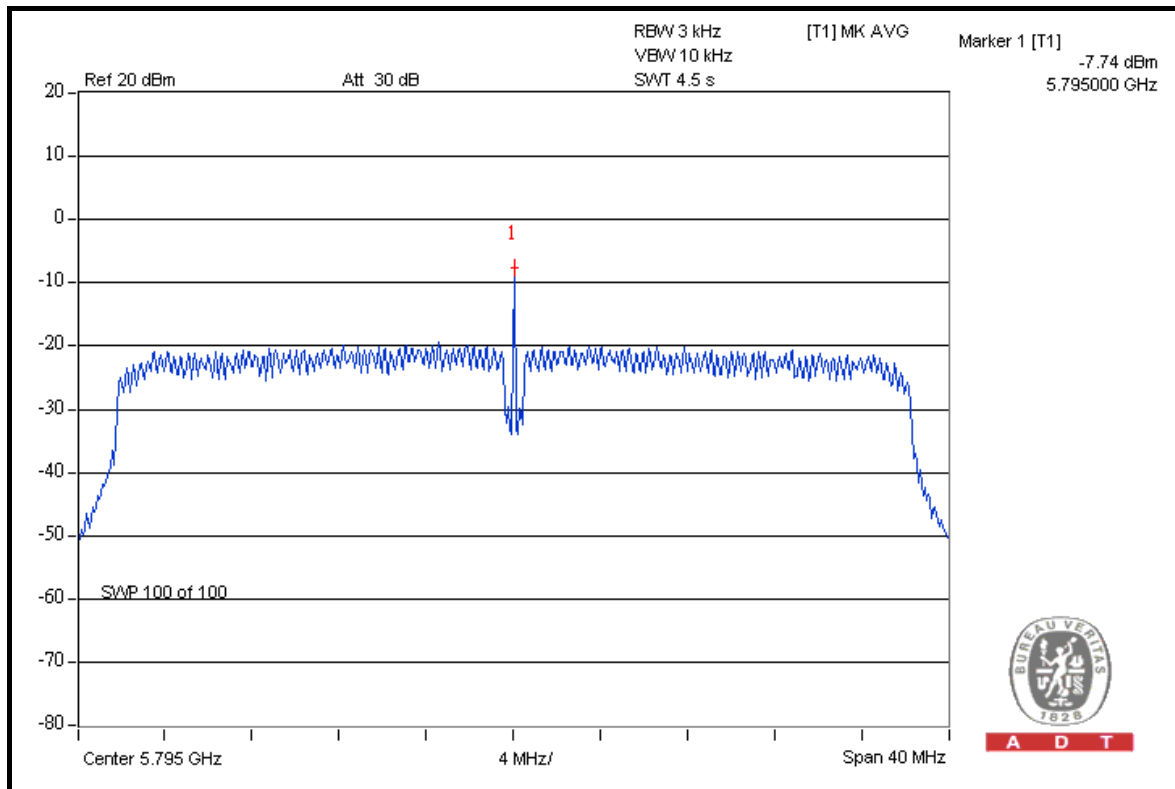

A D T



### 5.6 BAND EDGES MEASUREMENT

#### 5.6.1 LIMITS OF BAND EDGES MEASUREMENT

Below -20dB of the highest emission level of operating band (in 100kHz Resolution Bandwidth).

**Note:** Follow DTS measurement, If the device complies with the use of power option 2 the attenuation under this paragraph shall be 30 dB instead of 20 dB.

#### 5.6.2 TEST INSTRUMENTS

DESCRIPTION & MANUFACTURER	MODEL NO.	SERIAL NO.	DATE OF CALIBRATION	DUE DATE OF CALIBRATION
Test Receiver ROHDE & SCHWARZ	ESI7	100033	Jul. 06, 2009	Jul. 05, 2010
Spectrum Analyzer ROHDE & SCHWARZ	FSP40	100076	May. 26, 2009	May. 25, 2010
BILOG Antenna SCHWARZBECK	VULB9168	9168-160	Apr. 27, 2009	Apr. 26, 2010
HORN Antenna SCHWARZBECK	9120D	9120D-209	Jul. 01, 2009	Jun. 30, 2010
HORN Antenna SCHWARZBECK	BBHA 9170	BBHA9170243	Dec. 25, 2008	Dec. 24, 2009
Preamplifier Agilent	8447D	2944A10633	Nov. 03, 2008	Nov. 02, 2009
Preamplifier Agilent	8449B	3008A01964	Oct. 23, 2008	Oct. 22, 2009
RF signal cable HUBER+SUHNNER	SUCOFLEX 104	238141/4	May 13, 2009	May 12, 2010
RF signal cable HUBER+SUHNNER	SUCOFLEX 104	12738/6	May 13, 2009	May 12, 2010
Software ADT.	ADT_Radiated_ V7.6.15.9.2	NA	NA	NA
Antenna Tower inn-co GmbH	MA 4000	013303	NA	NA
Antenna Tower Controller inn-co GmbH	CO2000	017303	NA	NA
Turn Table ADT.	TT100.	TT93021703	NA	NA
Turn Table Controller ADT.	SC100.	SC93021703	NA	NA
26GHz ~ 40GHz Amplifier	EM26400	07026401	Aug. 27, 2008	Aug. 26, 2009

**NOTE:** The calibration interval of the above test instruments is 12 months and the calibrations are traceable to NML/ROC and NIST/USA.



A D T

### 5.6.3 TEST PROCEDURE

- a. The EUT was placed on the top of a rotating table 0.8 meters above the ground at a 3 meter semi-anechoic chamber. The table was rotated 360 degrees to determine the position of the highest radiation.
- b. The EUT was set 3 meters away from the interference-receiving antenna, which was mounted on the top of a variable-height antenna tower.
- c. The antenna is a broadband antenna, and its height is varied from one meter to four meters above the ground to determine the maximum value of the field strength. Both horizontal and vertical polarizations of the antenna are set to make the measurement.
- d. For each suspected emission, the EUT was arranged to its worst case and then the antenna was tuned to heights from 1 meter to 4 meters and the rotatable table was turned from 0 degrees to 360 degrees to find the maximum reading.
- e. Set both RBW and VBW of spectrum analyzer to 100kHz and 300kHz with suitable frequency span including 100MHz bandwidth from band edge. The band edges was measured and recorded.

**NOTE:** The resolution bandwidth of test receiver/spectrum analyzer is 1MHz and the video bandwidth is 10Hz for Average detection (AV) at frequency above 1GHz.



A D T

#### 5.6.4 DEVIATION FROM TEST STANDARD

No deviation.

#### 5.6.5 EUT OPERATING CONDITION

Same as Item 5.3.6.

#### 5.6.6 TEST RESULTS

The spectrum plots are attached on the following pages. D1 line indicates the highest level, D2 line indicates the 20dB offset below D1. It shows compliance with the requirement in part 15.247(d).



A D T

### 802.11a OFDM MODULATION

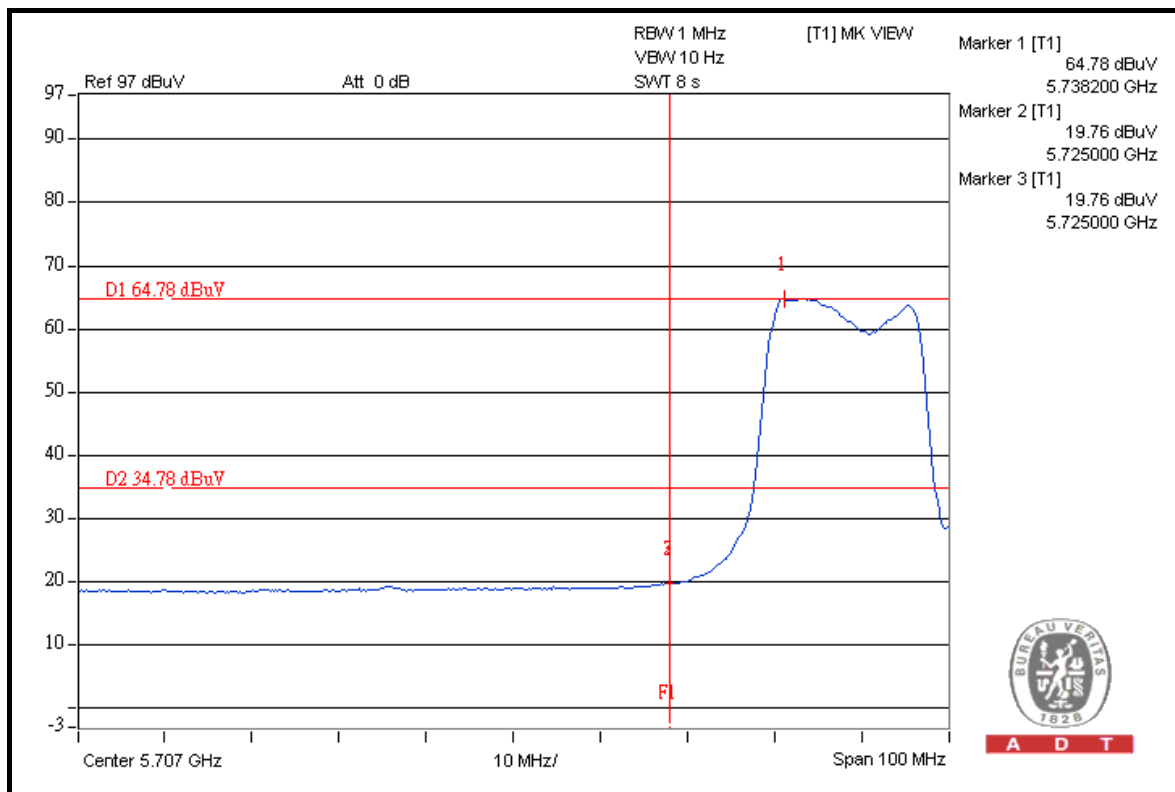
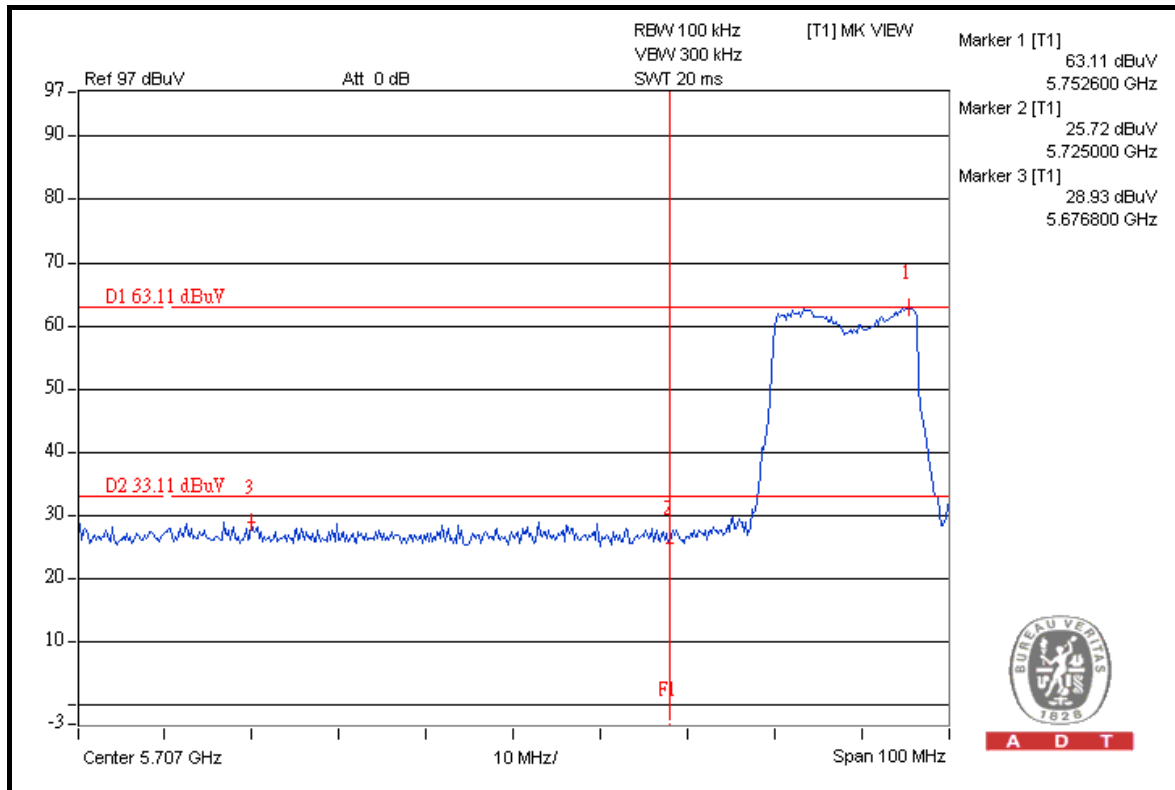



A D T

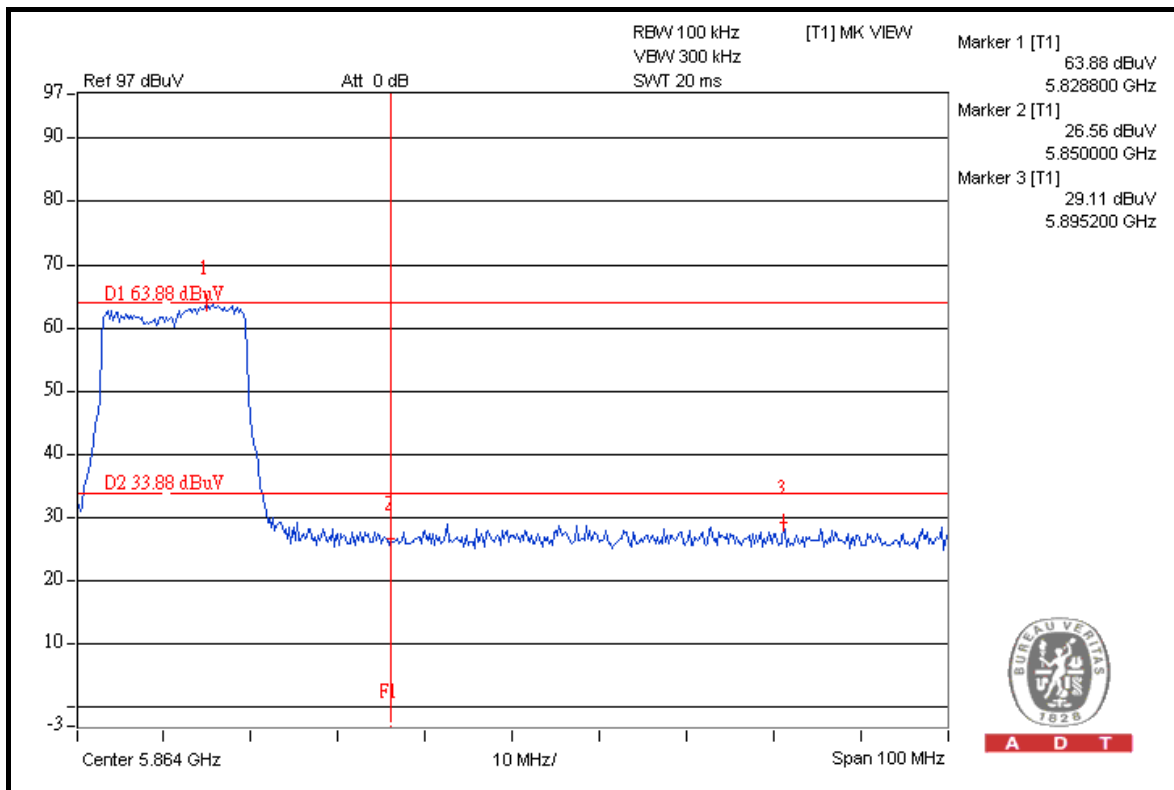
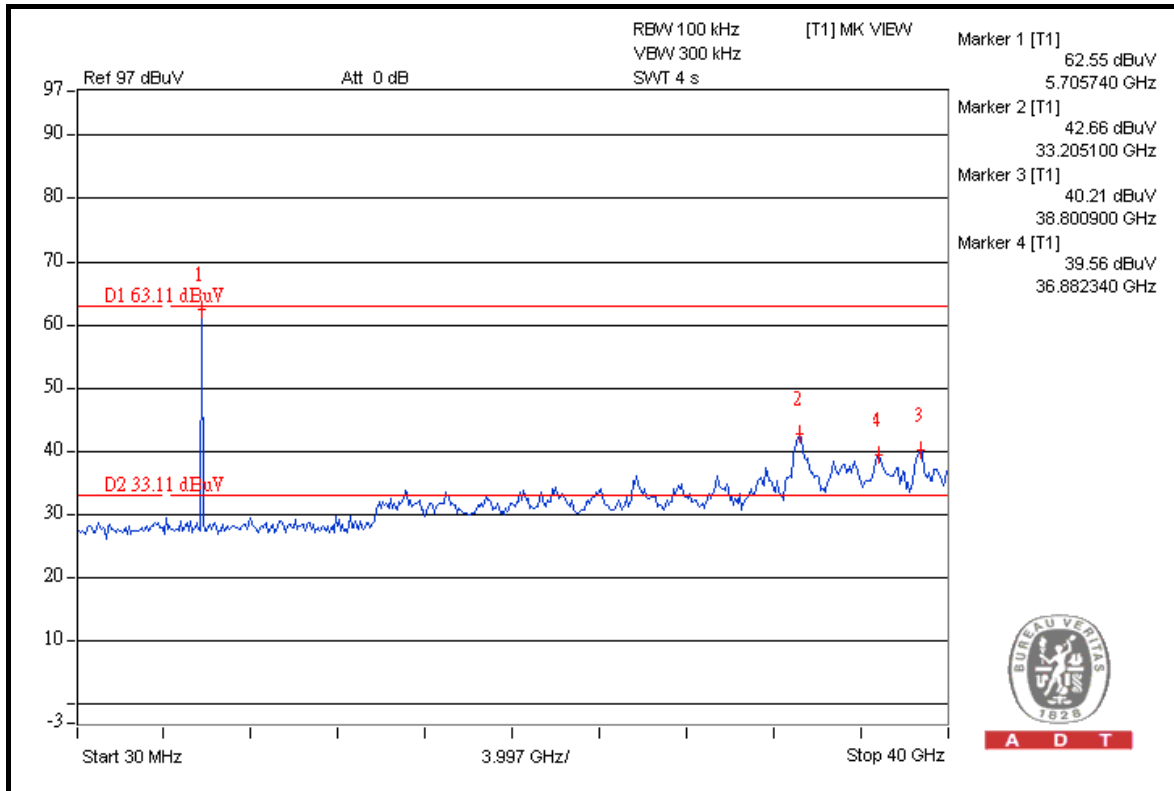



A D T

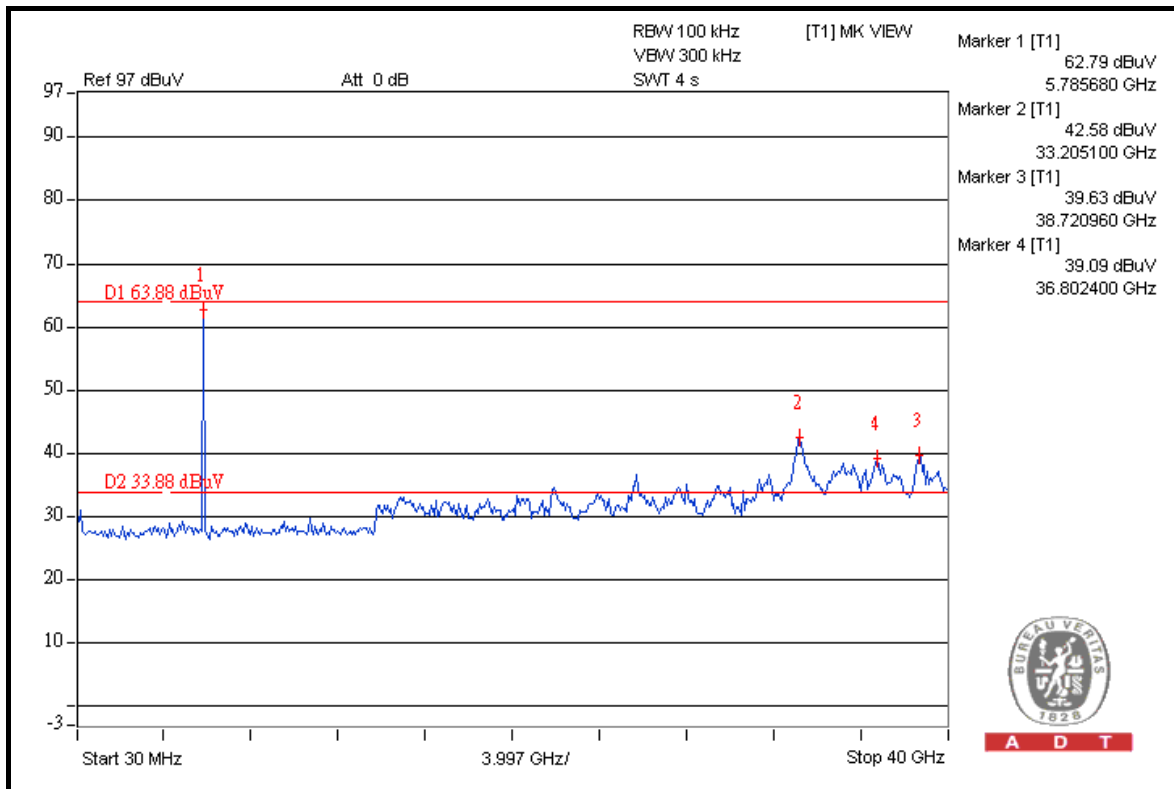
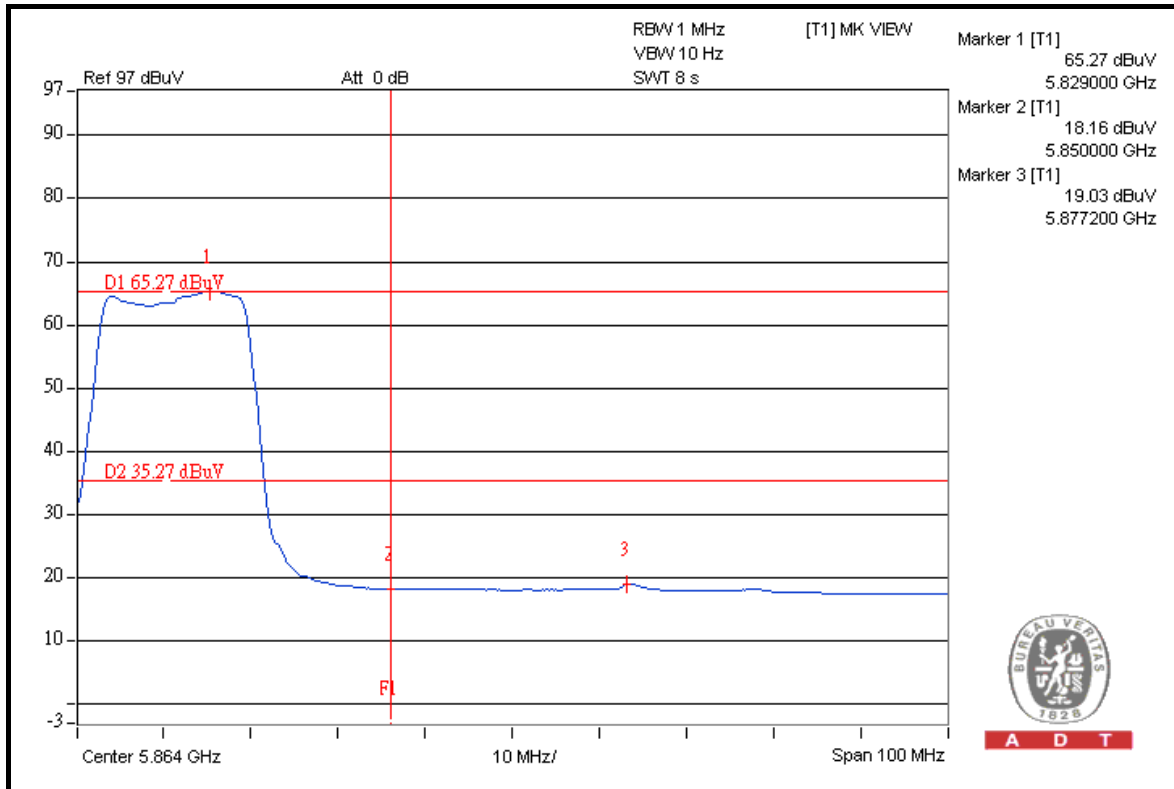





A D T

### DRAFT 802.11n (20MHz) OFDM MODULATION

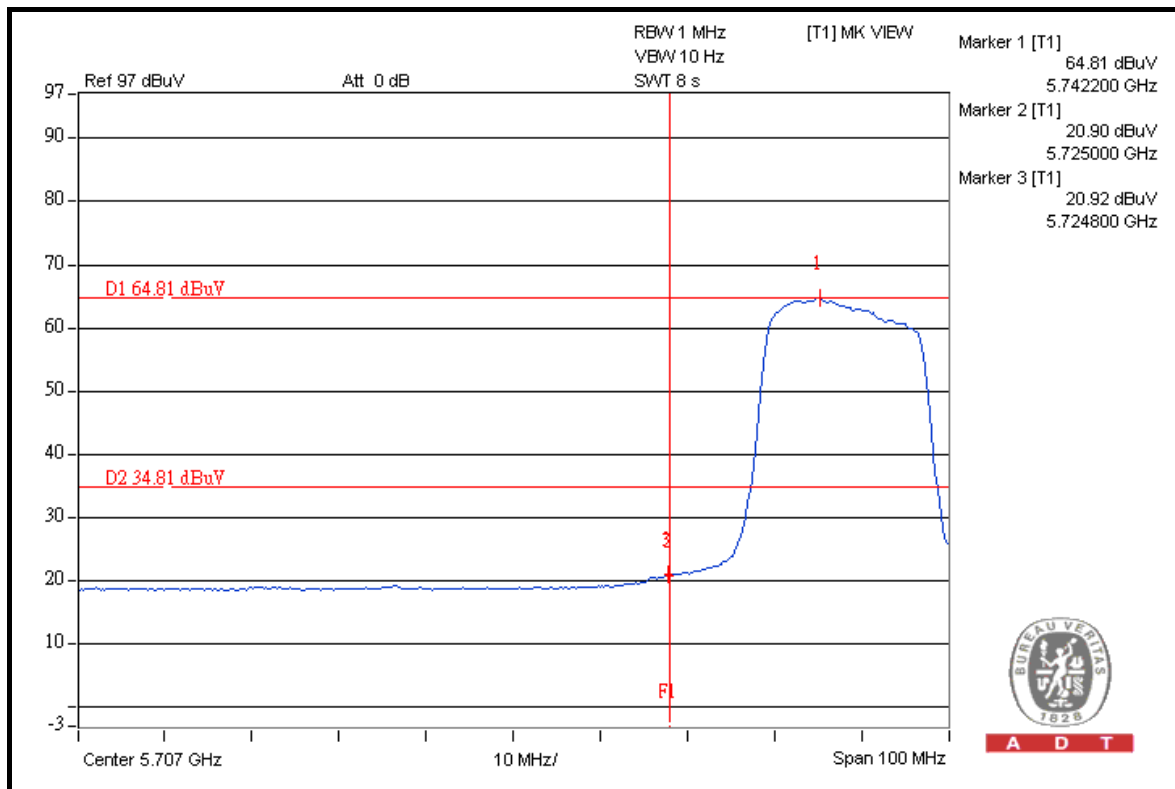
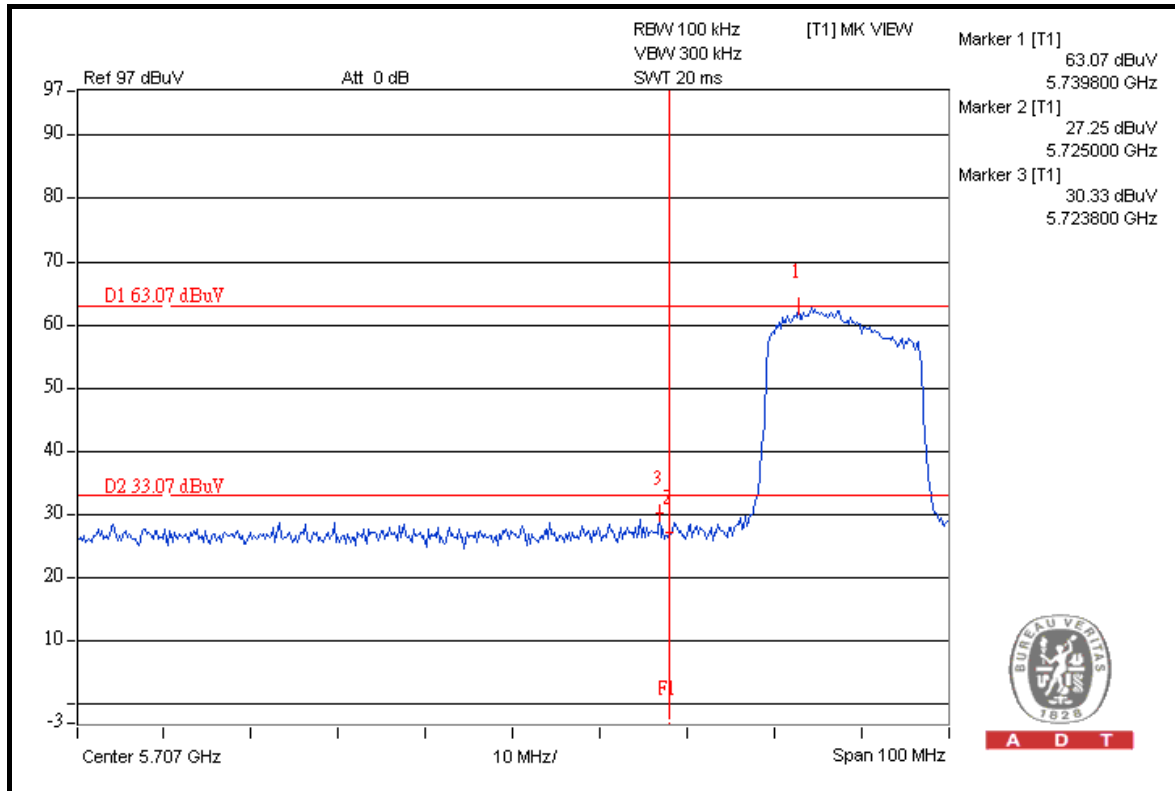



A D T

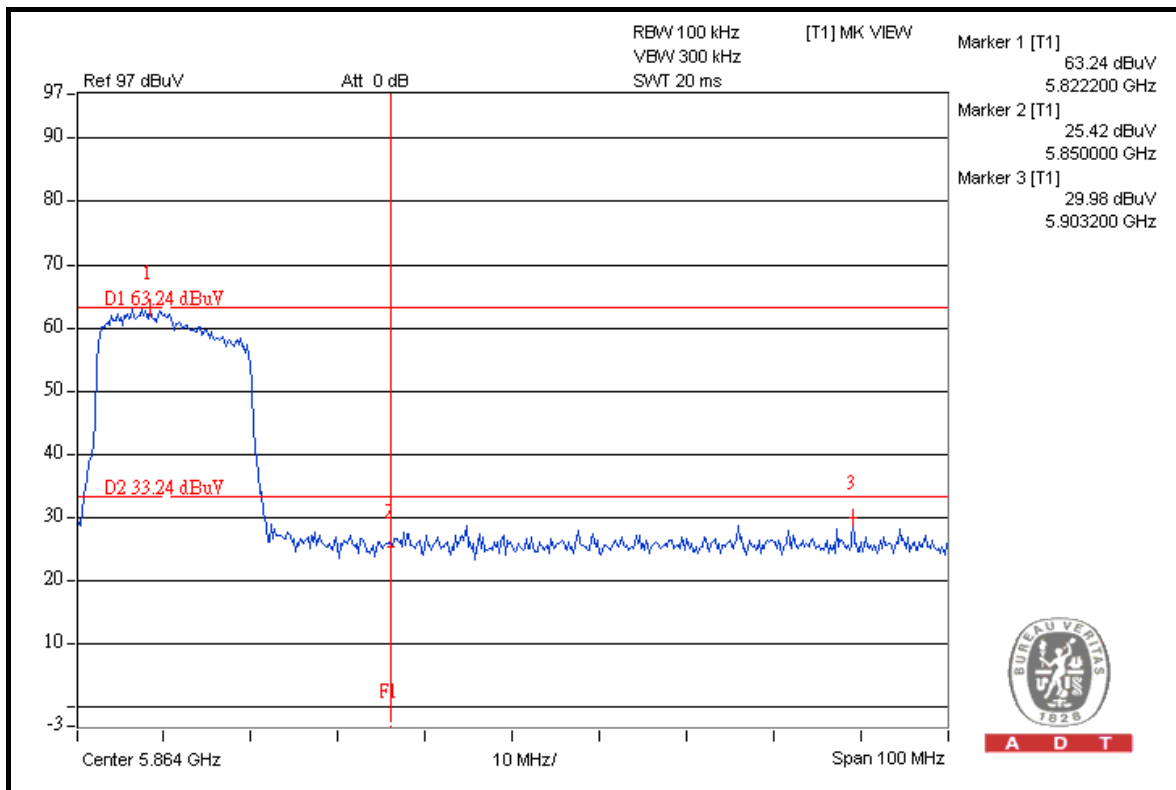
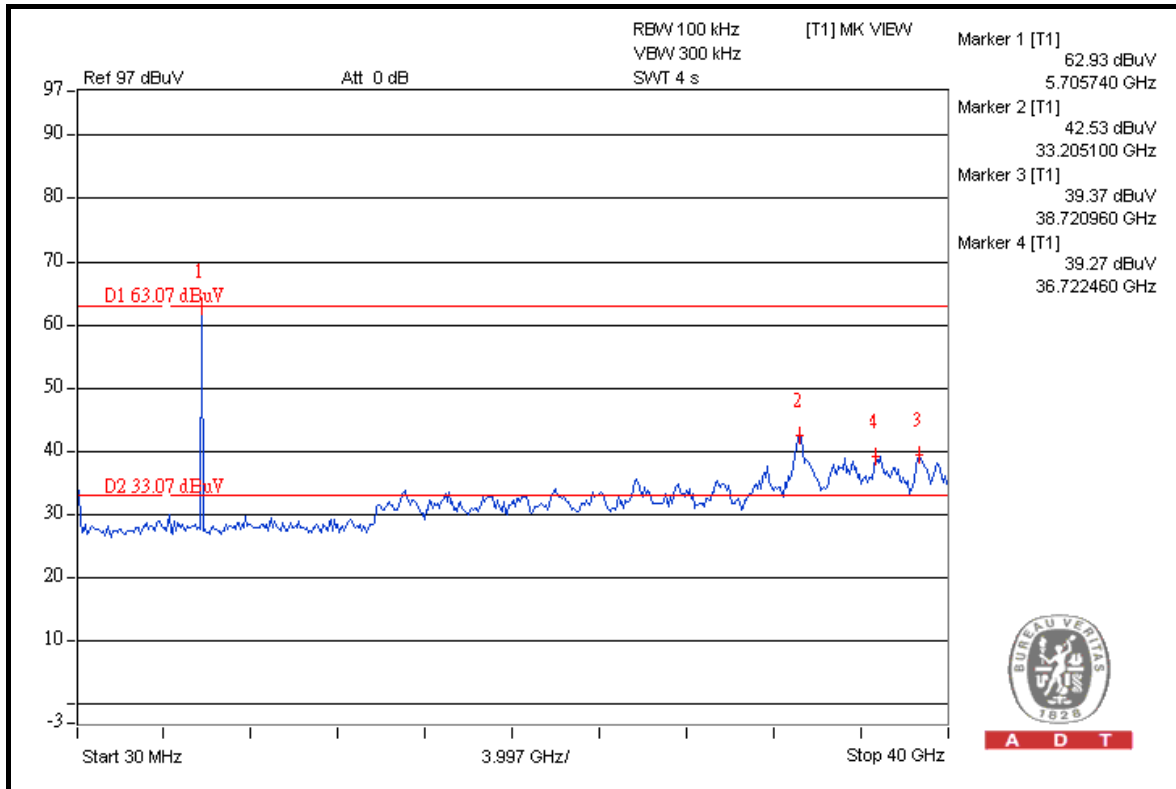



A D T

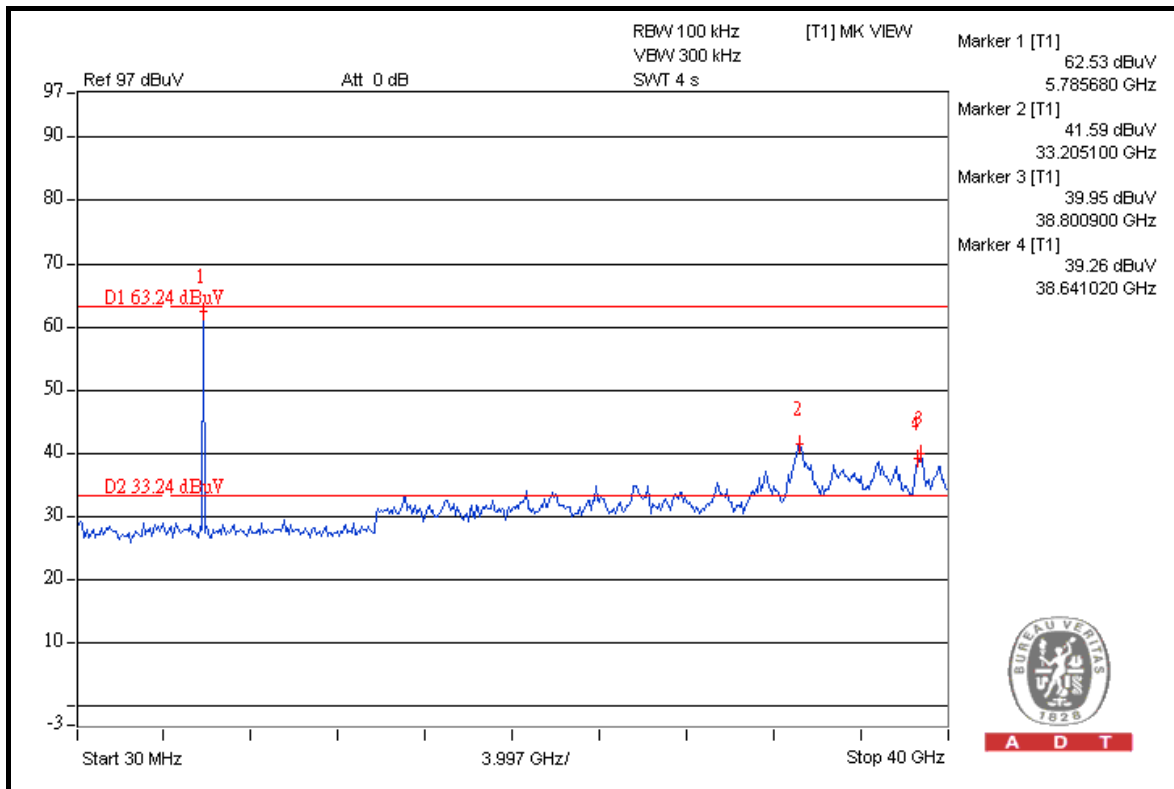
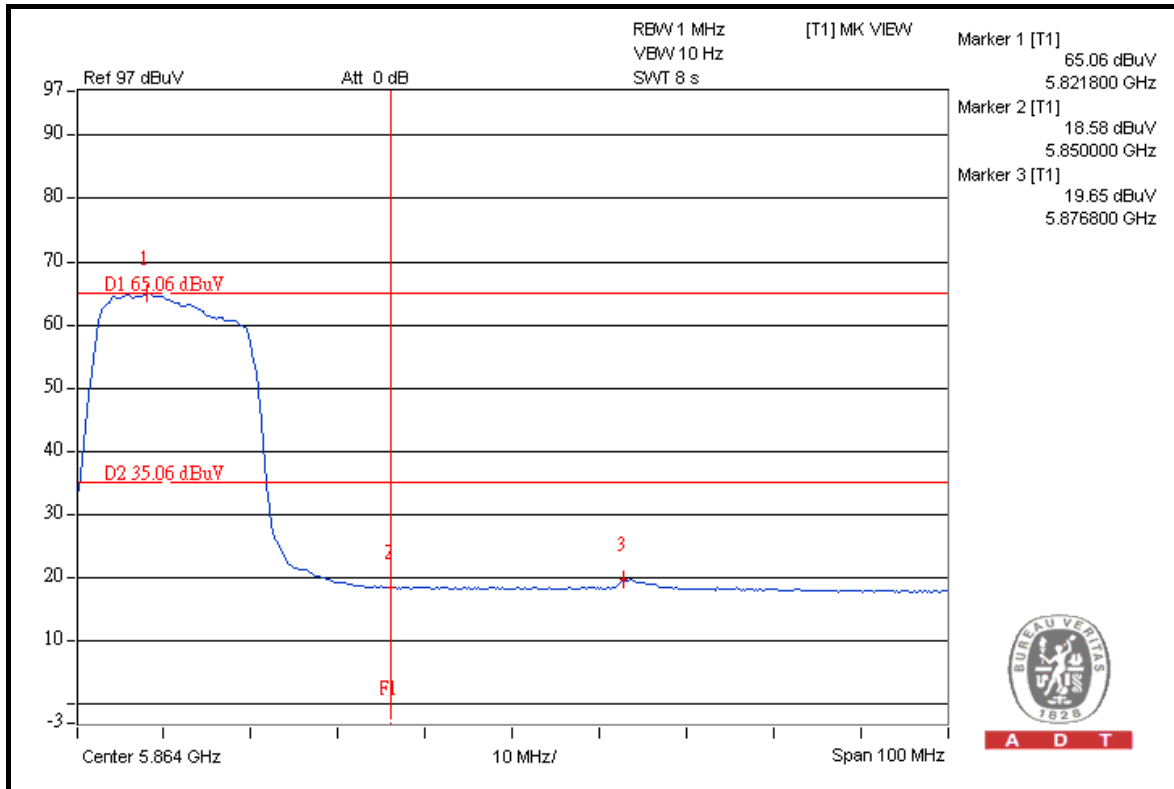



A D T

### DRAFT 802.11n (40MHz) OFDM MODULATION

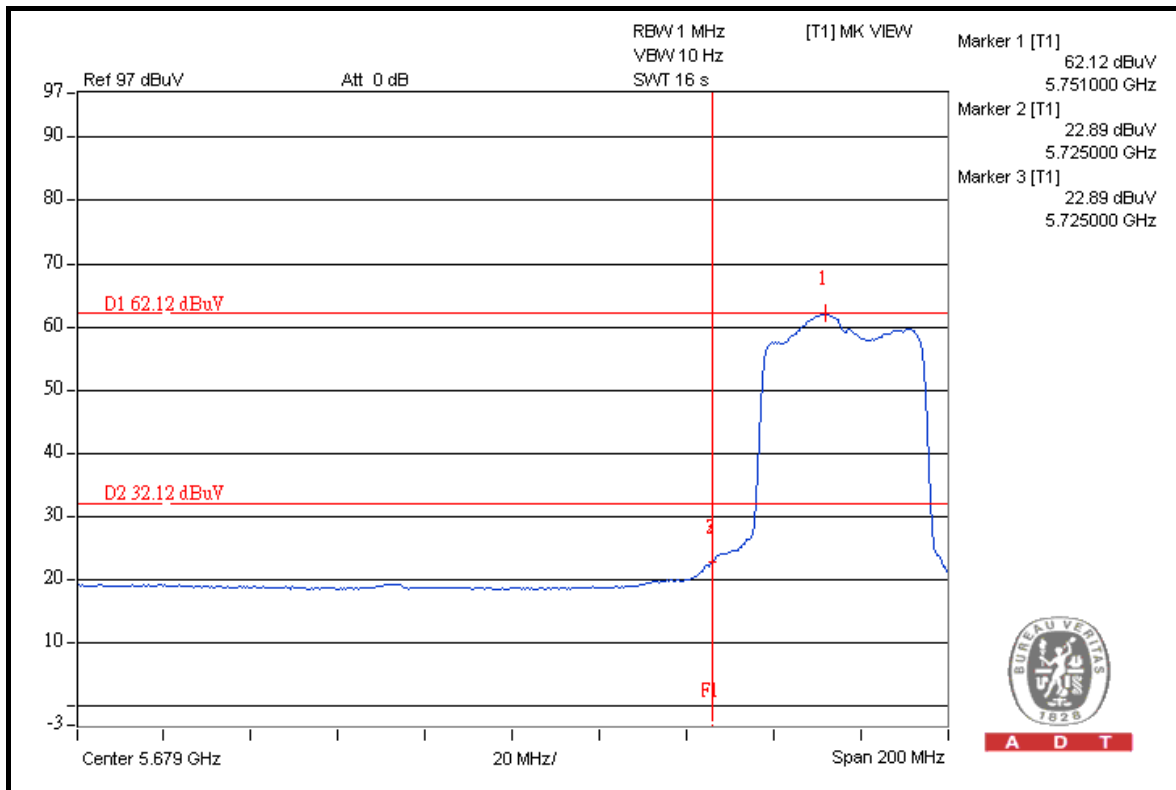
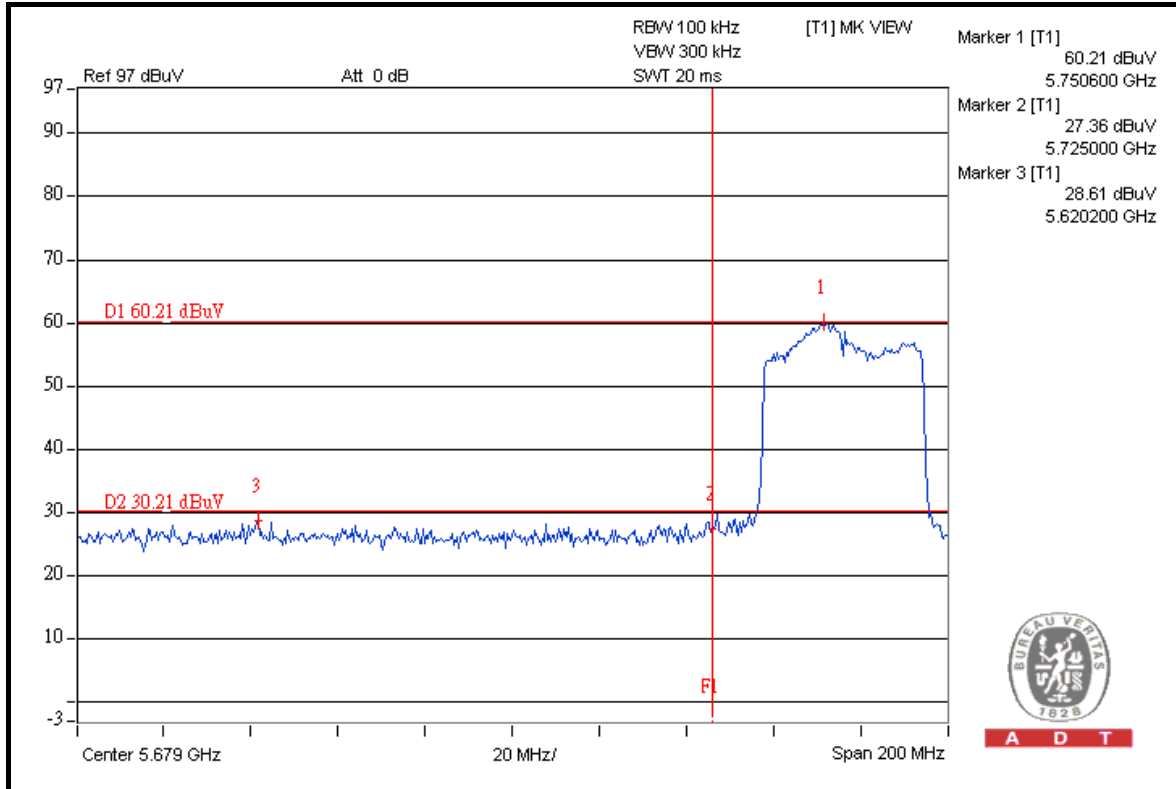



A D T

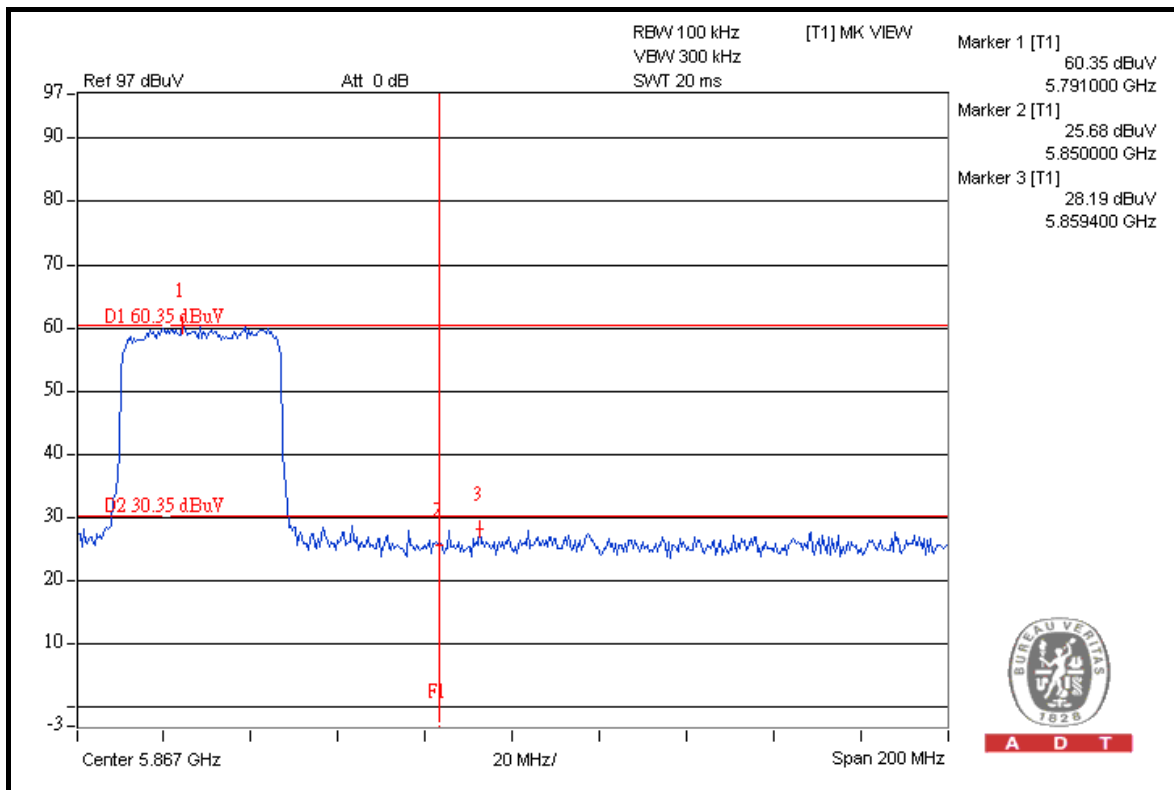
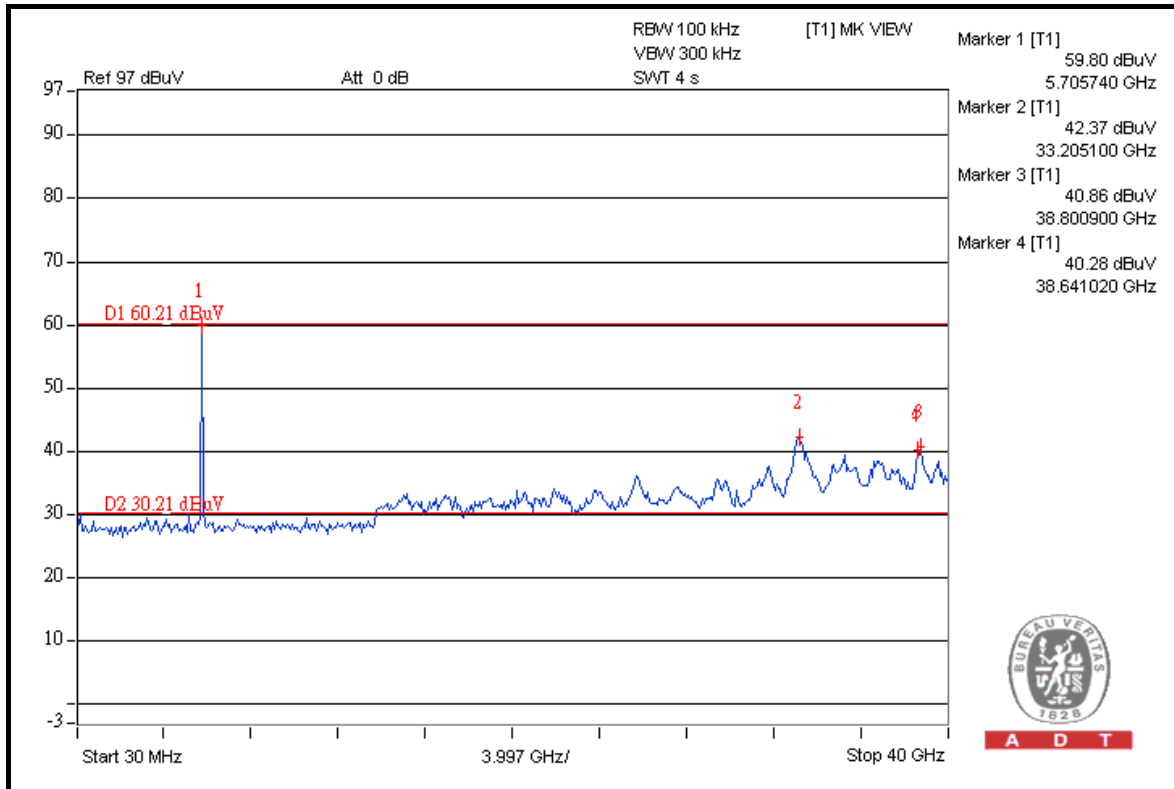



A D T

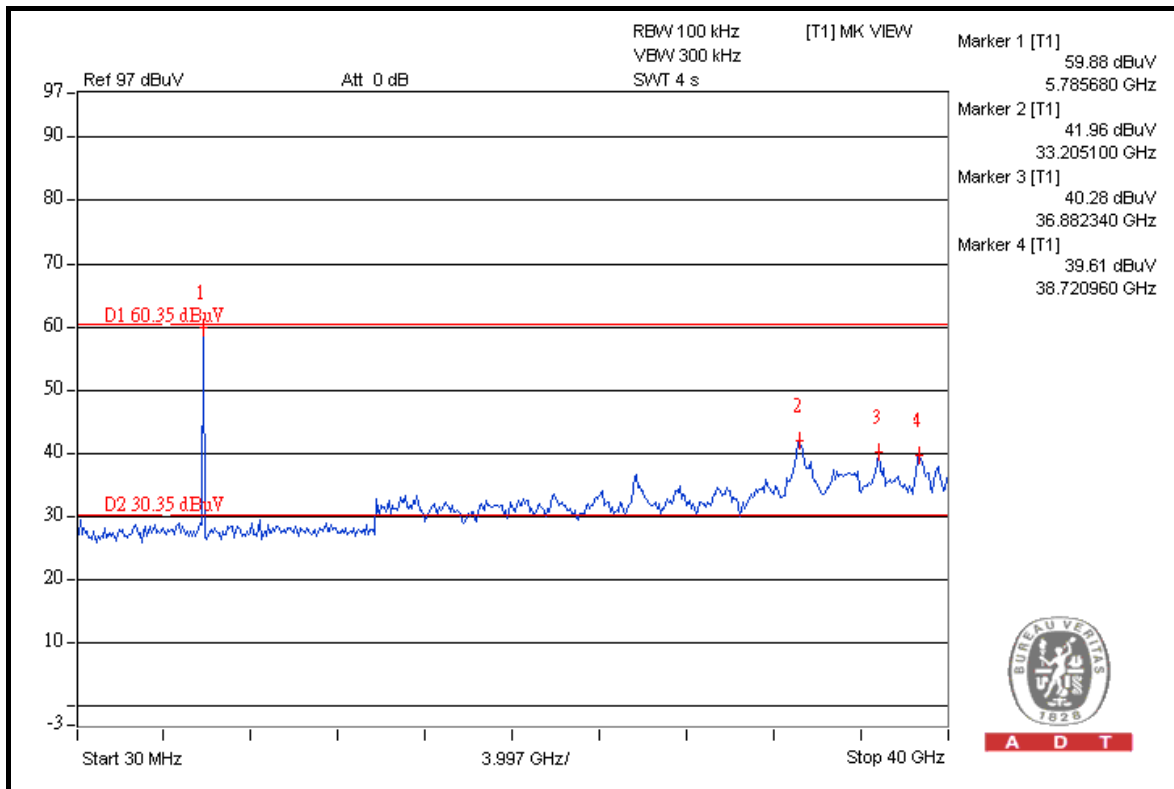
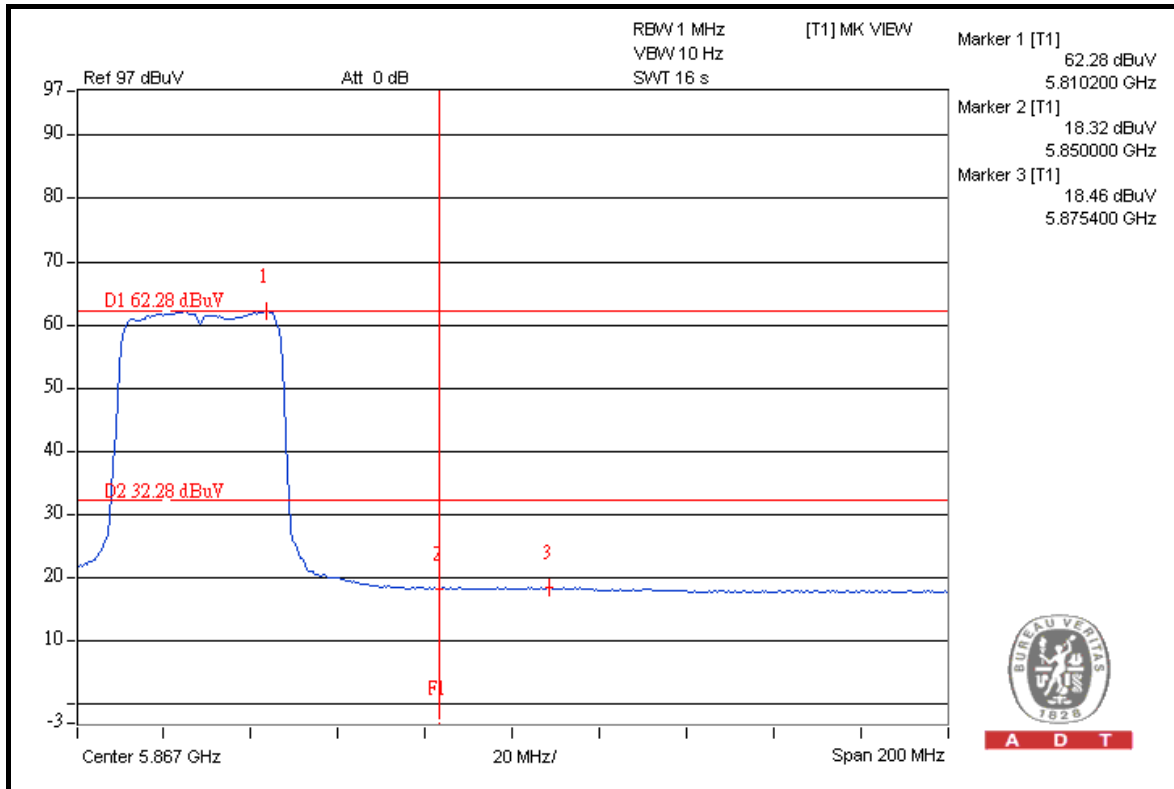



A D T

## 5.7 ANTENNA REQUIREMENT

### 5.7.1 STANDARD APPLICABLE

For intentional device, according to FCC 47 CFR Section 15.203, an intentional radiator shall be designed to ensure that no antenna other than that furnished by the responsible party shall be used with the device.

And according to FCC 47 CFR Section 15.247(a), if transmitting antennas of directional gain greater than 6dBi are used, the power shall be reduced by the amount in dB that the directional gain of the antenna exceeds 6dBi.

### 5.7.2 ANTENNA CONNECTED CONSTRUCTION

The antenna used in this product is Printed antenna without connector. The maximum gain of the antenna is -3dBi.



A D T

## 6. PHOTOGRAPHS OF THE TEST CONFIGURATION

Please refer to the attached file (Test Setup Photo).





A D T

## 7. INFORMATION ON THE TESTING LABORATORIES

We, Bureau Veritas Consumer Products Services (H.K.) Ltd., Taoyuan Branch, were founded in 1988 to provide our best service in EMC, Radio, Telecom and Safety consultation. Our laboratories are accredited and approved by the following approval agencies according to ISO/IEC 17025.

<b>USA</b>	FCC, NVLAP
<b>Germany</b>	TUV Rheinland
<b>Japan</b>	VCCI
<b>Norway</b>	NEMKO
<b>Canada</b>	INDUSTRY CANADA , CSA
<b>R.O.C.</b>	TAF, BSMI, NCC
<b>Netherlands</b>	Telefication
<b>Singapore</b>	GOST-ASIA(MOU)
<b>Russia</b>	CERTIS(MOU)

Copies of accreditation certificates of our laboratories obtained from approval agencies can be downloaded from our web site:

[www.adt.com.tw/index.5/phtml](http://www.adt.com.tw/index.5/phtml). If you have any comments, please feel free to contact us at the following:

**Linko EMC/RF Lab:**

Tel: 886-2-26052180

Fax: 886-2-26051924

**Hsin Chu EMC/RF Lab:**

Tel: 886-3-5935343

Fax: 886-3-5935342

**Hwa Ya EMC/RF/Safety Telecom Lab:**

Tel: 886-3-3183232

Fax: 886-3-3185050

**Web Site:** [www.adt.com.tw](http://www.adt.com.tw)

The address and road map of all our labs can be found in our web site also.



A D T

## 8. APPENDIX A - MODIFICATIONS RECORDERS FOR ENGINEERING CHANGES TO THE EUT BY THE LAB

No any modifications are made to the EUT by the lab during the test.

---END---