



A D T

FCC TEST REPORT

REPORT NO.: RF980508L08

MODEL NO.: WL-344

(refer to item 3.1 for more details)

RECEIVED: May 08, 2009

TESTED: May 18 ~ May 20, 2009

ISSUED: May 25, 2009

APPLICANT: Senao Networks Inc.

ADDRESS: 3F, No. 529, Chung Cheng Rd., Hsintien, Taipei,
Taiwan, R.O.C.

ISSUED BY: Bureau Veritas Consumer Products Services
(H.K.) Ltd., Taoyuan Branch

LAB ADDRESS: No. 47, 14th Ling, Chia Pau Tsuen, Lin Kou
Hsiang, Taipei Hsien 244, Taiwan, R.O.C.

TEST LOCATION: No. 19, Hwa Ya 2nd Rd, Wen Hwa Tsuen, Kwei
Shan Hsiang, Taoyuan Hsien 333, Taiwan,
R.O.C.

This test report consists of 94 pages in total. It may be duplicated completely for legal use with the approval of the applicant. It should not be reproduced except in full, without the written approval of our laboratory. The client should not use it to claim product endorsement by TAF or any government agencies. The test results in the report only apply to the tested sample.





A D T

TABLE OF CONTENTS

1.	CERTIFICATION.....	4
2.	SUMMARY OF TEST RESULTS	5
2.1	MEASUREMENT UNCERTAINTY	5
3.	GENERAL INFORMATION	6
3.1	GENERAL DESCRIPTION OF EUT	6
3.2	DESCRIPTION OF TEST MODES	7
3.2.1	CONFIGURATION OF SYSTEM UNDER TEST	7
3.2.2	TEST MODE APPLICABILITY AND TESTED CHANNEL DETAIL	8
3.3	GENERAL DESCRIPTION OF APPLIED STANDARDS	10
3.4	DESCRIPTION OF SUPPORT UNITS	10
4.	TEST TYPES AND RESULTS	11
4.1	RADIATED EMISSION MEASUREMENT	11
4.1.1	LIMITS OF RADIATED EMISSION MEASUREMENT	11
4.1.2	TEST INSTRUMENTS.....	12
4.1.3	TEST PROCEDURES	13
4.1.4	DEVIATION FROM TEST STANDARD.....	13
4.1.5	TEST SETUP.....	14
4.1.6	EUT OPERATING CONDITIONS	14
4.1.7	TEST RESULTS	15
4.2	CONDUCTED EMISSION MEASUREMENT	28
4.2.1	LIMITS OF CONDUCTED EMISSION MEASUREMENT	28
4.2.2	TEST INSTRUMENTS.....	28
4.2.3	TEST PROCEDURES	29
4.2.4	DEVIATION FROM TEST STANDARD.....	29
4.2.5	TEST SETUP.....	30
4.2.6	EUT OPERATING CONDITIONS	30
4.2.7	TEST RESULTS	31
4.3	6dB BANDWIDTH MEASUREMENT	33
4.3.1	LIMITS OF 6dB BANDWIDTH MEASUREMENT	33
4.3.2	TEST INSTRUMENTS.....	33
4.3.3	TEST PROCEDURE.....	33
4.3.4	DEVIATION FROM TEST STANDARD.....	33
4.3.5	TEST SETUP.....	34
4.3.6	EUT OPERATING CONDITIONS	34
4.3.7	TEST RESULTS	35
4.4	MAXIMUM PEAK OUTPUT POWER.....	51



4.4.1 LIMITS OF MAXIMUM PEAK OUTPUT POWER MEASUREMENT51

4.4.2 INSTRUMENTS51

4.4.3 TEST PROCEDURES51

4.4.4 DEVIATION FROM TEST STANDARD.....52

4.4.5 TEST SETUP52

4.4.6 EUT OPERATING CONDITIONS52

4.4.7 TEST RESULTS53

4.5 POWER SPECTRAL DENSITY MEASUREMENT55

4.5.1 LIMITS OF POWER SPECTRAL DENSITY MEASUREMENT55

4.5.2 TEST INSTRUMENTS.....55

4.5.3 TEST PROCEDURE.....55

4.5.4 DEVIATION FROM TEST STANDARD.....56

4.5.5 TEST SETUP.....56

4.5.6 EUT OPERATING CONDITION.....56

4.5.7 TEST RESULTS57

4.6 BAND EDGES MEASUREMENT73

4.6.1 LIMITS OF BAND EDGES MEASUREMENT73

4.6.2 TEST INSTRUMENTS.....73

4.6.3 TEST PROCEDURE.....74

4.6.4 DEVIATION FROM TEST STANDARD.....74

4.6.5 EUT OPERATING CONDITION.....74

4.6.6 TEST RESULTS75

4.7 ANTENNA REQUIREMENT91

4.7.1 STANDARD APPLICABLE91

4.7.2 ANTENNA CONNECTED CONSTRUCTION91

5. PHOTOGRAPHS OF THE TEST CONFIGURATION92

6. INFORMATION ON THE TESTING LABORATORIES93

7. APPENDIX A - MODIFICATIONS RECORDERS FOR ENGINEERING CHANGES
TO THE EUT BY THE LAB94



A D T

1. CERTIFICATION

PRODUCT: Wireless 802.11 b/g/n USB adapter
MODEL: WL-344 (refer to item 3.1 for more details)
BRAND: SITECOM (refer to item 3.1 for more details)
APPLICANT: Senao Networks Inc.
TEST SAMPLE: MASS-PRODUCTION
TESTED: May 18 ~ May 20, 2009
STANDARDS: **FCC Part 15, Subpart C (Section 15.247)**
ANSI C63.4-2003

The above equipment (Model: WL-344) has been tested by **Bureau Veritas Consumer Products Services (H.K.) Ltd., Taoyuan Branch**, and found compliance with the requirement of the above standards. The test record, data evaluation & Equipment Under Test (EUT) configurations represented herein are true and accurate accounts of the measurements of the sample's EMC characteristics under the conditions specified in this report.

PREPARED BY : Ivy Lin , **DATE:** May 25, 2008
Ivy Lin / Specialist

TECHNICAL ACCEPTANCE : Long Chen , **DATE:** May 25, 2008
Responsible for RF Long Chen / Senior Engineer

APPROVED BY : Gary Chang , **DATE:** May 25, 2008
Gary Chang / Assistant Manager



2. SUMMARY OF TEST RESULTS

The EUT has been tested according to the following specifications:

APPLIED STANDARD: FCC PART 15, SUBPART C (SECTION 15.247)			
STANDARD SECTION	TEST TYPE AND LIMIT	RESULT	REMARK
15.207	AC Power Conducted Emission	PASS	Meet the requirement of limit. Minimum passing margin is -10.41dB at 4.141MHz.
15.247(a)(2)	Spectrum Bandwidth of a Direct Sequence Spread Spectrum System Limit: min. 500kHz	PASS	Meet the requirement of limit.
15.247(b)	Maximum Peak Output Power Limit: max. 30dBm	PASS	Meet the requirement of limit.
15.247(d)	Radiated Emissions Limit: Table 15.209	PASS	Meet the requirement of limit. Minimum passing margin is -7.05dB at 2483.50MHz.
15.247(e)	Power Spectral Density Limit: max. 8dBm	PASS	Meet the requirement of limit.
15.247(d)	Band Edge Measurement Limit: 20dB less than the peak value of fundamental frequency	PASS	Meet the requirement of limit.

2.1 MEASUREMENT UNCERTAINTY

Where relevant, the following measurement uncertainty levels have been estimated for tests performed on the EUT as specified in CISPR 16-4-2:

MEASUREMENT	FREQUENCY	UNCERTAINTY
Conducted emissions	150kHz~30MHz	2.44dB
Radiated emissions	30MHz ~ 200MHz	3.19dB
	200MHz ~1000MHz	3.21dB
	1GHz ~ 18GHz	2.26dB
	18GHz ~ 40GHz	1.94dB

This uncertainty represents an expanded uncertainty expressed at approximately the 95% confidence level using a coverage factor of $k = 2$.



3. GENERAL INFORMATION

3.1 GENERAL DESCRIPTION OF EUT

EUT	Wireless 802.11 b/g/n USB adapter
MODEL NO.	WL-344 (refer to NOTE for more details)
FCC ID	U2M-UB97000901
POWER SUPPLY	5Vdc from host equipment
MODULATION TYPE	CCK, DQPSK, DBPSK for DSSS 64QAM, 16QAM, QPSK, BPSK for OFDM
MODULATION TECHNOLOGY	DSSS, OFDM
TRANSFER RATE	802.11b: 11.0/ 5.5/ 2.0/ 1.0Mbps 802.11g: 54.0/ 48.0/ 36.0/ 24.0/ 18.0/ 12.0/ 9.0/ 6.0Mbps Draft 802.11n: up to 300.0Mbps
OPERATING FREQUENCY	2412.0 ~ 2462.0MHz
NUMBER OF CHANNEL	11 for 802.11b, 802.11g, draft 802.11n (20MHz) 7 for draft 802.11n (40MHz)
OUTPUT POWER	19.754mW
ANTENNA TYPE	Printed antenna with -3.0dBi gain
DATA CABLE	NA
I/O PORTS	USB
ACCESSORY DEVICES	NA

NOTE:

1. The models are identical to each other except their model designation, brand name and external appearance due to marketing requirement.

BRAND	MODEL	REMARK
SITECOM	WL-344	Different in external appearance for marketing requirement
	WL-345	
Rosewill	RNX-N100LX	
	RNX-N1LX	
EnGenius	EUB-9706	
	EUB-9705	

2. The EUT incorporates a MIMO function. Physically, the EUT provides two completed transmitters and two receivers.

MODULATION MODE	TX FUNCTION
802.11b	2TX
802.11g	2TX
Draft 802.11n (20MHz)	2TX
Draft 802.11n (40MHz)	2TX

3. The above EUT information was declared by manufacturer and for more detailed features description, please refer to the manufacturer's specifications or user's manual.

3.2 DESCRIPTION OF TEST MODES

11 channels are provided for 802.11b, 802.11g and draft 802.11n (20MHz):

CHANNEL	FREQUENCY	CHANNEL	FREQUENCY
1	2412MHz	7	2442MHz
2	2417MHz	8	2447MHz
3	2422MHz	9	2452MHz
4	2427MHz	10	2457MHz
5	2432MHz	11	2462MHz
6	2437MHz		

7 channels are provided for draft 802.11n (40MHz):

CHANNEL	FREQUENCY	CHANNEL	FREQUENCY
1	2422MHz	5	2442MHz
2	2427MHz	6	2447MHz
3	2432MHz	7	2452MHz
4	2437MHz		

3.2.1 CONFIGURATION OF SYSTEM UNDER TEST

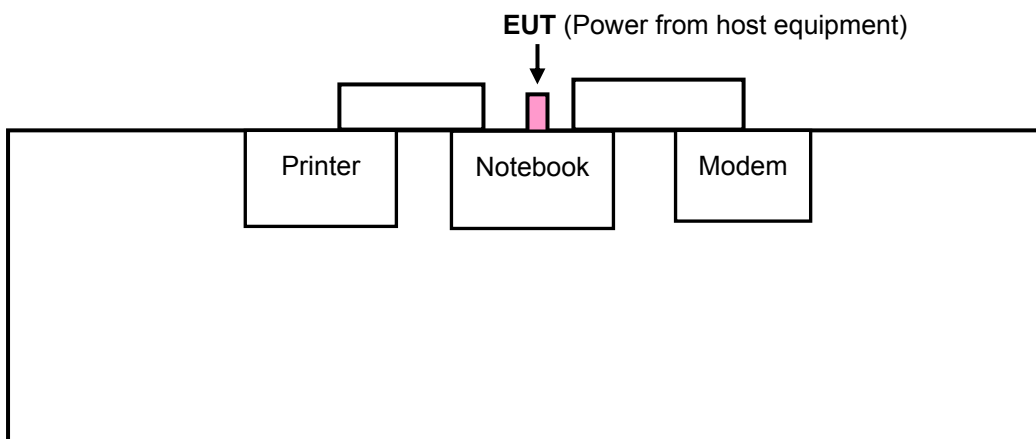



3.2.2 TEST MODE APPLICABILITY AND TESTED CHANNEL DETAIL

EUT CONFIGURE MODE	APPLICABLE TO				DESCRIPTION
	RE \geq 1G	RE<1G	PLC	APCM	
-	√	√	√	√	-

Where **RE \geq 1G**: Radiated Emission above 1GHz **RE<1G**: Radiated Emission below 1GHz
PLC: Power Line Conducted Emission **APCM**: Antenna Port Conducted Measurement

RADIATED EMISSION TEST (ABOVE 1GHz):

- Pre-Scan has been conducted to determine the worst-case mode from all possible combinations between available modulations, data rates and antenna ports (if EUT with antenna diversity architecture).
- Following channel(s) was (were) selected for the final test as listed below.

MODE	AVAILABLE CHANNEL	TESTED CHANNEL	MODULATION TECHNOLOGY	MODULATION TYPE	DATA RATE (Mbps)
802.11b	1 to 11	1, 6, 11	DSSS	DBPSK	1.0
802.11g	1 to 11	1, 6, 11	OFDM	BPSK	6.0
Draft 802.11n (20MHz)	1 to 11	1, 6, 11	OFDM	BPSK	6.5
Draft 802.11n (40MHz)	1 to 7	1, 4, 7	OFDM	BPSK	13.5

RADIATED EMISSION TEST (BELOW 1GHz):

- Pre-Scan has been conducted to determine the worst-case mode from all possible combinations between available modulations, data rates and antenna ports (if EUT with antenna diversity architecture).
- Following channel(s) was (were) selected for the final test as listed below.

MODE	AVAILABLE CHANNEL	TESTED CHANNEL	MODULATION TECHNOLOGY	MODULATION TYPE	DATA RATE (Mbps)
Draft 802.11n (20MHz)	1 to 11	11	OFDM	BPSK	6.5

POWER LINE CONDUCTED EMISSION TEST:

- Pre-Scan has been conducted to determine the worst-case mode from all possible combinations between available modulations, data rates and antenna ports (if EUT with antenna diversity architecture).
- Following channel(s) was (were) selected for the final test as listed below.

MODE	AVAILABLE CHANNEL	TESTED CHANNEL	MODULATION TECHNOLOGY	MODULATION TYPE	DATA RATE (Mbps)
Draft 802.11n (20MHz)	1 to 11	11	OFDM	BPSK	6.5



BANDEDGE MEASUREMENT:

- Pre-Scan has been conducted to determine the worst-case mode from all possible combinations between available modulations, data rates and antenna ports (if EUT with antenna diversity architecture).
- Following channel(s) was (were) selected for the final test as listed below.

MODE	AVAILABLE CHANNEL	TESTED CHANNEL	MODULATION TECHNOLOGY	MODULATION TYPE	DATA RATE (Mbps)
802.11b	1 to 11	1, 11	DSSS	DBPSK	1.0
802.11g	1 to 11	1, 11	OFDM	BPSK	6.0
Draft 802.11n (20MHz)	1 to 11	1, 11	OFDM	BPSK	6.5
Draft 802.11n (40MHz)	1 to 7	1, 7	OFDM	BPSK	13.5

ANTENNA PORT CONDUCTED MEASUREMENT:

- Pre-Scan has been conducted to determine the worst-case mode from all possible combinations between available modulations, data rates and antenna ports (if EUT with antenna diversity architecture).
- Following channel(s) was (were) selected for the final test as listed below.

MODE	AVAILABLE CHANNEL	TESTED CHANNEL	MODULATION TECHNOLOGY	MODULATION TYPE	DATA RATE (Mbps)
802.11b	1 to 11	1, 6, 11	DSSS	DBPSK	1.0
802.11g	1 to 11	1, 6, 11	OFDM	BPSK	6.0
Draft 802.11n (20MHz)	1 to 11	1, 6, 11	OFDM	BPSK	6.5
Draft 802.11n (40MHz)	1 to 7	1, 4, 7	OFDM	BPSK	13.5



3.3 GENERAL DESCRIPTION OF APPLIED STANDARDS

The EUT is a RF Product. According to the specifications of the manufacturer, it must comply with the requirements of the following standards:

FCC Part 15, Subpart C (15.247)

ANSI C63.4-2003

All test items have been performed and recorded as per the above standards.

NOTE: The EUT is also considered as a kind of computer peripheral, because the connection to computer is necessary for typical use. It has been verified to comply with the requirements of FCC Part 15, Subpart B, Class B (DoC). The test report has been issued separately.

3.4 DESCRIPTION OF SUPPORT UNITS

The EUT has been tested as an independent unit together with other necessary accessories or support units. The following support units or accessories were used to form a representative test configuration during the tests.

NO.	PRODUCT	BRAND	MODEL NO.	SERIAL NO.	FCC ID
1	NOTEBOOK	DELL	D600	CN-0G5152-48643-4 85-5636	FCC DoC Approved
2	PRINTER	EPSON	LQ-300+	DCGY047265	FCC DoC Approved
3	MODEM	ACEEX	1414V/3	0401008248	IFAXDM1414

NO.	SIGNAL CABLE DESCRIPTION OF THE ABOVE SUPPORT UNITS
1	NA
2	1.8m braid shielded wire , DB25 connector , w/o core.
3	1.2m braid shielded wire , DB25 & DB9 connector , w/o core.

NOTE: All power cords of the above support units are non shielded (1.8m).



4. TEST TYPES AND RESULTS

4.1 RADIATED EMISSION MEASUREMENT

4.1.1 LIMITS OF RADIATED EMISSION MEASUREMENT

Emissions radiated outside of the specified bands, shall be according to the general radiated limits in 15.209 as following:

FREQUENCIES (MHz)	FIELD STRENGTH (microvolts/meter)	MEASUREMENT DISTANCE (meters)
0.009 ~ 0.490	2400/F(kHz)	300
0.490 ~ 1.705	24000/F(kHz)	30
1.705 ~ 30.0	30	30
30 ~ 88	100	3
88 ~ 216	150	3
216 ~ 960	200	3
Above 960	500	3

NOTE:

1. The lower limit shall apply at the transition frequencies.
2. Emission level (dBuV/m) = 20 log Emission level (uV/m).
3. As shown in 15.35(b), for frequencies above 1000MHz, the field strength limits are based on average detector, however, the peak field strength of any emission shall not exceed the maximum permitted average limits, specified above by more than 20dB under any condition of modulation.



A D T

4.1.2 TEST INSTRUMENTS

DESCRIPTION & MANUFACTURER	MODEL NO.	SERIAL NO.	DATE OF CALIBRATION	DUE DATE OF CALIBRATION
Test Receiver ROHDE & SCHWARZ	ESI7	838496/016	Dec. 29, 2008	Dec. 28, 2009
Spectrum Analyzer ROHDE & SCHWARZ	FSP40	100039	Dec. 08, 2008	Dec. 07, 2009
BILOG Antenna SCHWARZBECK	VULB9168	9168-155	Apr. 30, 2008	Apr. 28, 2010
HORN Antenna SCHWARZBECK	BBHA 9120D	9120D-408	Dec. 29, 2008	Dec. 28, 2009
HORN Antenna SCHWARZBECK	BBHA 9170	BBHA9170242	Jan. 06, 2009	Jan. 05, 2010
Preamplifier Agilent	8449B	3008A01960	Nov. 03, 2008	Nov. 02, 2009
Preamplifier Agilent	8447D	2944A10631	Nov. 03, 2008	Nov. 02, 2009
RF signal cable HUBER+SUHNNER	SUCOFLEX 104	274041/4	Aug. 21, 2008	Aug. 20, 2009
RF signal cable HUBER+SUHNNER	SUCOFLEX 104	283397/4	Aug. 21, 2008	Aug. 20, 2009
Software ADT.	ADT_Radiated_ V7.6.15.9.2	NA	NA	NA
Antenna Tower inn-co GmbH	MA 4000	010303	NA	NA
Antenna Tower Controller inn-co GmbH	CO2000	019303	NA	NA
Turn Table ADT.	TT100.	TT93021704	NA	NA
Turn Table Controller ADT.	SC100.	SC93021704	NA	NA

- NOTE:** 1. The calibration interval of the above test instruments is 12 months and the calibrations are traceable to NML/ROC and NIST/USA.
2. The test was performed in HwaYa Chamber 4.
3. The horn antenna and HP preamplifier (model: 8449B) are used only for the measurement of emission frequency above 1GHz if tested.
4. The FCC Site Registration No. is 988962.
5. The IC Site Registration No. is IC7450F-4.



4.1.3 TEST PROCEDURES

- a. The EUT was placed on the top of a rotating table 0.8 meters above the ground at a 3 meters semi-anechoic chamber. The table was rotated 360 degrees to determine the position of the highest radiation.
- b. The EUT was set 3 meters away from the interference-receiving antenna, which was mounted on the top of a variable-height antenna tower.
- c. The antenna is a broadband antenna, and its height is varied from one meter to four meters above the ground to determine the maximum value of the field strength. Both horizontal and vertical polarizations of the antenna are set to make the measurement.
- d. For each suspected emission, the EUT was arranged to its worst case and then the antenna was tuned to heights from 1 meter to 4 meters and the rotatable table was turned from 0 degrees to 360 degrees to find the maximum reading.
- e. The test-receiver system was set to Peak Detect Function and Specified Bandwidth with Maximum Hold Mode.
- f. If the emission level of the EUT in peak mode was lower than the limit specified, then testing could be stopped and the peak values of the EUT would be reported. Otherwise the emissions would be re-tested one by one using peak, quasi-peak or average method as specified and then reported in a data sheet.

NOTE:

1. The resolution bandwidth and video bandwidth of test receiver/spectrum analyzer is 120kHz for Quasi-peak detection at frequency below 1GHz.
2. The resolution bandwidth of test receiver/spectrum analyzer is 1MHz and video bandwidth is 3MHz for Peak detection at frequency above 1GHz.
3. The resolution bandwidth of test receiver/spectrum analyzer is 1MHz and the video bandwidth is 10Hz for Average detection (AV) at frequency above 1GHz.
4. All modes of operation were investigated and the worst-case emissions are reported.

4.1.4 DEVIATION FROM TEST STANDARD

No deviation.

4.1.5 TEST SETUP

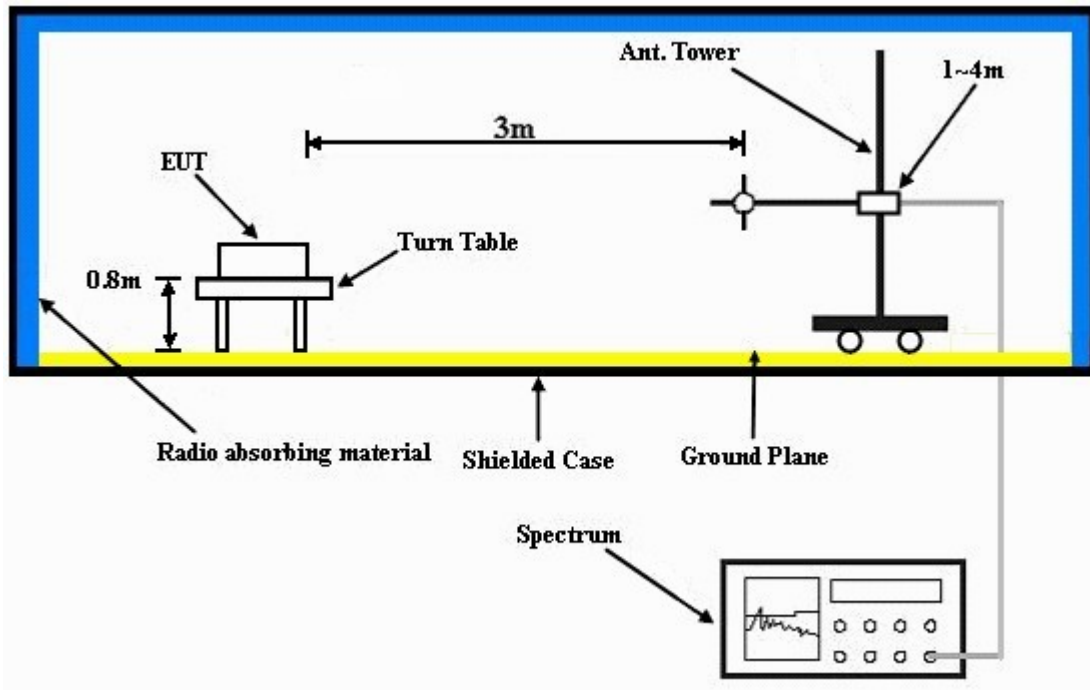

For the actual test configuration, please refer to the attached file (Test Setup Photo).

4.1.6 EUT OPERATING CONDITIONS

- Plugged the EUT via USB cable into a notebook system and placed on a testing table.
- The notebook system ran a test program (provided by manufacturer) to enable EUT under transmission condition continuously at specific channel frequency.
- The necessary accessories enable the system in full functions.



A D T

4.1.7 TEST RESULTS

802.11b DSSS MODULATION

EUT TEST CONDITION		MEASUREMENT DETAIL	
CHANNEL	Channel 1	FREQUENCY RANGE	1 ~ 25GHz
INPUT POWER (SYSTEM)	120Vac, 60 Hz	DETECTOR FUNCTION	Peak (PK) Average (AV)
ENVIRONMENTAL CONDITIONS	23.0deg. C, 70.0%RH 1009hPa	TESTED BY	Lori Chiu

ANTENNA POLARITY & TEST DISTANCE: HORIZONTAL AT 3 M								
NO.	FREQ. (MHz)	EMISSION LEVEL (dBuV/m)	LIMIT (dBuV/m)	MARGIN (dB)	ANTENNA HEIGHT (m)	TABLE ANGLE (Degree)	RAW VALUE (dBuV)	CORRECTION FACTOR (dB/m)
1	2390.00	55.94 PK	74.00	-18.06	1.39 H	242	23.65	32.29
2	2390.00	46.35 AV	54.00	-7.65	1.39 H	242	14.06	32.29
3	*2412.00	98.33 PK			1.39 H	242	65.95	32.38
4	*2412.00	93.76 AV			1.39 H	242	61.38	32.38
5	4824.00	49.88 PK	74.00	-24.12	1.18 H	332	11.31	38.56
6	4824.00	40.41 AV	54.00	-13.59	1.18 H	332	1.84	38.56
ANTENNA POLARITY & TEST DISTANCE: VERTICAL AT 3 M								
NO.	FREQ. (MHz)	EMISSION LEVEL (dBuV/m)	LIMIT (dBuV/m)	MARGIN (dB)	ANTENNA HEIGHT (m)	TABLE ANGLE (Degree)	RAW VALUE (dBuV)	CORRECTION FACTOR (dB/m)
1	2390.00	55.42 PK	74.00	-18.58	1.52 V	324	23.13	32.29
2	2390.00	46.20 AV	54.00	-7.80	1.52 V	324	13.91	32.29
3	*2412.00	98.14 PK			1.52 V	324	65.76	32.38
4	*2412.00	93.37 AV			1.52 V	324	60.99	32.38
5	4824.00	49.37 PK	74.00	-24.63	1.21 V	312	10.80	38.56
6	4824.00	38.58 AV	54.00	-15.42	1.21 V	312	0.01	38.56

- REMARKS:**
1. Emission level (dBuV/m) = Raw Value (dBuV) + Correction Factor (dB/m).
 2. Correction Factor (dB/m) = Antenna Factor (dB/m) + Cable Factor (dB).
 3. The other emission levels were very low against the limit.
 4. Margin value = Emission level – Limit value.
 5. “ * ”: Fundamental frequency.



A D T

EUT TEST CONDITION		MEASUREMENT DETAIL	
CHANNEL	Channel 6	FREQUENCY RANGE	1 ~ 25GHz
INPUT POWER (SYSTEM)	120Vac, 60 Hz	DETECTOR FUNCTION	Peak (PK) Average (AV)
ENVIRONMENTAL CONDITIONS	23.0deg. C, 70.0%RH 1009hPa	TESTED BY	Lori Chiu

ANTENNA POLARITY & TEST DISTANCE: HORIZONTAL AT 3 M								
NO.	FREQ. (MHz)	EMISSION LEVEL (dBuV/m)	LIMIT (dBuV/m)	MARGIN (dB)	ANTENNA HEIGHT (m)	TABLE ANGLE (Degree)	RAW VALUE (dBuV)	CORRECTION FACTOR (dB/m)
1	*2437.00	98.58 PK			1.38 H	270	66.10	32.48
2	*2437.00	93.87 AV			1.38 H	270	61.39	32.48
3	4874.00	49.58 PK	74.00	-24.42	1.00 H	120	10.91	38.67
4	4874.00	40.25 AV	54.00	-13.75	1.00 H	120	1.58	38.67
ANTENNA POLARITY & TEST DISTANCE: VERTICAL AT 3 M								
NO.	FREQ. (MHz)	EMISSION LEVEL (dBuV/m)	LIMIT (dBuV/m)	MARGIN (dB)	ANTENNA HEIGHT (m)	TABLE ANGLE (Degree)	RAW VALUE (dBuV)	CORRECTION FACTOR (dB/m)
1	*2437.00	98.31 PK			1.38 V	52	65.83	32.48
2	*2437.00	93.56 AV			1.38 V	52	61.08	32.48
3	4874.00	49.02 PK	74.00	-24.98	1.22 V	167	10.35	38.67
4	4874.00	37.50 AV	54.00	-16.50	1.22 V	167	-1.17	38.67

- REMARKS:**
1. Emission level (dBuV/m) = Raw Value (dBuV) + Correction Factor (dB/m).
 2. Correction Factor (dB/m) = Antenna Factor (dB/m) + Cable Factor (dB).
 3. The other emission levels were very low against the limit.
 4. Margin value = Emission level – Limit value.
 5. “ * “: Fundamental frequency.



A D T

EUT TEST CONDITION		MEASUREMENT DETAIL	
CHANNEL	Channel 11	FREQUENCY RANGE	1 ~ 25GHz
INPUT POWER (SYSTEM)	120Vac, 60 Hz	DETECTOR FUNCTION	Peak (PK) Average (AV)
ENVIRONMENTAL CONDITIONS	23.0deg. C, 70.0%RH 1009hPa	TESTED BY	Lori Chiu

ANTENNA POLARITY & TEST DISTANCE: HORIZONTAL AT 3 M								
NO.	FREQ. (MHz)	EMISSION LEVEL (dBuV/m)	LIMIT (dBuV/m)	MARGIN (dB)	ANTENNA HEIGHT (m)	TABLE ANGLE (Degree)	RAW VALUE (dBuV)	CORRECTION FACTOR (dB/m)
1	*2462.00	99.59 PK			1.37 H	286	67.01	32.58
2	*2462.00	94.99 AV			1.37 H	286	62.41	32.58
3	2483.50	56.51 PK	74.00	-17.49	1.37 H	286	23.85	32.66
4	2483.50	46.62 AV	54.00	-7.38	1.37 H	286	13.96	32.66
5	4924.00	49.01 PK	74.00	-24.99	1.37 H	57	10.22	38.79
6	4924.00	39.66 AV	54.00	-14.34	1.37 H	57	0.87	38.79
ANTENNA POLARITY & TEST DISTANCE: VERTICAL AT 3 M								
NO.	FREQ. (MHz)	EMISSION LEVEL (dBuV/m)	LIMIT (dBuV/m)	MARGIN (dB)	ANTENNA HEIGHT (m)	TABLE ANGLE (Degree)	RAW VALUE (dBuV)	CORRECTION FACTOR (dB/m)
1	*2462.00	99.24 PK			1.49 V	255	66.66	32.58
2	*2462.00	94.58 AV			1.49 V	255	62.00	32.58
3	2483.50	55.37 PK	74.00	-18.63	1.49 V	255	22.71	32.66
4	2483.50	46.74 AV	54.00	-7.26	1.49 V	255	14.08	32.66
5	4924.00	48.00 PK	74.00	-26.00	1.11 V	208	9.21	38.79
6	4924.00	35.49 AV	54.00	-18.51	1.11 V	208	-3.30	38.79

- REMARKS:**
1. Emission level (dBuV/m) = Raw Value (dBuV) + Correction Factor (dB/m).
 2. Correction Factor (dB/m) = Antenna Factor (dB/m) + Cable Factor (dB).
 3. The other emission levels were very low against the limit.
 4. Margin value = Emission level – Limit value.
 5. “ * “: Fundamental frequency.



A D T

802.11g OFDM MODULATION

EUT TEST CONDITION		MEASUREMENT DETAIL	
CHANNEL	Channel 1	FREQUENCY RANGE	1 ~ 25GHz
INPUT POWER (SYSTEM)	120Vac, 60 Hz	DETECTOR FUNCTION	Peak (PK) Average (AV)
ENVIRONMENTAL CONDITIONS	23.0deg. C, 70.0%RH 1009hPa	TESTED BY	Lori Chiu

ANTENNA POLARITY & TEST DISTANCE: HORIZONTAL AT 3 M								
NO.	FREQ. (MHz)	EMISSION LEVEL (dBuV/m)	LIMIT (dBuV/m)	MARGIN (dB)	ANTENNA HEIGHT (m)	TABLE ANGLE (Degree)	RAW VALUE (dBuV)	CORRECTION FACTOR (dB/m)
1	2390.00	57.61 PK	74.00	-16.39	1.38 H	101	25.32	32.29
2	2390.00	46.58 AV	54.00	-7.42	1.38 H	101	14.29	32.29
3	*2412.00	97.50 PK			1.38 H	101	65.12	32.38
4	*2412.00	87.24 AV			1.38 H	101	54.86	32.38
5	4824.00	49.63 PK	74.00	-24.37	1.03 H	214	11.06	38.56
6	4824.00	36.68 AV	54.00	-17.32	1.03 H	214	-1.89	38.56
ANTENNA POLARITY & TEST DISTANCE: VERTICAL AT 3 M								
NO.	FREQ. (MHz)	EMISSION LEVEL (dBuV/m)	LIMIT (dBuV/m)	MARGIN (dB)	ANTENNA HEIGHT (m)	TABLE ANGLE (Degree)	RAW VALUE (dBuV)	CORRECTION FACTOR (dB/m)
1	2390.00	57.47 PK	74.00	-16.53	1.00 V	339	25.18	32.29
2	2390.00	46.44 AV	54.00	-7.56	1.00 V	339	14.15	32.29
3	*2412.00	97.45 PK			1.00 V	339	65.07	32.38
4	*2412.00	87.01 AV			1.00 V	339	54.63	32.38
5	4824.00	50.12 PK	74.00	-23.88	1.08 V	259	11.56	38.56
6	4824.00	37.24 AV	54.00	-16.76	1.08 V	259	-1.32	38.56

- REMARKS:**
1. Emission level (dBuV/m) = Raw Value (dBuV) + Correction Factor (dB/m).
 2. Correction Factor (dB/m) = Antenna Factor (dB/m) + Cable Factor (dB).
 3. The other emission levels were very low against the limit.
 4. Margin value = Emission level – Limit value.
 5. “ * “: Fundamental frequency.



A D T

EUT TEST CONDITION		MEASUREMENT DETAIL	
CHANNEL	Channel 6	FREQUENCY RANGE	1 ~ 25GHz
INPUT POWER (SYSTEM)	120Vac, 60 Hz	DETECTOR FUNCTION	Peak (PK) Average (AV)
ENVIRONMENTAL CONDITIONS	23.0deg. C, 70.0%RH 1009hPa	TESTED BY	Lori Chiu

ANTENNA POLARITY & TEST DISTANCE: HORIZONTAL AT 3 M								
NO.	FREQ. (MHz)	EMISSION LEVEL (dBuV/m)	LIMIT (dBuV/m)	MARGIN (dB)	ANTENNA HEIGHT (m)	TABLE ANGLE (Degree)	RAW VALUE (dBuV)	CORRECTION FACTOR (dB/m)
1	*2437.00	97.99 PK			1.38 H	107	65.51	32.48
2	*2437.00	87.70 AV			1.38 H	107	55.22	32.48
3	4874.00	49.82 PK	74.00	-24.18	1.03 H	265	11.15	38.67
4	4874.00	36.91 AV	54.00	-17.09	1.03 H	265	-1.76	38.67
ANTENNA POLARITY & TEST DISTANCE: VERTICAL AT 3 M								
NO.	FREQ. (MHz)	EMISSION LEVEL (dBuV/m)	LIMIT (dBuV/m)	MARGIN (dB)	ANTENNA HEIGHT (m)	TABLE ANGLE (Degree)	RAW VALUE (dBuV)	CORRECTION FACTOR (dB/m)
1	*2437.00	97.62 PK			1.01 V	342	65.14	32.48
2	*2437.00	87.43 AV			1.01 V	342	54.95	32.48
3	4874.00	50.26 PK	74.00	-23.74	1.10 V	232	11.59	38.67
4	4874.00	37.35 AV	54.00	-16.65	1.10 V	232	-1.32	38.67

- REMARKS:**
1. Emission level (dBuV/m) = Raw Value (dBuV) + Correction Factor (dB/m).
 2. Correction Factor (dB/m) = Antenna Factor (dB/m) + Cable Factor (dB).
 3. The other emission levels were very low against the limit.
 4. Margin value = Emission level – Limit value.
 5. “ * “: Fundamental frequency.



A D T

EUT TEST CONDITION		MEASUREMENT DETAIL	
CHANNEL	Channel 11	FREQUENCY RANGE	1 ~ 25GHz
INPUT POWER (SYSTEM)	120Vac, 60 Hz	DETECTOR FUNCTION	Peak (PK) Average (AV)
ENVIRONMENTAL CONDITIONS	23.0deg. C, 70.0%RH 1009hPa	TESTED BY	Lori Chiu

ANTENNA POLARITY & TEST DISTANCE: HORIZONTAL AT 3 M								
NO.	FREQ. (MHz)	EMISSION LEVEL (dBuV/m)	LIMIT (dBuV/m)	MARGIN (dB)	ANTENNA HEIGHT (m)	TABLE ANGLE (Degree)	RAW VALUE (dBuV)	CORRECTION FACTOR (dB/m)
1	*2462.00	98.99 PK			1.31 H	101	66.41	32.58
2	*2462.00	88.62 AV			1.31 H	101	56.04	32.58
3	2483.50	58.08 PK	74.00	-15.92	1.31 H	101	25.42	32.66
4	2483.50	46.72 AV	54.00	-7.28	1.31 H	101	14.06	32.66
5	4924.00	49.86 PK	74.00	-24.14	1.03 H	269	11.07	38.79
6	4924.00	36.95 AV	54.00	-17.05	1.03 H	269	-1.84	38.79
ANTENNA POLARITY & TEST DISTANCE: VERTICAL AT 3 M								
NO.	FREQ. (MHz)	EMISSION LEVEL (dBuV/m)	LIMIT (dBuV/m)	MARGIN (dB)	ANTENNA HEIGHT (m)	TABLE ANGLE (Degree)	RAW VALUE (dBuV)	CORRECTION FACTOR (dB/m)
1	*2462.00	98.71 PK			1.02 V	345	66.13	32.58
2	*2462.00	88.36 AV			1.02 V	345	55.78	32.58
3	2483.50	57.81 PK	74.00	-16.19	1.02 V	345	25.15	32.66
4	2483.50	46.48 AV	54.00	-7.52	1.02 V	345	13.82	32.66
5	4924.00	50.49 PK	74.00	-23.51	1.01 V	25	11.70	38.79
6	4924.00	37.44 AV	54.00	-16.56	1.01 V	25	-1.35	38.79

- REMARKS:**
1. Emission level (dBuV/m) = Raw Value (dBuV) + Correction Factor (dB/m).
 2. Correction Factor (dB/m) = Antenna Factor (dB/m) + Cable Factor (dB).
 3. The other emission levels were very low against the limit.
 4. Margin value = Emission level – Limit value.
 5. “ * “: Fundamental frequency.



A D T

DRAFT 802.11n (20MHz) OFDM MODULATION

EUT TEST CONDITION		MEASUREMENT DETAIL	
CHANNEL	Channel 1	FREQUENCY RANGE	1 ~ 25GHz
INPUT POWER (SYSTEM)	120Vac, 60 Hz	DETECTOR FUNCTION	Peak (PK) Average (AV)
ENVIRONMENTAL CONDITIONS	23.0deg. C, 70.0%RH 1009hPa	TESTED BY	Lori Chiu

ANTENNA POLARITY & TEST DISTANCE: HORIZONTAL AT 3 M								
NO.	FREQ. (MHz)	EMISSION LEVEL (dBuV/m)	LIMIT (dBuV/m)	MARGIN (dB)	ANTENNA HEIGHT (m)	TABLE ANGLE (Degree)	RAW VALUE (dBuV)	CORRECTION FACTOR (dB/m)
1	2390.00	57.43 PK	74.00	-16.57	1.36 H	100	25.14	32.29
2	2390.00	46.39 AV	54.00	-7.61	1.36 H	100	14.10	32.29
3	*2412.00	97.62 PK			1.36 H	100	65.24	32.38
4	*2412.00	87.41 AV			1.36 H	100	55.03	32.38
5	4824.00	49.82 PK	74.00	-24.18	1.01 H	246	11.26	38.56
6	4824.00	36.94 AV	54.00	-17.06	1.01 H	246	-1.62	38.56
ANTENNA POLARITY & TEST DISTANCE: VERTICAL AT 3 M								
NO.	FREQ. (MHz)	EMISSION LEVEL (dBuV/m)	LIMIT (dBuV/m)	MARGIN (dB)	ANTENNA HEIGHT (m)	TABLE ANGLE (Degree)	RAW VALUE (dBuV)	CORRECTION FACTOR (dB/m)
1	2390.00	57.24 PK	74.00	-16.76	1.01 V	342	24.95	32.29
2	2390.00	46.18 AV	54.00	-7.82	1.01 V	342	13.89	32.29
3	*2412.00	97.35 PK			1.01 V	342	64.97	32.38
4	*2412.00	87.01 AV			1.01 V	342	54.63	32.38
5	4824.00	50.22 PK	74.00	-23.78	1.01 V	226	11.66	38.56
6	4824.00	37.41 AV	54.00	-16.59	1.01 V	226	-1.15	38.56

- REMARKS:**
1. Emission level (dBuV/m) = Raw Value (dBuV) + Correction Factor (dB/m).
 2. Correction Factor (dB/m) = Antenna Factor (dB/m) + Cable Factor (dB).
 3. The other emission levels were very low against the limit.
 4. Margin value = Emission level – Limit value.
 5. “ * “: Fundamental frequency.



A D T

EUT TEST CONDITION		MEASUREMENT DETAIL	
CHANNEL	Channel 6	FREQUENCY RANGE	1 ~ 25GHz
INPUT POWER (SYSTEM)	120Vac, 60 Hz	DETECTOR FUNCTION	Peak (PK) Average (AV)
ENVIRONMENTAL CONDITIONS	23.0deg. C, 70.0%RH 1009hPa	TESTED BY	Lori Chiu

ANTENNA POLARITY & TEST DISTANCE: HORIZONTAL AT 3 M								
NO.	FREQ. (MHz)	EMISSION LEVEL (dBuV/m)	LIMIT (dBuV/m)	MARGIN (dB)	ANTENNA HEIGHT (m)	TABLE ANGLE (Degree)	RAW VALUE (dBuV)	CORRECTION FACTOR (dB/m)
1	*2437.00	97.74 PK			1.39 H	105	65.26	32.48
2	*2437.00	87.43 AV			1.39 H	105	54.95	32.48
3	4874.00	49.96 PK	74.00	-24.04	1.05 H	236	11.29	38.67
4	4874.00	37.02 AV	54.00	-16.98	1.05 H	236	-1.65	38.67
ANTENNA POLARITY & TEST DISTANCE: VERTICAL AT 3 M								
NO.	FREQ. (MHz)	EMISSION LEVEL (dBuV/m)	LIMIT (dBuV/m)	MARGIN (dB)	ANTENNA HEIGHT (m)	TABLE ANGLE (Degree)	RAW VALUE (dBuV)	CORRECTION FACTOR (dB/m)
1	*2437.00	97.38 PK			1.03 V	346	64.90	32.48
2	*2437.00	87.05 AV			1.03 V	346	54.57	32.48
3	4874.00	50.49 PK	74.00	-23.51	1.13 V	272	11.82	38.67
4	4874.00	37.51 AV	54.00	-16.49	1.13 V	272	-1.16	38.67

- REMARKS:**
1. Emission level (dBuV/m) = Raw Value (dBuV) + Correction Factor (dB/m).
 2. Correction Factor (dB/m) = Antenna Factor (dB/m) + Cable Factor (dB).
 3. The other emission levels were very low against the limit.
 4. Margin value = Emission level – Limit value.
 5. “ * “: Fundamental frequency.



A D T

EUT TEST CONDITION		MEASUREMENT DETAIL	
CHANNEL	Channel 11	FREQUENCY RANGE	1 ~ 25GHz
INPUT POWER (SYSTEM)	120Vac, 60 Hz	DETECTOR FUNCTION	Peak (PK) Average (AV)
ENVIRONMENTAL CONDITIONS	23.0deg. C, 70.0%RH 1009hPa	TESTED BY	Lori Chiu

ANTENNA POLARITY & TEST DISTANCE: HORIZONTAL AT 3 M								
NO.	FREQ. (MHz)	EMISSION LEVEL (dBuV/m)	LIMIT (dBuV/m)	MARGIN (dB)	ANTENNA HEIGHT (m)	TABLE ANGLE (Degree)	RAW VALUE (dBuV)	CORRECTION FACTOR (dB/m)
1	*2462.00	98.42 PK			1.30 H	104	65.84	32.58
2	*2462.00	88.06 AV			1.30 H	104	55.48	32.58
3	2483.50	57.81 PK	74.00	-16.19	1.30 H	104	25.15	32.66
4	2483.50	46.59 AV	54.00	-7.41	1.30 H	104	13.93	32.66
5	4924.00	49.91 PK	74.00	-24.09	1.01 H	235	11.12	38.79
6	4924.00	37.04 AV	54.00	-16.96	1.01 H	235	-1.75	38.79
ANTENNA POLARITY & TEST DISTANCE: VERTICAL AT 3 M								
NO.	FREQ. (MHz)	EMISSION LEVEL (dBuV/m)	LIMIT (dBuV/m)	MARGIN (dB)	ANTENNA HEIGHT (m)	TABLE ANGLE (Degree)	RAW VALUE (dBuV)	CORRECTION FACTOR (dB/m)
1	*2462.00	97.92 PK			1.03 V	349	65.34	32.58
2	*2462.00	87.48 AV			1.03 V	349	54.90	32.58
3	2483.50	57.66 PK	74.00	-16.34	1.03 V	349	25.00	32.66
4	2483.50	46.31 AV	54.00	-7.69	1.03 V	349	13.65	32.66
5	4924.00	50.85 PK	74.00	-23.15	1.13 V	26	12.06	38.79
6	4924.00	37.74 AV	54.00	-16.26	1.13 V	26	-1.05	38.79

- REMARKS:**
1. Emission level (dBuV/m) = Raw Value (dBuV) + Correction Factor (dB/m).
 2. Correction Factor (dB/m) = Antenna Factor (dB/m) + Cable Factor (dB).
 3. The other emission levels were very low against the limit.
 4. Margin value = Emission level – Limit value.
 5. “ * “: Fundamental frequency.



A D T

DRAFT 802.11n (40MHz) OFDM MODULATION

EUT TEST CONDITION		MEASUREMENT DETAIL	
CHANNEL	Channel 1	FREQUENCY RANGE	1 ~ 25GHz
INPUT POWER (SYSTEM)	120Vac, 60 Hz	DETECTOR FUNCTION	Peak (PK) Average (AV)
ENVIRONMENTAL CONDITIONS	23.0deg. C, 70.0%RH 1009hPa	TESTED BY	Lori Chiu

ANTENNA POLARITY & TEST DISTANCE: HORIZONTAL AT 3 M								
NO.	FREQ. (MHz)	EMISSION LEVEL (dBuV/m)	LIMIT (dBuV/m)	MARGIN (dB)	ANTENNA HEIGHT (m)	TABLE ANGLE (Degree)	RAW VALUE (dBuV)	CORRECTION FACTOR (dB/m)
1	2390.00	57.46 PK	74.00	-16.54	1.36 H	105	25.17	32.29
2	2390.00	46.91 AV	54.00	-7.09	1.36 H	105	14.62	32.29
3	*2422.00	94.95 PK			1.36 H	105	62.53	32.42
4	*2422.00	84.89 AV			1.36 H	105	52.47	32.42
5	4844.00	49.73 PK	74.00	-24.27	1.03 H	215	11.12	38.61
6	4844.00	36.82 AV	54.00	-17.18	1.03 H	215	-1.79	38.61
ANTENNA POLARITY & TEST DISTANCE: VERTICAL AT 3 M								
NO.	FREQ. (MHz)	EMISSION LEVEL (dBuV/m)	LIMIT (dBuV/m)	MARGIN (dB)	ANTENNA HEIGHT (m)	TABLE ANGLE (Degree)	RAW VALUE (dBuV)	CORRECTION FACTOR (dB/m)
1	2390.00	57.23 PK	74.00	-16.77	1.01 V	342	24.94	32.29
2	2390.00	46.72 AV	54.00	-7.28	1.01 V	342	14.43	32.29
3	*2422.00	94.61 PK			1.01 V	342	62.19	32.42
4	*2422.00	84.56 AV			1.01 V	342	52.14	32.42
5	4844.00	50.04 PK	74.00	-23.96	1.03 V	241	11.43	38.61
6	4844.00	37.06 AV	54.00	-16.94	1.03 V	241	-1.55	38.61

- REMARKS:**
1. Emission level (dBuV/m) = Raw Value (dBuV) + Correction Factor (dB/m).
 2. Correction Factor (dB/m) = Antenna Factor (dB/m) + Cable Factor (dB).
 3. The other emission levels were very low against the limit.
 4. Margin value = Emission level – Limit value.
 5. “ * “: Fundamental frequency.



A D T

EUT TEST CONDITION		MEASUREMENT DETAIL	
CHANNEL	Channel 4	FREQUENCY RANGE	1 ~ 25GHz
INPUT POWER (SYSTEM)	120Vac, 60 Hz	DETECTOR FUNCTION	Peak (PK) Average (AV)
ENVIRONMENTAL CONDITIONS	23.0deg. C, 70.0%RH 1009hPa	TESTED BY	Lori Chiu

ANTENNA POLARITY & TEST DISTANCE: HORIZONTAL AT 3 M								
NO.	FREQ. (MHz)	EMISSION LEVEL (dBuV/m)	LIMIT (dBuV/m)	MARGIN (dB)	ANTENNA HEIGHT (m)	TABLE ANGLE (Degree)	RAW VALUE (dBuV)	CORRECTION FACTOR (dB/m)
1	*2437.00	94.93 PK			1.36 H	109	62.45	32.48
2	*2437.00	84.92 AV			1.36 H	109	52.44	32.48
3	4874.00	49.68 PK	74.00	-24.32	1.13 H	104	11.01	38.67
4	4874.00	36.72 AV	54.00	-17.28	1.13 H	104	-1.95	38.67
ANTENNA POLARITY & TEST DISTANCE: VERTICAL AT 3 M								
NO.	FREQ. (MHz)	EMISSION LEVEL (dBuV/m)	LIMIT (dBuV/m)	MARGIN (dB)	ANTENNA HEIGHT (m)	TABLE ANGLE (Degree)	RAW VALUE (dBuV)	CORRECTION FACTOR (dB/m)
1	*2437.00	94.86 PK			1.03 V	349	62.38	32.48
2	*2437.00	84.35 AV			1.03 V	349	51.87	32.48
3	4874.00	50.11 PK	74.00	-23.89	1.06 V	308	11.44	38.67
4	4874.00	37.24 AV	54.00	-16.76	1.06 V	308	-1.43	38.67

- REMARKS:**
1. Emission level (dBuV/m) = Raw Value (dBuV) + Correction Factor (dB/m).
 2. Correction Factor (dB/m) = Antenna Factor (dB/m) + Cable Factor (dB).
 3. The other emission levels were very low against the limit.
 4. Margin value = Emission level – Limit value.
 5. “ * “: Fundamental frequency.



A D T

EUT TEST CONDITION		MEASUREMENT DETAIL	
CHANNEL	Channel 7	FREQUENCY RANGE	1 ~ 25GHz
INPUT POWER (SYSTEM)	120Vac, 60 Hz	DETECTOR FUNCTION	Peak (PK) Average (AV)
ENVIRONMENTAL CONDITIONS	23.0deg. C, 70.0%RH 1009hPa	TESTED BY	Lori Chiu

ANTENNA POLARITY & TEST DISTANCE: HORIZONTAL AT 3 M								
NO.	FREQ. (MHz)	EMISSION LEVEL (dBuV/m)	LIMIT (dBuV/m)	MARGIN (dB)	ANTENNA HEIGHT (m)	TABLE ANGLE (Degree)	RAW VALUE (dBuV)	CORRECTION FACTOR (dB/m)
1	*2452.00	95.81 PK			1.30 H	106	63.27	32.54
2	*2452.00	85.54 AV			1.30 H	106	53.00	32.54
3	2483.50	58.26 PK	74.00	-15.74	1.30 H	106	25.60	32.66
4	2483.50	46.95 AV	54.00	-7.05	1.30 H	106	14.29	32.66
5	4904.00	49.68 PK	74.00	-24.32	1.13 H	295	10.94	38.74
6	4904.00	36.74 AV	54.00	-17.26	1.13 H	295	-2.00	38.74
ANTENNA POLARITY & TEST DISTANCE: VERTICAL AT 3 M								
NO.	FREQ. (MHz)	EMISSION LEVEL (dBuV/m)	LIMIT (dBuV/m)	MARGIN (dB)	ANTENNA HEIGHT (m)	TABLE ANGLE (Degree)	RAW VALUE (dBuV)	CORRECTION FACTOR (dB/m)
1	*2452.00	95.28 PK			1.06 V	352	62.74	32.54
2	*2452.00	85.11 AV			1.06 V	352	52.57	32.54
3	2483.50	57.99 PK	74.00	-16.01	1.06 V	352	25.33	32.66
4	2483.50	46.72 AV	54.00	-7.28	1.06 V	352	14.06	32.66
5	4904.00	50.38 PK	74.00	-23.62	1.14 V	72	11.64	38.74
6	4904.00	37.29 AV	54.00	-16.71	1.14 V	72	-1.45	38.74

- REMARKS:**
1. Emission level (dBuV/m) = Raw Value (dBuV) + Correction Factor (dB/m).
 2. Correction Factor (dB/m) = Antenna Factor (dB/m) + Cable Factor (dB).
 3. The other emission levels were very low against the limit.
 4. Margin value = Emission level – Limit value.
 5. “ * “: Fundamental frequency.



A D T

BELOW 1GHz WORST-CASE DATA : DRAFT 802.11n (20MHz) OFDM MODULATION

EUT TEST CONDITION		MEASUREMENT DETAIL	
CHANNEL	Channel 11	FREQUENCY RANGE	Below 1000MHz
INPUT POWER (SYSTEM)	120Vac, 60 Hz	DETECTOR FUNCTION	Quasi-Peak
ENVIRONMENTAL CONDITIONS	23.0deg. C, 70.0%RH 1010hPa	TESTED BY	Lori Chiu

ANTENNA POLARITY & TEST DISTANCE: HORIZONTAL AT 3 M								
NO.	FREQ. (MHz)	EMISSION LEVEL (dBuV/m)	LIMIT (dBuV/m)	MARGIN (dB)	ANTENNA HEIGHT (m)	TABLE ANGLE (Degree)	RAW VALUE (dBuV)	CORRECTION FACTOR (dB/m)
1	720.12	28.88 QP	46.00	-17.12	1.00 H	235	4.02	24.86
2	772.62	28.29 QP	46.00	-17.71	1.00 H	73	2.42	25.88
3	799.84	32.65 QP	46.00	-13.35	2.00 H	304	6.28	26.37
4	834.84	30.61 QP	46.00	-15.39	1.50 H	253	3.55	27.06
5	875.67	29.75 QP	46.00	-16.25	1.00 H	64	1.94	27.80
6	883.44	29.23 QP	46.00	-16.77	2.00 H	223	1.30	27.93
ANTENNA POLARITY & TEST DISTANCE: VERTICAL AT 3 M								
NO.	FREQ. (MHz)	EMISSION LEVEL (dBuV/m)	LIMIT (dBuV/m)	MARGIN (dB)	ANTENNA HEIGHT (m)	TABLE ANGLE (Degree)	RAW VALUE (dBuV)	CORRECTION FACTOR (dB/m)
1	632.63	30.96 QP	46.00	-15.04	2.00 V	346	7.41	23.55
2	770.67	30.12 QP	46.00	-15.88	2.00 V	202	4.28	25.84
3	799.84	35.41 QP	46.00	-10.59	2.00 V	202	9.04	26.37
4	829.00	31.40 QP	46.00	-14.60	2.00 V	214	4.46	26.95
5	869.83	33.66 QP	46.00	-12.34	1.25 V	181	5.95	27.70
6	877.61	34.08 QP	46.00	-11.92	1.25 V	202	6.25	27.83
7	947.60	35.23 QP	46.00	-10.77	1.00 V	139	6.58	28.65

- REMARKS:**
1. Emission level (dBuV/m) = Raw Value (dBuV) + Correction Factor (dB/m).
 2. Correction Factor (dB/m) = Antenna Factor (dB/m) + Cable Factor (dB).
 3. The other emission levels were very low against the limit.
 4. Margin value = Emission level – Limit value.



A D T

4.2 CONDUCTED EMISSION MEASUREMENT

4.2.1 LIMITS OF CONDUCTED EMISSION MEASUREMENT

FREQUENCY OF EMISSION (MHz)	CONDUCTED LIMIT (dB μ V)	
	Quasi-peak	Average
0.15 ~ 0.5	66 to 56	56 to 46
0.5 ~ 5	56	46
5 ~ 30	60	50

- NOTE:** 1. The lower limit shall apply at the transition frequencies.
2. The limit decreases in line with the logarithm of the frequency in the range of 0.15 to 0.50MHz.
3. All emanations from a class A/B digital device or system, including any network of conductors and apparatus connected thereto, shall not exceed the level of field strengths specified above.

4.2.2 TEST INSTRUMENTS

DESCRIPTION & MANUFACTURER	MODEL NO.	SERIAL NO.	DATE OF CALIBRATION	DUE DATE OF CALIBRATION
Test Receiver ROHDE & SCHWARZ	ESCS30	100291	Nov. 19, 2008	Nov. 18, 2009
RF signal cable Woken	5D-FB	Cable-HYC01-01	Dec. 31, 2008	Dec. 30, 2009
LISN ROHDE & SCHWARZ	ESH3-Z5	100312	Jun. 13, 2008	Jun. 12, 2009
LISN ROHDE & SCHWARZ	ESH2-Z5	100104	Dec. 04, 2008	Dec. 03, 2009
Software ADT	ADT_Cond_ V7.3.7	NA	NA	NA

- NOTE:** 1. The calibration interval of the above test instruments is 12 months and the calibrations are traceable to NML/ROC and NIST/USA.
2. The test was performed in HwaYa Shielded Room 1.
3. The VCCI Site Registration No. is C-2040.



A D T

4.2.3 TEST PROCEDURES

- a. The EUT was placed 0.4 meters from the conducting wall of the shielded room with EUT being connected to the power mains through a line impedance stabilization network (LISN). Other support units were connected to the power mains through another LISN. The two LISNs provide 50 ohm/ 50uH of coupling impedance for the measuring instrument.
- b. Both lines of the power mains connected to the EUT were checked for maximum conducted interference.
- c. The frequency range from 150kHz to 30MHz was searched. Emission levels under (Limit - 20dB) was not recorded.

NOTE: All modes of operation were investigated and the worst-case emissions are reported.

4.2.4 DEVIATION FROM TEST STANDARD

No deviation.

4.2.5 TEST SETUP

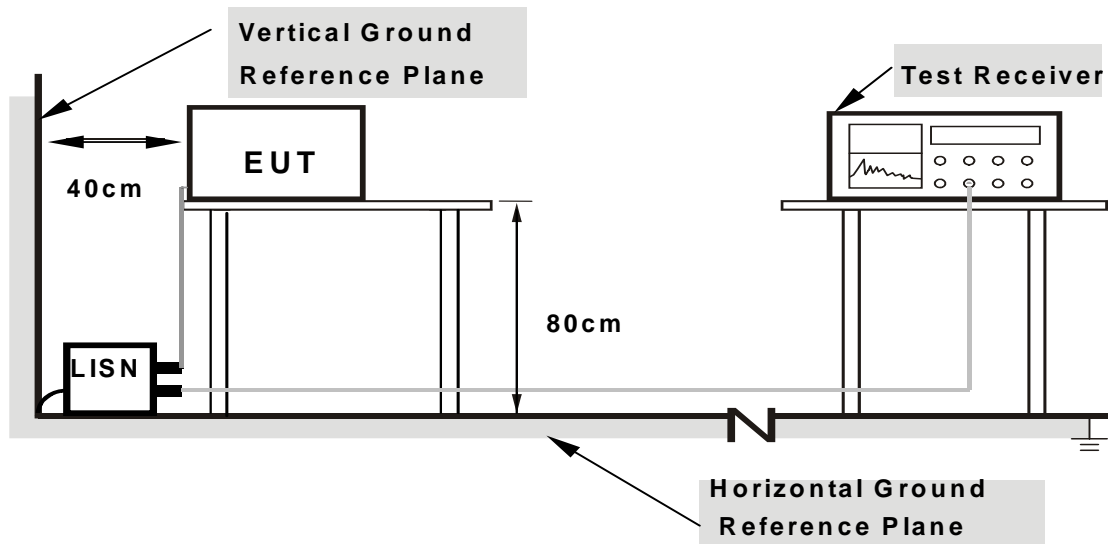

- Note:**
1. Support units were connected to second LISN.
 2. Both of LISNs (AMN) are 80 cm from EUT and at least 80 from other units and other metal planes

For the actual test configuration, please refer to the attached file (Test Setup Photo).

4.2.6 EUT OPERATING CONDITIONS

Same as 4.1.6.

4.2.7 TEST RESULTS

CONDUCTED WORST-CASE DATA : DRAFT 802.11n (20MHz) OFDM MODULATION

EUT TEST CONDITION		MEASUREMENT DETAIL	
CHANNEL	Channel 11	PHASE	Line 1
MODULATION TYPE	BPSK	INPUT POWER (SYSTEM)	120Vac, 60Hz
TRANSFER RATE	6.5Mbps	6dB BANDWIDTH	9kHz
ENVIRONMENTAL CONDITIONS	25deg. C, 65%RH, 1008hPa	TESTED BY	Mark Liao

No	Freq. [MHz]	Corr. Factor (dB)	Reading Value [dB (uV)]		Emission Level [dB (uV)]		Limit [dB (uV)]		Margin (dB)	
			Q.P.	AV.	Q.P.	AV.	Q.P.	AV.	Q.P.	AV.
1	0.173	0.13	52.47	-	52.60	-	64.79	54.79	-12.19	-
2	0.224	0.13	45.51	-	45.64	-	62.66	52.66	-17.02	-
3	0.396	0.14	36.42	-	36.56	-	57.93	47.93	-21.38	-
4	2.270	0.25	39.64	-	39.89	-	56.00	46.00	-16.11	-
5	4.141	0.38	45.21	-	45.59	-	56.00	46.00	-10.41	-
6	17.520	1.03	33.73	-	34.76	-	60.00	50.00	-25.24	-

- REMARKS:**
1. Q.P. and AV. are abbreviations of quasi-peak and average individually.
 2. "-": The Quasi-peak reading value also meets average limit and measurement with the average detector is unnecessary.
 3. The emission levels of other frequencies were very low against the limit.
 4. Margin value = Emission level - Limit value
 5. Correction factor = Insertion loss + Cable loss
 6. Emission Level = Correction Factor + Reading Value.

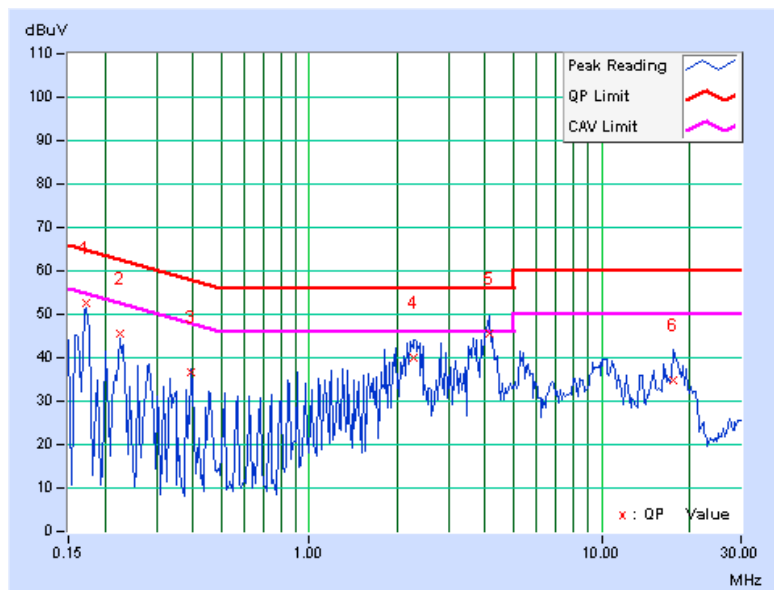



A D T

EUT TEST CONDITION		MEASUREMENT DETAIL	
CHANNEL	Channel 11	PHASE	Line 2
MODULATION TYPE	BPSK	INPUT POWER (SYSTEM)	120Vac, 60Hz
TRANSFER RATE	6.5Mbps	6dB BANDWIDTH	9kHz
ENVIRONMENTAL CONDITIONS	25deg. C, 65%RH, 1008hPa	TESTED BY	Mark Liao

No	Freq. [MHz]	Corr. Factor (dB)	Reading Value [dB (uV)]		Emission Level [dB (uV)]		Limit [dB (uV)]		Margin (dB)	
			Q.P.	AV.	Q.P.	AV.	Q.P.	AV.	Q.P.	AV.
1	0.172	0.14	54.13	-	54.27	-	64.86	54.86	-10.58	-
2	0.228	0.15	45.59	-	45.74	-	62.52	52.52	-16.78	-
3	0.283	0.15	42.35	-	42.50	-	60.73	50.73	-18.23	-
4	2.617	0.29	31.50	-	31.79	-	56.00	46.00	-24.21	-
5	3.978	0.39	43.56	-	43.95	-	56.00	46.00	-12.05	-
6	17.668	0.91	32.86	-	33.77	-	60.00	50.00	-26.23	-

- REMARKS:**
1. Q.P. and AV. are abbreviations of quasi-peak and average individually.
 2. "-": The Quasi-peak reading value also meets average limit and measurement with the average detector is unnecessary.
 3. The emission levels of other frequencies were very low against the limit.
 4. Margin value = Emission level - Limit value
 5. Correction factor = Insertion loss + Cable loss
 6. Emission Level = Correction Factor + Reading Value.

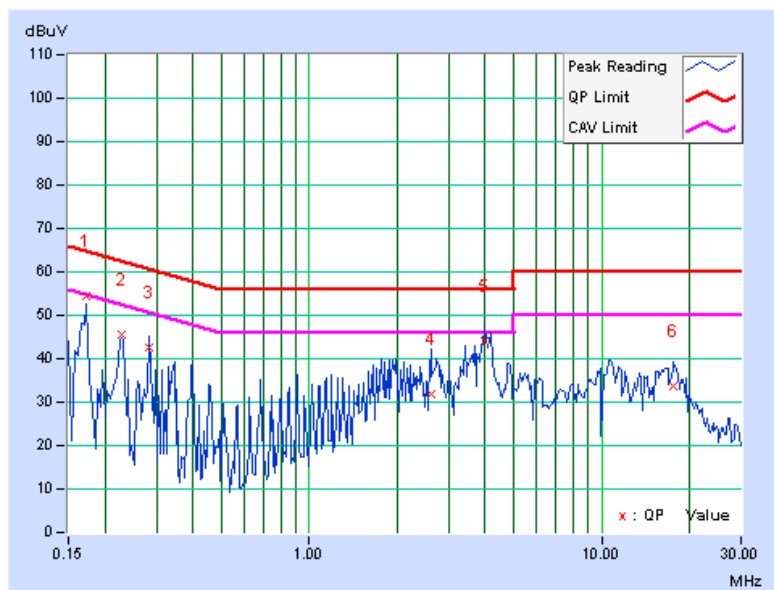

4.3 6dB BANDWIDTH MEASUREMENT

4.3.1 LIMITS OF 6dB BANDWIDTH MEASUREMENT

The minimum of 6dB Bandwidth Measurement is 0.5 MHz.

4.3.2 TEST INSTRUMENTS

DESCRIPTION & MANUFACTURER	MODEL NO.	SERIAL NO.	DATE OF CALIBRATION	DUE DATE OF CALIBRATION
R&S SPECTRUM ANALYZER	FSP40	100040	Jul. 04, 2008	Jul. 03, 2009

NOTE: The calibration interval of the above test instruments is 12 months and the calibrations are traceable to NML/ROC and NIST/USA.

4.3.3 TEST PROCEDURE

The transmitter output was connected to the spectrum analyzer through an attenuator. The bandwidth of the fundamental frequency was measured by spectrum analyzer with 100kHz RBW and 300kHz VBW. The 6dB bandwidth is defined as the total spectrum the power of which is higher than peak power minus 6dB.

4.3.4 DEVIATION FROM TEST STANDARD

No deviation.

4.3.5 TEST SETUP

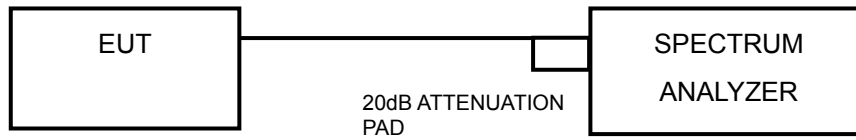

4.3.6 EUT OPERATING CONDITIONS

The software provided by client to enable the EUT under transmission condition continuously at lowest, middle and highest channel frequencies individually.



A D T

4.3.7 TEST RESULTS

802.11b DSSS MODULATION

MODULATION TYPE	DBPSK	TRANSFER RATE	1.0Mbps
INPUT POWER	120Vac, 60Hz	ENVIRONMENTAL CONDITIONS	23 deg.C, 70 %RH, 1009hPa
TESTED BY	Lori Chiu		

CHANNEL	CHANNEL FREQUENCY (MHz)	6dB BANDWIDTH (MHz)		MINIMUM LIMIT (MHz)	PASS / FAIL
		CHAIN 0	CHAIN 1		
1	2412	12.17	11.14	0.5	PASS
6	2437	12.24	11.15	0.5	PASS
11	2462	12.24	10.21	0.5	PASS



A D T

FOR CHAIN 0: CH 1

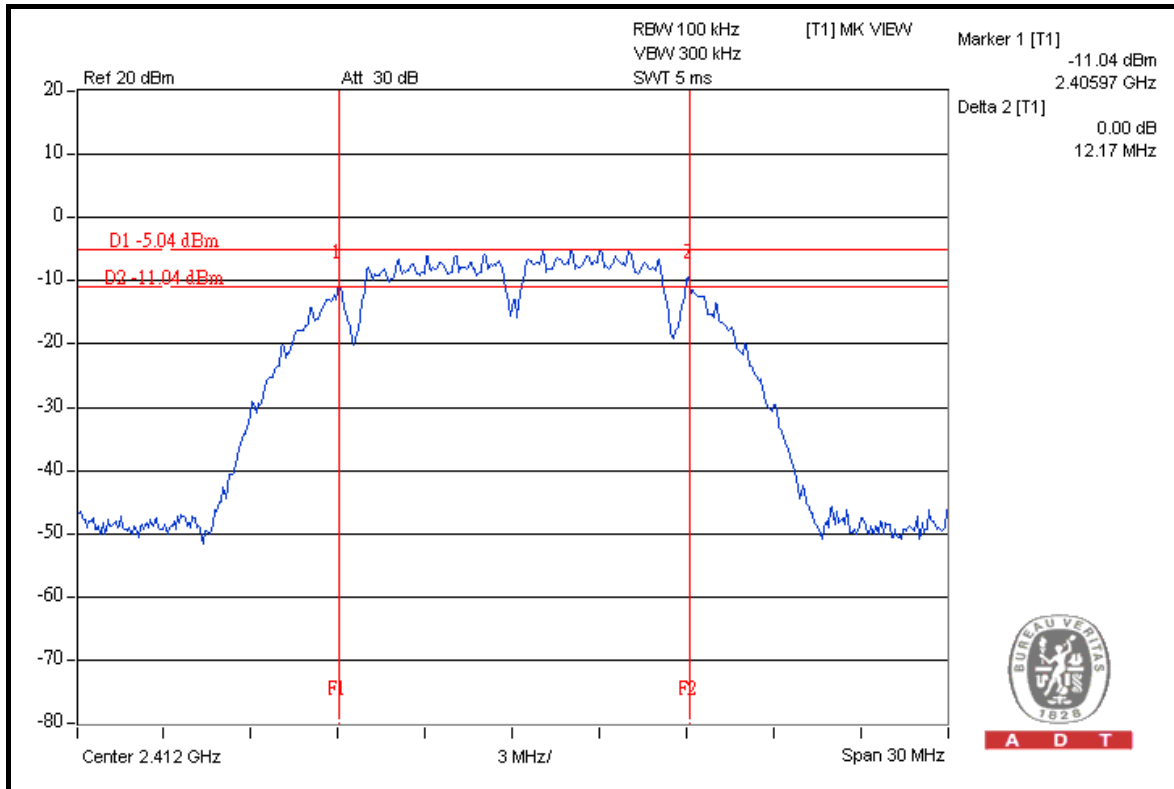

CH 6

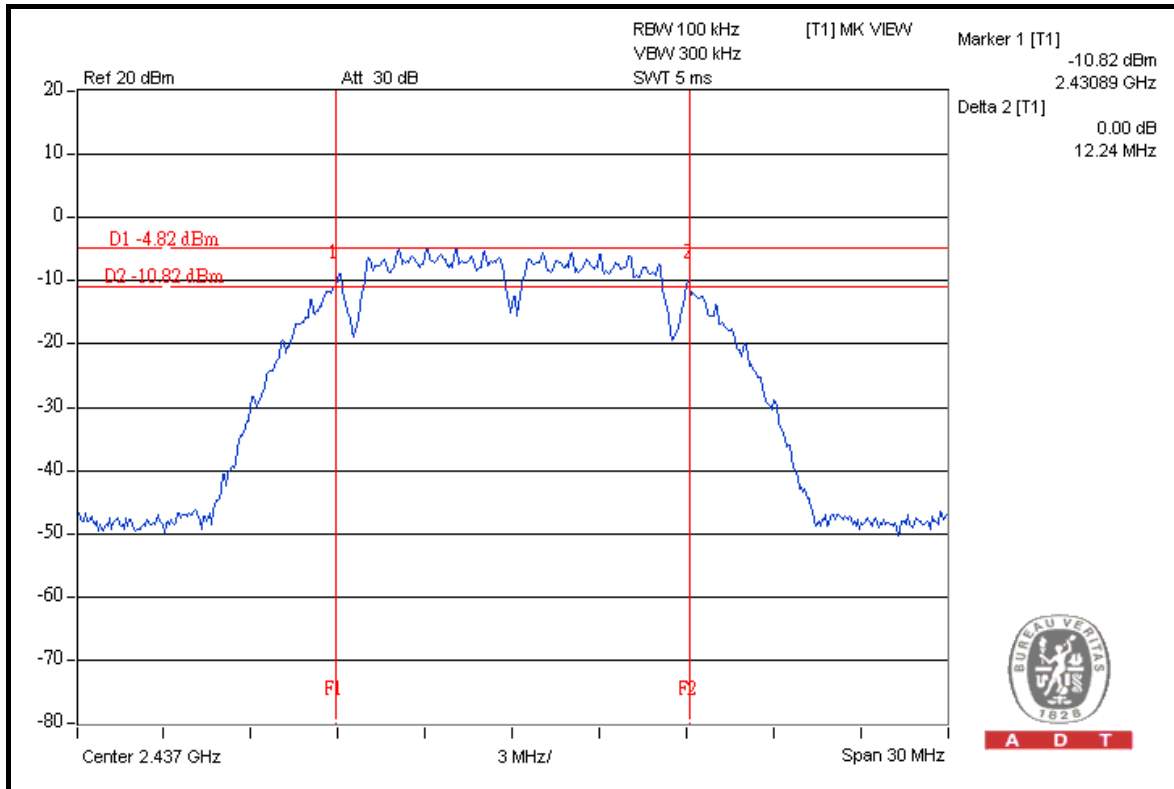



A D T

CH 11

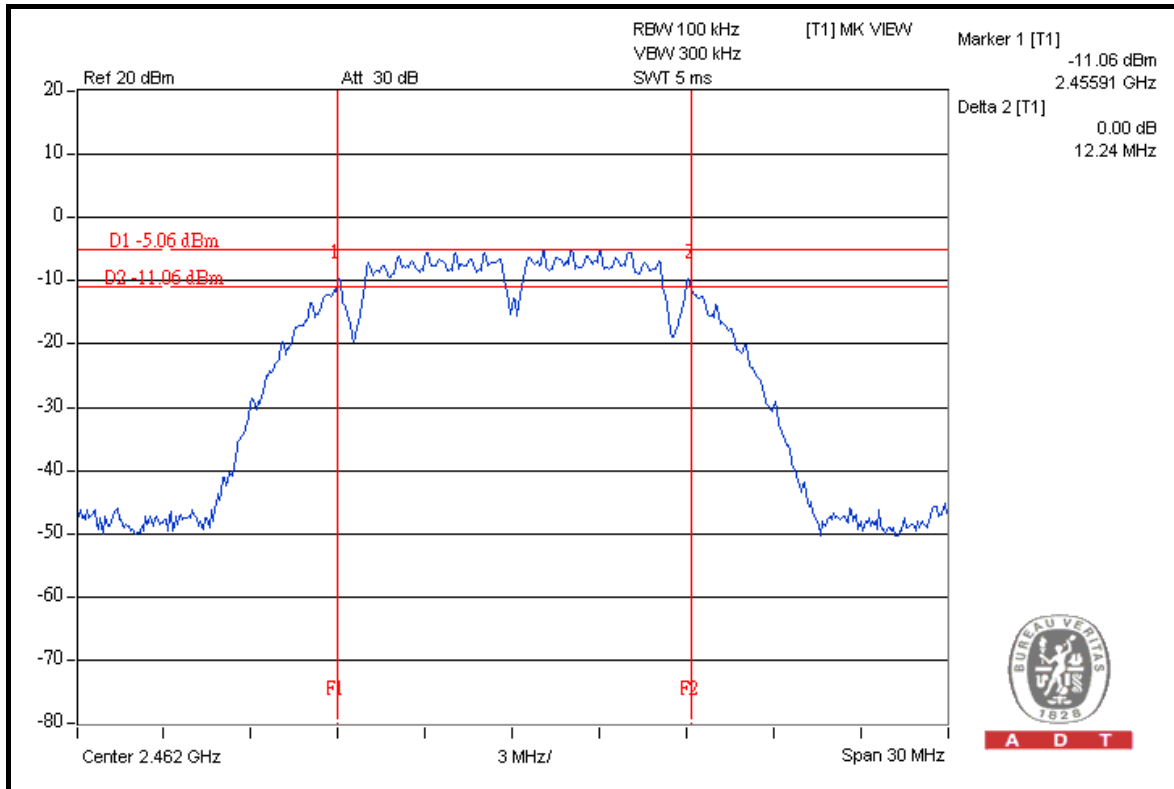

FOR CHAIN 1: CH 1

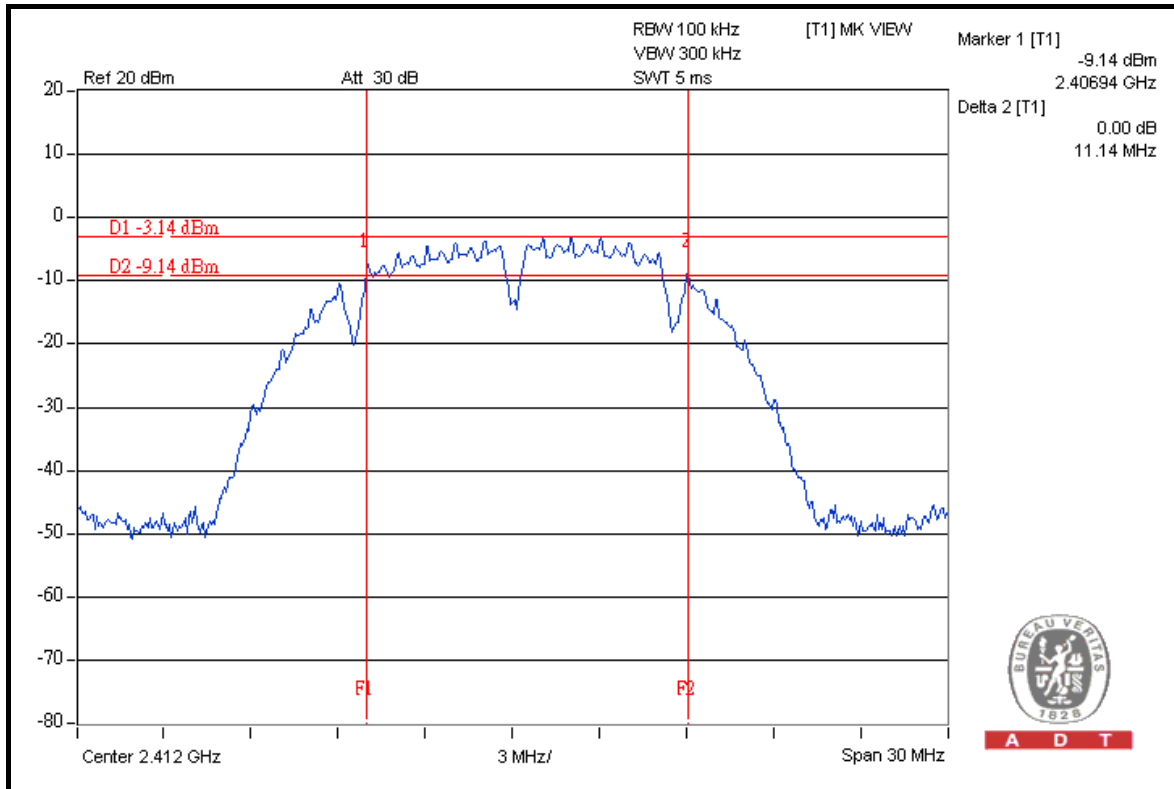



A D T

CH 6

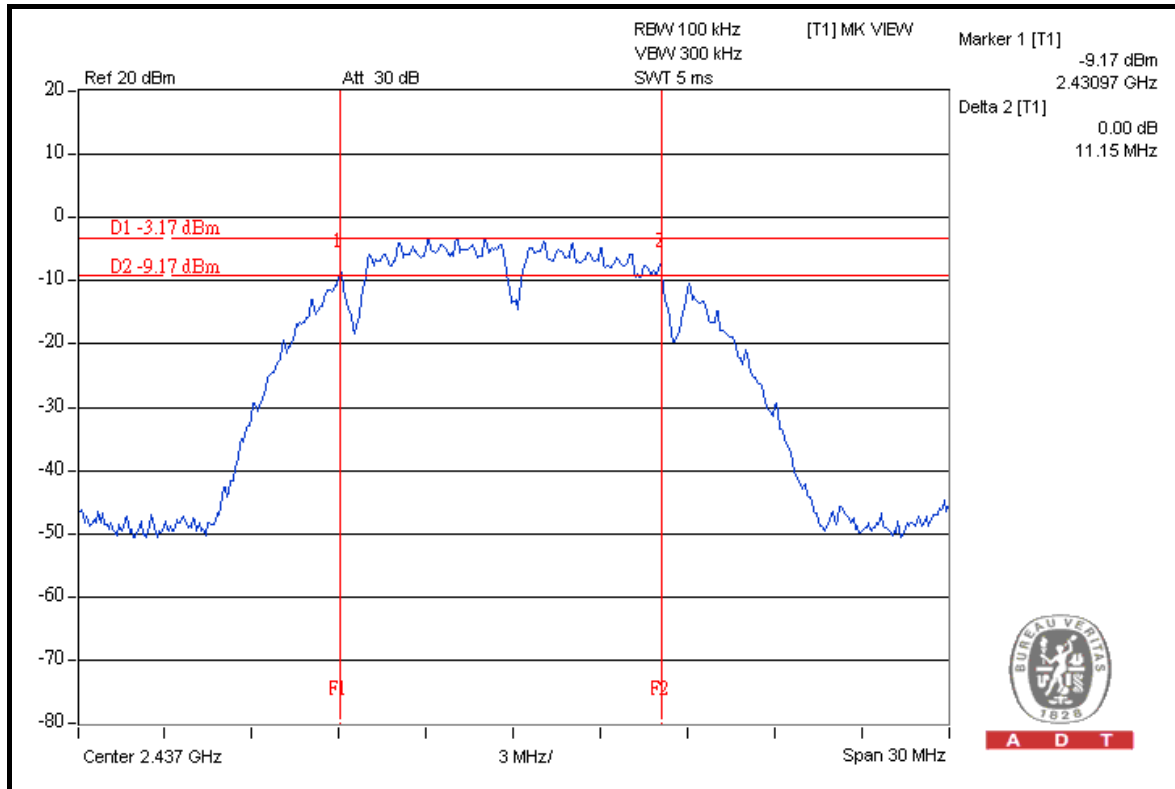

CH 11

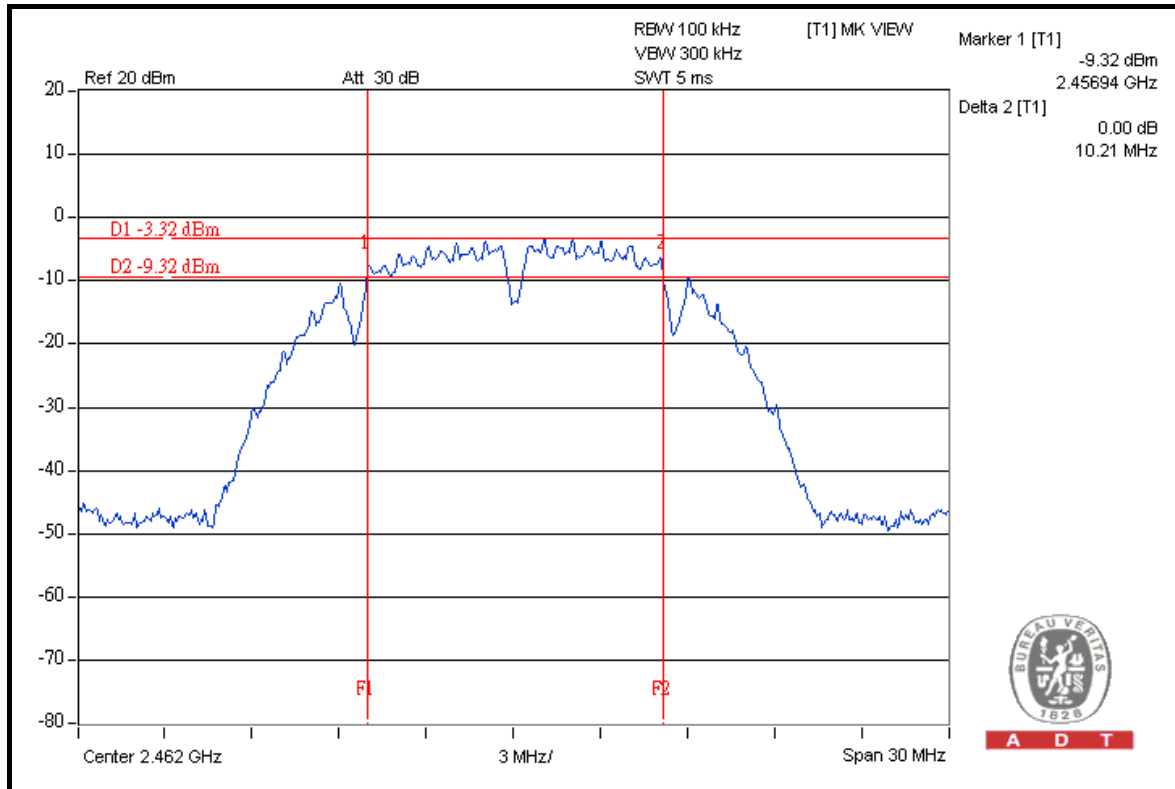



A D T

802.11g OFDM MODULATION

MODULATION TYPE	BPSK	TRANSFER RATE	6.0Mbps
INPUT POWER	120Vac, 60Hz	ENVIRONMENTAL CONDITIONS	23 deg.C, 70 %RH, 1009hPa
TESTED BY	Lori Chiu		

CHANNEL	CHANNEL FREQUENCY (MHz)	6dB BANDWIDTH (MHz)		MINIMUM LIMIT (MHz)	PASS / FAIL
		CHAIN 0	CHAIN 1		
1	2412	16.54	16.43	0.5	PASS
6	2437	16.40	16.46	0.5	PASS
11	2462	16.42	16.45	0.5	PASS



A D T

FOR CHAIN 0: CH 1

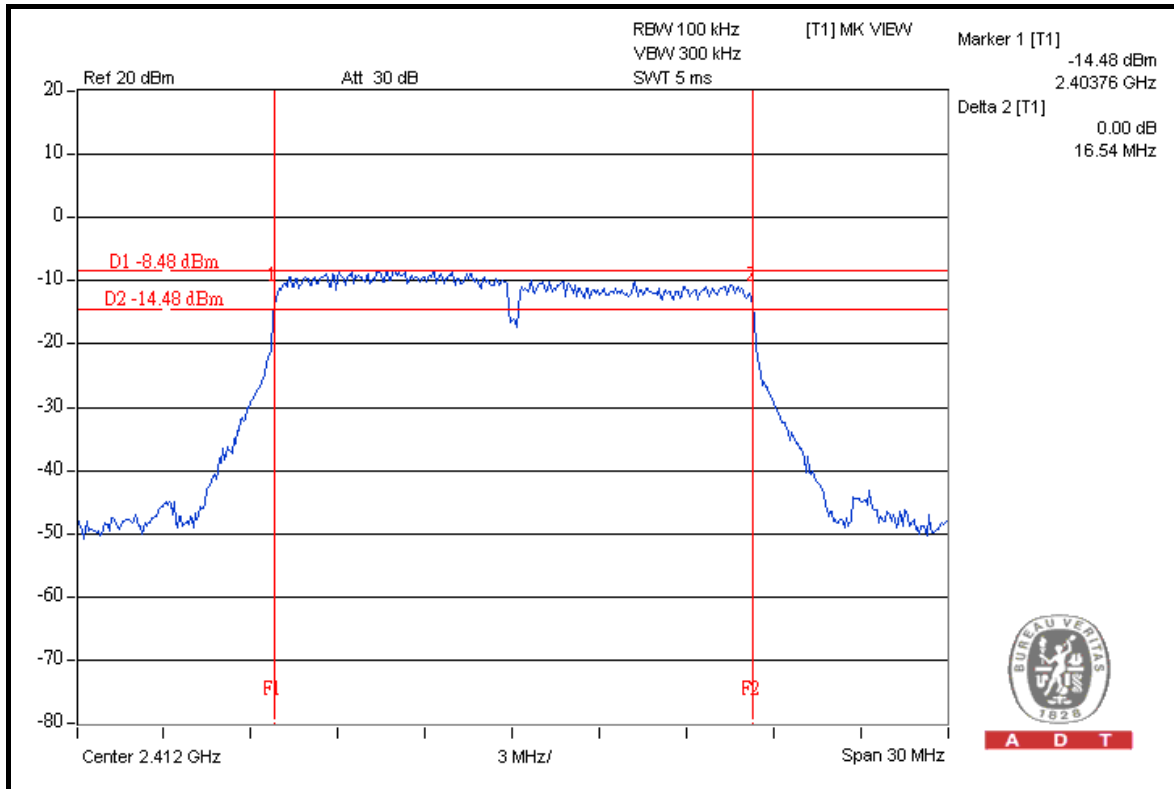

CH 6

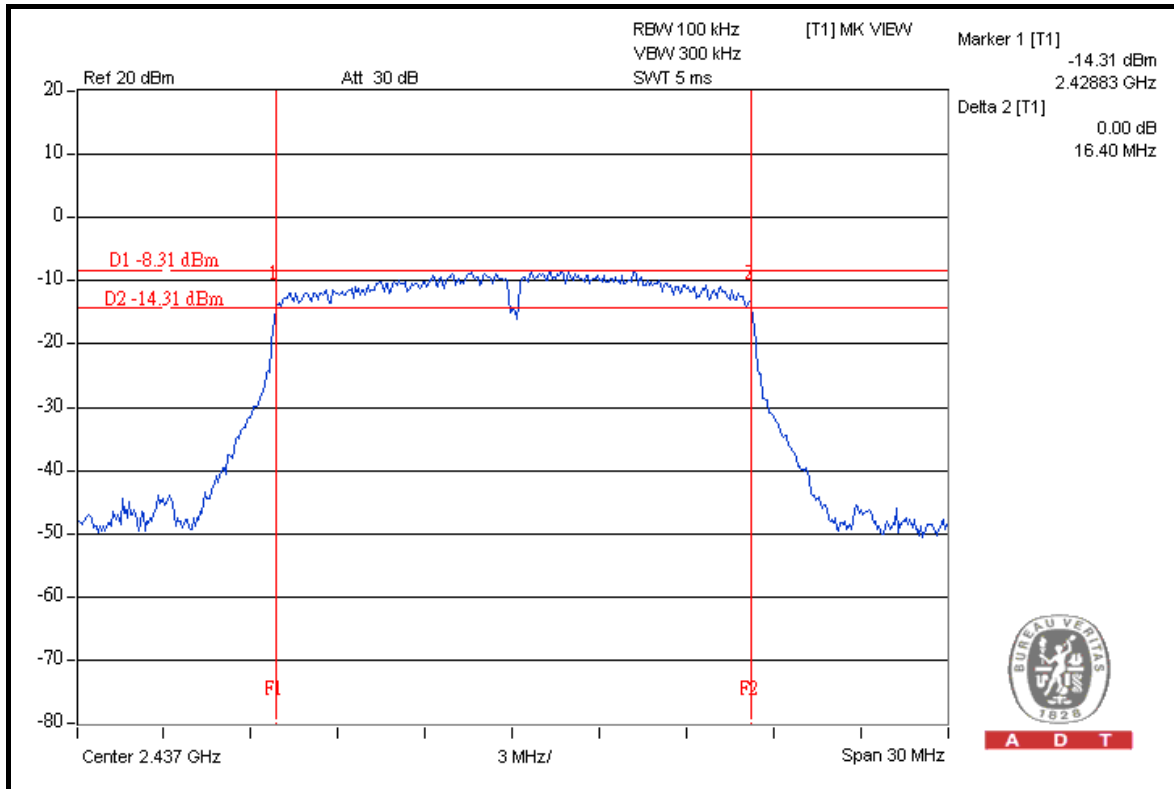



A D T

CH 11

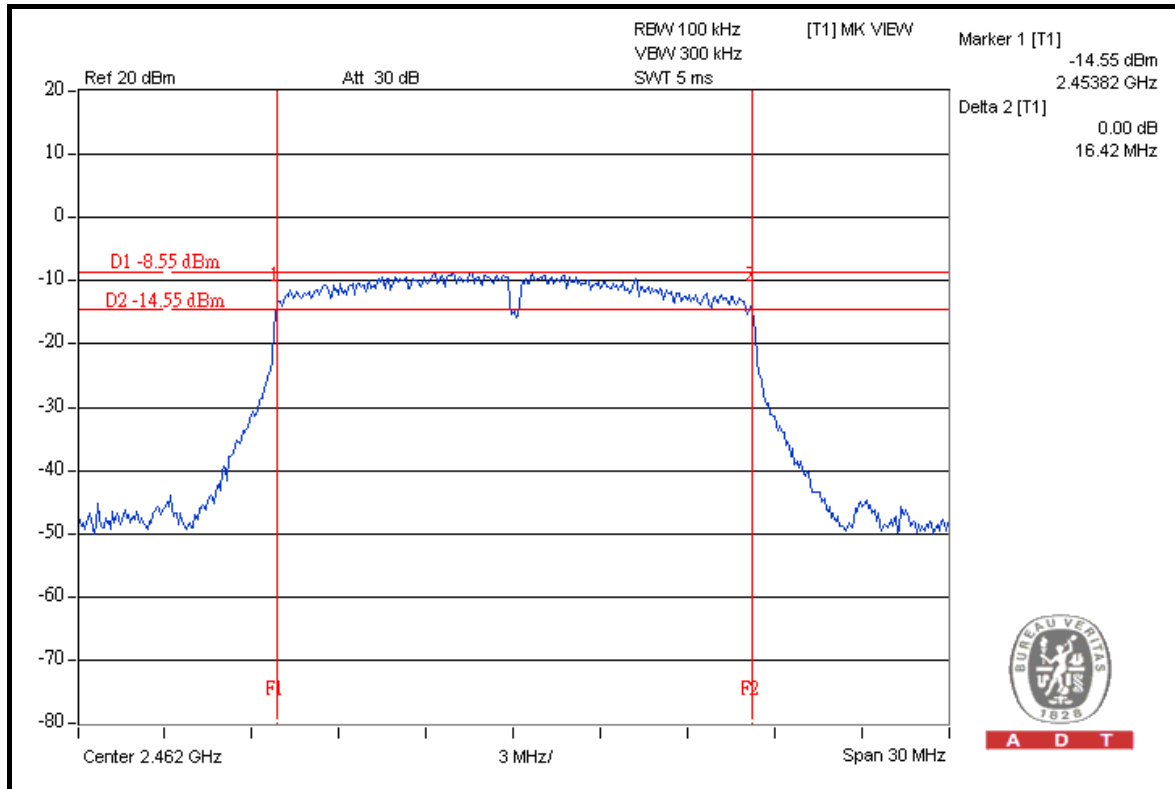

FOR CHAIN 1: CH 1

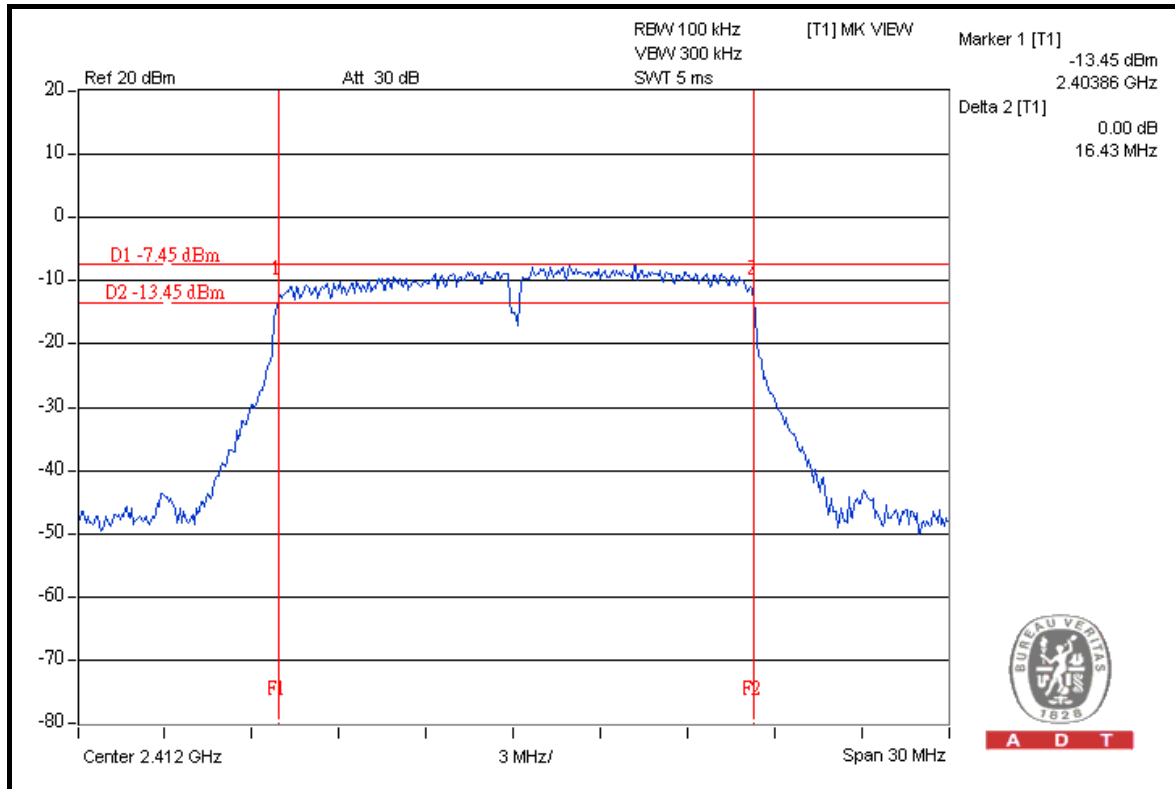



A D T

CH 6

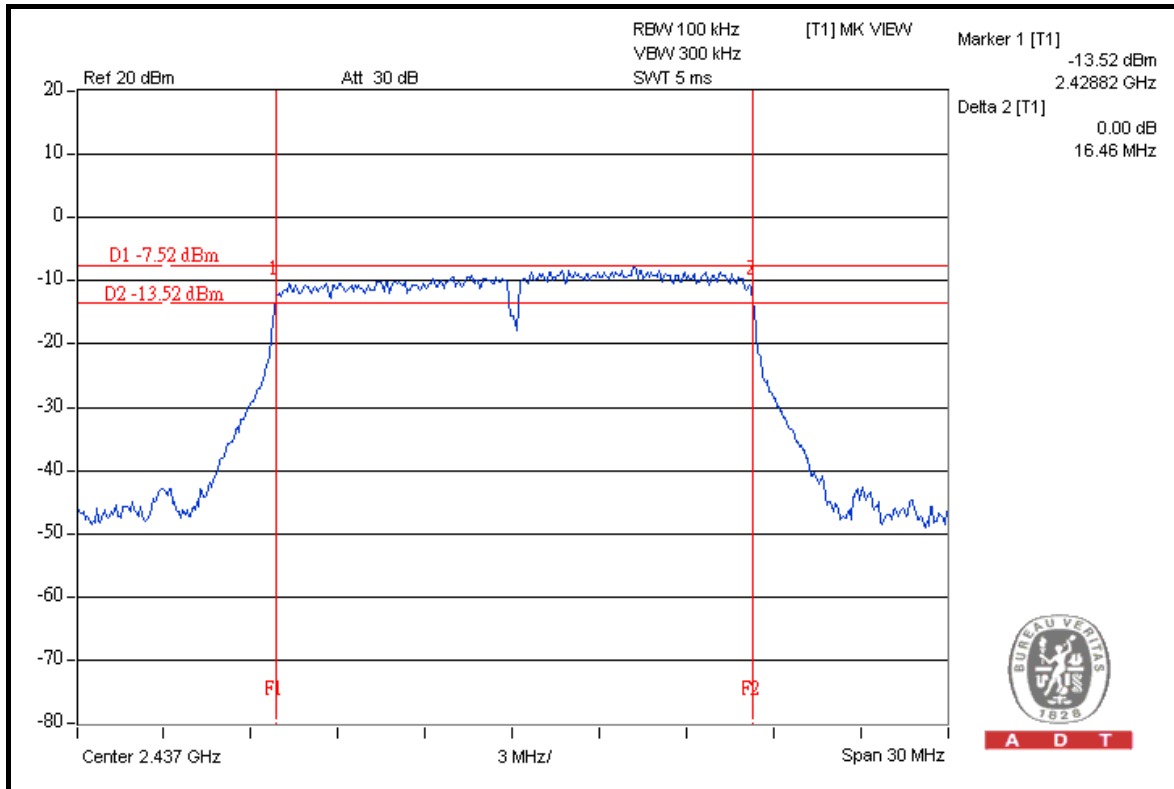

CH 11

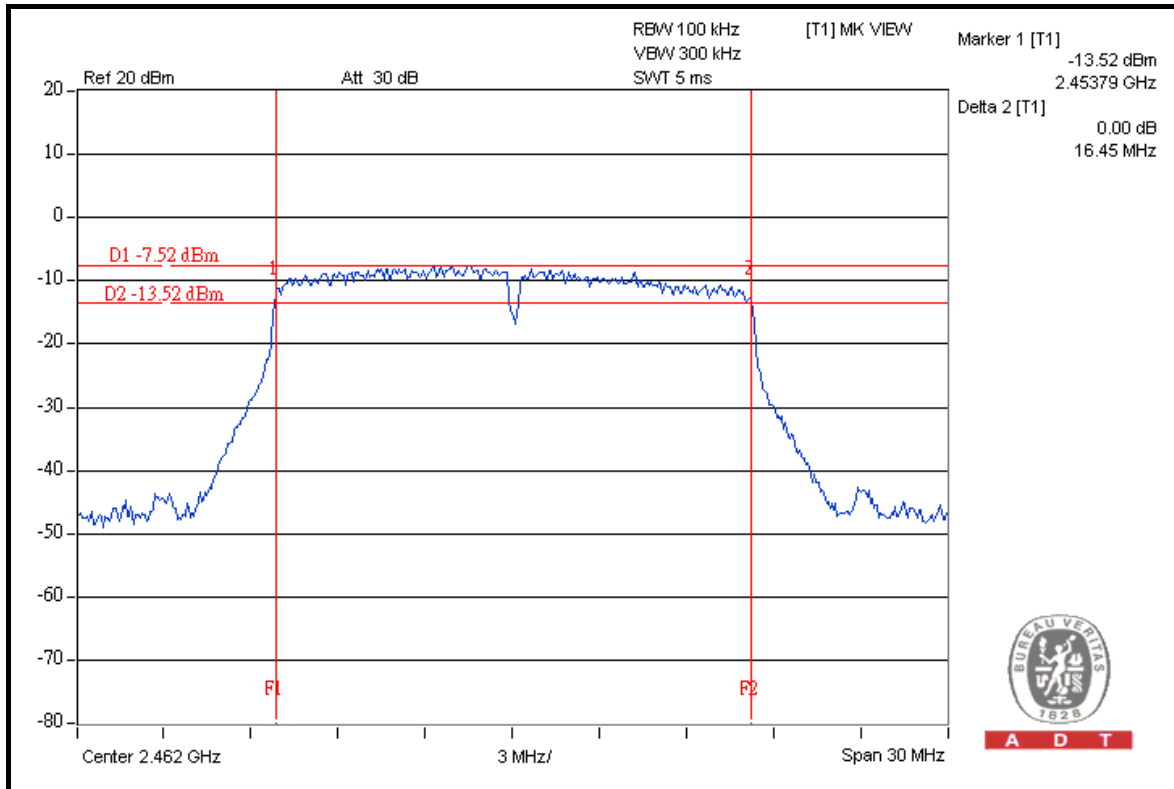



A D T

DRAFT 802.11n (20MHz) OFDM MODULATION

MODULATION TYPE	BPSK	TRANSFER RATE	6.5Mbps
INPUT POWER	120Vac, 60Hz	ENVIRONMENTAL CONDITIONS	23 deg.C, 70 %RH, 1009hPa
TESTED BY	Lori Chiu		

CHANNEL	CHANNEL FREQUENCY (MHz)	6dB BANDWIDTH (MHz)		MINIMUM LIMIT (MHz)	PASS / FAIL
		CHAIN 0	CHAIN 1		
1	2412	16.92	17.67	0.5	PASS
6	2437	17.68	17.66	0.5	PASS
11	2462	17.00	17.42	0.5	PASS



A D T

FOR CHAIN 0: CH 1

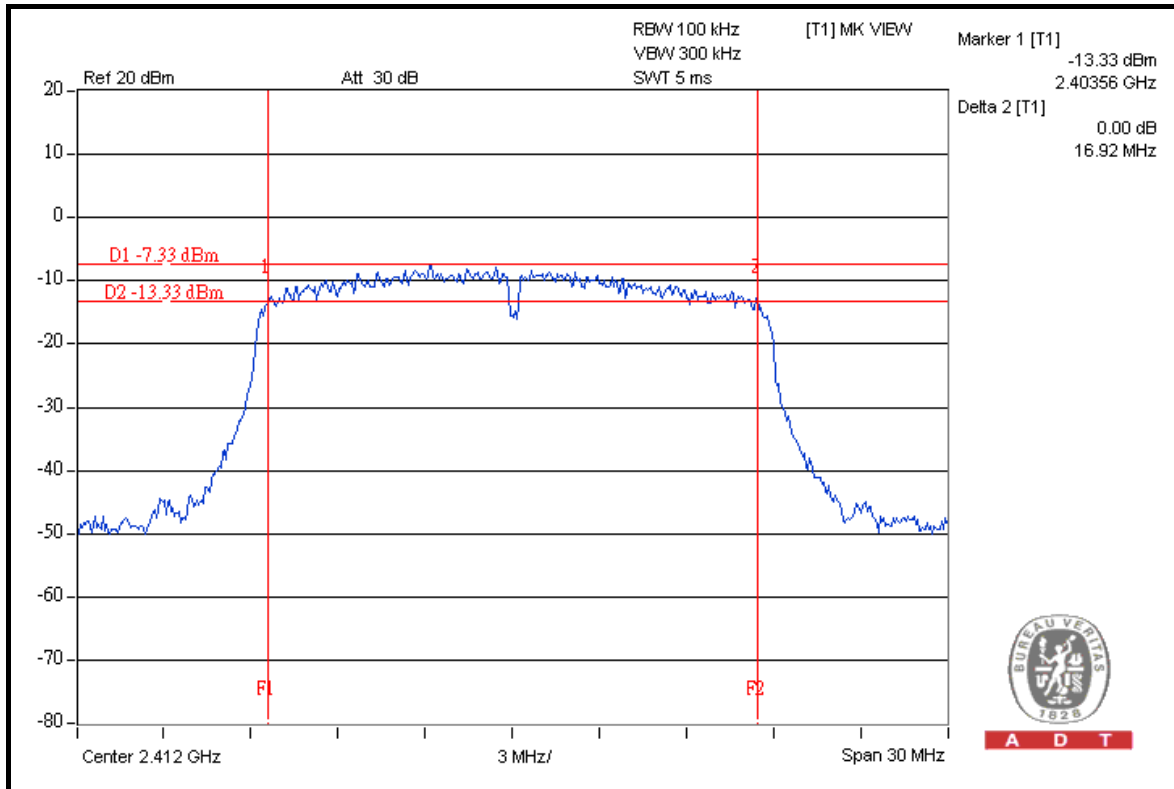

CH 6

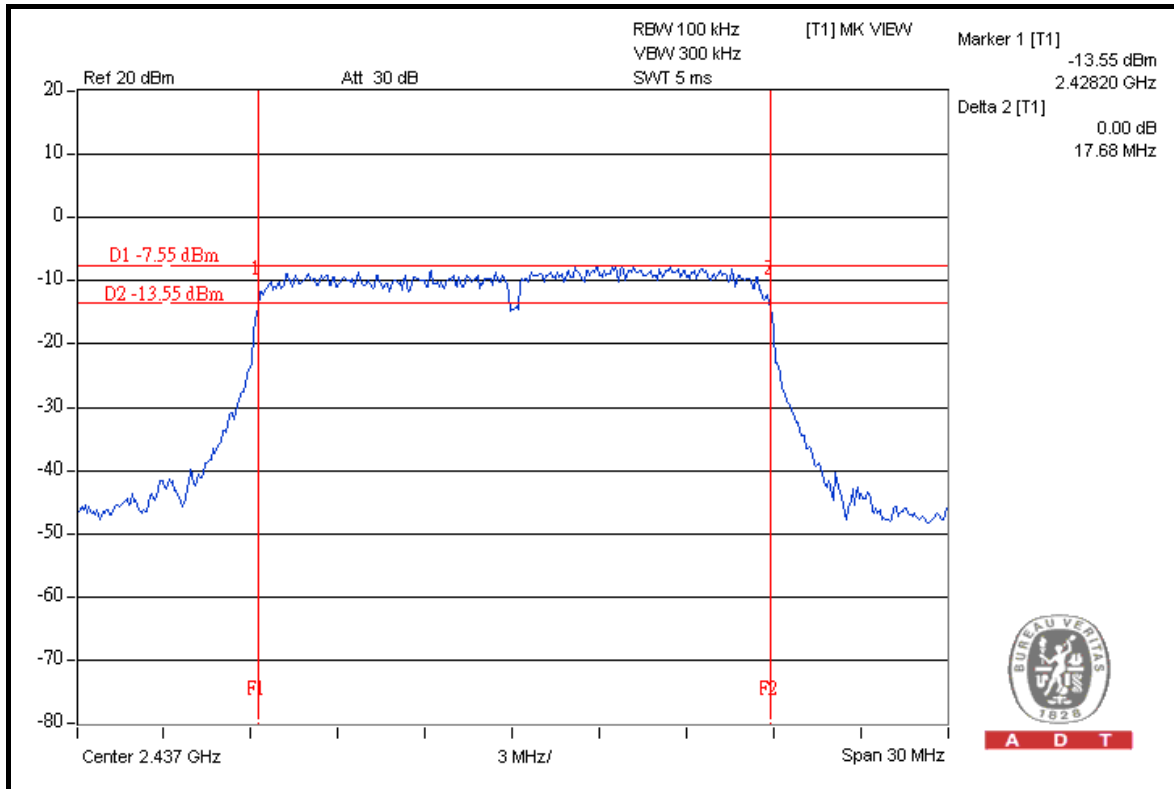



A D T

CH 11

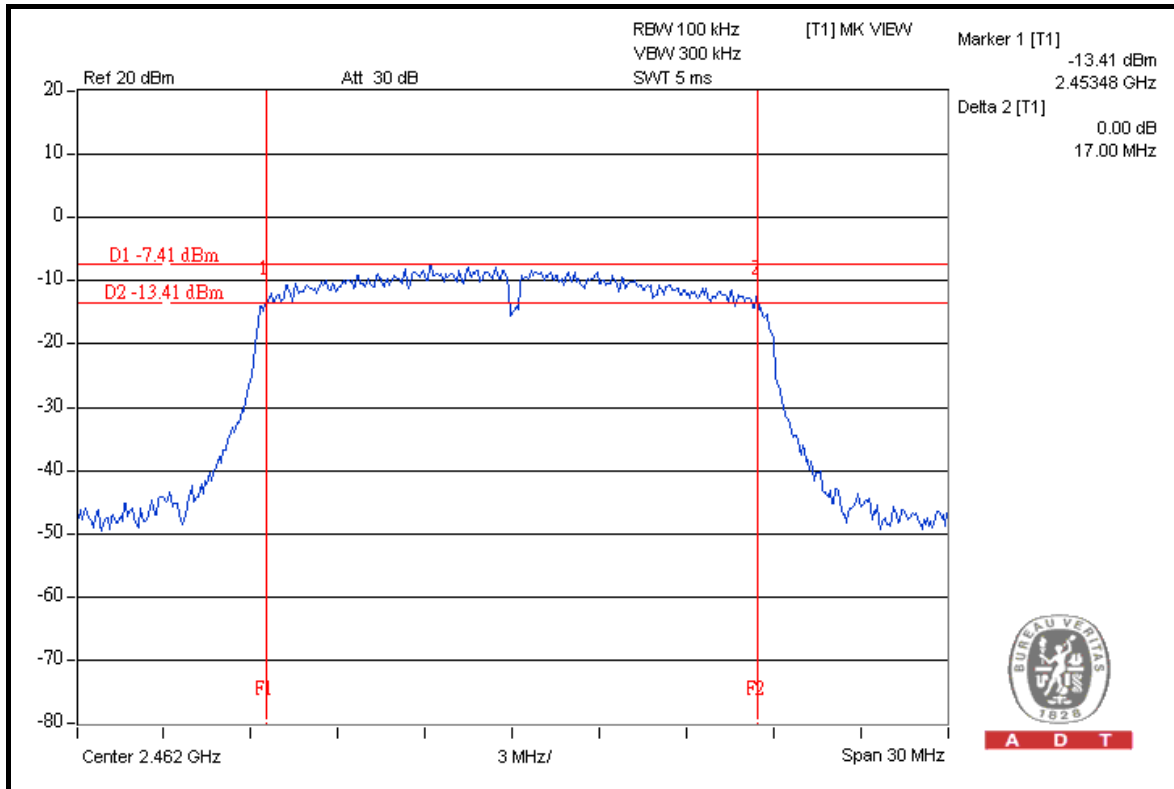

A D T

FOR CHAIN 1: CH 1

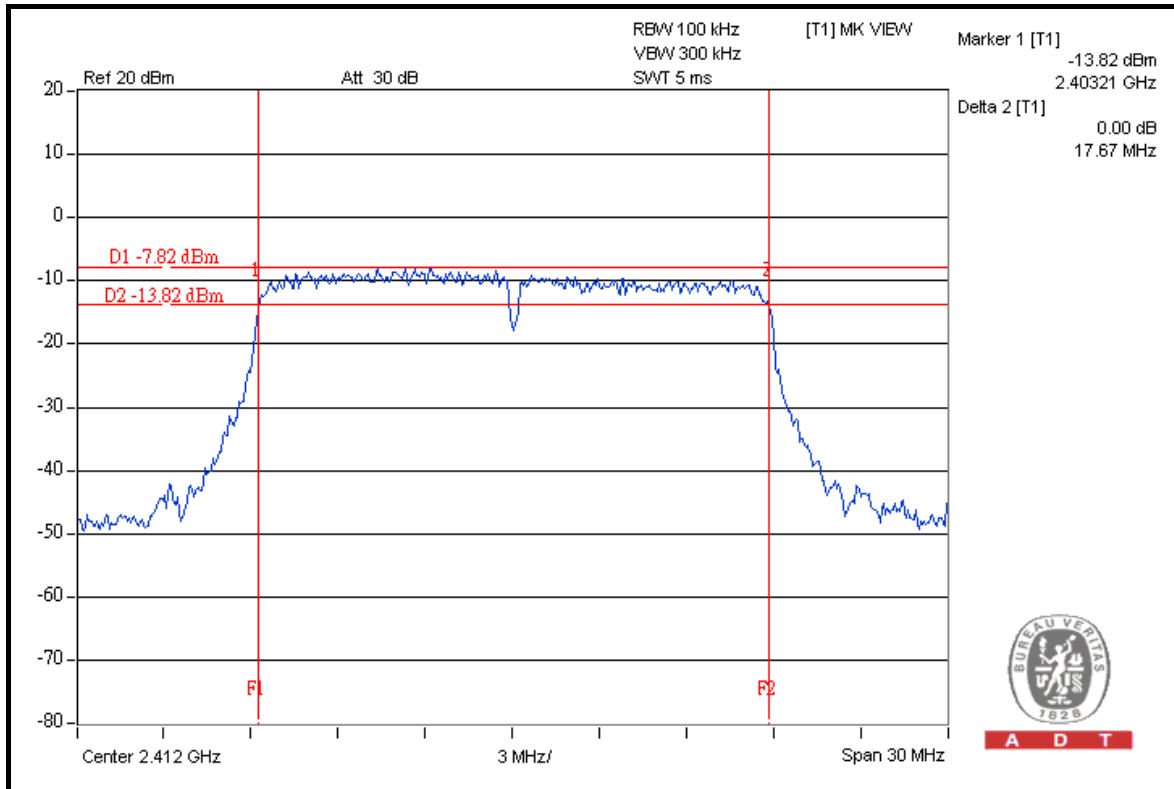

A D T



A D T

CH 6

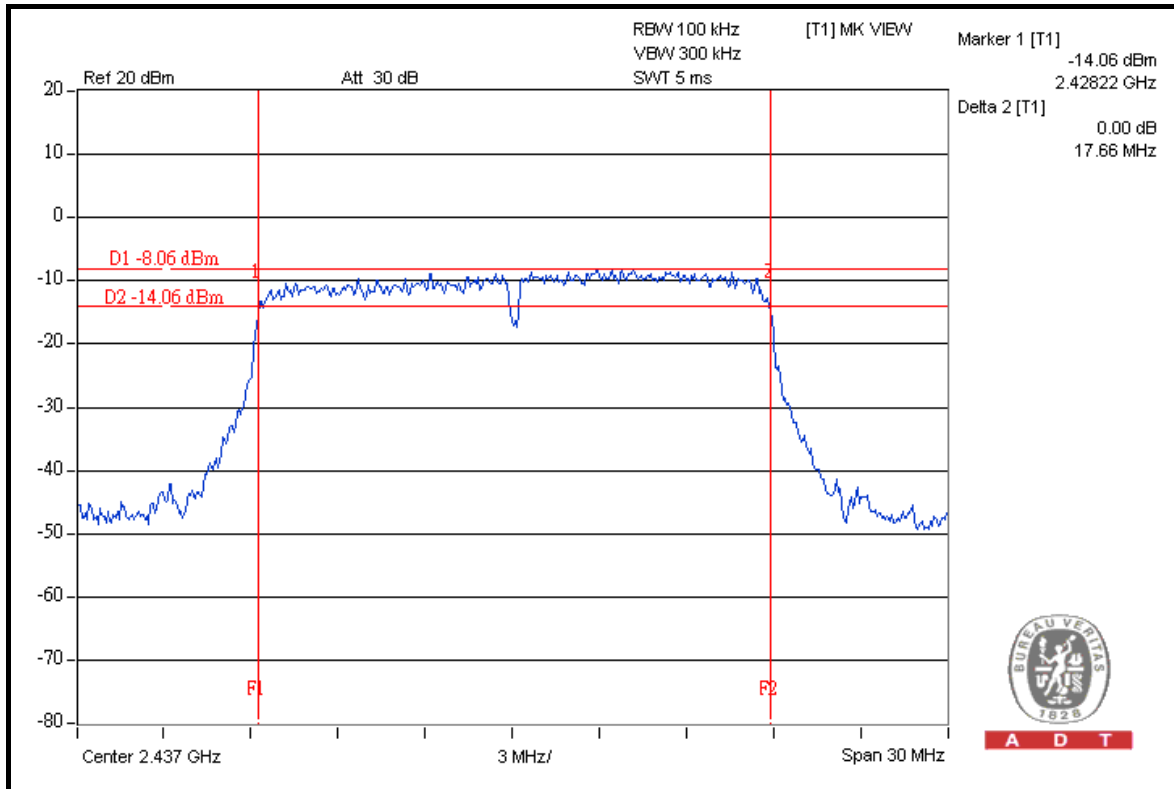

CH 11

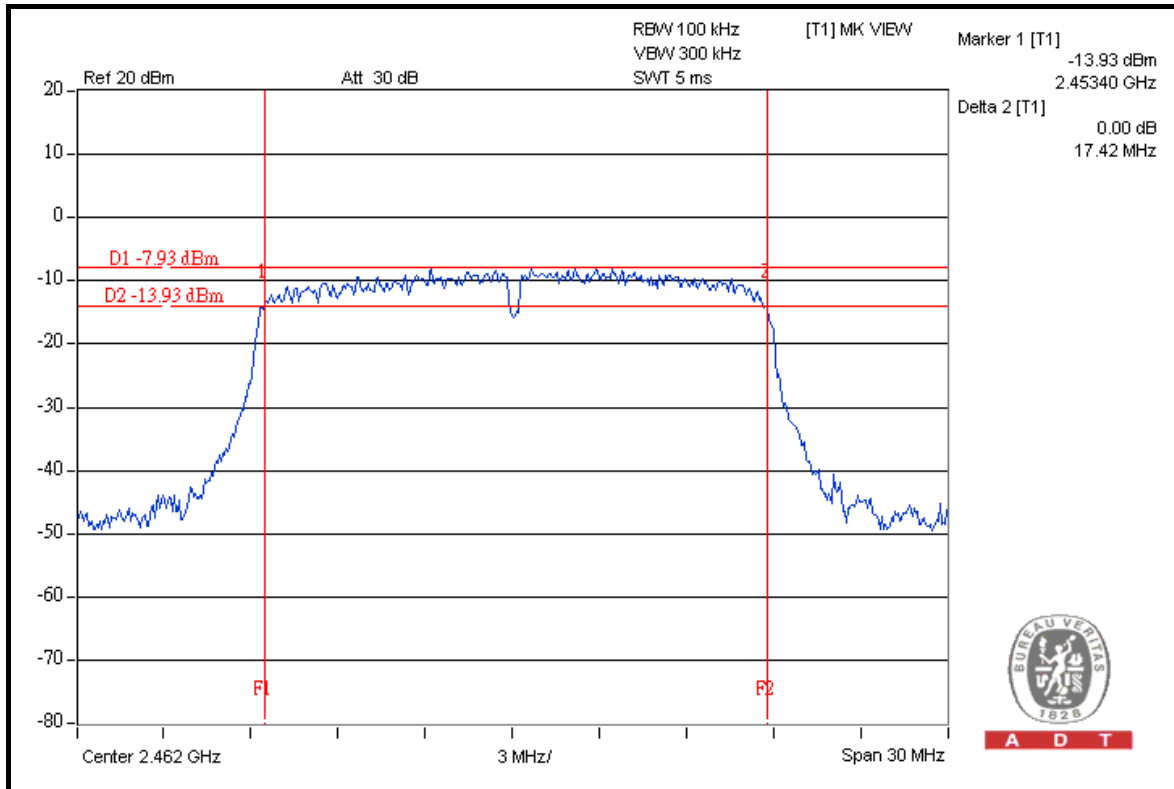



A D T

DRAFT 802.11n (40MHz) OFDM MODULATION

MODULATION TYPE	BPSK	TRANSFER RATE	13.5Mbps
INPUT POWER	120Vac, 60Hz	ENVIRONMENTAL CONDITIONS	23 deg.C, 70 %RH, 1009hPa
TESTED BY	Lori Chiu		

CHANNEL	CHANNEL FREQUENCY (MHz)	6dB BANDWIDTH (MHz)		MINIMUM LIMIT (MHz)	PASS / FAIL
		CHAIN 0	CHAIN 1		
1	2422	35.56	36.17	0.5	PASS
4	2437	36.29	36.25	0.5	PASS
7	2452	35.75	36.44	0.5	PASS



A D T

FOR CHAIN 0: CH 1

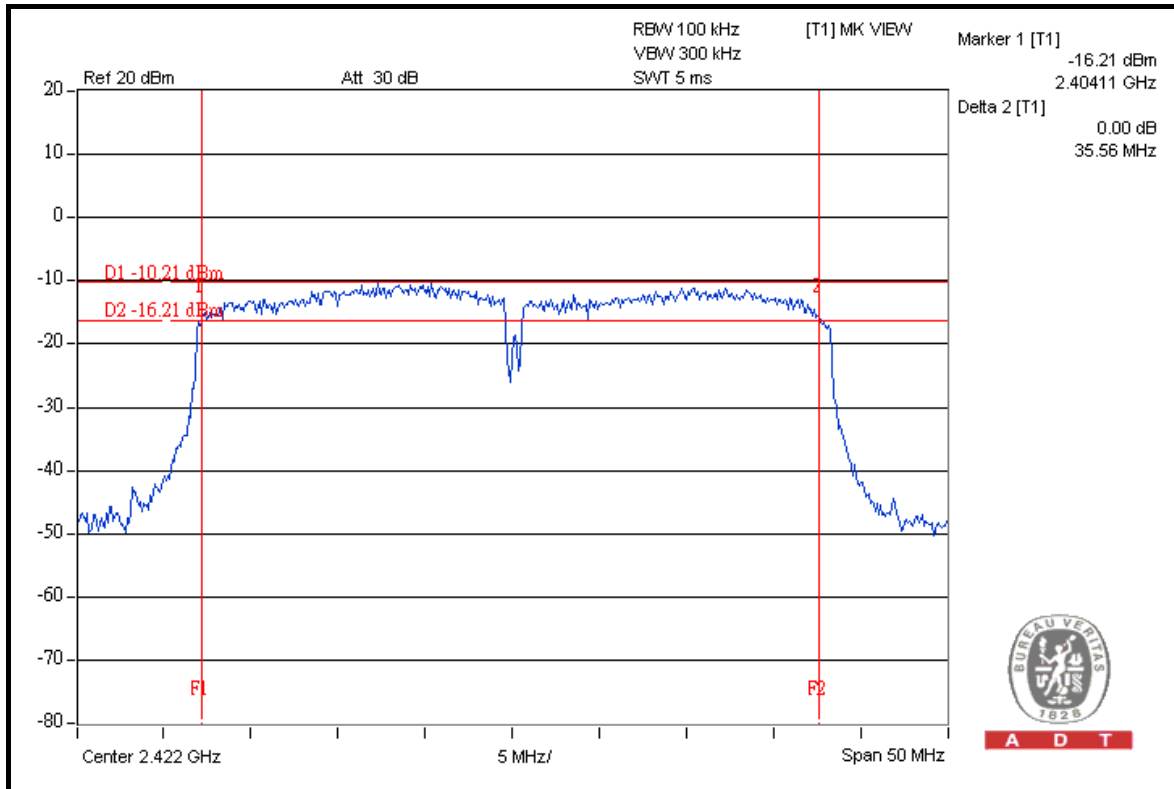

CH 4

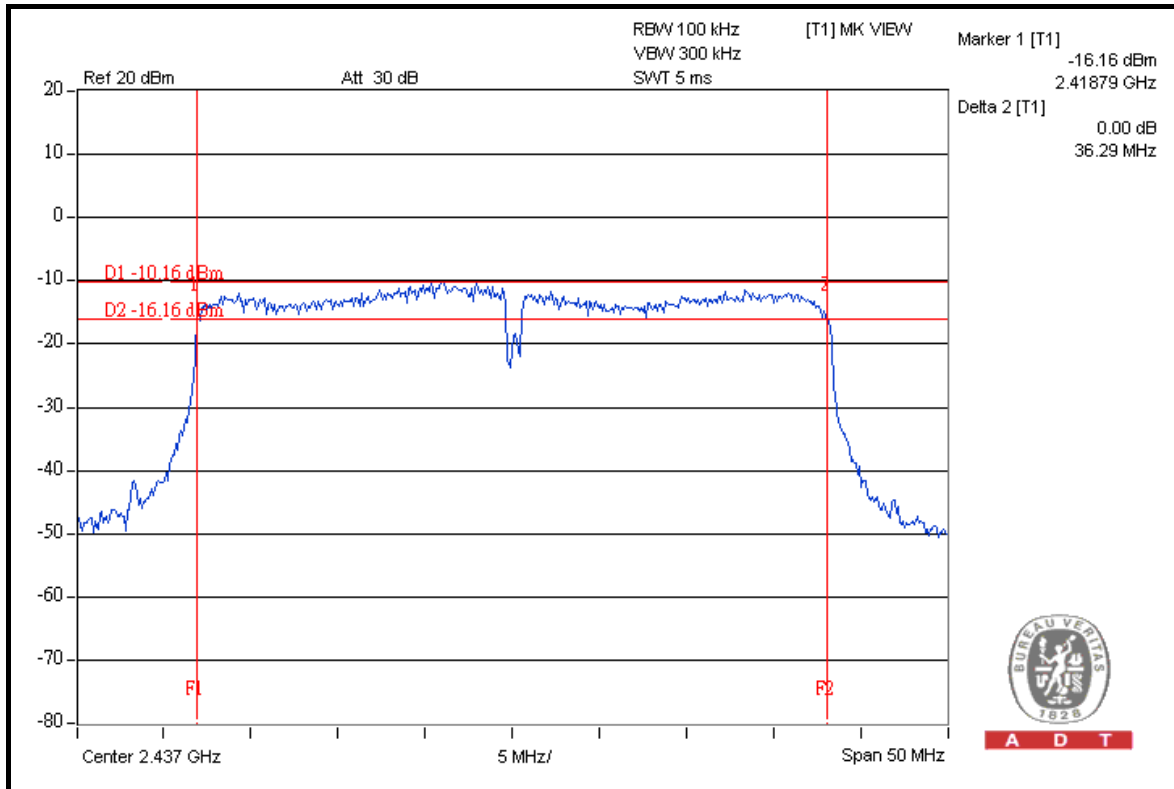



A D T

CH 7

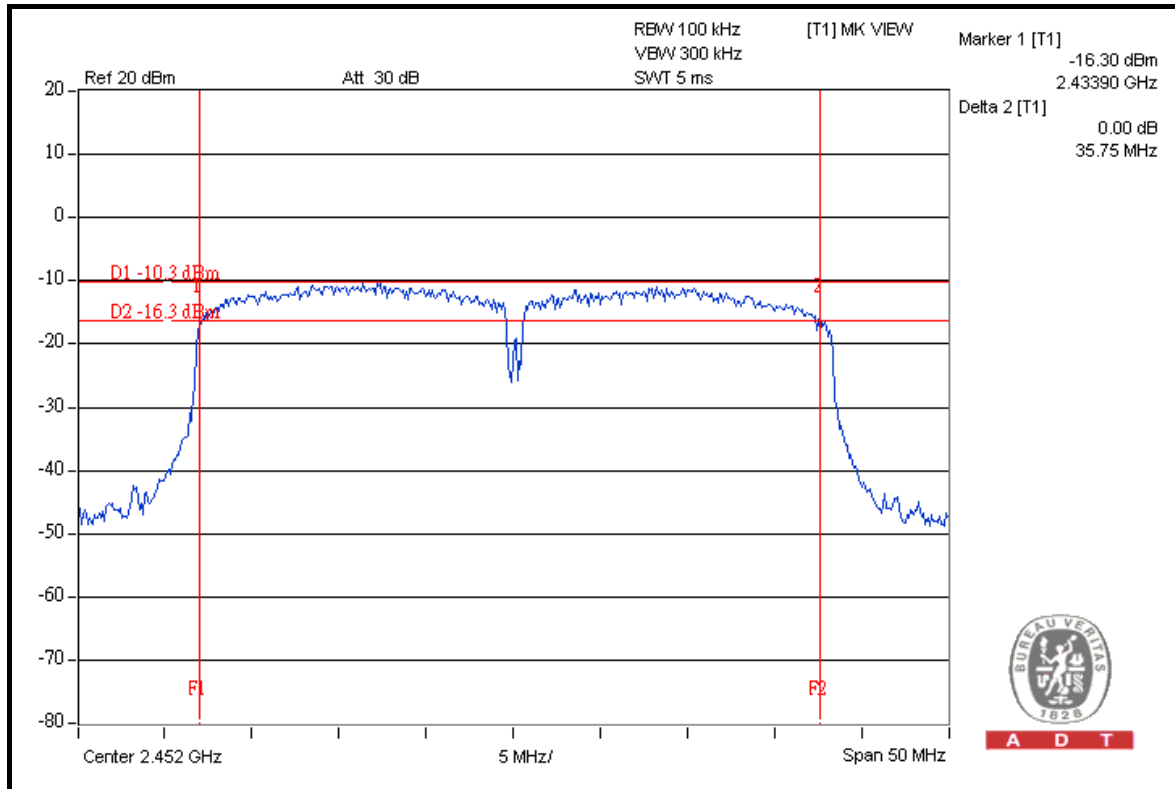

FOR CHAIN 1: CH 1

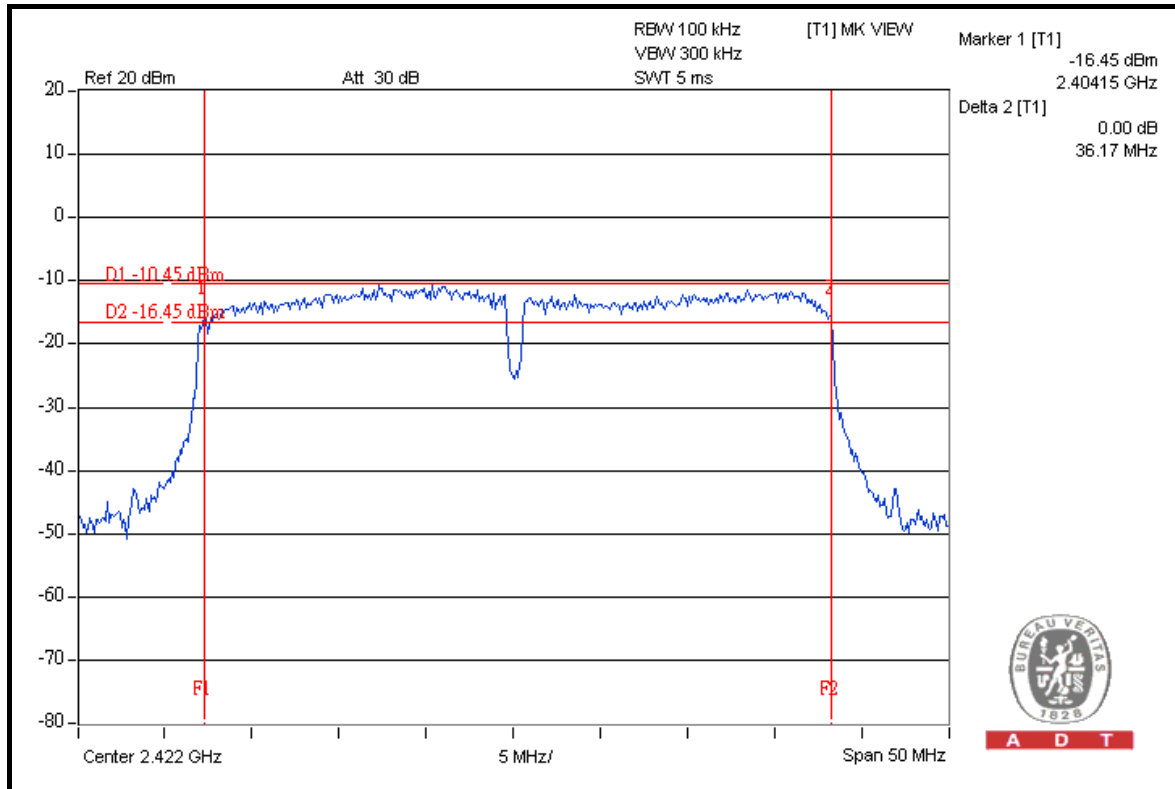



A D T

CH 4

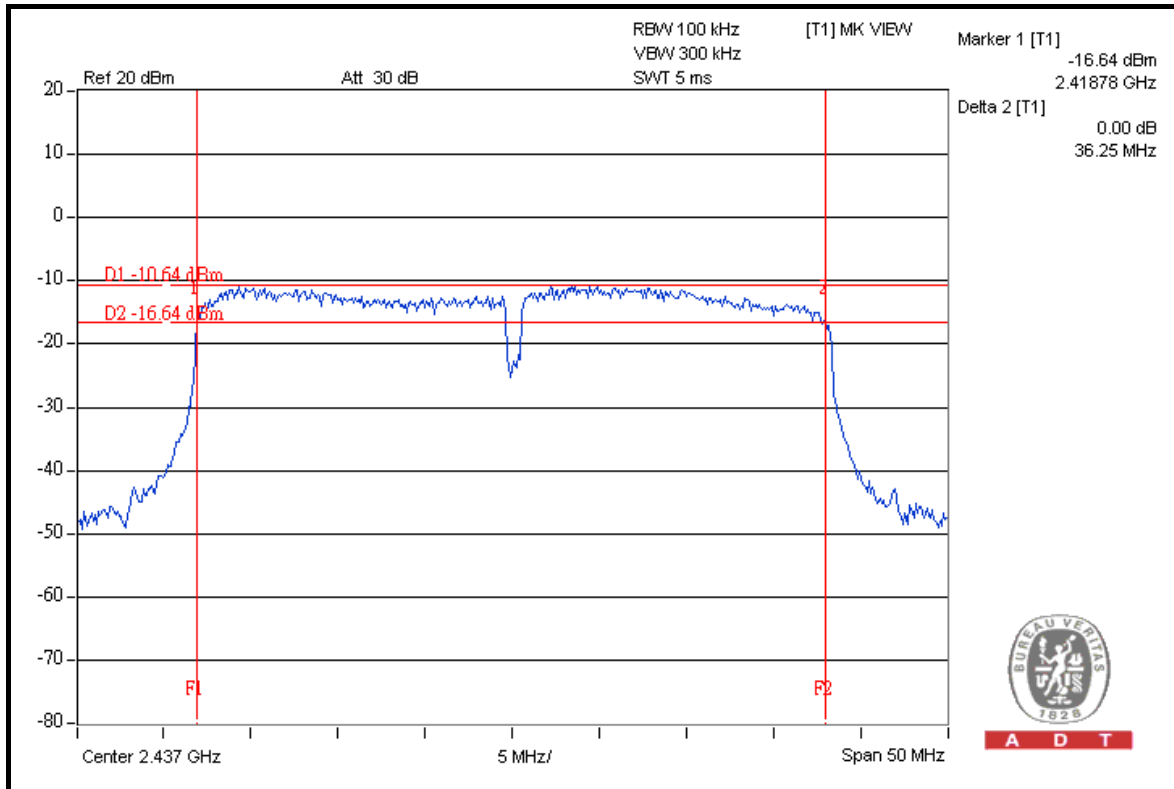

CH 7

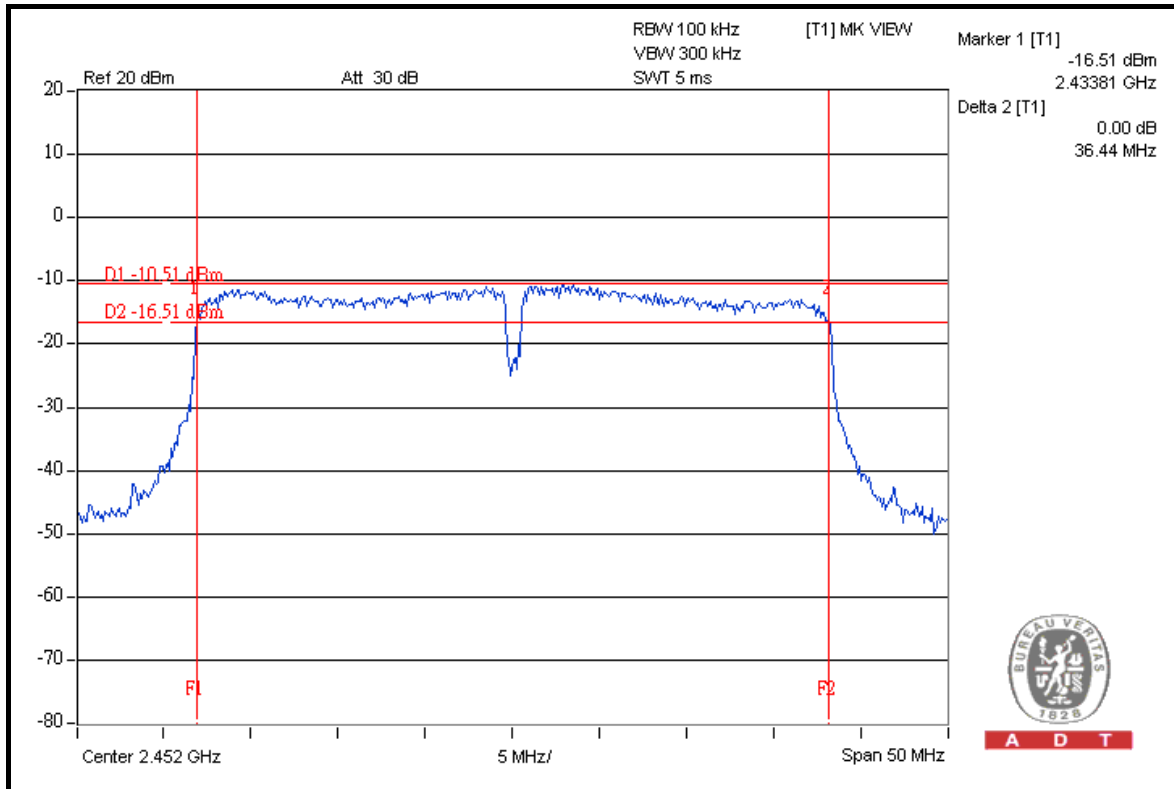



A D T

4.4 MAXIMUM PEAK OUTPUT POWER

4.4.1 LIMITS OF MAXIMUM PEAK OUTPUT POWER MEASUREMENT

The Maximum Peak Output Power Measurement is 30dBm.

4.4.2 INSTRUMENTS

DESCRIPTION & MANUFACTURER	MODEL NO.	SERIAL NO.	DATE OF CALIBRATION	DUE DATE OF CALIBRATION
High Speed Peak Power Meter	ML2495A	0824012	Aug. 04, 2008	Aug. 03, 2009
Power Sensor	MA2411B	0738138	Aug. 04, 2008	Aug. 03, 2009

NOTE:

1. The calibration interval of the above test instruments is 12 months and the calibrations are traceable to NML/ROC and NIST/USA.
2. Measurement Bandwidth of ML2495A is 65MHz greater than 6dB bandwidth of emission.

4.4.3 TEST PROCEDURES

A power sensor was used on the output port of the EUT. A power meter was used to read the response of the power sensor. Record the power level.

4.4.4 DEVIATION FROM TEST STANDARD

No deviation.

4.4.5 TEST SETUP

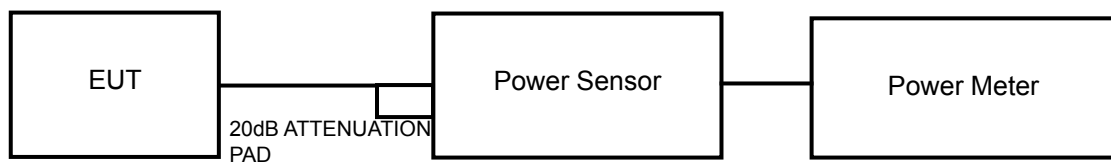

4.4.6 EUT OPERATING CONDITIONS

Same as Item 4.3.6.



A D T

4.4.7 TEST RESULTS

802.11b DSSS MODULATION

MODULATION TYPE	DBPSK	TRANSFER RATE	1.0Mbps
INPUT POWER	120Vac, 60Hz	ENVIRONMENTAL CONDITIONS	23 deg.C, 70 %RH, 1009hPa
TESTED BY	Lori Chiu		

CHAN.	CHAN. FREQ. (MHz)	PEAK POWER OUTPUT (dBm)		TOTAL PEAK POWER (mW)	TOTAL PEAK POWER (dBm)	PEAK POWER LIMIT (dBm)	PASS / FAIL
		CHAIN 0	CHAIN 1				
1	2412	10.02	9.84	19.684	12.94	30	PASS
6	2437	10.03	9.81	19.641	12.93	30	PASS
11	2462	10.01	9.87	19.728	12.95	30	PASS

802.11g OFDM MODULATION

MODULATION TYPE	BPSK	TRANSFER RATE	6.0Mbps
INPUT POWER	120Vac, 60Hz	ENVIRONMENTAL CONDITIONS	23 deg.C, 70 %RH, 1009hPa
TESTED BY	Lori Chiu		

CHAN.	CHAN. FREQ. (MHz)	PEAK POWER OUTPUT (dBm)		TOTAL PEAK POWER (mW)	TOTAL PEAK POWER (dBm)	PEAK POWER LIMIT (dBm)	PASS / FAIL
		CHAIN 0	CHAIN 1				
1	2412	10.02	9.83	19.662	12.94	30	PASS
6	2437	10.04	9.80	19.642	12.93	30	PASS
11	2462	10.05	9.84	19.754	12.96	30	PASS



A D T

DRAFT 802.11n (20MHz) OFDM MODULATION

MODULATION TYPE	BPSK	TRANSFER RATE	6.5Mbps
INPUT POWER	120Vac, 60Hz	ENVIRONMENTAL CONDITIONS	23 deg.C, 70 %RH, 1009hPa
TESTED BY	Lori Chiu		

CHAN.	CHAN. FREQ. (MHz)	PEAK POWER OUTPUT (dBm)		TOTAL PEAK POWER (mW)	TOTAL PEAK POWER (dBm)	PEAK POWER LIMIT (dBm)	PASS / FAIL
		CHAIN 0	CHAIN 1				
1	2412	10.05	9.84	19.754	12.96	30	PASS
6	2437	10.03	9.82	19.663	12.94	30	PASS
11	2462	10.01	9.83	19.639	12.93	30	PASS

DRAFT 802.11n (40MHz) OFDM MODULATION

MODULATION TYPE	BPSK	TRANSFER RATE	13.5Mbps
INPUT POWER	120Vac, 60Hz	ENVIRONMENTAL CONDITIONS	23 deg.C, 70 %RH, 1009hPa
TESTED BY	Lori Chiu		

CHAN.	CHAN. FREQ. (MHz)	PEAK POWER OUTPUT (dBm)		TOTAL PEAK POWER (mW)	TOTAL PEAK POWER (dBm)	PEAK POWER LIMIT (dBm)	PASS / FAIL
		CHAIN 0	CHAIN 1				
1	2422	9.91	9.9	19.658	12.9	30	PASS
4	2437	9.93	9.92	19.658	12.94	30	PASS
7	2452	9.90	9.91	19.567	12.92	30	PASS

4.5 POWER SPECTRAL DENSITY MEASUREMENT

4.5.1 LIMITS OF POWER SPECTRAL DENSITY MEASUREMENT

The Maximum of Power Spectral Density Measurement is 8dBm.

4.5.2 TEST INSTRUMENTS

DESCRIPTION & MANUFACTURER	MODEL NO.	SERIAL NO.	DATE OF CALIBRATION	DUE DATE OF CALIBRATION
R&S SPECTRUM ANALYZER	FSP40	100040	Jul. 04, 2008	Jul. 03, 2009

NOTE: The calibration interval of the above test instruments is 12 months and the calibrations are traceable to NML/ROC and NIST/USA.

4.5.3 TEST PROCEDURE

The transmitter output was connected to the spectrum analyzer through an attenuator, the bandwidth of the fundamental frequency was measured with the spectrum analyzer using 3kHz RBW and 30kHz VBW, set sweep time = span/3kHz. The power spectral density was measured and recorded.

The sweep time is allowed to be longer than span/3kHz for a full response of the mixer in the spectrum analyzer.

4.5.4 DEVIATION FROM TEST STANDARD

No deviation.

4.5.5 TEST SETUP

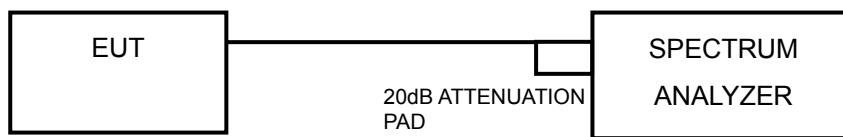

4.5.6 EUT OPERATING CONDITION

Same as Item 4.3.6



A D T

4.5.7 TEST RESULTS

802.11b DSSS MODULATION

MODULATION TYPE	DBPSK	TRANSFER RATE	1.0Mbps
INPUT POWER	120Vac, 60Hz	ENVIRONMENTAL CONDITIONS	23 deg.C, 70 %RH, 1009hPa
TESTED BY	Lori Chiu		

CHAN.	CHAN. FREQ. (MHz)	RF POWER LEVEL IN 3kHz BW (dBm)		TOTAL POWER DENSITY (mW)	TOTAL POWER DENSITY (dBm)	MAX. LIMIT (dBm)	PASS / FAIL
		CHAIN 0	CHAIN 1				
1	2412	-23.48	-21.30	0.012	-19.24	8	PASS
6	2437	-23.24	-21.37	0.012	-19.19	8	PASS
11	2462	-23.39	-21.27	0.012	-19.19	8	PASS



A D T

FOR CHAIN 0: CH 1

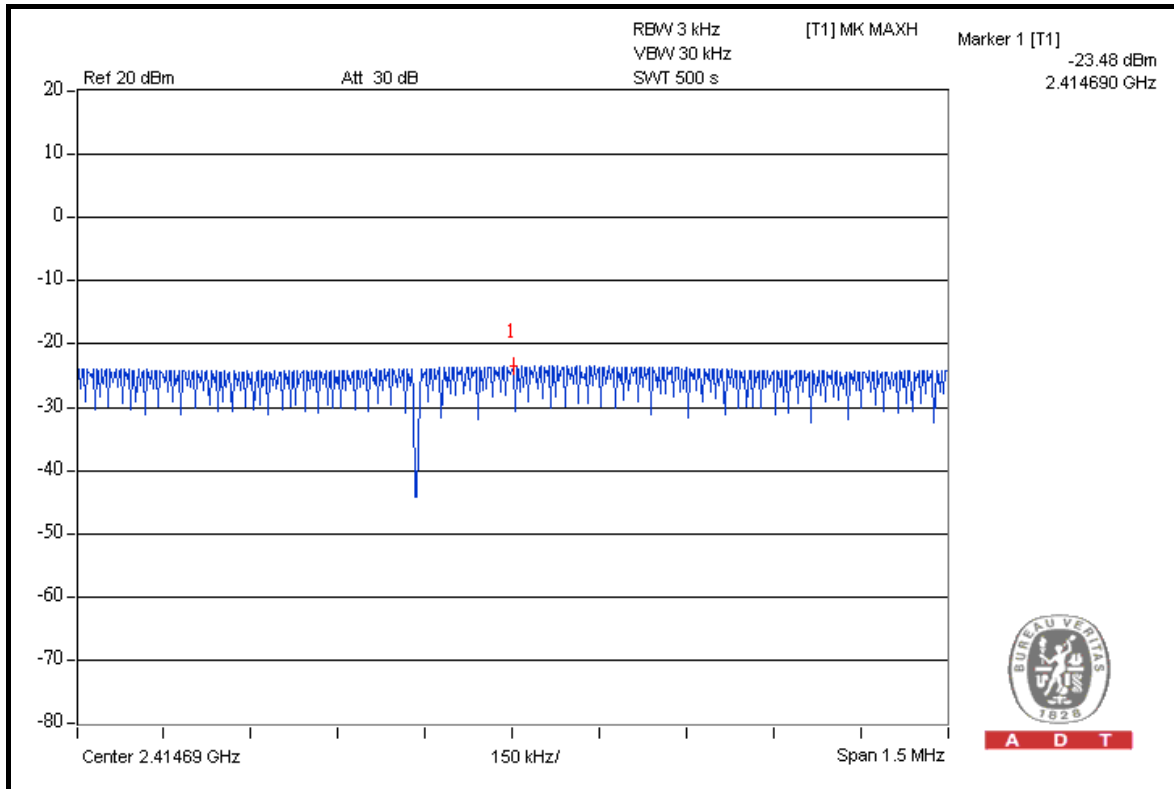

A D T

CH 6

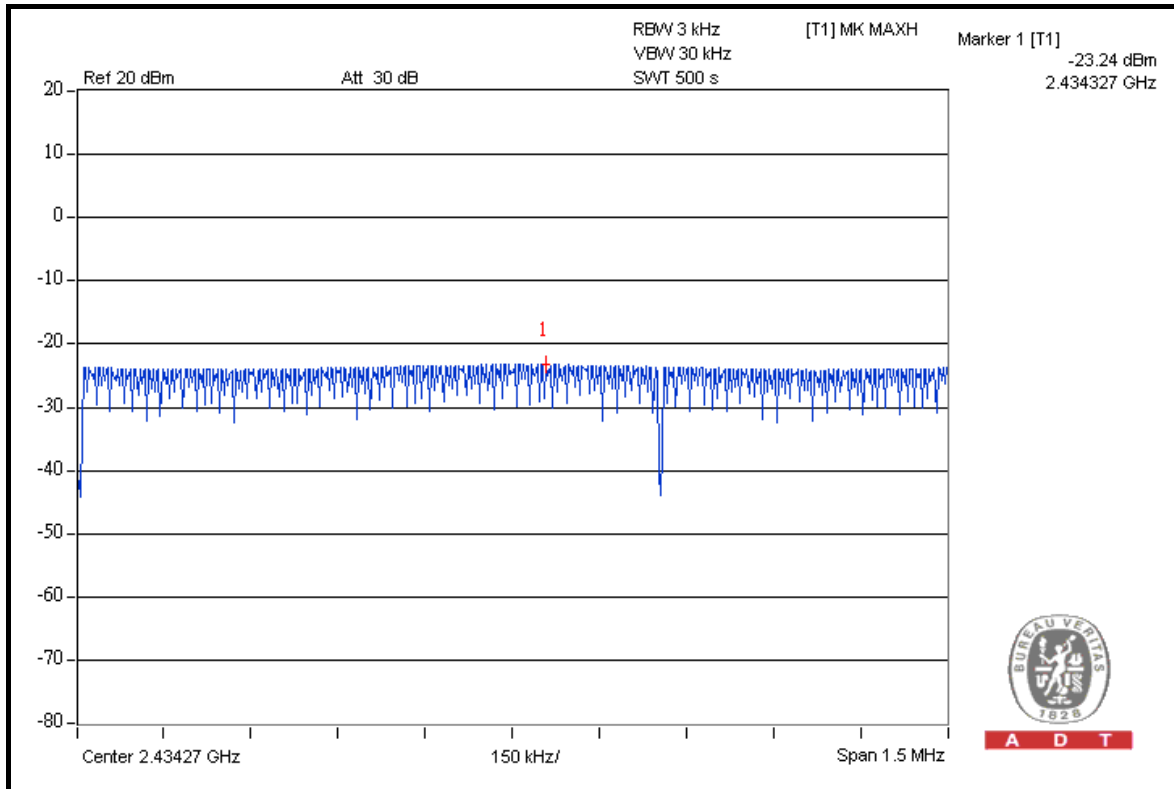

A D T



A D T

CH 11

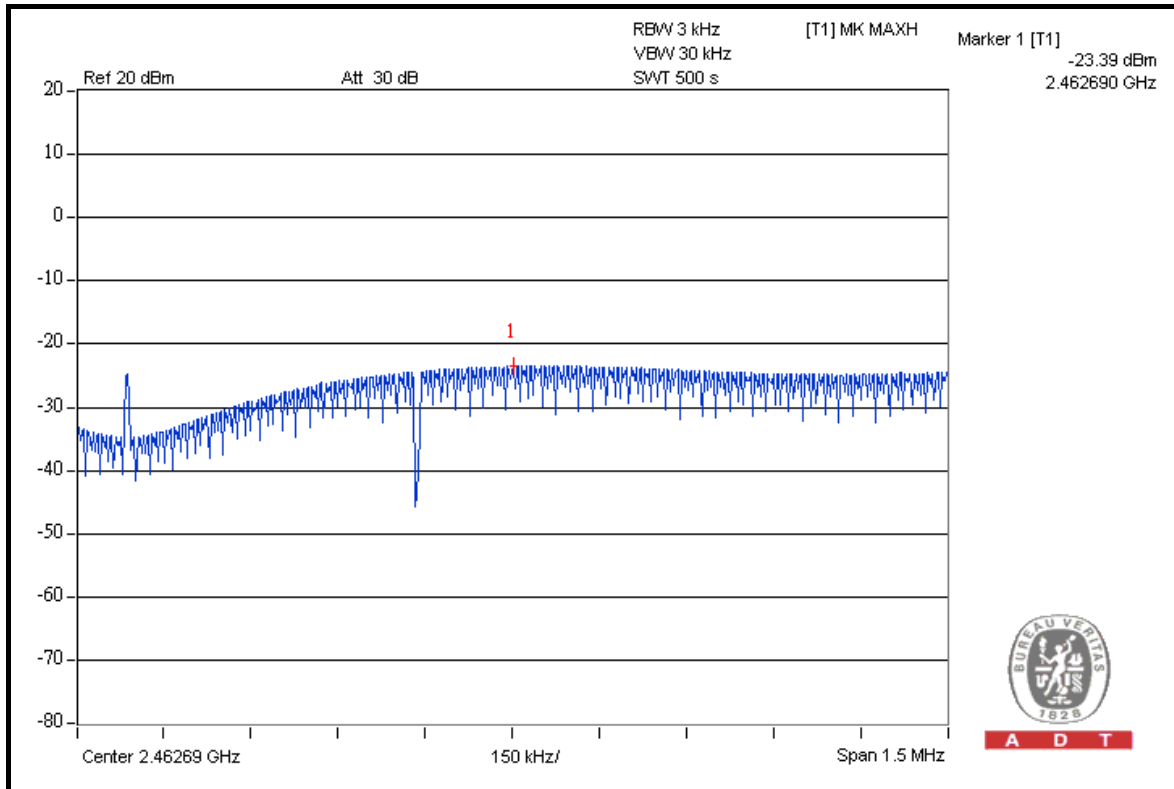

FOR CHAIN 1: CH 1

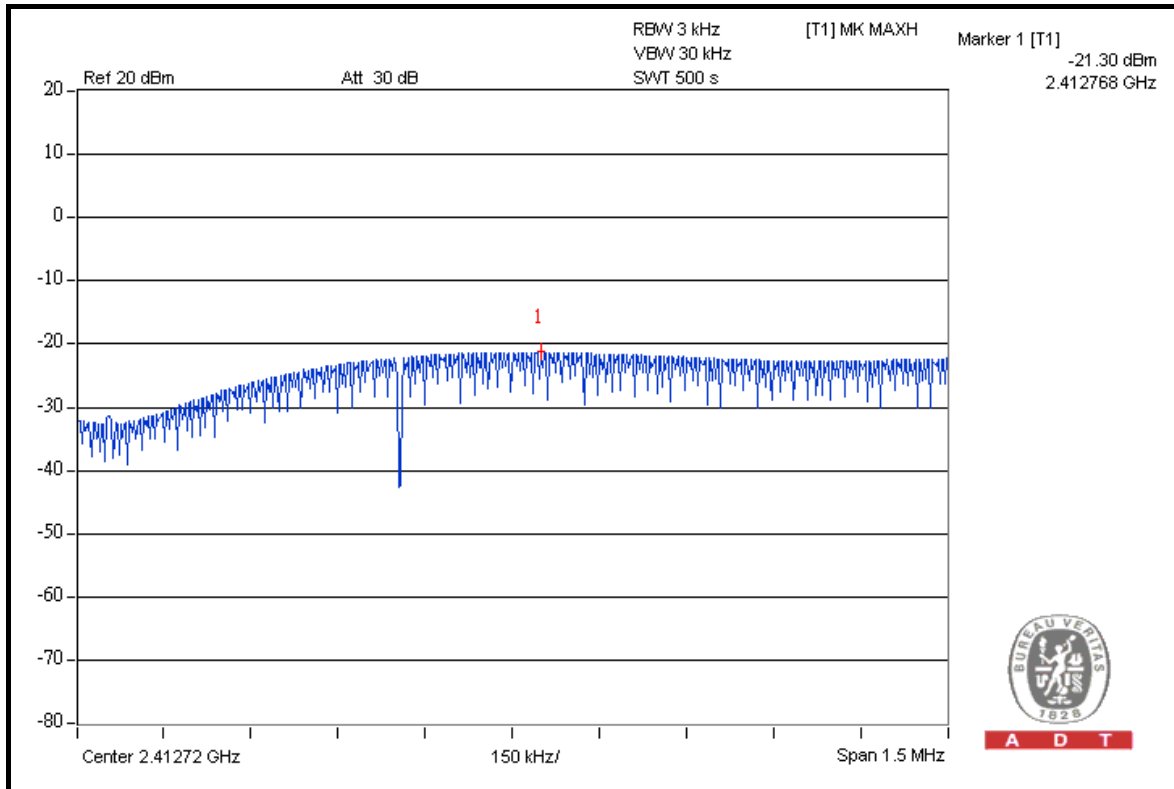



A D T

CH 6

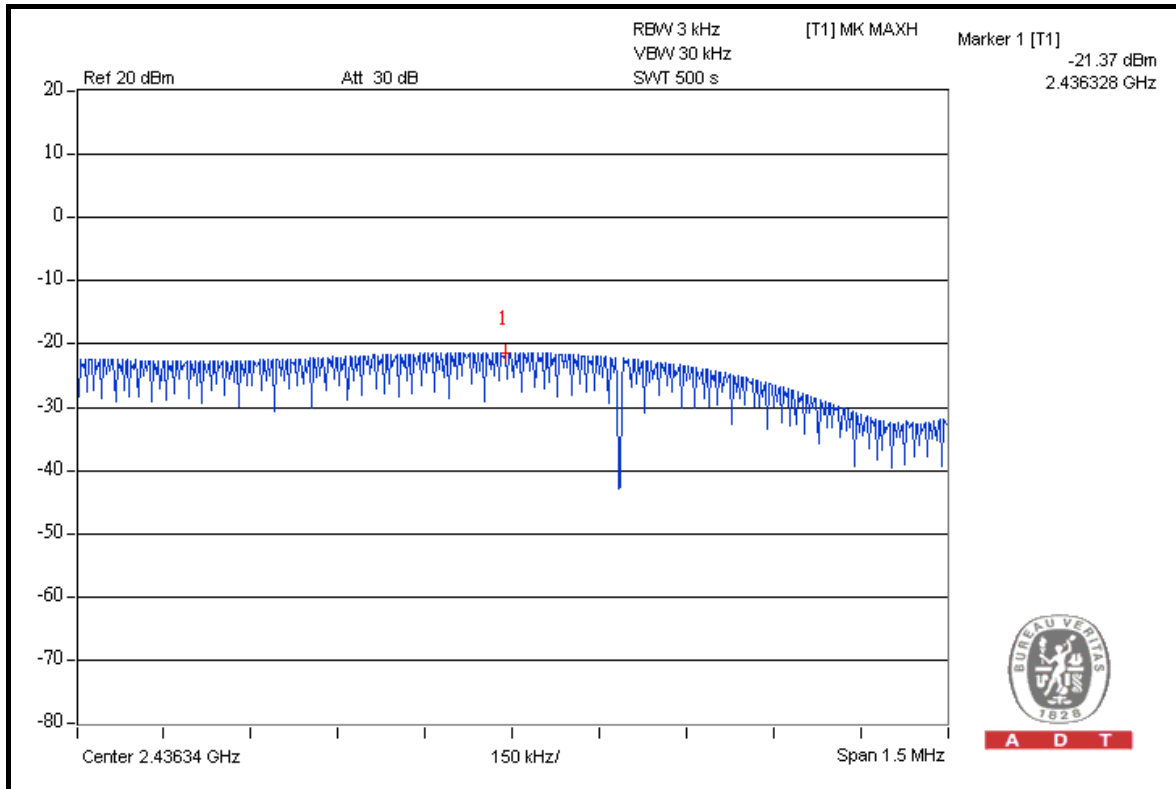

CH 11

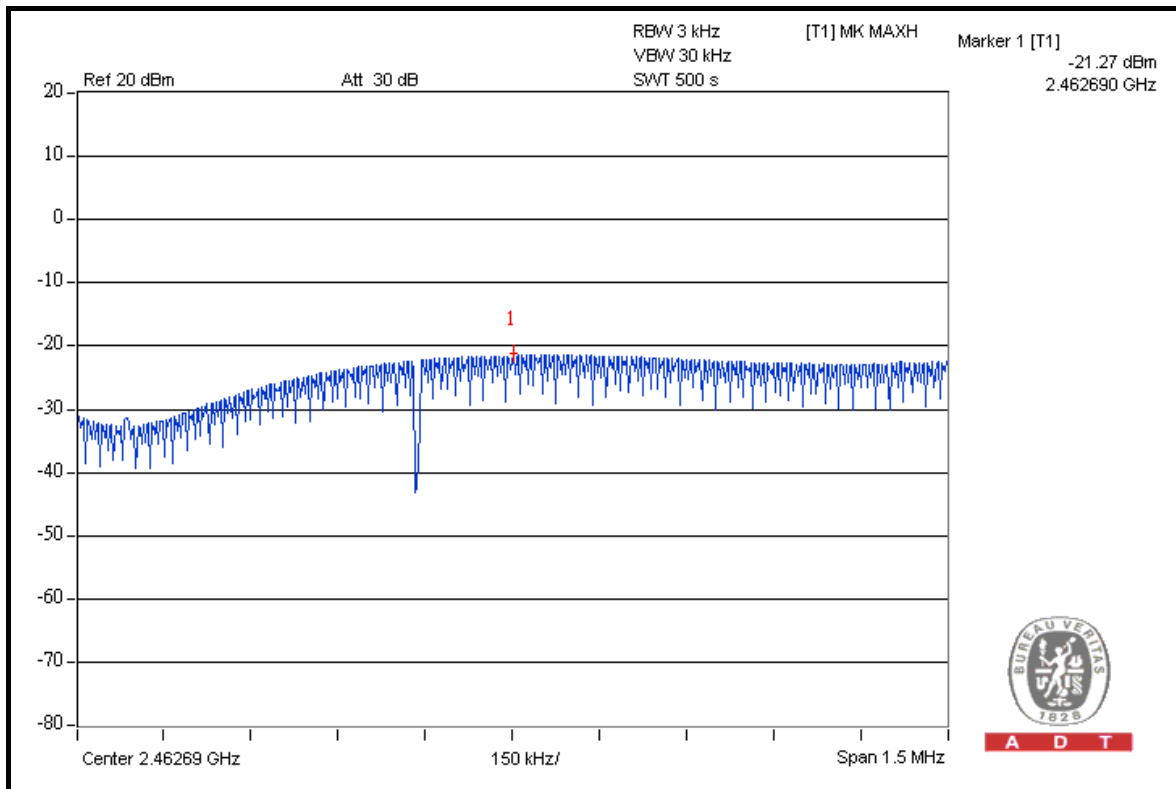



A D T

802.11g OFDM MODULATION

MODULATION TYPE	BPSK	TRANSFER RATE	6.0Mbps
INPUT POWER	120Vac, 60Hz	ENVIRONMENTAL CONDITIONS	23 deg.C, 70 %RH, 1009hPa
TESTED BY	Lori Chiu		

CHAN.	CHAN. FREQ. (MHz)	RF POWER LEVEL IN 3kHz BW (dBm)		TOTAL POWER DENSITY (mW)	TOTAL POWER DENSITY (dBm)	MAX. LIMIT (dBm)	PASS / FAIL
		CHAIN 0	CHAIN 1				
1	2412	-22.48	-21.76	0.012	-19.09	8	PASS
6	2437	-22.31	-21.58	0.013	-18.92	8	PASS
11	2462	-22.21	-21.92	0.012	-19.05	8	PASS



A D T

FOR CHAIN 0: CH 1

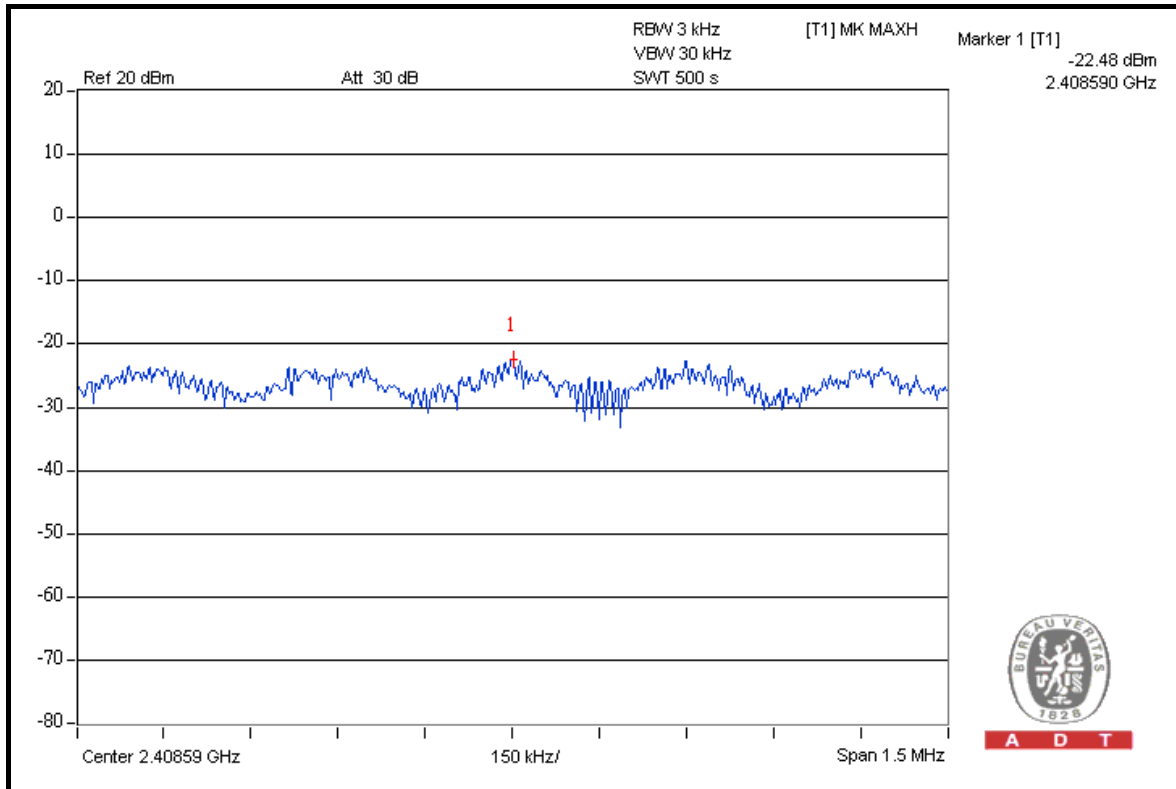

CH 6

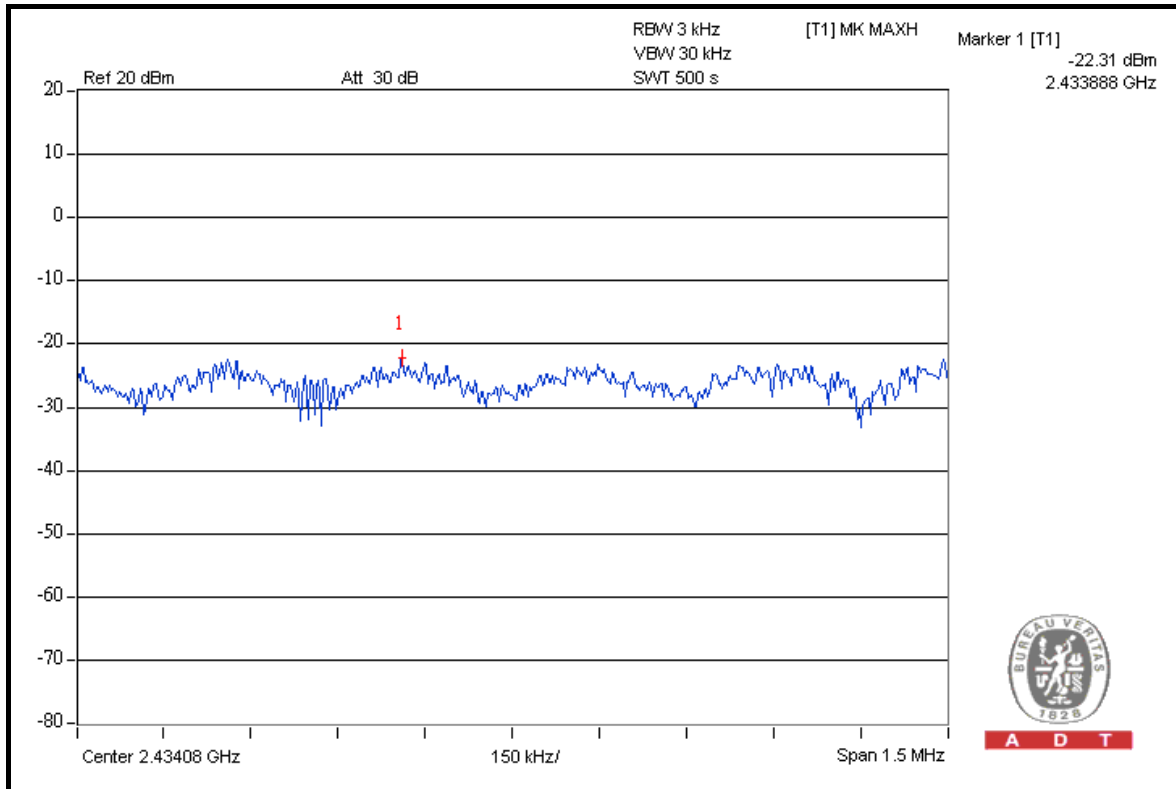



A D T

CH 11

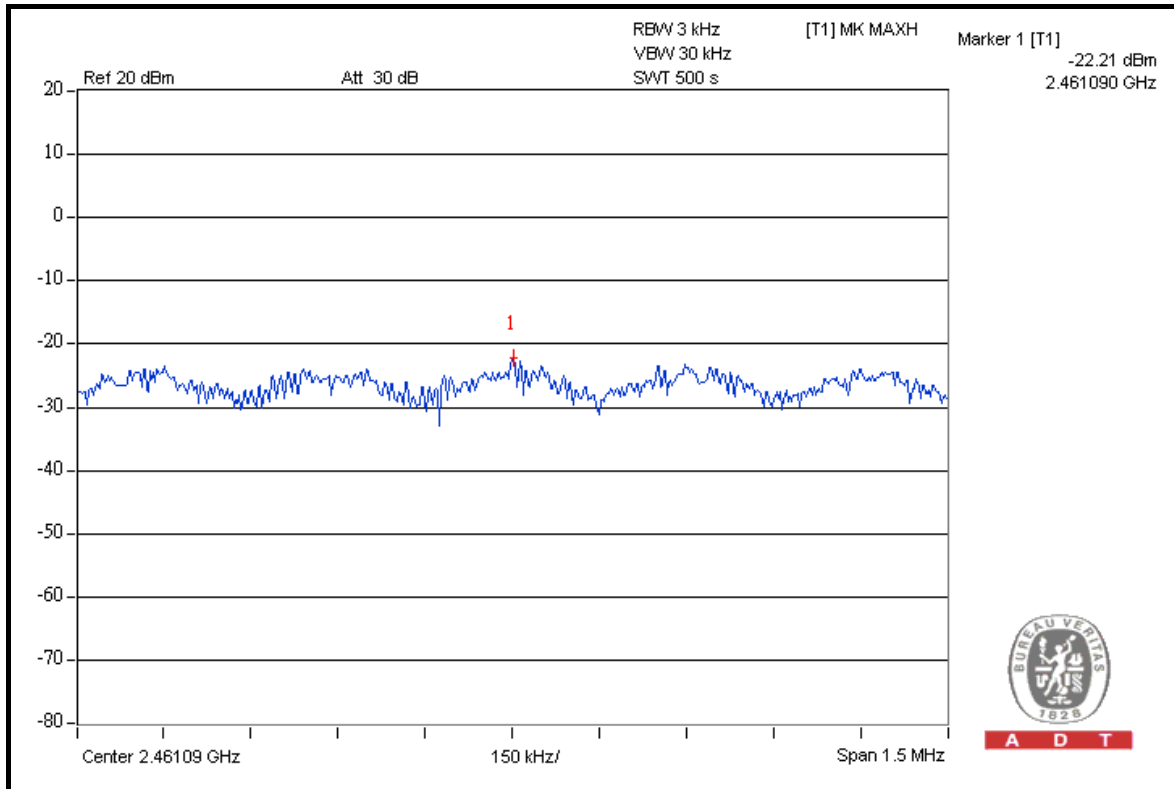

FOR CHAIN 1: CH 1

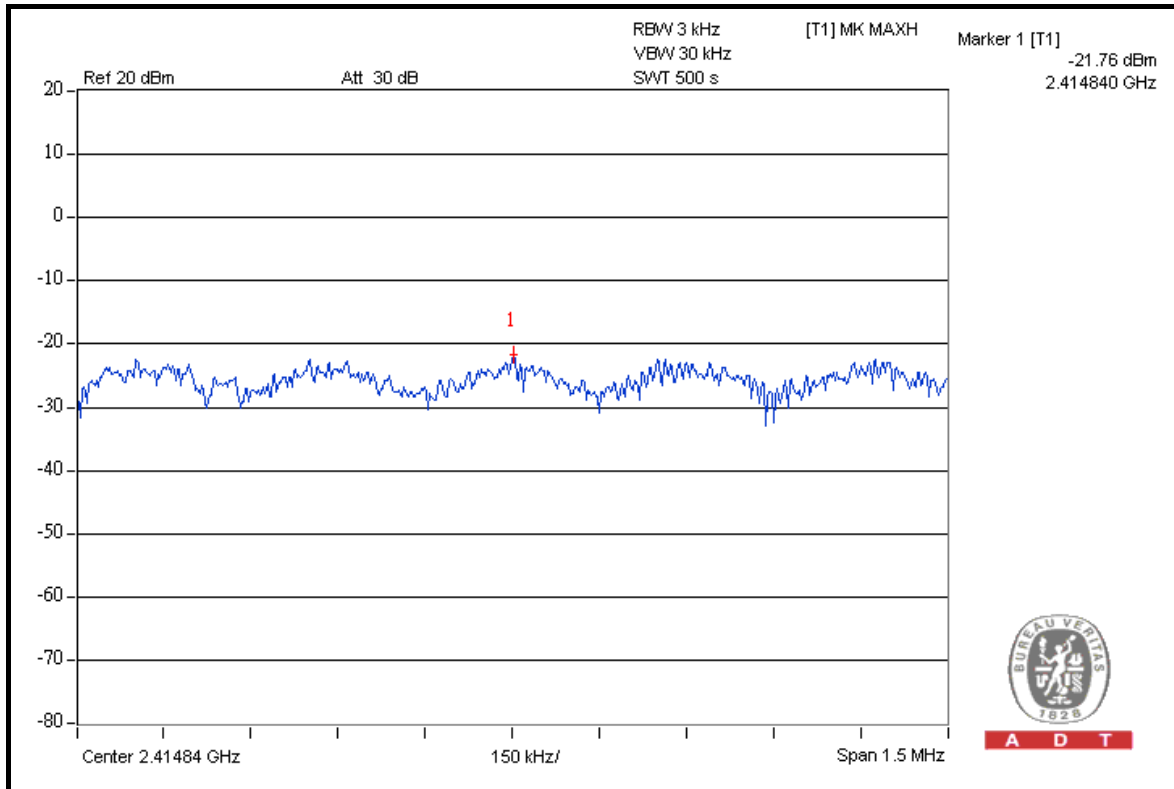



A D T

CH 6

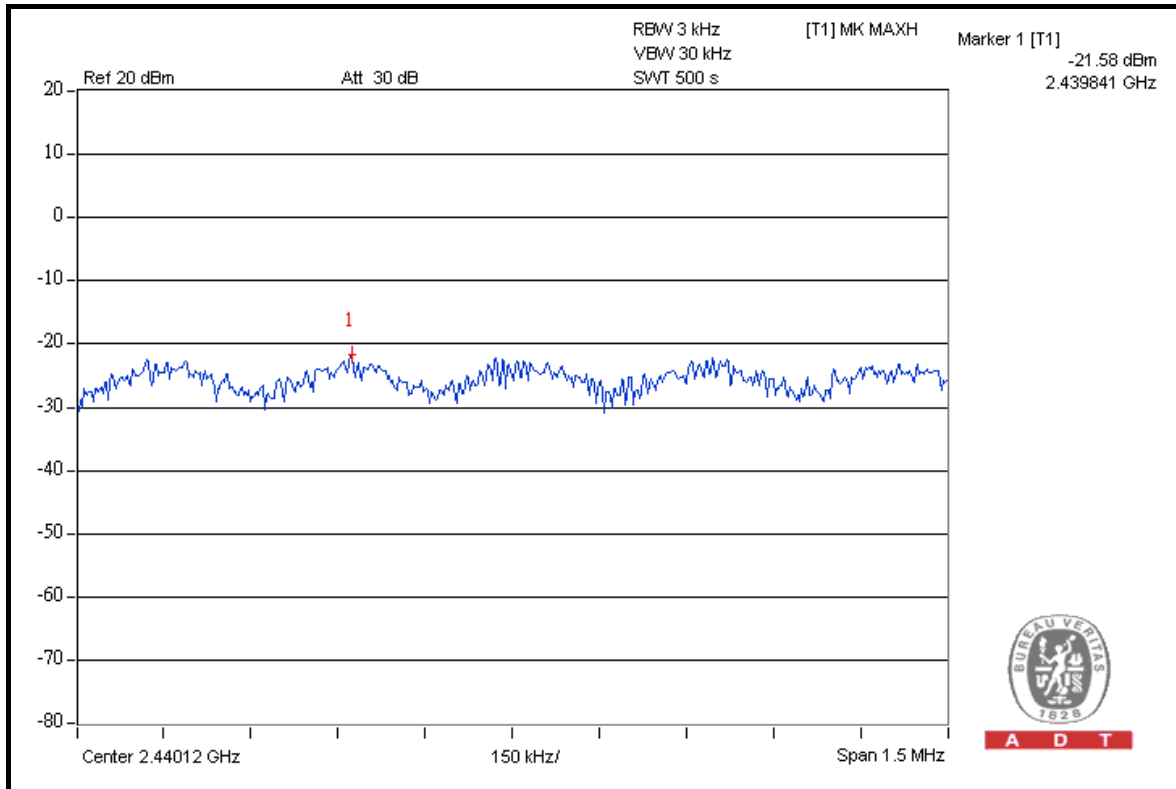

CH 11

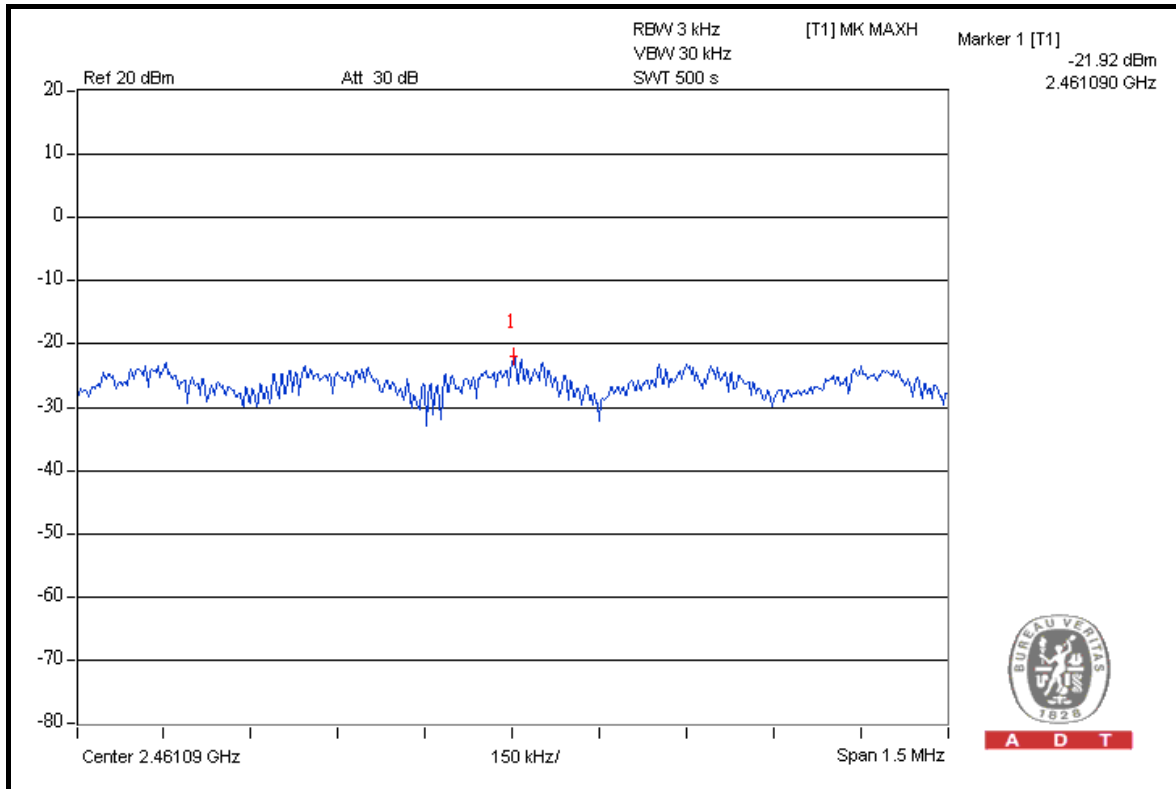



A D T

DRAFT 802.11n (20MHz) OFDM MODULATION

MODULATION TYPE	BPSK	TRANSFER RATE	6.5Mbps
INPUT POWER	120Vac, 60Hz	ENVIRONMENTAL CONDITIONS	23 deg.C, 70 %RH, 1009hPa
TESTED BY	Lori Chiu		

CHAN.	CHAN. FREQ. (MHz)	RF POWER LEVEL IN 3kHz BW (dBm)		TOTAL POWER DENSITY (mW)	TOTAL POWER DENSITY (dBm)	MAX. LIMIT (dBm)	PASS / FAIL
		CHAIN 0	CHAIN 1				
1	2412	-20.48	-20.75	0.017	-17.60	8	PASS
6	2437	-20.58	-20.62	0.017	-17.59	8	PASS
11	2462	-20.56	-20.48	0.018	-17.51	8	PASS



A D T

FOR CHAIN 0: CH 1

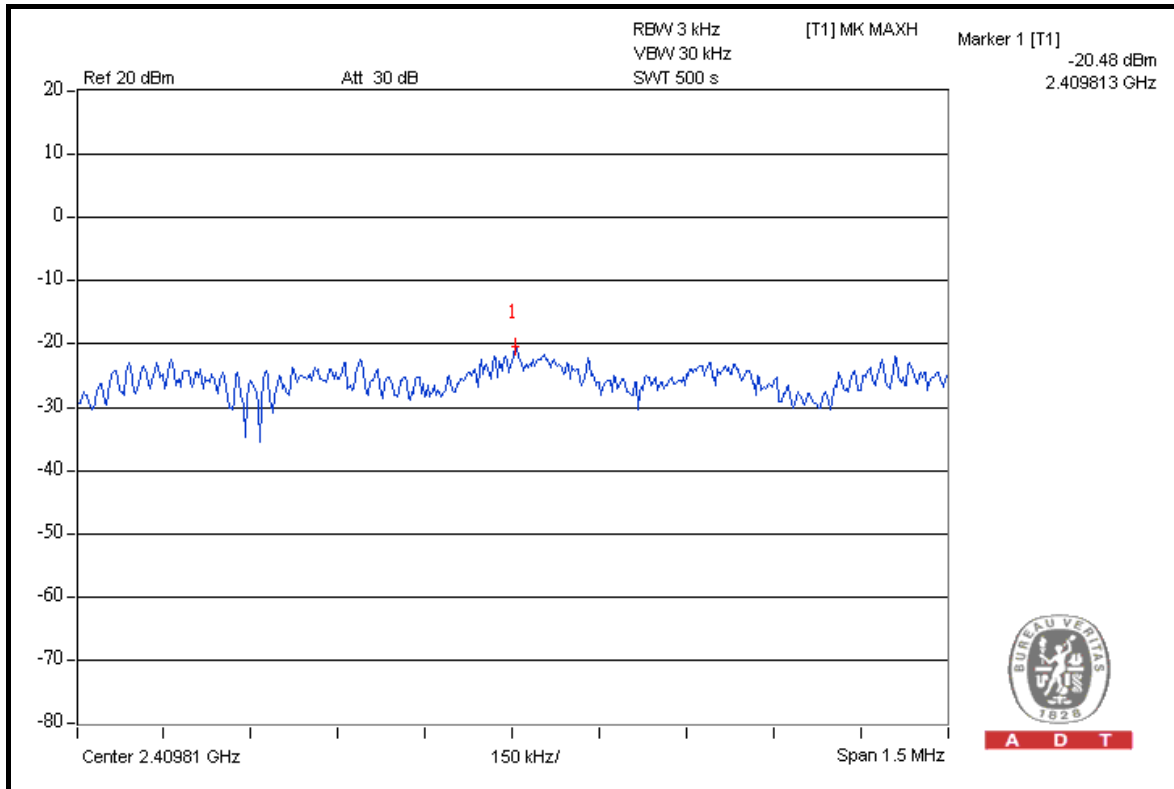

CH 6

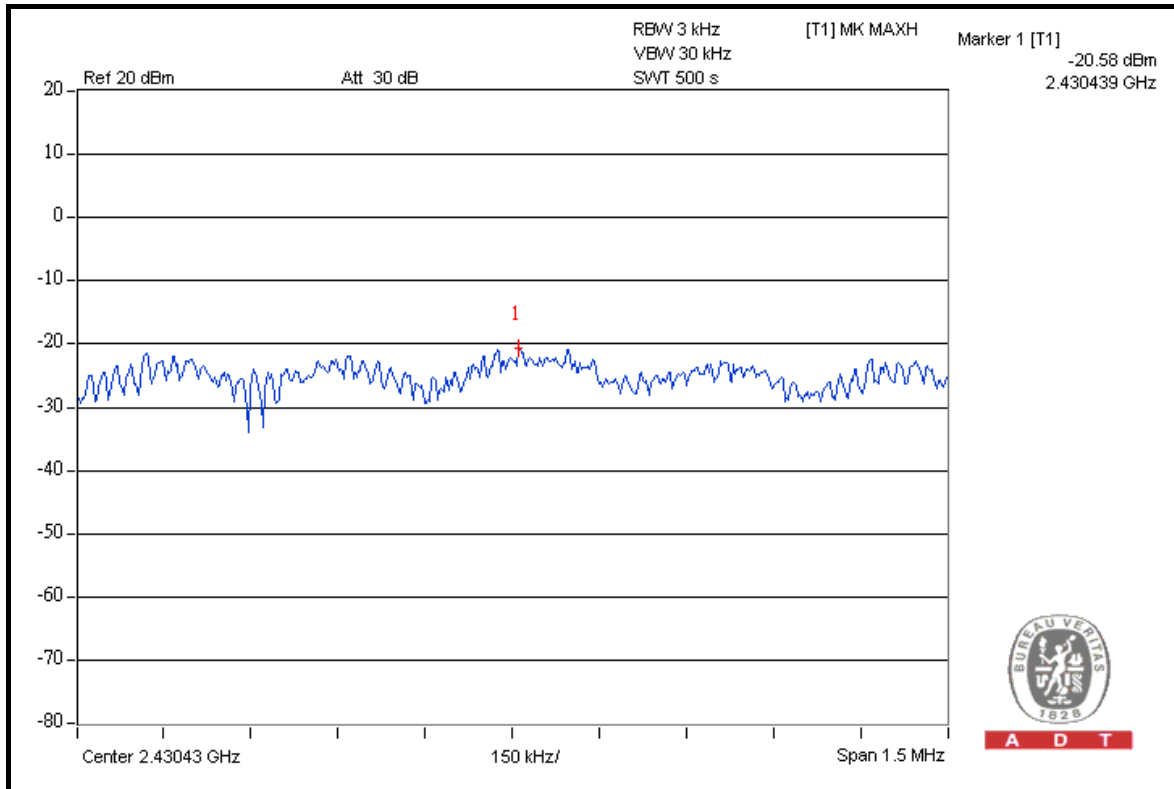



A D T

CH 11

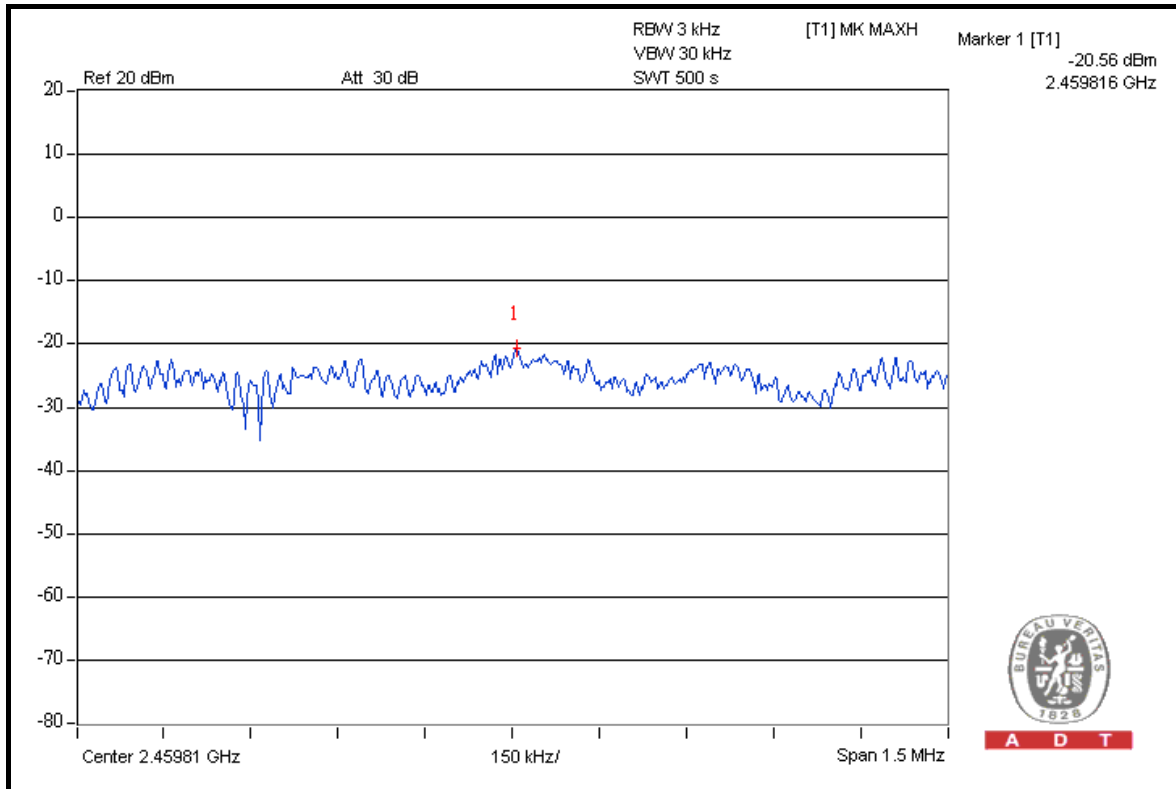

FOR CHAIN 1: CH 1

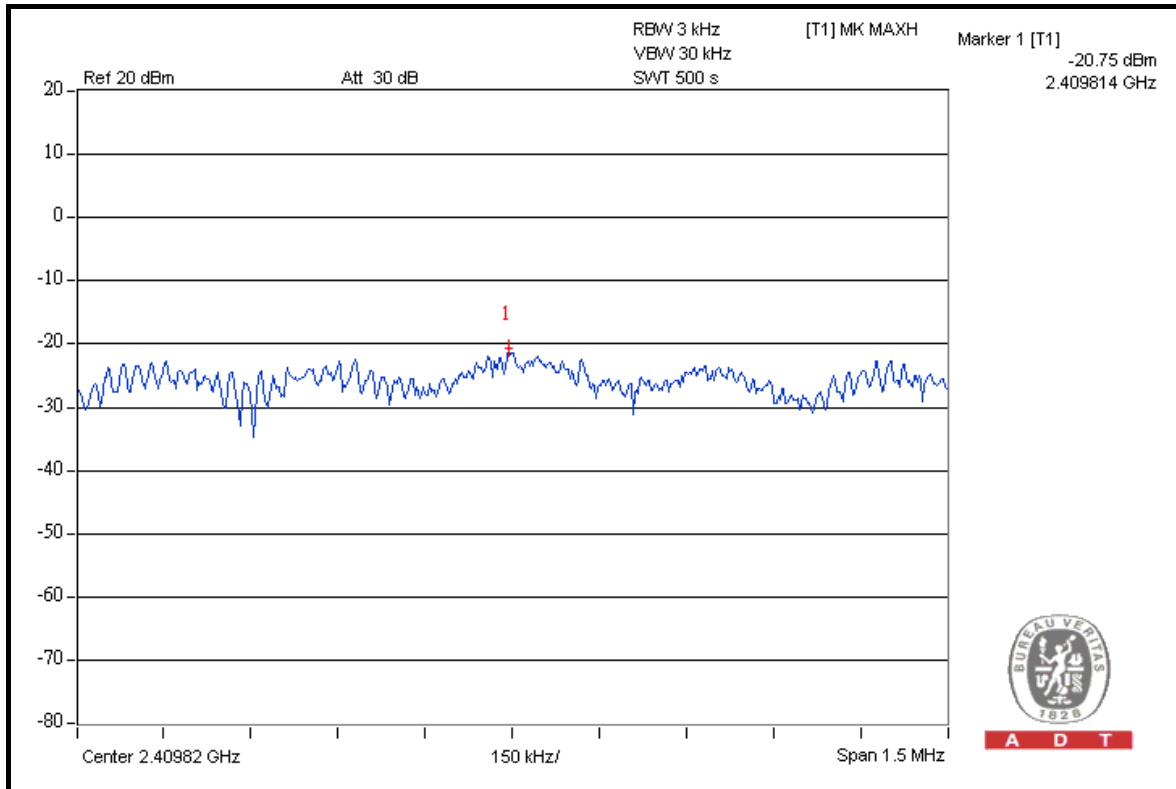



A D T

CH 6

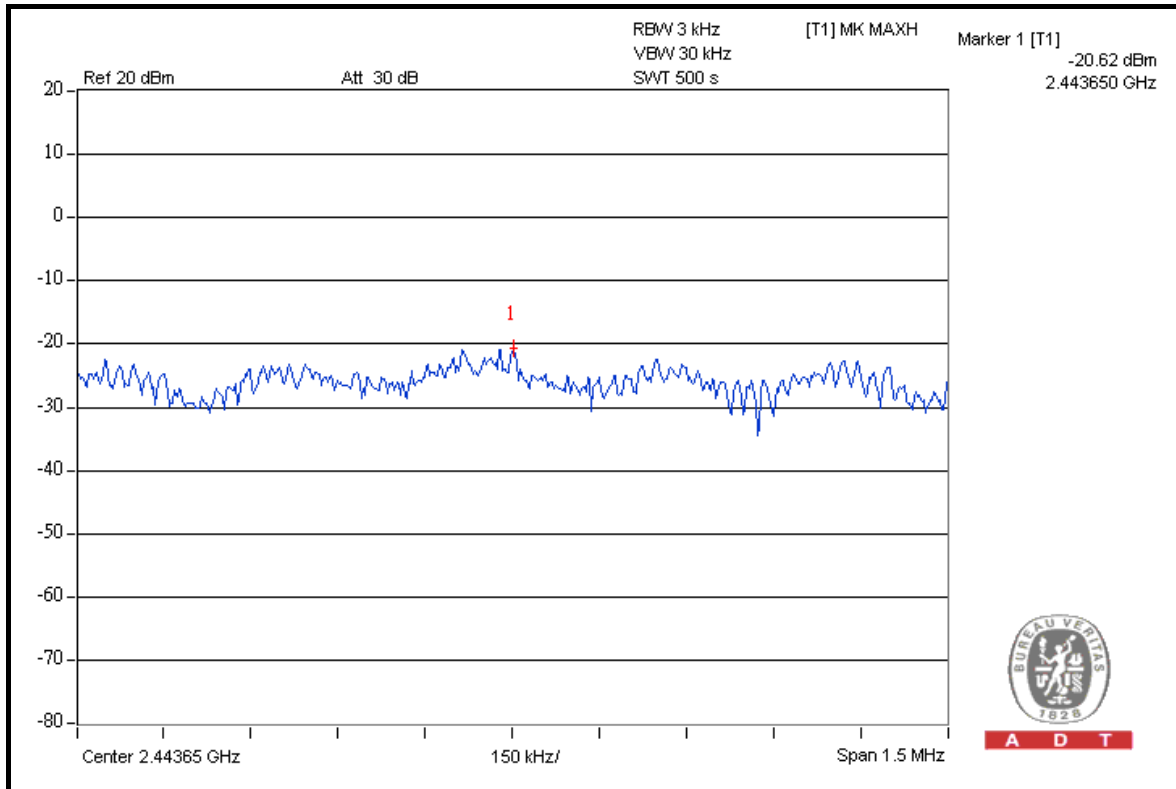

CH 11

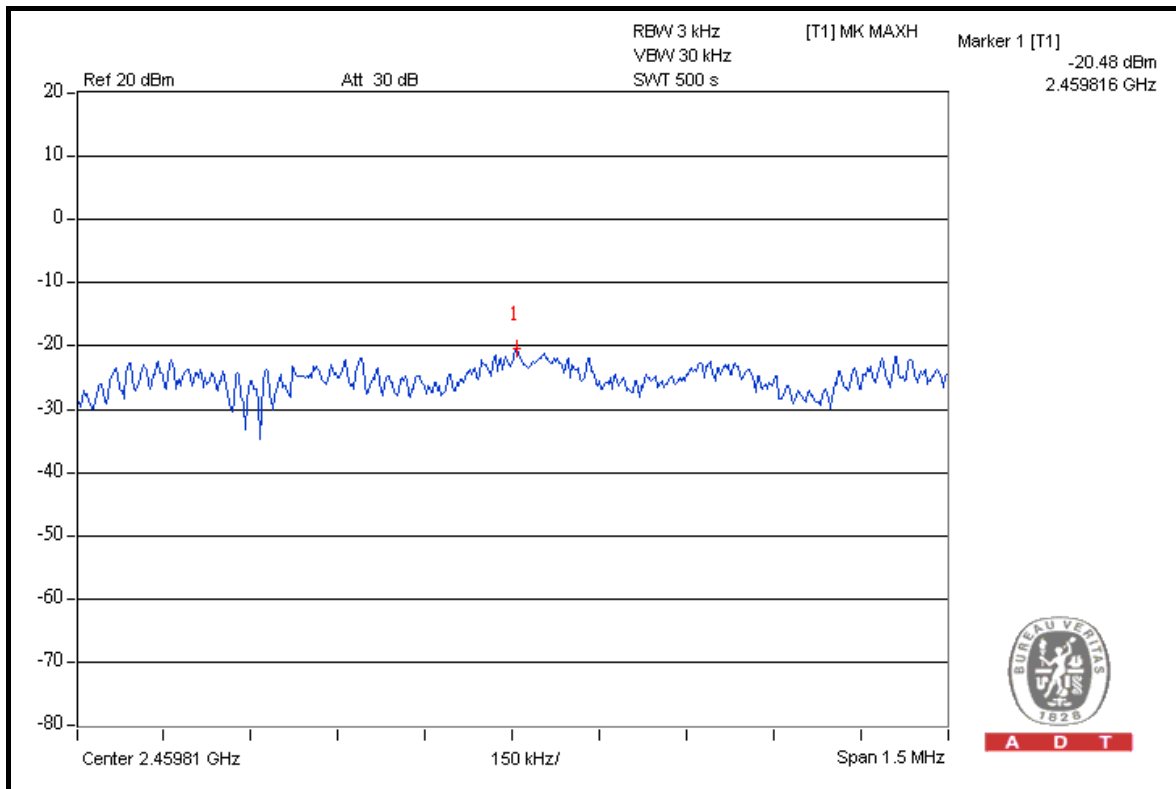



A D T

DRAFT 802.11n (40MHz) OFDM MODULATION

MODULATION TYPE	BPSK	TRANSFER RATE	13.5Mbps
INPUT POWER	120Vac, 60Hz	ENVIRONMENTAL CONDITIONS	23 deg.C, 70 %RH, 1009hPa
TESTED BY	Lori Chiu		

CHAN.	CHAN. FREQ. (MHz)	RF POWER LEVEL IN 3kHz BW (dBm)		TOTAL POWER DENSITY (mW)	TOTAL POWER DENSITY (dBm)	MAX. LIMIT (dBm)	PASS / FAIL
		CHAIN 0	CHAIN 1				
1	2422	-21.39	-23.81	0.011	-19.42	8	PASS
4	2437	-21.22	-23.67	0.012	-19.26	8	PASS
7	2452	-21.25	-23.60	0.012	-19.26	8	PASS



A D T

FOR CHAIN 0: CH 1

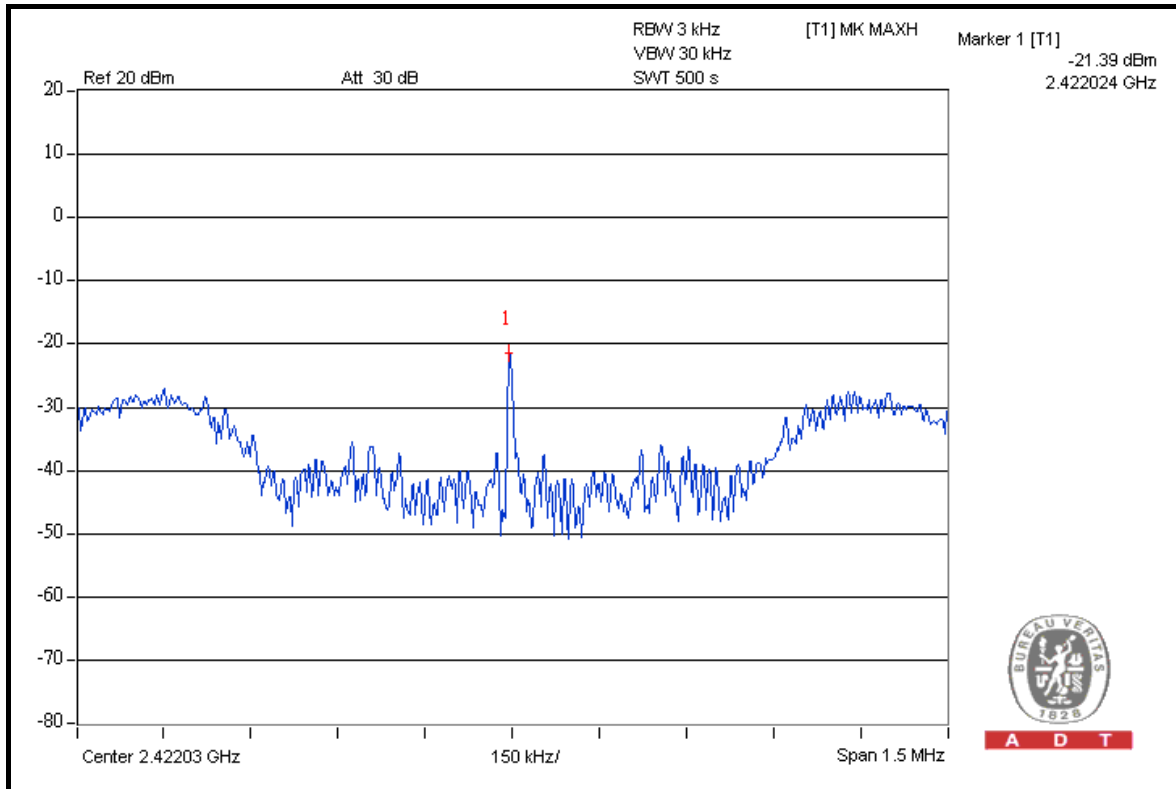

CH 4

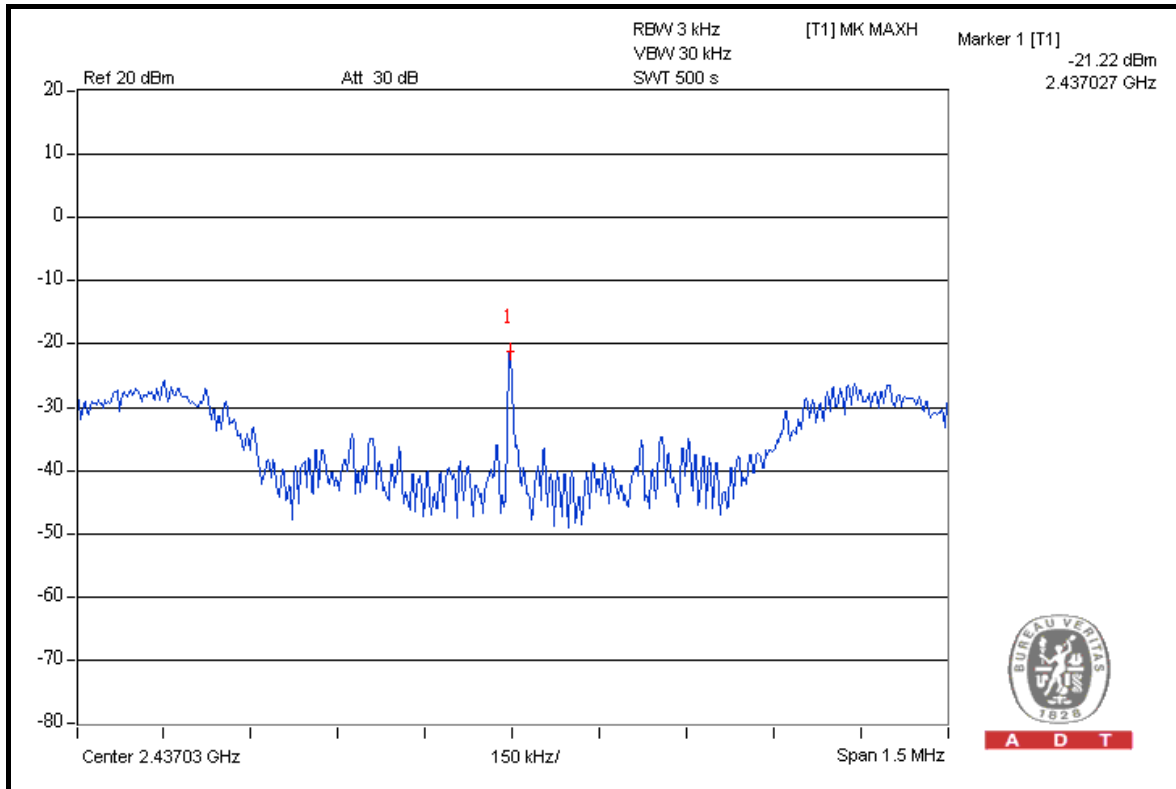



A D T

CH 7

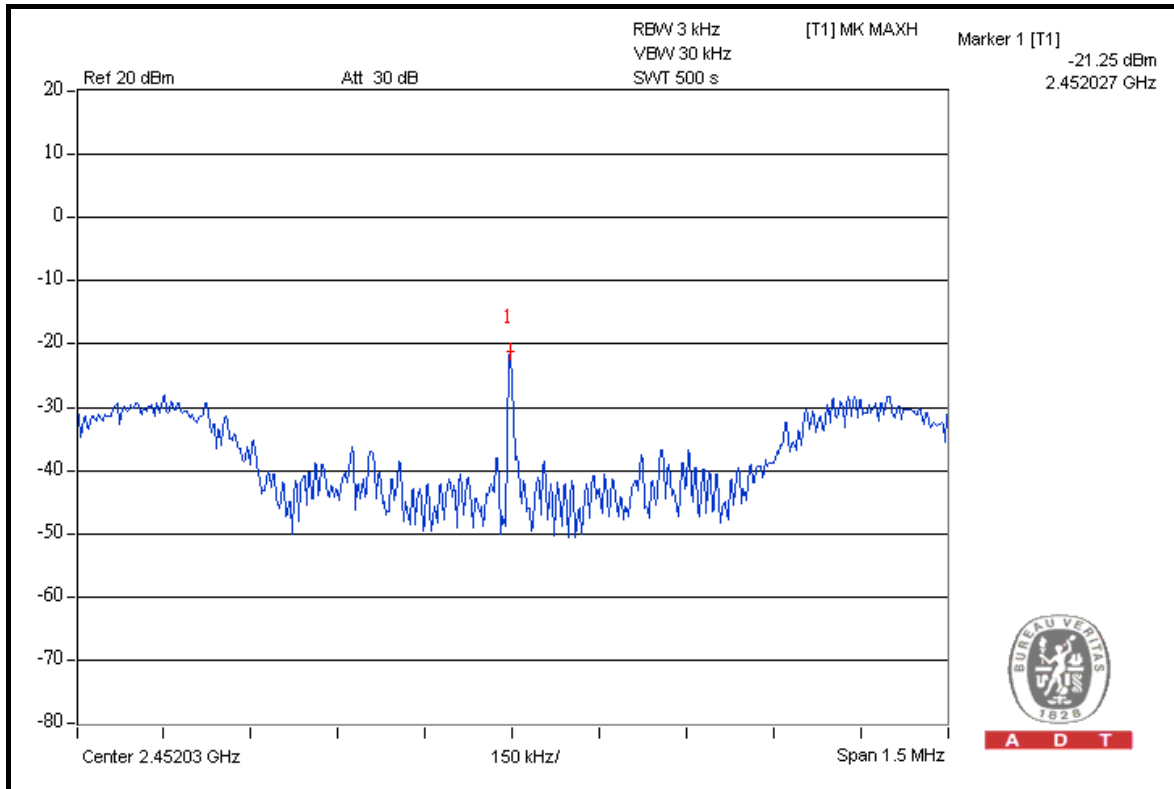

A D T

FOR CHAIN 1: CH 1

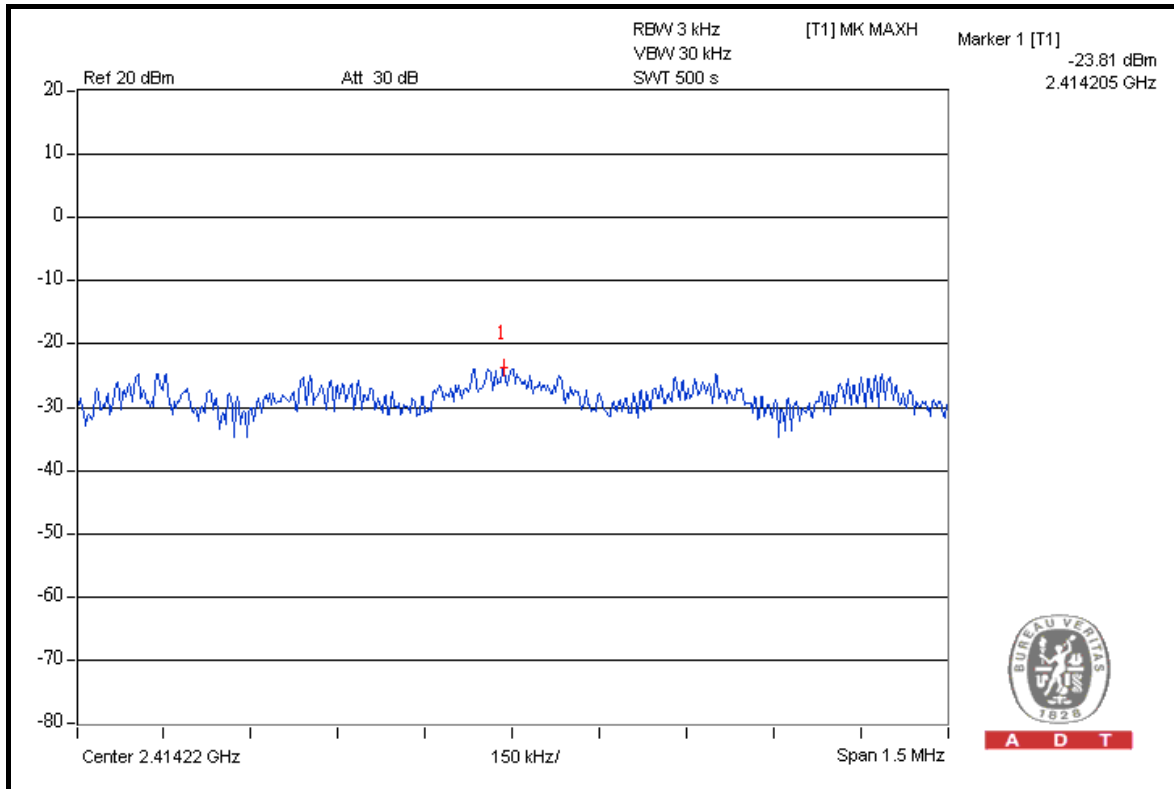

A D T



A D T

CH 4

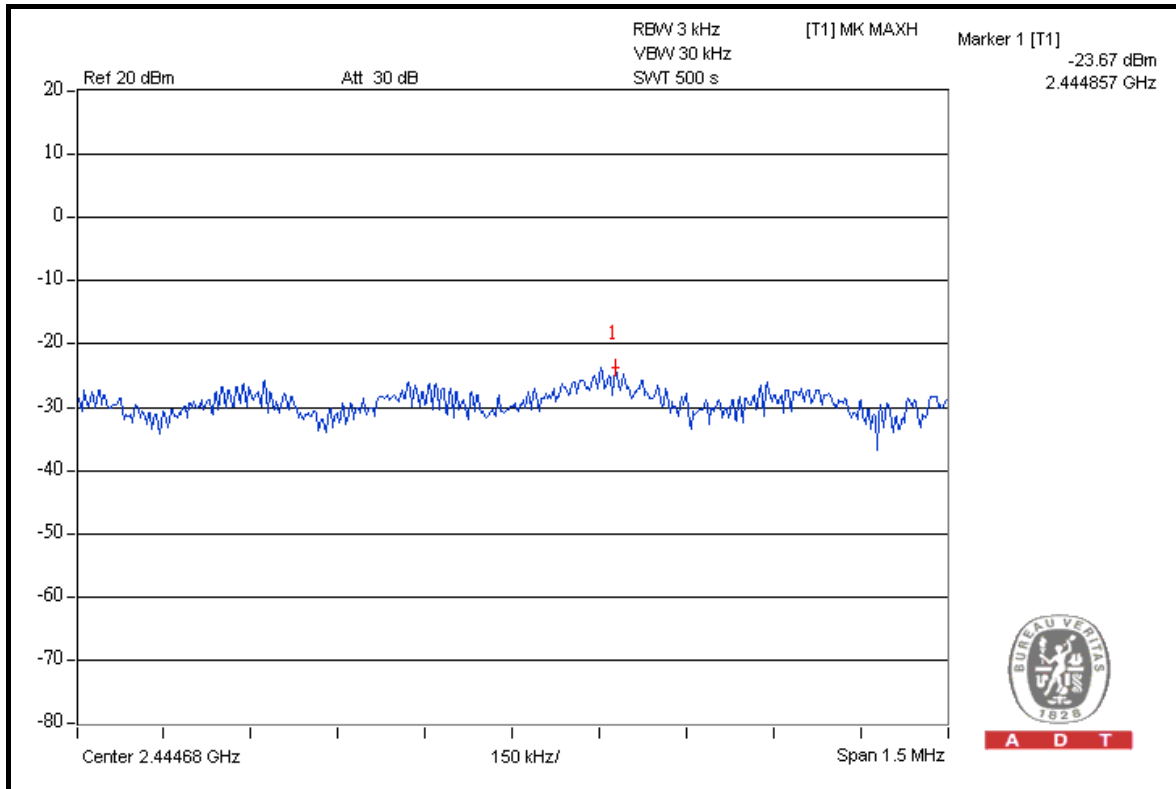

CH 7

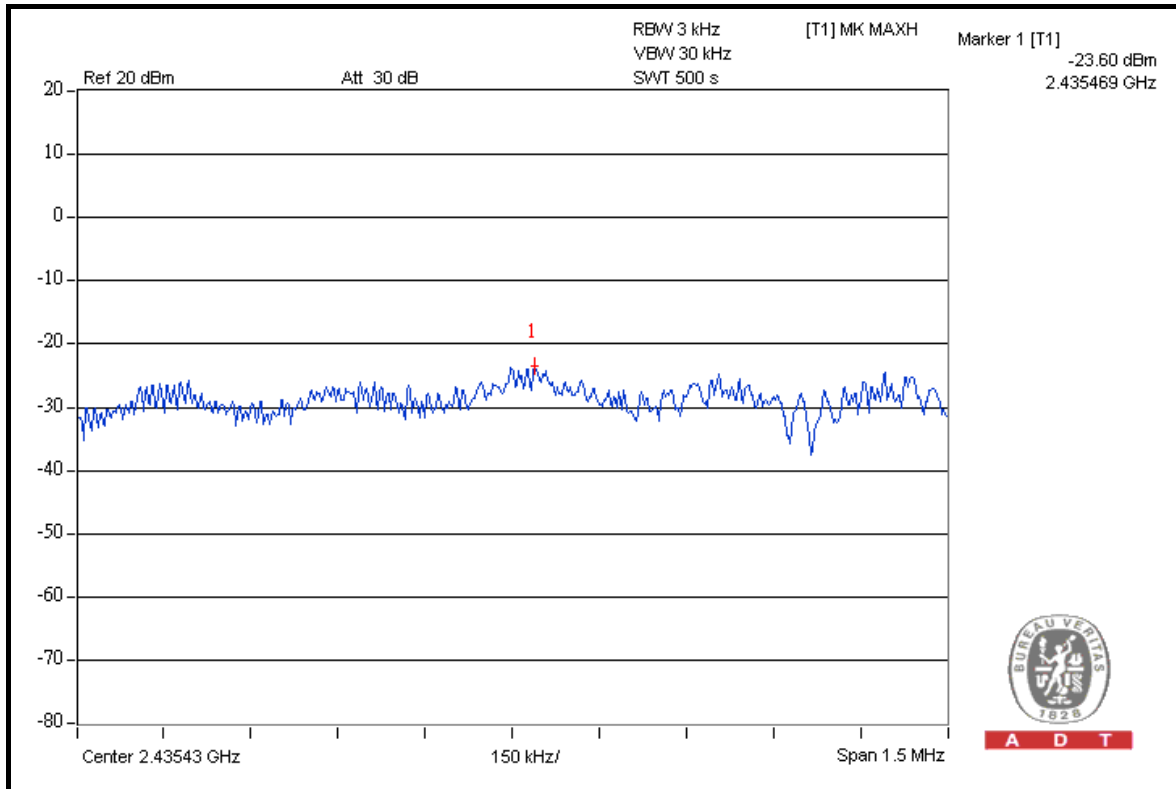

4.6 BAND EDGES MEASUREMENT

4.6.1 LIMITS OF BAND EDGES MEASUREMENT

Below -20dB of the highest emission level of operating band (in 100kHz Resolution Bandwidth).

4.6.2 TEST INSTRUMENTS

DESCRIPTION & MANUFACTURER	MODEL NO.	SERIAL NO.	DATE OF CALIBRATION	DUE DATE OF CALIBRATION
Test Receiver ROHDE & SCHWARZ	ESI7	838496/016	Dec. 29, 2008	Dec. 28, 2009
Spectrum Analyzer ROHDE & SCHWARZ	FSP40	100039	Dec. 08, 2008	Dec. 07, 2009
BILOG Antenna SCHWARZBECK	VULB9168	9168-155	Apr. 30, 2008	Apr. 28, 2010
HORN Antenna SCHWARZBECK	BBHA 9120D	9120D-408	Dec. 29, 2008	Dec. 28, 2009
HORN Antenna SCHWARZBECK	BBHA 9170	BBHA9170242	Jan. 06, 2009	Jan. 05, 2010
Preamplifier Agilent	8449B	3008A01960	Nov. 03, 2008	Nov. 02, 2009
Preamplifier Agilent	8447D	2944A10631	Nov. 03, 2008	Nov. 02, 2009
RF signal cable HUBER+SUHNNER	SUCOFLEX 104	274041/4	Aug. 21, 2008	Aug. 20, 2009
RF signal cable HUBER+SUHNNER	SUCOFLEX 104	283397/4	Aug. 21, 2008	Aug. 20, 2009
Software ADT.	ADT_Radiated_ V7.6.15.9.2	NA	NA	NA
Antenna Tower inn-co GmbH	MA 4000	010303	NA	NA
Antenna Tower Controller inn-co GmbH	CO2000	019303	NA	NA
Turn Table ADT.	TT100.	TT93021704	NA	NA
Turn Table Controller ADT.	SC100.	SC93021704	NA	NA

NOTE: The calibration interval of the above test instruments is 12 months and the calibrations are traceable to NML/ROC and NIST/USA.



4.6.3 TEST PROCEDURE

- a. The EUT was placed on the top of a rotating table 0.8 meters above the ground at a 3 meter semi-anechoic chamber. The table was rotated 360 degrees to determine the position of the highest radiation.
- b. The EUT was set 3 meters away from the interference-receiving antenna, which was mounted on the top of a variable-height antenna tower.
- c. The antenna is a broadband antenna, and its height is varied from one meter to four meters above the ground to determine the maximum value of the field strength. Both horizontal and vertical polarizations of the antenna are set to make the measurement.
- d. For each suspected emission, the EUT was arranged to its worst case and then the antenna was tuned to heights from 1 meter to 4 meters and the rotatable table was turned from 0 degrees to 360 degrees to find the maximum reading.
- e. Set both RBW and VBW of spectrum analyzer to 100kHz and 300kHz with suitable frequency span including 100MHz bandwidth from band edge. The band edges was measured and recorded.

The spectrum plots (Peak RBW = 100kHz, VBW = 300kHz) are attached on the following pages.

NOTE: The resolution bandwidth of test receiver/spectrum analyzer is 1MHz and the video bandwidth is 10Hz for Average detection (AV) at frequency above 1GHz.

4.6.4 DEVIATION FROM TEST STANDARD

No deviation.

4.6.5 EUT OPERATING CONDITION

Same as Item 4.3.6.

4.6.6 TEST RESULTS

The spectrum plots are attached on the following pages. D1 line indicates the highest level, and D2 line indicates the 20dB offset below D1. It shows compliance with the requirement in part 15.247(d).

802.11b DSSS MODULATION

NOTE 1: The band edge emission plot on the next page shows 40.38dBc between carrier maximum power and local maximum emission in restrict band (2.37960GHz). The emission of carrier strength list in the test result of channel 1 at the item 4.1.7 is 98.33dBuV/m (Peak), so the maximum field strength in restrict band is $98.33 - 40.38 = 57.95$ dBuV/m which is under 74dBuV/m limit.

The band edge emission plot of on the next page shows 55.68dBc between carrier maximum power and local maximum emission in restrict band (2.39000GHz). The emission of carrier strength list in the test result of channel 1 at the item 4.1.7 is 93.76dBuV/m (Average), so the maximum field strength in restrict band is $93.76 - 55.68 = 38.08$ dBuV/m which is under 54dBuV/m limit.

NOTE 2: The band edge emission plot on the next second page shows 42.13dBc between carrier maximum power and local maximum emission in restrict band (2.49340GHz). The emission of carrier strength list in the test result of channel 11 at the item 4.1.7 is 99.59dBuV/m (Peak), so the maximum field strength in restrict band is $99.59 - 42.13 = 57.46$ dBuV/m which is under 74dBuV/m limit.

The band edge emission plot on the next third page shows 57.13dBc between carrier maximum power and local maximum emission in restrict band (2.48400GHz). The emission of carrier strength list in the test result of channel 11 at the item 4.1.7 is 94.99dBuV/m (Average), so the maximum field strength in restrict band is $94.99 - 57.13 = 37.86$ dBuV/m which is under 54dBuV/m limit.



A D T

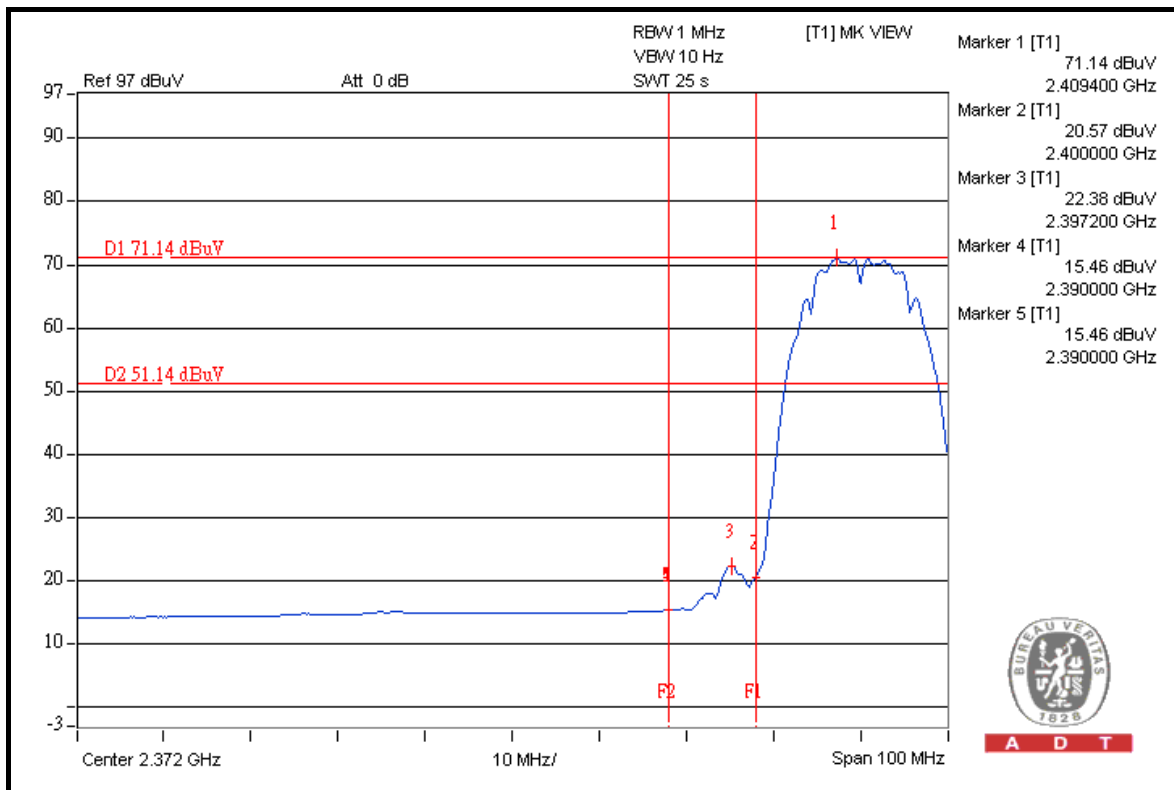
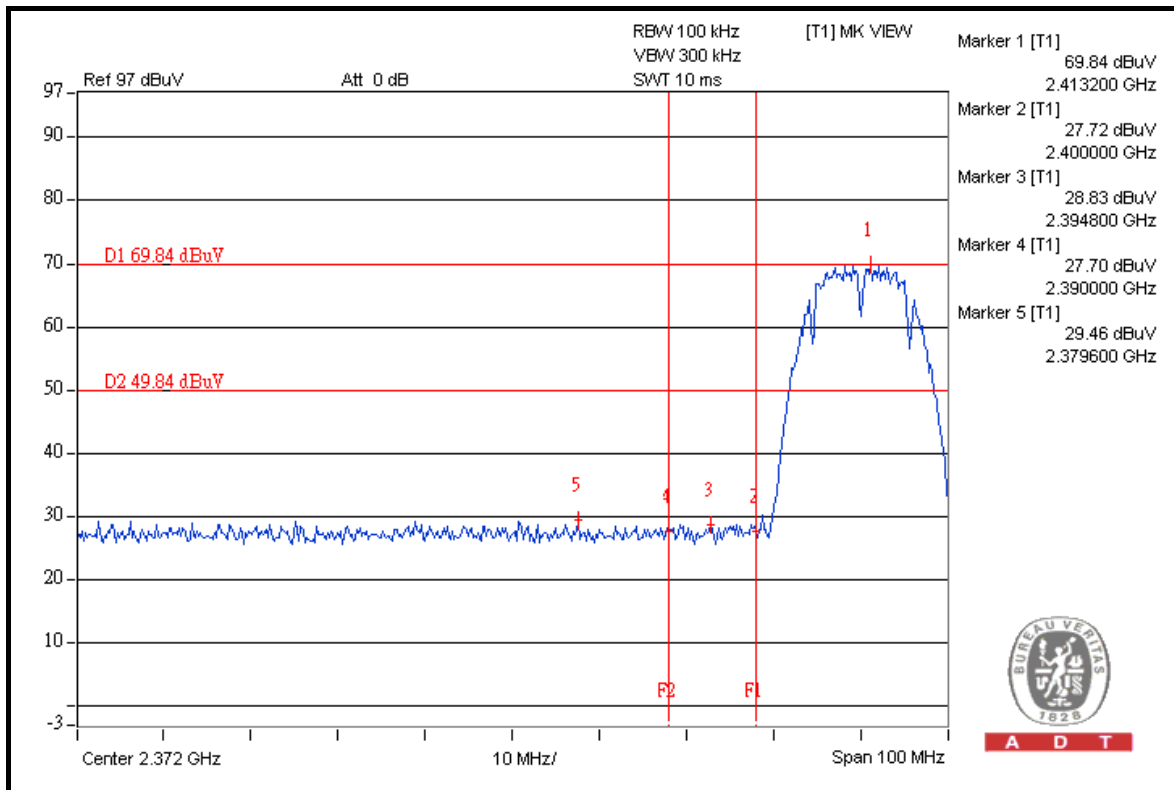



A D T

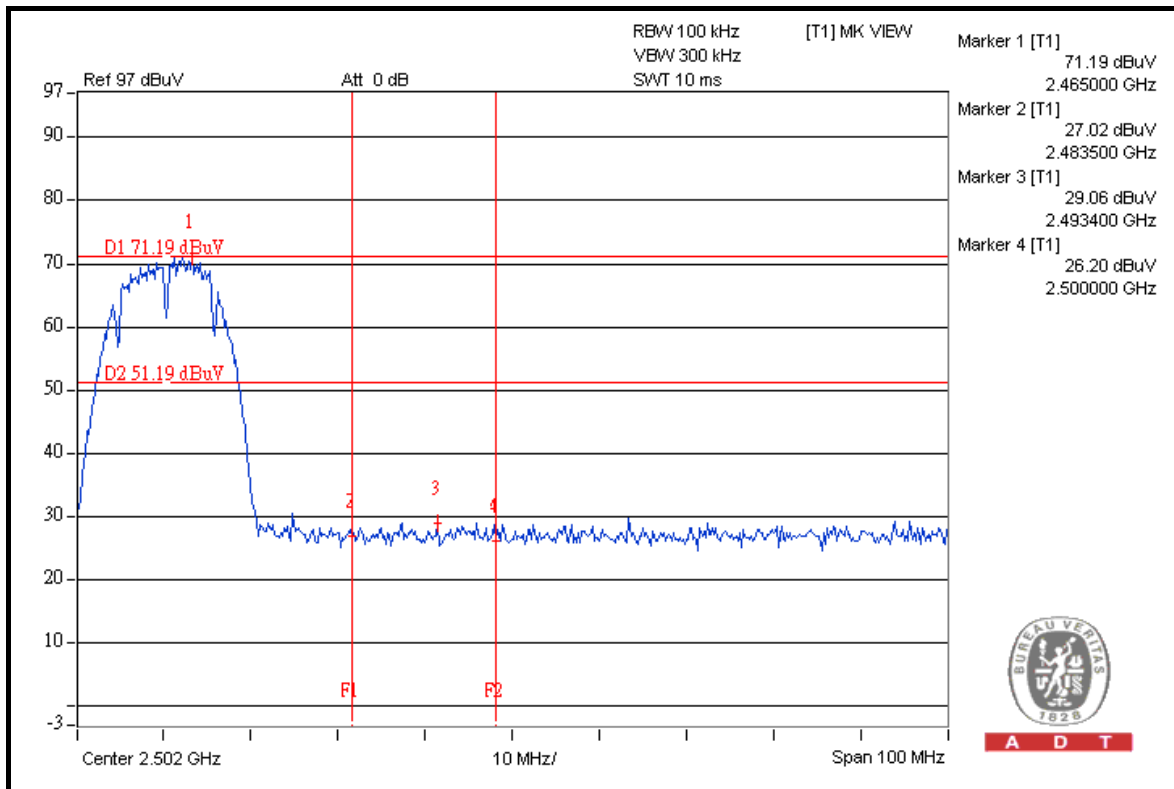
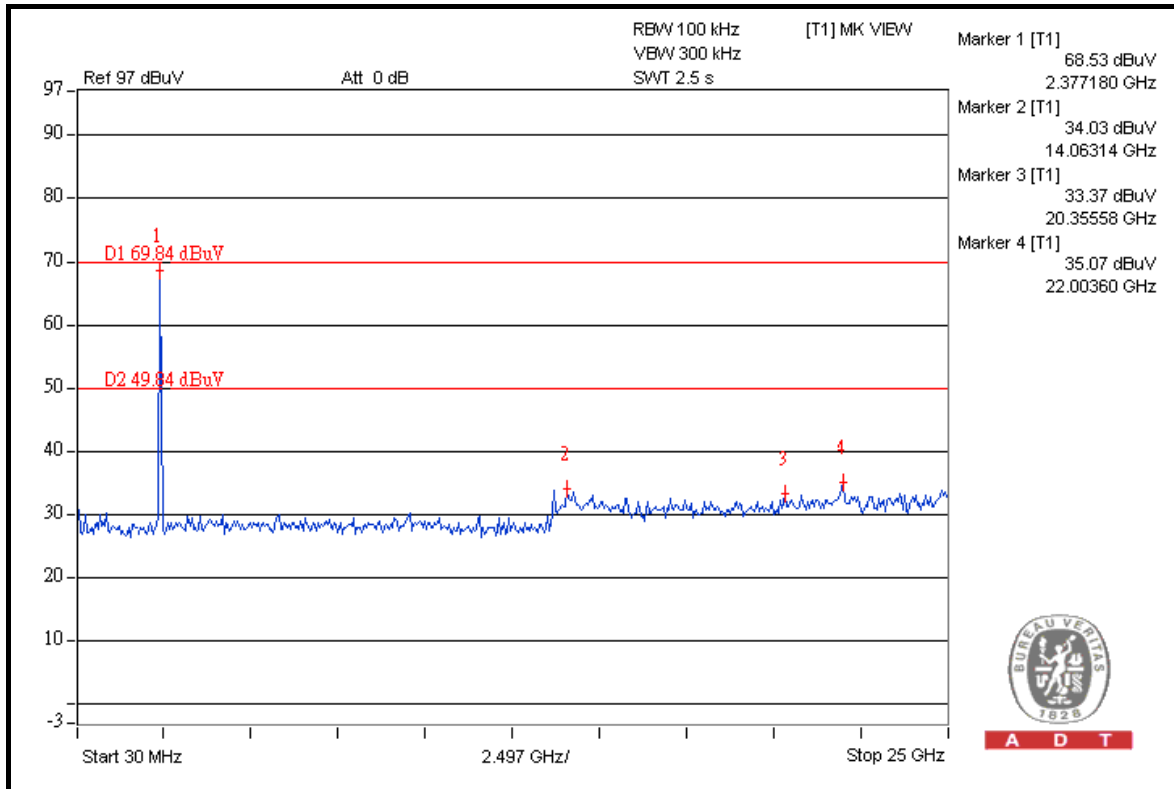



A D T

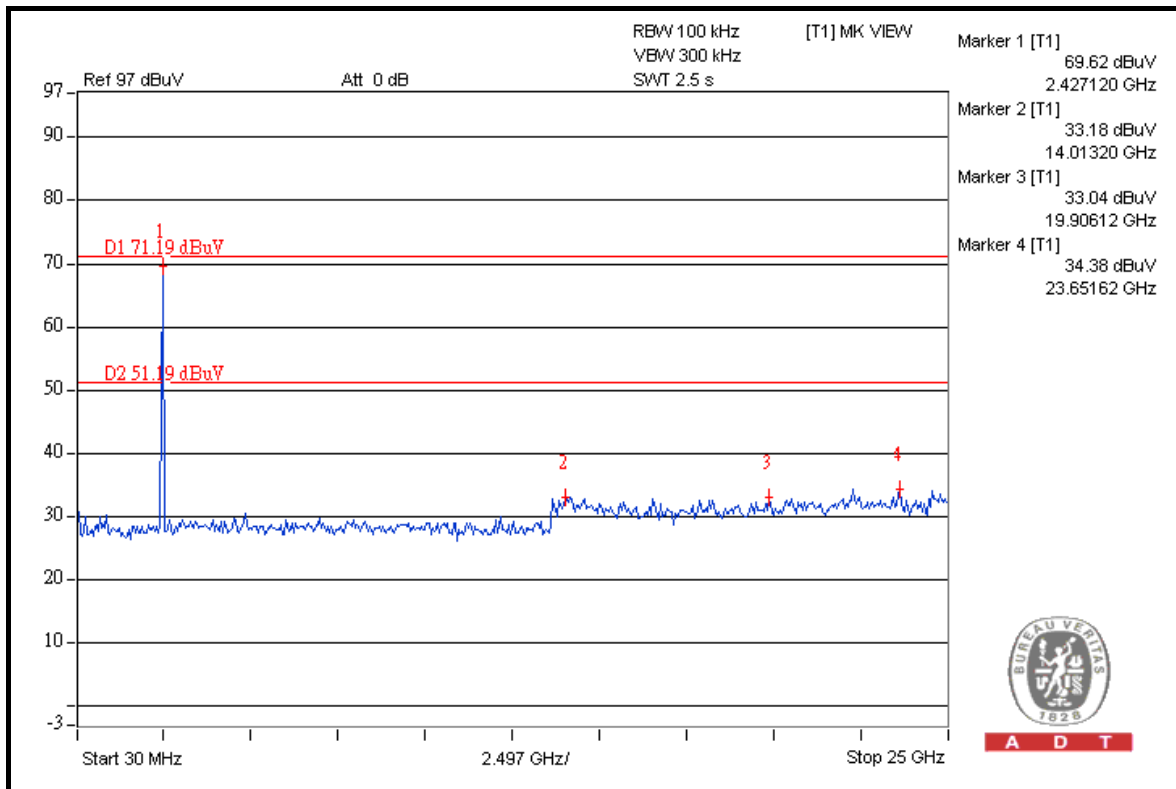
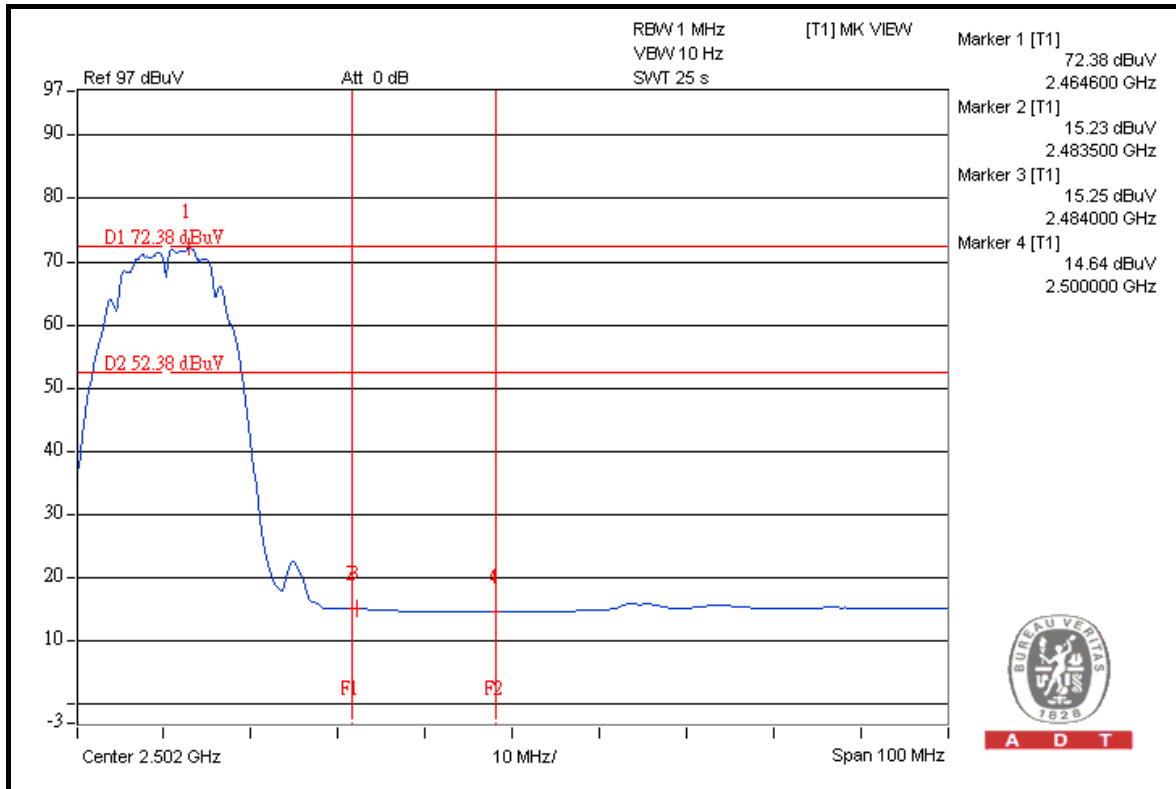



802.11g OFDM MODULATION

NOTE 1: The band edge emission plot on the next page shows 33.54dBc between carrier maximum power and local maximum emission in restrict band (2.38780GHz). The emission of carrier strength list in the test result of channel 1 at the item 4.1.7 is 97.50dBuV/m (Peak), so the maximum field strength in restrict band is $97.50 - 33.54 = 63.96$ dBuV/m which is under 74dBuV/m limit.

The band edge emission plot of on the next page shows 46.99dBc between carrier maximum power and local maximum emission in restrict band (2.35960GHz). The emission of carrier strength list in the test result of channel 1 at the item 4.1.7 is 87.24dBuV/m (Average), so the maximum field strength in restrict band is $87.24 - 46.99 = 40.25$ dBuV/m which is under 54dBuV/m limit.

NOTE 2: The band edge emission plot on the next second page shows 36.10dBc between carrier maximum power and local maximum emission in restrict band (2.48960GHz). The emission of carrier strength list in the test result of channel 11 at the item 4.1.7 is 98.99dBuV/m (Peak), so the maximum field strength in restrict band is $98.99 - 36.10 = 62.89$ dBuV/m which is under 74dBuV/m limit.

The band edge emission plot on the next third page shows 50.80dBc between carrier maximum power and local maximum emission in restrict band (2.48350GHz). The emission of carrier strength list in the test result of channel 11 at the item 4.1.7 is 88.62dBuV/m (Average), so the maximum field strength in restrict band is $88.62 - 50.80 = 37.82$ dBuV/m which is under 54dBuV/m limit.



A D T

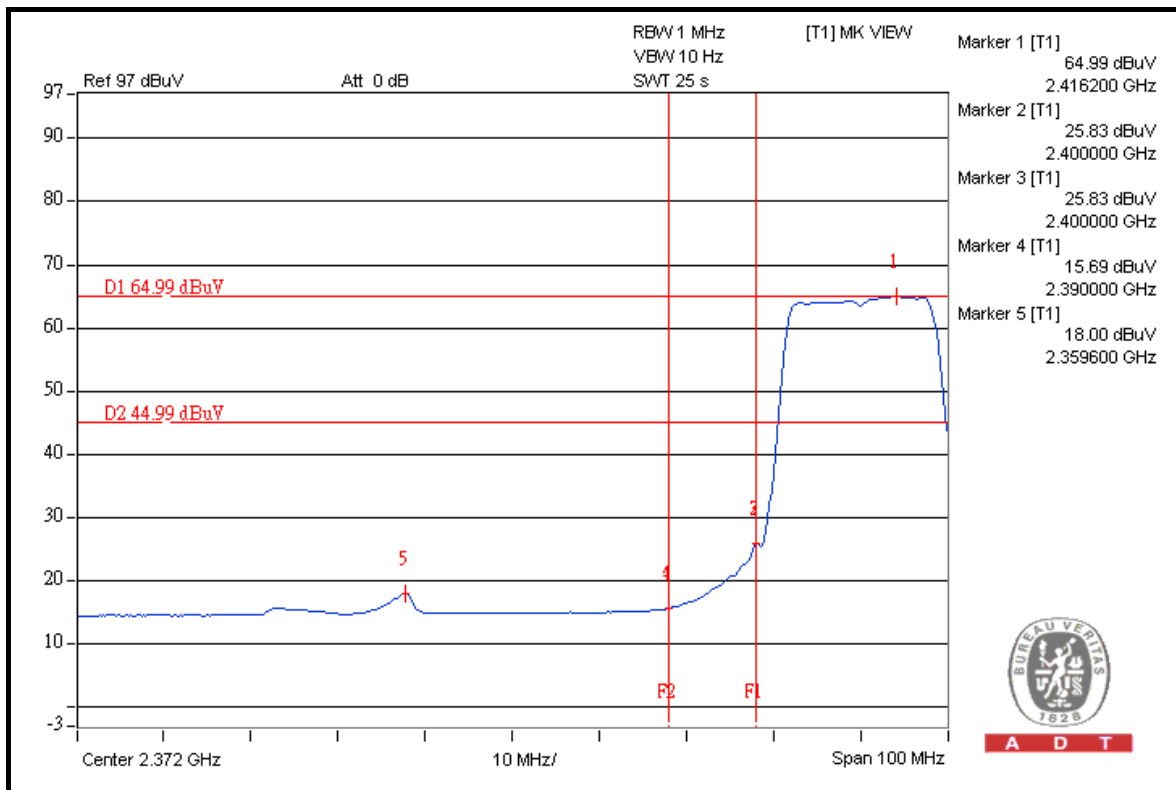
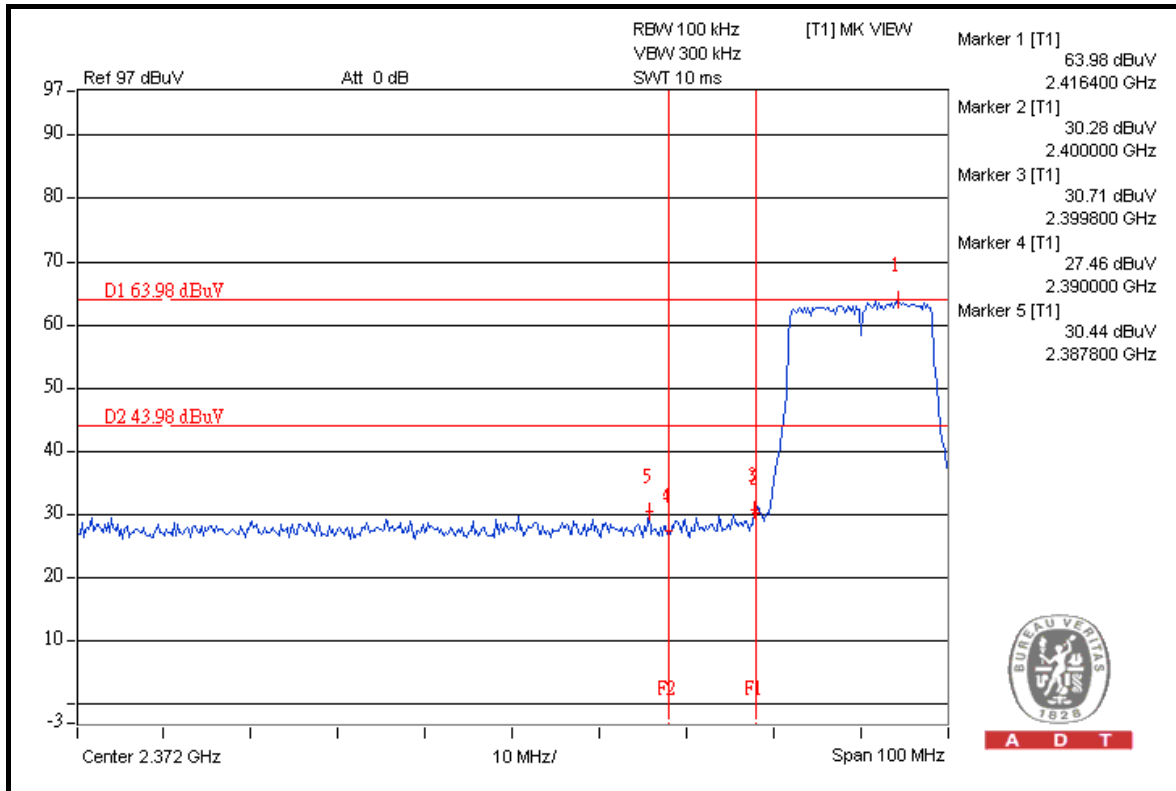



A D T

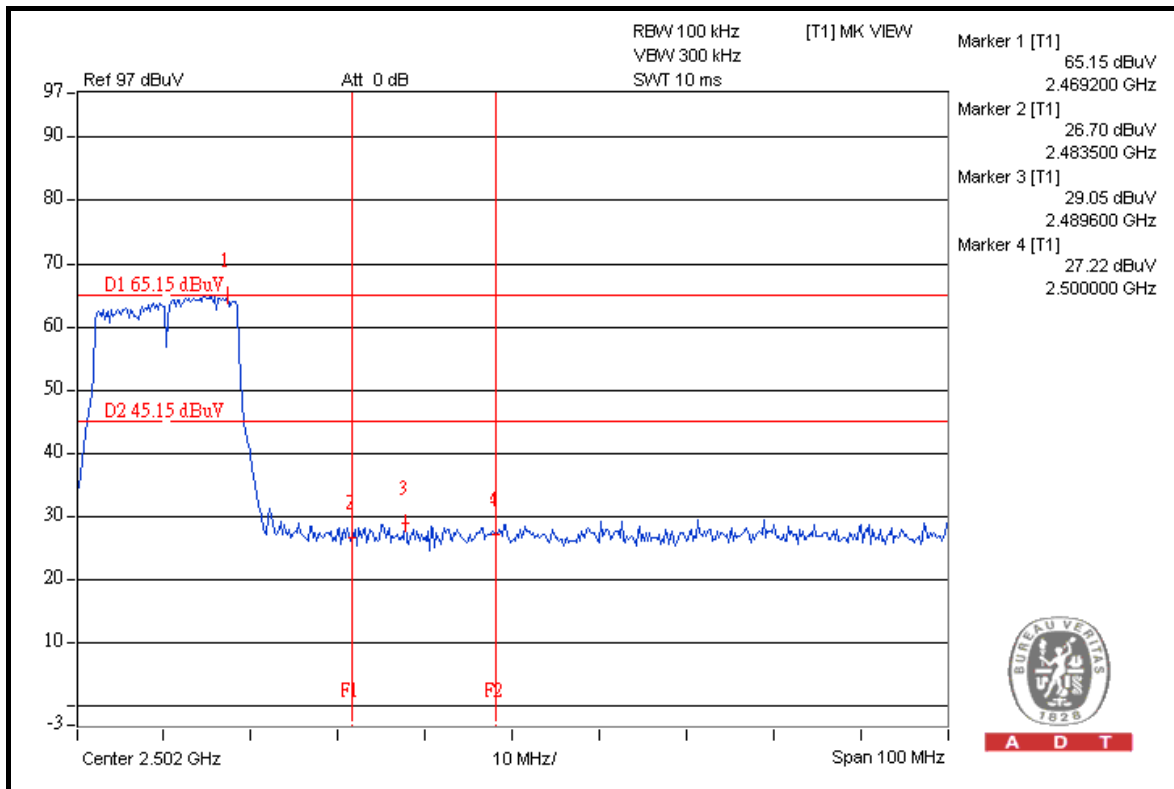
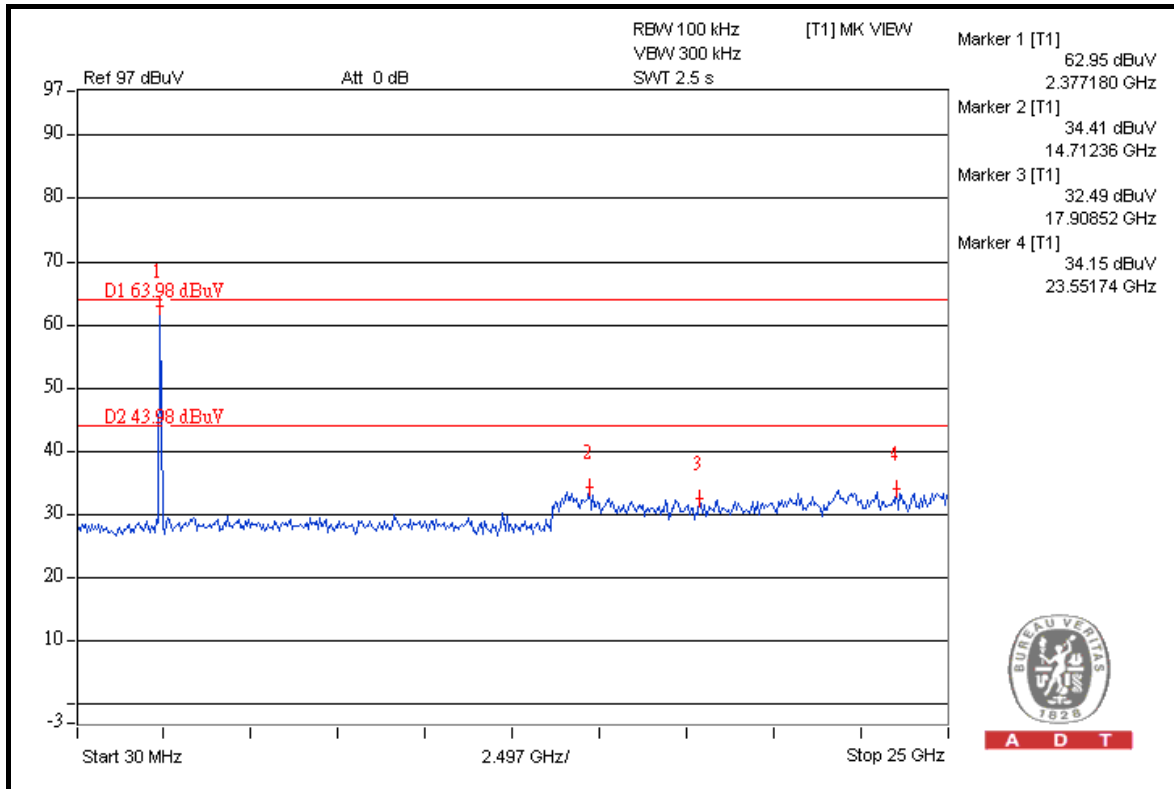



A D T

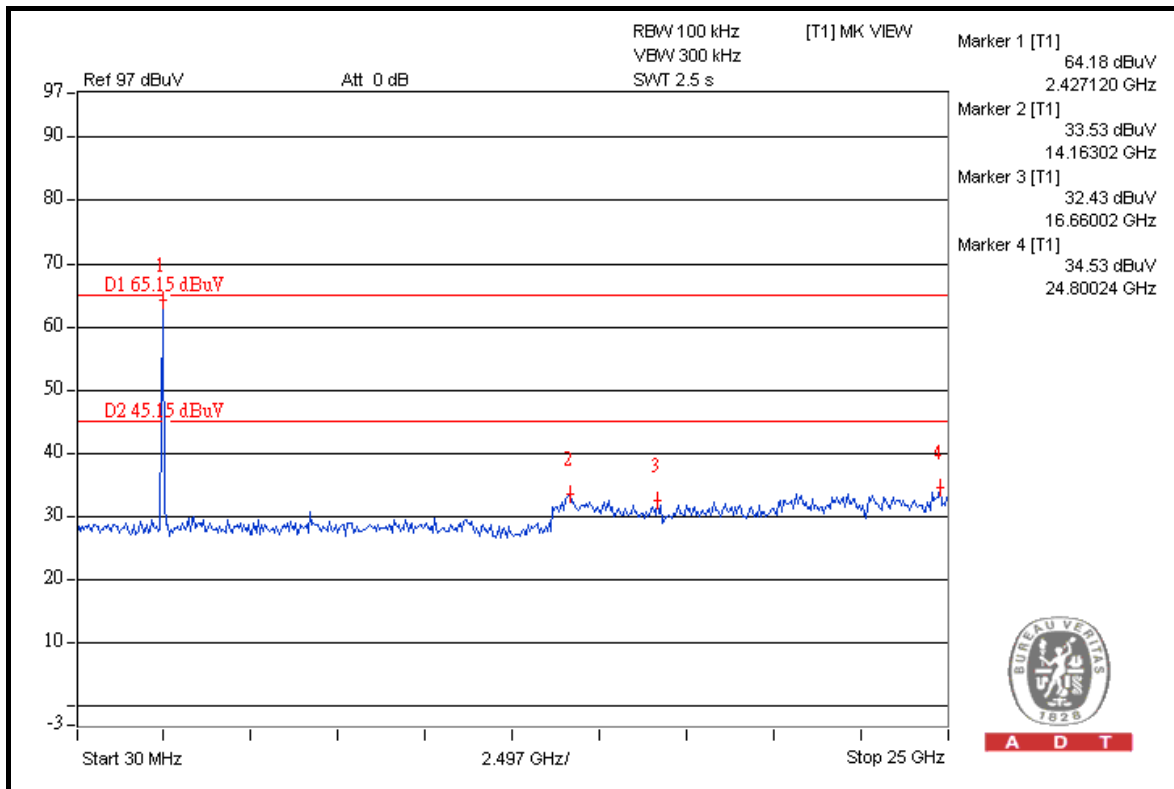
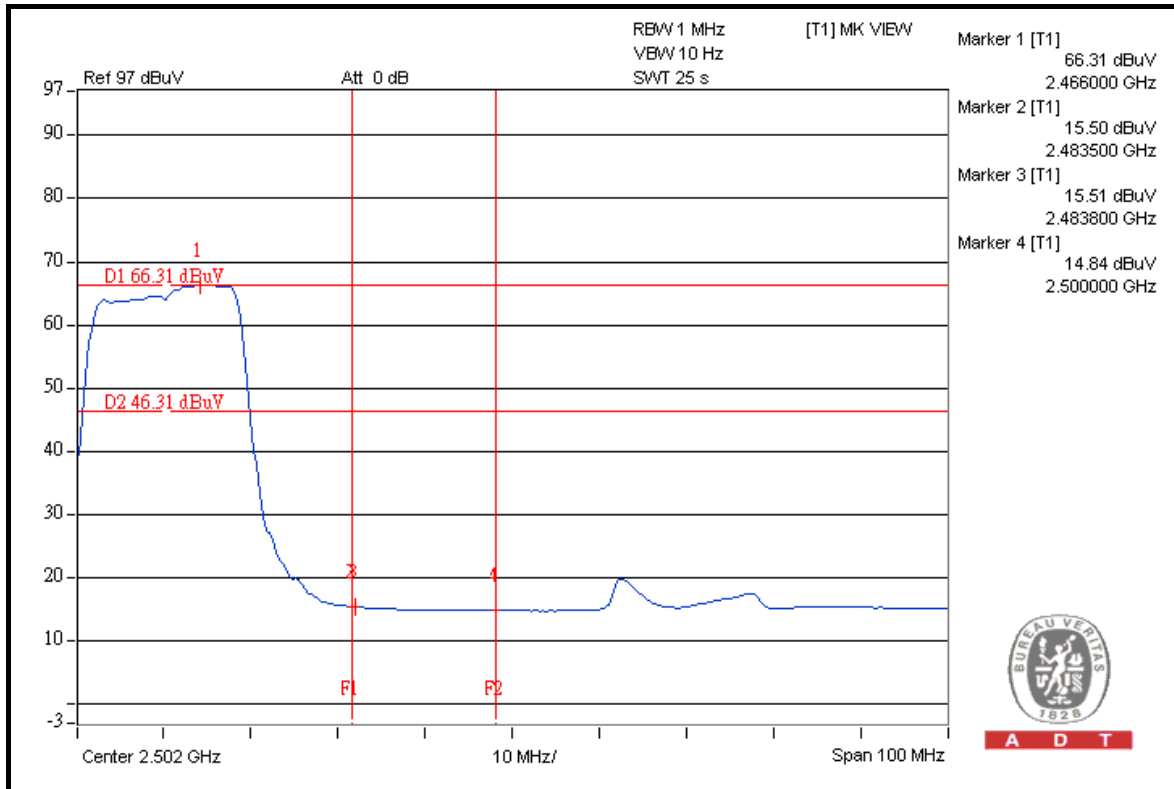



DRAFT 802.11n (20MHz) OFDM MODULATION

NOTE 1: The band edge emission plot on the next page shows 34.12dBc between carrier maximum power and local maximum emission in restrict band (2.336360GHz). The emission of carrier strength list in the test result of channel 1 at the item 4.1.7 is 97.62dBuV/m (Peak), so the maximum field strength in restrict band is $97.62 - 34.12 = 63.50$ dBuV/m which is under 74dBuV/m limit.

The band edge emission plot of on the next page shows 46.49dBc between carrier maximum power and local maximum emission in restrict band (2.36000GHz). The emission of carrier strength list in the test result of channel 1 at the item 4.1.7 is 87.41dBuV/m (Average), so the maximum field strength in restrict band is $87.41 - 46.49 = 40.92$ dBuV/m which is under 54dBuV/m limit.

NOTE 2: The band edge emission plot on the next second page shows 36.04dBc between carrier maximum power and local maximum emission in restrict band (2.48500GHz). The emission of carrier strength list in the test result of channel 11 at the item 4.1.7 is 98.42dBuV/m (Peak), so the maximum field strength in restrict band is $98.42 - 36.04 = 62.38$ dBuV/m which is under 74dBuV/m limit.

The band edge emission plot on the next third page shows 49.89dBc between carrier maximum power and local maximum emission in restrict band (2.48350GHz). The emission of carrier strength list in the test result of channel 11 at the item 4.1.7 is 88.06dBuV/m (Average), so the maximum field strength in restrict band is $88.06 - 49.89 = 38.17$ dBuV/m which is under 54dBuV/m limit.



A D T

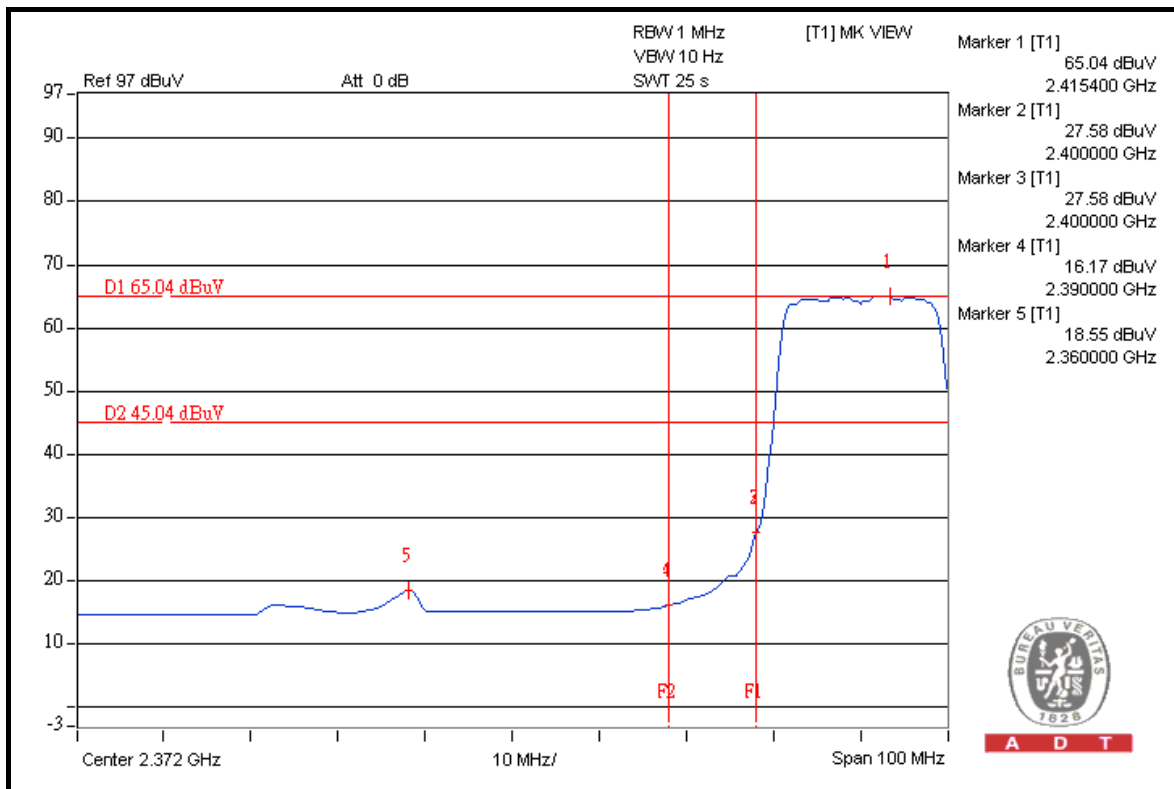
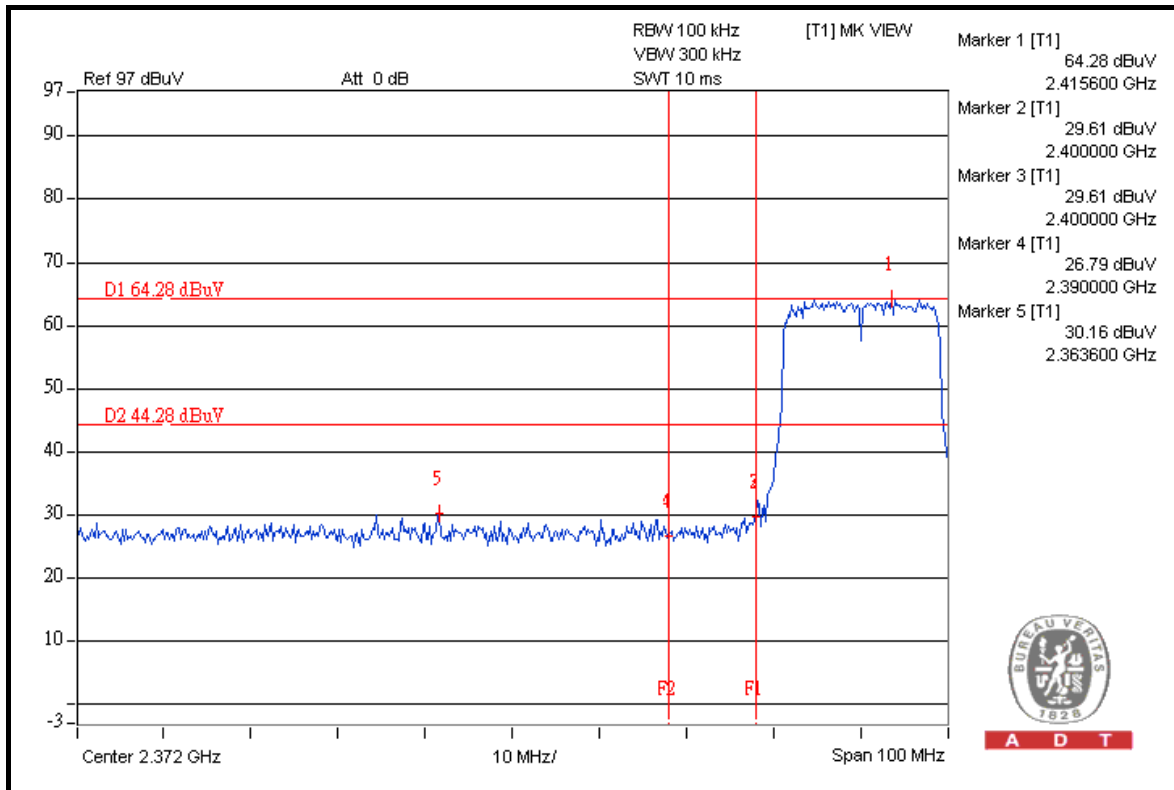



A D T

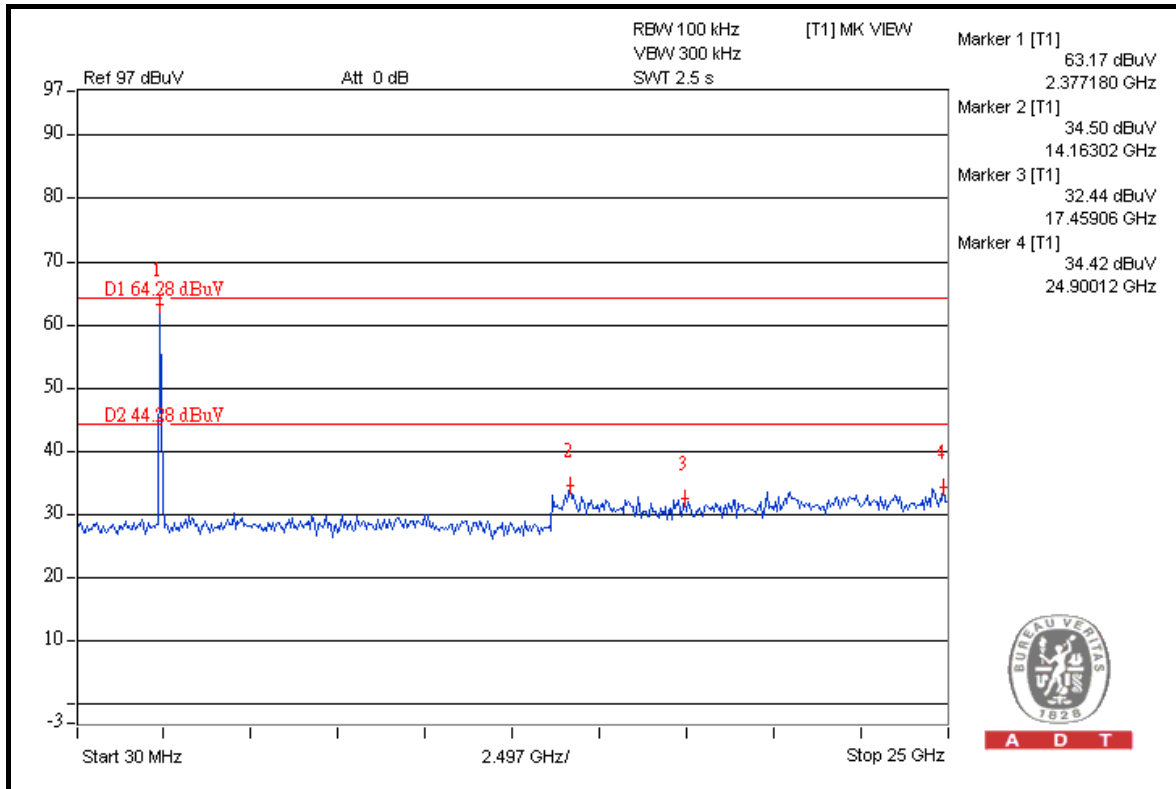

A D T

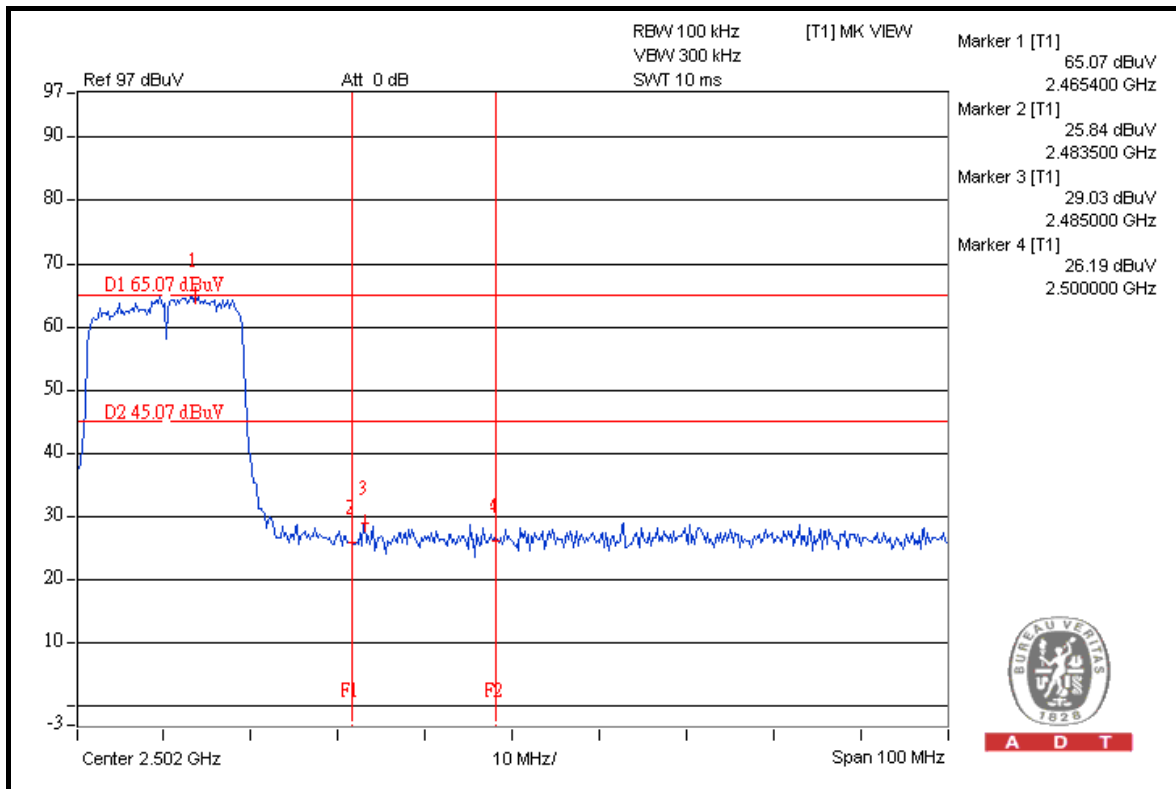

A D T



A D T

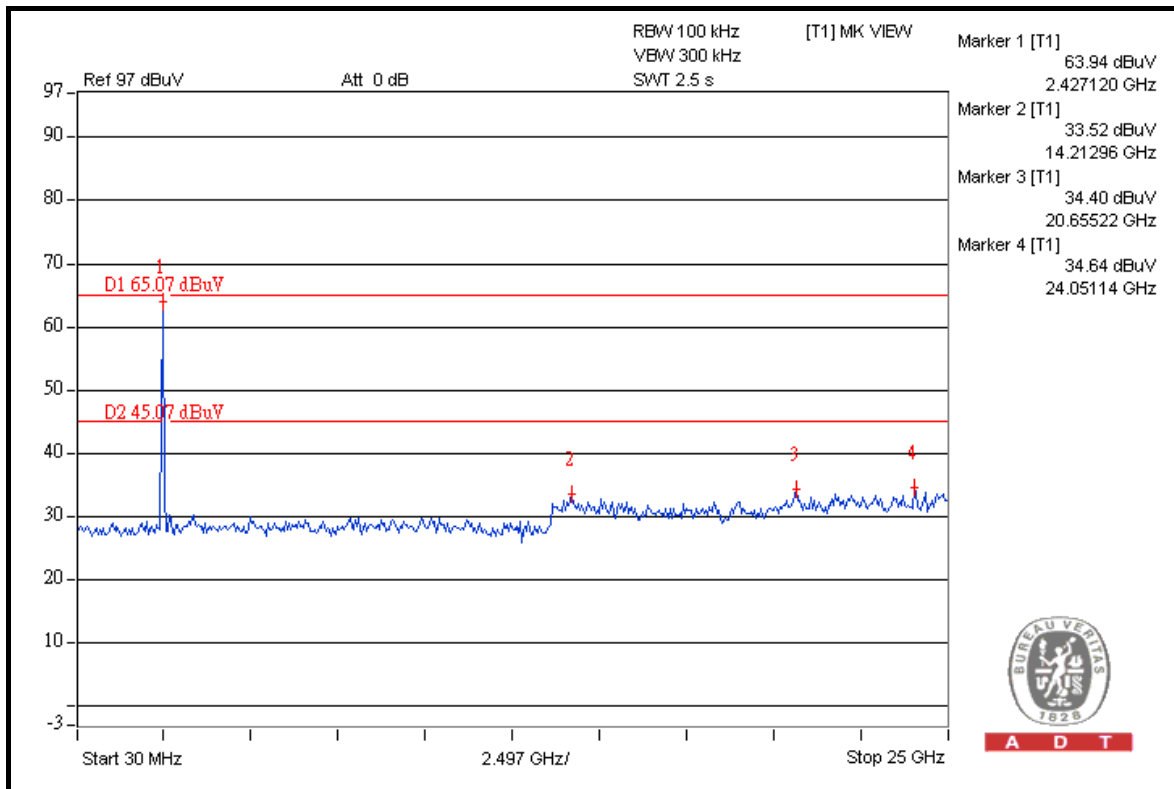
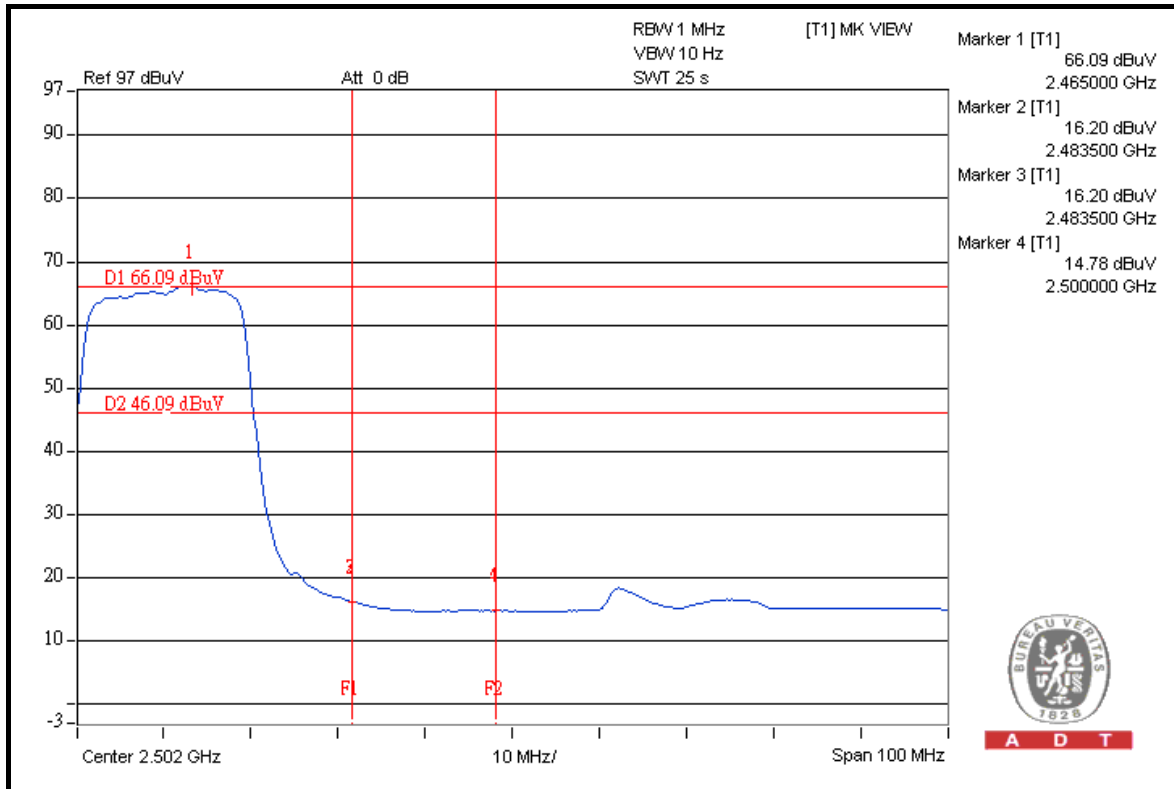



DRAFT 802.11n (40MHz) OFDM MODULATION

NOTE 1: The band edge emission plot on the next page shows 31.32dBc between carrier maximum power and local maximum emission in restrict band (2.37480GHz). The emission of carrier strength list in the test result of channel 1 at the item 4.1.7 is 94.95dBuV/m (Peak), so the maximum field strength in restrict band is $94.95 - 31.32 = 63.63$ dBuV/m which is under 74dBuV/m limit.

The band edge emission plot of on the next page shows 44.84dBc between carrier maximum power and local maximum emission in restrict band (2.39000GHz). The emission of carrier strength list in the test result of channel 1 at the item 4.1.7 is 84.89dBuV/m (Average), so the maximum field strength in restrict band is $84.89 - 44.84 = 40.05$ dBuV/m which is under 54dBuV/m limit.

NOTE 2: The band edge emission plot on the next second page shows 32.37dBc between carrier maximum power and local maximum emission in restrict band (2.49000GHz). The emission of carrier strength list in the test result of channel 7 at the item 4.1.7 is 95.81dBuV/m (Peak), so the maximum field strength in restrict band is $95.81 - 32.37 = 63.44$ dBuV/m which is under 74dBuV/m limit.

The band edge emission plot on the next third page shows 45.61dBc between carrier maximum power and local maximum emission in restrict band (2.48350GHz). The emission of carrier strength list in the test result of channel 7 at the item 4.1.7 is 85.54dBuV/m (Average), so the maximum field strength in restrict band is $85.54 - 45.61 = 39.93$ dBuV/m which is under 54dBuV/m limit.



A D T

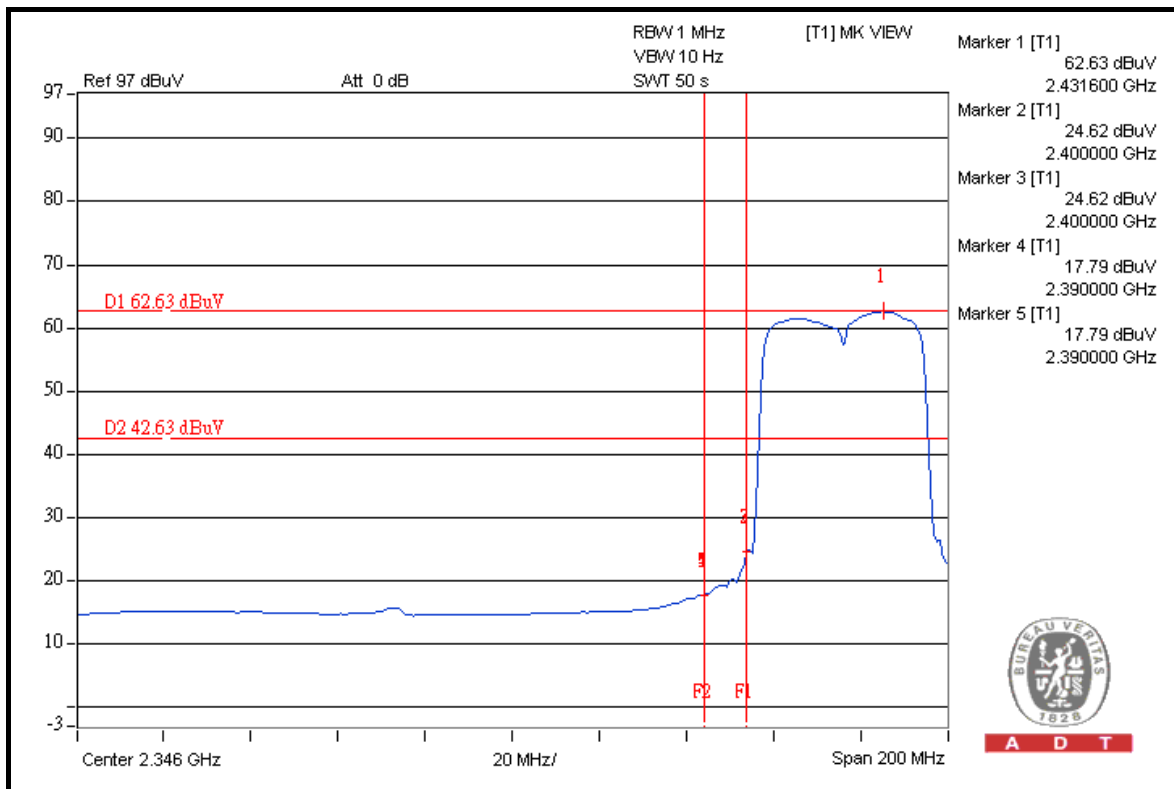
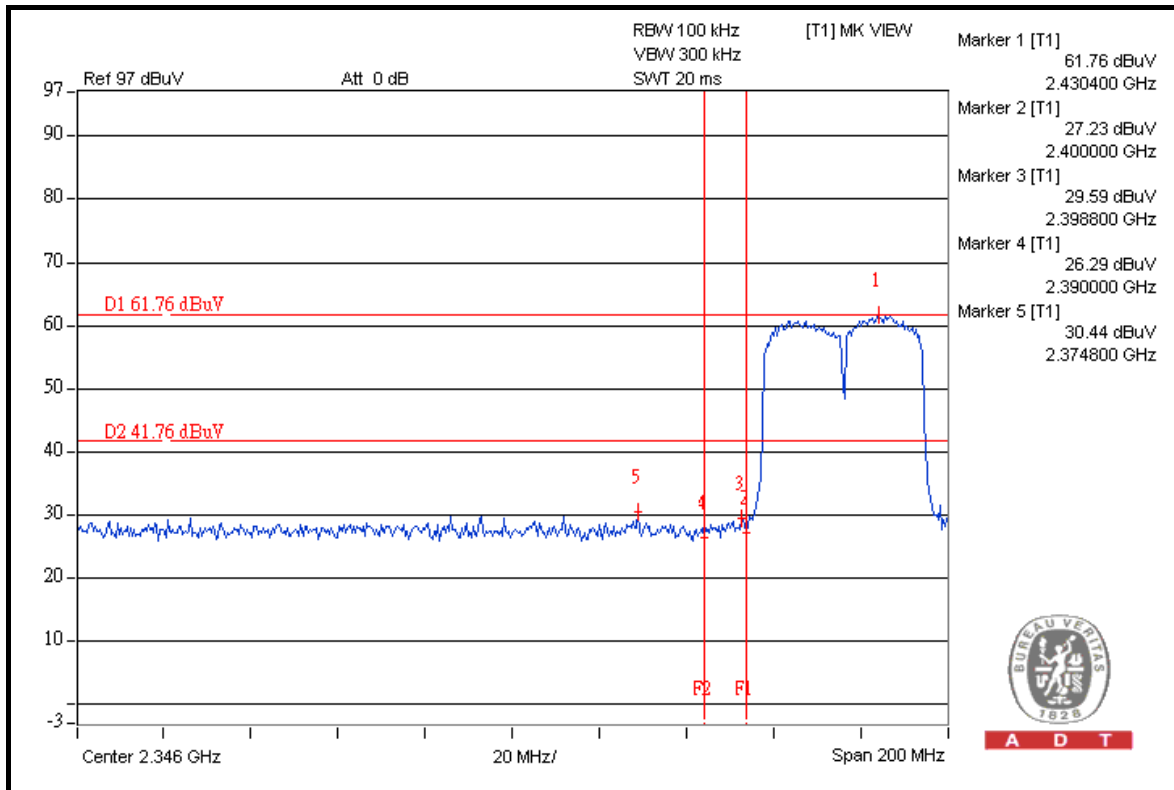



A D T

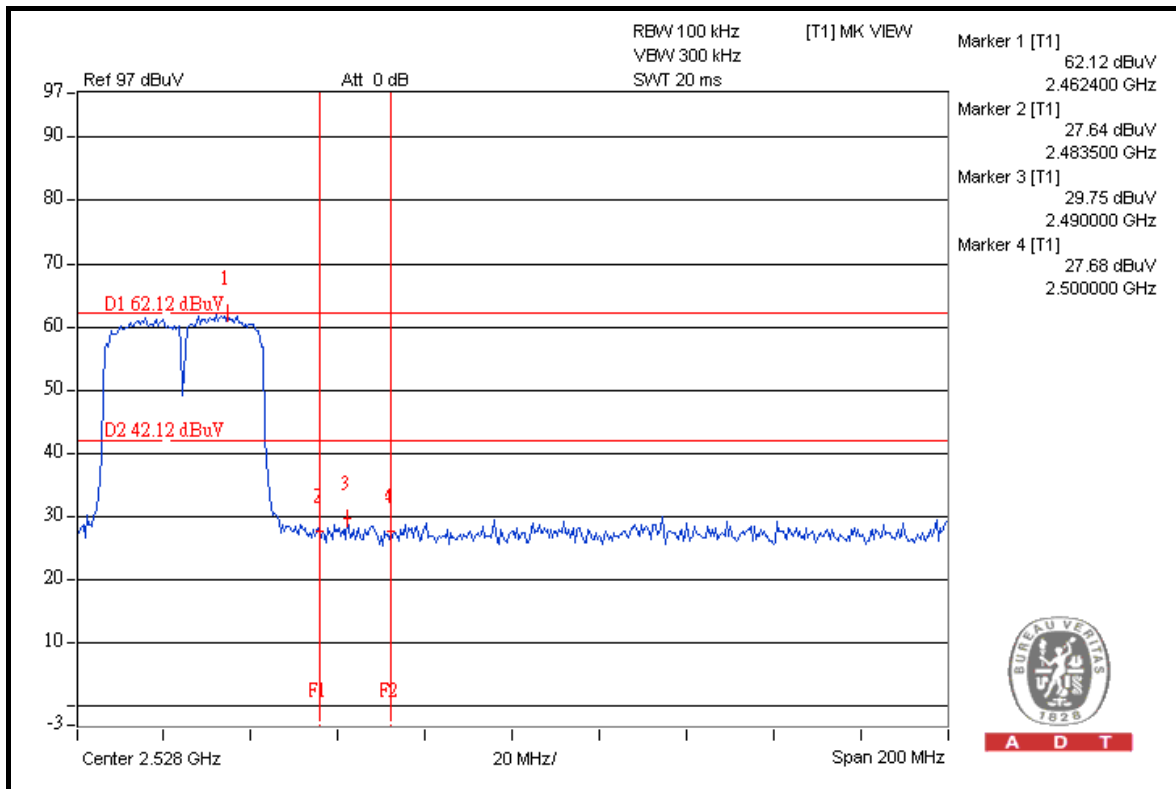
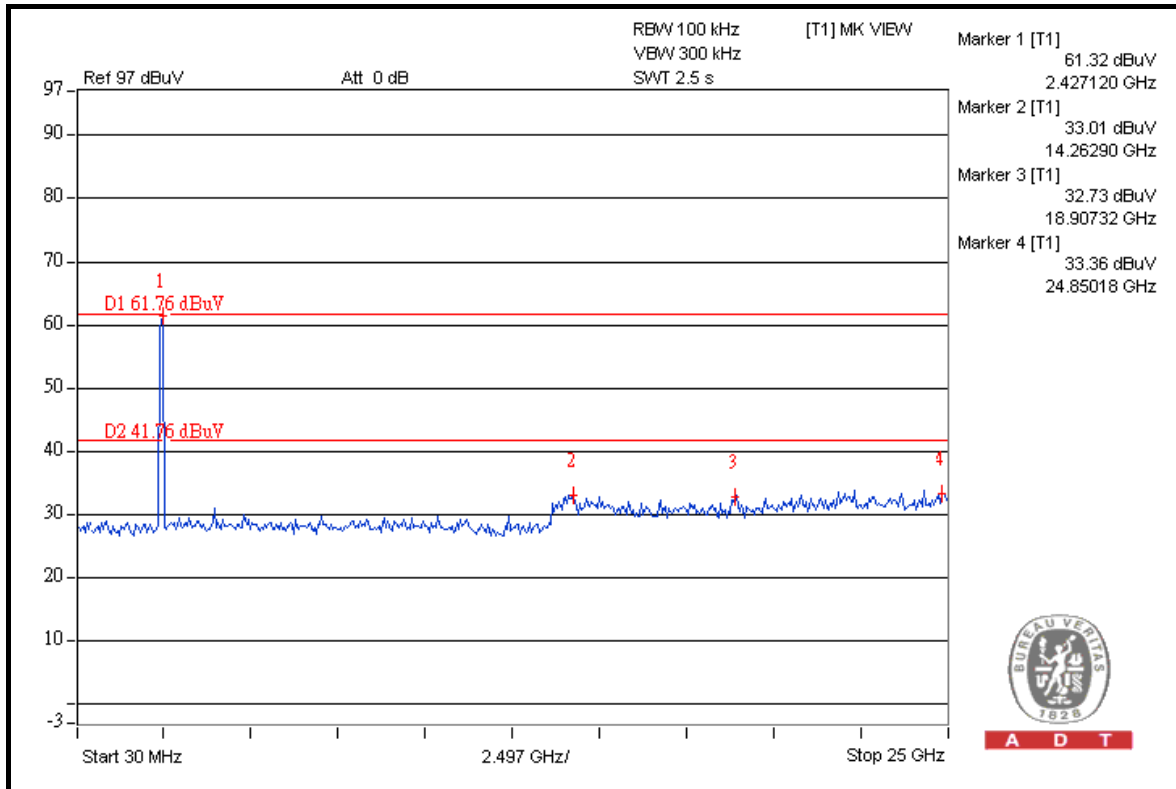



A D T

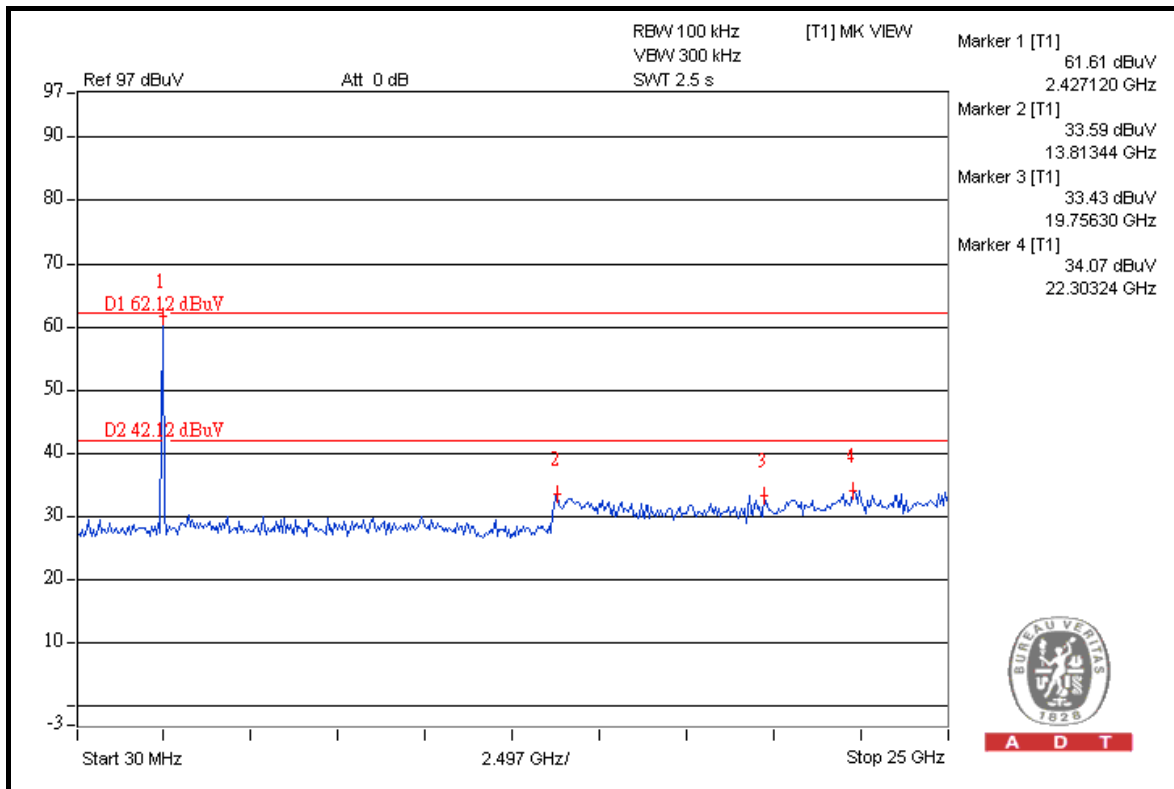
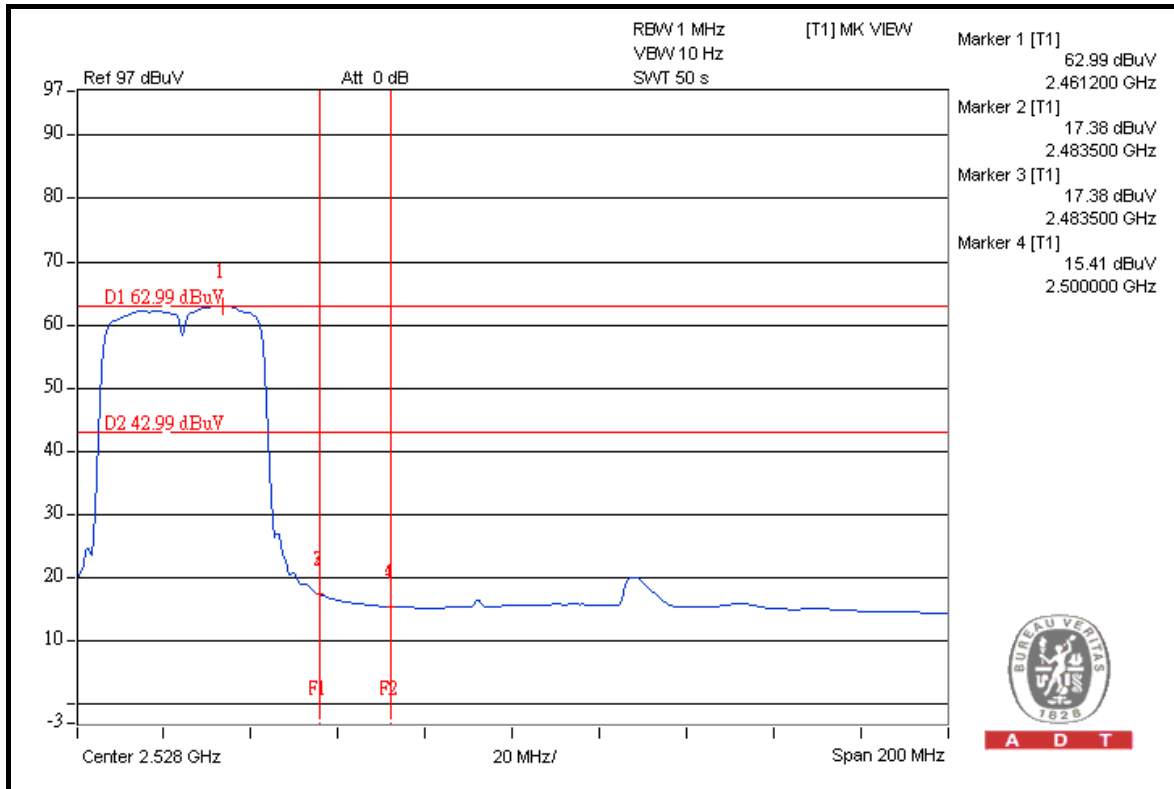



A D T

4.7 ANTENNA REQUIREMENT

4.7.1 STANDARD APPLICABLE

For intentional device, according to FCC 47 CFR Section 15.203, an intentional radiator shall be designed to ensure that no antenna other than that furnished by the responsible party shall be used with the device.

And according to FCC 47 CFR Section 15.247 (b), if transmitting antennas of directional gain greater than 6dBi are used, the power shall be reduced by the amount in dB that the directional gain of the antenna exceeds 6dBi.

4.7.2 ANTENNA CONNECTED CONSTRUCTION

The antenna used in this product is Printed antenna without connector. The maximum gain of the antenna is -3dBi.



A D T

5. PHOTOGRAPHS OF THE TEST CONFIGURATION

Please refer to the attached file (Test Setup Photo).



A D T

6. INFORMATION ON THE TESTING LABORATORIES

We, Bureau Veritas Consumer Products Services (H.K.) Ltd., Taoyuan Branch, were founded in 1988 to provide our best service in EMC, Radio, Telecom and Safety consultation. Our laboratories are accredited and approved by the following approval agencies according to ISO/IEC 17025.

USA	FCC, NVLAP
Germany	TUV Rheinland
Japan	VCCI
Norway	NEMKO
Canada	INDUSTRY CANADA, CSA
R.O.C.	TAF, BSMI, NCC
Netherlands	Telefication
Singapore	GOST-ASIA(MOU)
Russia	CERTIS(MOU)

Copies of accreditation certificates of our laboratories obtained from approval agencies can be downloaded from our web site:

www.adt.com.tw/index.5/phtml. If you have any comments, please feel free to contact us at the following:

Linko EMC/RF Lab:
Tel: 886-2-26052180
Fax: 886-2-26051924

Hsin Chu EMC/RF Lab:
Tel: 886-3-5935343
Fax: 886-3-5935342

Hwa Ya EMC/RF/Safety Telecom Lab:
Tel: 886-3-3183232
Fax: 886-3-3185050

Web Site: www.adt.com.tw

The address and road map of all our labs can be found in our web site also.



A D T

7. APPENDIX A - MODIFICATIONS RECORDERS FOR ENGINEERING CHANGES TO THE EUT BY THE LAB

No any modifications are made to the EUT by the lab during the test.

---END---