



A D T

FCC TEST REPORT

REPORT NO.: RF990118L07

MODEL NO.: ESR9855G

RECEIVED: Jan. 18, 2010

TESTED: Jan. 19 ~ Jan. 29, 2010

ISSUED: Feb. 03, 2010

APPLICANT: Senao Networks, Inc.

ADDRESS: 3F, No. 529, Chung Cheng Rd., Hsintien, Taipei,
Taiwan, R.O.C.

ISSUED BY: Bureau Veritas Consumer Products Services
(H.K.) Ltd., Taoyuan Branch

LAB ADDRESS: No. 47, 14th Ling, Chia Pau Tsuen, Lin Kou
Hsiang, Taipei Hsien 244, Taiwan, R.O.C.

TEST LOCATION: No. 19, Hwa Ya 2nd Rd, Wen Hwa Tsuen, Kwei
Shan Hsiang, Taoyuan Hsien 333, Taiwan,
R.O.C.

This test report consists of 68 pages in total. It may be duplicated completely for legal use with the approval of the applicant. It should not be reproduced except in full, without the written approval of our laboratory. The client should not use it to claim product endorsement by TAF or any government agencies. The test results in the report only apply to the tested sample.





TABLE OF CONTENTS

1.	CERTIFICATION.....	4
2.	SUMMARY OF TEST RESULTS	5
2.1	MEASUREMENT UNCERTAINTY.....	5
3.	GENERAL INFORMATION.....	6
3.1	GENERAL DESCRIPTION OF EUT	6
3.2	DESCRIPTION OF TEST MODES	7
3.2.1	CONFIGURATION OF SYSTEM UNDER TEST	7
3.2.2	TEST MODE APPLICABILITY AND TESTED CHANNEL DETAIL	8
3.3	GENERAL DESCRIPTION OF APPLIED STANDARDS	10
3.4	DESCRIPTION OF SUPPORT UNITS	10
4.	TEST TYPES AND RESULTS	11
4.1	RADIATED EMISSION MEASUREMENT	11
4.1.1	LIMITS OF RADIATED EMISSION MEASUREMENT.....	11
4.1.2	TEST INSTRUMENTS.....	12
4.1.3	TEST PROCEDURES	13
4.1.4	DEVIATION FROM TEST STANDARD.....	13
4.1.5	TEST SETUP.....	14
4.1.6	EUT OPERATING CONDITIONS	14
4.1.7	TEST RESULTS	15
4.2	CONDUCTED EMISSION MEASUREMENT	28
4.2.1	LIMITS OF CONDUCTED EMISSION MEASUREMENT.....	28
4.2.2	TEST INSTRUMENTS.....	28
4.2.3	TEST PROCEDURES	29
4.2.4	DEVIATION FROM TEST STANDARD.....	29
4.2.5	TEST SETUP.....	30
4.2.6	EUT OPERATING CONDITIONS	30
4.2.7	TEST RESULTS	31
4.3	6dB BANDWIDTH MEASUREMENT.....	33
4.3.1	LIMITS OF 6dB BANDWIDTH MEASUREMENT	33
4.3.2	TEST INSTRUMENTS.....	33
4.3.3	TEST PROCEDURE.....	33
4.3.4	DEVIATION FROM TEST STANDARD.....	33
4.3.5	TEST SETUP.....	34
4.3.6	EUT OPERATING CONDITIONS	34
4.3.7	TEST RESULTS	35
4.4	MAXIMUM OUTPUT POWER	39
4.4.1	LIMITS OF MAXIMUM OUTPUT POWER MEASUREMENT.....	39
4.4.2	INSTRUMENTS.....	39
4.4.3	TEST PROCEDURE.....	39



4.4.4	DEVIATION FROM TEST STANDARD.....	40
4.4.5	TEST SETUP.....	40
4.4.6	EUT OPERATING CONDITIONS.....	40
4.4.7	TEST RESULTS.....	41
4.5	POWER SPECTRAL DENSITY MEASUREMENT.....	42
4.5.1	LIMITS OF POWER SPECTRAL DENSITY MEASUREMENT.....	42
4.5.2	TEST INSTRUMENTS.....	42
4.5.3	TEST PROCEDURE.....	42
4.5.4	DEVIATION FROM TEST STANDARD.....	43
4.5.5	TEST SETUP.....	43
4.5.6	EUT OPERATING CONDITION.....	43
4.5.7	TEST RESULTS.....	44
4.6	BAND EDGES MEASUREMENT.....	48
4.6.1	LIMITS OF BAND EDGES MEASUREMENT.....	48
4.6.2	TEST INSTRUMENTS.....	48
4.6.3	TEST PROCEDURE.....	49
4.6.4	DEVIATION FROM TEST STANDARD.....	49
4.6.5	EUT OPERATING CONDITION.....	49
4.6.6	TEST RESULTS.....	50
5.	PHOTOGRAPHS OF THE TEST CONFIGURATION.....	66
6.	INFORMATION ON THE TESTING LABORATORIES.....	67
7.	APPENDIX A - MODIFICATIONS RECORDERS FOR ENGINEERING CHANGES TO THE EUT BY THE LAB.....	68



A D T

1. CERTIFICATION

PRODUCT: Wireless 300N Gigabit Gaming Router

MODEL: ESR9855G

BRAND: EnGenius

APPLICANT: Senao Networks, Inc.

TEST SAMPLE: ENGINEERING SAMPLE

TESTED: Jan. 19 ~ Jan. 29, 2010

STANDARDS: FCC Part 15, Subpart C (Section 15.247)

ANSI C63.4-2003

The above equipment (Model: ESR9855G) has been tested by **Bureau Veritas Consumer Products Services (H.K.) Ltd., Taoyuan Branch**, and found compliance with the requirement of the above standards. The test record, data evaluation & Equipment Under Test (EUT) configurations represented herein are true and accurate accounts of the measurements of the sample's EMC characteristics under the conditions specified in this report.

PREPARED BY : Polly Chien , **DATE** : Feb. 03, 2010
Polly Chien / Specialist

TECHNICAL ACCEPTANCE : Long Chen , **DATE** : Feb. 03, 2010
Responsible for RF Long Chen / Senior Engineer

APPROVED BY : Gary Chang , **DATE** : Feb. 03, 2010
Gary Chang / Assistant Manager



2. SUMMARY OF TEST RESULTS

The EUT has been tested according to the following specifications:

APPLIED STANDARD: FCC PART 15, SUBPART C (SECTION 15.247)			
STANDARD SECTION	TEST TYPE AND LIMIT	RESULT	REMARK
15.207	AC Power Conducted Emission	PASS	Meet the requirement of limit. Minimum passing margin is -18.27dB at 0.326MHz.
15.247(a)(2)	Spectrum Bandwidth of a Direct Sequence Spread Spectrum System Limit: min. 500kHz	PASS	Meet the requirement of limit.
15.247(b)	Maximum Output Power Limit: max. 30dBm	PASS	Meet the requirement of limit.
15.247(d)	Radiated Emissions Limit: Table 15.209	PASS	Meet the requirement of limit. Minimum passing margin is -0.6dB at 2483.50MHz.
15.247(e)	Power Spectral Density Limit: max. 8dBm	PASS	Meet the requirement of limit.
15.247(d)	Band Edge Measurement Limit: 20dB less than the peak value of fundamental frequency	PASS	Meet the requirement of limit.
15.203	Antenna Requirement	PASS	Antenna connector is RSMA not a standard connector.

2.1 MEASUREMENT UNCERTAINTY

Where relevant, the following measurement uncertainty levels have been estimated for tests performed on the EUT as specified in CISPR 16-4-2:

MEASUREMENT	FREQUENCY	UNCERTAINTY
Conducted emissions	150kHz~30MHz	2.44 dB
Radiated emissions	30MHz ~ 200MHz	3.34 dB
	200MHz ~1000MHz	3.35 dB
	1GHz ~ 18GHz	2.26 dB
	18GHz ~ 40GHz	1.94 dB

This uncertainty represents an expanded uncertainty expressed at approximately the 95% confidence level using a coverage factor of $k = 2$.



3. GENERAL INFORMATION

3.1 GENERAL DESCRIPTION OF EUT

EUT	Wireless 300N Gigabit Gaming Router
MODEL NO.	ESR9855G
FCC ID	U2M-SR9855G
POWER SUPPLY	12Vdc
MODULATION TYPE	CCK, DQPSK, DBPSK for DSSS 64QAM, 16QAM, QPSK, BPSK for OFDM
MODULATION TECHNOLOGY	DSSS, OFDM
TRANSFER RATE	802.11b: 11/5.5/2/1Mbps 802.11g: 54/48/36/24/18/12/9/6Mbps 802.11n: up to 270Mbps
OPERATING FREQUENCY	2412 ~ 2462MHz
NUMBER OF CHANNEL	11 for 802.11b, 802.11g, 802.11n (20MHz) 7 for 802.11n (40MHz)
OUTPUT POWER	347.7mW
ANTENNA TYPE	Dipole antenna with 3dBi gain
ANTENNA CONNECTOR	RSMA
I/O PORTS	RJ45
DATA CABLE	NA
ACCESSORY DEVICES	AC Adapter

NOTE:

- The EUT was powered by the following adapter:

BRAND:	DVE
MODEL:	DSA-15P-12 US 120150
INPUT:	100-240Vac, 50/60Hz, 0.5A
OUTPUT:	+12Vdc, 1.25A
POWER LINE:	1.8m non-shielded cable without core

- The EUT incorporates a MIMO function. Physically, the EUT provides two completed transmitters and two receivers.

MODULATION MODE	TX FUNCTION
802.11b	1TX
802.11g	2TX
802.11n (20MHz)	2TX
802.11n (40MHz)	2TX

- The above EUT information was declared by manufacturer and for more detailed features description, please refer to the manufacturer's specifications or user's manual.

3.2 DESCRIPTION OF TEST MODES

11 channels are provided for 802.11b, 802.11g and 802.11n (20MHz):

CHANNEL	FREQUENCY	CHANNEL	FREQUENCY
1	2412MHz	7	2442MHz
2	2417MHz	8	2447MHz
3	2422MHz	9	2452MHz
4	2427MHz	10	2457MHz
5	2432MHz	11	2462MHz
6	2437MHz		

7 channels are provided for 802.11n (40MHz):

CHANNEL	FREQUENCY	CHANNEL	FREQUENCY
1	2422MHz	5	2442MHz
2	2427MHz	6	2447MHz
3	2432MHz	7	2452MHz
4	2437MHz		

3.2.1 CONFIGURATION OF SYSTEM UNDER TEST

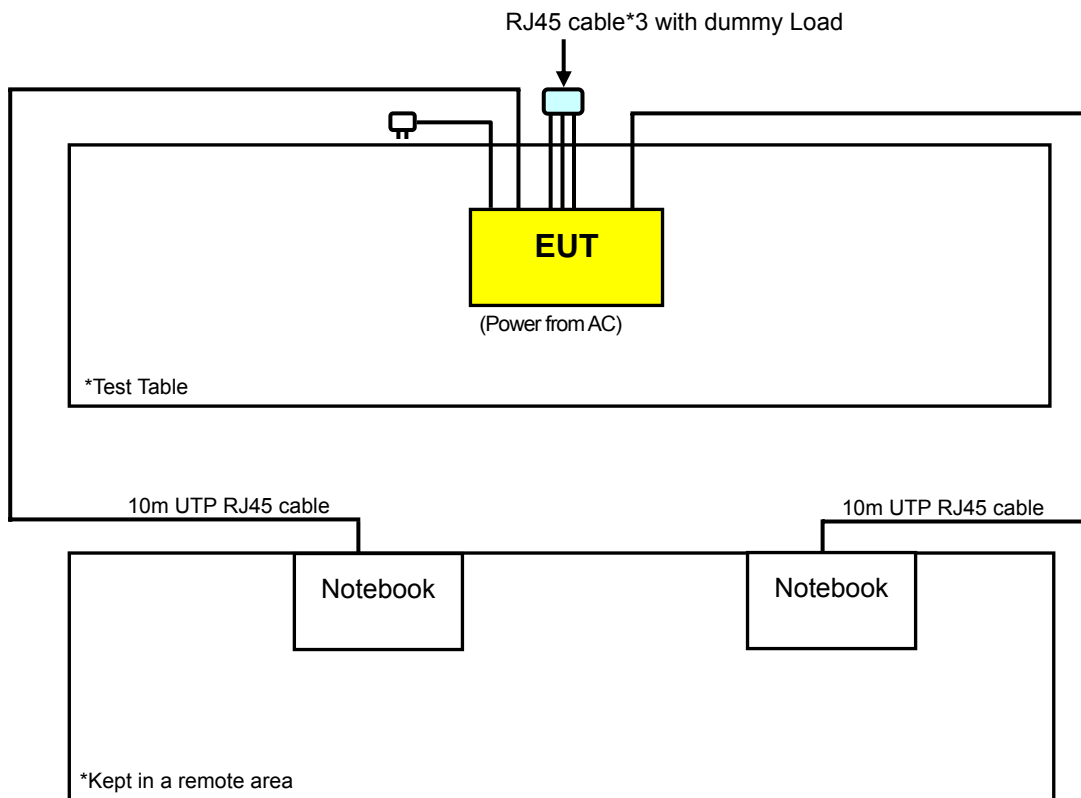

3.2.2 TEST MODE APPLICABILITY AND TESTED CHANNEL DETAIL

EUT CONFIGURE MODE	APPLICABLE TO				DESCRIPTION
	RE≥1G	RE<1G	PLC	APCM	
-	√	√	√	√	-

Where **RE≥1G**: Radiated Emission above 1GHz **RE<1G**: Radiated Emission below 1GHz
PLC: Power Line Conducted Emission **APCM**: Antenna Port Conducted Measurement

RADIATED EMISSION TEST (ABOVE 1GHz):

- Pre-Scan has been conducted to determine the worst-case mode from all possible combinations between available modulations, data rates, XYZ axis and antenna ports (if EUT with antenna diversity architecture).
- Following channel(s) was (were) selected for the final test as listed below.

EUT CONFIGURE MODE	MODE	AVAILABLE CHANNEL	TESTED CHANNEL	MODULATION TECHNOLOGY	MODULATION TYPE	DATA RATE (Mbps)	AXIS
-	802.11b	1 to 11	1, 6, 11	DSSS	DBPSK	1.0	Z
-	802.11g	1 to 11	1, 6, 11	OFDM	BPSK	6.0	Z
-	802.11n (20MHz)	1 to 11	1, 6, 11	OFDM	BPSK	6.5	Z
-	802.11n (40MHz)	1 to 7	1, 4, 7	OFDM	BPSK	13.5	Z

RADIATED EMISSION TEST (BELOW 1GHz):

- Pre-Scan has been conducted to determine the worst-case mode from all possible combinations between available modulations, data rates, XYZ axis and antenna ports (if EUT with antenna diversity architecture).
- Following channel(s) was (were) selected for the final test as listed below.

EUT CONFIGURE MODE	MODE	AVAILABLE CHANNEL	TESTED CHANNEL	MODULATION TECHNOLOGY	MODULATION TYPE	DATA RATE (Mbps)	AXIS
-	802.11g	1 to 11	6	OFDM	BPSK	6.0	Z

POWER LINE CONDUCTED EMISSION TEST:

- Pre-Scan has been conducted to determine the worst-case mode from all possible combinations between available modulations, data rates and antenna ports (if EUT with antenna diversity architecture).
- Following channel(s) was (were) selected for the final test as listed below.

EUT CONFIGURE MODE	MODE	AVAILABLE CHANNEL	TESTED CHANNEL	MODULATION TECHNOLOGY	MODULATION TYPE	DATA RATE (Mbps)
-	802.11g	1 to 11	6	OFDM	BPSK	6.0

BANDEDGE MEASUREMENT:

- Pre-Scan has been conducted to determine the worst-case mode from all possible combinations between available modulations, data rates and antenna ports (if EUT with antenna diversity architecture).
- Following channel(s) was (were) selected for the final test as listed below.

EUT CONFIGURE MODE	MODE	AVAILABLE CHANNEL	TESTED CHANNEL	MODULATION TECHNOLOGY	MODULATION TYPE	DATA RATE (Mbps)
-	802.11b	1 to 11	1, 11	DSSS	DBPSK	1.0
-	802.11g	1 to 11	1, 11	OFDM	BPSK	6.0
-	802.11n (20MHz)	1 to 11	1, 11	OFDM	BPSK	6.5
-	802.11n (40MHz)	1 to 7	1, 7	OFDM	BPSK	13.5

ANTENNA PORT CONDUCTED MEASUREMENT:

- This item includes all test value of each mode, but only includes spectrum plot of worst value of each mode.
- Pre-Scan has been conducted to determine the worst-case mode from all possible combinations between available modulations, data rates and antenna ports (if EUT with antenna diversity architecture).
- Following channel(s) was (were) selected for the final test as listed below.

EUT CONFIGURE MODE	MODE	AVAILABLE CHANNEL	TESTED CHANNEL	MODULATION TECHNOLOGY	MODULATION TYPE	DATA RATE (Mbps)
-	802.11b	1 to 11	1, 6, 11	DSSS	DBPSK	1.0
-	802.11g	1 to 11	1, 6, 11	OFDM	BPSK	6.0
-	802.11n (20MHz)	1 to 11	1, 6, 11	OFDM	BPSK	6.5
-	802.11n (40MHz)	1 to 7	1, 4, 7	OFDM	BPSK	13.5

TEST CONDITION:

APPLICABLE TO	ENVIRONMENTAL CONDITIONS	INPUT POWER (SYSTEM)	TESTED BY
RE \geq 1G	23deg. C, 63%RH, 1008 hPa	120Vac, 60Hz	Brad Wu, Lori Chiu
RE $<$ 1G	23deg. C, 65%RH, 1006 hPa	120Vac, 60Hz	Brad Wu
PLC	23deg. C, 75%RH, 1005 hPa	120Vac, 60Hz	Tim Mie
APCM	23deg. C, 63%RH, 1009 hPa	120Vac, 60Hz	Brad Wu



3.3 GENERAL DESCRIPTION OF APPLIED STANDARDS

The EUT is a RF Product. According to the specifications of the manufacturer, it must comply with the requirements of the following standards:

FCC Part 15, Subpart C (15.247)
ANSI C63.4-2003

All test items have been performed and recorded as per the above standards.

NOTE: The EUT is also considered as a kind of computer peripheral, because the connection to computer is necessary for typical use. It has been verified to comply with the requirements of FCC Part 15, Subpart B, Class B (DoC). The test report has been issued separately.

3.4 DESCRIPTION OF SUPPORT UNITS

The EUT has been tested as an independent unit together with other necessary accessories or support units. The following support units or accessories were used to form a representative test configuration during the tests.

NO.	PRODUCT	BRAND	MODEL NO.	SERIAL NO.	FCC ID
1	NOTEBOOK	DELL	D531	CN-0XM006-48643 -81U-2610	QDS-BRCM1020
2	NOTEBOOK	DELL	D531	CN-0XM006-48643 -81U-2973	QDS-BRCM1020

NO.	SIGNAL CABLE DESCRIPTION OF THE ABOVE SUPPORT UNITS
1	10m UTP RJ45 cable.
2	10m UTP RJ45 cable.

NOTE: 1. All power cords of the above support units are non shielded (1.8m).
2. Items 1~2 acted as communication partners to transfer data.



A D T

4. TEST TYPES AND RESULTS

4.1 RADIATED EMISSION MEASUREMENT

4.1.1 LIMITS OF RADIATED EMISSION MEASUREMENT

Emissions radiated outside of the specified bands, shall be according to the general radiated limits in 15.209 as following:

FREQUENCIES (MHz)	FIELD STRENGTH (microvolts/meter)	MEASUREMENT DISTANCE (meters)
0.009 ~ 0.490	2400/F(kHz)	300
0.490 ~ 1.705	24000/F(kHz)	30
1.705 ~ 30.0	30	30
30 ~ 88	100	3
88 ~ 216	150	3
216 ~ 960	200	3
Above 960	500	3

NOTE:

1. The lower limit shall apply at the transition frequencies.
2. Emission level (dBuV/m) = 20 log Emission level (uV/m).
3. As shown in 15.35(b), for frequencies above 1000MHz, the field strength limits are based on average detector, however, the peak field strength of any emission shall not exceed the maximum permitted average limits, specified above by more than 20dB under any condition of modulation.



A D T

4.1.2 TEST INSTRUMENTS

DESCRIPTION & MANUFACTURER	MODEL NO.	SERIAL NO.	DATE OF CALIBRATION	DUE DATE OF CALIBRATION
Test Receiver ROHDE & SCHWARZ	ESI7	100033	Jul. 06, 2009	Jul. 05, 2010
Spectrum Analyzer ROHDE & SCHWARZ	FSP40	100076	May 26, 2009	May 25, 2010
BILOG Antenna SCHWARZBECK	VULB9168	9168-160	Apr. 27, 2009	Apr. 26, 2010
HORN Antenna SCHWARZBECK	9120D	9120D-209	Jul. 01, 2009	Jun. 30, 2010
HORN Antenna SCHWARZBECK	BBHA 9170	BBHA9170243	Dec. 25, 2009	Dec. 24, 2010
Preamplifier Agilent	8447D	2944A10633	Nov. 10, 2009	Nov. 09, 2010
Preamplifier Agilent	8449B	3008A01964	Nov. 09, 2009	Nov. 08, 2010
RF signal cable HUBER+SUHNNER	SUCOFLEX 104	238141/4	May 13, 2009	May 12, 2010
RF signal cable HUBER+SUHNNER	SUCOFLEX 104	12738/6	May 13, 2009	May 12, 2010
Software ADT.	ADT_Radiated_ V7.6.15.9.2	NA	NA	NA
Antenna Tower inn-co GmbH	MA 4000	013303	NA	NA
Antenna Tower Controller inn-co GmbH	CO2000	017303	NA	NA
Turn Table ADT.	TT100.	TT93021703	NA	NA
Turn Table Controller ADT.	SC100.	SC93021703	NA	NA

- NOTE:**
1. The calibration interval of the above test instruments is 12 months and the calibrations are traceable to NML/ROC and NIST/USA.
 2. The test was performed in HwaYa Chamber 3.
 3. The horn antenna and HP preamplifier (model: 8449B) are used only for the measurement of emission frequency above 1GHz if tested.
 4. The FCC Site Registration No. is 988962.
 5. The IC Site Registration No. is IC 7450F-3.



A D T

4.1.3 TEST PROCEDURES

- a. The EUT was placed on the top of a rotating table 0.8 meters above the ground at a 3 meters semi-anechoic chamber. The table was rotated 360 degrees to determine the position of the highest radiation.
- b. The EUT was set 3 meters away from the interference-receiving antenna, which was mounted on the top of a variable-height antenna tower.
- c. The antenna is a broadband antenna, and its height is varied from one meter to four meters above the ground to determine the maximum value of the field strength. Both horizontal and vertical polarizations of the antenna are set to make the measurement.
- d. For each suspected emission, the EUT was arranged to its worst case and then the antenna was tuned to heights from 1 meter to 4 meters and the rotatable table was turned from 0 degrees to 360 degrees to find the maximum reading.
- e. The test-receiver system was set to Peak Detect Function and Specified Bandwidth with Maximum Hold Mode.
- f. If the emission level of the EUT in peak mode was lower than the limit specified, then testing could be stopped and the peak values of the EUT would be reported. Otherwise the emissions would be re-tested one by one using peak, quasi-peak or average method as specified and then reported in a data sheet.

NOTE:

1. The resolution bandwidth and video bandwidth of test receiver/spectrum analyzer is 120kHz for Quasi-peak detection at frequency below 1GHz.
2. The resolution bandwidth of test receiver/spectrum analyzer is 1MHz and video bandwidth is 3MHz for Peak detection at frequency above 1GHz.
3. The resolution bandwidth of test receiver/spectrum analyzer is 1MHz and the video bandwidth is 10Hz for Average detection (AV) at frequency above 1GHz.
4. All modes of operation were investigated and the worst-case emissions are reported.

4.1.4 DEVIATION FROM TEST STANDARD

No deviation.

4.1.5 TEST SETUP

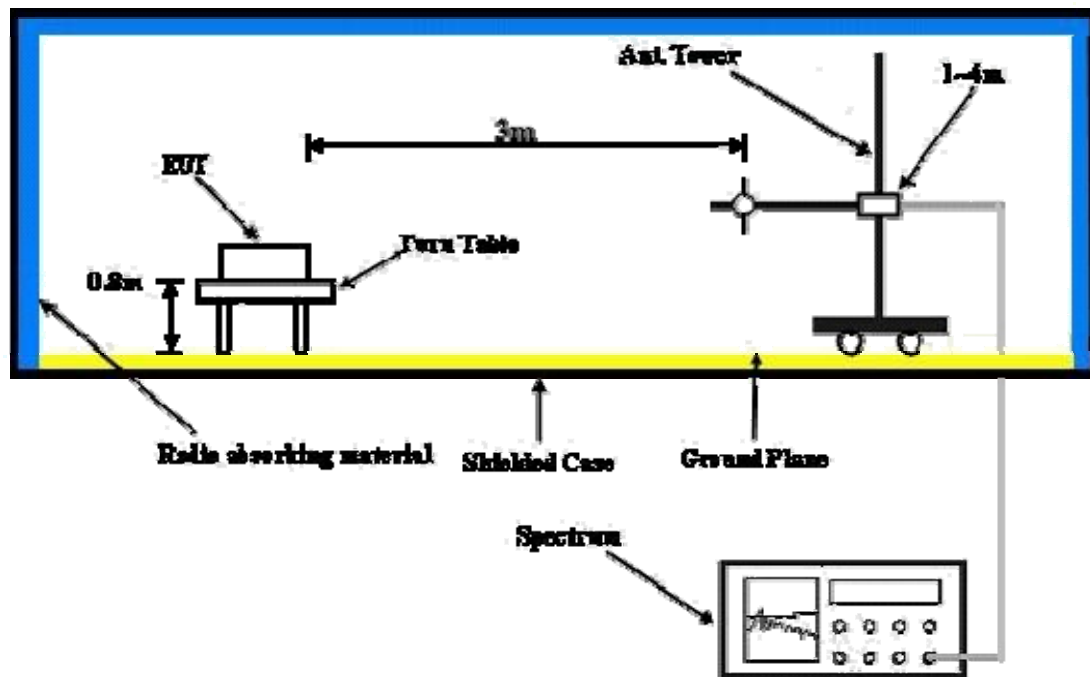

For the actual test configuration, please refer to the attached file (Test Setup Photo).

4.1.6 EUT OPERATING CONDITIONS

- a. Placed the EUT on the testing table.
- b. Prepared notebook systems to act as communication partners and placed them outside of testing area.
- c. The communication partners connected with EUT via a RJ45 cable and run a test program (provided by manufacturer) to enable EUT under transmission condition continuously at specific channel frequency.
- d. The necessary accessories enable the EUT in full functions.



A D T

4.1.7 TEST RESULTS

802.11b

EUT TEST CONDITION		MEASUREMENT DETAIL	
CHANNEL	Channel 1	FREQUENCY RANGE	1 ~ 25GHz
INPUT POWER	120Vac, 60 Hz	DETECTOR FUNCTION	Peak (PK) Average (AV)
ENVIRONMENTAL CONDITIONS	23deg. C, 63%RH 1008 hPa	TESTED BY	Brad Wu

ANTENNA POLARITY & TEST DISTANCE: HORIZONTAL AT 3 M								
NO.	FREQ. (MHz)	EMISSION LEVEL (dBuV/m)	LIMIT (dBuV/m)	MARGIN (dB)	ANTENNA HEIGHT (m)	TABLE ANGLE (Degree)	RAW VALUE (dBuV)	CORRECTION FACTOR (dB/m)
1	2288.00	55.7 PK	74.0	-18.3	1.00 H	20	25.60	30.10
2	2288.00	44.8 AV	54.0	-9.2	1.00 H	20	14.70	30.10
3	2376.00	56.7 PK	74.0	-17.3	1.43 H	11	26.30	30.40
4	2376.00	44.5 AV	54.0	-9.5	1.43 H	11	14.10	30.40
5	*2412.00	98.7 PK			1.43 H	11	68.10	30.60
6	*2412.00	94.6 AV			1.43 H	11	64.00	30.60
7	4824.00	49.2 PK	74.0	-24.8	1.41 H	26	13.10	36.10
8	4824.00	41.4 AV	54.0	-12.6	1.41 H	26	5.30	36.10

ANTENNA POLARITY & TEST DISTANCE: VERTICAL AT 3 M								
NO.	FREQ. (MHz)	EMISSION LEVEL (dBuV/m)	LIMIT (dBuV/m)	MARGIN (dB)	ANTENNA HEIGHT (m)	TABLE ANGLE (Degree)	RAW VALUE (dBuV)	CORRECTION FACTOR (dB/m)
1	2288.00	58.3 PK	74.0	-15.7	1.12 V	358	28.20	30.10
2	2288.00	50.0 AV	54.0	-4.0	1.12 V	358	19.90	30.10
3	2376.00	56.6 PK	74.0	-17.4	1.05 V	354	26.20	30.40
4	2376.00	47.3 AV	54.0	-6.7	1.05 V	354	16.90	30.40
5	*2412.00	110.7 PK			1.05 V	354	80.10	30.60
6	*2412.00	106.5 AV			1.05 V	354	75.90	30.60
7	4824.00	55.3 PK	74.0	-18.7	1.10 V	155	19.20	36.10
8	4824.00	51.1 AV	54.0	-2.9	1.10 V	155	15.00	36.10

- REMARKS:**
1. Emission level (dBuV/m) = Raw Value (dBuV) + Correction Factor (dB/m).
 2. Correction Factor (dB/m) = Antenna Factor (dB/m) + Cable Factor (dB).
 3. The other emission levels were very low against the limit.
 4. Margin value = Emission level – Limit value.
 5. “ * “: Fundamental frequency.



A D T

EUT TEST CONDITION		MEASUREMENT DETAIL	
CHANNEL	Channel 6	FREQUENCY RANGE	1 ~ 25GHz
INPUT POWER	120Vac, 60 Hz	DETECTOR FUNCTION	Peak (PK) Average (AV)
ENVIRONMENTAL CONDITIONS	23deg. C, 63%RH 1008 hPa	TESTED BY	Brad Wu

ANTENNA POLARITY & TEST DISTANCE: HORIZONTAL AT 3 M								
NO.	FREQ. (MHz)	EMISSION LEVEL (dBuV/m)	LIMIT (dBuV/m)	MARGIN (dB)	ANTENNA HEIGHT (m)	TABLE ANGLE (Degree)	RAW VALUE (dBuV)	CORRECTION FACTOR (dB/m)
1	*2437.00	98.4 PK			1.41 H	15	67.80	30.60
2	*2437.00	94.2 AV			1.41 H	15	63.60	30.60
3	4874.00	49.6 PK	74.0	-24.4	1.35 H	18	13.40	36.20
4	4874.00	41.9 AV	54.0	-12.1	1.35 H	18	5.70	36.20

ANTENNA POLARITY & TEST DISTANCE: VERTICAL AT 3 M								
NO.	FREQ. (MHz)	EMISSION LEVEL (dBuV/m)	LIMIT (dBuV/m)	MARGIN (dB)	ANTENNA HEIGHT (m)	TABLE ANGLE (Degree)	RAW VALUE (dBuV)	CORRECTION FACTOR (dB/m)
1	*2437.00	110.0 PK			1.04 V	348	79.40	30.60
2	*2437.00	106.3 AV			1.04 V	348	75.70	30.60
3	4874.00	55.4 PK	74.0	-18.6	1.08 V	149	19.20	36.20
4	4874.00	50.7 AV	54.0	-3.3	1.08 V	149	14.50	36.20

- REMARKS:**
1. Emission level (dBuV/m) = Raw Value (dBuV) + Correction Factor (dB/m).
 2. Correction Factor (dB/m) = Antenna Factor (dB/m) + Cable Factor (dB).
 3. The other emission levels were very low against the limit.
 4. Margin value = Emission level – Limit value.
 5. “ * “: Fundamental frequency.



A D T

EUT TEST CONDITION		MEASUREMENT DETAIL	
CHANNEL	Channel 11	FREQUENCY RANGE	1 ~ 25GHz
INPUT POWER	120Vac, 60 Hz	DETECTOR FUNCTION	Peak (PK) Average (AV)
ENVIRONMENTAL CONDITIONS	23deg. C, 63%RH 1008 hPa	TESTED BY	Brad Wu

ANTENNA POLARITY & TEST DISTANCE: HORIZONTAL AT 3 M								
NO.	FREQ. (MHz)	EMISSION LEVEL (dBuV/m)	LIMIT (dBuV/m)	MARGIN (dB)	ANTENNA HEIGHT (m)	TABLE ANGLE (Degree)	RAW VALUE (dBuV)	CORRECTION FACTOR (dB/m)
1	*2462.00	98.9 PK			1.40 H	16	68.20	30.70
2	*2462.00	94.6 AV			1.40 H	16	63.90	30.70
3	2483.50	53.6 PK	74.0	-20.4	1.40 H	16	22.80	30.80
4	2483.50	44.1 AV	54.0	-9.9	1.40 H	16	13.30	30.80
5	4924.00	50.2 PK	74.0	-23.8	1.31 H	24	13.90	36.30
6	4924.00	42.4 AV	54.0	-11.6	1.31 H	24	6.10	36.30
ANTENNA POLARITY & TEST DISTANCE: VERTICAL AT 3 M								
NO.	FREQ. (MHz)	EMISSION LEVEL (dBuV/m)	LIMIT (dBuV/m)	MARGIN (dB)	ANTENNA HEIGHT (m)	TABLE ANGLE (Degree)	RAW VALUE (dBuV)	CORRECTION FACTOR (dB/m)
1	*2462.00	110.3 PK			1.02 V	350	79.60	30.70
2	*2462.00	106.7 AV			1.02 V	350	76.00	30.70
3	2483.50	57.9 PK	74.0	-16.1	1.02 V	350	27.10	30.80
4	2483.50	48.3 AV	54.0	-5.7	1.02 V	350	17.50	30.80
5	4924.00	55.4 PK	74.0	-18.6	1.08 V	145	19.10	36.30
6	4924.00	51.7 AV	54.0	-2.3	1.08 V	145	15.40	36.30

- REMARKS:**
1. Emission level (dBuV/m) = Raw Value (dBuV) + Correction Factor (dB/m).
 2. Correction Factor (dB/m) = Antenna Factor (dB/m) + Cable Factor (dB).
 3. The other emission levels were very low against the limit.
 4. Margin value = Emission level – Limit value.
 5. “ * “: Fundamental frequency.



A D T

802.11g

EUT TEST CONDITION		MEASUREMENT DETAIL	
CHANNEL	Channel 1	FREQUENCY RANGE	1 ~ 25GHz
INPUT POWER	120Vac, 60 Hz	DETECTOR FUNCTION	Peak (PK) Average (AV)
ENVIRONMENTAL CONDITIONS	23deg. C, 63%RH 1008 hPa	TESTED BY	Lori Chiu

ANTENNA POLARITY & TEST DISTANCE: HORIZONTAL AT 3 M								
NO.	FREQ. (MHz)	EMISSION LEVEL (dBuV/m)	LIMIT (dBuV/m)	MARGIN (dB)	ANTENNA HEIGHT (m)	TABLE ANGLE (Degree)	RAW VALUE (dBuV)	CORRECTION FACTOR (dB/m)
1	2376.00	56.3 PK	74.0	-17.7	1.01 H	179	25.90	30.40
2	2376.00	46.5 AV	54.0	-7.5	1.01 H	179	16.10	30.40
3	2390.00	59.3 PK	74.0	-14.7	1.01 H	179	28.80	30.50
4	2390.00	45.6 AV	54.0	-8.4	1.01 H	179	15.10	30.50
5	*2412.00	101.5 PK			1.01 H	179	70.90	30.60
6	*2412.00	88.7 AV			1.01 H	179	58.10	30.60
7	4824.00	46.3 PK	74.0	-27.7	1.20 H	220	10.20	36.10
8	4824.00	34.7 AV	54.0	-19.3	1.20 H	220	-1.40	36.10
ANTENNA POLARITY & TEST DISTANCE: VERTICAL AT 3 M								
NO.	FREQ. (MHz)	EMISSION LEVEL (dBuV/m)	LIMIT (dBuV/m)	MARGIN (dB)	ANTENNA HEIGHT (m)	TABLE ANGLE (Degree)	RAW VALUE (dBuV)	CORRECTION FACTOR (dB/m)
1	2376.00	62.6 PK	74.0	-11.4	1.01 V	352	32.20	30.40
2	2376.00	51.5 AV	54.0	-2.5	1.01 V	352	21.10	30.40
3	2390.00	71.3 PK	74.0	-2.7	1.01 V	7	40.80	30.50
4	2390.00	52.5 AV	54.0	-1.5	1.01 V	7	22.00	30.50
5	*2412.00	114.2 PK			1.00 V	13	83.60	30.60
6	*2412.00	100.9 AV			1.00 V	13	70.30	30.60
7	4824.00	46.8 PK	74.0	-27.2	1.19 V	320	10.70	36.10
8	4824.00	35.2 AV	54.0	-18.8	1.19 V	320	-0.90	36.10

- REMARKS:**
1. Emission level (dBuV/m) = Raw Value (dBuV) + Correction Factor (dB/m).
 2. Correction Factor (dB/m) = Antenna Factor (dB/m) + Cable Factor (dB).
 3. The other emission levels were very low against the limit.
 4. Margin value = Emission level – Limit value.
 5. “ * “: Fundamental frequency.



A D T

EUT TEST CONDITION		MEASUREMENT DETAIL	
CHANNEL	Channel 6	FREQUENCY RANGE	1 ~ 25GHz
INPUT POWER	120Vac, 60 Hz	DETECTOR FUNCTION	Peak (PK) Average (AV)
ENVIRONMENTAL CONDITIONS	23deg. C, 63%RH 1008 hPa	TESTED BY	Lori Chiu

ANTENNA POLARITY & TEST DISTANCE: HORIZONTAL AT 3 M								
NO.	FREQ. (MHz)	EMISSION LEVEL (dBuV/m)	LIMIT (dBuV/m)	MARGIN (dB)	ANTENNA HEIGHT (m)	TABLE ANGLE (Degree)	RAW VALUE (dBuV)	CORRECTION FACTOR (dB/m)
1	2376.00	60.1 PK	74.0	-13.9	1.01 H	355	29.70	30.40
2	2376.00	46.9 AV	54.0	-7.1	1.01 H	355	16.50	30.40
3	*2437.00	102.0 PK			1.14 H	355	71.40	30.60
4	*2437.00	89.1 AV			1.14 H	355	58.50	30.60
5	4874.00	46.6 PK	74.0	-27.4	1.01 H	79	10.40	36.20
6	4874.00	34.8 AV	54.0	-19.2	1.01 H	79	-1.40	36.20
ANTENNA POLARITY & TEST DISTANCE: VERTICAL AT 3 M								
NO.	FREQ. (MHz)	EMISSION LEVEL (dBuV/m)	LIMIT (dBuV/m)	MARGIN (dB)	ANTENNA HEIGHT (m)	TABLE ANGLE (Degree)	RAW VALUE (dBuV)	CORRECTION FACTOR (dB/m)
1	2376.00	62.3 PK	74.0	-11.7	1.01 V	13	31.90	30.40
2	2376.00	52.8 AV	54.0	-1.2	1.01 V	13	22.40	30.40
3	*2437.00	114.5 PK			1.01 V	13	83.90	30.60
4	*2437.00	101.2 AV			1.01 V	13	70.60	30.60
5	4874.00	47.2 PK	74.0	-26.8	1.21 V	169	11.00	36.20
6	4874.00	35.4 AV	54.0	-18.6	1.21 V	169	-0.80	36.20

- REMARKS:**
1. Emission level (dBuV/m) = Raw Value (dBuV) + Correction Factor (dB/m).
 2. Correction Factor (dB/m) = Antenna Factor (dB/m) + Cable Factor (dB).
 3. The other emission levels were very low against the limit.
 4. Margin value = Emission level – Limit value.
 5. “ * “: Fundamental frequency.



A D T

EUT TEST CONDITION		MEASUREMENT DETAIL	
CHANNEL	Channel 11	FREQUENCY RANGE	1 ~ 25GHz
INPUT POWER	120Vac, 60 Hz	DETECTOR FUNCTION	Peak (PK) Average (AV)
ENVIRONMENTAL CONDITIONS	23deg. C, 63%RH 1008 hPa	TESTED BY	Lori Chiu

ANTENNA POLARITY & TEST DISTANCE: HORIZONTAL AT 3 M								
NO.	FREQ. (MHz)	EMISSION LEVEL (dBuV/m)	LIMIT (dBuV/m)	MARGIN (dB)	ANTENNA HEIGHT (m)	TABLE ANGLE (Degree)	RAW VALUE (dBuV)	CORRECTION FACTOR (dB/m)
1	2376.00	60.9 PK	74.0	-13.1	1.10 H	168	30.50	30.40
2	2376.00	46.5 AV	54.0	-7.5	1.10 H	168	16.10	30.40
3	*2462.00	100.1 PK			1.10 H	166	69.40	30.70
4	*2462.00	87.8 AV			1.10 H	166	57.10	30.70
5	2483.50	59.8 PK	74.0	-14.2	1.10 H	166	29.00	30.80
6	2483.50	45.6 AV	54.0	-8.4	1.10 H	166	14.80	30.80
7	4924.00	46.8 PK	74.0	-27.2	1.11 H	185	10.50	36.30
8	4924.00	35.0 AV	54.0	-19.0	1.11 H	185	-1.30	36.30
ANTENNA POLARITY & TEST DISTANCE: VERTICAL AT 3 M								
NO.	FREQ. (MHz)	EMISSION LEVEL (dBuV/m)	LIMIT (dBuV/m)	MARGIN (dB)	ANTENNA HEIGHT (m)	TABLE ANGLE (Degree)	RAW VALUE (dBuV)	CORRECTION FACTOR (dB/m)
1	2376.00	62.2 PK	74.0	-11.8	1.02 V	354	31.80	30.40
2	2376.00	52.3 AV	54.0	-1.7	1.02 V	354	21.90	30.40
3	*2462.00	113.3 PK			1.00 V	14	82.60	30.70
4	*2462.00	100.1 AV			1.00 V	14	69.40	30.70
5	2483.50	70.7 PK	74.0	-3.3	1.21 V	3	39.90	30.80
6	2483.50	51.5 AV	54.0	-2.5	1.21 V	3	20.70	30.80
7	4924.00	47.2 PK	74.0	-26.8	1.02 V	226	10.90	36.30
8	4924.00	35.6 AV	54.0	-18.4	1.02 V	226	-0.70	36.30

- REMARKS:**
1. Emission level (dBuV/m) = Raw Value (dBuV) + Correction Factor (dB/m).
 2. Correction Factor (dB/m) = Antenna Factor (dB/m) + Cable Factor (dB).
 3. The other emission levels were very low against the limit.
 4. Margin value = Emission level – Limit value.
 5. “ * “: Fundamental frequency.



A D T

802.11n (20MHz)

EUT TEST CONDITION		MEASUREMENT DETAIL	
CHANNEL	Channel 1	FREQUENCY RANGE	1 ~ 25GHz
INPUT POWER	120Vac, 60 Hz	DETECTOR FUNCTION	Peak (PK) Average (AV)
ENVIRONMENTAL CONDITIONS	23deg. C, 63%RH 1008 hPa	TESTED BY	Lori Chiu

ANTENNA POLARITY & TEST DISTANCE: HORIZONTAL AT 3 M								
NO.	FREQ. (MHz)	EMISSION LEVEL (dBuV/m)	LIMIT (dBuV/m)	MARGIN (dB)	ANTENNA HEIGHT (m)	TABLE ANGLE (Degree)	RAW VALUE (dBuV)	CORRECTION FACTOR (dB/m)
1	2376.00	56.7 PK	74.0	-17.3	1.00 H	177	26.30	30.40
2	2376.00	46.6 AV	54.0	-7.4	1.00 H	177	16.20	30.40
3	2390.00	59.1 PK	74.0	-14.9	1.00 H	177	28.60	30.50
4	2390.00	45.0 AV	54.0	-9.0	1.00 H	177	14.50	30.50
5	*2412.00	101.3 PK			1.00 H	177	70.70	30.60
6	*2412.00	88.5 AV			1.00 H	177	57.90	30.60
7	4824.00	46.2 PK	74.0	-27.8	1.01 H	204	10.10	36.10
8	4824.00	33.8 AV	54.0	-20.2	1.01 H	204	-2.30	36.10
ANTENNA POLARITY & TEST DISTANCE: VERTICAL AT 3 M								
NO.	FREQ. (MHz)	EMISSION LEVEL (dBuV/m)	LIMIT (dBuV/m)	MARGIN (dB)	ANTENNA HEIGHT (m)	TABLE ANGLE (Degree)	RAW VALUE (dBuV)	CORRECTION FACTOR (dB/m)
1	2376.00	62.7 PK	74.0	-11.3	1.29 V	17	32.30	30.40
2	2376.00	51.6 AV	54.0	-2.4	1.29 V	17	21.20	30.40
3	2390.00	71.5 PK	74.0	-2.5	1.27 V	21	41.00	30.50
4	2390.00	52.0 AV	54.0	-2.0	1.27 V	21	21.50	30.50
5	*2412.00	114.3 PK			1.01 V	13	83.70	30.60
6	*2412.00	101.0 AV			1.01 V	13	70.40	30.60
7	4824.00	46.6 PK	74.0	-27.4	1.01 V	13	10.50	36.10
8	4824.00	34.0 AV	54.0	-20.0	1.01 V	13	-2.10	36.10

- REMARKS:**
1. Emission level (dBuV/m) = Raw Value (dBuV) + Correction Factor (dB/m).
 2. Correction Factor (dB/m) = Antenna Factor (dB/m) + Cable Factor (dB).
 3. The other emission levels were very low against the limit.
 4. Margin value = Emission level – Limit value.
 5. “ * “: Fundamental frequency.



A D T

EUT TEST CONDITION		MEASUREMENT DETAIL	
CHANNEL	Channel 6	FREQUENCY RANGE	1 ~ 25GHz
INPUT POWER	120Vac, 60 Hz	DETECTOR FUNCTION	Peak (PK) Average (AV)
ENVIRONMENTAL CONDITIONS	23deg. C, 63%RH 1008 hPa	TESTED BY	Lori Chiu

ANTENNA POLARITY & TEST DISTANCE: HORIZONTAL AT 3 M								
NO.	FREQ. (MHz)	EMISSION LEVEL (dBuV/m)	LIMIT (dBuV/m)	MARGIN (dB)	ANTENNA HEIGHT (m)	TABLE ANGLE (Degree)	RAW VALUE (dBuV)	CORRECTION FACTOR (dB/m)
1	2376.00	60.3 PK	74.0	-13.7	1.00 H	183	29.90	30.40
2	2376.00	46.2 AV	54.0	-7.8	1.00 H	183	15.80	30.40
3	*2437.00	102.1 PK			1.00 H	183	71.50	30.60
4	*2437.00	89.3 AV			1.00 H	183	58.70	30.60
5	4874.00	46.0 PK	74.0	-28.0	1.03 H	25	9.80	36.20
6	4874.00	34.1 AV	54.0	-19.9	1.03 H	25	-2.10	36.20
ANTENNA POLARITY & TEST DISTANCE: VERTICAL AT 3 M								
NO.	FREQ. (MHz)	EMISSION LEVEL (dBuV/m)	LIMIT (dBuV/m)	MARGIN (dB)	ANTENNA HEIGHT (m)	TABLE ANGLE (Degree)	RAW VALUE (dBuV)	CORRECTION FACTOR (dB/m)
1	2376.00	62.1 PK	74.0	-11.9	1.02 V	352	31.70	30.40
2	2376.00	52.4 AV	54.0	-1.6	1.02 V	352	22.00	30.40
3	*2437.00	114.8 PK			1.01 V	8	84.20	30.60
4	*2437.00	101.8 AV			1.01 V	8	71.20	30.60
5	4874.00	46.9 PK	74.0	-27.1	1.01 V	119	10.70	36.20
6	4874.00	34.2 AV	54.0	-19.8	1.01 V	119	-2.00	36.20

- REMARKS:**
1. Emission level (dBuV/m) = Raw Value (dBuV) + Correction Factor (dB/m).
 2. Correction Factor (dB/m) = Antenna Factor (dB/m) + Cable Factor (dB).
 3. The other emission levels were very low against the limit.
 4. Margin value = Emission level – Limit value.
 5. “ * “: Fundamental frequency.



A D T

EUT TEST CONDITION		MEASUREMENT DETAIL	
CHANNEL	Channel 11	FREQUENCY RANGE	1 ~ 25GHz
INPUT POWER	120Vac, 60 Hz	DETECTOR FUNCTION	Peak (PK) Average (AV)
ENVIRONMENTAL CONDITIONS	23deg. C, 63%RH 1008 hPa	TESTED BY	Lori Chiu

ANTENNA POLARITY & TEST DISTANCE: HORIZONTAL AT 3 M								
NO.	FREQ. (MHz)	EMISSION LEVEL (dBuV/m)	LIMIT (dBuV/m)	MARGIN (dB)	ANTENNA HEIGHT (m)	TABLE ANGLE (Degree)	RAW VALUE (dBuV)	CORRECTION FACTOR (dB/m)
1	2376.00	61.8 PK	74.0	-12.2	1.00 H	180	31.40	30.40
2	2376.00	46.8 AV	54.0	-7.2	1.00 H	180	16.40	30.40
3	*2462.00	100.5 PK			1.01 H	180	69.80	30.70
4	*2462.00	87.9 AV			1.01 H	180	57.20	30.70
5	2483.50	60.2 PK	74.0	-13.8	1.01 H	180	29.40	30.80
6	2483.50	45.2 AV	54.0	-8.8	1.01 H	180	14.40	30.80
7	4924.00	45.9 PK	74.0	-28.1	1.23 H	226	9.60	36.30
8	4924.00	32.8 AV	54.0	-21.2	1.23 H	226	-3.50	36.30
ANTENNA POLARITY & TEST DISTANCE: VERTICAL AT 3 M								
NO.	FREQ. (MHz)	EMISSION LEVEL (dBuV/m)	LIMIT (dBuV/m)	MARGIN (dB)	ANTENNA HEIGHT (m)	TABLE ANGLE (Degree)	RAW VALUE (dBuV)	CORRECTION FACTOR (dB/m)
1	2376.00	62.2 PK	74.0	-11.8	1.02 V	353	31.80	30.40
2	2376.00	51.7 AV	54.0	-2.3	1.02 V	353	21.30	30.40
3	*2462.00	113.1 PK			1.01 V	15	82.40	30.70
4	*2462.00	99.1 AV			1.01 V	15	68.40	30.70
5	2483.50	71.0 PK	74.0	-3.0	1.00 V	360	40.20	30.80
6	2483.50	51.4 AV	54.0	-2.6	1.00 V	360	20.60	30.80
7	4924.00	46.8 PK	74.0	-27.2	1.00 V	166	10.50	36.30
8	4924.00	34.5 AV	54.0	-19.5	1.00 V	166	-1.80	36.30

- REMARKS:**
1. Emission level (dBuV/m) = Raw Value (dBuV) + Correction Factor (dB/m).
 2. Correction Factor (dB/m) = Antenna Factor (dB/m) + Cable Factor (dB).
 3. The other emission levels were very low against the limit.
 4. Margin value = Emission level – Limit value.
 5. “ * “: Fundamental frequency.



A D T

802.11n (40MHz)

EUT TEST CONDITION		MEASUREMENT DETAIL	
CHANNEL	Channel 1	FREQUENCY RANGE	1 ~ 25GHz
INPUT POWER	120Vac, 60 Hz	DETECTOR FUNCTION	Peak (PK) Average (AV)
ENVIRONMENTAL CONDITIONS	23deg. C, 63%RH 1008 hPa	TESTED BY	Brad Wu

ANTENNA POLARITY & TEST DISTANCE: HORIZONTAL AT 3 M								
NO.	FREQ. (MHz)	EMISSION LEVEL (dBuV/m)	LIMIT (dBuV/m)	MARGIN (dB)	ANTENNA HEIGHT (m)	TABLE ANGLE (Degree)	RAW VALUE (dBuV)	CORRECTION FACTOR (dB/m)
1	2390.00	56.4 PK	74.0	-17.6	1.07 H	303	25.70	30.70
2	2390.00	45.2 AV	54.0	-8.8	1.07 H	303	14.50	30.70
3	*2422.00	94.3 PK			1.07 H	303	63.50	30.80
4	*2422.00	79.6 AV			1.07 H	303	48.80	30.80
5	4844.00	46.7 PK	74.0	-27.3	1.21 H	142	10.20	36.50
6	4844.00	34.1 AV	54.0	-19.9	1.21 H	142	-2.40	36.50
ANTENNA POLARITY & TEST DISTANCE: VERTICAL AT 3 M								
NO.	FREQ. (MHz)	EMISSION LEVEL (dBuV/m)	LIMIT (dBuV/m)	MARGIN (dB)	ANTENNA HEIGHT (m)	TABLE ANGLE (Degree)	RAW VALUE (dBuV)	CORRECTION FACTOR (dB/m)
1	2390.00	71.6 PK	74.0	-2.4	1.06 V	347	40.90	30.70
2	2390.00	51.8 AV	54.0	-2.2	1.06 V	347	21.10	30.70
3	*2422.00	106.7 PK			1.05 V	351	75.90	30.80
4	*2422.00	94.6 AV			1.05 V	351	63.80	30.80
5	4844.00	47.4 PK	74.0	-26.6	1.01 V	254	10.90	36.50
6	4844.00	34.2 AV	54.0	-19.8	1.01 V	254	-2.30	36.50

- REMARKS:**
1. Emission level (dBuV/m) = Raw Value (dBuV) + Correction Factor (dB/m).
 2. Correction Factor (dB/m) = Antenna Factor (dB/m) + Cable Factor (dB).
 3. The other emission levels were very low against the limit.
 4. Margin value = Emission level – Limit value.
 5. “ * “: Fundamental frequency.



A D T

EUT TEST CONDITION		MEASUREMENT DETAIL	
CHANNEL	Channel 4	FREQUENCY RANGE	1 ~ 25GHz
INPUT POWER	120Vac, 60 Hz	DETECTOR FUNCTION	Peak (PK) Average (AV)
ENVIRONMENTAL CONDITIONS	23deg. C, 63%RH 1008 hPa	TESTED BY	Brad Wu

ANTENNA POLARITY & TEST DISTANCE: HORIZONTAL AT 3 M								
NO.	FREQ. (MHz)	EMISSION LEVEL (dBuV/m)	LIMIT (dBuV/m)	MARGIN (dB)	ANTENNA HEIGHT (m)	TABLE ANGLE (Degree)	RAW VALUE (dBuV)	CORRECTION FACTOR (dB/m)
1	2390.00	56.8 PK	74.0	-17.2	1.08 H	310	26.30	30.50
2	2390.00	45.6 AV	54.0	-8.4	1.08 H	310	15.10	30.50
3	*2437.00	100.2 PK			1.08 H	310	69.60	30.60
4	*2437.00	85.6 AV			1.08 H	310	55.00	30.60
5	2483.50	57.9 PK	74.0	-16.1	1.10 H	311	27.10	30.80
6	2483.50	46.6 AV	54.0	-7.4	1.10 H	311	15.80	30.80
7	4874.00	48.2 PK	74.0	-25.8	1.00 H	197	12.00	36.20
8	4874.00	35.8 AV	54.0	-18.2	1.00 H	197	-0.40	36.20
ANTENNA POLARITY & TEST DISTANCE: VERTICAL AT 3 M								
NO.	FREQ. (MHz)	EMISSION LEVEL (dBuV/m)	LIMIT (dBuV/m)	MARGIN (dB)	ANTENNA HEIGHT (m)	TABLE ANGLE (Degree)	RAW VALUE (dBuV)	CORRECTION FACTOR (dB/m)
1	2390.00	71.7 PK	74.0	-2.3	1.31 V	187	41.20	30.50
2	2390.00	51.9 AV	54.0	-2.1	1.31 V	187	21.40	30.50
3	*2437.00	112.6 PK			1.03 V	180	82.00	30.60
4	*2437.00	99.1 AV			1.03 V	180	68.50	30.60
5	2483.50	72.3 PK	74.0	-1.7	1.00 V	185	41.50	30.80
6	2483.50	53.4 AV	54.0	-0.6	1.00 V	185	22.60	30.80
7	4874.00	49.6 PK	74.0	-24.4	1.10 V	166	13.40	36.20
8	4874.00	36.7 AV	54.0	-17.3	1.10 V	166	0.50	36.20

- REMARKS:**
1. Emission level (dBuV/m) = Raw Value (dBuV) + Correction Factor (dB/m).
 2. Correction Factor (dB/m) = Antenna Factor (dB/m) + Cable Factor (dB).
 3. The other emission levels were very low against the limit.
 4. Margin value = Emission level – Limit value.
 5. “ * “: Fundamental frequency.



A D T

EUT TEST CONDITION		MEASUREMENT DETAIL	
CHANNEL	Channel 7	FREQUENCY RANGE	1 ~ 25GHz
INPUT POWER	120Vac, 60 Hz	DETECTOR FUNCTION	Peak (PK) Average (AV)
ENVIRONMENTAL CONDITIONS	23deg. C, 63%RH 1008 hPa	TESTED BY	Brad Wu

ANTENNA POLARITY & TEST DISTANCE: HORIZONTAL AT 3 M								
NO.	FREQ. (MHz)	EMISSION LEVEL (dBuV/m)	LIMIT (dBuV/m)	MARGIN (dB)	ANTENNA HEIGHT (m)	TABLE ANGLE (Degree)	RAW VALUE (dBuV)	CORRECTION FACTOR (dB/m)
1	*2452.00	95.3 PK			1.00 H	342	64.60	30.70
2	*2452.00	80.2 AV			1.00 H	342	49.50	30.70
3	2483.50	56.8 PK	74.0	-17.2	1.00 H	342	26.00	30.80
4	2483.50	46.0 AV	54.0	-8.0	1.00 H	342	15.20	30.80
5	4904.00	46.6 PK	74.0	-27.4	1.11 H	169	10.40	36.20
6	4904.00	33.9 AV	54.0	-20.1	1.11 H	169	-2.30	36.20

ANTENNA POLARITY & TEST DISTANCE: VERTICAL AT 3 M								
NO.	FREQ. (MHz)	EMISSION LEVEL (dBuV/m)	LIMIT (dBuV/m)	MARGIN (dB)	ANTENNA HEIGHT (m)	TABLE ANGLE (Degree)	RAW VALUE (dBuV)	CORRECTION FACTOR (dB/m)
1	*2452.00	107.4 PK			1.00 V	186	76.70	30.70
2	*2452.00	95.0 AV			1.00 V	186	64.30	30.70
3	2483.50	70.6 PK	74.0	-3.4	1.00 V	185	39.80	30.80
4	2483.50	52.9 AV	54.0	-1.1	1.00 V	185	22.10	30.80
5	4904.00	47.8 PK	74.0	-26.2	1.22 V	341	11.60	36.20
6	4904.00	34.6 AV	54.0	-19.4	1.22 V	341	-1.60	36.20

- REMARKS:**
1. Emission level (dBuV/m) = Raw Value (dBuV) + Correction Factor (dB/m).
 2. Correction Factor (dB/m) = Antenna Factor (dB/m) + Cable Factor (dB).
 3. The other emission levels were very low against the limit.
 4. Margin value = Emission level – Limit value.
 5. “ * “: Fundamental frequency.



A D T

BELOW 1GHz WORST-CASE DATA : 802.11g

EUT TEST CONDITION		MEASUREMENT DETAIL	
CHANNEL	Channel 6	FREQUENCY RANGE	Below 1000MHz
INPUT POWER	120Vac, 60 Hz	DETECTOR FUNCTION	Quasi-Peak
ENVIRONMENTAL CONDITIONS	23deg. C, 65%RH 1006 hPa	TESTED BY	Brad Wu

ANTENNA POLARITY & TEST DISTANCE: HORIZONTAL AT 3 M								
NO.	FREQ. (MHz)	EMISSION LEVEL (dBuV/m)	LIMIT (dBuV/m)	MARGIN (dB)	ANTENNA HEIGHT (m)	TABLE ANGLE (Degree)	RAW VALUE (dBuV)	CORRECTION FACTOR (dB/m)
1	125.17	41.7 QP	43.5	-1.8	1.50 H	244	29.90	11.80
2	267.10	44.8 QP	46.0	-1.2	1.00 H	238	31.00	13.80
3	700.68	40.4 QP	46.0	-5.6	1.00 H	10	15.30	25.10
4	733.73	41.0 QP	46.0	-5.0	1.00 H	10	15.60	25.40
5	766.79	41.7 QP	46.0	-4.3	1.00 H	16	16.00	25.70
6	799.84	44.3 QP	46.0	-1.7	1.00 H	337	18.20	26.10
7	875.67	44.3 QP	46.0	-1.7	1.50 H	322	16.80	27.50
ANTENNA POLARITY & TEST DISTANCE: VERTICAL AT 3 M								
NO.	FREQ. (MHz)	EMISSION LEVEL (dBuV/m)	LIMIT (dBuV/m)	MARGIN (dB)	ANTENNA HEIGHT (m)	TABLE ANGLE (Degree)	RAW VALUE (dBuV)	CORRECTION FACTOR (dB/m)
1	40.90	38.8 QP	40.0	-1.2	1.00 V	133	23.80	15.00
2	70.73	38.9 QP	40.0	-1.1	1.00 V	64	26.00	12.90
3	125.17	39.4 QP	43.5	-4.1	1.00 V	76	27.60	11.80
4	249.60	42.5 QP	46.0	-3.5	1.50 V	304	28.60	13.90
5	799.84	40.1 QP	46.0	-5.9	1.50 V	307	14.00	26.10
6	875.67	44.5 QP	46.0	-1.5	1.00 V	286	17.00	27.50
7	900.94	40.6 QP	46.0	-5.4	1.00 V	328	12.60	28.00

- REMARKS:**
1. Emission level (dBuV/m) = Raw Value (dBuV) + Correction Factor (dB/m).
 2. Correction Factor (dB/m) = Antenna Factor (dB/m) + Cable Factor (dB).
 3. The other emission levels were very low against the limit.
 4. Margin value = Emission level – Limit value.



4.2 CONDUCTED EMISSION MEASUREMENT

4.2.1 LIMITS OF CONDUCTED EMISSION MEASUREMENT

FREQUENCY OF EMISSION (MHz)	CONDUCTED LIMIT (dBµV)	
	Quasi-peak	Average
0.15 ~ 0.5	66 to 56	56 to 46
0.5 ~ 5	56	46
5 ~ 30	60	50

- NOTE:** 1. The lower limit shall apply at the transition frequencies.
 2. The limit decreases in line with the logarithm of the frequency in the range of 0.15 to 0.50MHz.
 3. All emanations from a class A/B digital device or system, including any network of conductors and apparatus connected thereto, shall not exceed the level of field strengths specified above.

4.2.2 TEST INSTRUMENTS

DESCRIPTION & MANUFACTURER	MODEL NO.	SERIAL NO.	DATE OF CALIBRATION	DUE DATE OF CALIBRATION
Test Receiver ROHDE & SCHWARZ	ESCS30	100291	Dec. 16, 2009	Dec. 15, 2010
RF signal cable Woken	5D-FB	Cable-HYC01-01	Nov. 12, 2009	Nov. 11, 2010
LISN ROHDE & SCHWARZ	ESH3-Z5	100312	Jun. 18, 2009	Jun. 17, 2010
LISN ROHDE & SCHWARZ	ESH3-Z5	835239/001	Feb. 24, 2009	Feb. 23, 2010
Software ADT	ADT_Cond_ V7.3.7	NA	NA	NA

- NOTE:** 1. The calibration interval of the above test instruments is 12 months and the calibrations are traceable to NML/ROC and NIST/USA.
 2. The test was performed in HwaYa Shielded Room 1.
 3. The VCCI Site Registration No. is C-2040.



A D T

4.2.3 TEST PROCEDURES

- a. The EUT was placed 0.4 meters from the conducting wall of the shielded room with EUT being connected to the power mains through a line impedance stabilization network (LISN). Other support units were connected to the power mains through another LISN. The two LISNs provide 50 ohm/ 50uH of coupling impedance for the measuring instrument.
- b. Both lines of the power mains connected to the EUT were checked for maximum conducted interference.
- c. The frequency range from 150kHz to 30MHz was searched. Emission levels under (Limit - 20dB) was not recorded.

NOTE: All modes of operation were investigated and the worst-case emissions are reported.

4.2.4 DEVIATION FROM TEST STANDARD

No deviation.

4.2.5 TEST SETUP

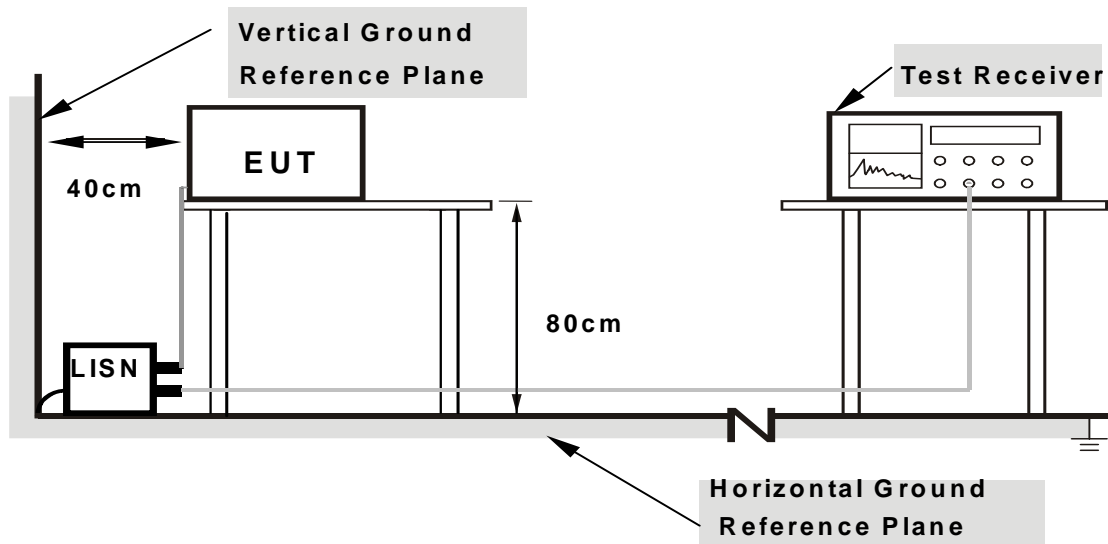

- Note:**
1. Support units were connected to second LISN.
 2. Both of LISNs (AMN) are 80 cm from EUT and at least 80 from other units and other metal planes

For the actual test configuration, please refer to the attached file (Test Setup Photo).

4.2.6 EUT OPERATING CONDITIONS

Same as 4.1.6.

4.2.7 TEST RESULTS

CONDUCTED WORST-CASE DATA : 802.11g

PHASE	Line 1	6dB BANDWIDTH	9kHz
--------------	--------	----------------------	------

No	Freq. [MHz]	Corr. Factor (dB)	Reading Value		Emission Level		Limit		Margin	
			[dB (uV)]		[dB (uV)]		[dB (uV)]		(dB)	
			Q.P.	AV.	Q.P.	AV.	Q.P.	AV.	Q.P.	AV.
1	0.279	0.13	40.51	-	40.64	-	60.85	50.85	-20.20	-
2	0.326	0.14	41.15	-	41.29	-	59.56	49.56	-18.27	-
3	1.004	0.18	32.76	-	32.94	-	56.00	46.00	-23.06	-
4	2.191	0.24	33.01	-	33.25	-	56.00	46.00	-22.75	-
5	3.930	0.37	32.62	-	32.99	-	56.00	46.00	-23.01	-
6	13.777	0.85	38.60	-	39.45	-	60.00	50.00	-20.55	-

- REMARKS:**
1. Q.P. and AV. are abbreviations of quasi-peak and average individually.
 2. "-": The Quasi-peak reading value also meets average limit and measurement with the average detector is unnecessary.
 3. The emission levels of other frequencies were very low against the limit.
 4. Margin value = Emission level - Limit value
 5. Correction factor = Insertion loss + Cable loss
 6. Emission Level = Correction Factor + Reading Value.

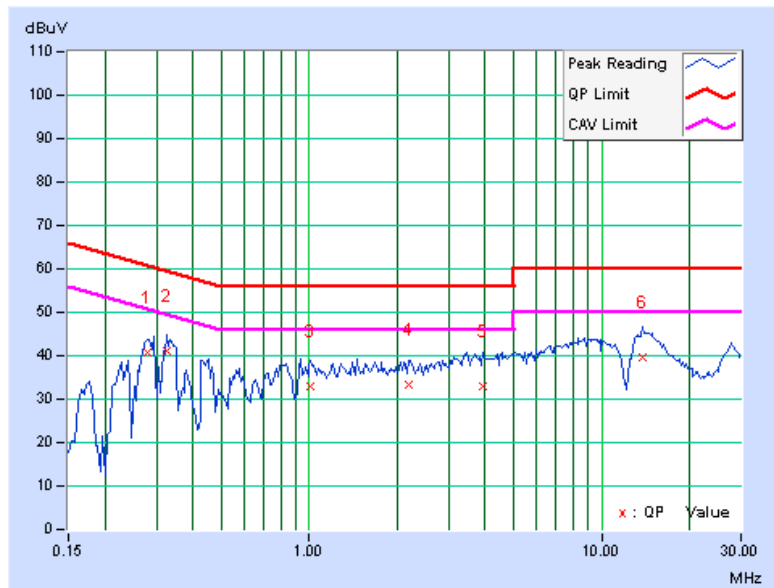

PHASE	Line 2	6dB BANDWIDTH	9kHz
-------	--------	---------------	------

No	Freq. [MHz]	Corr. Factor (dB)	Reading Value		Emission Level		Limit		Margin	
			[dB (uV)]		[dB (uV)]		[dB (uV)]		(dB)	
			Q.P.	AV.	Q.P.	AV.	Q.P.	AV.	Q.P.	AV.
1	0.283	0.15	39.69	-	39.84	-	60.73	50.73	-20.89	-
2	0.322	0.16	38.45	-	38.61	-	59.66	49.66	-21.05	-
3	0.705	0.18	28.79	-	28.97	-	56.00	46.00	-27.03	-
4	1.363	0.22	29.62	-	29.84	-	56.00	46.00	-26.16	-
5	1.898	0.24	29.52	-	29.76	-	56.00	46.00	-26.24	-
6	14.102	0.79	36.82	-	37.61	-	60.00	50.00	-22.39	-

- REMARKS:**
1. Q.P. and AV. are abbreviations of quasi-peak and average individually.
 2. "-": The Quasi-peak reading value also meets average limit and measurement with the average detector is unnecessary.
 3. The emission levels of other frequencies were very low against the limit.
 4. Margin value = Emission level - Limit value
 5. Correction factor = Insertion loss + Cable loss
 6. Emission Level = Correction Factor + Reading Value.

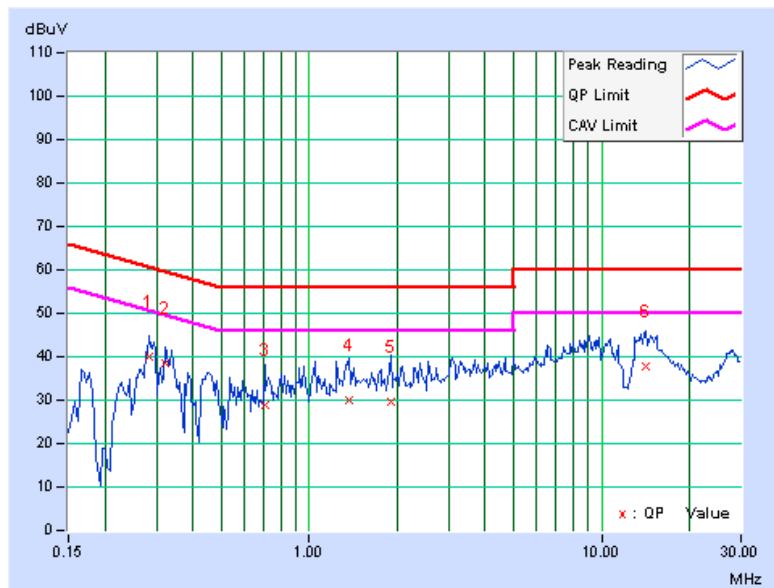



A D T

4.3 6dB BANDWIDTH MEASUREMENT

4.3.1 LIMITS OF 6dB BANDWIDTH MEASUREMENT

The minimum of 6dB Bandwidth Measurement is 0.5 MHz.

4.3.2 TEST INSTRUMENTS

DESCRIPTION & MANUFACTURER	MODEL NO.	SERIAL NO.	DATE OF CALIBRATION	DUE DATE OF CALIBRATION
R&S SPECTRUM ANALYZER	FSP40	100040	Jul. 07, 2009	Jul. 06, 2010

NOTE: The calibration interval of the above test instruments is 12 months and the calibrations are traceable to NML/ROC and NIST/USA.

4.3.3 TEST PROCEDURE

The transmitter output was connected to the spectrum analyzer through an attenuator. The bandwidth of the fundamental frequency was measured by spectrum analyzer with 100kHz RBW and 300kHz VBW. The 6dB bandwidth is defined as the total spectrum the power of which is higher than peak power minus 6dB.

4.3.4 DEVIATION FROM TEST STANDARD

No deviation.

4.3.5 TEST SETUP

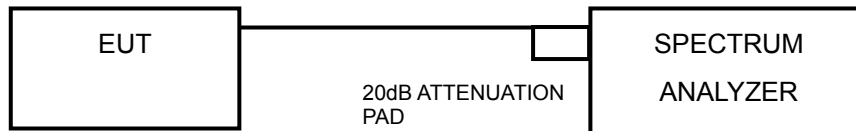

4.3.6 EUT OPERATING CONDITIONS

The software provided by client to enable the EUT under transmission condition continuously at lowest, middle and highest channel frequencies individually.



A D T

4.3.7 TEST RESULTS

802.11b

CHANNEL	CHANNEL FREQUENCY (MHz)	6dB BANDWIDTH (MHz)	MINIMUM LIMIT (MHz)	PASS / FAIL
1	2412	12.15	0.5	PASS
6	2437	12.10	0.5	PASS
11	2462	11.65	0.5	PASS

CH 1

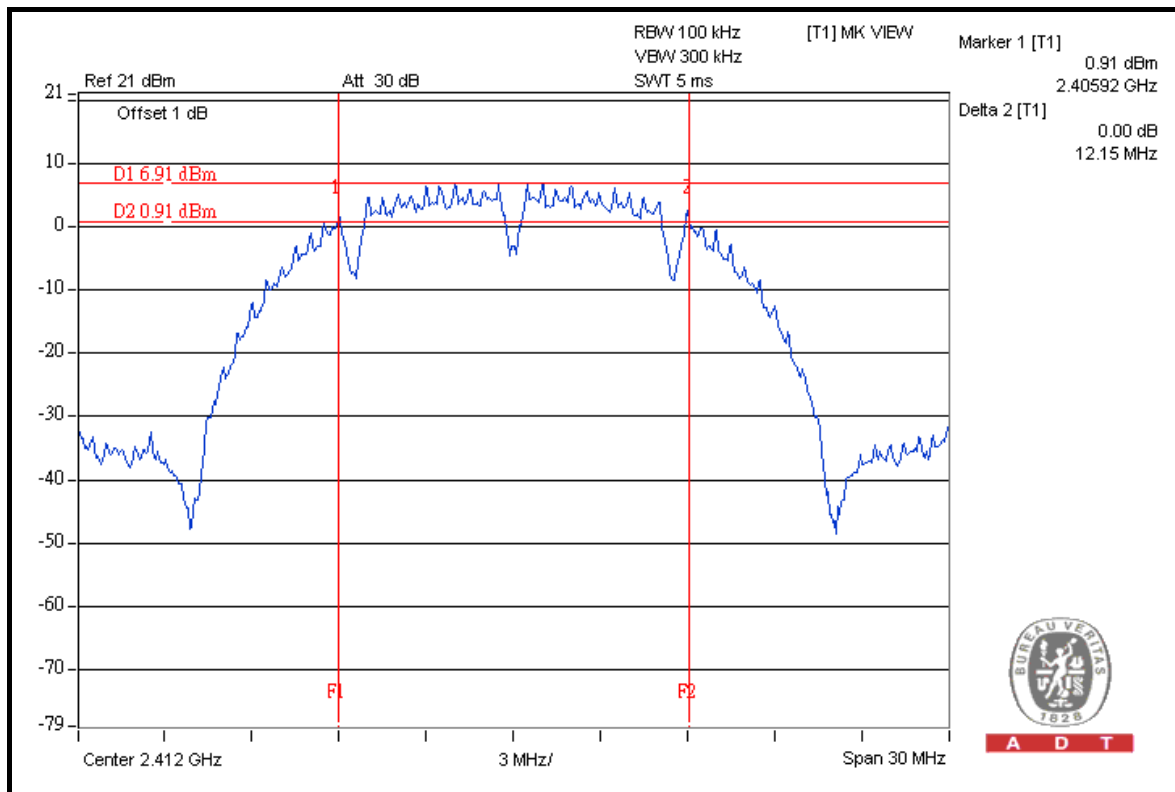



A D T

802.11g

CHANNEL	CHANNEL FREQUENCY (MHz)	6dB BANDWIDTH (MHz)		MINIMUM LIMIT (MHz)	PASS / FAIL
		CHAIN 0	CHAIN 1		
1	2412	16.47	16.47	0.5	PASS
6	2437	16.48	16.46	0.5	PASS
11	2462	16.42	16.42	0.5	PASS

CHAIN 0: CH 6

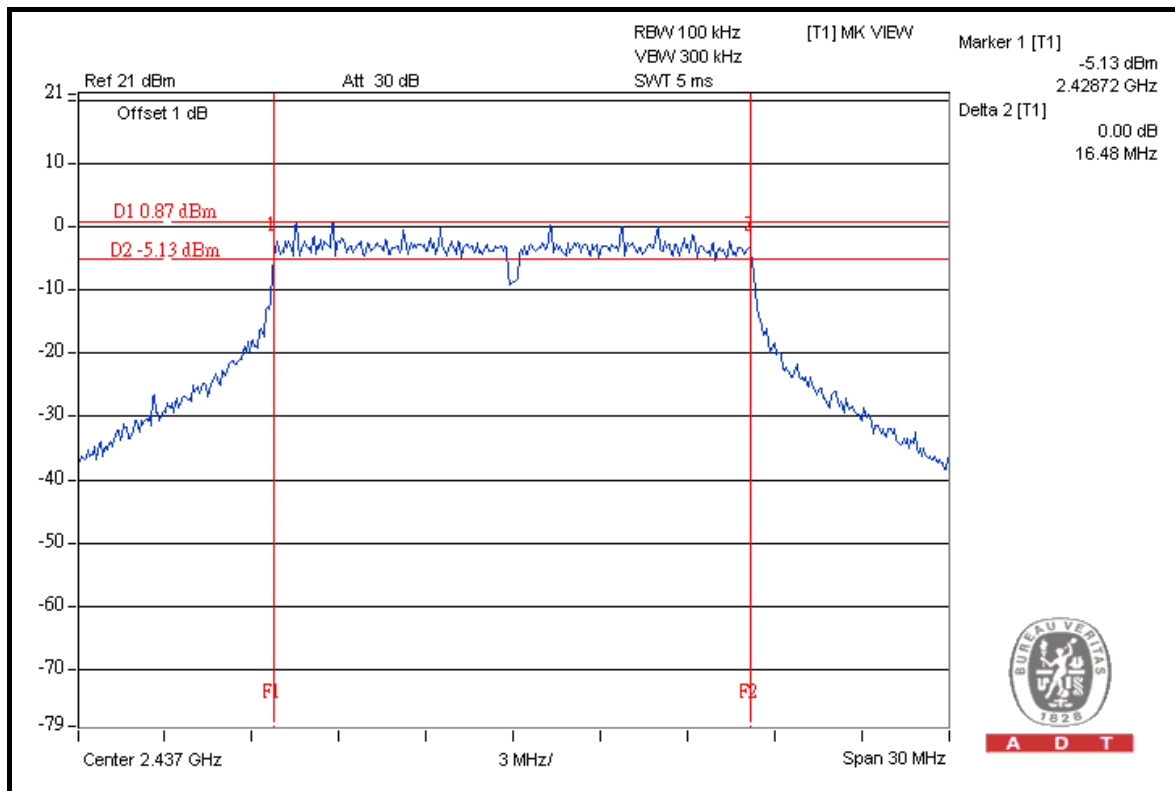



A D T

802.11n (20MHz)

CHANNEL	CHANNEL FREQUENCY (MHz)	6dB BANDWIDTH (MHz)		MINIMUM LIMIT (MHz)	PASS / FAIL
		CHAIN 0	CHAIN 1		
1	2412	17.69	17.69	0.5	PASS
6	2437	17.66	17.67	0.5	PASS
11	2462	17.68	17.66	0.5	PASS

CHAIN 0: CH 1

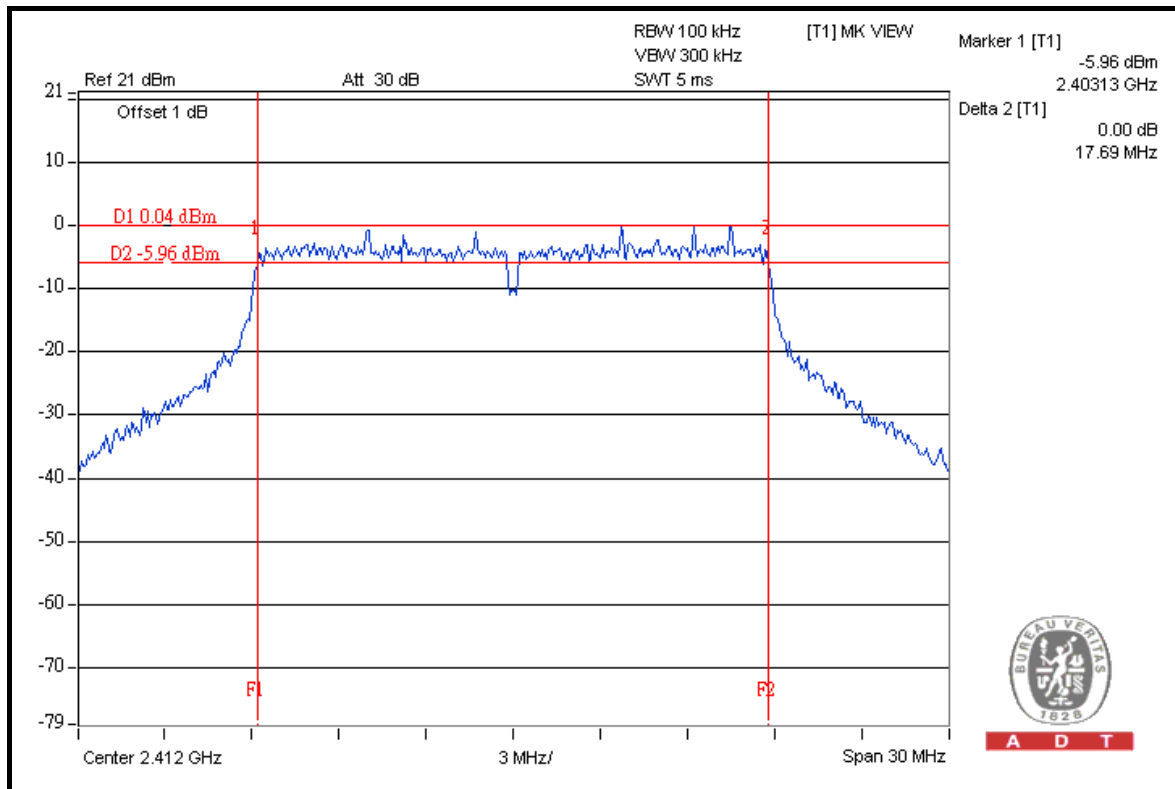

A D T



A D T

802.11n (40MHz)

CHANNEL	CHANNEL FREQUENCY (MHz)	6dB BANDWIDTH (MHz)		MINIMUM LIMIT (MHz)	PASS / FAIL
		CHAIN 0	CHAIN 1		
1	2422	36.45	36.46	0.5	PASS
4	2437	36.13	36.47	0.5	PASS
7	2452	36.47	36.18	0.5	PASS

CHAIN 1: CH 4

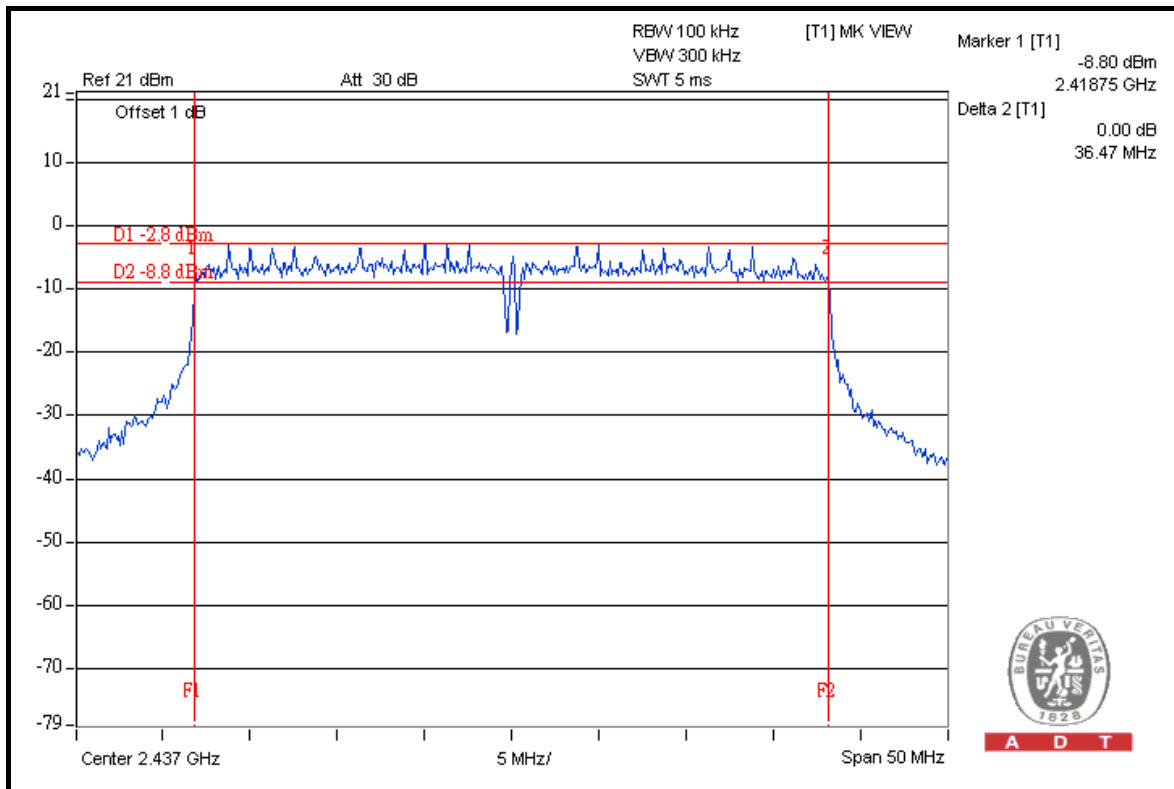



A D T

4.4 MAXIMUM OUTPUT POWER

4.4.1 LIMITS OF MAXIMUM OUTPUT POWER MEASUREMENT

The Maximum Output Power Measurement is 30dBm.

4.4.2 INSTRUMENTS

DESCRIPTION & MANUFACTURER	MODEL NO.	SERIAL NO.	DATE OF CALIBRATION	DUE DATE OF CALIBRATION
High Speed Peak Power Meter	ML2495A	0824012	Aug. 10, 2009	Aug. 09, 2010
Power Sensor	MA2411B	0738138	Aug. 10, 2009	Aug. 09, 2010

Note:

1. The calibration interval of the above test instruments is 12 months and the calibrations are traceable to NML/ROC and NIST/USA.
2. Measurement Bandwidth of ML2495A is 65MHz greater than 6dB bandwidth of emission.

4.4.3 TEST PROCEDURE

A power sensor was used on the output port of the EUT. A power meter was used to read the response of the power sensor. Record the power level.

4.4.4 DEVIATION FROM TEST STANDARD

No deviation.

4.4.5 TEST SETUP

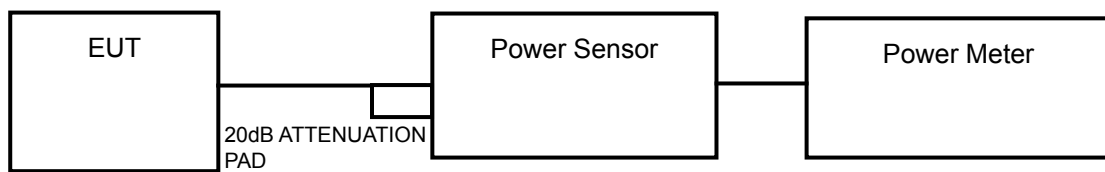

4.4.6 EUT OPERATING CONDITIONS

Same as Item 4.3.6.



A D T

4.4.7 TEST RESULTS

802.11b

CHAN.	CHANNEL FREQUENCY (MHz)	POWER OUTPUT (mW)	POWER OUTPUT (dBm)	POWER LIMIT (dBm)	PASS/FAIL
1	2412	107.2	20.3	30	PASS
6	2437	102.3	20.1	30	PASS
11	2462	109.6	20.4	30	PASS

802.11g

CHAN.	CHAN. FREQ. (MHz)	POWER OUTPUT (dBm)		TOTAL POWER (mW)	TOTAL POWER (dBm)	POWER LIMIT (dBm)	PASS / FAIL
		CHAIN 0	CHAIN 1				
1	2412	21.9	22.1	317.1	25.0	30	PASS
6	2437	22.3	22.5	347.7	25.4	30	PASS
11	2462	21.1	21.3	263.7	24.2	30	PASS

802.11n (20MHz)

CHAN.	CHAN. FREQ. (MHz)	POWER OUTPUT (dBm)		TOTAL POWER (mW)	TOTAL POWER (dBm)	POWER LIMIT (dBm)	PASS / FAIL
		CHAIN 0	CHAIN 1				
1	2412	21.8	21.7	299.3	24.8	30	PASS
6	2437	22.2	22.3	335.8	25.3	30	PASS
11	2462	20.9	21.1	251.9	24.0	30	PASS

802.11n (40MHz)

CHAN.	CHAN. FREQ. (MHz)	POWER OUTPUT (dBm)		TOTAL POWER (mW)	TOTAL POWER (dBm)	POWER LIMIT (dBm)	PASS / FAIL
		CHAIN 0	CHAIN 1				
1	2422	19.4	19.8	182.6	22.6	30	PASS
4	2437	22.1	22.4	336.0	25.3	30	PASS
7	2452	19.6	19.9	188.9	22.8	30	PASS



A D T

4.5 POWER SPECTRAL DENSITY MEASUREMENT

4.5.1 LIMITS OF POWER SPECTRAL DENSITY MEASUREMENT

The Maximum of Power Spectral Density Measurement is 8dBm.

4.5.2 TEST INSTRUMENTS

DESCRIPTION & MANUFACTURER	MODEL NO.	SERIAL NO.	DATE OF CALIBRATION	DUE DATE OF CALIBRATION
R&S SPECTRUM ANALYZER	FSP40	100040	Jul. 07, 2009	Jul. 06, 2010

NOTE: The calibration interval of the above test instruments is 12 months and the calibrations are traceable to NML/ROC and NIST/USA.

4.5.3 TEST PROCEDURE

The transmitter output was connected to the spectrum analyzer through an attenuator, the bandwidth of the fundamental frequency was measured with the spectrum analyzer using 3kHz RBW and 30kHz VBW, set sweep time = span/3kHz. The power spectral density was measured and recorded.

The sweep time is allowed to be longer than span/3kHz for a full response of the mixer in the spectrum analyzer.

4.5.4 DEVIATION FROM TEST STANDARD

No deviation

4.5.5 TEST SETUP

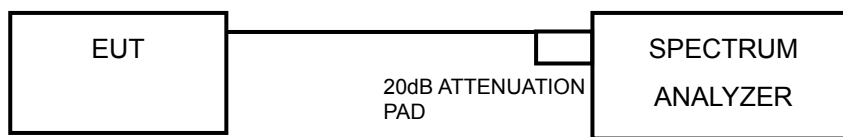

4.5.6 EUT OPERATING CONDITION

Same as Item 4.3.6



A D T

4.5.7 TEST RESULTS

802.11b

CHANNEL	CHANNEL FREQUENCY (MHz)	RF POWER LEVEL IN 3 kHz BW (dBm)	MAXIMUM LIMIT (dBm)	PASS/FAIL
1	2412	-7.0	8	PASS
6	2437	-7.4	8	PASS
11	2462	-6.9	8	PASS

CH 11

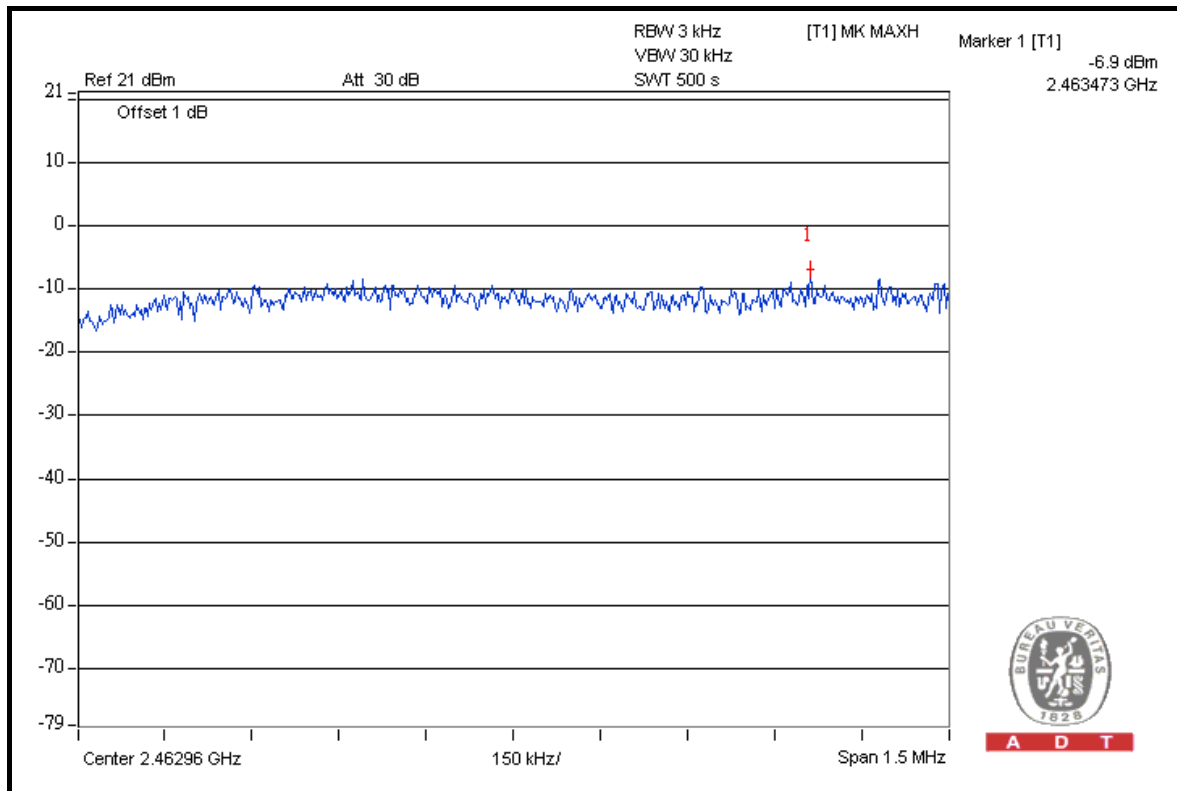



A D T

802.11g

CHANNEL	CHAN. FREQ. (MHz)	RF POWER LEVEL IN 3kHz BW (dBm)		TOTAL POWER DENSITY (dBm)	MAXIMUM LIMIT (dBm)	PASS / FAIL
		CHAIN 0	CHAIN 1			
1	2412	-13.8	-13.0	-10.4	8	PASS
6	2437	-13.2	-12.7	-9.9	8	PASS
11	2462	-14.6	-13.8	-11.2	8	PASS

CHAIN 1: CH 6

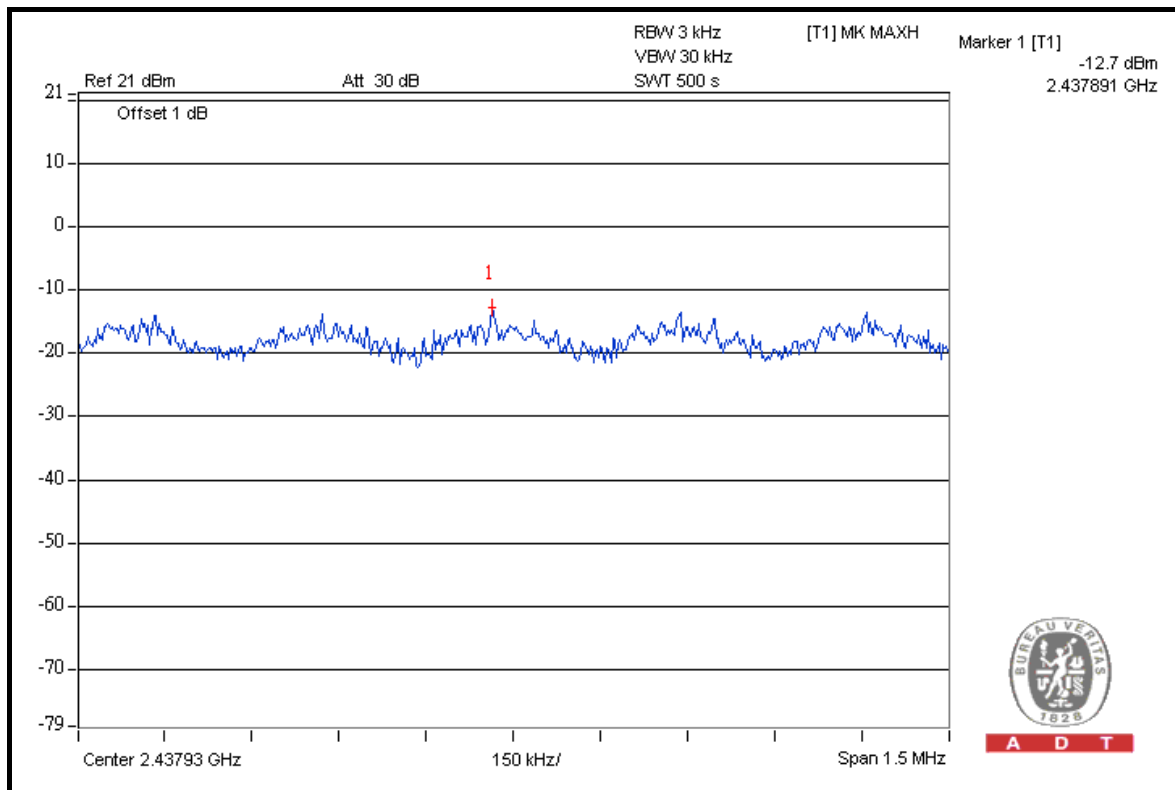



A D T

802.11n (20MHz)

CHANNEL	CHAN. FREQ. (MHz)	RF POWER LEVEL IN 3kHz BW (dBm)		TOTAL POWER DENSITY (dBm)	MAXIMUM LIMIT (dBm)	PASS / FAIL
		CHAIN 0	CHAIN 1			
1	2412	-14.4	-14.2	-11.3	8	PASS
6	2437	-13.9	-13.6	-10.7	8	PASS
11	2462	-15.2	-14.7	-11.9	8	PASS

CHAIN 1: CH 6

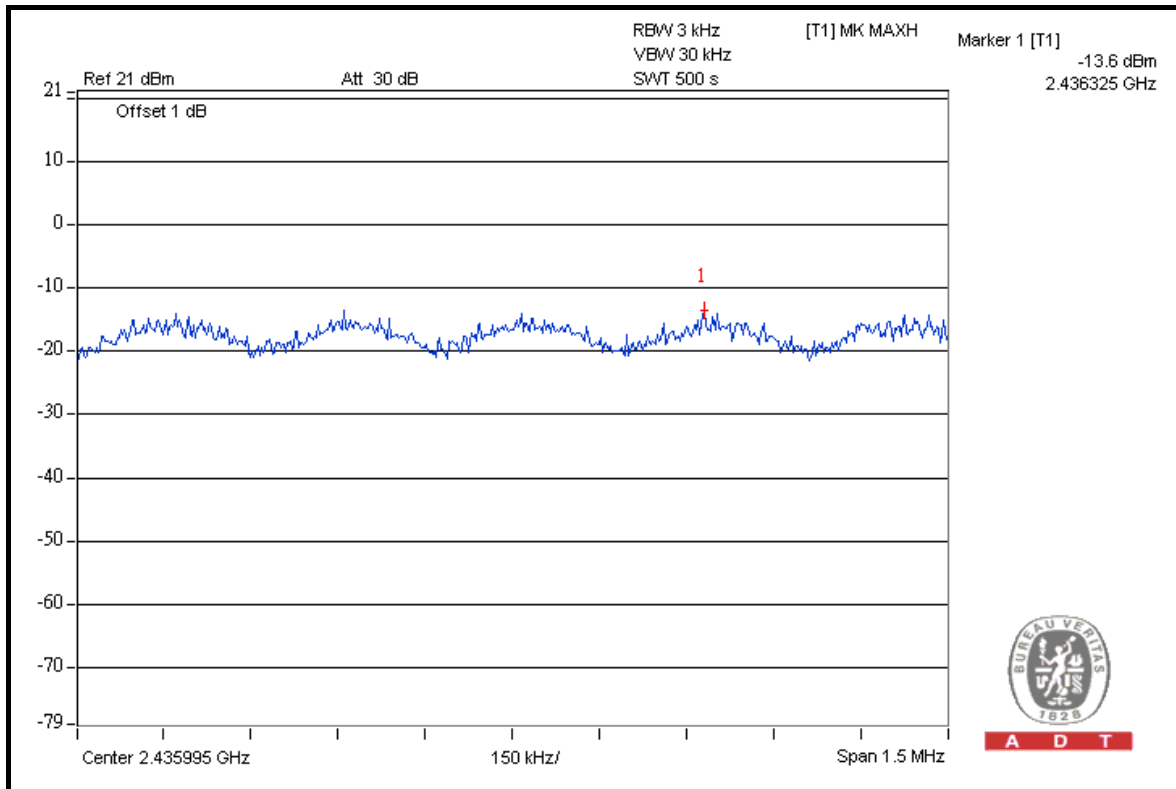

A D T



A D T

802.11n (40MHz)

CHANNEL	CHAN. FREQ. (MHz)	RF POWER LEVEL IN 3 kHz BW (dBm)		TOTAL POWER DENSITY (dBm)	MAXIMUM LIMIT (dBm)	PASS/FAIL
		CHAIN 0	CHAIN 1			
1	2422	-18.7	-19.7	-16.2	8	PASS
4	2437	-15.8	-16.8	-13.3	8	PASS
7	2452	-18.5	-19.6	-16.0	8	PASS

CHAIN 0: CH 4

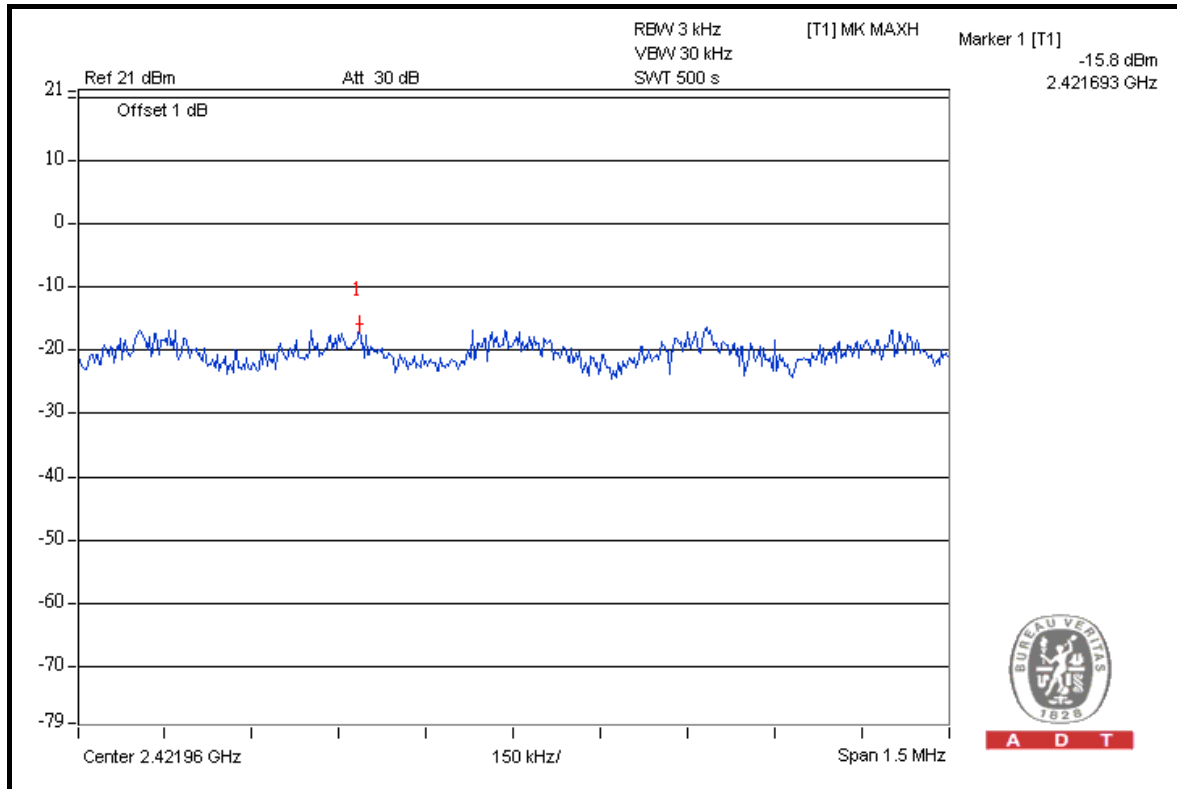



A D T

4.6 BAND EDGES MEASUREMENT

4.6.1 LIMITS OF BAND EDGES MEASUREMENT

Below -20dB of the highest emission level of operating band (in 100kHz Resolution Bandwidth).

4.6.2 TEST INSTRUMENTS

DESCRIPTION & MANUFACTURER	MODEL NO.	SERIAL NO.	DATE OF CALIBRATION	DUE DATE OF CALIBRATION
FOR CONDUCTED MEASUREMENT				
R&S SPECTRUM ANALYZER	FSP40	100040	Jul. 07, 2009	Jul. 06, 2010
FOR RADIATED MEASUREMENT				
Test Receiver ROHDE & SCHWARZ	ESI7	100033	Jul. 06, 2009	Jul. 05, 2010
Spectrum Analyzer ROHDE & SCHWARZ	FSP40	100076	May 26, 2009	May 25, 2010
BILOG Antenna SCHWARZBECK	VULB9168	9168-160	Apr. 27, 2009	Apr. 26, 2010
HORN Antenna SCHWARZBECK	9120D	9120D-209	Jul. 01, 2009	Jun. 30, 2010
HORN Antenna SCHWARZBECK	BBHA 9170	BBHA9170243	Dec. 25, 2009	Dec. 24, 2010
Preamplifier Agilent	8447D	2944A10633	Nov. 10, 2009	Nov. 09, 2010
Preamplifier Agilent	8449B	3008A01964	Nov. 09, 2009	Nov. 08, 2010
RF signal cable HUBER+SUHNNER	SUCOFLEX 104	238141/4	May 13, 2009	May 12, 2010
RF signal cable HUBER+SUHNNER	SUCOFLEX 104	12738/6	May 13, 2009	May 12, 2010
Software ADT.	ADT_Radiated_V7.6.15.9.2	NA	NA	NA
Antenna Tower inn-co GmbH	MA 4000	013303	NA	NA
Antenna Tower Controller inn-co GmbH	CO2000	017303	NA	NA
Turn Table ADT.	TT100.	TT93021703	NA	NA
Turn Table Controller ADT.	SC100.	SC93021703	NA	NA

NOTE: The calibration interval of the above test instruments is 12 months and the calibrations are traceable to NML/ROC and NIST/USA.



A D T

4.6.3 TEST PROCEDURE

FOR CONDUCTED MEASUREMENT

The transmitter output was connected to the spectrum analyzer via a low lose cable. Set both RBW and VBW of spectrum analyzer to 100kHz and 300kHz with suitable frequency span including 100MHz bandwidth from band edge. The band edges was measured and recorded.

The spectrum plots (Peak RBW = 100kHz, VBW = 300kHz; Average RBW = 1MHz, VBW = 10Hz) are attached on the following pages.

FOR RADIATED MEASUREMENT

- a. The EUT was placed on the top of a rotating table 0.8 meters above the ground at a 3 meter semi-anechoic chamber. The table was rotated 360 degrees to determine the position of the highest radiation.
- b. The EUT was set 3 meters away from the interference-receiving antenna, which was mounted on the top of a variable-height antenna tower.
- c. The antenna is a broadband antenna, and its height is varied from one meter to four meters above the ground to determine the maximum value of the field strength. Both horizontal and vertical polarizations of the antenna are set to make the measurement.
- d. For each suspected emission, the EUT was arranged to its worst case and then the antenna was tuned to heights from 1 meter to 4 meters and the rotatable table was turned from 0 degrees to 360 degrees to find the maximum reading.
- e. Set both RBW and VBW of spectrum analyzer to 100kHz and 300kHz with suitable frequency span including 100MHz bandwidth from band edge. The band edges was measured and recorded.

The spectrum plots (Peak RBW = 100kHz, VBW = 300kHz) are attached on the following pages.

NOTE: The resolution bandwidth of test receiver/spectrum analyzer is 1MHz and the video bandwidth is 10Hz for Average detection (AV) at frequency above 1GHz.

4.6.4 DEVIATION FROM TEST STANDARD

No deviation.

4.6.5 EUT OPERATING CONDITION

Same as Item 4.3.6.



4.6.6 TEST RESULTS

The spectrum plots are attached on the following pages. D1 line indicates the highest level, and D2 line indicates the 20dB offset below D1. It shows compliance with the requirement in part 15.247(d).

802.11b

RESTRICT BAND (2310 ~ 2390 MHz)

FREQUENCY (MHz)	FUNDAMENTAL EMISSION (dBuV/m)	DELTA (dB)	MAXIMUM FIELD STRENGTH IN RESTRICT BAND (dBuV/m)	LIMIT (dBuV/m)
2412.00 (PK)	110.7	52.7	58.0	74.00
2412.00 (AV)	106.5	61.6	44.9	54.00

RESTRICT BAND (2483.5 ~ 2500 MHz)

FREQUENCY (MHz)	FUNDAMENTAL EMISSION (dBuV/m)	DELTA (dB)	MAXIMUM FIELD STRENGTH IN RESTRICT BAND (dBuV/m)	LIMIT (dBuV/m)
2462.00 (PK)	110.3	52.6	57.7	74.00
2462.00 (AV)	106.7	59.3	47.4	54.00

NOTE:

1. Delta = Amplitude between the peak of the fundamental and the peak of the band edge emission. Please check following 3 pages.
2. Maximum field strength in restrict band = Fundamental emission – Delta.



A D T

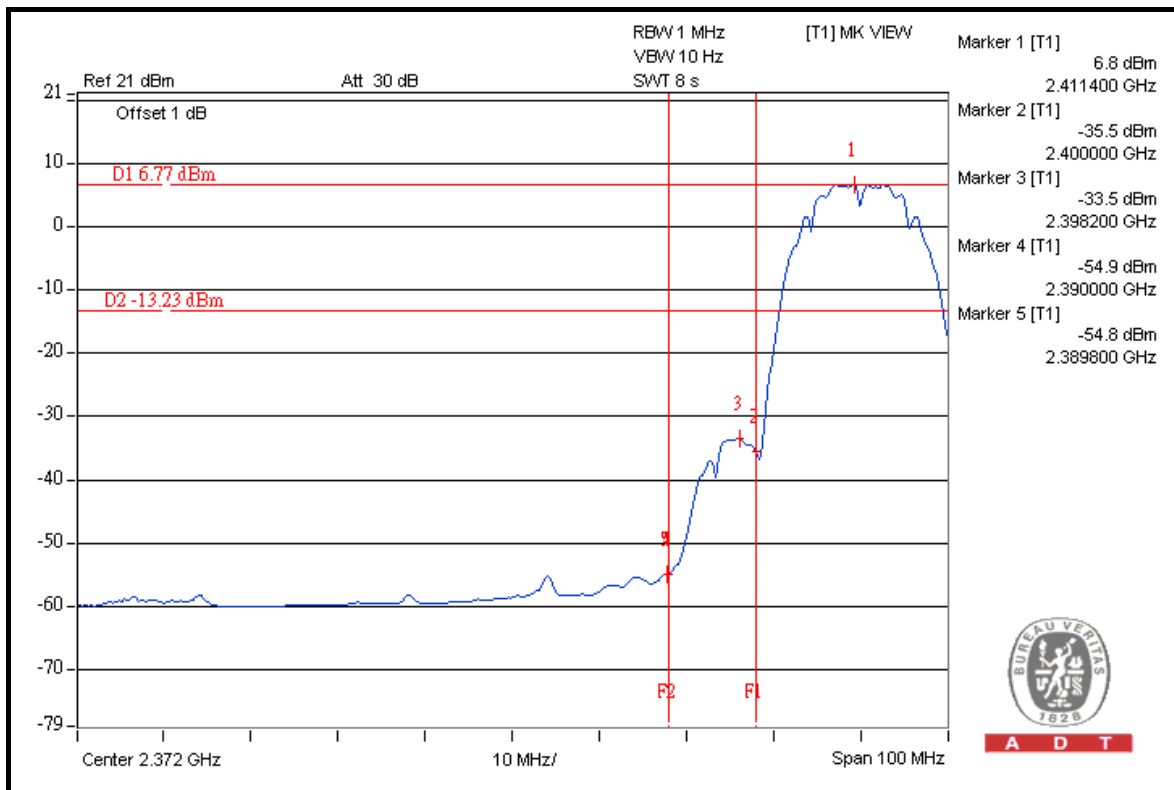
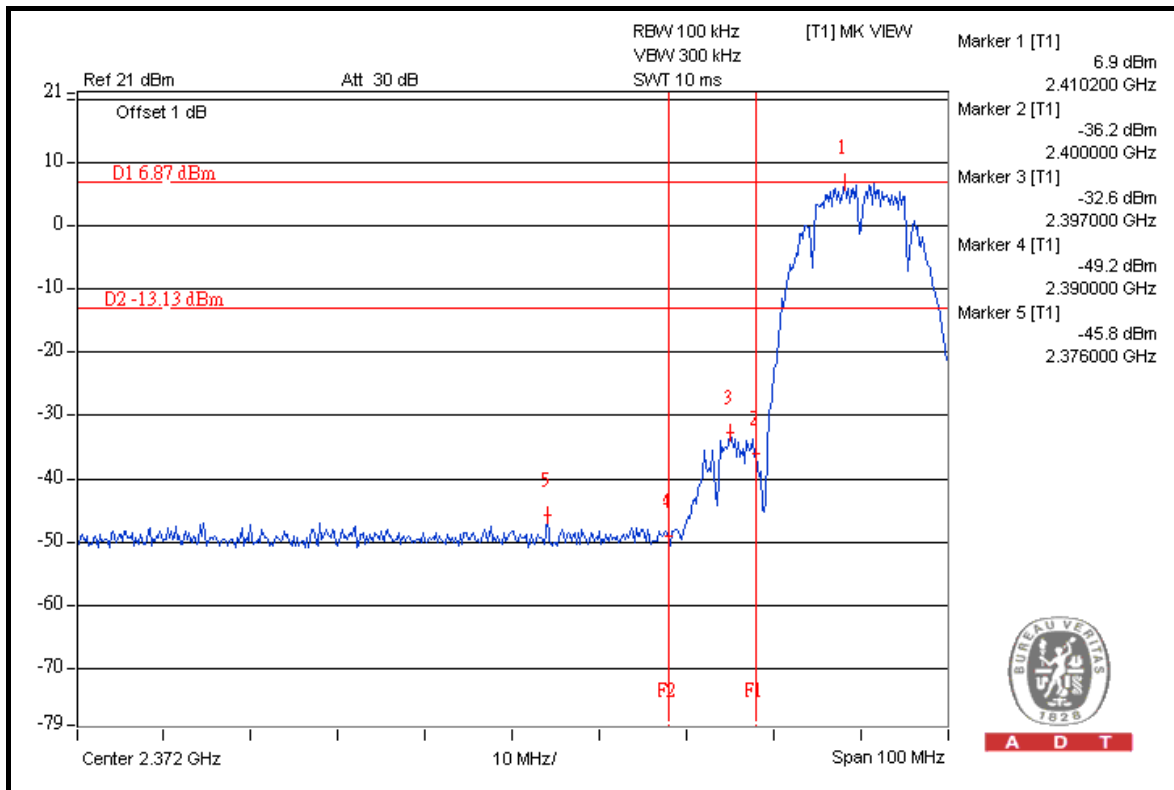



A D T

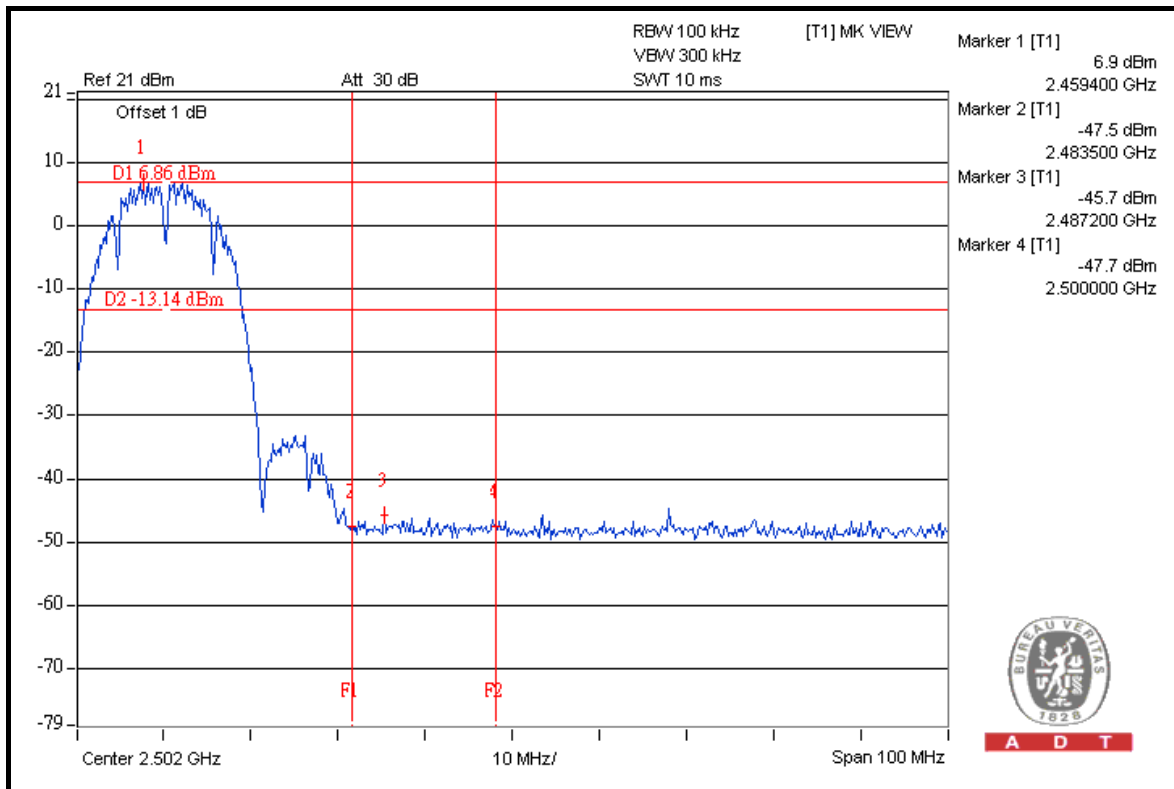
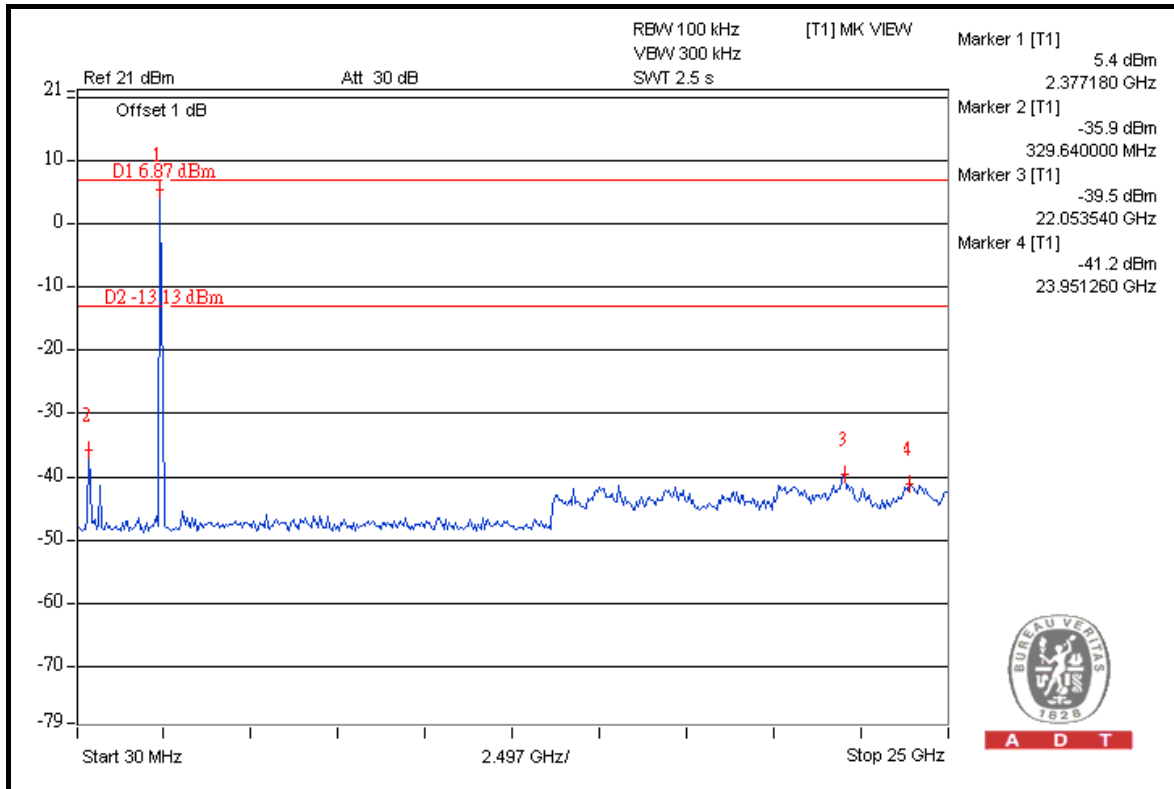



A D T

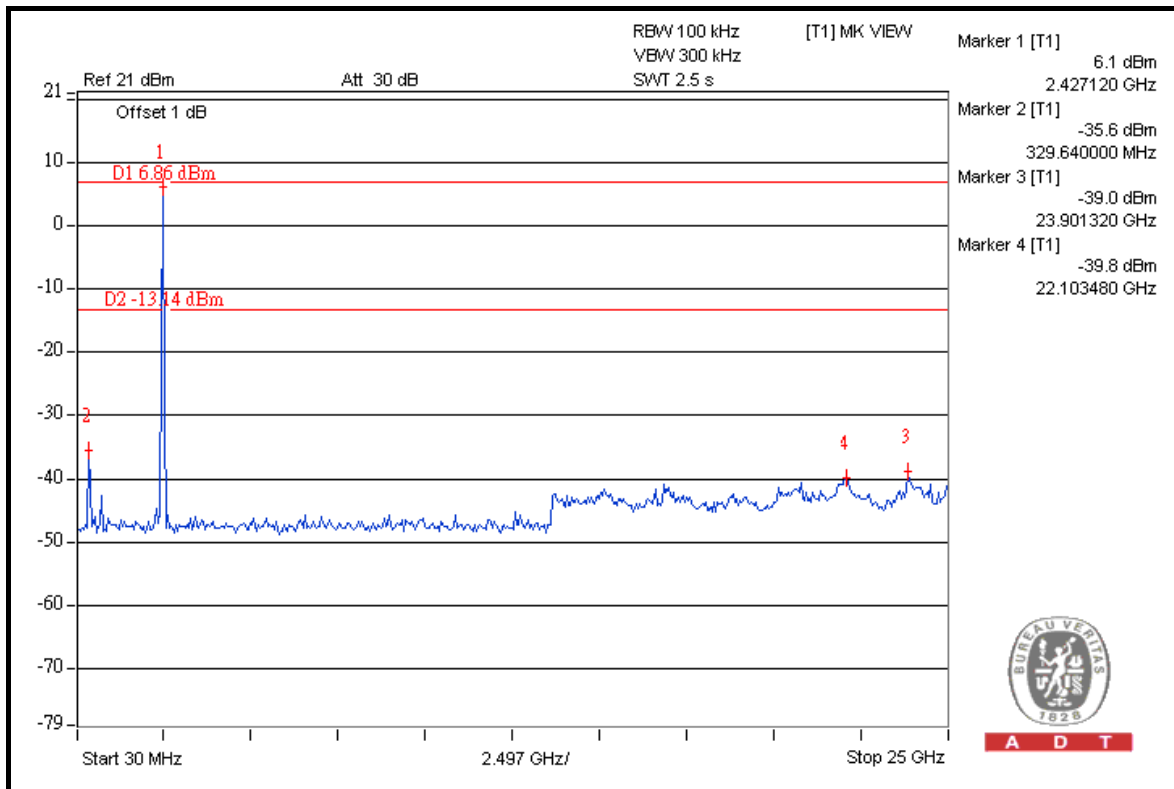
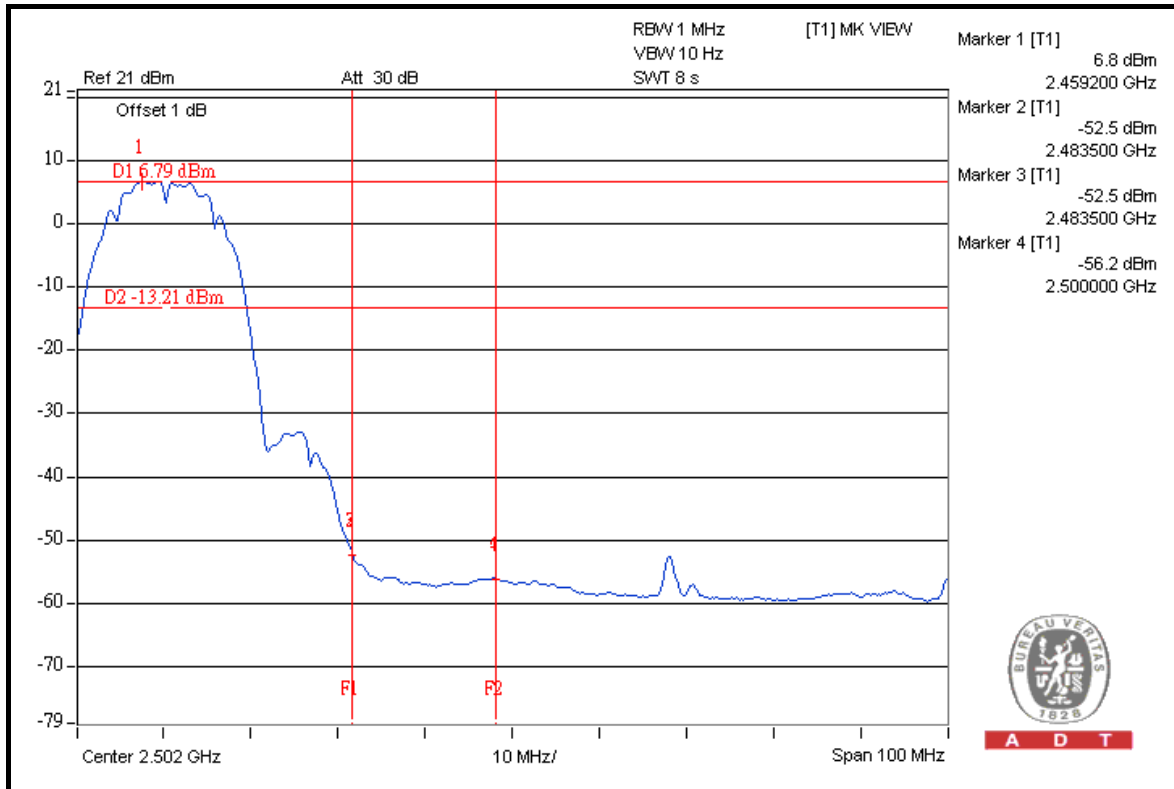



A D T

802.11g

RESTRICT BAND (2310 ~ 2390 MHz)

FREQUENCY (MHz)	FUNDAMENTAL EMISSION (dBuV/m)	DELTA (dB)	MAXIMUM FIELD STRENGTH IN RESTRICT BAND (dBuV/m)	LIMIT (dBuV/m)
2412.00 (PK)	114.2	46.3	67.9	74.00
2412.00 (AV)	100.9	50.6	50.3	54.00

RESTRICT BAND (2483.5 ~ 2500 MHz)

FREQUENCY (MHz)	FUNDAMENTAL EMISSION (dBuV/m)	DELTA (dB)	MAXIMUM FIELD STRENGTH IN RESTRICT BAND (dBuV/m)	LIMIT (dBuV/m)
2462.00 (PK)	113.3	46.2	67.1	74.00
2462.00 (AV)	100.1	50.0	50.1	54.00

NOTE:

1. Delta = Amplitude between the peak of the fundamental and the peak of the band edge emission. Please check following 3 pages.
2. Maximum field strength in restrict band = Fundamental emission – Delta.



A D T

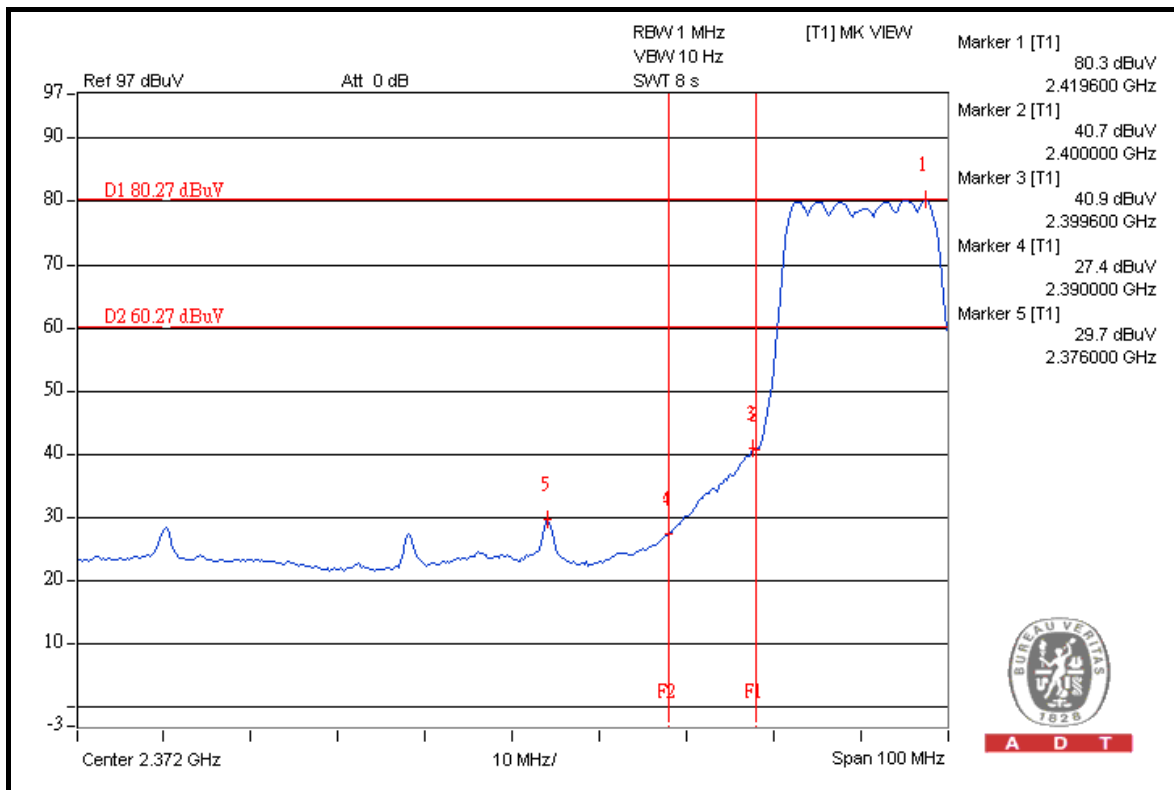
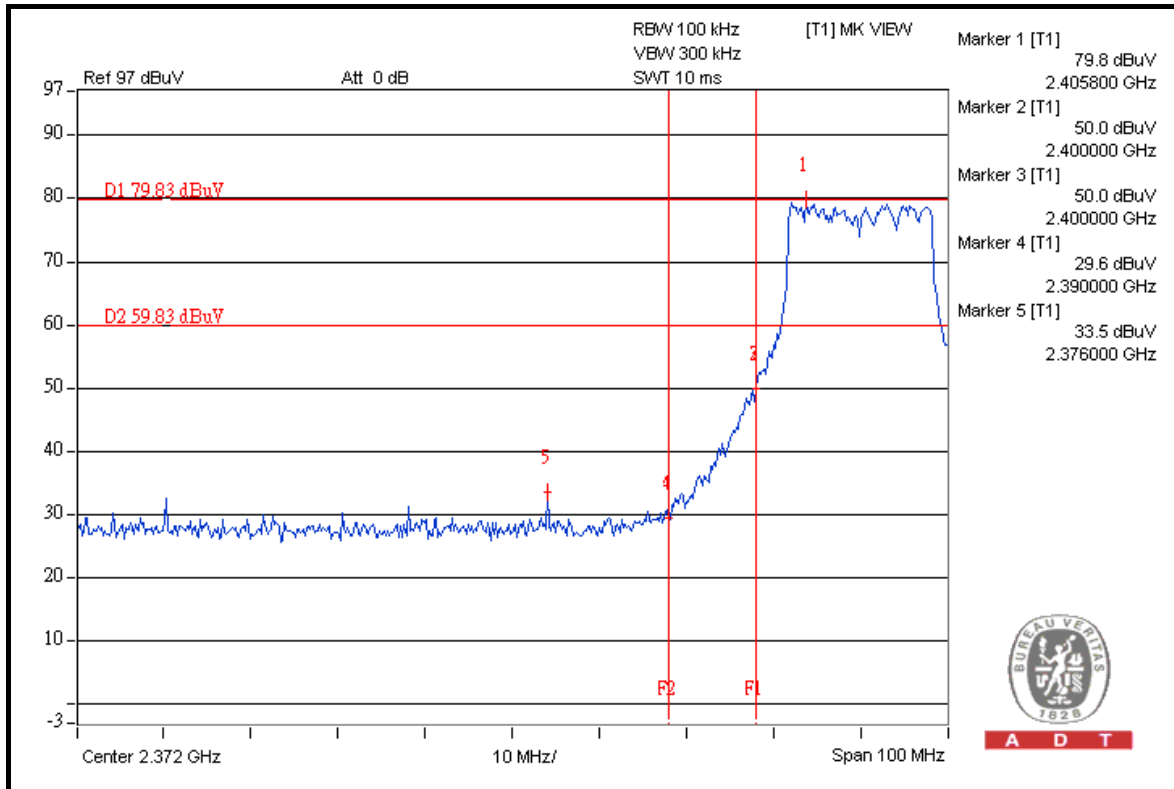



A D T

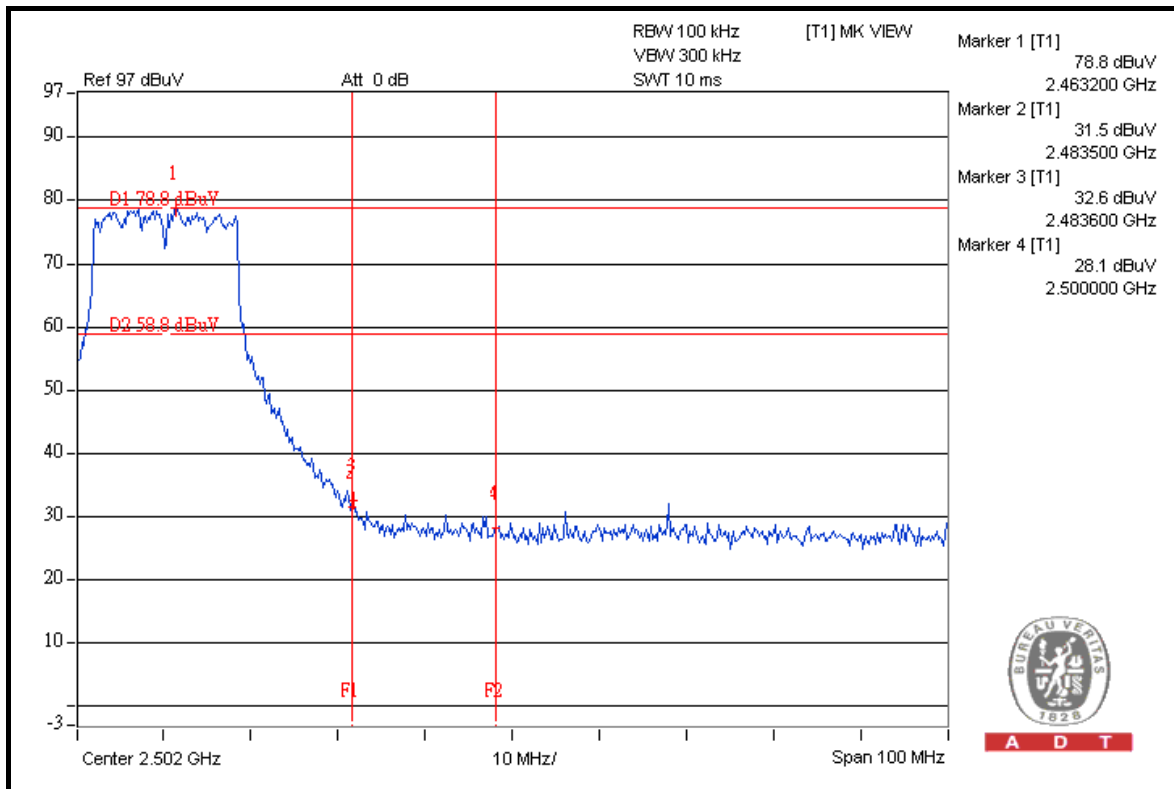
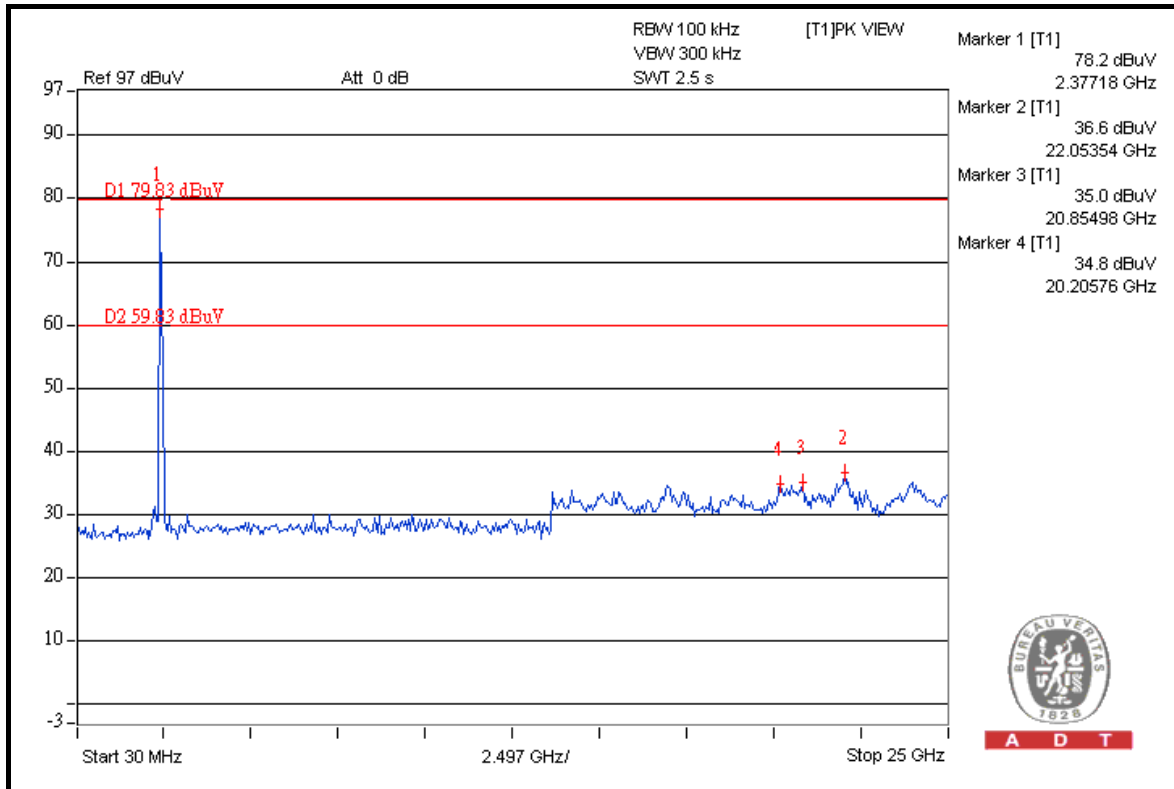



A D T

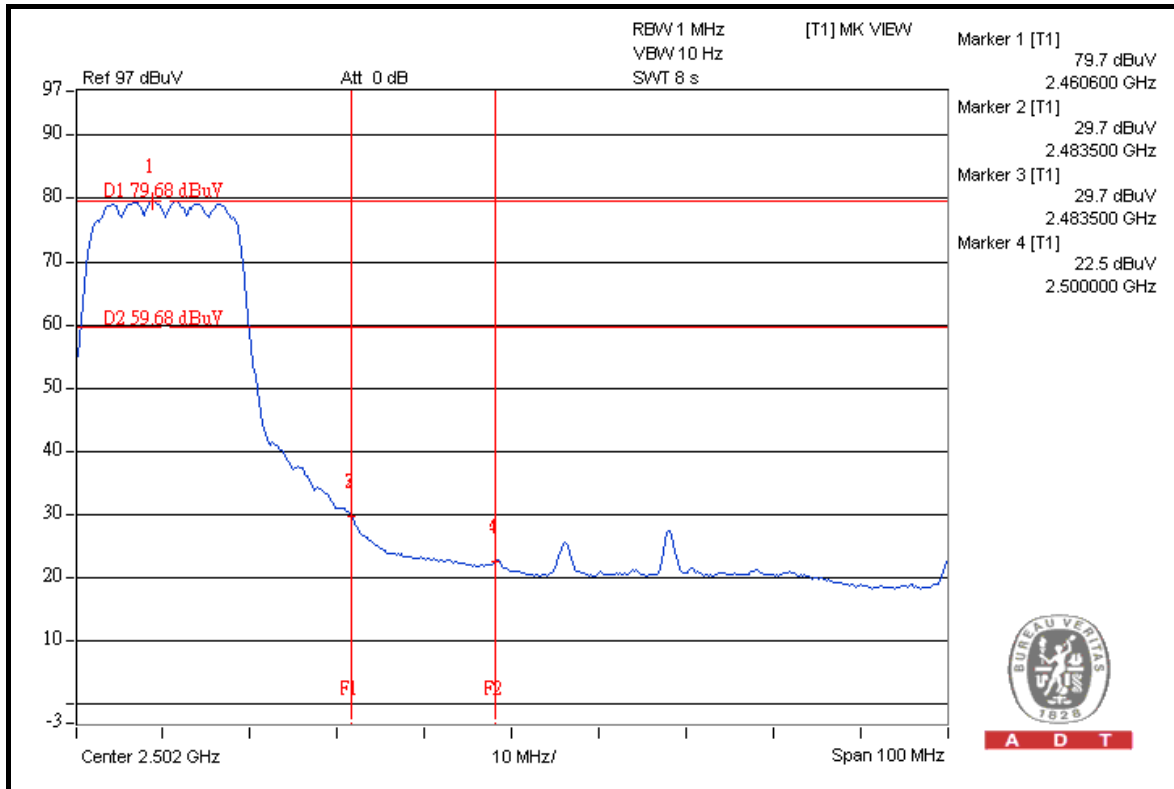

A D T

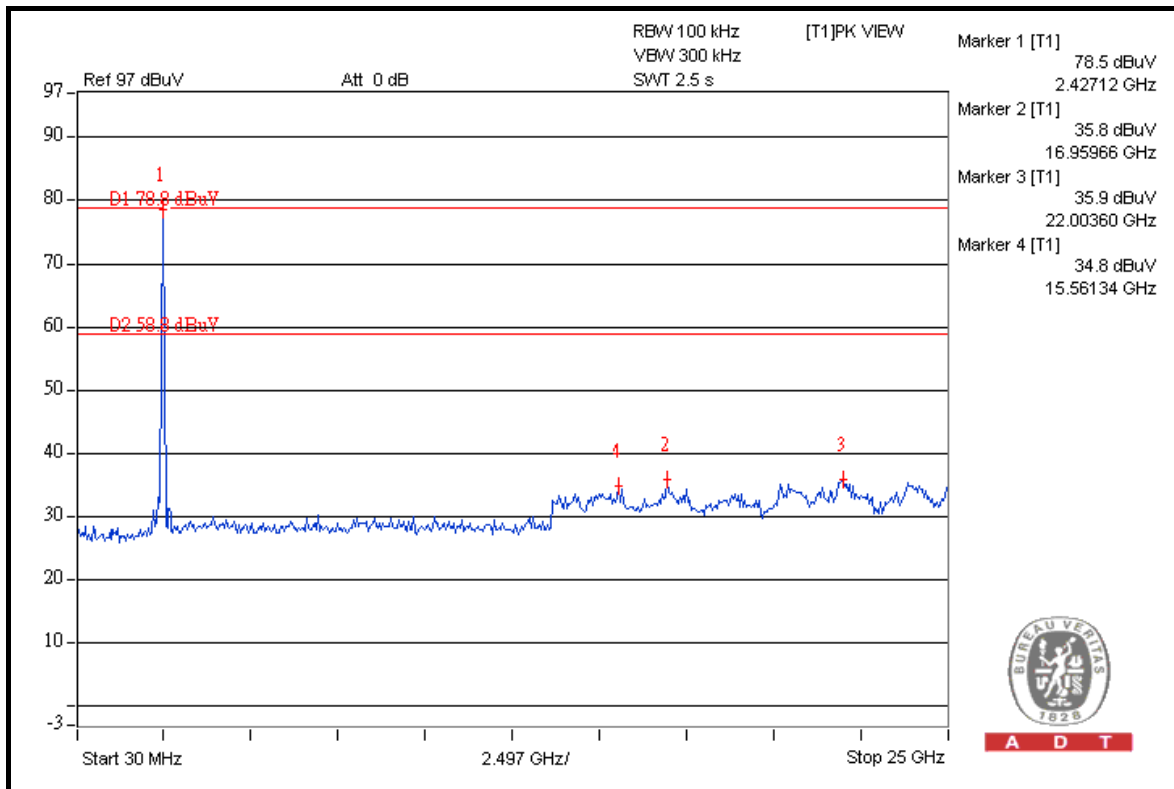

A D T



A D T

802.11n (20MHz)

RESTRICT BAND (2310 ~ 2390 MHz)

FREQUENCY (MHz)	FUNDAMENTAL EMISSION (dBuV/m)	DELTA (dB)	MAXIMUM FIELD STRENGTH IN RESTRICT BAND (dBuV/m)	LIMIT (dBuV/m)
2412.00 (PK)	114.3	45.1	69.2	74.00
2412.00 (AV)	101.0	49.4	51.6	54.00

RESTRICT BAND (2483.5 ~ 2500 MHz)

FREQUENCY (MHz)	FUNDAMENTAL EMISSION (dBuV/m)	DELTA (dB)	MAXIMUM FIELD STRENGTH IN RESTRICT BAND (dBuV/m)	LIMIT (dBuV/m)
2462.00 (PK)	113.1	44.8	68.3	74.00
2462.00 (AV)	99.1	47.5	51.6	54.00

NOTE:

1. Delta = Amplitude between the peak of the fundamental and the peak of the band edge emission. Please check following 3 pages.
2. Maximum field strength in restrict band = Fundamental emission – Delta.



A D T

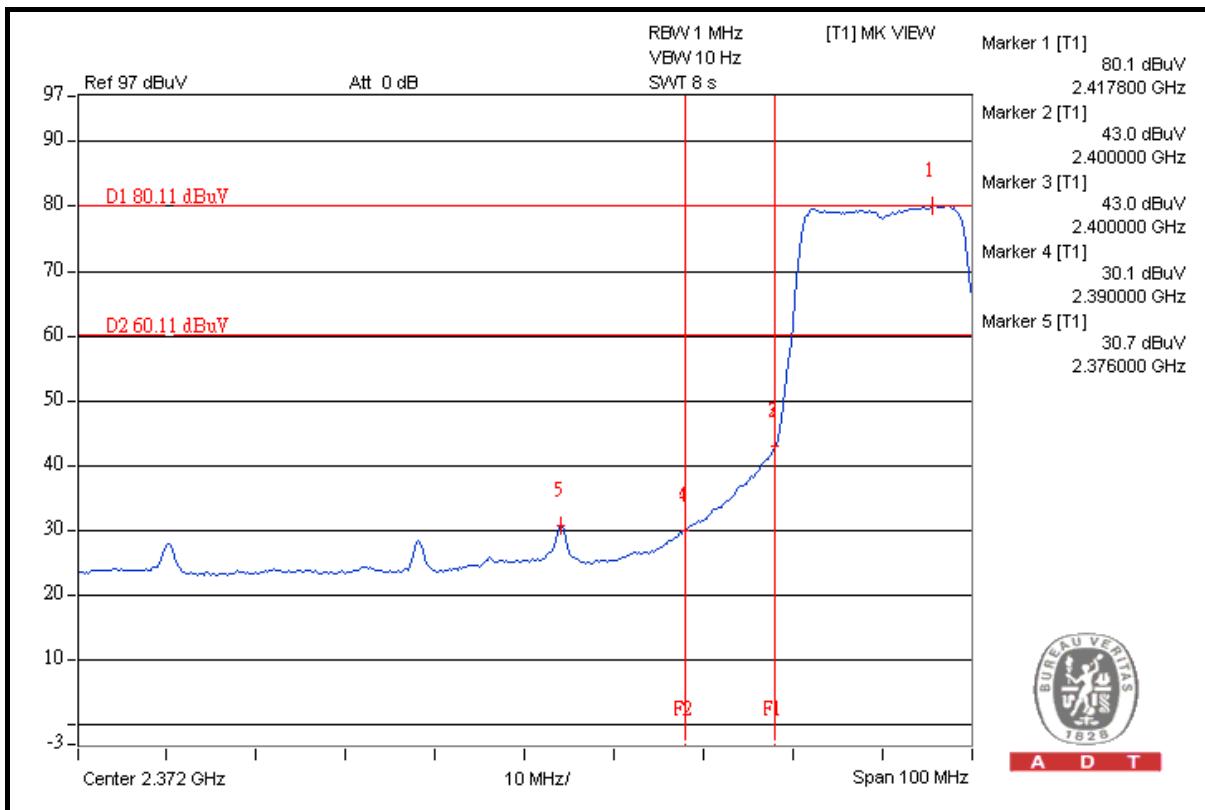
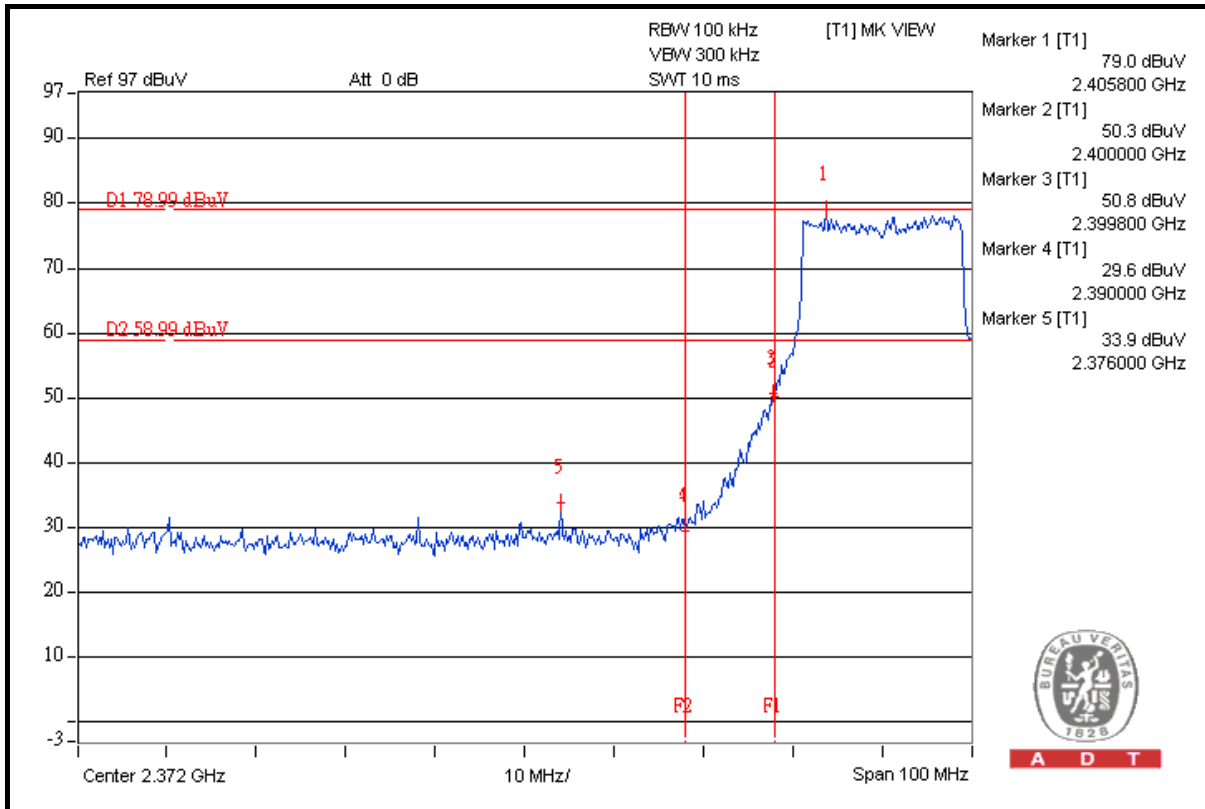



A D T

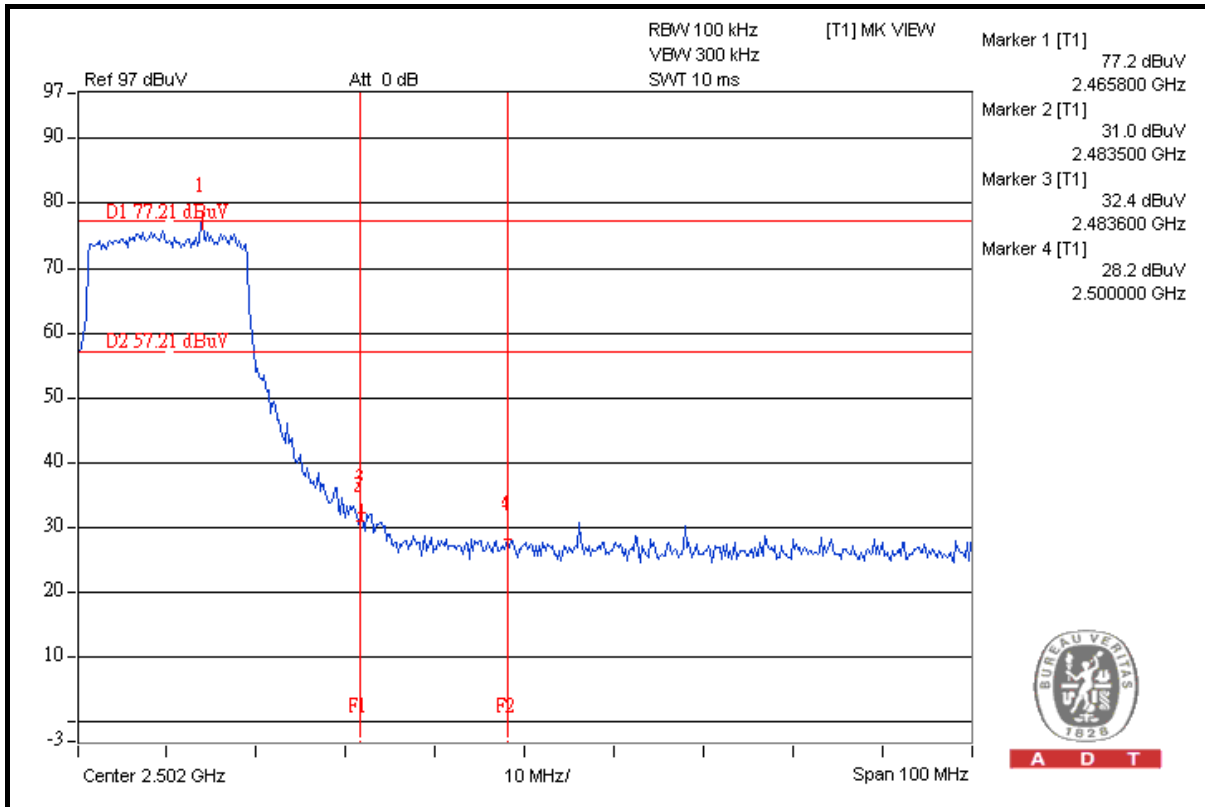
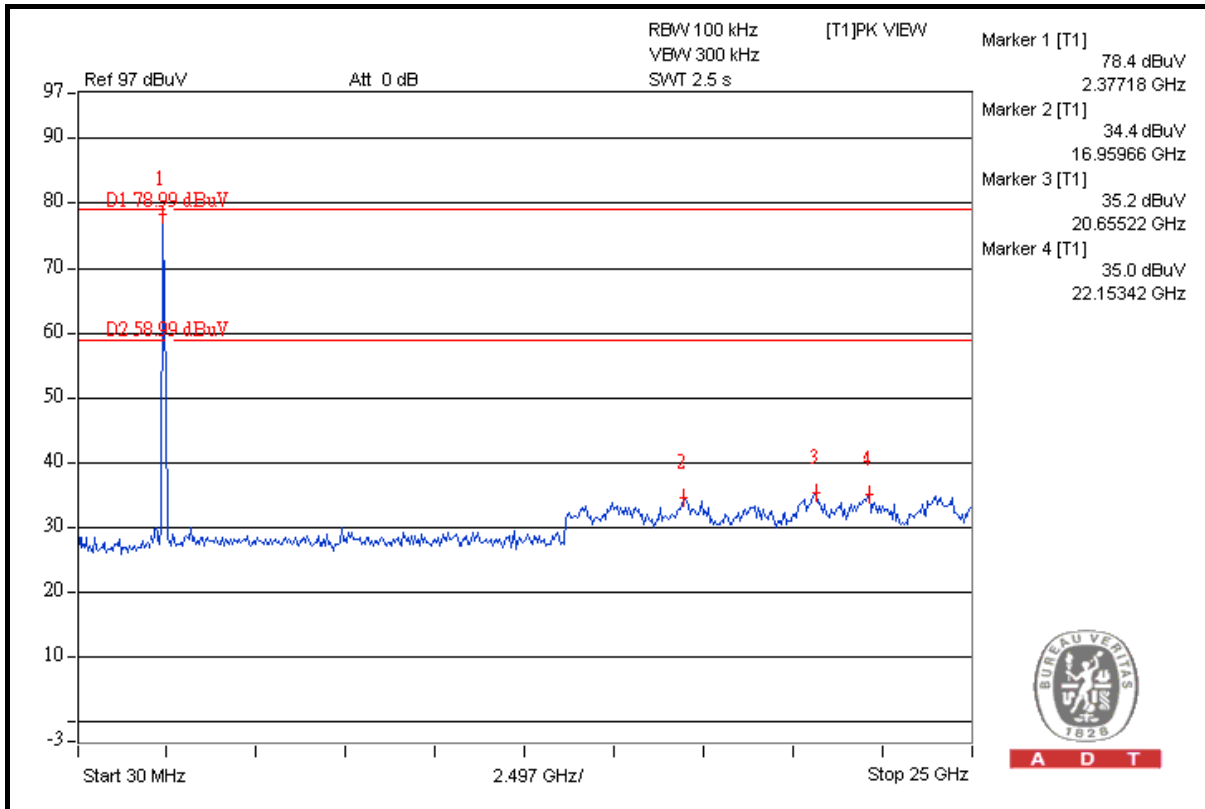



A D T

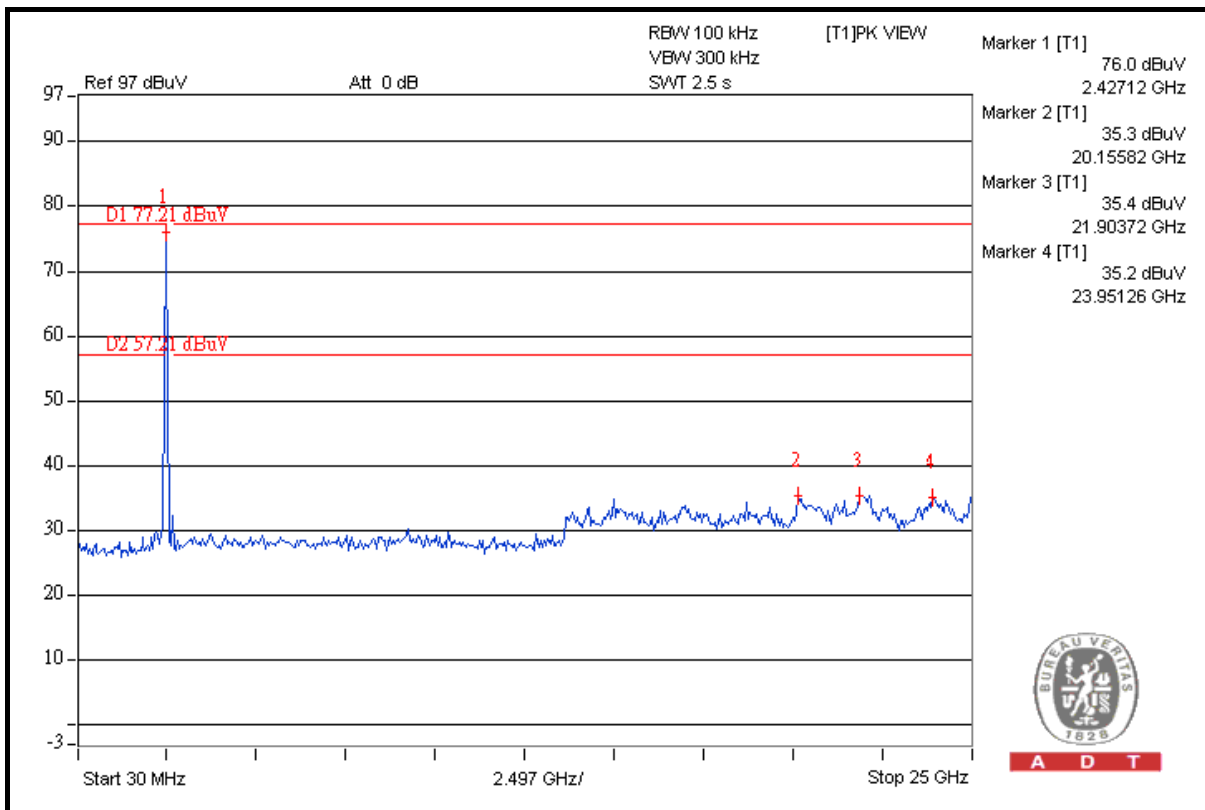
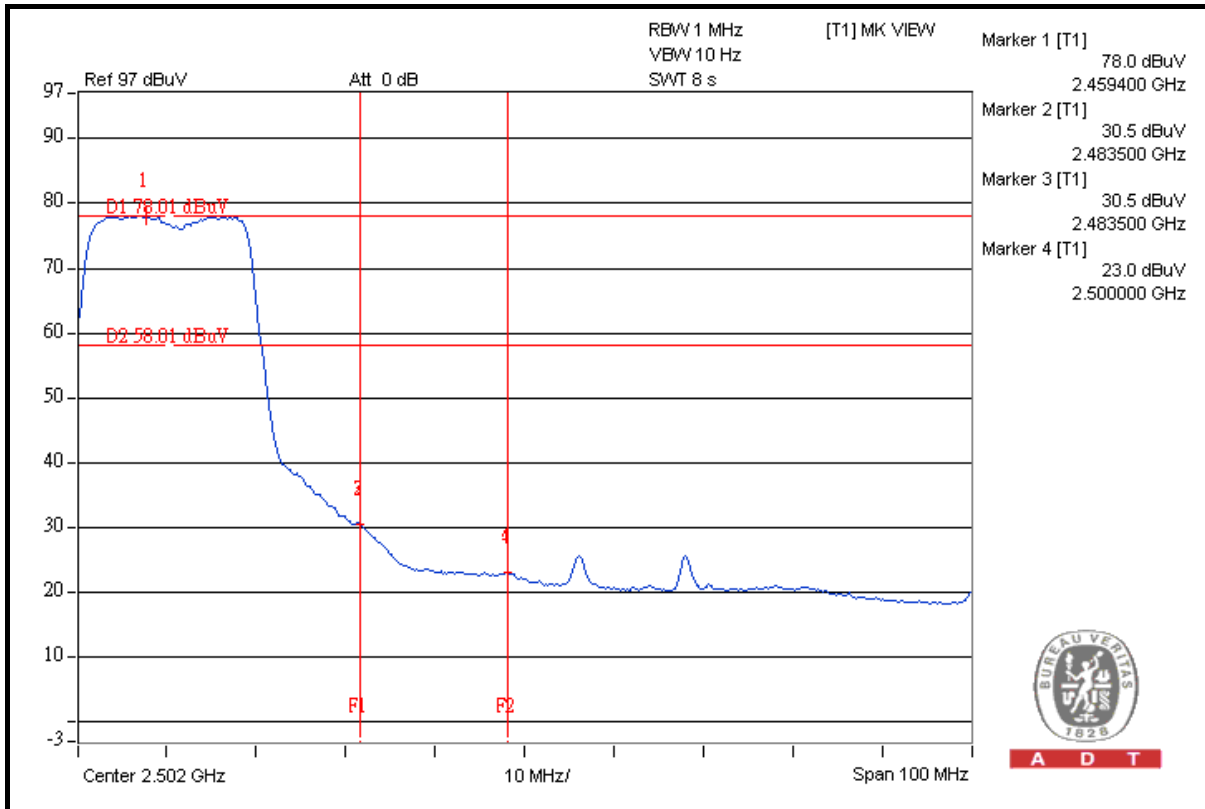



A D T

802.11n (40MHz)

RESTRICT BAND (2310 ~ 2390 MHz)

FREQUENCY (MHz)	FUNDAMENTAL EMISSION (dBuV/m)	DELTA (dB)	MAXIMUM FIELD STRENGTH IN RESTRICT BAND (dBuV/m)	LIMIT (dBuV/m)
2422.00 (PK)	106.7	40.6	66.1	74.00
2422.00 (AV)	94.6	43.2	51.4	54.00

RESTRICT BAND (2483.5 ~ 2500 MHz)

FREQUENCY (MHz)	FUNDAMENTAL EMISSION (dBuV/m)	DELTA (dB)	MAXIMUM FIELD STRENGTH IN RESTRICT BAND (dBuV/m)	LIMIT (dBuV/m)
2452.00 (PK)	107.4	41.9	65.5	74.00
2452.00 (AV)	95.0	43.6	51.4	54.00

NOTE:

1. Delta = Amplitude between the peak of the fundamental and the peak of the band edge emission. Please check following 3 pages.
2. Maximum field strength in restrict band = Fundamental emission – Delta.



A D T

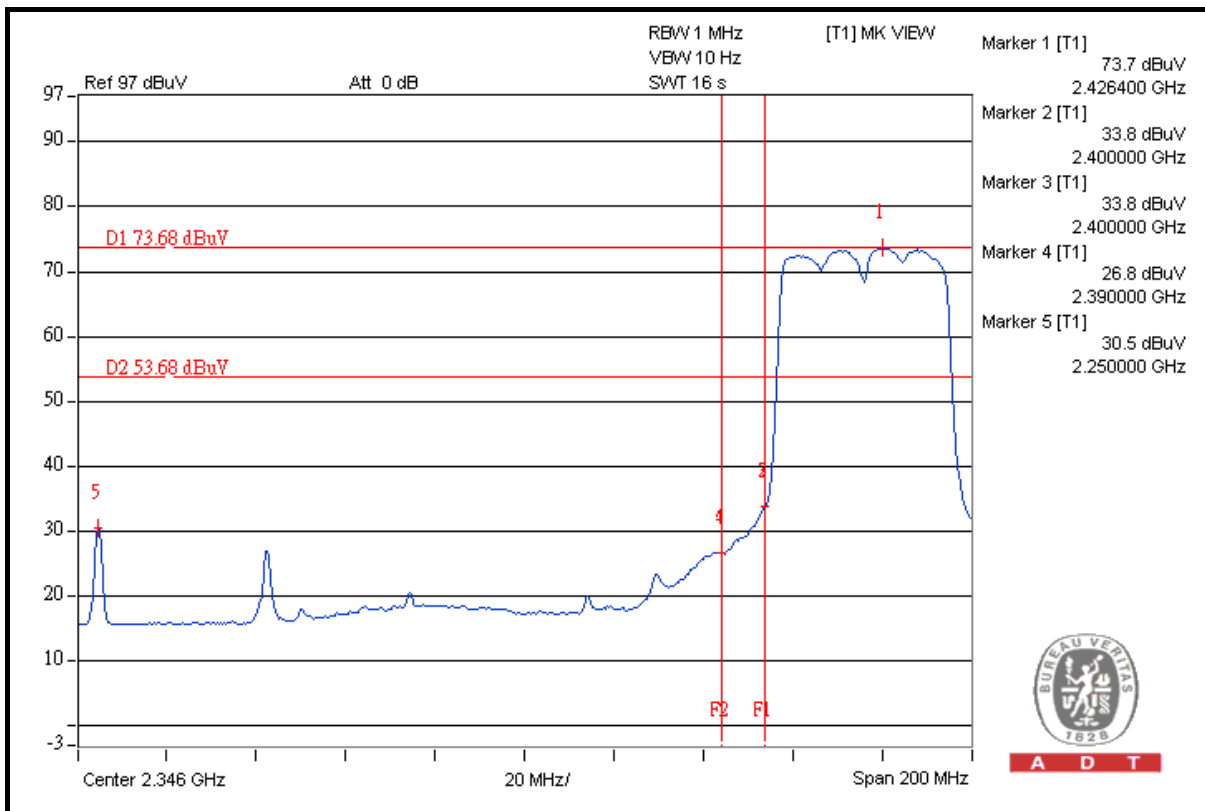
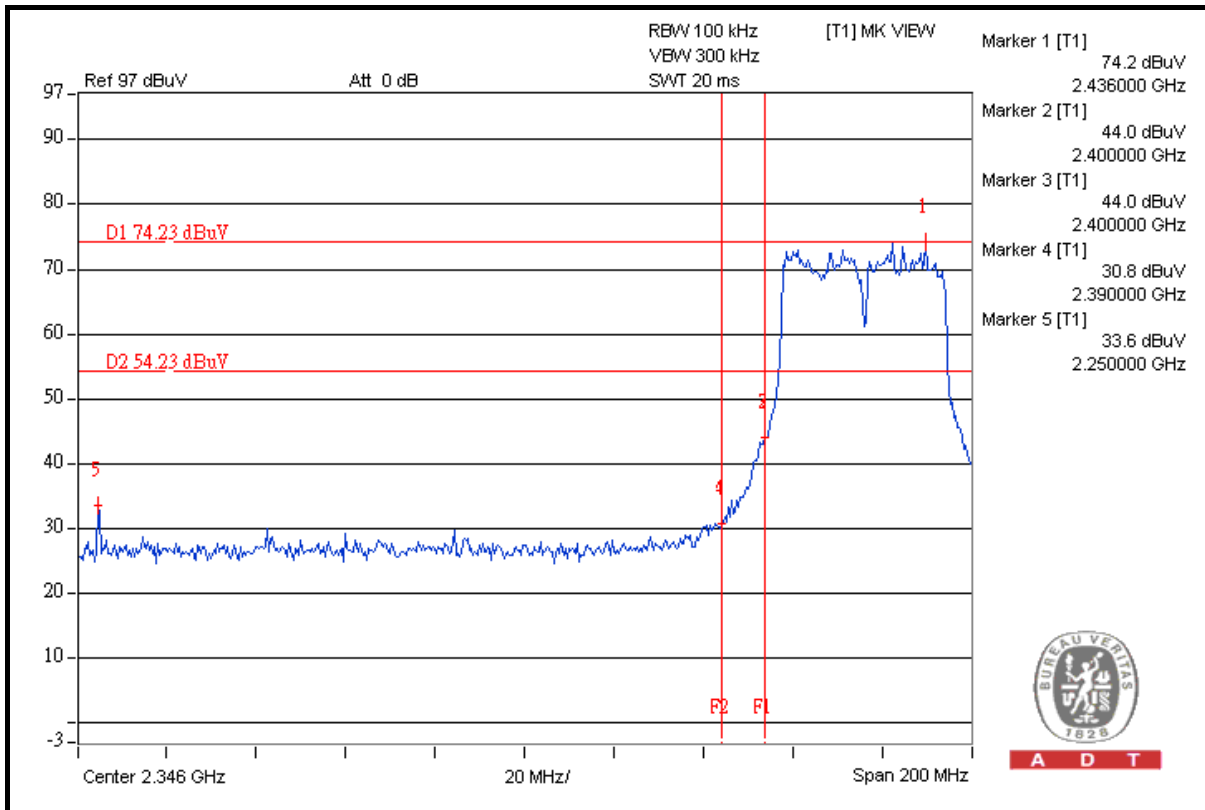



A D T

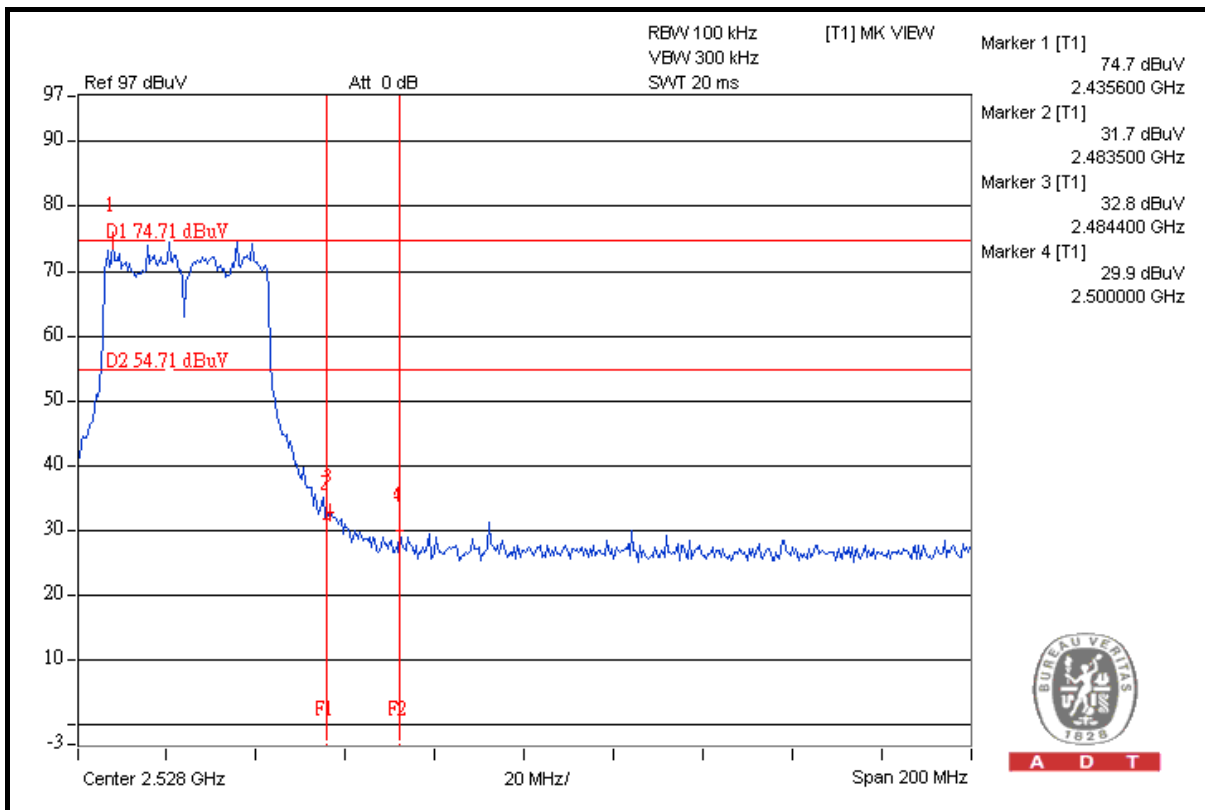
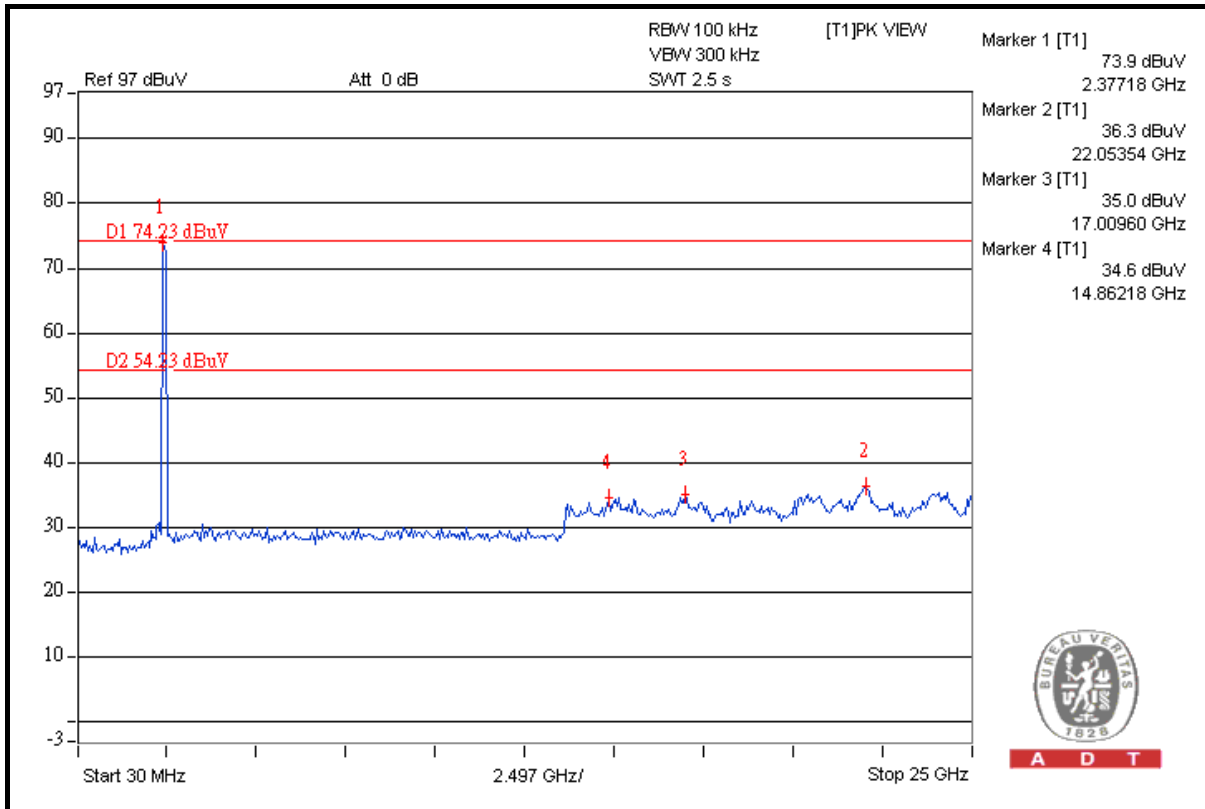



A D T

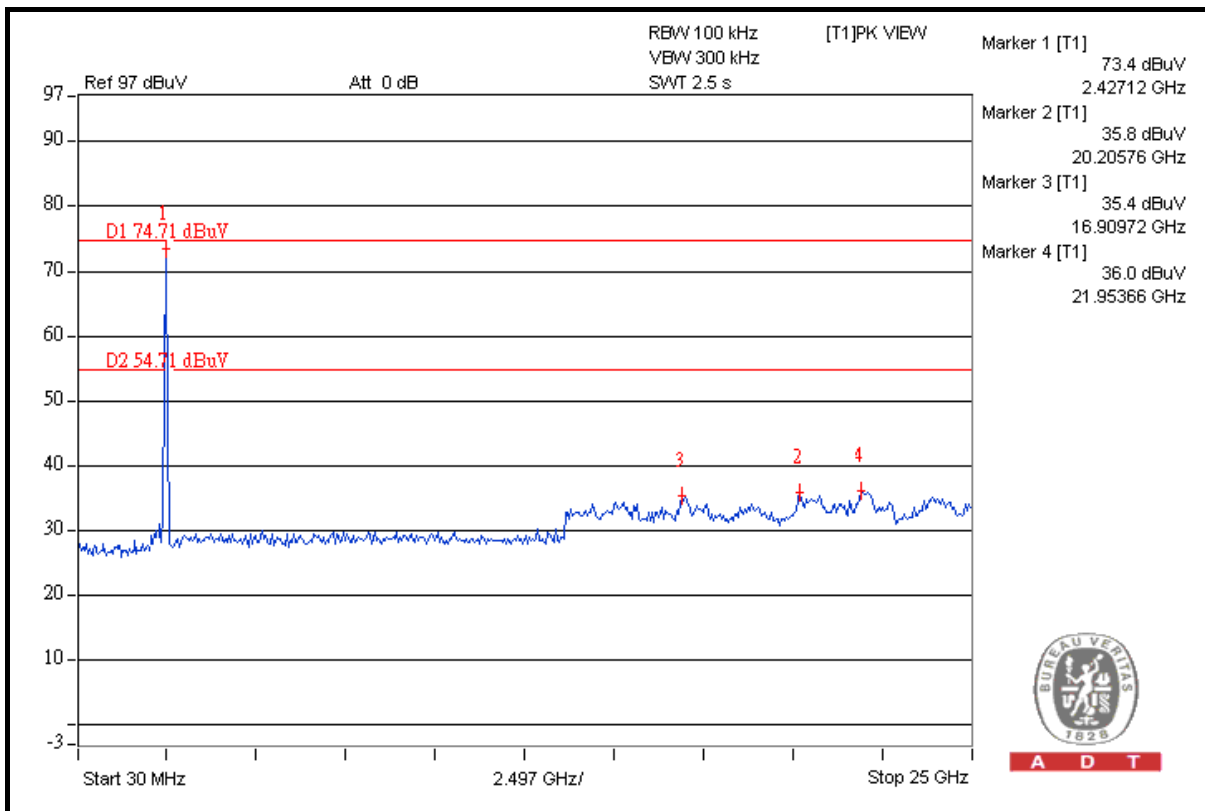
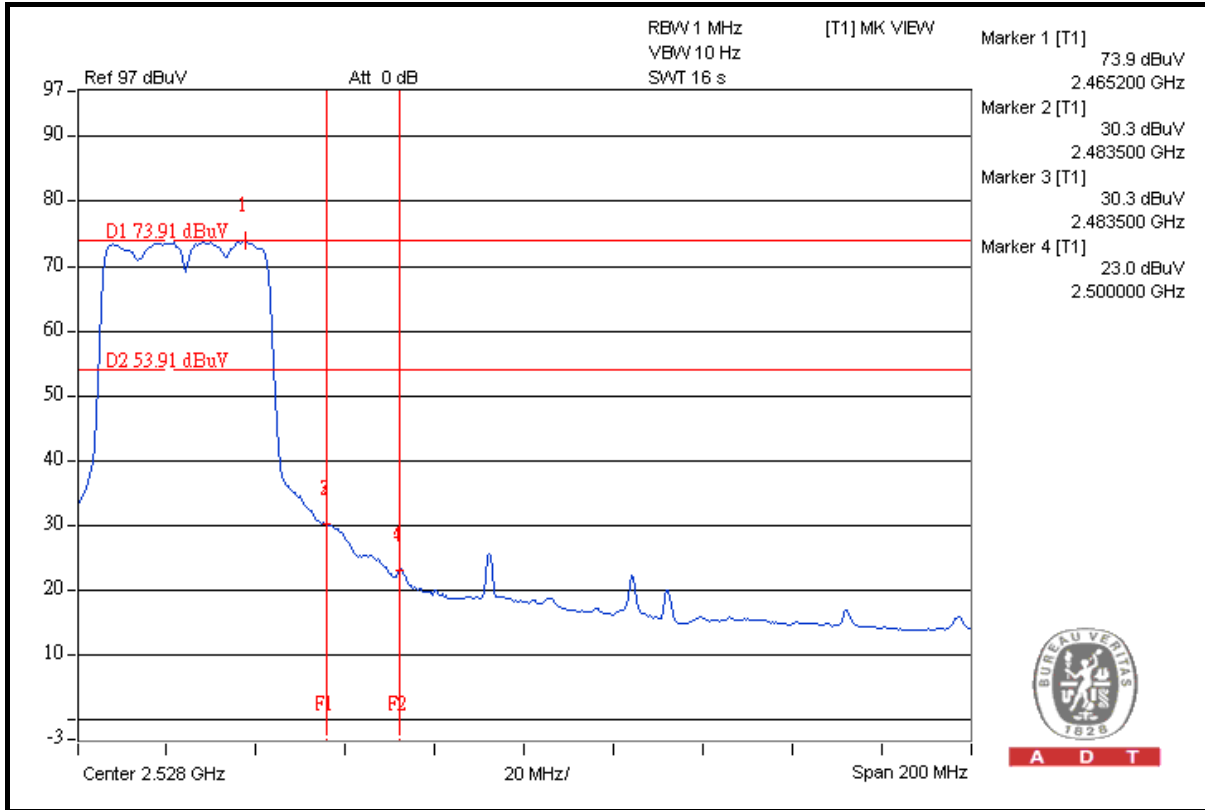



A D T

5. PHOTOGRAPHS OF THE TEST CONFIGURATION

Please refer to the attached file (Test Setup Photo).



A D T

6. INFORMATION ON THE TESTING LABORATORIES

We, Bureau Veritas Consumer Products Services (H.K.) Ltd., Taoyuan Branch, were founded in 1988 to provide our best service in EMC, Radio, Telecom and Safety consultation. Our laboratories are accredited and approved according to ISO/IEC 17025.

Copies of accreditation certificates of our laboratories obtained from approval agencies can be downloaded from our web site: www.adt.com.tw/index.5/phtml. If you have any comments, please feel free to contact us at the following:

Linko EMC/RF Lab:

Tel: 886-2-26052180

Fax: 886-2-26051924

Hsin Chu EMC/RF Lab:

Tel: 886-3-5935343

Fax: 886-3-5935342

Hwa Ya EMC/RF/Safety Telecom Lab:

Tel: 886-3-3183232

Fax: 886-3-3185050

Web Site: www.adt.com.tw

The address and road map of all our labs can be found in our web site also.



A D T

7. APPENDIX A - MODIFICATIONS RECORDERS FOR ENGINEERING CHANGES TO THE EUT BY THE LAB

No any modifications are made to the EUT by the lab during the test.

---END---