



FCC TEST REPORT

REPORT NO.: RF971218L04B

MODEL NO.: ESR6650 (Refer to item 3.1 for more details)

RECEIVED: May 21, 2009

TESTED: Jul. 07 ~ Jul. 09, 2009

ISSUED: Jul. 13, 2009

APPLICANT: Senao Networks Inc.

ADDRESS: 3F, No. 529, Chung Cheng Rd., Hsintien, Taipei,
Taiwan, R.O.C.

ISSUED BY: Bureau Veritas Consumer Products Services
(H.K.) Ltd., Taoyuan Branch

LAB ADDRESS: No. 47, 14th Ling, Chia Pau Tsuen, Lin Kou
Hsiang, Taipei Hsien 244, Taiwan, R.O.C.

TEST LOCATION: No. 19, Hwa Ya 2nd Rd, Wen Hwa Tsuen, Kwei
Shan Hsiang, Taoyuan Hsien 333, Taiwan,
R.O.C.

This test report consists of 44 pages in total. It may be duplicated completely for legal use with the approval of the applicant. It should not be reproduced except in full, without the written approval of our laboratory. The client should not use it to claim product endorsement by TAF or any government agencies. The test results in the report only apply to the tested sample.



TABLE OF CONTENTS

1.	CERTIFICATION.....	3
2.	SUMMARY OF TEST RESULTS	4
2.1	MEASUREMENT UNCERTAINTY.....	4
3.	GENERAL INFORMATION.....	5
3.1	GENERAL DESCRIPTION OF EUT	5
3.2	DESCRIPTION OF TEST MODES	8
3.2.1	CONFIGURATION OF SYSTEM UNDER TEST	8
3.2.2	TEST MODE APPLICABILITY AND TESTED CHANNEL DETAIL	9
3.3	GENERAL DESCRIPTION OF APPLIED STANDARDS	10
3.4	DESCRIPTION OF SUPPORT UNITS	10
4.	TEST TYPES AND RESULTS	11
4.1	RADIATED EMISSION MEASUREMENT	11
4.1.1	LIMITS OF RADIATED EMISSION MEASUREMENT.....	11
4.1.2	TEST INSTRUMENTS.....	12
4.1.3	TEST PROCEDURES	13
4.1.4	DEVIATION FROM TEST STANDARD.....	13
4.1.5	TEST SETUP	14
4.1.6	EUT OPERATING CONDITIONS	14
4.1.7	TEST RESULTS	15
4.2	CONDUCTED EMISSION MEASUREMENT	31
4.2.1	LIMITS OF CONDUCTED EMISSION MEASUREMENT.....	31
4.2.2	TEST INSTRUMENTS.....	31
4.2.3	TEST PROCEDURES	32
4.2.4	DEVIATION FROM TEST STANDARD.....	32
4.2.5	TEST SETUP.....	33
4.2.6	EUT OPERATING CONDITIONS	33
4.2.7	TEST RESULTS	34
5.	PHOTOGRAPHS OF THE TEST CONFIGURATION.....	42
6.	INFORMATION ON THE TESTING LABORATORIES	43
7.	APPENDIX A - MODIFICATIONS RECORDERS FOR ENGINEERING CHANGES TO THE EUT BY THE LAB.....	44



1. CERTIFICATION

PRODUCT: Wireless Micro Router
MODEL: ESR6650 (Refer to item 3.1 for more details)
BRAND: EnGenius (Refer to item 3.1 for more details)
APPLICANT: Senao Networks Inc.
TESTED: Jul. 07 ~ Jul. 09, 2009
TEST SAMPLE: R&D SAMPLE
STANDARDS: FCC Part 15, Subpart C (Section 15.247)
ANSI C63.4-2003

The above equipment (model: ESR6650) has been tested by **Bureau Veritas Consumer Products Services (H.K.) Ltd., Taoyuan Branch**, and found compliance with the requirement of the above standards. The test record, data evaluation & Equipment Under Test (EUT) configurations represented herein are true and accurate accounts of the measurements of the sample's EMC characteristics under the conditions specified in this report.

PREPARED BY : Ivy Lin , **DATE:** Jul. 13, 2009
Ivy Lin / Specialist

TECHNICAL ACCEPTANCE : Long Chen , **DATE:** Jul. 13, 2009
Responsible for RF Long Chen / Senior Engineer

APPROVED BY : Gary Chang , **DATE:** Jul. 13, 2009
Gary Chang / Assistant Manager

2. SUMMARY OF TEST RESULTS

The EUT has been tested according to the following specifications:

APPLIED STANDARD: FCC Part 15, Subpart C			
Standard Section	Test Type and Limit	Result	Remark
15.207	AC Power Conducted Emission	PASS	Meet the requirement of limit. Minimum passing margin is -6.91dB at 0.358MHz.
15.247(a)(2)	Spectrum Bandwidth of a Direct Sequence Spread Spectrum System Limit: min. 500kHz	NA	NA
15.247(b)	Maximum Peak Output Power Limit: max. 30dBm	NA	NA
15.247(d)	Radiated Emissions Limit: Table 15.209	PASS	Meet the requirement of limit. Minimum passing margin is -1.18dB at 30.00MHz.
15.247(e)	Power Spectral Density Limit: max. 8dBm	NA	NA
15.247(d)	Band Edge Measurement Limit: 20dB less than the peak value of fundamental frequency	NA	NA

2.1 MEASUREMENT UNCERTAINTY

Where relevant, the following measurement uncertainty levels have been estimated for tests performed on the EUT as specified in CISPR 16-4-2:

MEASUREMENT	FREQUENCY	UNCERTAINTY
Conducted emissions	150kHz~30MHz	2.44 dB
Radiated emissions	30MHz ~ 200MHz	3.34 dB
	200MHz ~1000MHz	3.35 dB
	1GHz ~ 18GHz	2.26 dB
	18GHz ~ 40GHz	1.94 dB

This uncertainty represents an expanded uncertainty expressed at approximately the 95% confidence level using a coverage factor of k=2.

3. GENERAL INFORMATION

3.1 GENERAL DESCRIPTION OF EUT

PRODUCT	Wireless Micro Router
MODEL NO.	ESR6650 (Refer to note for more details)
FCC ID	U2M-SR97908005
POWER SUPPLY	12Vdc from AC adapter
MODULATION TYPE	CCK, DQPSK, DBPSK for DSSS 64QAM, 16QAM, QPSK, BPSK for OFDM
MODULATION TECHNOLOGY	DSSS, OFDM
TRANSFER RATE	802.11b: 11.0/ 5.5/ 2.0/ 1.0Mbps 802.11g: 54.0/ 48.0/ 36.0/ 24.0/ 18.0/ 12.0/ 9.0/ 6.0Mbps Draft 802.11n: up to 150Mbps
OPERATING FREQUENCY	2412MHz ~ 2462MHz
NUMBER OF CHANNEL	11 for 802.11b, 802.11g, draft 802.11n (20MHz) 7 for draft 802.11n (40MHz)
MAXIMUM OUTPUT POWER	320.627mW
ANTENNA TYPE	Dipole antenna with 2dBi gain
DATA CABLE	NA
I/O PORTS	RJ45, USB
ACCESSORY DEVICES	AC adapter

NOTE:

1. This report is a supplementary report of RF971218L04. This report is prepared for FCC class II permissive change. The differences compared with original report are the addition of brand, adapter, and changing model and interface. Therefore test items of conducted emission and radiated emission were re-tested and performed them in the report.
2. The interfaces change are as below:
 - ✧ Four LAN ports change to two LAN ports
 - ✧ Add one USB port (This port can support 3G dongle)
3. The models as below are electrically identical, different brand names and models no. are for marketing purpose.

BRAND NAME	MODEL NO.
EnGenius	ESR6650
	ERB9250
	ECB9300
Rosewill	RNX-N4-3G
HIFULL	OBA-6800

4. The EUT was powered by the following adapter.

<Original>

ADAPTER 1	
BRAND:	AMIGO
MODEL:	AMS6-1201000SU
INPUT:	120Vac, 60Hz, 0.5A
OUTPUT:	12Vdc, 1.0A
POWER LINE:	1.8m non-shielded cable without core

ADAPTER 2	
BRAND:	DVE
MODEL:	DSA-12G-12 FUS 120120
INPUT:	100-240Vac, 50/60Hz, 0.3A
OUTPUT:	12Vdc, 1.0A
POWER LINE:	1.8m non-shielded cable without core

<New >

ADAPTER 1	
BRAND:	Powertron
MODEL:	PA1015-2HU
INPUT:	100-240Vac, 50-60Hz, 0.4A
OUTPUT:	12Vdc, 1.25A
POWER LINE:	1.8m non-shielded cable without core

ADAPTER 2	
BRAND:	DVE
MODEL:	DSA-15P-12 US 120150
INPUT:	100-240Vac, 50/60Hz, 0.5A
OUTPUT:	12Vdc, 1.25A
POWER LINE:	1.8m non-shielded cable without core

5. The EUT provides one completed transmitter and one receiver.
6. The above EUT information was declared by manufacturer and for more detailed features description, please refer to the manufacturer's specifications or user's manual.

3.2 DESCRIPTION OF TEST MODES

Eleven channels are provided for 802.11b, 802.11g and draft 802.11n (20MHz):

CHANNEL	FREQUENCY	CHANNEL	FREQUENCY
1	2412MHz	7	2442MHz
2	2417MHz	8	2447MHz
3	2422MHz	9	2452MHz
4	2427MHz	10	2457MHz
5	2432MHz	11	2462MHz
6	2437MHz		

Seven channels are provided for draft 802.11n (40MHz):

CHANNEL	FREQUENCY	CHANNEL	FREQUENCY
1	2422MHz	5	2442MHz
2	2427MHz	6	2447MHz
3	2432MHz	7	2452MHz
4	2437MHz		

3.2.1 CONFIGURATION OF SYSTEM UNDER TEST

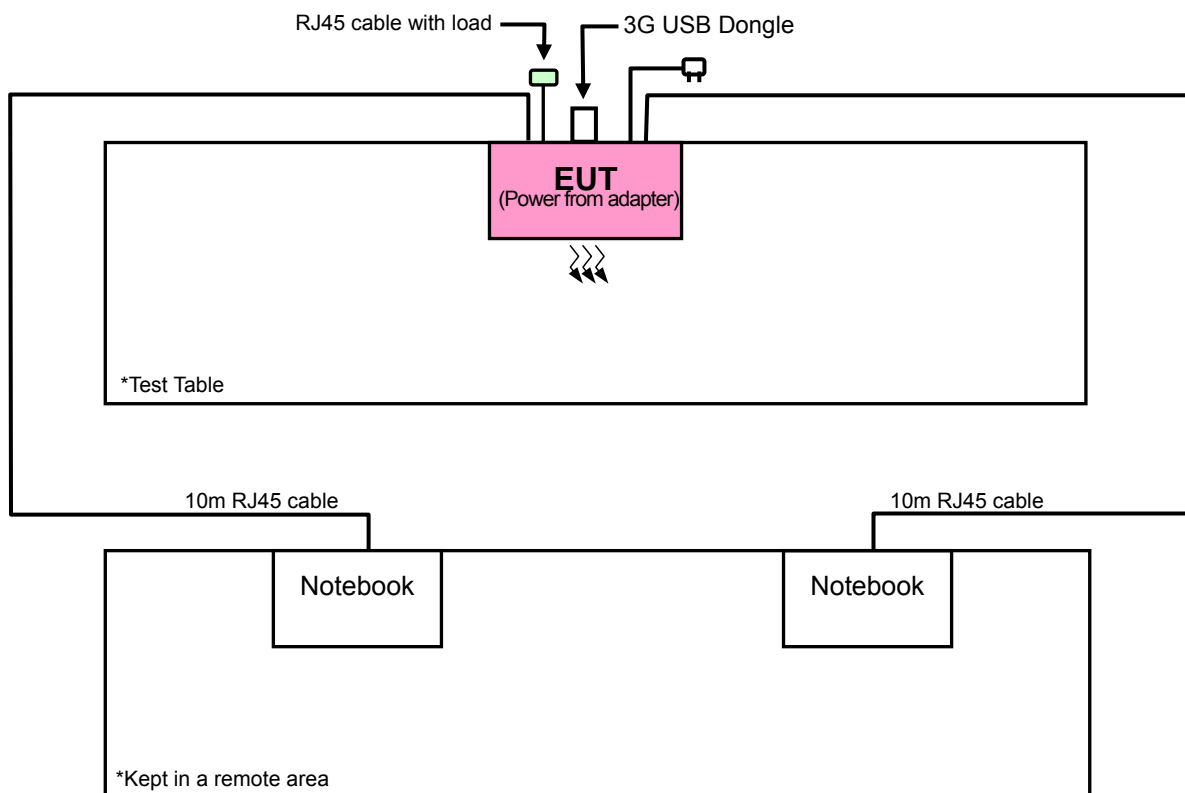



3.2.2 TEST MODE APPLICABILITY AND TESTED CHANNEL DETAIL

EUT CONFIGURE MODE	APPLICABLE TO			DESCRIPTION
	RE \geq 1G	RE<1G	PLC	
A	-	√	√	Adapter: AMS6-1201000SU
B	-	√	√	Adapter: DSA-12G-12 FUS 120120
C	√	√	√	Adapter: PA1015-2HU
D	-	√	√	Adapter: DSA-15P-12 US 120150

Where **PLC**: Power Line Conducted Emission **RE<1G**: Radiated Emission below 1GHz
RE \geq 1G: Radiated Emission above 1GHz **APCM**: Antenna Port Conducted Measurement
Note: "-" means no effect.

RADIATED EMISSION TEST (ABOVE 1 GHz):

- Pre-Scan has been conducted to determine the worst-case mode from all possible combinations between available modulations, data rates, XYZ axis and antenna ports (if EUT with antenna diversity architecture).
- Following channel(s) was (were) selected for the final test as listed below.

EUT CONFIGURE MODE	MODE	AVAILABLE CHANNEL	TESTED CHANNEL	MODULATION TECHNOLOGY	MODULATION TYPE	DATA RATE (Mbps)	AXIS
C	802.11b	1 to 11	1, 6, 11	DSSS	DBPSK	1	Z
C	802.11g	1 to 11	1, 6, 11	OFDM	BPSK	6	Z
C	Draft 802.11n (20MHz)	1 to 11	1, 6, 11	OFDM	BPSK	6.5	Z
C	Draft 802.11n (40MHz)	1 to 7	1, 4, 7	OFDM	BPSK	13.5	Z

RADIATED EMISSION TEST (BELOW 1 GHz):

- Pre-Scan has been conducted to determine the worst-case mode from all possible combinations between available modulations, data rates, XYZ axis and antenna ports (if EUT with antenna diversity architecture).
- Following channel(s) was (were) selected for the final test as listed below.

EUT CONFIGURE MODE	MODE	AVAILABLE CHANNEL	TESTED CHANNEL	MODULATION TECHNOLOGY	MODULATION TYPE	DATA RATE (Mbps)	AXIS
A, B, C, D	802.11g	1 to 11	6	OFDM	BPSK	6	Z

POWER LINE CONDUCTED EMISSION TEST:

- Pre-Scan has been conducted to determine the worst-case mode from all possible combinations between available modulations, data rates, and antenna ports (if EUT with antenna diversity architecture).
- Following channel(s) was (were) selected for the final test as listed below.

EUT CONFIGURE MODE	MODE	AVAILABLE CHANNEL	TESTED CHANNEL	MODULATION TECHNOLOGY	MODULATION TYPE	DATA RATE (Mbps)
A, B, C, D	802.11g	1 to 11	6	OFDM	BPSK	6

3.3 GENERAL DESCRIPTION OF APPLIED STANDARDS

The EUT is a RF product. According to the specifications of the manufacturer, it must comply with the requirements of the following standards:

FCC Part 15, Subpart C (15.247)

ANSI C63.4-2003

All test items have been performed and recorded as per the above standards.

NOTE: The EUT is also considered as a kind of computer peripheral, because the connection to computer is necessary for typical use. It has been verified to comply with the requirements of FCC Part 15, Subpart B, Class B (DoC). The test report has been issued separately.

3.4 DESCRIPTION OF SUPPORT UNITS

The EUT has been tested as an independent unit together with other necessary accessories or support units. The following support units or accessories were used to form a representative test configuration during the tests.

NO.	PRODUCT	BRAND	MODEL NO.	SERIAL NO.	FCC ID
1	NOTEBOOK	DELL	PP05L	12130898320	E2K24CLNS
2	NOTEBOOK	DELL	PP05L	9954115984	E2K24CLNS
3	3G USB DONGLE	Sierra Aircard	888U	NA	N7NC888

NO.	SIGNAL CABLE DESCRIPTION OF THE ABOVE SUPPORT UNITS
1	10m UTP RJ45 cable
2	10m UTP RJ45 cable
3	NA

NOTE: 1. All power cords of the above support units are non shielded (1.8m).
 2. Item 1-2 acted as a communication partner to transfer data.
 3. Item 3 was provided by client.

4. TEST TYPES AND RESULTS

4.1 RADIATED EMISSION MEASUREMENT

4.1.1 LIMITS OF RADIATED EMISSION MEASUREMENT

Emissions radiated outside of the specified bands, shall be according to the general radiated limits in 15.209 as following:

FREQUENCIES (MHz)	FIELD STRENGTH (microvolts/meter)	MEASUREMENT DISTANCE (meters)
0.009 ~ 0.490	2400 / F(kHz)	300
0.490 ~ 1.705	24000 / F(kHz)	30
1.705 ~ 30.0	30	30
30 ~ 88	100	3
88 ~ 216	150	3
216 ~ 960	200	3
Above 960	500	3

NOTE:

1. The lower limit shall apply at the transition frequencies.
2. Emission level (dBuV/m) = 20 log Emission level (uV/m).
3. As shown in 15.35(b), for frequencies above 1000MHz, the field strength limits are based on average detector, however, the peak field strength of any emission shall not exceed the maximum permitted average limits, specified above by more than 20dB under any condition of modulation.



4.1.2 TEST INSTRUMENTS

DESCRIPTION & MANUFACTURER	MODEL NO.	SERIAL NO.	DATE OF CALIBRATION	DUE DATE OF CALIBRATION
Test Receiver ROHDE & SCHWARZ	ESIB7	100212	May 25, 2009	May 24, 2010
Spectrum Analyzer ROHDE & SCHWARZ	FSP40	100269	Aug. 08, 2008	Aug. 07, 2009
BILOG Antenna SCHWARZBECK	VULB9168	9168-156	Apr. 30, 2009	Apr. 29, 2010
HORN Antenna SCHWARZBECK	BBHA 9120 D	9120D-563	Aug. 06, 2008	Aug. 05, 2009
HORN Antenna SCHWARZBECK	BBHA 9170	BBHA9170242	Jan. 06, 2009	Jan. 05, 2010
Preamplifier Agilent	8449B	3008A01911	Sep. 10, 2008	Sep. 09, 2009
Preamplifier Agilent	8447D	2944A10638	Dec. 26, 2008	Dec. 25, 2009
RF signal cable HUBER+SUHNNER	SUCOFLEX 104	218190/4 231241/4	May 13, 2009	May 12, 2010
RF signal cable Worken	8D-FB	Cable-HYCH9-01	Aug. 09, 2008	Aug. 08, 2009
Software	ADT_Radiated_ V7.6.15.9.2	NA	NA	NA
Antenna Tower EMCO	2070/2080	512.835.4684	NA	NA
Turn Table EMCO	2087-2.03	NA	NA	NA
Antenna Tower & Turn Table Controller EMCO	2090	NA	NA	NA

- NOTE:** 1. The calibration interval of the above test instruments is 12 months and the calibrations are traceable to NML/ROC and NIST/USA.
2. The test was performed in HwaYa Chamber 9.
3. The horn antenna and HP preamplifier (model: 8449B) are used only for the measurement of emission frequency above 1GHz if tested.
4. The FCC Site Registration No. is 460141.
5. The IC Site Registration No. is IC 7450F-4.

4.1.3 TEST PROCEDURES

- a. The EUT was placed on the top of a rotating table 0.8 meters above the ground at a 3 meters semi-anechoic chamber. The table was rotated 360 degrees to determine the position of the highest radiation.
- b. The EUT was set 3 meters away from the interference-receiving antenna, which was mounted on the top of a variable-height antenna tower.
- c. The antenna is a broadband antenna, and its height is varied from one meter to four meters above the ground to determine the maximum value of the field strength. Both horizontal and vertical polarizations of the antenna are set to make the measurement.
- d. For each suspected emission, the EUT was arranged to its worst case and then the antenna was tuned to heights from 1 meter to 4 meters and the rotatable table was turned from 0 degrees to 360 degrees to find the maximum reading.
- e. The test-receiver system was set to Peak Detect Function and Specified Bandwidth with Maximum Hold Mode.
- f. If the emission level of the EUT in peak mode was lower than the limit specified, then testing could be stopped and the peak values of the EUT would be reported. Otherwise the emissions would be re-tested one by one using peak, quasi-peak or average method as specified and then reported in a data sheet.

NOTE:

1. The resolution bandwidth and video bandwidth of test receiver/spectrum analyzer is 120kHz for Peak detection (PK) and Quasi-peak detection (QP) at frequency below 1GHz.
2. The resolution bandwidth of test receiver/spectrum analyzer is 1 MHz and video bandwidth is 3MHz for Peak detection at frequency above 1GHz.
3. The resolution bandwidth of test receiver/spectrum analyzer is 1MHz and the video bandwidth is 10Hz for Average detection (AV) at frequency above 1GHz.
4. All modes of operation were investigated and the worst-case emissions are reported.

4.1.4 DEVIATION FROM TEST STANDARD

No deviation.

4.1.5 TEST SETUP

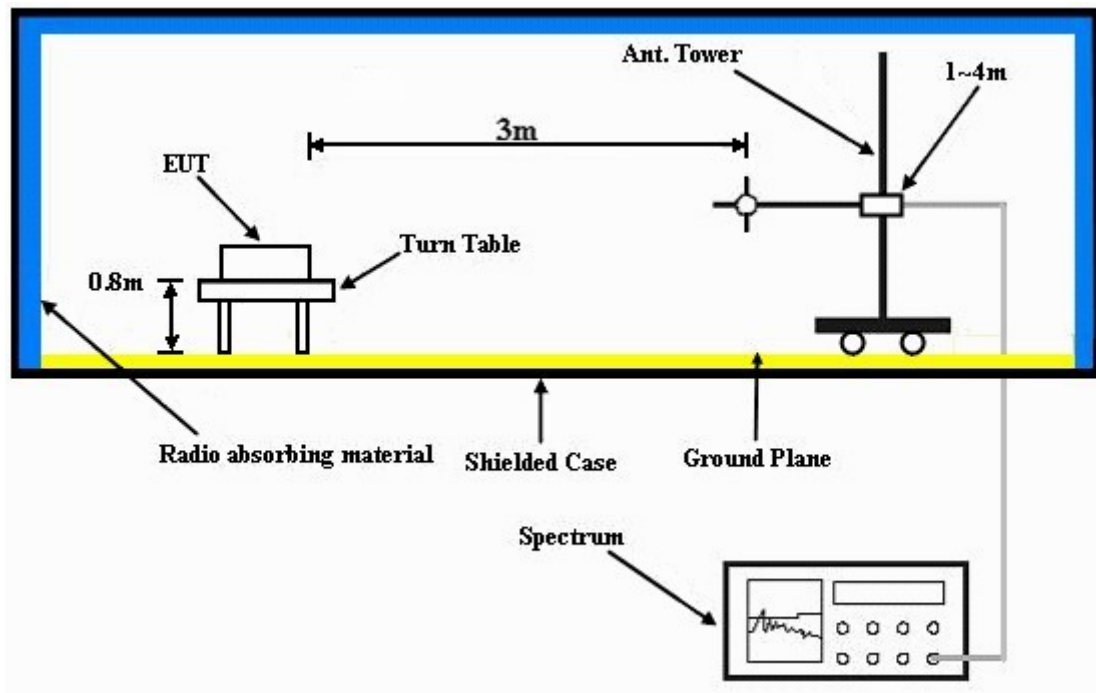

For the actual test configuration, please refer to the attached file (Test Setup Photo)

4.1.6 EUT OPERATING CONDITIONS

- a. Placed the EUT on the testing table.
- b. Prepared notebook systems to act as a communication partner and placed them outside of testing area.
- c. The communication partners connected with EUT via a RJ45 cable and run a test program (provided by manufacturer) to enable EUT under transmission condition continuously at specific channel frequency.
- d. The necessary accessories enable the EUT in full functions.

4.1.7 TEST RESULTS

802.11b DSSS MODULATION

EUT TEST CONDITION		MEASUREMENT DETAIL	
CHANNEL	Channel 1	FREQUENCY RANGE	1 ~ 25GHz
INPUT POWER (SYSTEM)	120Vac, 60 Hz	DETECTOR FUNCTION	Peak (PK) Average (AV)
ENVIRONMENTAL CONDITIONS	23.0deg. C, 70.0%RH 1012hPa	TESTED BY	Lori Chiu

ANTENNA POLARITY & TEST DISTANCE: HORIZONTAL AT 3 M								
NO.	FREQ. (MHz)	EMISSION LEVEL (dBuV/m)	LIMIT (dBuV/m)	MARGIN (dB)	ANTENNA HEIGHT (m)	TABLE ANGLE (Degree)	RAW VALUE (dBuV)	CORRECTION FACTOR (dB/m)
1	2386.00	56.60 PK	74.00	-17.40	1.00 H	16	24.39	32.21
2	2386.00	46.52 AV	54.00	-7.48	1.00 H	16	14.31	32.21
3	*2412.00	100.51 PK			1.00 H	16	68.21	32.30
4	*2412.00	97.03 AV			1.00 H	16	64.73	32.30
5	2491.00	57.75 PK	74.00	-16.25	1.00 H	16	25.16	32.59
6	2491.00	46.70 AV	54.00	-7.30	1.00 H	16	14.11	32.59
7	4824.00	49.52 PK	74.00	-24.48	1.30 H	37	11.19	38.33
8	4824.00	41.86 AV	54.00	-12.14	1.30 H	37	3.53	38.33
ANTENNA POLARITY & TEST DISTANCE: VERTICAL AT 3 M								
NO.	FREQ. (MHz)	EMISSION LEVEL (dBuV/m)	LIMIT (dBuV/m)	MARGIN (dB)	ANTENNA HEIGHT (m)	TABLE ANGLE (Degree)	RAW VALUE (dBuV)	CORRECTION FACTOR (dB/m)
1	2386.00	59.65 PK	74.00	-14.35	1.25 V	105	27.44	32.21
2	2386.00	49.13 AV	54.00	-4.87	1.25 V	105	16.92	32.21
3	*2412.00	108.67 PK			1.25 V	104	76.37	32.30
4	*2412.00	105.10 AV			1.25 V	104	72.80	32.30
5	2491.00	60.54 PK	74.00	-13.46	1.21 V	103	27.95	32.59
6	2491.00	50.24 AV	54.00	-3.76	1.21 V	103	17.65	32.59
7	4824.00	52.78 PK	74.00	-21.22	1.12 V	353	14.45	38.33
8	4824.00	47.70 AV	54.00	-6.30	1.12 V	353	9.37	38.33

- REMARKS:**
1. Emission level (dBuV/m) = Raw Value (dBuV) + Correction Factor (dB/m).
 2. Correction Factor (dB/m) = Antenna Factor (dB/m) + Cable Factor (dB).
 3. The other emission levels were very low against the limit.
 4. Margin value = Emission level – Limit value.
 5. “ * “: Fundamental frequency.



A D T

EUT TEST CONDITION		MEASUREMENT DETAIL	
CHANNEL	Channel 6	FREQUENCY RANGE	1 ~ 25GHz
INPUT POWER (SYSTEM)	120Vac, 60 Hz	DETECTOR FUNCTION	Peak (PK) Average (AV)
ENVIRONMENTAL CONDITIONS	23.0deg. C, 70.0%RH 1012hPa	TESTED BY	Lori Chiu

ANTENNA POLARITY & TEST DISTANCE: HORIZONTAL AT 3 M								
NO.	FREQ. (MHz)	EMISSION LEVEL (dBuV/m)	LIMIT (dBuV/m)	MARGIN (dB)	ANTENNA HEIGHT (m)	TABLE ANGLE (Degree)	RAW VALUE (dBuV)	CORRECTION FACTOR (dB/m)
1	*2437.00	100.52 PK			1.00 H	130	68.13	32.39
2	*2437.00	97.10 AV			1.00 H	130	64.71	32.39
3	4874.00	54.47 PK	74.00	-19.53	1.00 H	43	16.06	38.41
4	4874.00	49.86 AV	54.00	-4.14	1.00 H	43	11.45	38.41
ANTENNA POLARITY & TEST DISTANCE: VERTICAL AT 3 M								
NO.	FREQ. (MHz)	EMISSION LEVEL (dBuV/m)	LIMIT (dBuV/m)	MARGIN (dB)	ANTENNA HEIGHT (m)	TABLE ANGLE (Degree)	RAW VALUE (dBuV)	CORRECTION FACTOR (dB/m)
1	*2437.00	108.70 PK			1.22 V	106	76.31	32.39
2	*2437.00	105.39 AV			1.22 V	106	73.00	32.39
3	4874.00	52.70 PK	74.00	-21.30	1.11 V	6	14.29	38.41
4	4874.00	47.41 AV	54.00	-6.59	1.11 V	6	9.00	38.41

- REMARKS:**
1. Emission level (dBuV/m) = Raw Value (dBuV) + Correction Factor (dB/m).
 2. Correction Factor (dB/m) = Antenna Factor (dB/m) + Cable Factor (dB).
 3. The other emission levels were very low against the limit.
 4. Margin value = Emission level – Limit value.
 5. “ * “: Fundamental frequency.



A D T

EUT TEST CONDITION		MEASUREMENT DETAIL	
CHANNEL	Channel 11	FREQUENCY RANGE	1 ~ 25GHz
INPUT POWER (SYSTEM)	120Vac, 60 Hz	DETECTOR FUNCTION	Peak (PK) Average (AV)
ENVIRONMENTAL CONDITIONS	23.0deg. C, 70.0%RH 1012hPa	TESTED BY	Lori Chiu

ANTENNA POLARITY & TEST DISTANCE: HORIZONTAL AT 3 M								
NO.	FREQ. (MHz)	EMISSION LEVEL (dBuV/m)	LIMIT (dBuV/m)	MARGIN (dB)	ANTENNA HEIGHT (m)	TABLE ANGLE (Degree)	RAW VALUE (dBuV)	CORRECTION FACTOR (dB/m)
1	*2462.00	100.53 PK			1.16 H	41	68.05	32.48
2	*2462.00	97.16 AV			1.16 H	41	64.68	32.48
3	2483.50	57.90 PK	74.00	-16.10	1.16 H	41	25.34	32.56
4	2483.50	46.52 AV	54.00	-7.48	1.16 H	41	13.96	32.56
5	4924.00	50.23 PK	74.00	-23.77	1.25 H	44	11.71	38.51
6	4924.00	41.19 AV	54.00	-12.81	1.25 H	44	2.67	38.51
ANTENNA POLARITY & TEST DISTANCE: VERTICAL AT 3 M								
NO.	FREQ. (MHz)	EMISSION LEVEL (dBuV/m)	LIMIT (dBuV/m)	MARGIN (dB)	ANTENNA HEIGHT (m)	TABLE ANGLE (Degree)	RAW VALUE (dBuV)	CORRECTION FACTOR (dB/m)
1	*2462.00	108.78 PK			1.25 V	160	76.30	32.48
2	*2462.00	105.54 AV			1.25 V	160	73.06	32.48
3	2483.50	57.74 PK	74.00	-16.26	1.25 V	158	25.18	32.56
4	2483.50	47.72 AV	54.00	-6.28	1.25 V	158	15.16	32.56
5	4924.00	49.95 PK	74.00	-24.05	1.25 V	19	11.43	38.51
6	4924.00	42.02 AV	54.00	-11.98	1.25 V	19	3.50	38.51

- REMARKS:**
1. Emission level (dBuV/m) = Raw Value (dBuV) + Correction Factor (dB/m).
 2. Correction Factor (dB/m) = Antenna Factor (dB/m) + Cable Factor (dB).
 3. The other emission levels were very low against the limit.
 4. Margin value = Emission level – Limit value.
 5. “ * “: Fundamental frequency.



802.11g OFDM MODULATION

EUT TEST CONDITION		MEASUREMENT DETAIL	
CHANNEL	Channel 1	FREQUENCY RANGE	1 ~ 25GHz
INPUT POWER (SYSTEM)	120Vac, 60 Hz	DETECTOR FUNCTION	Peak (PK) Average (AV)
ENVIRONMENTAL CONDITIONS	23.0deg. C, 70.0%RH 1012hPa	TESTED BY	Lori Chiu

ANTENNA POLARITY & TEST DISTANCE: HORIZONTAL AT 3 M								
NO.	FREQ. (MHz)	EMISSION LEVEL (dBuV/m)	LIMIT (dBuV/m)	MARGIN (dB)	ANTENNA HEIGHT (m)	TABLE ANGLE (Degree)	RAW VALUE (dBuV)	CORRECTION FACTOR (dB/m)
1	2390.00	57.51 PK	74.00	-16.49	1.00 H	21	25.29	32.22
2	2390.00	47.37 AV	54.00	-6.63	1.00 H	21	15.15	32.22
3	*2412.00	104.17 PK			1.00 H	21	71.87	32.30
4	*2412.00	93.91 AV			1.00 H	21	61.61	32.30
5	4824.00	48.72 PK	74.00	-25.28	1.00 H	177	10.39	38.33
6	4824.00	36.66 AV	54.00	-17.34	1.00 H	177	-1.67	38.33
ANTENNA POLARITY & TEST DISTANCE: VERTICAL AT 3 M								
NO.	FREQ. (MHz)	EMISSION LEVEL (dBuV/m)	LIMIT (dBuV/m)	MARGIN (dB)	ANTENNA HEIGHT (m)	TABLE ANGLE (Degree)	RAW VALUE (dBuV)	CORRECTION FACTOR (dB/m)
1	2360.00	60.35 PK	74.00	-13.65	1.02 V	100	28.25	32.10
2	2360.00	48.90 AV	54.00	-5.10	1.02 V	100	16.80	32.10
3	2390.00	63.27 PK	74.00	-10.73	1.02 V	88	31.05	32.22
4	2390.00	50.68 AV	54.00	-3.32	1.02 V	88	18.46	32.22
5	*2412.00	111.08 PK			1.00 V	114	78.78	32.30
6	*2412.00	100.66 AV			1.00 V	114	68.36	32.30
7	4824.00	49.33 PK	74.00	-24.67	1.09 V	349	11.00	38.33
8	4824.00	37.62 AV	54.00	-16.38	1.09 V	349	-0.71	38.33

- REMARKS:**
1. Emission level (dBuV/m) = Raw Value (dBuV) + Correction Factor (dB/m).
 2. Correction Factor (dB/m) = Antenna Factor (dB/m) + Cable Factor (dB).
 3. The other emission levels were very low against the limit.
 4. Margin value = Emission level – Limit value.
 5. “ * “: Fundamental frequency.



A D T

EUT TEST CONDITION		MEASUREMENT DETAIL	
CHANNEL	Channel 6	FREQUENCY RANGE	1 ~ 25GHz
INPUT POWER (SYSTEM)	120Vac, 60 Hz	DETECTOR FUNCTION	Peak (PK) Average (AV)
ENVIRONMENTAL CONDITIONS	23.0deg. C, 70.0%RH 1012hPa	TESTED BY	Lori Chiu

ANTENNA POLARITY & TEST DISTANCE: HORIZONTAL AT 3 M								
NO.	FREQ. (MHz)	EMISSION LEVEL (dBuV/m)	LIMIT (dBuV/m)	MARGIN (dB)	ANTENNA HEIGHT (m)	TABLE ANGLE (Degree)	RAW VALUE (dBuV)	CORRECTION FACTOR (dB/m)
1	2384.00	57.84 PK	74.00	-16.16	1.20 H	20	25.64	32.20
2	2384.00	47.49 AV	54.00	-6.51	1.20 H	20	15.29	32.20
3	*2437.00	107.66 PK			1.20 H	20	75.27	32.39
4	*2437.00	96.70 AV			1.20 H	20	64.31	32.39
5	2489.00	57.38 PK	74.00	-16.62	1.20 H	20	24.80	32.58
6	2489.00	46.78 AV	54.00	-7.22	1.20 H	20	14.20	32.58
7	4874.00	51.30 PK	74.00	-22.70	1.43 H	21	12.89	38.41
8	4874.00	36.99 AV	54.00	-17.01	1.43 H	21	-1.42	38.41
9	7311.00	62.41 PK	74.00	-11.59	1.45 H	315	17.78	44.64
10	7311.00	48.17 AV	54.00	-5.83	1.45 H	315	3.54	44.64
ANTENNA POLARITY & TEST DISTANCE: VERTICAL AT 3 M								
NO.	FREQ. (MHz)	EMISSION LEVEL (dBuV/m)	LIMIT (dBuV/m)	MARGIN (dB)	ANTENNA HEIGHT (m)	TABLE ANGLE (Degree)	RAW VALUE (dBuV)	CORRECTION FACTOR (dB/m)
1	2384.00	63.83 PK	74.00	-10.17	1.00 V	87	31.63	32.20
2	2384.00	51.72 AV	54.00	-2.28	1.00 V	87	19.52	32.20
3	*2437.00	114.43 PK			1.00 V	81	82.04	32.39
4	*2437.00	104.19 AV			1.00 V	81	71.80	32.39
5	2489.00	64.89 PK	74.00	-9.11	1.00 V	90	32.31	32.58
6	2489.00	51.30 AV	54.00	-2.70	1.00 V	90	18.72	32.58
7	4874.00	51.75 PK	74.00	-22.25	1.00 V	19	13.34	38.41
8	4874.00	38.05 AV	54.00	-15.95	1.00 V	19	-0.36	38.41
9	7311.00	61.17 PK	74.00	-12.83	1.42 V	8	16.54	44.64

- REMARKS:**
1. Emission level (dBuV/m) = Raw Value (dBuV) + Correction Factor (dB/m).
 2. Correction Factor (dB/m) = Antenna Factor (dB/m) + Cable Factor (dB).
 3. The other emission levels were very low against the limit.
 4. Margin value = Emission level – Limit value.
 5. “ * “: Fundamental frequency.



A D T

EUT TEST CONDITION		MEASUREMENT DETAIL	
CHANNEL	Channel 11	FREQUENCY RANGE	1 ~ 25GHz
INPUT POWER (SYSTEM)	120Vac, 60 Hz	DETECTOR FUNCTION	Peak (PK) Average (AV)
ENVIRONMENTAL CONDITIONS	23.0deg. C, 70.0%RH 1012hPa	TESTED BY	Lori Chiu

ANTENNA POLARITY & TEST DISTANCE: HORIZONTAL AT 3 M								
NO.	FREQ. (MHz)	EMISSION LEVEL (dBuV/m)	LIMIT (dBuV/m)	MARGIN (dB)	ANTENNA HEIGHT (m)	TABLE ANGLE (Degree)	RAW VALUE (dBuV)	CORRECTION FACTOR (dB/m)
1	*2462.00	103.76 PK			1.00 H	31	71.28	32.48
2	*2462.00	93.55 AV			1.00 H	31	61.07	32.48
3	2483.50	59.74 PK	74.00	-14.26	1.00 H	19	27.18	32.56
4	2483.50	46.74 AV	54.00	-7.26	1.00 H	19	14.18	32.56
5	4924.00	48.81 PK	74.00	-25.19	1.02 H	266	10.30	38.51
6	4924.00	36.70 AV	54.00	-17.30	1.02 H	266	-1.81	38.51
ANTENNA POLARITY & TEST DISTANCE: VERTICAL AT 3 M								
NO.	FREQ. (MHz)	EMISSION LEVEL (dBuV/m)	LIMIT (dBuV/m)	MARGIN (dB)	ANTENNA HEIGHT (m)	TABLE ANGLE (Degree)	RAW VALUE (dBuV)	CORRECTION FACTOR (dB/m)
1	*2462.00	110.65 PK			1.00 V	103	78.17	32.48
2	*2462.00	100.51 AV			1.00 V	103	68.03	32.48
3	2483.50	61.71 PK	74.00	-12.29	1.00 V	103	29.15	32.56
4	2483.50	49.19 AV	54.00	-4.81	1.00 V	103	16.63	32.56
5	4924.00	49.52 PK	74.00	-24.48	1.00 V	133	11.01	38.51
6	4924.00	37.81 AV	54.00	-16.19	1.00 V	133	-0.70	38.51

- REMARKS:**
1. Emission level (dBuV/m) = Raw Value (dBuV) + Correction Factor (dB/m).
 2. Correction Factor (dB/m) = Antenna Factor (dB/m) + Cable Factor (dB).
 3. The other emission levels were very low against the limit.
 4. Margin value = Emission level – Limit value.
 5. “ * “: Fundamental frequency.

DRAFT 802.11n (20MHz) OFDM MODULATION

EUT TEST CONDITION		MEASUREMENT DETAIL	
CHANNEL	Channel 1	FREQUENCY RANGE	1 ~ 25GHz
INPUT POWER (SYSTEM)	120Vac, 60 Hz	DETECTOR FUNCTION	Peak (PK) Average (AV)
ENVIRONMENTAL CONDITIONS	23.0deg. C, 70.0%RH 1012hPa	TESTED BY	Lori Chiu

ANTENNA POLARITY & TEST DISTANCE: HORIZONTAL AT 3 M								
NO.	FREQ. (MHz)	EMISSION LEVEL (dBuV/m)	LIMIT (dBuV/m)	MARGIN (dB)	ANTENNA HEIGHT (m)	TABLE ANGLE (Degree)	RAW VALUE (dBuV)	CORRECTION FACTOR (dB/m)
1	2390.00	59.46 PK	74.00	-14.54	1.00 H	18	27.24	32.22
2	2390.00	47.45 AV	54.00	-6.55	1.00 H	18	15.23	32.22
3	*2412.00	102.32 PK			1.00 H	18	70.02	32.30
4	*2412.00	92.26 AV			1.00 H	18	59.96	32.30
5	4824.00	48.87 PK	74.00	-25.13	1.01 H	17	10.54	38.33
6	4824.00	36.72 AV	54.00	-17.28	1.01 H	17	-1.61	38.33
ANTENNA POLARITY & TEST DISTANCE: VERTICAL AT 3 M								
NO.	FREQ. (MHz)	EMISSION LEVEL (dBuV/m)	LIMIT (dBuV/m)	MARGIN (dB)	ANTENNA HEIGHT (m)	TABLE ANGLE (Degree)	RAW VALUE (dBuV)	CORRECTION FACTOR (dB/m)
1	2360.00	59.00 PK	74.00	-15.00	1.01 V	80	26.90	32.10
2	2360.00	48.32 AV	54.00	-5.68	1.01 V	80	16.22	32.10
3	2390.00	68.42 PK	74.00	-5.58	1.00 V	79	36.20	32.22
4	2390.00	50.50 AV	54.00	-3.50	1.00 V	79	18.28	32.22
5	*2412.00	109.28 PK			1.23 V	103	76.98	32.30
6	*2412.00	99.20 AV			1.23 V	103	66.90	32.30
7	4824.00	50.11 PK	74.00	-23.89	1.01 V	109	11.78	38.33
8	4824.00	36.68 AV	54.00	-17.32	1.01 V	109	-1.65	38.33

- REMARKS:**
1. Emission level (dBuV/m) = Raw Value (dBuV) + Correction Factor (dB/m).
 2. Correction Factor (dB/m) = Antenna Factor (dB/m) + Cable Factor (dB).
 3. The other emission levels were very low against the limit.
 4. Margin value = Emission level – Limit value.
 5. “ * “: Fundamental frequency.



A D T

EUT TEST CONDITION		MEASUREMENT DETAIL	
CHANNEL	Channel 6	FREQUENCY RANGE	1 ~ 25GHz
INPUT POWER (SYSTEM)	120Vac, 60 Hz	DETECTOR FUNCTION	Peak (PK) Average (AV)
ENVIRONMENTAL CONDITIONS	23.0deg. C, 70.0%RH 1012hPa	TESTED BY	Lori Chiu

ANTENNA POLARITY & TEST DISTANCE: HORIZONTAL AT 3 M								
NO.	FREQ. (MHz)	EMISSION LEVEL (dBuV/m)	LIMIT (dBuV/m)	MARGIN (dB)	ANTENNA HEIGHT (m)	TABLE ANGLE (Degree)	RAW VALUE (dBuV)	CORRECTION FACTOR (dB/m)
1	2384.00	57.90 PK	74.00	-16.10	1.33 H	211	25.70	32.20
2	2384.00	47.63 AV	54.00	-6.37	1.33 H	211	15.43	32.20
3	*2437.00	107.59 PK			1.13 H	211	75.20	32.39
4	*2437.00	96.61 AV			1.13 H	211	64.22	32.39
5	2488.00	57.60 PK	74.00	-16.40	1.16 H	200	25.02	32.58
6	2488.00	46.50 AV	54.00	-7.50	1.16 H	200	13.92	32.58
7	4874.00	48.95 PK	74.00	-25.05	1.01 H	64	10.54	38.41
8	4874.00	37.53 AV	54.00	-16.47	1.01 H	64	-0.88	38.41
9	7311.00	62.81 PK	74.00	-11.19	1.46 H	316	18.18	44.64
10	7311.00	47.72 AV	54.00	-6.28	1.46 H	316	3.09	44.64

ANTENNA POLARITY & TEST DISTANCE: VERTICAL AT 3 M								
NO.	FREQ. (MHz)	EMISSION LEVEL (dBuV/m)	LIMIT (dBuV/m)	MARGIN (dB)	ANTENNA HEIGHT (m)	TABLE ANGLE (Degree)	RAW VALUE (dBuV)	CORRECTION FACTOR (dB/m)
1	2384.00	68.07 PK	74.00	-5.93	1.00 V	89	35.87	32.20
2	2384.00	51.95 AV	54.00	-2.05	1.00 V	89	19.75	32.20
3	*2437.00	114.12 PK			1.00 V	82	81.73	32.39
4	*2437.00	103.98 AV			1.00 V	82	71.59	32.39
5	2488.00	68.00 PK	74.00	-6.00	1.00 V	81	35.42	32.58
6	2488.00	51.71 AV	54.00	-2.29	1.00 V	81	19.13	32.58
7	4874.00	52.22 PK	74.00	-21.78	1.00 V	334	13.81	38.41
8	4874.00	37.34 AV	54.00	-16.66	1.00 V	334	-1.07	38.41
9	7311.00	58.25 PK	74.00	-15.75	1.00 V	309	13.62	44.64
10	7311.00	44.27 AV	54.00	-9.73	1.00 V	309	-0.36	44.64

- REMARKS:**
1. Emission level (dBuV/m) = Raw Value (dBuV) + Correction Factor (dB/m).
 2. Correction Factor (dB/m) = Antenna Factor (dB/m) + Cable Factor (dB).
 3. The other emission levels were very low against the limit.
 4. Margin value = Emission level – Limit value.
 5. “ * “: Fundamental frequency.



A D T

EUT TEST CONDITION		MEASUREMENT DETAIL	
CHANNEL	Channel 11	FREQUENCY RANGE	1 ~ 25GHz
INPUT POWER (SYSTEM)	120Vac, 60 Hz	DETECTOR FUNCTION	Peak (PK) Average (AV)
ENVIRONMENTAL CONDITIONS	23.0deg. C, 70.0%RH 1012hPa	TESTED BY	Lori Chiu

ANTENNA POLARITY & TEST DISTANCE: HORIZONTAL AT 3 M								
NO.	FREQ. (MHz)	EMISSION LEVEL (dBuV/m)	LIMIT (dBuV/m)	MARGIN (dB)	ANTENNA HEIGHT (m)	TABLE ANGLE (Degree)	RAW VALUE (dBuV)	CORRECTION FACTOR (dB/m)
1	*2462.00	103.54 PK			1.02 H	355	71.06	32.48
2	*2462.00	93.38 AV			1.02 H	355	60.90	32.48
3	2483.50	57.26 PK	74.00	-16.74	1.02 H	356	24.70	32.56
4	2483.50	46.91 AV	54.00	-7.09	1.02 H	356	14.35	32.56
5	4924.00	50.39 PK	74.00	-23.61	1.42 H	16	11.88	38.51
6	4924.00	36.58 AV	54.00	-17.42	1.42 H	16	-1.93	38.51
ANTENNA POLARITY & TEST DISTANCE: VERTICAL AT 3 M								
NO.	FREQ. (MHz)	EMISSION LEVEL (dBuV/m)	LIMIT (dBuV/m)	MARGIN (dB)	ANTENNA HEIGHT (m)	TABLE ANGLE (Degree)	RAW VALUE (dBuV)	CORRECTION FACTOR (dB/m)
1	*2462.00	110.29 PK			1.00 V	115	77.81	32.48
2	*2462.00	100.12 AV			1.00 V	115	67.64	32.48
3	2483.50	64.75 PK	74.00	-9.25	1.00 V	127	32.19	32.56
4	2483.50	49.50 AV	54.00	-4.50	1.00 V	127	16.94	32.56
5	4924.00	50.24 PK	74.00	-23.76	1.00 V	267	11.73	38.51
6	4924.00	36.71 AV	54.00	-17.29	1.00 V	267	-1.80	38.51

- REMARKS:**
1. Emission level (dBuV/m) = Raw Value (dBuV) + Correction Factor (dB/m).
 2. Correction Factor (dB/m) = Antenna Factor (dB/m) + Cable Factor (dB).
 3. The other emission levels were very low against the limit.
 4. Margin value = Emission level – Limit value.
 5. “ * “: Fundamental frequency.

DRAFT 802.11n (40MHz) OFDM MODULATION

EUT TEST CONDITION		MEASUREMENT DETAIL	
CHANNEL	Channel 1	FREQUENCY RANGE	1 ~ 25GHz
INPUT POWER (SYSTEM)	120Vac, 60 Hz	DETECTOR FUNCTION	Peak (PK) Average (AV)
ENVIRONMENTAL CONDITIONS	23.0deg. C, 70.0%RH 1012hPa	TESTED BY	Lori Chiu

ANTENNA POLARITY & TEST DISTANCE: HORIZONTAL AT 3 M								
NO.	FREQ. (MHz)	EMISSION LEVEL (dBuV/m)	LIMIT (dBuV/m)	MARGIN (dB)	ANTENNA HEIGHT (m)	TABLE ANGLE (Degree)	RAW VALUE (dBuV)	CORRECTION FACTOR (dB/m)
1	2390.00	56.64 PK	74.00	-17.36	1.00 H	20	24.42	32.22
2	2390.00	46.78 AV	54.00	-7.22	1.00 H	20	14.56	32.22
3	*2422.00	94.18 PK			1.00 H	20	61.84	32.34
4	*2422.00	84.51 AV			1.00 H	20	52.17	32.34
5	4844.00	47.93 PK	74.00	-26.07	1.02 H	244	9.57	38.36
6	4844.00	36.16 AV	54.00	-17.84	1.02 H	244	-2.20	38.36
ANTENNA POLARITY & TEST DISTANCE: VERTICAL AT 3 M								
NO.	FREQ. (MHz)	EMISSION LEVEL (dBuV/m)	LIMIT (dBuV/m)	MARGIN (dB)	ANTENNA HEIGHT (m)	TABLE ANGLE (Degree)	RAW VALUE (dBuV)	CORRECTION FACTOR (dB/m)
1	2390.00	60.97 PK	74.00	-13.03	1.00 V	90	28.75	32.22
2	2390.00	49.52 AV	54.00	-4.48	1.00 V	90	17.30	32.22
3	*2422.00	102.10 PK			1.00 V	80	69.76	32.34
4	*2422.00	92.16 AV			1.00 V	80	59.82	32.34
5	4844.00	48.00 PK	74.00	-26.00	1.01 V	113	9.64	38.36
6	4844.00	35.50 AV	54.00	-18.50	1.01 V	113	-2.86	38.36

- REMARKS:**
1. Emission level (dBuV/m) = Raw Value (dBuV) + Correction Factor (dB/m).
 2. Correction Factor (dB/m) = Antenna Factor (dB/m) + Cable Factor (dB).
 3. The other emission levels were very low against the limit.
 4. Margin value = Emission level – Limit value.
 5. “ * “: Fundamental frequency.



A D T

EUT TEST CONDITION		MEASUREMENT DETAIL	
CHANNEL	Channel 4	FREQUENCY RANGE	1 ~ 25GHz
INPUT POWER (SYSTEM)	120Vac, 60 Hz	DETECTOR FUNCTION	Peak (PK) Average (AV)
ENVIRONMENTAL CONDITIONS	23.0deg. C, 70.0%RH 1012hPa	TESTED BY	Lori Chiu

ANTENNA POLARITY & TEST DISTANCE: HORIZONTAL AT 3 M								
NO.	FREQ. (MHz)	EMISSION LEVEL (dBuV/m)	LIMIT (dBuV/m)	MARGIN (dB)	ANTENNA HEIGHT (m)	TABLE ANGLE (Degree)	RAW VALUE (dBuV)	CORRECTION FACTOR (dB/m)
1	*2437.00	98.64 PK			1.32 H	156	66.25	32.39
2	*2437.00	89.12 AV			1.32 H	156	56.73	32.39
3	4874.00	48.11 PK	74.00	-25.89	1.09 H	33	9.70	38.41
4	4874.00	37.23 AV	54.00	-16.77	1.09 H	33	-1.18	38.41
ANTENNA POLARITY & TEST DISTANCE: VERTICAL AT 3 M								
NO.	FREQ. (MHz)	EMISSION LEVEL (dBuV/m)	LIMIT (dBuV/m)	MARGIN (dB)	ANTENNA HEIGHT (m)	TABLE ANGLE (Degree)	RAW VALUE (dBuV)	CORRECTION FACTOR (dB/m)
1	*2437.00	106.78 PK			1.00 V	81	74.39	32.39
2	*2437.00	97.08 AV			1.00 V	81	64.69	32.39
3	4874.00	47.94 PK	74.00	-26.06	1.21 V	16	9.53	38.41
4	4874.00	37.01 AV	54.00	-16.99	1.21 V	16	-1.40	38.41

- REMARKS:**
1. Emission level (dBuV/m) = Raw Value (dBuV) + Correction Factor (dB/m).
 2. Correction Factor (dB/m) = Antenna Factor (dB/m) + Cable Factor (dB).
 3. The other emission levels were very low against the limit.
 4. Margin value = Emission level – Limit value.
 5. “ * “: Fundamental frequency.



A D T

EUT TEST CONDITION		MEASUREMENT DETAIL	
CHANNEL	Channel 7	FREQUENCY RANGE	1 ~ 25GHz
INPUT POWER (SYSTEM)	120Vac, 60 Hz	DETECTOR FUNCTION	Peak (PK) Average (AV)
ENVIRONMENTAL CONDITIONS	23.0deg. C, 70.0%RH 1012hPa	TESTED BY	Lori Chiu

ANTENNA POLARITY & TEST DISTANCE: HORIZONTAL AT 3 M								
NO.	FREQ. (MHz)	EMISSION LEVEL (dBuV/m)	LIMIT (dBuV/m)	MARGIN (dB)	ANTENNA HEIGHT (m)	TABLE ANGLE (Degree)	RAW VALUE (dBuV)	CORRECTION FACTOR (dB/m)
1	*2452.00	95.63 PK			1.01 H	220	63.18	32.45
2	*2452.00	85.47 AV			1.01 H	220	53.02	32.45
3	2483.50	56.37 PK	74.00	-17.63	1.01 H	220	23.81	32.56
4	2483.50	46.82 AV	54.00	-7.18	1.01 H	220	14.26	32.56
5	4904.00	47.83 PK	74.00	-26.17	1.32 H	269	9.37	38.46
6	4904.00	36.38 AV	54.00	-17.62	1.32 H	269	-2.08	38.46
ANTENNA POLARITY & TEST DISTANCE: VERTICAL AT 3 M								
NO.	FREQ. (MHz)	EMISSION LEVEL (dBuV/m)	LIMIT (dBuV/m)	MARGIN (dB)	ANTENNA HEIGHT (m)	TABLE ANGLE (Degree)	RAW VALUE (dBuV)	CORRECTION FACTOR (dB/m)
1	*2452.00	103.29 PK			1.00 V	83	70.84	32.45
2	*2452.00	93.45 AV			1.00 V	83	61.00	32.45
3	2483.50	61.65 PK	74.00	-12.35	1.00 V	83	29.09	32.56
4	2483.50	50.29 AV	54.00	-3.71	1.00 V	83	17.73	32.56
5	4904.00	48.21 PK	74.00	-25.79	1.02 V	55	9.75	38.46
6	4904.00	35.61 AV	54.00	-18.39	1.02 V	55	-2.85	38.46

- REMARKS:**
1. Emission level (dBuV/m) = Raw Value (dBuV) + Correction Factor (dB/m).
 2. Correction Factor (dB/m) = Antenna Factor (dB/m) + Cable Factor (dB).
 3. The other emission levels were very low against the limit.
 4. Margin value = Emission level – Limit value.
 5. “ * “: Fundamental frequency.



BELOW 1GHz WORST-CASE DATA : 802.11g OFDM MODULATION

EUT TEST CONDITION		MEASUREMENT DETAIL	
CHANNEL	Channel 6	FREQUENCY RANGE	Below 1000MHz
INPUT POWER (SYSTEM)	120Vac, 60 Hz	DETECTOR FUNCTION	Quasi-Peak
ENVIRONMENTAL CONDITIONS	23.0deg. C, 70.0%RH 1012hPa	TESTED BY	Lori Chiu
TEST MODE	A		

ANTENNA POLARITY & TEST DISTANCE: HORIZONTAL AT 3 M								
NO.	FREQ. (MHz)	EMISSION LEVEL (dBuV/m)	LIMIT (dBuV/m)	MARGIN (dB)	ANTENNA HEIGHT (m)	TABLE ANGLE (Degree)	RAW VALUE (dBuV)	CORRECTION FACTOR (dB/m)
1	212.66	32.86 QP	43.50	-10.64	1.50 H	313	21.70	11.16
2	249.60	35.91 QP	46.00	-10.09	1.25 H	124	23.10	12.81
3	533.47	42.37 QP	46.00	-3.63	1.50 H	16	22.11	20.26
4	640.41	40.53 QP	46.00	-5.47	1.25 H	88	18.29	22.24
5	854.28	43.30 QP	46.00	-2.70	1.00 H	61	17.63	25.67
6	949.55	42.19 QP	46.00	-3.81	1.50 H	184	15.70	26.49
ANTENNA POLARITY & TEST DISTANCE: VERTICAL AT 3 M								
NO.	FREQ. (MHz)	EMISSION LEVEL (dBuV/m)	LIMIT (dBuV/m)	MARGIN (dB)	ANTENNA HEIGHT (m)	TABLE ANGLE (Degree)	RAW VALUE (dBuV)	CORRECTION FACTOR (dB/m)
1	30.00	38.21 QP	40.00	-1.79	1.25 V	241	25.93	12.28
2	96.01	34.67 QP	43.50	-8.83	1.25 V	235	25.39	9.29
3	533.47	41.90 QP	46.00	-4.10	1.00 V	271	21.64	20.26
4	640.41	40.50 QP	46.00	-5.50	1.00 V	10	18.26	22.24
5	854.28	40.88 QP	46.00	-5.12	1.25 V	325	15.20	25.67
6	949.55	42.67 QP	46.00	-3.33	1.25 V	256	16.18	26.49

- REMARKS:**
1. Emission level (dBuV/m) = Raw Value (dBuV) + Correction Factor (dB/m).
 2. Correction Factor (dB/m) = Antenna Factor (dB/m) + Cable Factor (dB).
 3. The other emission levels were very low against the limit.
 4. Margin value = Emission level – Limit value.



A D T

EUT TEST CONDITION		MEASUREMENT DETAIL	
CHANNEL	Channel 6	FREQUENCY RANGE	Below 1000MHz
INPUT POWER (SYSTEM)	120Vac, 60 Hz	DETECTOR FUNCTION	Quasi-Peak
ENVIRONMENTAL CONDITIONS	23.0deg. C, 70.0%RH 1012hPa	TESTED BY	Lori Chiu
TEST MODE	B		

ANTENNA POLARITY & TEST DISTANCE: HORIZONTAL AT 3 M								
NO.	FREQ. (MHz)	EMISSION LEVEL (dBuV/m)	LIMIT (dBuV/m)	MARGIN (dB)	ANTENNA HEIGHT (m)	TABLE ANGLE (Degree)	RAW VALUE (dBuV)	CORRECTION FACTOR (dB/m)
1	265.16	31.31 QP	46.00	-14.69	1.00 H	250	18.23	13.09
2	426.53	31.85 QP	46.00	-14.15	2.00 H	157	14.91	16.94
3	500.42	33.97 QP	46.00	-12.03	1.50 H	124	14.72	19.25
4	533.47	38.85 QP	46.00	-7.15	2.00 H	229	18.59	20.26
5	640.41	41.84 QP	46.00	-4.16	1.25 H	31	19.61	22.24
6	854.28	43.22 QP	46.00	-2.78	1.00 H	61	17.55	25.67
7	961.21	42.44 QP	54.00	-11.56	1.50 H	49	15.90	26.54
ANTENNA POLARITY & TEST DISTANCE: VERTICAL AT 3 M								
NO.	FREQ. (MHz)	EMISSION LEVEL (dBuV/m)	LIMIT (dBuV/m)	MARGIN (dB)	ANTENNA HEIGHT (m)	TABLE ANGLE (Degree)	RAW VALUE (dBuV)	CORRECTION FACTOR (dB/m)
1	31.84	36.75 QP	40.00	-3.25	1.50 V	331	24.53	12.22
2	62.95	28.37 QP	40.00	-11.63	1.00 V	292	15.52	12.85
3	426.53	34.57 QP	46.00	-11.43	1.25 V	286	17.63	16.94
4	500.42	33.82 QP	46.00	-12.18	1.00 V	319	14.57	19.25
5	533.47	41.21 QP	46.00	-4.79	1.00 V	274	20.95	20.26
6	640.41	40.54 QP	46.00	-5.46	1.00 V	355	18.31	22.24
7	854.28	39.65 QP	46.00	-6.35	1.25 V	16	13.98	25.67

- REMARKS:**
1. Emission level (dBuV/m) = Raw Value (dBuV) + Correction Factor (dB/m).
 2. Correction Factor (dB/m) = Antenna Factor (dB/m) + Cable Factor (dB).
 3. The other emission levels were very low against the limit.
 4. Margin value = Emission level – Limit value.



A D T

EUT TEST CONDITION		MEASUREMENT DETAIL	
CHANNEL	Channel 6	FREQUENCY RANGE	Below 1000MHz
INPUT POWER (SYSTEM)	120Vac, 60 Hz	DETECTOR FUNCTION	Quasi-Peak
ENVIRONMENTAL CONDITIONS	23.0deg. C, 70.0%RH 1012hPa	TESTED BY	Lori Chiu
TEST MODE	C		

ANTENNA POLARITY & TEST DISTANCE: HORIZONTAL AT 3 M								
NO.	FREQ. (MHz)	EMISSION LEVEL (dBuV/m)	LIMIT (dBuV/m)	MARGIN (dB)	ANTENNA HEIGHT (m)	TABLE ANGLE (Degree)	RAW VALUE (dBuV)	CORRECTION FACTOR (dB/m)
1	144.61	32.38 QP	43.50	-11.12	1.25 H	277	19.21	13.16
2	533.47	40.20 QP	46.00	-5.80	2.00 H	7	19.94	20.26
3	640.41	40.24 QP	46.00	-5.76	1.25 H	28	18.00	22.24
4	854.28	43.08 QP	46.00	-2.92	1.00 H	76	17.41	25.67
5	906.77	32.70 QP	46.00	-13.30	1.50 H	136	6.53	26.16
6	949.55	39.70 QP	46.00	-6.30	1.50 H	262	13.22	26.49
ANTENNA POLARITY & TEST DISTANCE: VERTICAL AT 3 M								
NO.	FREQ. (MHz)	EMISSION LEVEL (dBuV/m)	LIMIT (dBuV/m)	MARGIN (dB)	ANTENNA HEIGHT (m)	TABLE ANGLE (Degree)	RAW VALUE (dBuV)	CORRECTION FACTOR (dB/m)
1	30.00	38.82 QP	40.00	-1.18	1.00 V	160	26.54	12.28
2	96.01	32.19 QP	43.50	-11.31	1.25 V	220	22.90	9.29
3	426.53	34.03 QP	46.00	-11.97	1.25 V	289	17.09	16.94
4	533.47	41.60 QP	46.00	-4.40	1.00 V	265	21.34	20.26
5	640.41	39.74 QP	46.00	-6.26	1.00 V	310	17.51	22.24
6	797.89	34.96 QP	46.00	-11.04	1.25 V	268	9.70	25.26
7	854.28	40.45 QP	46.00	-5.55	1.25 V	16	14.78	25.67
8	949.55	41.21 QP	46.00	-4.79	1.25 V	10	14.72	26.49

- REMARKS:**
1. Emission level (dBuV/m) = Raw Value (dBuV) + Correction Factor (dB/m).
 2. Correction Factor (dB/m) = Antenna Factor (dB/m) + Cable Factor (dB).
 3. The other emission levels were very low against the limit.
 4. Margin value = Emission level – Limit value.



A D T

EUT TEST CONDITION		MEASUREMENT DETAIL	
CHANNEL	Channel 6	FREQUENCY RANGE	Below 1000MHz
INPUT POWER (SYSTEM)	120Vac, 60 Hz	DETECTOR FUNCTION	Quasi-Peak
ENVIRONMENTAL CONDITIONS	23.0deg. C, 70.0%RH 1012hPa	TESTED BY	Lori Chiu
TEST MODE	D		

ANTENNA POLARITY & TEST DISTANCE: HORIZONTAL AT 3 M								
NO.	FREQ. (MHz)	EMISSION LEVEL (dBuV/m)	LIMIT (dBuV/m)	MARGIN (dB)	ANTENNA HEIGHT (m)	TABLE ANGLE (Degree)	RAW VALUE (dBuV)	CORRECTION FACTOR (dB/m)
1	249.60	34.66 QP	46.00	-11.34	1.25 H	127	21.84	12.81
2	426.53	34.99 QP	46.00	-11.01	2.00 H	133	18.05	16.94
3	500.42	34.80 QP	46.00	-11.20	1.50 H	157	15.55	19.25
4	533.47	41.25 QP	46.00	-4.75	1.50 H	31	20.99	20.26
5	640.41	38.89 QP	46.00	-7.11	1.25 H	343	16.65	22.24
6	854.28	43.21 QP	46.00	-2.79	1.00 H	79	17.54	25.67
7	953.44	38.63 QP	46.00	-7.37	1.25 H	169	12.13	26.51
ANTENNA POLARITY & TEST DISTANCE: VERTICAL AT 3 M								
NO.	FREQ. (MHz)	EMISSION LEVEL (dBuV/m)	LIMIT (dBuV/m)	MARGIN (dB)	ANTENNA HEIGHT (m)	TABLE ANGLE (Degree)	RAW VALUE (dBuV)	CORRECTION FACTOR (dB/m)
1	30.00	38.16 QP	40.00	-1.84	1.00 V	220	25.88	12.28
2	426.53	34.82 QP	46.00	-11.18	1.25 V	283	17.88	16.94
3	533.47	41.36 QP	46.00	-4.64	1.00 V	268	21.10	20.26
4	640.41	39.29 QP	46.00	-6.71	1.00 V	10	17.05	22.24
5	854.28	42.54 QP	46.00	-3.46	1.25 V	118	16.87	25.67
6	949.55	40.02 QP	46.00	-5.98	1.25 V	145	13.53	26.49

- REMARKS:**
1. Emission level (dBuV/m) = Raw Value (dBuV) + Correction Factor (dB/m).
 2. Correction Factor (dB/m) = Antenna Factor (dB/m) + Cable Factor (dB).
 3. The other emission levels were very low against the limit.
 4. Margin value = Emission level – Limit value.

4.2 CONDUCTED EMISSION MEASUREMENT

4.2.1 LIMITS OF CONDUCTED EMISSION MEASUREMENT

FREQUENCY OF EMISSION (MHz)	CONDUCTED LIMIT (dB μ V)	
	Quasi-peak	Average
0.15-0.5	66 to 56	56 to 46
0.5-5	56	46
5-30	60	50

- NOTE:**
1. The lower limit shall apply at the transition frequencies.
 2. The limit decreases in line with the logarithm of the frequency in the range of 0.15 to 0.50 MHz.
 3. All emanations from a class A/B digital device or system, including any network of conductors and apparatus connected thereto, shall not exceed the level of field strengths specified above.

4.2.2 TEST INSTRUMENTS

DESCRIPTION & MANUFACTURER	MODEL NO.	SERIAL NO.	DATE OF CALIBRATION	DUE DATE OF CALIBRATION
Test Receiver ROHDE & SCHWARZ	ESCS30	100288	Sep. 22, 2008	Sep. 21, 2009
RF signal cable Woken	5D-FB	Cable-HYCO2-01	Dec. 31, 2008	Dec. 30, 2009
LISN ROHDE & SCHWARZ	ESH2-Z5	100100	Dec. 29, 2008	Dec. 28, 2009
LISN ROHDE & SCHWARZ	ESH3-Z5	100311	Jul. 30, 2008	Jul. 29, 2009
Software ADT	ADT_Cond_ V7.3.7	NA	NA	NA

- NOTE:**
1. The calibration interval of the above test instruments is 12 months and the calibrations are traceable to NML/ROC and NIST/USA.
 2. The test was performed in HwaYa Shielded Room 2.
 3. The VCCI Site Registration No. is C-2047.

4.2.3 TEST PROCEDURES

- a. The EUT was placed 0.4 meters from the conducting wall of the shielded room with EUT being connected to the power mains through a line impedance stabilization network (LISN). Other support units were connected to the power mains through another LISN. The two LISNs provide 50 ohm/ 50uH of coupling impedance for the measuring instrument.
- b. Both lines of the power mains connected to the EUT were checked for maximum conducted interference.
- c. The frequency range from 150kHz to 30MHz was searched. Emission levels under (Limit - 20dB) was not recorded.

NOTE: All modes of operation were investigated and the worst-case emissions are reported.

4.2.4 DEVIATION FROM TEST STANDARD

No deviation.

4.2.5 TEST SETUP

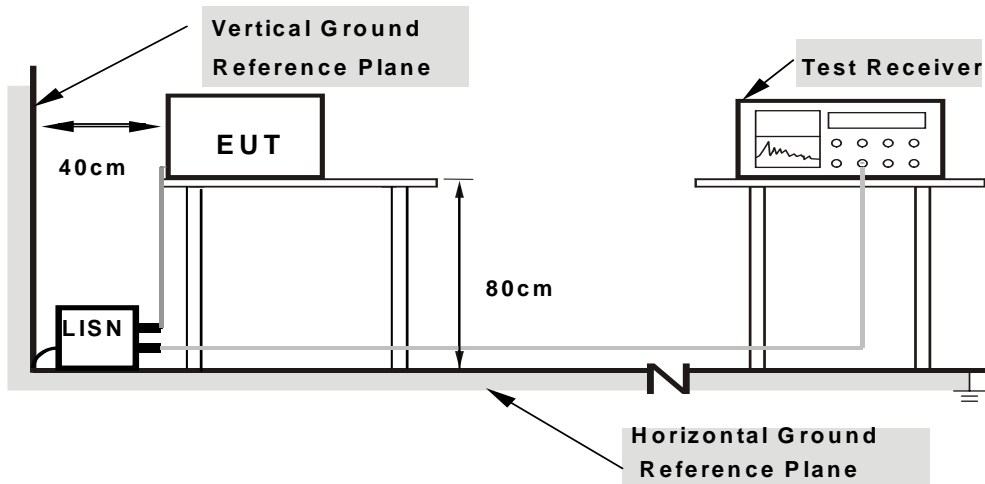

- Note:**
1. Support units were connected to second LISN.
 2. Both of LISNs (AMN) are 80 cm from EUT and at least 80 from other units and other metal planes

For the actual test configuration, please refer to the attached file (Test Setup Photo).

4.2.6 EUT OPERATING CONDITIONS

Same as 4.1.6.

4.2.7 TEST RESULTS

CONDUCTED WORST-CASE DATA: 802.11g OFDM MODULATION

EUT TEST CONDITION		MEASUREMENT DETAIL	
CHANNEL	Channel 6	PHASE	Line 1
MODULATION TYPE	BPSK	INPUT POWER (SYSTEM)	120Vac, 60Hz
TRANSFER RATE	6.0Mbps	6dB BANDWIDTH	9kHz
ENVIRONMENTAL CONDITIONS	27deg. C, 66%RH, 1013hPa	TESTED BY	Dean Wang
TEST MODE	A		

No	Freq. [MHz]	Corr. Factor [dB]	Reading Value [dB (uV)]		Emission Level [dB (uV)]		Limit [dB (uV)]		Margin [dB]	
			Q.P.	AV.	Q.P.	AV.	Q.P.	AV.	Q.P.	AV.
1	0.266	0.13	32.90	-	33.03	-	61.25	51.25	-28.21	-
2	0.656	0.15	29.45	-	29.60	-	56.00	46.00	-26.40	-
3	3.047	0.24	36.11	-	36.35	-	56.00	46.00	-19.65	-
4	4.095	0.28	44.00	-	44.28	-	56.00	46.00	-11.72	-
5	4.556	0.29	42.35	-	42.64	-	56.00	46.00	-13.36	-
6	5.939	0.33	47.05	-	47.38	-	60.00	50.00	-12.62	-

- REMARKS:**
1. Q.P. and AV. are abbreviations of quasi-peak and average individually.
 2. "-": The Quasi-peak reading value also meets average limit and measurement with the average detector is unnecessary.
 3. The emission levels of other frequencies were very low against the limit.
 4. Margin value = Emission level - Limit value
 5. Correction factor = Insertion loss + Cable loss
 6. Emission Level = Correction Factor + Reading Value.

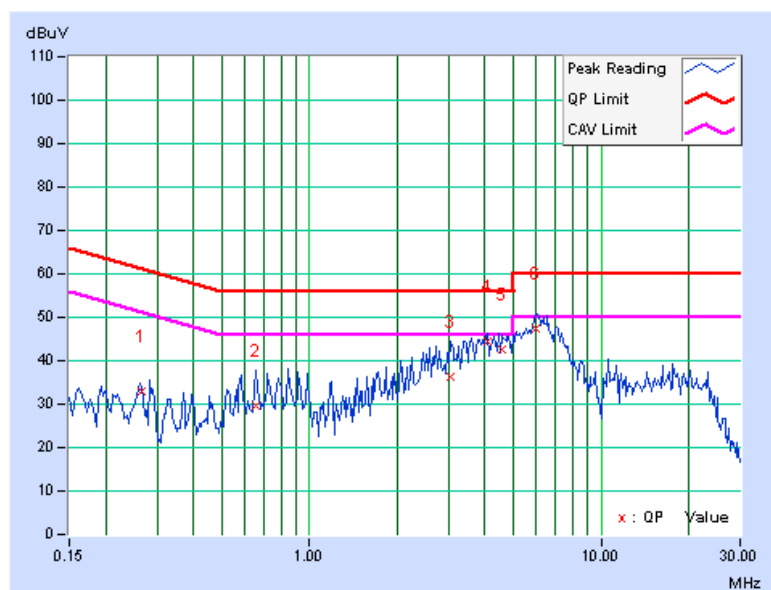



EUT TEST CONDITION		MEASUREMENT DETAIL	
CHANNEL	Channel 6	PHASE	Line 2
MODULATION TYPE	BPSK	INPUT POWER (SYSTEM)	120Vac, 60Hz
TRANSFER RATE	6.0Mbps	6dB BANDWIDTH	9kHz
ENVIRONMENTAL CONDITIONS	27deg. C, 66%RH, 1013hPa	TESTED BY	Dean Wang
TEST MODE	A		

No	Freq. [MHz]	Corr. Factor [dB]	Reading Value [dB (uV)]		Emission Level [dB (uV)]		Limit [dB (uV)]		Margin (dB)	
			Q.P.	AV.	Q.P.	AV.	Q.P.	AV.	Q.P.	AV.
			1	0.263	0.14	35.89	-	36.03	-	61.33
2	1.055	0.17	36.57	-	36.74	-	56.00	46.00	-19.26	-
3	3.539	0.28	41.72	-	42.00	-	56.00	46.00	-14.00	-
4	4.129	0.30	44.24	-	44.54	-	56.00	46.00	-11.46	-
5	5.970	0.37	47.84	-	48.21	-	60.00	50.00	-11.79	-
6	6.367	0.38	48.13	-	48.51	-	60.00	50.00	-11.49	-

- REMARKS:**
1. Q.P. and AV. are abbreviations of quasi-peak and average individually.
 2. "-": The Quasi-peak reading value also meets average limit and measurement with the average detector is unnecessary.
 3. The emission levels of other frequencies were very low against the limit.
 4. Margin value = Emission level - Limit value
 5. Correction factor = Insertion loss + Cable loss
 6. Emission Level = Correction Factor + Reading Value.

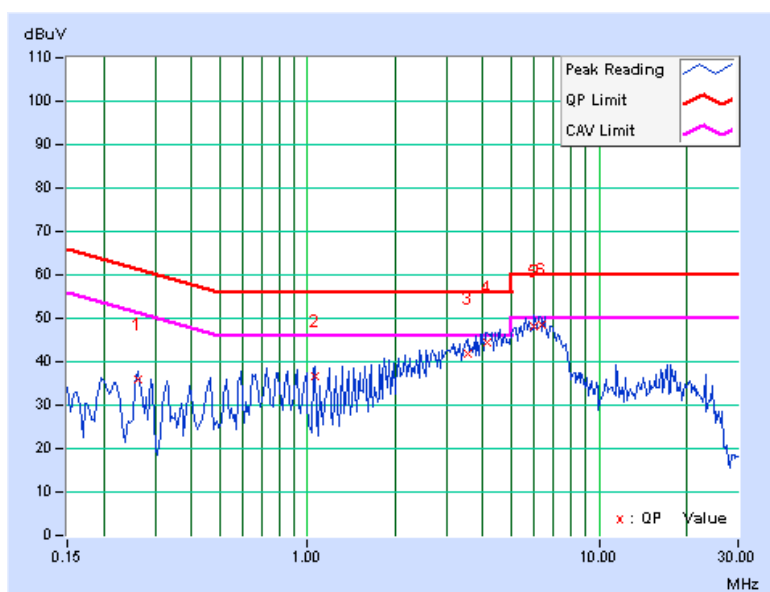



A D T

EUT TEST CONDITION		MEASUREMENT DETAIL	
CHANNEL	Channel 6	PHASE	Line 1
MODULATION TYPE	BPSK	INPUT POWER (SYSTEM)	120Vac, 60Hz
TRANSFER RATE	6.0Mbps	6dB BANDWIDTH	9kHz
ENVIRONMENTAL CONDITIONS	27deg. C, 66%RH, 1013hPa	TESTED BY	Dean Wang
TEST MODE	B		

No	Freq. [MHz]	Corr. Factor (dB)	Reading Value [dB (uV)]		Emission Level [dB (uV)]		Limit [dB (uV)]		Margin (dB)	
			Q.P.	AV.	Q.P.	AV.	Q.P.	AV.	Q.P.	AV.
1	0.220	0.13	40.35	-	40.48	-	62.81	52.81	-22.33	-
2	0.259	0.13	42.95	-	43.08	-	61.45	51.45	-18.37	-
3	0.603	0.15	33.80	-	33.95	-	56.00	46.00	-22.05	-
4	4.891	0.30	38.19	-	38.49	-	56.00	46.00	-17.51	-
5	6.270	0.34	38.91	-	39.25	-	60.00	50.00	-20.75	-
6	7.574	0.37	38.19	-	38.56	-	60.00	50.00	-21.44	-

- REMARKS:**
1. Q.P. and AV. are abbreviations of quasi-peak and average individually.
 2. "-": The Quasi-peak reading value also meets average limit and measurement with the average detector is unnecessary.
 3. The emission levels of other frequencies were very low against the limit.
 4. Margin value = Emission level - Limit value
 5. Correction factor = Insertion loss + Cable loss
 6. Emission Level = Correction Factor + Reading Value.

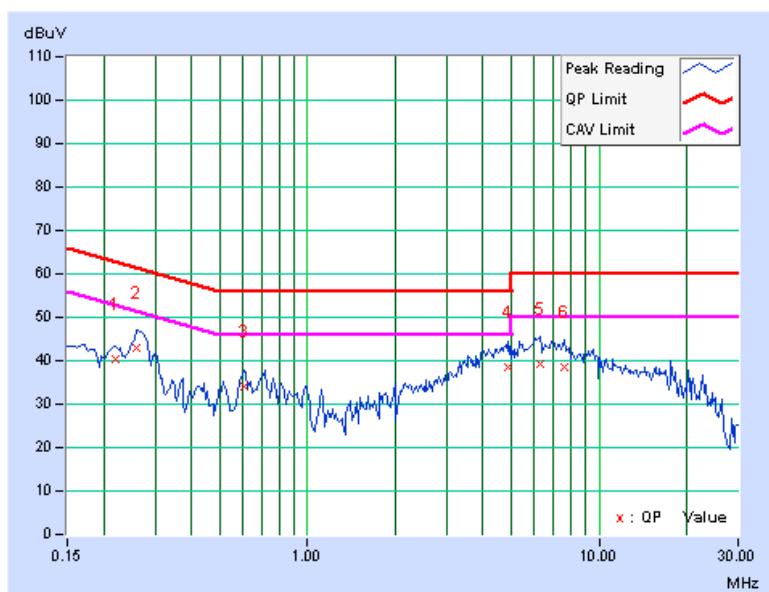

EUT TEST CONDITION		MEASUREMENT DETAIL	
CHANNEL	Channel 6	PHASE	Line 2
MODULATION TYPE	BPSK	INPUT POWER (SYSTEM)	120Vac, 60Hz
TRANSFER RATE	6.0Mbps	6dB BANDWIDTH	9kHz
ENVIRONMENTAL CONDITIONS	27deg. C, 66%RH, 1013hPa	TESTED BY	Dean Wang
TEST MODE	B		

No	Freq. [MHz]	Corr. Factor (dB)	Reading Value [dB (uV)]		Emission Level [dB (uV)]		Limit [dB (uV)]		Margin (dB)	
			Q.P.	AV.	Q.P.	AV.	Q.P.	AV.	Q.P.	AV.
1	0.223	0.13	43.01	-	43.14	-	62.69	52.69	-19.55	-
2	0.267	0.14	47.02	-	47.16	-	61.20	51.20	-14.05	-
3	0.611	0.16	38.17	-	38.33	-	56.00	46.00	-17.67	-
4	4.340	0.31	36.79	-	37.10	-	56.00	46.00	-18.90	-
5	5.359	0.35	37.35	-	37.70	-	60.00	50.00	-22.30	-
6	7.023	0.40	36.70	-	37.10	-	60.00	50.00	-22.90	-

- REMARKS:**
1. Q.P. and AV. are abbreviations of quasi-peak and average individually.
 2. "-": The Quasi-peak reading value also meets average limit and measurement with the average detector is unnecessary.
 3. The emission levels of other frequencies were very low against the limit.
 4. Margin value = Emission level - Limit value
 5. Correction factor = Insertion loss + Cable loss
 6. Emission Level = Correction Factor + Reading Value.

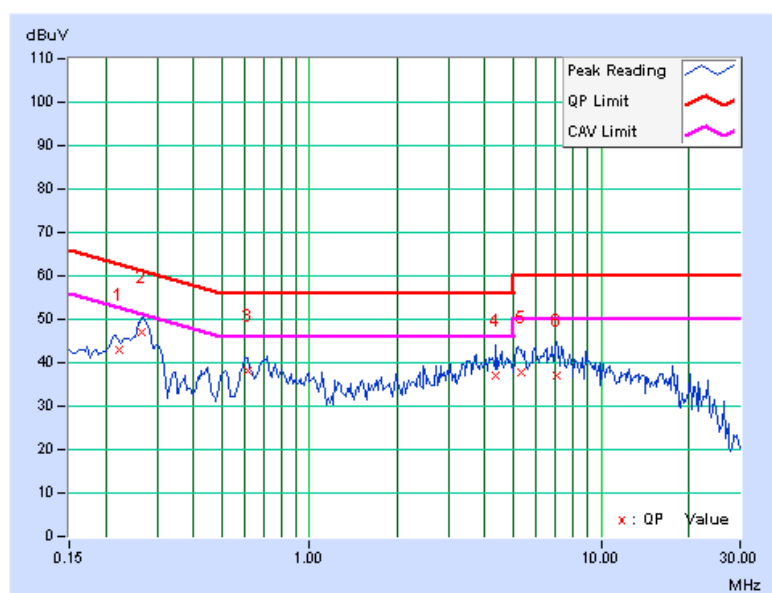



A D T

EUT TEST CONDITION		MEASUREMENT DETAIL	
CHANNEL	Channel 6	PHASE	Line 1
MODULATION TYPE	BPSK	INPUT POWER (SYSTEM)	120Vac, 60Hz
TRANSFER RATE	6.0Mbps	6dB BANDWIDTH	9kHz
ENVIRONMENTAL CONDITIONS	27deg. C, 66%RH, 1013hPa	TESTED BY	Dean Wang
TEST MODE	C		

No	Freq. [MHz]	Corr. Factor (dB)	Reading Value [dB (uV)]		Emission Level [dB (uV)]		Limit [dB (uV)]		Margin (dB)	
			Q.P.	AV.	Q.P.	AV.	Q.P.	AV.	Q.P.	AV.
1	0.177	0.13	48.64	-	48.77	-	64.61	54.61	-15.84	-
2	0.358	0.14	50.07	41.73	50.21	41.87	58.78	48.78	-8.57	-6.91
3	0.395	0.14	45.43	-	45.57	-	57.97	47.97	-12.40	-
4	0.481	0.14	44.38	-	44.52	-	56.33	46.33	-11.80	-
5	0.775	0.16	41.02	-	41.18	-	56.00	46.00	-14.82	-
6	18.246	0.63	40.17	-	40.80	-	60.00	50.00	-19.20	-

- REMARKS:**
1. Q.P. and AV. are abbreviations of quasi-peak and average individually.
 2. "-": The Quasi-peak reading value also meets average limit and measurement with the average detector is unnecessary.
 3. The emission levels of other frequencies were very low against the limit.
 4. Margin value = Emission level - Limit value
 5. Correction factor = Insertion loss + Cable loss
 6. Emission Level = Correction Factor + Reading Value.

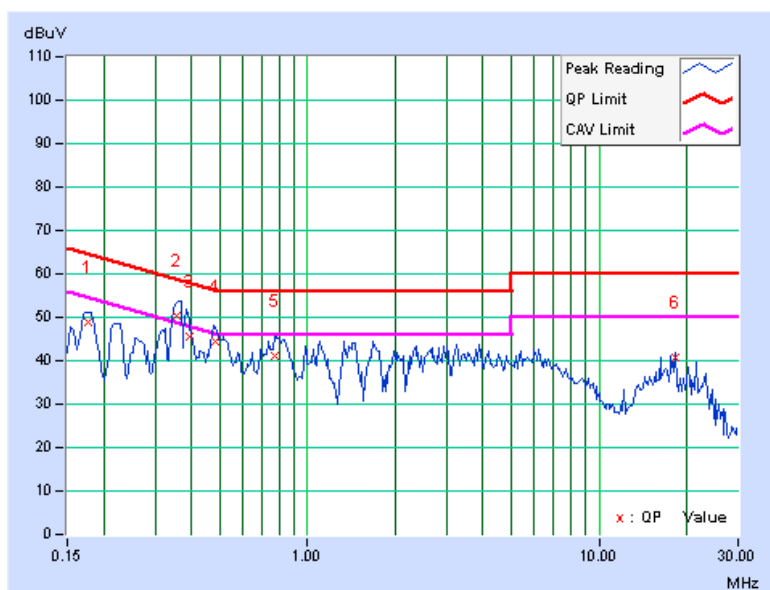



A D T

EUT TEST CONDITION		MEASUREMENT DETAIL	
CHANNEL	Channel 6	PHASE	Line 2
MODULATION TYPE	BPSK	INPUT POWER (SYSTEM)	120Vac, 60Hz
TRANSFER RATE	6.0Mbps	6dB BANDWIDTH	9kHz
ENVIRONMENTAL CONDITIONS	27deg. C, 66%RH, 1013hPa	TESTED BY	Dean Wang
TEST MODE	C		

No	Freq. [MHz]	Corr. Factor (dB)	Reading Value [dB (uV)]		Emission Level [dB (uV)]		Limit [dB (uV)]		Margin (dB)	
			Q.P.	AV.	Q.P.	AV.	Q.P.	AV.	Q.P.	AV.
			1	0.177	0.13	47.57	-	47.70	-	64.61
2	0.357	0.15	47.55	-	47.70	-	58.79	48.79	-11.10	-
3	0.394	0.15	42.90	-	43.05	-	57.99	47.99	-14.94	-
4	0.482	0.15	41.44	-	41.59	-	56.30	46.30	-14.70	-
5	0.779	0.16	38.78	-	38.94	-	56.00	46.00	-17.06	-
6	18.246	0.77	38.70	-	39.47	-	60.00	50.00	-20.53	-

- REMARKS:**
1. Q.P. and AV. are abbreviations of quasi-peak and average individually.
 2. "-": The Quasi-peak reading value also meets average limit and measurement with the average detector is unnecessary.
 3. The emission levels of other frequencies were very low against the limit.
 4. Margin value = Emission level - Limit value
 5. Correction factor = Insertion loss + Cable loss
 6. Emission Level = Correction Factor + Reading Value.

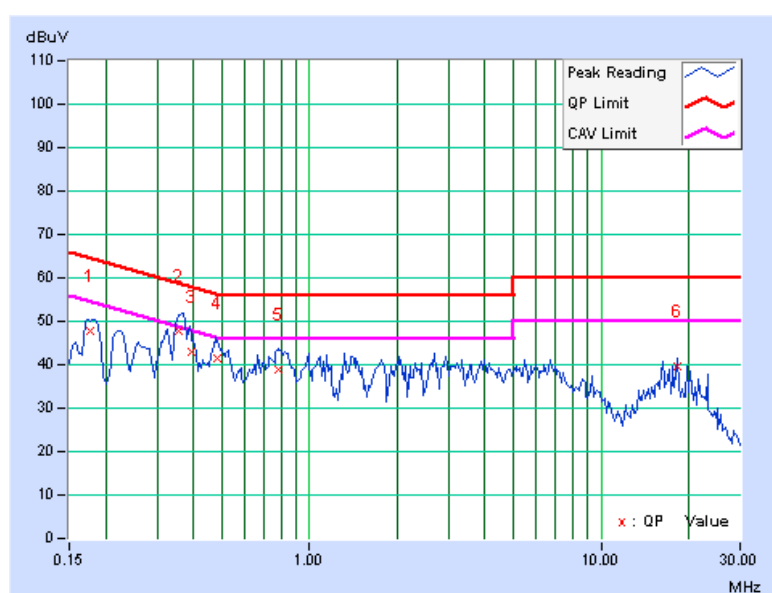



A D T

EUT TEST CONDITION		MEASUREMENT DETAIL	
CHANNEL	Channel 6	PHASE	Line 1
MODULATION TYPE	BPSK	INPUT POWER (SYSTEM)	120Vac, 60Hz
TRANSFER RATE	6.0Mbps	6dB BANDWIDTH	9kHz
ENVIRONMENTAL CONDITIONS	27deg. C, 66%RH, 1013hPa	TESTED BY	Dean Wang
TEST MODE	D		

No	Freq. [MHz]	Corr. Factor (dB)	Reading Value [dB (uV)]		Emission Level [dB (uV)]		Limit [dB (uV)]		Margin (dB)	
			Q.P.	AV.	Q.P.	AV.	Q.P.	AV.	Q.P.	AV.
1	0.296	0.13	44.51	-	44.64	-	60.36	50.36	-15.71	-
2	0.346	0.14	39.65	-	39.79	-	59.06	49.06	-19.28	-
3	0.547	0.15	33.53	-	33.68	-	56.00	46.00	-22.32	-
4	0.907	0.17	32.40	-	32.57	-	56.00	46.00	-23.43	-
5	8.672	0.40	34.35	-	34.75	-	60.00	50.00	-25.25	-
6	14.539	0.54	35.45	-	35.99	-	60.00	50.00	-24.01	-

- REMARKS:**
1. Q.P. and AV. are abbreviations of quasi-peak and average individually.
 2. "-": The Quasi-peak reading value also meets average limit and measurement with the average detector is unnecessary.
 3. The emission levels of other frequencies were very low against the limit.
 4. Margin value = Emission level - Limit value
 5. Correction factor = Insertion loss + Cable loss
 6. Emission Level = Correction Factor + Reading Value.

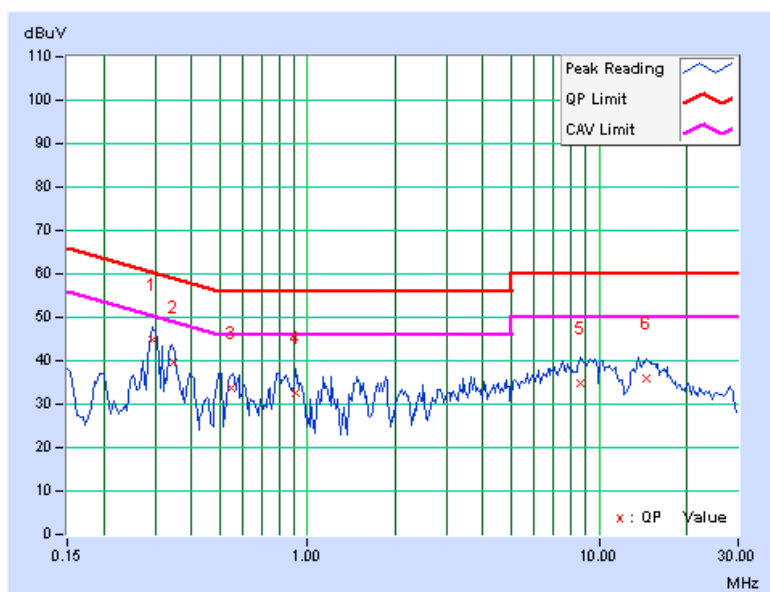



A D T

EUT TEST CONDITION		MEASUREMENT DETAIL	
CHANNEL	Channel 6	PHASE	Line 2
MODULATION TYPE	BPSK	INPUT POWER (SYSTEM)	120Vac, 60Hz
TRANSFER RATE	6.0Mbps	6dB BANDWIDTH	9kHz
ENVIRONMENTAL CONDITIONS	27deg. C, 66%RH, 1013hPa	TESTED BY	Dean Wang
TEST MODE	D		

No	Freq. [MHz]	Corr. Factor [dB]	Reading Value [dB (uV)]		Emission Level [dB (uV)]		Limit [dB (uV)]		Margin (dB)	
			Q.P.	AV.	Q.P.	AV.	Q.P.	AV.	Q.P.	AV.
1	0.296	0.14	43.39	-	43.53	-	60.36	50.36	-16.83	-
2	0.344	0.14	38.27	-	38.41	-	59.10	49.10	-20.69	-
3	0.542	0.15	33.04	-	33.19	-	56.00	46.00	-22.81	-
4	0.841	0.16	31.92	-	32.08	-	56.00	46.00	-23.92	-
5	8.395	0.45	32.14	-	32.59	-	60.00	50.00	-27.41	-
6	13.969	0.63	33.34	-	33.97	-	60.00	50.00	-26.03	-

- REMARKS:**
1. Q.P. and AV. are abbreviations of quasi-peak and average individually.
 2. "-": The Quasi-peak reading value also meets average limit and measurement with the average detector is unnecessary.
 3. The emission levels of other frequencies were very low against the limit.
 4. Margin value = Emission level - Limit value
 5. Correction factor = Insertion loss + Cable loss
 6. Emission Level = Correction Factor + Reading Value.

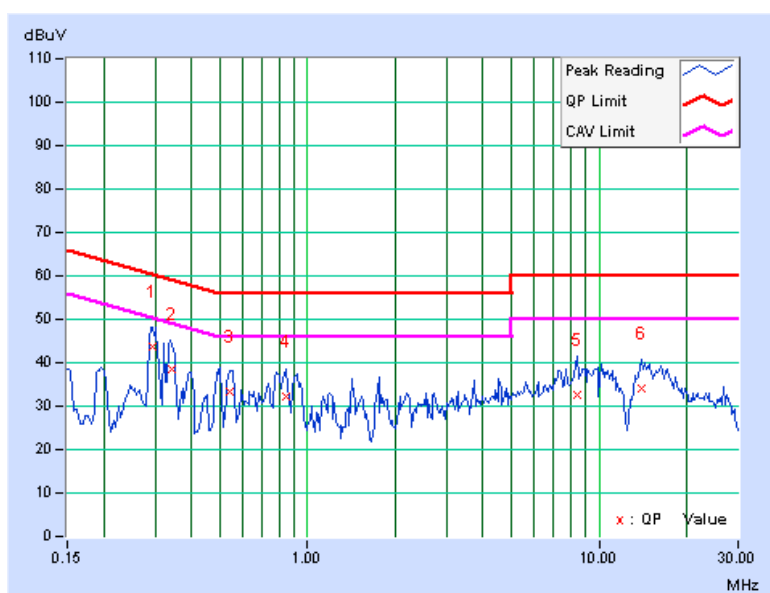

5. PHOTOGRAPHS OF THE TEST CONFIGURATION

Please refer to the attached file (Test Setup Photo).

6. INFORMATION ON THE TESTING LABORATORIES

We, Bureau Veritas Consumer Products Services (H.K.) Ltd., Taoyuan Branch, were founded in 1988 to provide our best service in EMC, Radio, Telecom and Safety consultation. Our laboratories are accredited and approved by the following approval agencies according to ISO/IEC 17025.

USA	FCC, NVLAP
Germany	TUV Rheinland
Japan	VCCI
Norway	NEMKO
Canada	INDUSTRY CANADA , CSA
R.O.C.	TAF, BSMI, NCC
Netherlands	Telefication
Singapore	GOST-ASIA(MOU)
Russia	CERTIS(MOU)

Copies of accreditation certificates of our laboratories obtained from approval agencies can be downloaded from our web site: www.adt.com.tw/index.5/phtml.
If you have any comments, please feel free to contact us at the following:

Linko EMC/RF Lab:

Tel: 886-2-26052180

Fax: 886-2-26051924

Hsin Chu EMC/RF Lab:

Tel: 886-3-5935343

Fax: 886-3-5935342

Hwa Ya EMC/RF/Safety Telecom Lab:

Tel: 886-3-3183232

Fax: 886-3-3185050

Web Site: www.adt.com.tw

The address and road map of all our labs can be found in our web site also.

7. APPENDIX A - MODIFICATIONS RECORDERS FOR ENGINEERING CHANGES TO THE EUT BY THE LAB

No any modifications are made to the EUT by the lab during the test.

--- END ---