



FCC TEST REPORT

REPORT NO.: RF970519L11
MODEL NO.: ESR-9750G
RECEIVED: May 19, 2008
TESTED: Jun. 09 ~ Jun. 15, 2008
ISSUED: Jun. 19, 2008

APPLICANT: Senao Networks Inc.

ADDRESS: 3F, No. 529, Chung Cheng Rd., Hsintien, Taipei,
Taiwan, R.O.C.

ISSUED BY: Advance Data Technology Corporation

LAB ADDRESS: 47 14th Lin, Chiapau Tsun, Linko, Taipei, Taiwan,
R.O.C.

TEST LOCATION: No. 19, Hwa Ya 2nd Rd., Kueishan, Taoyuan,
Taiwan, R.O.C.

This test report consists of 87 pages in total. It may be duplicated completely for legal use with the approval of the applicant. It should not be reproduced except in full, without the written approval of our laboratory. The client should not use it to claim product endorsement by TAF, A2LA or any government agencies. The test results in the report only apply to the tested sample.





TABLE OF CONTENTS

1.	CERTIFICATION	4
2.	SUMMARY OF TEST RESULTS	5
2.1	MEASUREMENT UNCERTAINTY	5
3.	GENERAL INFORMATION	6
3.1	GENERAL DESCRIPTION OF EUT	6
3.2	DESCRIPTION OF TEST MODES	7
3.2.1	CONFIGURATION OF SYSTEM UNDER TEST	8
3.2.2	TEST MODE APPLICABILITY AND TESTED CHANNEL DETAIL	9
3.3	GENERAL DESCRIPTION OF APPLIED STANDARDS	11
3.4	DESCRIPTION OF SUPPORT UNITS	11
4.	TEST TYPES AND RESULTS	12
4.1	RADIATED EMISSION MEASUREMENT	12
4.1.1	LIMITS OF RADIATED EMISSION MEASUREMENT	12
4.1.2	TEST INSTRUMENTS	13
4.1.3	TEST PROCEDURES	14
4.1.4	DEVIATION FROM TEST STANDARD	14
4.1.5	TEST SETUP	15
4.1.6	EUT OPERATING CONDITIONS	15
4.1.7	TEST RESULTS	16
4.2	CONDUCTED EMISSION MEASUREMENT	29
4.2.1	LIMITS OF CONDUCTED EMISSION MEASUREMENT	29
4.2.2	TEST INSTRUMENTS	29
4.2.3	TEST PROCEDURES	30
4.2.4	DEVIATION FROM TEST STANDARD	30
4.2.5	TEST SETUP	31
4.2.6	EUT OPERATING CONDITIONS	31
4.2.7	TEST RESULTS	32
4.3	6dB BANDWIDTH MEASUREMENT	34
4.3.1	LIMITS OF 6dB BANDWIDTH MEASUREMENT	34
4.3.2	TEST INSTRUMENTS	34
4.3.3	TEST PROCEDURE	34
4.3.4	DEVIATION FROM TEST STANDARD	34
4.3.5	TEST SETUP	35
4.3.6	EUT OPERATING CONDITIONS	35
4.3.7	TEST RESULTS	36
4.4	MAXIMUM PEAK OUTPUT POWER	48
4.4.1	LIMITS OF MAXIMUM PEAK OUTPUT POWER MEASUREMENT	48
4.4.2	INSTRUMENTS	48
4.4.3	TEST PROCEDURES	48
4.4.4	DEVIATION FROM TEST STANDARD	48
4.4.5	TEST SETUP	49
4.4.6	EUT OPERATING CONDITIONS	49
4.4.7	TEST RESULTS	50



4.5	POWER SPECTRAL DENSITY MEASUREMENT	52
4.5.1	LIMITS OF POWER SPECTRAL DENSITY MEASUREMENT	52
4.5.2	TEST INSTRUMENTS	52
4.5.3	TEST PROCEDURE	52
4.5.4	DEVIATION FROM TEST STANDARD	52
4.5.5	TEST SETUP	53
4.5.6	EUT OPERATING CONDITION	53
4.5.7	TEST RESULTS	54
4.6	BAND EDGES MEASUREMENT	66
4.6.1	LIMITS OF BAND EDGES MEASUREMENT	66
4.6.2	TEST INSTRUMENTS	66
4.6.3	TEST PROCEDURE	67
4.6.4	DEVIATION FROM TEST STANDARD	67
4.6.5	EUT OPERATING CONDITION	68
4.6.6	TEST RESULTS	68
4.7	ANTENNA REQUIREMENT	84
4.7.1	STANDARD APPLICABLE	84
4.7.2	ANTENNA CONNECTED CONSTRUCTION.....	84
5.	PHOTOGRAPHS OF THE TEST CONFIGURATION	85
6.	INFORMATION ON THE TESTING LABORATORIES.....	86
7.	APPENDIX A - MODIFICATIONS RECORDERS FOR ENGINEERING CHANGES TO THE EUT BY THE LAB.....	87



1. CERTIFICATION

PRODUCT: Wireless-N Router
MODEL: ESR-9750G
BRAND: EnGenius
APPLICANT: Senao Networks Inc.
TESTED: Jun. 09 ~ Jun. 15, 2008
TEST SAMPLE: ENGINEERING SAMPLE
STANDARDS: FCC Part 15, Subpart C (Section 15.247)
ANSI C63.4-2003

The above equipment (model: ESR-9750G) has been tested by **Advance Data Technology Corporation**, and found compliance with the requirement of the above standards. The test record, data evaluation & Equipment Under Test (EUT) configurations represented herein are true and accurate accounts of the measurements of the sample's EMC characteristics under the conditions specified in this report.

PREPARED BY : Ivy Lin , **DATE:** Jun. 19, 2008
Ivy Lin / Specialist

TECHNICAL ACCEPTANCE : Long Chen , **DATE:** Jun. 19, 2008
Responsible for RF Long Chen / Senior Engineer

APPROVED BY : Gary Chang , **DATE:** Jun. 19, 2008
Gary Chang / Assistant Manager

2. SUMMARY OF TEST RESULTS

The EUT has been tested according to the following specifications:

APPLIED STANDARD: FCC Part 15, Subpart C			
Standard Section	Test Type and Limit	Result	Remark
15.207	AC Power Conducted Emission	PASS	Meet the requirement of limit. Minimum passing margin is -18.31dB at 0.185MHz.
15.247(a)(2)	Spectrum Bandwidth of a Direct Sequence Spread Spectrum System Limit: min. 500kHz	PASS	Meet the requirement of limit.
15.247(b)	Maximum Peak Output Power Limit: max. 30dBm	PASS	Meet the requirement of limit.
15.247(d)	Radiated Emissions Limit: Table 15.209	PASS	Meet the requirement of limit. Minimum passing margin is -0.85dB at 125.01MHz.
15.247(e)	Power Spectral Density Limit: max. 8dBm	PASS	Meet the requirement of limit.
15.247(d)	Band Edge Measurement Limit: 20dB less than the peak value of fundamental frequency	PASS	Meet the requirement of limit.

2.1 MEASUREMENT UNCERTAINTY

Where relevant, the following measurement uncertainty levels have been estimated for tests performed on the EUT as specified in CISPR 16-4-2:

MEASUREMENT	FREQUENCY	UNCERTAINTY
Conducted emissions	9kHz ~ 30MHz	2.44 dB
Radiated emissions	30MHz ~ 200MHz	3.34 dB
	200MHz ~ 1000MHz	3.35 dB
	1GHz ~ 18GHz	2.26 dB
	18GHz ~ 40GHz	1.94 dB

This uncertainty represents an expanded uncertainty expressed at approximately the 95% confidence level using a coverage factor of k=2.

3. GENERAL INFORMATION

3.1 GENERAL DESCRIPTION OF EUT

PRODUCT	Wireless-N Router
MODEL NO.	ESR-9750G
FCC ID	U2M-SR97908002
POWER SUPPLY	12Vdc from AC adapter
MODULATION TYPE	CCK, DQPSK, DBPSK for DSSS 64QAM, 16QAM, QPSK, BPSK for OFDM
MODULATION TECHNOLOGY	DSSS, OFDM
TRANSFER RATE	802.11b: 11.0/ 5.5/ 2.0/ 1.0Mbps 802.11g: 54.0/ 48.0/ 36.0/ 24.0/ 18.0/ 12.0/ 9.0/ 6.0Mbps Draft 802.11n: up to 300.0Mbps
FREQUENCY RANGE	2412MHz ~ 2462MHz
NUMBER OF CHANNEL	11 for 802.11b, 802.11g, Draft 802.11n (20MHz) 7 for Draft 802.11n (40MHz)
MAXIMUM OUTPUT POWER	160.342mW
ANTENNA TYPE	Dipole antenna with 2dBi gain
DATA CABLE	NA
I/O PORTS	RJ45
ACCESSORY DEVICES	Adapter

NOTE:

- The EUT was powered by the following adapter:

BRAND	ENG
MODEL	3A-161WP-12
INPUT POWER	100-240Vac, 50-60Hz, 0.6A
OUTPUT POWER	12Vdc, 1.25A
POWER LINE	1.8m non-shielded cable with one core

- The EUT incorporates a MIMO function. Physically, the EUT provides two completed transmitters and three receivers.

MODULATION MODE	TX FUNCTION
802.11b	1TX
802.11g	1TX
Draft 802.11n (20MHz)	2TX
Draft 802.11n (40MHz)	2TX

- The above EUT information was declared by manufacturer and for more detailed features description, please refer to the manufacturer's specifications or user's manual.

3.2 DESCRIPTION OF TEST MODES

Eleven channels are provided for 802.11b, 802.11g and draft 802.11n (20MHz):

CHANNEL	FREQUENCY	CHANNEL	FREQUENCY
1	2412MHz	7	2442MHz
2	2417MHz	8	2447MHz
3	2422MHz	9	2452MHz
4	2427MHz	10	2457MHz
5	2432MHz	11	2462MHz
6	2437MHz		

Seven channels are provided for draft 802.11n (40MHz):

CHANNEL	FREQUENCY	CHANNEL	FREQUENCY
1	2422MHz	5	2442MHz
2	2427MHz	6	2447MHz
3	2432MHz	7	2452MHz
4	2437MHz		

3.2.1 CONFIGURATION OF SYSTEM UNDER TEST

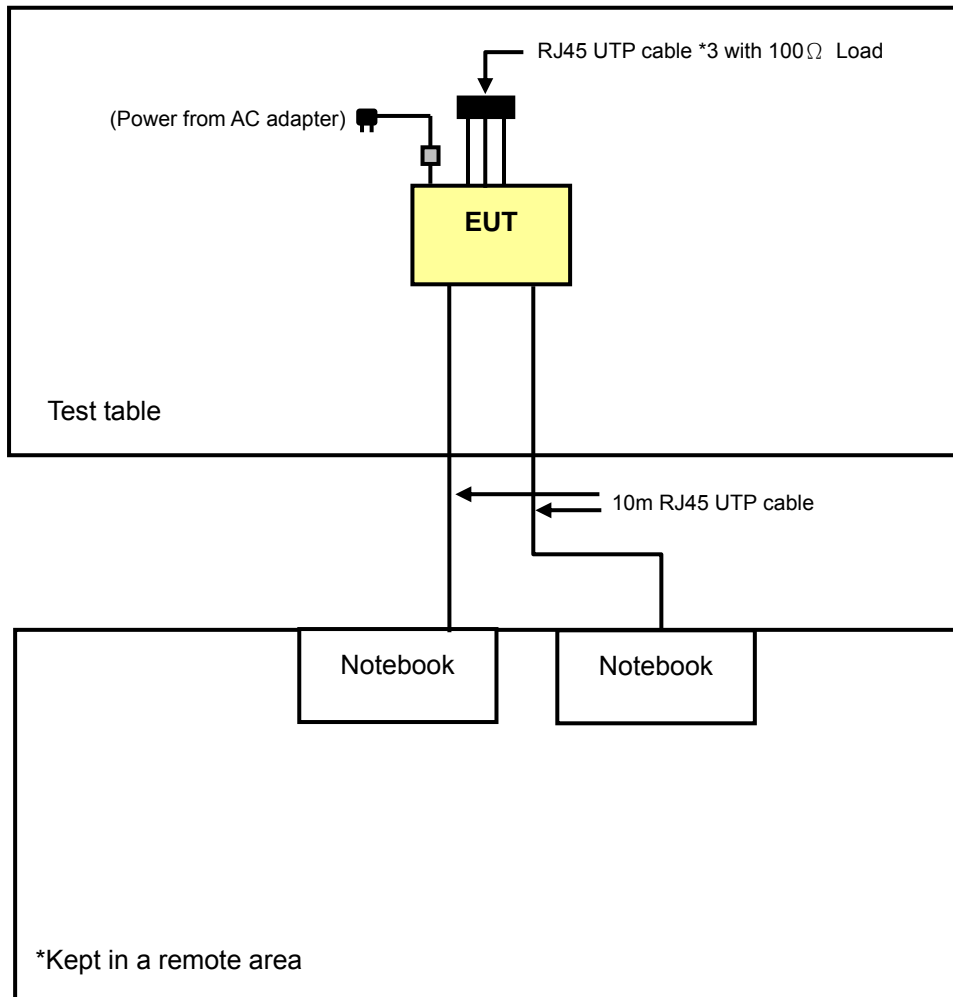

3.2.2 TEST MODE APPLICABILITY AND TESTED CHANNEL DETAIL

EUT Configure Mode	Applicable to				Description
	RE \geq 1G	RE<1G	PLC	APCM	
-	√	√	√	√	-

Where **PLC**: Power Line Conducted Emission **RE<1G**: Radiated Emission below 1GHz
RE \geq 1G: Radiated Emission above 1GHz **APCM**: Antenna Port Conducted Measurement

RADIATED EMISSION TEST (ABOVE 1 GHz):

- Pre-Scan has been conducted to determine the worst-case mode from all possible combinations between available modulations, data rates, and antenna ports (if EUT with antenna diversity architecture).
- Following channel(s) was (were) selected for the final test as listed below.

EUT Configure Mode	Mode	Available Channel	Tested Channel	Modulation Technology	Modulation Type	Data Rate (Mbps)
-	802.11b	1 to 11	1, 6, 11	DSSS	DBPSK	1
-	802.11g	1 to 11	1, 6, 11	OFDM	BPSK	6
-	Draft 802.11n (20MHz)	1 to 11	1, 6, 11	OFDM	BPSK	7.2
-	Draft 802.11n (40MHz)	1 to 7	1, 4, 7	OFDM	BPSK	15

RADIATED EMISSION TEST (BELOW 1 GHz):

- Pre-Scan has been conducted to determine the worst-case mode from all possible combinations between available modulations, data rates, and antenna ports (if EUT with antenna diversity architecture).
- Following channel(s) was (were) selected for the final test as listed below.

EUT Configure Mode	Mode	Available Channel	Tested Channel	Modulation Technology	Modulation Type	Data Rate (Mbps)
-	Draft 802.11n (20MHz)	1 to 11	6	OFDM	BPSK	7.2

POWER LINE CONDUCTED EMISSION TEST:

- Pre-Scan has been conducted to determine the worst-case mode from all possible combinations between available modulations, data rates, and antenna ports (if EUT with antenna diversity architecture).
- Following channel(s) was (were) selected for the final test as listed below.

EUT Configure Mode	Mode	Available Channel	Tested Channel	Modulation Technology	Modulation Type	Data Rate (Mbps)
-	Draft 802.11n (20MHz)	1 to 11	6	OFDM	BPSK	7.2

BANDEDGE MEASUREMENT:

- Pre-Scan has been conducted to determine the worst-case mode from all possible combinations between available modulations, data rates, and antenna ports (if EUT with antenna diversity architecture).
- Following channel(s) was (were) selected for the final test as listed below.

EUT Configure Mode	Mode	Available Channel	Tested Channel	Modulation Technology	Modulation Type	Data Rate (Mbps)
-	802.11b	1 to 11	1, 11	DSSS	DBPSK	1
-	802.11g	1 to 11	1, 11	OFDM	BPSK	6
-	Draft 802.11n (20MHz)	1 to 11	1, 11	OFDM	BPSK	7.2
-	Draft 802.11n (40MHz)	1 to 7	1, 7	OFDM	BPSK	15

ANTENNA PORT CONDUCTED MEASUREMENT:

- Pre-Scan has been conducted to determine the worst-case mode from all possible combinations between available modulations, data rates, and antenna ports (if EUT with antenna diversity architecture).
- Following channel(s) was (were) selected for the final test as listed below.

EUT Configure Mode	Mode	Available Channel	Tested Channel	Modulation Technology	Modulation Type	Data Rate (Mbps)
-	802.11b	1 to 11	1, 6, 11	DSSS	DBPSK	1
-	802.11g	1 to 11	1, 6, 11	OFDM	BPSK	6
-	Draft 802.11n (20MHz)	1 to 11	1, 6, 11	OFDM	BPSK	7.2
-	Draft 802.11n (40MHz)	1 to 7	1, 4, 7	OFDM	BPSK	15



3.3 GENERAL DESCRIPTION OF APPLIED STANDARDS

The EUT is a RF product. According to the specifications of the manufacturer, it must comply with the requirements of the following standards:

FCC Part 15, Subpart C. (15.247)

ANSI C63.4-2003

All test items have been performed and recorded as per the above standards.

NOTE: The EUT is also considered as a kind of computer peripheral, because the connection to computer is necessary for typical use. It has been verified to comply with the requirements of FCC Part 15, Subpart B, Class B (DoC). The test report has been issued separately.

3.4 DESCRIPTION OF SUPPORT UNITS

The EUT has been tested as an independent unit together with other necessary accessories or support units. The following support units or accessories were used to form a representative test configuration during the tests.

NO.	PRODUCT	BRAND	MODEL NO.	SERIAL NO.	FCC ID
1	NOTEBOOK COMPUTER	DELL	PP05L	12130898320	E2K24CLNS
2	NOTEBOOK COMPUTER	DELL	PP05L	9954115984	E2K24CLNS

NO.	SIGNAL CABLE DESCRIPTION OF THE ABOVE SUPPORT UNITS
1	10m UTP RJ45 cable
2	10m UTP RJ45 cable

NOTE:

1. All power cords of the above support units are non shielded (1.8m).
2. Item 1-2 acted as a communication partners to transfer data.

4. TEST TYPES AND RESULTS

4.1 RADIATED EMISSION MEASUREMENT

4.1.1 LIMITS OF RADIATED EMISSION MEASUREMENT

Emissions radiated outside of the specified bands, shall be according to the general radiated limits in 15.209 as following:

FREQUENCIES (MHz)	FIELD STRENGTH (microvolts/meter)	MEASUREMENT DISTANCE (meters)
0.009 ~ 0.490	2400 / F(kHz)	300
0.490 ~ 1.705	24000 / F(kHz)	30
1.705 ~ 30.0	30	30
30 ~ 88	100	3
88 ~ 216	150	3
216 ~ 960	200	3
Above 960	500	3

NOTE:

1. The lower limit shall apply at the transition frequencies.
2. Emission level (dBuV/m) = 20 log Emission level (uV/m).
3. As shown in 15.35(b), for frequencies above 1000MHz, the field strength limits are based on average detector, however, the peak field strength of any emission shall not exceed the maximum permitted average limits, specified above by more than 20dB under any condition of modulation.



4.1.2 TEST INSTRUMENTS

DESCRIPTION & MANUFACTURER	MODEL NO.	SERIAL NO.	CALIBRATED UNTIL
Test Receiver ROHDE & SCHWARZ	ESCI	100424	Jul. 27, 2008
Spectrum Analyzer Agilent	E4446A	MY44360128	Dec. 06, 2008
BILOG Antenna SCHWARZBECK	VULB9168	9168-160	May 01, 2009
HORN Antenna SCHWARZBECK	9120D	9120D-209	Jun. 28, 2008
HORN Antenna SCHWARZBECK	BBHA 9170	BBHA9170243	Dec. 24, 2008
Preamplifier Agilent	8447D	2944A10633	Oct. 28, 2008
Preamplifier Agilent	8449B	3008A01964	Oct. 23, 2008
RF signal cable HUBER+SUHNNER	SUCOFLEX 104	283402/4	Dec. 06, 2008
RF signal cable HUBER+SUHNNER	SUCOFLEX 104	251644/4	Dec. 06, 2008
Software ADT.	ADT_Radiated_V7.6	NA	NA
Antenna Tower inn-co GmbH	MA 4000	013303	NA
Antenna Tower Controller inn-co GmbH	CO2000	017303	NA
Turn Table ADT.	TT100.	TT93021703	NA
Turn Table Controller ADT.	SC100.	SC93021703	NA

- NOTE:**
1. The calibration interval of the above test instruments is 12 months and the calibrations are traceable to NML/ROC and NIST/USA.
 2. The test was performed in HwaYa Chamber 3.
 3. The horn antenna and HP preamplifier (model: 8449B) are used only for the measurement of emission frequency above 1GHz if tested.
 4. The FCC Site Registration No. is 988962.
 5. The IC Site Registration No. is IC3789B-3.

4.1.3 TEST PROCEDURES

- a. The EUT was placed on the top of a rotating table 0.8 meters above the ground at a 3 meters semi-anechoic chamber. The table was rotated 360 degrees to determine the position of the highest radiation.
- b. The EUT was set 3 meters away from the interference-receiving antenna, which was mounted on the top of a variable-height antenna tower.
- c. The antenna is a broadband antenna, and its height is varied from one meter to four meters above the ground to determine the maximum value of the field strength. Both horizontal and vertical polarizations of the antenna are set to make the measurement.
- d. For each suspected emission, the EUT was arranged to its worst case and then the antenna was tuned to heights from 1 meter to 4 meters and the rotatable table was turned from 0 degrees to 360 degrees to find the maximum reading.
- e. The test-receiver system was set to Peak Detect Function and Specified Bandwidth with Maximum Hold Mode.
- f. If the emission level of the EUT in peak mode was lower than the limit specified, then testing could be stopped and the peak values of the EUT would be reported. Otherwise the emissions would be re-tested one by one using peak, quasi-peak or average method as specified and then reported in a data sheet.

NOTE:

1. The resolution bandwidth and video bandwidth of test receiver/spectrum analyzer is 120kHz for Peak detection (PK) and Quasi-peak detection (QP) at frequency below 1GHz.
2. The resolution bandwidth of test receiver/spectrum analyzer is 1 MHz and video bandwidth is 3MHz for Peak detection at frequency above 1GHz.
3. The resolution bandwidth of test receiver/spectrum analyzer is 1MHz and the video bandwidth is 10Hz for Average detection (AV) at frequency above 1GHz.
4. All modes of operation were investigated and the worst-case emissions are reported.

4.1.4 DEVIATION FROM TEST STANDARD

No deviation

4.1.5 TEST SETUP

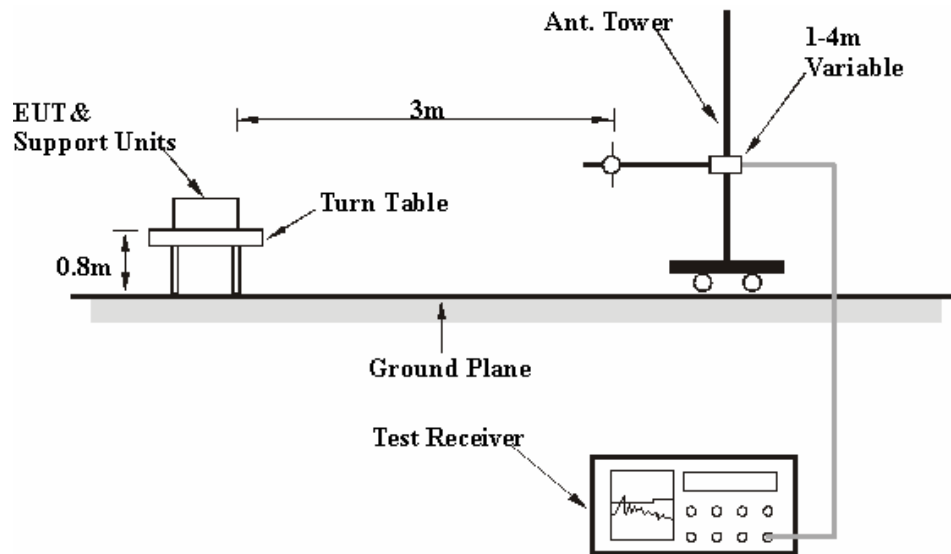

For the actual test configuration, please refer to the attached file (Test Setup Photo)

4.1.6 EUT OPERATING CONDITIONS

- Placed the EUT on the testing table.
- Prepared notebook systems to act as a communication partner and placed them outside of testing area.
- The communication partners connected with EUT via a UTP cable and run a test program (provided by manufacturer) to enable EUT under transmission condition continuously at specific channel frequency.
- The communication partners sent data to EUT by command "PING".

4.1.7 TEST RESULTS

802.11b DSSS MODULATION

EUT TEST CONDITION		MEASUREMENT DETAIL	
CHANNEL	Channel 1	FREQUENCY RANGE	1 ~ 25GHz
INPUT POWER (SYSTEM)	120Vac, 60 Hz	DETECTOR FUNCTION	Peak (PK) Average (AV)
ENVIRONMENTAL CONDITIONS	24deg. C, 68%RH 993hPa	TESTED BY	Lori Chiu

ANTENNA POLARITY & TEST DISTANCE: HORIZONTAL AT 3 M								
NO.	FREQ. (MHz)	EMISSION LEVEL (dBuV/m)	LIMIT (dBuV/m)	MARGIN (dB)	ANTENNA HEIGHT (m)	TABLE ANGLE (Degree)	RAW VALUE (dBuV)	CORRECTION FACTOR (dB/m)
1	1125.00	55.17 PK	74.00	-18.83	1.33 H	346	25.78	29.39
2	1125.00	45.96 AV	54.00	-8.04	1.33 H	346	16.57	29.39
3	2390.00	58.32 PK	74.00	-15.68	1.27 H	72	26.08	32.24
4	2390.00	47.42 AV	54.00	-6.58	1.27 H	72	15.18	32.24
5	*2412.00	104.92 PK			1.27 H	72	72.60	32.32
6	*2412.00	100.72 AV			1.27 H	72	68.40	32.32
7	4824.00	55.65 PK	74.00	-18.35	1.01 H	18	17.52	38.13
8	4824.00	52.72 AV	54.00	-1.28	1.01 H	18	14.59	38.13
ANTENNA POLARITY & TEST DISTANCE: VERTICAL AT 3 M								
NO.	FREQ. (MHz)	EMISSION LEVEL (dBuV/m)	LIMIT (dBuV/m)	MARGIN (dB)	ANTENNA HEIGHT (m)	TABLE ANGLE (Degree)	RAW VALUE (dBuV)	CORRECTION FACTOR (dB/m)
1	1125.00	56.17 PK	74.00	-17.83	1.00 V	47	26.78	29.39
2	1125.00	47.63 AV	54.00	-6.37	1.00 V	47	18.24	29.39
3	2390.00	59.20 PK	74.00	-14.80	1.16 V	186	26.96	32.24
4	2390.00	47.61 AV	54.00	-6.39	1.16 V	186	15.37	32.24
5	*2412.00	107.34 PK			1.16 V	186	75.02	32.32
6	*2412.00	102.96 AV			1.16 V	186	70.64	32.32
7	4824.00	54.46 PK	74.00	-19.54	1.01 V	104	16.33	38.13
8	4824.00	51.08 AV	54.00	-2.92	1.01 V	104	12.95	38.13

- REMARKS:**
1. Emission level (dBuV/m) = Raw Value (dBuV) + Correction Factor (dB/m).
 2. Correction Factor (dB/m) = Antenna Factor (dB/m) + Cable Factor (dB).
 3. The other emission levels were very low against the limit.
 4. Margin value = Emission level – Limit value.
 5. “ * “: Fundamental frequency.



EUT TEST CONDITION		MEASUREMENT DETAIL	
CHANNEL	Channel 6	FREQUENCY RANGE	1 ~ 25GHz
INPUT POWER (SYSTEM)	120Vac, 60 Hz	DETECTOR FUNCTION	Peak (PK) Average (AV)
ENVIRONMENTAL CONDITIONS	24deg. C, 68%RH 993hPa	TESTED BY	Lori Chiu

ANTENNA POLARITY & TEST DISTANCE: HORIZONTAL AT 3 M								
NO.	FREQ. (MHz)	EMISSION LEVEL (dBuV/m)	LIMIT (dBuV/m)	MARGIN (dB)	ANTENNA HEIGHT (m)	TABLE ANGLE (Degree)	RAW VALUE (dBuV)	CORRECTION FACTOR (dB/m)
1	1125.00	55.41 PK	74.00	-18.59	1.20 H	325	26.01	29.39
2	1125.00	45.88 AV	54.00	-8.12	1.20 H	325	16.49	29.39
3	*2437.00	105.22 PK			1.23 H	278	72.82	32.40
4	*2437.00	101.09 AV			1.23 H	278	68.69	32.40
5	4874.00	54.41 PK	74.00	-19.59	1.09 H	231	16.09	38.32
6	4874.00	51.49 AV	54.00	-2.51	1.09 H	231	13.17	38.32
ANTENNA POLARITY & TEST DISTANCE: VERTICAL AT 3 M								
NO.	FREQ. (MHz)	EMISSION LEVEL (dBuV/m)	LIMIT (dBuV/m)	MARGIN (dB)	ANTENNA HEIGHT (m)	TABLE ANGLE (Degree)	RAW VALUE (dBuV)	CORRECTION FACTOR (dB/m)
1	1125.00	55.97 PK	74.00	-18.03	1.02 V	55	26.57	29.39
2	1125.00	47.96 AV	54.00	-6.04	1.02 V	55	18.57	29.39
3	*2437.00	108.46 PK			1.10 V	162	76.06	32.40
4	*2437.00	103.39 AV			1.10 V	162	70.99	32.40
5	4874.00	53.72 PK	74.00	-20.28	1.02 V	103	15.40	38.32
6	4874.00	50.38 AV	54.00	-3.62	1.02 V	103	12.06	38.32

- REMARKS:**
1. Emission level (dBuV/m) = Raw Value (dBuV) + Correction Factor (dB/m).
 2. Correction Factor (dB/m) = Antenna Factor (dB/m) + Cable Factor (dB).
 3. The other emission levels were very low against the limit.
 4. Margin value = Emission level – Limit value.
 5. “ * “: Fundamental frequency.

EUT TEST CONDITION		MEASUREMENT DETAIL	
CHANNEL	Channel 11	FREQUENCY RANGE	1 ~ 25GHz
INPUT POWER (SYSTEM)	120Vac, 60 Hz	DETECTOR FUNCTION	Peak (PK) Average (AV)
ENVIRONMENTAL CONDITIONS	24deg. C, 68%RH 993hPa	TESTED BY	Lori Chiu

ANTENNA POLARITY & TEST DISTANCE: HORIZONTAL AT 3 M								
NO.	FREQ. (MHz)	EMISSION LEVEL (dBuV/m)	LIMIT (dBuV/m)	MARGIN (dB)	ANTENNA HEIGHT (m)	TABLE ANGLE (Degree)	RAW VALUE (dBuV)	CORRECTION FACTOR (dB/m)
1	1125.00	55.34 PK	74.00	-18.66	1.32 H	56	25.95	29.39
2	1125.00	45.16 AV	54.00	-8.84	1.32 H	56	15.76	29.39
3	*2462.00	105.24 PK			1.22 H	100	72.76	32.48
4	*2462.00	101.11 AV			1.22 H	100	68.63	32.48
5	2483.50	58.61 PK	74.00	-15.39	1.22 H	100	26.05	32.56
6	2483.50	47.77 AV	54.00	-6.23	1.22 H	100	15.21	32.56
7	4924.00	51.84 PK	74.00	-22.16	1.00 H	6	13.38	38.46
8	4924.00	46.52 AV	54.00	-7.48	1.00 H	6	8.06	38.46

ANTENNA POLARITY & TEST DISTANCE: VERTICAL AT 3 M								
NO.	FREQ. (MHz)	EMISSION LEVEL (dBuV/m)	LIMIT (dBuV/m)	MARGIN (dB)	ANTENNA HEIGHT (m)	TABLE ANGLE (Degree)	RAW VALUE (dBuV)	CORRECTION FACTOR (dB/m)
1	1125.00	56.01 PK	74.00	-17.99	1.02 V	224	26.61	29.39
2	1125.00	47.20 AV	54.00	-6.80	1.02 V	224	17.81	29.39
3	*2462.00	108.52 PK			1.07 V	141	76.04	32.48
4	*2462.00	103.48 AV			1.07 V	141	70.99	32.48
5	2483.50	59.78 PK	74.00	-14.22	1.08 V	144	27.22	32.56
6	2483.50	48.94 AV	54.00	-5.06	1.08 V	144	16.38	32.56
7	4924.00	50.37 PK	74.00	-23.63	1.07 V	129	11.91	38.46
8	4924.00	44.78 AV	54.00	-9.22	1.07 V	129	6.32	38.46

- REMARKS:**
1. Emission level (dBuV/m) = Raw Value (dBuV) + Correction Factor (dB/m).
 2. Correction Factor (dB/m) = Antenna Factor (dB/m) + Cable Factor (dB).
 3. The other emission levels were very low against the limit.
 4. Margin value = Emission level – Limit value.
 5. “ * “: Fundamental frequency.

802.11g OFDM MODULATION

EUT TEST CONDITION		MEASUREMENT DETAIL	
CHANNEL	Channel 1	FREQUENCY RANGE	1 ~ 25GHz
INPUT POWER (SYSTEM)	120Vac, 60 Hz	DETECTOR FUNCTION	Peak (PK) Average (AV)
ENVIRONMENTAL CONDITIONS	24deg. C, 68%RH 993hPa	TESTED BY	Lori Chiu

ANTENNA POLARITY & TEST DISTANCE: HORIZONTAL AT 3 M								
NO.	FREQ. (MHz)	EMISSION LEVEL (dBuV/m)	LIMIT (dBuV/m)	MARGIN (dB)	ANTENNA HEIGHT (m)	TABLE ANGLE (Degree)	RAW VALUE (dBuV)	CORRECTION FACTOR (dB/m)
1	1125.00	56.04 PK	74.00	-17.96	1.01 H	223	26.64	29.39
2	1125.00	45.96 AV	54.00	-8.04	1.01 H	223	16.57	29.39
3	2390.00	62.99 PK	74.00	-11.01	1.27 H	72	30.75	32.24
4	2390.00	48.91 AV	54.00	-5.09	1.27 H	72	16.67	32.24
5	*2412.00	105.68 PK			1.27 H	72	73.36	32.32
6	*2412.00	95.95 AV			1.27 H	72	63.63	32.32
7	4824.00	53.94 PK	74.00	-20.06	1.02 H	13	15.81	38.13
8	4824.00	38.66 AV	54.00	-15.34	1.02 H	13	0.53	38.13
ANTENNA POLARITY & TEST DISTANCE: VERTICAL AT 3 M								
NO.	FREQ. (MHz)	EMISSION LEVEL (dBuV/m)	LIMIT (dBuV/m)	MARGIN (dB)	ANTENNA HEIGHT (m)	TABLE ANGLE (Degree)	RAW VALUE (dBuV)	CORRECTION FACTOR (dB/m)
1	1125.00	56.37 PK	74.00	-17.63	1.01 V	60	26.97	29.39
2	1125.00	47.86 AV	54.00	-6.14	1.01 V	60	18.46	29.39
3	2390.00	66.31 PK	74.00	-7.69	1.10 V	54	34.07	32.24
4	2390.00	51.49 AV	54.00	-2.51	1.10 V	54	19.25	32.24
5	*2412.00	110.52 PK			1.08 V	153	78.20	32.32
6	*2412.00	100.18 AV			1.08 V	153	67.86	32.32
7	4824.00	51.73 PK	74.00	-22.27	1.07 V	355	13.60	38.13
8	4824.00	37.05 AV	54.00	-16.95	1.07 V	355	-1.08	38.13

- REMARKS:**
1. Emission level (dBuV/m) = Raw Value (dBuV) + Correction Factor (dB/m).
 2. Correction Factor (dB/m) = Antenna Factor (dB/m) + Cable Factor (dB).
 3. The other emission levels were very low against the limit.
 4. Margin value = Emission level – Limit value.
 5. “ * “: Fundamental frequency.



EUT TEST CONDITION		MEASUREMENT DETAIL	
CHANNEL	Channel 6	FREQUENCY RANGE	1 ~ 25GHz
INPUT POWER (SYSTEM)	120Vac, 60 Hz	DETECTOR FUNCTION	Peak (PK) Average (AV)
ENVIRONMENTAL CONDITIONS	24deg. C, 68%RH 993hPa	TESTED BY	Lori Chiu

ANTENNA POLARITY & TEST DISTANCE: HORIZONTAL AT 3 M								
NO.	FREQ. (MHz)	EMISSION LEVEL (dBuV/m)	LIMIT (dBuV/m)	MARGIN (dB)	ANTENNA HEIGHT (m)	TABLE ANGLE (Degree)	RAW VALUE (dBuV)	CORRECTION FACTOR (dB/m)
1	1125.00	55.91 PK	74.00	-18.09	1.39 H	96	26.52	29.39
2	1125.00	45.50 AV	54.00	-8.50	1.39 H	96	16.10	29.39
3	*2437.00	105.78 PK			1.11 H	193	73.38	32.40
4	*2437.00	95.52 AV			1.11 H	193	63.12	32.40
5	4874.00	57.31 PK	74.00	-16.69	1.24 H	358	18.99	38.32
6	4874.00	41.41 AV	54.00	-12.59	1.24 H	358	3.09	38.32
ANTENNA POLARITY & TEST DISTANCE: VERTICAL AT 3 M								
NO.	FREQ. (MHz)	EMISSION LEVEL (dBuV/m)	LIMIT (dBuV/m)	MARGIN (dB)	ANTENNA HEIGHT (m)	TABLE ANGLE (Degree)	RAW VALUE (dBuV)	CORRECTION FACTOR (dB/m)
1	1125.00	56.00 PK	74.00	-18.00	1.02 V	56	26.61	29.39
2	1125.00	47.30 AV	54.00	-6.70	1.02 V	56	17.90	29.39
3	*2437.00	110.56 PK			1.00 V	207	78.16	32.40
4	*2437.00	100.21 AV			1.00 V	207	67.81	32.40
5	4874.00	55.86 PK	74.00	-18.14	1.19 V	118	17.54	38.32
6	4874.00	41.12 AV	54.00	-12.88	1.19 V	118	2.80	38.32

- REMARKS:**
1. Emission level (dBuV/m) = Raw Value (dBuV) + Correction Factor (dB/m).
 2. Correction Factor (dB/m) = Antenna Factor (dB/m) + Cable Factor (dB).
 3. The other emission levels were very low against the limit.
 4. Margin value = Emission level – Limit value.
 5. “ * ”: Fundamental frequency.

EUT TEST CONDITION		MEASUREMENT DETAIL	
CHANNEL	Channel 11	FREQUENCY RANGE	1 ~ 25GHz
INPUT POWER (SYSTEM)	120Vac, 60 Hz	DETECTOR FUNCTION	Peak (PK) Average (AV)
ENVIRONMENTAL CONDITIONS	22deg. C, 66%RH 993hPa	TESTED BY	Lori Chiu

ANTENNA POLARITY & TEST DISTANCE: HORIZONTAL AT 3 M								
NO.	FREQ. (MHz)	EMISSION LEVEL (dBuV/m)	LIMIT (dBuV/m)	MARGIN (dB)	ANTENNA HEIGHT (m)	TABLE ANGLE (Degree)	RAW VALUE (dBuV)	CORRECTION FACTOR (dB/m)
1	1125.00	55.83 PK	74.00	-18.17	1.22 H	15	26.43	29.39
2	1125.00	45.53 AV	54.00	-8.47	1.22 H	15	16.14	29.39
3	*2462.00	105.55 PK			1.13 H	260	73.07	32.48
4	*2462.00	95.74 AV			1.13 H	260	63.26	32.48
5	2483.50	63.13 PK	74.00	-10.87	1.13 H	260	30.57	32.56
6	2483.50	49.00 AV	54.00	-5.00	1.13 H	260	16.44	32.56
7	4924.00	54.54 PK	74.00	-19.46	1.00 H	214	16.08	38.46
8	4924.00	39.60 AV	54.00	-14.40	1.00 H	214	1.14	38.46
ANTENNA POLARITY & TEST DISTANCE: VERTICAL AT 3 M								
NO.	FREQ. (MHz)	EMISSION LEVEL (dBuV/m)	LIMIT (dBuV/m)	MARGIN (dB)	ANTENNA HEIGHT (m)	TABLE ANGLE (Degree)	RAW VALUE (dBuV)	CORRECTION FACTOR (dB/m)
1	1125.00	55.92 PK	74.00	-18.08	1.10 V	189	26.53	29.39
2	1125.00	47.09 AV	54.00	-6.91	1.10 V	189	17.70	29.39
3	*2462.00	110.27 PK			1.09 V	144	77.78	32.48
4	*2462.00	100.14 AV			1.09 V	144	67.65	32.48
5	2483.50	71.18 PK	74.00	-2.82	1.29 V	154	38.62	32.56
6	2483.50	51.52 AV	54.00	-2.48	1.29 V	154	18.96	32.56
7	4924.00	52.33 PK	74.00	-21.67	1.11 V	16	13.87	38.46
8	4924.00	38.14 AV	54.00	-15.86	1.11 V	16	-0.32	38.46

- REMARKS:**
1. Emission level (dBuV/m) = Raw Value (dBuV) + Correction Factor (dB/m).
 2. Correction Factor (dB/m) = Antenna Factor (dB/m) + Cable Factor (dB).
 3. The other emission levels were very low against the limit.
 4. Margin value = Emission level – Limit value.
 5. “ * “: Fundamental frequency.

DRAFT 802.11n (20MHz) OFDM MODULATION

EUT TEST CONDITION		MEASUREMENT DETAIL	
CHANNEL	Channel 1	FREQUENCY RANGE	1 ~ 25GHz
INPUT POWER (SYSTEM)	120Vac, 60 Hz	DETECTOR FUNCTION	Peak (PK) Average (AV)
ENVIRONMENTAL CONDITIONS	25deg. C, 65%RH 993hPa	TESTED BY	Kevin Liang

ANTENNA POLARITY & TEST DISTANCE: HORIZONTAL AT 3 M								
NO.	FREQ. (MHz)	EMISSION LEVEL (dBuV/m)	LIMIT (dBuV/m)	MARGIN (dB)	ANTENNA HEIGHT (m)	TABLE ANGLE (Degree)	RAW VALUE (dBuV)	CORRECTION FACTOR (dB/m)
1	1125.00	55.78 PK	74.00	-18.22	1.36 H	97	26.39	29.39
2	1125.00	45.47 AV	54.00	-8.53	1.36 H	97	16.08	29.39
3	2390.00	67.90 PK	74.00	-6.10	1.42 H	235	35.66	32.24
4	2390.00	50.63 AV	54.00	-3.37	1.42 H	235	18.39	32.24
5	*2412.00	105.19 PK			1.37 H	52	72.87	32.32
6	*2412.00	95.19 AV			1.37 H	52	62.87	32.32
7	4824.00	57.08 PK	74.00	-16.92	1.10 H	175	18.95	38.13
8	4824.00	42.28 AV	54.00	-11.72	1.10 H	175	4.15	38.13
ANTENNA POLARITY & TEST DISTANCE: VERTICAL AT 3 M								
NO.	FREQ. (MHz)	EMISSION LEVEL (dBuV/m)	LIMIT (dBuV/m)	MARGIN (dB)	ANTENNA HEIGHT (m)	TABLE ANGLE (Degree)	RAW VALUE (dBuV)	CORRECTION FACTOR (dB/m)
1	1125.00	56.05 PK	74.00	-17.95	1.13 V	60	26.65	29.39
2	1125.00	47.31 AV	54.00	-6.69	1.13 V	60	17.92	29.39
3	2390.00	69.18 PK	74.00	-4.82	1.17 V	173	36.94	32.24
4	2390.00	52.95 AV	54.00	-1.05	1.17 V	173	20.71	32.24
5	*2412.00	113.38 PK			1.17 V	202	81.06	32.32
6	*2412.00	103.22 AV			1.17 V	202	70.90	32.32
7	4824.00	54.72 PK	74.00	-19.28	1.16 V	36	16.59	38.13
8	4824.00	40.44 AV	54.00	-13.56	1.16 V	36	2.31	38.13

- REMARKS:**
1. Emission level (dBuV/m) = Raw Value (dBuV) + Correction Factor (dB/m).
 2. Correction Factor (dB/m) = Antenna Factor (dB/m) + Cable Factor (dB).
 3. The other emission levels were very low against the limit.
 4. Margin value = Emission level – Limit value.
 5. “ * “: Fundamental frequency.

EUT TEST CONDITION		MEASUREMENT DETAIL	
CHANNEL	Channel 6	FREQUENCY RANGE	1 ~ 25GHz
INPUT POWER (SYSTEM)	120Vac, 60 Hz	DETECTOR FUNCTION	Peak (PK) Average (AV)
ENVIRONMENTAL CONDITIONS	25deg. C, 65%RH 993hPa	TESTED BY	Kevin Liang

ANTENNA POLARITY & TEST DISTANCE: HORIZONTAL AT 3 M								
NO.	FREQ. (MHz)	EMISSION LEVEL (dBuV/m)	LIMIT (dBuV/m)	MARGIN (dB)	ANTENNA HEIGHT (m)	TABLE ANGLE (Degree)	RAW VALUE (dBuV)	CORRECTION FACTOR (dB/m)
1	1125.00	55.93 PK	74.00	-18.07	1.37 H	95	26.54	29.39
2	1125.00	45.61 AV	54.00	-8.39	1.14 H	65	16.21	29.39
3	*2437.00	107.56 PK			1.41 H	243	75.16	32.40
4	*2437.00	97.21 AV			1.41 H	243	64.81	32.40
5	4874.00	55.87 PK	74.00	-18.13	1.33 H	212	17.55	38.32
6	4874.00	40.84 AV	54.00	-13.16	1.33 H	212	2.52	38.32
ANTENNA POLARITY & TEST DISTANCE: VERTICAL AT 3 M								
NO.	FREQ. (MHz)	EMISSION LEVEL (dBuV/m)	LIMIT (dBuV/m)	MARGIN (dB)	ANTENNA HEIGHT (m)	TABLE ANGLE (Degree)	RAW VALUE (dBuV)	CORRECTION FACTOR (dB/m)
1	1125.00	56.19 PK	74.00	-17.81	1.13 V	61	26.79	29.39
2	1125.00	47.22 AV	54.00	-6.78	1.13 V	61	17.82	29.39
3	*2437.00	114.16 PK			1.16 V	197	81.76	32.40
4	*2437.00	103.98 AV			1.16 V	197	71.58	32.40
5	4874.00	55.35 PK	74.00	-18.65	1.13 V	214	17.03	38.32
6	4874.00	40.09 AV	54.00	-13.91	1.13 V	214	1.77	38.32

- REMARKS:**
1. Emission level (dBuV/m) = Raw Value (dBuV) + Correction Factor (dB/m).
 2. Correction Factor (dB/m) = Antenna Factor (dB/m) + Cable Factor (dB).
 3. The other emission levels were very low against the limit.
 4. Margin value = Emission level – Limit value.
 5. “ * ”: Fundamental frequency.

EUT TEST CONDITION		MEASUREMENT DETAIL	
CHANNEL	Channel 11	FREQUENCY RANGE	1 ~ 25GHz
INPUT POWER (SYSTEM)	120Vac, 60 Hz	DETECTOR FUNCTION	Peak (PK) Average (AV)
ENVIRONMENTAL CONDITIONS	25deg. C, 65%RH 993hPa	TESTED BY	Kevin Liang

ANTENNA POLARITY & TEST DISTANCE: HORIZONTAL AT 3 M								
NO.	FREQ. (MHz)	EMISSION LEVEL (dBuV/m)	LIMIT (dBuV/m)	MARGIN (dB)	ANTENNA HEIGHT (m)	TABLE ANGLE (Degree)	RAW VALUE (dBuV)	CORRECTION FACTOR (dB/m)
1	1125.00	54.50 PK	74.00	-19.50	1.32 H	136	25.11	29.39
2	1125.00	44.66 AV	54.00	-9.34	1.32 H	136	15.26	29.39
3	*2462.00	103.96 PK			1.30 H	193	71.48	32.48
4	*2462.00	94.62 AV			1.30 H	193	62.14	32.48
5	2483.50	65.52 PK	74.00	-8.48	1.30 H	193	32.96	32.56
6	2483.50	48.22 AV	54.00	-5.78	1.30 H	193	15.66	32.56
7	4924.00	56.33 PK	74.00	-17.67	1.08 H	177	17.87	38.46
8	4924.00	41.04 AV	54.00	-12.96	1.08 H	177	2.58	38.46

ANTENNA POLARITY & TEST DISTANCE: VERTICAL AT 3 M								
NO.	FREQ. (MHz)	EMISSION LEVEL (dBuV/m)	LIMIT (dBuV/m)	MARGIN (dB)	ANTENNA HEIGHT (m)	TABLE ANGLE (Degree)	RAW VALUE (dBuV)	CORRECTION FACTOR (dB/m)
1	1125.00	55.92 PK	74.00	-18.08	1.14 V	62	26.53	29.39
2	1125.00	47.25 AV	54.00	-6.75	1.14 V	62	17.85	29.39
3	*2462.00	112.19 PK			1.13 V	197	79.71	32.48
4	*2462.00	102.13 AV			1.13 V	197	69.65	32.48
5	2483.50	72.92 PK	74.00	-1.08	1.13 V	197	40.36	32.56
6	2483.50	52.08 AV	54.00	-1.92	1.13 V	197	19.52	32.56
7	4924.00	54.07 PK	74.00	-19.93	1.18 V	42	15.61	38.46
8	4924.00	40.03 AV	54.00	-13.97	1.18 V	42	1.57	38.46

- REMARKS:**
1. Emission level (dBuV/m) = Raw Value (dBuV) + Correction Factor (dB/m).
 2. Correction Factor (dB/m) = Antenna Factor (dB/m) + Cable Factor (dB).
 3. The other emission levels were very low against the limit.
 4. Margin value = Emission level – Limit value.
 5. “ * “: Fundamental frequency.

DRAFT 802.11n (40MHz) OFDM MODULATION

EUT TEST CONDITION		MEASUREMENT DETAIL	
CHANNEL	Channel 1	FREQUENCY RANGE	1 ~ 25GHz
INPUT POWER (SYSTEM)	120Vac, 60 Hz	DETECTOR FUNCTION	Peak (PK) Average (AV)
ENVIRONMENTAL CONDITIONS	24deg. C, 68%RH 993hPa	TESTED BY	Lori Chiu

ANTENNA POLARITY & TEST DISTANCE: HORIZONTAL AT 3 M								
NO.	FREQ. (MHz)	EMISSION LEVEL (dBuV/m)	LIMIT (dBuV/m)	MARGIN (dB)	ANTENNA HEIGHT (m)	TABLE ANGLE (Degree)	RAW VALUE (dBuV)	CORRECTION FACTOR (dB/m)
1	1125.00	56.02 PK	74.00	-17.98	1.24 H	227	26.63	29.39
2	1125.00	45.86 AV	54.00	-8.14	1.24 H	227	16.46	29.39
3	2390.00	61.99 PK	74.00	-12.01	1.00 H	164	29.75	32.24
4	2390.00	49.33 AV	54.00	-4.67	1.00 H	164	17.09	32.24
5	*2422.00	101.12 PK			1.00 H	162	68.77	32.35
6	*2422.00	90.61 AV			1.00 H	162	58.26	32.35
7	4844.00	48.11 PK	74.00	-25.89	1.02 H	334	9.91	38.21
8	4844.00	34.93 AV	54.00	-19.07	1.02 H	334	-3.27	38.21
ANTENNA POLARITY & TEST DISTANCE: VERTICAL AT 3 M								
NO.	FREQ. (MHz)	EMISSION LEVEL (dBuV/m)	LIMIT (dBuV/m)	MARGIN (dB)	ANTENNA HEIGHT (m)	TABLE ANGLE (Degree)	RAW VALUE (dBuV)	CORRECTION FACTOR (dB/m)
1	1125.00	56.19 PK	74.00	-17.81	1.00 V	88	26.79	29.39
2	1125.00	47.62 AV	54.00	-6.38	1.00 V	88	18.22	29.39
3	2390.00	66.96 PK	74.00	-7.04	1.06 V	125	34.72	32.24
4	2390.00	52.95 AV	54.00	-1.05	1.06 V	125	20.71	32.24
5	*2422.00	105.18 PK			1.05 V	124	72.83	32.35
6	*2422.00	94.79 AV			1.05 V	124	62.44	32.35
7	4844.00	47.50 PK	74.00	-26.50	1.00 V	130	9.30	38.21
8	4844.00	34.45 AV	54.00	-19.55	1.00 V	130	-3.75	38.21

- REMARKS:**
1. Emission level (dBuV/m) = Raw Value (dBuV) + Correction Factor (dB/m).
 2. Correction Factor (dB/m) = Antenna Factor (dB/m) + Cable Factor (dB).
 3. The other emission levels were very low against the limit.
 4. Margin value = Emission level – Limit value.
 5. “ * “: Fundamental frequency.

EUT TEST CONDITION		MEASUREMENT DETAIL	
CHANNEL	Channel 4	FREQUENCY RANGE	1 ~ 25GHz
INPUT POWER (SYSTEM)	120Vac, 60 Hz	DETECTOR FUNCTION	Peak (PK) Average (AV)
ENVIRONMENTAL CONDITIONS	24deg. C, 68%RH 993hPa	TESTED BY	Lori Chiu

ANTENNA POLARITY & TEST DISTANCE: HORIZONTAL AT 3 M								
NO.	FREQ. (MHz)	EMISSION LEVEL (dBuV/m)	LIMIT (dBuV/m)	MARGIN (dB)	ANTENNA HEIGHT (m)	TABLE ANGLE (Degree)	RAW VALUE (dBuV)	CORRECTION FACTOR (dB/m)
1	1125.00	55.86 PK	74.00	-18.14	1.26 H	225	26.46	29.39
2	1125.00	45.61 AV	54.00	-8.39	1.26 H	225	16.21	29.39
3	2390.00	60.25 PK	74.00	-13.75	1.39 H	241	28.01	32.24
4	2390.00	47.39 AV	54.00	-6.61	1.39 H	241	15.15	32.24
5	*2437.00	102.04 PK			1.44 H	19	69.64	32.40
6	*2437.00	92.27 AV			1.44 H	19	59.87	32.40
7	2483.50	57.32 PK	74.00	-16.68	1.38 H	242	24.76	32.56
8	2483.50	46.52 AV	54.00	-7.48	1.38 H	242	13.96	32.56
9	4874.00	50.04 PK	74.00	-23.96	1.13 H	57	11.72	38.32
10	4874.00	37.82 AV	54.00	-16.18	1.13 H	57	-0.50	38.32

ANTENNA POLARITY & TEST DISTANCE: VERTICAL AT 3 M								
NO.	FREQ. (MHz)	EMISSION LEVEL (dBuV/m)	LIMIT (dBuV/m)	MARGIN (dB)	ANTENNA HEIGHT (m)	TABLE ANGLE (Degree)	RAW VALUE (dBuV)	CORRECTION FACTOR (dB/m)
1	1125.00	55.81 PK	74.00	-18.19	1.03 V	93	26.42	29.39
2	1125.00	47.09 AV	54.00	-6.91	1.03 V	93	17.70	29.39
3	2390.00	64.18 PK	74.00	-9.82	1.16 V	140	31.94	32.24
4	2390.00	49.45 AV	54.00	-4.55	1.16 V	140	17.21	32.24
5	*2437.00	109.28 PK			1.16 V	140	76.88	32.40
6	*2437.00	99.59 AV			1.16 V	140	67.19	32.40
7	2483.50	65.32 PK	74.00	-8.68	1.16 V	140	32.76	32.56
8	2483.50	50.75 AV	54.00	-3.25	1.16 V	140	18.19	32.56
9	4874.00	50.12 PK	74.00	-23.88	1.03 V	135	11.80	38.32
10	4874.00	37.30 AV	54.00	-16.70	1.03 V	135	-1.02	38.32

- REMARKS:**
1. Emission level (dBuV/m) = Raw Value (dBuV) + Correction Factor (dB/m).
 2. Correction Factor (dB/m) = Antenna Factor (dB/m) + Cable Factor (dB).
 3. The other emission levels were very low against the limit.
 4. Margin value = Emission level – Limit value.
 5. “ * ”: Fundamental frequency.

EUT TEST CONDITION		MEASUREMENT DETAIL	
CHANNEL	Channel 7	FREQUENCY RANGE	1 ~ 25GHz
INPUT POWER (SYSTEM)	120Vac, 60 Hz	DETECTOR FUNCTION	Peak (PK) Average (AV)
ENVIRONMENTAL CONDITIONS	24deg. C, 68%RH 993hPa	TESTED BY	Lori Chiu

ANTENNA POLARITY & TEST DISTANCE: HORIZONTAL AT 3 M								
NO.	FREQ. (MHz)	EMISSION LEVEL (dBuV/m)	LIMIT (dBuV/m)	MARGIN (dB)	ANTENNA HEIGHT (m)	TABLE ANGLE (Degree)	RAW VALUE (dBuV)	CORRECTION FACTOR (dB/m)
1	1125.00	55.76 PK	74.00	-18.24	1.06 H	200	26.36	29.39
2	1125.00	45.51 AV	54.00	-8.49	1.06 H	200	16.11	29.39
3	*2452.00	100.48 PK			1.00 H	167	68.03	32.45
4	*2452.00	89.73 AV			1.00 H	167	57.28	32.45
5	2483.50	64.15 PK	74.00	-9.85	1.00 H	207	31.59	32.56
6	2483.50	48.59 AV	54.00	-5.41	1.00 H	207	16.03	32.56
7	4904.00	47.77 PK	74.00	-26.23	1.01 H	123	9.34	38.43
8	4904.00	34.56 AV	54.00	-19.44	1.01 H	123	-3.87	38.43
ANTENNA POLARITY & TEST DISTANCE: VERTICAL AT 3 M								
NO.	FREQ. (MHz)	EMISSION LEVEL (dBuV/m)	LIMIT (dBuV/m)	MARGIN (dB)	ANTENNA HEIGHT (m)	TABLE ANGLE (Degree)	RAW VALUE (dBuV)	CORRECTION FACTOR (dB/m)
1	1125.00	55.91 PK	74.00	-18.09	1.00 V	68	26.51	29.39
2	1125.00	47.19 AV	54.00	-6.81	1.00 V	68	17.79	29.39
3	*2452.00	104.28 PK			1.02 V	126	71.83	32.45
4	*2452.00	93.71 AV			1.02 V	126	61.26	32.45
5	2483.50	69.06 PK	74.00	-4.94	1.02 V	132	36.50	32.56
6	2483.50	52.89 AV	54.00	-1.11	1.02 V	132	20.33	32.56
7	4904.00	48.30 PK	74.00	-25.70	1.04 V	25	9.87	38.43
8	4904.00	35.05 AV	54.00	-18.95	1.04 V	25	-3.38	38.43

- REMARKS:**
1. Emission level (dBuV/m) = Raw Value (dBuV) + Correction Factor (dB/m).
 2. Correction Factor (dB/m) = Antenna Factor (dB/m) + Cable Factor (dB).
 3. The other emission levels were very low against the limit.
 4. Margin value = Emission level – Limit value.
 5. “ * “: Fundamental frequency.

BELOW 1GHz WORST-CASE DATA : DRAFT 802.11n (20MHz) OFDM MODULATION

EUT TEST CONDITION		MEASUREMENT DETAIL	
CHANNEL	Channel 6	FREQUENCY RANGE	Below 1000MHz
INPUT POWER (SYSTEM)	120Vac, 60 Hz	DETECTOR FUNCTION	Quasi-Peak
ENVIRONMENTAL CONDITIONS	26deg. C, 70%RH 993hPa	TESTED BY	Lori Chiu

ANTENNA POLARITY & TEST DISTANCE: HORIZONTAL AT 3 M								
NO.	FREQ. (MHz)	EMISSION LEVEL (dBuV/m)	LIMIT (dBuV/m)	MARGIN (dB)	ANTENNA HEIGHT (m)	TABLE ANGLE (Degree)	RAW VALUE (dBuV)	CORRECTION FACTOR (dB/m)
1	125.17	38.37 QP	43.50	-5.13	1.50 H	67	26.42	11.94
2	156.28	33.79 QP	43.50	-9.71	1.50 H	178	20.05	13.74
3	249.60	41.37 QP	46.00	-4.63	1.00 H	184	28.60	12.76
4	374.04	37.78 QP	46.00	-8.22	1.25 H	22	22.41	15.37
5	624.85	40.09 QP	46.00	-5.91	1.25 H	154	18.35	21.75
6	667.63	43.33 QP	46.00	-2.67	1.50 H	82	21.16	22.16
7	799.84	38.62 QP	46.00	-7.38	1.00 H	238	13.69	24.92
8	875.67	42.44 QP	46.00	-3.56	1.00 H	187	16.82	25.62
ANTENNA POLARITY & TEST DISTANCE: VERTICAL AT 3 M								
NO.	FREQ. (MHz)	EMISSION LEVEL (dBuV/m)	LIMIT (dBuV/m)	MARGIN (dB)	ANTENNA HEIGHT (m)	TABLE ANGLE (Degree)	RAW VALUE (dBuV)	CORRECTION FACTOR (dB/m)
1	62.95	34.22 QP	40.00	-5.78	1.00 V	10	21.41	12.81
2	125.01	42.65 QP	43.50	-0.85	1.03 V	161	30.71	11.94
3	249.60	38.48 QP	46.00	-7.52	1.00 V	181	25.72	12.76
4	374.04	38.87 QP	46.00	-7.13	1.50 V	142	23.50	15.37
5	500.42	37.66 QP	46.00	-8.34	1.00 V	214	18.55	19.12
6	624.85	38.47 QP	46.00	-7.53	1.00 V	166	16.72	21.75
7	799.84	39.07 QP	46.00	-6.93	1.25 V	220	14.15	24.92
8	875.67	42.72 QP	46.00	-3.28	1.00 V	229	17.10	25.62
9	908.72	43.27 QP	46.00	-2.73	2.00 V	217	17.34	25.93

- REMARKS:**
1. Emission level (dBuV/m) = Raw Value (dBuV) + Correction Factor (dB/m).
 2. Correction Factor (dB/m) = Antenna Factor (dB/m) + Cable Factor (dB).
 3. The other emission levels were very low against the limit.
 4. Margin value = Emission level – Limit value.

4.2 CONDUCTED EMISSION MEASUREMENT

4.2.1 LIMITS OF CONDUCTED EMISSION MEASUREMENT

FREQUENCY OF EMISSION (MHz)	CONDUCTED LIMIT (dB μ V)	
	Quasi-peak	Average
0.15-0.5	66 to 56	56 to 46
0.5-5	56	46
5-30	60	50

- NOTE:**
1. The lower limit shall apply at the transition frequencies.
 2. The limit decreases in line with the logarithm of the frequency in the range of 0.15 to 0.50 MHz.
 3. All emanations from a class A/B digital device or system, including any network of conductors and apparatus connected thereto, shall not exceed the level of field strengths specified above.

4.2.2 TEST INSTRUMENTS

DESCRIPTION & MANUFACTURER	MODEL NO.	SERIAL NO.	CALIBRATED UNTIL
Test Receiver ROHDE & SCHWARZ	ESCS30	100288	Sep. 21, 2008
RF signal cable Woken	5D-FB	Cable-HYCO3-01	Jan. 06, 2009
LISN ROHDE & SCHWARZ	ESH2-Z5	100100	Jan. 09, 2009
LISN SCHWARZBECK	ESH3-Z5	100311	Jan. 21, 2009
Software ADT	ADT_Cond_V3	NA	NA

- NOTE:**
1. The calibration interval of the above test instruments is 12 months and the calibrations are traceable to NML/ROC and NIST/USA.
 2. The test was performed in HwaYa Shielded Room 2.
 3. The VCCI Site Registration No. is C-2047.

4.2.3 TEST PROCEDURES

- a. The EUT was placed 0.4 meters from the conducting wall of the shielded room with EUT being connected to the power mains through a line impedance stabilization network (LISN). Other support units were connected to the power mains through another LISN. The two LISNs provide 50 ohm/ 50uH of coupling impedance for the measuring instrument.
- b. Both lines of the power mains connected to the EUT were checked for maximum conducted interference.
- c. The frequency range from 150kHz to 30MHz was searched. Emission levels under (Limit - 20dB) was not recorded.

4.2.4 DEVIATION FROM TEST STANDARD

No deviation

4.2.5 TEST SETUP

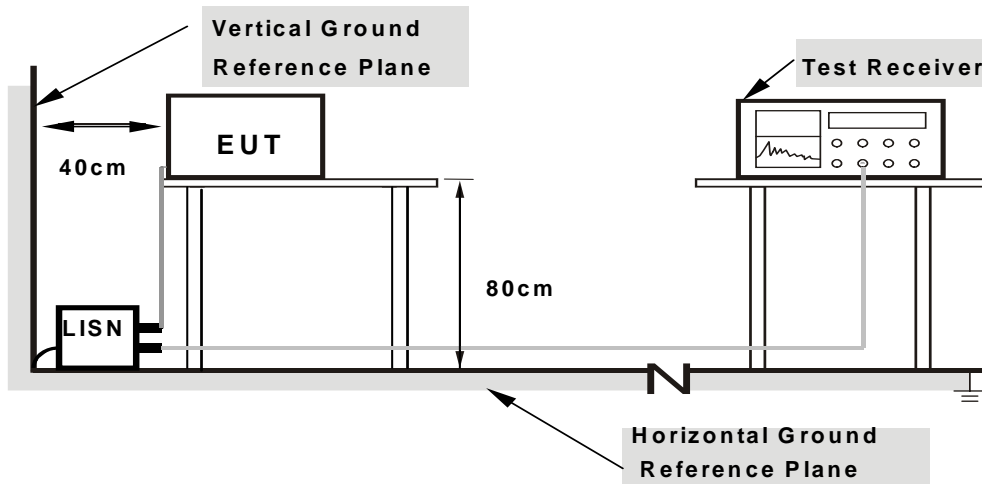

- Note:**
1. Support units were connected to second LISN.
 2. Both of LISNs (AMN) are 80 cm from EUT and at least 80 cm from other units and other metal planes

For the actual test configuration, please refer to the attached file (Test Setup Photo).

4.2.6 EUT OPERATING CONDITIONS

Same as 4.1.6

4.2.7 TEST RESULTS

CONDUCTED WORST-CASE DATA: 802.11n (20MHz) OFDM MODULATION

EUT TEST CONDITION		MEASUREMENT DETAIL	
CHANNEL	Channel 6	PHASE	Line 1
MODULATION TYPE	BPSK	6dB BANDWIDTH	9 kHz
TRANSFER RATE	7.2Mbps	INPUT POWER (SYSTEM)	120Vac, 60 Hz
ENVIRONMENTAL CONDITIONS	20deg. C, 60%RH, 991hPa	TESTED BY	Match Tsui

No	Freq.	Corr. Factor	Reading Value		Emission Level		Limit		Margin	
			[dB (uV)]	[dB (uV)]	[dB (uV)]	[dB (uV)]	[dB (uV)]	[dB (uV)]		
	[MHz]	(dB)	Q.P.	AV.	Q.P.	AV.	Q.P.	AV.	Q.P.	AV.
1	0.185	0.13	45.81	-	45.94	-	64.25	54.25	-18.31	-
2	0.377	0.14	37.75	-	37.89	-	58.35	48.35	-20.47	-
3	0.498	0.14	34.68	-	34.82	-	56.04	46.04	-21.21	-
4	0.873	0.16	33.42	-	33.58	-	56.00	46.00	-22.42	-
5	2.309	0.29	36.95	-	37.24	-	56.00	46.00	-18.76	-
6	6.590	0.52	34.71	-	35.23	-	60.00	50.00	-24.77	-

- REMARKS:**
1. Q.P. and AV. are abbreviations of quasi-peak and average individually.
 2. "-": The Quasi-peak reading value also meets average limit and measurement with the average detector is unnecessary.
 3. The emission levels of other frequencies were very low against the limit.
 4. Margin value = Emission level - Limit value
 5. Correction factor = Insertion loss + Cable loss
 6. Emission Level = Correction Factor + Reading Value.

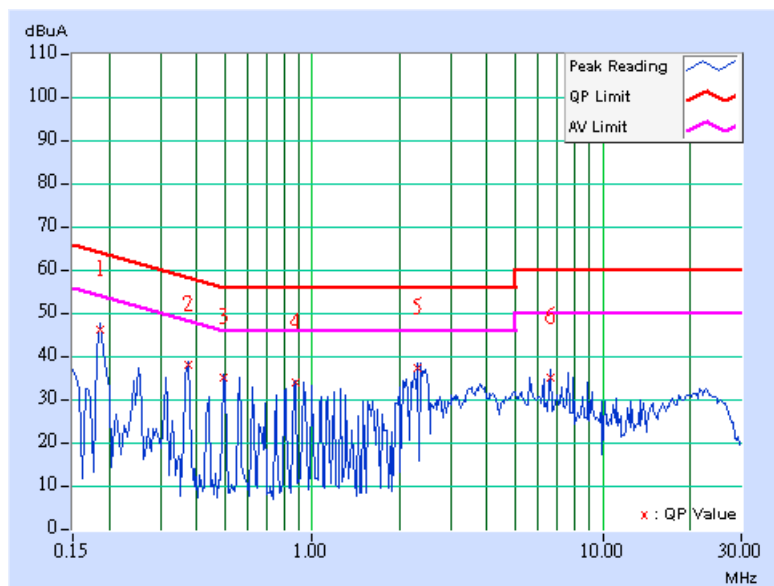

EUT TEST CONDITION		MEASUREMENT DETAIL	
CHANNEL	Channel 6	PHASE	Line 2
MODULATION TYPE	BPSK	6dB BANDWIDTH	9 kHz
TRANSFER RATE	7.2Mbps	INPUT POWER (SYSTEM)	120Vac, 60 Hz
ENVIRONMENTAL CONDITIONS	20deg. C, 60%RH, 991hPa	TESTED BY	Match Tsui

No	Freq. [MHz]	Corr. Factor (dB)	Reading Value [dB (uV)]		Emission Level [dB (uV)]		Limit [dB (uV)]		Margin (dB)	
			Q.P.	AV.	Q.P.	AV.	Q.P.	AV.	Q.P.	AV.
1	0.185	0.14	45.37	-	45.51	-	64.25	54.25	-18.74	-
2	0.252	0.14	37.93	-	38.07	-	61.71	51.71	-23.63	-
3	0.435	0.15	34.65	-	34.80	-	57.15	47.15	-22.35	-
4	1.313	0.21	32.41	-	32.62	-	56.00	46.00	-23.38	-
5	2.371	0.29	36.25	-	36.54	-	56.00	46.00	-19.46	-
6	6.258	0.48	33.75	-	34.23	-	60.00	50.00	-25.77	-

- REMARKS:**
1. Q.P. and AV. are abbreviations of quasi-peak and average individually.
 2. "-": The Quasi-peak reading value also meets average limit and measurement with the average detector is unnecessary.
 3. The emission levels of other frequencies were very low against the limit.
 4. Margin value = Emission level - Limit value
 5. Correction factor = Insertion loss + Cable loss
 6. Emission Level = Correction Factor + Reading Value.

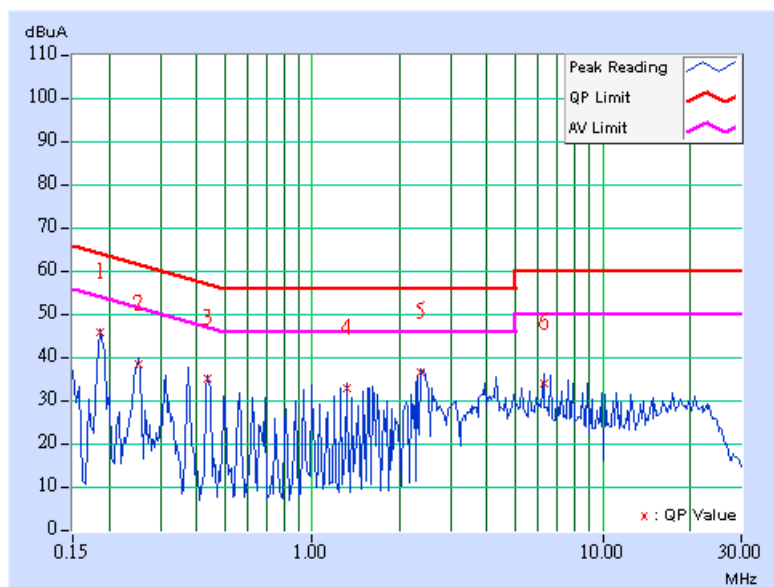



4.3 6dB BANDWIDTH MEASUREMENT

4.3.1 LIMITS OF 6dB BANDWIDTH MEASUREMENT

The minimum of 6dB Bandwidth Measurement is 0.5 MHz.

4.3.2 TEST INSTRUMENTS

DESCRIPTION & MANUFACTURER	MODEL NO.	SERIAL NO.	CALIBRATED UNTIL
SPECTRUM ANALYZER	FSP 40	100040	Jun. 28, 2008

NOTE: The calibration interval of the above test instruments is 12 months and the calibrations are traceable to NML/ROC and NIST/USA.

4.3.3 TEST PROCEDURE

The transmitter output was connected to the spectrum analyzer through an attenuator. The bandwidth of the fundamental frequency was measured by spectrum analyzer with 100kHz RBW and 100kHz VBW. The 6dB bandwidth is defined as the total spectrum the power of which is higher than peak power minus 6dB.

4.3.4 DEVIATION FROM TEST STANDARD

No deviation

4.3.5 TEST SETUP

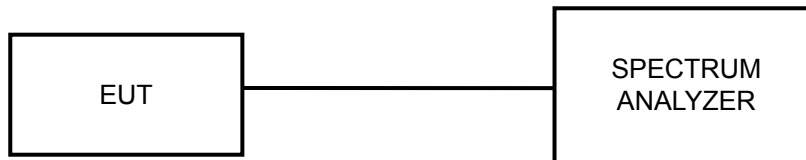

4.3.6 EUT OPERATING CONDITIONS

The software provided by client to enable the EUT under transmission condition continuously at lowest, middle and highest channel frequencies individually.

4.3.7 TEST RESULTS

802.11b DSSS MODULATION

MODULATION TYPE	DBPSK	TRANSFER RATE	1.0Mbps
INPUT POWER (SYSTEM)	120Vac, 60 Hz	ENVIRONMENTAL CONDITIONS	24deg.C, 64%RH, 991hPa
TESTED BY	Match Tsui		

CHANNEL	CHANNEL FREQUENCY (MHz)	6dB BANDWIDTH (MHz)	MINIMUM LIMIT (MHz)	PASS / FAIL
1	2412	12.17	0.5	PASS
6	2437	12.17	0.5	PASS
11	2462	12.29	0.5	PASS

CH 1

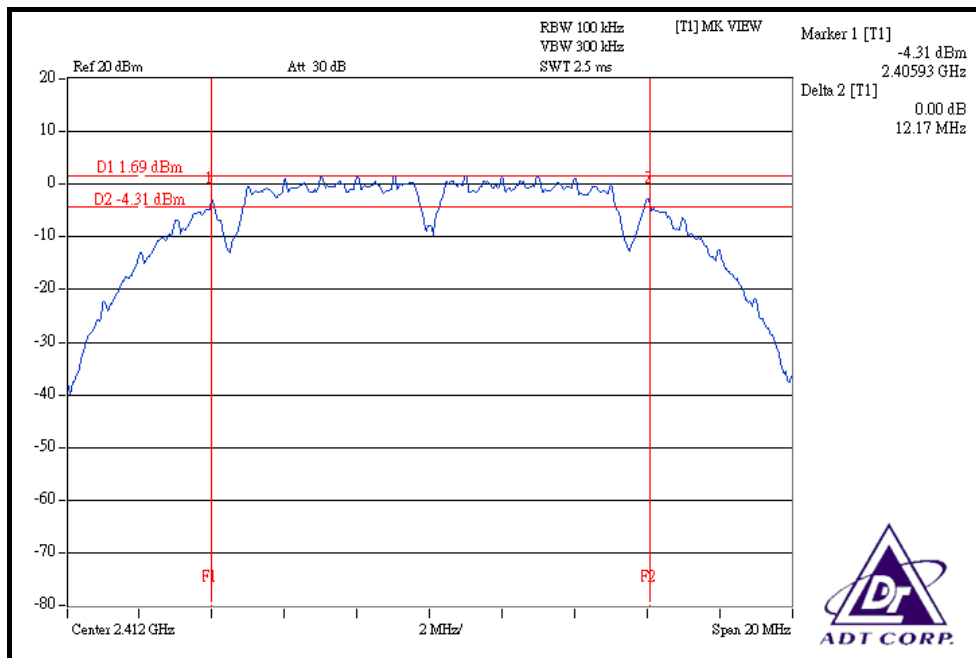

CH 6

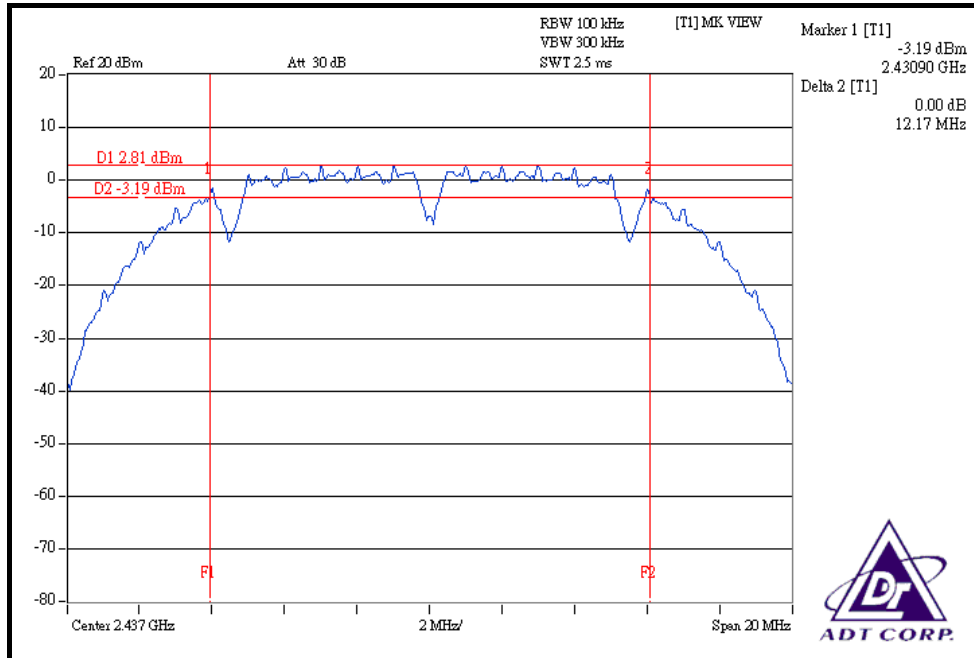

CH 11

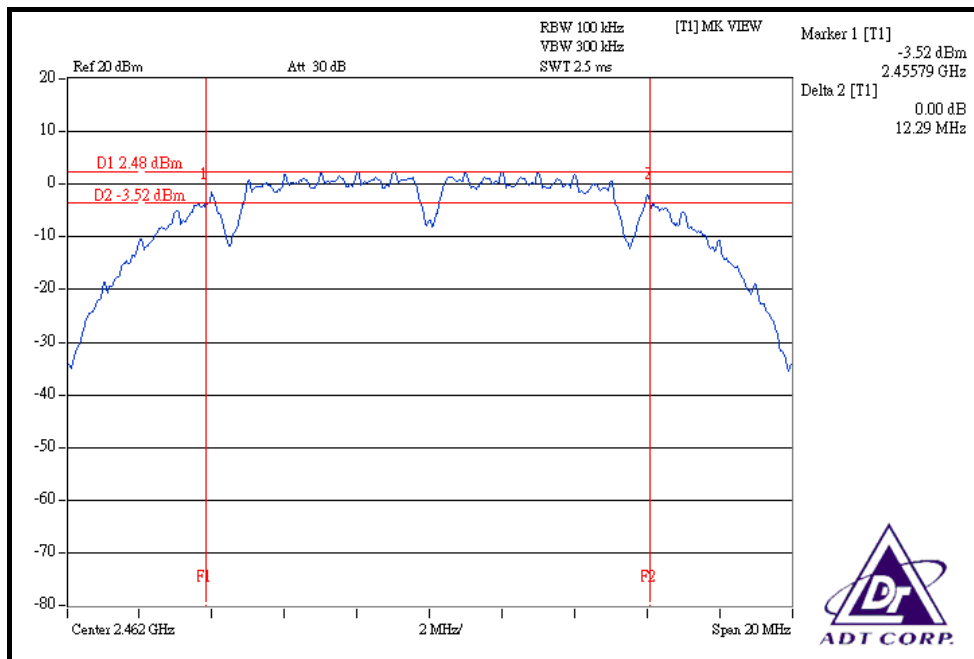

802.11g OFDM MODULATION

MODULATION TYPE	BPSK	TRANSFER RATE	6.0Mbps
INPUT POWER (SYSTEM)	120Vac, 60 Hz	ENVIRONMENTAL CONDITIONS	24deg.C, 64%RH, 991hPa
TESTED BY	Match Tsui		

CHANNEL	CHANNEL FREQUENCY (MHz)	6dB BANDWIDTH (MHz)	MINIMUM LIMIT (MHz)	PASS / FAIL
1	2412	16.62	0.5	PASS
6	2437	16.61	0.5	PASS
11	2462	16.63	0.5	PASS

CH 1

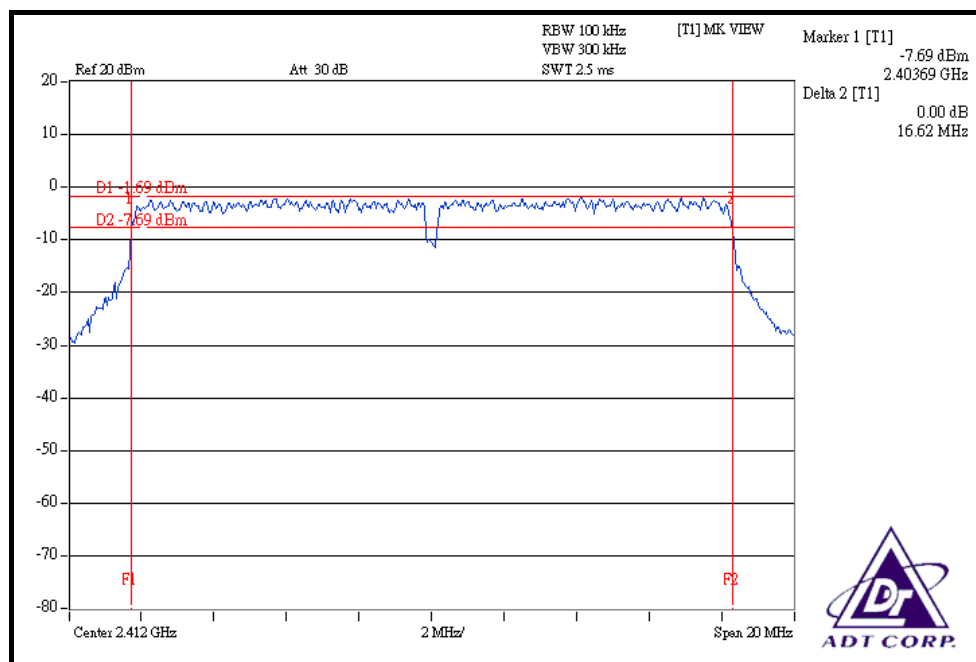

CH 6

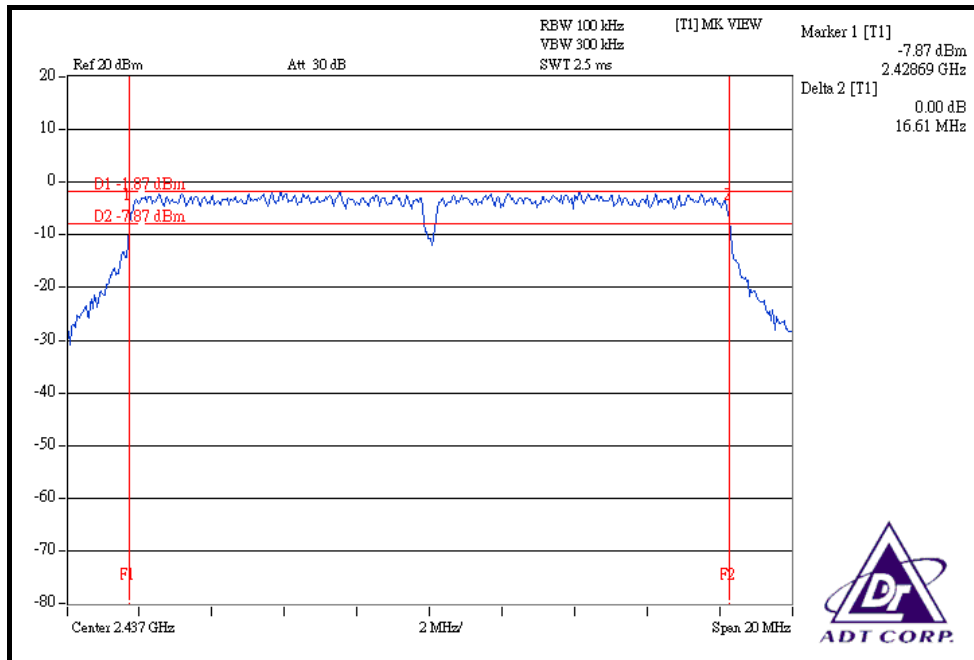

CH 11

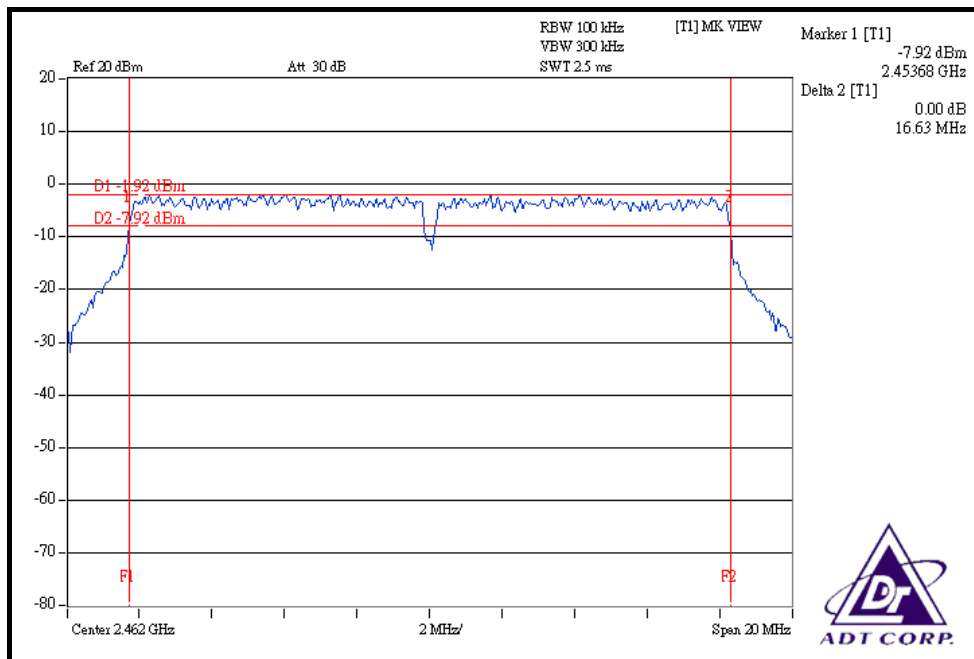

DRAFT 802.11n (20MHz) OFDM MODULATION

MODULATION TYPE	BPSK	TRANSFER RATE	7.2Mbps
INPUT POWER (SYSTEM)	120Vac, 60 Hz	ENVIRONMENTAL CONDITIONS	24deg.C, 64%RH, 991hPa
TESTED BY	Match Tsui		

CHANNEL	CHANNEL FREQUENCY (MHz)	6dB BANDWIDTH (MHz)		MINIMUM LIMIT (MHz)	PASS / FAIL
		CHAIN 0	CHAIN 1		
1	2412	17.73	17.74	0.5	PASS
6	2437	17.72	17.71	0.5	PASS
11	2462	17.75	17.75	0.5	PASS

FOR CHAIN 0: CH 1

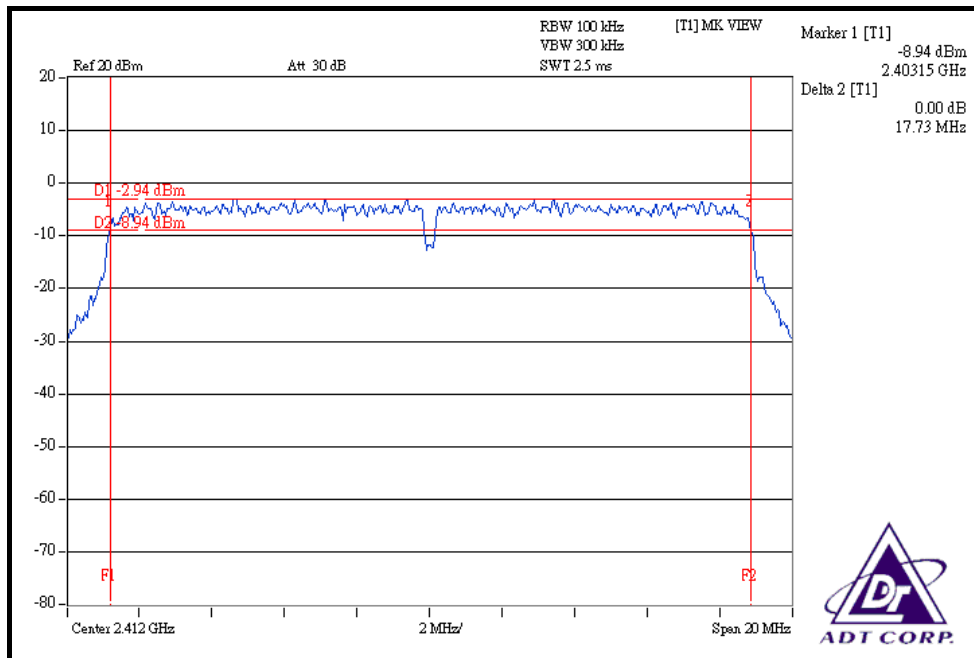

CH 6

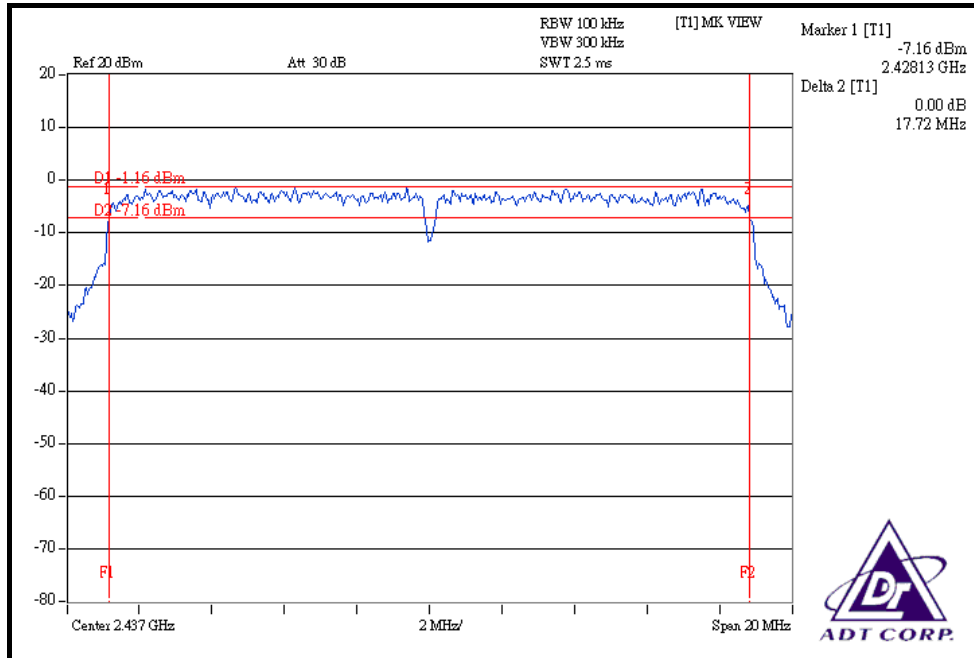

CH 11

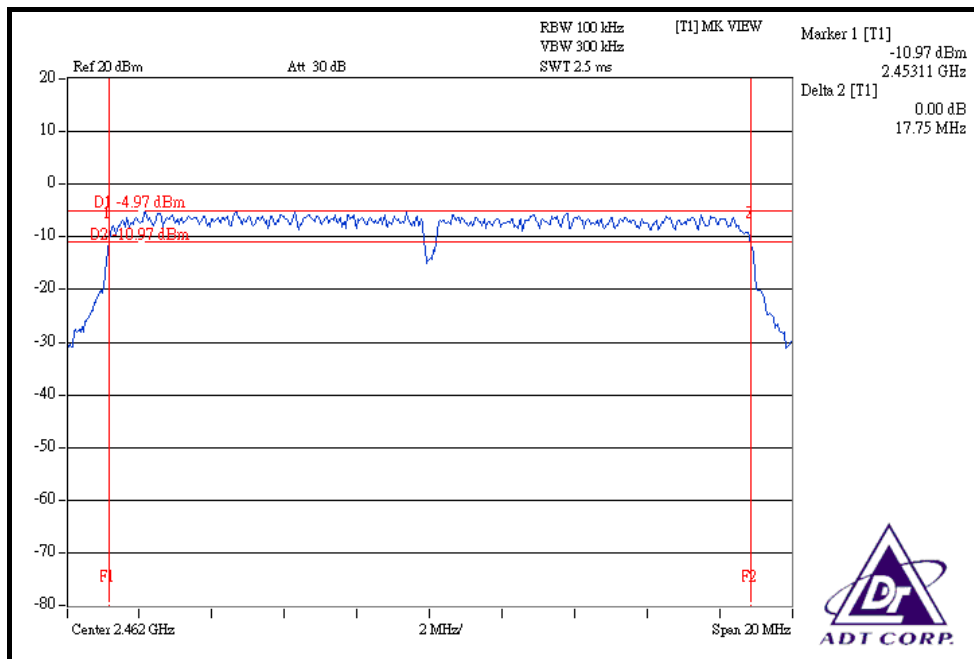

FOR CHAIN 1: CH 1

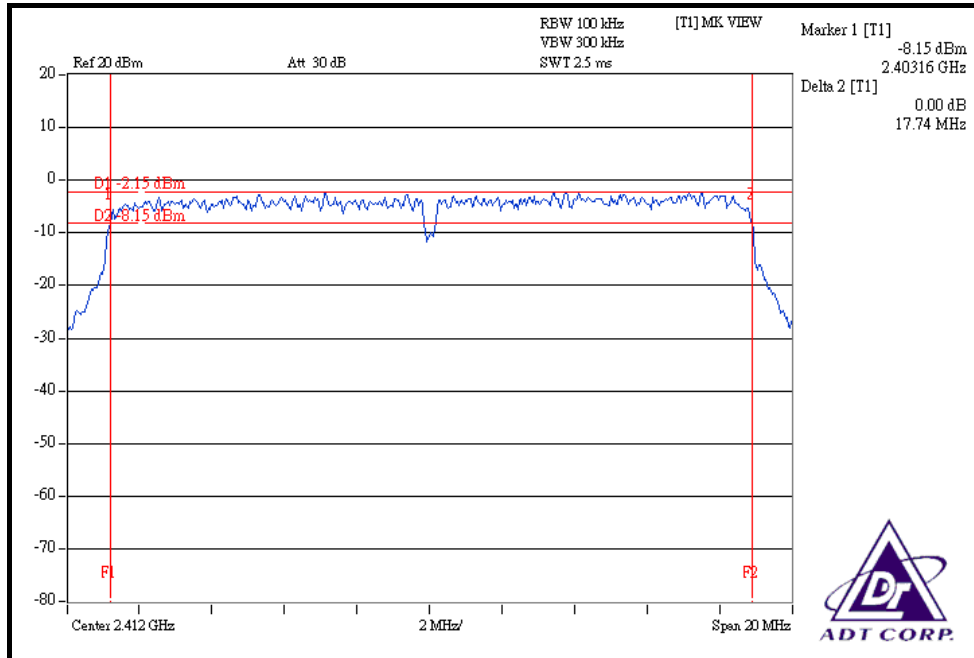

CH 6

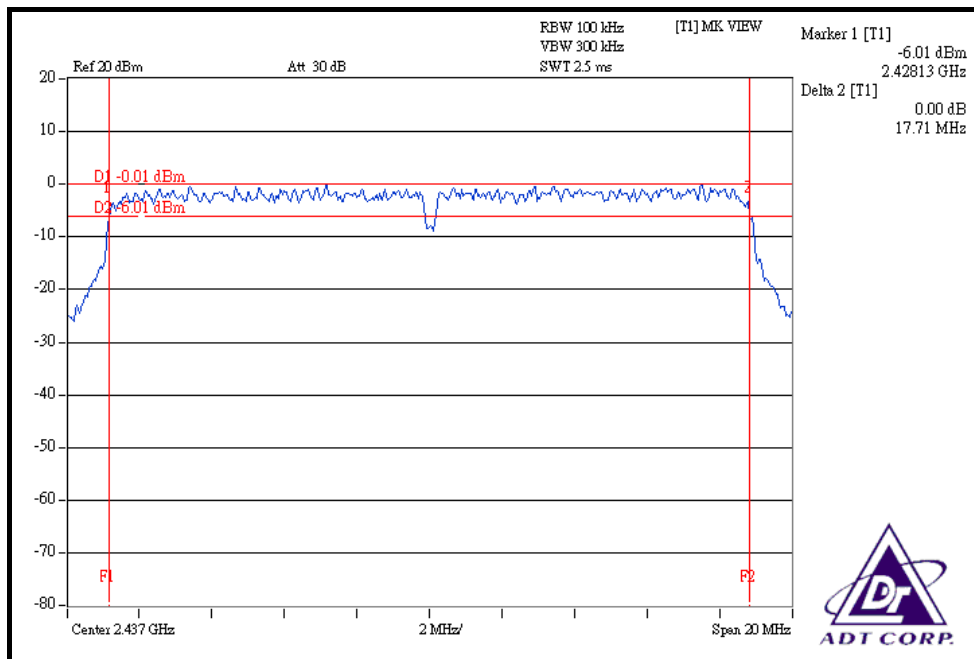

CH 11

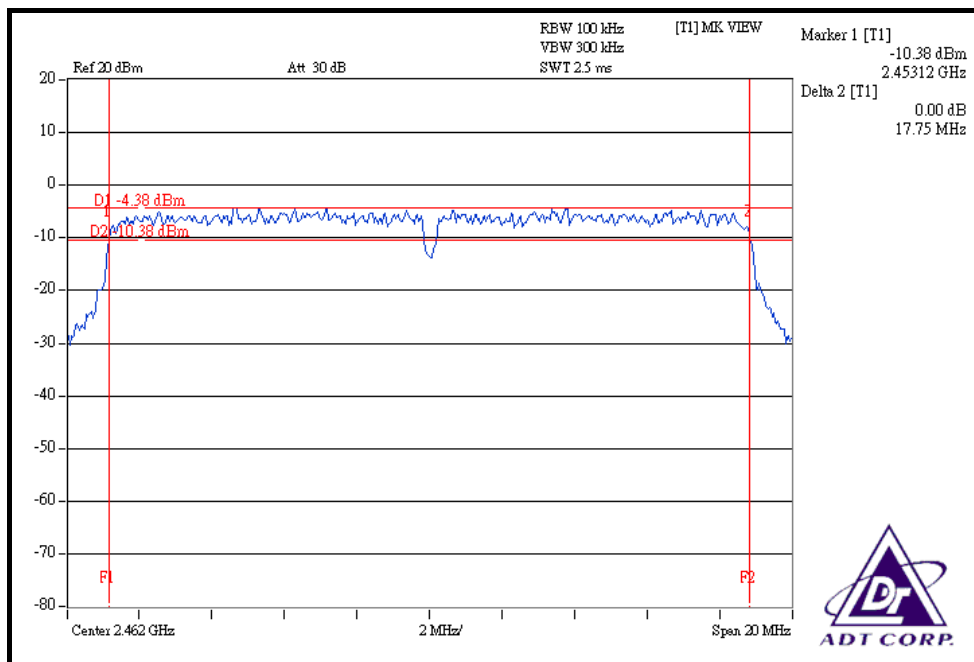



DRAFT 802.11n (40MHz) OFDM MODULATION

MODULATION TYPE	BPSK	TRANSFER RATE	15.0Mbps
INPUT POWER (SYSTEM)	120Vac, 60 Hz	ENVIRONMENTAL CONDITIONS	25deg.C, 65%RH, 991hPa
TESTED BY	Match Tsui		

CHANNEL	CHANNEL FREQUENCY (MHz)	6dB BANDWIDTH (MHz)		MINIMUM LIMIT (MHz)	PASS / FAIL
		CHAIN 0	CHAIN 1		
1	2422	36.42	36.46	0.5	PASS
4	2437	36.50	36.50	0.5	PASS
7	2452	36.52	36.54	0.5	PASS

FOR CHAIN 0: CH 1

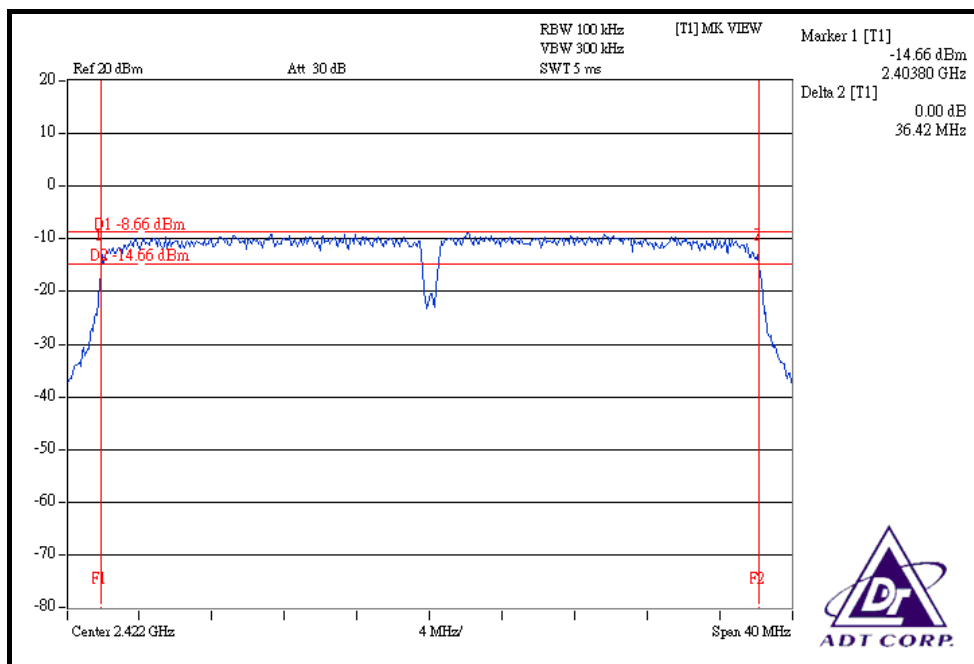

CH 4

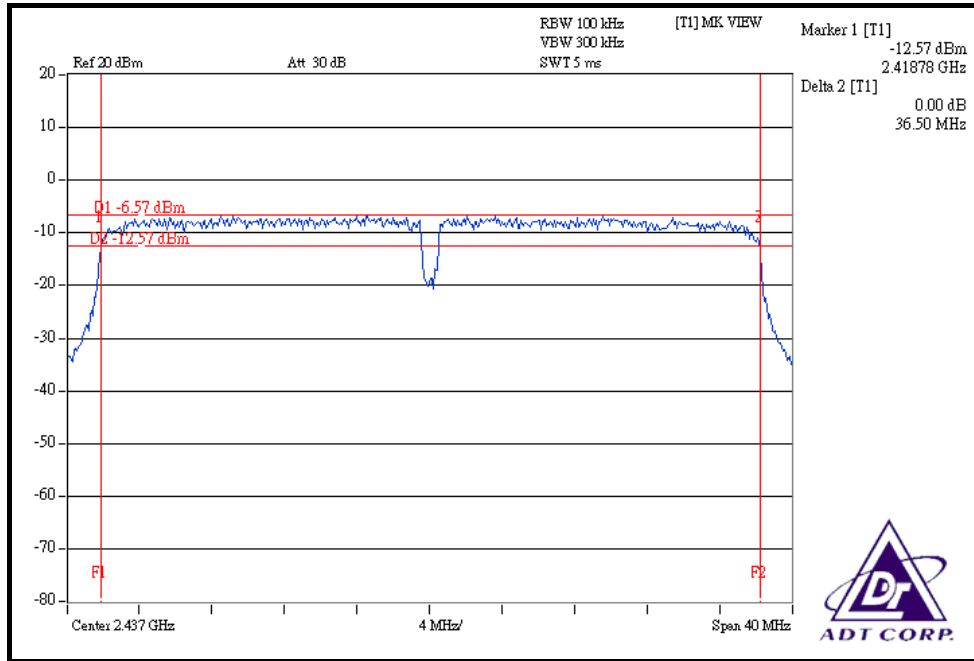

CH 7

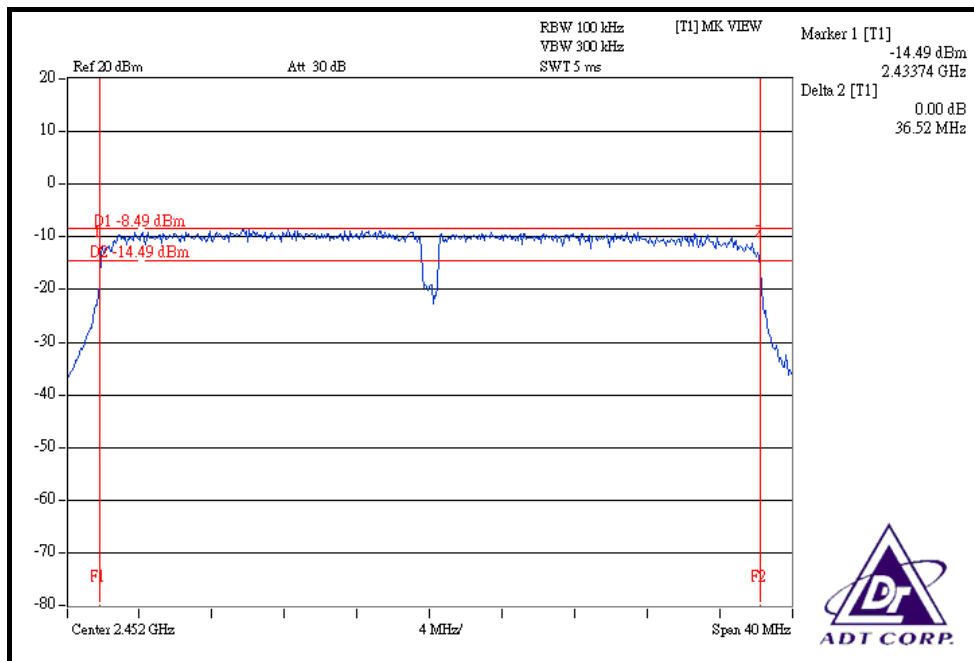

FOR CHAIN 1: CH 1

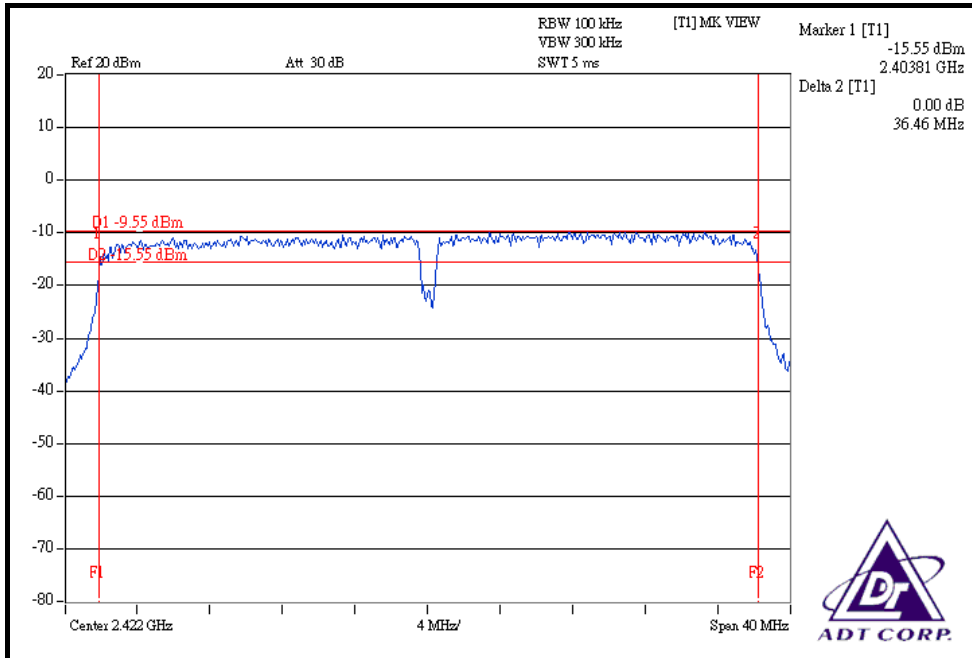

CH 4

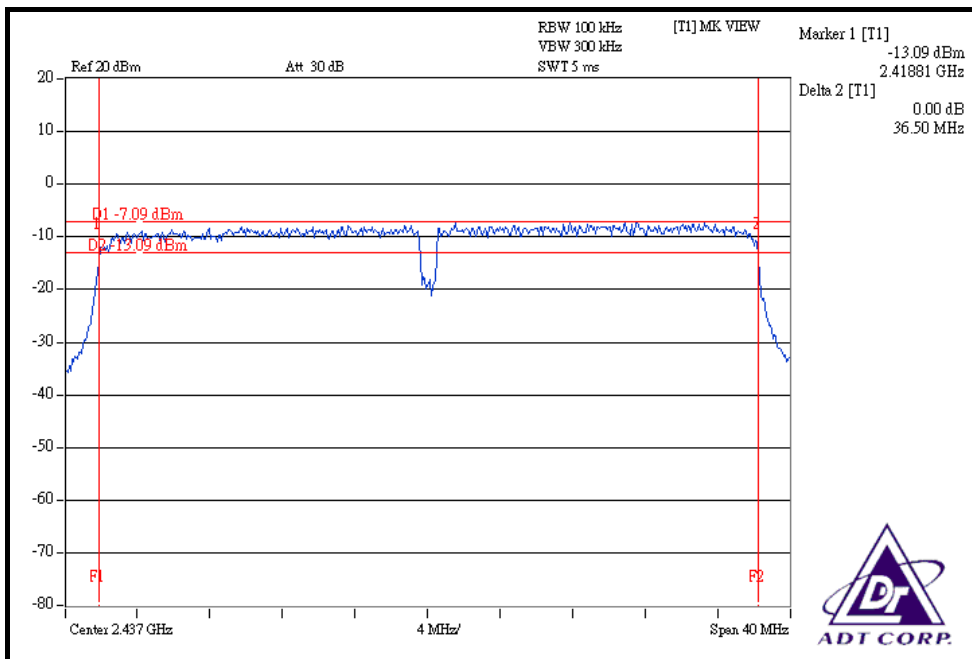

CH 7

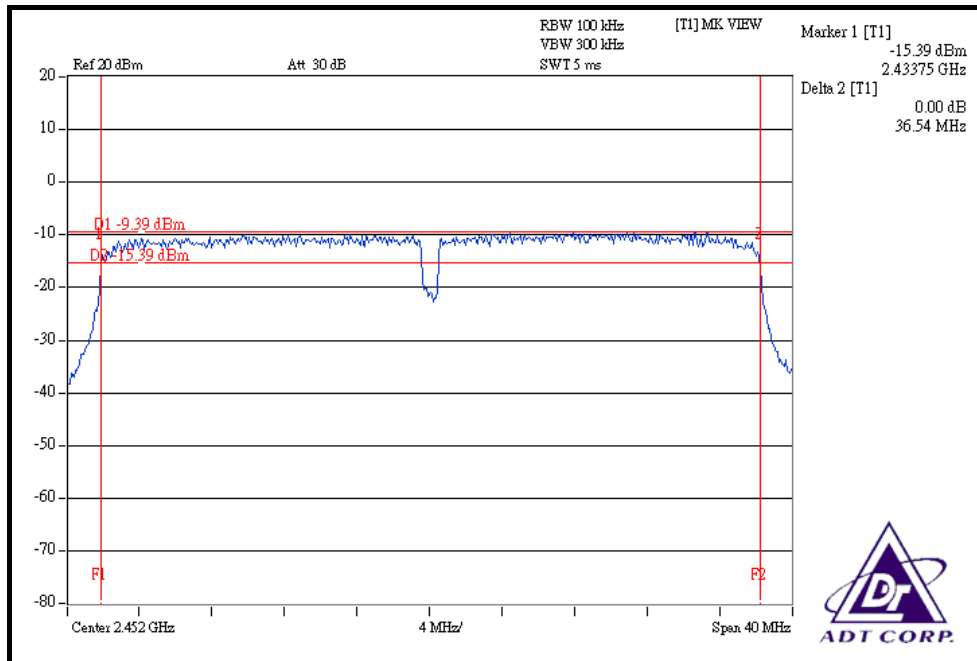



4.4 MAXIMUM PEAK OUTPUT POWER

4.4.1 LIMITS OF MAXIMUM PEAK OUTPUT POWER MEASUREMENT

The Maximum Peak Output Power Measurement is 30dBm.

4.4.2 INSTRUMENTS

DESCRIPTION & MANUFACTURER	MODEL NO.	SERIAL NO.	CALIBRATED UNTIL
SPECTRUM ANALYZER	FSP40	100040	Jun. 28, 2008
AGILENT SYNTHESIZED SIGNAL GENERATOR	E8257C	MY43320668	Dec. 25, 2008
DIGITAL RT OSCILLOSCOPE	TDS1012	C037299	Nov. 21, 2008
NARDA DETECTOR	4503A	FSCM99899	NA

NOTE: The calibration interval of the above test instruments is 12 months and the calibrations are traceable to NML/ROC and NIST/USA.

4.4.3 TEST PROCEDURES

- a. A detector was used on the output port of the EUT. An oscilloscope was used to read the response of the detector.
- b. Replaced the EUT by the signal generator. The center frequency of the S.G was adjusted to the center frequency of the measured channel.
- c. Adjusted the power to have the same reading on oscilloscope. Record the power level.

4.4.4 DEVIATION FROM TEST STANDARD

No deviation

4.4.5 TEST SETUP



4.4.6 EUT OPERATING CONDITIONS

Same as Item 4.3.6



4.4.7 TEST RESULTS

802.11b DSSS MODULATION

MODULATION TYPE	DBPSK	TRANSFER RATE	1.0Mbps
INPUT POWER (SYSTEM)	120Vac, 60 Hz	ENVIRONMENTAL CONDITIONS	24deg.C, 64%RH, 991hPa
TESTED BY	Match Tsui		

CHAN	CHANNEL FREQUENCY (MHz)	PEAK POWER OUTPUT (mW)	PEAK POWER OUTPUT (dBm)	PEAK POWER LIMIT (dBm)	PASS/FAIL
1	2412	50.234	17.01	30	PASS
6	2437	63.387	18.02	30	PASS
11	2462	63.533	18.03	30	PASS

802.11g OFDM MODULATION

MODULATION TYPE	BPSK	TRANSFER RATE	6.0Mbps
INPUT POWER (SYSTEM)	120Vac, 60 Hz	ENVIRONMENTAL CONDITIONS	24deg.C, 64%RH, 991hPa
TESTED BY	Match Tsui		

CHAN	CHANNEL FREQUENCY (MHz)	PEAK POWER OUTPUT (mW)	PEAK POWER OUTPUT (dBm)	PEAK POWER LIMIT (dBm)	PASS/FAIL
1	2412	79.616	19.01	30	PASS
6	2437	80.168	19.04	30	PASS
11	2462	79.983	19.03	30	PASS



DRAFT 802.11n (20MHz) OFDM MODULATION

MODULATION TYPE	BPSK	TRANSFER RATE	7.2Mbps
INPUT POWER (SYSTEM)	120Vac, 60 Hz	ENVIRONMENTAL CONDITIONS	25deg.C, 65%RH, 991hPa
TESTED BY	Match Tsui		

CHANNEL	CHANNEL FREQUENCY (MHz)	PEAK POWER OUTPUT (dBm)		TOTAL PEAK POWER (mW)	TOTAL PEAK POWER (dBm)	PEAK POWER LIMIT (dBm)	PASS / FAIL
		CHAIN 0	CHAIN 1				
1	2412	17.03	17.07	101.399	20.06	30	PASS
6	2437	19.08	19.00	160.342	22.05	30	PASS
11	2462	15.08	15.03	64.053	18.07	30	PASS

DRAFT 802.11n (40MHz) OFDM MODULATION

MODULATION TYPE	BPSK	TRANSFER RATE	15.0Mbps
INPUT POWER (SYSTEM)	120Vac, 60 Hz	ENVIRONMENTAL CONDITIONS	25deg.C, 65%RH, 991hPa
TESTED BY	Match Tsui		

CHANNEL	CHANNEL FREQUENCY (MHz)	PEAK POWER OUTPUT (dBm)		TOTAL PEAK POWER (mW)	TOTAL PEAK POWER (dBm)	PEAK POWER LIMIT (dBm)	PASS / FAIL
		CHAIN 0	CHAIN 1				
1	2422	13.76	12.84	42.999	16.33	30	PASS
4	2437	15.04	15.11	64.349	18.09	30	PASS
7	2452	13.50	13.13	42.946	16.33	30	PASS



4.5 POWER SPECTRAL DENSITY MEASUREMENT

4.5.1 LIMITS OF POWER SPECTRAL DENSITY MEASUREMENT

The Maximum of Power Spectral Density Measurement is 8dBm.

4.5.2 TEST INSTRUMENTS

DESCRIPTION & MANUFACTURER	MODEL NO.	SERIAL NO.	CALIBRATED UNTIL
R&S SPECTRUM ANALYZER	FSP 40	100040	Jun. 28, 2008

NOTE: The calibration interval of the above test instruments is 12 months and the calibrations are traceable to NML/ROC and NIST/USA.

4.5.3 TEST PROCEDURE

The transmitter output was connected to the spectrum analyzer through an attenuator, the bandwidth of the fundamental frequency was measured with the spectrum analyzer using 3kHz RBW and 30kHz VBW, set sweep time = span/3kHz. The power spectral density was measured and recorded.

The sweep time is allowed to be longer than span/3kHz for a full response of the mixer in the spectrum analyzer.

4.5.4 DEVIATION FROM TEST STANDARD

No deviation

4.5.5 TEST SETUP

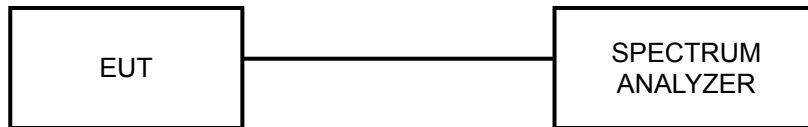

4.5.6 EUT OPERATING CONDITION

Same as Item 4.3.6

4.5.7 TEST RESULTS

802.11b DSSS MODULATION

MODULATION TYPE	DBPSK	TRANSFER RATE	1.0Mbps
INPUT POWER (SYSTEM)	120Vac, 60 Hz	ENVIRONMENTAL CONDITIONS	24deg.C, 64%RH, 991hPa
TESTED BY	Match Tsui		

CHANNEL	CHANNEL FREQUENCY (MHz)	RF POWER LEVEL IN 3 kHz BW (dBm)	MAXIMUM LIMIT (dBm)	PASS/FAIL
1	2412	-16.37	8	PASS
6	2437	-15.25	8	PASS
11	2462	-15.61	8	PASS

CH 1

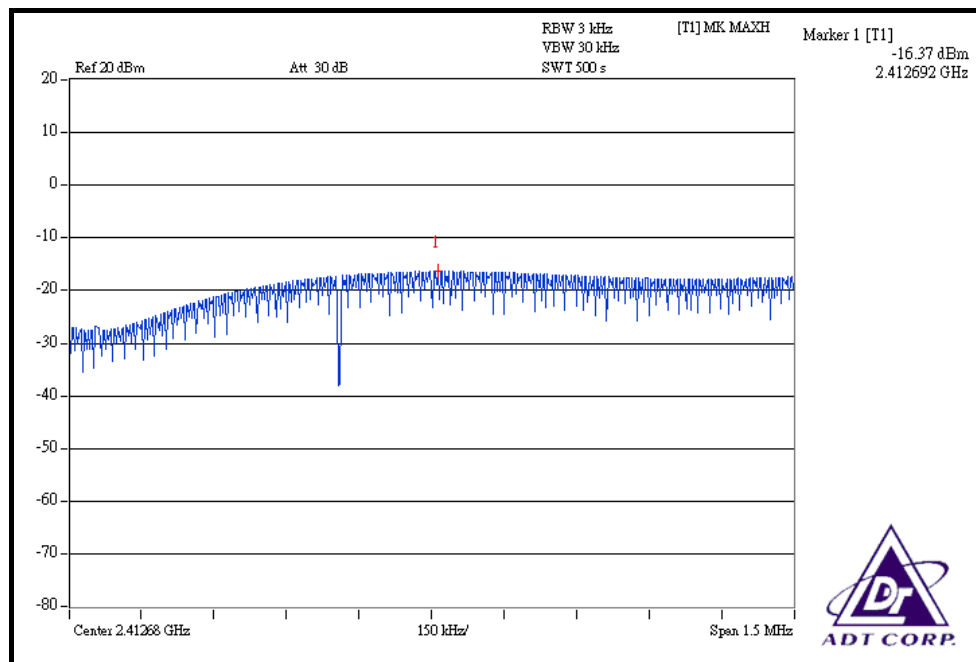

CH 6

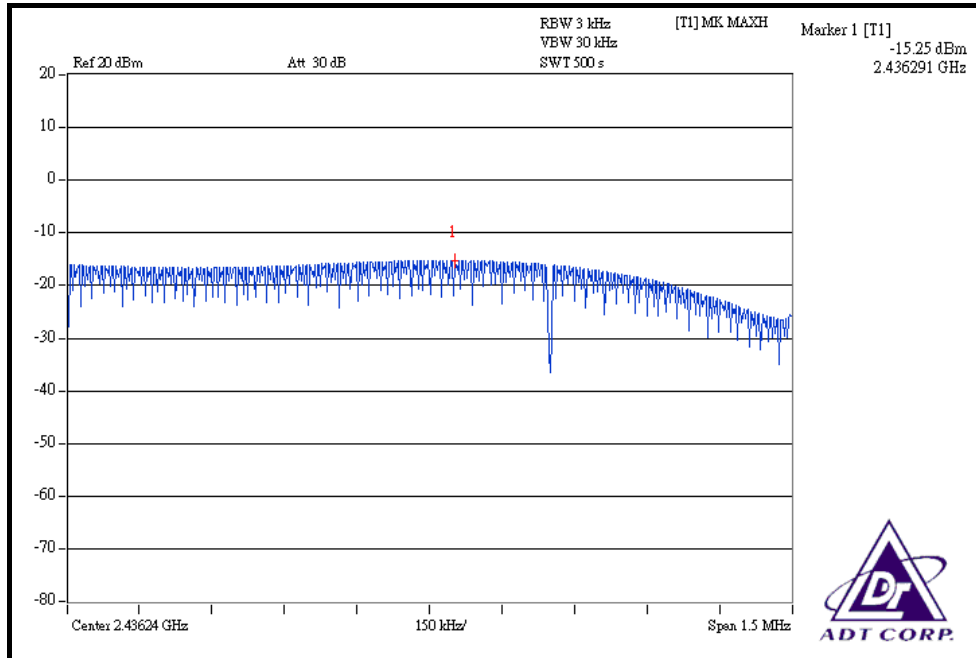

CH 11

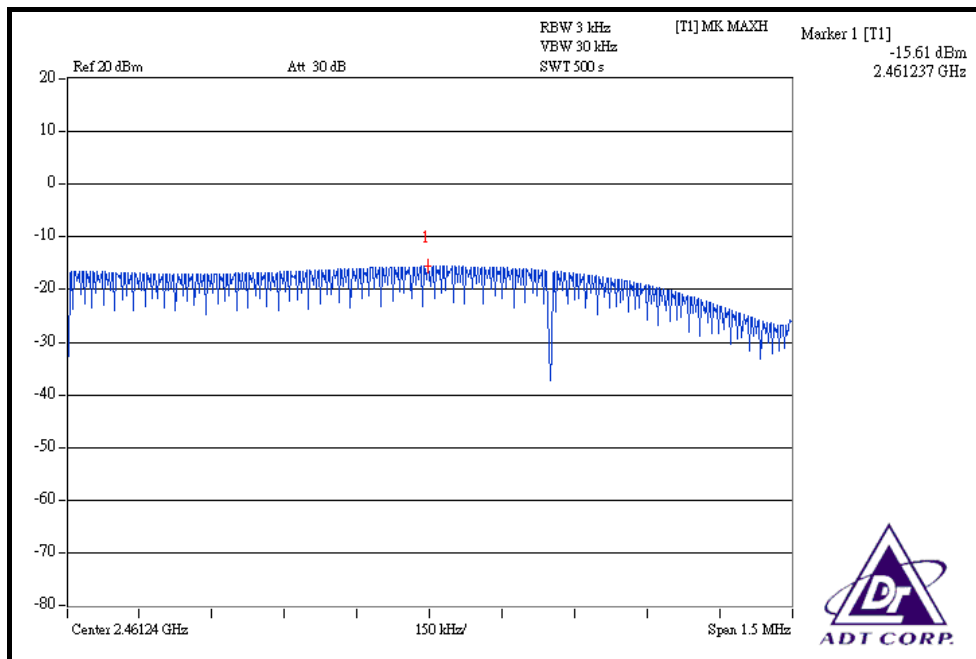



802.11g OFDM MODULATION

MODULATION TYPE	BPSK	TRANSFER RATE	6.0Mbps
INPUT POWER (SYSTEM)	120Vac, 60 Hz	ENVIRONMENTAL CONDITIONS	24deg.C, 64%RH, 991hPa
TESTED BY	Match Tsui		

CHANNEL	CHANNEL FREQUENCY (MHz)	RF POWER LEVEL IN 3 kHz BW (dBm)	MAXIMUM LIMIT (dBm)	PASS/FAIL
1	2412	-15.98	8	PASS
6	2437	-15.88	8	PASS
11	2462	-15.77	8	PASS

CH 1

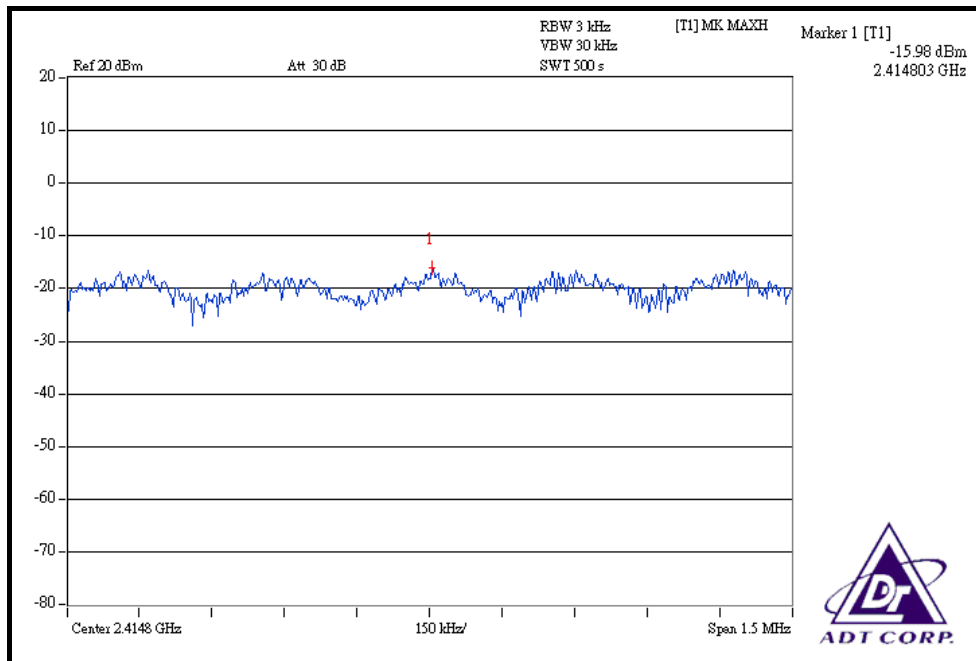

CH 6

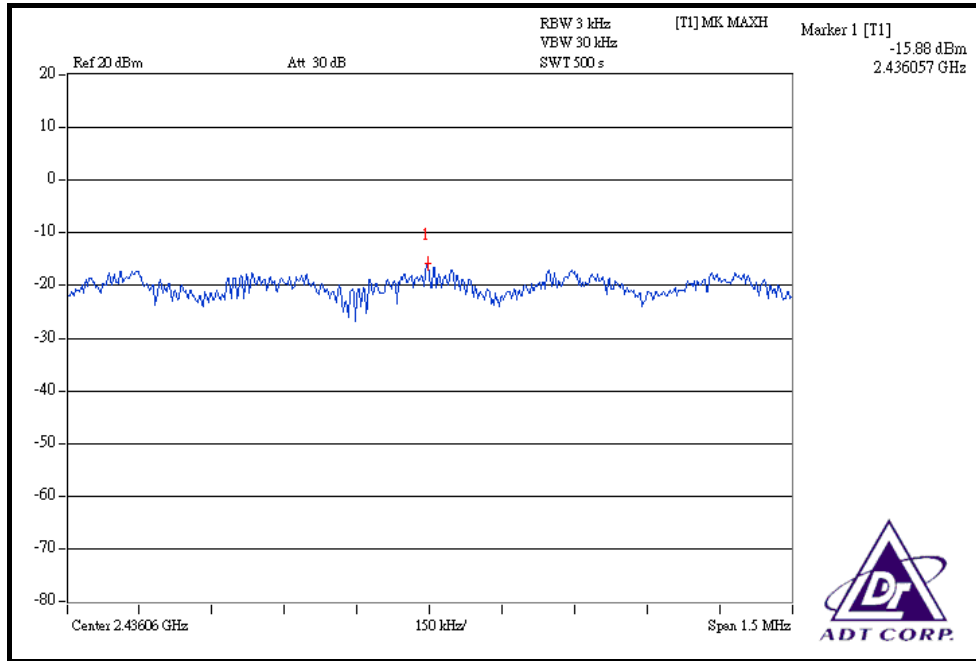

CH 11

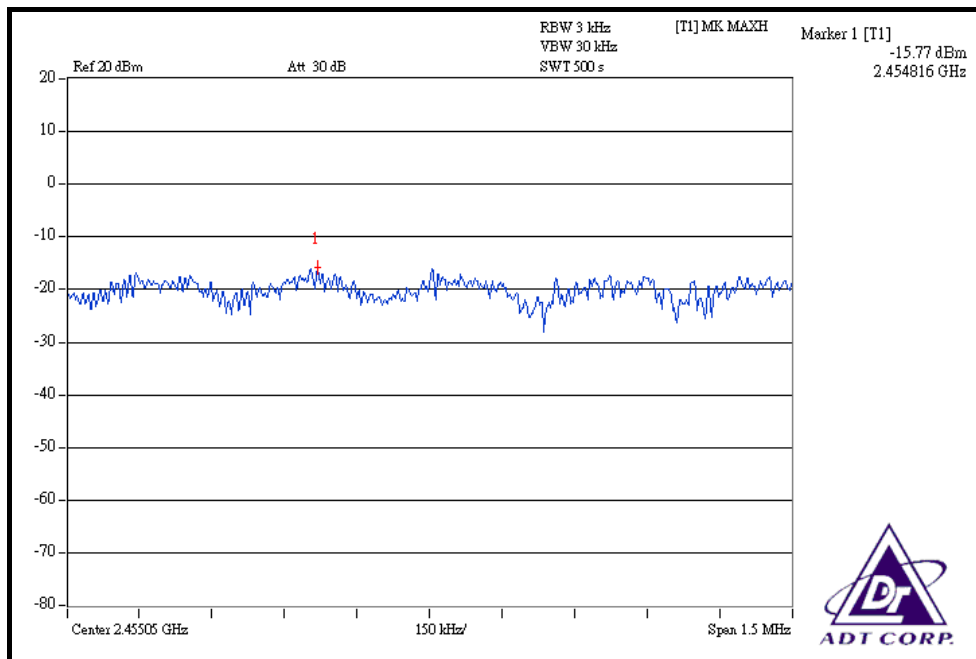



DRAFT 802.11n (20MHz) OFDM MODULATION

MODULATION TYPE	BPSK	TRANSFER RATE	7.2Mbps
INPUT POWER (SYSTEM)	120Vac, 60 Hz	ENVIRONMENTAL CONDITIONS	24deg.C, 64%RH, 991hPa
TESTED BY	Match Tsui		

CHANNEL	CHANNEL FREQUENCY (MHz)	RF POWER LEVEL IN 3kHz BW (dBm)		TOTAL POWER DENSITY (mW)	TOTAL POWER DENSITY (dBm)	MAX. LIMIT (dBm)	PASS / FAIL
		CHAIN 0	CHAIN 1				
1	2412	-15.99	-16.17	0.049	-13.07	8	PASS
6	2437	-14.17	-14.23	0.076	-11.19	8	PASS
11	2462	-18.19	-18.04	0.031	-15.10	8	PASS

FOR CHAIN 0: CH 1

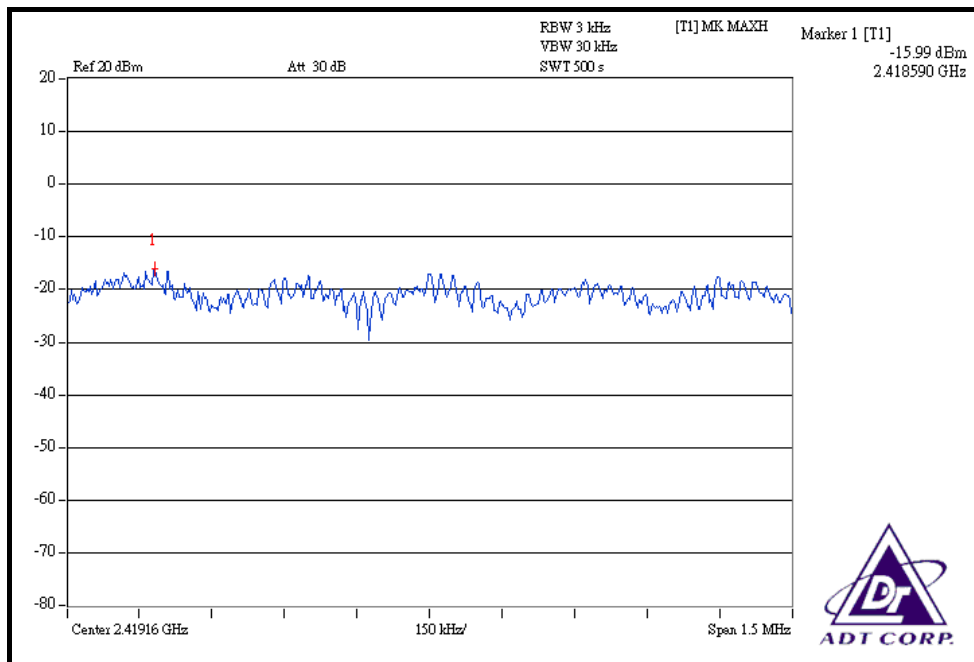

CH 6

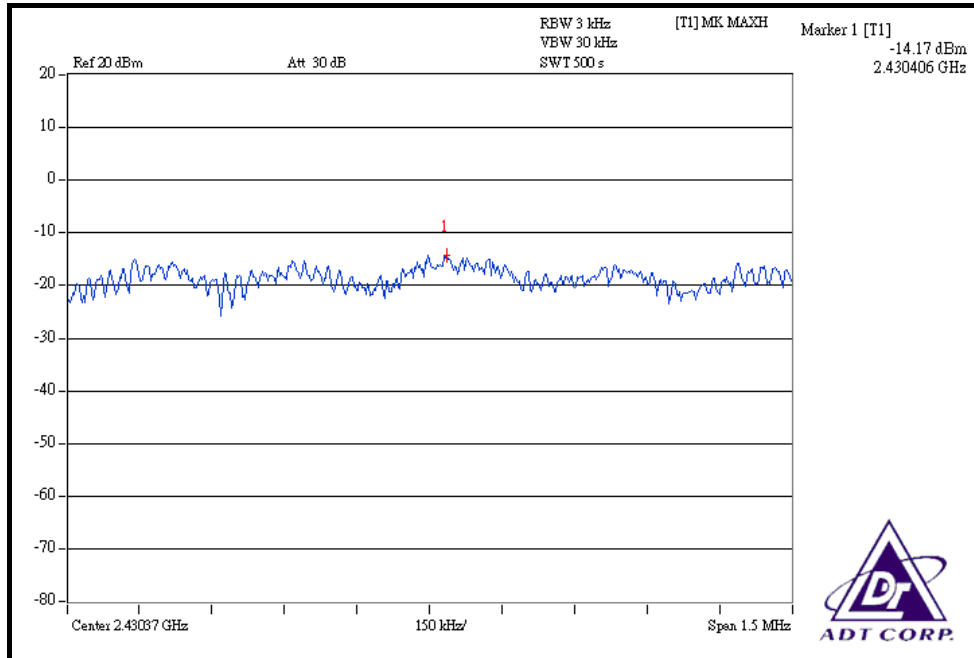

CH 11

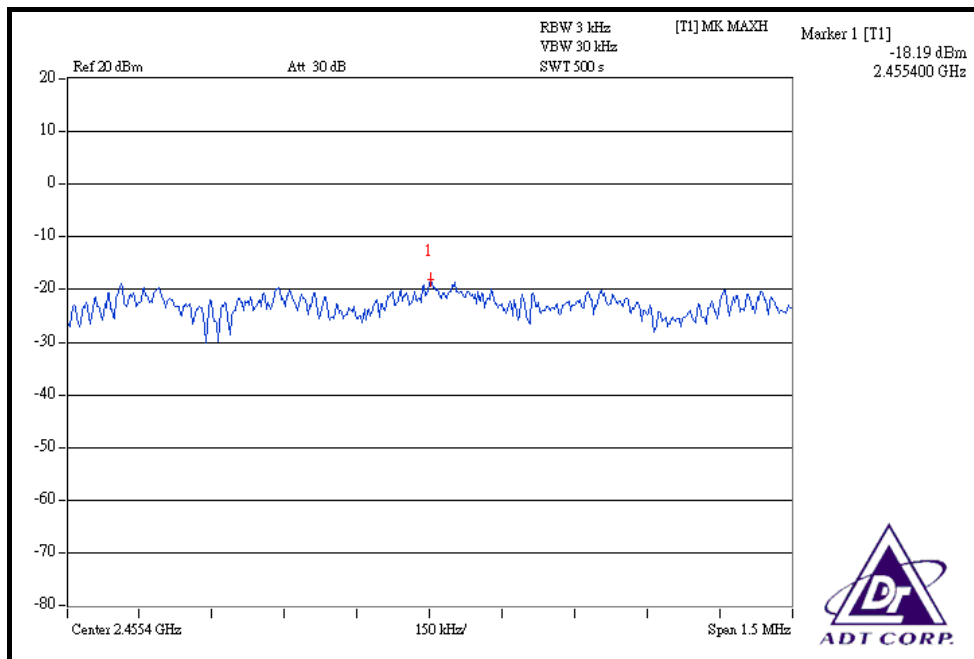

FOR CHAIN 1: CH 1

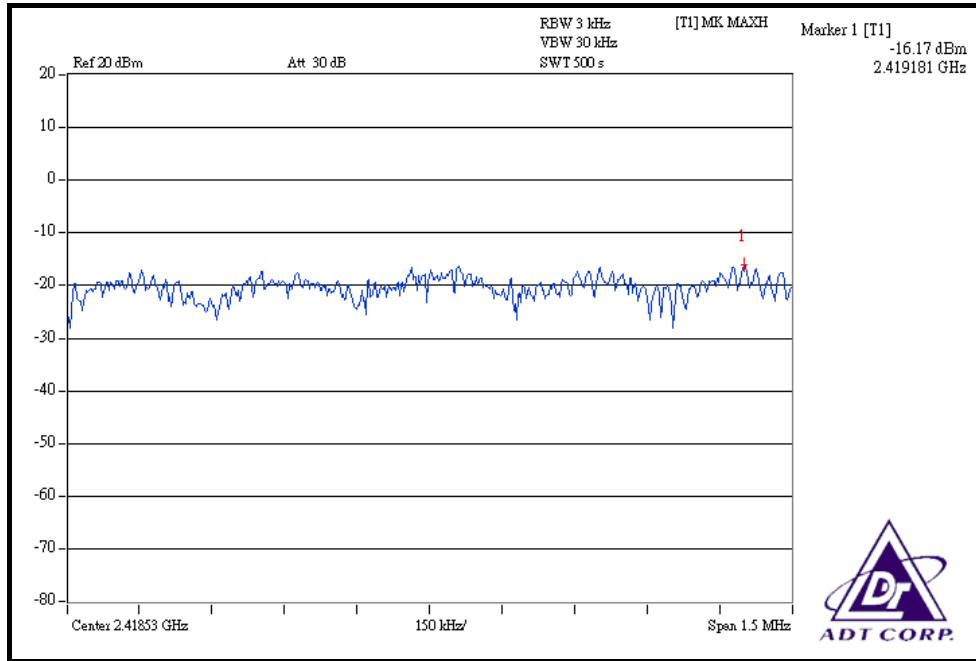

CH 6

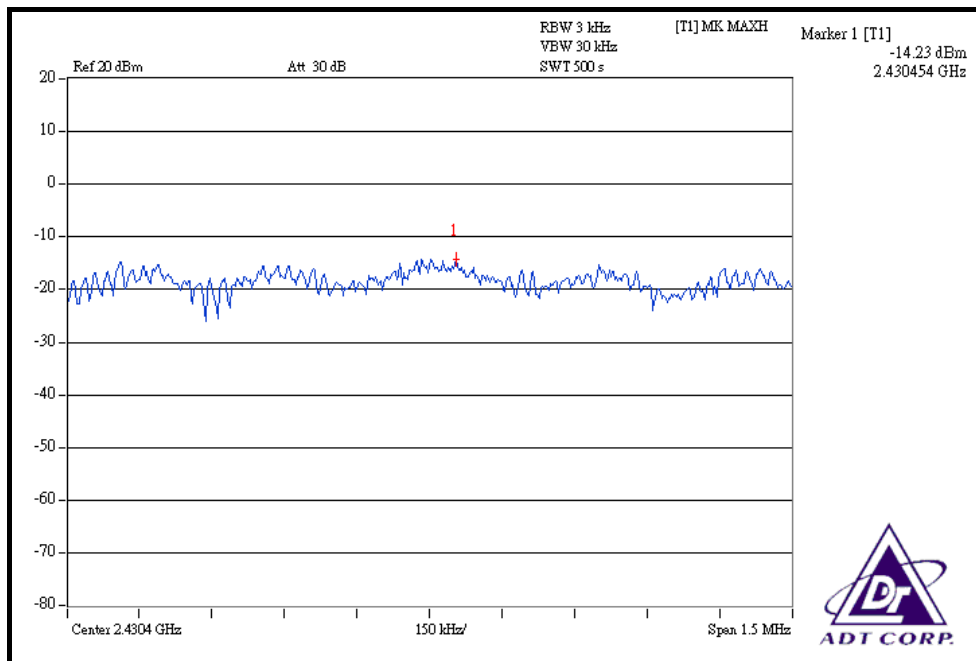



CH 11

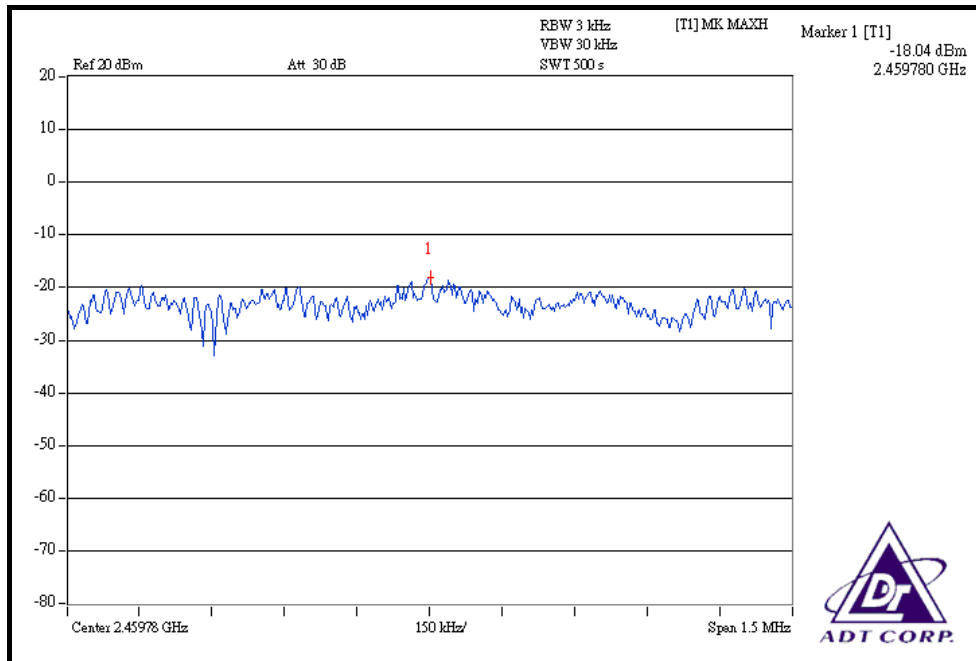



DRAFT 802.11n (40MHz) OFDM MODULATION

MODULATION TYPE	BPSK	TRANSFER RATE	15Mbps
INPUT POWER (SYSTEM)	120Vac, 60 Hz	ENVIRONMENTAL CONDITIONS	24deg.C, 64%RH, 991hPa
TESTED BY	Match Tsui		

CHANNEL	CHANNEL FREQUENCY (MHz)	RF POWER LEVEL IN 3kHz BW (dBm)		TOTAL POWER DENSITY (mW)	TOTAL POWER DENSITY (dBm)	MAX. LIMIT (dBm)	PASS / FAIL
		CHAIN 0	CHAIN 1				
1	2422	-21.98	-21.84	0.013	-18.90	8	PASS
4	2437	-20.72	-19.40	0.020	-17.00	8	PASS
7	2452	-21.54	-21.71	0.014	-18.61	8	PASS

FOR CHAIN 0: CH 1

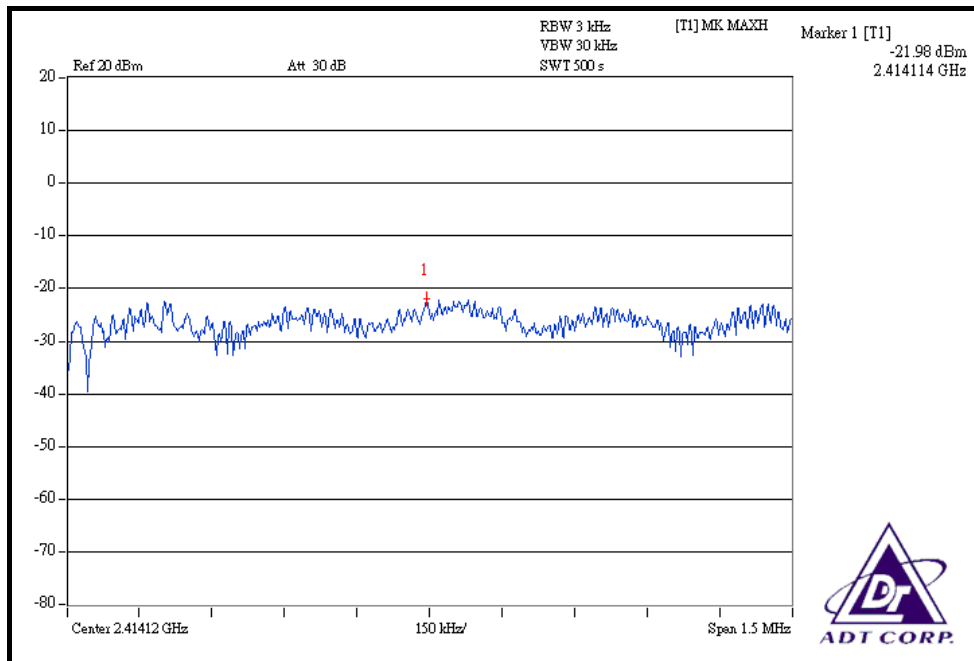

CH 4

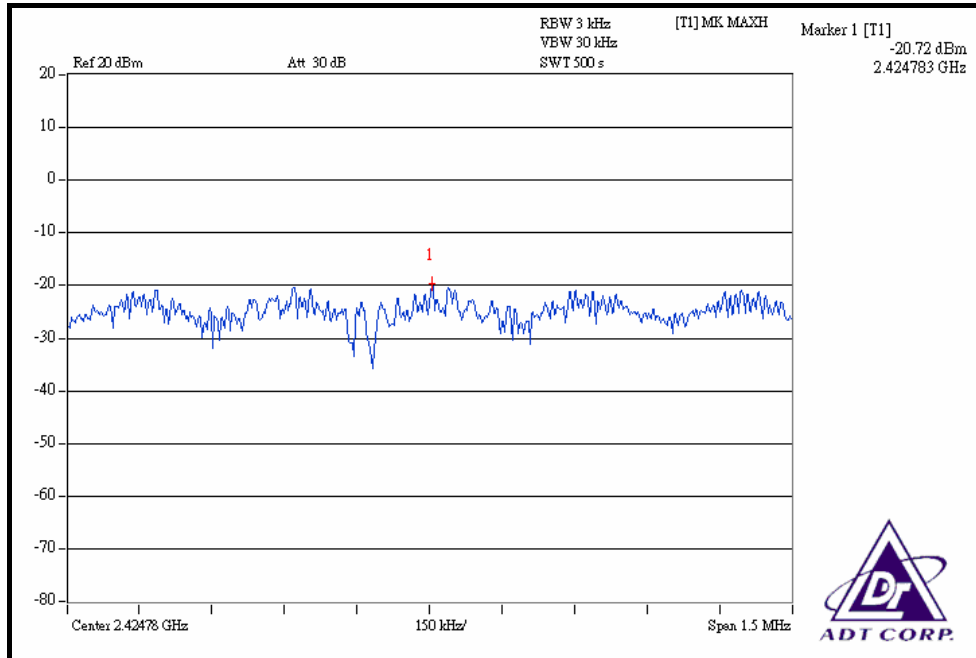

CH 7

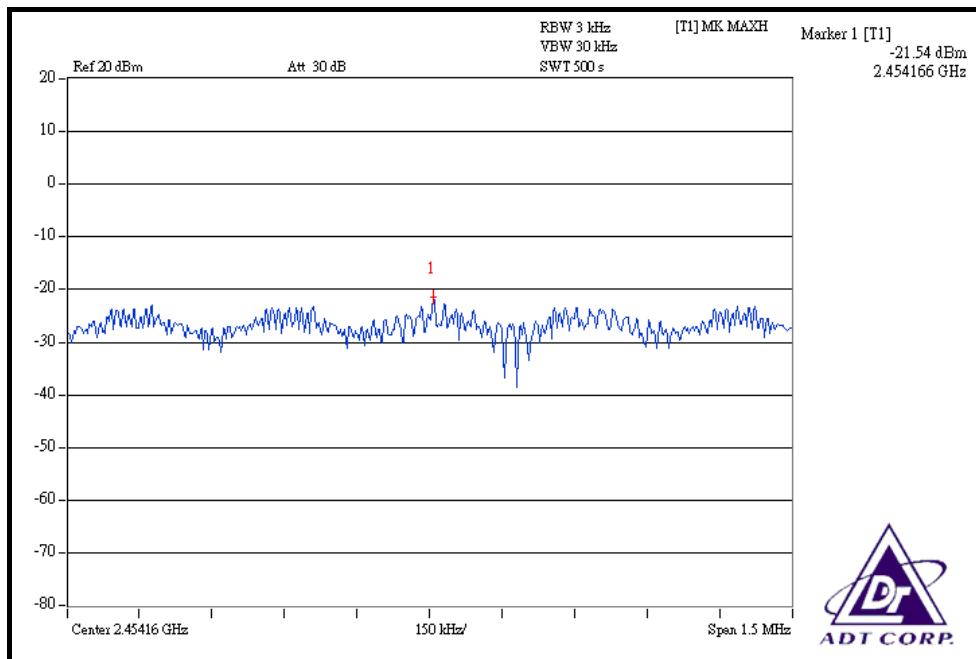

FOR CHAIN 1: CH 1

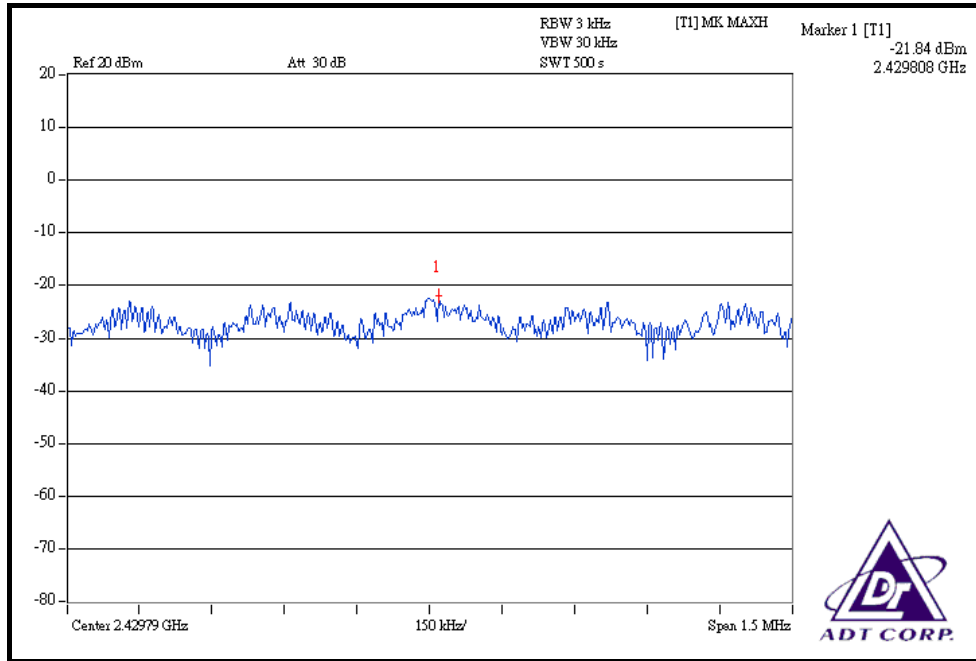

CH 4

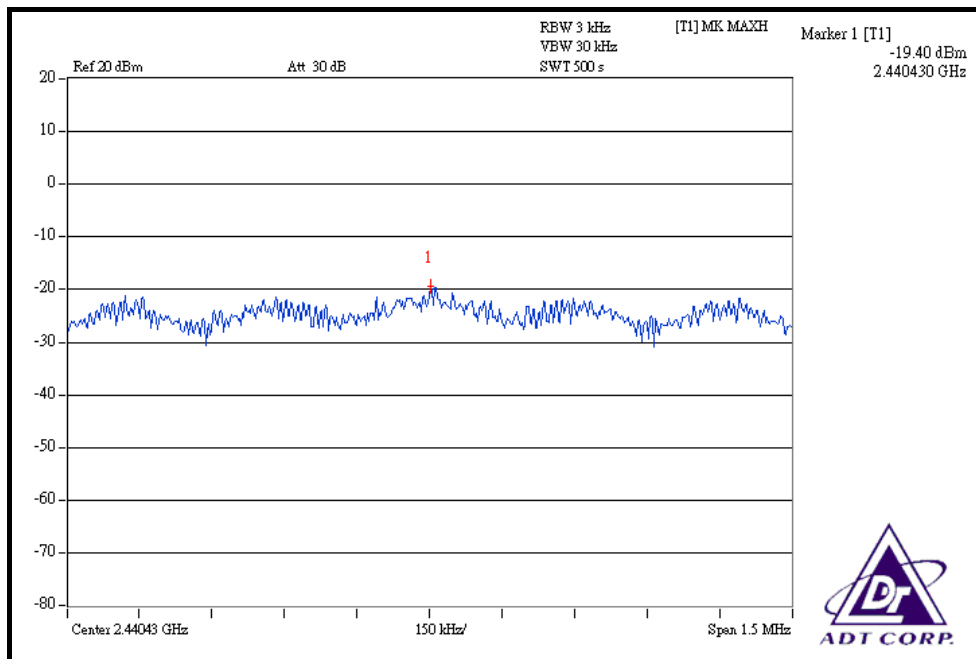

CH 7

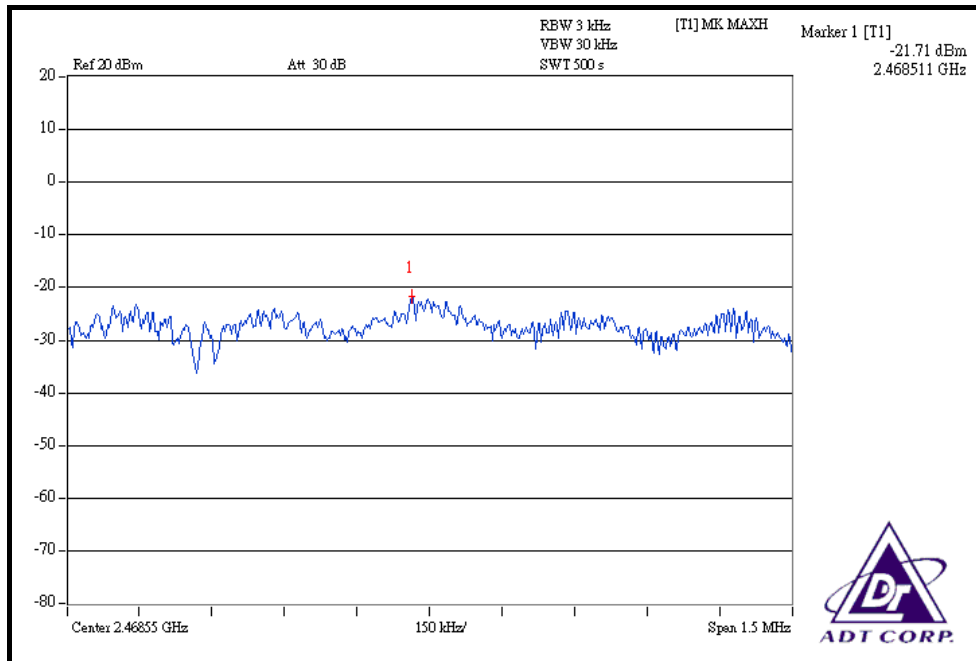



4.6 BAND EDGES MEASUREMENT

4.6.1 LIMITS OF BAND EDGES MEASUREMENT

Below –20dB of the highest emission level of operating band (in 100kHz Resolution Bandwidth).

4.6.2 TEST INSTRUMENTS

DESCRIPTION & MANUFACTURER	MODEL NO.	SERIAL NO.	CALIBRATED UNTIL
FOR CONDUCTED MEASUREMENT			
R&S SPECTRUM ANALYZER	FSP40	100040	Jun. 28, 2008
FOR RADIATED MEASUREMENT			
Test Receiver ROHDE & SCHWARZ	ESCI	100424	Jul. 27, 2008
Spectrum Analyzer Agilent	E4446A	MY44360128	Dec. 06, 2008
BILOG Antenna SCHWARZBECK	VULB9168	9168-160	May 31, 2008
HORN Antenna SCHWARZBECK	9120D	9120D-209	Jun. 28, 2008
HORN Antenna SCHWARZBECK	BBHA 9170	BBHA9170243	Dec. 24, 2008
Preamplifier Agilent	8447D	2944A10633	Oct. 28, 2008
Preamplifier Agilent	8449B	3008A01964	Oct. 23, 2008
RF signal cable HUBER+SUHNNER	SUCOFLEX 104	283402/4	Dec. 06, 2008
RF signal cable HUBER+SUHNNER	SUCOFLEX 104	251644/4	Dec. 06, 2008
Software ADT.	ADT_Radiated_V7.6	NA	NA
Antenna Tower inn-co GmbH	MA 4000	013303	NA
Antenna Tower Controller inn-co GmbH	CO2000	017303	NA
Turn Table ADT.	TT100.	TT93021703	NA
Turn Table Controller ADT.	SC100.	SC93021703	NA

NOTE: The calibration interval of the above test instruments is 12 months and the calibrations are traceable to NML/ROC and NIST/USA.

4.6.3 TEST PROCEDURE

FOR CONDUCTED MEASUREMENT

The transmitter output was connected to the spectrum analyzer via a low lose cable. Set both RBW and VBW of spectrum analyzer to 100kHz and 300kHz with suitable frequency span including 100MHz bandwidth from band edge. The band edges was measured and recorded.

The spectrum plots (Peak RBW = 100kHz, VBW = 300kHz; Average RBW = 1MHz, VBW = 10Hz) are attached on the following pages.

FOR RADIATED MEASUREMENT

- a. The EUT was placed on the top of a rotating table 0.8 meters above the ground at a 3 meter semi-anechoic chamber. The table was rotated 360 degrees to determine the position of the highest radiation.
- b. The EUT was set 3 meters away from the interference-receiving antenna, which was mounted on the top of a variable-height antenna tower.
- c. The antenna is a broadband antenna, and its height is varied from one meter to four meters above the ground to determine the maximum value of the field strength. Both horizontal and vertical polarizations of the antenna are set to make the measurement.
- d. For each suspected emission, the EUT was arranged to its worst case and then the antenna was tuned to heights from 1 meter to 4 meters and the rotatable table was turned from 0 degrees to 360 degrees to find the maximum reading.
- e. Set both RBW and VBW of spectrum analyzer to 100kHz with suitable frequency span including 100MHz bandwidth from band edge. The band edges was measured and recorded.

The spectrum plots (Peak RBW = 100kHz, VBW = 300kHz; Average RBW = 1MHz, VBW = 10Hz)

4.6.4 DEVIATION FROM TEST STANDARD

No deviation

4.6.5 EUT OPERATING CONDITION

Same as Item 4.3.6

4.6.6 TEST RESULTS

The spectrum plots are attached on the following 24 images. D1 line indicates the highest level, and D2 line indicates the 20dB offset below D1. It shows compliance with the requirement in part 15.247(d).

802.11b DSSS MODULATION

NOTE 1: The band edge emission plot on the next page shows 49.48dBc between carrier maximum power and local maximum emission in restrict band (2.38580GHz). The emission of carrier strength list in the test result of channel 1 at the item 4.2.7 is 107.34dBuV/m (Peak), so the maximum field strength in restrict band is $107.34 - 49.48 = 57.86$ dBuV/m which is under 74dBuV/m limit.

The band edge emission plot on the next page shows 57.14dBc between carrier maximum power and local maximum emission in restrict band (2.38660GHz). The emission of carrier strength list in the test result of channel 1 at the item 4.2.7 is 102.96dBuV/m (Average), so the maximum field strength in restrict band is $102.96 - 57.14 = 45.82$ dBuV/m which is under 54dBuV/m limit.

NOTE 2: The band edge emission plot on the next second page shows 49.64dBc between carrier maximum power and local maximum emission in restrict band (2.48780GHz). The emission of carrier strength list in the test result of channel 11 at the item 4.2.7 is 108.52dBuV/m (Peak), so the maximum field strength in restrict band is $108.52 - 49.64 = 58.88$ dBuV/m which is under 74dBuV/m limit.

The band edge emission plot on the next third page shows 56.63dBc between carrier maximum power and local maximum emission in restrict band (2.48350GHz). The emission of carrier strength list in the test result of channel 11 at the item 4.2.7 is 103.48dBuV/m (Average), so the maximum field strength in restrict band is $103.48 - 56.63 = 46.85$ dBuV/m which is under 54dBuV/m limit.

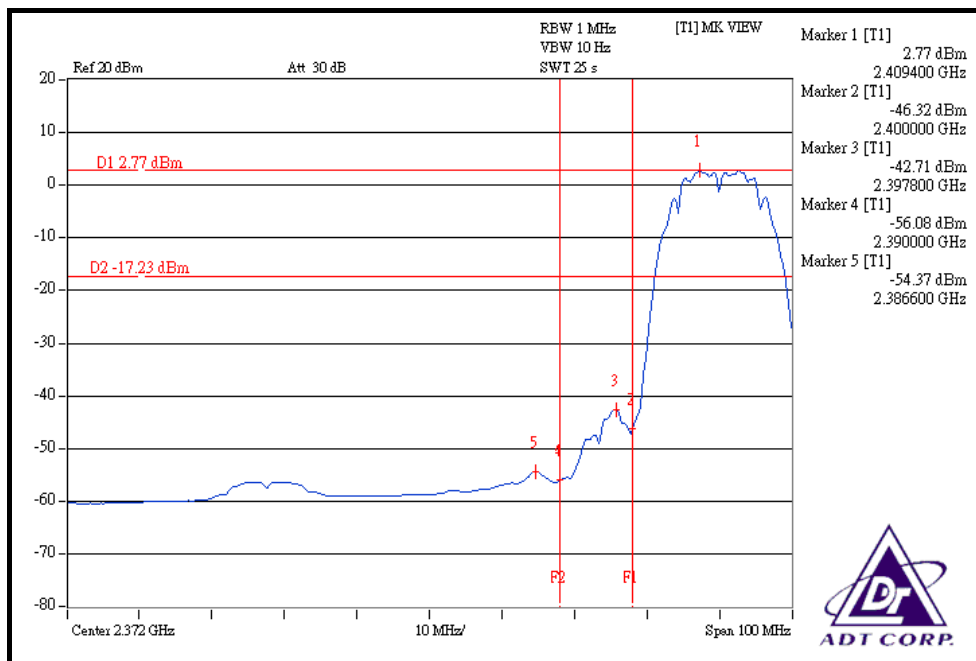
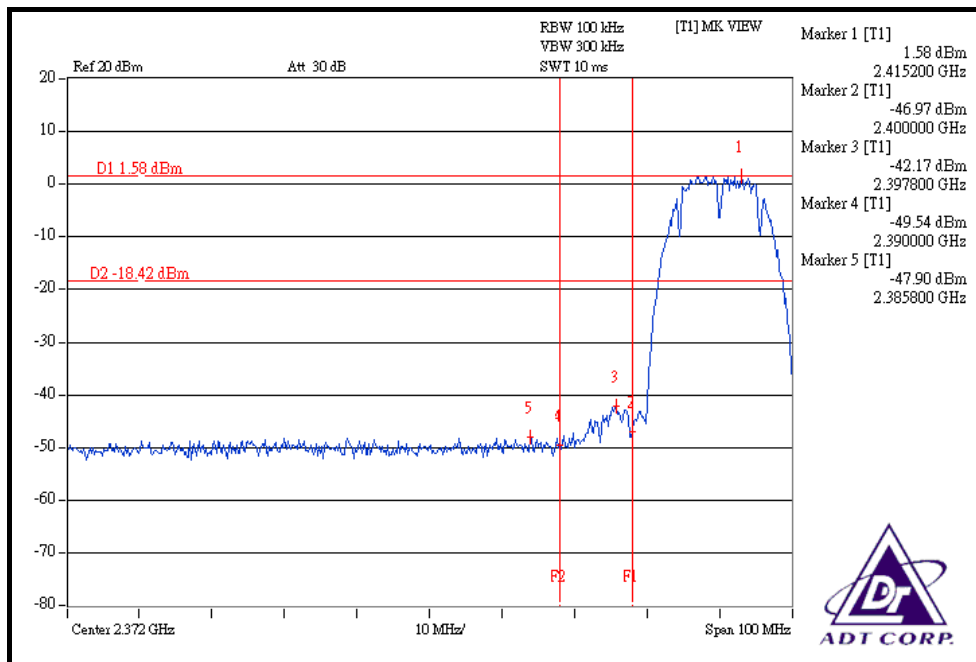

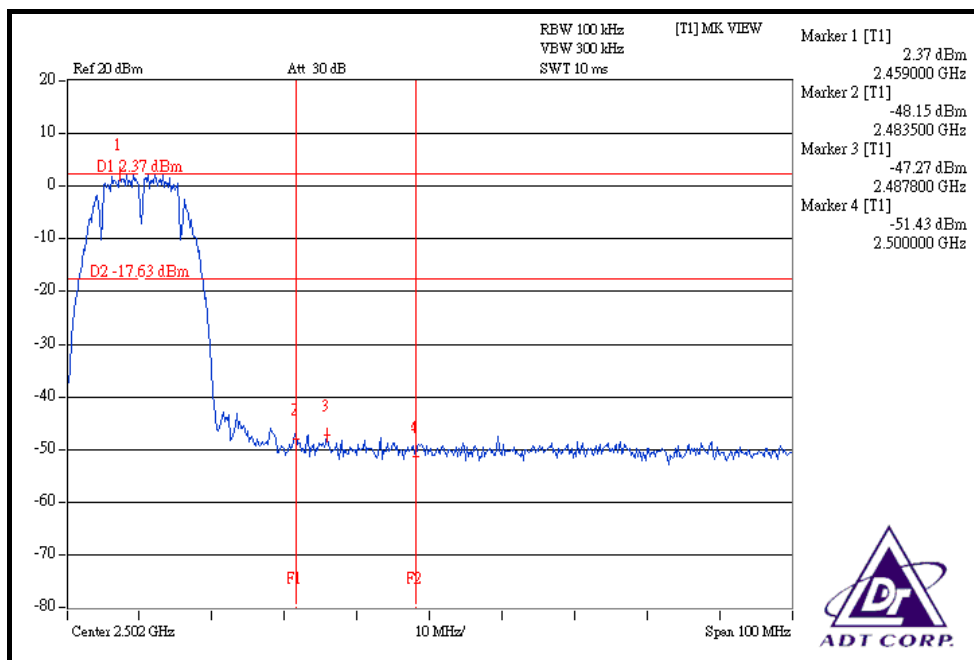
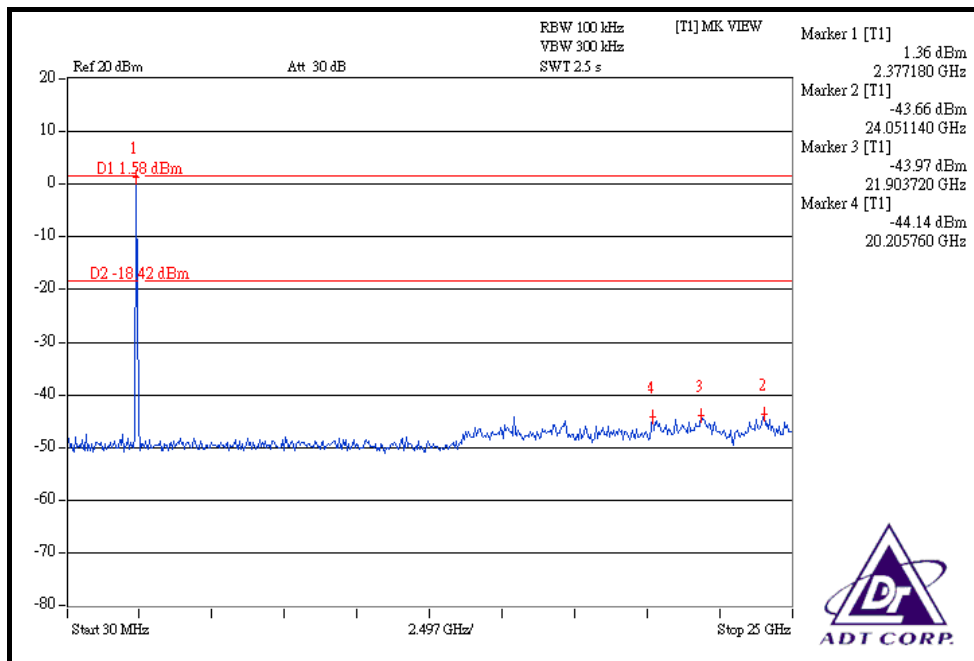

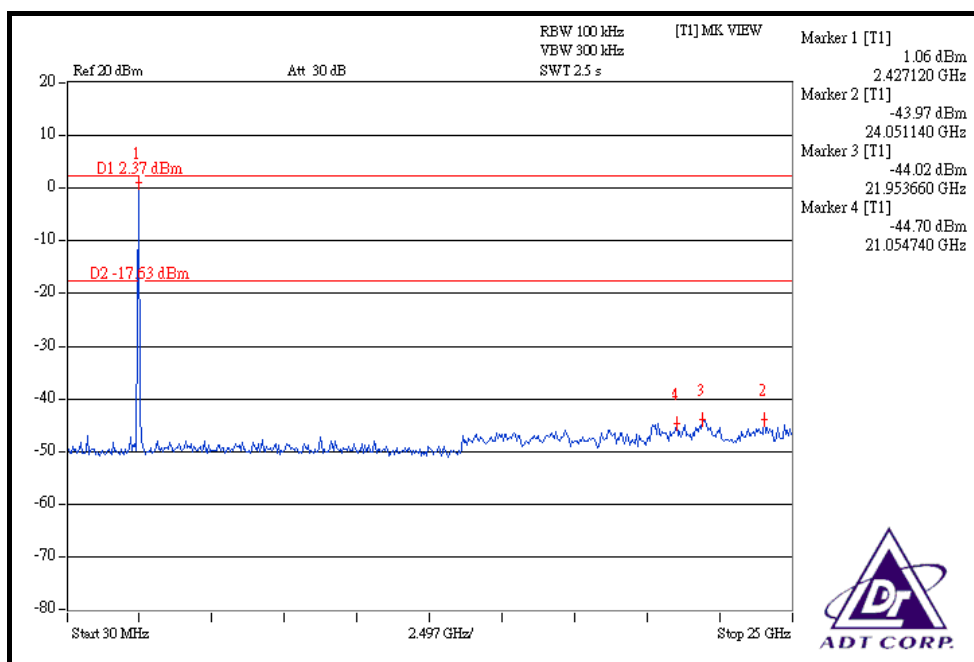
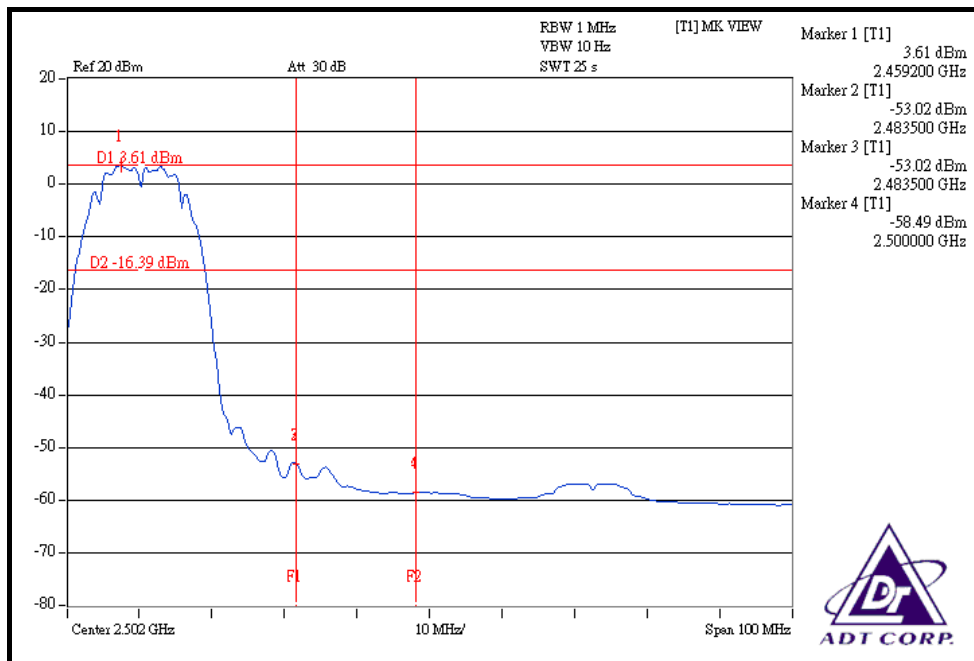

802.11g OFDM MODULATION

NOTE 1: The band edge emission plot on the next page shows 43.57dBc between carrier maximum power and local maximum emission in restrict band (2.38900GHz). The emission of carrier strength list in the test result of channel 1 at the item 4.2.7 is 110.52dBuV/m (Peak), so the maximum field strength in restrict band is $110.52 - 43.57 = 66.95$ dBuV/m which is under 74dBuV/m limit.

The band edge emission plot on the next page shows 50.01dBc between carrier maximum power and local maximum emission in restrict band (2.39000GHz). The emission of carrier strength list in the test result of channel 1 at the item 4.2.7 is 100.18dBuV/m (Average), so the maximum field strength in restrict band is $100.18 - 50.01 = 50.17$ dBuV/m which is under 54dBuV/m limit.

NOTE 2: The band edge emission plot on the next second page shows 45.08dBc between carrier maximum power and local maximum emission in restrict band (2.48540GHz). The emission of carrier strength list in the test result of channel 11 at the item 4.2.7 is 110.27dBuV/m (Peak), so the maximum field strength in restrict band is $110.27 - 45.08 = 65.19$ dBuV/m which is under 74dBuV/m limit.

The band edge emission plot on the next third page shows 50.88dBc between carrier maximum power and local maximum emission in restrict band (2.48350GHz). The emission of carrier strength list in the test result of channel 11 at the item 4.2.7 is 100.14dBuV/m (Average), so the maximum field strength in restrict band is $100.14 - 50.88 = 49.26$ dBuV/m which is under 54dBuV/m limit.

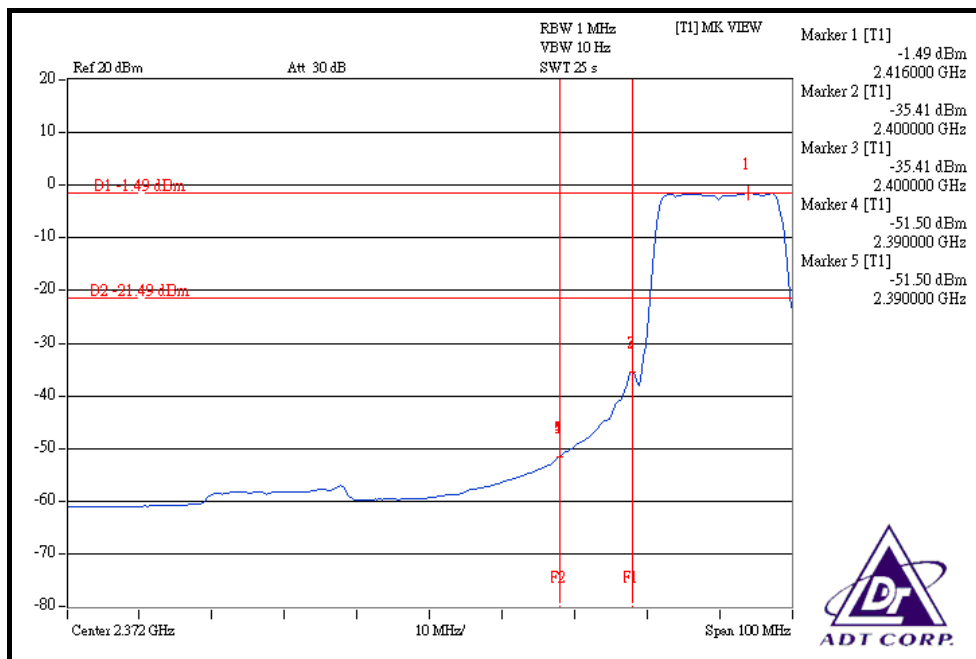
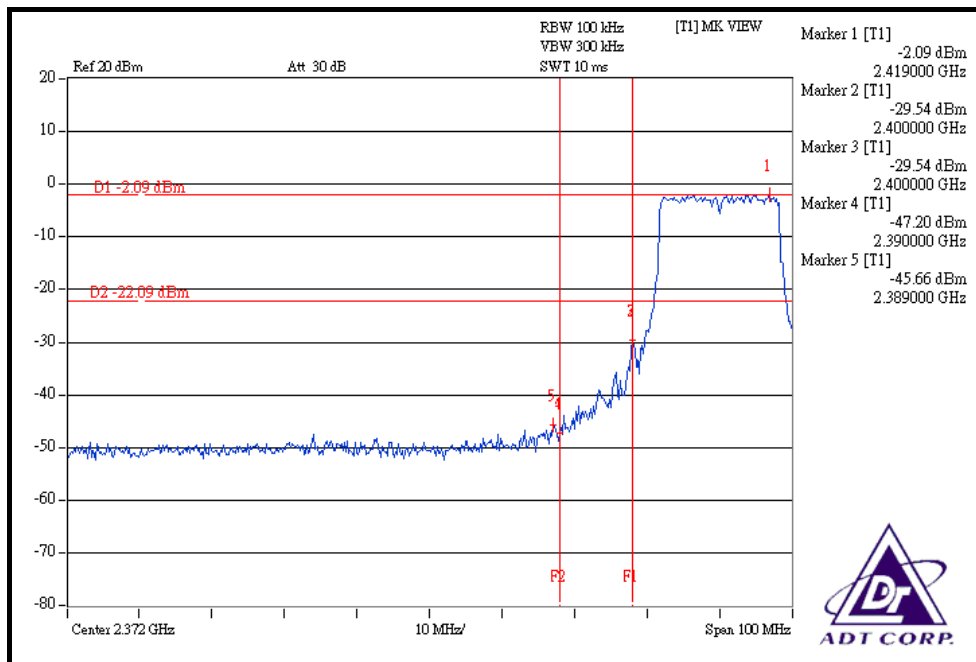

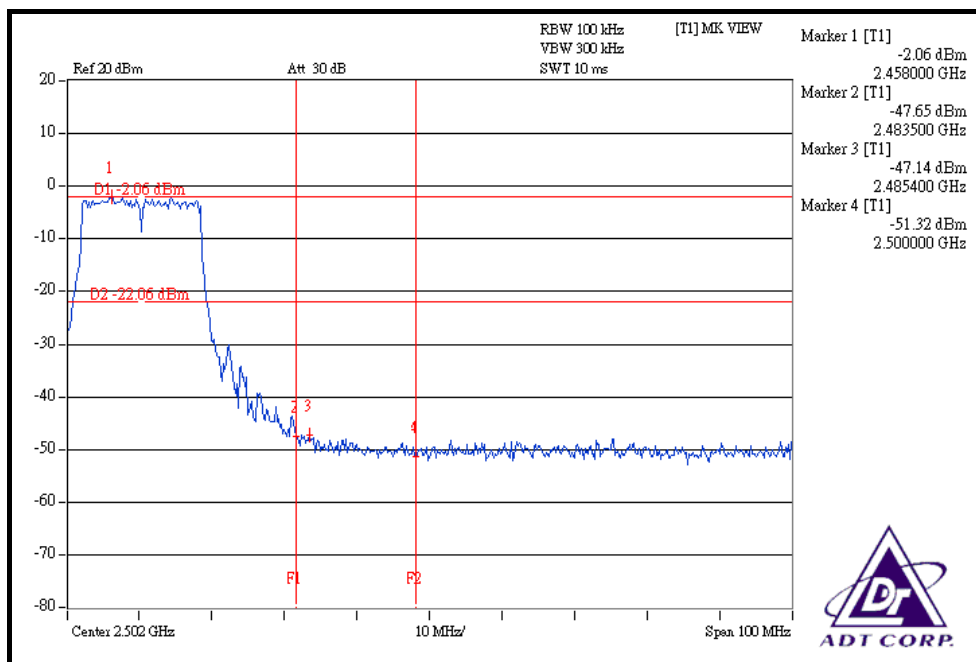
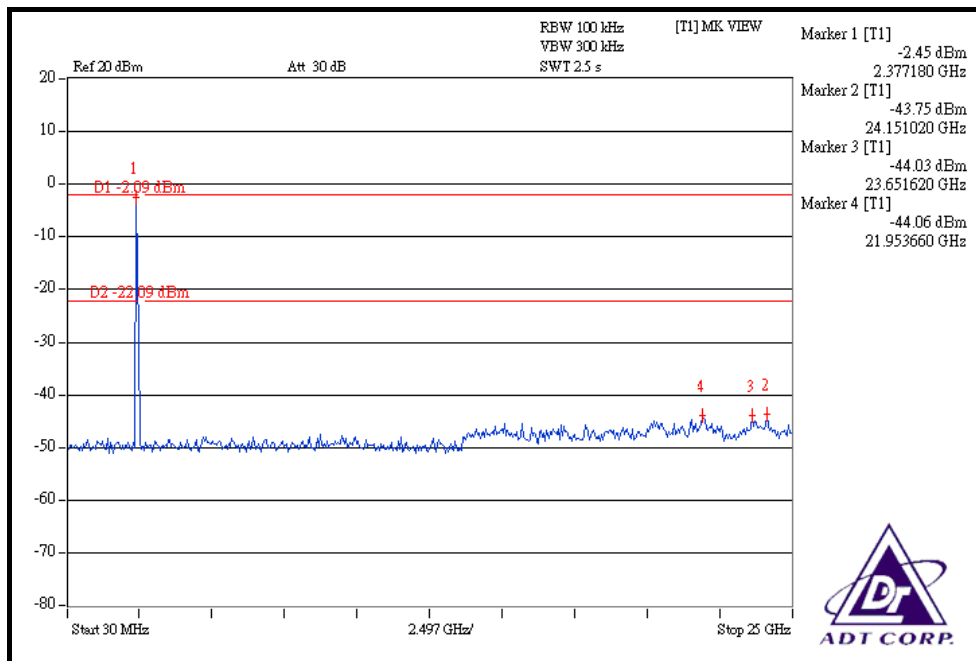

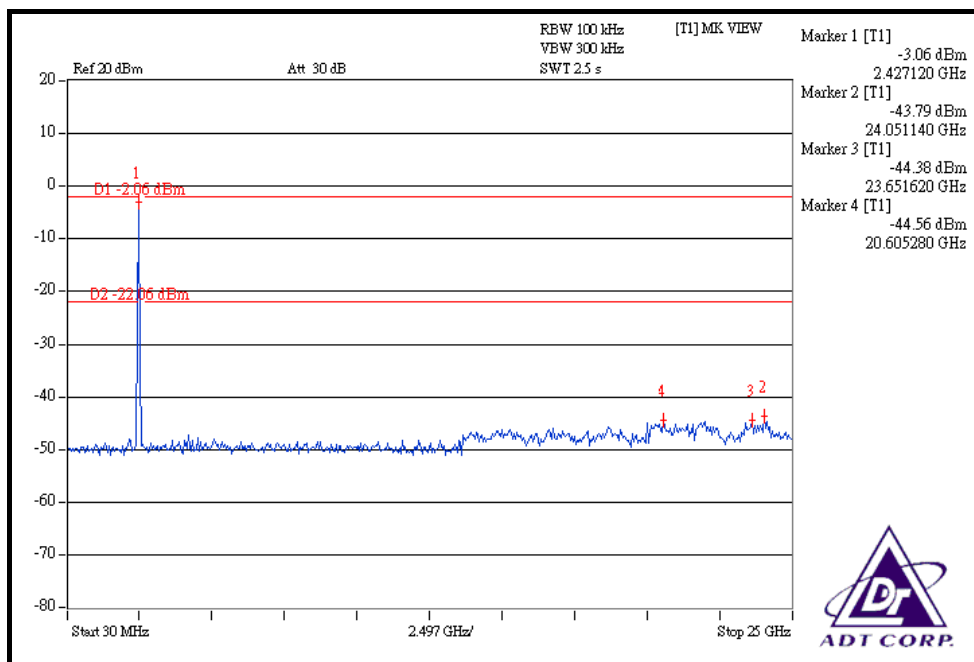
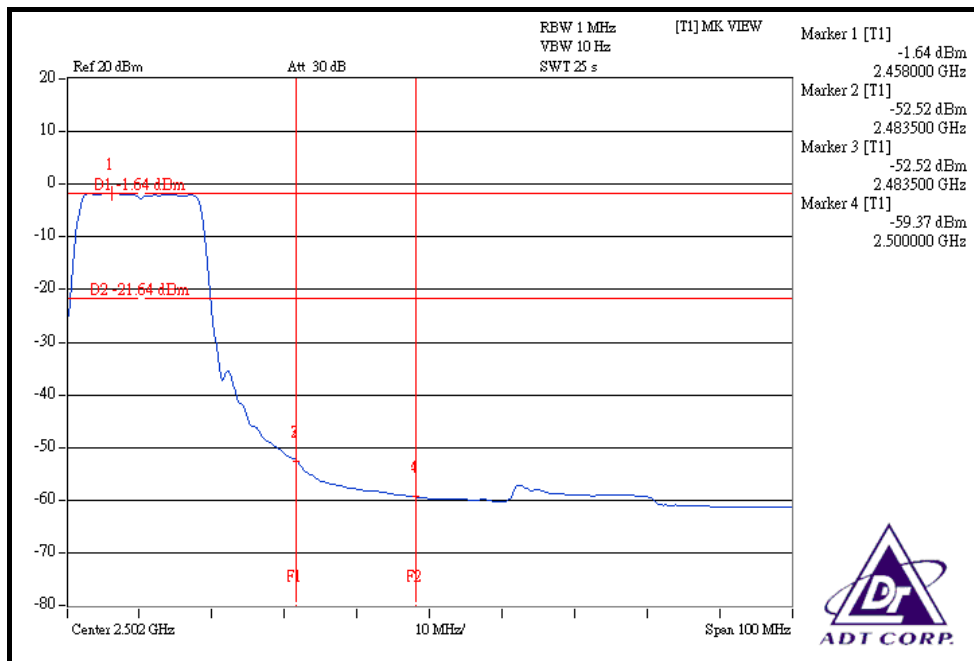

DRAFT 802.11n (20MHz) OFDM MODULATION

NOTE 1: The band edge emission plot on the next page shows 43.71dBc between carrier maximum power and local maximum emission in restrict band (2.379600GHz). The emission of carrier strength list in the test result of channel 1 at the item 4.2.7 is 113.38dBuV/m (Peak), so the maximum field strength in restrict band is $113.38 - 43.71 = 69.67$ dBuV/m which is under 74dBuV/m limit.

The band edge emission plot on the next page shows 50.36dBc between carrier maximum power and local maximum emission in restrict band (2.39000GHz). The emission of carrier strength list in the test result of channel 1 at the item 4.2.7 is 103.22dBuV/m (Average), so the maximum field strength in restrict band is $103.22 - 50.36 = 52.86$ dBuV/m which is under 54dBuV/m limit.

NOTE 2: The band edge emission plot on the next second page shows 42.09dBc between carrier maximum power and local maximum emission in restrict band (2.49980GHz). The emission of carrier strength list in the test result of channel 11 at the item 4.2.7 is 112.19dBuV/m (Peak), so the maximum field strength in restrict band is $112.19 - 42.09 = 70.10$ dBuV/m which is under 74dBuV/m limit.

The band edge emission plot on the next third page shows 49.17dBc between carrier maximum power and local maximum emission in restrict band (2.48350GHz). The emission of carrier strength list in the test result of channel 11 at the item 4.2.7 is 102.13dBuV/m (Average), so the maximum field strength in restrict band is $102.13 - 49.17 = 52.96$ dBuV/m which is under 54dBuV/m limit.

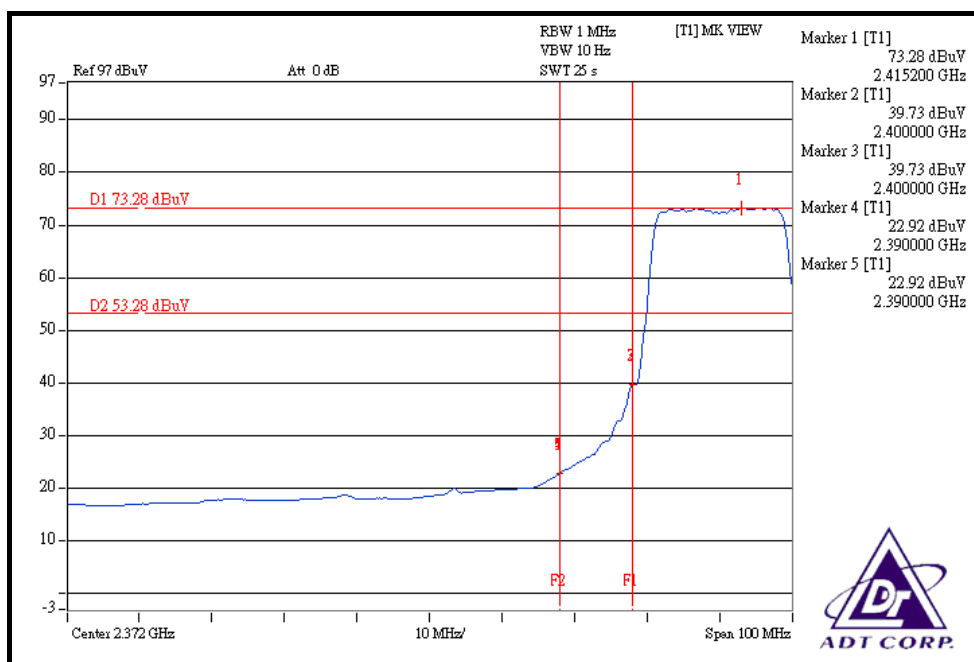
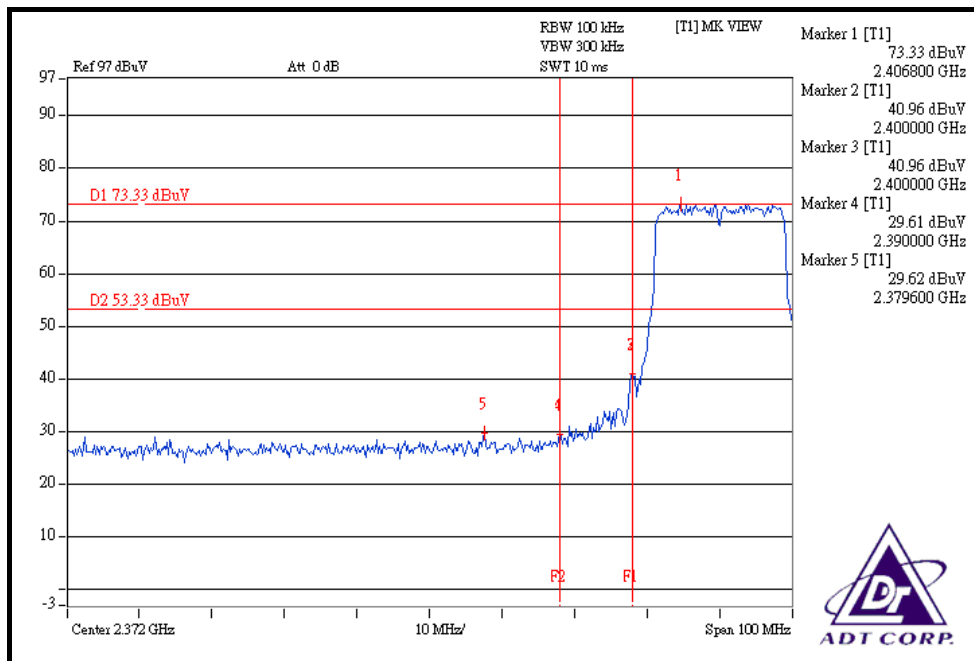

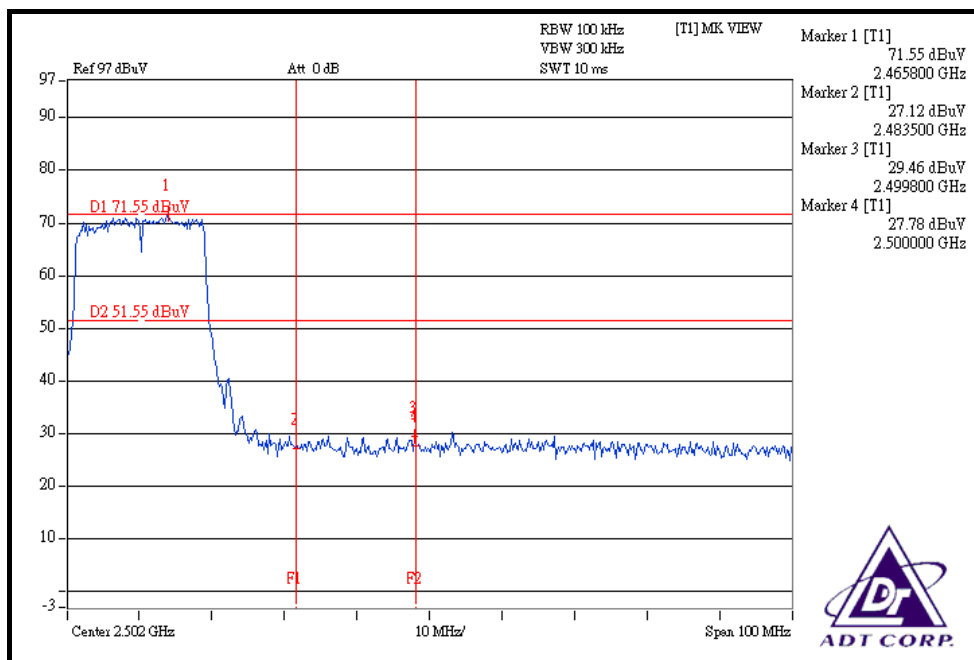
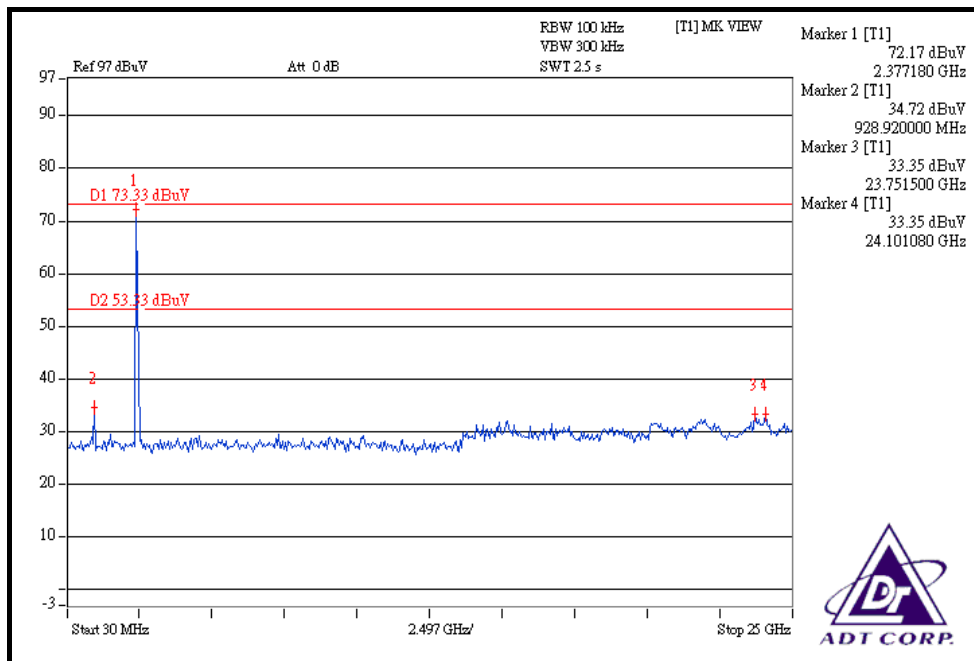

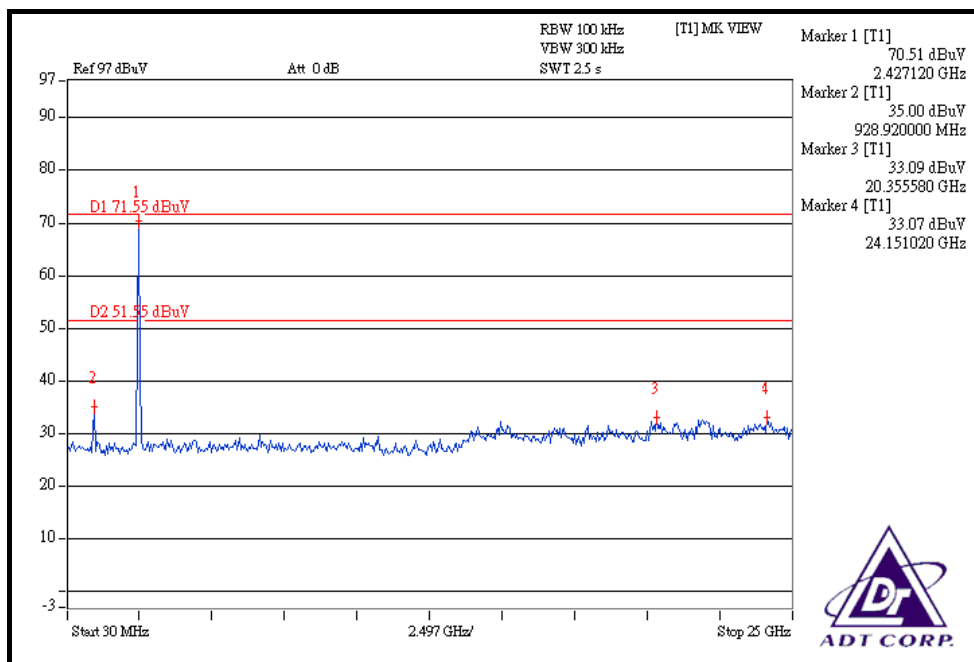
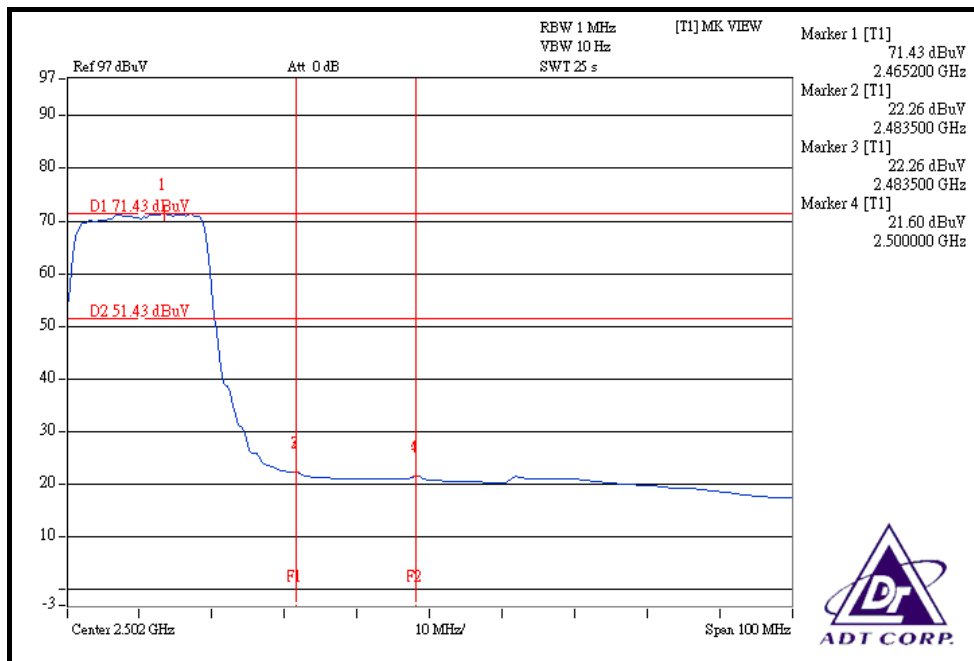

DRAFT 802.11n (40MHz) OFDM MODULATION

NOTE 1: The band edge emission plot on the next page shows 35.60dBc between carrier maximum power and local maximum emission in restrict band (2.38960GHz). The emission of carrier strength list in the test result of channel 1 at the item 4.2.7 is 105.18dBuV/m (Peak), so the maximum field strength in restrict band is $105.18 - 35.60 = 69.58$ dBuV/m which is under 74dBuV/m limit.

The band edge emission plot on the next page shows 45.22dBc between carrier maximum power and local maximum emission in restrict band (2.39000GHz). The emission of carrier strength list in the test result of channel 1 at the item 4.2.7 is 94.79dBuV/m (Average), so the maximum field strength in restrict band is $94.79 - 45.22 = 49.57$ dBuV/m which is under 54dBuV/m limit.

NOTE 2: The band edge emission plot on the next second page shows 36.29dBc between carrier maximum power and local maximum emission in restrict band (2.49320GHz). The emission of carrier strength list in the test result of channel 7 at the item 4.2.7 is 104.28dBuV/m (Peak), so the maximum field strength in restrict band is $104.28 - 36.29 = 67.99$ dBuV/m which is under 74dBuV/m limit.

The band edge emission plot on the next third page shows 44.38dBc between carrier maximum power and local maximum emission in restrict band (2.48400GHz). The emission of carrier strength list in the test result of channel 7 at the item 4.2.7 is 93.71dBuV/m (Average), so the maximum field strength in restrict band is $93.71 - 44.38 = 49.33$ dBuV/m which is under 54dBuV/m limit.

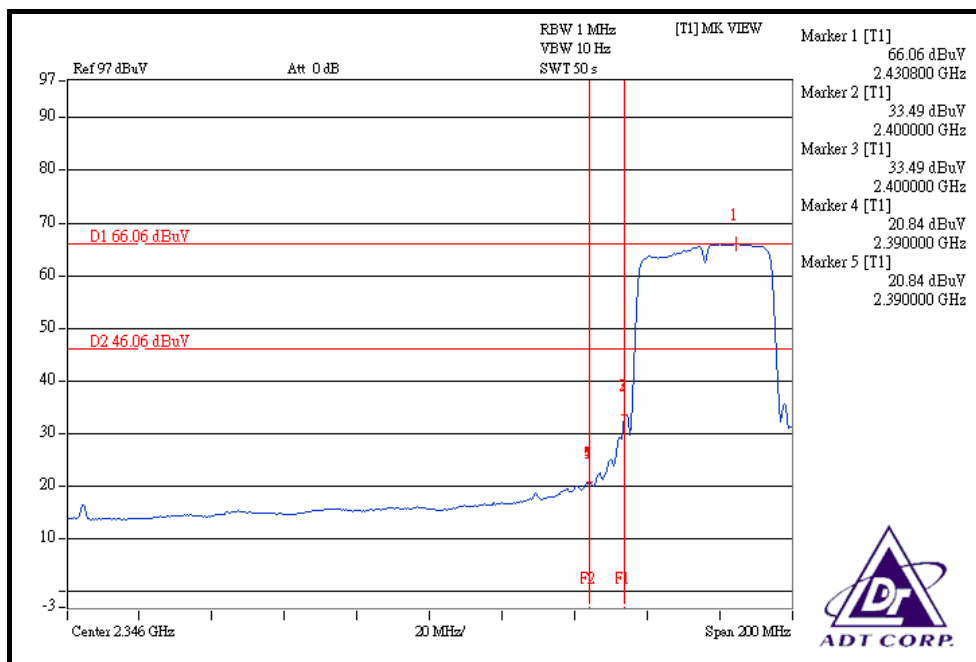
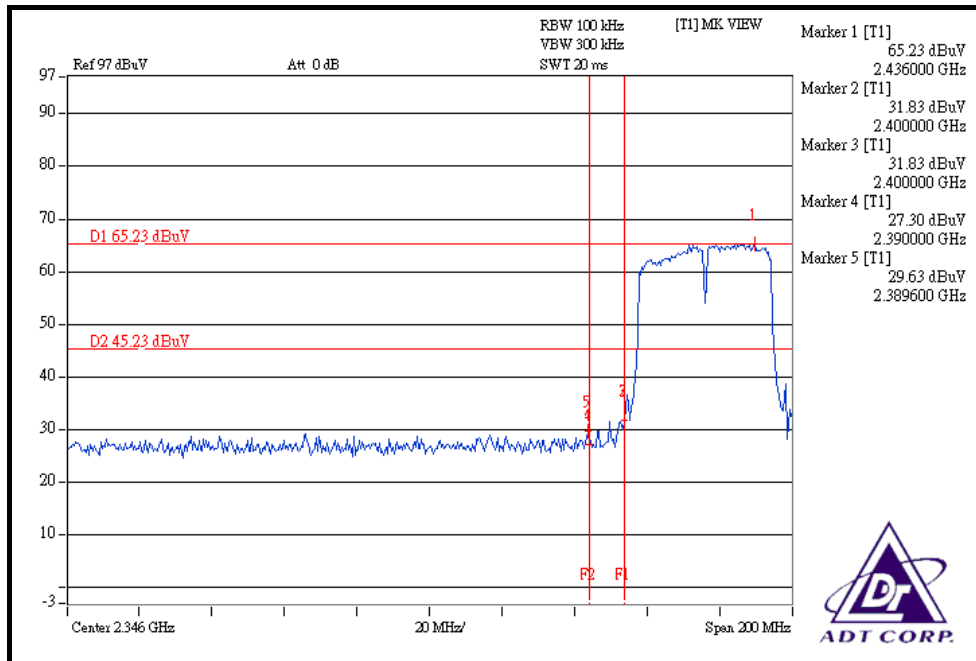

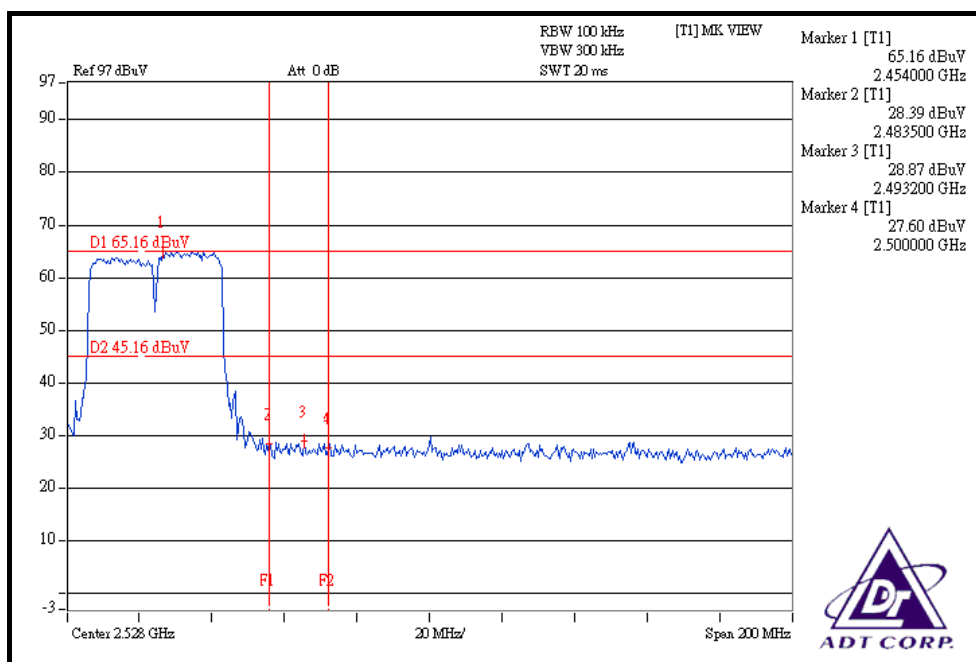
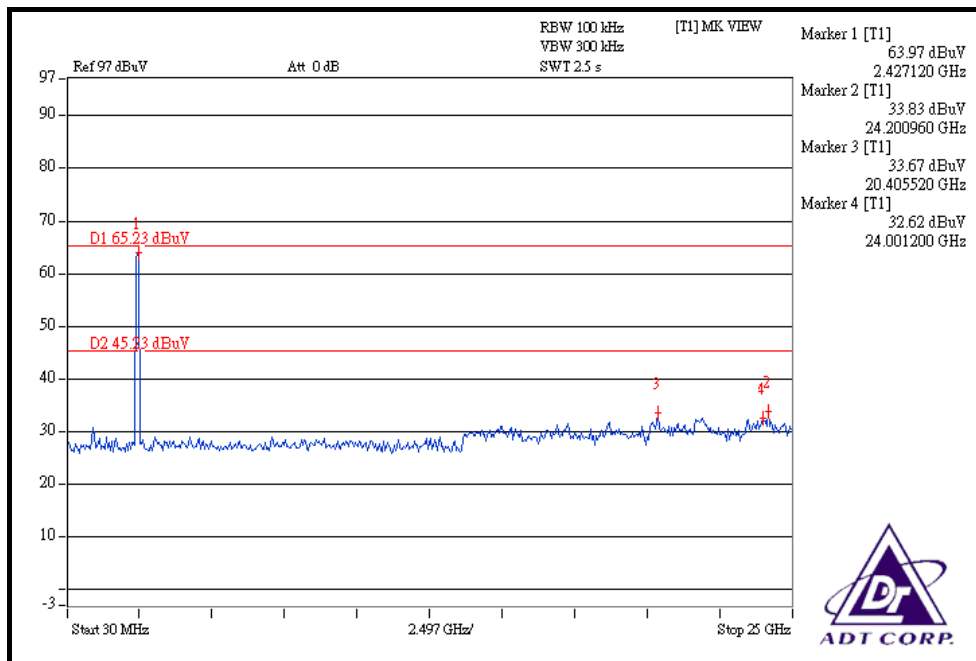

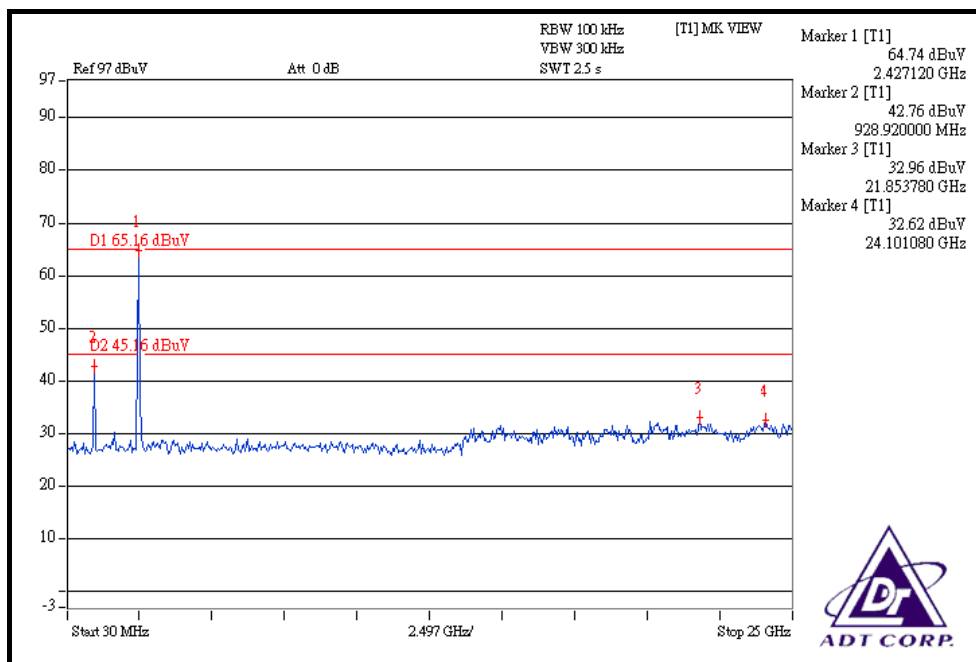
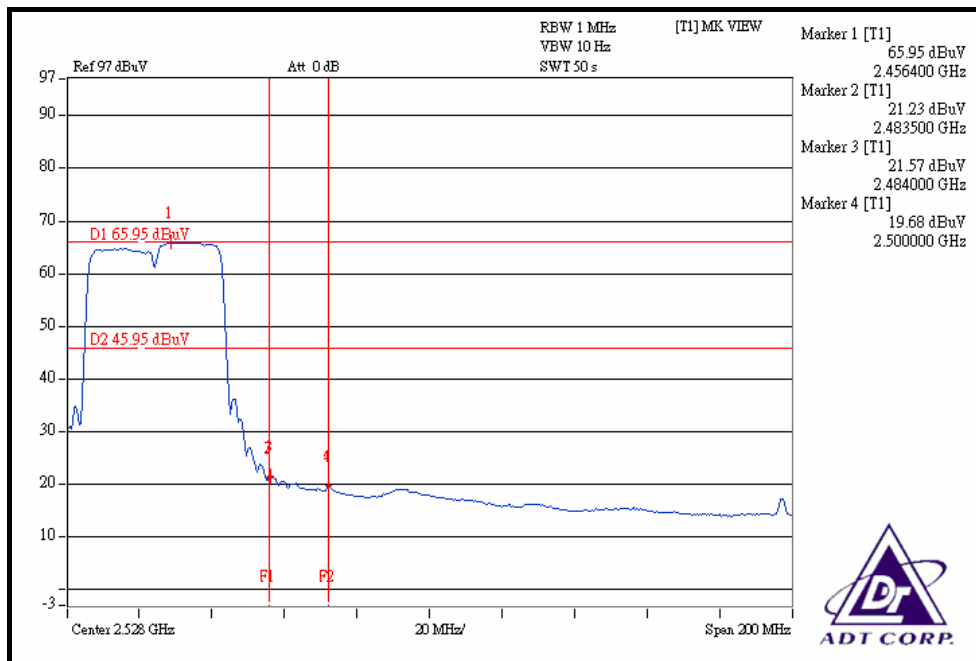



4.7 ANTENNA REQUIREMENT

4.7.1 STANDARD APPLICABLE

For intentional device, according to FCC 47 CFR Section 15.203, an intentional radiator shall be designed to ensure that no antenna other than that furnished by the responsible party shall be used with the device. And according to FCC 47 CFR Section 15.247 (b), if transmitting antennas of directional gain greater than 6dBi are used, the power shall be reduced by the amount in dB that the directional gain of the antenna exceeds 6dBi.

4.7.2 ANTENNA CONNECTED CONSTRUCTION

The antenna used in this product is Dipole antenna with R-SMA antenna connector. The maximum Gain of the antenna is 2dBi.



5. PHOTOGRAPHS OF THE TEST CONFIGURATION

Please refer to the attached file (Test Setup Photo).

--- END ---



6. INFORMATION ON THE TESTING LABORATORIES

We, ADT Corp., were founded in 1988 to provide our best service in EMC, Radio, Telecom and Safety consultation. Our laboratories are accredited and approved by the following approval agencies according to ISO/IEC 17025.

USA	FCC, UL, A2LA
Germany	TUV Rheinland
Japan	VCCI
Norway	NEMKO
Canada	INDUSTRY CANADA , CSA
R.O.C.	TAF, BSMI, NCC
Netherlands	Telefication
Singapore	GOST-ASIA(MOU)
Russia	CERTIS(MOU)

Copies of accreditation certificates of our laboratories obtained from approval agencies can be downloaded from our web site:

www.adt.com.tw/index.5/phtml. If you have any comments, please feel free to contact us at the following:

Linko EMC/RF Lab:

Tel: 886-2-26052180

Fax: 886-2-26051924

Hsin Chu EMC/RF Lab:

Tel: 886-3-5935343

Fax: 886-3-5935342

Hwa Ya EMC/RF/Safety Telecom Lab:

Tel: 886-3-3183232

Fax: 886-3-3185050

Web Site: www.adt.com.tw

The address and road map of all our labs can be found in our web site also.

7. APPENDIX A - MODIFICATIONS RECORDERS FOR ENGINEERING CHANGES TO THE EUT BY THE LAB

No any modifications are made to the EUT by the lab during the test.

--- END ---