



# FCC TEST REPORT

**REPORT NO.:** RF110919C28

**MODEL NO.:** ESR300H

**FCC ID:** U2M-SR300H

**RECEIVED:** Sep. 19, 2011

**TESTED:** Oct. 28 ~ Nov. 11, 2011

**ISSUED:** Nov. 15, 2011

**APPLICANT:** Senao Networks, Inc.

**ADDRESS:** 3F, No. 529, Chung Cheng Rd., Hsintien, Taipei,  
Taiwan, R.O.C.

**ISSUED BY:** Bureau Veritas Consumer Products Services (H.K.)  
Ltd., Taoyuan Branch

**LAB ADDRESS:** No. 47, 14th Ling, Chia Pau Vil., Lin Kou Dist., New  
Taipei City, Taiwan (R.O.C)

**TEST LOCATION:** No. 19, Hwa Ya 2nd Rd, Wen Hwa Tsuen, Kwei  
Shan Hsiang, Taoyuan Hsien 333, Taiwan, R.O.C.

This test report consists of 51 pages in total. It may be duplicated completely for legal use with the approval of the applicant. It should not be reproduced except in full, without the written approval of our laboratory. The client should not use it to claim product certification, approval or endorsement by TAF or any government agency. The test results in the report only apply to the tested sample.





# TABLE OF CONTENTS

RELEASE CONTROL RECORD.....	4
1. CERTIFICATION.....	5
2. SUMMARY OF TEST RESULTS .....	6
2.1 MEASUREMENT UNCERTAINTY.....	6
3. GENERAL INFORMATION.....	7
3.1 GENERAL DESCRIPTION OF EUT .....	7
3.2 DESCRIPTION OF TEST MODES.....	9
3.2.1 CONFIGURATION OF SYSTEM UNDER TEST .....	10
3.2.2 DESCRIPTION OF SUPPORT UNITS .....	11
3.2.3 TEST MODE APPLICABILITY AND TESTED CHANNEL DETAIL.....	12
3.3 GENERAL DESCRIPTION OF APPLIED STANDARDS .....	14
4. TEST TYPES AND RESULTS .....	15
4.1 RADIATED EMISSION MEASUREMENT .....	15
4.1.1 LIMITS OF RADIATED EMISSION MEASUREMENT.....	15
4.1.2 TEST INSTRUMENTS.....	16
4.1.3 TEST PROCEDURES .....	17
4.1.4 DEVIATION FROM TEST STANDARD .....	17
4.1.5 TEST SETUP .....	18
4.1.6 EUT OPERATING CONDITIONS .....	18
4.1.7 TEST RESULTS.....	19
4.2 CONDUCTED EMISSION MEASUREMENT .....	32
4.2.1 LIMITS OF CONDUCTED EMISSION MEASUREMENT .....	32
4.2.2 TEST INSTRUMENTS.....	32
4.2.3 TEST PROCEDURES .....	33
4.2.4 DEVIATION FROM TEST STANDARD .....	33
4.2.5 TEST SETUP .....	34
4.2.6 EUT OPERATING CONDITIONS .....	34
4.2.7 TEST RESULTS.....	35
4.3 6dB BANDWIDTH MEASUREMENT.....	37
4.3.1 LIMITS OF 6dB BANDWIDTH MEASUREMENT .....	37
4.3.2 TEST SETUP .....	37
4.3.3 TEST INSTRUMENTS.....	37
4.3.4 TEST PROCEDURE.....	37
4.3.5 DEVIATION FROM TEST STANDARD .....	37
4.3.6 EUT OPERATING CONDITIONS .....	37
4.3.7 TEST RESULTS.....	38
4.4 CONDUCTED OUTPUT POWER.....	39
4.4.1 LIMITS OF CONDUCTED OUTPUT POWER MEASUREMENT.....	39
4.4.2 TEST SETUP .....	39
4.4.3 TEST INSTRUMENTS.....	39
4.4.4 TEST PROCEDURES .....	39
4.4.5 DEVIATION FROM TEST STANDARD .....	39
4.4.6 EUT OPERATING CONDITIONS .....	39
4.4.7 TEST RESULTS.....	40
4.5 POWER SPECTRAL DENSITY MEASUREMENT.....	41
4.5.1 LIMITS OF POWER SPECTRAL DENSITY MEASUREMENT .....	41



A D T

4.5.2	TEST SETUP .....	41
4.5.3	TEST INSTRUMENTS .....	41
4.5.4	TEST PROCEDURE .....	41
4.5.5	DEVIATION FROM TEST STANDARD .....	41
4.5.6	EUT OPERATING CONDITION.....	41
4.5.7	TEST RESULTS.....	42
4.6	CONDUCTED EMISSION MEASUREMENT .....	43
4.6.1	LIMITS OF BAND EDGES MEASUREMENT.....	43
4.6.2	TEST SETUP .....	43
4.6.3	TEST INSTRUMENTS .....	43
4.6.4	TEST PROCEDURE .....	43
4.6.5	DEVIATION FROM TEST STANDARD .....	44
4.6.6	EUT OPERATING CONDITION.....	44
4.6.7	TEST RESULTS.....	44
5.	PHOTOGRAPHS OF THE TEST CONFIGURATION.....	49
6.	INFORMATION ON THE TESTING LABORATORIES .....	50
7.	APPENDIX A - MODIFICATIONS RECORDERS FOR ENGINEERING CHANGES TO THE EUT BY THE LAB .....	51



A D T

## RELEASE CONTROL RECORD

ISSUE NO.	REASON FOR CHANGE	DATE ISSUED
Original release	NA	Nov. 15, 2011



# 1. CERTIFICATION

**PRODUCT:** Wireless 300Mbps Router  
**MODEL:** ESR300H  
**BRAND:** EnGenius  
**APPLICANT:** Senao Networks, Inc.  
**TESTED:** Oct. 28 ~ Nov. 11, 2011  
**TEST SAMPLE:** ENGINEERING SAMPLE  
**STANDARDS:** **FCC Part 15, Subpart C (Section 15.247)**  
ANSI C63.4-2003  
ANSI C63.10-2009

The above equipment (model: ESR300H) has been tested by **Bureau Veritas Consumer Products Services (H.K.) Ltd., Taoyuan Branch**, and found compliance with the requirement of the above standards. The test record, data evaluation & Equipment Under Test (EUT) configurations represented herein are true and accurate accounts of the measurements of the sample's EMC characteristics under the conditions specified in this report.

PREPARED BY : Ivonne Wu , DATE : Nov. 15, 2011  
Ivonne Wu / Senior Specialist

APPROVED BY : Gary Chang , DATE : Nov. 15, 2011  
Gary Chang / Technical Manager

## 2. SUMMARY OF TEST RESULTS

The EUT has been tested according to the following specifications:

APPLIED STANDARD: FCC PART 15, SUBPART C (SECTION 15.247)			
STANDARD SECTION	TEST TYPE	RESULT	REMARK
15.207	AC Power Conducted Emission	PASS	Meet the requirement of limit. Minimum passing margin is -19.39dB at 0.162MHz.
15.247(d) 15.209	Radiated Emissions	PASS	Meet the requirement of limit. Minimum passing margin is -1.0dB at 4824.00MHz.
15.247(d)	Band Edge Measurement	PASS	Meet the requirement of limit.
15.247(a)(2)	6dB bandwidth	PASS	Meet the requirement of limit.
15.247(b)	Conducted power	PASS	Meet the requirement of limit.
15.247(e)	Power Spectral Density	PASS	Meet the requirement of limit.
15.203	Antenna Requirement	PASS	Antenna connector is RP SMA.

### 2.1 MEASUREMENT UNCERTAINTY

Where relevant, the following measurement uncertainty levels have been estimated for tests performed on the EUT as specified in CISPR 16-4-2:

MEASUREMENT	FREQUENCY	UNCERTAINTY
Conducted emissions	150kHz~30MHz	2.44 dB
Radiated emissions	30MHz ~ 200MHz	2.93 dB
	200MHz ~1000MHz	2.95 dB
	1GHz ~ 18GHz	2.26 dB
	18GHz ~ 40GHz	1.94 dB

This uncertainty represents an expanded uncertainty expressed at approximately the 95% confidence level using a coverage factor of  $k = 2$ .



### 3. GENERAL INFORMATION

#### 3.1 GENERAL DESCRIPTION OF EUT

<b>EUT</b>	Wireless 300Mbps Router
<b>MODEL NO.</b>	ESR300H
<b>FCC ID</b>	U2M-SR300H
<b>POWER SUPPLY</b>	12Vdc
<b>MODULATION TYPE</b>	CCK, DQPSK, DBPSK for DSSS 64QAM, 16QAM, QPSK, BPSK for OFDM
<b>MODULATION TECHNOLOGY</b>	DSSS, OFDM
<b>TRANSFER RATE</b>	802.11b:11.0/ 5.5/ 2.0/ 1.0Mbps 802.11g: 54.0/ 48.0/ 36.0/ 24.0/ 18.0/ 12.0/ 9.0/ 6.0Mbps 802.11n: up to 300.0Mbps
<b>OPERATING FREQUENCY</b>	2412 ~ 2462MHz
<b>NUMBER OF CHANNEL</b>	11 for 802.11b, 802.11g, 802.11n (20MHz) 7 for 802.11n (40MHz)
<b>OUTPUT POWER</b>	850.2mW
<b>ANTENNA TYPE</b>	Dipole antenna with 2dBi gain
<b>ANTENNA CONNECTOR</b>	RP SMA
<b>DATA CABLE</b>	NA
<b>I/O PORTS</b>	Refer to user's manual
<b>ACCESSORY DEVICES</b>	Adapter

**NOTE:**

1. The EUT incorporates a MIMO function. Physically, the EUT provides two completed transmitters and two receivers.

<b>MODULATION MODE</b>	<b>TX FUNCTION</b>
<b>802.11b</b>	1TX
<b>802.11g</b>	1TX
<b>802.11n (20MHz)(MCS 0-7)</b>	1TX
<b>802.11n (20MHz)(MCS 8-15)</b>	2TX
<b>802.11n (40MHz)(MCS 0-7)</b>	1TX
<b>802.11n (40MHz)(MCS 8-15)</b>	2TX



A D T

2. The EUT uses following adapter.

<b>BRAND:</b>	DVE
<b>MODEL:</b>	DSA-12G-12 FUS 120120
<b>INPUT:</b>	100-240Vac, 50/60Hz, 0.3A
<b>OUTPUT:</b>	12Vdc, 1.0A
<b>POWER LINE:</b>	1.8m non-shielded cable without core

3. The above EUT information is declared by manufacturer and for more detailed features description, please refer to the manufacturer's specifications or user's manual.



### 3.2 DESCRIPTION OF TEST MODES

11 channels are provided for 802.11b, 802.11g and 802.11n (20MHz):

CHANNEL	FREQUENCY	CHANNEL	FREQUENCY
1	2412MHz	7	2442MHz
2	2417MHz	8	2447MHz
3	2422MHz	9	2452MHz
4	2427MHz	10	2457MHz
5	2432MHz	11	2462MHz
6	2437MHz		

7 channels are provided for 802.11n (40MHz):

CHANNEL	FREQUENCY	CHANNEL	FREQUENCY
1	2422MHz	5	2442MHz
2	2427MHz	6	2447MHz
3	2432MHz	7	2452MHz
4	2437MHz		

### 3.2.1 CONFIGURATION OF SYSTEM UNDER TEST

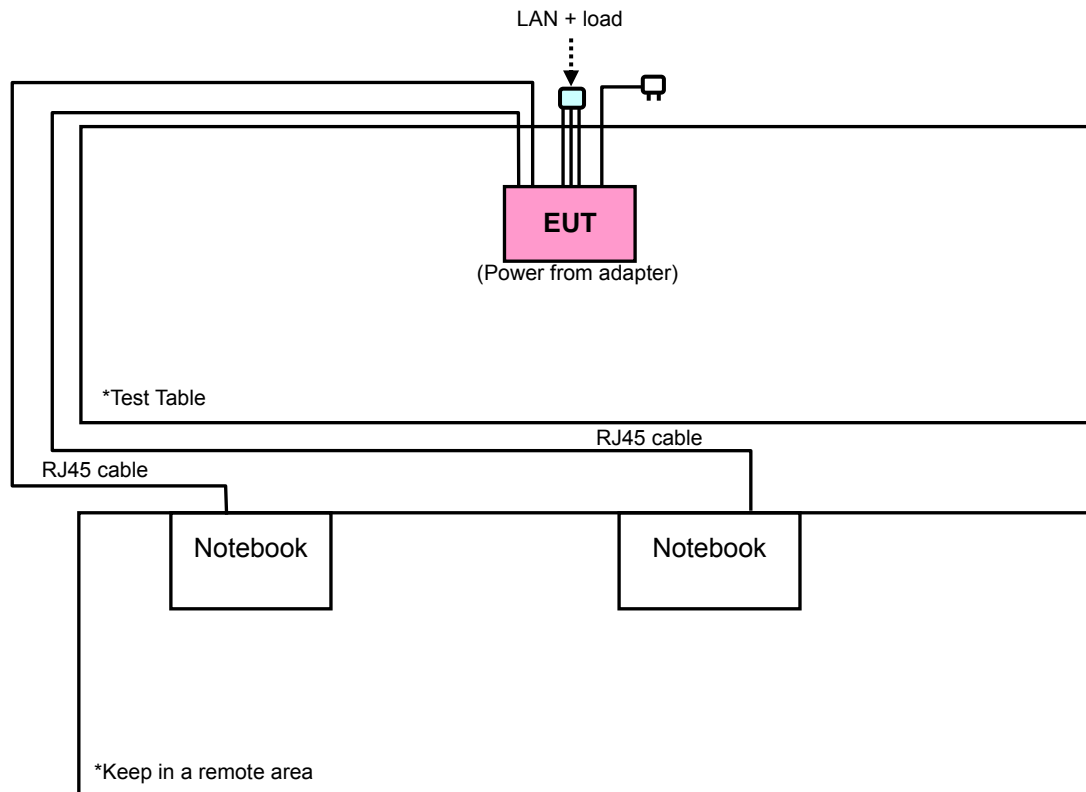

### 3.2.2 DESCRIPTION OF SUPPORT UNITS

The EUT has been tested as an independent unit together with other necessary accessories or support units. The following support units or accessories were used to form a representative test configuration during the tests.

NO.	PRODUCT	BRAND	MODEL NO.	SERIAL NO.	FCC ID
1	NOTEBOOK	DELL	D531	CN-0XM006-486 43-81U-2786	QDS-BRCM1020
2	NOTEBOOK	DELL	E5410	1HC2XM1	FCC DoC Approved

NO.	SIGNAL CABLE DESCRIPTION OF THE ABOVE SUPPORT UNITS
1	NA
2	NA

**NOTE:**

1. All power cords of the above support units are non shielded (1.8m).
2. Items 1 ~ 2 acted as communication partners to transfer data.

### 3.2.3 TEST MODE APPLICABILITY AND TESTED CHANNEL DETAIL

EUT CONFIGURE MODE	APPLICABLE TO				DESCRIPTION
	RE $\geq$ 1G	RE<1G	PLC	APCM	
-	√	√	√	√	-

Where **RE $\geq$ 1G**: Radiated Emission above 1GHz      **RE<1G**: Radiated Emission below 1GHz  
**PLC**: Power Line Conducted Emission      **APCM**: Antenna Port Conducted Measurement

#### **RADIATED EMISSION TEST (ABOVE 1GHz):**

- Pre-Scan has been conducted to determine the worst-case mode from all possible combinations between available modulations, data rates, XYZ axis and antenna ports (if EUT with antenna diversity architecture).
- Following channel(s) was (were) selected for the final test as listed below.

EUT CONFIGURE MODE	MODE	AVAILABLE CHANNEL	TESTED CHANNEL	MODULATION TECHNOLOGY	MODULATION TYPE	DATA RATE (Mbps)	AXIS
-	802.11b	1 to 11	1, 6, 11	DSSS	DBPSK	1.0	Z
-	802.11g	1 to 11	1, 6, 11	OFDM	BPSK	6.0	Z
-	802.11n (20MHz)	1 to 11	1, 6, 11	OFDM	BPSK	7.2	Z
-	802.11n (40MHz)	1 to 7	1, 4, 7	OFDM	BPSK	15.0	Z

#### **RADIATED EMISSION TEST (BELOW 1GHz):**

- Pre-Scan has been conducted to determine the worst-case mode from all possible combinations between available modulations, data rates, XYZ axis and antenna ports (if EUT with antenna diversity architecture).
- Following channel(s) was (were) selected for the final test as listed below.

EUT CONFIGURE MODE	MODE	AVAILABLE CHANNEL	TESTED CHANNEL	MODULATION TECHNOLOGY	MODULATION TYPE	DATA RATE (Mbps)	AXIS
-	802.11n (20MHz)	1 to 11	1	OFDM	BPSK	7.2	Z

#### **POWER LINE CONDUCTED EMISSION TEST:**

- Pre-Scan has been conducted to determine the worst-case mode from all possible combinations between available modulations, data rates and antenna ports (if EUT with antenna diversity architecture).
- Following channel(s) was (were) selected for the final test as listed below.

EUT CONFIGURE MODE	MODE	AVAILABLE CHANNEL	TESTED CHANNEL	MODULATION TECHNOLOGY	MODULATION TYPE	DATA RATE (Mbps)
-	802.11n (20MHz)	1 to 11	1	OFDM	BPSK	7.2

**BANDEDGE MEASUREMENT:**

- Pre-Scan has been conducted to determine the worst-case mode from all possible combinations between available modulations, data rates and antenna ports (if EUT with antenna diversity architecture).
- Following channel(s) was (were) selected for the final test as listed below.

EUT CONFIGURE MODE	MODE	AVAILABLE CHANNEL	TESTED CHANNEL	MODULATION TECHNOLOGY	MODULATION TYPE	DATA RATE (Mbps)
-	802.11b	1 to 11	1, 11	DSSS	DBPSK	1.0
-	802.11g	1 to 11	1, 11	OFDM	BPSK	6.0
-	802.11n (20MHz)	1 to 11	1, 11	OFDM	BPSK	7.2
-	802.11n (40MHz)	1 to 7	1, 7	OFDM	BPSK	15.0

**ANTENNA PORT CONDUCTED MEASUREMENT:**

- This item includes all test value of each mode, but only includes spectrum plot of worst value of each mode.
- Pre-Scan has been conducted to determine the worst-case mode from all possible combinations between available modulations, data rates and antenna ports (if EUT with antenna diversity architecture).
- Following channel(s) was (were) selected for the final test as listed below.

EUT CONFIGURE MODE	MODE	AVAILABLE CHANNEL	TESTED CHANNEL	MODULATION TECHNOLOGY	MODULATION TYPE	DATA RATE (Mbps)
-	802.11b	1 to 11	1, 6, 11	DSSS	DBPSK	1.0
-	802.11g	1 to 11	1, 6, 11	OFDM	BPSK	6.0
-	802.11n (20MHz)	1 to 11	1, 6, 11	OFDM	BPSK	7.2
-	802.11n (40MHz)	1 to 7	1, 4, 7	OFDM	BPSK	15.0

**TEST CONDITION:**

APPLICABLE TO	ENVIRONMENTAL CONDITIONS	INPUT POWER	TESTED BY
RE≥1G	25deg. C, 65%RH	120Vac, 60Hz	Antony Lee
RE<1G	25deg. C, 65%RH	120Vac, 60Hz	Antony Lee
PLC	24deg. C, 64%RH	120Vac, 60Hz	Match Tsui
APCM	25deg. C, 65%RH	120Vac, 60Hz	Antony Lee

### 3.3 GENERAL DESCRIPTION OF APPLIED STANDARDS

The EUT is a RF Product. According to the specifications of the manufacturer, it must comply with the requirements of the following standards:

**FCC Part 15, Subpart C (15.247)**

**ANSI C63.4-2003**

**ANSI C63.10-2009**

All test items have been performed and recorded as per the above standards.

**NOTE:** The EUT is also considered as a kind of computer peripheral, because the connection to computer is necessary for typical use. It has been verified to comply with the requirements of FCC Part 15, Subpart B, Class B (DoC). The test report has been issued separately.

## 4. TEST TYPES AND RESULTS

### 4.1 RADIATED EMISSION AND BANDEDGE MEASUREMENT

#### 4.1.1 LIMITS OF RADIATED AND BANDEDGE EMISSION MEASUREMENT

Radiated emissions which fall in the restricted bands, as defined in Section 15.205(a), must also comply with the radiated emission limits specified in Section 15.209(a). Other emissions shall be at least 20dB below the highest level of the desired power:

FREQUENCIES (MHz)	FIELD STRENGTH (microvolts/meter)	MEASUREMENT DISTANCE (meters)
0.009 ~ 0.490	2400/F(kHz)	300
0.490 ~ 1.705	24000/F(kHz)	30
1.705 ~ 30.0	30	30
30 ~ 88	100	3
88 ~ 216	150	3
216 ~ 960	200	3
Above 960	500	3

**NOTE:**

1. The lower limit shall apply at the transition frequencies.
2. Emission level (dBuV/m) = 20 log Emission level (uV/m).
3. As shown in 15.35(b), for frequencies above 1000MHz, the field strength limits are based on average detector, however, the peak field strength of any emission shall not exceed the maximum permitted average limits, specified above by more than 20dB under any condition of modulation.

#### 4.1.2 TEST INSTRUMENTS

DESCRIPTION & MANUFACTURER	MODEL NO.	SERIAL NO.	DATE OF CALIBRATION	DUE DATE OF CALIBRATION
Test Receiver ROHDE & SCHWARZ	ESI7	838496/016	Dec. 27, 2010	Dec. 26, 2011
Spectrum Analyzer ROHDE & SCHWARZ	FSP40	100039	Feb. 23, 2011	Feb. 22, 2012
BILOG Antenna SCHWARZBECK	VULB9168	9168-155	Apr. 12, 2011	Apr. 11, 2012
HORN Antenna SCHWARZBECK	BBHA 9120D	9120D-408	Jan. 06, 2011	Jan. 05, 2012
HORN Antenna SCHWARZBECK	BBHA 9170	BBHA9170243	Dec. 27, 2010	Dec. 26, 2011
Preamplifier Agilent	8449B	3008A01961	Oct. 29, 2011	Oct. 28, 2012
Preamplifier Agilent	8447D	2944A10738	Oct. 29, 2011	Oct. 28, 2012
RF signal cable HUBER+SUHNNER	SUCOFLEX 104	250792/4	Aug. 19, 2011	Aug. 18, 2012
RF signal cable HUBER+SUHNNER	SUCOFLEX 104	283397/4	Aug. 19, 2011	Aug. 18, 2012
RF signal cable HUBER+SUHNNER	SUCOFLEX 104	295012/4	Aug. 19, 2011	Aug. 18, 2012
Software ADT.	ADT_Radiated_V7.6.15.9.2	NA	NA	NA
Antenna Tower inn-co GmbH	MA 4000	010303	NA	NA
Antenna Tower Controller inn-co GmbH	CO2000	019303	NA	NA
Turn Table ADT.	TT100.	TT93021704	NA	NA
Turn Table Controller ADT.	SC100.	SC93021704	NA	NA
High Speed Peak Power Meter	ML2495A	0824011	Aug. 04, 2011	Aug. 03, 2012
Power Sensor	MA2411B	0738171	Aug. 04, 2011	Aug. 03, 2012

- NOTE:**
1. The calibration interval of the above test instruments is 12 months and the calibrations are traceable to NML/ROC and NIST/USA.
  2. The test was performed in HwaYa Chamber 4.
  3. The horn antenna and HP preamplifier (model: 8449B) are used only for the measurement of emission frequency above 1GHz if tested.
  4. The FCC Site Registration No. is 460141.
  5. The IC Site Registration No. is IC7450F-4.



#### 4.1.3 TEST PROCEDURES

- a. The EUT was placed on the top of a rotating table 0.8 meters above the ground at a 3 meters semi-anechoic chamber. The table was rotated 360 degrees to determine the position of the highest radiation.
- b. The EUT was set 3 meters away from the interference-receiving antenna, which was mounted on the top of a variable-height antenna tower.
- c. Height of receiving antenna is varied from one meter to four meters above the ground to determine the maximum value of the field strength. Both horizontal and vertical polarizations of the antenna are set to make the measurement.
- d. For each suspected emission, the EUT was arranged to its worst case and then the antenna was tuned to heights from 1 meter to 4 meters and the rotatable table was turned from 0 degrees to 360 degrees to find the maximum reading.
- e. The test-receiver system was set to Peak Detect Function and Specified Bandwidth with Maximum Hold Mode.
- f. If the emission level of the EUT in peak mode was lower than the limit specified, then testing could be stopped and the peak values of the EUT would be reported. Otherwise the emissions would be re-tested one by one using peak, quasi-peak or average method as specified and then reported in a data sheet.

**NOTE:**

1. The resolution bandwidth and video bandwidth of test receiver/spectrum analyzer is 120kHz for Quasi-peak detection at frequency below 1GHz.
2. The resolution bandwidth of test receiver/spectrum analyzer is 1MHz and video bandwidth is 3MHz for Peak detection at frequency above 1GHz.
3. The resolution bandwidth of test receiver/spectrum analyzer is 1MHz and the video bandwidth is 10Hz for Average detection (AV) at frequency above 1GHz.
4. All modes of operation were investigated and the worst-case emissions are reported.

#### 4.1.4 DEVIATION FROM TEST STANDARD

No deviation.

#### 4.1.5 TEST SETUP

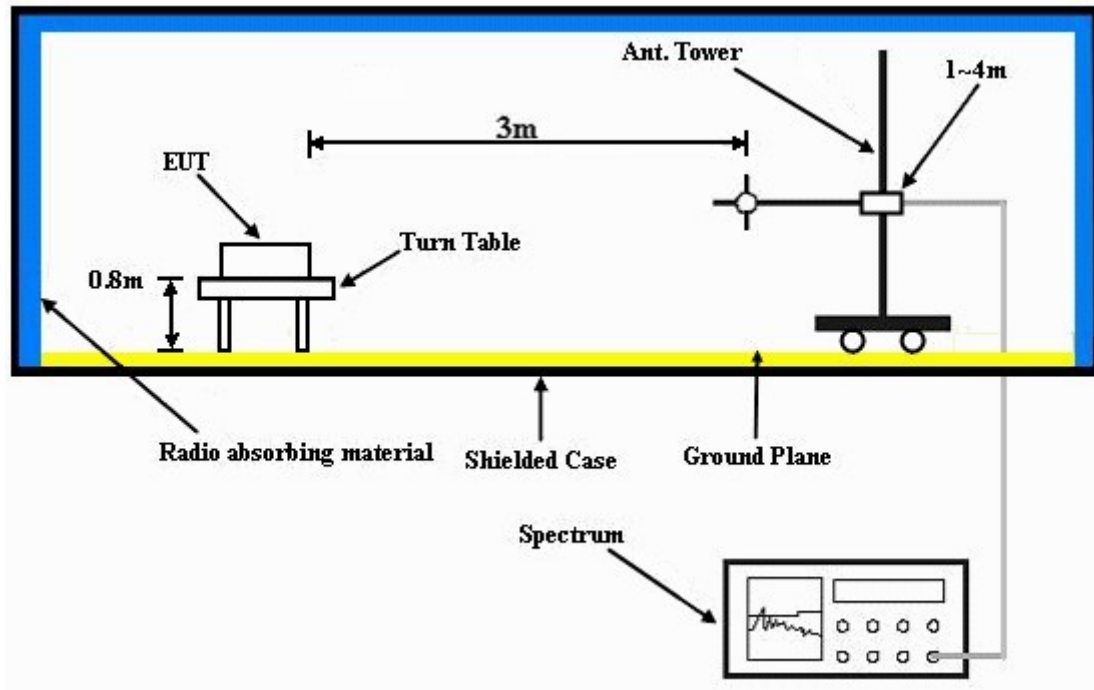

For the actual test configuration, please refer to the attached file (Test Setup Photo).

#### 4.1.6 EUT OPERATING CONDITIONS

- Placed the EUT on the testing table.
- Prepared two notebooks outside of testing area to act as communication partners.
- The communication partners connected with EUT via a RJ45 cable and run a test program (provided by manufacturer) to enable EUT under transmission condition continuously at specific channel frequency.
- The necessary accessories enable the system in full functions



A D T

## 4.1.7 TEST RESULTS

### 802.11b

EUT TEST CONDITION		MEASUREMENT DETAIL	
CHANNEL	Channel 1	FREQUENCY RANGE	1 ~ 25GHz
INPUT POWER (SYSTEM)	120Vac, 60 Hz	DETECTOR FUNCTION	Peak (PK) Average (AV)
ENVIRONMENTAL CONDITIONS	25deg. C, 65%RH	TESTED BY	Antony Lee

ANTENNA POLARITY & TEST DISTANCE: HORIZONTAL AT 3 M								
NO.	FREQ. (MHz)	EMISSION LEVEL (dBuV/m)	LIMIT (dBuV/m)	MARGIN (dB)	ANTENNA HEIGHT (m)	TABLE ANGLE (Degree)	RAW VALUE (dBuV)	CORRECTION FACTOR (dB/m)
1	2390.00	54.3 PK	74.0	-19.7	1.26 H	161	21.60	32.70
2	2390.00	44.4 AV	54.0	-9.6	1.26 H	161	11.70	32.70
3	*2412.00	100.3 PK			1.26 H	159	67.60	32.70
4	*2412.00	96.5 AV			1.26 H	159	63.80	32.70
5	4824.00	52.4 PK	74.0	-21.6	1.53 H	57	13.40	39.00
6	4824.00	47.7 AV	54.0	-6.3	1.53 H	57	8.70	39.00
ANTENNA POLARITY & TEST DISTANCE: VERTICAL AT 3 M								
NO.	FREQ. (MHz)	EMISSION LEVEL (dBuV/m)	LIMIT (dBuV/m)	MARGIN (dB)	ANTENNA HEIGHT (m)	TABLE ANGLE (Degree)	RAW VALUE (dBuV)	CORRECTION FACTOR (dB/m)
1	2390.00	54.1 PK	74.0	-19.9	1.00 V	252	21.40	32.70
2	2390.00	45.0 AV	54.0	-9.0	1.00 V	252	12.30	32.70
3	*2412.00	107.6 PK			1.02 V	252	74.90	32.70
4	*2412.00	103.7 AV			1.02 V	252	71.00	32.70
5	4824.00	56.2 PK	74.0	-17.8	1.39 V	334	17.20	39.00
6	4824.00	53.0 AV	54.0	-1.0	1.39 V	334	14.00	39.00

- REMARKS:**
1. Emission level (dBuV/m) = Raw Value (dBuV) + Correction Factor (dB/m).
  2. Correction Factor (dB/m) = Antenna Factor (dB/m) + Cable Factor (dB).
  3. The other emission levels were very low against the limit.
  4. Margin value = Emission level – Limit value.
  5. “ \* “: Fundamental frequency.



A D T

EUT TEST CONDITION		MEASUREMENT DETAIL	
CHANNEL	Channel 6	FREQUENCY RANGE	1 ~ 25GHz
INPUT POWER (SYSTEM)	120Vac, 60 Hz	DETECTOR FUNCTION	Peak (PK) Average (AV)
ENVIRONMENTAL CONDITIONS	25deg. C, 65%RH	TESTED BY	Antony Lee

ANTENNA POLARITY & TEST DISTANCE: HORIZONTAL AT 3 M								
NO.	FREQ. (MHz)	EMISSION LEVEL (dBuV/m)	LIMIT (dBuV/m)	MARGIN (dB)	ANTENNA HEIGHT (m)	TABLE ANGLE (Degree)	RAW VALUE (dBuV)	CORRECTION FACTOR (dB/m)
1	*2437.00	100.5 PK			1.07 H	142	67.70	32.80
2	*2437.00	96.4 AV			1.07 H	142	63.60	32.80
3	#3249.00	42.6 PK	80.5	-37.9	1.00 H	52	7.50	35.10
4	#3249.00	30.3 AV	76.4	-46.1	1.00 H	52	-4.80	35.10
5	4874.00	52.4 PK	74.0	-21.6	1.00 H	56	13.30	39.10
6	4874.00	45.3 AV	54.0	-8.7	1.00 H	56	6.20	39.10
ANTENNA POLARITY & TEST DISTANCE: VERTICAL AT 3 M								
NO.	FREQ. (MHz)	EMISSION LEVEL (dBuV/m)	LIMIT (dBuV/m)	MARGIN (dB)	ANTENNA HEIGHT (m)	TABLE ANGLE (Degree)	RAW VALUE (dBuV)	CORRECTION FACTOR (dB/m)
1	*2437.00	106.7 PK			1.02 V	315	73.90	32.80
2	*2437.00	103.0 AV			1.02 V	315	70.20	32.80
3	#3249.00	43.0 PK	86.7	-43.7	1.00 V	156	7.90	35.10
4	#3249.00	30.9 AV	83.0	-52.1	1.00 V	156	-4.20	35.10
5	4874.00	56.6 PK	74.0	-17.4	1.37 V	330	17.50	39.10
6	4874.00	52.9 AV	54.0	-1.1	1.37 V	330	13.80	39.10

- REMARKS:**
1. Emission level (dBuV/m) = Raw Value (dBuV) + Correction Factor (dB/m).
  2. Correction Factor (dB/m) = Antenna Factor (dB/m) + Cable Factor (dB).
  3. The other emission levels were very low against the limit.
  4. Margin value = Emission level – Limit value.
  5. “ \* “: Fundamental frequency.
  6. “#”: The radiated frequency is out the restricted band.



A D T

EUT TEST CONDITION		MEASUREMENT DETAIL	
CHANNEL	Channel 11	FREQUENCY RANGE	1 ~ 25GHz
INPUT POWER (SYSTEM)	120Vac, 60 Hz	DETECTOR FUNCTION	Peak (PK) Average (AV)
ENVIRONMENTAL CONDITIONS	25deg. C, 65%RH	TESTED BY	Antony Lee

ANTENNA POLARITY & TEST DISTANCE: HORIZONTAL AT 3 M								
NO.	FREQ. (MHz)	EMISSION LEVEL (dBuV/m)	LIMIT (dBuV/m)	MARGIN (dB)	ANTENNA HEIGHT (m)	TABLE ANGLE (Degree)	RAW VALUE (dBuV)	CORRECTION FACTOR (dB/m)
1	*2462.00	99.1 PK			1.00 H	144	66.20	32.90
2	*2462.00	95.1 AV			1.00 H	144	62.20	32.90
3	2483.50	54.2 PK	74.0	-19.8	1.00 H	144	21.20	33.00
4	2483.50	45.1 AV	54.0	-8.9	1.00 H	144	12.10	33.00
5	4924.00	51.9 PK	74.0	-22.1	1.46 H	58	12.70	39.20
6	4924.00	46.8 AV	54.0	-7.2	1.46 H	58	7.60	39.20
ANTENNA POLARITY & TEST DISTANCE: VERTICAL AT 3 M								
NO.	FREQ. (MHz)	EMISSION LEVEL (dBuV/m)	LIMIT (dBuV/m)	MARGIN (dB)	ANTENNA HEIGHT (m)	TABLE ANGLE (Degree)	RAW VALUE (dBuV)	CORRECTION FACTOR (dB/m)
1	*2462.00	106.8 PK			1.00 V	246	73.90	32.90
2	*2462.00	103.0 AV			1.00 V	246	70.10	32.90
3	2483.50	56.6 PK	74.0	-17.4	1.00 V	246	23.60	33.00
4	2483.50	46.0 AV	54.0	-8.0	1.00 V	246	13.00	33.00
5	4924.00	57.1 PK	74.0	-16.9	1.36 V	330	17.90	39.20
6	4924.00	52.9 AV	54.0	-1.1	1.36 V	330	13.70	39.20

- REMARKS:**
1. Emission level (dBuV/m) = Raw Value (dBuV) + Correction Factor (dB/m).
  2. Correction Factor (dB/m) = Antenna Factor (dB/m) + Cable Factor (dB).
  3. The other emission levels were very low against the limit.
  4. Margin value = Emission level – Limit value.
  5. “ \* “: Fundamental frequency.



802.11g

EUT TEST CONDITION		MEASUREMENT DETAIL	
CHANNEL	Channel 1	FREQUENCY RANGE	1 ~ 25GHz
INPUT POWER (SYSTEM)	120Vac, 60 Hz	DETECTOR FUNCTION	Peak (PK) Average (AV)
ENVIRONMENTAL CONDITIONS	25deg. C, 65%RH	TESTED BY	Antony Lee

ANTENNA POLARITY & TEST DISTANCE: HORIZONTAL AT 3 M								
NO.	FREQ. (MHz)	EMISSION LEVEL (dBuV/m)	LIMIT (dBuV/m)	MARGIN (dB)	ANTENNA HEIGHT (m)	TABLE ANGLE (Degree)	RAW VALUE (dBuV)	CORRECTION FACTOR (dB/m)
1	2390.00	62.4 PK	74.0	-11.6	1.21 H	171	29.70	32.70
2	2390.00	47.4 AV	54.0	-6.6	1.21 H	171	14.70	32.70
3	*2412.00	105.8 PK			1.21 H	169	73.10	32.70
4	*2412.00	96.3 AV			1.21 H	169	63.60	32.70
5	4824.00	56.8 PK	74.0	-17.2	1.00 H	38	17.80	39.00
6	4824.00	43.9 AV	54.0	-10.1	1.00 H	38	4.90	39.00
ANTENNA POLARITY & TEST DISTANCE: VERTICAL AT 3 M								
NO.	FREQ. (MHz)	EMISSION LEVEL (dBuV/m)	LIMIT (dBuV/m)	MARGIN (dB)	ANTENNA HEIGHT (m)	TABLE ANGLE (Degree)	RAW VALUE (dBuV)	CORRECTION FACTOR (dB/m)
1	2390.00	68.5 PK	74.0	-5.5	1.00 V	253	35.80	32.70
2	2390.00	52.6 AV	54.0	-1.4	1.00 V	253	19.90	32.70
3	*2412.00	112.9 PK			1.00 V	243	80.20	32.70
4	*2412.00	103.4 AV			1.00 V	243	70.70	32.70
5	4824.00	60.8 PK	74.0	-13.2	1.43 V	333	21.80	39.00
6	4824.00	47.9 AV	54.0	-6.1	1.43 V	333	8.90	39.00

- REMARKS:**
1. Emission level (dBuV/m) = Raw Value (dBuV) + Correction Factor (dB/m).
  2. Correction Factor (dB/m) = Antenna Factor (dB/m) + Cable Factor (dB).
  3. The other emission levels were very low against the limit.
  4. Margin value = Emission level – Limit value.
  5. “ \* “: Fundamental frequency.



A D T

EUT TEST CONDITION		MEASUREMENT DETAIL	
CHANNEL	Channel 6	FREQUENCY RANGE	1 ~ 25GHz
INPUT POWER (SYSTEM)	120Vac, 60 Hz	DETECTOR FUNCTION	Peak (PK) Average (AV)
ENVIRONMENTAL CONDITIONS	25deg. C, 65%RH	TESTED BY	Antony Lee

ANTENNA POLARITY & TEST DISTANCE: HORIZONTAL AT 3 M								
NO.	FREQ. (MHz)	EMISSION LEVEL (dBuV/m)	LIMIT (dBuV/m)	MARGIN (dB)	ANTENNA HEIGHT (m)	TABLE ANGLE (Degree)	RAW VALUE (dBuV)	CORRECTION FACTOR (dB/m)
1	*2437.00	106.3 PK			1.20 H	178	73.50	32.80
2	*2437.00	97.3 AV			1.20 H	178	64.50	32.80
3	#3249.00	41.8 PK	86.3	-44.5	1.05 H	46	6.70	35.10
4	#3249.00	29.6 AV	77.3	-47.7	1.05 H	46	-5.50	35.10
5	4874.00	57.3 PK	74.0	-16.7	1.00 H	45	18.20	39.10
6	4874.00	44.6 AV	54.0	-9.4	1.00 H	45	5.50	39.10
ANTENNA POLARITY & TEST DISTANCE: VERTICAL AT 3 M								
NO.	FREQ. (MHz)	EMISSION LEVEL (dBuV/m)	LIMIT (dBuV/m)	MARGIN (dB)	ANTENNA HEIGHT (m)	TABLE ANGLE (Degree)	RAW VALUE (dBuV)	CORRECTION FACTOR (dB/m)
1	*2437.00	114.4 PK			1.00 V	261	81.60	32.80
2	*2437.00	104.7 AV			1.00 V	261	71.90	32.80
3	#3249.00	42.9 PK	94.4	-51.5	1.00 V	263	7.80	35.10
4	#3249.00	30.2 AV	84.7	-54.5	1.00 V	263	-4.90	35.10
5	4874.00	64.7 PK	74.0	-9.3	1.35 V	299	25.60	39.10
6	4874.00	49.9 AV	54.0	-4.1	1.35 V	299	10.80	39.10

- REMARKS:**
1. Emission level (dBuV/m) = Raw Value (dBuV) + Correction Factor (dB/m).
  2. Correction Factor (dB/m) = Antenna Factor (dB/m) + Cable Factor (dB).
  3. The other emission levels were very low against the limit.
  4. Margin value = Emission level – Limit value.
  5. “ \* “: Fundamental frequency.
  6. “#”: The radiated frequency is out the restricted band.



A D T

EUT TEST CONDITION		MEASUREMENT DETAIL	
CHANNEL	Channel 11	FREQUENCY RANGE	1 ~ 25GHz
INPUT POWER (SYSTEM)	120Vac, 60 Hz	DETECTOR FUNCTION	Peak (PK) Average (AV)
ENVIRONMENTAL CONDITIONS	25deg. C, 65%RH	TESTED BY	Antony Lee

ANTENNA POLARITY & TEST DISTANCE: HORIZONTAL AT 3 M								
NO.	FREQ. (MHz)	EMISSION LEVEL (dBuV/m)	LIMIT (dBuV/m)	MARGIN (dB)	ANTENNA HEIGHT (m)	TABLE ANGLE (Degree)	RAW VALUE (dBuV)	CORRECTION FACTOR (dB/m)
1	*2462.00	104.9 PK			1.20 H	173	72.00	32.90
2	*2462.00	95.3 AV			1.20 H	173	62.40	32.90
3	2483.50	62.3 PK	74.0	-11.7	1.20 H	172	29.30	33.00
4	2483.50	46.8 AV	54.0	-7.2	1.20 H	172	13.80	33.00
5	4924.00	56.0 PK	74.0	-18.0	1.00 H	56	16.80	39.20
6	4924.00	42.1 AV	54.0	-11.9	1.00 H	56	2.90	39.20
ANTENNA POLARITY & TEST DISTANCE: VERTICAL AT 3 M								
NO.	FREQ. (MHz)	EMISSION LEVEL (dBuV/m)	LIMIT (dBuV/m)	MARGIN (dB)	ANTENNA HEIGHT (m)	TABLE ANGLE (Degree)	RAW VALUE (dBuV)	CORRECTION FACTOR (dB/m)
1	*2462.00	112.0 PK			1.00 V	310	79.10	32.90
2	*2462.00	102.3 AV			1.00 V	310	69.40	32.90
3	2483.50	68.1 PK	74.0	-5.9	1.00 V	218	35.10	33.00
4	2483.50	52.6 AV	54.0	-1.4	1.00 V	218	19.60	33.00
5	4924.00	59.3 PK	74.0	-14.7	1.36 V	329	20.10	39.20
6	4924.00	45.8 AV	54.0	-8.2	1.36 V	329	6.60	39.20

- REMARKS:**
1. Emission level (dBuV/m) = Raw Value (dBuV) + Correction Factor (dB/m).
  2. Correction Factor (dB/m) = Antenna Factor (dB/m) + Cable Factor (dB).
  3. The other emission levels were very low against the limit.
  4. Margin value = Emission level – Limit value.
  5. “ \* “: Fundamental frequency.





802.11n (20MHz)

EUT TEST CONDITION		MEASUREMENT DETAIL	
CHANNEL	Channel 1	FREQUENCY RANGE	1 ~ 25GHz
INPUT POWER (SYSTEM)	120Vac, 60 Hz	DETECTOR FUNCTION	Peak (PK) Average (AV)
ENVIRONMENTAL CONDITIONS	25deg. C, 65%RH	TESTED BY	Antony Lee

**ANTENNA POLARITY & TEST DISTANCE: HORIZONTAL AT 3 M**

NO.	FREQ. (MHz)	EMISSION LEVEL (dBuV/m)	LIMIT (dBuV/m)	MARGIN (dB)	ANTENNA HEIGHT (m)	TABLE ANGLE (Degree)	RAW VALUE (dBuV)	CORRECTION FACTOR (dB/m)
1	2390.00	57.8 PK	74.0	-16.2	1.00 H	223	25.10	32.70
2	2390.00	47.1 AV	54.0	-6.9	1.00 H	223	14.40	32.70
3	*2412.00	106.0 PK			1.00 H	225	73.30	32.70
4	*2412.00	94.1 AV			1.00 H	225	61.40	32.70
5	2492.00	57.2 PK	74.0	-16.8	1.22 H	325	24.20	33.00
6	2492.00	46.5 AV	54.0	-7.5	1.22 H	325	13.50	33.00
7	4824.00	55.7 PK	74.0	-18.3	1.00 H	314	16.70	39.00
8	4824.00	42.3 AV	54.0	-11.7	1.00 H	314	3.30	39.00

**ANTENNA POLARITY & TEST DISTANCE: VERTICAL AT 3 M**

NO.	FREQ. (MHz)	EMISSION LEVEL (dBuV/m)	LIMIT (dBuV/m)	MARGIN (dB)	ANTENNA HEIGHT (m)	TABLE ANGLE (Degree)	RAW VALUE (dBuV)	CORRECTION FACTOR (dB/m)
1	2390.00	61.8 PK	74.0	-12.2	1.00 V	218	29.10	32.70
2	2390.00	50.7 AV	54.0	-3.3	1.00 V	218	18.00	32.70
3	*2412.00	110.8 PK			1.00 V	209	78.10	32.70
4	*2412.00	99.5 AV			1.00 V	209	66.80	32.70
5	2492.00	61.1 PK	74.0	-12.9	1.00 V	236	28.10	33.00
6	2492.00	48.9 AV	54.0	-5.1	1.00 V	236	15.90	33.00
7	4824.00	58.8 PK	74.0	-15.2	1.36 V	1	19.80	39.00
8	4824.00	45.6 AV	54.0	-8.4	1.36 V	1	6.60	39.00

- REMARKS:**
1. Emission level (dBuV/m) = Raw Value (dBuV) + Correction Factor (dB/m).
  2. Correction Factor (dB/m) = Antenna Factor (dB/m) + Cable Factor (dB).
  3. The other emission levels were very low against the limit.
  4. Margin value = Emission level – Limit value.
  5. “ \* “: Fundamental frequency.



A D T

EUT TEST CONDITION		MEASUREMENT DETAIL	
CHANNEL	Channel 6	FREQUENCY RANGE	1 ~ 25GHz
INPUT POWER (SYSTEM)	120Vac, 60 Hz	DETECTOR FUNCTION	Peak (PK) Average (AV)
ENVIRONMENTAL CONDITIONS	25deg. C, 65%RH	TESTED BY	Antony Lee

ANTENNA POLARITY & TEST DISTANCE: HORIZONTAL AT 3 M								
NO.	FREQ. (MHz)	EMISSION LEVEL (dBuV/m)	LIMIT (dBuV/m)	MARGIN (dB)	ANTENNA HEIGHT (m)	TABLE ANGLE (Degree)	RAW VALUE (dBuV)	CORRECTION FACTOR (dB/m)
1	2377.00	61.8 PK	74.0	-12.2	1.02 H	257	29.20	32.60
2	2377.00	49.2 AV	54.0	-4.8	1.02 H	257	16.60	32.60
3	*2437.00	105.6 PK			1.00 H	225	72.80	32.80
4	*2437.00	93.6 AV			1.00 H	225	60.80	32.80
5	2497.00	62.1 PK	74.0	-11.9	1.00 H	226	29.10	33.00
6	2497.00	50.3 AV	54.0	-3.7	1.00 H	226	17.30	33.00
7	4874.00	56.2 PK	74.0	-17.8	1.00 H	320	17.10	39.10
8	4874.00	41.8 AV	54.0	-12.2	1.00 H	320	2.70	39.10

ANTENNA POLARITY & TEST DISTANCE: VERTICAL AT 3 M								
NO.	FREQ. (MHz)	EMISSION LEVEL (dBuV/m)	LIMIT (dBuV/m)	MARGIN (dB)	ANTENNA HEIGHT (m)	TABLE ANGLE (Degree)	RAW VALUE (dBuV)	CORRECTION FACTOR (dB/m)
1	2377.00	62.6 PK	74.0	-11.4	1.00 V	64	30.00	32.60
2	2377.00	50.9 AV	54.0	-3.1	1.00 V	64	18.30	32.60
3	*2437.00	110.4 PK			1.00 V	306	77.60	32.80
4	*2437.00	99.0 AV			1.00 V	306	66.20	32.80
5	2497.00	62.4 PK	74.0	-11.6	1.00 V	351	29.40	33.00
6	2497.00	51.0 AV	54.0	-3.0	1.00 V	351	18.00	33.00
7	4874.00	60.4 PK	74.0	-13.6	1.37 V	336	21.30	39.10
8	4874.00	47.0 AV	54.0	-7.0	1.37 V	336	7.90	39.10

- REMARKS:**
1. Emission level (dBuV/m) = Raw Value (dBuV) + Correction Factor (dB/m).
  2. Correction Factor (dB/m) = Antenna Factor (dB/m) + Cable Factor (dB).
  3. The other emission levels were very low against the limit.
  4. Margin value = Emission level – Limit value.
  5. “ \* “: Fundamental frequency.



A D T

EUT TEST CONDITION		MEASUREMENT DETAIL	
CHANNEL	Channel 11	FREQUENCY RANGE	1 ~ 25GHz
INPUT POWER (SYSTEM)	120Vac, 60 Hz	DETECTOR FUNCTION	Peak (PK) Average (AV)
ENVIRONMENTAL CONDITIONS	25deg. C, 65%RH	TESTED BY	Antony Lee

ANTENNA POLARITY & TEST DISTANCE: HORIZONTAL AT 3 M								
NO.	FREQ. (MHz)	EMISSION LEVEL (dBuV/m)	LIMIT (dBuV/m)	MARGIN (dB)	ANTENNA HEIGHT (m)	TABLE ANGLE (Degree)	RAW VALUE (dBuV)	CORRECTION FACTOR (dB/m)
1	2342.00	58.5 PK	74.0	-15.5	1.02 H	232	26.00	32.50
2	2342.00	48.3 AV	54.0	-5.7	1.02 H	232	15.80	32.50
3	*2462.00	105.1 PK			1.00 H	230	72.20	32.90
4	*2462.00	93.0 AV			1.00 H	230	60.10	32.90
5	2483.50	58.3 PK	74.0	-15.7	1.00 H	230	25.30	33.00
6	2483.50	47.6 AV	54.0	-6.4	1.00 H	230	14.60	33.00
7	4924.00	55.6 PK	74.0	-18.4	1.00 H	320	16.40	39.20
8	4924.00	43.1 AV	54.0	-10.9	1.00 H	320	3.90	39.20

ANTENNA POLARITY & TEST DISTANCE: VERTICAL AT 3 M								
NO.	FREQ. (MHz)	EMISSION LEVEL (dBuV/m)	LIMIT (dBuV/m)	MARGIN (dB)	ANTENNA HEIGHT (m)	TABLE ANGLE (Degree)	RAW VALUE (dBuV)	CORRECTION FACTOR (dB/m)
1	2342.00	62.3 PK	74.0	-11.7	1.00 V	189	29.80	32.50
2	2342.00	50.3 AV	54.0	-3.7	1.00 V	189	17.80	32.50
3	*2462.00	109.8 PK			1.00 V	233	76.90	32.90
4	*2462.00	98.6 AV			1.00 V	233	65.70	32.90
5	2483.50	61.5 PK	74.0	-12.5	1.00 V	234	28.50	33.00
6	2483.50	50.3 AV	54.0	-3.7	1.00 V	234	17.30	33.00
7	4924.00	58.9 PK	74.0	-15.1	1.51 V	358	19.70	39.20
8	4924.00	45.2 AV	54.0	-8.8	1.51 V	358	6.00	39.20

- REMARKS:**
1. Emission level (dBuV/m) = Raw Value (dBuV) + Correction Factor (dB/m).
  2. Correction Factor (dB/m) = Antenna Factor (dB/m) + Cable Factor (dB).
  3. The other emission levels were very low against the limit.
  4. Margin value = Emission level – Limit value.
  5. “ \* “: Fundamental frequency.



802.11n (40MHz)

EUT TEST CONDITION		MEASUREMENT DETAIL	
CHANNEL	Channel 1	FREQUENCY RANGE	1 ~ 25GHz
INPUT POWER (SYSTEM)	120Vac, 60 Hz	DETECTOR FUNCTION	Peak (PK) Average (AV)
ENVIRONMENTAL CONDITIONS	25deg. C, 65%RH	TESTED BY	Antony Lee

ANTENNA POLARITY & TEST DISTANCE: HORIZONTAL AT 3 M								
NO.	FREQ. (MHz)	EMISSION LEVEL (dBuV/m)	LIMIT (dBuV/m)	MARGIN (dB)	ANTENNA HEIGHT (m)	TABLE ANGLE (Degree)	RAW VALUE (dBuV)	CORRECTION FACTOR (dB/m)
1	2390.00	60.7 PK	74.0	-13.3	1.00 H	231	28.00	32.70
2	2390.00	47.4 AV	54.0	-6.6	1.00 H	231	14.70	32.70
3	*2422.00	103.6 PK			1.00 H	229	70.80	32.80
4	*2422.00	92.5 AV			1.00 H	229	59.70	32.80
5	4844.00	50.5 PK	74.0	-23.5	1.68 H	34	11.50	39.00
6	4844.00	38.6 AV	54.0	-15.4	1.68 H	34	-0.40	39.00
ANTENNA POLARITY & TEST DISTANCE: VERTICAL AT 3 M								
NO.	FREQ. (MHz)	EMISSION LEVEL (dBuV/m)	LIMIT (dBuV/m)	MARGIN (dB)	ANTENNA HEIGHT (m)	TABLE ANGLE (Degree)	RAW VALUE (dBuV)	CORRECTION FACTOR (dB/m)
1	2390.00	63.5 PK	74.0	-10.5	1.00 V	51	30.80	32.70
2	2390.00	50.0 AV	54.0	-4.0	1.00 V	51	17.30	32.70
3	*2422.00	107.2 PK			1.00 V	213	74.40	32.80
4	*2422.00	96.5 AV			1.00 V	213	63.70	32.80
5	4844.00	54.2 PK	74.0	-19.8	1.51 V	2	15.20	39.00
6	4844.00	40.8 AV	54.0	-13.2	1.51 V	2	1.80	39.00

- REMARKS:**
1. Emission level (dBuV/m) = Raw Value (dBuV) + Correction Factor (dB/m).
  2. Correction Factor (dB/m) = Antenna Factor (dB/m) + Cable Factor (dB).
  3. The other emission levels were very low against the limit.
  4. Margin value = Emission level – Limit value.
  5. “ \* “: Fundamental frequency.



A D T

EUT TEST CONDITION		MEASUREMENT DETAIL	
CHANNEL	Channel 4	FREQUENCY RANGE	1 ~ 25GHz
INPUT POWER (SYSTEM)	120Vac, 60 Hz	DETECTOR FUNCTION	Peak (PK) Average (AV)
ENVIRONMENTAL CONDITIONS	25deg. C, 65%RH	TESTED BY	Antony Lee

**ANTENNA POLARITY & TEST DISTANCE: HORIZONTAL AT 3 M**

NO.	FREQ. (MHz)	EMISSION LEVEL (dBuV/m)	LIMIT (dBuV/m)	MARGIN (dB)	ANTENNA HEIGHT (m)	TABLE ANGLE (Degree)	RAW VALUE (dBuV)	CORRECTION FACTOR (dB/m)
1	2377.00	57.2 PK	74.0	-16.8	1.02 H	349	24.60	32.60
2	2377.00	48.5 AV	54.0	-5.5	1.02 H	349	15.90	32.60
3	2390.00	57.5 PK	74.0	-16.5	1.00 H	253	24.80	32.70
4	2390.00	48.3 AV	54.0	-5.7	1.00 H	253	15.60	32.70
5	*2437.00	103.2 PK			1.00 H	253	70.40	32.80
6	*2437.00	92.0 AV			1.00 H	253	59.20	32.80
7	2497.00	63.8 PK	74.0	-10.2	1.00 H	65	30.80	33.00
8	2497.00	52.9 AV	54.0	-1.1	1.00 H	65	19.90	33.00
9	4874.00	50.6 PK	74.0	-23.4	1.59 H	19	11.50	39.10
10	4874.00	39.4 AV	54.0	-14.6	1.59 H	19	0.30	39.10

**ANTENNA POLARITY & TEST DISTANCE: VERTICAL AT 3 M**

NO.	FREQ. (MHz)	EMISSION LEVEL (dBuV/m)	LIMIT (dBuV/m)	MARGIN (dB)	ANTENNA HEIGHT (m)	TABLE ANGLE (Degree)	RAW VALUE (dBuV)	CORRECTION FACTOR (dB/m)
1	2377.00	62.4 PK	74.0	-11.6	1.02 V	187	29.80	32.60
2	2377.00	50.0 AV	54.0	-4.0	1.02 V	187	17.40	32.60
3	2390.00	60.8 PK	74.0	-13.2	1.00 V	51	28.10	32.70
4	2390.00	50.5 AV	54.0	-3.5	1.00 V	51	17.80	32.70
5	*2437.00	106.8 PK			1.49 V	25	74.00	32.80
6	*2437.00	96.0 AV			1.49 V	25	63.20	32.80
7	2497.00	62.5 PK	74.0	-11.5	1.12 V	174	29.50	33.00
8	2497.00	51.0 AV	54.0	-3.0	1.12 V	174	18.00	33.00
9	4874.00	55.3 PK	74.0	-18.7	1.45 V	4	16.20	39.10
10	4874.00	41.2 AV	54.0	-12.8	1.45 V	4	2.10	39.10

- REMARKS:**
1. Emission level (dBuV/m) = Raw Value (dBuV) + Correction Factor (dB/m).
  2. Correction Factor (dB/m) = Antenna Factor (dB/m) + Cable Factor (dB).
  3. The other emission levels were very low against the limit.
  4. Margin value = Emission level – Limit value.
  5. “ \* “: Fundamental frequency.



A D T

EUT TEST CONDITION		MEASUREMENT DETAIL	
CHANNEL	Channel 7	FREQUENCY RANGE	1 ~ 25GHz
INPUT POWER (SYSTEM)	120Vac, 60 Hz	DETECTOR FUNCTION	Peak (PK) Average (AV)
ENVIRONMENTAL CONDITIONS	25deg. C, 65%RH	TESTED BY	Antony Lee

**ANTENNA POLARITY & TEST DISTANCE: HORIZONTAL AT 3 M**

NO.	FREQ. (MHz)	EMISSION LEVEL (dBuV/m)	LIMIT (dBuV/m)	MARGIN (dB)	ANTENNA HEIGHT (m)	TABLE ANGLE (Degree)	RAW VALUE (dBuV)	CORRECTION FACTOR (dB/m)
1	2332.00	55.7 PK	74.0	-18.3	1.04 H	153	23.30	32.40
2	2332.00	47.9 AV	54.0	-6.1	1.04 H	153	15.50	32.40
3	*2452.00	102.8 PK			1.00 H	230	69.90	32.90
4	*2452.00	91.5 AV			1.00 H	230	58.60	32.90
5	2483.50	58.6 PK	74.0	-15.4	1.00 H	230	25.60	33.00
6	2483.50	50.2 AV	54.0	-3.8	1.00 H	230	17.20	33.00
7	2492.00	56.2 PK	74.0	-17.8	1.32 H	217	23.20	33.00
8	2492.00	48.0 AV	54.0	-6.0	1.32 H	217	15.00	33.00
9	4904.00	51.2 PK	74.0	-22.8	1.58 H	36	12.00	39.20
10	4904.00	39.3 AV	54.0	-14.7	1.58 H	36	0.10	39.20

**ANTENNA POLARITY & TEST DISTANCE: VERTICAL AT 3 M**

NO.	FREQ. (MHz)	EMISSION LEVEL (dBuV/m)	LIMIT (dBuV/m)	MARGIN (dB)	ANTENNA HEIGHT (m)	TABLE ANGLE (Degree)	RAW VALUE (dBuV)	CORRECTION FACTOR (dB/m)
1	2332.00	62.4 PK	74.0	-11.6	1.00 V	193	30.00	32.40
2	2332.00	50.0 AV	54.0	-4.0	1.00 V	193	17.60	32.40
3	*2452.00	106.2 PK			1.00 V	181	73.30	32.90
4	*2452.00	95.3 AV			1.00 V	181	62.40	32.90
5	2483.50	62.4 PK	74.0	-11.6	1.00 V	189	29.40	33.00
6	2483.50	50.8 AV	54.0	-3.2	1.00 V	189	17.80	33.00
7	2492.00	62.3 PK	74.0	-11.7	1.00 V	311	29.30	33.00
8	2492.00	50.0 AV	54.0	-4.0	1.00 V	311	17.00	33.00
9	4904.00	55.3 PK	74.0	-18.7	1.45 V	3	16.10	39.20
10	4904.00	41.6 AV	54.0	-12.4	1.45 V	3	2.40	39.20

- REMARKS:**
1. Emission level (dBuV/m) = Raw Value (dBuV) + Correction Factor (dB/m).
  2. Correction Factor (dB/m) = Antenna Factor (dB/m) + Cable Factor (dB).
  3. The other emission levels were very low against the limit.
  4. Margin value = Emission level – Limit value.
  5. “ \* “: Fundamental frequency.



A D T

**BELOW 1GHz WORST-CASE DATA : 802.11n (20MHz)**

EUT TEST CONDITION		MEASUREMENT DETAIL	
CHANNEL	Channel 1	FREQUENCY RANGE	Below 1000MHz
INPUT POWER (SYSTEM)	120Vac, 60 Hz	DETECTOR FUNCTION	Quasi-Peak
ENVIRONMENTAL CONDITIONS	25deg. C, 65%RH	TESTED BY	Antony Lee

**ANTENNA POLARITY & TEST DISTANCE: HORIZONTAL AT 3 M**

NO.	FREQ. (MHz)	EMISSION LEVEL (dBuV/m)	LIMIT (dBuV/m)	MARGIN (dB)	ANTENNA HEIGHT (m)	TABLE ANGLE (Degree)	RAW VALUE (dBuV)	CORRECTION FACTOR (dB/m)
1	45.45	34.3 QP	40.0	-5.7	1.25 H	223	19.30	15.00
2	156.28	36.8 QP	43.5	-6.7	1.75 H	247	22.00	14.80
3	261.27	38.7 QP	46.0	-7.3	1.00 H	241	24.80	13.90
4	469.31	34.0 QP	46.0	-12.0	1.75 H	133	13.50	20.50
5	626.80	36.1 QP	46.0	-9.9	1.50 H	328	12.00	24.10
6	784.28	32.0 QP	46.0	-14.0	1.00 H	250	5.00	27.00

**ANTENNA POLARITY & TEST DISTANCE: VERTICAL AT 3 M**

NO.	FREQ. (MHz)	EMISSION LEVEL (dBuV/m)	LIMIT (dBuV/m)	MARGIN (dB)	ANTENNA HEIGHT (m)	TABLE ANGLE (Degree)	RAW VALUE (dBuV)	CORRECTION FACTOR (dB/m)
1	43.82	37.7 QP	40.0	-2.3	1.73 V	279	22.90	14.80
2	107.67	34.3 QP	43.5	-9.2	1.25 V	220	22.60	11.70
3	313.77	34.6 QP	46.0	-11.4	1.50 V	223	18.80	15.80
4	469.31	33.1 QP	46.0	-12.9	1.00 V	253	12.60	20.50
5	626.80	40.2 QP	46.0	-5.8	1.00 V	304	16.10	24.10
6	784.28	38.7 QP	46.0	-7.3	1.75 V	151	11.70	27.00

- REMARKS:**
1. Emission level (dBuV/m) = Raw Value (dBuV) + Correction Factor (dB/m).
  2. Correction Factor (dB/m) = Antenna Factor (dB/m) + Cable Factor (dB).
  3. The other emission levels were very low against the limit.
  4. Margin value = Emission level – Limit value.

## 4.2 CONDUCTED EMISSION MEASUREMENT

### 4.2.1 LIMITS OF CONDUCTED EMISSION MEASUREMENT

FREQUENCY OF EMISSION (MHz)	CONDUCTED LIMIT (dB $\mu$ V)	
	Quasi-peak	Average
0.15 ~ 0.5	66 to 56	56 to 46
0.5 ~ 5	56	46
5 ~ 30	60	50

- NOTE:**
1. The lower limit shall apply at the transition frequencies.
  2. The limit decreases in line with the logarithm of the frequency in the range of 0.15 to 0.50MHz.
  3. All emanations from a class A/B digital device or system, including any network of conductors and apparatus connected thereto, shall not exceed the level of field strengths specified above.

### 4.2.2 TEST INSTRUMENTS

DESCRIPTION & MANUFACTURER	MODEL NO.	SERIAL NO.	DATE OF CALIBRATION	DUE DATE OF CALIBRATION
Test Receiver ROHDE & SCHWARZ	ESCS30	100291	Nov. 30, 2010	Nov. 29, 2011
RF signal cable Woken	5D-FB	Cable-HYC01-01	Dec. 30, 2010	Dec. 29, 2011
LISN ROHDE & SCHWARZ	ESH3-Z5	100312	Jul. 07, 2011	Jul. 06, 2012
LISN ROHDE & SCHWARZ	ESH2-Z5	100100	Jan. 06, 2011	Jan. 05, 2012
LISN ROHDE & SCHWARZ	ESH3-Z5	835239/001	Feb. 22, 2011	Feb. 21, 2012
V-LISN SCHWARZBECK	NNBL 8226-2	8226-142	Jun. 30, 2011	Jun. 29, 2012
LISN ROHDE & SCHWARZ	ENV216	100072	Jun. 10, 2011	Jun. 09, 2012
Software ADT	ADT_Cond_ V7.3.7	NA	NA	NA

- NOTE:**
1. The calibration interval of the above test instruments is 12 months and the calibrations are traceable to NML/ROC and NIST/USA.
  2. The test was performed in HwaYa Shielded Room 1.
  3. The VCCI Site Registration No. is C-2040.



#### 4.2.3 TEST PROCEDURES

- a. The EUT was placed 0.4 meters from the conducting wall of the shielded room with EUT being connected to the power mains through a line impedance stabilization network (LISN). Other support units were connected to the power mains through another LISN. The two LISNs provide 50 ohm/ 50uH of coupling impedance for the measuring instrument.
- b. Both lines of the power mains connected to the EUT were checked for maximum conducted interference.
- c. The frequency range from 150kHz to 30MHz was searched. Emission levels under (Limit - 20dB) was not recorded.

**NOTE:** All modes of operation were investigated and the worst-case emissions are reported.

#### 4.2.4 DEVIATION FROM TEST STANDARD

No deviation.

#### 4.2.5 TEST SETUP

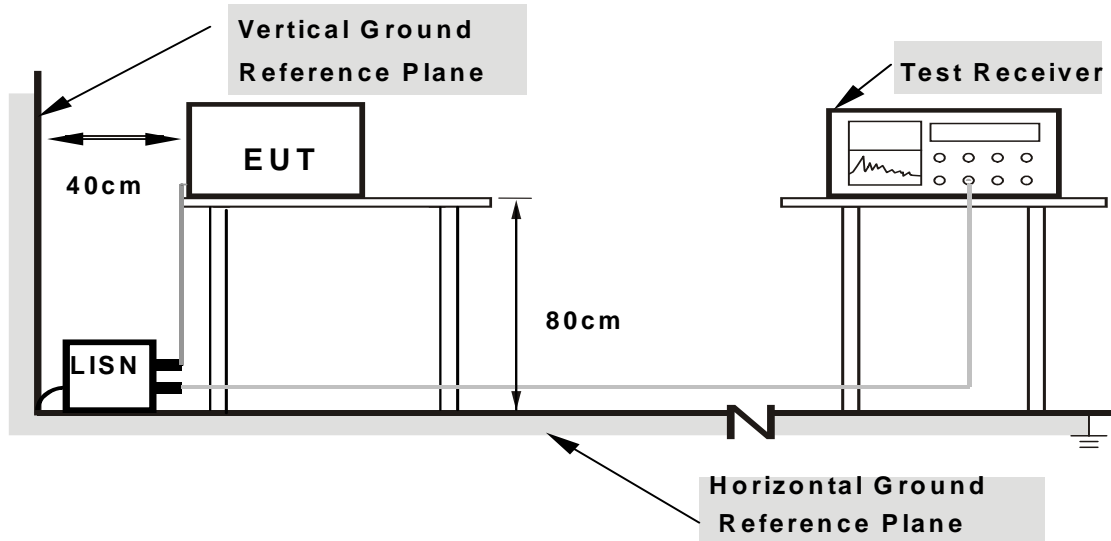

- Note:**
1. Support units were connected to second LISN.
  2. Both of LISNs (AMN) are 80 cm from EUT and at least 80 from other units and other metal planes

For the actual test configuration, please refer to the attached file (Test Setup Photo).

#### 4.2.6 EUT OPERATING CONDITIONS

Same as 4.1.6.

## 4.2.7 TEST RESULTS

### CONDUCTED WORST-CASE DATA : 802.11b

PHASE	Line 1	6dB BANDWIDTH	9kHz
-------	--------	---------------	------

No	Freq. [MHz]	Corr.	Reading Value		Emission Level		Limit		Margin	
		Factor	[dB (uV)]		[dB (uV)]		[dB (uV)]		(dB)	
		(dB)	Q.P.	AV.	Q.P.	AV.	Q.P.	AV.	Q.P.	AV.
1	0.162	0.12	45.87	32.12	45.99	32.24	65.38	55.38	-19.39	-23.14
2	0.255	0.12	40.55	29.90	40.67	30.02	61.58	51.58	-20.91	-21.56
3	0.771	0.14	25.45	13.26	25.59	13.40	56.00	46.00	-30.41	-32.60
4	4.570	0.34	31.74	18.83	32.08	19.17	56.00	46.00	-23.92	-26.83
5	14.547	0.86	30.48	17.32	31.34	18.18	60.00	50.00	-28.66	-31.82
6	22.996	1.27	28.16	14.59	29.43	15.86	60.00	50.00	-30.57	-34.14

- REMARKS:**
1. Q.P. and AV. are abbreviations of quasi-peak and average individually.
  2. "-": The Quasi-peak reading value also meets average limit and measurement with the average detector is unnecessary.
  3. The emission levels of other frequencies were very low against the limit.
  4. Margin value = Emission level - Limit value
  5. Correction factor = Insertion loss + Cable loss
  6. Emission Level = Correction Factor + Reading Value.

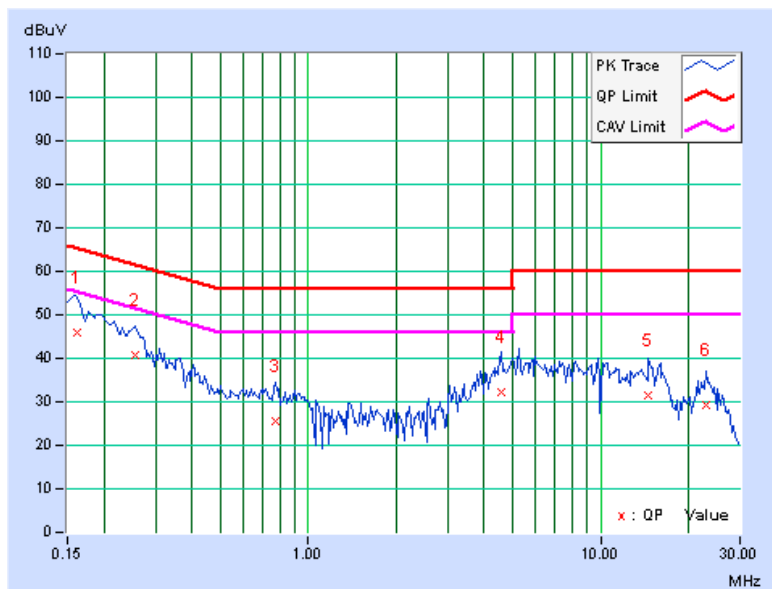

PHASE	Line 2	6dB BANDWIDTH	9kHz
-------	--------	---------------	------

No	Freq. [MHz]	Corr.	Reading Value		Emission Level		Limit		Margin	
		Factor	[dB (uV)]		[dB (uV)]		[dB (uV)]		(dB)	
		(dB)	Q.P.	AV.	Q.P.	AV.	Q.P.	AV.	Q.P.	AV.
1	0.162	0.13	45.53	27.92	45.66	28.05	65.38	55.38	-19.72	-27.33
2	0.255	0.13	39.83	28.53	39.96	28.66	61.58	51.58	-21.61	-22.91
3	0.724	0.16	21.57	9.22	21.73	9.38	56.00	46.00	-34.27	-36.62
4	4.621	0.35	29.21	16.85	29.56	17.20	56.00	46.00	-26.44	-28.80
5	15.527	0.77	26.98	14.13	27.75	14.90	60.00	50.00	-32.25	-35.10
6	23.496	1.06	26.17	10.80	27.23	11.86	60.00	50.00	-32.77	-38.14

- REMARKS:**
1. Q.P. and AV. are abbreviations of quasi-peak and average individually.
  2. "-": The Quasi-peak reading value also meets average limit and measurement with the average detector is unnecessary.
  3. The emission levels of other frequencies were very low against the limit.
  4. Margin value = Emission level - Limit value
  5. Correction factor = Insertion loss + Cable loss
  6. Emission Level = Correction Factor + Reading Value.

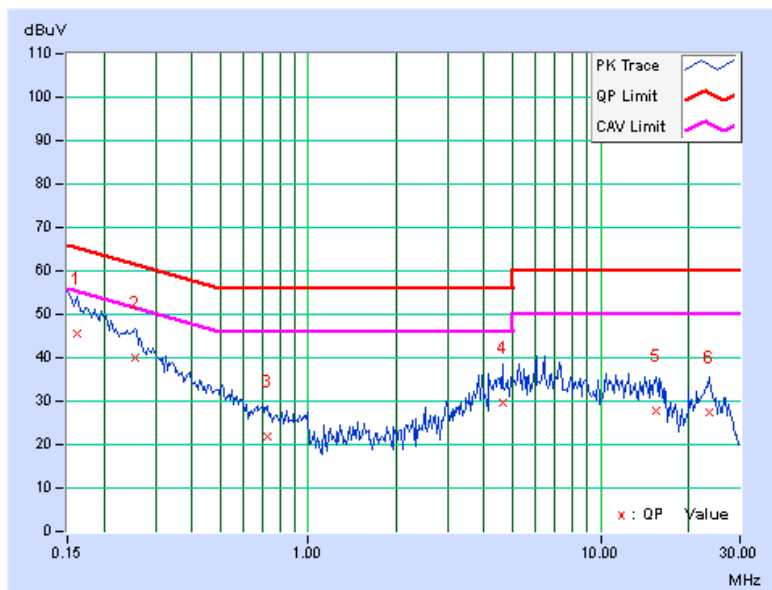

### 4.3 6dB BANDWIDTH MEASUREMENT

#### 4.3.1 LIMITS OF 6dB BANDWIDTH MEASUREMENT

The minimum of 6dB Bandwidth Measurement is 0.5 MHz.

#### 4.3.2 TEST SETUP

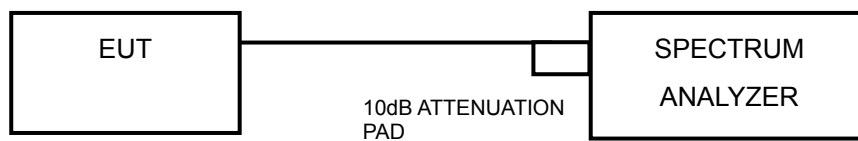

#### 4.3.3 TEST INSTRUMENTS

Refer to section 4.1.2 to get information of above instrument.

#### 4.3.4 TEST PROCEDURE

1. Set resolution bandwidth (RBW) = approximately 1% of the emission bandwidth
2. Set the video bandwidth (VBW)  $\geq 3 \times$  RBW, Detector = Peak.
3. Trace mode = max hold.
4. Sweep = auto couple.
5. Measure the maximum width of the emission that is constrained by the frequencies associated with the two amplitude points (upper and lower) that are attenuated by 6 dB relative to the maximum level measured in the fundamental emission

#### 4.3.5 DEVIATION FROM TEST STANDARD

No deviation.

#### 4.3.6 EUT OPERATING CONDITIONS

The software provided by client to enable the EUT under transmission condition continuously at lowest, middle and highest channel frequencies individually.



### 4.3.7 TEST RESULTS

#### 802.11b

CHANNEL	FREQUENCY (MHz)	6dB BANDWIDTH (MHz)	MINIMUM LIMIT (MHz)	PASS / FAIL
1	2412	10.24	0.5	PASS
6	2437	10.20	0.5	PASS
11	2462	10.20	0.5	PASS

#### 802.11g

CHANNEL	FREQUENCY (MHz)	6dB BANDWIDTH (MHz)	MINIMUM LIMIT (MHz)	PASS / FAIL
1	2412	16.49	0.5	PASS
6	2437	16.48	0.5	PASS
11	2462	16.53	0.5	PASS

#### 802.11n (20MHz)

CHANNEL	FREQUENCY (MHz)	6dB BANDWIDTH (MHz)		MINIMUM LIMIT (MHz)	PASS / FAIL
		CHAIN 0	CHAIN 1		
1	2412	17.68	17.65	0.5	PASS
6	2437	17.72	17.71	0.5	PASS
11	2462	17.68	17.73	0.5	PASS

#### 802.11n (40MHz)

CHANNEL	FREQUENCY (MHz)	6dB BANDWIDTH (MHz)		MINIMUM LIMIT (MHz)	PASS / FAIL
		CHAIN 0	CHAIN 1		
1	2422	36.16	36.05	0.5	PASS
4	2437	36.15	36.01	0.5	PASS
7	2452	36.09	36.09	0.5	PASS

## 4.4 CONDUCTED OUTPUT POWER

### 4.4.1 LIMITS OF CONDUCTED OUTPUT POWER MEASUREMENT

For systems using digital modulation in the 2400–2483.5 MHz: 1 Watt (30dBm)

### 4.4.2 TEST SETUP

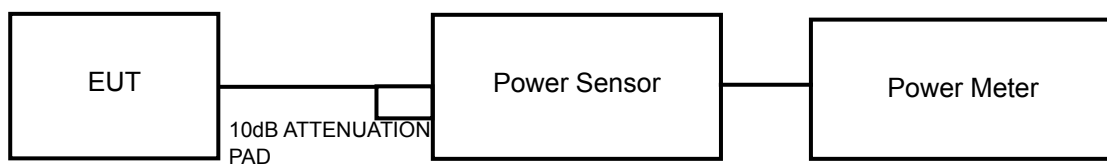

### 4.4.3 TEST INSTRUMENTS

Refer to section 4.1.2 to get information of above instrument.

### 4.4.4 TEST PROCEDURES

A power sensor was used on the output port of the EUT. A power meter was used to read the response of the power sensor. Record the power level.

### 4.4.5 DEVIATION FROM TEST STANDARD

No deviation.

### 4.4.6 EUT OPERATING CONDITIONS

Same as Item 4.3.6.



#### 4.4.7 TEST RESULTS

##### 802.11b

CHANNEL	FREQUENCY (MHz)	PEAK POWER (mW)	PEAK POWER (dBm)	LIMIT (dBm)	PASS/FAIL
1	2412	74.1	18.7	30	PASS
6	2437	70.8	18.5	30	PASS
11	2462	69.2	18.4	30	PASS

##### 802.11g

CHANNEL	FREQUENCY (MHz)	PEAK POWER (mW)	PEAK POWER (dBm)	LIMIT (dBm)	PASS/FAIL
1	2412	660.7	28.2	30	PASS
6	2437	741.3	28.7	30	PASS
11	2462	660.7	28.2	30	PASS

##### 802.11n (20MHz)

CHAN.	FREQUENCY (MHz)	PEAK POWER (dBm)		TOTAL POWER (mW)	TOTAL POWER (dBm)	LIMIT (dBm)	PASS / FAIL
		CHAIN 0	CHAIN 1				
1	2412	26.8	25.7	850.2	29.3	30	PASS
6	2437	26.8	25.7	850.2	29.3	30	PASS
11	2462	26.8	25.2	809.8	29.1	30	PASS

##### 802.11n (40MHz)

CHAN.	FREQUENCY (MHz)	PEAK POWER (dBm)		TOTAL POWER (mW)	TOTAL POWER (dBm)	LIMIT (dBm)	PASS / FAIL
		CHAIN 0	CHAIN 1				
1	2422	26.3	25.6	789.7	29.0	30	PASS
4	2437	26.5	25.7	818.2	29.1	30	PASS
7	2452	26.2	25.7	788.4	29.0	30	PASS



## 4.5 POWER SPECTRAL DENSITY MEASUREMENT

### 4.5.1 LIMITS OF POWER SPECTRAL DENSITY MEASUREMENT

The Maximum of Power Spectral Density Measurement is 8dBm.

### 4.5.2 TEST SETUP

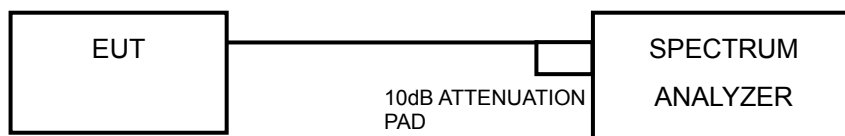

### 4.5.3 TEST INSTRUMENTS

Refer to section 4.1.2 to get information of above instrument.

### 4.5.4 TEST PROCEDURE

1. Set the RBW = 100 kHz, VBW =300 kHz, Detector = peak.
2. Sweep time = auto couple, Trace mode = max hold, allow trace to fully stabilize.
3. Use the peak marker function to determine the maximum power level in any 100 kHz band segment within the fundamental EBW.
4. Scale the observed power level to an equivalent value in 3 kHz by adjusting (reducing) the measured power by a bandwidth correction factor (BWCF) where  $BWCF = 10\log(3 \text{ kHz}/100\text{kHz})$

### 4.5.5 DEVIATION FROM TEST STANDARD

No deviation.

### 4.5.6 EUT OPERATING CONDITION

Same as Item 4.3.6

## 4.5.7 TEST RESULTS

### 802.11b

Channel	FREQ. (MHz)	PSD (dBm/100kHz)	PSD (dBm/3kHz)	Limit (dBm/3kHz)	PASS /FAIL
1	2412	7.70	-7.53	8	PASS
6	2437	7.72	-7.51	8	PASS
11	2462	7.20	-8.03	8	PASS

### 802.11g

Channel	FREQ. (MHz)	PSD (dBm/100kHz)	PSD (dBm/3kHz)	Limit (dBm/3kHz)	PASS /FAIL
1	2412	8.42	-6.81	8	PASS
6	2437	9.01	-6.22	8	PASS
11	2462	8.51	-6.72	8	PASS

### 802.11n (20MHz)

TX chain	Channel	FREQ. (MHz)	PSD (dBm/100kHz)	PSD (dBm/3kHz)	10 log (N=2) dB	Total PSD (dBm/3kHz)	Limit (dBm/3kHz)	PASS /FAIL
0	1	2412	4.56	-10.67	3.01	-7.66	8	PASS
	6	2437	4.75	-10.48	3.01	-7.47	8	PASS
	11	2462	4.46	-10.77	3.01	-7.76	8	PASS
1	1	2412	5.45	-9.78	3.01	-6.77	8	PASS
	6	2437	5.57	-9.66	3.01	-6.65	8	PASS
	11	2462	4.96	-10.27	3.01	-7.26	8	PASS

### 802.11n (40MHz)

TX chain	Channel	FREQ. (MHz)	PSD (dBm/100kHz)	PSD (dBm/3kHz)	10 log (N=2) dB	Total PSD (dBm/3kHz)	Limit (dBm/3kHz)	PASS /FAIL
0	1	2422	1.54	-13.69	3.01	-10.68	8	PASS
	4	2437	1.55	-13.68	3.01	-10.67	8	PASS
	7	2452	1.56	-13.67	3.01	-10.66	8	PASS
1	1	2422	1.87	-13.36	3.01	-10.35	8	PASS
	4	2437	2.14	-13.09	3.01	-10.08	8	PASS
	7	2452	2.04	-13.19	3.01	-10.18	8	PASS

## 4.6 CONDUCTED EMISSION MEASUREMENT

### 4.6.1 LIMITS OF BAND EDGES MEASUREMENT

Below  $-20\text{dB}$  of the highest emission level of operating band (in 100kHz Resolution Bandwidth).

### 4.6.2 TEST SETUP

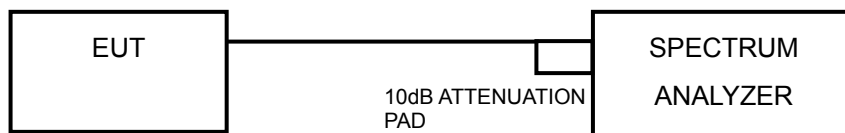

### 4.6.3 TEST INSTRUMENTS

Refer to section 4.1.2 to get information of above instrument.

### 4.6.4 TEST PROCEDURE

#### MEASUREMENT PROCEDURE REF

1. Set the RBW = 100 kHz.
2. Set the VBW  $\geq$  300 kHz.
3. Detector = peak.
4. Sweep time = auto couple.
5. Trace mode = max hold.
6. Allow trace to fully stabilize.
7. Use the peak marker function to determine the maximum power level in any 100 kHz band segment within the fundamental EBW.

## MEASUREMENT PROCEDURE OOB

1. Set RBW = 100 kHz.
2. Set VBW  $\geq$  300 kHz.
3. Set span to encompass the spectrum to be examined.
4. Detector = peak.
5. Trace Mode = max hold.
6. Sweep = auto couple.

### 4.6.5 DEVIATION FROM TEST STANDARD

No deviation.

### 4.6.6 EUT OPERATING CONDITION

Same as Item 4.3.6

### 4.6.7 TEST RESULTS

The conducted emission test is performed on each TX port of operating mode without summing or adding 10log (N) since the limit is relative emission limit. Only worst data of each operating mode is presented.

The spectrum plots are attached on the following pages. D1 line indicates the highest level, and D2 line indicates the 20dB offset below D1. It shows compliance with the requirement in part 15.247(d).

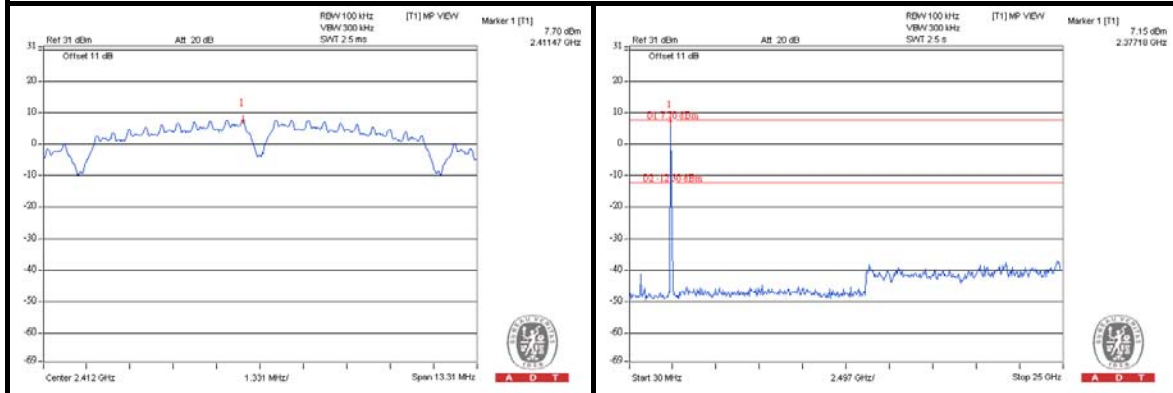
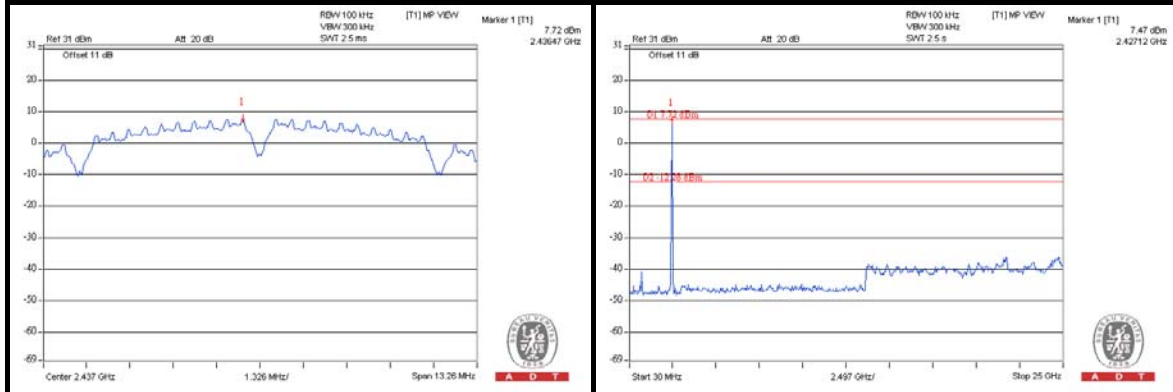
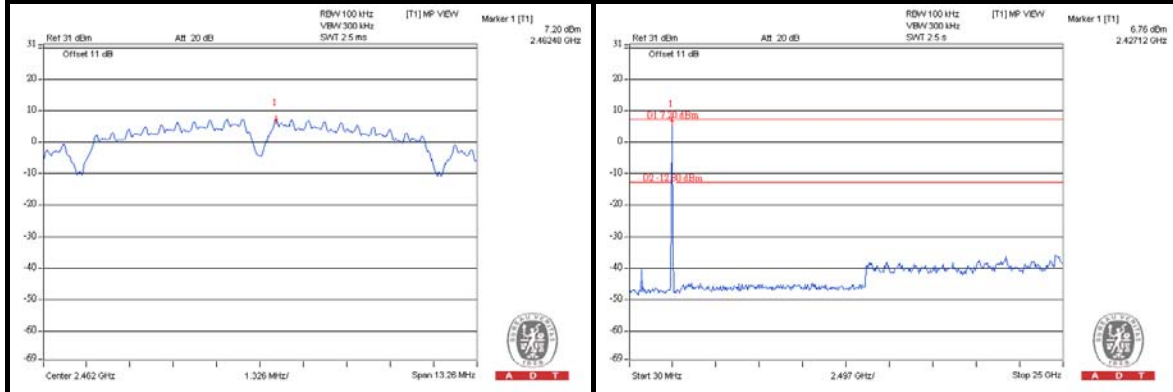
**802.11b****CH 1****CH 6****CH 11**

# 802.11g

## CH 1

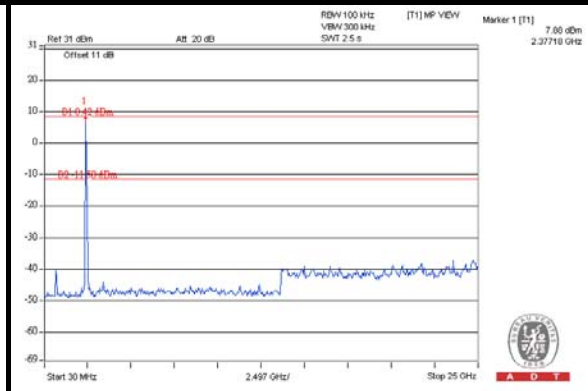
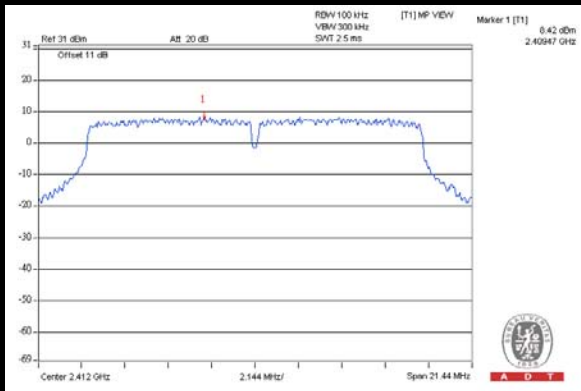

## CH 6

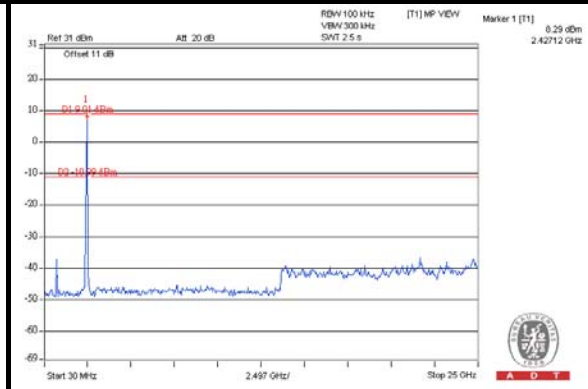
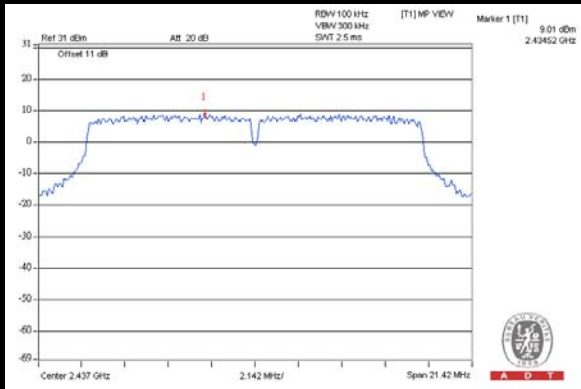

## CH 11

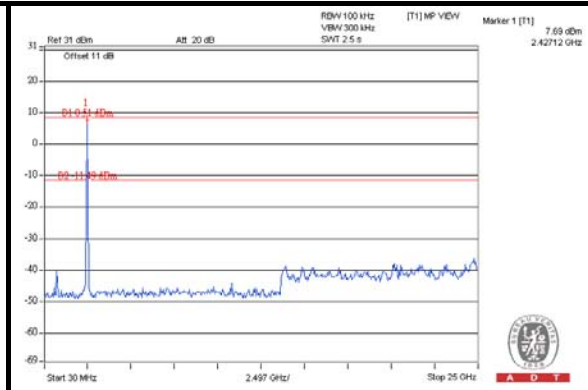
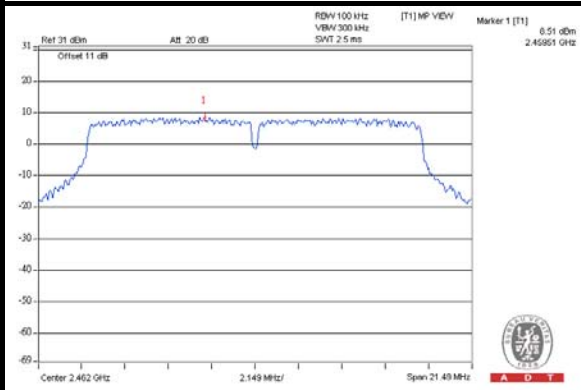

# 802.11n (20MHz)

## CH 1

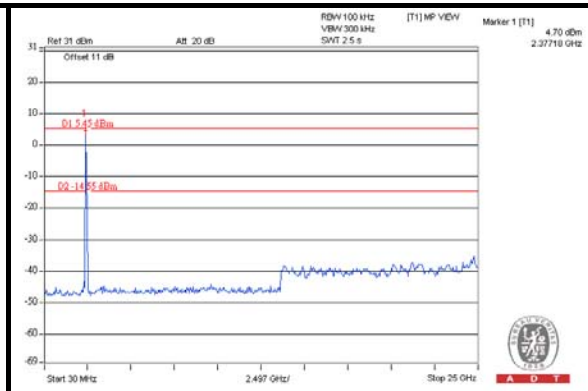
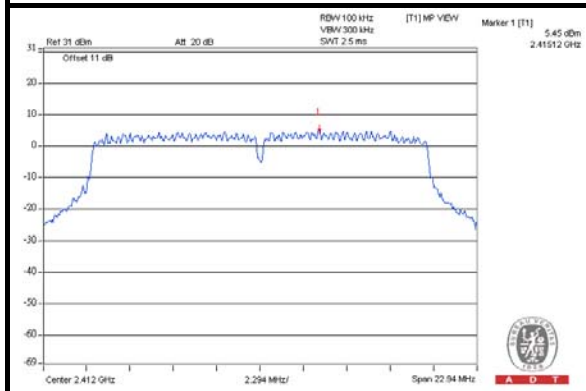

## CH 6

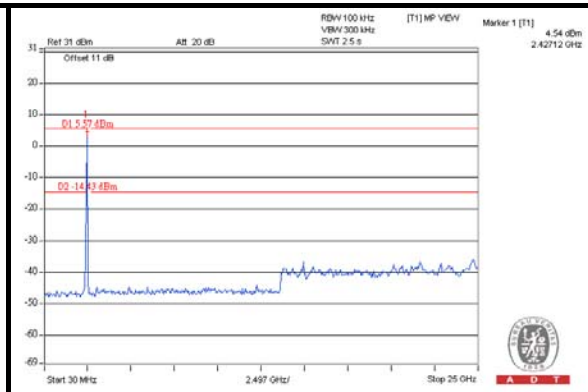
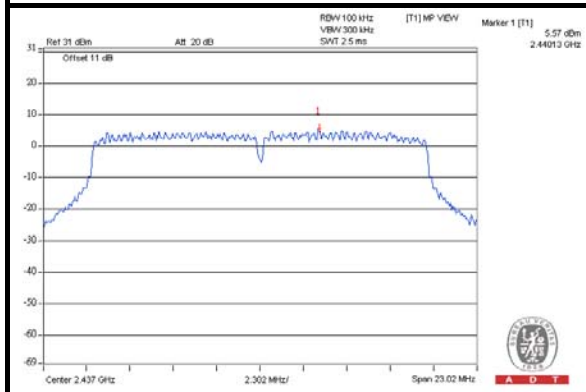

## CH 11

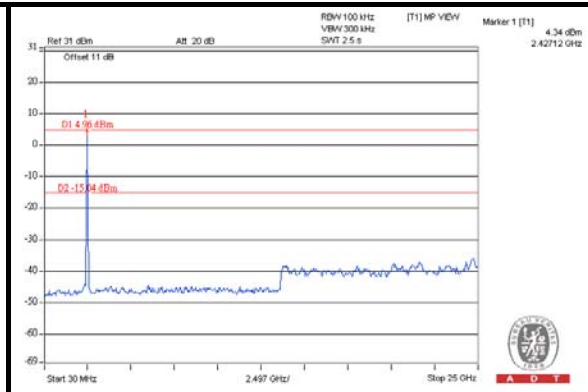
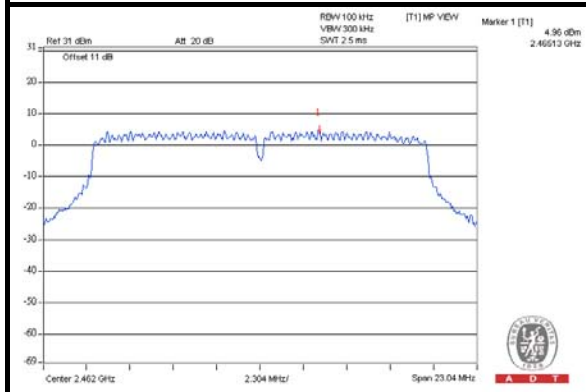

### 802.11n (40MHz)

#### CH 1

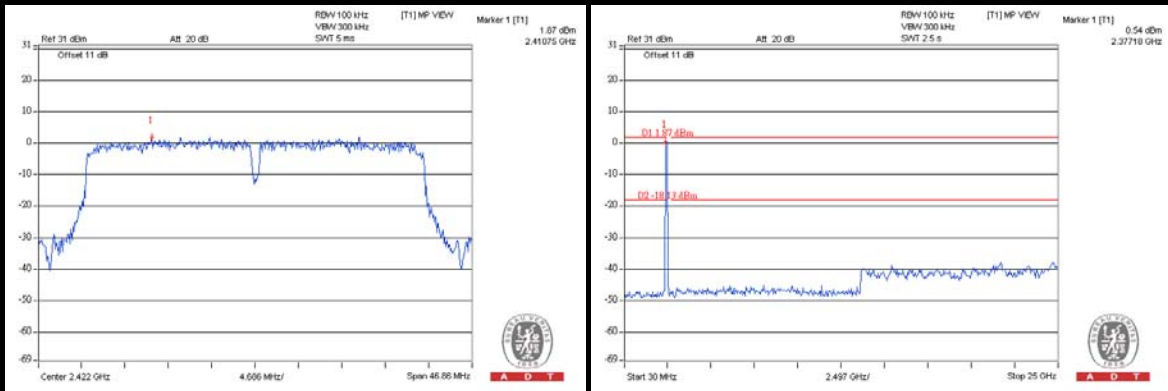

#### CH 4

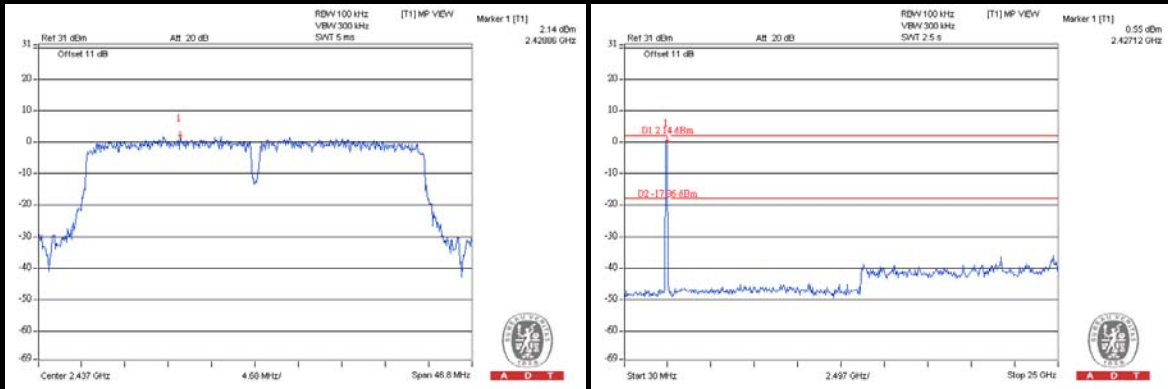

#### CH 7

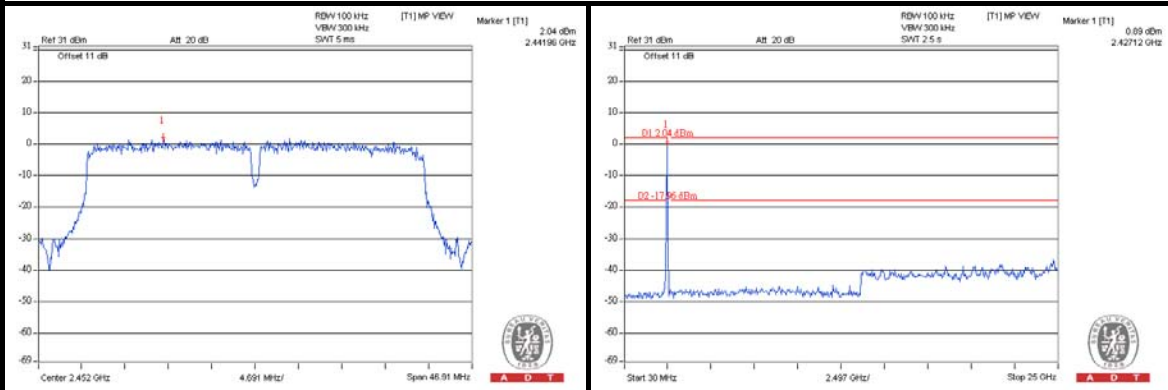



## 5. PHOTOGRAPHS OF THE TEST CONFIGURATION

Please refer to the attached file (Test Setup Photo).



## 6. INFORMATION ON THE TESTING LABORATORIES

We, Bureau Veritas Consumer Products Services (H.K.) Ltd., Taoyuan Branch, were founded in 1988 to provide our best service in EMC, Radio, Telecom and Safety consultation. Our laboratories are accredited and approved according to ISO/IEC 17025.

Copies of accreditation and authorization certificates of our laboratories obtained from approval agencies can be downloaded from our web site: [www.adt.com.tw/index.5.phtml](http://www.adt.com.tw/index.5.phtml). If you have any comments, please feel free to contact us at the following:

**Linko EMC/RF Lab:**

Tel: 886-2-26052180

Fax: 886-2-26051924

**Hsin Chu EMC/RF Lab:**

Tel: 886-3-5935343

Fax: 886-3-5935342

**Hwa Ya EMC/RF/Safety Telecom Lab:**

Tel: 886-3-3183232

Fax: 886-3-3185050

**Email:** [service.adt@tw.bureauveritas.com](mailto:service.adt@tw.bureauveritas.com)

**Web Site:** [www.adt.com.tw](http://www.adt.com.tw)

The address and road map of all our labs can be found in our web site also.

## **7. APPENDIX A - MODIFICATIONS RECORDERS FOR ENGINEERING CHANGES TO THE EUT BY THE LAB**

No any modifications were made to the EUT by the lab during the test.

**---END---**