



FCC TEST REPORT

REPORT NO.: RF970220L08
MODEL NO.: EPI-3601S
RECEIVED: Feb. 20, 2008
TESTED: Feb. 20 ~ Feb. 28, 2008
ISSUED: Mar. 07, 2008

APPLICANT : Senao Networks Inc.

ADDRESS : 3F, No. 529, Chung Cheng Rd., Hsintien, Taipei,
Taiwan, R.O.C.

ISSUED BY : Advance Data Technology Corporation

LAB ADDRESS : No. 47, 14th Ling, Chia Pau Tsuen, Lin Kou Hsiang
244, Taipei Hsien, Taiwan, R.O.C.

TEST LOCATION : No. 19, Hwa Ya 2nd Rd., Wen Hwa Tsuen, Kwei
Shan Hsiang, Taoyuan Hsien 333, Taiwan, R.O.C.

This test report consists of 60 pages in total. It may be duplicated completely for legal use with the approval of the applicant. It should not be reproduced except in full, without the written approval of our laboratory. The client should not use it to claim product endorsement by TAF, A2LA or any government agencies. The test results in the report only apply to the tested sample.





Table of Contents

1	CERTIFICATION	4
2	SUMMARY OF TEST RESULTS	5
2.1	MEASUREMENT UNCERTAINTY	5
3	GENERAL INFORMATION.....	6
3.1	GENERAL DESCRIPTION OF EUT	6
3.2	DESCRIPTION OF TEST MODES	7
3.2.1	CONFIGURATION OF SYSTEM UNDER TEST	7
3.2.2	TEST MODE APPLICABILITY AND TESTED CHANNEL DETAIL.....	8
3.3	GENERAL DESCRIPTION OF APPLIED STANDARDS	10
3.4	DESCRIPTION OF SUPPORT UNITS	10
4	TEST TYPES AND RESULTS	11
4.1	RADIATED EMISSION MEASUREMENT	11
4.1.1	LIMITS OF RADIATED EMISSION MEASUREMENT	11
4.1.2	TEST INSTRUMENTS.....	12
4.1.3	TEST PROCEDURES	13
4.1.4	DEVIATION FROM TEST STANDARD	13
4.1.5	TEST SETUP.....	14
4.1.6	EUT OPERATING CONDITIONS	14
4.1.7	TEST RESULTS	15
4.2	CONDUCTED EMISSION MEASUREMENT.....	23
4.2.1	LIMITS OF CONDUCTED EMISSION MEASUREMENT	23
4.2.2	TEST INSTRUMENTS.....	23
4.2.3	TEST PROCEDURES	24
4.2.4	DEVIATION FROM TEST STANDARD	24
4.2.5	TEST SETUP.....	25
4.2.6	EUT OPERATING CONDITIONS	25
4.2.7	TEST RESULTS	26
4.3	6DB BANDWIDTH MEASUREMENT	28
4.3.1	LIMITS OF 6DB BANDWIDTH MEASUREMENT	28
4.3.2	TEST INSTRUMENTS.....	28
4.3.3	TEST PROCEDURE.....	28
4.3.4	DEVIATION FROM TEST STANDARD	28
4.3.5	TEST SETUP.....	29
4.3.6	EUT OPERATING CONDITIONS	29
4.3.7	TEST RESULTS	30



4.4	MAXIMUM PEAK OUTPUT POWER.....	35
4.4.1	LIMITS OF MAXIMUM PEAK OUTPUT POWER MEASUREMENT.....	35
4.4.2	TEST INSTRUMENTS.....	35
4.4.3	TEST PROCEDURES	36
4.4.4	DEVIATION FROM TEST STANDARD	36
4.4.5	TEST SETUP.....	36
4.4.6	EUT OPERATING CONDITIONS	36
4.4.7	TEST RESULTS	37
4.5	POWER SPECTRAL DENSITY MEASUREMENT	38
4.5.1	LIMITS OF POWER SPECTRAL DENSITY MEASUREMENT.....	38
4.5.2	TEST INSTRUMENTS.....	38
4.5.3	TEST PROCEDURE.....	38
4.5.4	DEVIATION FROM TEST STANDARD	38
4.5.5	TEST SETUP.....	38
4.5.6	EUT OPERATING CONDITIONS	38
4.5.7	TEST RESULTS	39
4.6	BAND EDGES MEASUREMENT.....	44
4.6.1	LIMITS OF BAND EDGES MEASUREMENT	44
4.6.2	TEST INSTRUMENTS.....	44
4.6.3	TEST PROCEDURE.....	44
4.6.4	DEVIATION FROM TEST STANDARD	44
4.6.5	EUT OPERATING CONDITION	44
4.6.6	TEST RESULTS	45
4.7	ANTENNA REQUIREMENT	57
4.7.1	STANDARD APPLICABLE	57
4.7.2	ANTENNA CONNECTED CONSTRUCTION	57
5	PHOTOGRAPHS OF THE TEST CONFIGURATION.....	58
6	INFORMATION ON THE TESTING LABORATORIES.....	59
7	APPENDIX A – MODIFICATIONS RECORDERS FOR ENGINEERING CHANGES TO THE EUT BY THE LAB	60



1 CERTIFICATION

PRODUCT: 802.11 b/g High Power WLAN PCI Adaptor
MODEL NO.: EPI-3601S
BRAND: EnGenius
APPLICANT: Senao Networks Inc.
TESTED: Feb. 20 ~ Feb. 28, 2008
TEST SAMPLE: MASS-PRODUCTION
STANDARDS: **FCC Part 15, Subpart C (Section 15.247)**
ANSI C63.4-2003

The above equipment (model: EPI-3601S) has been tested by **Advance Data Technology Corporation**, and found compliance with the requirement of the above standards. The test record, data evaluation & Equipment Under Test (EUT) configurations represented herein are true and accurate accounts of the measurements of the sample's EMC characteristics under the conditions specified in this report.

PREPARED BY : Ivy Lin , **DATE:** Mar. 07, 2008
Ivy Lin / Specialist

TECHNICAL ACCEPTANCE : Long Chen , **DATE:** Mar. 07, 2008
Responsible for RF Long Chen / Senior Engineer

APPROVED BY : Gary Chang , **DATE:** Mar. 07, 2008
Gary Chang / Assistant Manager

2 SUMMARY OF TEST RESULTS

The EUT has been tested according to the following specifications:

APPLIED STANDARD: FCC Part 15, Subpart C			
Standard Section	Test Type and Limit	Result	Remark
15.207	AC Power Conducted Emission	PASS	Meet the requirement of limit. Minimum passing margin is -15.35dB at 0.654MHz
15.247(a)(2)	Spectrum Bandwidth of a Direct Sequence Spread Spectrum System Limit: min. 500kHz	PASS	Meet the requirement of limit.
15.247(b)	Maximum Peak Output Power Limit: max. 30dBm	PASS	Meet the requirement of limit.
15.247(d)	Radiated Emissions Limit: Table 15.209	PASS	Meet the requirement of limit. Minimum passing margin is -1.05dB at 2320.00MHz
15.247(e)	Power Spectral Density Limit: max. 8dBm	PASS	Meet the requirement of limit.
15.247(d)	Band Edge Measurement Limit: 20dB less than the peak value of fundamental frequency	PASS	Meet the requirement of limit.

2.1 MEASUREMENT UNCERTAINTY

Where relevant, the following measurement uncertainty levels have been estimated for tests performed on the EUT as specified in CISPR 16-4-2:

MEASUREMENT	FREQUENCY	UNCERTAINTY
Conducted emissions	9kHz~30MHz	2.44 dB
Radiated emissions	30MHz ~ 200MHz	3.19 dB
	200MHz ~1000MHz	3.21 dB
	1GHz ~ 18GHz	2.26 dB
	18GHz ~ 40GHz	1.94 dB

This uncertainty represents an expanded uncertainty expressed at approximately the 95% confidence level using a coverage factor of k=2.

3 GENERAL INFORMATION

3.1 GENERAL DESCRIPTION OF EUT

PRODUCT	802.11 b/g High Power WLAN PCI Adaptor
MODEL NO.	EPI-3601S
FCC ID	U2M-PI360701
POWER SUPPLY	5.0Vdc from host equipment
MODULATION TYPE	CCK, DQPSK, DBPSK for DSSS 64QAM, 16QAM, QPSK, BPSK for OFDM
MODULATION TECHNOLOGY	DSSS, OFDM
TRANSFER RATE	802.11b: 11/5.5/2/1Mbps 802.11g: 54/48/36/24/18/12/9/6Mbps (up to 108Mbps for turbo mode)
FREQUENCY RANGE	2412MHz ~ 2462MHz
NUMBER OF CHANNEL	11 for Normal mode/ 1 for Turbo mode
MAXIMUM OUTPUT POWER	51.17mW
ANTENNA TYPE	Dipole antenna with 2dBi gain
DATA CABLE	NA
I/O PORTS	NA
ACCESSORY DEVICES	NA

NOTE:

1. The EUT, operates in the 2.4GHz frequency range, lets you connect IEEE 802.11g or IEEE 802.11b devices to the network. With its high-speed data transmissions of up to 54Mbps.
2. The EUT is capable of providing data rates of up to 108Mbps in Turbo Mode depending upon reception quality.
3. The above EUT information was declared by manufacturer and for more detailed features description, please refer to the manufacturer's specifications or User's Manual.

3.2 DESCRIPTION OF TEST MODES

Eleven channels are provided to this EUT.

CHANNEL	FREQUENCY	CHANNEL	FREQUENCY
1	2412 MHz	7	2442 MHz
2	2417 MHz	8	2447 MHz
3	2422 MHz	9	2452 MHz
4	2427 MHz	10	2457 MHz
5	2432 MHz	11	2462 MHz
6	2437 MHz		

For 802.11g: One channel is provided to this EUT for turbo mode.

CHANNEL	FREQUENCY
6	2437 MHz

3.2.1 CONFIGURATION OF SYSTEM UNDER TEST

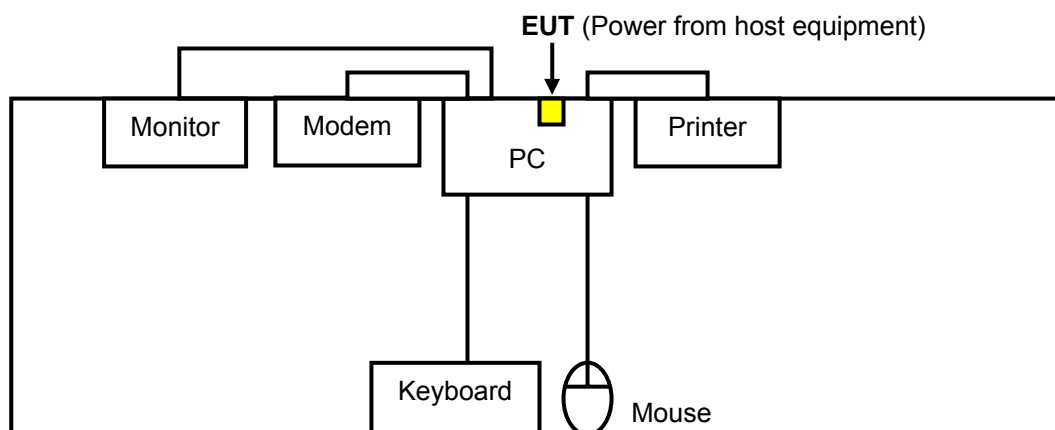

3.2.2 TEST MODE APPLICABILITY AND TESTED CHANNEL DETAIL

EUT CONFIGURE MODE	APPLICABLE TO				DESCRIPTION
	PLC	RE<1G	RE≥1G	APCM	
-	√	√	√	√	-

Where **PLC**: Power Line Conducted Emission **RE<1G**: Radiated Emission below 1GHz
RE≥1G: Radiated Emission above 1GHz **APCM**: Antenna Port Conducted Measurement

RADIATED EMISSION TEST (ABOVE 1 GHz):

- Pre-Scan has been conducted to determine the worst-case mode from all possible combinations between available modulations, data rates, antenna ports (if EUT with antenna diversity architecture) and packet type.
- Following channel(s) was (were) selected for the final test as listed below.

MODE	AVAILABLE CHANNEL	TESTED CHANNEL	MODULATION TECHNOLOGY	MODULATION TYPE	DATA RATE (Mbps)
802.11b	1 to 11	1, 6, 11	DSSS	DBPSK	1
802.11g	1 to 11	1, 6, 11	OFDM	BPSK	6
802.11g Turbo	6	6	OFDM	QPSK	12

RADIATED EMISSION TEST (BELOW 1 GHz):

- Pre-Scan has been conducted to determine the worst-case mode from all possible combinations between available modulations, data rates, antenna ports (if EUT with antenna diversity architecture) and packet type.
- Following channel(s) was (were) selected for the final test as listed below.

MODE	AVAILABLE CHANNEL	TESTED CHANNEL	MODULATION TECHNOLOGY	MODULATION TYPE	DATA RATE (Mbps)
802.11b	1 to 11	1	DSSS	DBPSK	1

POWER LINE CONDUCTED EMISSION TEST:

- Pre-Scan has been conducted to determine the worst-case mode from all possible combinations between available modulations, data rates and antenna ports (if EUT with antenna diversity architecture).
- Following channel(s) was (were) selected for the final test as listed below.

MODE	AVAILABLE CHANNEL	TESTED CHANNEL	MODULATION TECHNOLOGY	MODULATION TYPE	DATA RATE (Mbps)
802.11b	1 to 11	1	DSSS	DBPSK	1

BANDEDGE MEASUREMENT:

- Pre-Scan has been conducted to determine the worst-case mode from all possible combinations between available modulations, data rates and antenna ports (if EUT with antenna diversity architecture).
- Following channel(s) was (were) selected for the final test as listed below.

MODE	AVAILABLE CHANNEL	TESTED CHANNEL	MODULATION TECHNOLOGY	MODULATION TYPE	DATA RATE (Mbps)
802.11b	1 to 11	1, 11	DSSS	DBPSK	1
802.11g	1 to 11	1, 11	OFDM	BPSK	6
802.11g Turbo	6	6	OFDM	QPSK	12

ANTENNA PORT CONDUCTED MEASUREMENT:

- Pre-Scan has been conducted to determine the worst-case mode from all possible combinations between available modulations, data rates and antenna ports (if EUT with antenna diversity architecture).
- Following channel(s) was (were) selected for the final test as listed below.

MODE	AVAILABLE CHANNEL	TESTED CHANNEL	MODULATION TECHNOLOGY	MODULATION TYPE	DATA RATE (Mbps)
802.11b	1 to 11	1, 6, 11	DSSS	DBPSK	1
802.11g	1 to 11	1, 6, 11	OFDM	BPSK	6
802.11g Turbo	6	6	OFDM	QPSK	12

3.3 GENERAL DESCRIPTION OF APPLIED STANDARDS

The EUT is a RF product. According to the specifications of the manufacturer, it must comply with the requirements of the following standards:

FCC Part 15, Subpart C. (15.247)

ANSI C63.4- 2003

All test items have been performed and recorded as per the above standards.

NOTE: The EUT is also considered as a kind of computer peripheral, because the connection to computer is necessary for typical use. It has been verified to comply with the requirements of FCC Part 15, Subpart B, Class B (DoC). The test report has been issued separately.

3.4 DESCRIPTION OF SUPPORT UNITS

The EUT has been tested as an independent unit together with other necessary accessories or support units. The following support units or accessories were used to form a representative test configuration during the tests.

NO.	PRODUCT	BRAND	MODEL NO.	SERIAL NO.	FCC ID
1	PC	MSI	Hetis 865G Giga	3AS0119574	NA
2	LCD Minitor	Samsung	173v	N/A	NA
3	MODEM	ACEEX	1414V/3	0401008269	IFAXDM1414
4	PRINTER	EPSON	LQ-300+	DCGY047265	FCC DoC Approved
5	MOUSE	DELL	M056U0	349003917	FCC DoC Approved
6	KEYBOARD	BTO	EZ9900	03086664	FCC DoC Approved

NO.	SIGNAL CABLE DESCRIPTION OF THE ABOVE SUPPORT UNITS
1	NA
2	1.8m shielded cable without core.
3	1.2m braid shielded wire, DB25 & DB9 connector, w/o core.
4	1.8m braid shielded wire, DB25 connector, w/o core.
5	1.8m foil shielded wire, USB Connector, w/o core.
6	1.8m foil shielded wire, PS/2 Connector, w/o core.

NOTE : All power cords of the above support units are non shielded (1.8m).

4 TEST TYPES AND RESULTS

4.1 RADIATED EMISSION MEASUREMENT

4.1.1 LIMITS OF RADIATED EMISSION MEASUREMENT

Emissions radiated outside of the specified bands, shall be according to the general radiated limits in 15.209 as following:

Frequencies (MHz)	Field strength (microvolts/meter)	Measurement distance (meters)
0.009-0.490	2400/F(kHz)	300
0.490-1.705	24000/F(kHz)	30
1.705-30.0	30	30
30-88	100	3
88-216	150	3
216-960	200	3
Above 960	500	3

NOTE:

1. The lower limit shall apply at the transition frequencies.
2. Emission level (dBuV/m) = 20 log Emission level (uV/m).
3. As shown in 15.35(b), for frequencies above 1000MHz, the field strength limits are based on average detector, however, the peak field strength of any emission shall not exceed the maximum permitted average limits, specified above by more than 20dB under any condition of modulation.

4.1.2 TEST INSTRUMENTS

DESCRIPTION & MANUFACTURER	MODEL NO.	SERIAL NO.	CALIBRATED UNTIL
Test Receiver ROHDE & SCHWARZ	ESI7	838496/016	Dec. 25, 2008
Spectrum Analyzer ROHDE & SCHWARZ	FSP40	100039	Dec. 02, 2008
BILOG Antenna SCHWARZBECK	VULB9168	9168-155	Jan. 03, 2009
HORN Antenna SCHWARZBECK	BBHA 9120D	9120D-405	Dec. 17, 2008
HORN Antenna SCHWARZBECK	BBHA 9170	BBHA9170242	Jan. 06, 2009
Preamplifier Agilent	8449B	3008A01910	Sep. 19, 2008
Preamplifier Agilent	8447D	2944A10634	Dec. 12, 2008
RF signal cable HUBER+SUHNNER	SUCOFLEX 104	274397/4	Nov. 07, 2008
RF signal cable HUBER+SUHNNER	SUCOFLEX 104	283401/4	Nov. 07, 2008
Software ADT.	ADT_Radiated_V7.6	NA	NA
Antenna Tower inn-co GmbH	MA 4000	010303	NA
Antenna Tower Controller inn-co GmbH	CO2000	019303	NA
Turn Table ADT.	TT100.	TT93021704	NA
Turn Table Controller ADT.	SC100.	SC93021704	NA

- NOTE:**
1. The calibration interval of the above test instruments is 12 months and the calibrations are traceable to NML/ROC and NIST/USA.
 2. The test was performed in HwaYa Chamber 4.
 3. The horn antenna and HP preamplifier (model: 8449B) are used only for the measurement of emission frequency above 1GHz if tested.
 4. The IC Site Registration No. is IC3789B-4.

4.1.3 TEST PROCEDURES

- a. The EUT was placed on the top of a rotating table 0.8 meters above the ground at a 3 meters semi-anechoic chamber. The table was rotated 360 degrees to determine the position of the highest radiation.
- b. The EUT was set 3 meters away from the interference-receiving antenna, which was mounted on the top of a variable-height antenna tower.
- c. The antenna is a broadband antenna, and its height is varied from one meter to four meters above the ground to determine the maximum value of the field strength. Both horizontal and vertical polarizations of the antenna are set to make the measurement.
- d. For each suspected emission, the EUT was arranged to its worst case and then the antenna was tuned to heights from 1 meter to 4 meters and the rotatable table was turned from 0 degrees to 360 degrees to find the maximum reading.
- e. The test-receiver system was set to Peak Detect Function and Specified Bandwidth with Maximum Hold Mode.
- f. If the emission level of the EUT in peak mode was lower than the limit specified, then testing could be stopped and the peak values of the EUT would be reported. Otherwise the emissions would be re-tested one by one using peak, quasi-peak method or average method as specified and then reported in data sheet.

NOTE:

1. The resolution bandwidth and video bandwidth of test receiver/spectrum analyzer is 120kHz for Peak detection (PK) and Quasi-peak detection (QP) at frequency below 1GHz.
2. The resolution bandwidth of test receiver/spectrum analyzer is 1 MHz and video bandwidth is 3MHz for Peak detection at frequency above 1GHz.
3. The resolution bandwidth of test receiver/spectrum analyzer is 1 MHz and the video bandwidth is 10 Hz for Average detection (AV) at frequency above 1GHz.

4.1.4 DEVIATION FROM TEST STANDARD

No deviation.

4.1.5 TEST SETUP

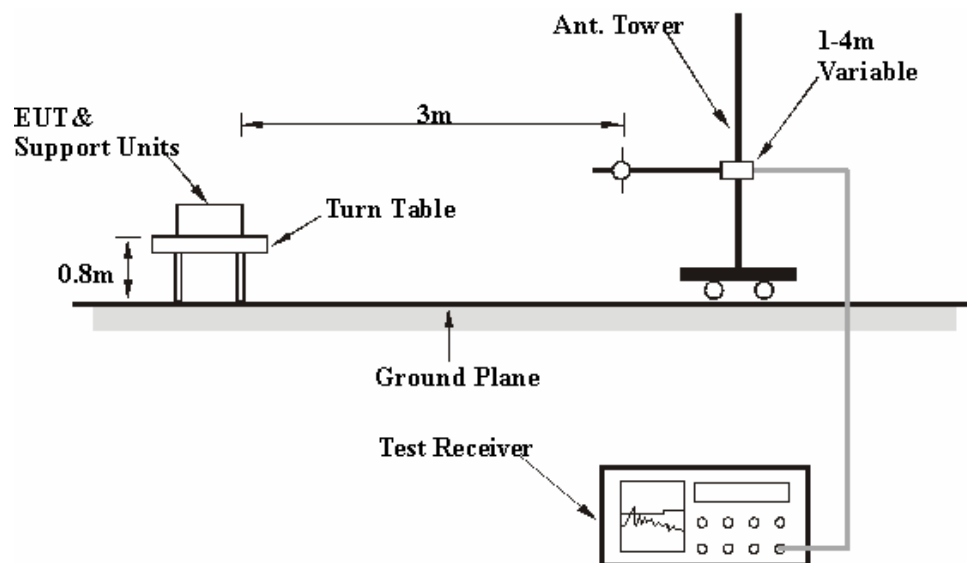

For the actual test configuration, please refer to the attached file (Test Setup Photo).

4.1.6 EUT OPERATING CONDITIONS

- Plugged the EUT into PC and placed on a testing table.
- The PC ran a test program (provided by manufacturer) to enable EUT under transmission condition continuously at specific channel frequency.
- The necessary accessories enable the system in full functions.

4.1.7 TEST RESULTS

802.11b DSSS MODULATION

EUT TEST CONDITION		MEASUREMENT DETAIL	
CHANNEL	Channel 1	FREQUENCY RANGE	1 ~ 25GHz
INPUT POWER (SYSTEM)	120Vac, 60 Hz	DETECTOR FUNCTION	Peak (PK) Average (AV)
ENVIRONMENTAL CONDITIONS	18deg. C, 60%RH 1022hPa	TESTED BY	Kevin Liang

ANTENNA POLARITY & TEST DISTANCE: HORIZONTAL AT 3 M								
NO.	FREQ. (MHz)	EMISSION LEVEL (dBuV/m)	LIMIT (dBuV/m)	MARGIN (dB)	ANTENNA HEIGHT (m)	TABLE ANGLE (Degree)	RAW VALUE (dBuV)	CORRECTION FACTOR (dB/m)
1	2386.00	57.35 PK	74.00	-16.65	1.15 H	157	25.98	31.37
2	2386.00	46.96 AV	54.00	-7.04	1.15 H	157	15.59	31.37
3	*2412.00	103.52 PK			1.15 H	157	72.06	31.46
4	*2412.00	99.34 AV			1.15 H	157	67.88	31.46
5	4824.00	49.64 PK	74.00	-24.36	1.25 H	9	11.98	37.66
6	4824.00	37.14 AV	54.00	-16.86	1.25 H	9	-0.52	37.66
ANTENNA POLARITY & TEST DISTANCE: VERTICAL AT 3 M								
NO.	FREQ. (MHz)	EMISSION LEVEL (dBuV/m)	LIMIT (dBuV/m)	MARGIN (dB)	ANTENNA HEIGHT (m)	TABLE ANGLE (Degree)	RAW VALUE (dBuV)	CORRECTION FACTOR (dB/m)
1	2386.00	60.83 PK	74.00	-13.17	1.00 V	218	29.46	31.37
2	2386.00	52.16 AV	54.00	-1.84	1.00 V	218	20.79	31.37
3	*2412.00	109.77 PK			1.14 V	200	78.31	31.46
4	*2412.00	105.27 AV			1.14 V	200	73.81	31.46
5	4824.00	48.48 PK	74.00	-25.52	1.11 V	249	10.82	37.66
6	4824.00	38.61 AV	54.00	-15.39	1.11 V	249	0.95	37.66

- REMARKS:**
1. Emission level (dBuV/m) = Raw Value (dBuV) + Correction Factor (dB/m).
 2. Correction Factor (dB/m) = Antenna Factor (dB/m) + Cable Factor (dB).
 3. The other emission levels were very low against the limit.
 4. Margin value = Emission level – Limit value.
 5. “ * “: Fundamental frequency.

EUT TEST CONDITION		MEASUREMENT DETAIL	
CHANNEL	Channel 6	FREQUENCY RANGE	1 ~ 25GHz
INPUT POWER (SYSTEM)	120Vac, 60 Hz	DETECTOR FUNCTION	Peak (PK) Average (AV)
ENVIRONMENTAL CONDITIONS	18deg. C, 60%RH 1022hPa	TESTED BY	Kevin Liang

ANTENNA POLARITY & TEST DISTANCE: HORIZONTAL AT 3 M								
NO.	FREQ. (MHz)	EMISSION LEVEL (dBuV/m)	LIMIT (dBuV/m)	MARGIN (dB)	ANTENNA HEIGHT (m)	TABLE ANGLE (Degree)	RAW VALUE (dBuV)	CORRECTION FACTOR (dB/m)
1	*2437.00	103.21 PK			1.00 H	245	71.66	31.55
2	*2437.00	98.52 AV			1.00 H	245	66.97	31.55
3	4874.00	47.84 PK	74.00	-26.16	1.14 H	284	10.05	37.79
4	4874.00	36.81 AV	54.00	-17.19	1.14 H	284	-0.98	37.79
ANTENNA POLARITY & TEST DISTANCE: VERTICAL AT 3 M								
NO.	FREQ. (MHz)	EMISSION LEVEL (dBuV/m)	LIMIT (dBuV/m)	MARGIN (dB)	ANTENNA HEIGHT (m)	TABLE ANGLE (Degree)	RAW VALUE (dBuV)	CORRECTION FACTOR (dB/m)
1	*2437.00	109.57 PK			1.18 V	209	78.02	31.55
2	*2437.00	105.01 AV			1.18 V	209	73.46	31.55
3	4874.00	49.90 PK	74.00	-24.10	1.14 V	181	12.11	37.79
4	4874.00	43.89 AV	54.00	-10.11	1.14 V	181	6.10	37.79

- REMARKS:**
1. Emission level (dBuV/m) = Raw Value (dBuV) + Correction Factor (dB/m).
 2. Correction Factor (dB/m) = Antenna Factor (dB/m) + Cable Factor (dB).
 3. The other emission levels were very low against the limit.
 4. Margin value = Emission level – Limit value.
 5. “ * “: Fundamental frequency.

EUT TEST CONDITION		MEASUREMENT DETAIL	
CHANNEL	Channel 11	FREQUENCY RANGE	1 ~ 25GHz
INPUT POWER (SYSTEM)	120Vac, 60 Hz	DETECTOR FUNCTION	Peak (PK) Average (AV)
ENVIRONMENTAL CONDITIONS	18deg. C, 60%RH 1022hPa	TESTED BY	Kevin Liang

ANTENNA POLARITY & TEST DISTANCE: HORIZONTAL AT 3 M								
NO.	FREQ. (MHz)	EMISSION LEVEL (dBuV/m)	LIMIT (dBuV/m)	MARGIN (dB)	ANTENNA HEIGHT (m)	TABLE ANGLE (Degree)	RAW VALUE (dBuV)	CORRECTION FACTOR (dB/m)
1	*2462.00	104.95 PK			1.15 H	228	73.31	31.64
2	*2462.00	100.15 AV			1.15 H	228	68.51	31.64
3	2483.50	59.33 PK	74.00	-14.67	1.14 H	228	27.62	31.71
4	2483.50	49.17 AV	54.00	-4.83	1.14 H	228	17.46	31.71
5	4924.00	48.89 PK	74.00	-25.11	1.11 H	232	10.97	37.92
6	4924.00	41.64 AV	54.00	-12.36	1.11 H	232	3.72	37.92
ANTENNA POLARITY & TEST DISTANCE: VERTICAL AT 3 M								
NO.	FREQ. (MHz)	EMISSION LEVEL (dBuV/m)	LIMIT (dBuV/m)	MARGIN (dB)	ANTENNA HEIGHT (m)	TABLE ANGLE (Degree)	RAW VALUE (dBuV)	CORRECTION FACTOR (dB/m)
1	*2462.00	110.20 PK			1.00 V	153	78.56	31.64
2	*2462.00	105.52 AV			1.00 V	153	73.88	31.64
3	2483.50	60.74 PK	74.00	-13.26	1.00 V	153	29.03	31.71
4	2483.50	52.18 AV	54.00	-1.82	1.00 V	153	20.47	31.71
5	4924.00	51.86 PK	74.00	-22.14	1.01 V	178	13.94	37.92
6	4924.00	47.58 AV	54.00	-6.42	1.01 V	178	9.66	37.92

- REMARKS:**
1. Emission level (dBuV/m) = Raw Value (dBuV) + Correction Factor (dB/m).
 2. Correction Factor (dB/m) = Antenna Factor (dB/m) + Cable Factor (dB).
 3. The other emission levels were very low against the limit.
 4. Margin value = Emission level – Limit value.
 5. “ * “: Fundamental frequency.

802.11g OFDM MODULATION_ NORMAL MODE

EUT TEST CONDITION		MEASUREMENT DETAIL	
CHANNEL	Channel 1	FREQUENCY RANGE	1 ~ 25GHz
INPUT POWER (SYSTEM)	120Vac, 60 Hz	DETECTOR FUNCTION	Peak (PK) Average (AV)
ENVIRONMENTAL CONDITIONS	18deg. C, 60%RH 1022hPa	TESTED BY	Kevin Liang

ANTENNA POLARITY & TEST DISTANCE: HORIZONTAL AT 3 M								
NO.	FREQ. (MHz)	EMISSION LEVEL (dBuV/m)	LIMIT (dBuV/m)	MARGIN (dB)	ANTENNA HEIGHT (m)	TABLE ANGLE (Degree)	RAW VALUE (dBuV)	CORRECTION FACTOR (dB/m)
1	2320.00	59.06 PK	74.00	-14.94	1.02 H	144	27.92	31.14
2	2320.00	50.53 AV	54.00	-3.47	1.02 H	144	19.39	31.14
3	2390.00	58.67 PK	74.00	-15.33	1.04 H	127	27.29	31.38
4	2390.00	46.21 AV	54.00	-7.79	1.04 H	127	14.83	31.38
5	*2412.00	101.66 PK			1.04 H	127	70.20	31.46
6	*2412.00	90.85 AV			1.04 H	127	59.39	31.46
7	4824.00	46.74 PK	74.00	-27.26	1.09 H	58	9.08	37.66
8	4824.00	34.10 AV	54.00	-19.90	1.09 H	58	-3.56	37.66

ANTENNA POLARITY & TEST DISTANCE: VERTICAL AT 3 M								
NO.	FREQ. (MHz)	EMISSION LEVEL (dBuV/m)	LIMIT (dBuV/m)	MARGIN (dB)	ANTENNA HEIGHT (m)	TABLE ANGLE (Degree)	RAW VALUE (dBuV)	CORRECTION FACTOR (dB/m)
1	2320.00	61.98 PK	74.00	-12.02	1.00 V	232	30.84	31.14
2	2320.00	52.95 AV	54.00	-1.05	1.00 V	232	21.81	31.14
3	2390.00	67.61 PK	74.00	-6.39	1.19 V	220	36.23	31.38
4	2390.00	51.13 AV	54.00	-2.87	1.19 V	220	19.75	31.38
5	*2412.00	109.64 PK			1.19 V	220	78.18	31.46
6	*2412.00	98.98 AV			1.19 V	220	67.52	31.46
7	4824.00	48.12 PK	74.00	-25.88	1.37 V	329	10.46	37.66
8	4824.00	35.69 AV	54.00	-18.31	1.37 V	329	-1.97	37.66

- REMARKS:**
1. Emission level (dBuV/m) = Raw Value (dBuV) + Correction Factor (dB/m).
 2. Correction Factor (dB/m) = Antenna Factor (dB/m) + Cable Factor (dB).
 3. The other emission levels were very low against the limit.
 4. Margin value = Emission level – Limit value.
 5. “ * “: Fundamental frequency.

EUT TEST CONDITION		MEASUREMENT DETAIL	
CHANNEL	Channel 6	FREQUENCY RANGE	1 ~ 25GHz
INPUT POWER (SYSTEM)	120Vac, 60 Hz	DETECTOR FUNCTION	Peak (PK) Average (AV)
ENVIRONMENTAL CONDITIONS	18deg. C, 60%RH 1030hPa	TESTED BY	Kevin Liang

ANTENNA POLARITY & TEST DISTANCE: HORIZONTAL AT 3 M								
NO.	FREQ. (MHz)	EMISSION LEVEL (dBuV/m)	LIMIT (dBuV/m)	MARGIN (dB)	ANTENNA HEIGHT (m)	TABLE ANGLE (Degree)	RAW VALUE (dBuV)	CORRECTION FACTOR (dB/m)
1	2320.00	60.14 PK	74.00	-13.86	1.00 H	239	29.00	31.14
2	2320.00	51.90 AV	54.00	-2.10	1.00 H	239	20.76	31.14
3	*2437.00	102.84 PK			1.00 H	243	71.29	31.55
4	*2437.00	92.36 AV			1.00 H	243	60.81	31.55
5	4874.00	47.01 PK	74.00	-26.99	1.15 H	232	9.22	37.79
6	4874.00	34.24 AV	54.00	-19.76	1.15 H	232	-3.55	37.79

ANTENNA POLARITY & TEST DISTANCE: VERTICAL AT 3 M								
NO.	FREQ. (MHz)	EMISSION LEVEL (dBuV/m)	LIMIT (dBuV/m)	MARGIN (dB)	ANTENNA HEIGHT (m)	TABLE ANGLE (Degree)	RAW VALUE (dBuV)	CORRECTION FACTOR (dB/m)
1	2320.00	61.21 PK	74.00	-12.79	1.05 V	154	30.07	31.14
2	2320.00	52.90 AV	54.00	-1.10	1.05 V	154	21.76	31.14
3	*2437.00	109.55 PK			1.00 V	148	78.00	31.55
4	*2437.00	99.53 AV			1.00 V	148	67.98	31.55
5	4874.00	48.18 PK	74.00	-25.82	1.06 V	354	10.39	37.79
6	4874.00	35.93 AV	54.00	-18.07	1.06 V	354	-1.86	37.79

- REMARKS:**
1. Emission level (dBuV/m) = Raw Value (dBuV) + Correction Factor (dB/m).
 2. Correction Factor (dB/m) = Antenna Factor (dB/m) + Cable Factor (dB).
 3. The other emission levels were very low against the limit.
 4. Margin value = Emission level – Limit value.
 5. “ * “: Fundamental frequency.

EUT TEST CONDITION		MEASUREMENT DETAIL	
CHANNEL	Channel 11	FREQUENCY RANGE	1 ~ 25GHz
INPUT POWER (SYSTEM)	120Vac, 60 Hz	DETECTOR FUNCTION	Peak (PK) Average (AV)
ENVIRONMENTAL CONDITIONS	18deg. C, 60%RH 1030hPa	TESTED BY	Kevin Liang

ANTENNA POLARITY & TEST DISTANCE: HORIZONTAL AT 3 M								
NO.	FREQ. (MHz)	EMISSION LEVEL (dBuV/m)	LIMIT (dBuV/m)	MARGIN (dB)	ANTENNA HEIGHT (m)	TABLE ANGLE (Degree)	RAW VALUE (dBuV)	CORRECTION FACTOR (dB/m)
1	2320.00	58.36 PK	74.00	-15.64	1.25 H	225	27.22	31.14
2	2320.00	48.75 AV	54.00	-5.25	1.25 H	225	17.61	31.14
3	*2462.00	104.76 PK			1.20 H	148	73.12	31.64
4	*2462.00	94.63 AV			1.20 H	148	62.99	31.64
5	2483.50	65.52 PK	74.00	-8.48	1.20 H	148	33.81	31.71
6	2483.50	49.18 AV	54.00	-4.82	1.20 H	148	17.47	31.71
7	4924.00	46.95 PK	74.00	-27.05	1.24 H	223	9.03	37.92
8	4924.00	34.67 AV	54.00	-19.33	1.24 H	223	-3.25	37.92
ANTENNA POLARITY & TEST DISTANCE: VERTICAL AT 3 M								
NO.	FREQ. (MHz)	EMISSION LEVEL (dBuV/m)	LIMIT (dBuV/m)	MARGIN (dB)	ANTENNA HEIGHT (m)	TABLE ANGLE (Degree)	RAW VALUE (dBuV)	CORRECTION FACTOR (dB/m)
1	2320.00	61.03 PK	74.00	-12.97	1.00 V	223	29.89	31.14
2	2320.00	52.85 AV	54.00	-1.15	1.00 V	223	21.71	31.14
3	*2462.00	109.93 PK			1.00 V	151	78.29	31.64
4	*2462.00	99.46 AV			1.00 V	151	67.82	31.64
5	2483.50	66.05 PK	74.00	-7.95	1.00 V	152	34.34	31.71
6	2483.50	51.85 AV	54.00	-2.15	1.00 V	152	20.14	31.71
7	4924.00	49.15 PK	74.00	-24.85	1.07 V	318	11.23	37.92
8	4924.00	35.79 AV	54.00	-18.21	1.07 V	318	-2.13	37.92

- REMARKS:**
1. Emission level (dBuV/m) = Raw Value (dBuV) + Correction Factor (dB/m).
 2. Correction Factor (dB/m) = Antenna Factor (dB/m) + Cable Factor (dB).
 3. The other emission levels were very low against the limit.
 4. Margin value = Emission level – Limit value.
 5. “ * “: Fundamental frequency.

802.11g OFDM MODULATION_TURBO MODE

EUT TEST CONDITION		MEASUREMENT DETAIL	
CHANNEL	Channel 6	FREQUENCY RANGE	1 ~ 25GHz
INPUT POWER (SYSTEM)	120Vac, 60 Hz	DETECTOR FUNCTION	Peak (PK) Average (AV)
ENVIRONMENTAL CONDITIONS	18deg. C, 60%RH 1022hPa	TESTED BY	Kevin Liang

ANTENNA POLARITY & TEST DISTANCE: HORIZONTAL AT 3 M								
NO.	FREQ. (MHz)	EMISSION LEVEL (dBuV/m)	LIMIT (dBuV/m)	MARGIN (dB)	ANTENNA HEIGHT (m)	TABLE ANGLE (Degree)	RAW VALUE (dBuV)	CORRECTION FACTOR (dB/m)
1	2320.00	57.52 PK	74.00	-16.48	1.52 H	155	26.38	31.14
2	2320.00	48.72 AV	54.00	-5.28	1.52 H	155	17.58	31.14
3	2390.00	55.69 PK	74.00	-18.31	1.00 H	140	24.30	31.38
4	2390.00	45.80 AV	54.00	-8.20	1.00 H	140	14.41	31.38
5	*2437.00	99.65 PK			1.00 H	139	68.10	31.55
6	*2437.00	90.41 AV			1.00 H	139	58.86	31.55
7	2483.50	57.20 PK	74.00	-16.80	1.01 H	139	25.49	31.71
8	2483.50	46.27 AV	54.00	-7.73	1.01 H	139	14.56	31.71
9	4874.00	47.14 PK	74.00	-26.86	1.34 H	216	9.35	37.79
10	4874.00	33.80 AV	54.00	-20.20	1.34 H	216	-3.99	37.79

ANTENNA POLARITY & TEST DISTANCE: VERTICAL AT 3 M								
NO.	FREQ. (MHz)	EMISSION LEVEL (dBuV/m)	LIMIT (dBuV/m)	MARGIN (dB)	ANTENNA HEIGHT (m)	TABLE ANGLE (Degree)	RAW VALUE (dBuV)	CORRECTION FACTOR (dB/m)
1	2320.00	60.24 PK	74.00	-13.76	1.01 V	231	29.10	31.14
2	2320.00	52.21 AV	54.00	-1.79	1.01 V	231	21.07	31.14
3	2390.00	60.73 PK	74.00	-13.27	1.01 V	147	29.35	31.38
4	2390.00	47.97 AV	54.00	-6.03	1.01 V	147	16.59	31.38
5	*2437.00	105.85 PK			1.01 V	147	74.30	31.55
6	*2437.00	95.90 AV			1.01 V	147	64.35	31.55
7	2483.50	60.23 PK	74.00	-13.77	1.01 V	148	28.52	31.71
8	2483.50	48.38 AV	54.00	-5.62	1.01 V	148	16.67	31.71
9	4874.00	48.01 PK	74.00	-25.99	1.13 V	219	10.22	37.79
10	4874.00	34.74 AV	54.00	-19.26	1.13 V	219	-3.05	37.79

- REMARKS:**
1. Emission level (dBuV/m) = Raw Value (dBuV) + Correction Factor (dB/m).
 2. Correction Factor (dB/m) = Antenna Factor (dB/m) + Cable Factor (dB).
 3. The other emission levels were very low against the limit.
 4. Margin value = Emission level – Limit value.
 5. “ * “: Fundamental frequency.

BELOW 1GHz WORST-CASE DATA : 802.11b DSSS MODULATION

EUT TEST CONDITION		MEASUREMENT DETAIL	
CHANNEL	Channel 1	FREQUENCY RANGE	Below 1000MHz
INPUT POWER (SYSTEM)	120Vac, 60 Hz	DETECTOR FUNCTION	Quasi-Peak
ENVIRONMENTAL CONDITIONS	22deg. C, 66%RH 1022hPa	TESTED BY	Dean Wang

ANTENNA POLARITY & TEST DISTANCE: HORIZONTAL AT 3 M								
NO.	FREQ. (MHz)	EMISSION LEVEL (dBuV/m)	LIMIT (dBuV/m)	MARGIN (dB)	ANTENNA HEIGHT (m)	TABLE ANGLE (Degree)	RAW VALUE (dBuV)	CORRECTION FACTOR (dB/m)
1	43.51	26.46 QP	40.00	-13.54	1.50 H	166	12.14	14.32
2	368.21	29.49 QP	46.00	-16.51	2.50 H	232	12.59	16.90
3	399.31	29.20 QP	46.00	-16.80	2.00 H	331	11.58	17.62
4	525.69	29.04 QP	46.00	-16.96	1.25 H	4	8.26	20.78
5	603.47	28.92 QP	46.00	-17.08	1.25 H	196	6.38	22.54
6	667.63	32.85 QP	46.00	-13.15	1.25 H	226	9.05	23.80
7	743.45	28.03 QP	46.00	-17.97	1.00 H	34	2.57	25.46
8	941.77	28.51 QP	46.00	-17.49	1.50 H	316	0.31	28.20
ANTENNA POLARITY & TEST DISTANCE: VERTICAL AT 3 M								
NO.	FREQ. (MHz)	EMISSION LEVEL (dBuV/m)	LIMIT (dBuV/m)	MARGIN (dB)	ANTENNA HEIGHT (m)	TABLE ANGLE (Degree)	RAW VALUE (dBuV)	CORRECTION FACTOR (dB/m)
1	43.51	23.13 QP	40.00	-16.87	2.00 V	1	8.82	14.32
2	399.31	32.69 QP	46.00	-13.31	1.25 V	343	15.06	17.62
3	537.36	30.48 QP	46.00	-15.52	1.00 V	97	9.47	21.01
4	607.35	30.13 QP	46.00	-15.87	1.50 V	184	7.51	22.62
5	667.63	34.78 QP	46.00	-11.22	1.00 V	196	10.98	23.80
6	743.45	30.78 QP	46.00	-15.22	1.50 V	184	5.32	25.46

- REMARKS:**
1. Emission level (dBuV/m) = Raw Value (dBuV) + Correction Factor (dB/m).
 2. Correction Factor (dB/m) = Antenna Factor (dB/m) + Cable Factor (dB).
 3. The other emission levels were very low against the limit.
 4. Margin value = Emission level – Limit value.

4.2 CONDUCTED EMISSION MEASUREMENT

4.2.1 LIMITS OF CONDUCTED EMISSION MEASUREMENT

FREQUENCY OF EMISSION (MHz)	CONDUCTED LIMIT (dB μ V)	
	Quasi-peak	Average
0.15 ~ 0.5	66 to 56	56 to 46
0.5 ~ 5	56	46
5 ~ 30	60	50

- NOTE:**
1. The lower limit shall apply at the transition frequencies.
 2. The limit decreases in line with the logarithm of the frequency in the range of 0.15 to 0.50 MHz.
 3. All emanations from a class A/B digital device or system, including any network of conductors and apparatus connected thereto, shall not exceed the level of field strengths specified above.

4.2.2 TEST INSTRUMENTS

DESCRIPTION & MANUFACTURER	MODEL NO.	SERIAL NO.	CALIBRATED UNTIL
Test Receiver ROHDE & SCHWARZ	ESCS30	100288	Sep. 21, 2008
RF signal cable Woken	5D-FB	Cable-HYCO3-01	Jan. 06, 2009
LISN ROHDE & SCHWARZ	ESH2-Z5	100100	Jan. 09, 2009
LISN SCHWARZBECK	NNBL 8226-2	8226-142	May 07, 2008
Software ADT	ADT_Cond_V3	NA	NA

- NOTE:**
1. The calibration interval of the above test instruments is 12 months and the calibrations are traceable to NML/ROC and NIST/USA.
 2. The test was performed in HwaYa Shielded Room 2.
 3. The VCCI Site Registration No. is C-2047.

4.2.3 TEST PROCEDURES

- a. The EUT was placed 0.4 meters from the conducting wall of the shielded room with EUT being connected to the power mains through a line impedance stabilization network (LISN). Other support units were connected to the power mains through another LISN. The two LISNs provide 50 ohm/ 50uH of coupling impedance for the measuring instrument.
- b. Both lines of the power mains connected to the EUT were checked for maximum conducted interference.
- c. The frequency range from 150kHz to 30MHz was searched. Emission levels under (Limit - 20dB) was not recorded.

4.2.4 DEVIATION FROM TEST STANDARD

No deviation.

4.2.5 TEST SETUP

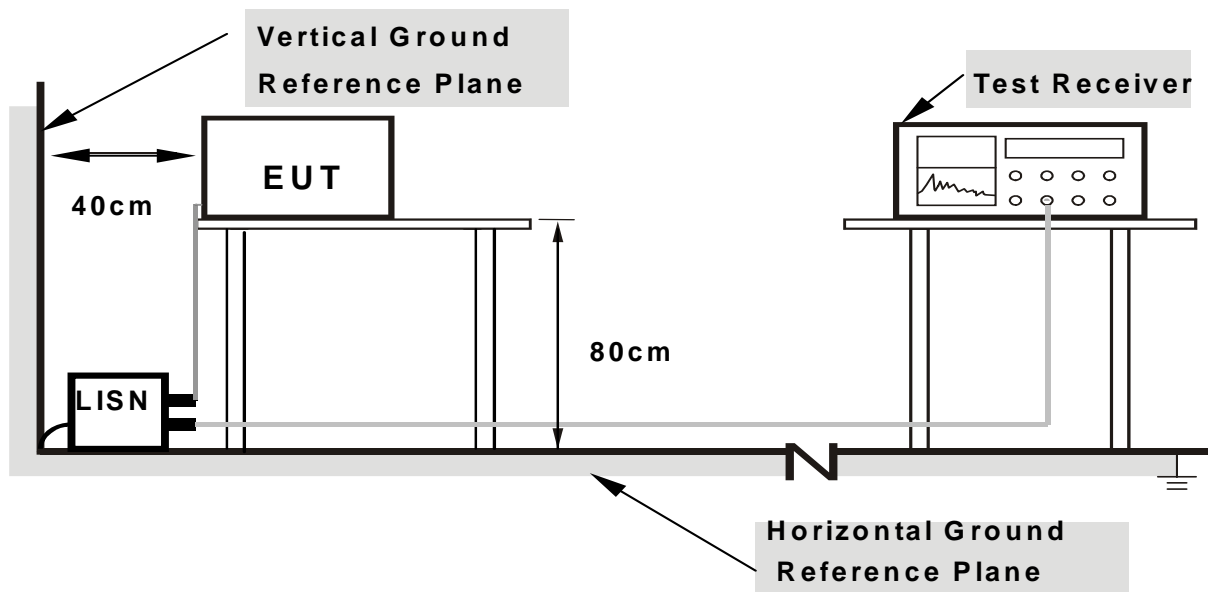

- Note:**
1. Support units were connected to second LISN.
 2. Both of LISNs (AMN) are 80 cm from EUT and at least 80 from other units and other metal planes

For the actual test configuration, please refer to the attached file (Test Setup Photo).

4.2.6 EUT OPERATING CONDITIONS

Same as 4.1.6

4.2.7 TEST RESULTS

CONDUCTED WORST-CASE DATA

EUT TEST CONDITION		MEASUREMENT DETAIL	
CHANNEL	Channel 1	PHASE	Line 1
MODULATION TYPE	DBPSK	6dB BANDWIDTH	9 kHz
TRANSFER RATE	1Mbps	ENVIRONMENTAL CONDITIONS	20deg. C, 60%RH, 1026.0hPa
INPUT POWER (SYSTEM)	120Vac, 60 Hz	TESTED BY	Match Tsui

No	Freq. [MHz]	Corr.	Reading Value		Emission Level		Limit		Margin	
		Factor (dB)	Q.P. [dB (uV)]	AV. [dB (uV)]	Q.P. [dB (uV)]	AV. [dB (uV)]	Q.P. [dB (uV)]	AV. [dB (uV)]	Q.P. (dB)	AV. (dB)
1	0.193	0.10	45.12	-	45.22	-	63.91	53.91	-18.69	-
2	0.388	0.10	36.28	-	36.38	-	58.10	48.10	-21.72	-
3	0.646	0.10	34.89	-	34.99	-	56.00	46.00	-21.01	-
4	1.551	0.17	35.56	-	35.73	-	56.00	46.00	-20.27	-
5	3.491	0.26	36.56	-	36.82	-	56.00	46.00	-19.18	-
6	24.385	0.79	37.62	-	38.41	-	60.00	50.00	-21.59	-

- REMARKS:**
1. Q.P. and AV. are abbreviations of quasi-peak and average individually.
 2. "-": The Quasi-peak reading value also meets average limit and measurement with the average detector is unnecessary.
 3. The emission levels of other frequencies were very low against the limit.
 4. Margin value = Emission level - Limit value
 5. Correction factor = Insertion loss + Cable loss
 6. Emission Level = Correction Factor + Reading Value.

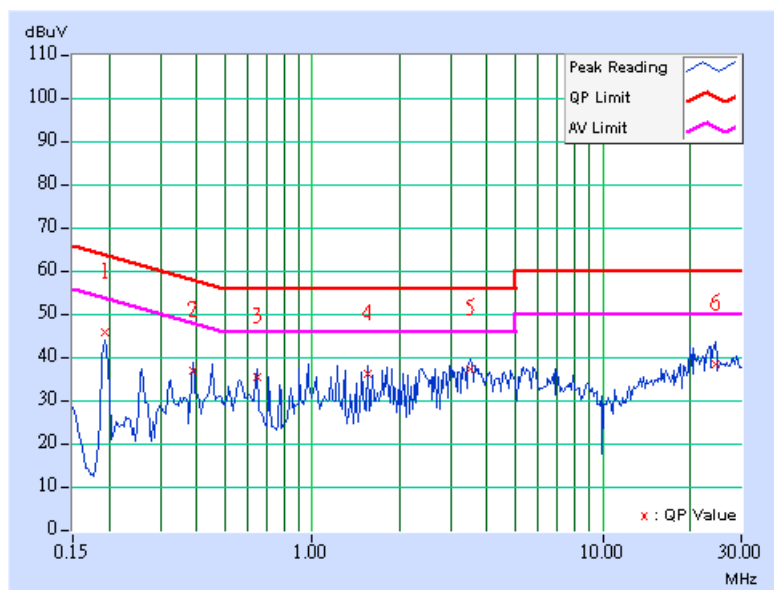

EUT TEST CONDITION		MEASUREMENT DETAIL	
CHANNEL	Channel 1	PHASE	Line 2
MODULATION TYPE	DBPSK	6dB BANDWIDTH	9 kHz
TRANSFER RATE	1Mbps	ENVIRONMENTAL CONDITIONS	20deg. C, 60%RH, 1026.0hPa
INPUT POWER (SYSTEM)	120Vac, 60 Hz	TESTED BY	Match Tsui

No	Freq. [MHz]	Corr. Factor (dB)	Reading Value [dB (uV)]		Emission Level [dB (uV)]		Limit [dB (uV)]		Margin (dB)	
			Q.P.	AV.	Q.P.	AV.	Q.P.	AV.	Q.P.	AV.
1	0.197	0.10	43.67	-	43.77	-	63.74	53.74	-19.97	-
2	0.392	0.10	41.54	-	41.64	-	58.02	48.02	-16.38	-
3	0.654	0.15	40.50	-	40.65	-	56.00	46.00	-15.35	-
4	1.500	0.22	38.14	-	38.36	-	56.00	46.00	-17.64	-
5	3.527	0.27	35.64	-	35.91	-	56.00	46.00	-20.09	-
6	23.506	0.68	39.06	-	39.74	-	60.00	50.00	-20.26	-

- REMARKS:**
1. Q.P. and AV. are abbreviations of quasi-peak and average individually.
 2. "-": The Quasi-peak reading value also meets average limit and measurement with the average detector is unnecessary.
 3. The emission levels of other frequencies were very low against the limit.
 4. Margin value = Emission level - Limit value
 5. Correction factor = Insertion loss + Cable loss
 6. Emission Level = Correction Factor + Reading Value.

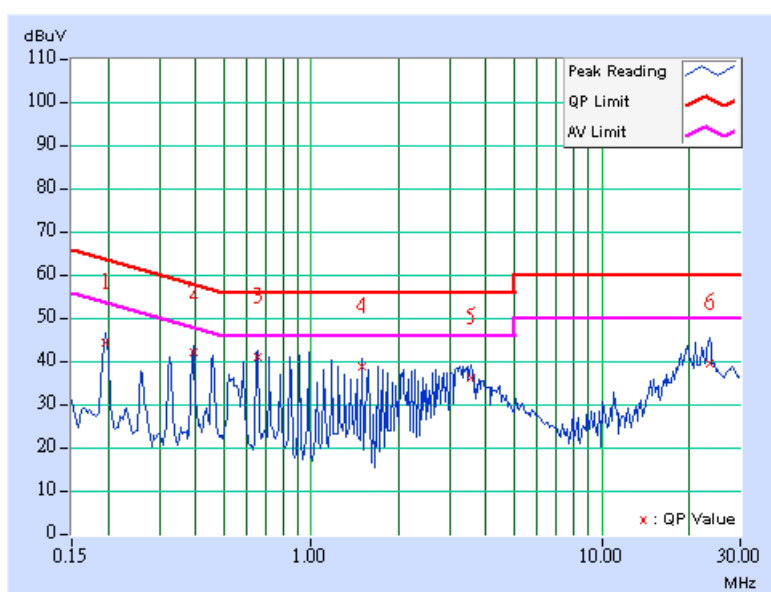

4.3 6dB BANDWIDTH MEASUREMENT

4.3.1 LIMITS OF 6dB BANDWIDTH MEASUREMENT

The minimum of 6dB Bandwidth Measurement is 0.5 MHz.

4.3.2 TEST INSTRUMENTS

DESCRIPTION & MANUFACTURER	MODEL NO.	SERIAL NO.	CALIBRATED UNTIL
SPECTRUM ANALYZER	FSP 40	100040	Jun. 28, 2008

NOTE: The calibration interval of the above test instruments is 12 months and the calibrations are traceable to NML/ROC and NIST/USA.

4.3.3 TEST PROCEDURE

The transmitter output was connected to the spectrum analyzer through an attenuator. The bandwidth of the fundamental frequency was measured by spectrum analyzer with 100 kHz RBW and 300kHz VBW. The 6dB bandwidth is defined as the total spectrum the power of which is higher than peak power minus 6dB.

4.3.4 DEVIATION FROM TEST STANDARD

No deviation.

4.3.5 TEST SETUP

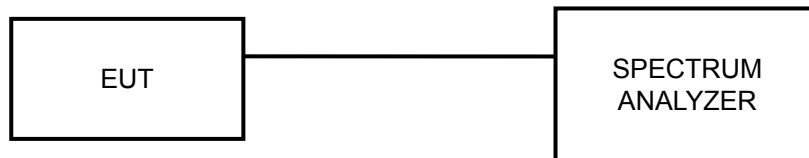

For the actual test configuration, please refer to the related Item – Photographs of the Test Configuration.

4.3.6 EUT OPERATING CONDITIONS

The software provided by client to enable the EUT under transmission condition continuously at lowest, middle and highest channel frequencies individually.

4.3.7 TEST RESULTS

802.11b DSSS MODULATION

MODULATION TYPE	DBPSK	TRANSFER RATE	1Mbps
INPUT POWER (SYSTEM)	120Vac, 60 Hz	ENVIRONMENTAL CONDITIONS	25deg. C, 65%RH, 1032hPa
TESTED BY	Brad Wu		

CHANNEL	CHANNEL FREQUENCY (MHz)	6dB BANDWIDTH (MHz)	MINIMUM LIMIT (MHz)	PASS/FAIL
1	2412	12.12	0.5	PASS
6	2437	11.15	0.5	PASS
11	2462	12.10	0.5	PASS

CH 1

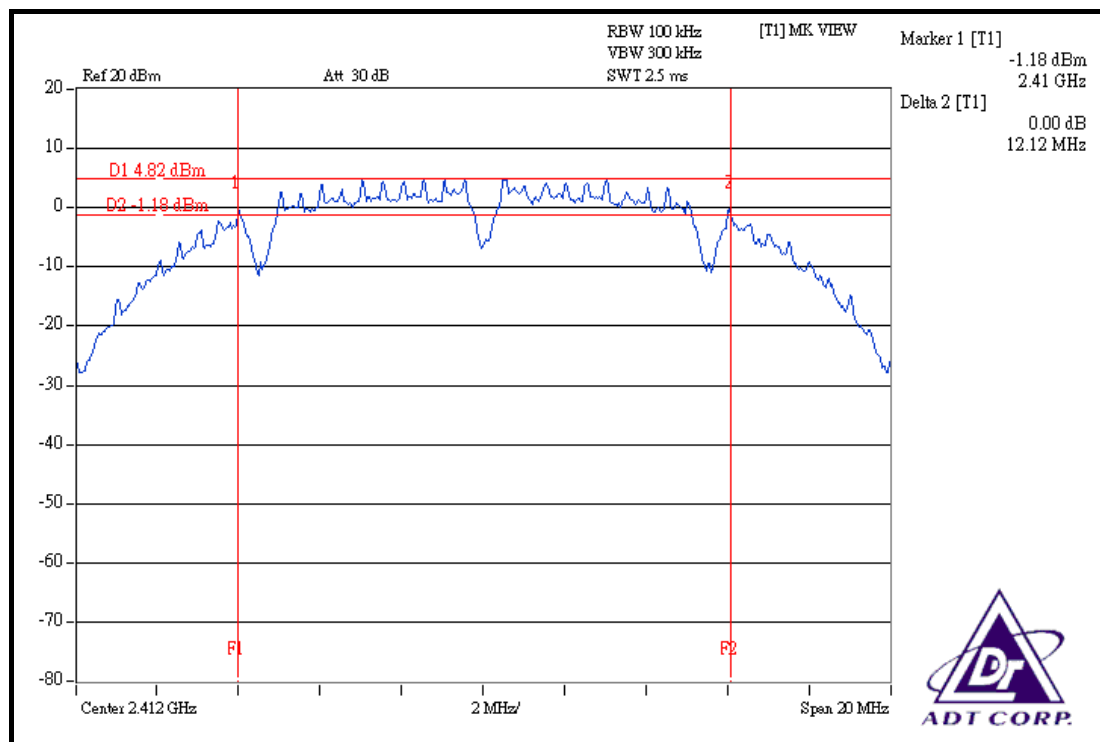

CH 6

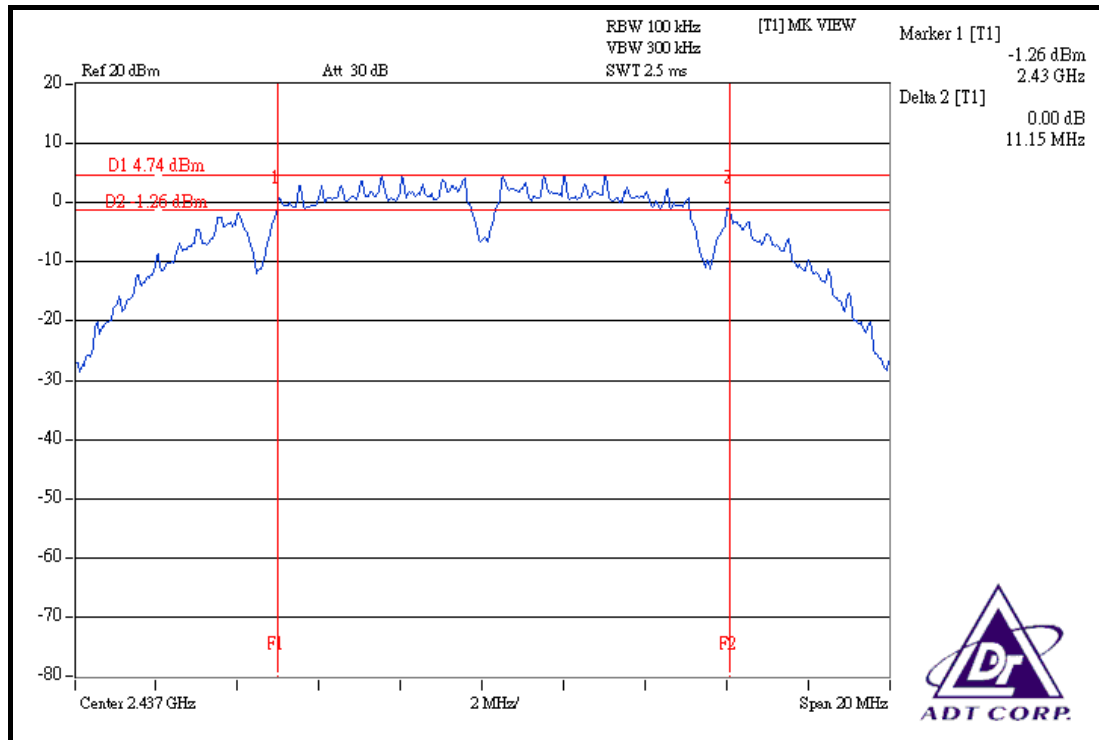

CH 11

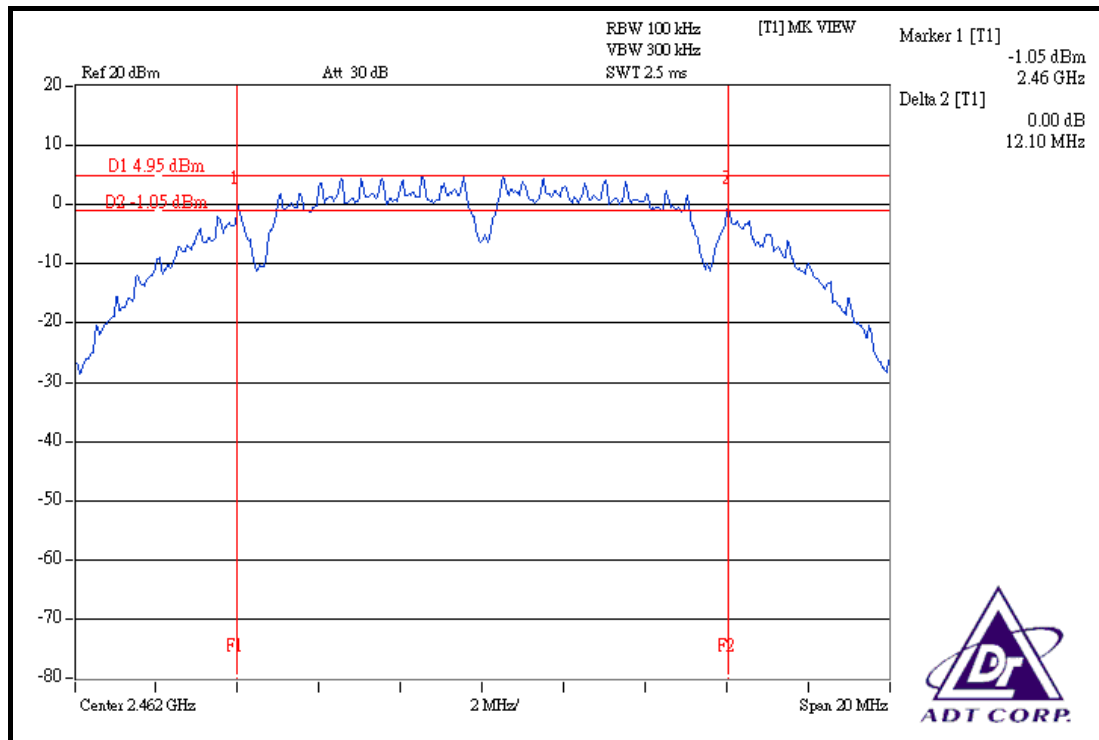

802.11g OFDM MODULATION_NORMAL MODE

MODULATION TYPE	BPSK	TRANSFER RATE	6Mbps
INPUT POWER (SYSTEM)	120Vac, 60 Hz	ENVIRONMENTAL CONDITIONS	25deg. C, 65%RH, 1032hPa
TESTED BY	Brad Wu		

CHANNEL	CHANNEL FREQUENCY (MHz)	6dB BANDWIDTH (MHz)	MINIMUM LIMIT (MHz)	PASS/FAIL
1	2412	16.42	0.5	PASS
6	2437	16.43	0.5	PASS
11	2462	16.41	0.5	PASS

CH 1

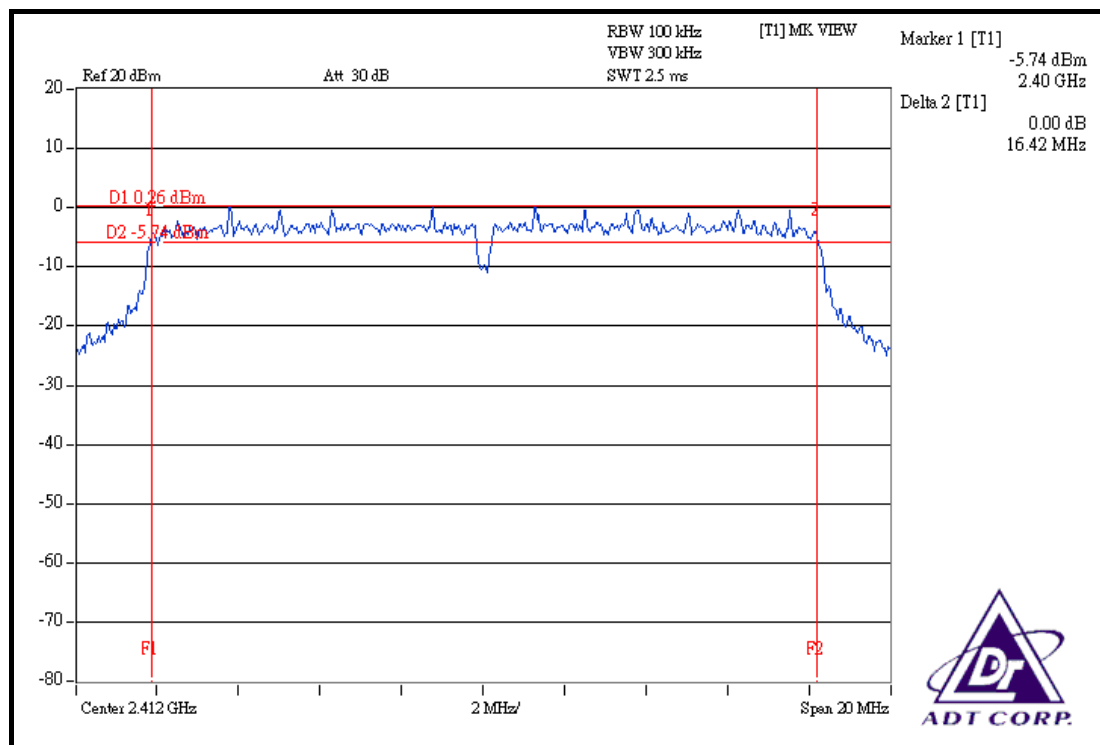

CH 6

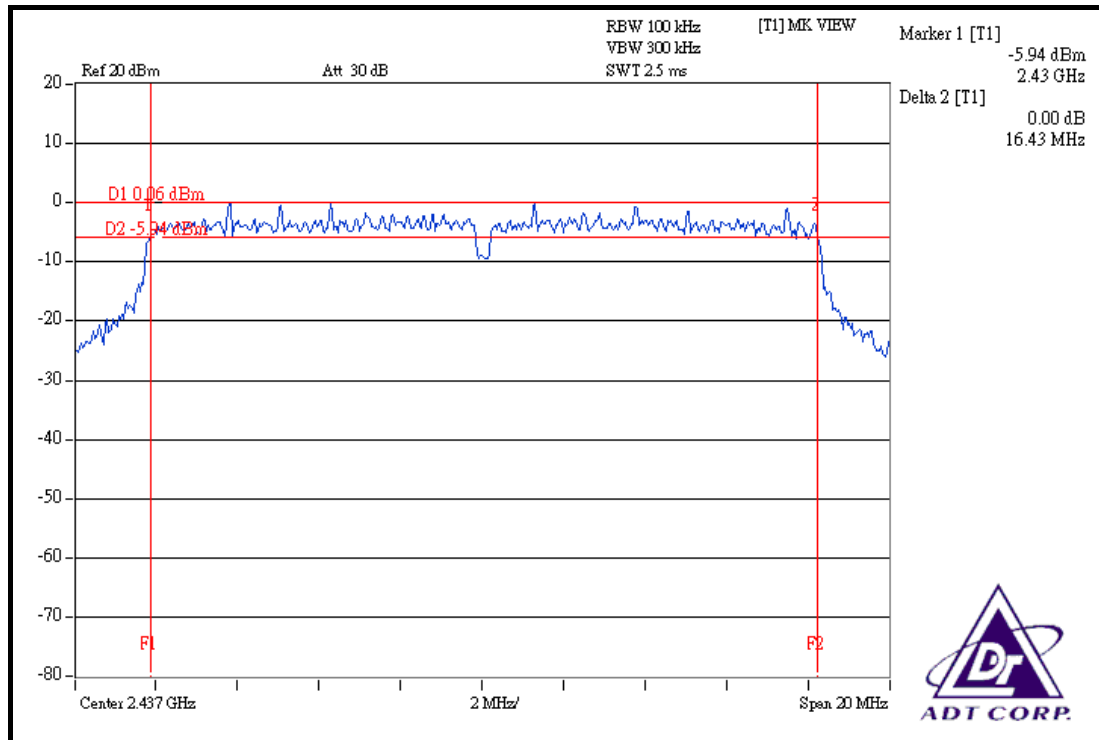

CH 11

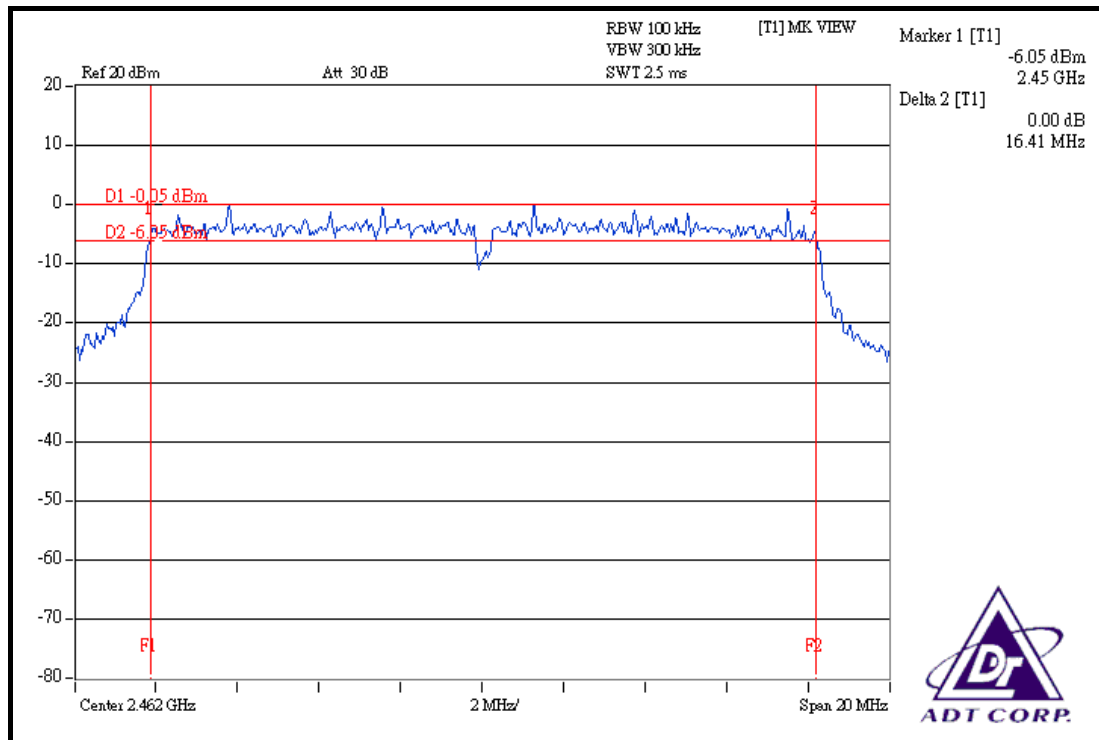

802.11g OFDM MODULATION_TURBO MODE

MODULATION TYPE	QPSK	TRANSFER RATE	12Mbps
INPUT POWER (SYSTEM)	120Vac, 60 Hz	ENVIRONMENTAL CONDITIONS	25deg. C, 65%RH, 1032hPa
TESTED BY	Brad Wu		

CHANNEL	CHANNEL FREQUENCY (MHz)	6dB BANDWIDTH (MHz)	MINIMUM LIMIT (MHz)	PASS/FAIL
6	2437	32.74	0.5	PASS

CH 6

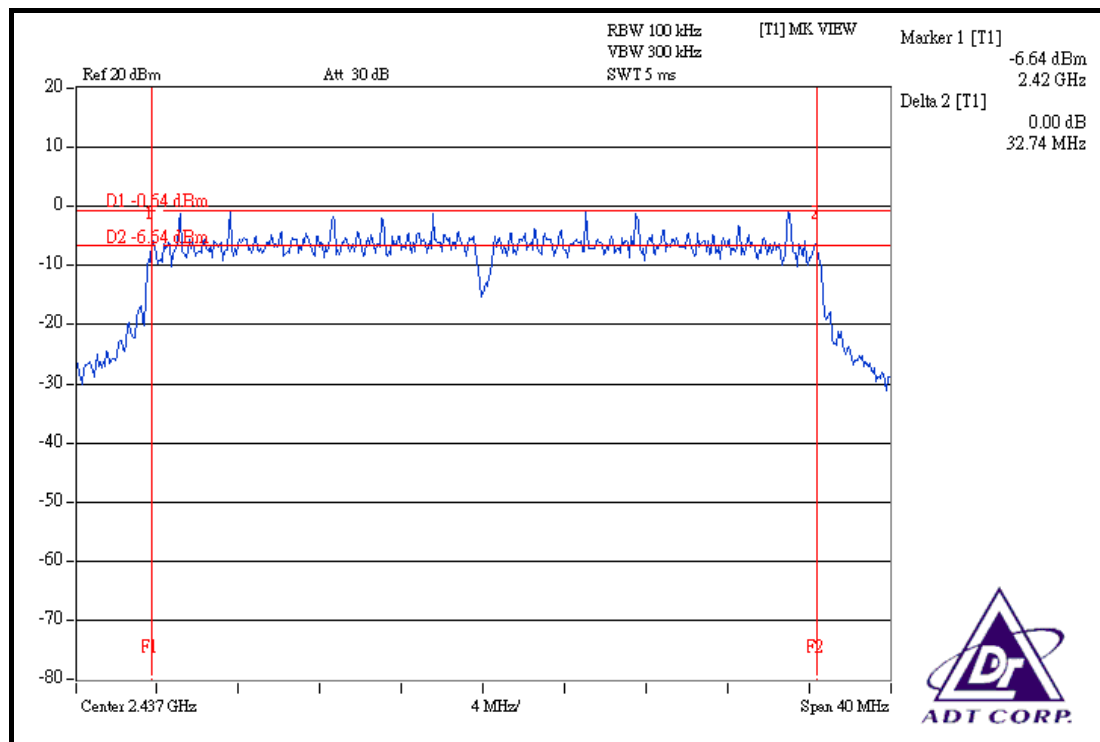



4.4 MAXIMUM PEAK OUTPUT POWER

4.4.1 LIMITS OF MAXIMUM PEAK OUTPUT POWER MEASUREMENT

The Maximum Peak Output Power Measurement is 30dBm.

4.4.2 TEST INSTRUMENTS

4.4.2 TEST INSTRUMENTS	MODEL NO.	SERIAL NO.	CALIBRATED UNTIL
R&S SPECTRUM ANALYZER	FSP40	100040	Jun. 28, 2008
AGILENT SIGNAL GENERATOR	E8257C	MY43320668	Dec. 25, 2008
TEKTRONIX OSCILLOSCOPE	TDS1012	C037299	Nov. 21, 2008
NARDA DETECTOR	4503A	FSCM99899	NA

NOTE: The calibration interval of the above test instruments is 12 months and the calibrations are traceable to NML/ROC and NIST/USA.

4.4.3 TEST PROCEDURES

- a. A detector was used on the output port of the EUT. An oscilloscope was used to peak the response of the detector.
- b. Replaced the EUT by the signal generator. The center frequency of the S.G was adjusted to the center frequency of the measured channel.
- c. Adjusted the power to have the same peak reading on oscilloscope. Record the power level.

4.4.4 DEVIATION FROM TEST STANDARD

No deviation.

4.4.5 TEST SETUP

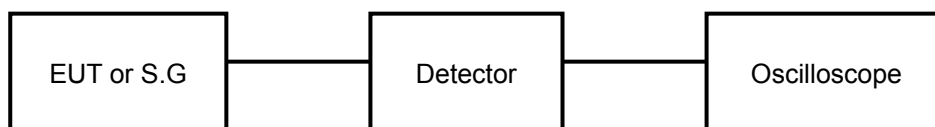

4.4.6 EUT OPERATING CONDITIONS

Same as 4.3.6.

4.4.7 TEST RESULTS

802.11b DSSS MODULATION

MODULATION TYPE	DBPSK	TRANSFER RATE	1Mbps
INPUT POWER (SYSTEM)	120Vac, 60 Hz	ENVIRONMENTAL CONDITIONS	25deg. C, 65%RH, 1032hPa
TESTED BY	Brad Wu		

CHANNEL	CHANNEL FREQUENCY (MHz)	PEAK POWER OUTPUT (mW)	PEAK POWER OUTPUT (dBm)	PEAK POWER LIMIT (dBm)	PASS/FAIL
1	2412	51.17	17.09	30	PASS
6	2437	50.58	17.04	30	PASS
11	2462	50.35	17.02	30	PASS

802.11g OFDM MODULATION_NORMAL MODE

MODULATION TYPE	BPSK	TRANSFER RATE	6Mbps
INPUT POWER (SYSTEM)	120Vac, 60 Hz	ENVIRONMENTAL CONDITIONS	25deg. C, 65%RH, 1032hPa
TESTED BY	Brad Wu		

CHANNEL	CHANNEL FREQUENCY (MHz)	PEAK POWER OUTPUT (mW)	PEAK POWER OUTPUT (dBm)	PEAK POWER LIMIT (dBm)	PASS/FAIL
1	2412	50.93	17.07	30	PASS
6	2437	50.93	17.07	30	PASS
11	2462	44.77	16.51	30	PASS

802.11g OFDM MODULATION_TURBO MODE

MODULATION TYPE	QPSK	TRANSFER RATE	12Mbps
INPUT POWER (SYSTEM)	120Vac, 60 Hz	ENVIRONMENTAL CONDITIONS	25deg. C, 65%RH, 1032hPa
TESTED BY	Brad Wu		

CHANNEL	CHANNEL FREQUENCY (MHz)	PEAK POWER OUTPUT (mW)	PEAK POWER OUTPUT (dBm)	PEAK POWER LIMIT (dBm)	PASS/FAIL
6	2437	35.81	15.54	30	PASS

4.5 POWER SPECTRAL DENSITY MEASUREMENT

4.5.1 LIMITS OF POWER SPECTRAL DENSITY MEASUREMENT

The Maximum of Power Spectral Density Measurement is 8dBm.

4.5.2 TEST INSTRUMENTS

DESCRIPTION & MANUFACTURER	MODEL NO.	SERIAL NO.	CALIBRATED UNTIL
R&S SPECTRUM ANALYZER	FSP 40	100040	Jun. 28, 2008

NOTE: The calibration interval of the above test instruments is 12 months and the calibrations are traceable to NML/ROC and NIST/USA.

4.5.3 TEST PROCEDURE

The transmitter output was connected to the spectrum analyzer through an attenuator, the bandwidth of the fundamental frequency was measured with the spectrum analyzer using 3kHz RBW and 30kHz VBW, set sweep time = span/3kHz. The power spectral density was measured and recorded.

The sweep time is allowed to be longer than span/3kHz for a full response of the mixer in the spectrum analyzer.

4.5.4 DEVIATION FROM TEST STANDARD

No deviation.

4.5.5 TEST SETUP

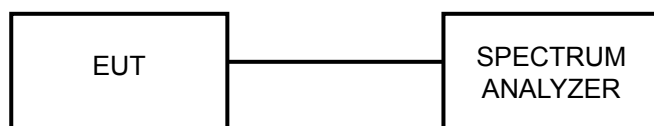

4.5.6 EUT OPERATING CONDITIONS

Same as 4.3.6.

4.5.7 TEST RESULTS

802.11b DSSS MODULATION

MODULATION TYPE	DBPSK	TRANSFER RATE	1Mbps
INPUT POWER (SYSTEM)	120Vac, 60 Hz	ENVIRONMENTAL CONDITIONS	25deg. C, 65%RH, 1032hPa
TESTED BY	Brad Wu		

CHANNEL	CHANNEL FREQUENCY (MHz)	RF POWER LEVEL IN 3 kHz BW (dBm)	MAXIMUM LIMIT (dBm)	PASS/FAIL
1	2412	-8.42	8	PASS
6	2437	-8.32	8	PASS
11	2462	-8.59	8	PASS

CH 1

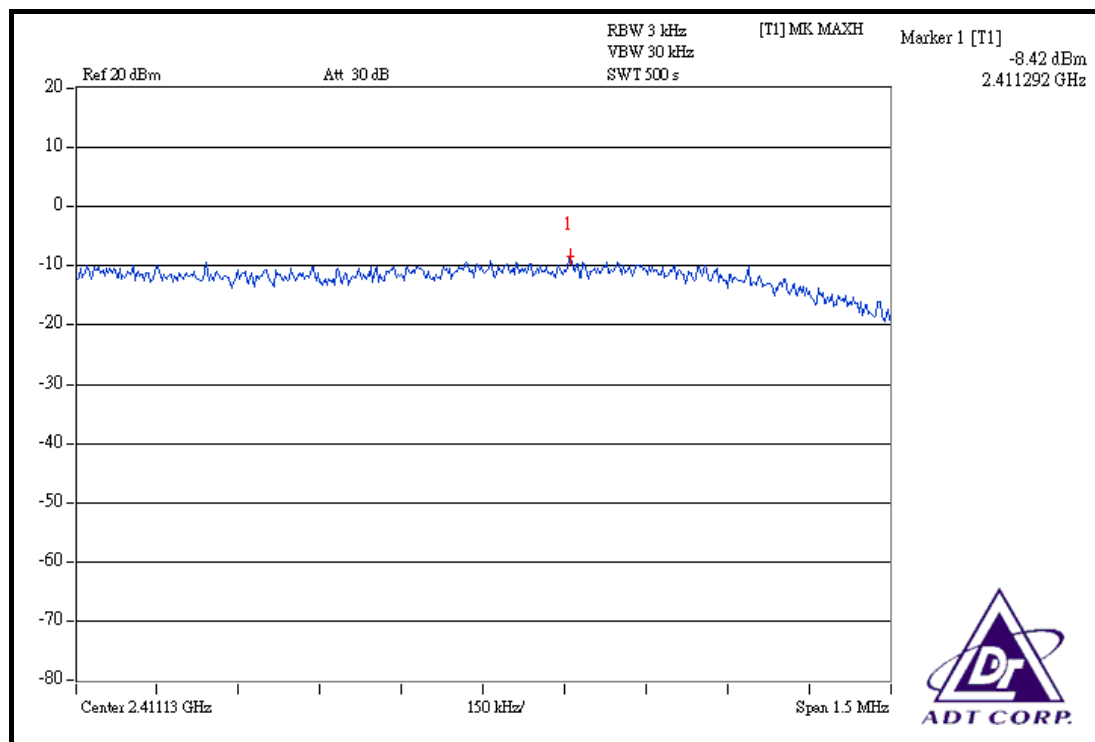

CH 6

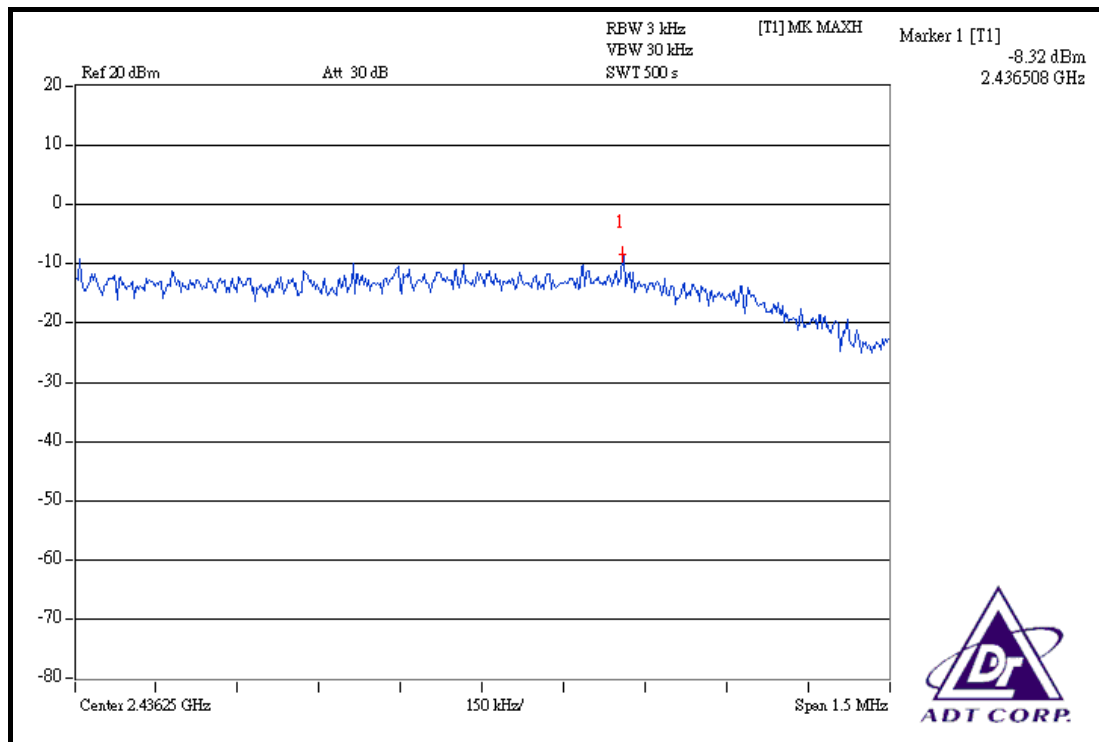

CH 11

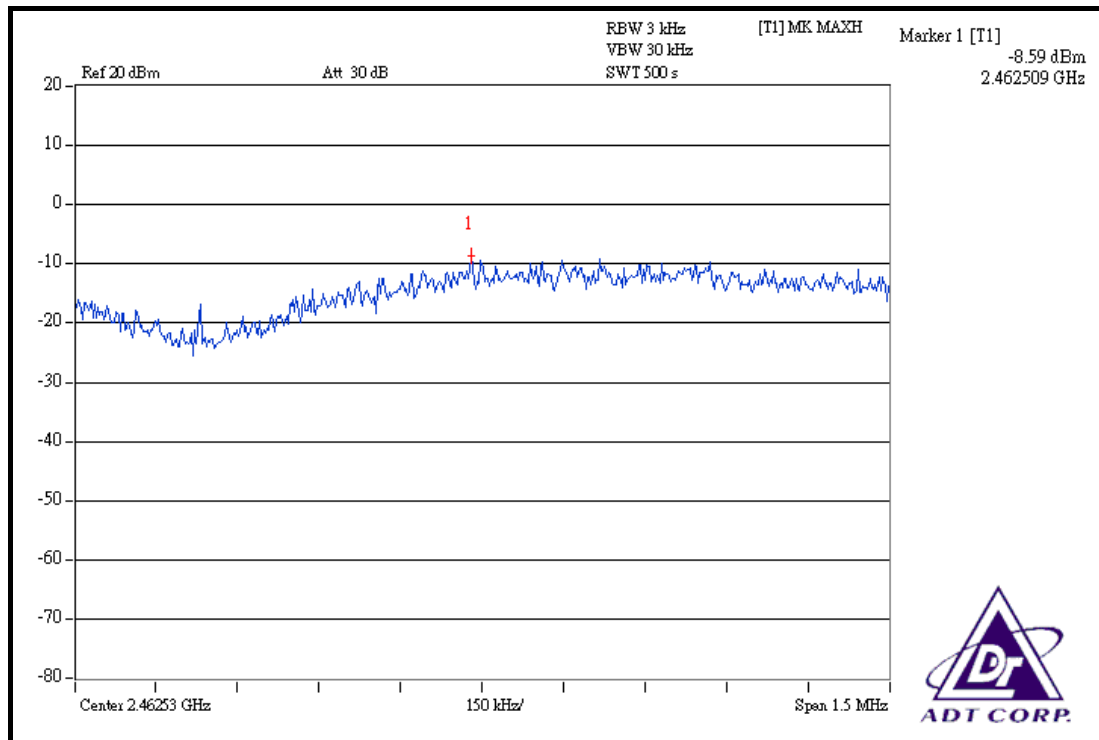



802.11g OFDM MODULATION_NORMAL MODE

MODULATION TYPE	BPSK	TRANSFER RATE	6Mbps
INPUT POWER (SYSTEM)	120Vac, 60 Hz	ENVIRONMENTAL CONDITIONS	25deg. C, 65%RH, 1032hPa
TESTED BY	Brad Wu		

CHANNEL	CHANNEL FREQUENCY (MHz)	RF POWER LEVEL IN 3 kHz BW (dBm)	MAXIMUM LIMIT (dBm)	PASS/FAIL
1	2412	-13.04	8	PASS
6	2437	-13.08	8	PASS
11	2462	-13.44	8	PASS

CH 1

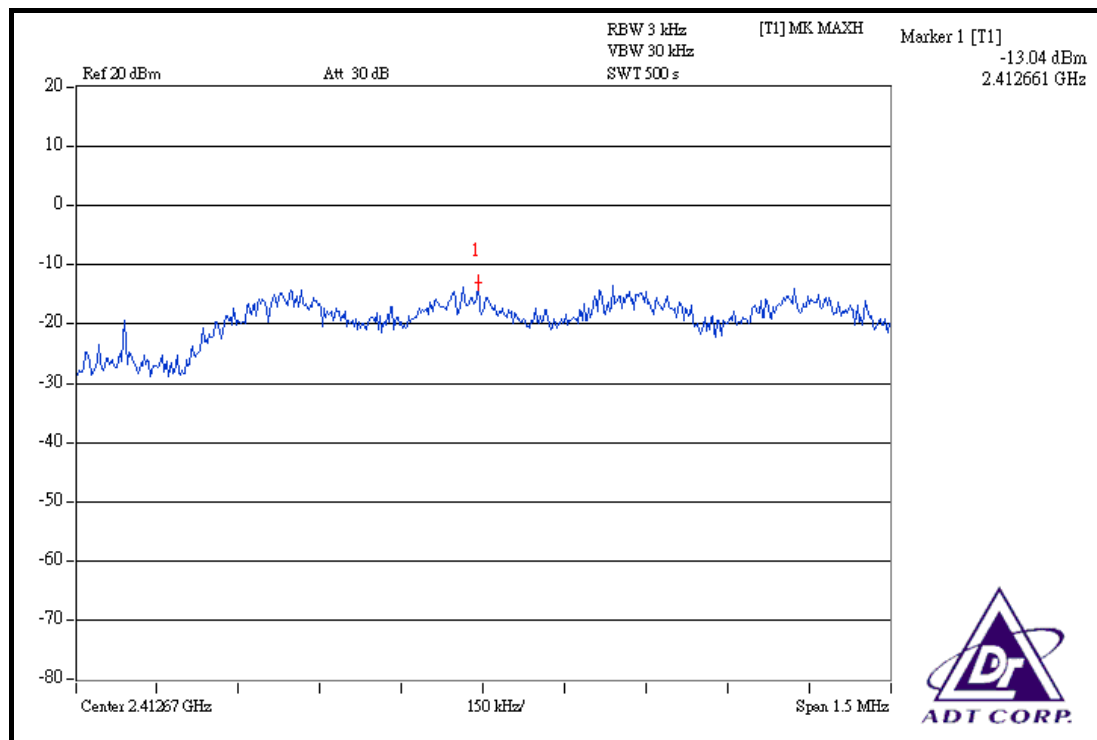

CH 6

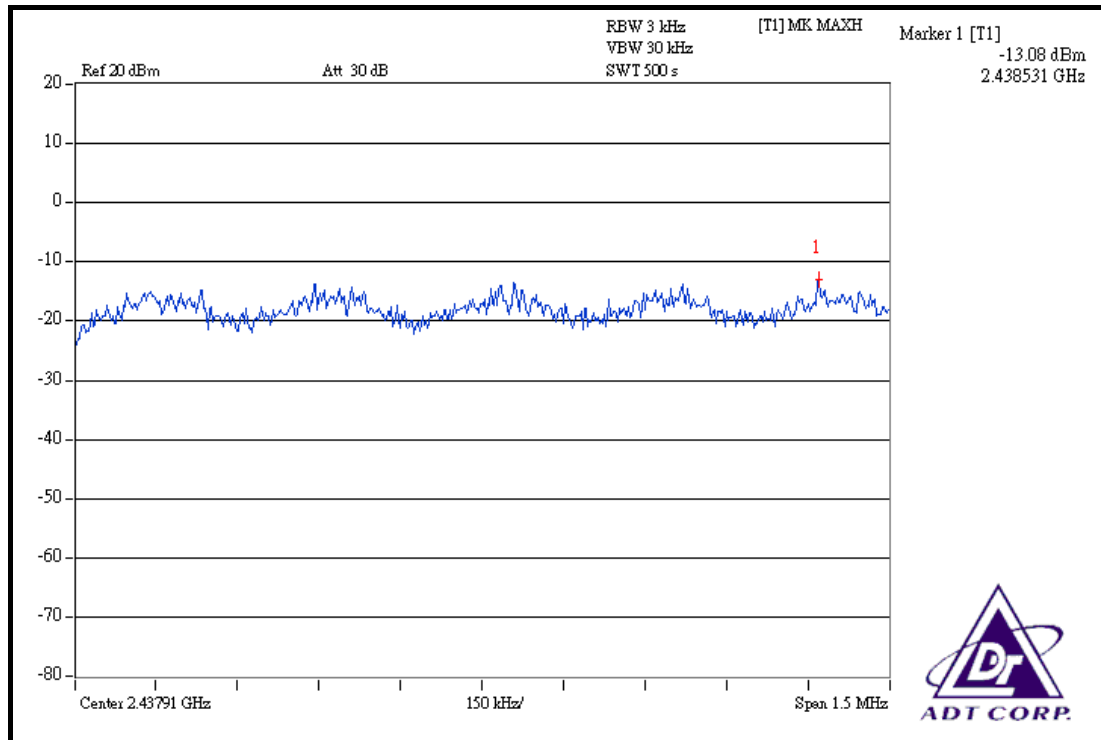

CH 11

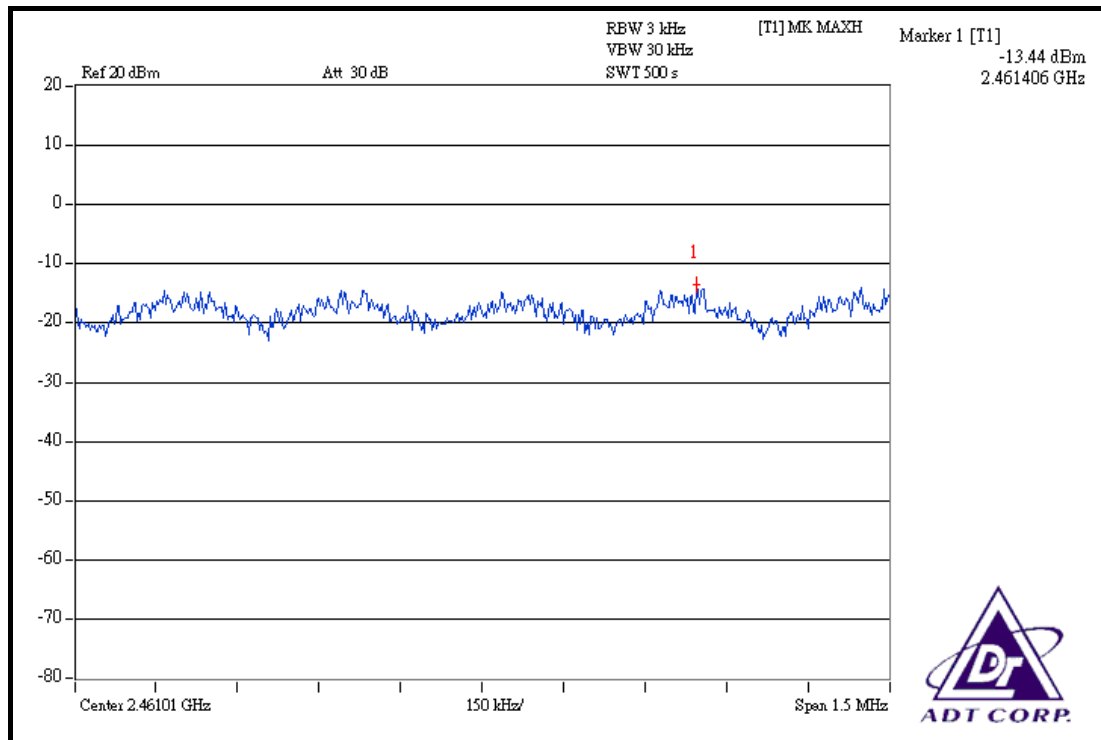



802.11g OFDM MODULATION_TURBO MODE

MODULATION TYPE	QPSK	TRANSFER RATE	12Mbps
INPUT POWER (SYSTEM)	120Vac, 60 Hz	ENVIRONMENTAL CONDITIONS	25deg. C, 65%RH, 1032hPa
TESTED BY	Brad Wu		

CHANNEL	CHANNEL FREQUENCY (MHz)	RF POWER LEVEL IN 3 kHz BW (dBm)	MAXIMUM LIMIT (dBm)	PASS/FAIL
6	2437	-17.01	8	PASS

CH 6

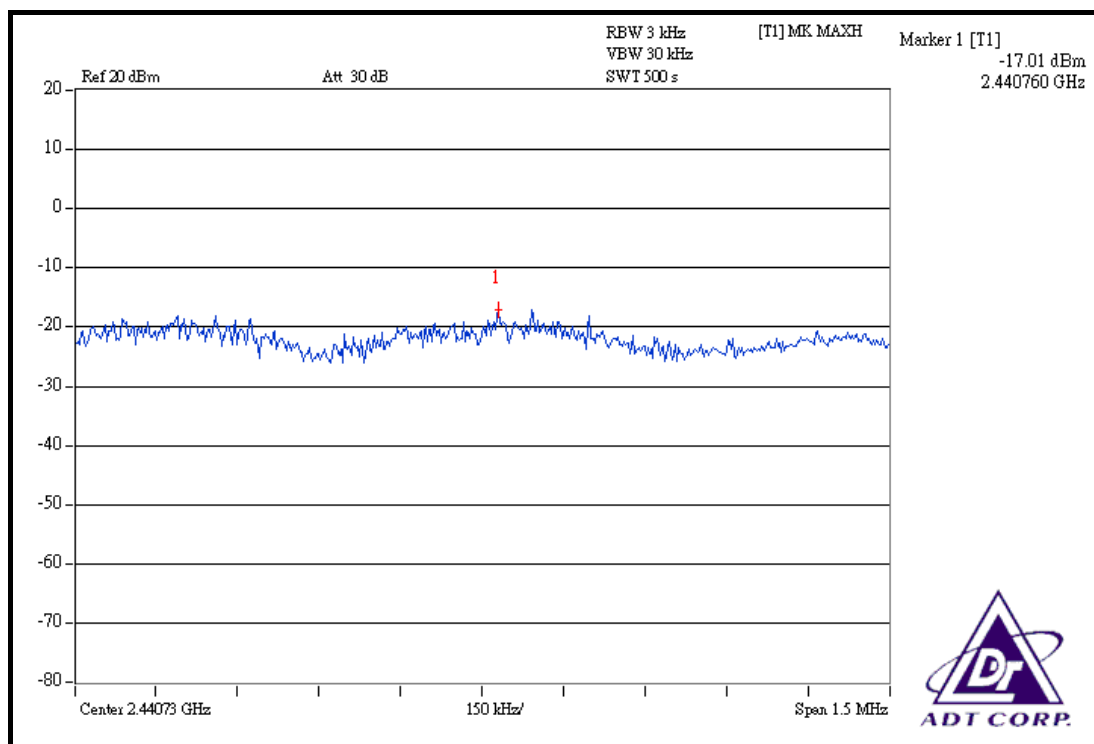

4.6 BAND EDGES MEASUREMENT

4.6.1 LIMITS OF BAND EDGES MEASUREMENT

Below -20dB of the highest emission level of operating band (in 100kHz Resolution Bandwidth).

4.6.2 TEST INSTRUMENTS

DESCRIPTION & MANUFACTURER	MODEL NO.	SERIAL NO.	CALIBRATED UNTIL
R&S SPECTRUM ANALYZER	FSP 40	100040	Jun. 28, 2008

NOTE: The calibration interval of the above test instruments is 12 months and the calibrations are traceable to NML/ROC and NIST/USA.

4.6.3 TEST PROCEDURE

The transmitter output was connected to the spectrum analyzer via a low lose cable. Set both RBW and VBW of spectrum analyzer to 100kHz and 300kHz with suitable frequency span including 100MHz bandwidth from band edge. The band edges was measured and recorded.

The spectrum plots (Peak RBW=100kHz, VBW=300kHz; Average RBW=1MHz, VBW= 10Hz are attached on the following pages.

4.6.4 DEVIATION FROM TEST STANDARD

No deviation.

4.6.5 EUT OPERATING CONDITION

Same as 4.3.6.

4.6.6 TEST RESULTS

The spectrum plots are attached on the following 18 images. D1 line indicates the highest level, and D2 line indicates the 20dB offset below D1. It shows compliance with the requirement in part 15.247(d).

802.11b DSSS MODULATION

NOTE 1: The band edge emission plot on the next second page shows 50.82dBc between carrier maximum power and local maximum emission in restrict band (2.3766GHz). The emission of carrier strength list in the test result of channel 1 at the item 4.2.7 is 109.77dBuV/m (Peak), so the maximum field strength in restrict band is $109.77 - 50.82 = 58.95$ dBuV/m which is under 74dBuV/m limit.

The band edge emission plot on the next second page shows 54.25dBc between carrier maximum power and local maximum emission in restrict band (2.3868GHz). The emission of carrier strength list in the test result of channel 1 at the item 4.2.7 is 105.27dBuV/m (Peak), so the maximum field strength in restrict band is $105.27 - 54.25 = 51.02$ dBuV/m which is under 54dBuV/m limit.

NOTE 2: The band edge emission plot on the next third page shows 51.49dBc between carrier maximum power and local maximum emission in restrict band (2.4872GHz). The emission of carrier strength list in the test result of channel 11 at the item 4.2.7 is 110.20dBuV/m (Peak), so the maximum field strength in restrict band is $110.20 - 51.49 = 58.71$ dBuV/m which is under 74dBuV/m limit.

The band edge emission plot on the next fourth page shows 56.30dBc between carrier maximum power and local maximum emission in restrict band (2.4888GHz). The emission of carrier strength list in the test result of channel 11 at the item 4.2.7 is 105.52dBuV/m (Peak), so the maximum field strength in restrict band is $105.52 - 56.30 = 49.22$ dBuV/m which is under 54dBuV/m limit.

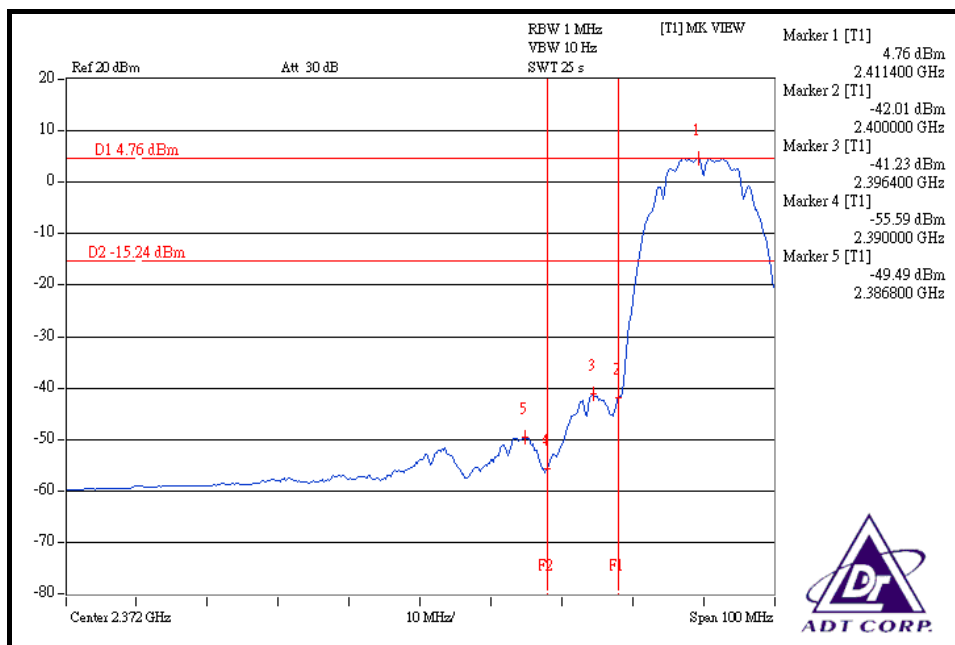
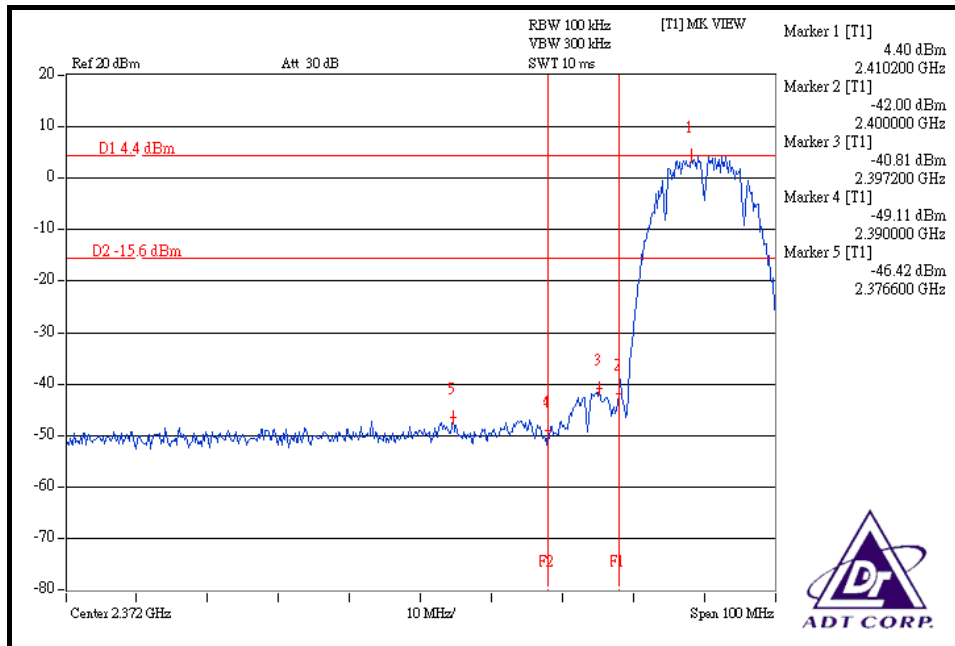

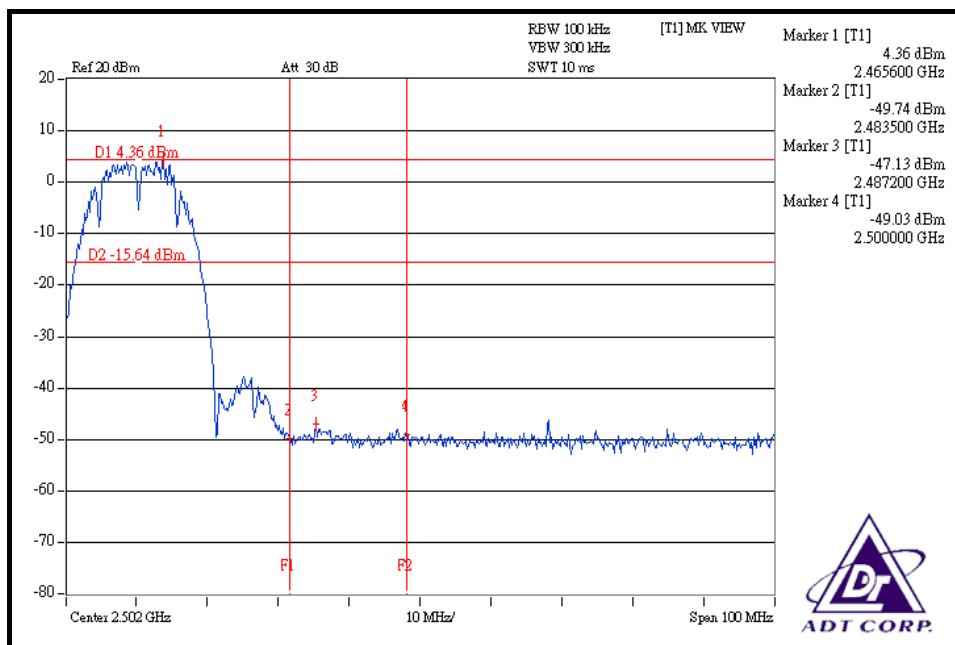
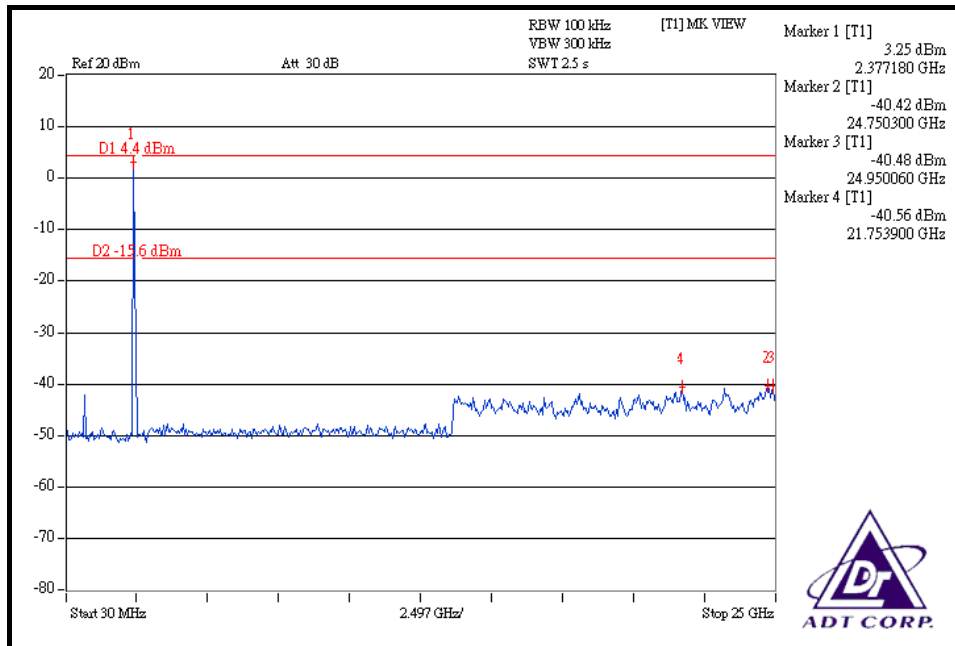

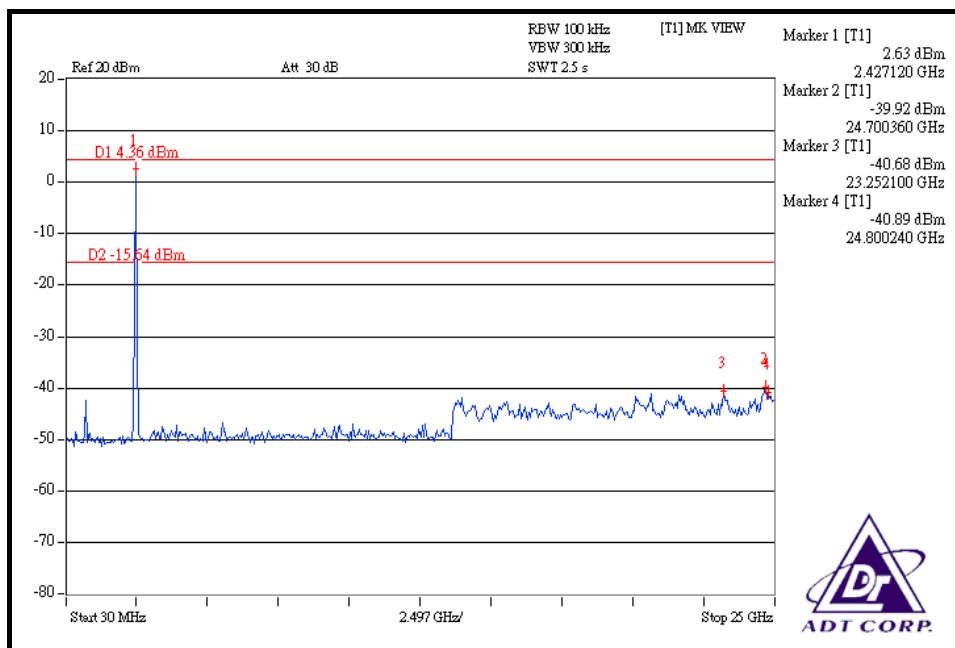
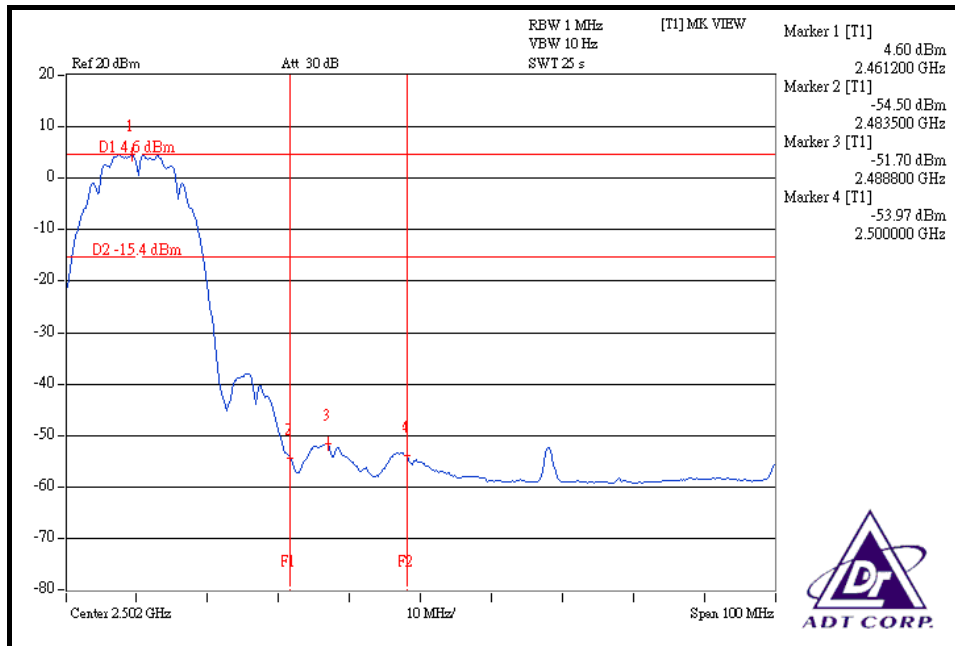

802.11g OFDM MODULATION _NORMAL MODE

NOTE 1: The band edge emission plot on the next second page shows 46.32dBc between carrier maximum power and local maximum emission in restrict band (2.3656GHz). The emission of carrier strength list in the test result of channel 1 at the item 4.2.7 is 109.64dBuV/m (Peak), so the maximum field strength in restrict band is $109.64 - 46.32 = 63.32$ dBuV/m which is under 74dBuV/m limit.

The band edge emission plot on the next second page shows 50.68dBc between carrier maximum power and local maximum emission in restrict band (2.3900GHz). The emission of carrier strength list in the test result of channel 1 at the item 4.2.7 is 98.98dBuV/m (Peak), so the maximum field strength in restrict band is $98.98 - 50.68 = 48.30$ dBuV/m which is under 54dBuV/m limit.

NOTE 2: The band edge emission plot on the next third page shows 45.98dBc between carrier maximum power and local maximum emission in restrict band (2.4836GHz). The emission of carrier strength list in the test result of channel 11 at the item 4.2.7 is 109.93 dBuV/m (Peak), so the maximum field strength in restrict band is $109.93 - 45.98 = 63.95$ dBuV/m which is under 74dBuV/m limit.

The band edge emission plot on the next fourth page shows 49.50Bc between carrier maximum power and local maximum emission in restrict band (2.4835GHz). The emission of carrier strength list in the test result of channel 11 at the item 4.2.7 is 99.46dBuV/m (Peak), so the maximum field strength in restrict band is $99.46 - 49.50 = 49.96$ dBuV/m which is under 54dBuV/m limit.

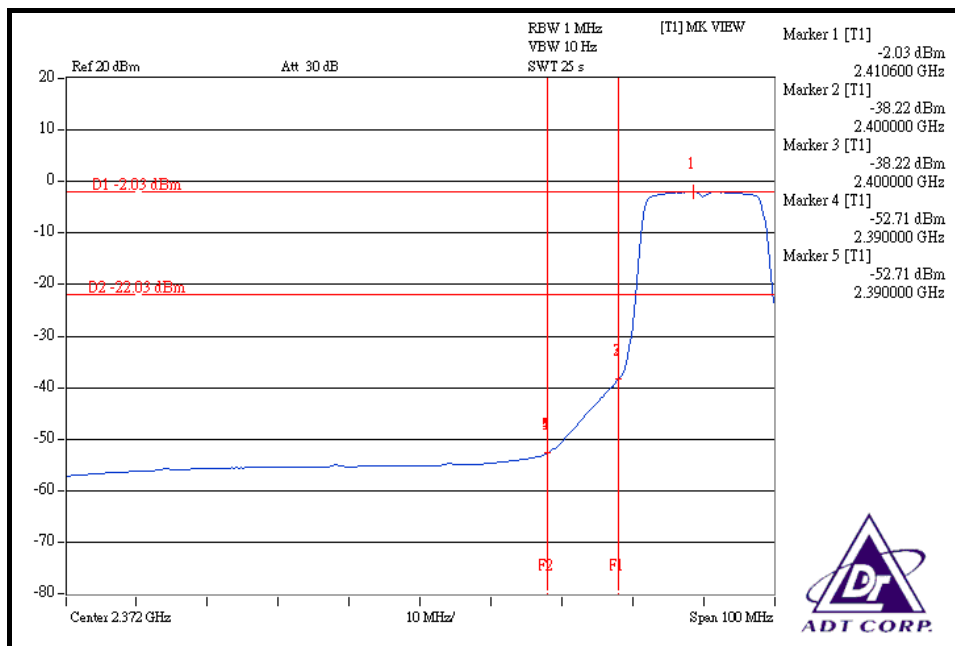
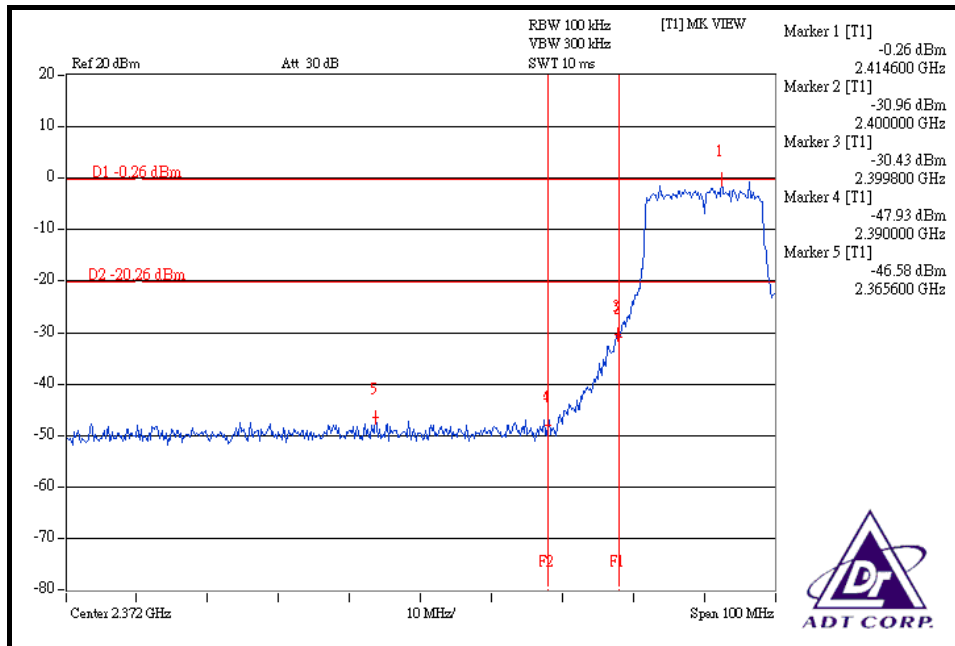

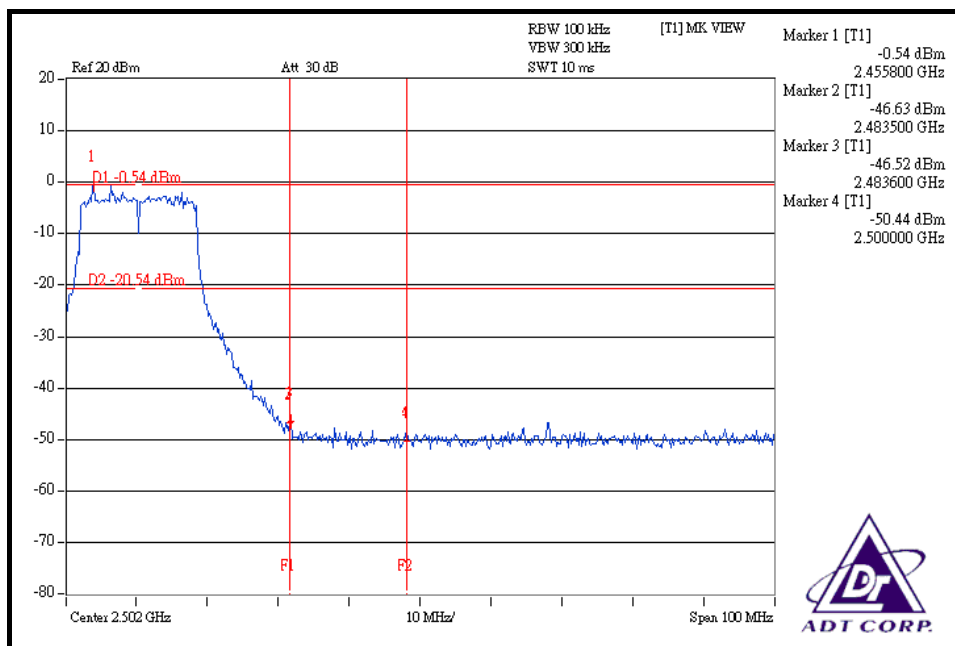
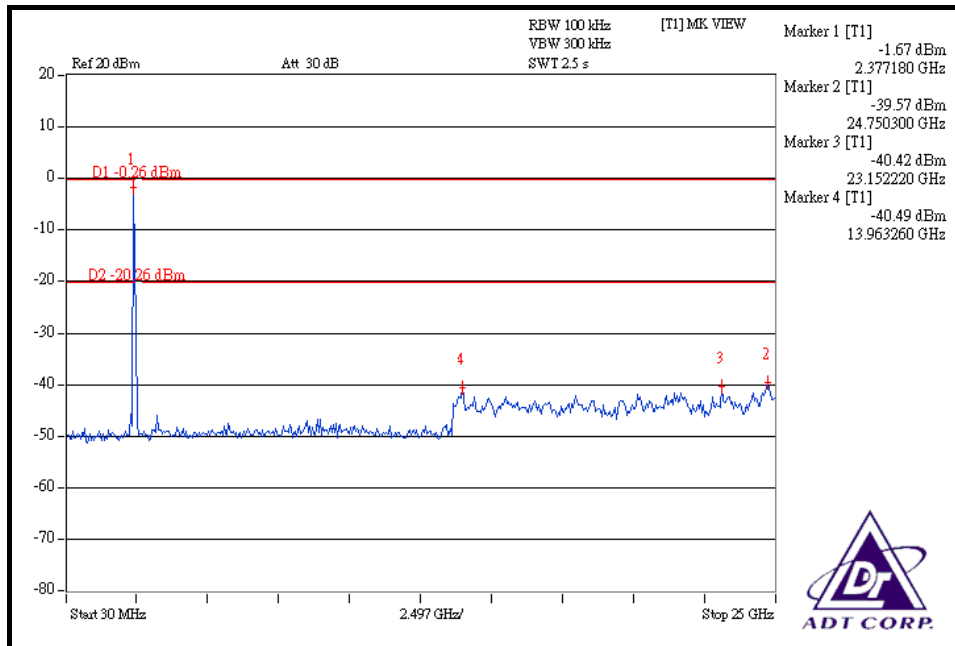

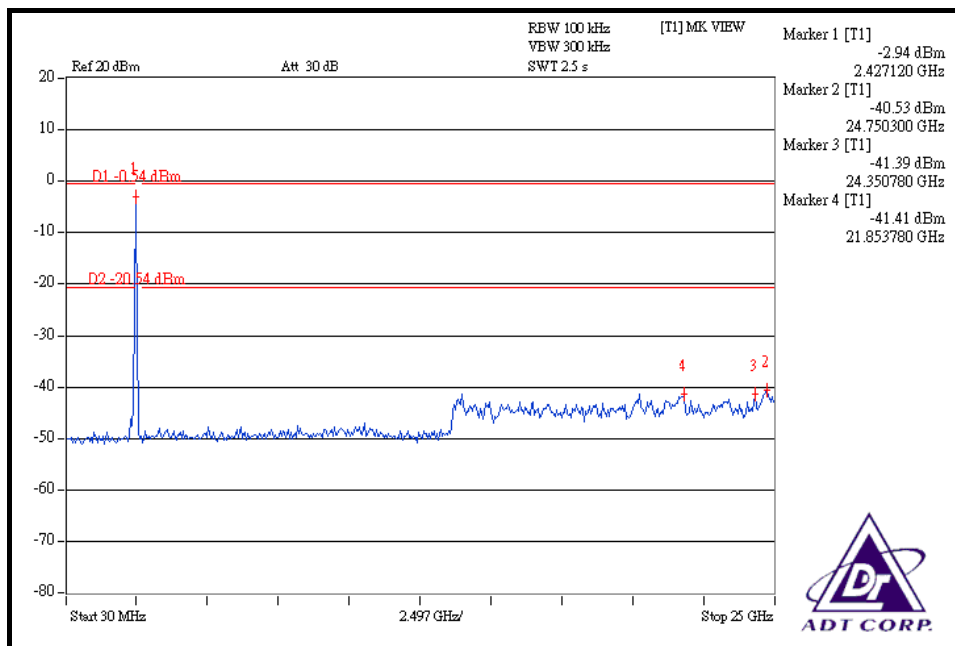
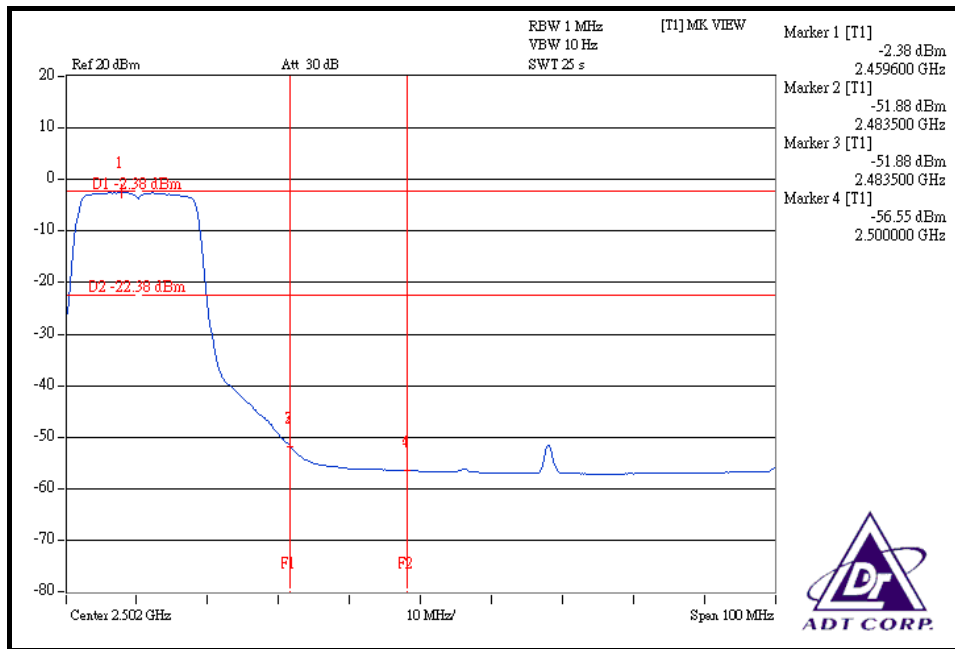

802.11g OFDM MODULATION _TURBO MODE

NOTE 1: The band edge emission plot on the next second page shows 44.69dBc between carrier maximum power and local maximum emission in restrict band (2.3202GHz). The emission of carrier strength list in the test result of channel 6 at the item 4.2.7 is 105.85dBuV/m (Peak), so the maximum field strength in restrict band is $105.85 - 44.69 = 61.16$ dBuV/m which is under 74dBuV/m limit.

The band edge emission plot on the next second page shows 45.17dBc between carrier maximum power and local maximum emission in restrict band (2.31980GHz). The emission of carrier strength list in the test result of channel 6 at the item 4.2.7 is 95.90dBuV/m (Peak), so the maximum field strength in restrict band is $95.90 - 45.17 = 50.73$ dBuV/m which is under 54dBuV/m limit.

NOTE 2: The band edge emission plot on the next third page shows 46.74dBc between carrier maximum power and local maximum emission in restrict band (2.4924GHz). The emission of carrier strength list in the test result of channel 6 at the item 4.2.7 is 105.85 dBuV/m (Peak), so the maximum field strength in restrict band is $105.85 - 46.74 = 59.11$ dBuV/m which is under 74dBuV/m limit.

The band edge emission plot on the next fourth page shows 49.84dBc between carrier maximum power and local maximum emission in restrict band (2.4836GHz). The emission of carrier strength list in the test result of channel 6 at the item 4.2.7 is 95.90dBuV/m (Peak), so the maximum field strength in restrict band is $95.90 - 49.84 = 46.06$ dBuV/m which is under 54dBuV/m limit.

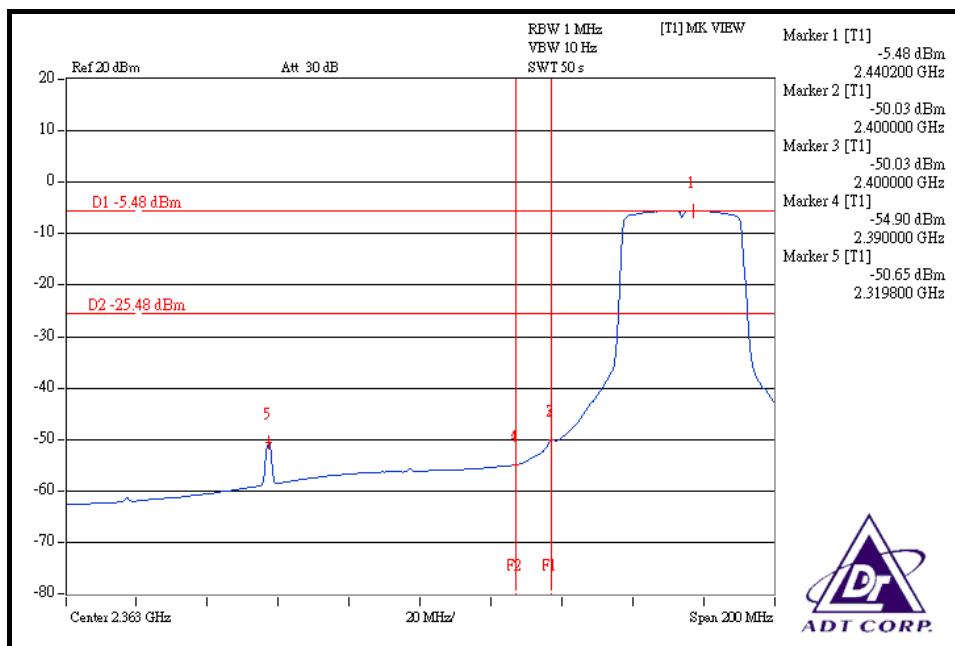
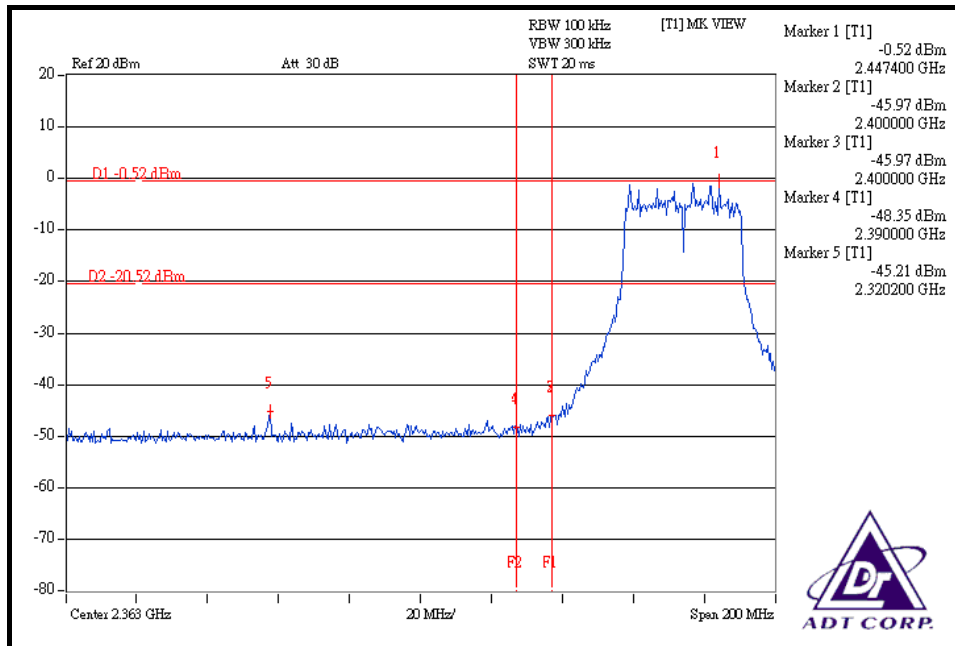

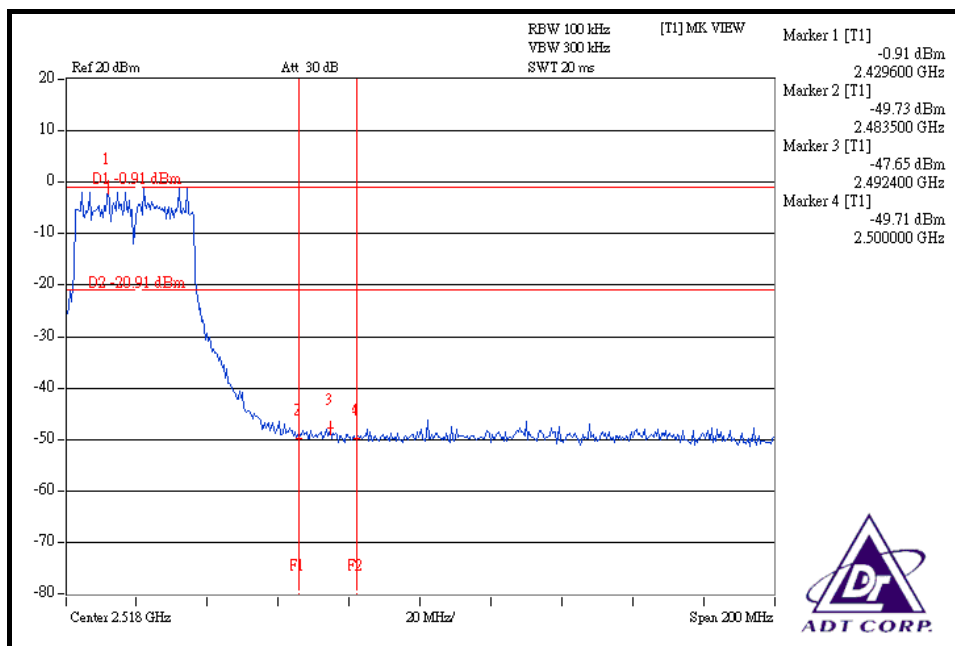
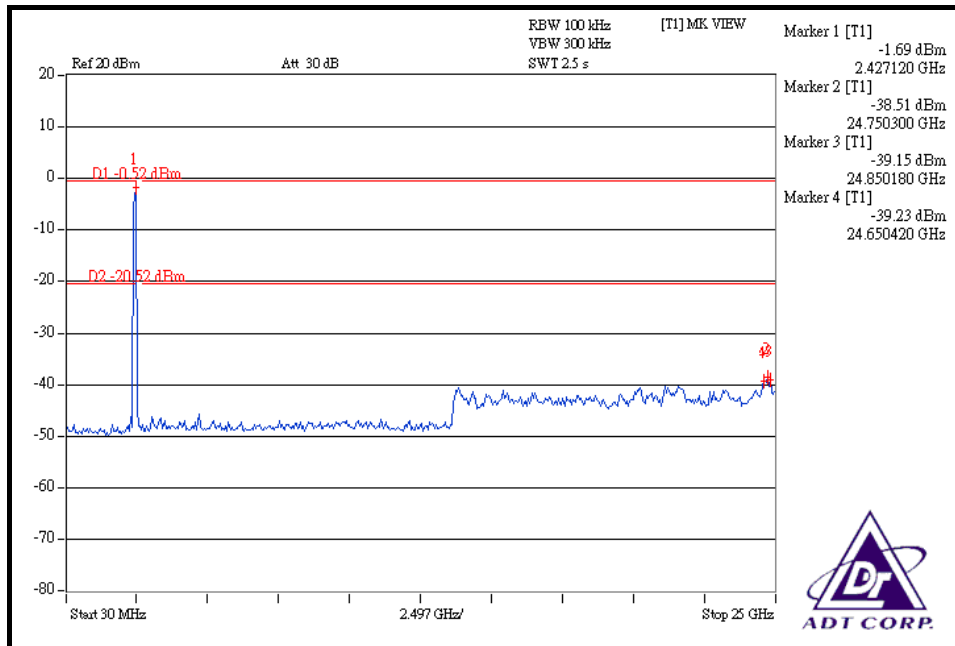

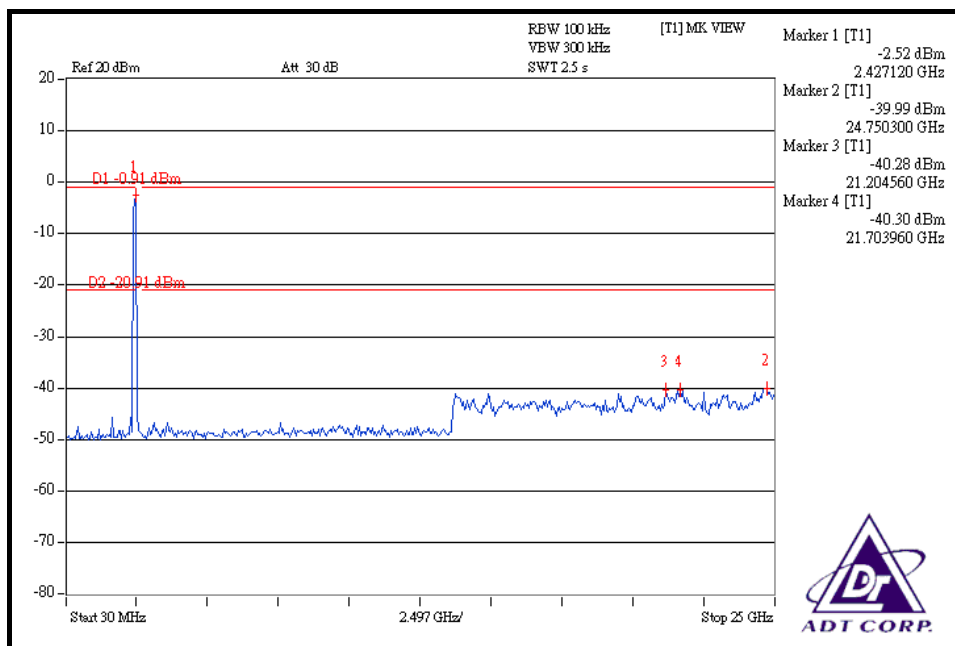
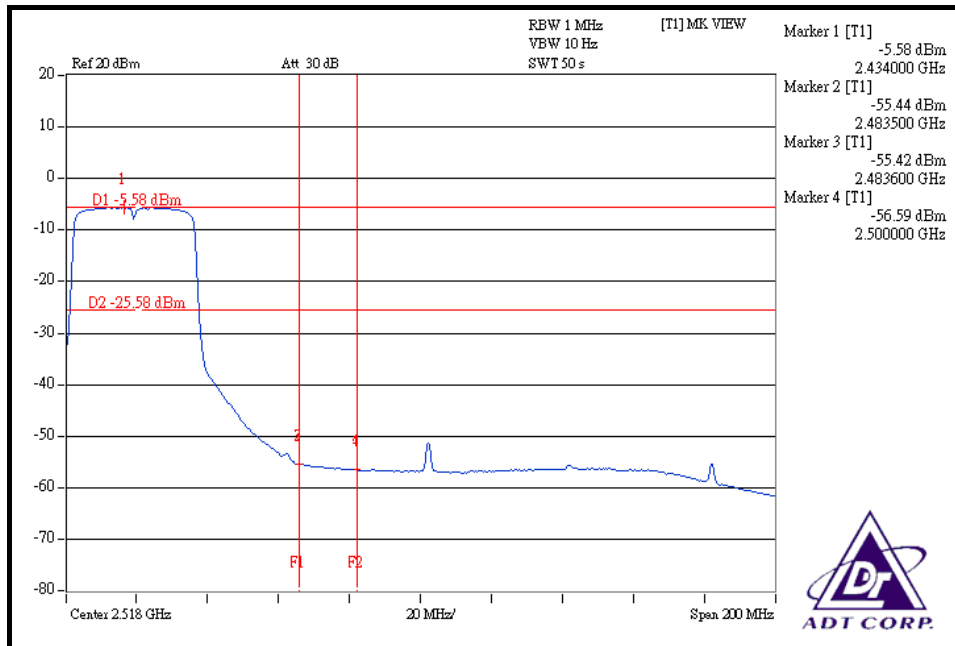

4.7 ANTENNA REQUIREMENT

4.7.1 STANDARD APPLICABLE

For intentional device, according to FCC 47 CFR Section 15.203, an intentional radiator shall be designed to ensure that no antenna other than that furnished by the responsible party shall be used with the device.

And according to FCC 47 CFR Section 15.247 (b), if transmitting antennas of directional gain greater than 6dBi are used, the power shall be reduced by the amount in dB that the directional gain of the antenna exceeds 6dBi.

4.7.2 ANTENNA CONNECTED CONSTRUCTION

The antenna used in this product is dipole antenna with R-SMA connector. The maximum Gain of the antenna is 2dBi.

5 PHOTOGRAPHS OF THE TEST CONFIGURATION

Please refer to the attached file (Test Setup Photo).

6 INFORMATION ON THE TESTING LABORATORIES

We, ADT Corp., were founded in 1988 to provide our best service in EMC, Radio, Telecom and Safety consultation. Our laboratories are accredited and approved by the following approval agencies according to ISO/IEC 17025.

USA	FCC, UL, A2LA
Germany	TUV Rheinland
Japan	VCCI
Norway	NEMKO
Canada	INDUSTRY CANADA , CSA
R.O.C.	TAF, BSMI, NCC
Netherlands	Telefication
Singapore	GOST-ASIA(MOU)
Russia	CERTIS(MOU)

Copies of accreditation certificates of our laboratories obtained from approval agencies can be downloaded from our web site: www.adt.com.tw/index.5/phtml. If you have any comments, please feel free to contact us at the following:

Linko EMC/RF Lab

Tel: 886-2-26052180
Fax: 886-2-26051924

Hsin Chu EMC/RF Lab

Tel: 886-3-5935343
Fax: 886-3-5935342

Hwa Ya EMC/RF/Safety/Telecom Lab

Tel: 886-3-3183232
Fax: 886-3-3185050

Web Site: www.adt.com.tw

The address and road map of all our labs can be found in our web site also.

7 APPENDIX A – MODIFICATIONS RECORDERS FOR ENGINEERING CHANGES TO THE EUT BY THE LAB

No any modifications are made to the EUT by the lab during the test.