

## FCC Test Report

**Report No.:** RF150427C31D-1

**FCC ID:** U2M-PCE4302AN

**Test Model:** PCE4302AN

**Series Model:** PCE4302AN-xxxxxx (where "x" can be used as "A-Z", or "-0-9", or "-", or blank for software changes or marketing purposes only)

**Received Date:** Apr. 27, 2015

**Test Date:** May 14 ~ May 29, 2015 (For U-NII-1 Band)

Feb. 06 ~ Feb. 08, 2018 (For U-NII-3 Band)

**Issued Date:** Feb. 27, 2018

**Applicant:** Senao Networks, Inc.

**Address:** 3F, No. 529, Chung Cheng Rd., Hsintien, New Taipei City, R.O.C

**Issued By:** Bureau Veritas Consumer Products Services (H.K.) Ltd., Taoyuan Branch

**Lab Address:** No. 47-2, 14th Ling, Chia Pau Vil., Lin Kou Dist., New Taipei City, Taiwan (R.O.C.)

**Test Location:** No. 19, Hwa Ya 2nd Rd., Wen Hwa Vil., Kwei Shan Dist., Taoyuan City 33383, TAIWAN (R.O.C.)

**FCC Registration /  
Designation Number:** 788550 / TW0003



This report is for your exclusive use. Any copying or replication of this report to or for any other person or entity, or use of our name or trademark, is permitted only with our prior written permission. This report sets forth our findings solely with respect to the test samples identified herein. The results set forth in this report are not indicative or representative of the quality or characteristics of the lot from which a test sample was taken or any similar or identical product specifically and expressly noted. Our report includes all of the tests requested by you and the results thereof based upon the information that you provided to us. You have 60 days from date of issuance of this report to notify us of any material error or omission caused by our negligence, provided, however, that such notice shall be in writing and shall specifically address the issue you wish to raise. A failure to raise such issue within the prescribed time shall constitute your unqualified acceptance of the completeness of this report, the tests conducted and the correctness of the report contents. Unless specific mention, the uncertainty of measurement has been explicitly taken into account to declare the compliance or non-compliance to the specification. This report should not be used by the client to claim product certification, approval, or endorsement by TAF or any government agencies.

## Table of Contents

<b>Release Control Record</b> .....	<b>4</b>
<b>1 Certificate of Conformity</b> .....	<b>5</b>
<b>2 Summary of Test Results</b> .....	<b>6</b>
2.1 Measurement Uncertainty.....	6
2.2 Modification Record.....	6
<b>3 General Information</b> .....	<b>7</b>
3.1 General Description of EUT.....	7
3.2 Description of Test Modes.....	8
3.2.1 Test Mode Applicability and Tested Channel Detail.....	9
3.3 Duty Cycle of Test Signal.....	11
3.4 Description of Support Units.....	12
3.4.1 Configuration of System under Test.....	12
3.5 General Description of Applied Standards.....	13
<b>4 Test Types and Results</b> .....	<b>14</b>
4.1 Radiated Emission and Bandedge Measurement.....	14
4.1.1 Limits of Radiated Emission and Bandedge Measurement.....	14
4.1.2 Test Instruments.....	15
4.1.3 Test Procedures.....	17
4.1.4 Deviation from Test Standard.....	17
4.1.5 Test Setup.....	18
4.1.6 EUT Operating Conditions.....	19
4.1.7 Test Results.....	20
4.2 Conducted Emission Measurement.....	39
4.2.1 Limits of Conducted Emission Measurement.....	39
4.2.2 Test Instruments.....	39
4.2.3 Test Procedures.....	40
4.2.4 Deviation from Test Standard.....	40
4.2.5 Test Setup.....	40
4.2.6 EUT Operating Conditions.....	40
4.2.7 Test Results.....	41
4.3 Transmit Power Measurement.....	43
4.3.1 Limits of Transmit Power Measurement.....	43
4.3.2 Test Setup.....	43
4.3.3 Test Instruments.....	43
4.3.4 Test Procedure.....	44
4.3.5 Deviation from Test Standard.....	44
4.3.6 EUT Operating Conditions.....	44
4.3.7 Test Result.....	45
4.4 Occupied Bandwidth Measurement.....	46
4.4.1 Test Setup.....	46
4.4.2 Test Instruments.....	46
4.4.3 Test Procedure.....	46
4.4.4 Test Result.....	47
4.5 Peak Power Spectral Density Measurement.....	49
4.5.1 Limits of Peak Power Spectral Density Measurement.....	49
4.5.2 Test Setup.....	49
4.5.3 Test Instruments.....	49
4.5.4 Test Procedures.....	49
4.5.5 Deviation from Test Standard.....	50
4.5.6 EUT Operating Conditions.....	50
4.5.7 Test Results.....	51
4.6 Frequency Stability.....	56
4.6.1 Limits of Frequency Stability Measurement.....	56

4.6.2	Test Setup.....	56
4.6.3	Test Instruments .....	56
4.6.4	Test Procedure .....	56
4.6.5	Deviation from Test Standard .....	56
4.6.6	EUT Operating Condition .....	56
4.6.7	Test Results .....	57
4.7	6dB Bandwidth Measurement.....	58
4.7.1	Limits of 6dB Bandwidth Measurement.....	58
4.7.2	Test Setup.....	58
4.7.3	Test Instruments .....	58
4.7.4	Test Procedure .....	58
4.7.5	Deviation from Test Standard .....	58
4.7.6	EUT Operating Condition .....	58
4.7.7	Test Results .....	59
<b>5</b>	<b>Pictures of Test Arrangements.....</b>	<b>61</b>
	<b>Annex A- Radiated Out of Band Emission (OOBE) Measurement (For U-NII-3 band).....</b>	<b>62</b>
	<b>Appendix – Information on the Testing Laboratories .....</b>	<b>65</b>

### Release Control Record

Issue No.	Description	Date Issued
RF150427C31D-1	Original release	Feb. 27, 2018

## 1 Certificate of Conformity

**Product:** 802.11 ac 2x2 Module

**Brand:** Senao

**Test Model:** PCE4302AN

**Series Model:** PCE4302AN-xxxxxx (where "x" can be used as "A-Z", or "-0-9", or "-", or blank for software changes or marketing purposes only)

**Sample Status:** Engineering sample

**Applicant:** Senao Networks, Inc.

**Test Date:** May 14 ~ May 29, 2015 (For U-NII-1 Band)

Feb. 06 ~ Feb. 08, 2018 (For U-NII-3 Band)

**Standards:** 47 CFR FCC Part 15, Subpart E (Section 15.407)

ANSI C63.10:2013

The above equipment has been tested by **Bureau Veritas Consumer Products Services (H.K.) Ltd., Taoyuan Branch**, and found compliance with the requirement of the above standards. The test record, data evaluation & Equipment Under Test (EUT) configurations represented herein are true and accurate accounts of the measurements of the sample's RF characteristics under the conditions specified in this report.

**Prepared by :** Celine Chou , **Date:** Feb. 27, 2018  
Celine Chou / Specialist

**Approved by :** Bruce Chen , **Date:** Feb. 27, 2018  
Bruce Chen / Project Engineer

## 2 Summary of Test Results

47 CFR FCC Part 15, Subpart E (Section 15.407)			
FCC Clause	Test Item	Result	Remarks
15.407(b)(6)	AC Power Conducted Emissions	Pass	Meet the requirement of limit. Minimum passing margin is -3.28dB at 4.29800MHz.
15.407(b)(1/2/3/4(i/ii)/6)	Radiated Emissions & Band Edge Measurement	Pass	Meet the requirement of limit. Minimum passing margin is -1.1dB at 5150.00MHz.
15.407(a)(1/2/3)	Max Average Transmit Power	Pass	Meet the requirement of limit.
---	Occupied Bandwidth Measurement	-	Reference only.
15.407(a)(1/2/3)	Peak Power Spectral Density	Pass	Meet the requirement of limit.
15.407(e)	6dB bandwidth	Pass	Meet the requirement of limit. (U-NII-3 Band only)
15.407(g)	Frequency Stability	Pass	Meet the requirement of limit.
15.203	Antenna Requirement	Pass	Antenna connector is R-SMA not a standard connector.

### 2.1 Measurement Uncertainty

Where relevant, the following measurement uncertainty levels have been estimated for tests performed on the EUT as specified in CISPR 16-4-2:

Measurement	Frequency	Expanded Uncertainty (k=2) ( $\pm$ )
Conducted Emissions at mains ports	150kHz ~ 30MHz	2.94 dB
Radiated Emissions up to 1 GHz	30MHz ~ 200MHz	3.86 dB
	200MHz ~ 1000MHz	3.87 dB
Radiated Emissions above 1 GHz	1GHz ~ 18GHz	2.29 dB
	18GHz ~ 40GHz	2.29 dB

### 2.2 Modification Record

There were no modifications required for compliance.

### 3 General Information

#### 3.1 General Description of EUT

Product	802.11 ac 2x2 Module
Brand	Senao
Test Model	PCE4302AN
Series Model	PCE4302AN-xxxxxx (where "x" can be used as "A-Z", or "-0-9", or "-", or blank for software changes or marketing purposes only)
Model Difference	For software changes or marketing purposes only
Status of EUT	Engineering sample
Power Supply Rating	3.3Vdc (External Board)
Modulation Type	256QAM, 64QAM, 16QAM, QPSK, BPSK
Modulation Technology	OFDM
Transfer Rate	802.11a: 54.0/ 48.0/ 36.0/ 24.0/ 18.0/ 12.0/ 9.0/ 6.0Mbps 802.11n: up to 300Mbps 802.11ac: up to 867Mbps
Operating Frequency	5180 ~ 5240MHz, 5745 ~ 5825MHz
Number of Channel	5180 ~ 5240MHz: 802.11a, 802.11n (HT20), 802.11ac (VHT20): 4 802.11n (HT40), 802.11ac (VHT40): 2 802.11ac (VHT80): 1 5745 ~ 5825MHz: 802.11a, 802.11n (HT20), 802.11ac (VHT20): 5 802.11n (HT40), 802.11ac (VHT40): 2 802.11ac (VHT80): 1
Output Power	5180 ~ 5240MHz: 231.698mW 5745 ~ 5825MHz: 157.714mW
Antenna Type	Refer to Note
Antenna Connector	Refer to Note
Accessory Device	NA
Data Cable Supplied	NA

Note:

- The EUT incorporates a MIMO function. Physically, the EUT provides 2 completed transmitters and 2 receivers.

Modulation Mode	TX Function
802.11a	2TX
802.11n (HT20)	2TX
802.11n (HT40)	2TX
802.11ac (VHT20)	2TX
802.11ac (VHT40)	2TX
802.11ac (VHT80)	2TX

\* The modulation and bandwidth are similar for 802.11n mode for 20MHz/40MHz and 802.11ac mode for 20MHz/40MHz, therefore investigated worst case to representative mode in test report. (Final test mode refer section 3.2.1)

2. The EUT uses following adapter. (For support unit only)

Adapter	
Brand	DVE
Model	DSA-12G-12 FUS 120120
Input	100-240Vac, 50/60Hz, 0.3A
Output	12Vdc, 1A
Power Line	1.5m cable without core attached on adapter

3. The following antennas were provided to the EUT.

No.	Type	Gain(dBi)		Connector
		2.4GHz Band	5GHz Band	
1	Dipole	3	6	R-SMA
2	Dipole	2	3	R-SMA

4. WLAN 2.4GHz and 5GHz technology cannot transmit simultaneously.

### 3.2 Description of Test Modes

For 5180 ~ 5240MHz:

4 channels are provided for 802.11a, 802.11n (HT20), 802.11ac (VHT20):

Channel	Frequency	Channel	Frequency
36	5180 MHz	44	5220 MHz
40	5200 MHz	48	5240 MHz

2 channels are provided for 802.11n (HT40), 802.11ac (VHT40):

Channel	Frequency	Channel	Frequency
38	5190 MHz	46	5230 MHz

1 channel is provided for 802.11ac (VHT80):

Channel	Frequency
42	5210MHz

For 5745 ~ 5825MHz:

5 channels are provided for 802.11a, 802.11n (HT20), 802.11ac (VHT20):

Channel	Frequency	Channel	Frequency
149	5745MHz	161	5805MHz
153	5765MHz	165	5825MHz
157	5785MHz		

2 channels are provided for 802.11n (HT40), 802.11ac (VHT40):

Channel	Frequency	Channel	Frequency
151	5755MHz	159	5795MHz

1 channel is provided for 802.11ac (VHT80):

Channel	Frequency
155	5775MHz



### 3.2.1 Test Mode Applicability and Tested Channel Detail

EUT Configure Mode	Applicable to				Description
	RE $\geq$ 1G	RE $<$ 1G	PLC	APCM	
-	√	√	√	√	-

Where RE $\geq$ 1G: Radiated Emission above 1GHz & Bandedge Measurement  
 RE $<$ 1G: Radiated Emission below 1GHz  
 PLC: Power Line Conducted Emission  
 APCM: Antenna Port Conducted Measurement

Note: The EUT had been pre-tested on the positioned of each 3 axis. The worst case was found when positioned on **X-plane**.

#### **Radiated Emission Test (Above 1GHz):**

- Pre-Scan has been conducted to determine the worst-case mode from all possible combinations between available modulations, data rates and antenna ports (if EUT with antenna diversity architecture).
- Following channel(s) was (were) selected for the final test as listed below.

EUT Configure Mode	Mode	Frequency Band (MHz)	Available Channel	Tested Channel	Modulation Technology	Data Rate (Mbps)
-	802.11a	5180-5240	36 to 48	36, 40, 48	OFDM	6.0
	802.11n (HT20)		36 to 48	36, 40, 48	OFDM	7.2
	802.11n (HT40)		38 to 46	38, 46	OFDM	15.0
	802.11ac (VHT80)		42	42	OFDM	65.0
-	802.11a	5745-5825	149 to 165	149, 157, 165	OFDM	6.0
	802.11n (HT20)		149 to 165	149, 157, 165	OFDM	7.2
	802.11n (HT40)		151 to 159	151, 159	OFDM	15.0
	802.11ac (VHT80)		155	155	OFDM	65.0

#### **Radiated Emission Test (Below 1GHz):**

- Pre-Scan has been conducted to determine the worst-case mode from all possible combinations between available modulations, data rates and antenna ports (if EUT with antenna diversity architecture).
- Following channel(s) was (were) selected for the final test as listed below.

EUT Configure Mode	Mode	Frequency Band (MHz)	Available Channel	Tested Channel	Modulation Technology	Data Rate (Mbps)
-	802.11a	5180-5240	36 to 48	149	OFDM	6.0
-	802.11a	5745-5825	149 to 165		OFDM	6.0

#### **Power Line Conducted Emission Test:**

- Pre-Scan has been conducted to determine the worst-case mode from all possible combinations between available modulations, data rates and antenna ports (if EUT with antenna diversity architecture).
- Following channel(s) was (were) selected for the final test as listed below.

EUT Configure Mode	Mode	Frequency Band (MHz)	Available Channel	Tested Channel	Modulation Technology	Data Rate (Mbps)
-	802.11a	5180-5240	36 to 48	149	OFDM	6.0
-	802.11a	5745-5825	149 to 165		OFDM	6.0

**Antenna Port Conducted Measurement:**

- This item includes all test value of each mode, but only includes spectrum plot of worst value of each mode.
- Pre-Scan has been conducted to determine the worst-case mode from all possible combinations between available modulations, data rates and antenna ports (if EUT with antenna diversity architecture).
- Following channel(s) was (were) selected for the final test as listed below.

EUT Configure Mode	Mode	Frequency Band (MHz)	Available Channel	Tested Channel	Modulation Technology	Data Rate (Mbps)
-	802.11a	5180-5240	36 to 48	36, 40, 48	OFDM	6.0
	802.11n (HT20)		36 to 48	36, 40, 48	OFDM	7.2
	802.11n (HT40)		38 to 46	38, 46	OFDM	15.0
	802.11ac (VHT80)		42	42	OFDM	65.0
-	802.11a	5745-5825	149 to 165	149, 157, 165	OFDM	6.0
	802.11n (HT20)		149 to 165	149, 157, 165	OFDM	7.2
	802.11n (HT40)		151 to 159	151, 159	OFDM	15.0
	802.11ac (VHT80)		155	155	OFDM	65.0

**Test Condition:**

Applicable to	Environmental Conditions	Input Power	Tested by
<b>RE<sub>≥</sub>1G</b>	19deg. C, 69%RH	120Vac, 60Hz	Jones Chang
	22deg. C, 68%RH		Adair Peng
<b>RE&lt;1G</b>	20deg. C, 68%RH	120Vac, 60Hz	Willy Cheng
<b>PLC</b>	19deg. C, 63%RH	120Vac, 60Hz	Willy Cheng
<b>APCM</b>	25deg. C, 60%RH	120Vac, 60Hz	Leo Tsai
			Frank Lui

### 3.3 Duty Cycle of Test Signal

Duty cycle of test signal is < 98 %, duty factor is required

802.11a: Duty cycle = 2.022/2.105 = 0.961, Duty factor =  $10 * \log(1/0.961) = 0.17$

802.11n (HT20): Duty cycle = 1.879/2.024 = 0.928, Duty factor =  $10 * \log(1/0.928) = 0.32$

802.11n (HT40): Duty cycle = 0.922/0.999 = 0.923, Duty factor =  $10 * \log(1/0.923) = 0.35$

802.11ac (VHT80): Duty cycle = 0.452/0.545 = 0.829, Duty factor =  $10 * \log(1/0.829) = 0.81$

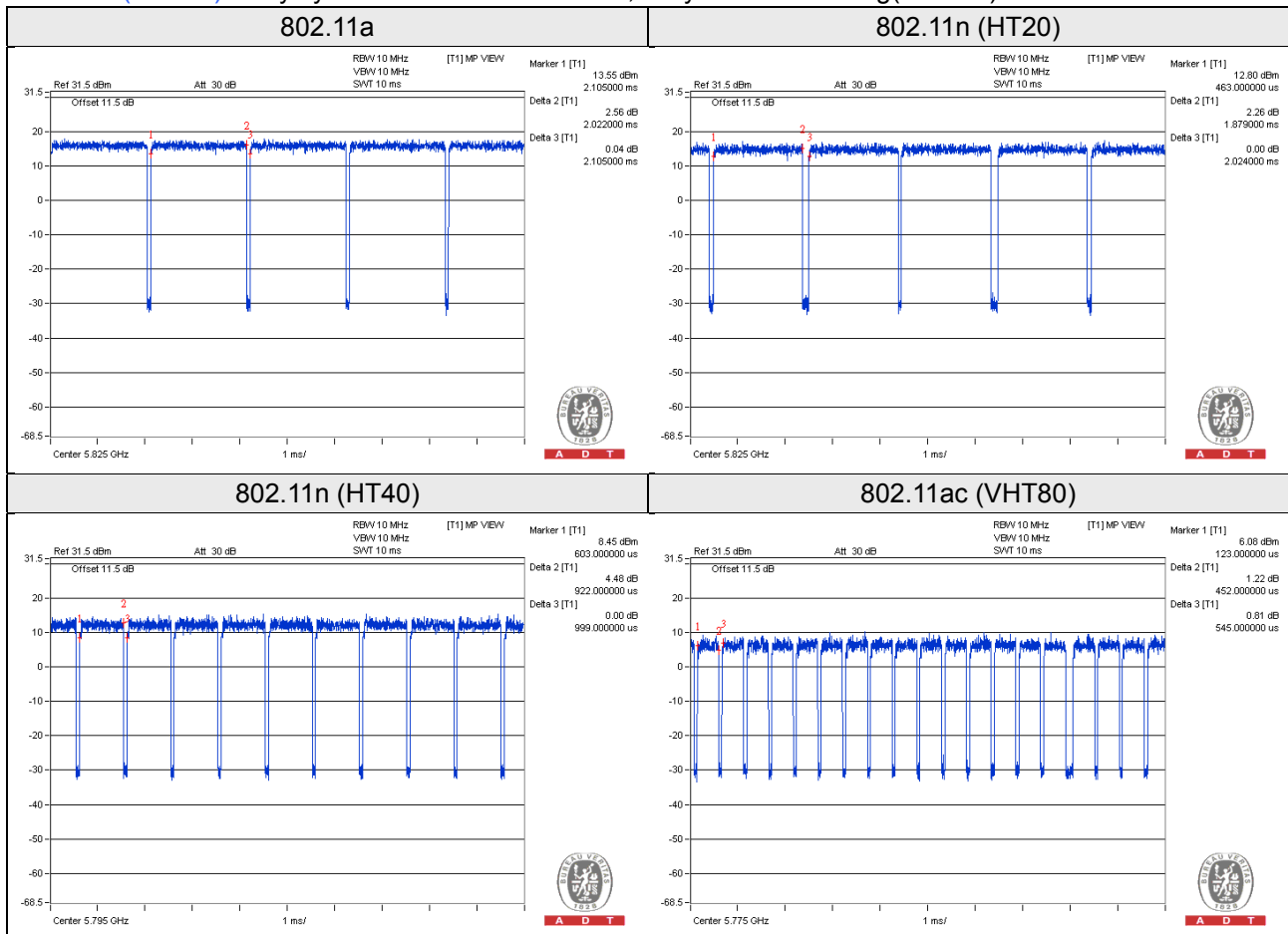

### 3.4 Description of Support Units

The EUT has been tested as an independent unit together with other necessary accessories or support units. The following support units or accessories were used to form a representative test configuration during the tests.

ID	Product	Brand	Model No.	Serial No.	FCC ID	Remarks
A.	Notebook	DELL	E5410	1HC2XM1	FCC DoC Approved	-
B.	External Board	NA	NA	NA	NA	Provided by Manufacturer
C.	Adapter	DVE	DSA-12G-12 FUS 120120	NA	NA	Provided by Manufacturer

Note:

1. All power cords of the above support units are non-shielded (1.8m).
2. Item A acted as a communication partner to transfer data.

ID	Descriptions	Qty.	Length (m)	Shielding (Yes/No)	Cores (Qty.)	Remarks
1.	RJ45 , Cat5e	1	3	N	0	-
2.	Power	1	1.5	N	0	Attached on adapter Provided by Manufacturer

#### 3.4.1 Configuration of System under Test

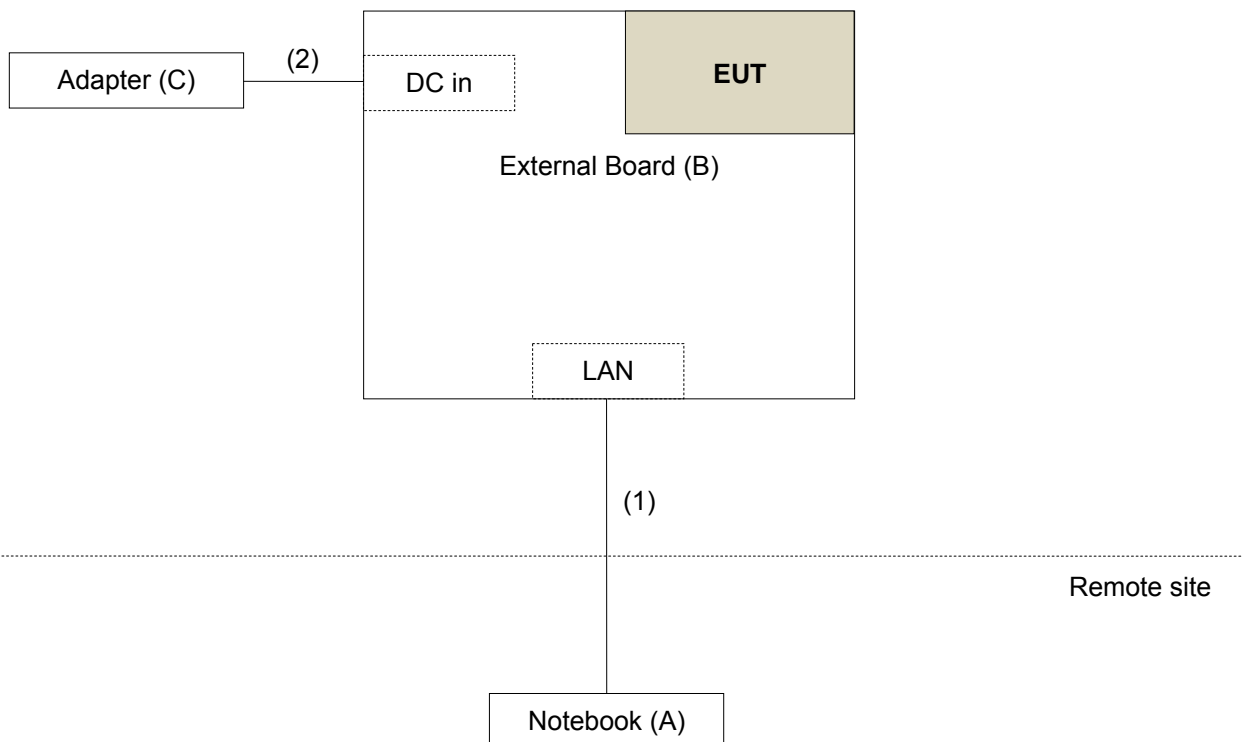

### 3.5 General Description of Applied Standards

The EUT is a RF Product. According to the specifications of the manufacturer, it must comply with the requirements of the following standards:

**FCC Part 15, Subpart E (15.407)**

**KDB 789033 D02 General UNII Test Procedure New Rules v02r01**

**KDB 662911 D01 Multiple Transmitter Output v02r01**

ANSI C63.10:2013

All test items have been performed and recorded as per the above standards.

## 4 Test Types and Results

### 4.1 Radiated Emission and Bandedge Measurement

#### 4.1.1 Limits of Radiated Emission and Bandedge Measurement

Radiated emissions which fall in the restricted bands must comply with the radiated emission limits specified as below table.

Frequencies (MHz)	Field Strength (microvolts/meter)	Measurement Distance (meters)
0.009 ~ 0.490	2400/F(kHz)	300
0.490 ~ 1.705	24000/F(kHz)	30
1.705 ~ 30.0	30	30
30 ~ 88	100	3
88 ~ 216	150	3
216 ~ 960	200	3
Above 960	500	3

Note:

1. The lower limit shall apply at the transition frequencies.
2. Emission level (dBuV/m) = 20 log Emission level (uV/m).
3. For frequencies above 1000MHz, the field strength limits are based on average detector, however, the peak field strength of any emission shall not exceed the maximum permitted average limits, specified above by more than 20dB under any condition of modulation.

Limits of unwanted emission out of the restricted bands

Applicable To		Limit	
789033 D02 General UNII Test Procedure New Rules v02r01		Field Strength at 3m	
		PK: 74 (dBuV/m)	AV: 54 (dBuV/m)
Frequency Band	Applicable To	EIRP Limit	Equivalent Field Strength at 3m
5150~5250 MHz	15.407(b)(1)	PK: -27 (dBm/MHz)	PK: 68.2(dBuV/m)
5250~5350 MHz	15.407(b)(2)		
5470~5725 MHz	15.407(b)(3)		
5725~5850 MHz	<input checked="" type="checkbox"/> 15.407(b)(4)(i)	PK: -27 (dBm/MHz) <sup>*1</sup> PK: 10 (dBm/MHz) <sup>*2</sup> PK: 15.6 (dBm/MHz) <sup>*3</sup> PK: 27 (dBm/MHz) <sup>*4</sup>	PK: 68.2(dBuV/m) <sup>*1</sup> PK: 105.2 (dBuV/m) <sup>*2</sup> PK: 110.8(dBuV/m) <sup>*3</sup> PK: 122.2 (dBuV/m) <sup>*4</sup>
	<input type="checkbox"/> 15.407(b)(4)(ii)	Emission limits in section 15.247(d)	
<sup>*1</sup> beyond 75 MHz or more above of the band edge.		<sup>*2</sup> below the band edge increasing linearly to 10 dBm/MHz at 25 MHz above.	
<sup>*3</sup> below the band edge increasing linearly to a level of 15.6 dBm/MHz at 5 MHz above.		<sup>*4</sup> from 5 MHz above or below the band edge increasing linearly to a level of 27 dBm/MHz at the band edge.	

Note: The following formula is used to convert the equipment isotropic radiated power (eirp) to field strength:

$$E = \frac{1000000\sqrt{30P}}{3} \mu\text{V/m, where P is the eirp (Watts).}$$

#### 4.1.2 Test Instruments

For test date: May 14 ~ May 29, 2015 (For U-NII-1 Band)

Description & Manufacturer	Model No.	Serial No.	Cal. Date	Cal. Due
Test Receiver ROHDE & SCHWARZ	ESIB7	100187	Apr. 10, 2015	Apr. 09, 2016
Spectrum Analyzer ROHDE & SCHWARZ	FSP40	100041	Aug. 29, 2014	Aug. 28, 2015
BILOG Antenna SCHWARZBECK	VULB9168	9168-160	Feb. 05, 2015	Feb. 04, 2016
HORN Antenna SCHWARZBECK	9120D	209	Feb. 09, 2015	Feb. 08, 2016
HORN Antenna SCHWARZBECK	BBHA 9170	BBHA9170241	Feb. 09, 2015	Feb. 08, 2016
Loop Antenna EMCI	EM-6879	269	Aug. 13, 2014	Aug. 12, 2015
Preamplifier Agilent	8447D	2944A10738	Oct. 18, 2014	Oct. 17, 2015
Preamplifier Agilent	8449B	3008A01964	Aug. 22, 2014	Aug. 21, 2015
RF signal cable HUBER+SUHNNER	SUCOFLEX 104	214378/4	Aug. 22, 2014	Aug. 21, 2015
RF signal cable HUBER+SUHNNER	SUCOFLEX 106	12738/6 +309224/4	Aug. 22, 2014	Aug. 21, 2015
Software BV ADT	ADT_Radiated_ V7.6.15.9.4	NA	NA	NA
Antenna Tower inn-co GmbH	MA 4000	013303	NA	NA
Antenna Tower Controller BV ADT	AT100	AT93021702	NA	NA
Turn Table BV ADT	TT100	TT93021702	NA	NA
Turn Table Controller BV ADT	SC100	SC93021702	NA	NA
26GHz ~ 40GHz Amplifier	EM26400	815221	Oct. 18, 2014	Oct. 17, 2015
High Speed Power Meter	ML2495A	0824011	Jul. 26, 2014	Jul. 25, 2015
Power Sensor	MA2411B	0738171	Jul. 26, 2014	Jul. 25, 2015
WIT Standard Temperature And Humidity Chamber	TH-4S-C	W981030	Jun. 09, 2014	Jun. 08, 2015

- Note: 1. The calibration interval of the above test instruments is 12 months and the calibrations are traceable to NML/ROC and NIST/USA.  
 2. The test was performed in HwaYa Chamber 3.  
 3. The FCC Designation Number is TW0003. The number will be varied with the Lab location and scope as attached.  
 4. The IC Site Registration No. is IC 7450F-3.

For test date: Feb. 06 ~ Feb. 08, 2018 (For U-NII-3 Band)

Description & Manufacturer	Model No.	Serial No.	Cal. Date	Cal. Due
Test Receiver ROHDE & SCHWARZ	ESIB7	100187	May 02, 2017	May 01, 2018
Spectrum Analyzer ROHDE & SCHWARZ	FSP40	100041	Dec. 12, 2017	Dec. 11, 2018
BILOG Antenna SCHWARZBECK	VULB9168	9168-171	Dec. 11, 2017	Dec. 10, 2018
HORN Antenna SCHWARZBECK	9120D	209	Dec. 13, 2017	Dec. 12, 2018
HORN Antenna SCHWARZBECK	BBHA 9170	BBHA9170241	Dec. 01, 2017	Nov. 30, 2018
Loop Antenna EMCI	EM-6879	269	Aug. 11, 2017	Aug. 10, 2018
Preamplifier Agilent (Below 1GHz)	8447D	2944A10738	Aug. 21, 2017	Aug. 20, 2018
Preamplifier Agilent (Above 1GHz)	8449B	3008A02465	Apr. 05, 2017	Apr. 04, 2018
RF signal cable HUBER+SUHNER	SUCOFLEX 104	Cable-CH3-03 (223653/4)	Aug. 21, 2017	Aug. 20, 2018
RF signal cable HUBER+SUHNER& EMCI	SUCOFLEX 104&EMC104-SM-SM-8 000	Cable-CH3-03 (309224+170907)	Sep.11, 2017	Sep. 10, 2018
Software BV ADT	ADT_Radiated_ V7.6.15.9.4	NA	NA	NA
Antenna Tower inn-co GmbH	MA 4000	013303	NA	NA
Antenna Tower Controller BV ADT	AT100	AT93021702	NA	NA
Turn Table BV ADT	TT100	TT93021702	NA	NA
Turn Table Controller BV ADT	SC100	SC93021702	NA	NA
26GHz ~ 40GHz Amplifier Agilent	8449B	3008A1960	Aug. 08, 2017	Aug. 07, 2018
High Speed Peak Power Meter	ML2495A	0824012	Aug. 18, 2017	Aug. 17, 2018
Power Sensor	MA2411B	0738171	Aug. 18, 2017	Aug. 17, 2018
WIT Standard Temperature And Humidity Chamber	TH-4S-C	W981030	Jun. 07, 2017	Jun. 06, 2018

- Note: 1. The calibration interval of the above test instruments is 12 months and the calibrations are traceable to NML/ROC and NIST/USA.  
 2. The test was performed in HwaYa Chamber 3.  
 3. The horn antenna and preamplifier (model: 8449B) are used only for the measurement of emission frequency above 1GHz if tested.  
 4. The FCC Designation Number is TW0003. The number will be varied with the Lab location and scope as attached.  
 5. The IC Site Registration No. is IC 7450F-3.



### 4.1.3 Test Procedures

#### For Radiated emission below 30MHz

- a. The EUT was placed on the top of a rotating table 0.8 meters above the ground at a 3 meter chamber room. The table was rotated 360 degrees to determine the position of the highest radiation.
- b. The EUT was set 3 meters away from the interference-receiving antenna, which was mounted on the top of a variable-height antenna tower.
- c. Both X and Y axes of the antenna are set to make the measurement.
- d. For each suspected emission, the EUT was arranged to its worst case and the rotatable table was turned from 0 degrees to 360 degrees to find the maximum reading.
- e. The test-receiver system was set to Quasi-Peak Detect Function and Specified Bandwidth with Maximum Hold Mode.

Note:

1. The resolution bandwidth and video bandwidth of test receiver/spectrum analyzer is 9kHz at frequency below 30MHz.

#### For Radiated emission above 30MHz

- a. The EUT was placed on the top of a rotating table 0.8 meters (for 30MHz ~ 1GHz) / 1.5 meters (for above 1GHz) above the ground at 3 meter chamber room for test. The table was rotated 360 degrees to determine the position of the highest radiation.
- b. The EUT was set 3 meters away from the interference-receiving antenna, which was mounted on the top of a variable-height antenna tower.
- c. The height of antenna is varied from one meter to four meters above the ground to determine the maximum value of the field strength. Both horizontal and vertical polarizations of the antenna are set to make the measurement.
- d. For each suspected emission, the EUT was arranged to its worst case and then the antenna was tuned to heights from 1 meter to 4 meters and the rotatable table was turned from 0 degrees to 360 degrees to find the maximum reading.
- e. The test-receiver system was set to quasi-peak detect function and specified bandwidth with maximum hold mode when the test frequency is below 1 GHz.
- f. The test-receiver system was set to peak and average detect function and specified bandwidth with maximum hold mode when the test frequency is above 1 GHz. If the peak reading value also meets average limit, measurement with the average detector is unnecessary.

Note:

1. The resolution bandwidth and video bandwidth of test receiver/spectrum analyzer is 120kHz for Quasi-peak detection (QP) at frequency below 1GHz.
2. The resolution bandwidth of test receiver/spectrum analyzer is 1 MHz and the video bandwidth is 3 MHz for Peak detection (PK) at frequency above 1GHz.
3. The resolution bandwidth of test receiver/spectrum analyzer is 1MHz and the video bandwidth is  $\geq 1/T$  (Duty cycle < 98%) or 10Hz (Duty cycle  $\geq 98\%$ ) for Average detection (AV) at frequency above 1GHz.
4. All modes of operation were investigated and the worst-case emissions are reported.

### 4.1.4 Deviation from Test Standard

No deviation.

#### 4.1.5 Test Setup

##### For Radiated emission below 30MHz

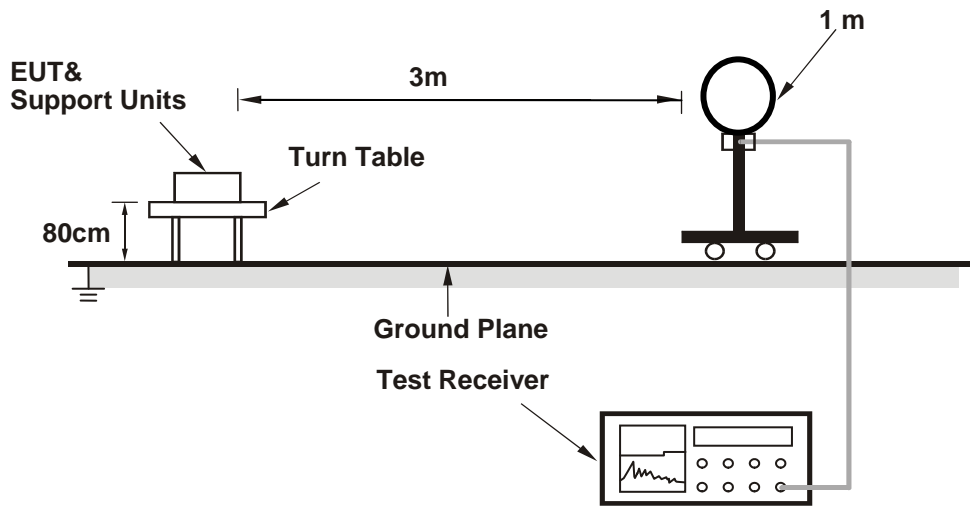

##### For Radiated emission 30MHz to 1GHz

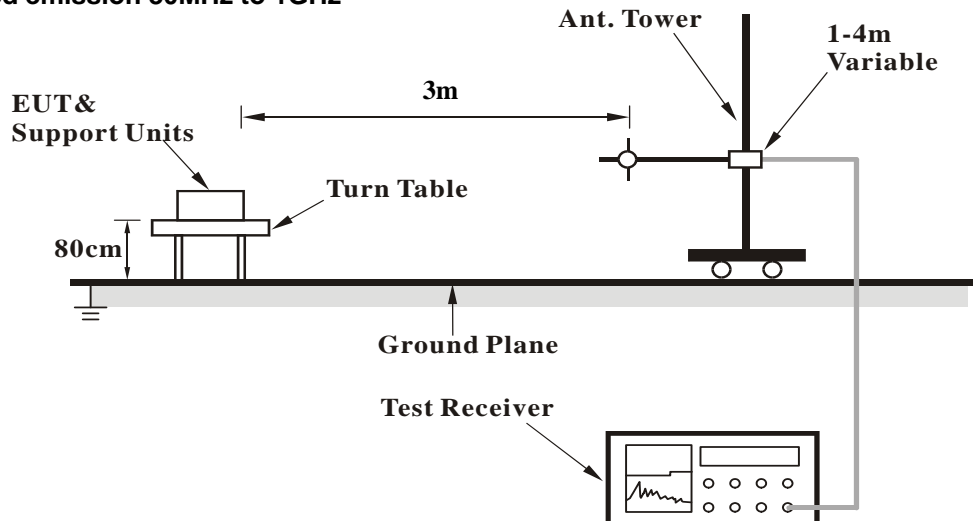

### For Radiated emission above 1GHz

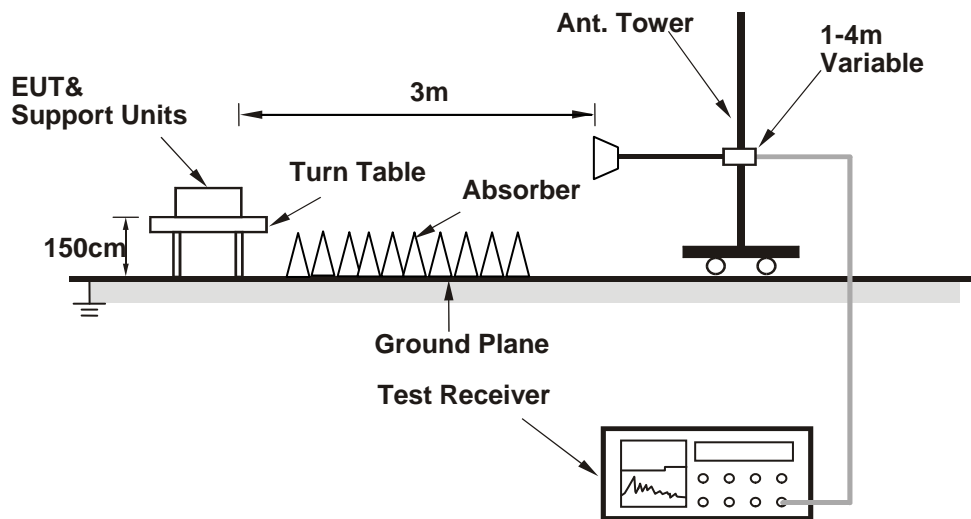

For the actual test configuration, please refer to the attached file (Test Setup Photo).

#### 4.1.6 EUT Operating Conditions

- Installed EUT in external board and placed them on the testing table.
- Prepared a notebook to act as a communication partner and placed it outside of testing area.
- The communication partner connected with EUT via external board through a RJ45 cable and ran a test program (provided by manufacturer) to enable EUT under transmission condition continuously at specific channel frequency.
- The communication partner sent data to EUT by command "PING".

#### 4.1.7 Test Results

Above 1GHz data:

802.11a

CHANNEL	TX Channel 36	DETECTOR	Peak (PK)
FREQUENCY RANGE	1GHz ~ 40GHz	FUNCTION	Average (AV)

ANTENNA POLARITY & TEST DISTANCE: HORIZONTAL AT 3 M								
NO.	FREQ. (MHz)	EMISSION LEVEL (dBuV/m)	LIMIT (dBuV/m)	MARGIN (dB)	ANTENNA HEIGHT (m)	TABLE ANGLE (Degree)	RAW VALUE (dBuV)	CORRECTION FACTOR (dB/m)
1	5150.00	57.6 PK	74.0	-16.4	1.23 H	215	51.60	6.00
2	5150.00	46.4 AV	54.0	-7.6	1.23 H	215	40.40	6.00
3	*5180.00	104.7 PK			1.18 H	130	65.20	39.50
4	*5180.00	94.5 AV			1.18 H	130	55.00	39.50
5	5350.00	58.2 PK	74.0	-15.8	1.30 H	304	52.10	6.10
6	5350.00	47.1 AV	54.0	-6.9	1.30 H	304	41.00	6.10
7	#10360.00	60.5 PK	74.0	-13.5	1.50 H	252	42.10	18.40
8	#10360.00	47.4 AV	54.0	-6.6	1.50 H	252	29.00	18.40
ANTENNA POLARITY & TEST DISTANCE: VERTICAL AT 3 M								
NO.	FREQ. (MHz)	EMISSION LEVEL (dBuV/m)	LIMIT (dBuV/m)	MARGIN (dB)	ANTENNA HEIGHT (m)	TABLE ANGLE (Degree)	RAW VALUE (dBuV)	CORRECTION FACTOR (dB/m)
1	5150.00	69.4 PK	74.0	-4.6	1.71 V	254	63.40	6.00
2	5150.00	52.1 AV	54.0	-1.9	1.71 V	254	46.10	6.00
3	*5180.00	118.7 PK			1.71 V	276	79.20	39.50
4	*5180.00	108.9 AV			1.71 V	276	69.40	39.50
5	5350.00	64.6 PK	74.0	-9.4	1.88 V	275	58.50	6.10
6	5350.00	51.6 AV	54.0	-2.4	1.88 V	275	45.50	6.10
7	#10360.00	61.2 PK	74.0	-12.8	1.48 V	354	42.80	18.40
8	#10360.00	48.1 AV	54.0	-5.9	1.48 V	354	29.70	18.40

Remarks:

1. Emission Level(dBuV/m) = Raw Value(dBuV) + Correction Factor(dB/m)
2. Correction Factor(dB/m) = Antenna Factor(dB/m) + Cable Factor(dB) – Pre-Amplifier Factor(dB)
3. The other emission levels were very low against the limit.
4. Margin value = Emission Level – Limit value
5. " \* ": Fundamental frequency.
6. " # ": The radiated frequency is out of the restricted band.

CHANNEL	TX Channel 40	DETECTOR FUNCTION	Peak (PK)
FREQUENCY RANGE	1GHz ~ 40GHz		Average (AV)

ANTENNA POLARITY & TEST DISTANCE: HORIZONTAL AT 3 M								
NO.	FREQ. (MHz)	EMISSION LEVEL (dBuV/m)	LIMIT (dBuV/m)	MARGIN (dB)	ANTENNA HEIGHT (m)	TABLE ANGLE (Degree)	RAW VALUE (dBuV)	CORRECTION FACTOR (dB/m)
1	5150.00	58.9 PK	74.0	-15.1	1.40 H	217	52.90	6.00
2	5150.00	47.0 AV	54.0	-7.0	1.40 H	217	41.00	6.00
3	*5200.00	104.1 PK			1.57 H	57	64.50	39.60
4	*5200.00	93.9 AV			1.57 H	57	54.30	39.60
5	5440.00	58.3 PK	74.0	-15.7	1.57 H	19	52.00	6.30
6	5440.00	46.6 AV	54.0	-7.4	1.57 H	19	40.30	6.30
7	#10400.00	60.6 PK	74.0	-13.4	1.29 H	256	42.10	18.50
8	#10400.00	47.4 AV	54.0	-6.6	1.29 H	256	28.90	18.50

ANTENNA POLARITY & TEST DISTANCE: VERTICAL AT 3 M								
NO.	FREQ. (MHz)	EMISSION LEVEL (dBuV/m)	LIMIT (dBuV/m)	MARGIN (dB)	ANTENNA HEIGHT (m)	TABLE ANGLE (Degree)	RAW VALUE (dBuV)	CORRECTION FACTOR (dB/m)
1	5150.00	66.5 PK	74.0	-7.5	2.00 V	273	60.50	6.00
2	5150.00	52.1 AV	54.0	-1.9	2.00 V	273	46.10	6.00
3	*5200.00	120.9 PK			1.96 V	276	81.30	39.60
4	*5200.00	110.9 AV			1.96 V	276	71.30	39.60
5	5360.00	65.6 PK	74.0	-8.4	1.69 V	274	59.50	6.10
6	5360.00	52.6 AV	54.0	-1.4	1.69 V	274	46.50	6.10
7	#10400.00	65.2 PK	74.0	-8.8	2.05 V	70	46.70	18.50
8	#10400.00	51.0 AV	54.0	-3.0	2.05 V	70	32.50	18.50

Remarks:

1. Emission Level(dBuV/m) = Raw Value(dBuV) + Correction Factor(dB/m)
2. Correction Factor(dB/m) = Antenna Factor(dB/m) + Cable Factor(dB) – Pre-Amplifier Factor(dB)
3. The other emission levels were very low against the limit.
4. Margin value = Emission Level – Limit value
5. " \* ": Fundamental frequency.
6. " # ": The radiated frequency is out of the restricted band.

CHANNEL	TX Channel 48	DETECTOR FUNCTION	Peak (PK)
FREQUENCY RANGE	1GHz ~ 40GHz		Average (AV)

ANTENNA POLARITY & TEST DISTANCE: HORIZONTAL AT 3 M								
NO.	FREQ. (MHz)	EMISSION LEVEL (dBuV/m)	LIMIT (dBuV/m)	MARGIN (dB)	ANTENNA HEIGHT (m)	TABLE ANGLE (Degree)	RAW VALUE (dBuV)	CORRECTION FACTOR (dB/m)
1	*5240.00	107.3 PK			1.20 H	110	67.7	39.6
2	*5240.00	96.5 AV			1.20 H	110	56.9	39.6
3	5350.00	56.6 PK	74.0	-17.4	1.25 H	77	50.5	6.1
4	5350.00	45.3 AV	54.0	-8.7	1.25 H	77	39.2	6.1
5	5400.00	58.4 PK	74.0	-15.6	1.28 H	72	52.1	6.3
6	5400.00	46.3 AV	54.0	-7.7	1.28 H	72	40.0	6.3
7	#10480.00	61.3 PK	74.0	-12.7	1.39 H	244	42.3	19.0
8	#10480.00	48.2 AV	54.0	-5.8	1.39 H	244	29.2	19.0

ANTENNA POLARITY & TEST DISTANCE: VERTICAL AT 3 M								
NO.	FREQ. (MHz)	EMISSION LEVEL (dBuV/m)	LIMIT (dBuV/m)	MARGIN (dB)	ANTENNA HEIGHT (m)	TABLE ANGLE (Degree)	RAW VALUE (dBuV)	CORRECTION FACTOR (dB/m)
1	*5240.00	120.5 PK			1.79 V	277	80.9	39.6
2	*5240.00	110.4 AV			1.79 V	277	70.8	39.6
3	5350.00	65.1 PK	74.0	-8.9	1.90 V	275	59.0	6.1
4	5350.00	51.1 AV	54.0	-2.9	1.90 V	275	45.0	6.1
5	5360.00	66.0 PK	74.0	-8.0	1.91 V	277	59.9	6.1
6	5360.00	52.5 AV	54.0	-1.5	1.91 V	277	46.4	6.1
7	#10480.00	65.3 PK	74.0	-8.7	2.01 V	88	46.3	19.0
8	#10480.00	51.4 AV	54.0	-2.6	2.01 V	88	32.4	19.0

Remarks:

1. Emission Level(dBuV/m) = Raw Value(dBuV) + Correction Factor(dB/m)
2. Correction Factor(dB/m) = Antenna Factor(dB/m) + Cable Factor(dB) – Pre-Amplifier Factor(dB)
3. The other emission levels were very low against the limit.
4. Margin value = Emission Level – Limit value
5. " \* ": Fundamental frequency.
6. " # ": The radiated frequency is out of the restricted band.

CHANNEL	TX Channel 149	DETECTOR FUNCTION	Peak (PK)
FREQUENCY RANGE	1GHz ~ 40GHz		Average (AV)

ANTENNA POLARITY & TEST DISTANCE: HORIZONTAL AT 3 M								
NO.	FREQ. (MHz)	EMISSION LEVEL (dBuV/m)	LIMIT (dBuV/m)	MARGIN (dB)	ANTENNA HEIGHT (m)	TABLE ANGLE (Degree)	RAW VALUE (dBuV)	CORRECTION FACTOR (dB/m)
1	#5620.80	54.7 PK	68.2	-13.5	1.08 H	42	50.5	4.2
2	*5745.00	98.3 PK			1.08 H	42	58.2	40.1
3	*5745.00	88.5 AV			1.08 H	42	48.4	40.1
4	#5996.00	56.3 PK	68.2	-11.9	1.08 H	42	51.3	5.0
5	11490.00	55.1 PK	74.0	-18.9	1.27 H	86	37.3	17.8
6	11490.00	41.8 AV	54.0	-12.2	1.27 H	86	24.0	17.8

ANTENNA POLARITY & TEST DISTANCE: VERTICAL AT 3 M								
NO.	FREQ. (MHz)	EMISSION LEVEL (dBuV/m)	LIMIT (dBuV/m)	MARGIN (dB)	ANTENNA HEIGHT (m)	TABLE ANGLE (Degree)	RAW VALUE (dBuV)	CORRECTION FACTOR (dB/m)
1	#5609.60	59.5 PK	68.2	-8.7	1.98 V	98	55.3	4.2
2	*5745.00	117.1 PK			1.98 V	98	77.0	40.1
3	*5745.00	107.0 AV			1.98 V	98	66.9	40.1
4	#5962.40	58.3 PK	68.2	-9.9	1.98 V	98	53.3	5.0
5	11490.00	54.8 PK	74.0	-19.2	1.87 V	110	37.0	17.8
6	11490.00	42.3 AV	54.0	-11.7	1.87 V	110	24.5	17.8

Remarks:

1. Emission Level(dBuV/m) = Raw Value(dBuV) + Correction Factor(dB/m)
2. Correction Factor(dB/m) = Antenna Factor(dB/m) + Cable Factor(dB) – Pre-Amplifier Factor(dB)
3. The other emission levels were very low against the limit.
4. Margin value = Emission Level – Limit value
5. " \* ": Fundamental frequency.
6. " # ": The radiated frequency is out of the restricted band.

CHANNEL	TX Channel 157	DETECTOR FUNCTION	Peak (PK)
FREQUENCY RANGE	1GHz ~ 40GHz		Average (AV)

ANTENNA POLARITY & TEST DISTANCE: HORIZONTAL AT 3 M								
NO.	FREQ. (MHz)	EMISSION LEVEL (dBuV/m)	LIMIT (dBuV/m)	MARGIN (dB)	ANTENNA HEIGHT (m)	TABLE ANGLE (Degree)	RAW VALUE (dBuV)	CORRECTION FACTOR (dB/m)
1	#5637.60	54.4 PK	68.2	-13.8	1.13 H	58	50.2	4.2
2	*5785.00	102.5 PK			1.13 H	58	62.2	40.3
3	*5785.00	92.5 AV			1.13 H	58	52.2	40.3
4	#5952.00	55.7 PK	68.2	-12.5	1.13 H	58	50.7	5.0
5	11570.00	56.5 PK	74.0	-17.5	1.33 H	77	38.4	18.1
6	11570.00	42.6 AV	54.0	-11.4	1.33 H	77	24.5	18.1

ANTENNA POLARITY & TEST DISTANCE: VERTICAL AT 3 M								
NO.	FREQ. (MHz)	EMISSION LEVEL (dBuV/m)	LIMIT (dBuV/m)	MARGIN (dB)	ANTENNA HEIGHT (m)	TABLE ANGLE (Degree)	RAW VALUE (dBuV)	CORRECTION FACTOR (dB/m)
1	#5623.20	60.2 PK	68.2	-8.0	2.00 V	84	56.0	4.2
2	*5785.00	117.9 PK			2.00 V	84	77.6	40.3
3	*5785.00	108.1 AV			2.00 V	84	67.8	40.3
4	#5930.40	56.8 PK	68.2	-11.4	2.00 V	84	51.8	5.0
5	11570.00	57.1 PK	74.0	-16.9	1.91 V	103	39.0	18.1
6	11570.00	43.9 AV	54.0	-10.1	1.91 V	103	25.8	18.1

Remarks:

1. Emission Level(dBuV/m) = Raw Value(dBuV) + Correction Factor(dB/m)
2. Correction Factor(dB/m) = Antenna Factor(dB/m) + Cable Factor(dB) – Pre-Amplifier Factor(dB)
3. The other emission levels were very low against the limit.
4. Margin value = Emission Level – Limit value
5. " \* ": Fundamental frequency.
6. " # ": The radiated frequency is out of the restricted band.



CHANNEL	TX Channel 165	DETECTOR FUNCTION	Peak (PK)
FREQUENCY RANGE	1GHz ~ 40GHz		Average (AV)

ANTENNA POLARITY & TEST DISTANCE: HORIZONTAL AT 3 M								
NO.	FREQ. (MHz)	EMISSION LEVEL (dBuV/m)	LIMIT (dBuV/m)	MARGIN (dB)	ANTENNA HEIGHT (m)	TABLE ANGLE (Degree)	RAW VALUE (dBuV)	CORRECTION FACTOR (dB/m)
1	#5632.00	54.7 PK	68.2	-13.5	1.07 H	58	50.5	4.2
2	*5825.00	105.0 PK			1.07 H	58	64.5	40.5
3	*5825.00	94.7 AV			1.07 H	58	54.2	40.5
4	#5930.40	56.6 PK	68.2	-11.6	1.07 H	58	51.6	5.0
5	11650.00	55.7 PK	74.0	-18.3	1.39 H	101	38.0	17.7
6	11650.00	42.6 AV	54.0	-11.4	1.39 H	101	24.9	17.7

ANTENNA POLARITY & TEST DISTANCE: VERTICAL AT 3 M								
NO.	FREQ. (MHz)	EMISSION LEVEL (dBuV/m)	LIMIT (dBuV/m)	MARGIN (dB)	ANTENNA HEIGHT (m)	TABLE ANGLE (Degree)	RAW VALUE (dBuV)	CORRECTION FACTOR (dB/m)
1	#5603.20	59.9 PK	68.2	-8.3	1.97 V	90	55.7	4.2
2	*5825.00	119.4 PK			1.97 V	90	78.9	40.5
3	*5825.00	108.8 AV			1.97 V	90	68.3	40.5
4	#5951.20	57.9 PK	68.2	-10.3	1.97 V	90	52.9	5.0
5	11650.00	57.2 PK	74.0	-16.8	1.91 V	117	39.5	17.7
6	11650.00	44.1 AV	54.0	-9.9	1.91 V	117	26.4	17.7

Remarks:

1. Emission Level(dBuV/m) = Raw Value(dBuV) + Correction Factor(dB/m)
2. Correction Factor(dB/m) = Antenna Factor(dB/m) + Cable Factor(dB) – Pre-Amplifier Factor(dB)
3. The other emission levels were very low against the limit.
4. Margin value = Emission Level – Limit value
5. " \* ": Fundamental frequency.
6. " # ": The radiated frequency is out of the restricted band.

802.11n (HT20)

CHANNEL	TX Channel 36	DETECTOR FUNCTION	Peak (PK)
FREQUENCY RANGE	1GHz ~ 40GHz		Average (AV)

ANTENNA POLARITY & TEST DISTANCE: HORIZONTAL AT 3 M

NO.	FREQ. (MHz)	EMISSION LEVEL (dBuV/m)	LIMIT (dBuV/m)	MARGIN (dB)	ANTENNA HEIGHT (m)	TABLE ANGLE (Degree)	RAW VALUE (dBuV)	CORRECTION FACTOR (dB/m)
1	5150.00	57.5 PK	74.0	-16.5	1.28 H	306	51.50	6.00
2	5150.00	46.3 AV	54.0	-7.7	1.28 H	306	40.30	6.00
3	*5180.00	102.6 PK			1.28 H	237	63.10	39.50
4	*5180.00	92.8 AV			1.28 H	237	53.30	39.50
5	5350.00	58.7 PK	74.0	-15.3	1.33 H	202	52.60	6.10
6	5350.00	47.6 AV	54.0	-6.4	1.33 H	202	41.50	6.10
7	#10360.00	60.5 PK	74.0	-13.5	1.00 H	123	42.10	18.40
8	#10360.00	47.3 AV	54.0	-6.7	1.00 H	123	28.90	18.40

ANTENNA POLARITY & TEST DISTANCE: VERTICAL AT 3 M

NO.	FREQ. (MHz)	EMISSION LEVEL (dBuV/m)	LIMIT (dBuV/m)	MARGIN (dB)	ANTENNA HEIGHT (m)	TABLE ANGLE (Degree)	RAW VALUE (dBuV)	CORRECTION FACTOR (dB/m)
1	5150.00	71.1 PK	74.0	-2.9	1.73 V	281	65.10	6.00
2	5150.00	52.9 AV	54.0	-1.1	1.73 V	281	46.90	6.00
3	*5180.00	119.3 PK			2.01 V	73	79.80	39.50
4	*5180.00	108.9 AV			2.01 V	73	69.40	39.50
5	5360.00	62.8 PK	74.0	-11.2	1.85 V	276	56.70	6.10
6	5360.00	51.4 AV	54.0	-2.6	1.85 V	276	45.30	6.10
7	#10360.00	61.7 PK	74.0	-12.3	1.53 V	80	43.30	18.40
8	#10360.00	48.2 AV	54.0	-5.8	1.53 V	80	29.80	18.40

Remarks:

1. Emission Level(dBuV/m) = Raw Value(dBuV) + Correction Factor(dB/m)
2. Correction Factor(dB/m) = Antenna Factor(dB/m) + Cable Factor(dB) – Pre-Amplifier Factor(dB)
3. The other emission levels were very low against the limit.
4. Margin value = Emission Level – Limit value
5. " \* ": Fundamental frequency.
6. " # ": The radiated frequency is out of the restricted band.

CHANNEL	TX Channel 40	DETECTOR FUNCTION	Peak (PK)
FREQUENCY RANGE	1GHz ~ 40GHz		Average (AV)

ANTENNA POLARITY & TEST DISTANCE: HORIZONTAL AT 3 M								
NO.	FREQ. (MHz)	EMISSION LEVEL (dBuV/m)	LIMIT (dBuV/m)	MARGIN (dB)	ANTENNA HEIGHT (m)	TABLE ANGLE (Degree)	RAW VALUE (dBuV)	CORRECTION FACTOR (dB/m)
1	5150.00	57.5 PK	74.0	-16.5	1.30 H	133	51.50	6.00
2	5150.00	46.7 AV	54.0	-7.3	1.30 H	133	40.70	6.00
3	*5200.00	105.2 PK			1.23 H	112	65.60	39.60
4	*5200.00	95.1 AV			1.23 H	112	55.50	39.60
5	5400.00	59.2 PK	74.0	-14.8	1.20 H	341	52.90	6.30
6	5400.00	48.2 AV	54.0	-5.8	1.20 H	341	41.90	6.30
7	#10400.00	61.1 PK	74.0	-12.9	1.40 H	301	42.60	18.50
8	#10400.00	47.8 AV	54.0	-6.2	1.40 H	301	29.30	18.50

ANTENNA POLARITY & TEST DISTANCE: VERTICAL AT 3 M								
NO.	FREQ. (MHz)	EMISSION LEVEL (dBuV/m)	LIMIT (dBuV/m)	MARGIN (dB)	ANTENNA HEIGHT (m)	TABLE ANGLE (Degree)	RAW VALUE (dBuV)	CORRECTION FACTOR (dB/m)
1	5150.00	64.2 PK	74.0	-9.8	1.80 V	222	58.20	6.00
2	5150.00	51.4 AV	54.0	-2.6	1.80 V	222	45.40	6.00
3	*5200.00	120.7 PK			1.94 V	219	81.10	39.60
4	*5200.00	110.0 AV			1.94 V	219	70.40	39.60
5	5360.00	65.4 PK	74.0	-8.6	1.79 V	278	59.30	6.10
6	5360.00	52.7 AV	54.0	-1.3	1.79 V	278	46.60	6.10
7	#10360.00	64.7 PK	74.0	-9.3	1.85 V	81	46.30	18.40
8	#10360.00	51.0 AV	54.0	-3.0	1.85 V	81	32.60	18.40

Remarks:

1. Emission Level(dBuV/m) = Raw Value(dBuV) + Correction Factor(dB/m)
2. Correction Factor(dB/m) = Antenna Factor(dB/m) + Cable Factor(dB) – Pre-Amplifier Factor(dB)
3. The other emission levels were very low against the limit.
4. Margin value = Emission Level – Limit value
5. " \* ": Fundamental frequency.
6. " # ": The radiated frequency is out of the restricted band.

CHANNEL	TX Channel 48	DETECTOR FUNCTION	Peak (PK)
FREQUENCY RANGE	1GHz ~ 40GHz		Average (AV)

**ANTENNA POLARITY & TEST DISTANCE: HORIZONTAL AT 3 M**

NO.	FREQ. (MHz)	EMISSION LEVEL (dBuV/m)	LIMIT (dBuV/m)	MARGIN (dB)	ANTENNA HEIGHT (m)	TABLE ANGLE (Degree)	RAW VALUE (dBuV)	CORRECTION FACTOR (dB/m)
1	*5240.00	106.1 PK			1.16 H	111	66.5	39.6
2	*5240.00	95.9 AV			1.16 H	111	56.3	39.6
3	5350.00	57.2 PK	74.0	-16.8	1.30 H	90	51.1	6.1
4	5350.00	46.2 AV	54.0	-7.8	1.30 H	90	40.1	6.1
5	5400.00	58.5 PK	74.0	-15.5	1.33 H	88	52.2	6.3
6	5400.00	47.3 AV	54.0	-6.7	1.33 H	88	41.0	6.3
7	#10480.00	60.9 PK	74.0	-13.1	1.44 H	266	41.9	19.0
8	#10480.00	47.8 AV	54.0	-6.2	1.44 H	266	28.8	19.0

**ANTENNA POLARITY & TEST DISTANCE: VERTICAL AT 3 M**

NO.	FREQ. (MHz)	EMISSION LEVEL (dBuV/m)	LIMIT (dBuV/m)	MARGIN (dB)	ANTENNA HEIGHT (m)	TABLE ANGLE (Degree)	RAW VALUE (dBuV)	CORRECTION FACTOR (dB/m)
1	*5240.00	120.9 PK			1.79 V	278	81.3	39.6
2	*5240.00	110.8 AV			1.79 V	278	71.2	39.6
3	5350.00	65.0 PK	74.0	-9.0	1.71 V	277	58.9	6.1
4	5350.00	51.2 AV	54.0	-2.8	1.71 V	277	45.1	6.1
5	5360.00	65.3 PK	74.0	-8.7	1.75 V	278	59.2	6.1
6	5360.00	52.3 AV	54.0	-1.7	1.75 V	278	46.2	6.1
7	#10480.00	64.3 PK	74.0	-9.7	1.81 V	94	45.3	19.0
8	#10480.00	50.9 AV	54.0	-3.1	1.81 V	94	31.9	19.0

**Remarks:**

1. Emission Level(dBuV/m) = Raw Value(dBuV) + Correction Factor(dB/m)
2. Correction Factor(dB/m) = Antenna Factor(dB/m) + Cable Factor(dB) – Pre-Amplifier Factor(dB)
3. The other emission levels were very low against the limit.
4. Margin value = Emission Level – Limit value
5. " \* ": Fundamental frequency.
6. " # ": The radiated frequency is out of the restricted band.

CHANNEL	TX Channel 149	DETECTOR FUNCTION	Peak (PK)
FREQUENCY RANGE	1GHz ~ 40GHz		Average (AV)

ANTENNA POLARITY & TEST DISTANCE: HORIZONTAL AT 3 M								
NO.	FREQ. (MHz)	EMISSION LEVEL (dBuV/m)	LIMIT (dBuV/m)	MARGIN (dB)	ANTENNA HEIGHT (m)	TABLE ANGLE (Degree)	RAW VALUE (dBuV)	CORRECTION FACTOR (dB/m)
1	#5617.60	54.7 PK	68.2	-13.5	1.15 H	59	50.5	4.2
2	*5745.00	98.8 PK			1.15 H	59	58.7	40.1
3	*5745.00	88.5 AV			1.15 H	59	48.4	40.1
4	#5975.20	55.7 PK	68.2	-12.5	1.15 H	59	50.7	5.0
5	11490.00	56.4 PK	74.0	-17.6	1.31 H	93	38.6	17.8
6	11490.00	42.1 AV	54.0	-11.9	1.31 H	93	24.3	17.8

ANTENNA POLARITY & TEST DISTANCE: VERTICAL AT 3 M								
NO.	FREQ. (MHz)	EMISSION LEVEL (dBuV/m)	LIMIT (dBuV/m)	MARGIN (dB)	ANTENNA HEIGHT (m)	TABLE ANGLE (Degree)	RAW VALUE (dBuV)	CORRECTION FACTOR (dB/m)
1	#5631.20	60.0 PK	68.2	-8.2	1.87 V	87	55.8	4.2
2	*5745.00	117.9 PK			1.87 V	87	77.8	40.1
3	*5745.00	107.6 AV			1.87 V	87	67.5	40.1
4	#5961.60	58.1 PK	68.2	-10.1	1.87 V	87	53.1	5.0
5	11490.00	55.5 PK	74.0	-18.5	1.87 V	110	37.7	17.8
6	11490.00	42.0 AV	54.0	-12.0	1.87 V	110	24.2	17.8

Remarks:

1. Emission Level(dBuV/m) = Raw Value(dBuV) + Correction Factor(dB/m)
2. Correction Factor(dB/m) = Antenna Factor(dB/m) + Cable Factor(dB) – Pre-Amplifier Factor(dB)
3. The other emission levels were very low against the limit.
4. Margin value = Emission Level – Limit value
5. " \* ": Fundamental frequency.
6. " # ": The radiated frequency is out of the restricted band.

CHANNEL	TX Channel 157	DETECTOR FUNCTION	Peak (PK)
FREQUENCY RANGE	1GHz ~ 40GHz		Average (AV)

**ANTENNA POLARITY & TEST DISTANCE: HORIZONTAL AT 3 M**

NO.	FREQ. (MHz)	EMISSION LEVEL (dBuV/m)	LIMIT (dBuV/m)	MARGIN (dB)	ANTENNA HEIGHT (m)	TABLE ANGLE (Degree)	RAW VALUE (dBuV)	CORRECTION FACTOR (dB/m)
1	#5630.40	55.4 PK	68.2	-12.8	1.14 H	56	51.2	4.2
2	*5785.00	100.9 PK			1.14 H	56	60.6	40.3
3	*5785.00	91.9 AV			1.14 H	56	51.6	40.3
4	#5931.20	55.8 PK	68.2	-12.4	1.14 H	56	50.8	5.0
5	11570.00	57.1 PK	74.0	-16.9	1.29 H	77	39.0	18.1
6	11570.00	43.8 AV	54.0	-10.2	1.29 H	77	25.7	18.1

**ANTENNA POLARITY & TEST DISTANCE: VERTICAL AT 3 M**

NO.	FREQ. (MHz)	EMISSION LEVEL (dBuV/m)	LIMIT (dBuV/m)	MARGIN (dB)	ANTENNA HEIGHT (m)	TABLE ANGLE (Degree)	RAW VALUE (dBuV)	CORRECTION FACTOR (dB/m)
1	#5615.20	59.6 PK	68.2	-8.6	2.12 V	88	55.4	4.2
2	*5785.00	118.3 PK			2.12 V	88	78.0	40.3
3	*5785.00	108.0 AV			2.12 V	88	67.7	40.3
4	#5945.60	57.2 PK	68.2	-11.0	2.12 V	88	52.2	5.0
5	11570.00	56.5 PK	74.0	-17.5	1.81 V	110	38.4	18.1
6	11570.00	43.6 AV	54.0	-10.4	1.81 V	110	25.5	18.1

Remarks:

1. Emission Level(dBuV/m) = Raw Value(dBuV) + Correction Factor(dB/m)
2. Correction Factor(dB/m) = Antenna Factor(dB/m) + Cable Factor(dB) – Pre-Amplifier Factor(dB)
3. The other emission levels were very low against the limit.
4. Margin value = Emission Level – Limit value
5. " \* ": Fundamental frequency.
6. " # ": The radiated frequency is out of the restricted band.

CHANNEL	TX Channel 165	DETECTOR FUNCTION	Peak (PK)
FREQUENCY RANGE	1GHz ~ 40GHz		Average (AV)

ANTENNA POLARITY & TEST DISTANCE: HORIZONTAL AT 3 M								
NO.	FREQ. (MHz)	EMISSION LEVEL (dBuV/m)	LIMIT (dBuV/m)	MARGIN (dB)	ANTENNA HEIGHT (m)	TABLE ANGLE (Degree)	RAW VALUE (dBuV)	CORRECTION FACTOR (dB/m)
1	#5623.20	54.6 PK	68.2	-13.6	1.10 H	60	50.4	4.2
2	*5825.00	104.4 PK			1.10 H	60	63.9	40.5
3	*5825.00	94.1 AV			1.10 H	60	53.6	40.5
4	#5963.20	55.6 PK	68.2	-12.6	1.10 H	60	50.6	5.0
5	11650.00	56.7 PK	74.0	-17.3	1.19 H	87	39.0	17.7
6	11650.00	41.7 AV	54.0	-12.3	1.19 H	87	24.0	17.7

ANTENNA POLARITY & TEST DISTANCE: VERTICAL AT 3 M								
NO.	FREQ. (MHz)	EMISSION LEVEL (dBuV/m)	LIMIT (dBuV/m)	MARGIN (dB)	ANTENNA HEIGHT (m)	TABLE ANGLE (Degree)	RAW VALUE (dBuV)	CORRECTION FACTOR (dB/m)
1	#5620.80	60.1 PK	68.2	-8.1	1.90 V	64	55.9	4.2
2	*5825.00	119.2 PK			1.90 V	64	78.7	40.5
3	*5825.00	108.5 AV			1.90 V	64	68.0	40.5
4	#5949.60	58.1 PK	68.2	-10.1	1.90 V	64	53.1	5.0
5	11650.00	55.6 PK	74.0	-18.4	1.90 V	121	37.9	17.7
6	11650.00	42.7 AV	54.0	-11.3	1.90 V	121	25.0	17.7

Remarks:

1. Emission Level(dBuV/m) = Raw Value(dBuV) + Correction Factor(dB/m)
2. Correction Factor(dB/m) = Antenna Factor(dB/m) + Cable Factor(dB) – Pre-Amplifier Factor(dB)
3. The other emission levels were very low against the limit.
4. Margin value = Emission Level – Limit value
5. " \* ": Fundamental frequency.
6. " # ": The radiated frequency is out of the restricted band.

802.11n (HT40)

CHANNEL	TX Channel 38	DETECTOR	Peak (PK)
FREQUENCY RANGE	1GHz ~ 40GHz	FUNCTION	Average (AV)

ANTENNA POLARITY & TEST DISTANCE: HORIZONTAL AT 3 M

NO.	FREQ. (MHz)	EMISSION LEVEL (dBuV/m)	LIMIT (dBuV/m)	MARGIN (dB)	ANTENNA HEIGHT (m)	TABLE ANGLE (Degree)	RAW VALUE (dBuV)	CORRECTION FACTOR (dB/m)
1	5150.00	56.5 PK	74.0	-17.5	1.22 H	180	50.50	6.00
2	5150.00	45.3 AV	54.0	-8.7	1.22 H	180	39.30	6.00
3	*5190.00	94.5 PK			1.17 H	109	55.00	39.50
4	*5190.00	84.6 AV			1.17 H	109	45.10	39.50
5	#10380.00	60.3 PK	74.0	-13.7	1.10 H	70	41.80	18.50
6	#10380.00	47.2 AV	54.0	-6.8	1.10 H	70	28.70	18.50

ANTENNA POLARITY & TEST DISTANCE: VERTICAL AT 3 M

NO.	FREQ. (MHz)	EMISSION LEVEL (dBuV/m)	LIMIT (dBuV/m)	MARGIN (dB)	ANTENNA HEIGHT (m)	TABLE ANGLE (Degree)	RAW VALUE (dBuV)	CORRECTION FACTOR (dB/m)
1	5150.00	68.9 PK	74.0	-5.1	2.04 V	98	62.90	6.00
2	5150.00	52.5 AV	54.0	-1.5	2.04 V	98	46.50	6.00
3	*5190.00	109.3 PK			1.91 V	277	69.80	39.50
4	*5190.00	99.0 AV			1.91 V	277	59.50	39.50
5	#10380.00	61.1 PK	74.0	-12.9	1.37 V	310	42.60	18.50
6	#10380.00	47.9 AV	54.0	-6.1	1.37 V	310	29.40	18.50

Remarks:

1. Emission Level(dBuV/m) = Raw Value(dBuV) + Correction Factor(dB/m)
2. Correction Factor(dB/m) = Antenna Factor(dB/m) + Cable Factor(dB) – Pre-Amplifier Factor(dB)
3. The other emission levels were very low against the limit.
4. Margin value = Emission Level – Limit value
5. " \* ": Fundamental frequency.
6. " # ": The radiated frequency is out of the restricted band.



CHANNEL	TX Channel 46	DETECTOR FUNCTION	Peak (PK)
FREQUENCY RANGE	1GHz ~ 40GHz		Average (AV)

**ANTENNA POLARITY & TEST DISTANCE: HORIZONTAL AT 3 M**

NO.	FREQ. (MHz)	EMISSION LEVEL (dBuV/m)	LIMIT (dBuV/m)	MARGIN (dB)	ANTENNA HEIGHT (m)	TABLE ANGLE (Degree)	RAW VALUE (dBuV)	CORRECTION FACTOR (dB/m)
1	5150.00	56.0 PK	74.0	-18.0	1.48 H	95	50.0	6.0
2	5150.00	46.1 AV	54.0	-7.9	1.48 H	95	40.1	6.0
3	*5230.00	101.6 PK			1.24 H	199	62.0	39.6
4	*5230.00	91.5 AV			1.24 H	199	51.9	39.6
5	5350.00	57.2 PK	74.0	-16.8	1.25 H	102	51.1	6.1
6	5350.00	46.1 AV	54.0	-7.9	1.25 H	102	40.0	6.1
7	5400.00	58.5 PK	74.0	-15.5	1.24 H	102	52.2	6.3
8	5400.00	47.4 AV	54.0	-6.6	1.24 H	102	41.1	6.3
9	#10460.00	60.7 PK	74.0	-13.3	1.20 H	197	41.8	18.9
10	#10460.00	47.3 AV	54.0	-6.7	1.20 H	197	28.4	18.9

**ANTENNA POLARITY & TEST DISTANCE: VERTICAL AT 3 M**

NO.	FREQ. (MHz)	EMISSION LEVEL (dBuV/m)	LIMIT (dBuV/m)	MARGIN (dB)	ANTENNA HEIGHT (m)	TABLE ANGLE (Degree)	RAW VALUE (dBuV)	CORRECTION FACTOR (dB/m)
1	5150.00	67.0 PK	74.0	-7.0	1.70 V	280	61.0	6.0
2	5150.00	52.1 AV	54.0	-1.9	1.70 V	280	46.1	6.0
3	*5230.00	117.8 PK			1.98 V	276	78.2	39.6
4	*5230.00	107.7 AV			1.98 V	276	68.1	39.6
5	5350.00	64.0 PK	74.0	-10.0	1.71 V	280	57.9	6.1
6	5350.00	50.5 AV	54.0	-3.5	1.71 V	280	44.4	6.1
7	5360.00	65.1 PK	74.0	-8.9	1.71 V	280	59.0	6.1
8	5360.00	51.6 AV	54.0	-2.4	1.71 V	280	45.5	6.1
9	#10460.00	64.6 PK	74.0	-9.4	2.00 V	81	45.7	18.9
10	#10460.00	50.2 AV	54.0	-3.8	2.00 V	81	31.3	18.9

Remarks:

1. Emission Level(dBuV/m) = Raw Value(dBuV) + Correction Factor(dB/m)
2. Correction Factor(dB/m) = Antenna Factor(dB/m) + Cable Factor(dB) – Pre-Amplifier Factor(dB)
3. The other emission levels were very low against the limit.
4. Margin value = Emission Level – Limit value
5. " \* ": Fundamental frequency.
6. " # ": The radiated frequency is out of the restricted band.

CHANNEL	TX Channel 151	DETECTOR FUNCTION	Peak (PK)
FREQUENCY RANGE	1GHz ~ 40GHz		Average (AV)

ANTENNA POLARITY & TEST DISTANCE: HORIZONTAL AT 3 M								
NO.	FREQ. (MHz)	EMISSION LEVEL (dBuV/m)	LIMIT (dBuV/m)	MARGIN (dB)	ANTENNA HEIGHT (m)	TABLE ANGLE (Degree)	RAW VALUE (dBuV)	CORRECTION FACTOR (dB/m)
1	#5634.40	55.2 PK	68.2	-13.0	1.08 H	57	51.0	4.2
2	*5755.00	96.9 PK			1.08 H	57	56.8	40.1
3	*5755.00	87.3 AV			1.08 H	57	47.2	40.1
4	#5942.40	56.3 PK	68.2	-11.9	1.08 H	57	51.4	4.9
5	11510.00	55.6 PK	74.0	-18.4	1.21 H	79	37.8	17.8
6	11510.00	41.7 AV	54.0	-12.3	1.21 H	79	23.9	17.8

ANTENNA POLARITY & TEST DISTANCE: VERTICAL AT 3 M								
NO.	FREQ. (MHz)	EMISSION LEVEL (dBuV/m)	LIMIT (dBuV/m)	MARGIN (dB)	ANTENNA HEIGHT (m)	TABLE ANGLE (Degree)	RAW VALUE (dBuV)	CORRECTION FACTOR (dB/m)
1	#5608.80	58.8 PK	68.2	-9.4	2.02 V	90	54.6	4.2
2	*5755.00	115.7 PK			2.02 V	90	75.6	40.1
3	*5755.00	104.8 AV			2.02 V	90	64.7	40.1
4	#5927.20	57.9 PK	68.2	-10.3	2.02 V	90	53.0	4.9
5	11510.00	56.0 PK	74.0	-18.0	1.87 V	107	38.2	17.8
6	11510.00	42.7 AV	54.0	-11.3	1.87 V	107	24.9	17.8

Remarks:

1. Emission Level(dBuV/m) = Raw Value(dBuV) + Correction Factor(dB/m)
2. Correction Factor(dB/m) = Antenna Factor(dB/m) + Cable Factor(dB) – Pre-Amplifier Factor(dB)
3. The other emission levels were very low against the limit.
4. Margin value = Emission Level – Limit value
5. " \* ": Fundamental frequency.
6. " # ": The radiated frequency is out of the restricted band.

CHANNEL	TX Channel 159	DETECTOR FUNCTION	Peak (PK)
FREQUENCY RANGE	1GHz ~ 40GHz		Average (AV)

**ANTENNA POLARITY & TEST DISTANCE: HORIZONTAL AT 3 M**

NO.	FREQ. (MHz)	EMISSION LEVEL (dBuV/m)	LIMIT (dBuV/m)	MARGIN (dB)	ANTENNA HEIGHT (m)	TABLE ANGLE (Degree)	RAW VALUE (dBuV)	CORRECTION FACTOR (dB/m)
1	#5635.20	55.3 PK	68.2	-12.9	1.09 H	60	51.1	4.2
2	*5795.00	101.1 PK			1.09 H	60	60.8	40.3
3	*5795.00	91.1 AV			1.09 H	60	50.8	40.3
4	#5951.20	56.2 PK	68.2	-12.0	1.09 H	60	51.2	5.0
5	11590.00	57.3 PK	74.0	-16.7	1.61 H	103	39.3	18.0
6	11590.00	42.1 AV	54.0	-11.9	1.61 H	103	24.1	18.0

**ANTENNA POLARITY & TEST DISTANCE: VERTICAL AT 3 M**

NO.	FREQ. (MHz)	EMISSION LEVEL (dBuV/m)	LIMIT (dBuV/m)	MARGIN (dB)	ANTENNA HEIGHT (m)	TABLE ANGLE (Degree)	RAW VALUE (dBuV)	CORRECTION FACTOR (dB/m)
1	#5605.60	58.4 PK	68.2	-9.8	2.01 V	58	54.2	4.2
2	*5795.00	115.9 PK			2.01 V	58	75.6	40.3
3	*5795.00	105.9 AV			2.01 V	58	65.6	40.3
4	#5940.80	56.8 PK	68.2	-11.4	2.01 V	58	51.9	4.9
5	11590.00	55.7 PK	74.0	-18.3	1.81 V	129	37.7	18.0
6	11590.00	42.3 AV	54.0	-11.7	1.81 V	129	24.3	18.0

Remarks:

1. Emission Level(dBuV/m) = Raw Value(dBuV) + Correction Factor(dB/m)
2. Correction Factor(dB/m) = Antenna Factor(dB/m) + Cable Factor(dB) – Pre-Amplifier Factor(dB)
3. The other emission levels were very low against the limit.
4. Margin value = Emission Level – Limit value
5. " \* ": Fundamental frequency.
6. " # ": The radiated frequency is out of the restricted band.

802.11ac (VHT80)

CHANNEL	TX Channel 42	DETECTOR FUNCTION	Peak (PK)
FREQUENCY RANGE	1GHz ~ 40GHz		Average (AV)

ANTENNA POLARITY & TEST DISTANCE: HORIZONTAL AT 3 M

NO.	FREQ. (MHz)	EMISSION LEVEL (dBuV/m)	LIMIT (dBuV/m)	MARGIN (dB)	ANTENNA HEIGHT (m)	TABLE ANGLE (Degree)	RAW VALUE (dBuV)	CORRECTION FACTOR (dB/m)
1	5150.00	57.6 PK	74.0	-16.4	1.10 H	66	51.6	6.0
2	5150.00	46.4 AV	54.0	-7.6	1.10 H	66	40.4	6.0
3	*5210.00	90.5 PK			1.06 H	109	50.9	39.6
4	*5210.00	80.9 AV			1.06 H	109	41.3	39.6
5	5350.00	56.1 PK	74.0	-17.9	1.05 H	111	50.0	6.1
6	5350.00	46.3 AV	54.0	-7.7	1.05 H	111	40.2	6.1
7	#10420.00	60.6 PK	74.0	-13.4	1.43 H	155	42.0	18.6
8	#10420.00	47.3 AV	54.0	-6.7	1.43 H	155	28.7	18.6

ANTENNA POLARITY & TEST DISTANCE: VERTICAL AT 3 M

NO.	FREQ. (MHz)	EMISSION LEVEL (dBuV/m)	LIMIT (dBuV/m)	MARGIN (dB)	ANTENNA HEIGHT (m)	TABLE ANGLE (Degree)	RAW VALUE (dBuV)	CORRECTION FACTOR (dB/m)
1	5150.00	66.5 PK	74.0	-7.5	2.01 V	50	60.5	6.0
2	5150.00	52.7 AV	54.0	-1.3	2.01 V	50	46.7	6.0
3	*5210.00	105.7 PK			1.97 V	274	66.1	39.6
4	*5210.00	95.3 AV			1.97 V	274	55.7	39.6
5	5350.00	60.2 PK	74.0	-13.8	2.00 V	270	54.1	6.1
6	5350.00	49.4 AV	54.0	-4.6	2.00 V	270	43.3	6.1
7	#10420.00	61.3 PK	74.0	-12.7	1.40 V	313	42.7	18.6
8	#10420.00	48.1 AV	54.0	-5.9	1.40 V	313	29.5	18.6

Remarks:

1. Emission Level(dBuV/m) = Raw Value(dBuV) + Correction Factor(dB/m)
2. Correction Factor(dB/m) = Antenna Factor(dB/m) + Cable Factor(dB) – Pre-Amplifier Factor(dB)
3. The other emission levels were very low against the limit.
4. Margin value = Emission Level – Limit value
5. " \* ": Fundamental frequency.
6. " # ": The radiated frequency is out of the restricted band.

CHANNEL	TX Channel 155	DETECTOR FUNCTION	Peak (PK)
FREQUENCY RANGE	1GHz ~ 40GHz		Average (AV)

ANTENNA POLARITY & TEST DISTANCE: HORIZONTAL AT 3 M								
NO.	FREQ. (MHz)	EMISSION LEVEL (dBuV/m)	LIMIT (dBuV/m)	MARGIN (dB)	ANTENNA HEIGHT (m)	TABLE ANGLE (Degree)	RAW VALUE (dBuV)	CORRECTION FACTOR (dB/m)
1	#5600.80	55.6 PK	68.2	-12.6	1.10 H	60	51.4	4.2
2	#5650.00	55.0 PK	68.2	-13.2	1.08 H	66	50.7	4.3
3	*5775.00	96.8 PK			1.10 H	60	56.6	40.2
4	*5775.00	86.3 AV			1.10 H	60	46.1	40.2
5	#5949.60	56.0 PK	68.2	-12.2	1.10 H	60	51.0	5.0
6	11550.00	55.8 PK	74.0	-18.2	1.55 H	99	37.8	18.0
7	11550.00	43.8 AV	54.0	-10.2	1.55 H	99	25.8	18.0
ANTENNA POLARITY & TEST DISTANCE: VERTICAL AT 3 M								
NO.	FREQ. (MHz)	EMISSION LEVEL (dBuV/m)	LIMIT (dBuV/m)	MARGIN (dB)	ANTENNA HEIGHT (m)	TABLE ANGLE (Degree)	RAW VALUE (dBuV)	CORRECTION FACTOR (dB/m)
1	#5650.00	64.5 PK	68.2	-3.7	2.01 V	110	60.2	4.3
2	#5653.60	63.8 PK	70.9	-7.1	1.93 V	90	59.5	4.3
3	*5775.00	113.5 PK			1.93 V	90	73.3	40.2
4	*5775.00	100.7 AV			1.93 V	90	60.5	40.2
5	#5932.80	61.4 PK	68.2	-6.8	1.93 V	90	56.4	5.0
6	11550.00	54.7 PK	74.0	-19.3	1.89 V	103	36.7	18.0
7	11550.00	42.9 AV	54.0	-11.1	1.89 V	103	24.9	18.0

Remarks:

1. Emission Level(dBuV/m) = Raw Value(dBuV) + Correction Factor(dB/m)
2. Correction Factor(dB/m) = Antenna Factor(dB/m) + Cable Factor(dB) – Pre-Amplifier Factor(dB)
3. The other emission levels were very low against the limit.
4. Margin value = Emission Level – Limit value
5. " \* ": Fundamental frequency.
6. " # ": The radiated frequency is out of the restricted band.

Below 1GHz Worst-Case Data: 802.11a

CHANNEL	TX Channel 149	DETECTOR FUNCTION	Quasi-Peak (QP)
FREQUENCY RANGE	9kHz ~ 1GHz		

ANTENNA POLARITY & TEST DISTANCE: HORIZONTAL AT 3 M								
NO.	FREQ. (MHz)	EMISSION LEVEL (dBuV/m)	LIMIT (dBuV/m)	MARGIN (dB)	ANTENNA HEIGHT (m)	TABLE ANGLE (Degree)	RAW VALUE (dBuV)	CORRECTION FACTOR (dB/m)
1	57.12	33.5 QP	40.0	-6.5	1.51 H	3	47.9	-14.4
2	103.78	38.2 QP	43.5	-5.3	2.00 H	324	56.3	-18.1
3	160.17	37.8 QP	43.5	-5.7	1.00 H	16	51.6	-13.8
4	181.55	34.7 QP	43.5	-8.8	1.00 H	262	50.0	-15.3
5	374.04	21.0 QP	46.0	-25.0	1.00 H	158	32.6	-11.6
6	681.24	25.3 QP	46.0	-20.7	2.00 H	249	31.5	-6.2
ANTENNA POLARITY & TEST DISTANCE: VERTICAL AT 3 M								
NO.	FREQ. (MHz)	EMISSION LEVEL (dBuV/m)	LIMIT (dBuV/m)	MARGIN (dB)	ANTENNA HEIGHT (m)	TABLE ANGLE (Degree)	RAW VALUE (dBuV)	CORRECTION FACTOR (dB/m)
1	47.80	36.9 QP	40.0	-3.1	1.00 V	63	51.1	-14.2
2	103.78	36.0 QP	43.5	-7.5	1.00 V	122	54.1	-18.1
3	154.33	29.8 QP	43.5	-13.7	1.99 V	4	43.6	-13.8
4	197.11	27.9 QP	43.5	-15.6	1.00 V	266	44.7	-16.8
5	424.59	21.6 QP	46.0	-24.4	1.00 V	219	32.2	-10.6
6	607.35	23.1 QP	46.0	-22.9	1.00 V	80	30.3	-7.2

Remarks:

1. Emission Level(dBuV/m) = Raw Value(dBuV) + Correction Factor(dB/m)
2. Correction Factor(dB/m) = Antenna Factor(dB/m) + Cable Factor(dB) – Pre-Amplifier Factor(dB)
3. The other emission levels were very low against the limit.
4. Margin value = Emission Level – Limit value

## 4.2 Conducted Emission Measurement

### 4.2.1 Limits of Conducted Emission Measurement

Frequency (MHz)	Conducted Limit (dBuV)	
	Quasi-peak	Average
0.15 - 0.5	66 - 56	56 - 46
0.50 - 5.0	56	46
5.0 - 30.0	60	50

Note: 1. The lower limit shall apply at the transition frequencies.

2. The limit decreases in line with the logarithm of the frequency in the range of 0.15 to 0.50MHz.

### 4.2.2 Test Instruments

Description & Manufacturer	Model No.	Serial No.	Cal. Date	Cal. Due
Test Receiver ROHDE & SCHWARZ	ESCI	100613	Nov. 23, 2017	Nov. 22, 2018
RF signal cable (with 10dB PAD) Woken	5D-FB	Cable-cond1-01	Sep. 05, 2017	Sep. 04, 2018
LISN ROHDE & SCHWARZ (EUT)	ESH3-Z5	835239/001	Mar. 10, 2017	Mar. 09, 2018
LISN ROHDE & SCHWARZ (Peripheral)	ESH3-Z5	100311	Aug. 15, 2017	Aug. 14, 2018
Software ADT	BV ADT_Cond_ V7.3.7.3	NA	NA	NA

Note: 1. The calibration interval of the above test instruments is 12 months and the calibrations are traceable to NML/ROC and NIST/USA.

2. The test was performed in HwaYa Shielded Room 1.

3. The VCCI Site Registration No. is C-2040.

4. Test Date: Feb. 06, 2018

#### 4.2.3 Test Procedures

- The EUT was placed 0.4 meters from the conducting wall of the shielded room with EUT being connected to the power mains through a line impedance stabilization network (LISN). Other support units were connected to the power mains through another LISN. The two LISNs provide 50 ohm/ 50uH of coupling impedance for the measuring instrument.
- Both lines of the power mains connected to the EUT were checked for maximum conducted interference.
- The frequency range from 150kHz to 30MHz was searched. Emission levels under (Limit - 20dB) was not recorded.

Note: The resolution bandwidth and video bandwidth of test receiver is 9kHz for quasi-peak detection (QP) and average detection (AV) at frequency 0.15MHz-30MHz.

#### 4.2.4 Deviation from Test Standard

No deviation.

#### 4.2.5 Test Setup

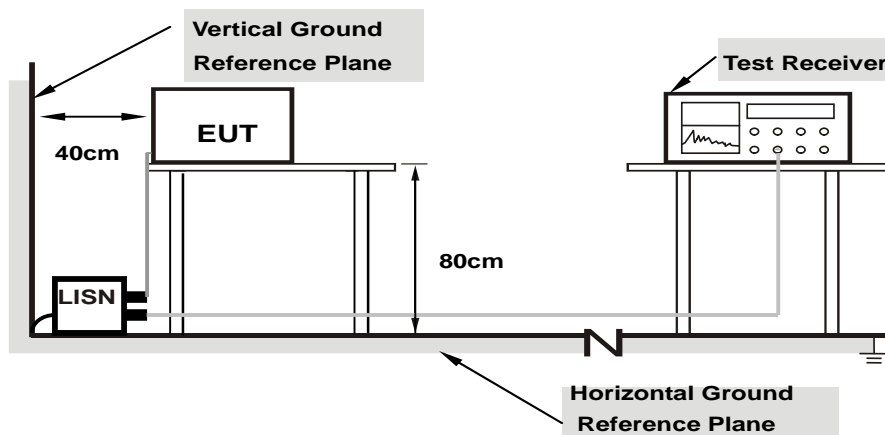

Note: 1.Support units were connected to second LISN.

For the actual test configuration, please refer to the attached file (Test Setup Photo).

#### 4.2.6 EUT Operating Conditions

Same as 4.1.6.



#### 4.2.7 Test Results

Worst-case data: 802.11a

Phase	Line (L)	Detector Function	Quasi-Peak (QP) / Average (AV)
-------	----------	-------------------	--------------------------------

No	Freq. [MHz]	Corr. Factor (dB)	Reading Value [dB (uV)]		Emission Level [dB (uV)]		Limit [dB (uV)]		Margin (dB)	
			Q.P.	AV.	Q.P.	AV.	Q.P.	AV.	Q.P.	AV.
			1	0.23412	10.16	43.38	34.32	53.54	44.48	62.30
2	0.26152	10.17	44.61	36.47	54.78	46.64	61.38	51.38	-6.60	-4.74
3	0.46200	10.20	34.15	24.53	44.35	34.73	56.66	46.66	-12.31	-11.93
4	3.66200	10.33	40.86	31.88	51.19	42.21	56.00	46.00	-4.81	-3.79
<b>5</b>	<b>4.29800</b>	<b>10.36</b>	<b>41.40</b>	<b>32.36</b>	<b>51.76</b>	<b>42.72</b>	<b>56.00</b>	<b>46.00</b>	<b>-4.24</b>	<b>-3.28</b>
6	6.14200	10.45	38.81	29.97	49.26	40.42	60.00	50.00	-10.74	-9.58

Remarks:

1. Q.P. and AV. are abbreviations of quasi-peak and average individually.
2. The emission levels of other frequencies were very low against the limit.
3. Margin value = Emission level - Limit value
4. Correction factor = Insertion loss + Cable loss
5. Emission Level = Correction Factor + Reading Value.

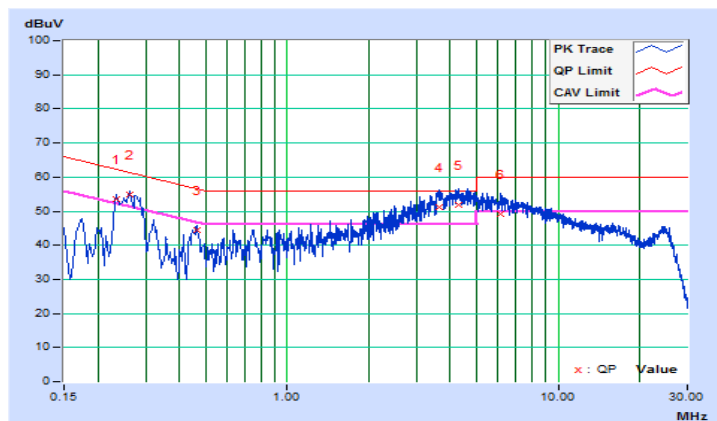

Phase	Neutral (N)	Detector Function	Quasi-Peak (QP) / Average (AV)
-------	-------------	-------------------	--------------------------------

No	Freq. [MHz]	Corr. Factor (dB)	Reading Value		Emission Level		Limit		Margin	
			[dB (uV)]		[dB (uV)]		[dB (uV)]		(dB)	
			Q.P.	AV.	Q.P.	AV.	Q.P.	AV.	Q.P.	AV.
1	0.24600	10.17	40.63	28.32	50.80	38.49	61.89	51.89	-11.09	-13.40
2	0.26779	10.17	39.54	29.24	49.71	39.41	61.19	51.19	-11.48	-11.78
3	2.81000	10.27	33.33	23.30	43.60	33.57	56.00	46.00	-12.40	-12.43
4	3.90600	10.34	37.20	27.84	47.54	38.18	56.00	46.00	-8.46	-7.82
5	5.03000	10.38	36.67	27.55	47.05	37.93	60.00	50.00	-12.95	-12.07
6	7.35400	10.47	34.05	25.03	44.52	35.50	60.00	50.00	-15.48	-14.50

Remarks:

1. Q.P. and AV. are abbreviations of quasi-peak and average individually.
2. The emission levels of other frequencies were very low against the limit.
3. Margin value = Emission level - Limit value
4. Correction factor = Insertion loss + Cable loss
5. Emission Level = Correction Factor + Reading Value.

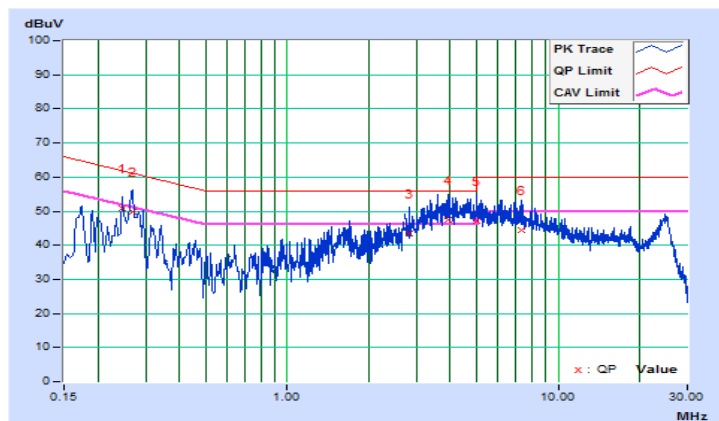

### 4.3 Transmit Power Measurement

#### 4.3.1 Limits of Transmit Power Measurement

Operation Band	EUT Category		Limit
U-NII-1		Outdoor Access Point	1 Watt (30 dBm) (Max. e.i.r.p $\leq$ 125mW(21 dBm) at any elevation angle above 30 degrees as measured from the horizon)
		Fixed point-to-point Access Point	1 Watt (30 dBm)
		Indoor Access Point	1 Watt (30 dBm)
	√	Mobile and Portable client device	250mW (24 dBm)
U-NII-2A	-		250mW (24 dBm) or 11 dBm+10 log B*
U-NII-2C	-		250mW (24 dBm) or 11 dBm+10 log B*
U-NII-3	√		1 Watt (30 dBm)

\*B is the 26 dB emission bandwidth in megahertz

Per KDB 662911 Method of conducted output power measurement on IEEE 802.11 devices,

Array Gain = 0 dB (i.e., no array gain) for  $N_{ANT} \leq 4$ ;

Array Gain = 0 dB (i.e., no array gain) for channel widths  $\geq 40$  MHz for any  $N_{ANT}$ ;

Array Gain =  $5 \log(N_{ANT}/N_{SS})$  dB or 3 dB, whichever is less for 20-MHz channel widths with  $N_{ANT} \geq 5$ .

For power measurements on all other devices: Array Gain =  $10 \log(N_{ANT}/N_{SS})$  dB.

#### 4.3.2 Test Setup

For Power Output

802.11a, 802.11n (HT20), 802.11n (HT40)

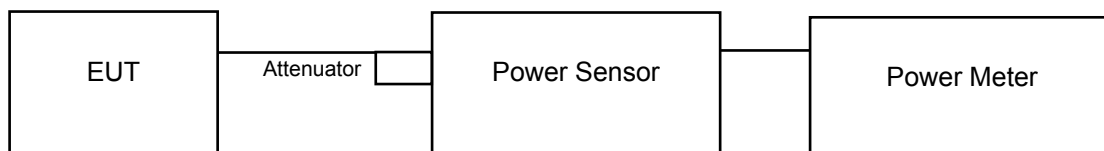

802.11ac (VHT80)

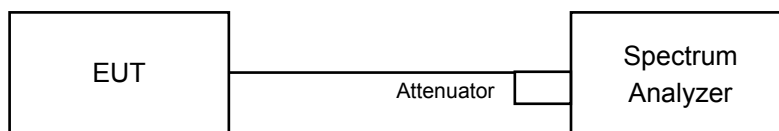

#### 4.3.3 Test Instruments

Refer to section 4.1.2 to get information of above instrument.

#### 4.3.4 Test Procedure

##### For Average Power Measurement

##### For 802.11a, 802.11n (HT20), 802.11n (HT40)

Method PM is used to perform output power measurement, trigger and gating function of wide band power meter is enabled to measure max output power of TX on burst. Duty factor is not added to measured value.

##### For 802.11ac (VHT80)

- a. Set span to encompass the entire 26 dB EBW (or, alternatively, the entire 99% occupied bandwidth) of the signal.
- b. Set sweep trigger to “free run”.
- c. Set RBW = 1 MHz.
- d. Set VBW  $\geq$  3 MHz.
- e. Number of points in sweep  $\geq$  2 Span / RBW.
- f. Sweep time  $\leq$  (number of points in sweep) \* T
- g. Using emission bandwidth to determine the frequency span for integration the channel bandwidth.
- h. Detector = RMS.
- i. Trace mode = max hold.
- j. Allow max hold to run for at least 60 seconds, or longer as needed to allow the trace to stabilize.
- k. Compute power by integrating the spectrum across the EBW (or, alternatively, the entire 99% occupied bandwidth) of the signal using the instrument’s band power measurement function with band limits set equal to the EBW (or occupied bandwidth) band edges. If the instrument does not have a band power function, sum the spectrum levels (in power units) at 1 MHz intervals extending across the EBW (or, alternatively, the entire 99% occupied bandwidth) of the spectrum.

#### 4.3.5 Deviation from Test Standard

No deviation.

#### 4.3.6 EUT Operating Conditions

The software provided by client to enable the EUT under transmission condition continuously at lowest, middle and highest channel frequencies individually.

#### 4.3.7 Test Result

##### Power Output:

##### 802.11a

Chan.	Freq. (MHz)	Maximum Conducted Power (dBm)		Total Power (mW)	Total Power (dBm)	Power Limit (dBm)	Pass / Fail
		Chain 0	Chain 1				
36	5180	18.65	17.65	131.492	21.19	24.00	Pass
40	5200	18.54	17.51	127.814	21.07	24.00	Pass
48	5240	18.71	17.64	132.378	21.22	24.00	Pass
149	5745	17.91	18.47	132.109	21.21	30.00	Pass
157	5785	17.97	18.57	134.606	21.29	30.00	Pass
165	5825	18.02	18.77	138.723	21.42	30.00	Pass

##### 802.11n (HT20)

Chan.	Freq. (MHz)	Maximum Conducted Power (dBm)		Total Power (mW)	Total Power (dBm)	Power Limit (dBm)	Pass / Fail
		Chain 0	Chain 1				
36	5180	18.85	17.42	131.944	21.20	24.00	Pass
40	5200	18.78	17.56	132.525	21.22	24.00	Pass
48	5240	18.67	17.51	129.985	21.14	24.00	Pass
149	5745	17.81	18.48	130.864	21.17	30.00	Pass
157	5785	17.83	18.86	137.587	21.39	30.00	Pass
165	5825	18.05	18.85	140.562	21.48	30.00	Pass

##### 802.11n (HT40)

Chan.	Freq. (MHz)	Maximum Conducted Power (dBm)		Total Power (mW)	Total Power (dBm)	Power Limit (dBm)	Pass / Fail
		Chain 0	Chain 1				
38	5190	13.03	12.25	36.879	15.67	24.00	Pass
46	5230	20.82	20.45	<b>231.698</b>	23.65	24.00	Pass
151	5755	17.80	18.51	131.214	21.18	30.00	Pass
159	5795	18.69	19.23	<b>157.714</b>	21.98	30.00	Pass

##### 802.11ac (VHT80)

Chan.	Freq. (MHz)	Maximum Conducted Power (dBm)		Total Power (mW)	Total Power (dBm)	Power Limit (dBm)	Pass / Fail
		Chain 0	Chain 1				
42	5210	11.25	10.23	23.879	13.78	24.00	Pass
155	5775	17.79	18.40	129.300	21.12	30.00	Pass

## 4.4 Occupied Bandwidth Measurement

### 4.4.1 Test Setup

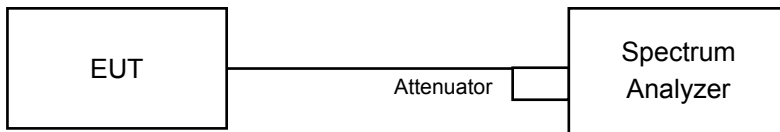

### 4.4.2 Test Instruments

Refer to section 4.1.2 to get information of above instrument.

### 4.4.3 Test Procedure

The transmitter output was connected to the spectrum analyzer through an attenuator. The bandwidth of the fundamental frequency was measured by spectrum analyzer with resolution bandwidth in the range of 1% to 5% of the anticipated emission bandwidth, and a video bandwidth at least 3x the resolution bandwidth and set the detector to sampling. The width of a frequency band such that, below the lower and above the upper frequency limits, the mean powers emitted are each equal to a specified percentage 0.5 %of the total mean power of a given emission.

#### 4.4.4 Test Result

##### 802.11a

Chan.	Freq. (MHz)	Occupied Bandwidth (MHz)	
		Chain 0	Chain 1
36	5180	17.22	16.86
40	5200	17.52	16.80
48	5240	17.64	16.80
149	5745	17.22	17.31
157	5785	17.28	17.64
165	5825	17.16	17.64

##### 802.11n (HT20)

Chan.	Freq. (MHz)	Occupied Bandwidth (MHz)	
		Chain 0	Chain 1
36	5180	18.24	18.00
40	5200	18.48	18.00
48	5240	18.60	18.00
149	5745	18.24	18.36
157	5785	18.24	18.72
165	5825	18.24	18.36

##### 802.11n (HT40)

Chan.	Freq. (MHz)	Occupied Bandwidth (MHz)	
		Chain 0	Chain 1
38	5190	36.96	36.96
46	5230	39.24	37.92
151	5755	37.32	37.32
159	5795	37.80	37.44

##### 802.11ac (VHT80)

Chan.	Freq. (MHz)	Occupied Bandwidth (MHz)	
		Chain 0	Chain 1
42	5210	76.32	76.08
155	5775	76.56	76.56

### Spectrum Plot of Worst Value

#### 802.11a

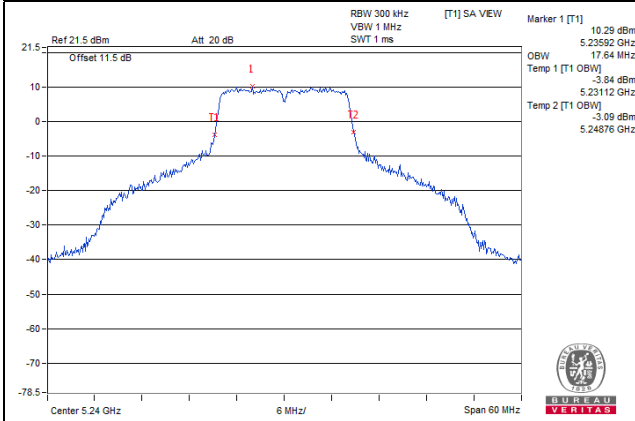

#### 802.11n (HT20)

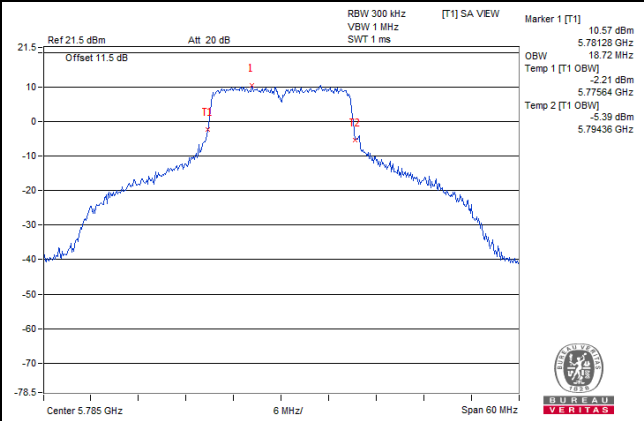

#### 802.11n (HT40)

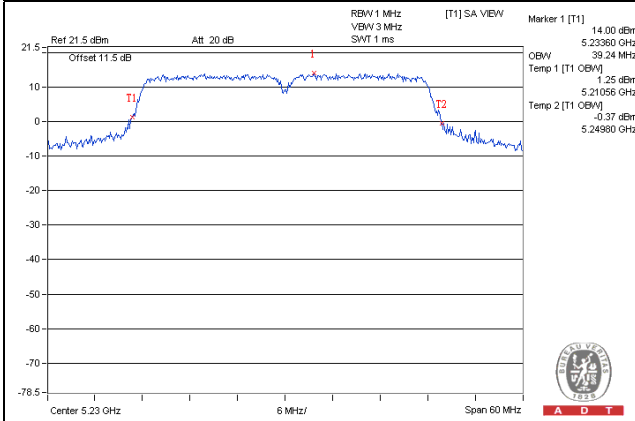

#### 802.11ac (VHT80)

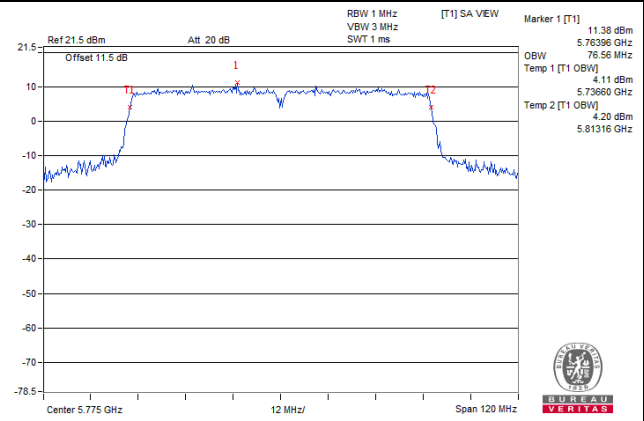



## 4.5 Peak Power Spectral Density Measurement

### 4.5.1 Limits of Peak Power Spectral Density Measurement

Operation Band	EUT Category		Limit
U-NII-1		Outdoor Access Point	17dBm/ MHz
		Fixed point-to-point Access Point	
		Indoor Access Point	
	√	Mobile and Portable client device	11dBm/ MHz
U-NII-2A			11dBm/ MHz
U-NII-2C			11dBm/ MHz
U-NII-3	√		30dBm/ 500kHz

### 4.5.2 Test Setup

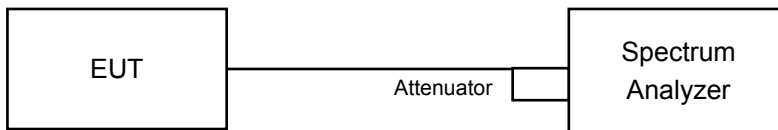

### 4.5.3 Test Instruments

Refer to section 4.1.2 to get information of above instrument.

### 4.5.4 Test Procedures

For U-NII-1 band:

Using method SA-2

- Set span to encompass the entire emission bandwidth (EBW) of the signal.
- Set RBW = 1MHz, Set VBW  $\geq$  3 MHz, Detector = RMS
- Set Channel power measure = 1MHz
- Sweep time = auto, trigger set to "free run".
- Trace average at least 100 traces in power averaging mode.
- Record the max value and add 10 log (1/duty cycle)

For U-NII-3 band:

- Set span to encompass the entire emission bandwidth (EBW) of the signal.
- Set RBW = 300 kHz, Set VBW  $\geq$  1 MHz, Detector = RMS
- Use the peak marker function to determine the maximum power level in any 300 kHz band segment within the fundamental EBW.
- Scale the observed power level to an equivalent value in 500 kHz by adjusting (reducing) the measured power by a bandwidth correction factor (BWCF) where  $BWCF = 10\log(500 \text{ kHz} / 300 \text{ kHz})$
- Sweep time = auto, trigger set to "free run".
- Trace average at least 100 traces in power averaging mode.
- Record the max value and add 10 log (1/duty cycle)

#### **4.5.5 Deviation from Test Standard**

No deviation.

#### **4.5.6 EUT Operating Conditions**

Same as 4.3.6.

#### 4.5.7 Test Results

For U-NII-1 band:

##### 802.11a

Chan.	Freq. (MHz)	PSD w/o Duty Factor (dBm/MHz)		Duty Factor (dB)	Total PSD with Duty Factor (dBm/MHz)	Max. Limit (dBm/MHz)	Pass / Fail
		Chain 0	Chain 1				
36	5180	4.51	4.09	0.17	7.49	9.36	Pass
40	5200	4.96	4.28	0.17	7.82	9.36	Pass
48	5240	5.01	4.28	0.17	7.85	9.36	Pass

Note:

- Method 1 of power density measurement of KDB 662911 is using for calculating total power density. Total power density is summing entire spectra across corresponding frequency bins on the various outputs by computer.
- Directional gain =  $10 \log[(10^{G1/20} + 10^{G2/20} + \dots + 10^{GN/20})^2/2] = 7.64 \text{ dBi} > 6\text{dBi}$ , so the power density limit shall be reduced to  $11-(7.64-6) = 9.36\text{dBm}$ .
- Refer to section 3.3 for duty cycle spectrum plot.

##### 802.11n (HT20)

Chan.	Freq. (MHz)	PSD w/o Duty Factor (dBm/MHz)		Duty Factor (dB)	Total PSD with Duty Factor (dBm/MHz)	Max. Limit (dBm/MHz)	Pass / Fail
		Chain 0	Chain 1				
36	5180	4.85	3.44	0.32	7.54	9.36	Pass
40	5200	4.48	3.65	0.32	7.42	9.36	Pass
48	5240	4.34	3.92	0.32	7.47	9.36	Pass

Note:

- Method 1 of power density measurement of KDB 662911 is using for calculating total power density. Total power density is summing entire spectra across corresponding frequency bins on the various outputs by computer.
- Directional gain =  $10 \log[(10^{G1/20} + 10^{G2/20} + \dots + 10^{GN/20})^2/2] = 7.64 \text{ dBi} > 6\text{dBi}$ , so the power density limit shall be reduced to  $11-(7.64-6) = 9.36\text{dBm}$ .
- Refer to section 3.3 for duty cycle spectrum plot.

##### 802.11n (HT40)

Chan.	Freq. (MHz)	PSD w/o Duty Factor (dBm/MHz)		Duty Factor (dB)	Total PSD with Duty Factor (dBm/MHz)	Max. Limit (dBm/MHz)	Pass / Fail
		Chain 0	Chain 1				
38	5190	-3.95	-4.92	0.35	-1.05	9.36	Pass
46	5230	3.64	3.27	0.35	6.79	9.36	Pass

Note:

- Method 1 of power density measurement of KDB 662911 is using for calculating total power density. Total power density is summing entire spectra across corresponding frequency bins on the various outputs by computer.
- Directional gain =  $10 \log[(10^{G1/20} + 10^{G2/20} + \dots + 10^{GN/20})^2/2] = 7.64 \text{ dBi} > 6\text{dBi}$ , so the power density limit shall be reduced to  $11-(7.64-6) = 9.36\text{dBm}$ .
- Refer to section 3.3 for duty cycle spectrum plot.

802.11ac (VHT80)

Chan.	Freq. (MHz)	PSD w/o Duty Factor (dBm/MHz)		Duty Factor (dB)	Total PSD with Duty Factor (dBm/MHz)	Max. Limit (dBm/MHz)	Pass / Fail
		Chain 0	Chain 1				
42	5210	-9.13	-10.27	0.81	-5.85	9.36	Pass

Note:

1. Method 1 of power density measurement of KDB 662911 is using for calculating total power density. Total power density is summing entire spectra across corresponding frequency bins on the various outputs by computer.
2. Directional gain =  $10 \log[(10^{G1/20} + 10^{G2/20} + \dots + 10^{GN/20})^2/2] = 7.64 \text{ dBi} > 6\text{dBi}$ , so the power density limit shall be reduced to  $17 - (7.64 - 6) = 15.36\text{dBm}$ .
3. Refer to section 3.3 for duty cycle spectrum plot.

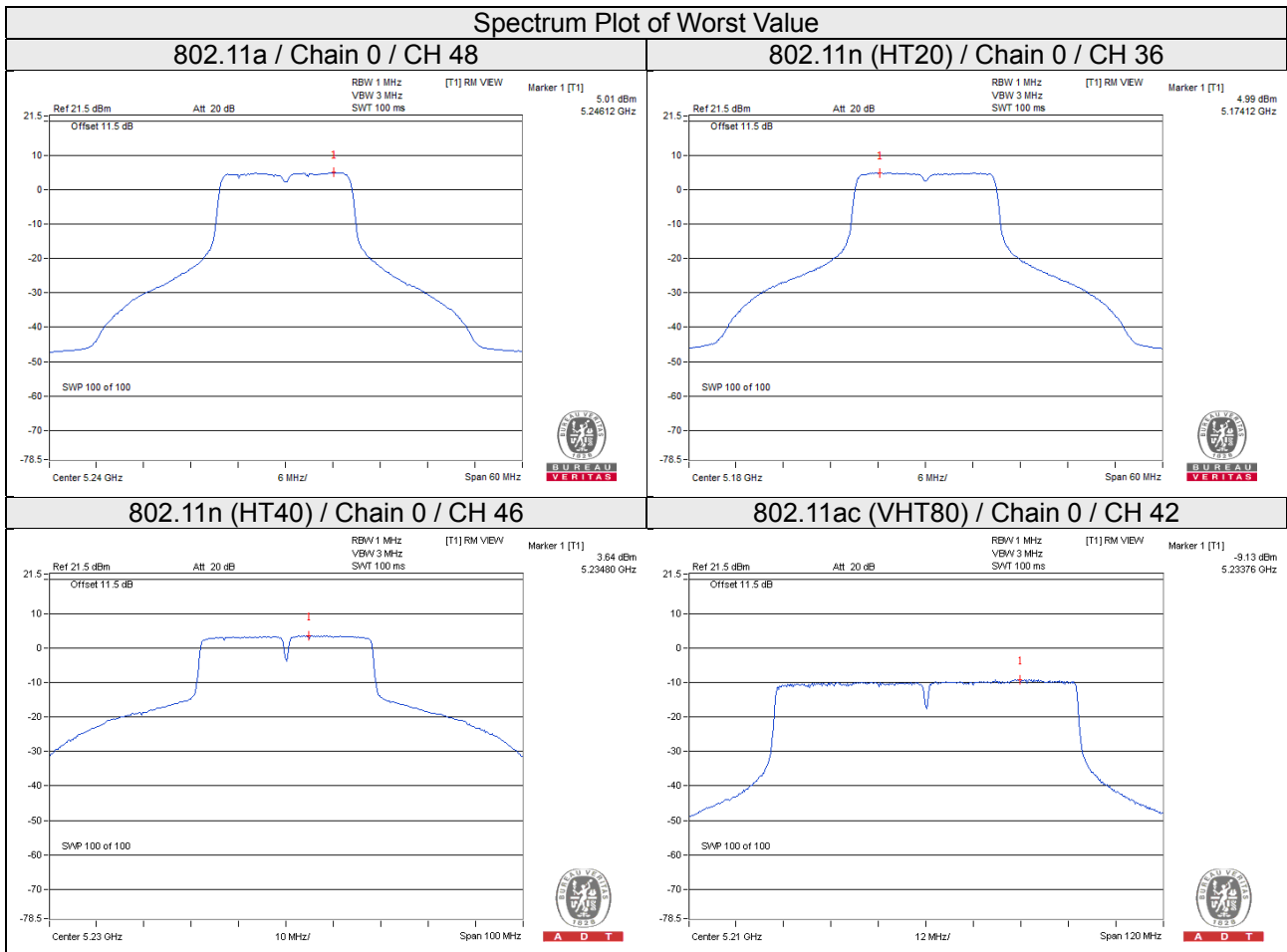

For U-NII-3 band:

802.11a

TX chain	Chan.	Freq. (MHz)	PSD W/O Duty Factor		10 log (N=2) dB	Duty Factor (dB)	Total PSD With Duty Factor (dBm/500kHz)	Limit (dBm/500kHz)	Pass / Fail
			(dBm/300kHz)	(dBm/500kHz)					
0	149	5745	-2.85	-0.63	3.01	0.17	2.55	28.36	Pass
	157	5785	-2.78	-0.56	3.01	0.17	2.62	28.36	Pass
	165	5825	-2.88	-0.66	3.01	0.17	2.52	28.36	Pass
1	149	5745	-2.55	-0.33	3.01	0.17	2.85	28.36	Pass
	157	5785	-2.10	0.12	3.01	0.17	3.30	28.36	Pass
	165	5825	-1.99	0.23	3.01	0.17	3.41	28.36	Pass

Note:

- Method 1 of power density measurement of KDB 662911 is using for calculating total power density. Total power density is summing entire spectra across corresponding frequency bins on the various outputs by computer.
- Directional gain =  $10 \log[(10^{G1/20} + 10^{G2/20} + \dots + 10^{GN/20})^2/2] = 7.64 \text{ dBi} > 6\text{dBi}$ , so the power density limit shall be reduced to  $30 - (7.64 - 6) = 28.36\text{dBm}$ .
- Refer to section 3.3 for duty cycle spectrum plot.

802.11n (HT20)

TX chain	Chan.	Freq. (MHz)	PSD W/O Duty Factor		10 log (N=2) dB	Duty Factor (dB)	Total PSD With Duty Factor (dBm/500kHz)	Limit (dBm/500kHz)	Pass / Fail
			(dBm/300kHz)	(dBm/500kHz)					
0	149	5745	-3.11	-0.89	3.01	0.32	2.44	28.36	Pass
	157	5785	-3.14	-0.92	3.01	0.32	2.41	28.36	Pass
	165	5825	-3.07	-0.85	3.01	0.32	2.48	28.36	Pass
1	149	5745	-2.88	-0.66	3.01	0.32	2.67	28.36	Pass
	157	5785	-2.45	-0.23	3.01	0.32	3.10	28.36	Pass
	165	5825	-2.44	-0.22	3.01	0.32	3.11	28.36	Pass

Note:

- Method 1 of power density measurement of KDB 662911 is using for calculating total power density. Total power density is summing entire spectra across corresponding frequency bins on the various outputs by computer.
- Directional gain =  $10 \log[(10^{G1/20} + 10^{G2/20} + \dots + 10^{GN/20})^2/2] = 7.64 \text{ dBi} > 6\text{dBi}$ , so the power density limit shall be reduced to  $30 - (7.64 - 6) = 28.36\text{dBm}$ .
- Refer to section 3.3 for duty cycle spectrum plot.

### 802.11n (HT40)

TX chain	Chan.	Freq. (MHz)	PSD W/O Duty Factor		10 log (N=2) dB	Duty Factor (dB)	Total PSD With Duty Factor (dBm/500kHz)	Limit (dBm/500kHz)	Pass / Fail
			(dBm/300kHz)	(dBm/500kHz)					
0	151	5755	-6.52	-4.30	3.01	0.35	-0.94	28.36	Pass
	159	5795	-5.19	-2.97	3.01	0.35	0.39	28.36	Pass
1	151	5755	-5.99	-3.77	3.01	0.35	-0.41	28.36	Pass
	159	5795	-5.80	-3.58	3.01	0.35	-0.22	28.36	Pass

Note:

- Method 1 of power density measurement of KDB 662911 is using for calculating total power density. Total power density is summing entire spectra across corresponding frequency bins on the various outputs by computer.
- Directional gain =  $10 \log[(10^{G1/20} + 10^{G2/20} + \dots + 10^{GN/20})^2/2] = 7.64 \text{ dBi} > 6\text{dBi}$ , so the power density limit shall be reduced to  $30 - (7.64 - 6) = 28.36\text{dBm}$ .
- Refer to section 3.3 for duty cycle spectrum plot.

### 802.11ac (VHT80)

TX chain	Chan.	Freq. (MHz)	PSD W/O Duty Factor		10 log (N=2) dB	Duty Factor (dB)	Total PSD With Duty Factor (dBm/500kHz)	Limit (dBm/500kHz)	Pass / Fail
			(dBm/300kHz)	(dBm/500kHz)					
0	155	5775	-9.72	-7.50	3.01	0.81	-3.68	28.36	Pass
1	155	5775	-12.29	-10.07	3.01	0.81	-6.25	28.36	Pass

Note:

- Method 1 of power density measurement of KDB 662911 is using for calculating total power density. Total power density is summing entire spectra across corresponding frequency bins on the various outputs by computer.
- Directional gain =  $10 \log[(10^{G1/20} + 10^{G2/20} + \dots + 10^{GN/20})^2/2] = 7.64 \text{ dBi} > 6\text{dBi}$ , so the power density limit shall be reduced to  $30 - (7.64 - 6) = 28.36\text{dBm}$ .
- Refer to section 3.3 for duty cycle spectrum plot.

### Spectrum Plot of Worst Value

#### 802.11a

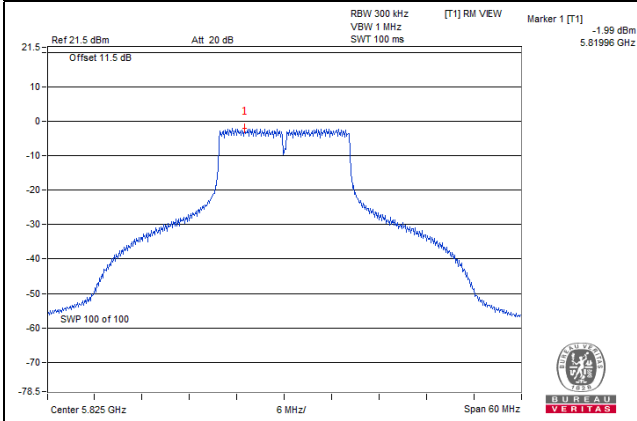

#### 802.11n (HT20)

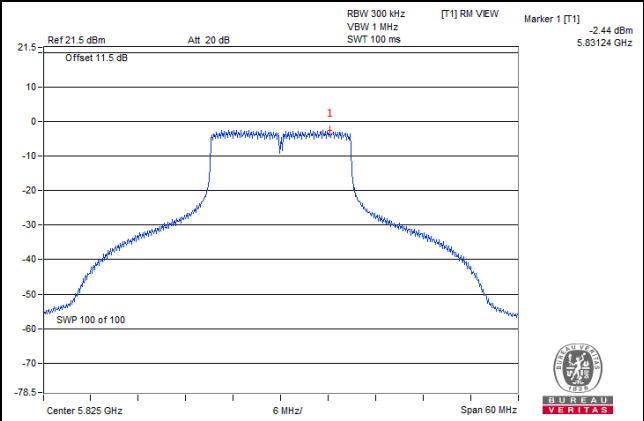

#### 802.11n (HT40)

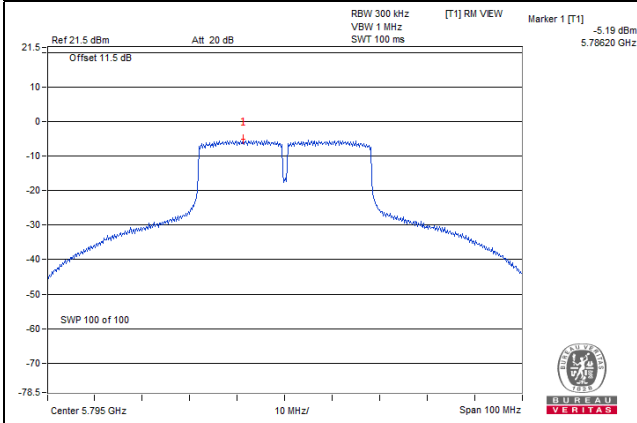

#### 802.11ac (VHT80)

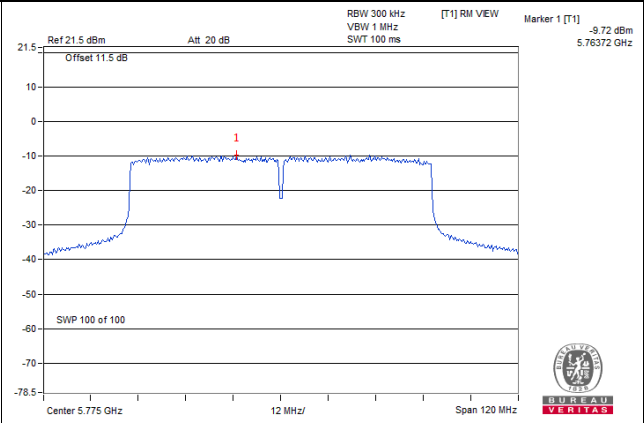

## 4.6 Frequency Stability

### 4.6.1 Limits of Frequency Stability Measurement

The frequency of the carrier signal shall be maintained within band of operation

### 4.6.2 Test Setup

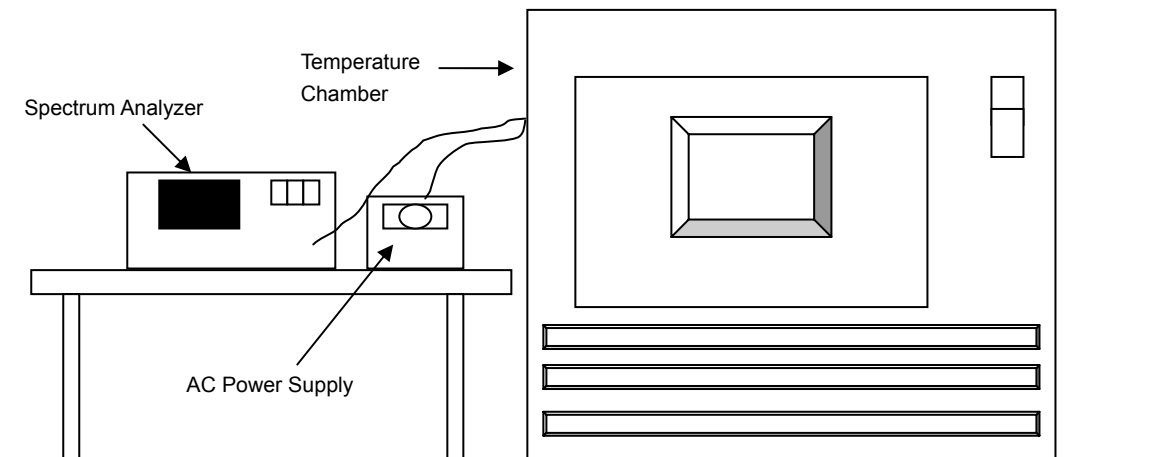

### 4.6.3 Test Instruments

Refer to section 4.1.2 to get information of above instrument.

### 4.6.4 Test Procedure

- The EUT was placed inside the environmental test chamber and powered by nominal AC voltage.
- Turn the EUT on and couple its output to a spectrum analyzer.
- Turn the EUT off and set the chamber to the highest temperature specified.
- Allow sufficient time (approximately 30 min) for the temperature of the chamber to stabilize, turn the EUT on and measure the operating frequency after 2, 5, and 10 minutes.
- Repeat step 2 and 3 with the temperature chamber set to the lowest temperature.
- The test chamber was allowed to stabilize at +20 degree C for a minimum of 30 minutes. The supply voltage was then adjusted on the EUT from 85% to 115% and the frequency record.

### 4.6.5 Deviation from Test Standard

No deviation.

### 4.6.6 EUT Operating Condition

Set the EUT transmit at un-modulation mode to test frequency stability.



#### 4.6.7 Test Results

Frequency Stability Versus Temp.									
Operating Frequency: 5240MHz									
Temp. (°C)	Power Supply (Vac)	0 Minute		2 Minute		5 Minute		10 Minute	
		Measured Frequency (MHz)	Frequency Drift (%)	Measured Frequency (MHz)	Frequency Drift (%)	Measured Frequency (MHz)	Frequency Drift (%)	Measured Frequency (MHz)	Frequency Drift (%)
50	120	5239.987	-0.00025	5239.9876	-0.00024	5239.9875	-0.00024	5239.9839	-0.00031
40	120	5240.0238	0.00045	5240.0245	0.00047	5240.0274	0.00052	5240.0269	0.00051
30	120	5239.981	-0.00036	5239.9839	-0.00031	5239.9804	-0.00037	5239.984	-0.00031
20	120	5240.0143	0.00027	5240.0106	0.00020	5240.014	0.00027	5240.0111	0.00021
10	120	5240.0216	0.00041	5240.0194	0.00037	5240.0225	0.00043	5240.0242	0.00046
0	120	5239.9759	-0.00046	5239.9759	-0.00046	5239.9798	-0.00039	5239.9796	-0.00039
-10	120	5239.9858	-0.00027	5239.9821	-0.00034	5239.9857	-0.00027	5239.985	-0.00029
-20	120	5239.9934	-0.00013	5239.9941	-0.00011	5239.9947	-0.00010	5239.9948	-0.00010
-30	120	5239.9927	-0.00014	5239.9932	-0.00013	5239.9901	-0.00019	5239.9946	-0.00010

Frequency Stability Versus Voltage									
Operating Frequency: 5240MHz									
Temp. (°C)	Power Supply (Vac)	0 Minute		2 Minute		5 Minute		10 Minute	
		Measured Frequency (MHz)	Frequency Drift (%)	Measured Frequency (MHz)	Frequency Drift (%)	Measured Frequency (MHz)	Frequency Drift (%)	Measured Frequency (MHz)	Frequency Drift (%)
20	138	5240.0142	0.00027	5240.0111	0.00021	5240.0145	0.00028	5240.0101	0.00019
	120	5240.0143	0.00027	5240.0106	0.00020	5240.014	0.00027	5240.0111	0.00021
	102	5240.0138	0.00026	5240.0113	0.00022	5240.013	0.00025	5240.0114	0.00022

## 4.7 6dB Bandwidth Measurement

### 4.7.1 Limits of 6dB Bandwidth Measurement

The minimum of 6dB Bandwidth Measurement is 0.5MHz.

### 4.7.2 Test Setup

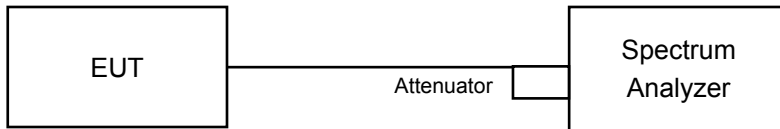

### 4.7.3 Test Instruments

Refer to section 4.1.2 to get information of above instrument.

### 4.7.4 Test Procedure

#### Measurement Procedure REF

- Set resolution bandwidth (RBW) = 100kHz
- Set the video bandwidth (VBW)  $\geq 3 \times$  RBW, Detector = Peak.
- Trace mode = max hold.
- Sweep = auto couple.
- Measure the maximum width of the emission that is constrained by the frequencies associated with the two amplitude points (upper and lower) that are attenuated by 6 dB relative to the maximum level measured in the fundamental emission

### 4.7.5 Deviation from Test Standard

No deviation.

### 4.7.6 EUT Operating Condition

The software provided by client to enable the EUT under transmission condition continuously at lowest, middle and highest channel frequencies individually.

#### 4.7.7 Test Results

##### 802.11a

Channel	Frequency (MHz)	6dB Bandwidth (MHz)		Minimum Limit (MHz)	Pass / Fail
		Chain 0	Chain 1		
149	5745	16.37	16.37	0.5	Pass
157	5785	16.41	16.39	0.5	Pass
165	5825	16.39	16.39	0.5	Pass

##### 802.11n (HT20)

Channel	Frequency (MHz)	6dB Bandwidth (MHz)		Minimum Limit (MHz)	Pass / Fail
		Chain 0	Chain 1		
149	5745	17.60	17.59	0.5	Pass
157	5785	17.60	17.59	0.5	Pass
165	5825	17.62	17.60	0.5	Pass

##### 802.11n (HT40)

Channel	Frequency (MHz)	6dB Bandwidth (MHz)		Minimum Limit (MHz)	Pass / Fail
		Chain 0	Chain 1		
151	5755	36.43	36.05	0.5	Pass
159	5795	36.40	35.78	0.5	Pass

##### 802.11ac (VHT80)

Channel	Frequency (MHz)	6dB Bandwidth (MHz)		Minimum Limit (MHz)	Pass / Fail
		Chain 0	Chain 1		
155	5775	75.46	75.60	0.5	Pass

### Spectrum Plot of Worst Value

#### 802.11a

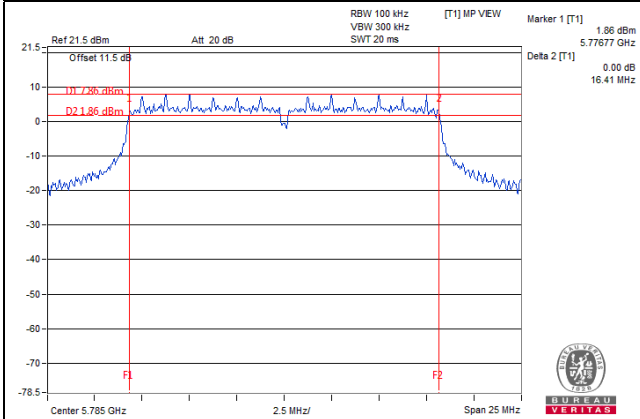

#### 802.11n (HT20)

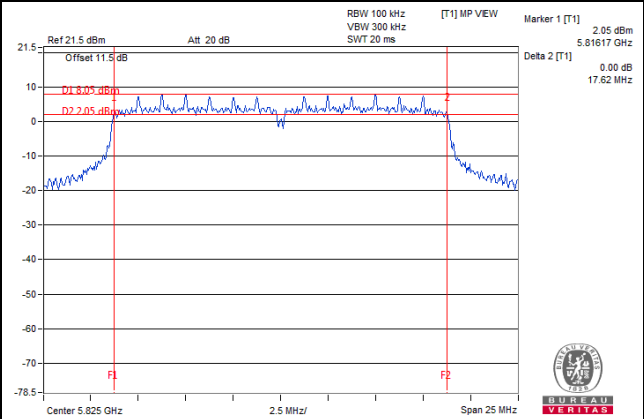

#### 802.11n (HT40)

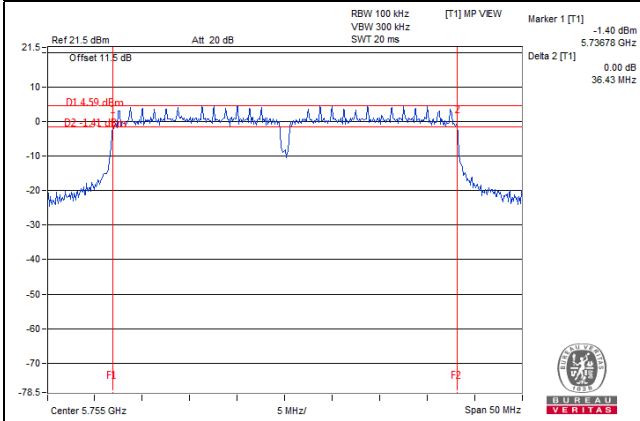

#### 802.11ac (VHT80)

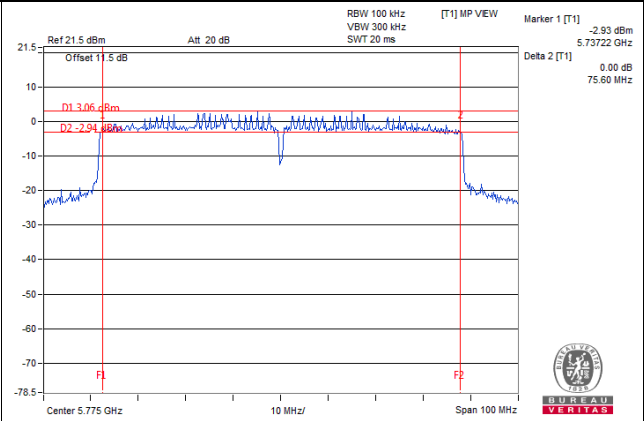

## 5 Pictures of Test Arrangements

Please refer to the attached file (Test Setup Photo).

### Annex A- Radiated Out of Band Emission (OOBE) Measurement (For U-NII-3 band)

802.11a

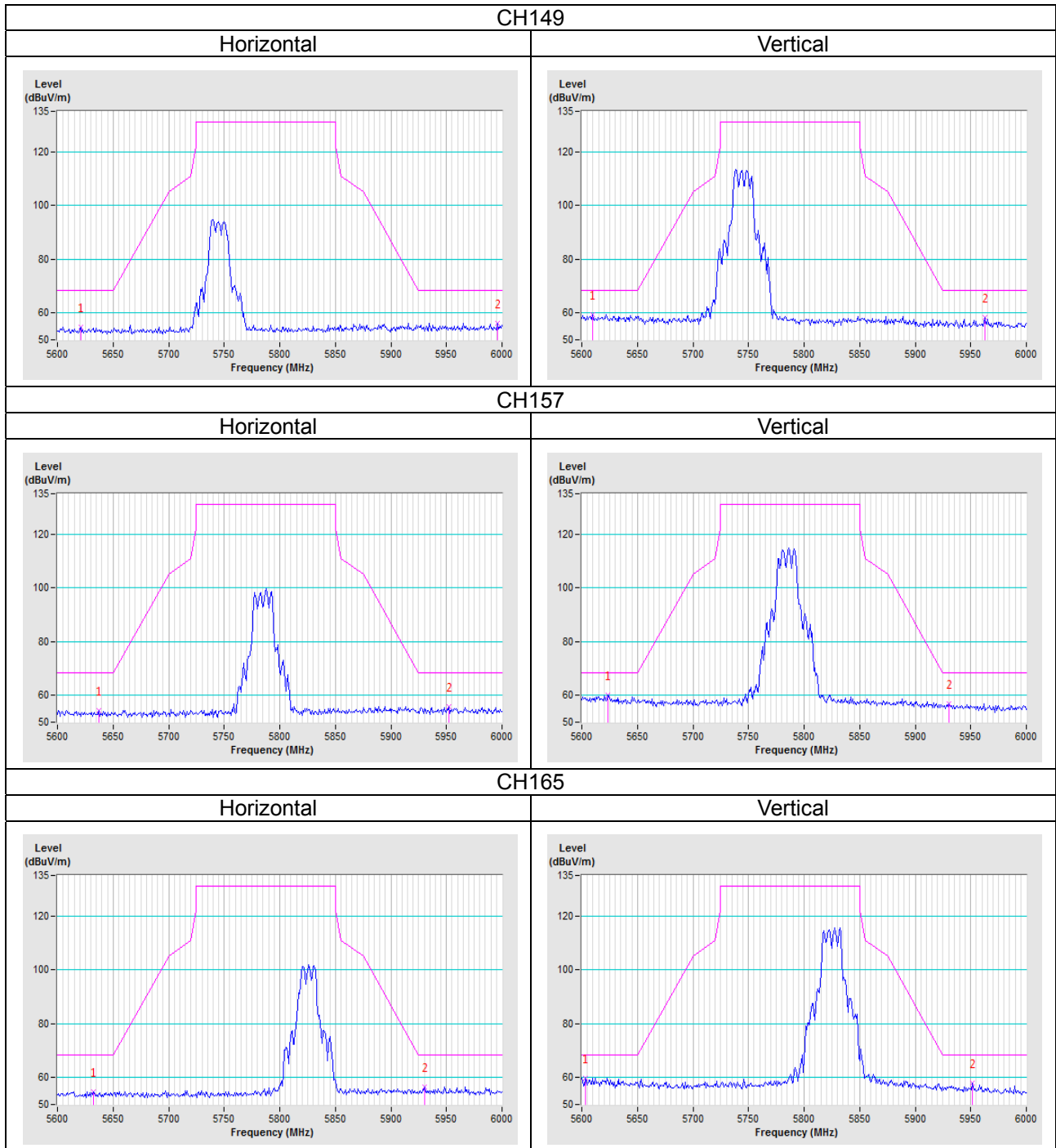

802.11n (HT20)

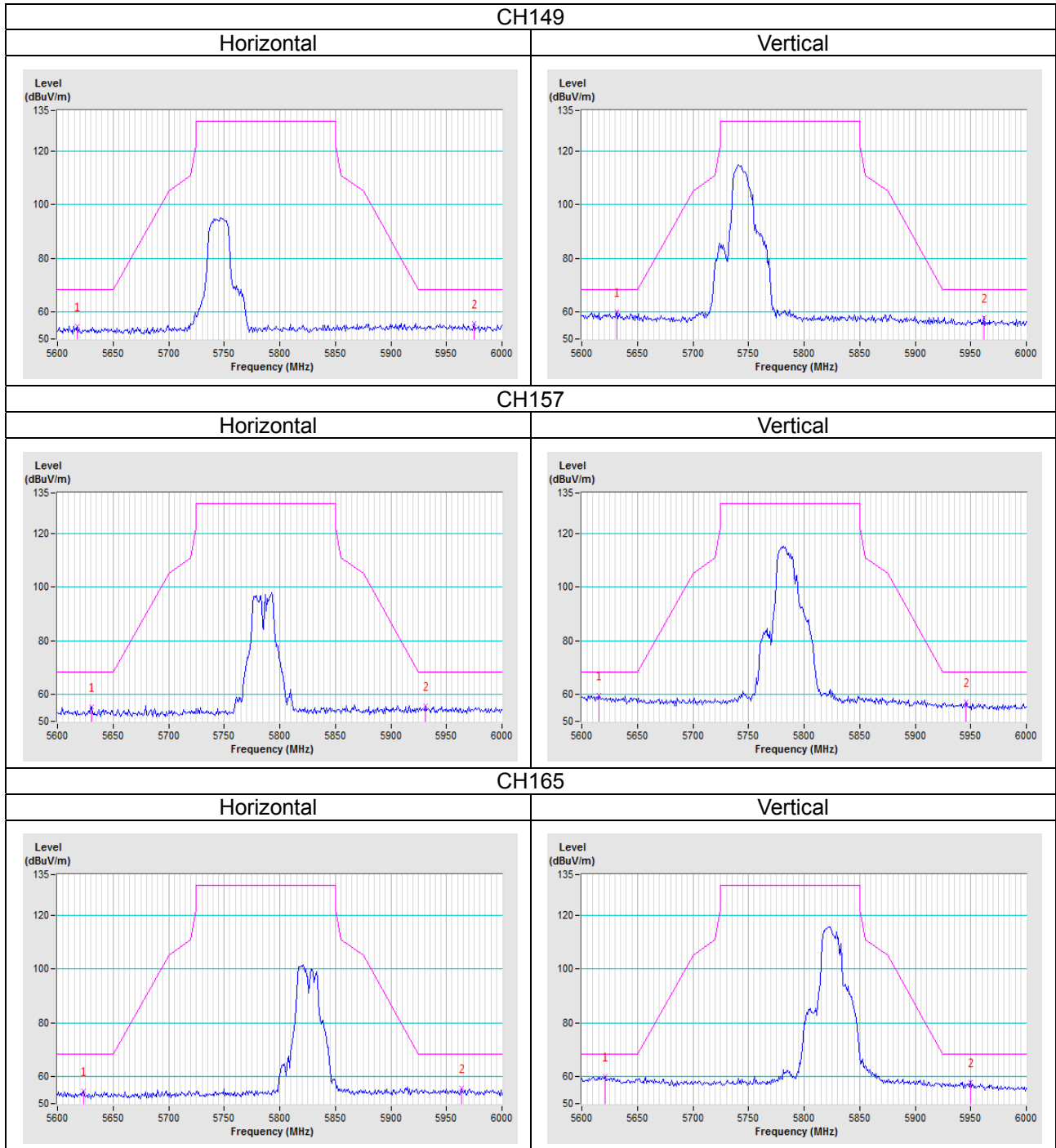

802.11n (HT40)

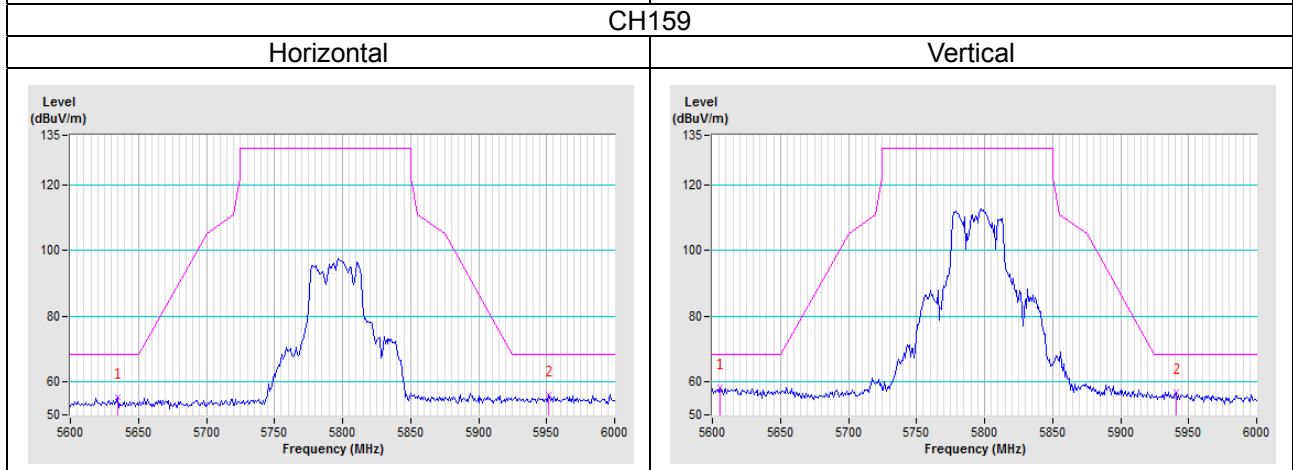
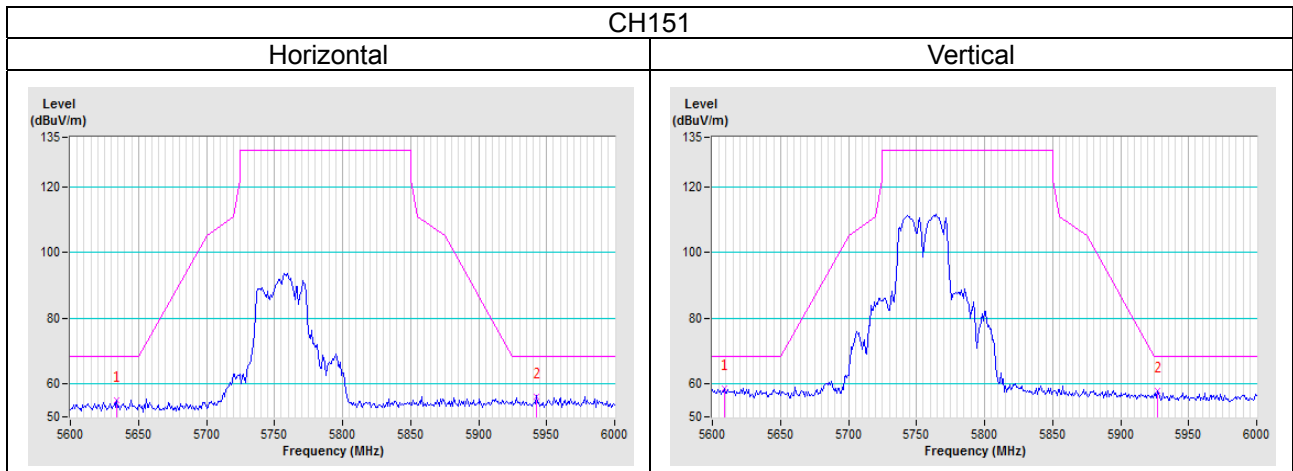

802.11ac (VHT80)

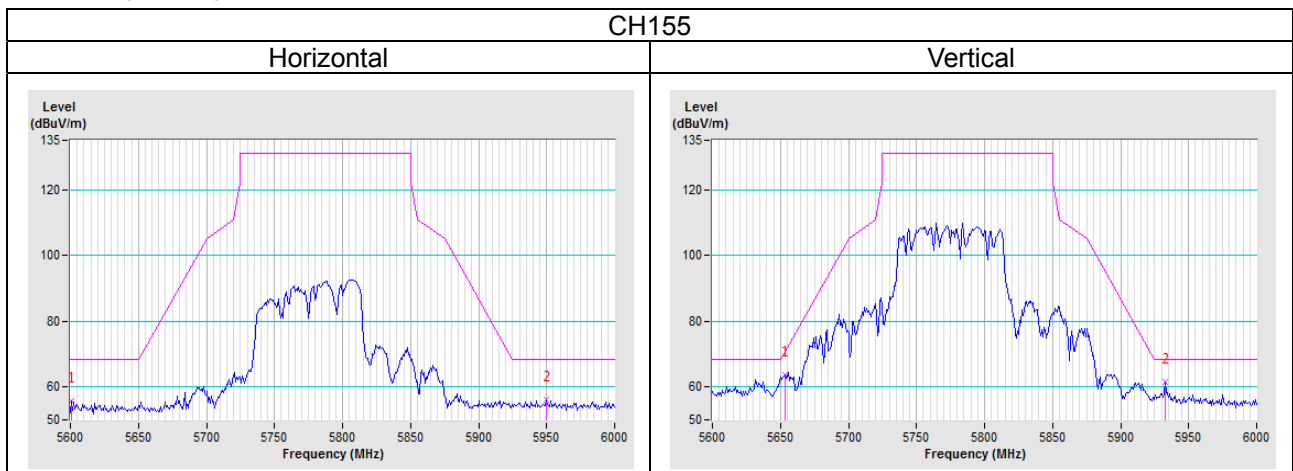



## Appendix – Information on the Testing Laboratories

We, Bureau Veritas Consumer Products Services (H.K.) Ltd., Taoyuan Branch, were founded in 1988 to provide our best service in EMC, Radio, Telecom and Safety consultation. Our laboratories are FCC recognized accredited test firms and accredited and approved according to ISO/IEC 17025.

If you have any comments, please feel free to contact us at the following:

### Linko EMC/RF Lab

Tel: 886-2-26052180

Fax: 886-2-26051924

### Hsin Chu EMC/RF/Telecom Lab

Tel: 886-3-6668565

Fax: 886-3-6668323

### Hwa Ya EMC/RF/Safety

Tel: 886-3-3183232

Fax: 886-3-3270892

**Email:** [service.adt@tw.bureauveritas.com](mailto:service.adt@tw.bureauveritas.com)

**Web Site:** [www.bureauveritas-adt.com](http://www.bureauveritas-adt.com)

The address and road map of all our labs can be found in our web site also.

--- END ---