

## FCC Test Report

**Report No.:** RF150427C31D

**FCC ID:** U2M-PCE4302AN

**Test Model:** PCE4302AN

**Series Model:** PCE4302AN-xxxxxx (where "x" can be used as "A-Z", or "-0-9", or "-", or blank for software changes or marketing purposes only)

**Received Date:** Apr. 27, 2015

**Test Date:** May 10 ~ May 29, 2015

**Issued Date:** Feb. 27, 2018

**Applicant:** Senao Networks, Inc.

**Address:** 3F, No. 529, Chung Cheng Rd., Hsintien, New Taipei City, R.O.C

**Issued By:** Bureau Veritas Consumer Products Services (H.K.) Ltd., Taoyuan Branch

**Lab Address:** No. 47-2, 14th Ling, Chia Pau Vil., Lin Kou Dist., New Taipei City, Taiwan (R.O.C.)

**Test Location:** No. 19, Hwa Ya 2nd Rd., Wen Hwa Vil., Kwei Shan Dist., Taoyuan City 33383, TAIWAN (R.O.C.)

**FCC Registration /  
Designation Number:** 788550 / TW0003



This report is for your exclusive use. Any copying or replication of this report to or for any other person or entity, or use of our name or trademark, is permitted only with our prior written permission. This report sets forth our findings solely with respect to the test samples identified herein. The results set forth in this report are not indicative or representative of the quality or characteristics of the lot from which a test sample was taken or any similar or identical product unless specifically and expressly noted. Our report includes all of the tests requested by you and the results thereof based upon the information that you provided to us. You have 60 days from date of issuance of this report to notify us of any material error or omission caused by our negligence, provided, however, that such notice shall be in writing and shall specifically address the issue you wish to raise. A failure to raise such issue within the prescribed time shall constitute your unqualified acceptance of the completeness of this report, the tests conducted and the correctness of the report contents. Unless specific mention, the uncertainty of measurement has been explicitly taken into account to declare the compliance or non-compliance to the specification. This report should not be used by the client to claim product certification, approval, or endorsement by TAF or any government agencies.

## Table of Contents

<b>Release Control Record</b> .....	<b>4</b>
<b>1 Certificate of Conformity</b> .....	<b>5</b>
<b>2 Summary of Test Results</b> .....	<b>6</b>
2.1 Measurement Uncertainty.....	6
2.2 Modification Record.....	6
<b>3 General Information</b> .....	<b>7</b>
3.1 General Description of EUT.....	7
3.2 Description of Test Modes.....	8
3.2.1 Test Mode Applicability and Tested Channel Detail.....	9
3.3 Duty Cycle of Test Signal.....	10
3.4 Description of Support Units.....	11
3.4.1 Configuration of System under Test.....	11
3.5 General Description of Applied Standards.....	12
<b>4 Test Types and Results</b> .....	<b>13</b>
4.1 Radiated Emission and Bandedge Measurement.....	13
4.1.1 Limits of Radiated Emission and Bandedge Measurement.....	13
4.1.2 Test Instruments.....	14
4.1.3 Test Procedures.....	15
4.1.4 Deviation from Test Standard.....	15
4.1.5 Test Set Up.....	16
4.1.6 EUT Operating Conditions.....	17
4.1.7 Test Results.....	18
4.2 Conducted Emission Measurement.....	31
4.2.1 Limits of Conducted Emission Measurement.....	31
4.2.2 Test Instruments.....	31
4.2.3 Test Procedures.....	32
4.2.4 Deviation from Test Standard.....	32
4.2.5 Test Setup.....	32
4.2.6 EUT Operating Conditions.....	32
4.2.7 Test Results.....	33
4.3 6dB Bandwidth Measurement.....	35
4.3.1 Limits of 6dB Bandwidth Measurement.....	35
4.3.2 Test Setup.....	35
4.3.3 Test Instruments.....	35
4.3.4 Test Procedure.....	35
4.3.5 Deviation from Test Standard.....	35
4.3.6 EUT Operating Conditions.....	35
4.3.7 Test Result.....	36
4.4 Conducted Output Power Measurement.....	38
4.4.1 Limits of Conducted Output Power Measurement.....	38
4.4.2 Test Setup.....	38
4.4.3 Test Instruments.....	38
4.4.4 Test Procedures.....	38
4.4.5 Deviation from Test Standard.....	38
4.4.6 EUT Operating Conditions.....	38
4.4.7 Test Results.....	39
4.5 Power Spectral Density Measurement.....	41
4.5.1 Limits of Power Spectral Density Measurement.....	41
4.5.2 Test Setup.....	41
4.5.3 Test Instruments.....	41
4.5.4 Test Procedure.....	41
4.5.5 Deviation from Test Standard.....	41
4.5.6 EUT Operating Condition.....	41

4.5.7 Test Results .....	42
4.6 Conducted Out of Band Emission Measurement.....	45
4.6.1 Limits of Conducted Out of Band Emission Measurement .....	45
4.6.2 Test Setup.....	45
4.6.3 Test Instruments .....	45
4.6.4 Test Procedure .....	45
4.6.5 Deviation from Test Standard .....	45
4.6.6 EUT Operating Condition .....	45
4.6.7 Test Results .....	45
<b>5 Pictures of Test Arrangements.....</b>	<b>54</b>
<b>Appendix – Information on the Testing Laboratories .....</b>	<b>55</b>

### Release Control Record

Issue No.	Description	Date Issued
RF150427C31D	Original release	Feb. 27, 2018

## 1 Certificate of Conformity

**Product:** 802.11 ac 2x2 Module

**Brand:** Senao

**Test Model:** PCE4302AN

**Series Model:** PCE4302AN-xxxxxx (where "x" can be used as "A-Z", or "-0-9", or "-", or blank for software changes or marketing purposes only)

**Sample Status:** Engineering sample

**Applicant:** Senao Networks, Inc.

**Test Date:** May 10 ~ May 29, 2015

**Standards:** 47 CFR FCC Part 15, Subpart C (Section 15.247)  
ANSI C63.10:2013

The above equipment has been tested by **Bureau Veritas Consumer Products Services (H.K.) Ltd., Taoyuan Branch**, and found compliance with the requirement of the above standards. The test record, data evaluation & Equipment Under Test (EUT) configurations represented herein are true and accurate accounts of the measurements of the sample's RF characteristics under the conditions specified in this report.

**Prepared by :** Celine Chou , **Date:** Feb. 27, 2018  
Celine Chou / Specialist

**Approved by :** Bruce Chen , **Date:** Feb. 27, 2018  
Bruce Chen / Project Engineer

## 2 Summary of Test Results

47 CFR FCC Part 15, Subpart C (Section 15.247)			
FCC Clause	Test Item	Result	Remarks
15.207	AC Power Conducted Emission	Pass	Meet the requirement of limit. Minimum passing margin is -16.01dB at 4.66214MHz
15.205 / 15.209 / 15.247(d)	Radiated Emissions and Band Edge Measurement	Pass	Meet the requirement of limit. Minimum passing margin is -1.0dB at 2390.00MHz.
15.247(d)	Antenna Port Emission	Pass	Meet the requirement of limit.
15.247(a)(2)	6dB bandwidth	Pass	Meet the requirement of limit.
15.247(b)	Conducted power	Pass	Meet the requirement of limit.
15.247(e)	Power Spectral Density	Pass	Meet the requirement of limit.
15.203	Antenna Requirement	Pass	Antenna connector is R-SMA not a standard connector.

### 2.1 Measurement Uncertainty

Where relevant, the following measurement uncertainty levels have been estimated for tests performed on the EUT as specified in CISPR 16-4-2:

Measurement	Frequency	Expanded Uncertainty (k=2) (±)
Conducted Emissions at mains ports	150kHz ~ 30MHz	2.44 dB
Radiated Emissions up to 1 GHz	30MHz ~ 200MHz	3.86 dB
	200MHz ~ 1000MHz	3.87 dB
Radiated Emissions above 1 GHz	1GHz ~ 18GHz	2.29 dB
	18GHz ~ 40GHz	2.29 dB

### 2.2 Modification Record

There were no modifications required for compliance.

### 3 General Information

#### 3.1 General Description of EUT

Product	802.11 ac 2x2 Module
Brand	Senao
Test Model	PCE4302AN
Series Model	PCE4302AN-xxxxxx (where "x" can be used as "A-Z", or "-0-9", or "-", or blank for software changes or marketing purposes only)
Model Difference	For software changes or marketing purposes only
Status of EUT	Engineering sample
Power Supply Rating	3.3Vdc (External Board)
Modulation Type	CCK, DQPSK, DBPSK for DSSS 64QAM, 16QAM, QPSK, BPSK for OFDM
Modulation Technology	DSSS, OFDM
Transfer Rate	802.11b: 11.0/ 5.5/ 2.0/ 1.0Mbps 802.11g: 54.0/ 48.0/ 36.0/ 24.0/ 18.0/ 12.0/ 9.0/ 6.0Mbps 802.11n: up to 300Mbps
Operating Frequency	2412 ~ 2462MHz
Number of Channel	11 for 802.11b, 802.11g, 802.11n (HT20) 7 for 802.11n (HT40)
Output Power	831.842mW
Antenna Type	Refer to Note
Antenna Connector	Refer to Note
Accessory Device	NA
Data Cable Supplied	NA

Note:

- The EUT incorporates a MIMO function. Physically, the EUT provides 2 completed transmitters and 2 receivers.

Modulation Mode	TX Function
802.11b	2TX
802.11g	2TX
802.11n (HT20)	2TX
802.11n (HT40)	2TX

- The EUT uses following adapter. (For support unit only)

Adapter	
Brand	DVE
Model	DSA-12G-12 FUS 120120
Input	100-240Vac, 50/60Hz, 0.3A
Output	12Vdc, 1A
Power Line	1.5m cable without core attached on adapter

3. The following antennas were provided to the EUT.

No.	Type	Gain(dBi)		Connector
		2.4GHz Band	5GHz Band	
1	Dipole	3	6	R-SMA
2	Dipole	2	3	R-SMA

4. WLAN 2.4GHz and 5GHz technology cannot transmit simultaneously.

### 3.2 Description of Test Modes

11 channels are provided for 802.11b, 802.11g and 802.11n (HT20):

Channel	Frequency	Channel	Frequency
1	2412MHz	7	2442MHz
2	2417MHz	8	2447MHz
3	2422MHz	9	2452MHz
4	2427MHz	10	2457MHz
5	2432MHz	11	2462MHz
6	2437MHz		

7 channels are provided for 802.11n (HT40):

Channel	Frequency	Channel	Frequency
3	2422MHz	7	2442MHz
4	2427MHz	8	2447MHz
5	2432MHz	9	2452MHz
6	2437MHz		



### 3.2.1 Test Mode Applicability and Tested Channel Detail

EUT Configure Mode	Applicable to				Description
	RE $\geq$ 1G	RE $<$ 1G	PLC	APCM	
-	√	√	√	√	-

Where RE $\geq$ 1G: Radiated Emission above 1GHz & Bandedge Measurement  
 RE $<$ 1G: Radiated Emission below 1GHz  
 PLC: Power Line Conducted Emission  
 APCM: Antenna Port Conducted Measurement

Note: The EUT had been pre-tested on the positioned of each 3 axis. The worst case was found when positioned on **X-plane**.

#### **Radiated Emission Test (Above 1GHz):**

- Pre-Scan has been conducted to determine the worst-case mode from all possible combinations between available modulations, data rates and antenna ports (if EUT with antenna diversity architecture).
- Following channel(s) was (were) selected for the final test as listed below.

EUT Configure Mode	Mode	Available Channel	Tested Channel	Modulation Technology	Modulation Type	Data Rate (Mbps)
-	802.11b	1 to 11	1, 6, 11	DSSS	DBPSK	1.0
-	802.11g	1 to 11	1, 6, 11	OFDM	BPSK	6.0
-	802.11n (HT20)	1 to 11	1, 6, 11	OFDM	BPSK	7.2
-	802.11n (HT40)	3 to 9	3, 6, 9	OFDM	BPSK	15.0

#### **Radiated Emission Test (Below 1GHz):**

- Pre-Scan has been conducted to determine the worst-case mode from all possible combinations between available modulations, data rates and antenna ports (if EUT with antenna diversity architecture).
- Following channel(s) was (were) selected for the final test as listed below.

EUT Configure Mode	Mode	Available Channel	Tested Channel	Modulation Technology	Modulation Type	Data Rate (Mbps)
-	802.11b	1 to 11	1	DSSS	DBPSK	1.0

#### **Power Line Conducted Emission Test:**

- Pre-Scan has been conducted to determine the worst-case mode from all possible combinations between available modulations, data rates and antenna ports (if EUT with antenna diversity architecture).
- Following channel(s) was (were) selected for the final test as listed below.

EUT Configure Mode	Mode	Available Channel	Tested Channel	Modulation Technology	Modulation Type	Data Rate (Mbps)
-	802.11b	1 to 11	1	DSSS	DBPSK	1.0

#### **Antenna Port Conducted Measurement:**

- This item includes all test value of each mode, but only includes spectrum plot of worst value of each mode.
- Pre-Scan has been conducted to determine the worst-case mode from all possible combinations between available modulations, data rates and antenna ports (if EUT with antenna diversity architecture).
- Following channel(s) was (were) selected for the final test as listed below.

EUT Configure Mode	Mode	Available Channel	Tested Channel	Modulation Technology	Modulation Type	Data Rate (Mbps)
-	802.11b	1 to 11	1, 6, 11	DSSS	DBPSK	1.0
-	802.11g	1 to 11	1, 6, 11	OFDM	BPSK	6.0
-	802.11n (HT20)	1 to 11	1, 6, 11	OFDM	BPSK	7.2
-	802.11n (HT40)	3 to 9	3, 6, 9	OFDM	BPSK	15.0

**Test Condition:**

Applicable to	Environmental Conditions	Input Power	Tested by
RE≥1G	19deg. C, 69%RH	120Vac, 60Hz	Jones Chang
RE<1G	20deg. C, 69%RH	120Vac, 60Hz	Jones Chang
PLC	23deg. C, 70%RH	120Vac, 60Hz	Jones Chang
APCM	25deg. C, 60%RH	120Vac, 60Hz	Leo Tsai

**3.3 Duty Cycle of Test Signal**

802.11b: Duty cycle of test signal is > 98%.

802.11g, 802.11n (HT20), 802.11n (HT40): Duty cycle of test signal is < 98%.

802.11g: Duty cycle = 2.023/2.112 = 0.958, Duty factor = 10 \* log(1/0.958) = 0.19

802.11n (HT20): Duty cycle = 1.886/1.967 = 0.959, Duty factor = 10 \* log(1/0.959) = 0.18

802.11n (HT40): Duty cycle = 0.926/1.004 = 0.922, Duty factor = 10 \* log(1/0.922) = 0.35

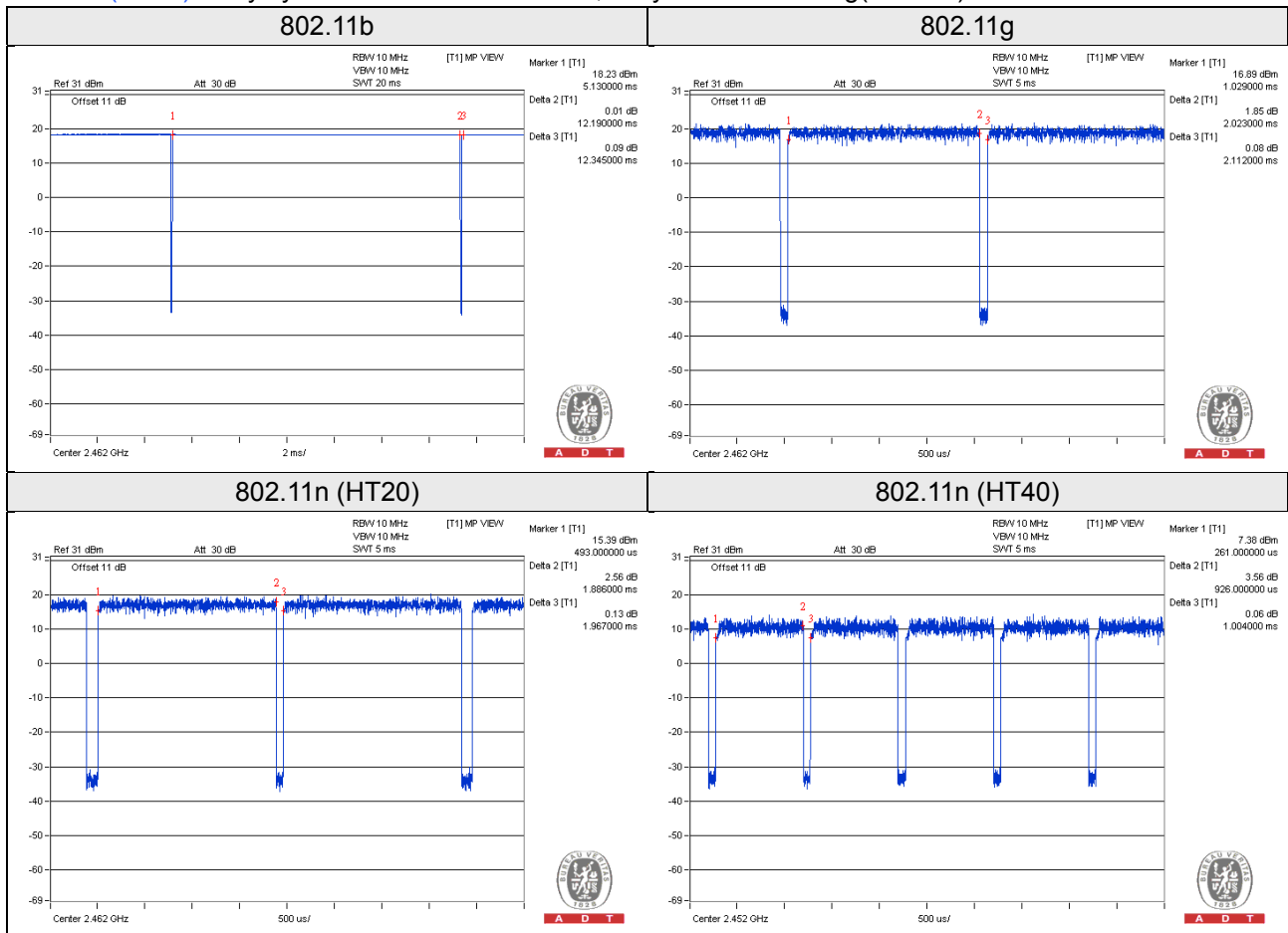

### 3.4 Description of Support Units

The EUT has been tested as an independent unit together with other necessary accessories or support units. The following support units or accessories were used to form a representative test configuration during the tests.

ID	Product	Brand	Model No.	Serial No.	FCC ID	Remarks
A.	Notebook	DELL	E5410	1HC2XM1	FCC DoC Approved	-
B.	External Board	NA	NA	NA	NA	Provided by Manufacturer
C.	Adapter	DVE	DSA-12G-12 FUS 120120	NA	NA	Provided by Manufacturer

Note:

1. All power cords of the above support units are non-shielded (1.8m).
2. Item A acted as a communication partner to transfer data.

ID	Descriptions	Qty.	Length (m)	Shielding (Yes/No)	Cores (Qty.)	Remarks
1.	RJ45 , Cat5e	1	3	N	0	-
2.	Power	1	1.5	N	0	Attached on adapter Provided by Manufacturer

#### 3.4.1 Configuration of System under Test

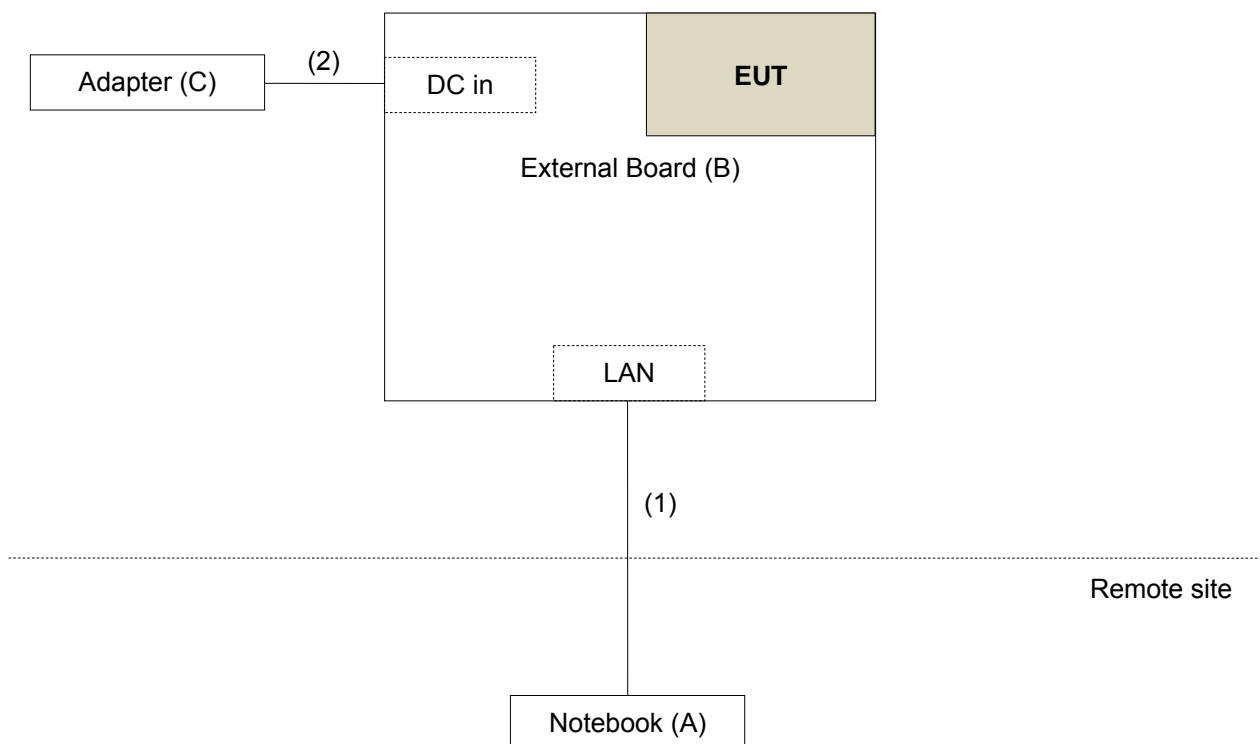

### 3.5 General Description of Applied Standards

The EUT is a RF Product. According to the specifications of the manufacturer, it must comply with the requirements of the following standards:

**FCC Part 15, Subpart C (15.247)**

**KDB 558074 D01 DTS Meas Guidance v04**

**KDB 662911 D01 Multiple Transmitter Output v02r01**

**ANSI C63.10-2013**

All test items have been performed and recorded as per the above standards.

## 4 Test Types and Results

### 4.1 Radiated Emission and Bandedge Measurement

#### 4.1.1 Limits of Radiated Emission and Bandedge Measurement

Radiated emissions which fall in the restricted bands must comply with the radiated emission limits specified as below table. Other emissions shall be at least 30dB below the highest level of the desired power:

Frequencies (MHz)	Field Strength (microvolts/meter)	Measurement Distance (meters)
0.009 ~ 0.490	2400/F(kHz)	300
0.490 ~ 1.705	24000/F(kHz)	30
1.705 ~ 30.0	30	30
30 ~ 88	100	3
88 ~ 216	150	3
216 ~ 960	200	3
Above 960	500	3

**Note:**

1. The lower limit shall apply at the transition frequencies.
2. Emission level (dBuV/m) = 20 log Emission level (uV/m).
3. For frequencies above 1000MHz, the field strength limits are based on average detector, however, the peak field strength of any emission shall not exceed the maximum permitted average limits, specified above by more than 20dB under any condition of modulation.

#### 4.1.2 Test Instruments

Description & Manufacturer	Model No.	Serial No.	Cal. Date	Cal. Due
Test Receiver ROHDE & SCHWARZ	ESIB7	100187	Apr. 10, 2015	Apr. 09, 2016
Spectrum Analyzer ROHDE & SCHWARZ	FSP40	100041	Aug. 29, 2014	Aug. 28, 2015
BILOG Antenna SCHWARZBECK	VULB9168	9168-160	Feb. 05, 2015	Feb. 04, 2016
HORN Antenna SCHWARZBECK	9120D	209	Feb. 09, 2015	Feb. 08, 2016
HORN Antenna SCHWARZBECK	BBHA 9170	BBHA9170241	Feb. 09, 2015	Feb. 08, 2016
Loop Antenna EMCI	EM-6879	269	Aug. 13, 2014	Aug. 12, 2015
Preamplifier Agilent	8447D	2944A10738	Oct.18, 2014	Oct. 17, 2015
Preamplifier Agilent	8449B	3008A01964	Aug. 22, 2014	Aug. 21, 2015
RF signal cable HUBER+SUHNNER	SUCOFLEX 104	214378/4	Aug. 22, 2014	Aug. 21, 2015
RF signal cable HUBER+SUHNNER	SUCOFLEX 106	12738/6 +309224/4	Aug. 22, 2014	Aug. 21, 2015
Software BV ADT	ADT_Radiated_ V7.6.15.9.4	NA	NA	NA
Antenna Tower inn-co GmbH	MA 4000	013303	NA	NA
Antenna Tower Controller BV ADT	AT100	AT93021702	NA	NA
Turn Table BV ADT	TT100	TT93021702	NA	NA
Turn Table Controller BV ADT	SC100	SC93021702	NA	NA
High Speed Power Meter	ML2495A	0824011	Jul. 26, 2014	Jul. 25, 2015
Power Sensor	MA2411B	0738171	Jul. 26, 2014	Jul. 25, 2015

- Note: 1. The calibration interval of the above test instruments is 12 months and the calibrations are traceable to NML/ROC and NIST/USA.  
 2. The test was performed in HwaYa Chamber 3.  
 3. The FCC Designation Number is TW0003. The number will be varied with the Lab location and scope as attached.  
 4. The IC Site Registration No. is IC 7450F-3.

### 4.1.3 Test Procedures

#### For Radiated emission below 30MHz

- a. The EUT was placed on the top of a rotating table 0.8 meters above the ground at a 3 meter chamber room. The table was rotated 360 degrees to determine the position of the highest radiation.
- b. The EUT was set 3 meters away from the interference-receiving antenna, which was mounted on the top of a variable-height antenna tower.
- c. Both X and Y axes of the antenna are set to make the measurement.
- d. For each suspected emission, the EUT was arranged to its worst case and the rotatable table was turned from 0 degrees to 360 degrees to find the maximum reading.
- e. The test-receiver system was set to Quasi-Peak Detect Function and Specified Bandwidth with Maximum Hold Mode.

Note:

1. The resolution bandwidth and video bandwidth of test receiver/spectrum analyzer is 9kHz at frequency below 30MHz.

#### For Radiated emission above 30MHz

- a. The EUT was placed on the top of a rotating table 0.8 meters (for 30MHz ~ 1GHz) / 1.5 meters (for above 1GHz) above the ground at 3 meter chamber room for test. The table was rotated 360 degrees to determine the position of the highest radiation.
- b. The EUT was set 3 meters away from the interference-receiving antenna, which was mounted on the top of a variable-height antenna tower.
- c. The height of antenna is varied from one meter to four meters above the ground to determine the maximum value of the field strength. Both horizontal and vertical polarizations of the antenna are set to make the measurement.
- d. For each suspected emission, the EUT was arranged to its worst case and then the antenna was tuned to heights from 1 meter to 4 meters and the rotatable table was turned from 0 degrees to 360 degrees to find the maximum reading.
- e. The test-receiver system was set to quasi-peak detect function and specified bandwidth with maximum hold mode when the test frequency is below 1 GHz.
- f. The test-receiver system was set to peak and average detect function and specified bandwidth with maximum hold mode when the test frequency is above 1 GHz. If the peak reading value also meets average limit, measurement with the average detector is unnecessary.

Note:

1. The resolution bandwidth and video bandwidth of test receiver/spectrum analyzer is 120kHz for Quasi-peak detection (QP) at frequency below 1GHz.
2. The resolution bandwidth of test receiver/spectrum analyzer is 1 MHz and the video bandwidth is 3 MHz for Peak detection (PK) at frequency above 1GHz.
3. The resolution bandwidth of test receiver/spectrum analyzer is 1 MHz and the video bandwidth is  $\geq 1/T$  (Duty cycle < 98%) or 10 Hz (Duty cycle  $\geq 98\%$ ) for Peak detection at frequency above 1GHz.
4. All modes of operation were investigated and the worst-case emissions are reported.

### 4.1.4 Deviation from Test Standard

No deviation.

#### 4.1.5 Test Set Up

##### For Radiated emission below 30MHz

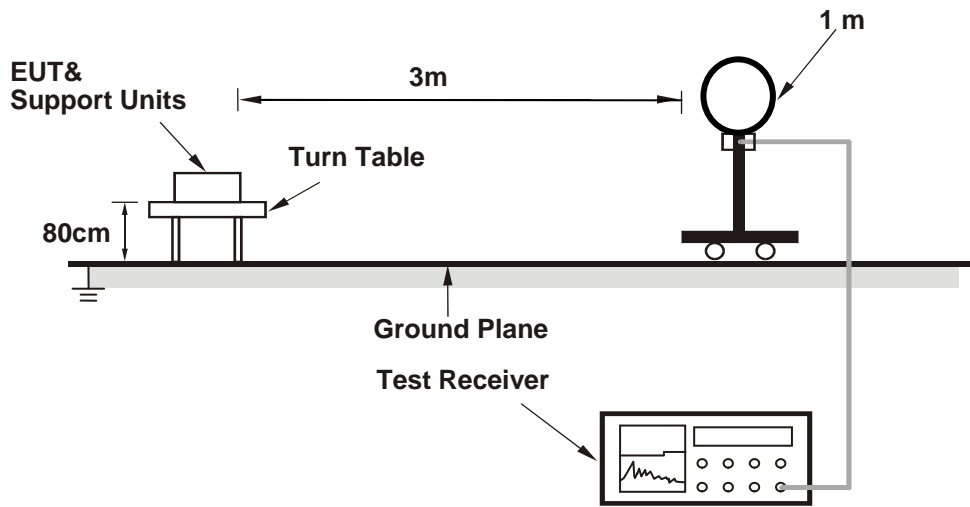

##### For Radiated emission 30MHz to 1GHz

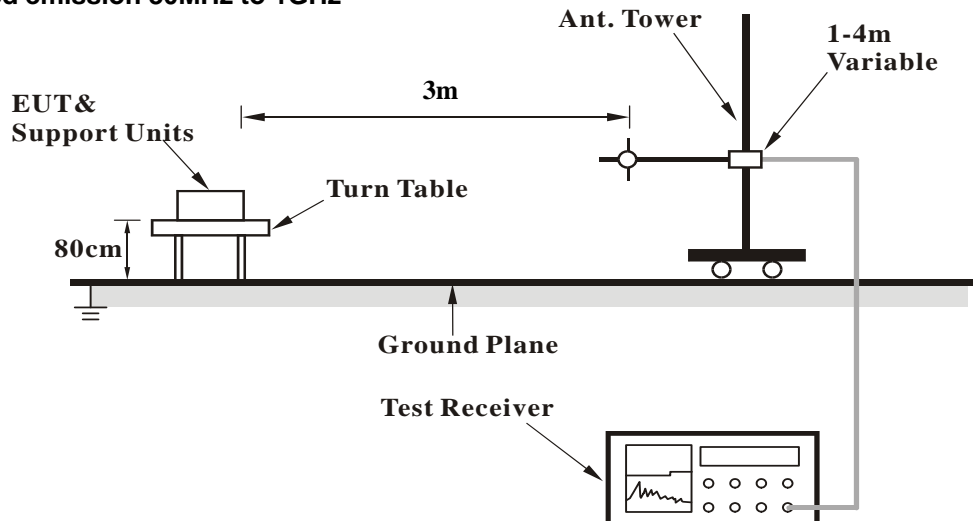



### For Radiated emission above 1GHz

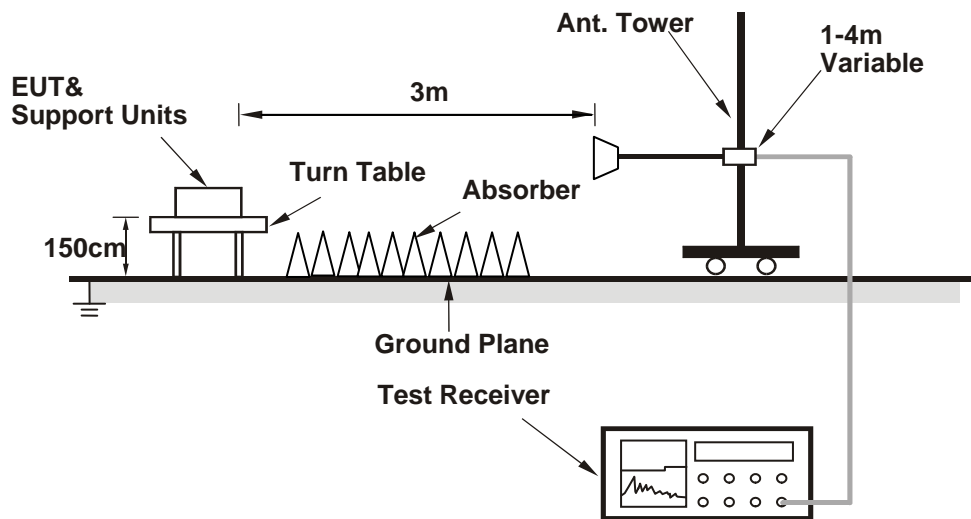

For the actual test configuration, please refer to the attached file (Test Setup Photo).

#### 4.1.6 EUT Operating Conditions

- Installed EUT in external board and placed them on the testing table.
- Prepared a notebook to act as a communication partner and placed it outside of testing area.
- The communication partner connected with EUT via external board through a RJ45 cable and ran a test program (provided by manufacturer) to enable EUT under transmission condition continuously at specific channel frequency.
- The communication partner sent data to EUT by command "PING".

#### 4.1.7 Test Results

Above 1GHz data:

802.11b

CHANNEL	TX Channel 1	DETECTOR FUNCTION	Peak (PK) Average (AV)
FREQUENCY RANGE	1GHz ~ 25GHz		

ANTENNA POLARITY & TEST DISTANCE: HORIZONTAL AT 3 M								
NO.	FREQ. (MHz)	EMISSION LEVEL (dBuV/m)	LIMIT (dBuV/m)	MARGIN (dB)	ANTENNA HEIGHT (m)	TABLE ANGLE (Degree)	RAW VALUE (dBuV)	CORRECTION FACTOR (dB/m)
1	2390.00	55.5 PK	74.0	-18.5	1.24 H	116	23.00	32.50
2	2390.00	45.1 AV	54.0	-8.9	1.24 H	116	12.60	32.50
3	*2412.00	99.7 PK			1.24 H	116	67.10	32.60
4	*2412.00	96.4 AV			1.24 H	116	63.80	32.60
5	4824.00	49.7 PK	74.0	-24.3	1.38 H	224	43.80	5.90
6	4824.00	36.6 AV	54.0	-17.4	1.38 H	224	30.70	5.90
ANTENNA POLARITY & TEST DISTANCE: VERTICAL AT 3 M								
NO.	FREQ. (MHz)	EMISSION LEVEL (dBuV/m)	LIMIT (dBuV/m)	MARGIN (dB)	ANTENNA HEIGHT (m)	TABLE ANGLE (Degree)	RAW VALUE (dBuV)	CORRECTION FACTOR (dB/m)
1	2390.00	60.9 PK	74.0	-13.1	1.99 V	19	28.40	32.50
2	2390.00	50.5 AV	54.0	-3.5	1.99 V	19	18.00	32.50
3	*2412.00	113.4 PK			1.76 V	19	80.80	32.60
4	*2412.00	109.9 AV			1.76 V	19	77.30	32.60
5	4824.00	55.6 PK	74.0	-18.4	1.65 V	204	49.70	5.90
6	4824.00	52.2 AV	54.0	-1.8	1.65 V	204	46.30	5.90

Remarks:

1. Emission Level(dBuV/m) = Raw Value(dBuV) + Correction Factor(dB/m)
2. Correction Factor(dB/m) = Antenna Factor(dB/m) + Cable Factor(dB) – Pre-Amplifier Factor(dB)
3. The other emission levels were very low against the limit.
4. Margin value = Emission Level – Limit value
5. " \* ": Fundamental frequency.

CHANNEL	TX Channel 6	DETECTOR FUNCTION	Peak (PK)
FREQUENCY RANGE	1GHz ~ 25GHz		Average (AV)

**ANTENNA POLARITY & TEST DISTANCE: HORIZONTAL AT 3 M**

NO.	FREQ. (MHz)	EMISSION LEVEL (dBuV/m)	LIMIT (dBuV/m)	MARGIN (dB)	ANTENNA HEIGHT (m)	TABLE ANGLE (Degree)	RAW VALUE (dBuV)	CORRECTION FACTOR (dB/m)
1	*2437.00	98.9 PK			1.22 H	319	66.20	32.70
2	*2437.00	95.7 AV			1.22 H	319	63.00	32.70
3	4874.00	48.8 PK	74.0	-25.2	1.40 H	229	42.90	5.90
4	4874.00	35.7 AV	54.0	-18.3	1.40 H	229	29.80	5.90

**ANTENNA POLARITY & TEST DISTANCE: VERTICAL AT 3 M**

NO.	FREQ. (MHz)	EMISSION LEVEL (dBuV/m)	LIMIT (dBuV/m)	MARGIN (dB)	ANTENNA HEIGHT (m)	TABLE ANGLE (Degree)	RAW VALUE (dBuV)	CORRECTION FACTOR (dB/m)
1	*2437.00	113.4 PK			1.99 V	21	80.70	32.70
2	*2437.00	110.0 AV			1.99 V	21	77.30	32.70
3	4874.00	56.0 PK	74.0	-18.0	1.85 V	247	50.10	5.90
4	4874.00	52.6 AV	54.0	-1.4	1.85 V	247	46.70	5.90

**Remarks:**

1. Emission Level(dBuV/m) = Raw Value(dBuV) + Correction Factor(dB/m)
2. Correction Factor(dB/m) = Antenna Factor(dB/m) + Cable Factor(dB) – Pre-Amplifier Factor(dB)
3. The other emission levels were very low against the limit.
4. Margin value = Emission Level – Limit value
5. " \* ": Fundamental frequency.

CHANNEL	TX Channel 11	DETECTOR FUNCTION	Peak (PK)
FREQUENCY RANGE	1GHz ~ 25GHz		Average (AV)

ANTENNA POLARITY & TEST DISTANCE: HORIZONTAL AT 3 M								
NO.	FREQ. (MHz)	EMISSION LEVEL (dBuV/m)	LIMIT (dBuV/m)	MARGIN (dB)	ANTENNA HEIGHT (m)	TABLE ANGLE (Degree)	RAW VALUE (dBuV)	CORRECTION FACTOR (dB/m)
1	*2462.00	96.0 PK			1.05 H	221	63.40	32.60
2	*2462.00	92.5 AV			1.05 H	221	59.90	32.60
3	2483.50	57.1 PK	74.0	-16.9	1.05 H	221	24.40	32.70
4	2483.50	46.2 AV	54.0	-7.8	1.05 H	221	13.50	32.70
5	4924.00	48.5 PK	74.0	-25.5	1.33 H	211	42.50	6.00
6	4924.00	35.5 AV	54.0	-18.5	1.33 H	211	29.50	6.00
ANTENNA POLARITY & TEST DISTANCE: VERTICAL AT 3 M								
NO.	FREQ. (MHz)	EMISSION LEVEL (dBuV/m)	LIMIT (dBuV/m)	MARGIN (dB)	ANTENNA HEIGHT (m)	TABLE ANGLE (Degree)	RAW VALUE (dBuV)	CORRECTION FACTOR (dB/m)
1	*2462.00	111.1 PK			1.97 V	232	78.50	32.60
2	*2462.00	107.7 AV			1.97 V	232	75.10	32.60
3	2483.50	61.7 PK	74.0	-12.3	1.78 V	232	29.00	32.70
4	2483.50	49.8 AV	54.0	-4.2	1.78 V	232	17.10	32.70
5	4924.00	56.7 PK	74.0	-17.3	2.11 V	245	50.70	6.00
6	4924.00	52.9 AV	54.0	-1.1	2.11 V	245	46.90	6.00

Remarks:

1. Emission Level(dBuV/m) = Raw Value(dBuV) + Correction Factor(dB/m)
2. Correction Factor(dB/m) = Antenna Factor(dB/m) + Cable Factor(dB) – Pre-Amplifier Factor(dB)
3. The other emission levels were very low against the limit.
4. Margin value = Emission Level – Limit value
5. " \* ": Fundamental frequency.

802.11g

CHANNEL	TX Channel 1	DETECTOR FUNCTION	Peak (PK)
FREQUENCY RANGE	1GHz ~ 25GHz		Average (AV)

ANTENNA POLARITY & TEST DISTANCE: HORIZONTAL AT 3 M

NO.	FREQ. (MHz)	EMISSION LEVEL (dBuV/m)	LIMIT (dBuV/m)	MARGIN (dB)	ANTENNA HEIGHT (m)	TABLE ANGLE (Degree)	RAW VALUE (dBuV)	CORRECTION FACTOR (dB/m)
1	2390.00	58.4 PK	74.0	-15.6	1.22 H	311	25.90	32.50
2	2390.00	48.2 AV	54.0	-5.8	1.22 H	311	15.70	32.50
3	*2412.00	100.7 PK			1.22 H	311	68.10	32.60
4	*2412.00	90.5 AV			1.22 H	311	57.90	32.60
5	4824.00	48.6 PK	74.0	-25.4	1.00 H	19	42.70	5.90
6	4824.00	35.5 AV	54.0	-18.5	1.00 H	19	29.60	5.90

ANTENNA POLARITY & TEST DISTANCE: VERTICAL AT 3 M

NO.	FREQ. (MHz)	EMISSION LEVEL (dBuV/m)	LIMIT (dBuV/m)	MARGIN (dB)	ANTENNA HEIGHT (m)	TABLE ANGLE (Degree)	RAW VALUE (dBuV)	CORRECTION FACTOR (dB/m)
1	2390.00	72.0 PK	74.0	-2.0	1.26 V	148	39.50	32.50
2	2390.00	52.9 AV	54.0	-1.1	1.26 V	148	20.40	32.50
3	*2412.00	114.6 PK			1.74 V	19	82.00	32.60
4	*2412.00	104.9 AV			1.74 V	19	72.30	32.60
5	4824.00	50.4 PK	74.0	-23.6	1.42 V	235	44.50	5.90
6	4824.00	39.2 AV	54.0	-14.8	1.42 V	235	33.30	5.90

Remarks:

1. Emission Level(dBuV/m) = Raw Value(dBuV) + Correction Factor(dB/m)
2. Correction Factor(dB/m) = Antenna Factor(dB/m) + Cable Factor(dB) – Pre-Amplifier Factor(dB)
3. The other emission levels were very low against the limit.
4. Margin value = Emission Level – Limit value
5. " \* ": Fundamental frequency.

CHANNEL	TX Channel 6	DETECTOR FUNCTION	Peak (PK)
FREQUENCY RANGE	1GHz ~ 25GHz		Average (AV)

ANTENNA POLARITY & TEST DISTANCE: HORIZONTAL AT 3 M								
NO.	FREQ. (MHz)	EMISSION LEVEL (dBuV/m)	LIMIT (dBuV/m)	MARGIN (dB)	ANTENNA HEIGHT (m)	TABLE ANGLE (Degree)	RAW VALUE (dBuV)	CORRECTION FACTOR (dB/m)
1	2390.00	57.6 PK	74.0	-16.4	1.40 H	115	25.10	32.50
2	2390.00	46.7 AV	54.0	-7.3	1.40 H	115	14.20	32.50
3	*2437.00	104.1 PK			1.40 H	115	71.40	32.70
4	*2437.00	94.6 AV			1.40 H	115	61.90	32.70
5	2483.50	56.7 PK	74.0	-17.3	1.50 H	122	24.00	32.70
6	2483.50	45.6 AV	54.0	-8.4	1.50 H	122	12.90	32.70
7	4874.00	48.9 PK	74.0	-25.1	1.36 H	106	43.00	5.90
8	4874.00	35.8 AV	54.0	-18.2	1.36 H	106	29.90	5.90

ANTENNA POLARITY & TEST DISTANCE: VERTICAL AT 3 M								
NO.	FREQ. (MHz)	EMISSION LEVEL (dBuV/m)	LIMIT (dBuV/m)	MARGIN (dB)	ANTENNA HEIGHT (m)	TABLE ANGLE (Degree)	RAW VALUE (dBuV)	CORRECTION FACTOR (dB/m)
<b>1</b>	<b>2390.00</b>	<b>73.0 PK</b>	<b>74.0</b>	<b>-1.0</b>	<b>1.95 V</b>	<b>283</b>	<b>40.50</b>	<b>32.50</b>
2	2390.00	52.5 AV	54.0	-1.5	1.95 V	283	20.00	32.50
3	*2437.00	119.4 PK			2.05 V	19	86.70	32.70
4	*2437.00	109.9 AV			2.05 V	19	77.20	32.70
5	2483.50	67.5 PK	74.0	-6.5	1.89 V	336	34.80	32.70
6	2483.50	52.3 AV	54.0	-1.7	1.89 V	336	19.60	32.70
7	4874.00	58.6 PK	74.0	-15.4	1.76 V	262	52.70	5.90
8	4874.00	44.7 AV	54.0	-9.3	1.76 V	262	38.80	5.90

Remarks:

1. Emission Level(dBuV/m) = Raw Value(dBuV) + Correction Factor(dB/m)
2. Correction Factor(dB/m) = Antenna Factor(dB/m) + Cable Factor(dB) – Pre-Amplifier Factor(dB)
3. The other emission levels were very low against the limit.
4. Margin value = Emission Level – Limit value
5. " \* ": Fundamental frequency.

CHANNEL	TX Channel 11	DETECTOR FUNCTION	Peak (PK)
FREQUENCY RANGE	1GHz ~ 25GHz		Average (AV)

ANTENNA POLARITY & TEST DISTANCE: HORIZONTAL AT 3 M								
NO.	FREQ. (MHz)	EMISSION LEVEL (dBuV/m)	LIMIT (dBuV/m)	MARGIN (dB)	ANTENNA HEIGHT (m)	TABLE ANGLE (Degree)	RAW VALUE (dBuV)	CORRECTION FACTOR (dB/m)
1	*2462.00	99.1 PK			1.55 H	136	66.50	32.60
2	*2462.00	89.1 AV			1.55 H	136	56.50	32.60
3	2483.50	58.8 PK	74.0	-15.2	1.55 H	136	26.10	32.70
4	2483.50	47.3 AV	54.0	-6.7	1.55 H	136	14.60	32.70
5	4924.00	48.1 PK	74.0	-25.9	1.50 H	100	42.10	6.00
6	4924.00	35.3 AV	54.0	-18.7	1.50 H	100	29.30	6.00
ANTENNA POLARITY & TEST DISTANCE: VERTICAL AT 3 M								
NO.	FREQ. (MHz)	EMISSION LEVEL (dBuV/m)	LIMIT (dBuV/m)	MARGIN (dB)	ANTENNA HEIGHT (m)	TABLE ANGLE (Degree)	RAW VALUE (dBuV)	CORRECTION FACTOR (dB/m)
1	*2462.00	112.0 PK			1.95 V	18	79.40	32.60
2	*2462.00	102.6 AV			1.95 V	18	70.00	32.60
3	2483.50	71.6 PK	74.0	-2.4	2.14 V	299	38.90	32.70
4	2483.50	52.3 AV	54.0	-1.7	2.14 V	299	19.60	32.70
5	4924.00	54.2 PK	74.0	-19.8	1.76 V	259	48.20	6.00
6	4924.00	40.6 AV	54.0	-13.4	1.76 V	259	34.60	6.00

Remarks:

1. Emission Level(dBuV/m) = Raw Value(dBuV) + Correction Factor(dB/m)
2. Correction Factor(dB/m) = Antenna Factor(dB/m) + Cable Factor(dB) – Pre-Amplifier Factor(dB)
3. The other emission levels were very low against the limit.
4. Margin value = Emission Level – Limit value
5. " \* ": Fundamental frequency.

802.11n (HT20)

CHANNEL	TX Channel 1	DETECTOR FUNCTION	Peak (PK)
FREQUENCY RANGE	1GHz ~ 25GHz		Average (AV)

ANTENNA POLARITY & TEST DISTANCE: HORIZONTAL AT 3 M

NO.	FREQ. (MHz)	EMISSION LEVEL (dBuV/m)	LIMIT (dBuV/m)	MARGIN (dB)	ANTENNA HEIGHT (m)	TABLE ANGLE (Degree)	RAW VALUE (dBuV)	CORRECTION FACTOR (dB/m)
1	2390.00	57.7 PK	74.0	-16.3	1.50 H	179	25.20	32.50
2	2390.00	46.8 AV	54.0	-7.2	1.50 H	179	14.30	32.50
3	*2412.00	95.8 PK			1.50 H	179	63.20	32.60
4	*2412.00	86.6 AV			1.50 H	179	54.00	32.60
5	4824.00	48.1 PK	74.0	-25.9	1.42 H	104	42.20	5.90
6	4824.00	35.1 AV	54.0	-18.9	1.42 H	104	29.20	5.90

ANTENNA POLARITY & TEST DISTANCE: VERTICAL AT 3 M

NO.	FREQ. (MHz)	EMISSION LEVEL (dBuV/m)	LIMIT (dBuV/m)	MARGIN (dB)	ANTENNA HEIGHT (m)	TABLE ANGLE (Degree)	RAW VALUE (dBuV)	CORRECTION FACTOR (dB/m)
1	2390.00	70.0 PK	74.0	-4.0	1.25 V	234	37.50	32.50
2	2390.00	52.9 AV	54.0	-1.1	1.25 V	234	20.40	32.50
3	*2412.00	111.3 PK			1.78 V	0	78.70	32.60
4	*2412.00	102.0 AV			1.78 V	0	69.40	32.60
5	4824.00	48.5 PK	74.0	-25.5	1.78 V	277	42.60	5.90
6	4824.00	35.9 AV	54.0	-18.1	1.78 V	277	30.00	5.90

Remarks:

1. Emission Level(dBuV/m) = Raw Value(dBuV) + Correction Factor(dB/m)
2. Correction Factor(dB/m) = Antenna Factor(dB/m) + Cable Factor(dB) – Pre-Amplifier Factor(dB)
3. The other emission levels were very low against the limit.
4. Margin value = Emission Level – Limit value
5. " \* ": Fundamental frequency.



CHANNEL	TX Channel 6	DETECTOR FUNCTION	Peak (PK)
FREQUENCY RANGE	1GHz ~ 25GHz		Average (AV)

**ANTENNA POLARITY & TEST DISTANCE: HORIZONTAL AT 3 M**

NO.	FREQ. (MHz)	EMISSION LEVEL (dBuV/m)	LIMIT (dBuV/m)	MARGIN (dB)	ANTENNA HEIGHT (m)	TABLE ANGLE (Degree)	RAW VALUE (dBuV)	CORRECTION FACTOR (dB/m)
1	2390.00	56.6 PK	74.0	-17.4	1.28 H	314	24.10	32.50
2	2390.00	45.5 AV	54.0	-8.5	1.28 H	314	13.00	32.50
3	*2437.00	103.0 PK			1.28 H	314	70.30	32.70
4	*2437.00	93.6 AV			1.28 H	314	60.90	32.70
5	2483.50	56.6 PK	74.0	-17.4	1.33 H	321	23.90	32.70
6	2483.50	45.6 AV	54.0	-8.4	1.33 H	321	12.90	32.70
7	4874.00	47.8 PK	74.0	-26.2	1.31 H	175	41.90	5.90
8	4874.00	34.6 AV	54.0	-19.4	1.31 H	175	28.70	5.90

**ANTENNA POLARITY & TEST DISTANCE: VERTICAL AT 3 M**

NO.	FREQ. (MHz)	EMISSION LEVEL (dBuV/m)	LIMIT (dBuV/m)	MARGIN (dB)	ANTENNA HEIGHT (m)	TABLE ANGLE (Degree)	RAW VALUE (dBuV)	CORRECTION FACTOR (dB/m)
1	2390.00	71.9 PK	74.0	-2.1	2.02 V	19	39.40	32.50
2	2390.00	52.1 AV	54.0	-1.9	2.02 V	19	19.60	32.50
3	*2437.00	118.4 PK			1.98 V	0	85.70	32.70
4	*2437.00	108.4 AV			1.98 V	0	75.70	32.70
5	2483.50	66.9 PK	74.0	-7.1	1.23 V	275	34.20	32.70
6	2483.50	50.8 AV	54.0	-3.2	1.23 V	275	18.10	32.70
7	4874.00	53.1 PK	74.0	-20.9	1.79 V	267	47.20	5.90
8	4874.00	40.5 AV	54.0	-13.5	1.79 V	267	34.60	5.90

**Remarks:**

1. Emission Level(dBuV/m) = Raw Value(dBuV) + Correction Factor(dB/m)
2. Correction Factor(dB/m) = Antenna Factor(dB/m) + Cable Factor(dB) – Pre-Amplifier Factor(dB)
3. The other emission levels were very low against the limit.
4. Margin value = Emission Level – Limit value
5. " \* ": Fundamental frequency.

CHANNEL	TX Channel 11	DETECTOR FUNCTION	Peak (PK)
FREQUENCY RANGE	1GHz ~ 25GHz		Average (AV)

ANTENNA POLARITY & TEST DISTANCE: HORIZONTAL AT 3 M								
NO.	FREQ. (MHz)	EMISSION LEVEL (dBuV/m)	LIMIT (dBuV/m)	MARGIN (dB)	ANTENNA HEIGHT (m)	TABLE ANGLE (Degree)	RAW VALUE (dBuV)	CORRECTION FACTOR (dB/m)
1	*2462.00	95.8 PK			1.37 H	29	63.20	32.60
2	*2462.00	86.8 AV			1.37 H	29	54.20	32.60
3	2483.50	57.3 PK	74.0	-16.7	1.37 H	29	24.60	32.70
4	2483.50	45.8 AV	54.0	-8.2	1.37 H	29	13.10	32.70
5	4924.00	48.5 PK	74.0	-25.5	1.44 H	111	42.50	6.00
6	4924.00	35.3 AV	54.0	-18.7	1.44 H	111	29.30	6.00
ANTENNA POLARITY & TEST DISTANCE: VERTICAL AT 3 M								
NO.	FREQ. (MHz)	EMISSION LEVEL (dBuV/m)	LIMIT (dBuV/m)	MARGIN (dB)	ANTENNA HEIGHT (m)	TABLE ANGLE (Degree)	RAW VALUE (dBuV)	CORRECTION FACTOR (dB/m)
1	*2462.00	110.5 PK			1.97 V	19	77.90	32.60
2	*2462.00	100.7 AV			1.97 V	19	68.10	32.60
3	2483.50	68.3 PK	74.0	-5.7	1.91 V	333	35.60	32.70
4	2483.50	52.6 AV	54.0	-1.4	1.91 V	333	19.90	32.70
5	4924.00	54.2 PK	74.0	-19.8	1.78 V	266	48.20	6.00
6	4924.00	42.0 AV	54.0	-12.0	1.78 V	266	36.00	6.00

Remarks:

1. Emission Level(dBuV/m) = Raw Value(dBuV) + Correction Factor(dB/m)
2. Correction Factor(dB/m) = Antenna Factor(dB/m) + Cable Factor(dB) – Pre-Amplifier Factor(dB)
3. The other emission levels were very low against the limit.
4. Margin value = Emission Level – Limit value
5. " \* ": Fundamental frequency.

802.11n (HT40)

CHANNEL	TX Channel 3	DETECTOR FUNCTION	Peak (PK) Average (AV)
FREQUENCY RANGE	1GHz ~ 25GHz		

ANTENNA POLARITY & TEST DISTANCE: HORIZONTAL AT 3 M

NO.	FREQ. (MHz)	EMISSION LEVEL (dBuV/m)	LIMIT (dBuV/m)	MARGIN (dB)	ANTENNA HEIGHT (m)	TABLE ANGLE (Degree)	RAW VALUE (dBuV)	CORRECTION FACTOR (dB/m)
1	2390.00	57.0 PK	74.0	-17.0	1.67 H	313	24.50	32.50
2	2390.00	45.9 AV	54.0	-8.1	1.67 H	313	13.40	32.50
3	*2422.00	91.6 PK			1.67 H	313	59.00	32.60
4	*2422.00	82.7 AV			1.67 H	313	50.10	32.60
5	4844.00	47.3 PK	74.0	-26.7	1.32 H	99	41.40	5.90
6	4844.00	34.4 AV	54.0	-19.6	1.32 H	99	28.50	5.90

ANTENNA POLARITY & TEST DISTANCE: VERTICAL AT 3 M

NO.	FREQ. (MHz)	EMISSION LEVEL (dBuV/m)	LIMIT (dBuV/m)	MARGIN (dB)	ANTENNA HEIGHT (m)	TABLE ANGLE (Degree)	RAW VALUE (dBuV)	CORRECTION FACTOR (dB/m)
1	2390.00	66.6 PK	74.0	-7.4	1.94 V	152	34.10	32.50
2	2390.00	52.8 AV	54.0	-1.2	1.94 V	152	20.30	32.50
3	*2422.00	104.9 PK			2.07 V	357	72.30	32.60
4	*2422.00	95.1 AV			2.07 V	357	62.50	32.60
5	4844.00	47.6 PK	74.0	-26.4	1.40 V	58	41.70	5.90
6	4844.00	34.7 AV	54.0	-19.3	1.40 V	58	28.80	5.90

Remarks:

1. Emission Level(dBuV/m) = Raw Value(dBuV) + Correction Factor(dB/m)
2. Correction Factor(dB/m) = Antenna Factor(dB/m) + Cable Factor(dB) – Pre-Amplifier Factor(dB)
3. The other emission levels were very low against the limit.
4. Margin value = Emission Level – Limit value
5. " \* ": Fundamental frequency.

CHANNEL	TX Channel 6	DETECTOR FUNCTION	Peak (PK)
FREQUENCY RANGE	1GHz ~ 25GHz		Average (AV)

ANTENNA POLARITY & TEST DISTANCE: HORIZONTAL AT 3 M								
NO.	FREQ. (MHz)	EMISSION LEVEL (dBuV/m)	LIMIT (dBuV/m)	MARGIN (dB)	ANTENNA HEIGHT (m)	TABLE ANGLE (Degree)	RAW VALUE (dBuV)	CORRECTION FACTOR (dB/m)
1	2390.00	56.0 PK	74.0	-18.0	1.70 H	303	23.50	32.50
2	2390.00	45.3 AV	54.0	-8.7	1.70 H	303	12.80	32.50
3	*2437.00	96.0 PK			1.70 H	317	63.30	32.70
4	*2437.00	85.8 AV			1.70 H	317	53.10	32.70
5	2483.50	56.7 PK	74.0	-17.3	1.70 H	311	24.00	32.70
6	2483.50	45.7 AV	54.0	-8.3	1.70 H	311	13.00	32.70
7	4874.00	47.9 PK	74.0	-26.1	1.48 H	59	42.00	5.90
8	4874.00	34.8 AV	54.0	-19.2	1.48 H	59	28.90	5.90

ANTENNA POLARITY & TEST DISTANCE: VERTICAL AT 3 M								
NO.	FREQ. (MHz)	EMISSION LEVEL (dBuV/m)	LIMIT (dBuV/m)	MARGIN (dB)	ANTENNA HEIGHT (m)	TABLE ANGLE (Degree)	RAW VALUE (dBuV)	CORRECTION FACTOR (dB/m)
1	2390.00	69.1 PK	74.0	-4.9	1.96 V	185	36.60	32.50
2	2390.00	52.5 AV	54.0	-1.5	1.96 V	185	20.00	32.50
3	*2437.00	109.2 PK			1.89 V	332	76.50	32.70
4	*2437.00	99.6 AV			1.89 V	332	66.90	32.70
5	2483.50	65.0 PK	74.0	-9.0	1.52 V	190	32.30	32.70
6	2483.50	51.3 AV	54.0	-2.7	1.52 V	190	18.60	32.70
7	4874.00	48.7 PK	74.0	-25.3	1.66 V	126	42.80	5.90
8	4874.00	35.5 AV	54.0	-18.5	1.66 V	126	29.60	5.90

Remarks:

1. Emission Level(dBuV/m) = Raw Value(dBuV) + Correction Factor(dB/m)
2. Correction Factor(dB/m) = Antenna Factor(dB/m) + Cable Factor(dB) – Pre-Amplifier Factor(dB)
3. The other emission levels were very low against the limit.
4. Margin value = Emission Level – Limit value
5. " \* ": Fundamental frequency.

CHANNEL	TX Channel 9	DETECTOR FUNCTION	Peak (PK)
FREQUENCY RANGE	1GHz ~ 25GHz		Average (AV)

ANTENNA POLARITY & TEST DISTANCE: HORIZONTAL AT 3 M								
NO.	FREQ. (MHz)	EMISSION LEVEL (dBuV/m)	LIMIT (dBuV/m)	MARGIN (dB)	ANTENNA HEIGHT (m)	TABLE ANGLE (Degree)	RAW VALUE (dBuV)	CORRECTION FACTOR (dB/m)
1	*2452.00	89.6 PK			1.74 H	113	56.90	32.70
2	*2452.00	80.4 AV			1.74 H	113	47.70	32.70
3	2483.50	56.6 PK	74.0	-17.4	1.74 H	113	23.90	32.70
4	2483.50	45.6 AV	54.0	-8.4	1.74 H	113	12.90	32.70
5	4904.00	47.1 PK	74.0	-26.9	1.43 H	129	41.30	5.80
6	4904.00	33.9 AV	54.0	-20.1	1.43 H	129	28.10	5.80
ANTENNA POLARITY & TEST DISTANCE: VERTICAL AT 3 M								
NO.	FREQ. (MHz)	EMISSION LEVEL (dBuV/m)	LIMIT (dBuV/m)	MARGIN (dB)	ANTENNA HEIGHT (m)	TABLE ANGLE (Degree)	RAW VALUE (dBuV)	CORRECTION FACTOR (dB/m)
1	*2452.00	104.5 PK			1.97 V	291	71.80	32.70
2	*2452.00	94.2 AV			1.97 V	291	61.50	32.70
3	2483.50	67.6 PK	74.0	-6.4	1.97 V	216	34.90	32.70
4	2483.50	52.9 AV	54.0	-1.1	1.97 V	216	20.20	32.70
5	4904.00	47.8 PK	74.0	-26.2	1.77 V	261	42.00	5.80
6	4904.00	34.7 AV	54.0	-19.3	1.77 V	261	28.90	5.80

Remarks:

1. Emission Level(dBuV/m) = Raw Value(dBuV) + Correction Factor(dB/m)
2. Correction Factor(dB/m) = Antenna Factor(dB/m) + Cable Factor(dB) – Pre-Amplifier Factor(dB)
3. The other emission levels were very low against the limit.
4. Margin value = Emission Level – Limit value
5. " \* ": Fundamental frequency.

Below 1GHz worst-case data: 802.11b

CHANNEL	TX Channel 1	DETECTOR FUNCTION	Quasi-Peak (QP)
FREQUENCY RANGE	9kHz ~ 1GHz		

ANTENNA POLARITY & TEST DISTANCE: HORIZONTAL AT 3 M								
NO.	FREQ. (MHz)	EMISSION LEVEL (dBuV/m)	LIMIT (dBuV/m)	MARGIN (dB)	ANTENNA HEIGHT (m)	TABLE ANGLE (Degree)	RAW VALUE (dBuV)	CORRECTION FACTOR (dB/m)
1	57.12	31.7 QP	40.0	-8.3	2.00 H	34	46.30	-14.60
2	134.89	28.8 QP	43.5	-14.7	2.00 H	62	44.00	-15.20
3	201.00	31.2 QP	43.5	-12.3	1.50 H	96	48.00	-16.80
4	294.32	28.0 QP	46.0	-18.0	1.01 H	131	40.60	-12.60
5	500.42	27.8 QP	46.0	-18.2	1.50 H	143	36.20	-8.40
6	599.58	26.7 QP	46.0	-19.3	1.01 H	15	33.00	-6.30
ANTENNA POLARITY & TEST DISTANCE: VERTICAL AT 3 M								
NO.	FREQ. (MHz)	EMISSION LEVEL (dBuV/m)	LIMIT (dBuV/m)	MARGIN (dB)	ANTENNA HEIGHT (m)	TABLE ANGLE (Degree)	RAW VALUE (dBuV)	CORRECTION FACTOR (dB/m)
1	33.79	29.4 QP	40.0	-10.6	1.49 V	235	45.20	-15.80
2	57.12	28.5 QP	40.0	-11.5	1.49 V	16	43.10	-14.60
3	117.39	24.3 QP	43.5	-19.2	1.00 V	9	41.10	-16.80
4	208.77	26.6 QP	43.5	-16.9	1.00 V	225	43.50	-16.90
5	298.21	24.6 QP	46.0	-21.4	1.00 V	75	37.10	-12.50
6	500.42	27.5 QP	46.0	-18.5	1.00 V	225	35.90	-8.40

Remarks:

1. Emission Level(dBuV/m) = Raw Value(dBuV) + Correction Factor(dB/m)
2. Correction Factor(dB/m) = Antenna Factor(dB/m) + Cable Factor(dB) – Pre-Amplifier Factor(dB)
3. The other emission levels were very low against the limit.
4. Margin value = Emission Level – Limit value

## 4.2 Conducted Emission Measurement

### 4.2.1 Limits of Conducted Emission Measurement

Frequency (MHz)	Conducted Limit (dBuV)	
	Quasi-peak	Average
0.15 - 0.5	66 - 56	56 - 46
0.50 - 5.0	56	46
5.0 - 30.0	60	50

- Note: 1. The lower limit shall apply at the transition frequencies.  
 2. The limit decreases in line with the logarithm of the frequency in the range of 0.15 to 0.50MHz.

### 4.2.2 Test Instruments

Description & Manufacturer	Model No.	Serial No.	Cal. Date	Cal. Due
Test Receiver ROHDE & SCHWARZ	ESCI	100613	Nov. 11, 2014	Nov. 10, 2015
RF signal cable Woken	5D-FB	Cable-HYC01-01	Dec. 26, 2014	Dec. 25, 2015
LISN ROHDE & SCHWARZ (EUT)	ESH3-Z5	835239/001	Mar. 02, 2015	Mar. 01, 2016
LISN ROHDE & SCHWARZ (Peripheral)	ESH3-Z5	100311	Jul. 21, 2014	Jul. 20, 2015
Software ADT	BV ADT_Cond_ V7.3.7.3	NA	NA	NA

- Note: 1. The calibration interval of the above test instruments is 12 months and the calibrations are traceable to NML/ROC and NIST/USA.  
 2. The test was performed in HwaYa Shielded Room 1.  
 3. The VCCI Site Registration No. is C-2040.

#### 4.2.3 Test Procedures

- The EUT was placed 0.4 meters from the conducting wall of the shielded room with EUT being connected to the power mains through a line impedance stabilization network (LISN). Other support units were connected to the power mains through another LISN. The two LISNs provide 50 ohm/ 50uH of coupling impedance for the measuring instrument.
- Both lines of the power mains connected to the EUT were checked for maximum conducted interference.
- The frequency range from 150kHz to 30MHz was searched. Emission levels under (Limit - 20dB) was not recorded.

Note: The resolution bandwidth and video bandwidth of test receiver is 9kHz for quasi-peak detection (QP) and average detection (AV) at frequency 0.15MHz-30MHz.

#### 4.2.4 Deviation from Test Standard

No deviation.

#### 4.2.5 Test Setup

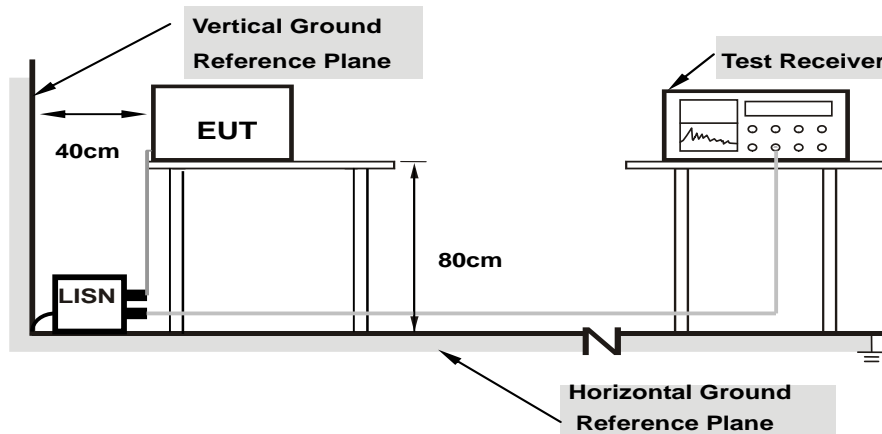

Note: 1.Support units were connected to second LISN.

For the actual test configuration, please refer to the attached file (Test Setup Photo).

#### 4.2.6 EUT Operating Conditions

Same as 4.1.6.



#### 4.2.7 Test Results

Worst-case data: 802.11b

Phase	Line (L)	Detector Function	Quasi-Peak (QP) / Average (AV)
-------	----------	-------------------	--------------------------------

No	Freq. [MHz]	Corr. Factor (dB)	Reading Value [dB (uV)]		Emission Level [dB (uV)]		Limit [dB (uV)]		Margin (dB)	
			Q.P.	AV.	Q.P.	AV.	Q.P.	AV.	Q.P.	AV.
			1	0.23155	0.14	39.18	29.44	39.32	29.58	62.39
2	0.26730	0.13	40.45	31.10	40.58	31.23	61.20	51.20	-20.62	-19.97
3	0.45097	0.09	32.55	19.09	32.64	19.18	56.86	46.86	-24.22	-27.68
4	0.71695	0.13	34.67	20.10	34.80	20.23	56.00	46.00	-21.20	-25.77
<b>5</b>	<b>4.66214</b>	<b>0.28</b>	<b>39.40</b>	<b>29.71</b>	<b>39.68</b>	<b>29.99</b>	<b>56.00</b>	<b>46.00</b>	<b>-16.32</b>	<b>-16.01</b>
6	5.22909	0.30	39.22	29.16	39.52	29.46	60.00	50.00	-20.48	-20.54

Remarks:

1. Q.P. and AV. are abbreviations of quasi-peak and average individually.
2. The emission levels of other frequencies were very low against the limit.
3. Margin value = Emission level - Limit value
4. Correction factor = Insertion loss + Cable loss
5. Emission Level = Correction Factor + Reading Value.

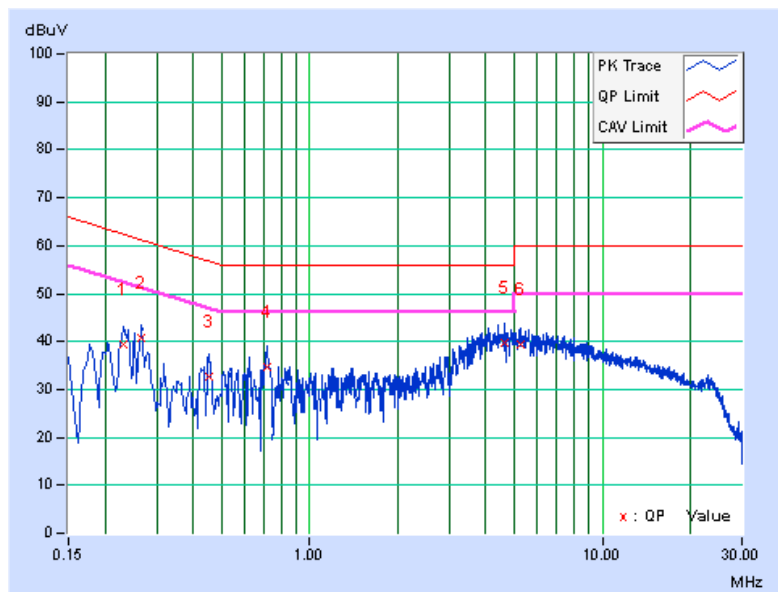

Phase	Neutral (N)	Detector Function	Quasi-Peak (QP) / Average (AV)
-------	-------------	-------------------	--------------------------------

No	Freq. [MHz]	Corr. Factor (dB)	Reading Value [dB (uV)]		Emission Level [dB (uV)]		Limit [dB (uV)]		Margin (dB)	
			Q.P.	AV.	Q.P.	AV.	Q.P.	AV.	Q.P.	AV.
			1	0.19692	0.24	36.18	24.44	36.42	24.68	63.74
2	0.26346	0.22	39.06	32.38	39.28	32.60	61.32	51.32	-22.04	-18.72
3	0.71304	0.18	33.51	22.47	33.69	22.65	56.00	46.00	-22.31	-23.35
4	4.32979	0.40	37.29	27.03	37.69	27.43	56.00	46.00	-18.31	-18.57
5	7.14108	0.46	34.44	24.49	34.90	24.95	60.00	50.00	-25.10	-25.05
6	21.61590	0.88	37.89	26.84	38.77	27.72	60.00	50.00	-21.23	-22.28

Remarks:

1. Q.P. and AV. are abbreviations of quasi-peak and average individually.
2. The emission levels of other frequencies were very low against the limit.
3. Margin value = Emission level - Limit value
4. Correction factor = Insertion loss + Cable loss
5. Emission Level = Correction Factor + Reading Value.

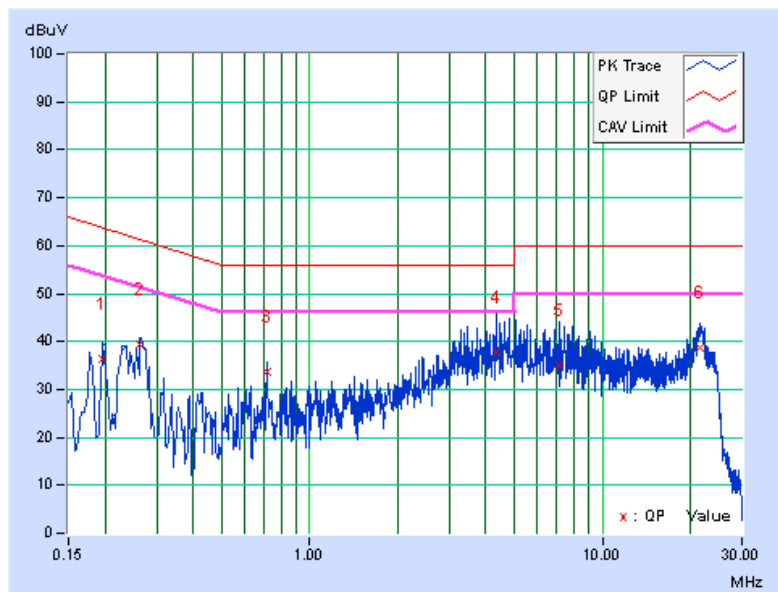

### 4.3 6dB Bandwidth Measurement

#### 4.3.1 Limits of 6dB Bandwidth Measurement

The minimum of 6dB Bandwidth Measurement is 0.5 MHz.

#### 4.3.2 Test Setup

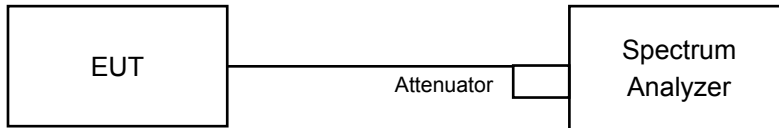

#### 4.3.3 Test Instruments

Refer to section 4.1.2 to get information of above instrument.

#### 4.3.4 Test Procedure

- a. Set resolution bandwidth (RBW) = 100kHz
- b. Set the video bandwidth (VBW)  $\geq 3 \times$  RBW, Detector = Peak.
- c. Trace mode = max hold.
- d. Sweep = auto couple.
- e. Measure the maximum width of the emission that is constrained by the frequencies associated with the two amplitude points (upper and lower) that are attenuated by 6 dB relative to the maximum level measured in the fundamental emission

#### 4.3.5 Deviation from Test Standard

No deviation.

#### 4.3.6 EUT Operating Conditions

The software provided by client to enable the EUT under transmission condition continuously at lowest, middle and highest channel frequencies individually.

#### 4.3.7 Test Result

##### 802.11b

Channel	Frequency (MHz)	6dB Bandwidth (MHz)		Minimum Limit (MHz)	Pass / Fail
		Chain 0	Chain 1		
1	2412	10.10	10.10	0.5	Pass
6	2437	10.12	10.12	0.5	Pass
11	2462	10.10	10.11	0.5	Pass

##### 802.11g

Channel	Frequency (MHz)	6dB Bandwidth (MHz)		Minimum Limit (MHz)	Pass / Fail
		Chain 0	Chain 1		
1	2412	16.35	16.37	0.5	Pass
6	2437	16.36	16.32	0.5	Pass
11	2462	16.36	16.35	0.5	Pass

##### 802.11n (HT20)

Channel	Frequency (MHz)	6dB Bandwidth (MHz)		Minimum Limit (MHz)	Pass / Fail
		Chain 0	Chain 1		
1	2412	17.31	16.97	0.5	Pass
6	2437	17.34	16.96	0.5	Pass
11	2462	17.56	17.14	0.5	Pass

##### 802.11n (HT40)

Channel	Frequency (MHz)	6dB Bandwidth (MHz)		Minimum Limit (MHz)	Pass / Fail
		Chain 0	Chain 1		
3	2422	35.88	35.78	0.5	Pass
6	2437	36.05	35.76	0.5	Pass
9	2452	36.37	35.80	0.5	Pass

### Spectrum Plot of Worst Value

802.11b

802.11g

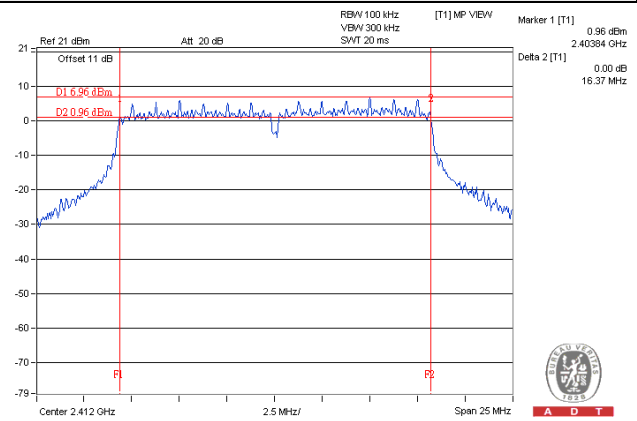
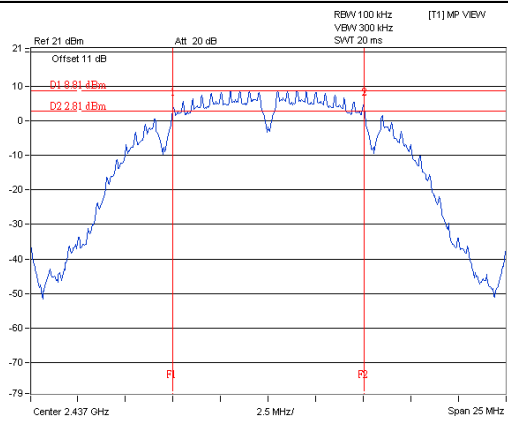

802.11n (HT20)

802.11n (HT40)

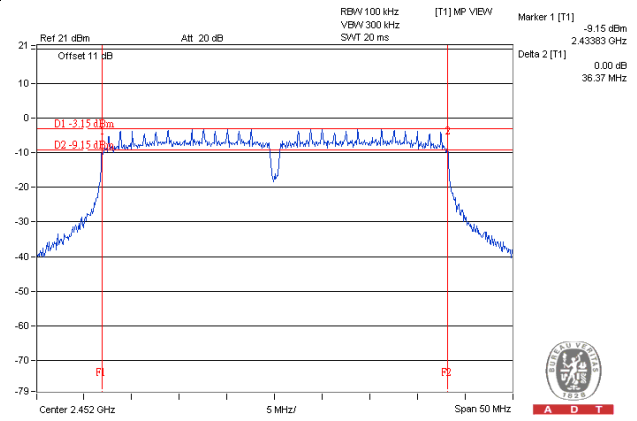
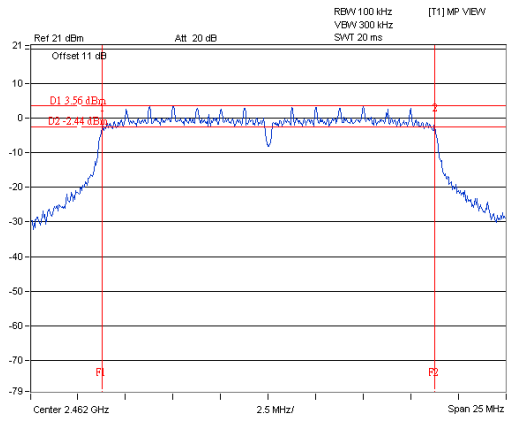

## 4.4 Conducted Output Power Measurement

### 4.4.1 Limits of Conducted Output Power Measurement

For systems using digital modulation in the 2400–2483.5 MHz bands: 1 Watt (30dBm)

Per KDB 662911 D01 Multiple Transmitter Output Method of conducted output power measurement on IEEE 802.11 devices,

Array Gain = 0 dB (i.e., no array gain) for  $N_{ANT} \leq 4$ ;

Array Gain = 0 dB (i.e., no array gain) for channel widths  $\geq 40$  MHz for any  $N_{ANT}$ ;

Array Gain =  $5 \log(N_{ANT}/N_{SS})$  dB or 3 dB, whichever is less for 20-MHz channel widths with  $N_{ANT} \geq 5$ .

For power measurements on all other devices: Array Gain =  $10 \log(N_{ANT}/N_{SS})$  dB.

### 4.4.2 Test Setup

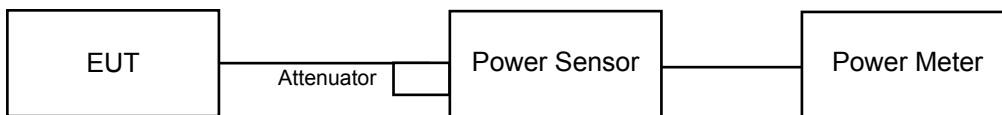

### 4.4.3 Test Instruments

Refer to section 4.1.2 to get information of above instrument.

### 4.4.4 Test Procedures

For peak power

A peak power sensor was used on the output port of the EUT. A power meter was used to read the response of the peak power sensor. Record the power level.

For average power

Average power sensor was used to perform output power measurement, trigger and gating function of wide band power meter is enabled to measure max output power of TX on burst. Duty factor is not added to measured value.

### 4.4.5 Deviation from Test Standard

No deviation.

### 4.4.6 EUT Operating Conditions

Same as Item 4.3.6.

#### 4.4.7 Test Results

For Peak Power

##### 802.11b

Channel	Frequency (MHz)	Peak Power (dBm)		Total Power (mW)	Total Power (dBm)	Limit (dBm)	Pass / Fail
		Chain 0	Chain 1				
1	2412	20.65	20.95	240.596	23.81	30.00	Pass
6	2437	20.41	20.70	227.391	23.57	30.00	Pass
11	2462	18.89	19.11	158.916	22.01	30.00	Pass

##### 802.11g

Channel	Frequency (MHz)	Peak Power (dBm)		Total Power (mW)	Total Power (dBm)	Limit (dBm)	Pass / Fail
		Chain 0	Chain 1				
1	2412	22.20	22.40	339.739	25.31	30.00	Pass
6	2437	26.16	26.22	<b>831.842</b>	29.20	30.00	Pass
11	2462	21.94	21.68	303.546	24.82	30.00	Pass

##### 802.11n (HT20)

Channel	Frequency (MHz)	Peak Power (dBm)		Total Power (mW)	Total Power (dBm)	Limit (dBm)	Pass / Fail
		Chain 0	Chain 1				
1	2412	20.24	20.67	222.363	23.47	30.00	Pass
6	2437	25.54	25.91	748.038	28.74	30.00	Pass
11	2462	20.13	20.50	215.241	23.33	30.00	Pass

##### 802.11n (HT40)

Channel	Frequency (MHz)	Peak Power (dBm)		Total Power (mW)	Total Power (dBm)	Limit (dBm)	Pass / Fail
		Chain 0	Chain 1				
3	2422	17.41	17.82	115.615	20.63	30.00	Pass
6	2437	21.41	21.76	288.325	24.60	30.00	Pass
9	2452	17.06	17.12	102.339	20.10	30.00	Pass

For Average Power

802.11b

Channel	Frequency (MHz)	Average Power (dBm)		Total Power (mW)	Total Power (dBm)
		Chain 0	Chain 1		
1	2412	18.51	18.81	146.991	21.67
6	2437	18.25	18.38	135.699	21.33
11	2462	16.80	16.97	97.637	19.90

802.11g

Channel	Frequency (MHz)	Average Power (dBm)		Total Power (mW)	Total Power (dBm)
		Chain 0	Chain 1		
1	2412	16.70	17.01	97.008	19.87
6	2437	22.33	22.41	345.183	25.38
11	2462	16.18	16.45	85.652	19.33

802.11n (HT20)

Channel	Frequency (MHz)	Average Power (dBm)		Total Power (mW)	Total Power (dBm)
		Chain 0	Chain 1		
1	2412	14.93	14.98	62.594	17.97
6	2437	21.27	21.62	279.179	24.46
11	2462	14.77	15.09	62.277	17.94

802.11n (HT40)

Channel	Frequency (MHz)	Average Power (dBm)		Total Power (mW)	Total Power (dBm)
		Chain 0	Chain 1		
3	2422	11.85	12.31	32.333	15.10
6	2437	15.91	16.31	81.750	19.12
9	2452	11.51	11.56	28.480	14.55



## 4.5 Power Spectral Density Measurement

### 4.5.1 Limits of Power Spectral Density Measurement

The Maximum of Power Spectral Density Measurement is 8dBm.

### 4.5.2 Test Setup

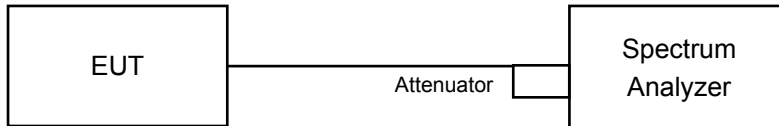

### 4.5.3 Test Instruments

Refer to section 4.1.2 to get information of above instrument.

### 4.5.4 Test Procedure

- Set analyzer center frequency to DTS channel center frequency.
- Set the span to 1.5 times the DTS bandwidth.
- Set the RBW to:  $3 \text{ kHz} \leq \text{RBW} \leq 100 \text{ kHz}$ .
- Set the VBW  $\geq 3 \times \text{RBW}$ .
- Detector = peak.
- Sweep time = auto couple.
- Trace mode = max hold.
- Allow trace to fully stabilize.
- Use the peak marker function to determine the maximum amplitude level within the RBW.

### 4.5.5 Deviation from Test Standard

No deviation.

### 4.5.6 EUT Operating Condition

Same as Item 4.3.6

#### 4.5.7 Test Results

##### 802.11b

TX chain	Channel	Frequency (MHz)	PSD (dBm/3kHz)	10 log (N=2) dB	Total PSD (dBm/3kHz)	Limit (dBm/3kHz)	Pass / Fail
0	1	2412	-4.67	3.01	-1.66	8.00	Pass
	6	2437	-5.26	3.01	-2.25	8.00	Pass
	11	2462	-7.06	3.01	-4.05	8.00	Pass
1	1	2412	-4.18	3.01	-1.17	8.00	Pass
	6	2437	-4.52	3.01	-1.51	8.00	Pass
	11	2462	-5.98	3.01	-2.97	8.00	Pass

Note:

- Method 1 of power density measurement of KDB 662911 is using for calculating total power density. Total power density is summing entire spectra across corresponding frequency bins on the various outputs by computer.
- Directional gain =  $10 \log[(10G^{1/20} + 10G^{2/20} + \dots + 10G^{N/20})^2/2] = 5.52 \text{ dBi} < 6\text{dBi}$ , so the power density limit no need to reduce.

##### 802.11g

TX chain	Channel	Frequency (MHz)	PSD (dBm/3kHz)	10 log (N=2) dB	Total PSD (dBm/3kHz)	Limit (dBm/3kHz)	Pass / Fail
0	1	2412	-9.00	3.01	-5.80	8.00	Pass
	6	2437	-2.93	3.01	0.27	8.00	Pass
	11	2462	-8.64	3.01	-5.44	8.00	Pass
1	1	2412	-7.51	3.01	-4.31	8.00	Pass
	6	2437	-1.97	3.01	1.23	8.00	Pass
	11	2462	-8.42	3.01	-5.22	8.00	Pass

Note:

- Method 1 of power density measurement of KDB 662911 is using for calculating total power density. Total power density is summing entire spectra across corresponding frequency bins on the various outputs by computer.
- Directional gain =  $10 \log[(10G^{1/20} + 10G^{2/20} + \dots + 10G^{N/20})^2/2] = 5.52 \text{ dBi} < 6\text{dBi}$ , so the power density limit no need to reduce.

### 802.11n (HT20)

TX chain	Channel	Frequency (MHz)	PSD (dBm/3kHz)	10 log (N=2) dB	Total PSD (dBm/3kHz)	Limit (dBm/3kHz)	Pass / Fail
0	1	2412	-11.17	3.01	-7.98	8.00	Pass
	6	2437	-4.33	3.01	-1.14	8.00	Pass
	11	2462	-11.21	3.01	-8.02	8.00	Pass
1	1	2412	-10.64	3.01	-7.45	8.00	Pass
	6	2437	-3.67	3.01	-0.48	8.00	Pass
	11	2462	-10.35	3.01	-7.16	8.00	Pass

Note:

- Method 1 of power density measurement of KDB 662911 is using for calculating total power density. Total power density is summing entire spectra across corresponding frequency bins on the various outputs by computer.
- Directional gain =  $10 \log[(10G^{1/20} + 10G^{2/20} + \dots + 10G^{N/20})^2/2] = 5.52 \text{ dBi} < 6\text{dBi}$ , so the power density limit no need to reduce.

### 802.11n (HT40)

TX chain	Channel	Frequency (MHz)	PSD (dBm/3kHz)	10 log (N=2) dB	Total PSD (dBm/3kHz)	Limit (dBm/3kHz)	Pass / Fail
0	3	2422	-18.09	3.01	-14.73	8.00	Pass
	6	2437	-12.97	3.01	-9.61	8.00	Pass
	9	2452	-18.86	3.01	-15.50	8.00	Pass
1	3	2422	-16.84	3.01	-13.48	8.00	Pass
	6	2437	-12.59	3.01	-9.23	8.00	Pass
	9	2452	-18.00	3.01	-14.64	8.00	Pass

Note:

- Method 1 of power density measurement of KDB 662911 is using for calculating total power density. Total power density is summing entire spectra across corresponding frequency bins on the various outputs by computer.
- Directional gain =  $10 \log[(10G^{1/20} + 10G^{2/20} + \dots + 10G^{N/20})^2/2] = 5.52 \text{ dBi} < 6\text{dBi}$ , so the power density limit no need to reduce.

### Spectrum Plot of Worst Value

802.11b

802.11g

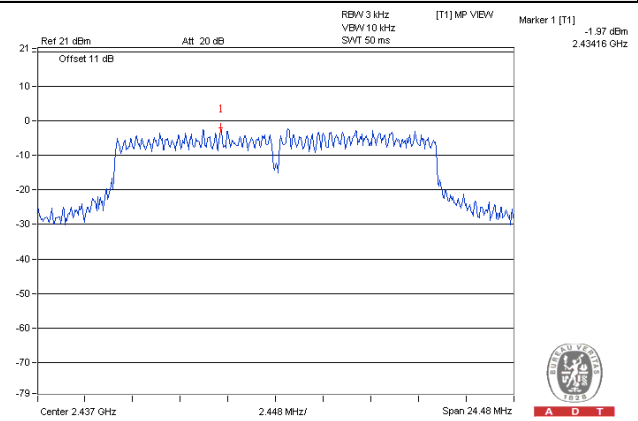
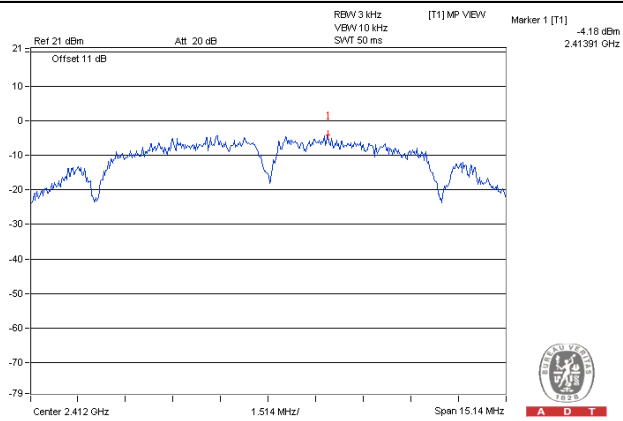

802.11n (HT20)

802.11n (HT40)

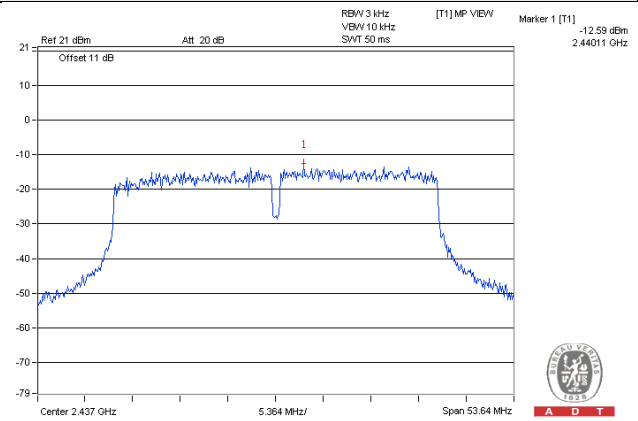
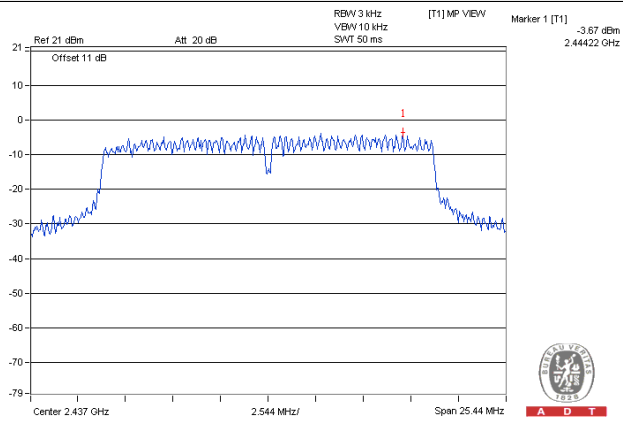

## 4.6 Conducted Out of Band Emission Measurement

### 4.6.1 Limits of Conducted Out of Band Emission Measurement

Below 20dB of the highest emission level of operating band (in 100kHz Resolution Bandwidth).

### 4.6.2 Test Setup

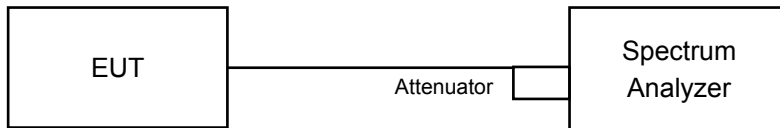

### 4.6.3 Test Instruments

Refer to section 4.1.2 to get information of above instrument.

### 4.6.4 Test Procedure

#### MEASUREMENT PROCEDURE REF

- Set the RBW = 100 kHz.
- Set the VBW  $\geq$  300 kHz.
- Detector = peak.
- Sweep time = auto couple.
- Trace mode = max hold.
- Allow trace to fully stabilize.
- Use the peak marker function to determine the maximum power level in any 100 kHz band segment within the fundamental EBW.

#### MEASUREMENT PROCEDURE OOBE

- Set RBW = 100 kHz.
- Set VBW  $\geq$  300 kHz.
- Detector = peak.
- Sweep = auto couple.
- Trace Mode = max hold.
- Allow trace to fully stabilize.
- Use the peak marker function to determine the maximum amplitude level.

### 4.6.5 Deviation from Test Standard

No deviation.

### 4.6.6 EUT Operating Condition

Same as Item 4.3.6

### 4.6.7 Test Results

The conducted emission test is performed on each TX port of operating mode without summing or adding  $10\log(N)$  since the limit is relative emission limit.

The spectrum plots are attached on the following pages. D1 line indicates the highest level, and D2 line indicates the 30dB offset below D1. It shows compliance with the requirement.

802.11b\_Chain 0

CH 1

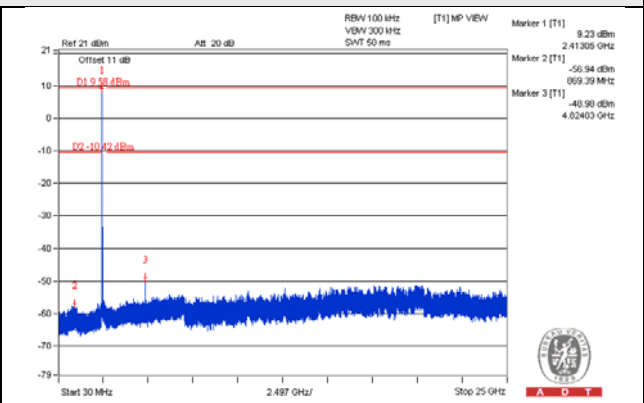
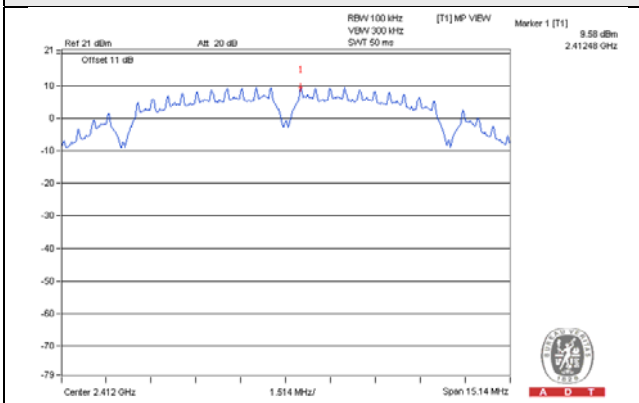

CH 6

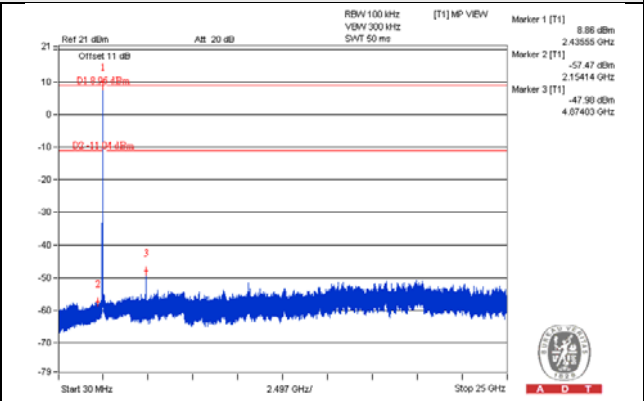
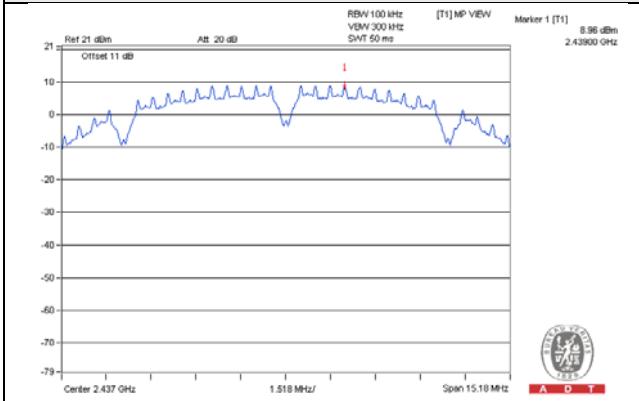

CH 11

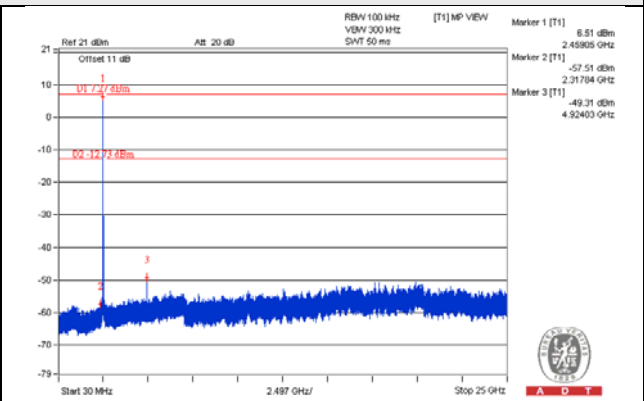
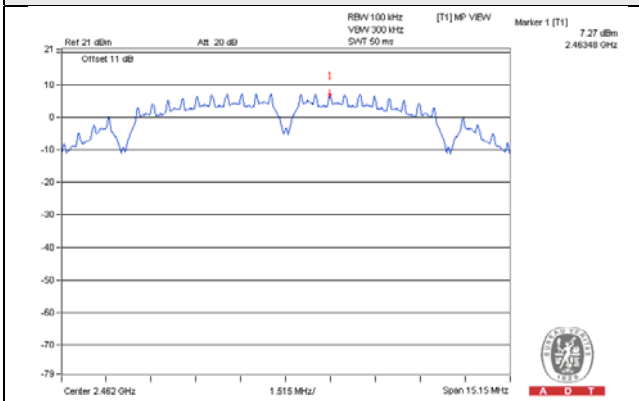

CH 1 Band edge

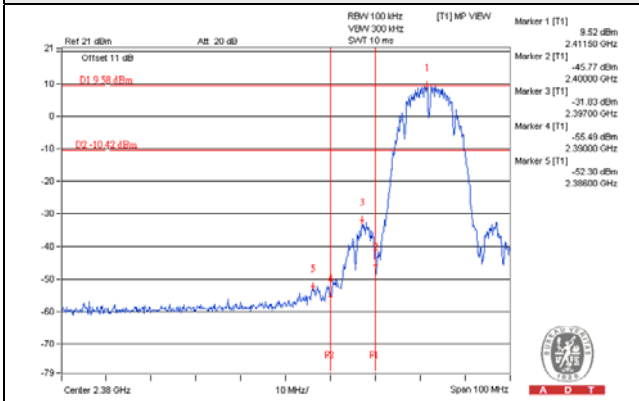

CH 11 Band edge

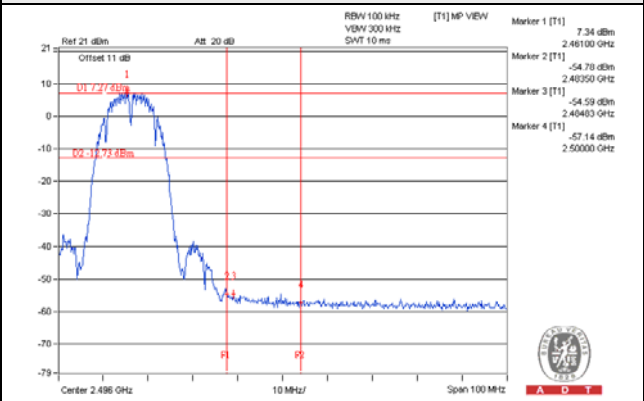

802.11b\_Chain 1

CH 1

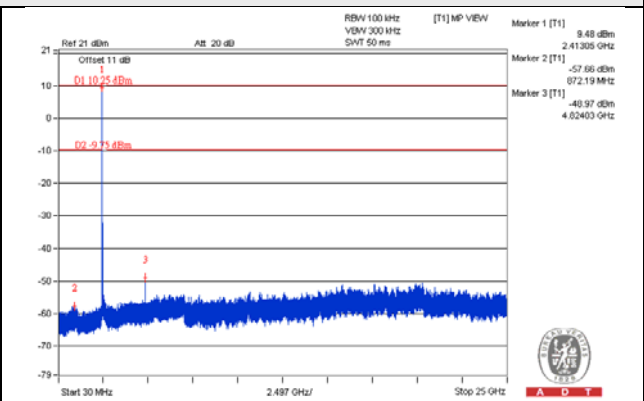
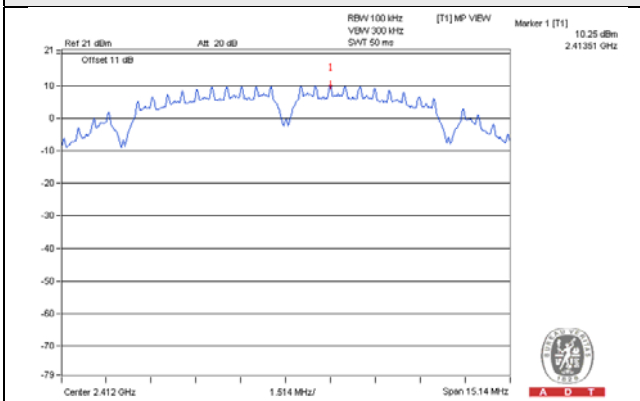

CH 6

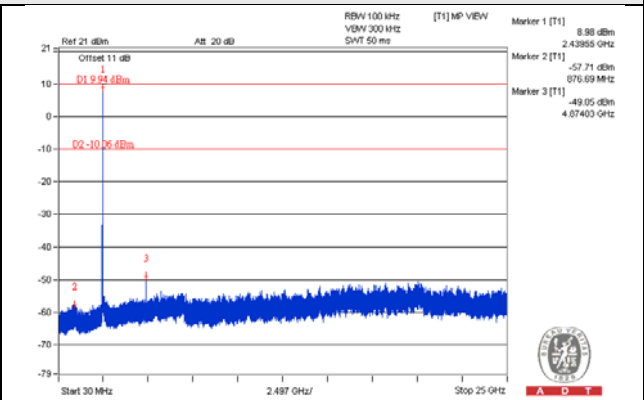
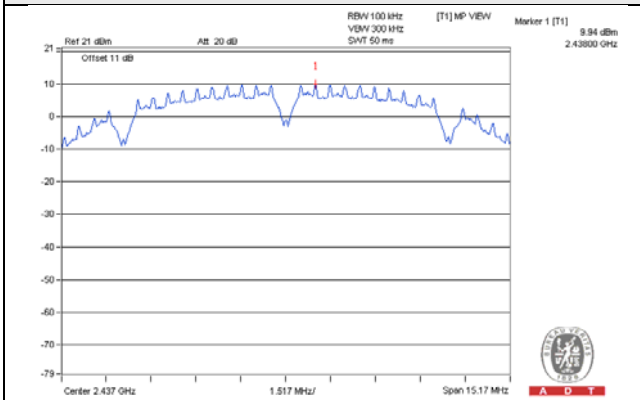

CH 11

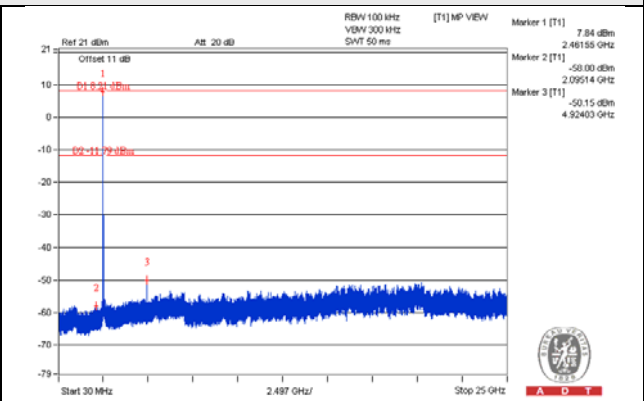
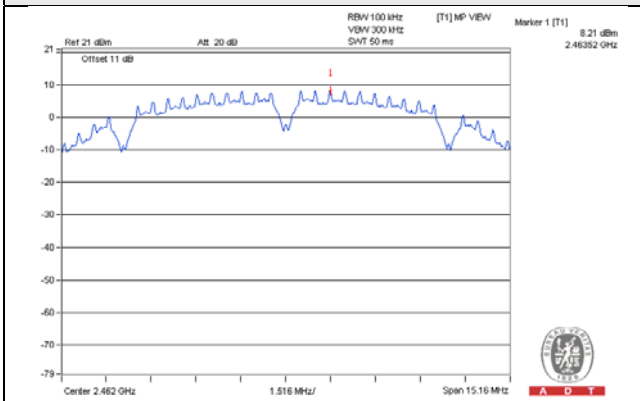

CH 1 Band edge

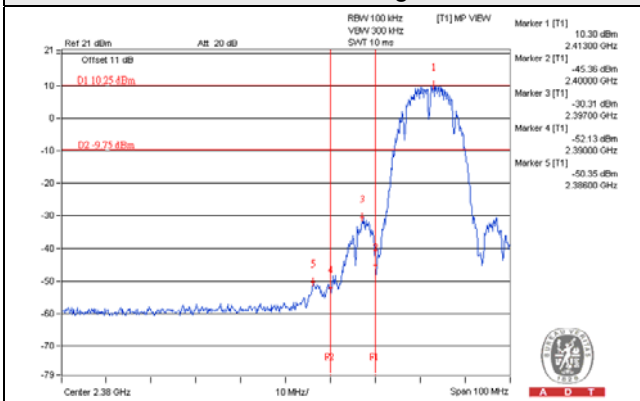

CH 11 Band edge

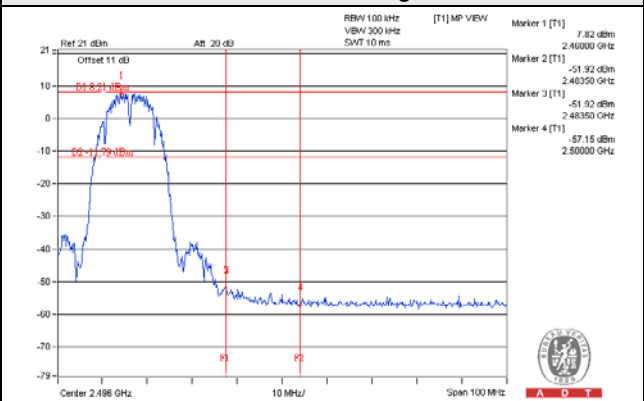

802.11g\_Chain 0

CH 1

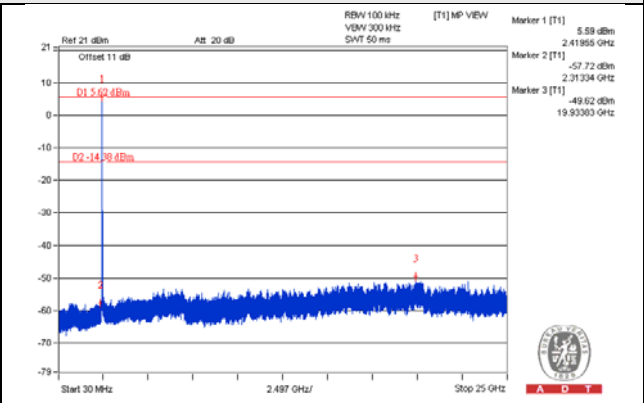
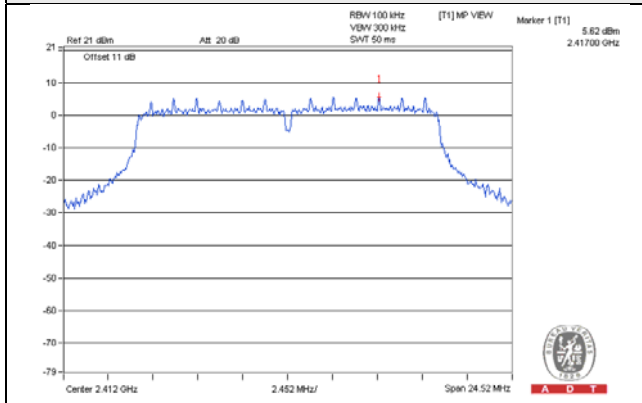

CH 6

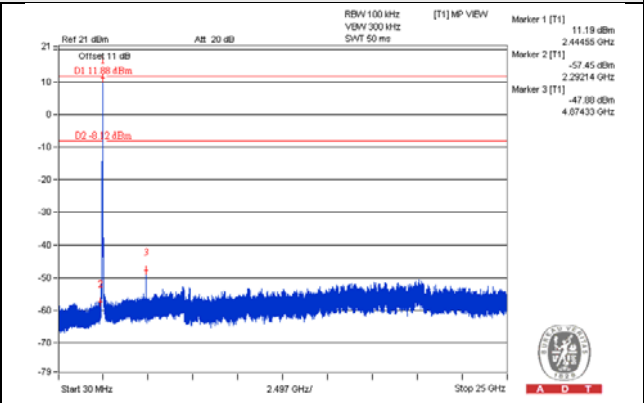
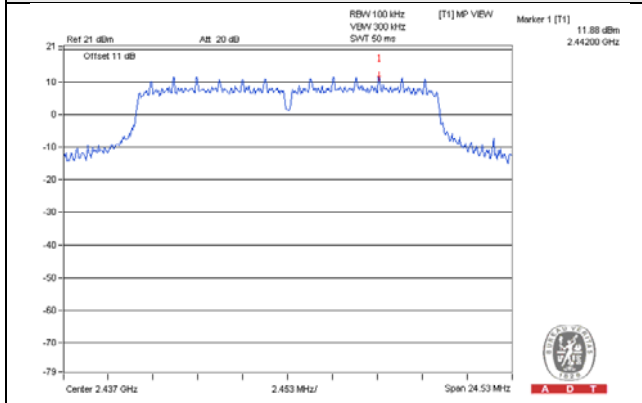

CH 11

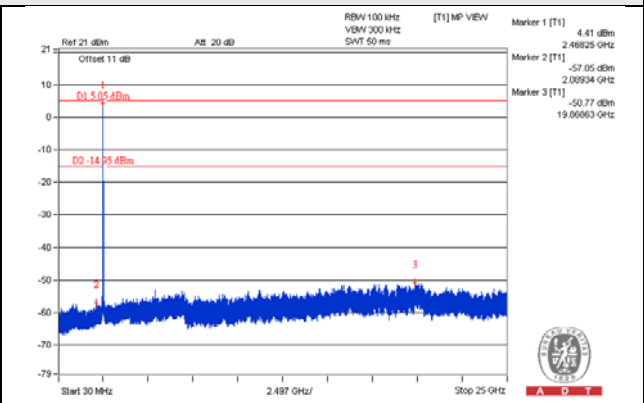
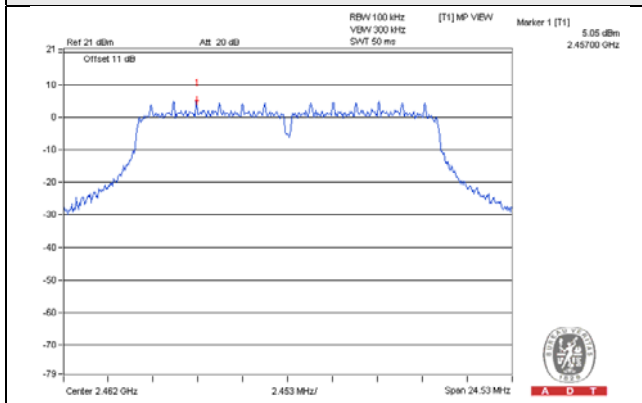

CH 1 Band edge

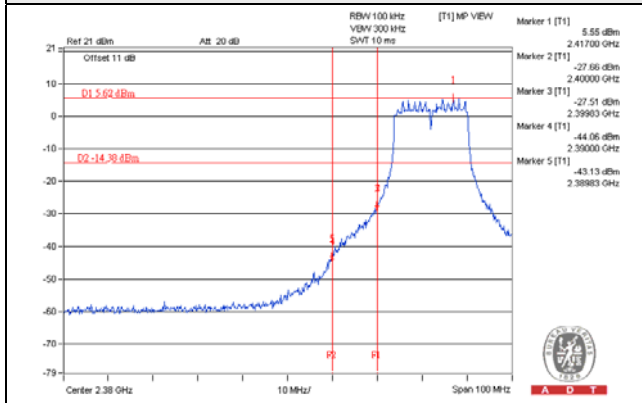

CH 11 Band edge

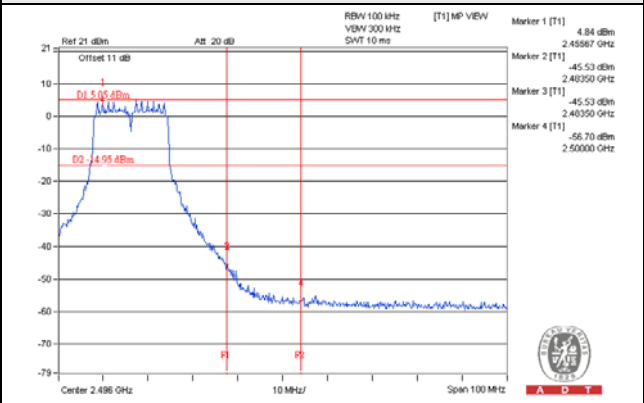



802.11g\_Chain 1

CH 1

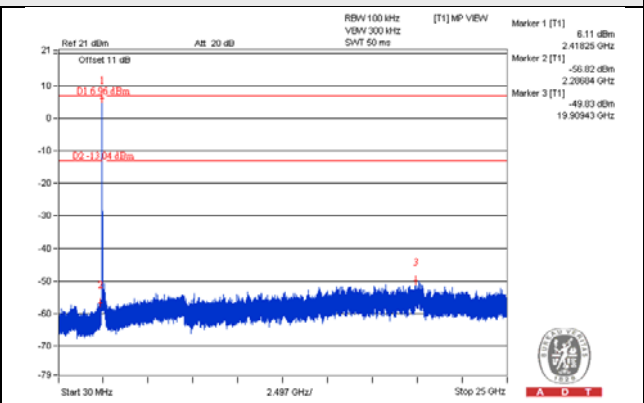
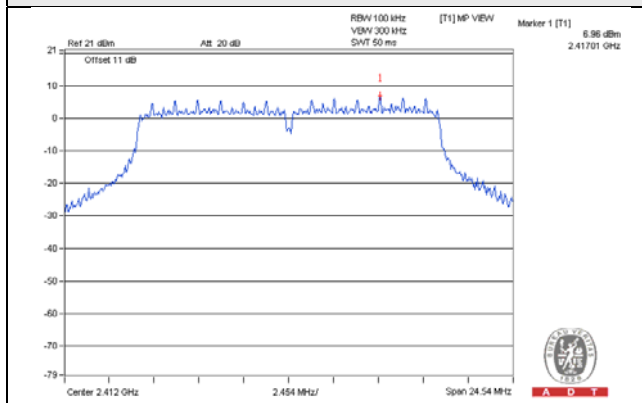

CH 6

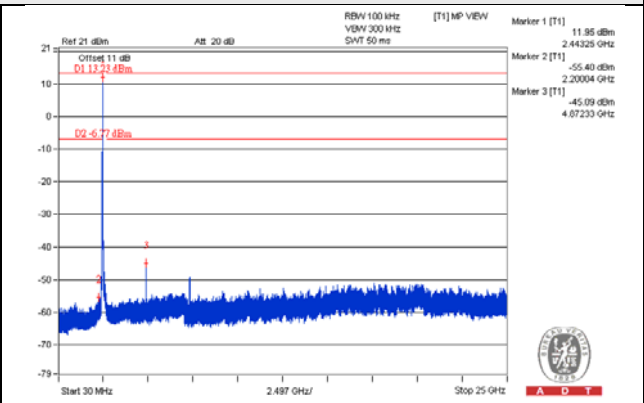
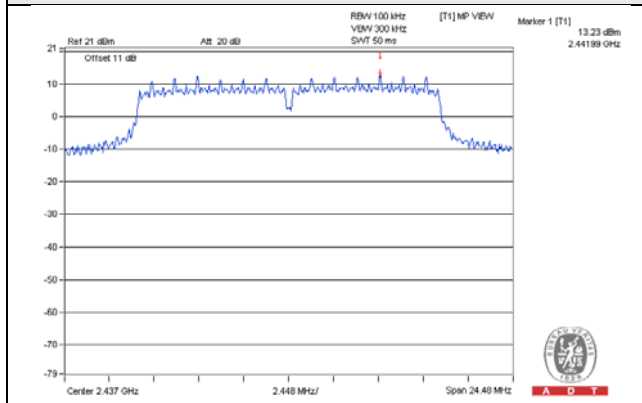

CH 11

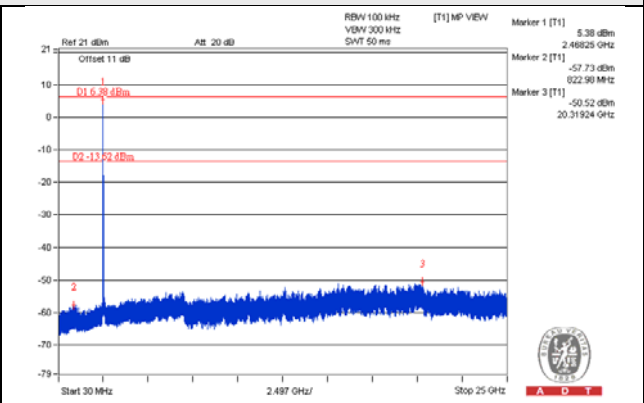
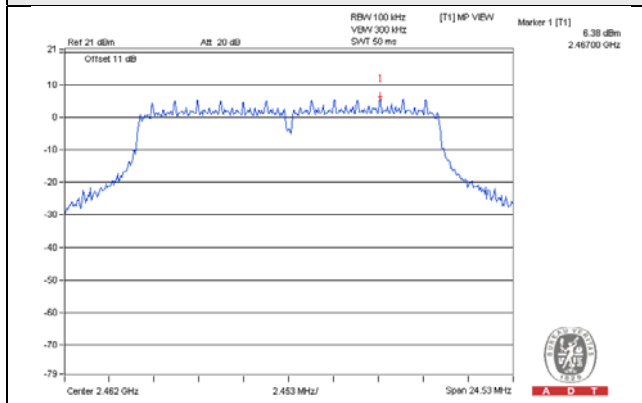

CH 1 Band edge

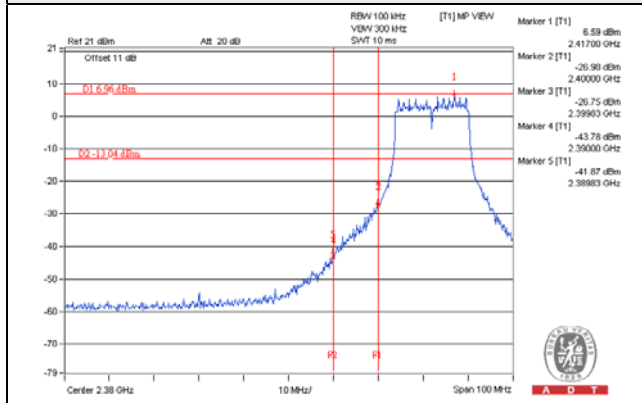

CH 11 Band edge

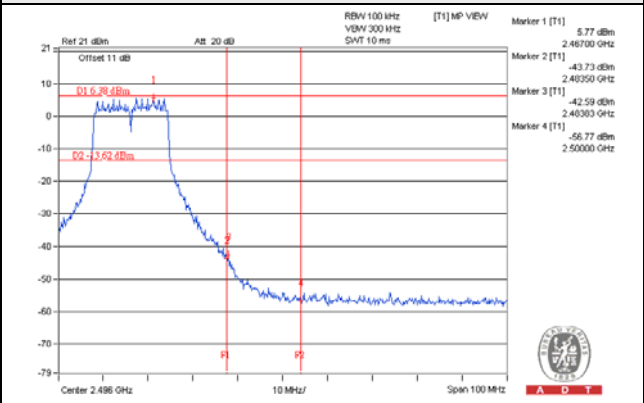

802.11n (HT20)\_ Chain 0

CH 1

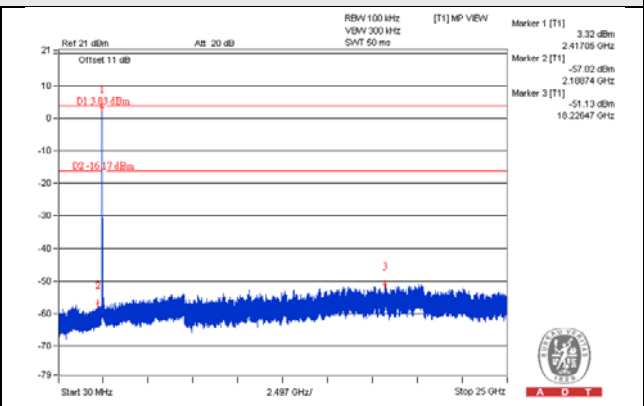
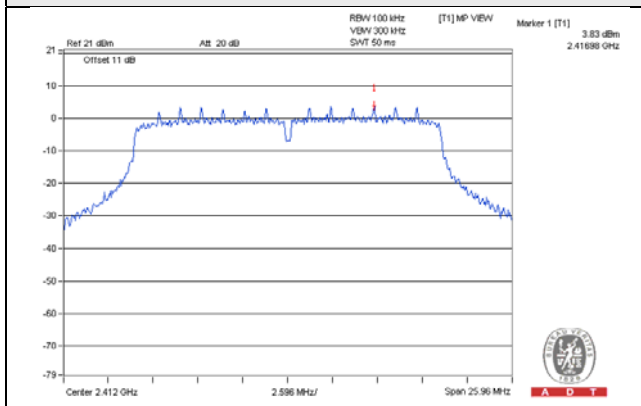

CH 6

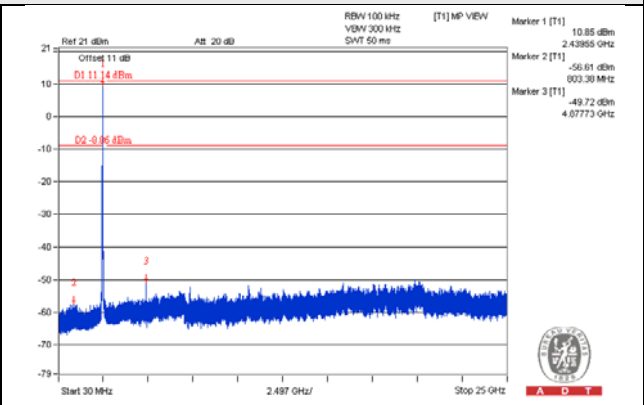
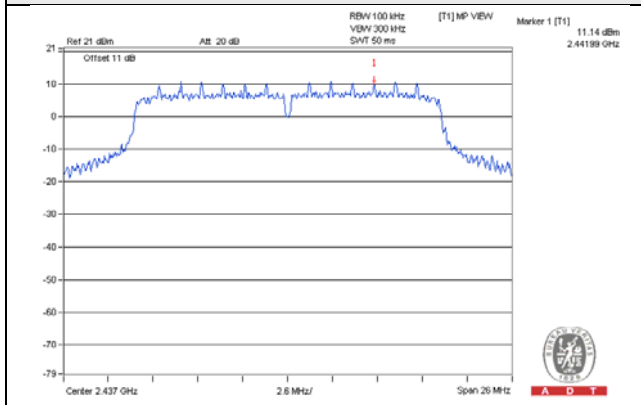

CH 11

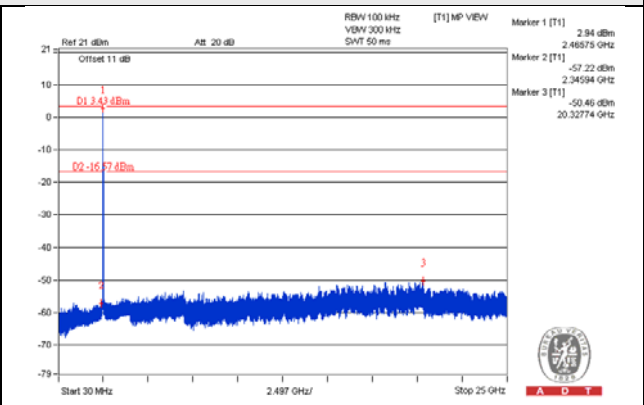
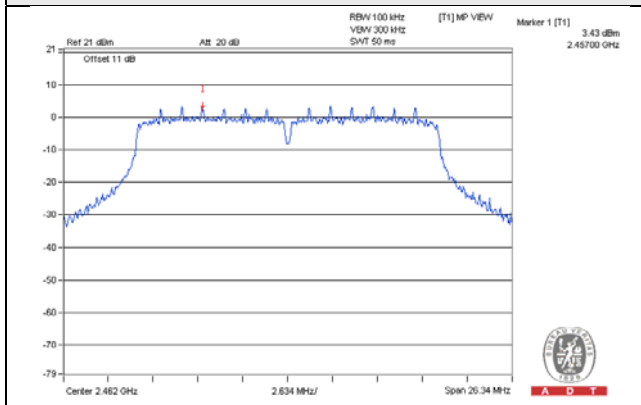

CH 1 Band edge

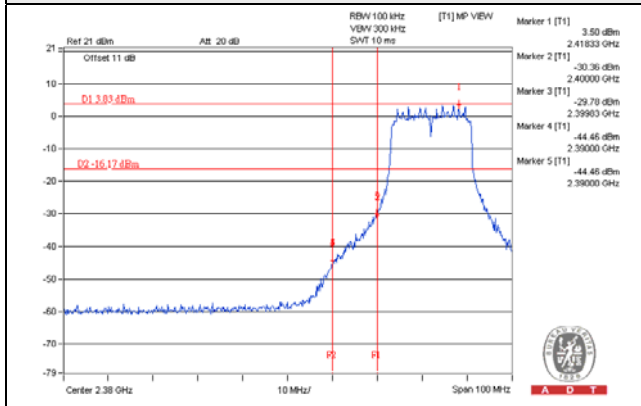

CH 11 Band edge

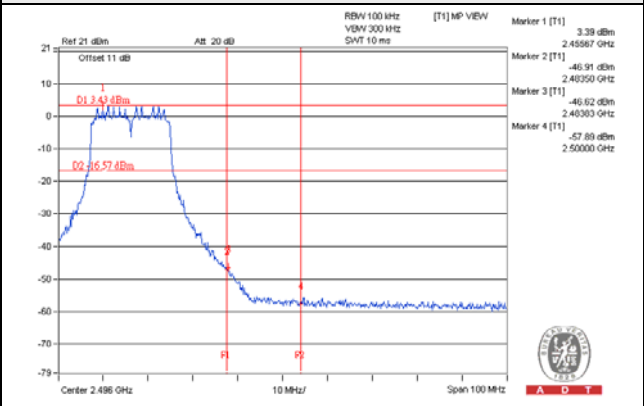

802.11n (HT20)\_ Chain 1

CH 1

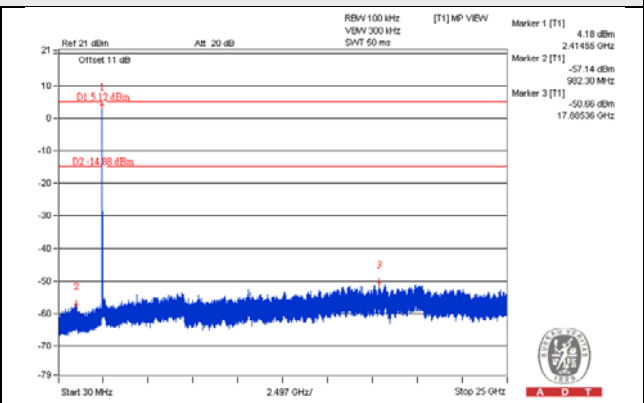
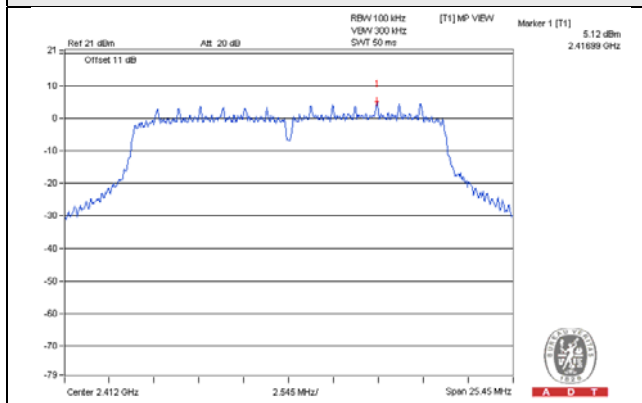

CH 6

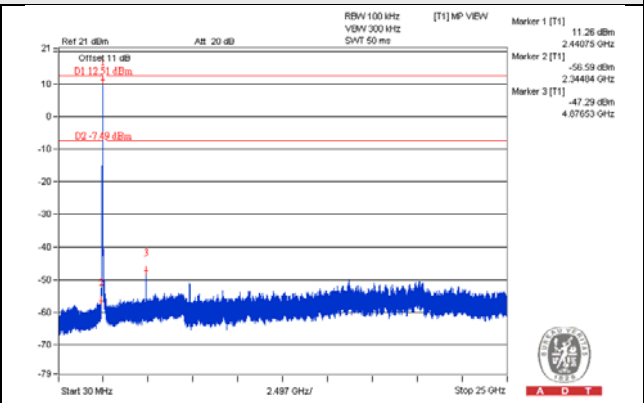
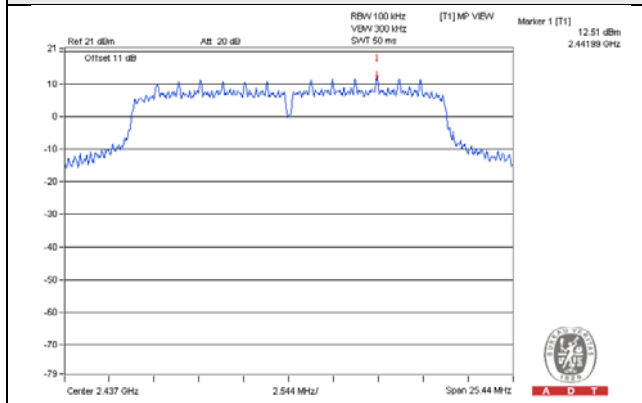

CH 11

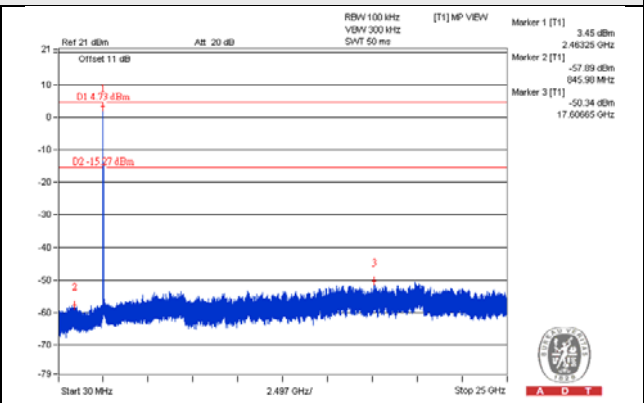
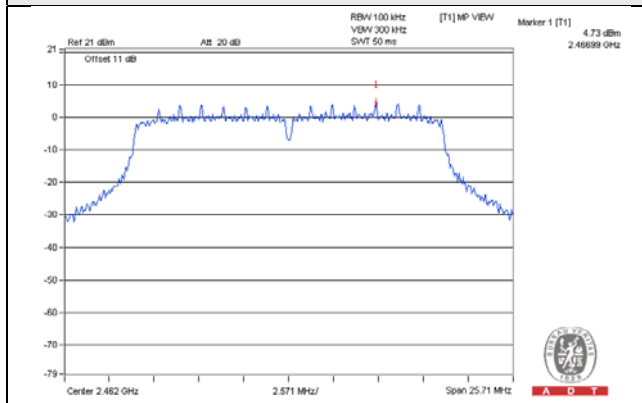

CH 1 Band edge

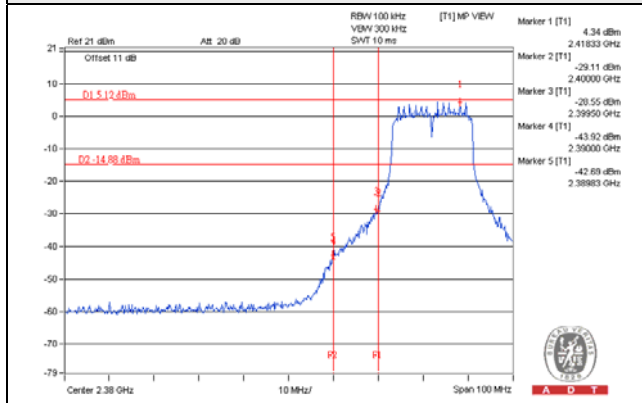

CH 11 Band edge

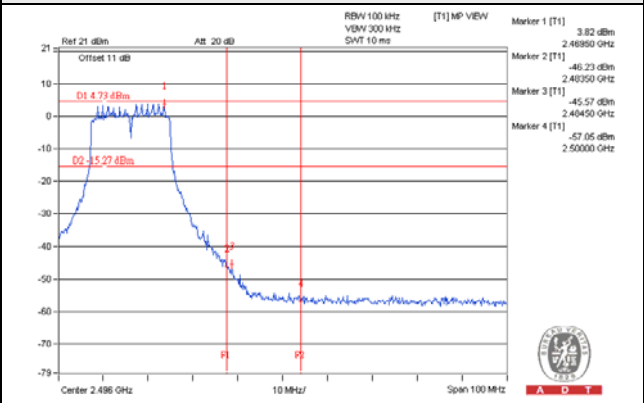

802.11n (HT40)\_ Chain 0

CH 3

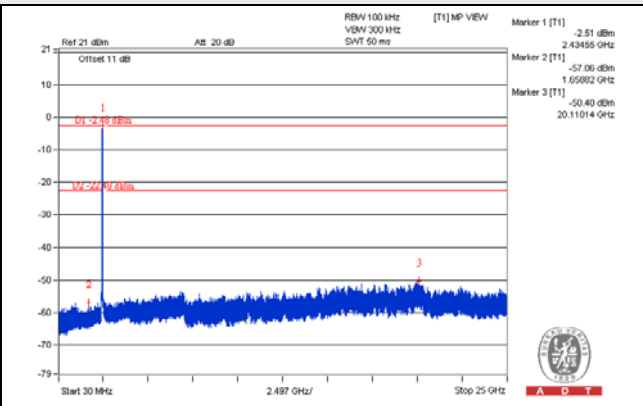
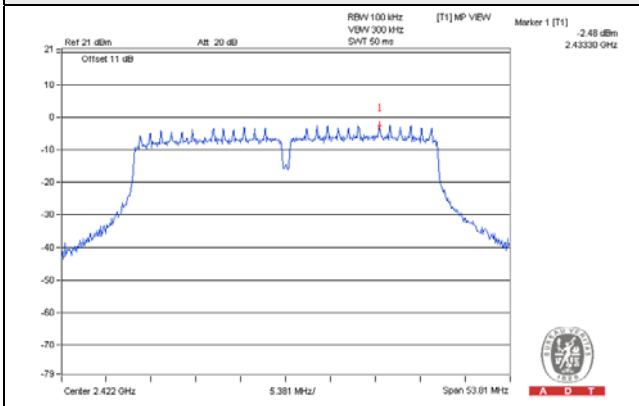

CH 6

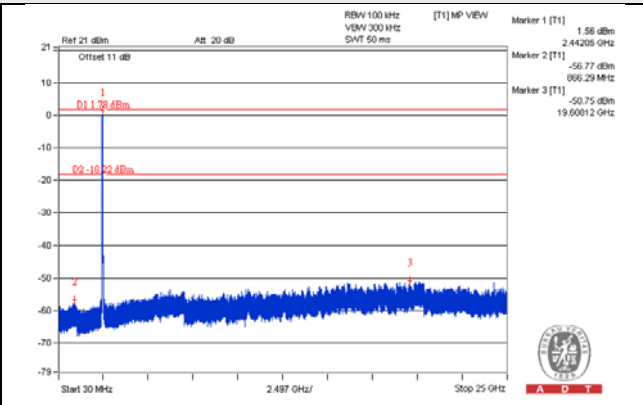
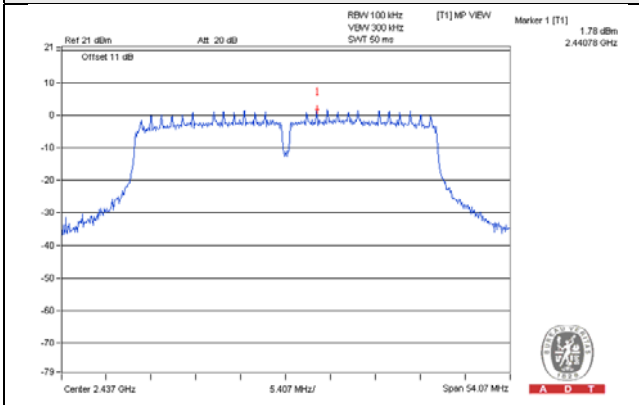

CH 9

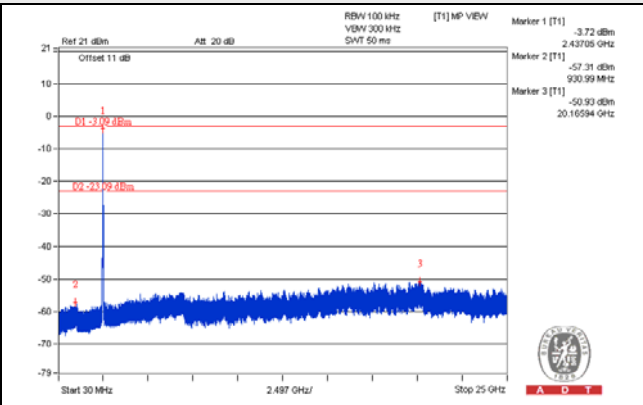
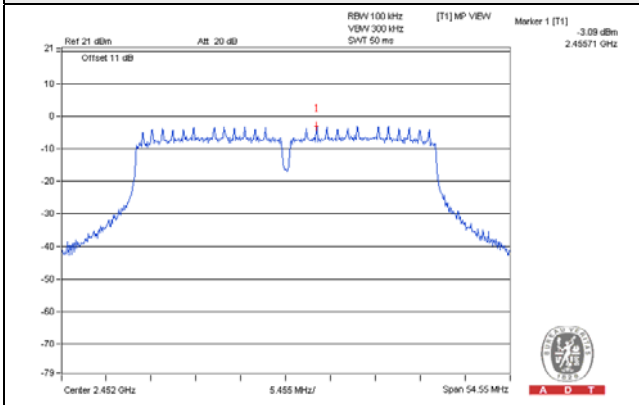

CH 3 Band edge

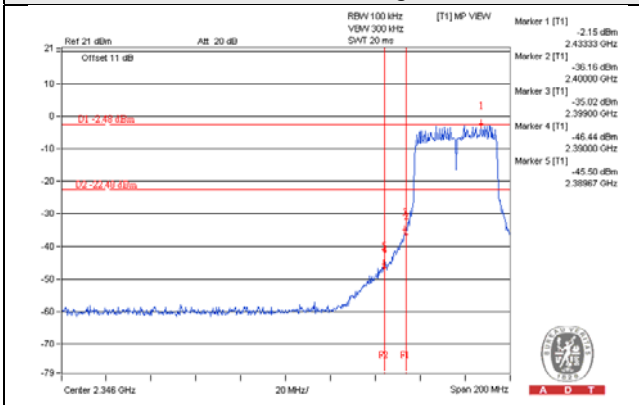

CH 9 Band edge

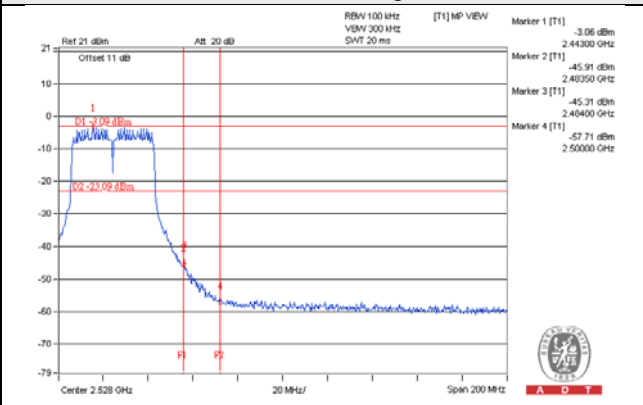

802.11n (HT40)\_ Chain 1

CH 3

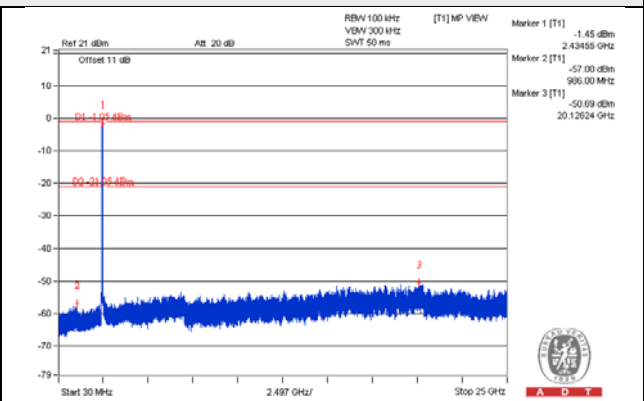
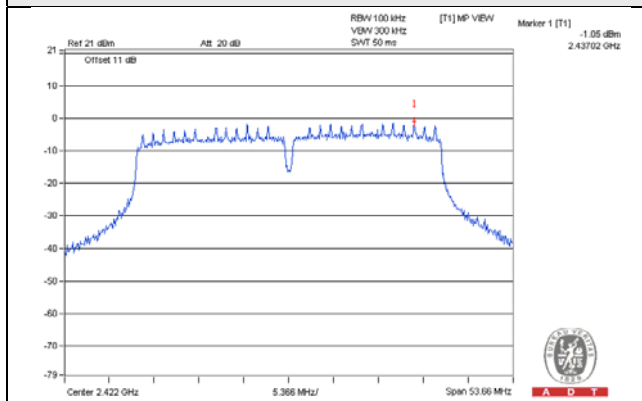

CH 6

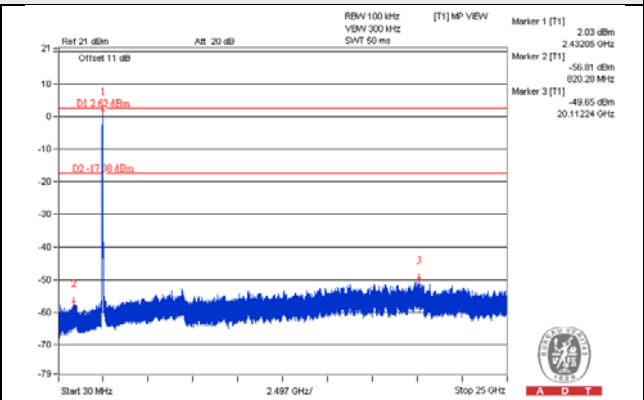
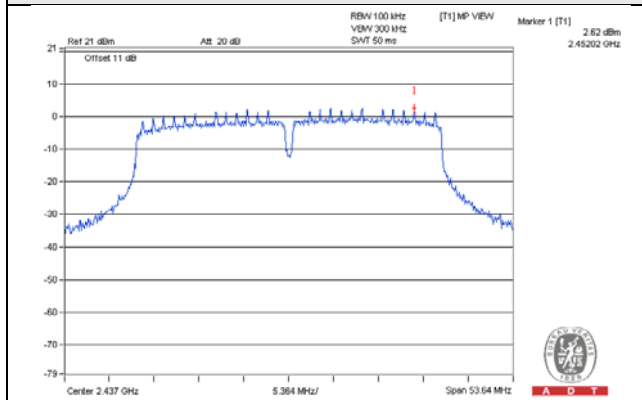

CH 9

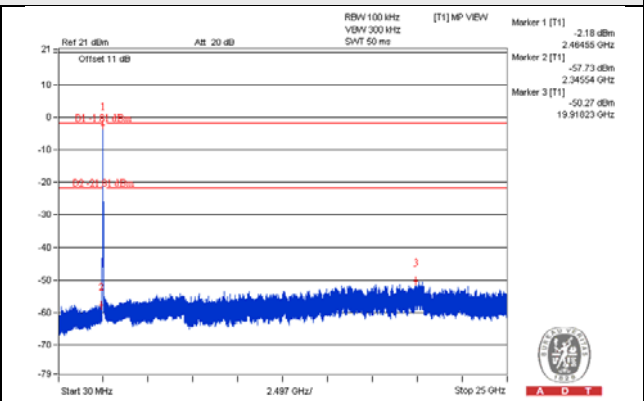
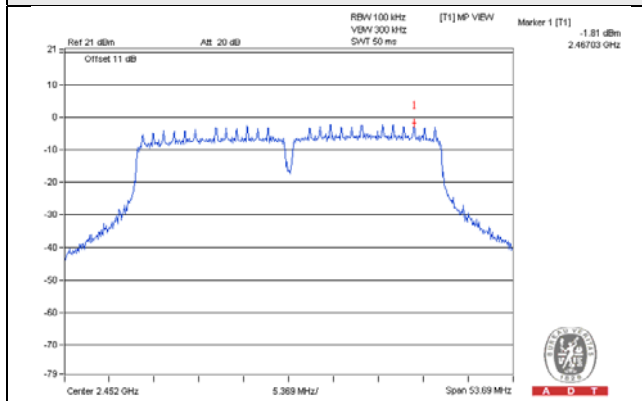

CH 3 Band edge

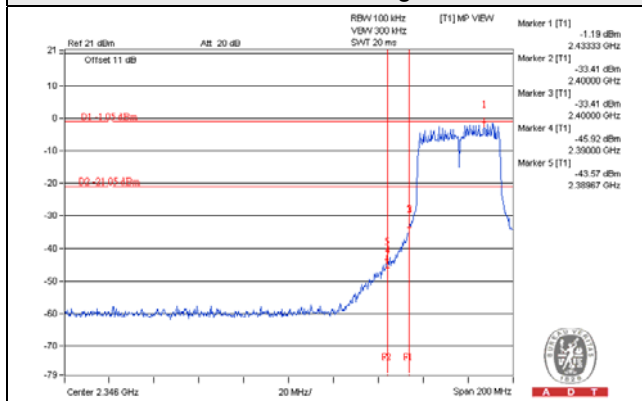

CH 9 Band edge

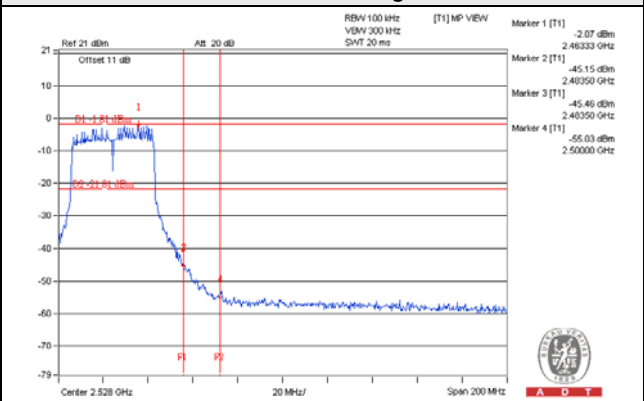

## 5 Pictures of Test Arrangements

Please refer to the attached file (Test Setup Photo).

## Appendix – Information on the Testing Laboratories

We, Bureau Veritas Consumer Products Services (H.K.) Ltd., Taoyuan Branch, were founded in 1988 to provide our best service in EMC, Radio, Telecom and Safety consultation. Our laboratories are FCC recognized accredited test firms and accredited and approved according to ISO/IEC 17025.

If you have any comments, please feel free to contact us at the following:

### Linko EMC/RF Lab

Tel: 886-2-26052180

Fax: 886-2-26051924

### Hsin Chu EMC/RF/Telecom Lab

Tel: 886-3-6668565

Fax: 886-3-6668323

### Hwa Ya EMC/RF/Safety Lab

Tel: 886-3-3183232

Fax: 886-3-3270892

**Email:** [service.adt@tw.bureauveritas.com](mailto:service.adt@tw.bureauveritas.com)

**Web Site:** [www.bureauveritas-adt.com](http://www.bureauveritas-adt.com)

The address and road map of all our labs can be found in our web site also.

--- END ---