



# SPORTON International Inc.

No. 52, Hwa Ya 1st Rd., Kwei-Shan Hsiang, TaoYuan Hsien, Taiwan, R.O.C.  
Ph: 886-3-327-3456 / FAX: 886-3-327-0973 / www.sporton.com.tw

## FCC RADIO TEST REPORT

|                        |  |
|------------------------|--|
| Applicant's company    | Senao Networks, Inc.                                   |
| Applicant Address      | 3F, No. 529, Chung Cheng Rd., Hsintien, Taipei, Taiwan |
| FCC ID                 | U2M-PCE3200AH  |
| Manufacturer's company | Senao Networks, Inc.                                   |
| Manufacturer Address   | 3F, No. 529, Chung Cheng Rd., Hsintien, Taipei, Taiwan |

|                   |                                       |
|-------------------|---------------------------------------|
| Product Name      | 802.11 bgn PCIe Module                |
| Brand Name        | Senao                                 |
| Model Name        | PCE3200AH                             |
| Test Rule Part(s) | 47 CFR FCC Part 15 Subpart C § 15.247 |
| Test Freq. Range  | 2400 ~ 2483.5MHz                      |
| Received Date     | Sep. 12, 2012                         |
| Final Test Date   | Nov. 22, 2012                         |
| Submission Type   | Original Equipment                    |

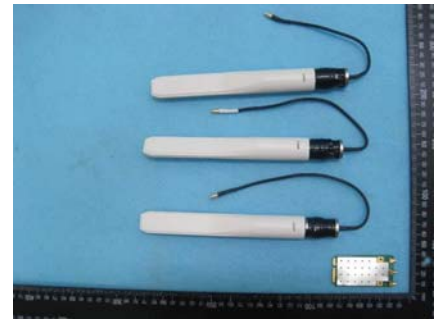

### Statement

**Test result included is only for the IEEE 802.11n, IEEE 802.11b/g part of the product.**

The test result in this report refers exclusively to the presented test model / sample.

Without written approval of SPORTON International Inc., the test report shall not be reproduced except in full.

The measurements and test results shown in this test report were made in accordance with the procedures and found in compliance with the limit given in **ANSI C63.10-2009**,

**47 CFR FCC Part 15 Subpart C, KDB 558074 D01 v02 and KDB 662911 D01 v01r02.**

The test equipment used to perform the test is calibrated and traceable to NML/ROC.



## Table of Contents

|   |                |
|---|----------------|
| <b>1. CERTIFICATE OF COMPLIANCE</b> .....                     | <b>1</b>       |
| <b>2. SUMMARY OF THE TEST RESULT</b> .....                    | <b>2</b>       |
| <b>3. GENERAL INFORMATION</b> .....                           | <b>3</b>       |
| 3.1. Product Details .....                                    | 3              |
| 3.2. Accessories .....  | 5              |
| 3.3. Table for Filed Antenna .....                            | 6              |
| 3.4. Table for Carrier Frequencies .....                      | 7              |
| 3.5. Table for Test Modes .....                               | 8              |
| 3.6. Table for Testing Locations.....                         | 9              |
| 3.7. Table for Supporting Units .....                         | 9              |
| 3.8. Table for Parameters of Test Software Setting .....      | 9              |
| 3.9. Test Configurations.....                                 | 10             |
| <b>4. TEST RESULT</b> .....                                   | <b>13</b>      |
| 4.1. AC Power Line Conducted Emissions Measurement .....      | 13             |
| 4.2. Maximum Conducted Average Output Power Measurement ..... | 17             |
| 4.3. Power Spectral Density Measurement.....                  | 20             |
| 4.4. 6dB Spectrum Bandwidth Measurement .....                 | 26             |
| 4.5. Radiated Emissions Measurement.....                      | 31             |
| 4.6. Band Edge Emissions Measurement.....                     | 49             |
| 4.7. Antenna Requirements .....                               | 62             |
| <b>5. LIST OF MEASURING EQUIPMENTS</b> .....                  | <b>63</b>      |
| <b>6. TEST LOCATION</b> .....                                 | <b>65</b>      |
| <b>7. TAF CERTIFICATE OF ACCREDITATION</b> .....              | <b>66</b>      |
| <b>APPENDIX A. TEST PHOTOS</b> .....                          | <b>A1 ~ A6</b> |
| <b>APPENDIX B. MAXIMUM PERMISSIBLE EXPOSURE</b> .....         | <b>B1 ~ B3</b> |



### History of This Test Report

| REPORT NO. | VERSION | DESCRIPTION             | ISSUED DATE   |
|------------|---------|-------------------------|---------------|
| FR291211AC | Rev. 01 | Initial issue of report | Jan. 07, 2013 |
|            |         |                         |               |
|            |         |                         |               |
|            |         |                         |               |
|            |         |                         |               |
|            |         |                         |               |
|            |         |                         |               |
|            |         |                         |               |
|            |         |                         |               |
|            |         |                         |               |
|            |         |                         |               |
|            |         |                         |               |
|            |         |                         |               |
|            |         |                         |               |
|            |         |                         |               |



## 1. CERTIFICATE OF COMPLIANCE

Product Name : 802.11 bgn PCIe Module  
Brand Name : Senao  
Model Name : PCE3200AH  
Applicant : Senao Networks, Inc.  
Test Rule Part(s) : 47 CFR FCC Part 15 Subpart C § 15.247

Sporton International as requested by the applicant to evaluate the EMC performance of the product sample received on Sep. 12, 2012 would like to declare that the tested sample has been evaluated and found to be in compliance with the tested rule parts. The data recorded as well as the test configuration specified is true and accurate for showing the sample's EMC nature.

A handwritten signature in blue ink that reads 'Jordan Hsiao' is written over a horizontal line.

Jordan Hsiao

SPORTON INTERNATIONAL INC.

## 2. SUMMARY OF THE TEST RESULT

| Applied Standard: 47 CFR FCC Part 15 Subpart C |              |  |          |             |
|--|--------------|--|----------|-------------|
| Part   | Rule Section | Description of Test                    | Result   | Under Limit |
| 4.1  | 15.207       | AC Power Line Conducted Emissions      | Complies | 14.83 dB    |
| 4.2  | 15.247(b)(3) | Maximum Conducted Average Output Power | Complies | 1.16 dB     |
| 4.3  | 15.247(e)    | Power Spectral Density                 | Complies | 1.5 dB      |
| 4.4  | 15.247(a)(2) | 6dB Spectrum Bandwidth                 | Complies | -           |
| 4.5  | 15.247(d)    | Radiated Emissions                     | Complies | 6.59 dB     |
| 4.6  | 15.247(d)    | Band Edge Emissions                    | Complies | 1.17 dB     |
| 4.7  | 15.203       | Antenna Requirements                   | Complies | -           |

| Test Items                                  | Uncertainty           | Remark                   |
|---|-----------------------|--------------------------|
| AC Power Line Conducted Emissions           | ±2.3dB                | Confidence levels of 95% |
| Maximum Conducted Average Output Power      | ±0.8dB                | Confidence levels of 95% |
| Power Spectral Density                      | ±0.5dB                | Confidence levels of 95% |
| 6dB Spectrum Bandwidth                      | ±8.5×10 <sup>-8</sup> | Confidence levels of 95% |
| Radiated Emissions (9kHz~30MHz)             | ±0.8dB                | Confidence levels of 95% |
| Radiated Emissions (30MHz~1000MHz)          | ±1.9dB                | Confidence levels of 95% |
| Radiated / Band Edge Emissions (1GHz~18GHz) | ±1.9dB                | Confidence levels of 95% |
| Radiated Emissions (18GHz~40GHz)            | ±1.9dB                | Confidence levels of 95% |
| Temperature                                 | ±0.7°C                | Confidence levels of 95% |
| Humidity                                    | ±3.2%                 | Confidence levels of 95% |
| DC / AC Power Source                        | ±1.4%                 | Confidence levels of 95% |

### 3. GENERAL INFORMATION

#### 3.1. Product Details

##### IEEE 802.11n

| Items                                  | Description                                       |
|--|---|
| Product Type                           | WLAN (3TX, 3RX)                                   |
| Radio Type                             | Intentional Transceiver                           |
| Power Type                             | From Host System                                  |
| Modulation                             | see the below table for IEEE 802.11n              |
| Data Modulation                        | OFDM (BPSK / QPSK / 16QAM / 64QAM)                |
| Data Rate (Mbps)                       | see the below table for IEEE 802.11n              |
| Frequency Range                        | 2400 ~ 2483.5MHz                                  |
| Channel Number                         | 11 for 20MHz bandwidth ; 7 for 40MHz bandwidth    |
| Channel Band Width (99%)               | MCS0 (20MHz): 17.84 MHz ; MCS0 (40MHz): 36.32 MHz |
| Maximum Conducted Average Output Power | MCS0 (20MHz): 28.75 dBm ; MCS0 (40MHz): 23 dBm    |
| Carrier Frequencies                    | Please refer to section 3.4                       |
| Antenna                                | Please refer to section 3.3                       |

##### 802.11b/g

| Items                                  | Description   |
|--|---|
| Product Type                           | WLAN (3TX, 3RX)   |
| Radio Type                             | Intentional Transceiver                                       |
| Power Type                             | From Host System  |
| Modulation                             | DSSS for IEEE 802.11b ; OFDM for IEEE 802.11g                 |
| Data Modulation                        | DSSS (BPSK / QPSK / CCK) ; OFDM (BPSK / QPSK / 16QAM / 64QAM) |
| Data Rate (Mbps)                       | DSSS (1/ 2/ 5.5/11) ; OFDM (6/9/12/18/24/36/48/54)            |
| Frequency Range                        | 2400 ~ 2483.5MHz  |
| Channel Number                         | 11b/g: 11   |
| Channel Band Width (99%)               | 11b: 15.20 MHz ; 11g: 16.88 MHz                               |
| Maximum Conducted Average Output Power | 11b: 28.61 dBm ; 11g: 28.84 dBm                               |
| Carrier Frequencies                    | Please refer to section 3.4                                   |
| Antenna                                | Please refer to section 3.3                                   |

**Antenna & Band width**

| Antenna         | Single (TX) |        | Two (TX) |        | Three (TX) |        |
|-----------------|-------------|--------|----------|--------|------------|--------|
|                 | 20 MHz      | 40 MHz | 20 MHz   | 40 MHz | 20 MHz     | 40 MHz |
| Band width Mode | 20 MHz      | 40 MHz | 20 MHz   | 40 MHz | 20 MHz     | 40 MHz |
| IEEE 802.11b    | X           | X      | X        | X      | V          | X      |
| IEEE 802.11g    | X           | X      | X        | X      | V          | X      |
| IEEE 802.11n    | X           | X      | X        | X      | V          | V      |

**IEEE 802.11n spec**

| MCS<br>index | Spatial<br>streams | Modulation<br>type | Coding<br>rate | Data rate (Mbit/s) |           |                |           |
|--------------|--------------------|--------------------|----------------|--------------------|-----------|----------------|-----------|
|              |                    |                    |                | 20 MHz channel     |           | 40 MHz channel |           |
|              |                    |                    |                | 800 ns GI          | 400 ns GI | 800 ns GI      | 400 ns GI |
| 0            | 1                  | BPSK               | 1/2            | 6.5                | 7.2       | 13.5           | 15        |
| 1            | 1                  | QPSK               | 1/2            | 13                 | 14.4      | 27             | 30        |
| 2            | 1                  | QPSK               | 3/4            | 19.5               | 21.7      | 40.5           | 45        |
| 3            | 1                  | 16-QAM             | 1/2            | 26                 | 28.9      | 54             | 60        |
| 4            | 1                  | 16-QAM             | 3/4            | 39                 | 43.3      | 81             | 90        |
| 5            | 1                  | 64-QAM             | 2/3            | 52                 | 57.8      | 108            | 120       |
| 6            | 1                  | 64-QAM             | 3/4            | 58.5               | 65        | 121.5          | 135       |
| 7            | 1                  | 64-QAM             | 5/6            | 65                 | 72.2      | 135            | 150       |
| 8            | 2                  | BPSK               | 1/2            | 13                 | 14.4      | 27             | 30        |
| 9            | 2                  | QPSK               | 1/2            | 26                 | 28.9      | 54             | 60        |
| 10           | 2                  | QPSK               | 3/4            | 39                 | 43.3      | 81             | 90        |
| 11           | 2                  | 16-QAM             | 1/2            | 52                 | 57.8      | 108            | 120       |
| 12           | 2                  | 16-QAM             | 3/4            | 78                 | 86.7      | 162            | 180       |
| 13           | 2                  | 64-QAM             | 2/3            | 104                | 115.6     | 216            | 240       |
| 14           | 2                  | 64-QAM             | 3/4            | 117                | 130       | 243            | 270       |
| 15           | 2                  | 64-QAM             | 5/6            | 130                | 144.4     | 270            | 300       |
| 16           | 3                  | BPSK               | 1/2            | 19.5               | 21.7      | 40.5           | 45        |
| 17           | 3                  | QPSK               | 1/2            | 39                 | 43.3      | 81             | 90        |
| 18           | 3                  | QPSK               | 3/4            | 58.5               | 65        | 121.5          | 135       |
| 19           | 3                  | 16-QAM             | 1/2            | 78                 | 86.7      | 162            | 180       |
| 20           | 3                  | 16-QAM             | 3/4            | 117                | 130       | 243            | 270       |
| 21           | 3                  | 64-QAM             | 2/3            | 156                | 173.3     | 324            | 360       |
| 22           | 3                  | 64-QAM             | 3/4            | 175.5              | 195       | 364.5          | 405       |
| 23           | 3                  | 64-QAM             | 5/6            | 195                | 216.7     | 405            | 450       |

| Symbol | Explanation                             |
|--------|---|
| NSS    | Number of spatial streams               |
| R      | Code rate                               |
| NBPSC  | Number of coded bits per single carrier |
| NCBPS  | Number of coded bits per symbol         |
| NDBPS  | Number of data bits per symbol          |
| GI     | guard interval                          |

### 3.2. Accessories

N/A



### 3.3. Table for Filed Antenna

| Ant. | Brand                           | Model Name   | Antenna Type   | Connector | Gain (dBi) |
|------|---------------------------------|--------------|----------------|-----------|------------|
| 1    | Master Wave Technology CO., LTD | 98618MNXX001 | Dipole Antenna | MMCX      | 5          |
| 2    | Master Wave Technology CO., LTD | 98618MNXX001 | Dipole Antenna | MMCX      | 5          |
| 3    | Master Wave Technology CO., LTD | 98618MNXX001 | Dipole Antenna | MMCX      | 5          |

Note: The EUT has three antennas. (3TX/3RX)

**For IEEE 802.11bgn mode (3TX/3RX)**

Antenna 1 & Antenna 2 and Antenna 3 could transmit/receive simultaneously

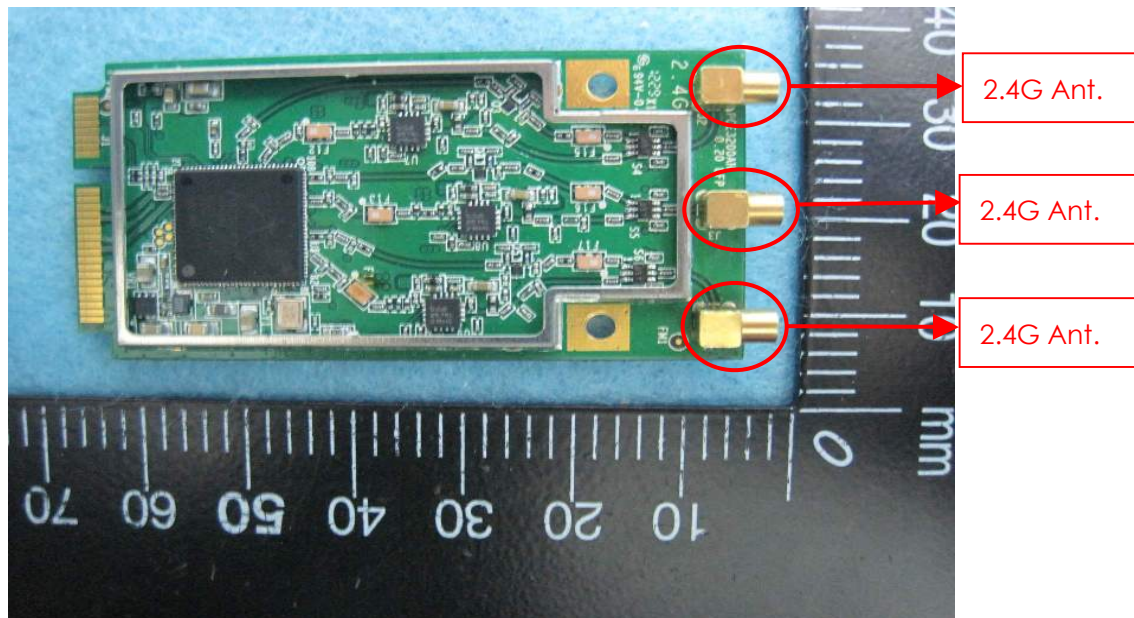

### 3.4. Table for Carrier Frequencies

For IEEE 802.11b/g, use Channel 1~Channel 11.

There are two bandwidth systems for IEEE 802.11n.

For both 20MHz bandwidth systems, use Channel 1~Channel 11.

For both 40MHz bandwidth systems, use Channel 3~Channel 9.

| Frequency Band | Channel No. | Frequency | Channel No. | Frequency |
|----------------|-------------|-----------|-------------|-----------|
| 2400~2483.5MHz | 1           | 2412 MHz  | 7           | 2442 MHz  |
|                | 2           | 2417 MHz  | 8           | 2447 MHz  |
|                | 3           | 2422 MHz  | 9           | 2452 MHz  |
|                | 4           | 2427 MHz  | 10          | 2457 MHz  |
|                | 5           | 2432 MHz  | 11          | 2462 MHz  |
|                | 6           | 2437 MHz  | -           | -         |

### 3.5. Table for Test Modes

Preliminary tests were performed in different data rate to find the worst radiated emission. The data rate shown in the table below is the worst-case rate with respect to the specific test item. Investigation has been done on all the possible configurations for searching the worst cases. The following table is a list of the test modes shown in this test report.

| Test Items                             | Mode       | Data Rate | Channel | Antenna     |
|--|------------|-----------|---------|-------------|
| AC Power Line Conducted Emissions      | CTX        | Auto      | -       | -           |
| Maximum Conducted Average Output Power | MCS0/20MHz | 7.2 Mbps  | 1/6/11  | 1/2/3/1+2+3 |
|  | MCS0/40MHz | 14.4 Mbps | 3/6/9   | 1/2/3/1+2+3 |
|  | 11b/CCK    | 1 Mbps    | 1/6/11  | 1/2/3/1+2+3 |
|  | 11g/BPSK   | 6 Mbps    | 1/6/11  | 1/2/3/1+2+3 |
| Power Spectral Density                 | MCS0/20MHz | 7.2 Mbps  | 1/6/11  | 1/2/3       |
|  | MCS0/40MHz | 14.4 Mbps | 3/6/9   | 1/2/3       |
|  | 11b/CCK    | 1 Mbps    | 1/6/11  | 1/2/3       |
|  | 11g/BPSK   | 6 Mbps    | 1/6/11  | 1/2/3       |
| 6dB Spectrum Bandwidth                 | MCS0/20MHz | 7.2 Mbps  | 1/6/11  | 1+2+3       |
|  | MCS0/40MHz | 14.4 Mbps | 3/6/9   | 1+2+3       |
|  | 11b/CCK    | 1 Mbps    | 1/6/11  | 1+2+3       |
|  | 11g/BPSK   | 6 Mbps    | 1/6/11  | 1+2+3       |
| Radiated Emissions Below 1GHz          | CTX        | Auto      | -       | -           |
| Radiated Emissions Above 1GHz          | MCS0/20MHz | 7.2 Mbps  | 1/6/11  | 1+2+3       |
|  | MCS0/40MHz | 14.4 Mbps | 3/6/9   | 1+2+3       |
|  | 11b/CCK    | 1 Mbps    | 1/6/11  | 1+2+3       |
|  | 11g/BPSK   | 6 Mbps    | 1/6/11  | 1+2+3       |
| Band Edge Emissions                    | MCS0/20MHz | 7.2 Mbps  | 1/6/11  | 1+2+3       |
|  | MCS0/40MHz | 14.4 Mbps | 3/6/9   | 1+2+3       |
|  | 11b/CCK    | 1 Mbps    | 1/6/11  | 1+2+3       |
|  | 11g/BPSK   | 6 Mbps    | 1/6/11  | 1+2+3       |

### 3.6. Table for Testing Locations

| Test Site No. | Site Category | Location | FCC Reg. No. | IC File No. |
|---------------|---------------|----------|--------------|-------------|
| 03CH01-CB     | SAC           | Hsin Chu | 262045       | IC 4086D    |
| CO01-CB       | Conduction    | Hsin Chu | 262045       | IC 4086D    |
| TH01-CB       | OVEN Room     | Hsin Chu | -            | -           |

Open Area Test Site (OATS); Semi Anechoic Chamber (SAC).

Please refer section 6 for Test Site Address.

### 3.7. Table for Supporting Units

| Support Unit | Brand | Model | FCC ID       |
|--------------|-------|-------|--------------|
| Notebook     | DELL  | E6220 | E2KWM3945ABG |

### 3.8. Table for Parameters of Test Software Setting

During testing, Channel & Power Controlling Software provided by the customer was used to control the operating channel as well as the output power level. The RF output power selection is for the setting of RF output power expected by the customer and is going to be fixed on the firmware of the final end product.

#### Power Parameters of IEEE 802.11n MCS0 20MHz

| Test Software Version | ART2-GUI Version:2.3 Build |          |          |
|-----------------------|----------------------------|----------|----------|
| Frequency             | 2412 MHz                   | 2437 MHz | 2462 MHz |
| MCS0 20MHz            | 15.5                       | 25       | 15       |

#### Power Parameters of IEEE 802.11n MCS0 40MHz

| Test Software Version | ART2-GUI Version:2.3 Build |          |          |
|-----------------------|----------------------------|----------|----------|
| Frequency             | 2422 MHz                   | 2437 MHz | 2452 MHz |
| MCS0 40MHz            | 13                         | 17.5     | 12.5     |

#### Power Parameters of IEEE 802.11b/g

| Test Software Version | ART2-GUI Version:2.3 Build |          |          |
|-----------------------|----------------------------|----------|----------|
| Frequency             | 2412 MHz                   | 2437 MHz | 2462 MHz |
| IEEE 802.11b          | 21                         | 25       | 21.5     |
| IEEE 802.11g          | 18                         | 25       | 14       |

During the test, "ART2-GUI Version:2.3 Build" under WIN XP was executed the test program to control the EUT continuously transmit RF signal.

### 3.9. Test Configurations

#### 3.9.1. Radiation Emissions Test Configuration

Test Configuration: 30MHz~1GHz

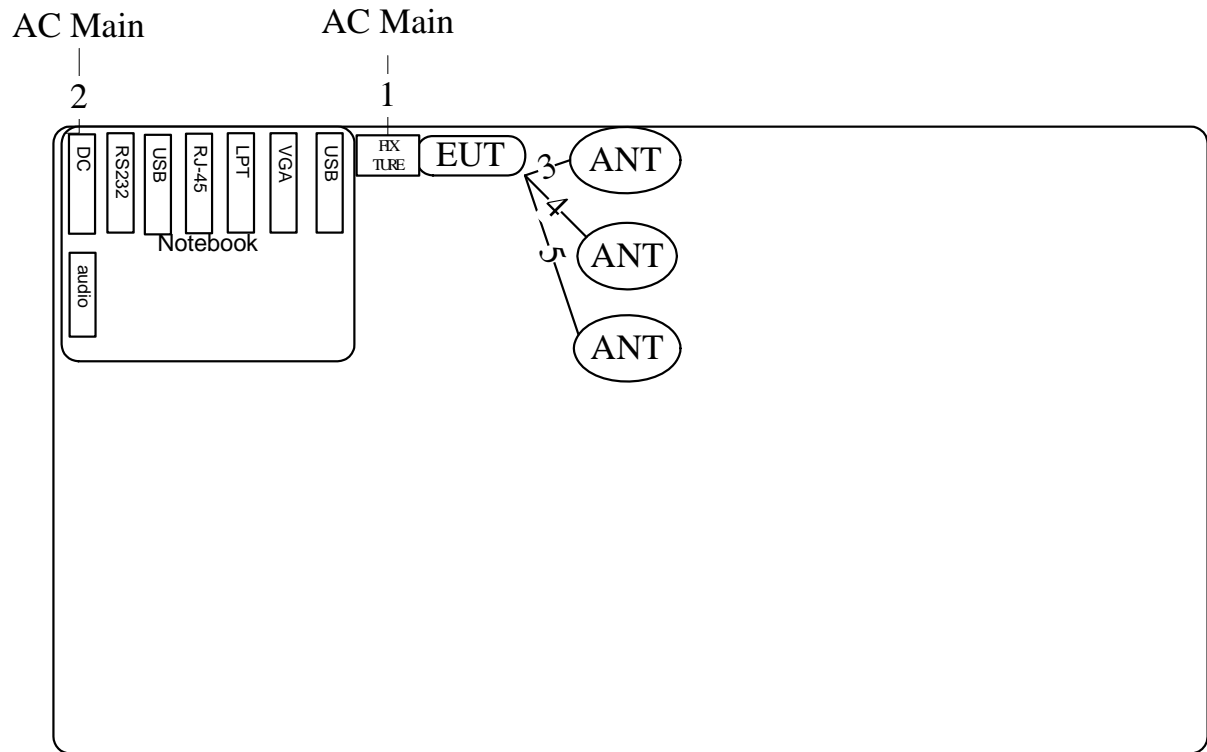

| Item | Connection  | Shield | Length |
|------|-------------|--------|--------|
| 1    | Power cable | No     | 3.4M   |
| 2    | Power cable | No     | 2.6M   |
| 3    | ANT cable   | No     | 0.2M   |
| 4    | ANT cable   | No     | 0.2M   |
| 5    | ANT cable   | No     | 0.2M   |

Test Configuration: above 1GHz

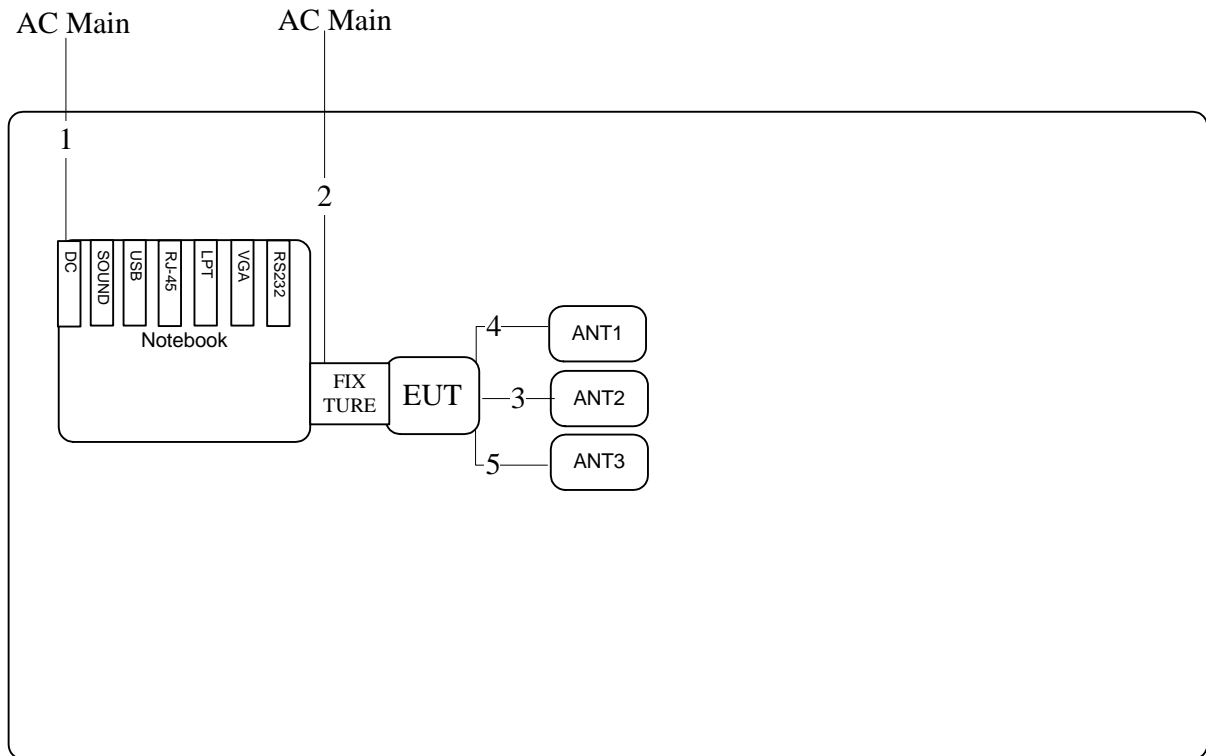

| Item | Connection  | Shield | Length |
|------|-------------|--------|--------|
| 1    | Power cable | No     | 1.8M   |
| 2    | Power cable | No     | 1.8M   |
| 3    | ANT cable   | Yes    | 0.105M |
| 4    | ANT cable   | No     | 0.175M |
| 5    | ANT cable   | Yes    | 0.175M |

### 3.9.2. AC Power Line Conduction Emissions Test Configuration

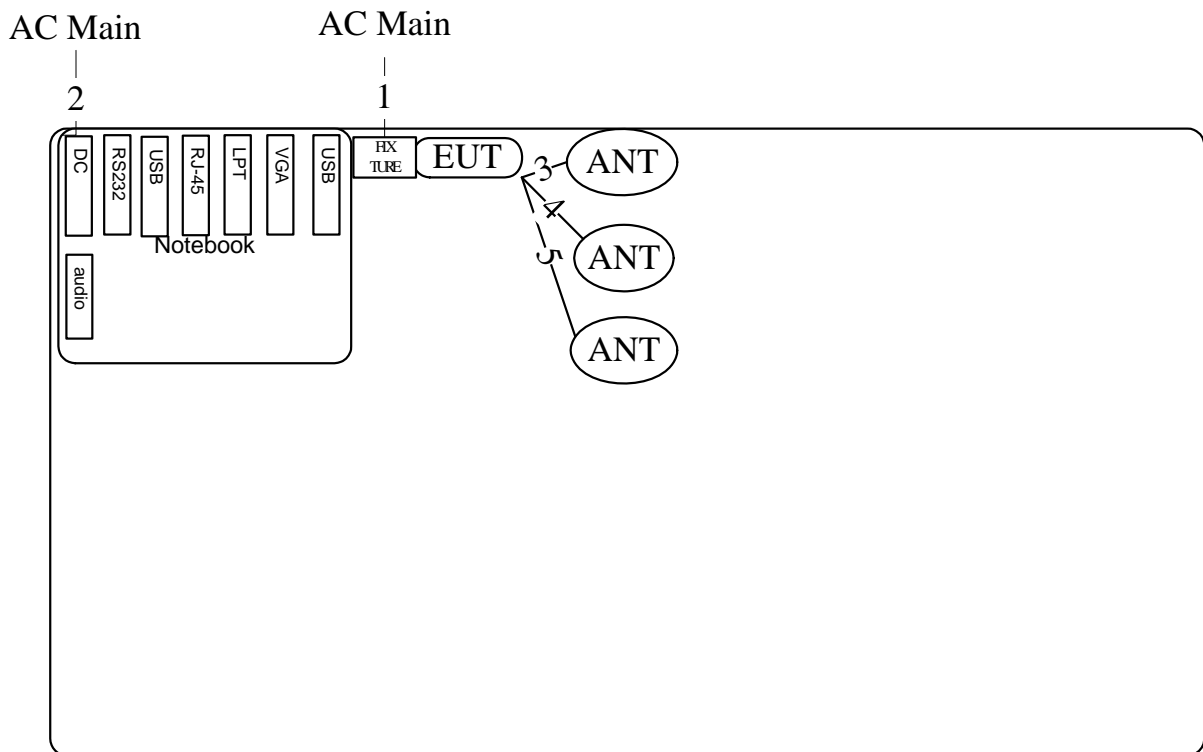

| Item | Connection  | Shield | Length |
|------|-------------|--------|--------|
| 1    | Power cable | No     | 3.4M   |
| 2    | Power cable | No     | 2.6M   |
| 3    | ANT cable   | No     | 0.2M   |
| 4    | ANT cable   | No     | 0.2M   |
| 5    | ANT cable   | No     | 0.2M   |

## 4. TEST RESULT

### 4.1. AC Power Line Conducted Emissions Measurement

#### 4.1.1. Limit

For this product which is designed to be connected to the AC power line, the radio frequency voltage that is conducted back onto the AC power line on any frequency or frequencies within the band 150 kHz to 30 MHz shall not exceed below limits table.

| Frequency (MHz) | QP Limit (dBuV) | AV Limit (dBuV) |
|-----------------|-----------------|-----------------|
| 0.15~0.5        | 66~56           | 56~46           |
| 0.5~5           | 56              | 46              |
| 5~30            | 60              | 50              |

#### 4.1.2. Measuring Instruments and Setting

Please refer to section 5 of equipments list in this report. The following table is the setting of the receiver.

| Receiver Parameters | Setting  |
|---------------------|----------|
| Attenuation         | 10 dB    |
| Start Frequency     | 0.15 MHz |
| Stop Frequency      | 30 MHz   |
| IF Bandwidth        | 9 KHz    |

#### 4.1.3. Test Procedures

1. Configure the EUT according to ANSI C63.10. The EUT or host of EUT has to be placed 0.4 meter far from the conducting wall of the shielding room and at least 80 centimeters from any other grounded conducting surface.
2. Connect EUT or host of EUT to the power mains through a line impedance stabilization network (LISN).
3. All the support units are connected to the other LISNs. The LISN should provide 50uH/50ohms coupling impedance.
4. The frequency range from 150 KHz to 30 MHz was searched.
5. Set the test-receiver system to Peak Detect Function and Specified Bandwidth with Maximum Hold Mode.
6. The measurement has to be done between each power line and ground at the power terminal.



#### 4.1.4. Test Setup Layout

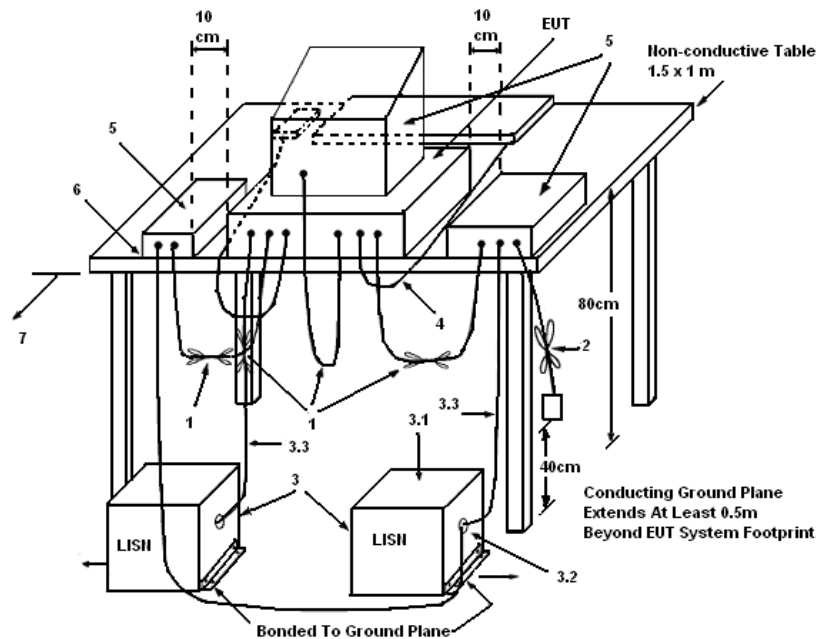

#### LEGEND:

- (1) Interconnecting cables that hang closer than 40 cm to the ground plane shall be folded back and forth in the center forming a bundle 30 to 40 cm long.
- (2) I/O cables that are not connected to a peripheral shall be bundled in the center. The end of the cable may be terminated, if required, using the correct terminating impedance. The overall length shall not exceed 1 m.
- (3) EUT connected to one LISN. Unused LISN measuring port connectors shall be terminated in 50  $\Omega$ . LISN can be placed on top of, or immediately beneath, reference ground plane.
  - (3.1) All other equipment powered from additional LISN(s).
  - (3.2) Multiple outlet strip can be used for multiple power cords of non-EUT equipment.
  - (3.3) LISN at least 80 cm from nearest part of EUT chassis.
- (4) Cables of hand-operated devices, such as keyboards, mice, etc., shall be placed as for normal use.
- (5) Non-EUT components of EUT system being tested.
- (6) Rear of EUT, including peripherals, shall all be aligned and flush with rear of tabletop.
- (7) Rear of tabletop shall be 40 cm removed from a vertical conducting plane that is bonded to the ground plane.

#### 4.1.5. Test Deviation

There is no deviation with the original standard.

#### 4.1.6. EUT Operation during Test

The EUT was placed on the test table and programmed in normal function.

## 4.1.7. Results of AC Power Line Conducted Emissions Measurement

|               |          |          |      |
|---------------|----------|----------|------|
| Temperature   | 24°C     | Humidity | 58%  |
| Test Engineer | Sollo Lo | Phase    | Line |
| Configuration | CTX      |          |      |

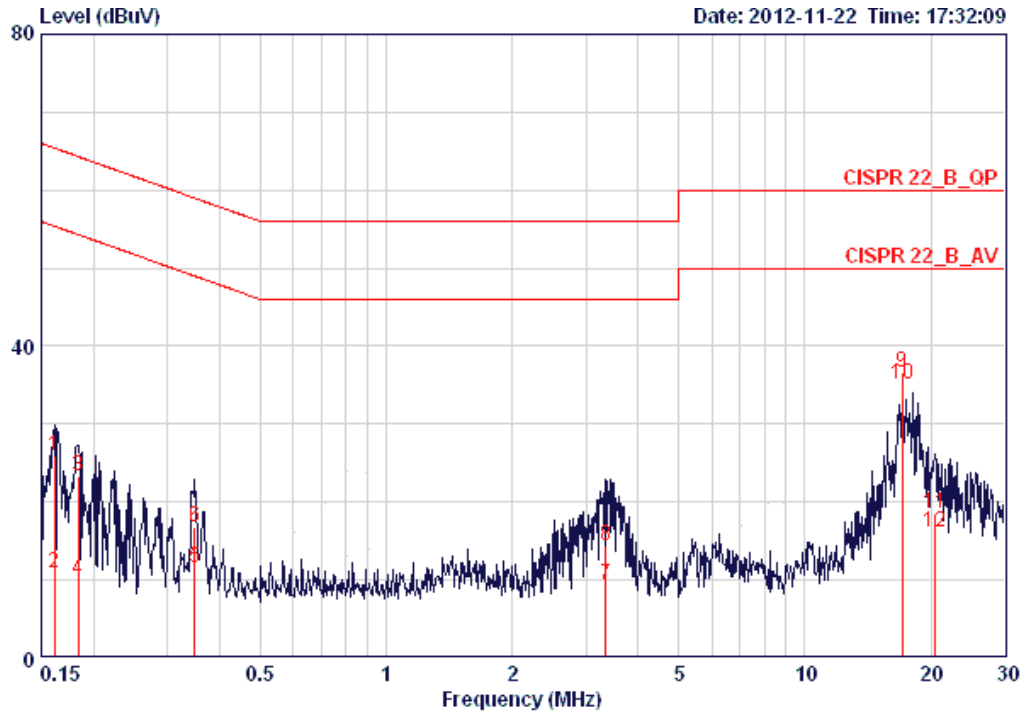

|    | Freq    | Level | Over Limit | Limit Line | Read Level | LISN Factor | Cable Loss | Pol/Phase | Remark  |
|----|---------|-------|------------|------------|------------|-------------|------------|-----------|---------|
|    | MHz     | dBuV  | dB         | dBuV       | dBuV       | dB          | dB         |           |         |
| 1  | 0.16155 | 25.95 | -39.43     | 65.38      | 25.59      | 0.16        | 0.20       | LINE      | QP      |
| 2  | 0.16155 | 10.93 | -44.45     | 55.38      | 10.57      | 0.16        | 0.20       | LINE      | AVERAGE |
| 3  | 0.18346 | 23.41 | -40.92     | 64.33      | 23.06      | 0.15        | 0.20       | LINE      | QP      |
| 4  | 0.18346 | 10.04 | -44.29     | 54.33      | 9.69       | 0.15        | 0.20       | LINE      | AVERAGE |
| 5  | 0.34830 | 11.51 | -37.49     | 49.00      | 11.16      | 0.15        | 0.20       | LINE      | AVERAGE |
| 6  | 0.34830 | 16.81 | -42.19     | 59.00      | 16.46      | 0.15        | 0.20       | LINE      | QP      |
| 7  | 3.347   | 9.30  | -36.70     | 46.00      | 8.82       | 0.21        | 0.27       | LINE      | AVERAGE |
| 8  | 3.347   | 14.32 | -41.68     | 56.00      | 13.84      | 0.21        | 0.27       | LINE      | QP      |
| 9  | 17.109  | 36.63 | -23.37     | 60.00      | 35.69      | 0.44        | 0.50       | LINE      | QP      |
| 10 | 17.109  | 35.17 | -14.83     | 50.00      | 34.23      | 0.44        | 0.50       | LINE      | AVERAGE |
| 11 | 20.377  | 18.45 | -41.55     | 60.00      | 17.46      | 0.49        | 0.50       | LINE      | QP      |
| 12 | 20.377  | 16.04 | -33.96     | 50.00      | 15.05      | 0.49        | 0.50       | LINE      | AVERAGE |

|               |          |          |         |
|---------------|----------|----------|---------|
| Temperature   | 24°C     | Humidity | 58%     |
| Test Engineer | Sollo Lo | Phase    | Neutral |
| Configuration | CTX      |          |         |

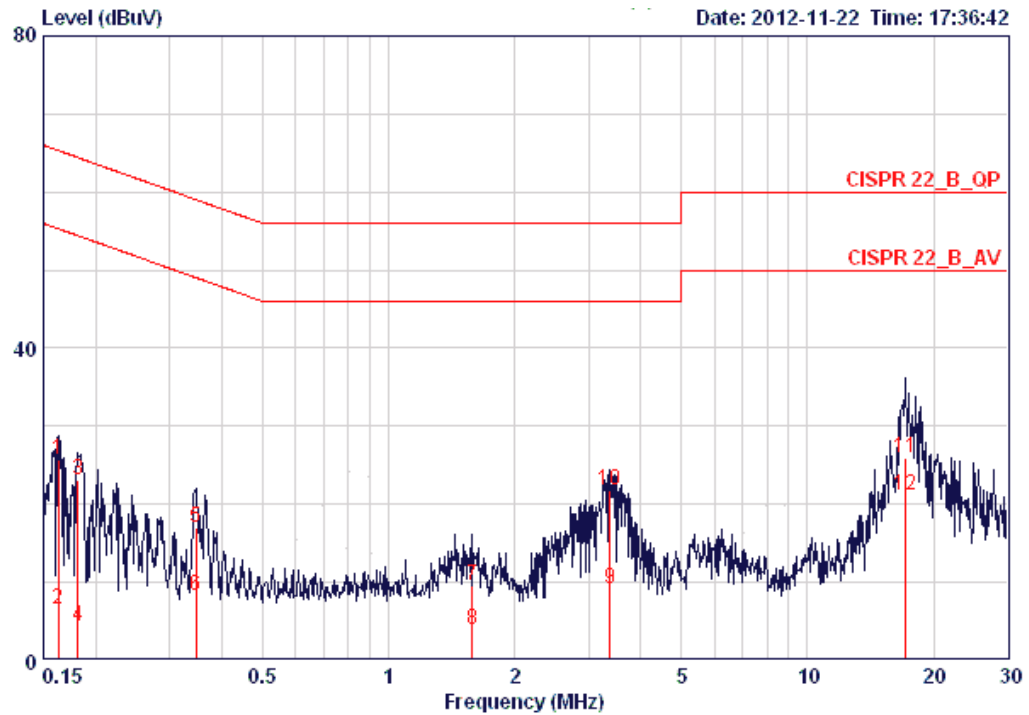

|    | Freq    | Level | Over Limit | Limit Line | Read Level | LISN Factor | Cable Loss | Pol/Phase | Remark  |
|----|---------|-------|------------|------------|------------|-------------|------------|-----------|---------|
|    | MHz     | dBuV  | dB         | dBuV       | dBuV       | dB          | dB         |           |         |
| 1  | 0.16241 | 25.70 | -39.64     | 65.34      | 25.42      | 0.08        | 0.20       | NEUTRAL   | QP      |
| 2  | 0.16241 | 6.50  | -48.84     | 55.34      | 6.22       | 0.08        | 0.20       | NEUTRAL   | AVERAGE |
| 3  | 0.18152 | 23.08 | -41.34     | 64.42      | 22.80      | 0.08        | 0.20       | NEUTRAL   | QP      |
| 4  | 0.18152 | 4.29  | -50.13     | 54.42      | 4.01       | 0.08        | 0.20       | NEUTRAL   | AVERAGE |
| 5  | 0.34646 | 16.90 | -42.15     | 59.05      | 16.62      | 0.08        | 0.20       | NEUTRAL   | QP      |
| 6  | 0.34646 | 8.33  | -40.72     | 49.05      | 8.05       | 0.08        | 0.20       | NEUTRAL   | AVERAGE |
| 7  | 1.585   | 9.59  | -46.41     | 56.00      | 9.37       | 0.10        | 0.12       | NEUTRAL   | QP      |
| 8  | 1.585   | 3.87  | -42.13     | 46.00      | 3.65       | 0.10        | 0.12       | NEUTRAL   | AVERAGE |
| 9  | 3.374   | 9.10  | -36.90     | 46.00      | 8.70       | 0.12        | 0.28       | NEUTRAL   | AVERAGE |
| 10 | 3.374   | 21.82 | -34.18     | 56.00      | 21.42      | 0.12        | 0.28       | NEUTRAL   | QP      |
| 11 | 17.201  | 26.05 | -33.95     | 60.00      | 25.20      | 0.35        | 0.50       | NEUTRAL   | QP      |
| 12 | 17.201  | 21.20 | -28.80     | 50.00      | 20.35      | 0.35        | 0.50       | NEUTRAL   | AVERAGE |

Note:

Level = Read Level + LISN Factor + Cable Loss

## 4.2. Maximum Conducted Average Output Power Measurement

### 4.2.1. Limit

For systems using digital modulation in the 2400-2483.5MHz, the limit for output power is 30dBm. The limited has to be reduced by the amount in dB that the gain of the antenna exceed 6dBi. In case of point-to-point operation, the limit has to be reduced by 1dB for every 3dB that the directional gain of the antenna exceeds 6dBi. Systems operating in the 5725-5850 MHz band that are used exclusively for fixed, point-to-point operations may employ transmitting antennas with directional gain greater than 6 dBi without any corresponding reduction in transmitter output power.

### 4.2.2. Measuring Instruments and Setting

Please refer to section 5 of equipments list in this report. The following table is the setting of the power meter.

| Power Meter Parameter | Setting  |
|-----------------------|--|
| Bandwidth             | 50MHz bandwidth is greater than the EUT emission bandwidth |
| Detector              | Average  |

### 4.2.3. Test Procedures

1. Test procedures refer KDB558074 v01 r02 section 8.2.3 option 3.
2. This procedure provides an alternative for determining the RMS output power using a broadband RF average power meter with a thermocouple detector.

### 4.2.4. Test Setup Layout

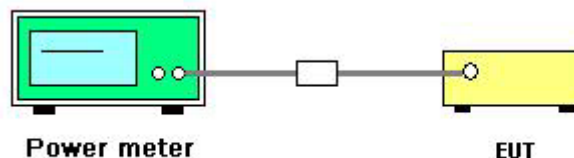

### 4.2.5. Test Deviation

There is no deviation with the original standard.

### 4.2.6. EUT Operation during Test

The EUT was programmed to be in continuously transmitting mode.

#### 4.2.7. Test Result of Maximum Conducted Average Output Power

|               |               |                |              |
|---------------|---------------|----------------|--------------|
| Temperature   | 25°C          | Humidity       | 56%          |
| Test Engineer | Denis Su      | Configurations | IEEE 802.11n |
| Test Date     | Nov. 22, 2012 |                |              |

##### Configuration IEEE 802.11n MCS0 20MHz

| Channel | Frequency | Conducted Average Power (dBm) |        |        | Total Conducted Average Power (dBm) | Max. Limit (dBm) | Result   |
|---------|-----------|-------------------------------|--------|--------|-------------------------------------|------------------|----------|
|         |           | Ant. 1                        | Ant. 2 | Ant. 3 |                                     |                  |          |
| 1       | 2412 MHz  | 15.50                         | 15.46  | 16.38  | 20.57                               | 30.00            | Complies |
| 6       | 2437 MHz  | 23.63                         | 23.85  | 24.42  | 28.75                               | 30.00            | Complies |
| 11      | 2462 MHz  | 15.47                         | 15.63  | 15.72  | 20.38                               | 30.00            | Complies |

##### Configuration IEEE 802.11n MCS0 40MHz

| Channel | Frequency | Conducted Average Power (dBm) |        |        | Total Conducted Average Power (dBm) | Max. Limit (dBm) | Result   |
|---------|-----------|-------------------------------|--------|--------|-------------------------------------|------------------|----------|
|         |           | Ant. 1                        | Ant. 2 | Ant. 3 |                                     |                  |          |
| 3       | 2422 MHz  | 13.21                         | 13.41  | 14.38  | 18.47                               | 30.00            | Complies |
| 6       | 2437 MHz  | 17.38                         | 18.09  | 19.05  | 23.00                               | 30.00            | Complies |
| 9       | 2452 MHz  | 12.64                         | 13.13  | 14.01  | 18.07                               | 30.00            | Complies |

|               |               |                |                |
|---------------|---------------|----------------|----------------|
| Temperature   | 25°C          | Humidity       | 56%            |
| Test Engineer | Denis Su      | Configurations | IEEE 802.11b/g |
| Test Date     | Nov. 22, 2012 |                |                |

**Configuration IEEE 802.11b**

| Channel | Frequency | Conducted Average Power (dBm) |        |        | Total Conducted Average Power (dBm) | Max. Limit (dBm) | Result   |
|---------|-----------|-------------------------------|--------|--------|-------------------------------------|------------------|----------|
|         |           | Ant. 1                        | Ant. 2 | Ant. 3 |                                     |                  |          |
| 1       | 2412 MHz  | 20.45                         | 20.46  | 21.35  | 25.55                               | 30.00            | Complies |
| 6       | 2437 MHz  | 23.52                         | 23.86  | 24.12  | 28.61                               | 30.00            | Complies |
| 11      | 2462 MHz  | 20.78                         | 21.22  | 21.62  | 25.99                               | 30.00            | Complies |

**Configuration IEEE 802.11g**

| Channel | Frequency | Conducted Average Power (dBm) |        |        | Total Conducted Average Power (dBm) | Max. Limit (dBm) | Result   |
|---------|-----------|-------------------------------|--------|--------|-------------------------------------|------------------|----------|
|         |           | Ant. 1                        | Ant. 2 | Ant. 3 |                                     |                  |          |
| 1       | 2412 MHz  | 17.85                         | 17.78  | 18.82  | 22.95                               | 30.00            | Complies |
| 6       | 2437 MHz  | 23.92                         | 23.95  | 24.32  | 28.84                               | 30.00            | Complies |
| 11      | 2462 MHz  | 14.13                         | 14.62  | 15.12  | 19.41                               | 30.00            | Complies |

### 4.3. Power Spectral Density Measurement

#### 4.3.1. Limit

For digitally modulated systems, the power spectral density conducted from the intentional radiator to the antenna shall not be greater than 8dBm in any 3 kHz band during any time interval of continuous transmission.

#### 4.3.2. Measuring Instruments and Setting

Please refer to section 5 of equipments list in this report. The following table is the setting of the spectrum analyzer.

| Spectrum Parameter | Setting  |
|--------------------|--|
| Attenuation        | Auto   |
| Span Frequency     | Set the span to 1.5 times the DTS channel bandwidth. |
| RB                 | 100 kHz  |
| VB                 | 300 kHz  |
| Detector           | Pesk   |
| Trace              | Max Hold   |
| Sweep Time         | Auto   |

#### 4.3.3. Test Procedures

1. Test procedures refer KDB558074 v01 r02 section 9.1 option 1
2. Spectrum analyzer must be capable of utilizing a number of measurement points in each sweep that is greater than or equal to twice the span/RBW in order to ensure bin-to-bin spacing of  $\leq RBW/2$  so that narrowband signals are not lost between frequency bins.
3. Use this procedure when the Maximum Conducted Average Output Power in the fundamental emission is used to demonstrate compliance. The EUT must be configured to transmit continuously at full power over the measurement duration.
4. Ensure that the number of measurement points in the sweep  $\geq 2 \times \text{span}/\text{RBW}$  (use of a greater number of measurement points than this minimum requirement is recommended).
5. Use the peak marker function to determine the maximum level in any 100 kHz band segment within the fundamental EBW.
6. Scale the observed power level to an equivalent level in 3 kHz by adjusting (reducing) the measured power by a bandwidth correction factor (BWCF) where:  $BWCF = 10\log(3 \text{ kHz}/100 \text{ kHz} = -15.2 \text{ dB})$ .
7. The resulting PSD level must be  $\leq 8 \text{ dBm}$ .
8. When measuring power spectral density with multiple antenna systems, add every result of the values by mathematic formula.

#### 4.3.4. Test Setup Layout

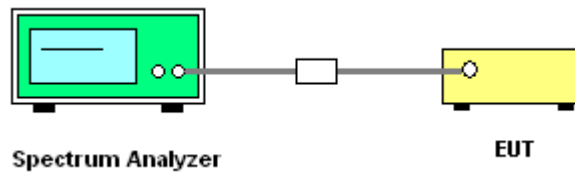

#### 4.3.5. Test Deviation

There is no deviation with the original standard.

#### 4.3.6. EUT Operation during Test

The EUT was programmed to be in continuously transmitting mode.



## 4.3.7. Test Result of Power Spectral Density

|               |          |                |              |
|---------------|----------|----------------|--------------|
| Temperature   | 25°C     | Humidity       | 56%          |
| Test Engineer | Denis Su | Configurations | IEEE 802.11n |

## Configuration IEEE 802.11n MCS0 20MHz

| Channel | Frequency | Power Density (dBm/100kHz) |        |        | BWCF factor (100KHz to 3KHz) | Power Density (dBm/3kHz) |        |        | Single port Limit (dBm/3kHz) | Result   |
|---------|-----------|----------------------------|--------|--------|------------------------------|--------------------------|--------|--------|------------------------------|----------|
|         |           | Ant. 1                     | Ant. 2 | Ant. 3 |                              | Ant. 1                   | Ant. 2 | Ant. 3 |                              |          |
| 1       | 2412 MHz  | 2.36                       | 2.82   | 3.55   | -15.23                       | -12.87                   | -12.41 | -11.68 | 3.23                         | Complies |
| 6       | 2437 MHz  | 11.44                      | 11.86  | 12.13  | -15.23                       | -3.79                    | -3.37  | -3.10  | 3.23                         | Complies |
| 11      | 2462 MHz  | 2.21                       | 2.02   | 2.31   | -15.23                       | -13.02                   | -13.21 | -12.92 | 3.23                         | Complies |

Note: PSD Limit = (8dBm/MHz - (10log(3))) = 3.23dBm/MHz

## Configuration IEEE 802.11n MCS0 40MHz

| Channel | Frequency | Power Density (dBm/100kHz) |        |        | BWCF factor (100KHz to 3KHz) | Power Density (dBm/3kHz) |        |        | Single port Limit (dBm/3kHz) | Result   |
|---------|-----------|----------------------------|--------|--------|------------------------------|--------------------------|--------|--------|------------------------------|----------|
|         |           | Ant. 1                     | Ant. 2 | Ant. 3 |                              | Ant. 1                   | Ant. 2 | Ant. 3 |                              |          |
| 3       | 2422 MHz  | -2.60                      | -2.69  | -0.83  | -15.23                       | -17.83                   | -17.92 | -16.06 | 3.23                         | Complies |
| 6       | 2437 MHz  | 2.52                       | 2.95   | 3.77   | -15.23                       | -12.71                   | -12.28 | -11.46 | 3.23                         | Complies |
| 9       | 2452 MHz  | -3.16                      | -2.54  | -1.88  | -15.23                       | -18.39                   | -17.77 | -17.11 | 3.23                         | Complies |

Note: PSD Limit = (8dBm/MHz - (10log(3))) = 3.23dBm/MHz

|               |          |                |                |
|---------------|----------|----------------|----------------|
| Temperature   | 25°C     | Humidity       | 56%            |
| Test Engineer | Denis Su | Configurations | IEEE 802.11b/g |

**Configuration IEEE 802.11b**

| Channel | Frequency | Power Density (dBm/100kHz) |        |        | BWCF factor (100KHz to 3KHz) | Power Density (dBm/3kHz) |        |        | Single port Limit (dBm/3kHz) | Result   |
|---------|-----------|----------------------------|--------|--------|------------------------------|--------------------------|--------|--------|------------------------------|----------|
|         |           | Ant. 1                     | Ant. 2 | Ant. 3 |                              | Ant. 1                   | Ant. 2 | Ant. 3 |                              |          |
| 1       | 2412 MHz  | 12.28                      | 12.57  | 13.58  | -15.23                       | -2.95                    | -2.66  | -1.65  | 3.23                         | Complies |
| 6       | 2437 MHz  | 16.09                      | 16.54  | 16.96  | -15.23                       | 0.86                     | 1.31   | 1.73   | 3.23                         | Complies |
| 11      | 2462 MHz  | 12.97                      | 12.63  | 14.70  | -15.23                       | -2.26                    | -2.60  | -0.53  | 3.23                         | Complies |

Note: PSD Limit = (8dBm/MHz - (10log(3))) = 3.23dBm/MHz

**Configuration IEEE 802.11g**

| Channel | Frequency | Power Density (dBm/100kHz) |        |        | BWCF factor (100KHz to 3KHz) | Power Density (dBm/3kHz) |        |        | Single port Limit (dBm/3kHz) | Result   |
|---------|-----------|----------------------------|--------|--------|------------------------------|--------------------------|--------|--------|------------------------------|----------|
|         |           | Ant. 1                     | Ant. 2 | Ant. 3 |                              | Ant. 1                   | Ant. 2 | Ant. 3 |                              |          |
| 1       | 2412 MHz  | 4.62                       | 5.32   | 6.70   | -15.23                       | -10.61                   | -9.91  | -8.53  | 3.23                         | Complies |
| 6       | 2437 MHz  | 12.06                      | 12.07  | 12.92  | -15.23                       | -3.17                    | -3.16  | -2.31  | 3.23                         | Complies |
| 11      | 2462 MHz  | 1.61                       | 2.08   | 2.39   | -15.23                       | -13.62                   | -13.15 | -12.84 | 3.23                         | Complies |

Note: PSD Limit = (8dBm/MHz - (10log(3))) = 3.23dBm/MHz

Note: All the test values were listed in the report.

For plots, only the channel with maximum results was shown.

Power Density Plot on Configuration IEEE 802.11n MCS0 20MHz / Ant. 3 / 2437 MHz

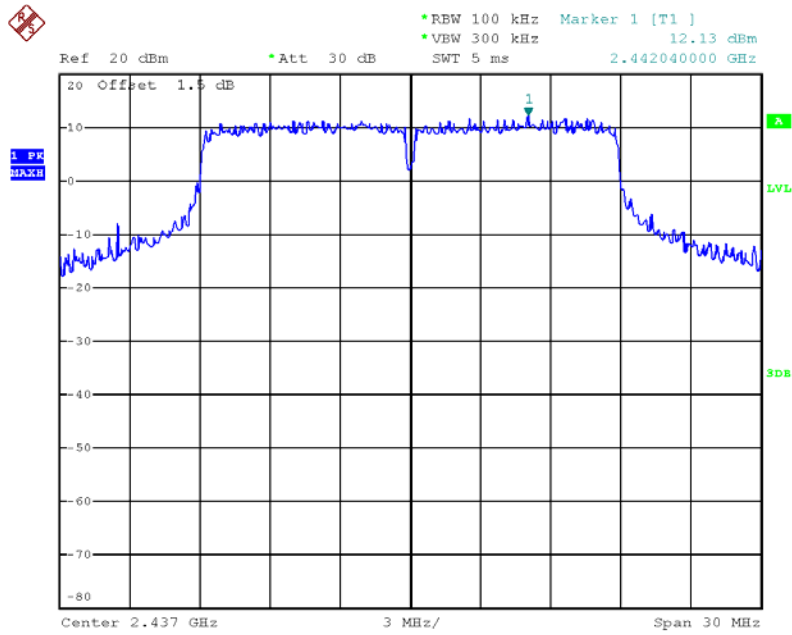

Date: 22.NOV.2012 16:33:51

Power Density Plot on Configuration IEEE 802.11n MCS0 40MHz / Ant. 3 / 2437 MHz

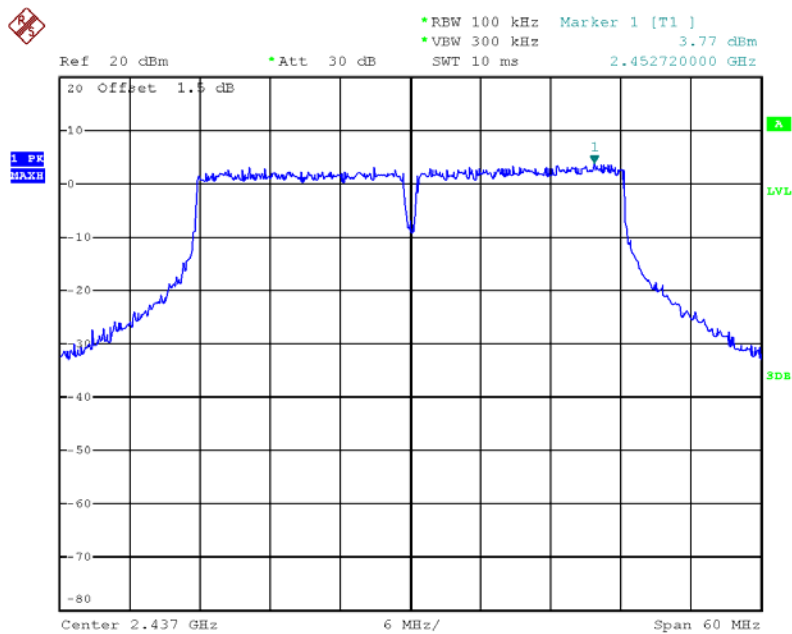

Date: 22.NOV.2012 16:30:39

Power Density Plot on Configuration IEEE 802.11b / Ant. 3 / 2437 MHz

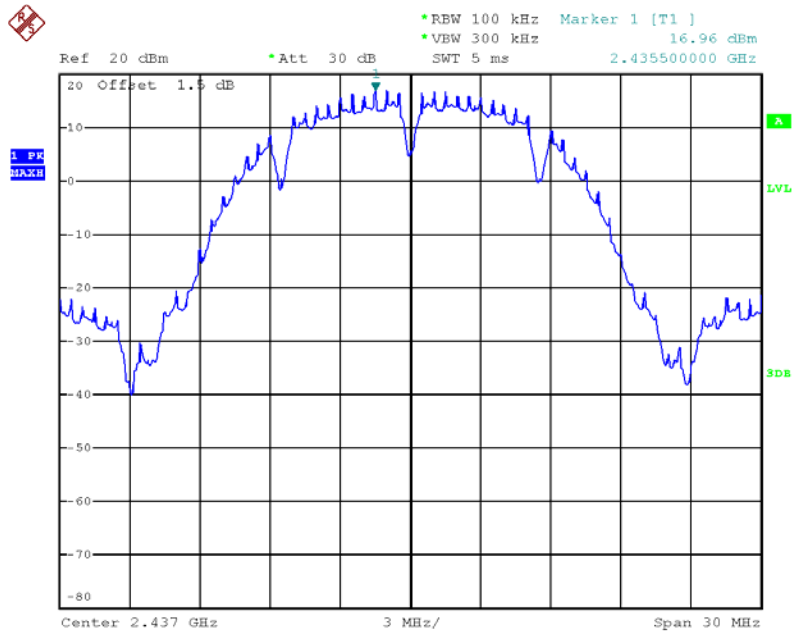

Date: 22.NOV.2012 16:37:32

Power Density Plot on Configuration IEEE 802.11g / Ant. 3 / 2437 MHz

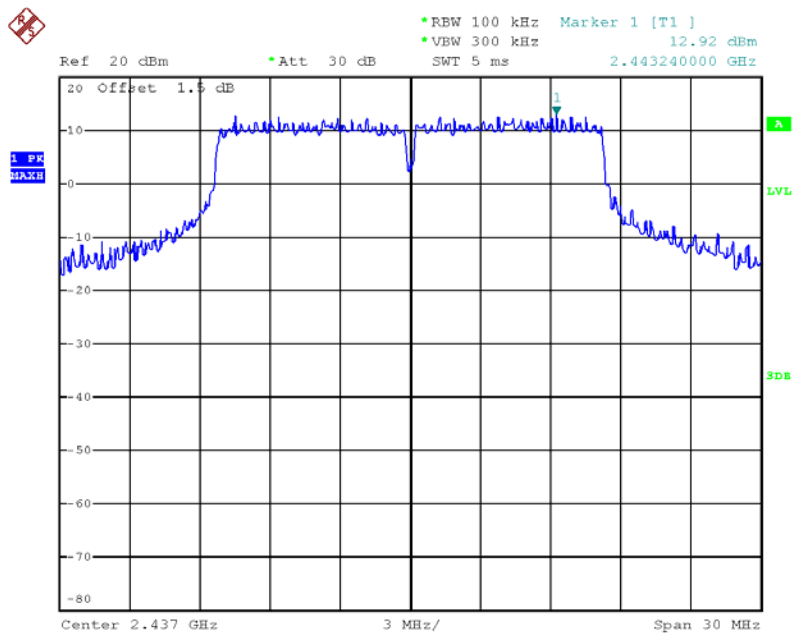

Date: 22.NOV.2012 16:35:49

## 4.4. 6dB Spectrum Bandwidth Measurement

### 4.4.1. Limit

For digital modulation systems, the minimum 6dB bandwidth shall be at least 500 kHz.

### 4.4.2. Measuring Instruments and Setting

Please refer to section 5 of equipments list in this report. The following table is the setting of the spectrum analyzer.

| Spectrum Parameters | Setting                            |
|---------------------|------------------------------------|
| Attenuation         | Auto                               |
| Span Frequency      | > 6dB Bandwidth                    |
| RB                  | 1-5 % or DTS BW, not exceed 100KHz |
| VB                  | $\geq 3 \times \text{RBW}$         |
| Detector            | Peak                               |
| Trace               | Max Hold                           |
| Sweep Time          | Auto                               |

### 4.4.3. Test Procedures

1. The transmitter output (antenna port) was connected to the spectrum analyzer in peak hold mode.
2. Test was performed in accordance with KDB 558074 Guidance for Performing Compliance Measurements on Digital Transmission Systems (DTS) Operating Under §15.247 section 5.1.1 EBW Measurement Procedure
3. Multiple antenna system was performed in accordance with KDB 662911 Emissions Testing of Transmitters with Multiple Outputs in the Same Band.
4. Measured the spectrum width with power higher than 6dB below carrier.

### 4.4.4. Test Setup Layout

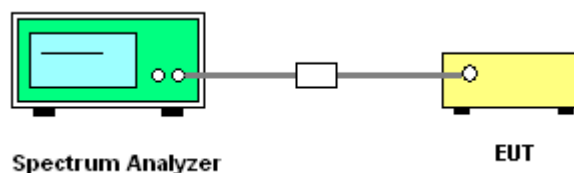

### 4.4.5. Test Deviation

There is no deviation with the original standard.

### 4.4.6. EUT Operation during Test

The EUT was programmed to be in continuously transmitting mode.

#### 4.4.7. Test Result of 6dB Spectrum Bandwidth

|               |          |                |              |
|---------------|----------|----------------|--------------|
| Temperature   | 25°C     | Humidity       | 56%          |
| Test Engineer | Denis Su | Configurations | IEEE 802.11n |

##### Configuration IEEE 802.11n MCS0 20MHz / Ant. 1 + Ant. 2 + Ant. 3

| Channel | Frequency | 6dB Bandwidth (MHz) | 99% Occupied Bandwidth (MHz) | Min. Limit (kHz) | Test Result |
|---------|-----------|---------------------|------------------------------|------------------|-------------|
| 1       | 2412 MHz  | 15.20               | 17.84                        | 500              | Complies    |
| 6       | 2437 MHz  | 15.68               | 17.68                        | 500              | Complies    |
| 11      | 2462 MHz  | 16.08               | 17.52                        | 500              | Complies    |

##### Configuration IEEE 802.11n MCS0 40MHz / Ant. 1 + Ant. 2 + Ant. 3

| Channel | Frequency | 6dB Bandwidth (MHz) | 99% Occupied Bandwidth (MHz) | Min. Limit (kHz) | Test Result |
|---------|-----------|---------------------|------------------------------|------------------|-------------|
| 3       | 2422 MHz  | 34.72               | 36.32                        | 500              | Complies    |
| 6       | 2437 MHz  | 34.72               | 36.32                        | 500              | Complies    |
| 9       | 2452 MHz  | 27.68               | 35.04                        | 500              | Complies    |

|               |          |                |                |
|---------------|----------|----------------|----------------|
| Temperature   | 25°C     | Humidity       | 56%            |
| Test Engineer | Denis Su | Configurations | IEEE 802.11b/g |

**Configuration IEEE 802.11b / Ant. 1 + Ant. 2 + Ant. 3**

| Channel | Frequency | 6dB Bandwidth (MHz) | 99% Occupied Bandwidth (MHz) | Min. Limit (kHz) | Test Result |
|---------|-----------|---------------------|------------------------------|------------------|-------------|
| 1       | 2412 MHz  | 6.32                | 10.40                        | 500              | Complies    |
| 6       | 2437 MHz  | 6.48                | 10.40                        | 500              | Complies    |
| 11      | 2462 MHz  | 9.60                | 15.20                        | 500              | Complies    |

**Configuration IEEE 802.11g / Ant. 1 + Ant. 2 + Ant. 3**

| Channel | Frequency | 6dB Bandwidth (MHz) | 99% Occupied Bandwidth (MHz) | Min. Limit (kHz) | Test Result |
|---------|-----------|---------------------|------------------------------|------------------|-------------|
| 1       | 2412 MHz  | 16.48               | 16.56                        | 500              | Complies    |
| 6       | 2437 MHz  | 16.24               | 16.88                        | 500              | Complies    |
| 11      | 2462 MHz  | 13.92               | 15.76                        | 500              | Complies    |

6 dB Bandwidth Plot on Configuration IEEE 802.11n MCS0 20MHz / Ant. 1 + Ant. 2 + Ant. 3 / 2462 MHz

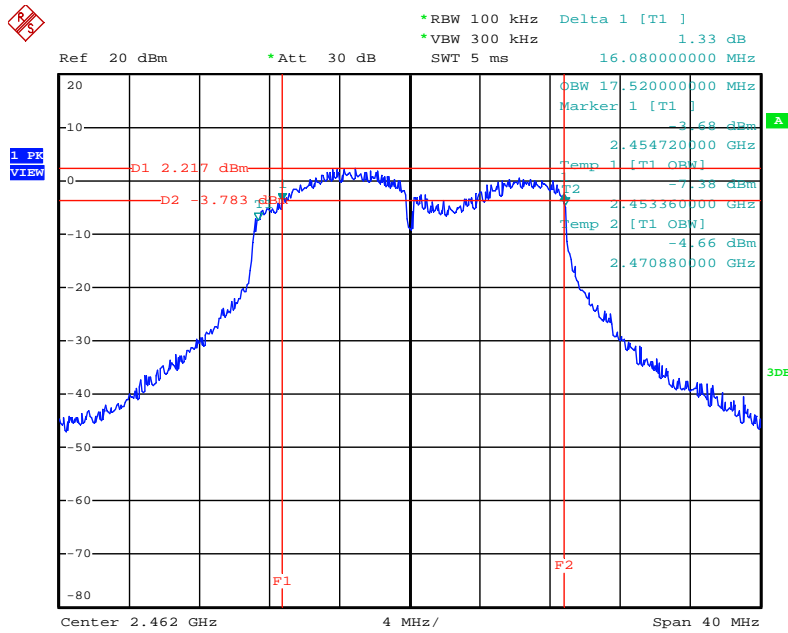

Date: 22.NOV.2012 15:50:36

6 dB Bandwidth Plot on Configuration IEEE 802.11n MCS0 40MHz / Ant. 1 + Ant. 2 + Ant. 3 / 2437 MHz

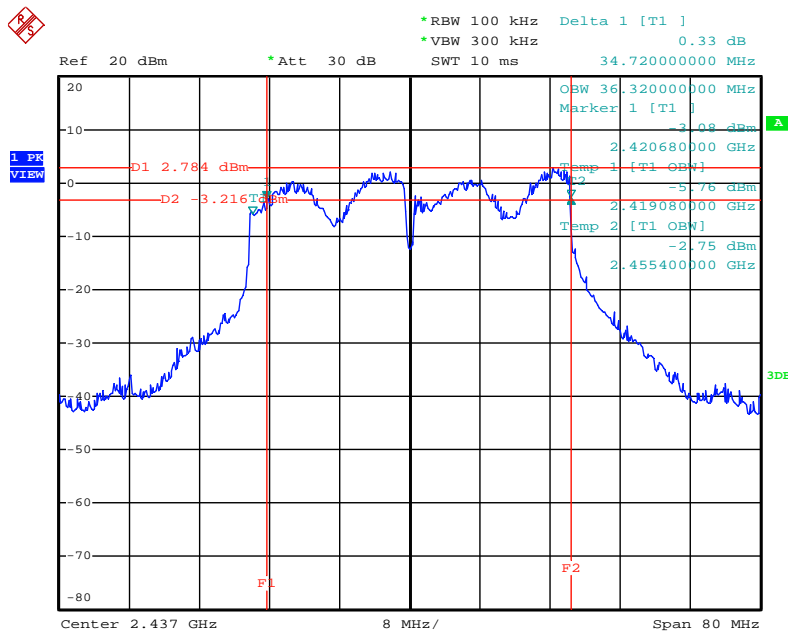

Date: 22.NOV.2012 15:52:18



6 dB Bandwidth Plot on Configuration IEEE 802.11b / Ant. 1 + Ant. 2 + Ant. 3 / 2462 MHz

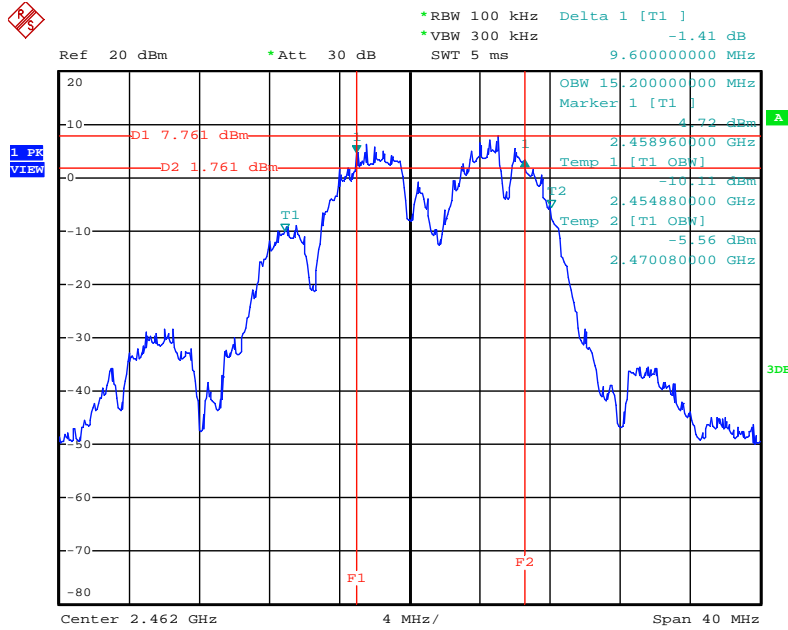

Date: 22.NOV.2012 15:43:58

6 dB Bandwidth Plot on Configuration IEEE 802.11g / Ant. 1 + Ant. 2 + Ant. 3 / 2412 MHz

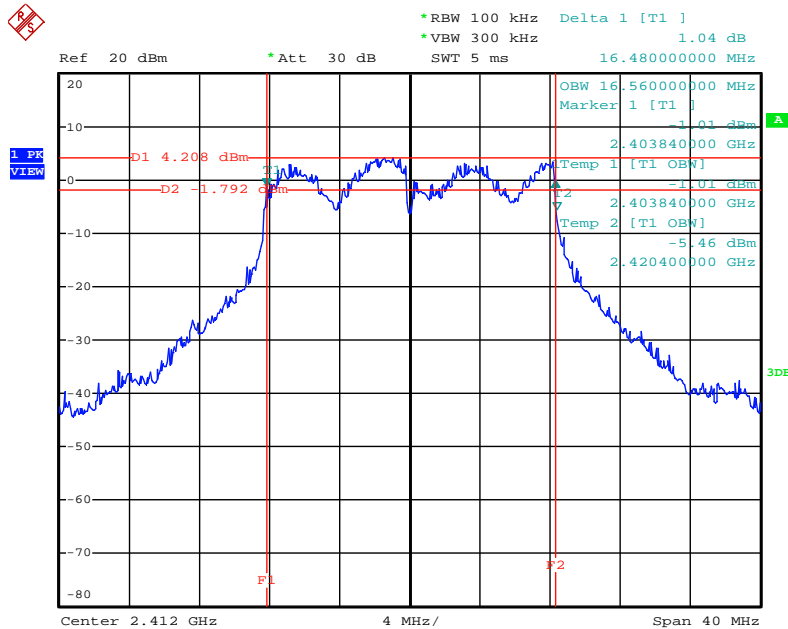

Date: 22.NOV.2012 15:47:35

## 4.5. Radiated Emissions Measurement

### 4.5.1. Limit

30dBc in any 100 kHz bandwidth outside the operating frequency band. In case the emission fall within the restricted band specified on 15.205(a), then the 15.209(a) limit in the table below has to be followed.

| Frequencies (MHz) | Field Strength (micorvolts/meter) | Measurement Distance (meters) |
|-------------------|-----------------------------------|-------------------------------|
| 0.009~0.490       | 2400/F(KHz)                       | 300                           |
| 0.490~1.705       | 24000/F(KHz)                      | 30                            |
| 1.705~30.0        | 30                                | 30                            |
| 30~88             | 100                               | 3                             |
| 88~216            | 150                               | 3                             |
| 216~960           | 200                               | 3                             |
| Above 960         | 500                               | 3                             |

### 4.5.2. Measuring Instruments and Setting

Please refer to section 5 of equipments list in this report. The following table is the setting of spectrum analyzer and receiver.

| Spectrum Parameter                        | Setting  |
|---|--|
| Attenuation                               | Auto   |
| Start Frequency                           | 1000 MHz                                       |
| Stop Frequency                            | 10th carrier harmonic                          |
| RB / VB (Emission in restricted band)     | 1MHz / 3MHz for Peak, 1 MHz / 10Hz for Average |
| RB / VB (Emission in non-restricted band) | 1MHz / 3MHz for peak                           |

| Receiver Parameter     | Setting                          |
|------------------------|----------------------------------|
| Attenuation            | Auto                             |
| Start ~ Stop Frequency | 9kHz~150kHz / RB 200Hz for QP    |
| Start ~ Stop Frequency | 150kHz~30MHz / RB 9kHz for QP    |
| Start ~ Stop Frequency | 30MHz~1000MHz / RB 120kHz for QP |

### 4.5.3. Test Procedures

1. Configure the EUT according to ANSI C63.10. The EUT was placed on the top of the turntable 0.8 meter above ground. The phase center of the receiving antenna mounted on the top of a height-variable antenna tower was placed 3 meters far away from the turntable.
2. Power on the EUT and all the supporting units. The turntable was rotated by 360 degrees to determine the position of the highest radiation.
3. The height of the broadband receiving antenna was varied between one meter and four meters above ground to find the maximum emissions field strength of both horizontal and vertical polarization.
4. For each suspected emissions, the antenna tower was scan (from 1 M to 4 M) and then the turntable was rotated (from 0 degree to 360 degrees) to find the maximum reading.
5. Set the test-receiver system to Peak or CISPR quasi-peak Detect Function with specified bandwidth under Maximum Hold Mode.
6. For emissions above 1GHz, use 1MHz VBW and 3MHz RBW for peak reading. Then 1MHz RBW and 10Hz VBW for average reading in spectrum analyzer.
7. When the radiated emissions limits are expressed in terms of the average value of the emissions, and pulsed operation is employed, the measurement field strength shall be determined by averaging over one complete pulse train, including blanking intervals, as long as the pulse train does not exceed 0.1 seconds. As an alternative (provided the transmitter operates for longer than 0.1 seconds) or in cases where the pulse train exceeds 0.1 seconds, the measured field strength shall be determined from the average absolute voltage during a 0.1 second interval during which the field strength is at its maximum value.
8. If the emissions level of the EUT in peak mode was 3 dB lower than the average limit specified, then testing will be stopped and peak values of EUT will be reported, otherwise, the emissions which do not have 3 dB margin will be repeated one by one using the quasi-peak method for below 1GHz.
9. For testing above 1GHz, the emissions level of the EUT in peak mode was lower than average limit (that means the emissions level in peak mode also complies with the limit in average mode), then testing will be stopped and peak values of EUT will be reported, otherwise, the emissions will be measured in average mode again and reported.
10. In case the emission is lower than 30MHz, loop antenna has to be used for measurement and the recorded data should be QP measured by receiver. High – Low scan is not required in this case.

#### 4.5.4. Test Setup Layout

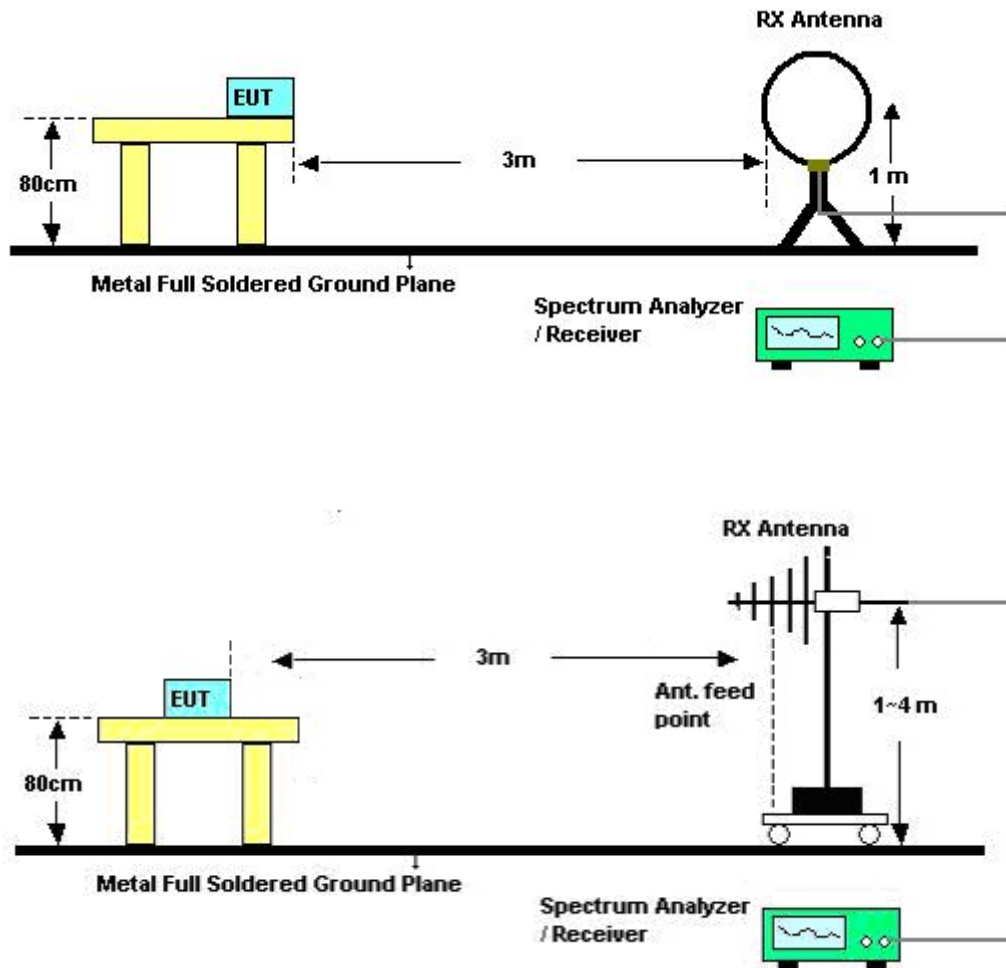

#### 4.5.5. Test Deviation

There is no deviation with the original standard.

#### 4.5.6. EUT Operation during Test

The EUT was programmed to be in continuously transmitting mode.

#### 4.5.7. Results of Radiated Emissions (9kHz~30MHz)

|               |               |                |     |
|---------------|---------------|----------------|-----|
| Temperature   | 20°C          | Humidity       | 60% |
| Test Engineer | Kenneth Huang | Configurations | CTX |
| Test Date     | Nov. 22, 2012 |                |     |

| Freq. (MHz) | Level (dBuV) | Over Limit (dB) | Limit Line (dBuV) | Remark   |
|-------------|--------------|-----------------|-------------------|----------|
| -           | -            | -               | -                 | See Note |

Note:

The amplitude of spurious emissions that are attenuated by more than 20 dB below the permissible value has no need to be reported.

Distance extrapolation factor =  $40 \log (\text{specific distance} / \text{test distance})$  (dB);

Limit line = specific limits (dBuV) + distance extrapolation factor.

4.5.8. Results of Radiated Emissions (30MHz~1GHz)

|               |               |                |     |
|---------------|---------------|----------------|-----|
| Temperature   | 20°C          | Humidity       | 60% |
| Test Engineer | Kenneth Huang | Configurations | CTX |

Horizontal

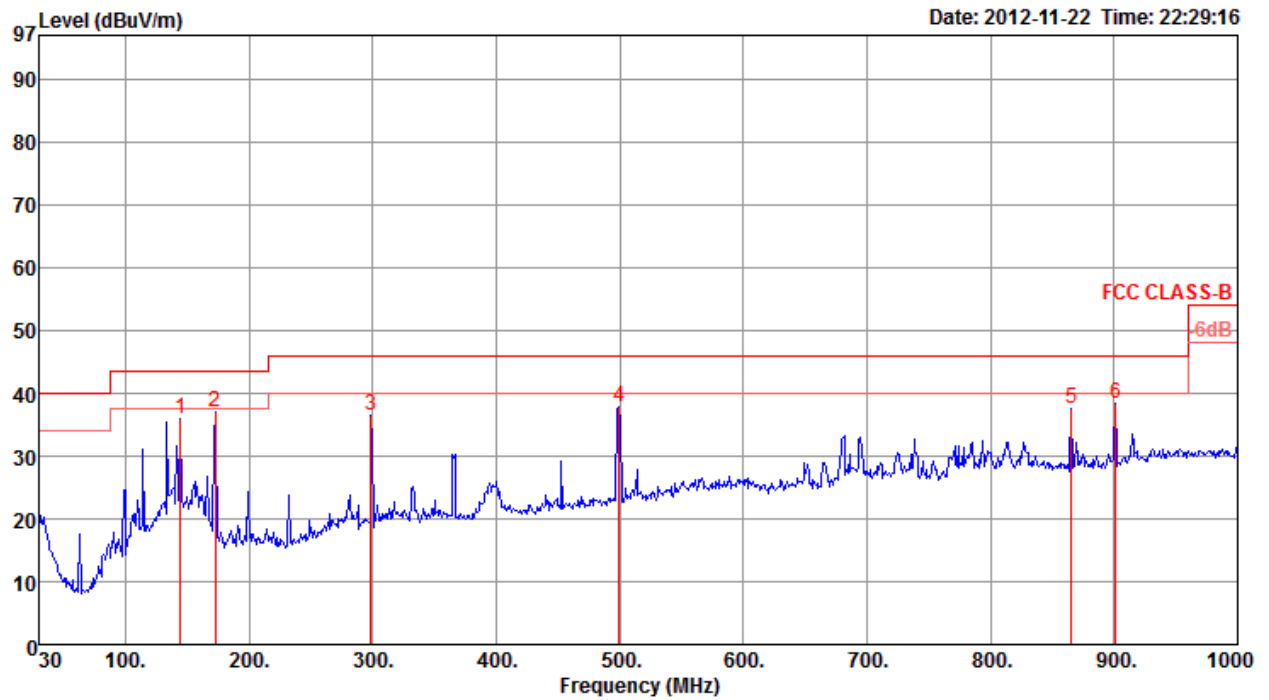

|   | Freq   | Level  | Limit  | Over  | Read  | Cable | Preamp | Antenna | Remark | T/Pos | A/Pos | Pol/Phase  |
|---|--------|--------|--------|-------|-------|-------|--------|---------|--------|-------|-------|------------|
|   | MHz    | dBuV/m | dBuV/m | dB    | dBuV  | dB    | dB     | dB/m    |        | deg   | cm    |            |
| 1 | 144.46 | 35.83  | 43.50  | -7.67 | 49.92 | 1.75  | 27.53  | 11.69   | Peak   | 0     | 400   | HORIZONTAL |
| 2 | 172.59 | 36.89  | 43.50  | -6.61 | 52.14 | 1.96  | 27.40  | 10.19   | Peak   | 0     | 400   | HORIZONTAL |
| 3 | 298.69 | 36.41  | 46.00  | -9.59 | 46.93 | 2.51  | 26.83  | 13.80   | Peak   | 0     | 400   | HORIZONTAL |
| 4 | 499.48 | 37.69  | 46.00  | -8.31 | 44.46 | 3.38  | 27.93  | 17.78   | Peak   | 0     | 400   | HORIZONTAL |
| 5 | 865.17 | 37.67  | 46.00  | -8.33 | 38.78 | 4.48  | 26.88  | 21.29   | Peak   | 0     | 400   | HORIZONTAL |
| 6 | 901.06 | 38.28  | 46.00  | -7.72 | 38.99 | 4.60  | 26.82  | 21.51   | Peak   | 0     | 400   | HORIZONTAL |

Vertical

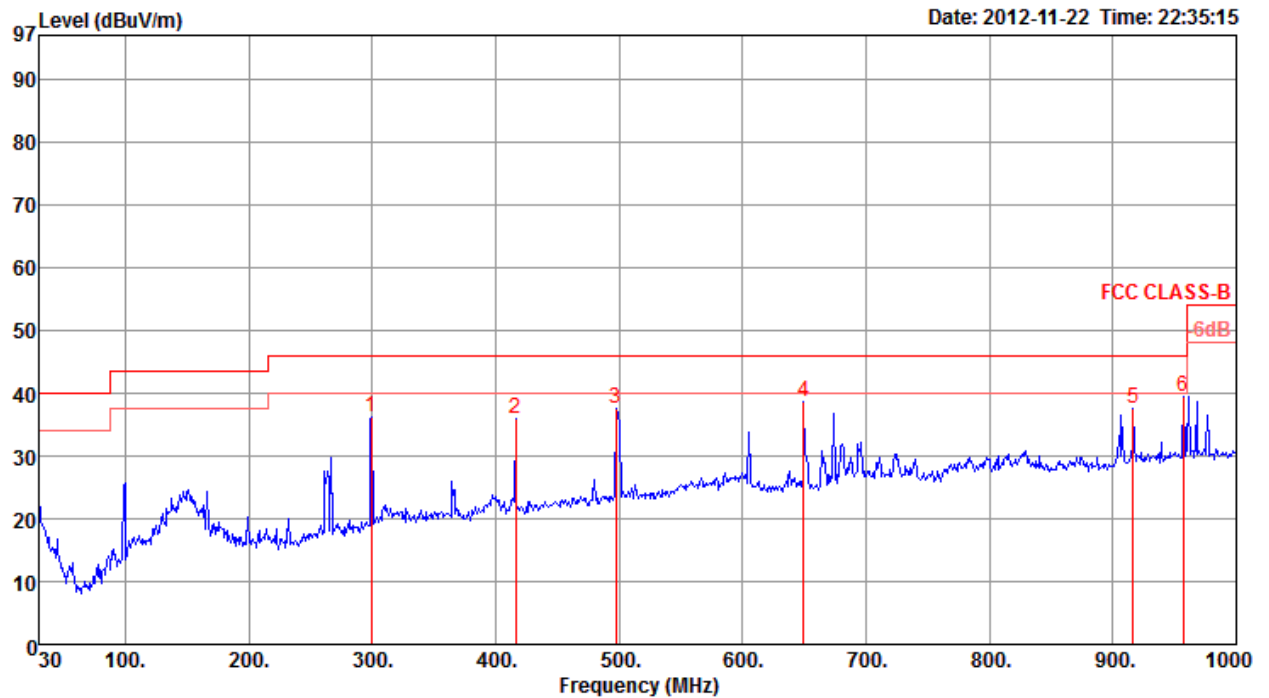

|     | Freq   | Level  | Limit  | Over  | Read  | Cable | Preamp | Antenna | Remark | T/Pos | A/Pos | Pol/Phase |
|-----|--------|--------|--------|-------|-------|-------|--------|---------|--------|-------|-------|-----------|
|     | MHz    | dBuV/m | dBuV/m | dB    | dBuV  | dB    | dB     | dB/m    |        | deg   | cm    |           |
| 1   | 299.66 | 36.19  | 46.00  | -9.81 | 46.71 | 2.51  | 26.83  | 13.80   | Peak   | 0     | 100   | VERTICAL  |
| 2   | 416.06 | 36.01  | 46.00  | -9.99 | 43.90 | 3.07  | 27.62  | 16.66   | Peak   | 0     | 100   | VERTICAL  |
| 3   | 497.54 | 37.51  | 46.00  | -8.49 | 44.32 | 3.37  | 27.93  | 17.75   | Peak   | 0     | 100   | VERTICAL  |
| 4   | 649.83 | 38.58  | 46.00  | -7.42 | 42.64 | 3.90  | 27.56  | 19.60   | Peak   | 0     | 100   | VERTICAL  |
| 5   | 916.58 | 37.63  | 46.00  | -8.37 | 38.04 | 4.68  | 26.72  | 21.63   | Peak   | 0     | 100   | VERTICAL  |
| 6 p | 957.32 | 39.41  | 46.00  | -6.59 | 39.07 | 4.86  | 26.47  | 21.95   | Peak   | 0     | 100   | VERTICAL  |

Note:

The amplitude of spurious emissions that are attenuated by more than 20dB below the permissible value has no need to be reported.

Emission level (dBuV/m) = 20 log Emission level (uV/m).

Corrected Reading: Antenna Factor + Cable Loss + Read Level - Preamp Factor = Level.

4.5.9. Results for Radiated Emissions (1GHz~10<sup>th</sup> Harmonic)

|               |               |                |   |
|---------------|---------------|----------------|---|
| Temperature   | 20°C          | Humidity       | 60%   |
| Test Engineer | Kenneth Huang | Configurations | IEEE 802.11n MCS0 20MHz Ch 1 / Ant. 1 + Ant. 2 + Ant. 3 |
| Test Date     | Nov. 15, 2012 |                |   |

*Horizontal*

|   | Freq    | Level  | Limit Line | Over Limit | Read Level | Cable Loss | Antenna Factor | Preamp Factor | Remark  | A/Pos | T/Pos | Pol/Phase  |
|---|---------|--------|------------|------------|------------|------------|----------------|---------------|---------|-------|-------|------------|
|   | MHz     | dBuV/m | dBuV/m     | dB         | dBuV       | dB         | dB/m           | dB            |         | cm    | deg   |            |
| 1 | 4824.60 | 45.53  | 74.00      | -28.47     | 41.07      | 6.27       | 33.39          | 35.20         | Peak    | 100   | 212   | HORIZONTAL |
| 2 | 4824.94 | 31.44  | 54.00      | -22.56     | 26.98      | 6.27       | 33.39          | 35.20         | Average | 100   | 212   | HORIZONTAL |

*Vertical*

|   | Freq    | Level  | Limit Line | Over Limit | Read Level | Cable Loss | Antenna Factor | Preamp Factor | Remark  | A/Pos | T/Pos | Pol/Phase |
|---|---------|--------|------------|------------|------------|------------|----------------|---------------|---------|-------|-------|-----------|
|   | MHz     | dBuV/m | dBuV/m     | dB         | dBuV       | dB         | dB/m           | dB            |         | cm    | deg   |           |
| 1 | 4823.39 | 44.90  | 74.00      | -29.10     | 40.44      | 6.27       | 33.39          | 35.20         | Peak    | 100   | 39    | VERTICAL  |
| 2 | 4824.98 | 31.42  | 54.00      | -22.58     | 26.96      | 6.27       | 33.39          | 35.20         | Average | 100   | 39    | VERTICAL  |



|               |               |                |  |
|---------------|---------------|----------------|--|
| Temperature   | 20°C          | Humidity       | 60%  |
| Test Engineer | Kenneth Huang | Configurations | IEEE 802.11n MCS0 20MHz Ch 6 /<br>Ant. 1 + Ant. 2 + Ant. 3 |
| Test Date     | Nov. 15, 2012 |                |  |

### Horizontal

|   | Freq    | Level  | Limit  | Over   | Read  | Cable | Antenna | Preamp | Remark  | A/Pos | T/Pos | Pol/Phase  |
|---|---------|--------|--------|--------|-------|-------|---------|--------|---------|-------|-------|------------|
|   | MHz     | dBuV/m | dBuV/m | dB     | dBuV  | dB    | dB/m    | dB     |         | cm    | deg   |            |
| 1 | 4877.56 | 30.94  | 54.00  | -23.06 | 29.48 | 3.33  | 33.16   | 35.03  | Average | 100   | 283   | HORIZONTAL |
| 2 | 4877.62 | 43.61  | 74.00  | -30.39 | 42.15 | 3.33  | 33.16   | 35.03  | Peak    | 100   | 283   | HORIZONTAL |
| 3 | 7310.41 | 45.21  | 74.00  | -28.79 | 40.59 | 4.06  | 35.96   | 35.40  | Peak    | 100   | 119   | HORIZONTAL |
| 4 | 7314.81 | 33.18  | 54.00  | -20.82 | 28.56 | 4.06  | 35.96   | 35.40  | Average | 100   | 119   | HORIZONTAL |

### Vertical

|   | Freq    | Level  | Limit  | Over   | Read  | Cable | Antenna | Preamp | Remark  | A/Pos | T/Pos | Pol/Phase |
|---|---------|--------|--------|--------|-------|-------|---------|--------|---------|-------|-------|-----------|
|   | MHz     | dBuV/m | dBuV/m | dB     | dBuV  | dB    | dB/m    | dB     |         | cm    | deg   |           |
| 1 | 4879.03 | 46.08  | 74.00  | -27.92 | 44.62 | 3.33  | 33.16   | 35.03  | Peak    | 100   | 70    | VERTICAL  |
| 2 | 4879.74 | 33.77  | 54.00  | -20.23 | 32.31 | 3.33  | 33.16   | 35.03  | Average | 100   | 70    | VERTICAL  |
| 3 | 7315.57 | 35.64  | 54.00  | -18.36 | 31.02 | 4.06  | 35.96   | 35.40  | Average | 100   | 328   | VERTICAL  |
| 4 | 7315.70 | 48.83  | 74.00  | -25.17 | 44.21 | 4.06  | 35.96   | 35.40  | Peak    | 100   | 328   | VERTICAL  |

|               |               |                |  |
|---------------|---------------|----------------|--|
| Temperature   | 20°C          | Humidity       | 60%  |
| Test Engineer | Kenneth Huang | Configurations | IEEE 802.11n MCS0 20MHz Ch11 /<br>Ant. 1 + Ant. 2 + Ant. 3 |
| Test Date     | Nov. 15, 2012 |                |  |

### Horizontal

|   | Freq    | Level  | Limit<br>Line | Over<br>Limit | Read<br>Level | Cable<br>Loss | Antenna<br>Factor | Preamp<br>Factor | Remark  | A/Pos | T/Pos | Pol/Phase  |
|---|---------|--------|---------------|---------------|---------------|---------------|-------------------|------------------|---------|-------|-------|------------|
|   | MHz     | dBuV/m | dBuV/m        | dB            | dBuV          | dB            | dB/m              | dB               |         | cm    | deg   |            |
| 1 | 4926.95 | 29.84  | 54.00         | -24.16        | 28.24         | 3.35          | 33.26             | 35.01            | Average | 100   | 180   | HORIZONTAL |
| 2 | 4928.31 | 42.25  | 74.00         | -31.75        | 40.65         | 3.35          | 33.26             | 35.01            | Peak    | 100   | 180   | HORIZONTAL |
| 3 | 7385.81 | 45.26  | 74.00         | -28.74        | 40.51         | 4.06          | 36.09             | 35.40            | Peak    | 100   | 85    | HORIZONTAL |
| 4 | 7386.47 | 32.79  | 54.00         | -21.21        | 28.04         | 4.06          | 36.09             | 35.40            | Average | 100   | 85    | HORIZONTAL |

### Vertical

|   | Freq    | Level  | Limit<br>Line | Over<br>Limit | Read<br>Level | Cable<br>Loss | Antenna<br>Factor | Preamp<br>Factor | Remark  | A/Pos | T/Pos | Pol/Phase |
|---|---------|--------|---------------|---------------|---------------|---------------|-------------------|------------------|---------|-------|-------|-----------|
|   | MHz     | dBuV/m | dBuV/m        | dB            | dBuV          | dB            | dB/m              | dB               |         | cm    | deg   |           |
| 1 | 4922.25 | 30.21  | 54.00         | -23.79        | 28.61         | 3.35          | 33.26             | 35.01            | Average | 100   | 323   | VERTICAL  |
| 2 | 4925.60 | 42.60  | 74.00         | -31.40        | 41.00         | 3.35          | 33.26             | 35.01            | Peak    | 100   | 323   | VERTICAL  |
| 3 | 7383.53 | 45.76  | 74.00         | -28.24        | 41.01         | 4.06          | 36.09             | 35.40            | Peak    | 100   | 211   | VERTICAL  |
| 4 | 7387.28 | 33.00  | 54.00         | -21.00        | 28.25         | 4.06          | 36.09             | 35.40            | Average | 100   | 211   | VERTICAL  |

|               |               |                |  |
|---------------|---------------|----------------|--|
| Temperature   | 20°C          | Humidity       | 60%  |
| Test Engineer | Kenneth Huang | Configurations | IEEE 802.11n MCS0 40MHz Ch 3 /<br>Ant. 1 + Ant. 2 + Ant. 3 |
| Test Date     | Nov. 15, 2012 |                |  |

#### Horizontal

|   | Freq    | Level  | Limit Line | Over Limit | Read Level | Cable Loss | Antenna Factor | Preamp Factor | Remark  | A/Pos | T/Pos | Pol/Phase  |
|---|---------|--------|------------|------------|------------|------------|----------------|---------------|---------|-------|-------|------------|
|   | MHz     | dBuV/m | dBuV/m     | dB         | dBuV       | dB         | dB/m           | dB            |         | cm    | deg   |            |
| 1 | 4841.65 | 42.12  | 74.00      | -31.88     | 40.74      | 3.32       | 33.09          | 35.03         | Peak    | 100   | 123   | HORIZONTAL |
| 2 | 4844.39 | 29.04  | 54.00      | -24.96     | 27.66      | 3.32       | 33.09          | 35.03         | Average | 100   | 123   | HORIZONTAL |

#### Vertical

|   | Freq    | Level  | Limit Line | Over Limit | Read Level | Cable Loss | Antenna Factor | Preamp Factor | Remark  | A/Pos | T/Pos | Pol/Phase |
|---|---------|--------|------------|------------|------------|------------|----------------|---------------|---------|-------|-------|-----------|
|   | MHz     | dBuV/m | dBuV/m     | dB         | dBuV       | dB         | dB/m           | dB            |         | cm    | deg   |           |
| 1 | 4844.07 | 42.21  | 74.00      | -31.79     | 40.83      | 3.32       | 33.09          | 35.03         | Peak    | 100   | 266   | VERTICAL  |
| 2 | 4845.70 | 29.24  | 54.00      | -24.76     | 27.86      | 3.32       | 33.09          | 35.03         | Average | 100   | 266   | VERTICAL  |

|               |               |                |  |
|---------------|---------------|----------------|--|
| Temperature   | 20°C          | Humidity       | 60%  |
| Test Engineer | Kenneth Huang | Configurations | IEEE 802.11n MCS0 40MHz Ch 6 /<br>Ant. 1 + Ant. 2 + Ant. 3 |
| Test Date     | Nov. 15, 2012 |                |  |

#### Horizontal

|   | Freq    | Level  | Limit  | Over   | Read  | Cable | Antenna | Preamp | Remark  | A/Pos | T/Pos | Pol/Phase  |
|---|---------|--------|--------|--------|-------|-------|---------|--------|---------|-------|-------|------------|
|   | MHz     | dBuV/m | dBuV/m | dB     | dBuV  | dB    | dB/m    | dB     |         | cm    | deg   |            |
| 1 | 4871.60 | 29.12  | 54.00  | -24.88 | 27.66 | 3.33  | 33.16   | 35.03  | Average | 100   | 286   | HORIZONTAL |
| 2 | 4872.53 | 42.14  | 74.00  | -31.86 | 40.68 | 3.33  | 33.16   | 35.03  | Peak    | 100   | 286   | HORIZONTAL |
| 3 | 7311.14 | 32.67  | 54.00  | -21.33 | 28.05 | 4.06  | 35.96   | 35.40  | Average | 100   | 150   | HORIZONTAL |
| 4 | 7312.88 | 45.40  | 74.00  | -28.60 | 40.78 | 4.06  | 35.96   | 35.40  | Peak    | 100   | 150   | HORIZONTAL |

#### Vertical

|   | Freq    | Level  | Limit  | Over   | Read  | Cable | Antenna | Preamp | Remark  | A/Pos | T/Pos | Pol/Phase |
|---|---------|--------|--------|--------|-------|-------|---------|--------|---------|-------|-------|-----------|
|   | MHz     | dBuV/m | dBuV/m | dB     | dBuV  | dB    | dB/m    | dB     |         | cm    | deg   |           |
| 1 | 4871.63 | 41.71  | 74.00  | -32.29 | 40.25 | 3.33  | 33.16   | 35.03  | Peak    | 100   | 159   | VERTICAL  |
| 2 | 4872.49 | 29.75  | 54.00  | -24.25 | 28.29 | 3.33  | 33.16   | 35.03  | Average | 100   | 159   | VERTICAL  |
| 3 | 7312.60 | 44.84  | 74.00  | -29.16 | 40.22 | 4.06  | 35.96   | 35.40  | Peak    | 100   | 287   | VERTICAL  |
| 4 | 7312.68 | 32.69  | 54.00  | -21.31 | 28.07 | 4.06  | 35.96   | 35.40  | Average | 100   | 287   | VERTICAL  |

|               |               |                |  |
|---------------|---------------|----------------|--|
| Temperature   | 20°C          | Humidity       | 60%  |
| Test Engineer | Kenneth Huang | Configurations | IEEE 802.11n MCS0 40MHz Ch 9 /<br>Ant. 1 + Ant. 2 + Ant. 3 |
| Test Date     | Nov. 15, 2012 |                |  |

#### Horizontal

|   | Freq    | Level  | Limit  | Over   | Read  | CableAntenna | Preamp | Remark        | A/Pos | T/Pos | Pol/Phase  |
|---|---------|--------|--------|--------|-------|--------------|--------|---------------|-------|-------|------------|
|   | MHz     | dBuV/m | dBuV/m | dB     | dBuV  | dB           | dB/m   | dB            | cm    | deg   |            |
| 1 | 4903.29 | 45.36  | 74.00  | -28.64 | 40.72 | 6.33         | 33.51  | 35.20 Peak    | 100   | 215   | HORIZONTAL |
| 2 | 4903.86 | 31.70  | 54.00  | -22.30 | 27.06 | 6.33         | 33.51  | 35.20 Average | 100   | 215   | HORIZONTAL |
| 3 | 7355.90 | 35.75  | 54.00  | -18.25 | 27.06 | 7.57         | 36.56  | 35.44 Average | 100   | 92    | HORIZONTAL |
| 4 | 7356.43 | 50.40  | 74.00  | -23.60 | 41.71 | 7.57         | 36.56  | 35.44 Peak    | 100   | 92    | HORIZONTAL |

#### Vertical

|   | Freq    | Level  | Limit  | Over   | Read  | CableAntenna | Preamp | Remark        | A/Pos | T/Pos | Pol/Phase |
|---|---------|--------|--------|--------|-------|--------------|--------|---------------|-------|-------|-----------|
|   | MHz     | dBuV/m | dBuV/m | dB     | dBuV  | dB           | dB/m   | dB            | cm    | deg   |           |
| 1 | 4903.44 | 31.78  | 54.00  | -22.22 | 27.14 | 6.33         | 33.51  | 35.20 Average | 100   | 182   | VERTICAL  |
| 2 | 4904.82 | 45.59  | 74.00  | -28.41 | 40.92 | 6.33         | 33.54  | 35.20 Peak    | 100   | 182   | VERTICAL  |
| 3 | 7356.39 | 49.42  | 74.00  | -24.58 | 40.73 | 7.57         | 36.56  | 35.44 Peak    | 100   | 84    | VERTICAL  |
| 4 | 7356.69 | 35.83  | 54.00  | -18.17 | 27.14 | 7.57         | 36.56  | 35.44 Average | 100   | 84    | VERTICAL  |

|               |               |                |   |
|---------------|---------------|----------------|---|
| Temperature   | 20°C          | Humidity       | 60%   |
| Test Engineer | Kenneth Huang | Configurations | IEEE 802.11b CH 1 /<br>Ant. 1 + Ant. 2 + Ant. 3 |
| Test Date     | Nov. 15, 2012 |                |   |

#### Horizontal

|   | Freq    | Level  | Limit  | Over   | Read  | Cable | Antenna | Preamp | Remark  | A/Pos | T/Pos | Pol/Phase  |
|---|---------|--------|--------|--------|-------|-------|---------|--------|---------|-------|-------|------------|
|   | MHz     | dBuV/m | dBuV/m | dB     | dBuV  | Loss  | Factor  | Factor |         | cm    | deg   |            |
| 1 | 4823.99 | 37.40  | 54.00  | -16.60 | 36.06 | 3.31  | 33.06   | 35.03  | Average | 100   | 166   | HORIZONTAL |
| 2 | 4823.99 | 45.52  | 74.00  | -28.48 | 44.18 | 3.31  | 33.06   | 35.03  | Peak    | 100   | 166   | HORIZONTAL |

#### Vertical

|   | Freq    | Level  | Limit  | Over   | Read  | Cable | Antenna | Preamp | Remark  | A/Pos | T/Pos | Pol/Phase |
|---|---------|--------|--------|--------|-------|-------|---------|--------|---------|-------|-------|-----------|
|   | MHz     | dBuV/m | dBuV/m | dB     | dBuV  | Loss  | Factor  | Factor |         | cm    | deg   |           |
| 1 | 4823.86 | 48.07  | 74.00  | -25.93 | 46.73 | 3.31  | 33.06   | 35.03  | Peak    | 100   | 244   | VERTICAL  |
| 2 | 4824.02 | 43.29  | 54.00  | -10.71 | 41.95 | 3.31  | 33.06   | 35.03  | Average | 100   | 244   | VERTICAL  |

|               |               |                |   |
|---------------|---------------|----------------|---|
| Temperature   | 20°C          | Humidity       | 60%   |
| Test Engineer | Kenneth Huang | Configurations | IEEE 802.11b CH 6 /<br>Ant. 1 + Ant. 2 + Ant. 3 |
| Test Date     | Nov. 15, 2012 |                |   |

### Horizontal

|   | Freq    | Level  | Limit  | Over   | Read  | Cable | Antenna | Preamp | Remark  | A/Pos | T/Pos | Pol/Phase  |
|---|---------|--------|--------|--------|-------|-------|---------|--------|---------|-------|-------|------------|
|   | MHz     | dBuV/m | dBuV/m | dB     | dBuV  | dB    | dB/m    | dB     |         | cm    | deg   |            |
| 1 | 4873.97 | 47.02  | 74.00  | -26.98 | 45.56 | 3.33  | 33.16   | 35.03  | Peak    | 101   | 130   | HORIZONTAL |
| 2 | 4874.00 | 41.73  | 54.00  | -12.27 | 40.27 | 3.33  | 33.16   | 35.03  | Average | 101   | 130   | HORIZONTAL |
| 3 | 7310.17 | 45.67  | 74.00  | -28.33 | 41.05 | 4.06  | 35.96   | 35.40  | Peak    | 100   | 257   | HORIZONTAL |
| 4 | 7310.31 | 33.13  | 54.00  | -20.87 | 28.51 | 4.06  | 35.96   | 35.40  | Average | 100   | 257   | HORIZONTAL |

### Vertical

|   | Freq    | Level  | Limit  | Over   | Read  | Cable | Antenna | Preamp | Remark  | A/Pos | T/Pos | Pol/Phase |
|---|---------|--------|--------|--------|-------|-------|---------|--------|---------|-------|-------|-----------|
|   | MHz     | dBuV/m | dBuV/m | dB     | dBuV  | dB    | dB/m    | dB     |         | cm    | deg   |           |
| 1 | 4873.94 | 49.82  | 74.00  | -24.18 | 48.36 | 3.33  | 33.16   | 35.03  | Peak    | 109   | 212   | VERTICAL  |
| 2 | 4874.00 | 46.45  | 54.00  | -7.55  | 44.99 | 3.33  | 33.16   | 35.03  | Average | 109   | 212   | VERTICAL  |
| 3 | 7310.25 | 36.78  | 54.00  | -17.22 | 32.16 | 4.06  | 35.96   | 35.40  | Average | 100   | 72    | VERTICAL  |
| 4 | 7311.40 | 47.59  | 74.00  | -26.41 | 42.97 | 4.06  | 35.96   | 35.40  | Peak    | 100   | 72    | VERTICAL  |

|               |               |                |  |
|---------------|---------------|----------------|--|
| Temperature   | 20°C          | Humidity       | 60%  |
| Test Engineer | Kenneth Huang | Configurations | IEEE 802.11b CH 11 /<br>Ant. 1 + Ant. 2 + Ant. 3 |
| Test Date     | Nov. 15, 2012 |                |  |

### Horizontal

|   | Freq    | Level  | Limit  | Over   | Read  | Cable | Antenna | Preamp | Remark  | A/Pos | T/Pos | Pol/Phase  |
|---|---------|--------|--------|--------|-------|-------|---------|--------|---------|-------|-------|------------|
|   | MHz     | dBuV/m | dBuV/m | dB     | dBuV  | dB    | dB/m    | dB     |         | cm    | deg   |            |
| 1 | 4924.01 | 46.24  | 74.00  | -27.76 | 44.64 | 3.35  | 33.26   | 35.01  | Peak    | 178   | 296   | HORIZONTAL |
| 2 | 4924.02 | 39.01  | 54.00  | -14.99 | 37.41 | 3.35  | 33.26   | 35.01  | Average | 178   | 296   | HORIZONTAL |
| 3 | 7384.27 | 45.05  | 74.00  | -28.95 | 40.30 | 4.06  | 36.09   | 35.40  | Peak    | 100   | 136   | HORIZONTAL |
| 4 | 7387.09 | 32.80  | 54.00  | -21.20 | 28.05 | 4.06  | 36.09   | 35.40  | Average | 100   | 136   | HORIZONTAL |

### Vertical

|   | Freq    | Level  | Limit  | Over   | Read  | Cable | Antenna | Preamp | Remark  | A/Pos | T/Pos | Pol/Phase |
|---|---------|--------|--------|--------|-------|-------|---------|--------|---------|-------|-------|-----------|
|   | MHz     | dBuV/m | dBuV/m | dB     | dBuV  | dB    | dB/m    | dB     |         | cm    | deg   |           |
| 1 | 4924.00 | 45.11  | 54.00  | -8.89  | 43.51 | 3.35  | 33.26   | 35.01  | Average | 105   | 150   | VERTICAL  |
| 2 | 4924.04 | 49.67  | 74.00  | -24.33 | 48.07 | 3.35  | 33.26   | 35.01  | Peak    | 105   | 150   | VERTICAL  |
| 3 | 7385.04 | 34.81  | 54.00  | -19.19 | 30.06 | 4.06  | 36.09   | 35.40  | Average | 100   | 77    | VERTICAL  |
| 4 | 7385.33 | 45.26  | 74.00  | -28.74 | 40.51 | 4.06  | 36.09   | 35.40  | Peak    | 100   | 77    | VERTICAL  |



|               |               |                |   |
|---------------|---------------|----------------|---|
| Temperature   | 20°C          | Humidity       | 60%   |
| Test Engineer | Kenneth Huang | Configurations | IEEE 802.11g CH 1 /<br>Ant. 1 + Ant. 2 + Ant. 3 |
| Test Date     | Nov. 15, 2012 |                |   |

#### Horizontal

|   | Freq    | Level  | Limit  | Over   | Read  | Cable | Antenna | Preamp | Remark  | A/Pos | T/Pos | Pol/Phase  |
|---|---------|--------|--------|--------|-------|-------|---------|--------|---------|-------|-------|------------|
|   | MHz     | dBuV/m | dBuV/m | dB     | dBuV  | Loss  | Factor  | Factor |         | cm    | deg   |            |
| 1 | 4828.04 | 29.55  | 54.00  | -24.45 | 28.21 | 3.31  | 33.06   | 35.03  | Average | 100   | 168   | HORIZONTAL |
| 2 | 4833.01 | 41.38  | 74.00  | -32.62 | 40.04 | 3.31  | 33.06   | 35.03  | Peak    | 100   | 168   | HORIZONTAL |

#### Vertical

|   | Freq    | Level  | Limit  | Over   | Read  | Cable | Antenna | Preamp | Remark  | A/Pos | T/Pos | Pol/Phase |
|---|---------|--------|--------|--------|-------|-------|---------|--------|---------|-------|-------|-----------|
|   | MHz     | dBuV/m | dBuV/m | dB     | dBuV  | Loss  | Factor  | Factor |         | cm    | deg   |           |
| 1 | 4830.03 | 29.54  | 54.00  | -24.46 | 28.20 | 3.31  | 33.06   | 35.03  | Average | 100   | 253   | VERTICAL  |
| 2 | 4832.53 | 41.63  | 74.00  | -32.37 | 40.29 | 3.31  | 33.06   | 35.03  | Peak    | 100   | 253   | VERTICAL  |

|               |               |                |   |
|---------------|---------------|----------------|---|
| Temperature   | 20°C          | Humidity       | 60%   |
| Test Engineer | Kenneth Huang | Configurations | IEEE 802.11g CH 6 /<br>Ant. 1 + Ant. 2 + Ant. 3 |
| Test Date     | Nov. 15, 2012 |                |   |

### Horizontal

|   | Freq    | Level  | Limit  | Over   | Read  | Cable | Antenna | Preamp | Remark  | A/Pos | T/Pos | Pol/Phase  |
|---|---------|--------|--------|--------|-------|-------|---------|--------|---------|-------|-------|------------|
|   | MHz     | dBuV/m | dBuV/m | dB     | dBuV  | dB    | dB/m    | dB     |         | cm    | deg   |            |
| 1 | 4871.34 | 43.02  | 74.00  | -30.98 | 41.56 | 3.33  | 33.16   | 35.03  | Peak    | 100   | 167   | HORIZONTAL |
| 2 | 4872.27 | 31.29  | 54.00  | -22.71 | 29.83 | 3.33  | 33.16   | 35.03  | Average | 100   | 167   | HORIZONTAL |
| 3 | 7301.74 | 45.35  | 74.00  | -28.65 | 40.77 | 4.06  | 35.92   | 35.40  | Peak    | 100   | 240   | HORIZONTAL |
| 4 | 7313.44 | 33.18  | 54.00  | -20.82 | 28.56 | 4.06  | 35.96   | 35.40  | Average | 100   | 240   | HORIZONTAL |

### Vertical

|   | Freq    | Level  | Limit  | Over   | Read  | Cable | Antenna | Preamp | Remark  | A/Pos | T/Pos | Pol/Phase |
|---|---------|--------|--------|--------|-------|-------|---------|--------|---------|-------|-------|-----------|
|   | MHz     | dBuV/m | dBuV/m | dB     | dBuV  | dB    | dB/m    | dB     |         | cm    | deg   |           |
| 1 | 4876.95 | 45.08  | 74.00  | -28.92 | 43.62 | 3.33  | 33.16   | 35.03  | Peak    | 100   | 60    | VERTICAL  |
| 2 | 4877.62 | 33.94  | 54.00  | -20.06 | 32.48 | 3.33  | 33.16   | 35.03  | Average | 100   | 60    | VERTICAL  |
| 3 | 7303.72 | 48.42  | 74.00  | -25.58 | 43.84 | 4.06  | 35.92   | 35.40  | Peak    | 100   | 81    | VERTICAL  |
| 4 | 7313.28 | 35.96  | 54.00  | -18.04 | 31.34 | 4.06  | 35.96   | 35.40  | Average | 100   | 81    | VERTICAL  |

|               |               |                |  |
|---------------|---------------|----------------|--|
| Temperature   | 20°C          | Humidity       | 60%  |
| Test Engineer | Kenneth Huang | Configurations | IEEE 802.11g CH 11 /<br>Ant. 1 + Ant. 2 + Ant. 3 |
| Test Date     | Nov. 15, 2012 |                |  |

#### Horizontal

|   | Freq    | Level  | Limit  | Over   | Read  | CableAntenna | Preamp | Remark | A/Pos | T/Pos | Pol/Phase  |
|---|---------|--------|--------|--------|-------|--------------|--------|--------|-------|-------|------------|
|   | MHz     | dBuV/m | dBuV/m | dB     | dBuV  | dB           | dB/m   | dB     | cm    | deg   |            |
| 1 | 4914.29 | 29.80  | 54.00  | -24.20 | 28.24 | 3.35         | 33.23  | 35.02  | 100   | 63    | HORIZONTAL |
| 2 | 4920.19 | 41.58  | 74.00  | -32.42 | 40.01 | 3.35         | 33.23  | 35.01  | 100   | 63    | HORIZONTAL |
| 3 | 7383.05 | 32.65  | 54.00  | -21.35 | 27.90 | 4.06         | 36.09  | 35.40  | 100   | 215   | HORIZONTAL |
| 4 | 7384.40 | 45.18  | 74.00  | -28.82 | 40.43 | 4.06         | 36.09  | 35.40  | 100   | 215   | HORIZONTAL |

#### Vertical

|   | Freq    | Level  | Limit  | Over   | Read  | CableAntenna | Preamp | Remark | A/Pos | T/Pos | Pol/Phase |
|---|---------|--------|--------|--------|-------|--------------|--------|--------|-------|-------|-----------|
|   | MHz     | dBuV/m | dBuV/m | dB     | dBuV  | dB           | dB/m   | dB     | cm    | deg   |           |
| 1 | 4917.49 | 29.80  | 54.00  | -24.20 | 28.24 | 3.35         | 33.23  | 35.02  | 100   | 175   | VERTICAL  |
| 2 | 4927.56 | 42.41  | 74.00  | -31.59 | 40.81 | 3.35         | 33.26  | 35.01  | 100   | 175   | VERTICAL  |
| 3 | 7381.00 | 44.93  | 74.00  | -29.07 | 40.18 | 4.06         | 36.09  | 35.40  | 100   | 259   | VERTICAL  |
| 4 | 7382.51 | 32.66  | 54.00  | -21.34 | 27.91 | 4.06         | 36.09  | 35.40  | 100   | 259   | VERTICAL  |

## 4.6. Band Edge Emissions Measurement

### 4.6.1. Limit

30dBc in any 100 kHz bandwidth outside the operating frequency band. In case the emission fall within the restricted band specified on 15.205(a), then the 15.209(a) limit in the table below has to be followed.

| Frequencies (MHz) | Field Strength (micorvolts/meter) | Measurement Distance (meters) |
|-------------------|-----------------------------------|-------------------------------|
| 0.009~0.490       | 2400/F(KHz)                       | 300                           |
| 0.490~1.705       | 24000/F(KHz)                      | 30                            |
| 1.705~30.0        | 30                                | 30                            |
| 30~88             | 100                               | 3                             |
| 88~216            | 150                               | 3                             |
| 216~960           | 200                               | 3                             |
| Above 960         | 500                               | 3                             |

### 4.6.2. Measuring Instruments and Setting

Please refer to section 5 of equipments list in this report. The following table is the setting of the spectrum analyzer.

| Spectrum Parameter                        | Setting  |
|---|--|
| Attenuation                               | Auto   |
| Span Frequency                            | 100 MHz  |
| RB / VB (Emission in restricted band)     | 1MHz / 3MHz for Peak, 1 MHz / 10Hz for Average |
| RB / VB (Emission in non-restricted band) | 100 KHz / 300 KHz for Peak                     |

### 4.6.3. Test Procedures

- The test procedure is the same as section 4.5.3, only the frequency range investigated is limited to 100MHz around bandedges.

### 4.6.4. Test Setup Layout

This test setup layout is the same as that shown in section 4.5.4.

### 4.6.5. Test Deviation

There is no deviation with the original standard.

### 4.6.6. EUT Operation during Test

The EUT was programmed to be in continuously transmitting mode.

#### 4.6.7. Test Result of Band Edge and Fundamental Emissions

|               |               |                |   |
|---------------|---------------|----------------|---|
| Temperature   | 20°C          | Humidity       | 60%   |
| Test Engineer | Kenneth Huang | Configurations | IEEE 802.11n MCS0 20MHz Ch 1, 6, 11 /<br>Ant. 1 + Ant. 2 + Ant. 3 |
| Test date     | Nov. 15, 2012 |                |   |

##### Channel 1

|   | Freq    | Level  | Limit Line | Over Limit | Read Level | CableAntenna Loss | Antenna Factor | Preamp Factor | Remark  | A/Pos | T/Pos | Pol/Phase |
|---|---------|--------|------------|------------|------------|-------------------|----------------|---------------|---------|-------|-------|-----------|
|   | MHz     | dBuV/m | dBuV/m     | dB         | dBuV       | dB                | dB/m           | dB            |         | cm    | deg   |           |
| 1 | 2389.00 | 69.27  | 74.00      | -4.73      | 36.88      | 4.34              | 28.05          | 0.00          | Peak    | 143   | 326   | VERTICAL  |
| 2 | 2390.00 | 52.54  | 54.00      | -1.46      | 20.15      | 4.34              | 28.05          | 0.00          | Average | 143   | 326   | VERTICAL  |
| 3 | 2409.40 | 97.01  |            |            |            | 4.34              | 28.09          | 0.00          | Average | 143   | 326   | VERTICAL  |
| 4 | 2409.40 | 110.69 |            |            |            | 4.34              | 28.09          | 0.00          | Peak    | 143   | 326   | VERTICAL  |

Item 3, 4 are the fundamental frequency at 2412 MHz.

##### Channel 6

|   | Freq    | Level  | Limit Line | Over Limit | Read Level | CableAntenna Loss | Antenna Factor | Preamp Factor | Remark  | A/Pos | T/Pos | Pol/Phase |
|---|---------|--------|------------|------------|------------|-------------------|----------------|---------------|---------|-------|-------|-----------|
|   | MHz     | dBuV/m | dBuV/m     | dB         | dBuV       | dB                | dB/m           | dB            |         | cm    | deg   |           |
| 1 | 2356.03 | 50.67  | 54.00      | -3.33      | 20.38      | 2.19              | 28.10          | 0.00          | Average | 100   | 293   | VERTICAL  |
| 2 | 2356.03 | 60.76  | 74.00      | -13.24     | 30.47      | 2.19              | 28.10          | 0.00          | Peak    | 100   | 293   | VERTICAL  |
| 3 | 2444.05 | 112.20 |            |            |            | 2.24              | 28.29          | 0.00          | Average | 100   | 293   | VERTICAL  |
| 4 | 2444.05 | 121.51 |            |            |            | 2.24              | 28.29          | 0.00          | Peak    | 100   | 293   | VERTICAL  |
| 5 | 2484.46 | 64.90  | 74.00      | -9.10      | 34.27      | 2.26              | 28.37          | 0.00          | Peak    | 100   | 293   | VERTICAL  |
| 6 | 2484.78 | 52.21  | 54.00      | -1.79      | 21.58      | 2.26              | 28.37          | 0.00          | Average | 100   | 293   | VERTICAL  |

Item 3, 4 are the fundamental frequency at 2437MHz.

##### Channel 11

|   | Freq    | Level  | Limit Line | Over Limit | Read Level | CableAntenna Loss | Antenna Factor | Preamp Factor | Remark  | A/Pos | T/Pos | Pol/Phase |
|---|---------|--------|------------|------------|------------|-------------------|----------------|---------------|---------|-------|-------|-----------|
|   | MHz     | dBuV/m | dBuV/m     | dB         | dBuV       | dB                | dB/m           | dB            |         | cm    | deg   |           |
| 1 | 2463.44 | 115.41 |            |            |            | 2.24              | 28.33          | 0.00          | Peak    | 100   | 23    | VERTICAL  |
| 2 | 2463.60 | 105.13 |            |            |            | 2.24              | 28.33          | 0.00          | Average | 100   | 23    | VERTICAL  |
| 3 | 2483.50 | 52.69  | 54.00      | -1.31      | 22.06      | 2.26              | 28.37          | 0.00          | Average | 100   | 23    | VERTICAL  |
| 4 | 2483.50 | 64.06  | 74.00      | -9.94      | 33.43      | 2.26              | 28.37          | 0.00          | Peak    | 100   | 23    | VERTICAL  |

Item 1, 2 are the fundamental frequency at 2462 MHz.

|               |               |                |  |
|---------------|---------------|----------------|--|
| Temperature   | 20°C          | Humidity       | 60%  |
| Test Engineer | Kenneth Huang | Configurations | IEEE 802.11n MCS0 40MHz Ch 3, 6, 9 /<br>Ant. 1 + Ant. 2 + Ant. 3 |
| Test date     | Nov. 15, 2012 |                |  |

**Channel 3**

|   | Freq    | Level  | Limit Line | Over Limit | Read Level | CableAntenna Loss | Antenna Factor | Preamp Factor | Remark  | A/Pos | T/Pos | Pol/Phase |
|---|---------|--------|------------|------------|------------|-------------------|----------------|---------------|---------|-------|-------|-----------|
|   | MHz     | dBuV/m | dBuV/m     | dB         | dBuV       | dB                | dB/m           | dB            |         | cm    | deg   |           |
| 1 | 2390.00 | 52.52  | 54.00      | -1.48      | 22.13      | 2.22              | 28.17          | 0.00          | Average | 100   | 19    | VERTICAL  |
| 2 | 2390.00 | 68.87  | 74.00      | -5.13      | 38.48      | 2.22              | 28.17          | 0.00          | Peak    | 100   | 19    | VERTICAL  |
| 3 | 2428.09 | 99.12  |            |            |            | 2.23              | 28.25          | 0.00          | Average | 100   | 19    | VERTICAL  |
| 4 | 2428.09 | 108.71 |            |            |            | 2.23              | 28.25          | 0.00          | Peak    | 100   | 19    | VERTICAL  |

Item 3, 4 are the fundamental frequency at 2422 MHz.

**Channel 6**

|   | Freq    | Level  | Limit Line | Over Limit | Read Level | CableAntenna Loss | Antenna Factor | Preamp Factor | Remark  | A/Pos | T/Pos | Pol/Phase |
|---|---------|--------|------------|------------|------------|-------------------|----------------|---------------|---------|-------|-------|-----------|
|   | MHz     | dBuV/m | dBuV/m     | dB         | dBuV       | dB                | dB/m           | dB            |         | cm    | deg   |           |
| 1 | 2388.08 | 66.96  | 74.00      | -7.04      | 36.58      | 2.21              | 28.17          | 0.00          | Peak    | 100   | 21    | VERTICAL  |
| 2 | 2390.00 | 52.63  | 54.00      | -1.37      | 22.24      | 2.22              | 28.17          | 0.00          | Average | 100   | 21    | VERTICAL  |
| 3 | 2448.22 | 114.52 |            |            |            | 2.24              | 28.29          | 0.00          | Peak    | 100   | 21    | VERTICAL  |
| 4 | 2448.54 | 105.35 |            |            |            | 2.24              | 28.29          | 0.00          | Average | 100   | 21    | VERTICAL  |
| 5 | 2484.46 | 64.40  | 74.00      | -9.60      | 33.77      | 2.26              | 28.37          | 0.00          | Peak    | 100   | 21    | VERTICAL  |
| 6 | 2485.74 | 51.49  | 54.00      | -2.51      | 20.82      | 2.26              | 28.41          | 0.00          | Average | 100   | 21    | VERTICAL  |

Item 3, 4 are the fundamental frequency at 2437MHz.

**Channel 9**

|   | Freq    | Level  | Limit Line | Over Limit | Read Level | CableAntenna Loss | Antenna Factor | Preamp Factor | Remark  | A/Pos | T/Pos | Pol/Phase |
|---|---------|--------|------------|------------|------------|-------------------|----------------|---------------|---------|-------|-------|-----------|
|   | MHz     | dBuV/m | dBuV/m     | dB         | dBuV       | dB                | dB/m           | dB            |         | cm    | deg   |           |
| 1 | 2441.60 | 105.40 |            |            |            | 4.38              | 28.18          | 0.00          | Peak    | 137   | 50    | VERTICAL  |
| 2 | 2463.60 | 92.93  |            |            |            | 4.40              | 28.22          | 0.00          | Average | 137   | 50    | VERTICAL  |
| 3 | 2483.50 | 52.69  | 54.00      | -1.31      | 20.03      | 4.40              | 28.26          | 0.00          | Average | 137   | 50    | VERTICAL  |
| 4 | 2483.50 | 70.13  | 74.00      | -3.87      | 37.47      | 4.40              | 28.26          | 0.00          | Peak    | 137   | 50    | VERTICAL  |

Item 1, 2 are the fundamental frequency at 2452 MHz.

Note:

Emission level (dBuV/m) = 20 log Emission level (uV/m).

Corrected Reading: Antenna Factor + Cable Loss + Read Level - Preamp Factor = Level.

|               |               |                |  |
|---------------|---------------|----------------|--|
| Temperature   | 20°C          | Humidity       | 60%  |
| Test Engineer | Kenneth Huang | Configurations | IEEE 802.11b CH 1, 6, 11 /<br>Ant. 1 + Ant. 2 + Ant. 3 |
| Test Date     | Nov. 15, 2012 |                |  |

**Channel 1**

|   | Freq    | Level  | Limit  | Over   | Read  | Cable | Antenna | Preamp | Remark  | A/Pos | T/Pos | Pol/Phase |
|---|---------|--------|--------|--------|-------|-------|---------|--------|---------|-------|-------|-----------|
|   | MHz     | dBuV/m | dBuV/m | dB     | dBuV  | Loss  | Factor  | Factor |         | cm    | deg   |           |
| 1 | 2389.68 | 48.37  | 54.00  | -5.63  | 17.99 | 2.21  | 28.17   | 0.00   | Average | 118   | 147   | VERTICAL  |
| 2 | 2389.68 | 57.68  | 74.00  | -16.32 | 27.30 | 2.21  | 28.17   | 0.00   | Peak    | 118   | 147   | VERTICAL  |
| 3 | 2409.44 | 119.25 |        |        |       | 2.22  | 28.21   | 0.00   | Peak    | 118   | 147   | VERTICAL  |
| 4 | 2410.40 | 116.05 |        |        |       | 2.22  | 28.21   | 0.00   | Average | 118   | 147   | VERTICAL  |
| 5 | 2490.87 | 52.83  | 54.00  | -1.17  | 22.16 | 2.26  | 28.41   | 0.00   | Average | 118   | 147   | VERTICAL  |
| 6 | 2493.12 | 63.59  | 74.00  | -10.41 | 32.91 | 2.27  | 28.41   | 0.00   | Peak    | 118   | 147   | VERTICAL  |

Item 3, 4 are the fundamental frequency at 2412 MHz.

**Channel 6**

|   | Freq    | Level  | Limit  | Over   | Read  | Cable | Antenna | Preamp | Remark  | A/Pos | T/Pos | Pol/Phase |
|---|---------|--------|--------|--------|-------|-------|---------|--------|---------|-------|-------|-----------|
|   | MHz     | dBuV/m | dBuV/m | dB     | dBuV  | Loss  | Factor  | Factor |         | cm    | deg   |           |
| 1 | 2352.50 | 61.03  | 74.00  | -12.97 | 30.74 | 2.19  | 28.10   | 0.00   | Peak    | 100   | 216   | VERTICAL  |
| 2 | 2352.82 | 51.58  | 54.00  | -2.42  | 21.29 | 2.19  | 28.10   | 0.00   | Average | 100   | 216   | VERTICAL  |
| 3 | 2435.08 | 114.13 |        |        |       | 2.23  | 28.29   | 0.00   | Peak    | 100   | 216   | VERTICAL  |
| 4 | 2435.40 | 111.16 |        |        |       | 2.23  | 28.29   | 0.00   | Average | 100   | 216   | VERTICAL  |
| 5 | 2496.00 | 49.54  | 54.00  | -4.46  | 18.86 | 2.27  | 28.41   | 0.00   | Average | 100   | 216   | VERTICAL  |
| 6 | 2496.00 | 59.32  | 74.00  | -14.68 | 28.64 | 2.27  | 28.41   | 0.00   | Peak    | 100   | 216   | VERTICAL  |

Item 3, 4 are the fundamental frequency at 2437 MHz.

**Channel 11**

|   | Freq    | Level  | Limit  | Over   | Read  | Cable | Antenna | Preamp | Remark  | A/Pos | T/Pos | Pol/Phase |
|---|---------|--------|--------|--------|-------|-------|---------|--------|---------|-------|-------|-----------|
|   | MHz     | dBuV/m | dBuV/m | dB     | dBuV  | Loss  | Factor  | Factor |         | cm    | deg   |           |
| 1 | 2460.08 | 116.49 |        |        |       | 2.24  | 28.33   | 0.00   | Average | 104   | 180   | VERTICAL  |
| 2 | 2461.36 | 120.14 |        |        |       | 2.24  | 28.33   | 0.00   | Peak    | 104   | 180   | VERTICAL  |
| 3 | 2483.50 | 52.78  | 54.00  | -1.22  | 22.15 | 2.26  | 28.37   | 0.00   | Average | 104   | 180   | VERTICAL  |
| 4 | 2483.50 | 63.53  | 74.00  | -10.47 | 32.90 | 2.26  | 28.37   | 0.00   | Peak    | 104   | 180   | VERTICAL  |

Item 1, 2 are the fundamental frequency at 2462 MHz.



|               |               |                |  |
|---------------|---------------|----------------|--|
| Temperature   | 20°C          | Humidity       | 60%  |
| Test Engineer | Kenneth Huang | Configurations | IEEE 802.11g CH 1, 6, 11 /<br>Ant. 1 + Ant. 2 + Ant. 3 |
| Test Date     | Nov. 15, 2012 |                |  |

**Channel 1**

|   | Freq    | Level  | Limit Line | Over Limit | Read Level | Cable Loss | Antenna Factor | Preamp Factor | Remark  | A/Pos | T/Pos | Pol/Phase |
|---|---------|--------|------------|------------|------------|------------|----------------|---------------|---------|-------|-------|-----------|
|   | MHz     | dBuV/m | dBuV/m     | dB         | dBuV       | dB         | dB/m           | dB            |         | cm    | deg   |           |
| 1 | 2389.68 | 65.22  | 74.00      | -8.78      | 34.84      | 2.21       | 28.17          | 0.00          | Peak    | 119   | 135   | VERTICAL  |
| 2 | 2390.00 | 52.56  | 54.00      | -1.44      | 22.17      | 2.22       | 28.17          | 0.00          | Average | 119   | 135   | VERTICAL  |
| 3 | 2410.72 | 108.21 |            |            |            | 2.22       | 28.21          | 0.00          | Average | 119   | 135   | VERTICAL  |
| 4 | 2411.36 | 118.28 |            |            |            | 2.22       | 28.21          | 0.00          | Peak    | 119   | 135   | VERTICAL  |

Item 3, 4 are the fundamental frequency at 2412 MHz.

**Channel 6**

|   | Freq    | Level  | Limit Line | Over Limit | Read Level | Cable Loss | Antenna Factor | Preamp Factor | Remark  | A/Pos | T/Pos | Pol/Phase |
|---|---------|--------|------------|------------|------------|------------|----------------|---------------|---------|-------|-------|-----------|
|   | MHz     | dBuV/m | dBuV/m     | dB         | dBuV       | dB         | dB/m           | dB            |         | cm    | deg   |           |
| 1 | 2389.68 | 64.13  | 74.00      | -9.87      | 33.75      | 2.21       | 28.17          | 0.00          | Peak    | 100   | 119   | VERTICAL  |
| 2 | 2390.00 | 52.04  | 54.00      | -1.96      | 21.65      | 2.22       | 28.17          | 0.00          | Average | 100   | 119   | VERTICAL  |
| 3 | 2430.27 | 111.94 |            |            |            | 2.23       | 28.25          | 0.00          | Average | 100   | 119   | VERTICAL  |
| 4 | 2430.27 | 121.97 |            |            |            | 2.23       | 28.25          | 0.00          | Peak    | 100   | 119   | VERTICAL  |
| 5 | 2485.10 | 50.28  | 54.00      | -3.72      | 19.61      | 2.26       | 28.41          | 0.00          | Average | 100   | 119   | VERTICAL  |
| 6 | 2485.10 | 61.71  | 74.00      | -12.29     | 31.04      | 2.26       | 28.41          | 0.00          | Peak    | 100   | 119   | VERTICAL  |

Item 3, 4 are the fundamental frequency at 2437 MHz.

**Channel 11**

|   | Freq    | Level  | Limit Line | Over Limit | Read Level | Cable Loss | Antenna Factor | Preamp Factor | Remark  | A/Pos | T/Pos | Pol/Phase |
|---|---------|--------|------------|------------|------------|------------|----------------|---------------|---------|-------|-------|-----------|
|   | MHz     | dBuV/m | dBuV/m     | dB         | dBuV       | dB         | dB/m           | dB            |         | cm    | deg   |           |
| 1 | 2462.96 | 104.48 |            |            |            | 2.24       | 28.33          | 0.00          | Average | 104   | 166   | VERTICAL  |
| 2 | 2463.28 | 113.78 |            |            |            | 2.24       | 28.33          | 0.00          | Peak    | 104   | 166   | VERTICAL  |
| 3 | 2483.50 | 52.13  | 54.00      | -1.87      | 21.50      | 2.26       | 28.37          | 0.00          | Average | 104   | 166   | VERTICAL  |
| 4 | 2484.46 | 65.20  | 74.00      | -8.80      | 34.57      | 2.26       | 28.37          | 0.00          | Peak    | 104   | 166   | VERTICAL  |

Item 1, 2 are the fundamental frequency at 2462 MHz.



For Emission not in Restricted Band

Plot on Configuration IEEE 802.11n MCS0 20MHz / Reference Level

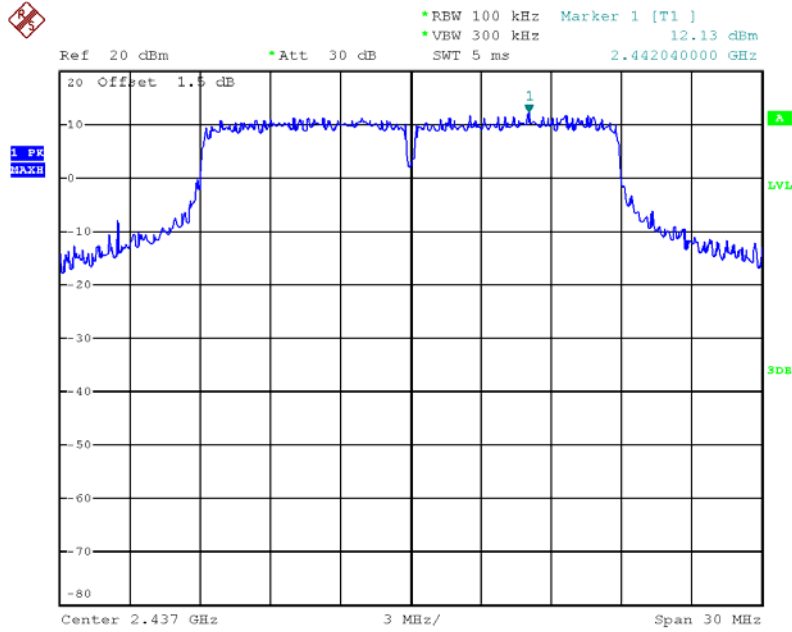

Date: 22.NOV.2012 16:33:51

Plot on Configuration IEEE 802.11n MCS0 20MHz / CH 1 (down 30dBc)

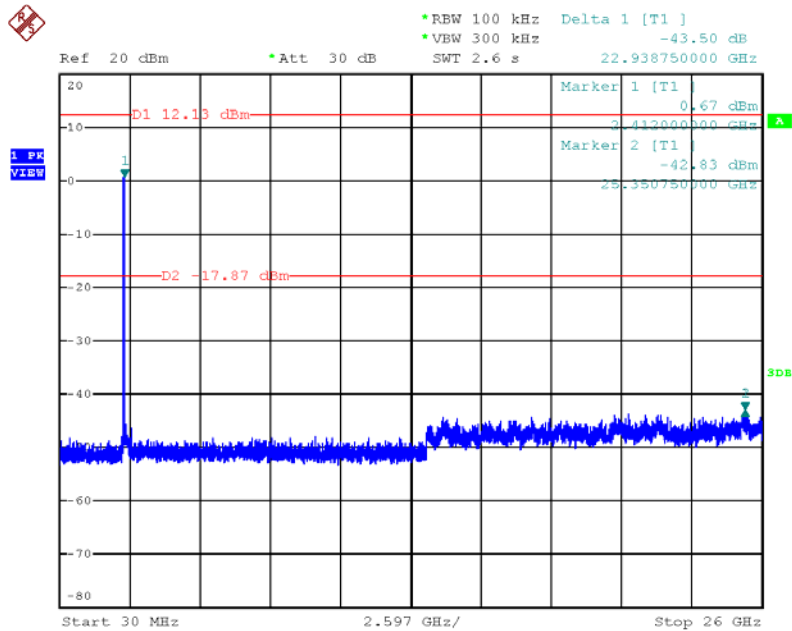

Date: 22.NOV.2012 16:59:30

Plot on Configuration IEEE 802.11n MCS0 20MHz / CH 6 (down 30dBc)

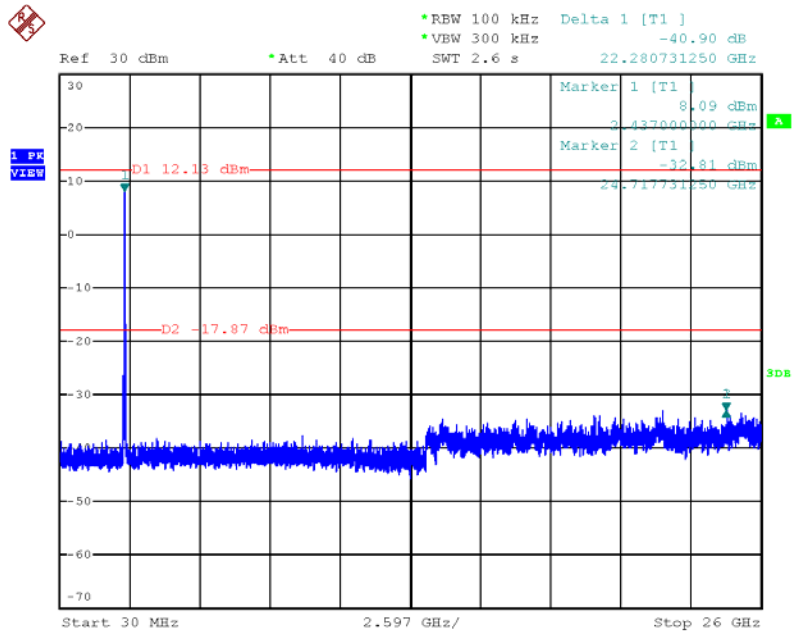

Date: 22.NOV.2012 17:00:47

Plot on Configuration IEEE 802.11n MCS0 20MHz / CH 11 (down 30dBc)

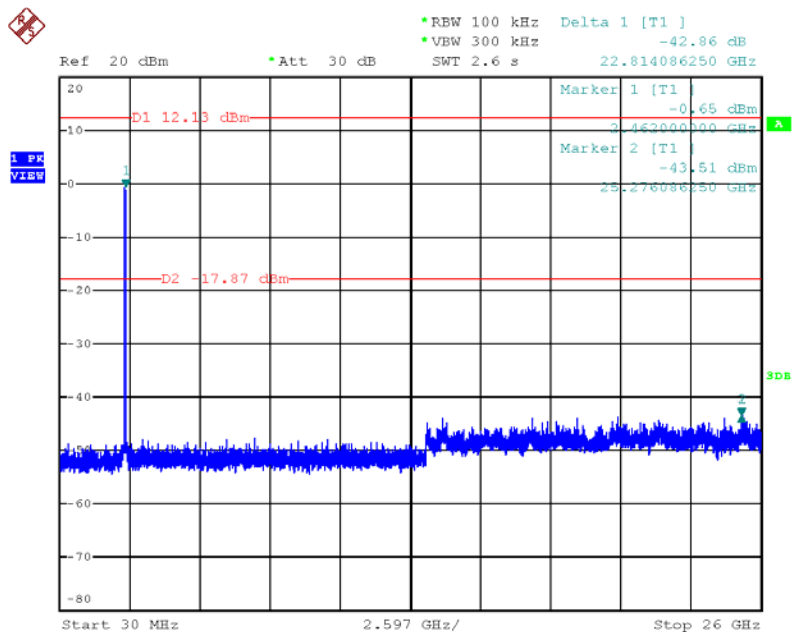

Date: 22.NOV.2012 17:01:59

Plot on Configuration IEEE 802.11n MCS0 40MHz / Reference Level

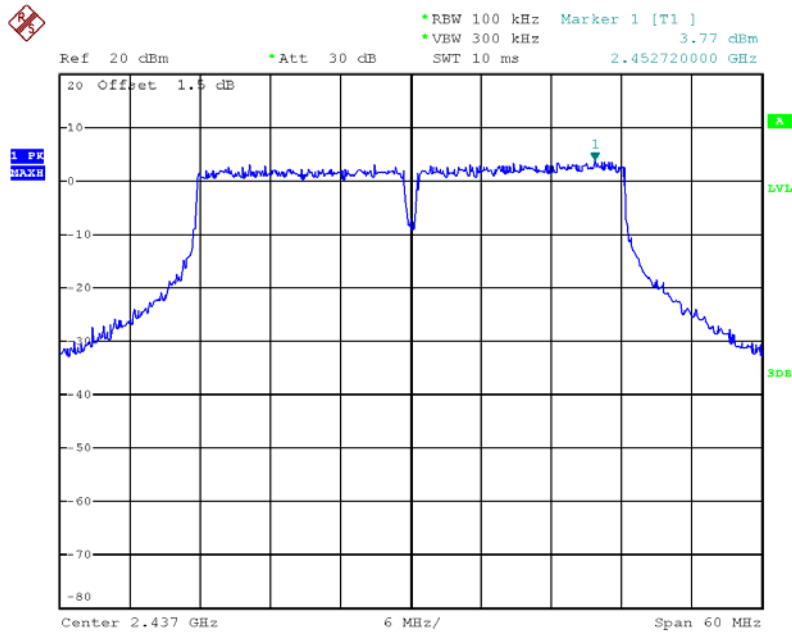

Date: 22.NOV.2012 16:30:39

Plot on Configuration IEEE 802.11n MCS0 40MHz / CH 3 (down 30dBc)

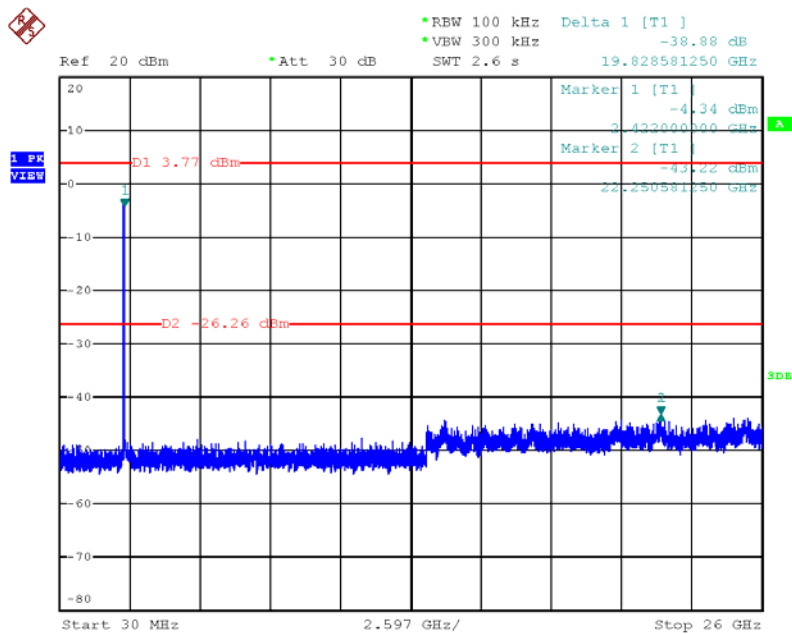

Date: 22.NOV.2012 17:03:12

Plot on Configuration IEEE 802.11n MCS0 40MHz / CH 6 (down 30dBc)

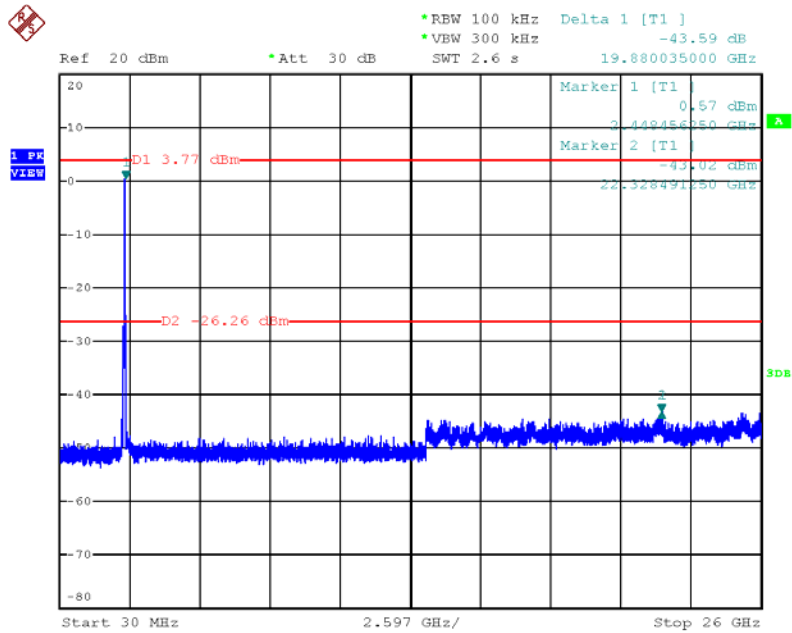

Date: 22.NOV.2012 17:04:46

Plot on Configuration IEEE 802.11n MCS0 40MHz / CH 9 (down 30dBc)

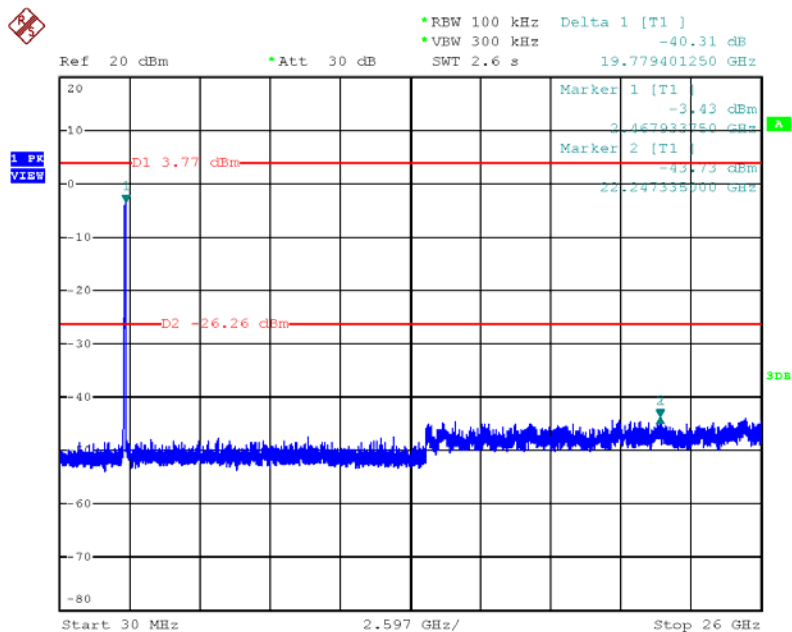

Date: 22.NOV.2012 17:05:43

Plot on Configuration IEEE 802.11b / Reference Level

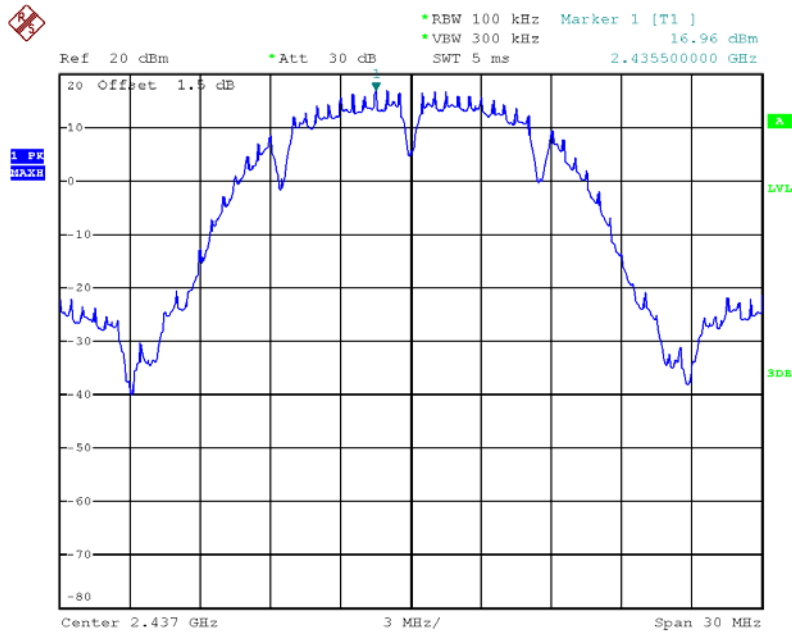

Date: 22.NOV.2012 16:37:32

Plot on Configuration IEEE 802.11b / CH 1 (down 30dBc)

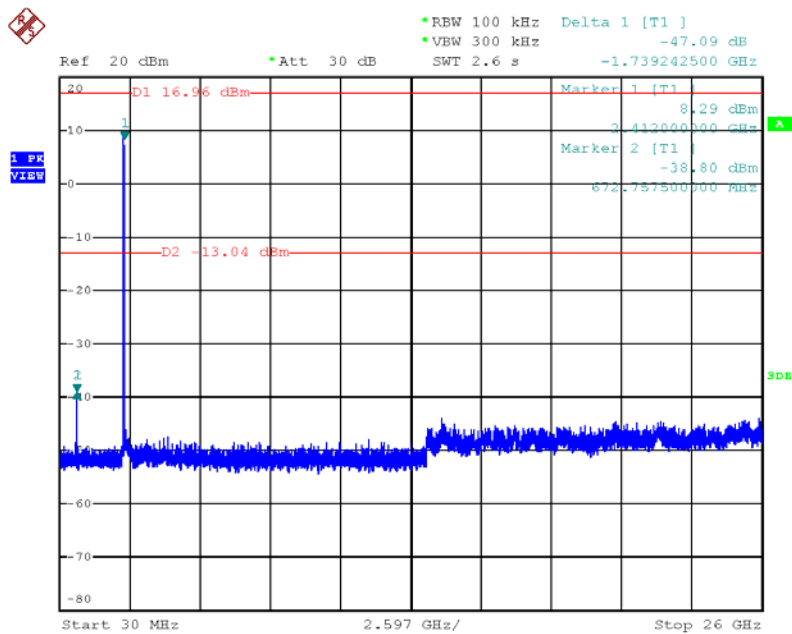

Date: 22.NOV.2012 16:49:52

Plot on Configuration IEEE 802.11b / CH 6 (down 30dBc)

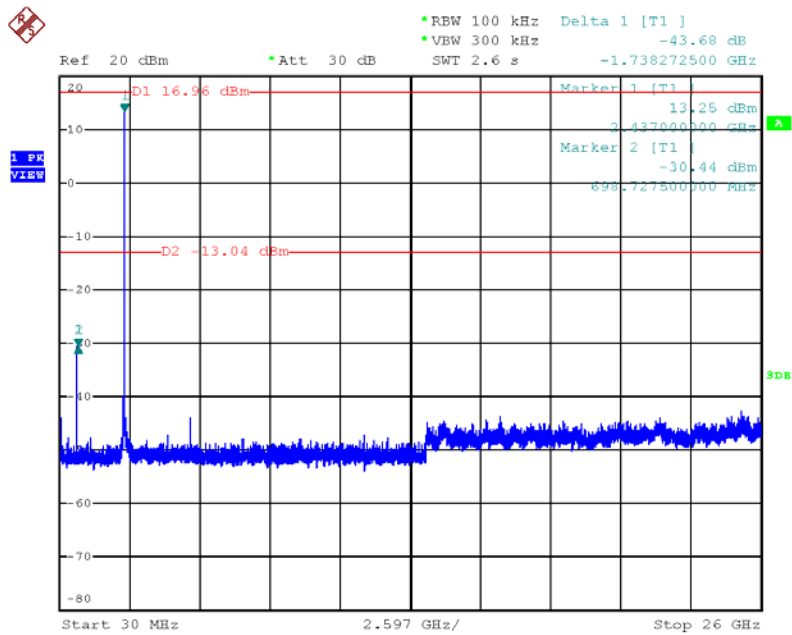

Date: 22.NOV.2012 16:51:04

Plot on Configuration IEEE 802.11b / CH 11 (down 30dBc)

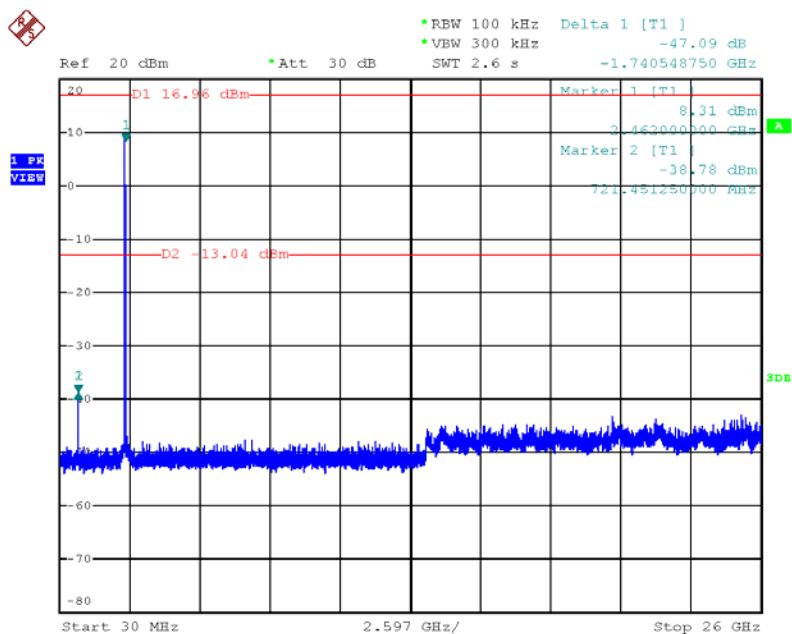

Date: 22.NOV.2012 16:52:03

Plot on Configuration IEEE 802.11g / Reference Level

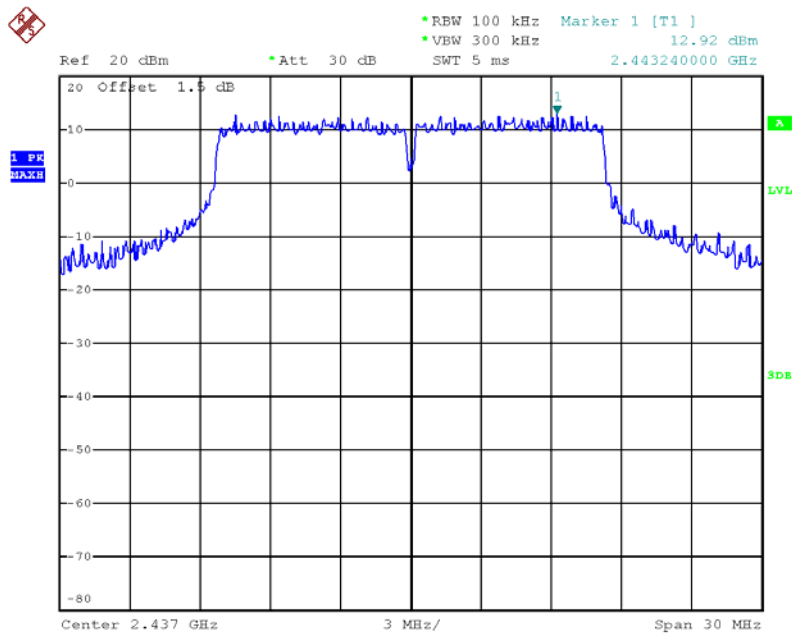

Date: 22.NOV.2012 16:35:49

Plot on Configuration IEEE 802.11g / CH 1 (down 30dBc)

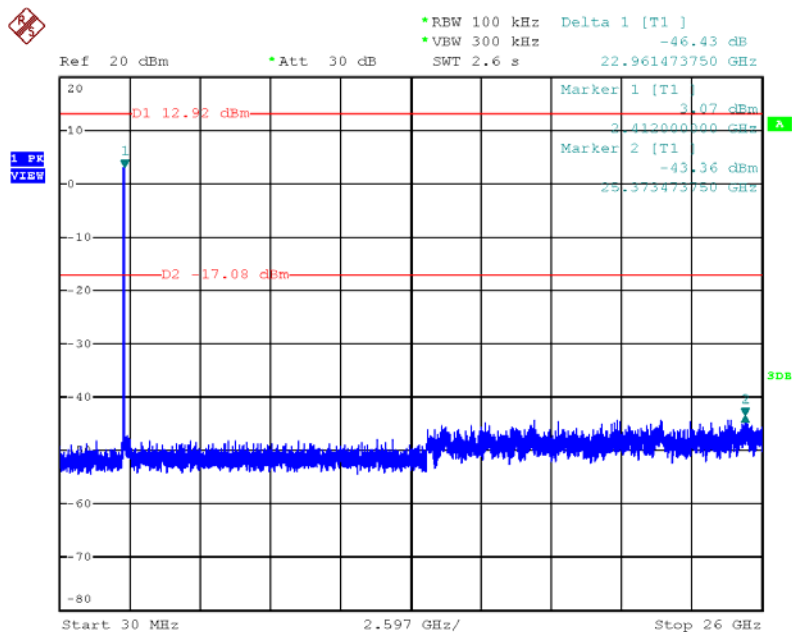

Date: 22.NOV.2012 16:58:00

Plot on Configuration IEEE 802.11g / CH 6 (down 30dBc)

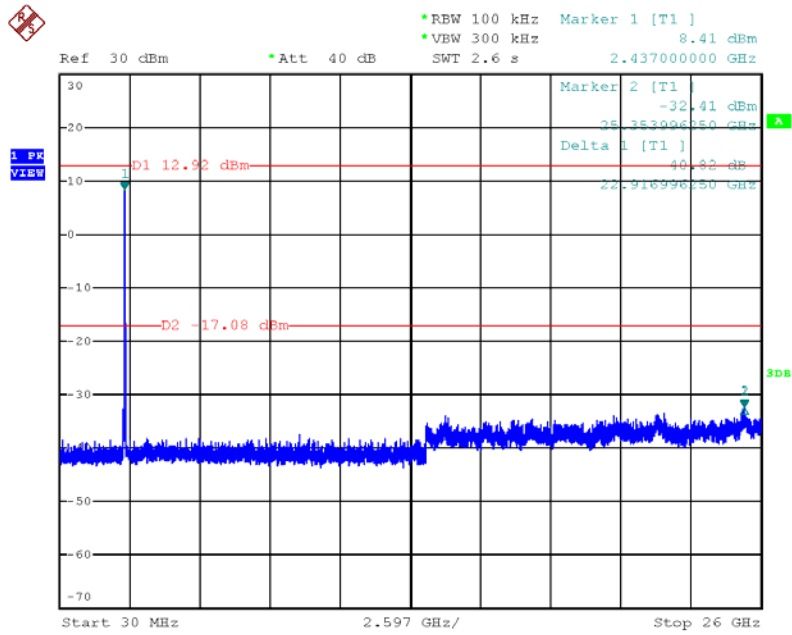

Date: 22.NOV.2012 16:56:38

Plot on Configuration IEEE 802.11g / CH 11 (down 30dBc)

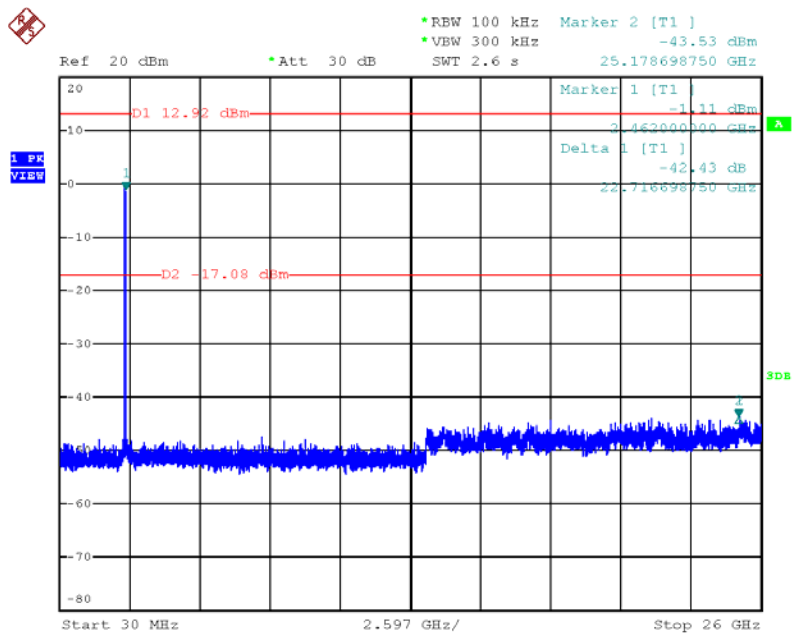

Date: 22.NOV.2012 16:54:19



## 4.7. Antenna Requirements

### 4.7.1. Limit

Except for special regulations, the Low-power Radio-frequency Devices must not be equipped with any jacket for installing an antenna with extension cable. An intentional radiator shall be designed to ensure that no antenna other than that furnished by the responsible party shall be used with the device. The use of a permanently attached antenna or of an antenna that uses a unique coupling to the intentional radiator shall be considered sufficient to comply with the provisions of this Section. The manufacturer may design the unit so that the user can replace a broken antenna, but the use of a standard antenna jack or electrical connector is prohibited. Further, this requirement does not apply to intentional radiators that must be professionally installed.

### 4.7.2. Antenna Connector Construction

Please refer to section 3.3 in this test report; antenna connector complied with the requirements.

## 5. LIST OF MEASURING EQUIPMENTS

| Instrument                       | Manufacturer  | Model No.        | Serial No.  | Characteristics  | Calibration Date | Remark                   |
|----------------------------------|---------------|------------------|-------------|------------------|------------------|--------------------------|
| BILOG ANTENNA                    | Schaffner     | CBL6112D         | 22021       | 20MHz ~ 2GHz     | Jan. 11, 2012    | Radiation<br>(03CH01-CB) |
| Horn Antenna                     | EMCO          | 3115             | 00075790    | 750MHz~18GHz     | Nov. 25, 2011    | Radiation<br>(03CH01-CB) |
| Horn Antenna                     | SCHWARZBEAK   | BBHA 9170        | BBHA9170252 | 15GHz ~ 40GHz    | Nov. 22, 2011    | Radiation<br>(03CH01-CB) |
| Horn Antenna                     | SCHWARZBEAK   | BBHA 9170        | BBHA9170252 | 15GHz ~ 40GHz    | Nov. 22, 2012    | Radiation<br>(03CH01-CB) |
| Pre-Amplifier                    | Agilent       | 8447D            | 2944A10991  | 0.1MHz ~ 1.3GHz  | Nov. 17, 2011    | Radiation<br>(03CH01-CB) |
| Pre-Amplifier                    | Agilent       | 8447D            | 2944A10991  | 0.1MHz ~ 1.3GHz  | Nov. 17, 2012    | Radiation<br>(03CH01-CB) |
| Pre-Amplifier                    | Agilent       | 8449B            | 3008A02310  | 1GHz ~ 26.5GHz   | Nov. 29, 2011    | Radiation<br>(03CH01-CB) |
| Pre-Amplifier                    | WM            | TF-130N-R1       | 923365      | 26.5GHz ~ 40GHz  | Jul. 31, 2012    | Radiation<br>(03CH01-CB) |
| Spectrum analyzer                | R&S           | FSP40            | 100056      | 9KHz~40GHz       | Nov. 03, 2012    | Radiation<br>(03CH01-CB) |
| EMI Test Receiver                | R&S           | ESCS 30          | 100355      | 9KHz ~ 2.75GHz   | Mar. 20, 2012    | Radiation<br>(03CH01-CB) |
| Loop Antenna                     | Teseq         | HLA 6120         | 24155       | 9 kHz - 30 MHz   | Sep. 09, 2011*   | Radiation<br>(03CH01-CB) |
| Turn Table                       | INN CO        | CO 2000          | N/A         | 0 ~ 360 degree   | N/A              | Radiation<br>(03CH01-CB) |
| Antenna Mast                     | INN CO        | CO2000           | N/A         | 1 m - 4 m        | N/A              | Radiation<br>(03CH01-CB) |
| RF Cable-low                     | Woken         | Low Cable-1      | N/A         | 30 MHz - 1 GHz   | Nov. 17, 2011    | Radiation<br>(03CH01-CB) |
| RF Cable-high                    | Woken         | High Cable-1     | N/A         | 1 GHz – 26.5 GHz | Nov. 17, 2011    | Radiation<br>(03CH01-CB) |
| RF Cable-high                    | Woken         | High Cable-2     | N/A         | 1 GHz – 26.5 GHz | Nov. 17, 2011    | Radiation<br>(03CH01-CB) |
| RF Cable-high                    | Woken         | High Cable-3     | N/A         | 1 GHz - 40 GHz   | Nov. 17, 2011    | Radiation<br>(03CH01-CB) |
| RF Cable-high                    | Woken         | High Cable-4     | N/A         | 1 GHz - 40 GHz   | Nov. 17, 2011    | Radiation<br>(03CH01-CB) |
| EMI Test Receiver                | R&S           | ESCS 30          | 100377      | 9kHz ~ 2.75GHz   | Oct. 23, 2012    | Conduction<br>(CO01-CB)  |
| LISN                             | F.C.C.        | FCC-LISN-50-16-2 | 04083       | 150kHz ~ 100MHz  | Nov. 14, 2012    | Conduction<br>(CO01-CB)  |
| V- LISN                          | Schwarzbeck   | NSLK 8127        | 8127-478    | 9kHz ~ 30MHz     | Jun. 22, 2012    | Conduction<br>(CO01-CB)  |
| Impulsbegrenzer<br>Pulse Limiter | Rohde&Schwarz | ESH3-Z2          | 100430      | 9kHz~30MHz       | Feb. 03, 2012    | Conduction<br>(CO01-CB)  |
| COND Cable                       | Woken         | Cable            | 01          | 0.15MHz~30MHz    | Dec. 4, 2011     | Conduction<br>(CO01-CB)  |
| Signal analyzer                  | R&S           | FSV40            | 100979      | 9KHz~40GHz       | Oct. 08, 2012    | Conducted<br>(TH01-CB)   |
| Temp. and Humidity<br>Chamber    | Ten Billion   | TTH-D3SP         | TBN-931011  | -30~100 degree   | Jun. 05, 2012    | Conducted<br>(TH01-CB)   |
| Thermo-Hygro<br>Meter            | N/A           | HC 520           | #1          | 15~70 degree     | Nov. 02, 2012    | Conducted<br>(TH01-CB)   |

| Instrument        | Manufacturer | Model No.     | Serial No. | Characteristics  | Calibration Date | Remark              |
|-------------------|--------------|---------------|------------|------------------|------------------|---------------------|
| Signal Generator  | R&S          | SMR40         | 100302     | 10MHz-40GHz      | Nov. 22, 2012    | Conducted (TH01-CB) |
| RF Power Divider  | HP           | 11636A        | 00306      | 2GHz ~ 18GHz     | N/A              | Conducted (TH01-CB) |
| RF Power Splitter | Anaren       | 44100         | 1839       | 2GHz ~ 18GHz     | N/A              | Conducted (TH01-CB) |
| RF Power Splitter | Anaren       | 42100         | 17930      | 2GHz ~ 18GHz     | N/A              | Conducted (TH01-CB) |
| Signal generator  | R&S          | SMU200A       | 102782     | 10MHz-40GHz      | Sep. 26, 2012    | Conducted (TH01-CB) |
| Horn Antenna      | COM-POWER    | AH-118        | 071187     | 1GHz – 18GHz     | May 09, 2012     | Conducted (TH01-CB) |
| RF Cable-high     | Woken        | High Cable-7  | -          | 1 GHz – 26.5 GHz | Nov. 17, 2012    | Conducted (TH01-CB) |
| RF Cable-high     | Woken        | High Cable-8  | -          | 1 GHz – 26.5 GHz | Nov. 17, 2012    | Conducted (TH01-CB) |
| RF Cable-high     | Woken        | High Cable-9  | -          | 1 GHz – 26.5 GHz | Nov. 17, 2012    | Conducted (TH01-CB) |
| RF Cable-high     | Woken        | High Cable-10 | -          | 1 GHz – 26.5 GHz | Nov. 17, 2012    | Conducted (TH01-CB) |
| RF Cable-high     | Woken        | High Cable-11 | -          | 1 GHz – 26.5 GHz | Nov. 17, 2012    | Conducted (TH01-CB) |
| RF Cable-high     | Woken        | High Cable-12 | -          | 1 GHz – 26.5 GHz | Nov. 17, 2012    | Conducted (TH01-CB) |
| RF Cable-high     | Woken        | High Cable-13 | -          | 1 GHz – 26.5 GHz | Nov. 17, 2012    | Conducted (TH01-CB) |
| Power Sensor      | Anritsu      | MA2411B       | 0917223    | 300MHz~40GHz     | Nov. 01, 2012    | Conducted (TH01-CB) |
| Power Meter       | Anritsu      | ML2495A       | 1035008    | 300MHz~40GHz     | Nov. 01, 2012    | Conducted (TH01-CB) |

Note: Calibration Interval of instruments listed above is one year.

Note: "\*" Calibration Interval of instruments listed above is two years.

## 6. TEST LOCATION

|        |  |
|--------|--|
| SHIJR  | ADD : 6Fl., No. 106, Sec. 1, Shintai 5th Rd., Shijr City, Taipei, Taiwan 221, R.O.C.<br>TEL : 886-2-2696-2468<br>FAX : 886-2-2696-2255 |
| HWA YA | ADD : No. 52, Hwa Ya 1st Rd., Kwei-Shan Hsiang, Tao Yuan Hsien, Taiwan, R.O.C.<br>TEL : 886-3-327-3456<br>FAX : 886-3-318-0055         |
| LINKOU | ADD : No. 30-2, Dingfu Tsuen, Linkou Shiang, Taipei, Taiwan 244, R.O.C<br>TEL : 886-2-2601-1640<br>FAX : 886-2-2601-1695               |
| DUNGHU | ADD : No. 3, Lane 238, Kangle St., Neihu Chiu, Taipei, Taiwan 114, R.O.C.<br>TEL : 886-2-2631-4739<br>FAX : 886-2-2631-9740            |
| JUNGHE | ADD : 7Fl., No. 758, Jungjeng Rd., Junghe City, Taipei, Taiwan 235, R.O.C.<br>TEL : 886-2-8227-2020<br>FAX : 886-2-8227-2626           |
| NEIHU  | ADD : 4Fl., No. 339, Hsin Hu 2 <sup>nd</sup> Rd., Taipei 114, Taiwan, R.O.C.<br>TEL : 886-2-2794-8886<br>FAX : 886-2-2794-9777         |
| JHUBEI | ADD : No.8, Lane 724, Bo-ai St., Jhubei City, HsinChu County 302, Taiwan, R.O.C.<br>TEL : 886-3-656-9065<br>FAX : 886-3-656-9085       |

## 7. TAF CERTIFICATE OF ACCREDITATION



Certificate No. : L1190-110702

財團法人全國認證基金會  
Taiwan Accreditation Foundation

### Certificate of Accreditation

This is to certify that

**Sporton International Inc.**  
**EMC & Wireless Communications Laboratory**  
No.52, Hwa Ya 1st Road, Hwa Ya Technology Park, Kwei-Shan Hsiang, Tao Yuan Hsien,  
Taiwan, R.O.C.

**is accredited in respect of laboratory**

|                                       |  |
|---------------------------------------|--|
| <b>Accreditation Criteria</b>         | : ISO/IEC 17025:2005   |
| <b>Accreditation Number</b>           | : 1190   |
| <b>Originally Accredited</b>          | : December 15, 2003  |
| <b>Effective Period</b>               | : January 10, 2010 to January 09, 2013   |
| <b>Accredited Scope</b>               | : Testing Field, see described in the Appendix   |
| <b>Specific Accreditation Program</b> | : Accreditation Program for Designated Testing Laboratory for Commodities Inspection<br>Accreditation Program for Telecommunication Equipment Testing Laboratory<br>Accreditation Program for BSMI Mutual Recognition Arrangement with Foreign Authorities |

  
Jay-San Chen  
President, Taiwan Accreditation Foundation  
Date : July 02, 2011

P1, total 22 pages

The Appendix forms an integral part of this Certificate, which shall be invalid when use without the Appendix