



# FCC TEST REPORT (15.407)

**REPORT NO.:** RF960129L09A-1  
**MODEL NO.:** NOC-8610 EXT  
(refer to item 3.1 for more details)  
**RECEIVED:** Apr. 16, 2007  
**TESTED:** May 24, 2007 ~ May 27, 2008  
**ISSUED:** May 28, 2008

**APPLICANT:** Senao Networks Inc.

**ADDRESS:** 3F, No. 529, Chung Cheng Rd., Hsintien, Taipei,  
Taiwan, R.O.C.

**ISSUED BY:** Advance Data Technology Corporation

**LAB ADDRESS:** No. 47, 14<sup>th</sup> Ling, Chia Pau Tsuen, Lin Kou  
Hsiang 244, Taipei Hsien, Taiwan, R.O.C.

**TEST LOCATION:** No. 19, Hwa Ya 2<sup>nd</sup> Rd., Wen Hwa Tsuen, Kwei  
Shan Hsiang, Taoyuan Hsien 333, Taiwan,  
R.O.C.

This test report consists of 66 pages in total. It may be duplicated completely for legal use with the approval of the applicant. It should not be reproduced except in full, without the written approval of our laboratory. The client should not use it to claim product endorsement by TAF, A2LA or any government agencies. The test results in the report only apply to the tested sample.



## Table of Contents

1.	CERTIFICATION .....	4
2.	SUMMARY OF TEST RESULTS .....	5
2.1	MEASUREMENT UNCERTAINTY .....	5
3.	GENERAL INFORMATION.....	6
3.1	GENERAL DESCRIPTION OF EUT .....	6
3.2	DESCRIPTION OF TEST MODES.....	8
3.2.1	CONFIGURATION OF SYSTEM UNDER TEST .....	8
3.2.2	TEST MODE APPLICABILITY AND TESTED CHANNEL DETAIL:.....	9
3.3	GENERAL DESCRIPTION OF APPLIED STANDARDS .....	11
3.4	DESCRIPTION OF SUPPORT UNITS .....	11
4.	TEST TYPES AND RESULTS .....	12
4.1	RADIATED EMISSION MEASUREMENT .....	12
4.1.1	LIMITS OF RADIATED EMISSION MEASUREMENT.....	12
4.1.2	LIMITS OF UNWANTED EMISSION OUT OF THE RESTRICTED BANDS.....	12
4.1.3	TEST INSTRUMENTS .....	13
4.1.4	TEST PROCEDURES .....	14
4.1.5	DEVIATION FROM TEST STANDARD .....	14
4.1.6	TEST SETUP .....	15
4.1.7	EUT OPERATING CONDITION .....	15
4.1.8	TEST RESULTS .....	16
4.2	CONDUCTED EMISSION MEASUREMENT .....	24
4.2.1	LIMITS OF CONDUCTED EMISSION MEASUREMENT.....	24
4.2.2	TEST INSTRUMENTS .....	24
4.2.3	TEST PROCEDURES .....	25
4.2.4	DEVIATION FROM TEST STANDARD .....	25
4.2.5	TEST SETUP .....	26
4.2.6	EUT OPERATING CONDITIONS .....	26
4.2.7	TEST RESULTS .....	27
4.3	PEAK TRANSMIT POWER MEASUREMENT .....	29
4.3.1	LIMITS OF PEAK TRANSMIT POWER MEASUREMENT .....	29
4.3.2	TEST INSTRUMENTS .....	29
4.3.3	TEST PROCEDURE .....	30
4.3.4	DEVIATION FROM TEST STANDARD .....	30
4.3.5	TEST SETUP .....	30
4.3.6	EUT OPERATING CONDITIONS .....	30
4.3.7	TEST RESULTS .....	31
4.4	PEAK POWER EXCURSION MEASUREMENT .....	39
4.4.1	LIMITS OF PEAK POWER EXCURSION MEASUREMENT.....	39
4.4.2	TEST INSTRUMENTS .....	39
4.4.3	TEST PROCEDURE .....	40
4.4.4	DEVIATION FROM TEST STANDARD .....	40
4.4.5	TEST SETUP .....	40
4.4.6	EUT OPERATING CONDITIONS .....	40
4.4.7	TEST RESULTS .....	41
4.5	PEAK POWER SPECTRAL DENSITY MEASUREMENT .....	45
4.5.1	LIMITS OF PEAK POWER SPECTRAL DENSITY MEASUREMENT.....	45



4.5.2	TEST INSTRUMENTS .....	45
4.5.3	TEST PROCEDURES .....	46
4.5.4	DEVIATION FROM TEST STANDARD .....	46
4.5.5	TEST SETUP .....	46
4.5.6	EUT OPERATING CONDITIONS .....	46
4.5.7	TEST RESULTS .....	47
4.6	FREQUENCY STABILITY .....	51
4.6.1	LIMITS OF FREQUENCY STABILITY MEASUREMENT .....	51
4.6.2	TEST INSTRUMENTS .....	51
4.6.3	TEST PROCEDURE .....	51
4.6.4	DEVIATION FROM TEST STANDARD .....	52
4.6.5	TEST SETUP .....	52
4.6.6	EUT OPERATING CONDITION .....	52
4.6.7	TEST RESULTS .....	53
4.7	BAND EDGES MEASUREMENT .....	54
4.7.1	TEST INSTRUMENTS .....	54
4.7.2	TEST PROCEDURE .....	54
4.7.3	EUT OPERATING CONDITION .....	54
4.7.4	TEST RESULTS .....	54
4.8	ANTENNA REQUIREMENT .....	63
4.8.1	STANDARD APPLICABLE .....	63
4.8.2	ANTENNA CONNECTED CONSTRUCTION .....	63
5.	PHOTOGRAPHS OF THE TEST CONFIGURATION .....	64
6.	INFORMATION ON THE TESTING LABORATORIES .....	65
7.	APPENDIX A - MODIFICATIONS RECORDERS FOR ENGINEERING CHANGES TO THE EUT BY THE LAB .....	66



# 1. CERTIFICATION

**PRODUCT:** Wireless-A/G

**MODEL:** NOC-8610 EXT (refer to item 3.1 for more details)

**BRAND:** Senao (refer to item 3.1 for more details)

**APPLICANT:** Senao Networks Inc.

**TEST SAMPLE:** R&D SAMPLE

**TESTED:** May 24, 2007 ~ May 27, 2008

**STANDARDS: FCC Part 15, Subpart E (Section 15.407)**  
ANSI C63.4-2003

The above equipment (Model: NOC-8610 EXT, NOC-8610 PLUS) has been tested by **Advance Data Technology Corporation**, and found compliance with the requirement of the above standards. The test record, data evaluation & Equipment Under Test (EUT) configurations represented herein are true and accurate accounts of the measurements of the sample's EMC characteristics under the conditions specified in this report.

**PREPARED BY** : Andrea Hsia , **DATE:** May 28, 2008  
Andrea Hsia / Specialist

**TECHNICAL ACCEPTANCE** : Long Chen , **DATE:** May 28, 2008  
Responsible for RF Long Chen / Senior Engineer

**APPROVED BY** : Gary Chang , **DATE:** May 28, 2008  
Gary Chang / Supervisor

## 2. SUMMARY OF TEST RESULTS

The EUT has been tested according to the following specifications:

APPLIED STANDARD: FCC Part 15, Subpart E (Section 15.407)			
Standard Section	Test Type	Result	Remark
15.407(b)(5)	AC Power Conducted Emission	PASS	Meet the requirement of limit. Minimum passing margin is -11.40dB at 19.712MHz
15.407(b)(1/2/3) (b)(5)	Electric Field Strength Spurious Emissions, 30MHz ~ 40000MHz	PASS	Meet the requirement of limit. Minimum passing margin is -1.22dB at 200.02MHz
15.407(a)(1/2/3)	Peak Transmit Power	PASS	Meet the requirement of limit.
15.407(a)(6)	Peak Power Excursion	PASS	Meet the requirement of limit.
15.407(a)(1/2/3)	Peak Power Spectral Density	PASS	Meet the requirement of limit.
15.407(g)	Frequency Stability	PASS	Meet the requirement of limit.

### 2.1 MEASUREMENT UNCERTAINTY

Where relevant, the following measurement uncertainty levels have been estimated for tests performed on the EUT as specified in CISPR 16-4-2:

MEASUREMENT	FREQUENCY	UNCERTAINTY
Conducted emissions	9kHz~30MHz	2.44 dB
Radiated emissions	30MHz ~ 200MHz	3.34 dB
	200MHz ~1000MHz	3.35 dB
	1GHz ~ 18GHz	2.26 dB
	18GHz ~ 40GHz	1.94 dB

This uncertainty represents an expanded uncertainty expressed at approximately the 95% confidence level using a coverage factor of k=2.

### 3. GENERAL INFORMATION

#### 3.1 GENERAL DESCRIPTION OF EUT

<b>EUT</b>	Wireless-A/G
<b>MODEL NO.</b>	NOC-8610 EXT (refer to note as below)
<b>FCC ID</b>	U2M-OC86107001
<b>POWER SUPPLY</b>	48Vdc from Adapter
<b>MODULATION TYPE</b>	CCK, DQPSK, DBPSK for DSSS 64QAM, 16QAM, QPSK, BPSK for OFDM
<b>MODULATION TECHNOLOGY</b>	DSSS, OFDM
<b>TRANSFER RATE</b>	802.11b: 11/5.5/2/1Mbps 802.11g: 54/48/36/24/18/12/9/6Mbps 802.11a: 54/48/36/24/18/12/9/6Mbps
<b>FREQUENCY RANGE</b>	802.11b & 802.11g: 2.400 ~ 2.483.5GHz 802.11a: 5.150 ~ 5.250GHz, 5.725 ~ 5.850GHz
<b>NUMBER OF CHANNEL</b>	802.11b & 802.11g: 11 802.11a: 5.150 ~ 5.250GHz: 4 5.725 ~ 5.850GHz: 5
<b>CHANNEL SPACING</b>	802.11b & 802.11g: 5MHz 802.11a: 20MHz
<b>OUTPUT POWER</b>	56.885mW for 802.11b 184.077mW for 802.11g 16.255mW for 5.150 ~ 5.250GHz 26.002mW for 5.725 ~ 5.850GHz
<b>ANTENNA TYPE</b>	Dipole antenna with 4dBi gain for 2.4GHz & 5GHz Patch antenna with 14dBi gain for 5GHz
<b>DATA CABLE</b>	NA
<b>I/O PORTS</b>	RJ45
<b>ACCESSORY DEVICES</b>	Adapter, POE

**NOTE:**

- The details of model no. listed as below:

Brand	Model	REMARK
Senao	NOC-8610 EXT	Dipole antenna
Senao	NOC-8610 PLUS	Patch antenna
EnGenius	EOC-8610 EXT	Dipole antenna
EnGenius	EOC-8610 PLUS	Patch antenna
Senao	SOC-8610 EXT	Dipole antenna
Senao	SOC-8610 PLUS	Patch antenna

2. The EUT was operated with following adapter and POE.

ADAPTER	
<b>BRAND:</b>	MW
<b>MODEL:</b>	ES18U48-480
<b>INPUT:</b>	100-240Vac, 50-60Hz, 0.5A
<b>OUTPUT:</b>	48Vdc, 0.375A, 18W Max.
<b>POWER LINE:</b>	1.8m non-shielded cable with one core

POE	
<b>MODEL:</b>	NPE-4818
<b>OUTPUT:</b>	48Vdc, 0.375A

**NOTE:** The EUT was power from adapter via POE. The POE & adapter were not work alone.

3. The EUT operates in both the 5GHz and 2.4GHz Bands and compatibility with 802.11a and 802.11b, 802.11g technology.
4. The above EUT information was declared by the manufacturer and for more detailed features description, please refer to the manufacturer's specifications or User's Manual.

### 3.2 DESCRIPTION OF TEST MODES

4 channels are provided to this EUT.

CHANNEL	FREQUENCY	CHANNEL	FREQUENCY
36	5180MHz	44	5220MHz
40	5200MHz	48	5240MHz

#### 3.2.1 CONFIGURATION OF SYSTEM UNDER TEST

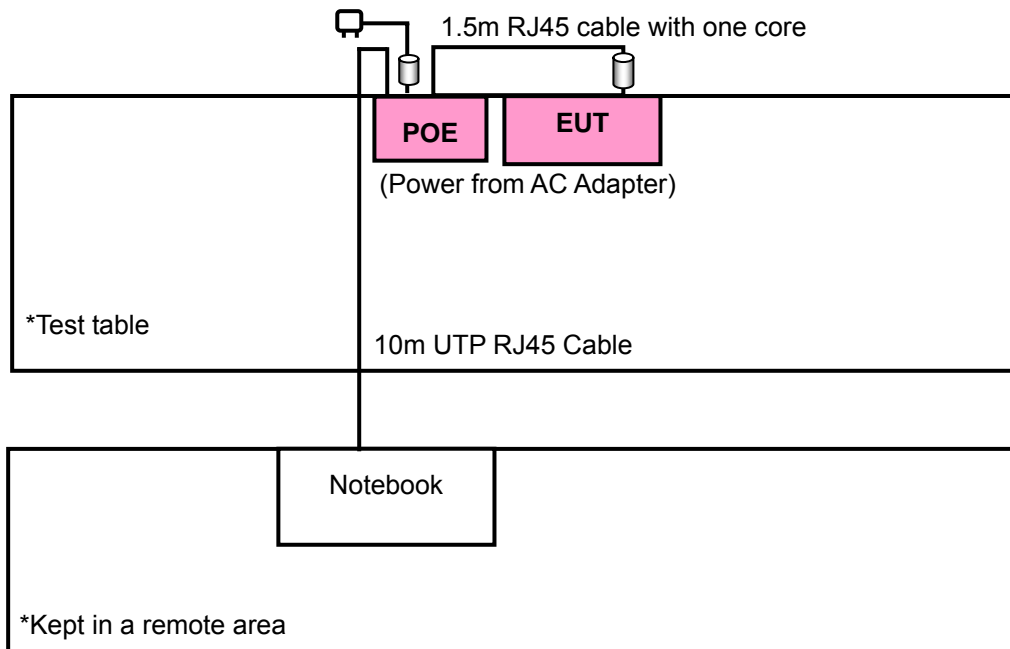



### 3.2.2 TEST MODE APPLICABILITY AND TESTED CHANNEL DETAIL:

EUT CONFIGURE MODE	APPLICABLE TO				DESCRIPTION
	RE $\geq$ 1G	RE<1G	PLC	APCM	
A	√	√	√	√	Dipole Antenna
B	√	√	-	√	Patch Antenna

Where **RE $\geq$ 1G**: Radiated Emission above 1GHz

**RE<1G**: Radiated Emission below 1GHz

**PLC**: Power Line Conducted Emission

**APCM**: Antenna Port Conducted Measurement

**NOTE**: "-" means no effect.

#### RADIATED EMISSION TEST (ABOVE 1 GHz):

- Pre-Scan has been conducted to determine the worst-case mode from all possible combinations between available modulations, data rates and antenna ports (if EUT with antenna diversity architecture).
- Following channel(s) was (were) selected for the final test as listed below.

EUT CONFIGURE MODE	MODE	AVAILABLE CHANNEL	TESTED CHANNEL	MODULATION TECHNOLOGY	MODULATION TYPE	DATA RATE (Mbps)	AXIS
A	802.11a	36 to 48	36, 40, 48	OFDM	BPSK	6	Z
B	802.11a	36 to 48	36, 40, 48	OFDM	BPSK	6	Z

#### RADIATED EMISSION TEST (BELOW 1 GHz):

- Pre-Scan has been conducted to determine the worst-case mode from all possible combinations between available modulations, data rates, antenna ports (if EUT with antenna diversity architecture).
- Following channel(s) was (were) selected for the final test as listed below.

EUT CONFIGURE MODE	MODE	AVAILABLE CHANNEL	TESTED CHANNEL	MODULATION TECHNOLOGY	MODULATION TYPE	DATA RATE (Mbps)	AXIS
A	802.11a	36 to 48	36	OFDM	BPSK	6	Z
B	802.11a	36 to 48	36	OFDM	BPSK	6	Z

#### POWER LINE CONDUCTED EMISSION TEST:

- Pre-Scan has been conducted to determine the worst-case mode from all possible combinations between available modulations, data rates and antenna ports (if EUT with antenna diversity architecture).
- Following channel(s) was (were) selected for the final test as listed below.

EUT CONFIGURE MODE	MODE	AVAILABLE CHANNEL	TESTED CHANNEL	MODULATION TECHNOLOGY	MODULATION TYPE	DATA RATE (Mbps)
A	802.11a	36 to 48	36	OFDM	BPSK	6

**BANDEDGE MEASUREMENT:**

- Pre-Scan has been conducted to determine the worst-case mode from all possible combinations between available modulations, data rates and antenna ports (if EUT with antenna diversity architecture).
- Following channel(s) was (were) selected for the final test as listed below.

EUT CONFIGURE MODE	MODE	AVAILABLE CHANNEL	TESTED CHANNEL	MODULATION TECHNOLOGY	MODULATION TYPE	DATA RATE (Mbps)
A	802.11a	36 to 48	36, 48	OFDM	BPSK	6
B	802.11a	36 to 48	36, 48	OFDM	BPSK	6

**ANTENNA PORT CONDUCTED MEASUREMENT:**

- Pre-Scan has been conducted to determine the worst-case mode from all possible combinations between available modulations, data rates and antenna ports (if EUT with antenna diversity architecture).
- Following channel(s) was (were) selected for the final test as listed below.

EUT CONFIGURE MODE	MODE	AVAILABLE CHANNEL	TESTED CHANNEL	MODULATION TECHNOLOGY	MODULATION TYPE	DATA RATE (Mbps)
A	802.11a	36 to 48	36, 40, 48	OFDM	BPSK	6
B	802.11a	36 to 48	36, 40, 48	OFDM	BPSK	6



### 3.3 GENERAL DESCRIPTION OF APPLIED STANDARDS

The EUT is a RF Product. According to the specifications of the manufacturer, it must comply with the requirements of the following standards:

#### FCC Part 15, Subpart E (15.407)

#### ANSI C63.4-2003

All test items have been performed and recorded as per the above standards.

**NOTE:** The EUT is also considered as a kind of computer peripheral, because the connection to computer is necessary for typical use. It has been verified to comply with the requirements of FCC Part 15, Subpart B, Class B (DoC). The test report has been issued separately.

### 3.4 DESCRIPTION OF SUPPORT UNITS

The EUT has been tested as an independent unit together with other necessary accessories or support units. The following support units or accessories were used to form a representative test configuration during the tests.

NO.	PRODUCT	BRAND	MODEL NO.	SERIAL NO.	FCC ID
1	NOTEBOOK COMPUTER	DELL	PP05L	12130898320	E2K24CLNS

NO.	SIGNAL CABLE DESCRIPTION OF THE ABOVE SUPPORT UNITS
1	1.5m RJ45 non-shielded cable with one core

**NOTE:** All power cords of the above support units are non shielded (1.8m).

## 4. TEST TYPES AND RESULTS

### 4.1 RADIATED EMISSION MEASUREMENT

#### 4.1.1 LIMITS OF RADIATED EMISSION MEASUREMENT

Emissions radiated outside of the specified bands, shall be according to the general radiated limits in 15.209 as following:

Frequencies (MHz)	Field strength (microvolts/meter)	Measurement distance (meters)
0.009-0.490	2400/F(kHz)	300
0.490-1.705	24000/F(kHz)	30
1.705-30.0	30	30
30-88	100	3
88-216	150	3
216-960	200	3
Above 960	500	3

**NOTE:**

1. The lower limit shall apply at the transition frequencies.
2. Emission level (dBuV/m) = 20 log Emission level (uV/m).
3. As shown in 15.35(b), for frequencies above 1000MHz, the field strength limits are based on average detector, however, the peak field strength of any emission shall not exceed the maximum permitted average limits, specified above by more than 20dB under any condition of modulation.

#### 4.1.2 LIMITS OF UNWANTED EMISSION OUT OF THE RESTRICTED BANDS

FREQUENCIES (MHz)	EIRP LIMIT (dBm)		EQUIVALENT FIELD STRENGTH AT 3m (dBμV/m) *NOTE 3	
	PK	AV	PK	AV
5150 ~ 5250	-7	-27	88.3	68.3

**NOTE:**

1. For frequencies 10MHz or greater above or below the band edge.
2. All emissions within the frequency range from the band edge to 10MHz above or below the band edge.
3. The following formula is used to convert the equipment isotropic radiated power (eirp) to field strength

$$E = \frac{1000000\sqrt{30P}}{3} \mu\text{V/m, where P is the eirp (Watts)}$$



#### 4.1.3 TEST INSTRUMENTS

DESCRIPTION & MANUFACTURER	MODEL NO.	SERIAL NO.	CALIBRATED UNTIL
Test Receiver ROHDE & SCHWARZ	ESCI	100424	Jul. 27, 2008
Spectrum Analyzer Agilent	E4446A	MY44360128	Dec. 06, 2008
BILOG Antenna SCHWARZBECK	VULB9168	9168-160	May 31, 2008
HORN Antenna SCHWARZBECK	9120D	9120D-209	Jun. 28, 2008
HORN Antenna SCHWARZBECK	BBHA 9170	BBHA9170243	Dec. 24, 2008
Preamplifier Agilent	8447D	2944A10633	Oct. 28, 2008
Preamplifier Agilent	8449B	3008A01964	Oct. 23, 2008
RF signal cable HUBER+SUHNNER	SUCOFLEX 104	283402/4	Dec. 06, 2008
RF signal cable HUBER+SUHNNER	SUCOFLEX 104	251644/4	Dec. 06, 2008
Software ADT.	ADT_Radiated_V7.6	NA	NA
Antenna Tower inn-co GmbH	MA 4000	013303	NA
Antenna Tower Controller inn-co GmbH	CO2000	017303	NA
Turn Table ADT.	TT100.	TT93021703	NA
Turn Table Controller ADT.	SC100.	SC93021703	NA

- NOTE:**
1. The calibration interval of the above test instruments is 12 months and the calibrations are traceable to NML/ROC and NIST/USA.
  2. The test was performed in HwaYa Chamber 3.
  3. The horn antenna and HP preamplifier (model: 8449B) are used only for the measurement of emission frequency above 1GHz if tested.
  4. The FCC Site Registration No. is 988962.
  5. The IC Site Registration No. is IC3789B-3.

#### 4.1.4 TEST PROCEDURES

- a. The EUT was placed on the top of a rotating table 0.8 meters above the ground at a 3 meter semi-anechoic chamber. The table was rotated 360 degrees to determine the position of the highest radiation.
- b. The EUT was set 3 meters away from the interference-receiving antenna, which was mounted on the top of a variable-height antenna tower.
- c. The antenna is a broadband antenna, and its height is varied from one meter to four meters above the ground to determine the maximum value of the field strength. Both horizontal and vertical polarizations of the antenna are set to make the measurement.
- d. For each suspected emission, the EUT was arranged to its worst case and then the antenna was tuned to heights from 1 meter to 4 meters and the rotatable table was turned from 0 degrees to 360 degrees to find the maximum reading.
- e. The test-receiver system was set to Peak Detect Function and Specified Bandwidth with Maximum Hold Mode.
- f. If the emission level of the EUT in peak mode was 10dB lower than the limit specified, then testing could be stopped and the peak values of the EUT would be reported. Otherwise the emissions that did not have 10dB margin would be re-tested one by one using peak, quasi-peak or average method as specified and then reported in a data sheet.

**NOTE:**

1. The resolution bandwidth and video bandwidth of test receiver/spectrum analyzer is 120kHz for Peak detection (PK) and Quasi-peak detection (QP) at frequency below 1GHz.
2. The resolution bandwidth of test receiver/spectrum analyzer is 1 MHz and video bandwidth is 3MHz for Peak detection at frequency above 1GHz.
3. The resolution bandwidth of test receiver/spectrum analyzer is 1 MHz and the video bandwidth is 10Hz for Average detection (AV) at frequency above 1GHz.
4. All modes of operation were investigated and the worst-case emissions are reported.

#### 4.1.5 DEVIATION FROM TEST STANDARD

No deviation

#### 4.1.6 TEST SETUP

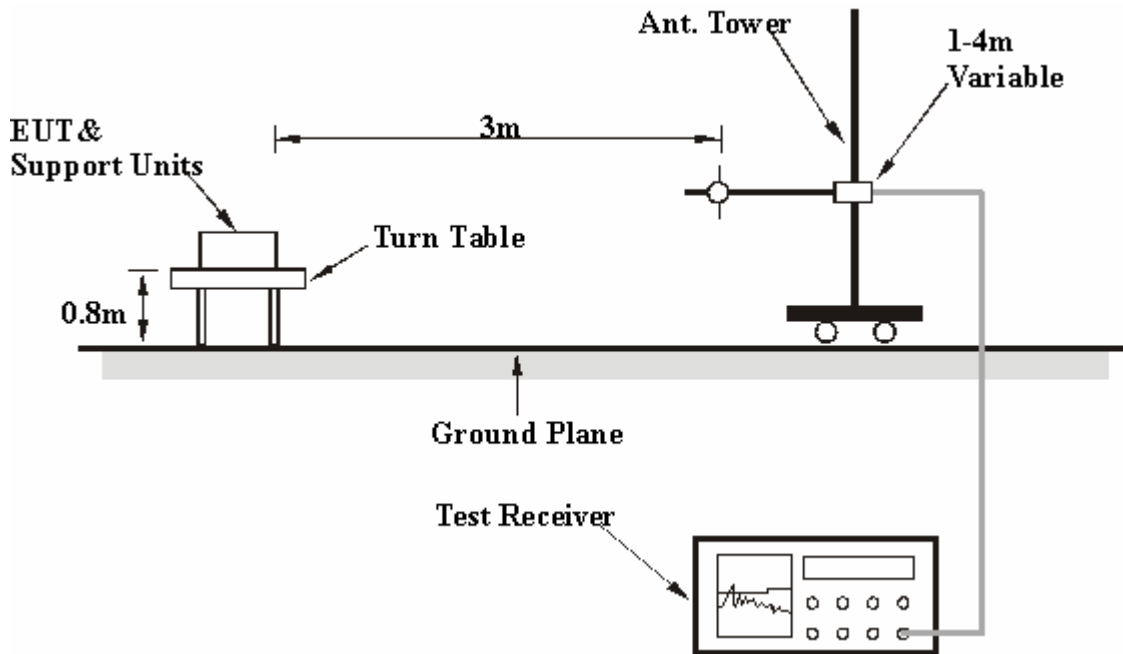

For the actual test configuration, please refer to the attached file (Test Setup Photo).

#### 4.1.7 EUT OPERATING CONDITION

- a. Placed the EUT on a testing table.
- b. Prepared a notebook computer and placed it outside of testing area to act as communication partner for EUT.
- c. The EUT ran a test program (provided by manufacturer) to enable all functions under transmission condition continuously at specific channel frequency.
- d. The necessary accessories enable the EUT in full functions.



#### 4.1.8 TEST RESULTS

##### 802.11a OFDM MODULATION

EUT TEST CONDITION		MEASUREMENT DETAIL	
CHANNEL	Channel 36	FREQUENCY RANGE	1 ~ 40GHz
INPUT POWER (SYSTEM)	120Vac, 60 Hz	DETECTOR FUNCTION	Peak (PK) Average (AV)
ENVIRONMENTAL CONDITIONS	26deg. C, 68%RH 999hPa	TEST MODE	A
TESTED BY	Dean Wang		

ANTENNA POLARITY & TEST DISTANCE: HORIZONTAL AT 3 M								
NO.	FREQ. (MHz)	EMISSION LEVEL (dBuV/m)	LIMIT (dBuV/m)	MARGIN (dB)	ANTENNA HEIGHT (m)	TABLE ANGLE (Degree)	RAW VALUE (dBuV)	CORRECTION FACTOR (dB/m)
1	#5150.00	56.73 PK	74.00	-17.27	1.04 H	268	17.36	39.37
2	#5150.00	41.42 AV	54.00	-12.58	1.04 H	268	2.05	39.37
3	*5180.00	100.30 PK			1.03 H	269	60.91	39.39
4	*5180.00	89.68 AV			1.03 H	269	50.29	39.39
5	10360.00	59.87 PK	88.30	-28.43	1.04 H	189	9.17	50.70
6	10360.00	49.96 AV	68.30	-18.34	1.04 H	189	-0.74	50.70
ANTENNA POLARITY & TEST DISTANCE: VERTICAL AT 3 M								
NO.	FREQ. (MHz)	EMISSION LEVEL (dBuV/m)	LIMIT (dBuV/m)	MARGIN (dB)	ANTENNA HEIGHT (m)	TABLE ANGLE (Degree)	RAW VALUE (dBuV)	CORRECTION FACTOR (dB/m)
1	#5120.00	53.14 PK	74.00	-20.86	1.07 V	0	13.79	39.35
2	#5120.00	44.40 AV	54.00	-9.60	1.07 V	0	5.05	39.35
3	#5150.00	69.21 PK	74.00	-4.79	1.05 V	6	29.84	39.37
4	#5150.00	52.04 AV	54.00	-1.96	1.05 V	6	12.67	39.37
5	*5180.00	112.06 PK			1.05 V	4	72.67	39.39
6	*5180.00	101.11 AV			1.05 V	4	61.72	39.39
7	10360.00	66.58 PK	88.30	-21.72	1.01 V	18	15.88	50.70
8	10360.00	55.63 AV	68.30	-12.67	1.01 V	18	4.93	50.70

- REMARKS:**
1. Emission level (dBuV/m) = Raw Value (dBuV) + Correction Factor (dB/m).
  2. Correction Factor (dB/m) = Antenna Factor (dB/m) + Cable Factor (dB).
  3. The other emission levels were very low against the limit.
  4. Margin value = Emission level – Limit value.
  5. “ \* “: Fundamental frequency.
  6. “ # “: The radiated frequency falling in the restricted band.



EUT TEST CONDITION		MEASUREMENT DETAIL	
CHANNEL	Channel 40	FREQUENCY RANGE	1 ~ 40GHz
INPUT POWER (SYSTEM)	120Vac, 60 Hz	DETECTOR FUNCTION	Peak (PK) Average (AV)
ENVIRONMENTAL CONDITIONS	26deg. C, 68%RH 999hPa	TEST MODE	A
TESTED BY	Dean Wang		

**ANTENNA POLARITY & TEST DISTANCE: HORIZONTAL AT 3 M**

NO.	FREQ. (MHz)	EMISSION LEVEL (dBuV/m)	LIMIT (dBuV/m)	MARGIN (dB)	ANTENNA HEIGHT (m)	TABLE ANGLE (Degree)	RAW VALUE (dBuV)	CORRECTION FACTOR (dB/m)
1	*5200.00	100.05 PK			1.07 H	296	61.01	39.04
2	*5200.00	89.34 AV			1.07 H	296	50.30	39.04
3	10400.00	59.55 PK	88.30	-28.75	1.05 H	199	9.87	49.68
4	10400.00	49.63 AV	68.30	-18.67	1.05 H	199	-0.05	49.68

**ANTENNA POLARITY & TEST DISTANCE: VERTICAL AT 3 M**

NO.	FREQ. (MHz)	EMISSION LEVEL (dBuV/m)	LIMIT (dBuV/m)	MARGIN (dB)	ANTENNA HEIGHT (m)	TABLE ANGLE (Degree)	RAW VALUE (dBuV)	CORRECTION FACTOR (dB/m)
1	#5120.00	54.21 PK	74.00	-19.79	1.10 V	360	15.41	38.80
2	#5120.00	44.10 AV	54.00	-9.90	1.10 V	360	5.30	38.80
3	*5200.00	112.58 PK			1.10 V	355	73.54	39.04
4	*5200.00	102.43 AV			1.10 V	355	63.39	39.04
5	10400.00	65.89 PK	88.30	-22.41	1.00 V	310	16.21	49.68
6	10400.00	56.64 AV	68.30	-11.66	1.00 V	310	6.96	49.68

- REMARKS:**
1. Emission level (dBuV/m) = Raw Value (dBuV) + Correction Factor (dB/m).
  2. Correction Factor (dB/m) = Antenna Factor (dB/m) + Cable Factor (dB).
  3. The other emission levels were very low against the limit.
  4. Margin value = Emission level – Limit value.
  5. “ \* ”: Fundamental frequency.
  6. “ # ”: The radiated frequency falling in the restricted band.



EUT TEST CONDITION		MEASUREMENT DETAIL	
CHANNEL	Channel 48	FREQUENCY RANGE	1 ~ 40GHz
INPUT POWER (SYSTEM)	120Vac, 60 Hz	DETECTOR FUNCTION	Peak (PK) Average (AV)
ENVIRONMENTAL CONDITIONS	26deg. C, 68%RH 999hPa	TEST MODE	A
TESTED BY	Dean Wang		

**ANTENNA POLARITY & TEST DISTANCE: HORIZONTAL AT 3 M**

NO.	FREQ. (MHz)	EMISSION LEVEL (dBuV/m)	LIMIT (dBuV/m)	MARGIN (dB)	ANTENNA HEIGHT (m)	TABLE ANGLE (Degree)	RAW VALUE (dBuV)	CORRECTION FACTOR (dB/m)
1	*5240.00	101.29 PK			1.06 H	221	61.73	39.56
2	*5240.00	90.57 AV			1.06 H	221	51.01	39.56
3	#5350.00	50.69 PK	74.00	-23.31	1.06 H	156	10.84	39.84
4	#5350.00	38.28 AV	54.00	-15.72	1.06 H	156	-1.56	39.84
5	10480.00	60.68 PK	88.30	-27.62	1.05 H	213	9.69	50.99
6	10480.00	49.65 AV	68.30	-18.65	1.05 H	213	-1.34	50.99

**ANTENNA POLARITY & TEST DISTANCE: VERTICAL AT 3 M**

NO.	FREQ. (MHz)	EMISSION LEVEL (dBuV/m)	LIMIT (dBuV/m)	MARGIN (dB)	ANTENNA HEIGHT (m)	TABLE ANGLE (Degree)	RAW VALUE (dBuV)	CORRECTION FACTOR (dB/m)
1	*5240.00	112.36 PK			1.07 V	166	72.80	39.56
2	*5240.00	102.25 AV			1.07 V	166	62.69	39.56
3	#5350.00	52.81 PK	74.00	-21.19	1.07 V	165	12.97	39.84
4	#5350.00	40.56 AV	54.00	-13.44	1.07 V	165	0.72	39.84
5	10480.00	66.98 PK	88.30	-21.32	1.07 V	174	15.99	50.99
6	10480.00	55.97 AV	68.30	-12.33	1.07 V	174	4.98	50.99

- REMARKS:**
1. Emission level (dBuV/m) = Raw Value (dBuV) + Correction Factor (dB/m).
  2. Correction Factor (dB/m) = Antenna Factor (dB/m) + Cable Factor (dB).
  3. The other emission levels were very low against the limit.
  4. Margin value = Emission level – Limit value.
  5. “ \* “: Fundamental frequency.
  6. “ # “: The radiated frequency falling in the restricted band.



EUT TEST CONDITION		MEASUREMENT DETAIL	
CHANNEL	Channel 36	FREQUENCY RANGE	1 ~ 40GHz
INPUT POWER (SYSTEM)	120Vac, 60 Hz	DETECTOR FUNCTION	Peak (PK) Average (AV)
ENVIRONMENTAL CONDITIONS	26deg. C, 68%RH 999hPa	TEST MODE	B
TESTED BY	Dean Wang		

**ANTENNA POLARITY & TEST DISTANCE: HORIZONTAL AT 3 M**

NO.	FREQ. (MHz)	EMISSION LEVEL (dBuV/m)	LIMIT (dBuV/m)	MARGIN (dB)	ANTENNA HEIGHT (m)	TABLE ANGLE (Degree)	RAW VALUE (dBuV)	CORRECTION FACTOR (dB/m)
1	#5150.00	51.15 PK	74.00	-22.85	1.24 H	216	11.78	39.37
2	#5150.00	38.43 AV	54.00	-15.57	1.24 H	216	-0.94	39.37
3	*5180.00	102.59 PK			1.22 H	219	63.20	39.39
4	*5180.00	92.80 AV			1.22 H	219	53.41	39.39
5	10360.00	61.34 PK	88.30	-26.96	1.03 H	216	10.64	50.70
6	10360.00	49.25 AV	68.30	-19.05	1.03 H	216	-1.45	50.70

**ANTENNA POLARITY & TEST DISTANCE: VERTICAL AT 3 M**

NO.	FREQ. (MHz)	EMISSION LEVEL (dBuV/m)	LIMIT (dBuV/m)	MARGIN (dB)	ANTENNA HEIGHT (m)	TABLE ANGLE (Degree)	RAW VALUE (dBuV)	CORRECTION FACTOR (dB/m)
1	#5120.00	58.60 PK	74.00	-15.40	1.03 V	165	19.25	39.35
2	#5120.00	49.70 AV	54.00	-4.30	1.03 V	165	10.35	39.35
3	#5150.00	55.28 PK	74.00	-18.72	1.03 V	166	15.91	39.37
4	#5150.00	45.98 AV	54.00	-8.02	1.03 V	166	6.61	39.37
5	*5180.00	116.63 PK			1.11 V	165	77.24	39.39
6	*5180.00	105.87 AV			1.11 V	165	66.48	39.39
7	10360.00	62.94 PK	88.30	-25.36	1.03 V	304	12.24	50.70
8	10360.00	51.23 AV	68.30	-17.07	1.03 V	304	0.53	50.70

- REMARKS:**
1. Emission level (dBuV/m) = Raw Value (dBuV) + Correction Factor (dB/m).
  2. Correction Factor (dB/m) = Antenna Factor (dB/m) + Cable Factor (dB).
  3. The other emission levels were very low against the limit.
  4. Margin value = Emission level – Limit value.
  5. “ \* “: Fundamental frequency.
  6. “ # “: The radiated frequency falling in the restricted band.



EUT TEST CONDITION		MEASUREMENT DETAIL	
CHANNEL	Channel 40	FREQUENCY RANGE	1 ~ 40GHz
INPUT POWER (SYSTEM)	120Vac, 60 Hz	DETECTOR FUNCTION	Peak (PK) Average (AV)
ENVIRONMENTAL CONDITIONS	26deg. C, 68%RH 999hPa	TEST MODE	B
TESTED BY	Dean Wang		

**ANTENNA POLARITY & TEST DISTANCE: HORIZONTAL AT 3 M**

NO.	FREQ. (MHz)	EMISSION LEVEL (dBuV/m)	LIMIT (dBuV/m)	MARGIN (dB)	ANTENNA HEIGHT (m)	TABLE ANGLE (Degree)	RAW VALUE (dBuV)	CORRECTION FACTOR (dB/m)
1	*5200.00	102.04 PK			1.19 H	269	62.64	39.40
2	*5200.00	92.47 AV			1.19 H	269	53.07	39.40
3	10400.00	61.28 PK	88.30	-27.02	1.10 H	217	10.52	50.76
4	10400.00	50.36 AV	68.30	-17.94	1.10 H	217	-0.40	50.76

**ANTENNA POLARITY & TEST DISTANCE: VERTICAL AT 3 M**

NO.	FREQ. (MHz)	EMISSION LEVEL (dBuV/m)	LIMIT (dBuV/m)	MARGIN (dB)	ANTENNA HEIGHT (m)	TABLE ANGLE (Degree)	RAW VALUE (dBuV)	CORRECTION FACTOR (dB/m)
1	#5120.00	57.96 PK	74.00	-16.04	1.04 V	198	18.61	39.35
2	#5120.00	50.06 AV	54.00	-3.94	1.04 V	198	10.71	39.35
3	*5200.00	116.62 PK			1.15 V	182	77.22	39.40
4	*5200.00	105.98 AV			1.15 V	182	66.58	39.40
5	10400.00	63.05 PK	88.30	-25.25	1.00 V	355	12.29	50.76
6	10400.00	51.42 AV	68.30	-16.88	1.00 V	355	0.66	50.76

- REMARKS:**
1. Emission level (dBuV/m) = Raw Value (dBuV) + Correction Factor (dB/m).
  2. Correction Factor (dB/m) = Antenna Factor (dB/m) + Cable Factor (dB).
  3. The other emission levels were very low against the limit.
  4. Margin value = Emission level – Limit value.
  5. “ \* ”: Fundamental frequency.
  6. “ # ”: The radiated frequency falling in the restricted band.



EUT TEST CONDITION		MEASUREMENT DETAIL	
CHANNEL	Channel 48	FREQUENCY RANGE	1 ~ 40GHz
INPUT POWER (SYSTEM)	120Vac, 60 Hz	DETECTOR FUNCTION	Peak (PK) Average (AV)
ENVIRONMENTAL CONDITIONS	26deg. C, 68%RH 999hPa	TEST MODE	B
TESTED BY	Dean Wang		

**ANTENNA POLARITY & TEST DISTANCE: HORIZONTAL AT 3 M**

NO.	FREQ. (MHz)	EMISSION LEVEL (dBuV/m)	LIMIT (dBuV/m)	MARGIN (dB)	ANTENNA HEIGHT (m)	TABLE ANGLE (Degree)	RAW VALUE (dBuV)	CORRECTION FACTOR (dB/m)
1	*5240.00	102.26 PK			1.00 H	253	62.70	39.56
2	*5240.00	91.54 AV			1.00 H	253	51.98	39.56
3	#5350.00	51.31 PK	74.00	-22.69	1.02 H	116	11.47	39.84
4	#5350.00	39.10 AV	54.00	-14.90	1.02 H	116	-0.74	39.84
5	10480.00	60.15 PK	88.30	-28.15	1.06 H	224	9.16	50.99
6	10480.00	49.21 AV	68.30	-19.09	1.06 H	224	-1.78	50.99

**ANTENNA POLARITY & TEST DISTANCE: VERTICAL AT 3 M**

NO.	FREQ. (MHz)	EMISSION LEVEL (dBuV/m)	LIMIT (dBuV/m)	MARGIN (dB)	ANTENNA HEIGHT (m)	TABLE ANGLE (Degree)	RAW VALUE (dBuV)	CORRECTION FACTOR (dB/m)
1	*5240.00	116.51 PK			1.00 V	167	76.95	39.56
2	*5240.00	105.71 AV			1.00 V	167	66.15	39.56
3	#5350.00	57.62 PK	74.00	-16.37	1.00 V	167	17.78	39.84
4	#5350.00	47.30 AV	54.00	-6.70	1.00 V	167	7.46	39.84
5	#5440.00	60.38 PK	74.00	-13.62	1.05 V	164	20.46	39.92
6	#5440.00	50.84 AV	54.00	-3.16	1.05 V	164	10.92	39.92
7	10480.00	62.42 PK	88.30	-25.88	1.00 V	323	11.43	50.99
8	10480.00	51.02 AV	68.30	-17.28	1.00 V	323	0.03	50.99

- REMARKS:**
1. Emission level (dBuV/m) = Raw Value (dBuV) + Correction Factor (dB/m).
  2. Correction Factor (dB/m) = Antenna Factor (dB/m) + Cable Factor (dB).
  3. The other emission levels were very low against the limit.
  4. Margin value = Emission level – Limit value.
  5. “ \* “: Fundamental frequency.
  6. “ # “: The radiated frequency falling in the restricted band.



**BELOW 1GHz WORST-CASE DATA :**

EUT TEST CONDITION		MEASUREMENT DETAIL	
CHANNEL	Channel 36	FREQUENCY RANGE	Below 1000MHz
INPUT POWER (SYSTEM)	120Vac, 60 Hz	DETECTOR FUNCTION	Quasi-Peak
ENVIRONMENTAL CONDITIONS	25deg. C, 65%RH 999hPa	TEST MODE	A
TESTED BY	Dean Wang		

**ANTENNA POLARITY & TEST DISTANCE: HORIZONTAL AT 3 M**

NO.	FREQ. (MHz)	EMISSION LEVEL (dBuV/m)	LIMIT (dBuV/m)	MARGIN (dB)	ANTENNA HEIGHT (m)	TABLE ANGLE (Degree)	RAW VALUE (dBuV)	CORRECTION FACTOR (dB/m)
1	35.73	32.98 QP	40.00	-7.02	1.50 H	52	19.01	13.97
2	107.67	35.99 QP	43.50	-7.51	1.50 H	349	24.86	11.13
3	199.05	36.76 QP	43.50	-6.74	2.00 H	97	25.42	11.34
4	249.60	40.65 QP	46.00	-5.35	1.00 H	139	27.17	13.47
5	300.16	41.79 QP	46.00	-4.21	1.00 H	16	26.65	15.14
6	434.31	37.95 QP	46.00	-8.05	2.00 H	154	19.10	18.85
7	620.96	37.07 QP	46.00	-8.93	1.00 H	136	14.14	22.93
8	683.18	38.06 QP	46.00	-7.94	1.00 H	181	14.07	23.99
9	751.23	41.40 QP	46.00	-4.60	1.00 H	175	15.75	25.65

**ANTENNA POLARITY & TEST DISTANCE: VERTICAL AT 3 M**

NO.	FREQ. (MHz)	EMISSION LEVEL (dBuV/m)	LIMIT (dBuV/m)	MARGIN (dB)	ANTENNA HEIGHT (m)	TABLE ANGLE (Degree)	RAW VALUE (dBuV)	CORRECTION FACTOR (dB/m)
1	57.12	37.91 QP	40.00	-2.09	1.00 V	157	23.67	14.24
2	199.05	31.52 QP	43.50	-11.98	1.00 V	352	20.18	11.34
3	249.60	34.95 QP	46.00	-11.05	1.50 V	16	21.48	13.47
4	300.16	36.56 QP	46.00	-9.44	1.00 V	10	21.42	15.14
5	558.75	40.24 QP	46.00	-5.76	1.50 V	19	18.78	21.46
6	683.18	42.47 QP	46.00	-3.53	1.50 V	181	18.47	23.99
7	751.23	44.50 QP	46.00	-1.50	1.50 V	196	18.85	25.65
8	807.62	37.57 QP	46.00	-8.43	1.00 V	124	11.52	26.05

- REMARKS:**
1. Emission level (dBuV/m) = Raw Value (dBuV) + Correction Factor (dB/m).
  2. Correction Factor (dB/m) = Antenna Factor (dB/m) + Cable Factor (dB).
  3. The other emission levels were very low against the limit.
  4. Margin value = Emission level – Limit value.



EUT TEST CONDITION		MEASUREMENT DETAIL	
CHANNEL	Channel 36	FREQUENCY RANGE	Below 1000MHz
INPUT POWER (SYSTEM)	120Vac, 60 Hz	DETECTOR FUNCTION	Quasi-Peak
ENVIRONMENTAL CONDITIONS	25deg. C, 65%RH 999hPa	TEST MODE	B
TESTED BY	Dean Wang		

**ANTENNA POLARITY & TEST DISTANCE: HORIZONTAL AT 3 M**

NO.	FREQ. (MHz)	EMISSION LEVEL (dBuV/m)	LIMIT (dBuV/m)	MARGIN (dB)	ANTENNA HEIGHT (m)	TABLE ANGLE (Degree)	RAW VALUE (dBuV)	CORRECTION FACTOR (dB/m)
1	125.17	36.63 QP	43.50	-6.87	1.50 H	85	23.71	12.93
2	200.01	42.27 QP	43.50	-1.23	2.00 H	246	31.01	11.26
3	249.60	42.78 QP	46.00	-3.22	1.00 H	319	29.30	13.47
4	350.71	33.02 QP	46.00	-12.98	1.00 H	226	16.54	16.49
5	500.42	42.08 QP	46.00	-3.92	1.50 H	340	21.78	20.29
6	550.97	35.60 QP	46.00	-10.40	1.50 H	133	14.33	21.28
7	753.18	44.04 QP	46.00	-1.96	1.50 H	10	18.37	25.66

**ANTENNA POLARITY & TEST DISTANCE: VERTICAL AT 3 M**

NO.	FREQ. (MHz)	EMISSION LEVEL (dBuV/m)	LIMIT (dBuV/m)	MARGIN (dB)	ANTENNA HEIGHT (m)	TABLE ANGLE (Degree)	RAW VALUE (dBuV)	CORRECTION FACTOR (dB/m)
1	60.23	38.23 QP	40.00	-1.77	1.29 V	225	24.29	13.94
2	105.73	38.38 QP	43.50	-5.12	1.50 V	319	27.49	10.89
3	200.02	42.28 QP	43.50	-1.22	1.00 V	52	31.02	11.26
4	249.60	38.64 QP	46.00	-7.36	2.00 V	19	25.16	13.47
5	500.42	39.40 QP	46.00	-6.60	1.00 V	25	19.10	20.29
6	550.97	37.25 QP	46.00	-8.75	1.00 V	145	15.97	21.28
7	751.23	37.56 QP	46.00	-8.44	1.50 V	4	11.91	25.65
8	902.89	40.70 QP	46.00	-5.30	1.50 V	280	13.05	27.64

- REMARKS:**
1. Emission level (dBuV/m) = Raw Value (dBuV) + Correction Factor (dB/m).
  2. Correction Factor (dB/m) = Antenna Factor (dB/m) + Cable Factor (dB).
  3. The other emission levels were very low against the limit.
  4. Margin value = Emission level – Limit value.

## 4.2 CONDUCTED EMISSION MEASUREMENT

### 4.2.1 LIMITS OF CONDUCTED EMISSION MEASUREMENT

FREQUENCY OF EMISSION (MHz)	CONDUCTED LIMIT (dB $\mu$ V)	
	Quasi-peak	Average
0.15-0.5	66 to 56	56 to 46
0.5-5	56	46
5-30	60	50

- NOTE:**
1. The lower limit shall apply at the transition frequencies.
  2. The limit decreases in line with the logarithm of the frequency in the range of 0.15 to 0.50 MHz.
  3. All emanations from a class A/B digital device or system, including any network of conductors and apparatus connected thereto, shall not exceed the level of field strengths specified above.

### 4.2.2 TEST INSTRUMENTS

DESCRIPTION & MANUFACTURER	MODEL NO.	SERIAL NO.	CALIBRATED UNTIL
Test Receiver ROHDE & SCHWARZ	ESCS30	100288	Sep. 21, 2008
RF signal cable Woken	5D-FB	Cable-HYCO3-01	Jan. 06, 2009
LISN ROHDE & SCHWARZ	ESH2-Z5	100100	Jan. 09, 2009
LISN SCHWARZBECK	ESH3-Z5	100311	Jan. 21, 2009
Software ADT	ADT_Cond_V3	NA	NA

- NOTE:**
1. The calibration interval of the above test instruments is 12 months and the calibrations are traceable to NML/ROC and NIST/USA.
  2. The test was performed in HwaYa Shielded Room 2.
  3. The VCCI Site Registration No. is C-2047.



#### 4.2.3 TEST PROCEDURES

- a. The EUT was placed 0.4 meters from the conducting wall of the shielded room with EUT being connected to the power mains through a line impedance stabilization network (LISN). Other support units were connected to the power mains through another LISN. The two LISNs provide 50 ohm/ 50uH of coupling impedance for the measuring instrument.
- b. Both lines of the power mains connected to the EUT were checked for maximum conducted interference.
- c. The frequency range from 150kHz to 30MHz was searched. Emission levels under (Limit - 20dB) was not recorded.

**NOTE:** All modes of operation were investigated and the worst-case emissions are reported.

#### 4.2.4 DEVIATION FROM TEST STANDARD

No deviation

#### 4.2.5 TEST SETUP

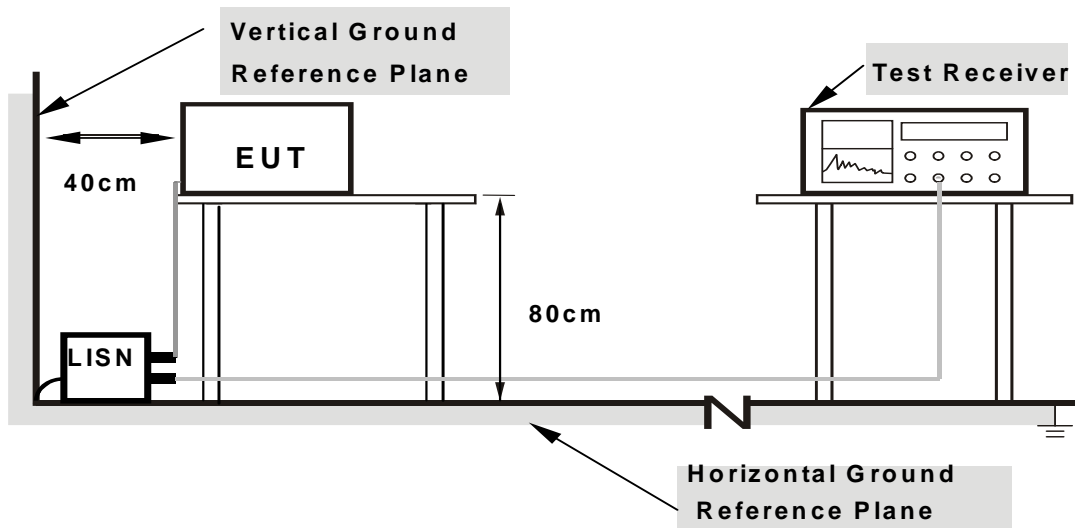

- Note:**
1. Support units were connected to second LISN.
  2. Both of LISNs (AMN) are 80 cm from EUT and at least 80 from other units and other metal planes

For the actual test configuration, please refer to the related item – Photographs of the Test Configuration.

#### 4.2.6 EUT OPERATING CONDITIONS

Same as 4.1.7

## 4.2.7 TEST RESULTS

### Conducted Worst-Case Data:

EUT TEST CONDITION		MEASUREMENT DETAIL	
CHANNEL	Channel 36	PHASE	Line 1
MODULATION TYPE	BPSK	6dB BANDWIDTH	9 kHz
TRANSFER RATE	6Mbps	ENVIRONMENTAL CONDITIONS	20deg. C, 60%RH, 991hPa
INPUT POWER (SYSTEM)	120Vac, 60 Hz	TEST MODE	A
TESTED BY	Match Tsui		

No	Freq. [MHz]	Corr. Factor [dB]	Reading Value [dB (uV)]		Emission Level [dB (uV)]		Limit [dB (uV)]		Margin (dB)	
			Q.P.	AV.	Q.P.	AV.	Q.P.	AV.	Q.P.	AV.
1	0.181	0.10	42.28	-	42.38	-	64.43	54.43	-22.05	-
2	0.545	0.10	36.43	-	36.53	-	56.00	46.00	-19.47	-
3	0.728	0.11	36.38	-	36.49	-	56.00	46.00	-19.51	-
4	1.934	0.21	27.36	-	27.57	-	56.00	46.00	-28.43	-
5	8.297	0.32	43.42	-	43.74	-	60.00	50.00	-16.26	-
6	19.711	0.56	47.74	-	48.30	-	60.00	50.00	-11.70	-

- REMARKS:**
1. Q.P. and AV. are abbreviations of quasi-peak and average individually.
  2. "-": The Quasi-peak reading value also meets average limit and measurement with the average detector is unnecessary.
  3. The emission levels of other frequencies were very low against the limit.
  4. Margin value = Emission level - Limit value
  5. Correction factor = Insertion loss + Cable loss
  6. Emission Level = Correction Factor + Reading Value.

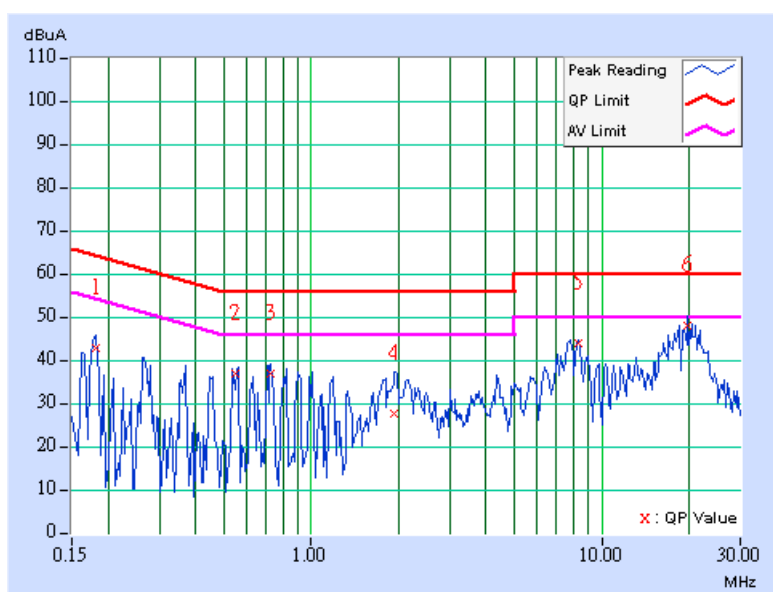

EUT TEST CONDITION		MEASUREMENT DETAIL	
CHANNEL	Channel 36	PHASE	Line 2
MODULATION TYPE	BPSK	6dB BANDWIDTH	9 kHz
TRANSFER RATE	6Mbps	ENVIRONMENTAL CONDITIONS	20deg. C, 60%RH, 991hPa
INPUT POWER (SYSTEM)	120Vac, 60 Hz	TEST MODE	A
TESTED BY	Match Tsui		

No	Freq. [MHz]	Corr. Factor [dB]	Reading Value [dB (uV)]		Emission Level [dB (uV)]		Limit [dB (uV)]		Margin (dB)	
			Q.P.	AV.	Q.P.	AV.	Q.P.	AV.	Q.P.	AV.
1	0.181	0.10	38.77	-	38.87	-	64.43	54.43	-25.56	-
2	0.541	0.13	35.00	-	35.13	-	56.00	46.00	-20.87	-
3	0.728	0.16	35.78	-	35.94	-	56.00	46.00	-20.06	-
4	1.980	0.22	31.83	-	32.05	-	56.00	46.00	-23.95	-
5	7.852	0.38	43.57	-	43.95	-	60.00	50.00	-16.05	-
6	19.712	0.56	48.04	-	48.60	-	60.00	50.00	-11.40	-

- REMARKS:**
1. Q.P. and AV. are abbreviations of quasi-peak and average individually.
  2. "-": The Quasi-peak reading value also meets average limit and measurement with the average detector is unnecessary.
  3. The emission levels of other frequencies were very low against the limit.
  4. Margin value = Emission level - Limit value
  5. Correction factor = Insertion loss + Cable loss
  6. Emission Level = Correction Factor + Reading Value.

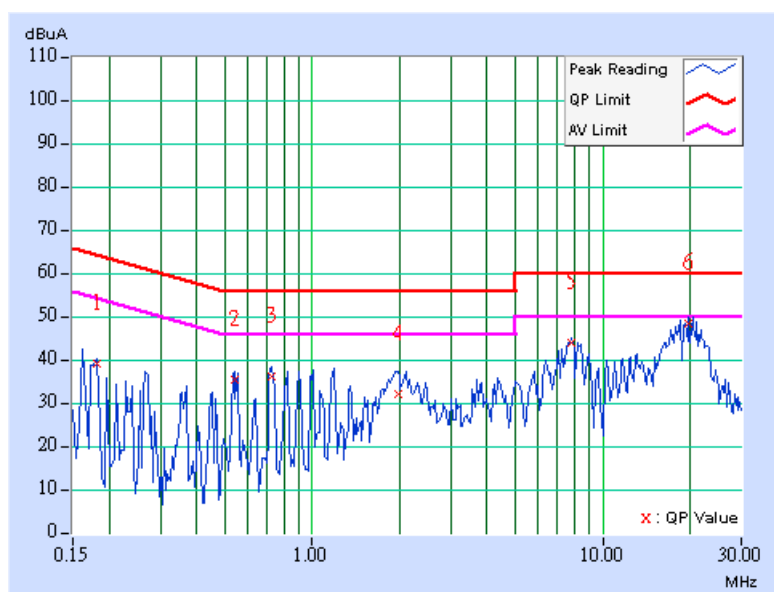



### 4.3 PEAK TRANSMIT POWER MEASUREMENT

#### 4.3.1 LIMITS OF PEAK TRANSMIT POWER MEASUREMENT

Frequency Band	Limit
5.15 ~ 5.25GHz	The lesser of 50mW (17dBm) or 4dBm + 10logB
5.25 ~ 5.35GHz	The lesser of 250mW (24dBm) or 11dBm + 10logB
5.725 ~ 5.825GHz	The lesser of 1W (30dBm) or 17dBm + 10logB

**NOTE:** Where B is the 26dB emission bandwidth in MHz.

#### 4.3.2 TEST INSTRUMENTS

Description & Manufacturer	Model No.	Serial No.	Calibrated Until
SPECTRUM ANALYZER	FSP40	100040	Jun. 28, 2008

**NOTE:** The calibration interval of the above test instruments is 12 months and the calibrations are traceable to NML/ROC and NIST/USA.

#### 4.3.3 TEST PROCEDURE

1. The transmitter output was connected to the spectrum analyzer.
2. Set span to encompass the entire emission bandwidth of the signal.
3. Set RBW to 1MHz, VBW to 300kHz.
4. Using the spectrum analyzer's channel power measurement function to measure the output power.

**NOTE:**

The test is performed in accordance with FCC Public Notice: APPENDIX A Guidelines for Assessing Unlicensed National Information Infrastructure (U-NII) Devices – Part 15, Subpart E, August 2002.

The transmitter output operates continuously therefore Method # 1 is used.

#### 4.3.4 DEVIATION FROM TEST STANDARD

No deviation

#### 4.3.5 TEST SETUP

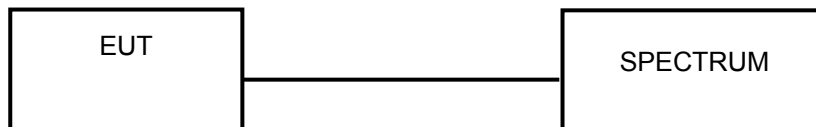

#### 4.3.6 EUT OPERATING CONDITIONS

The software provided by client to enable the EUT under transmission condition continuously at specific channel frequencies individually.

### 4.3.7 TEST RESULTS

#### 802.11a OFDM Modulation

<b>MODULATION TYPE</b>	BPSK	<b>TRANSFER RATE</b>	6Mbps
<b>INPUT POWER (SYSTEM)</b>	120Vac, 60 Hz	<b>ENVIRONMENTAL CONDITIONS</b>	25deg.C, 63%RH, 991hPa
<b>TEST MODE</b>	A	<b>TESTED BY</b>	Dean Wang

CHANNEL	CHANNEL FREQUENCY (MHz)	PEAK POWER OUTPUT (mW)	PEAK POWER OUTPUT (dBm)	PEAK POWER LIMIT (dBm)	PASS / FAIL
36	5180	16.255	12.11	17.00	PASS
40	5200	16.069	12.06	17.00	PASS
48	5240	16.144	12.08	17.00	PASS

#### CH 36

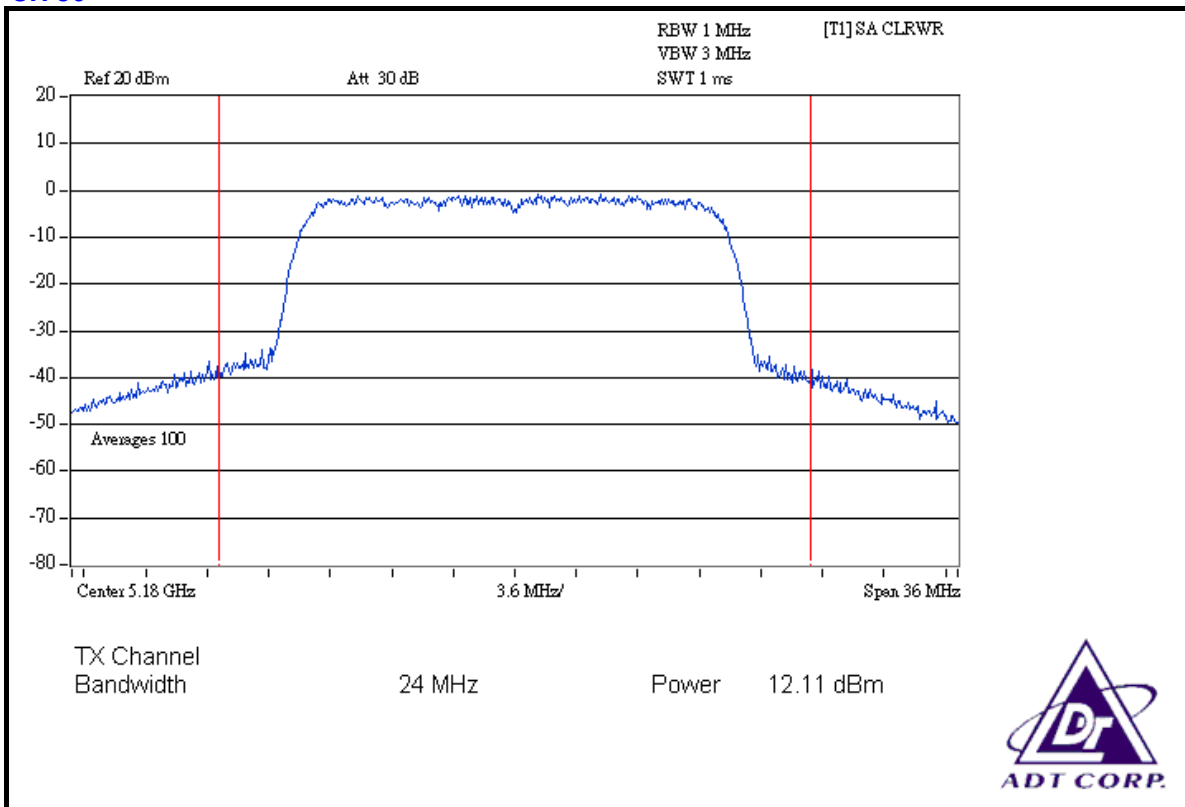

### CH 40

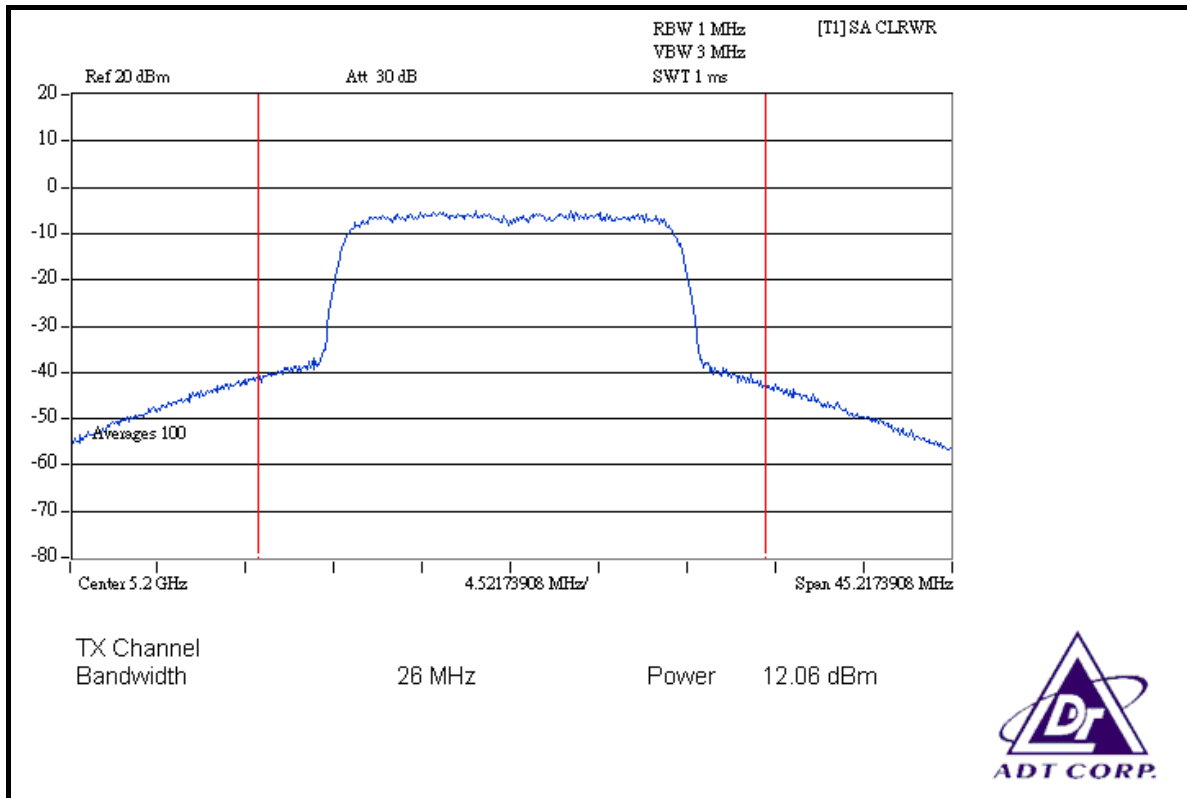

### CH 48

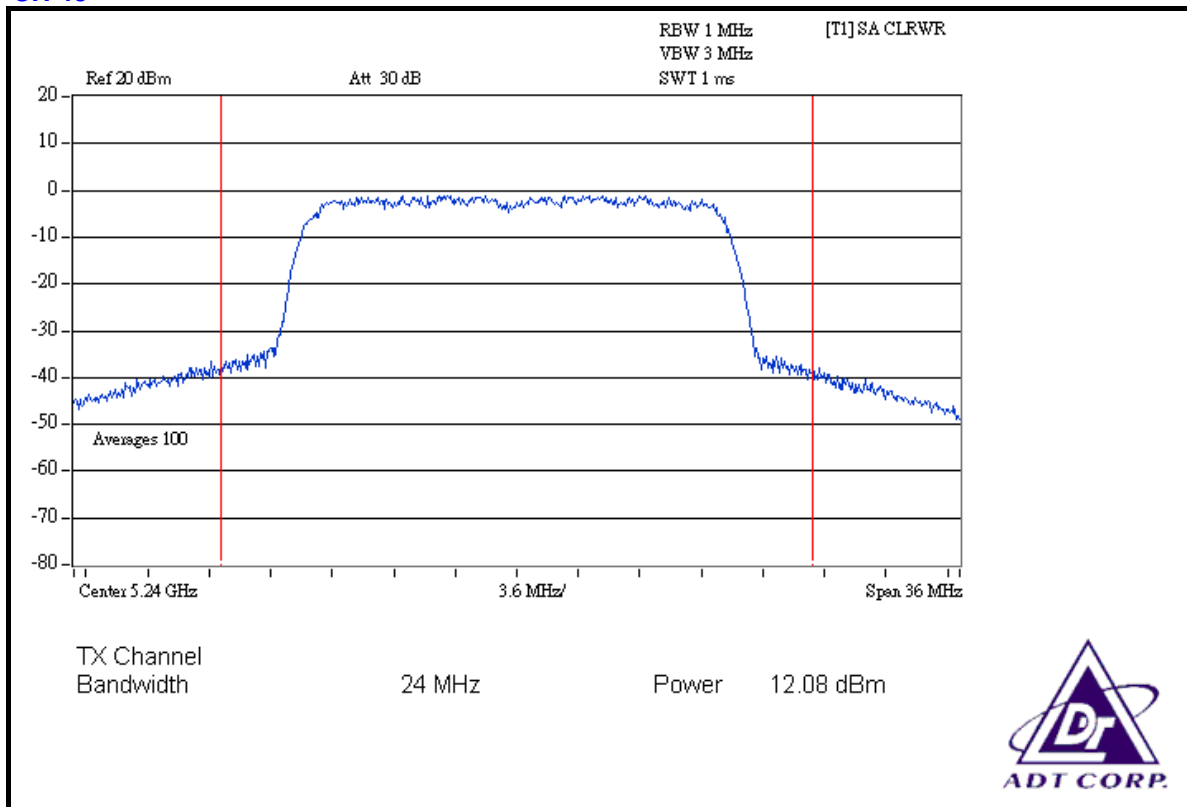





<b>MODULATION TYPE</b>	BPSK	<b>TRANSFER RATE</b>	6Mbps
<b>INPUT POWER (SYSTEM)</b>	120Vac, 60 Hz	<b>ENVIRONMENTAL CONDITIONS</b>	25deg.C, 63%RH, 991hPa
<b>TEST MODE</b>	B	<b>TESTED BY</b>	Dean Wang

CHANNEL	CHANNEL FREQUENCY (MHz)	PEAK POWER OUTPUT (mW)	PEAK POWER OUTPUT (dBm)	PEAK POWER LIMIT (dBm)	PASS / FAIL
36	5180	7.328	8.65	9.00	PASS
40	5200	7.145	8.54	9.00	PASS
48	5240	7.079	8.50	9.00	PASS

**NOTE:** According to 15.407(a)(1)(2), the maximum antenna gain 14dBi is higher than 6dBi, so the limit of peak power shall be reduced by 8dB.

### CH 36

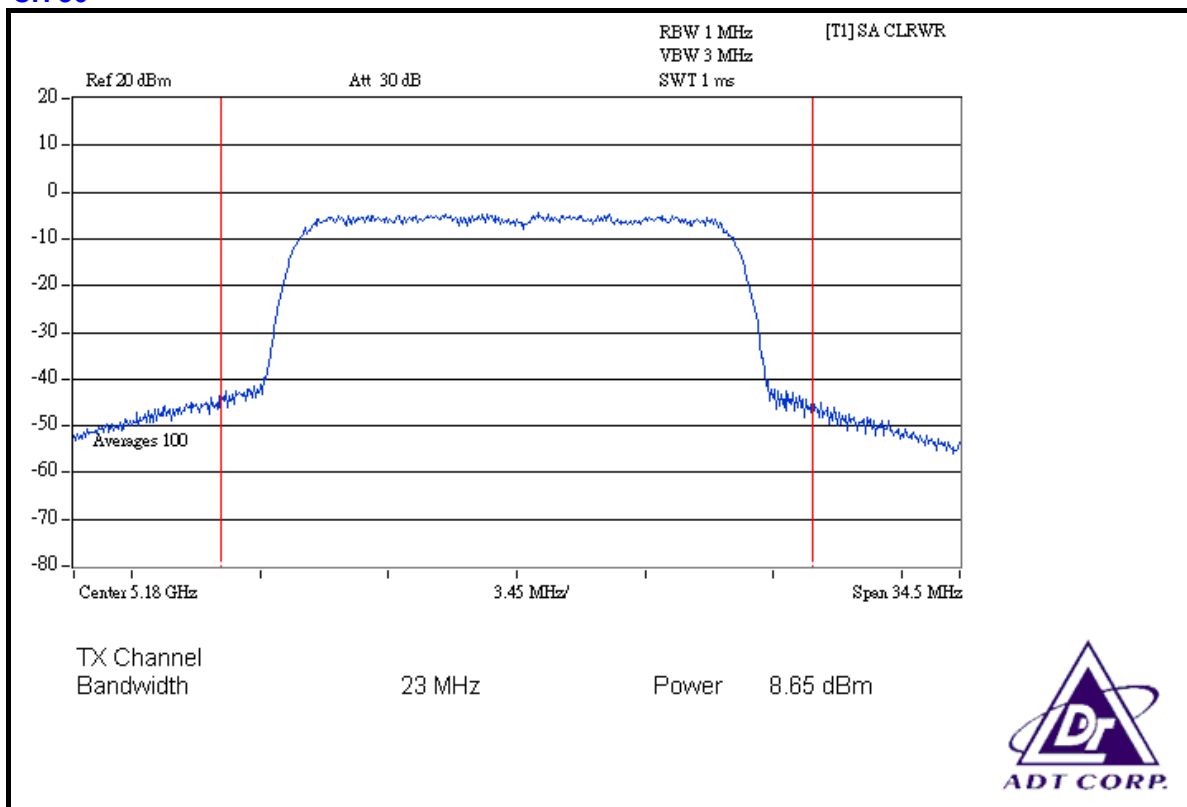

### CH 40

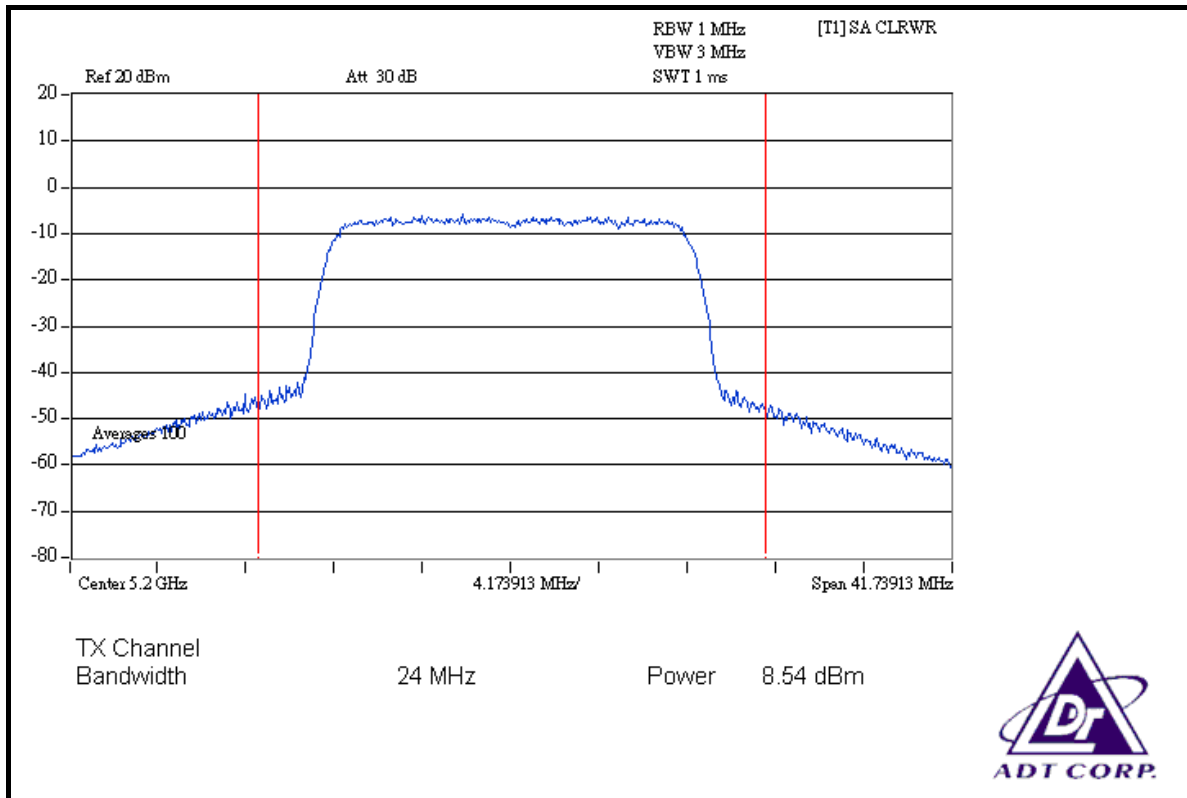

### CH 48

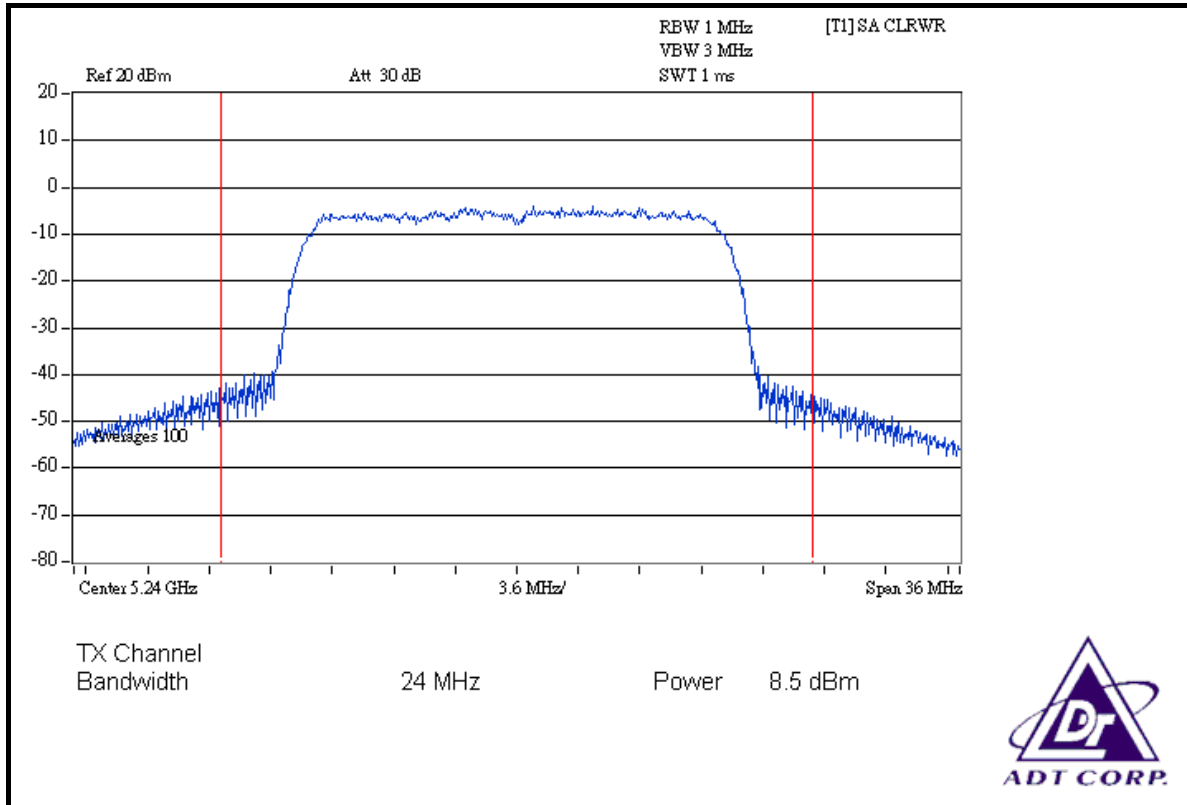



**26dB OCCUPIED BANDWIDTH:**

<b>MODULATION TYPE</b>	BPSK	<b>TRANSFER RATE</b>	6Mbps
<b>INPUT POWER (SYSTEM)</b>	120Vac, 60Hz	<b>ENVIRONMENTAL CONDITIONS</b>	25deg.C, 63%RH, 991hPa
<b>TEST MODE</b>	A	<b>TESTED BY</b>	Dean Wang

CHANNEL	CHANNEL FREQUENCY (MHz)	26dBc OCCUPIED BANDWIDTH (MHz)	PASS / FAIL
36	5180	23.87	PASS
40	5200	25.31	PASS
48	5240	23.27	PASS

**CH 36**

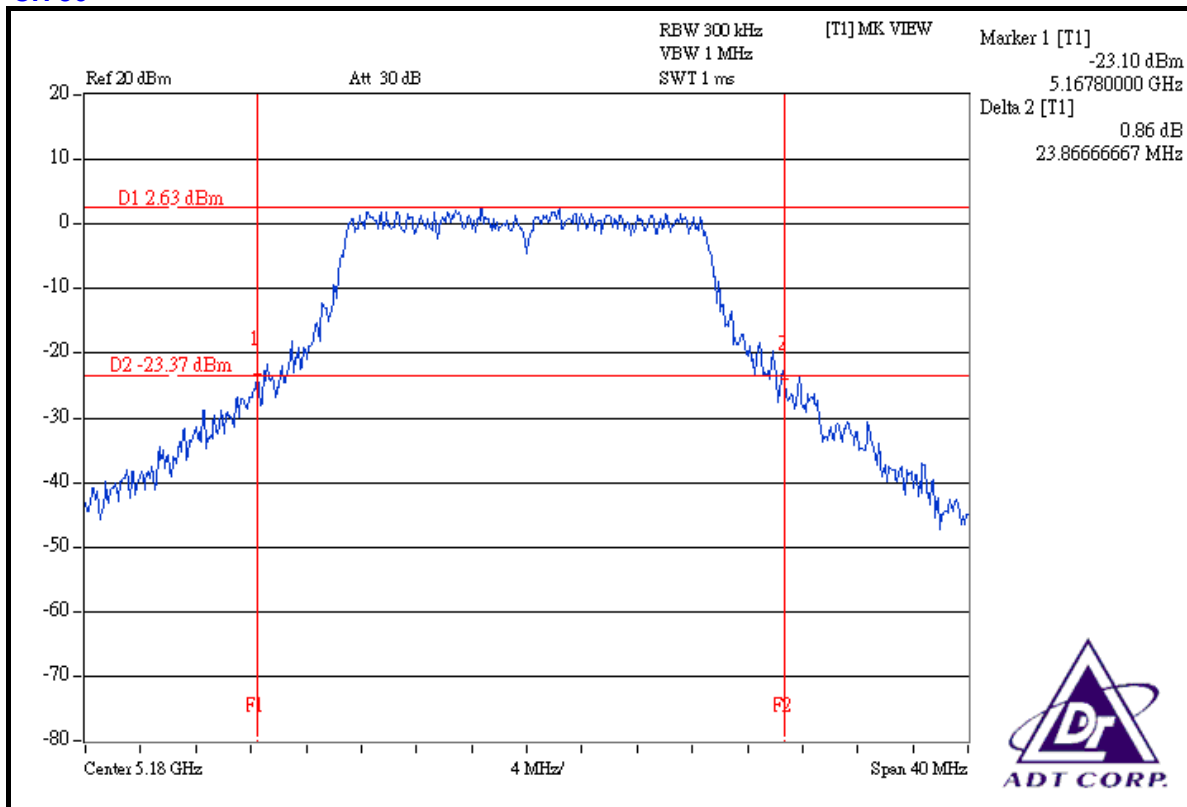

### CH 40

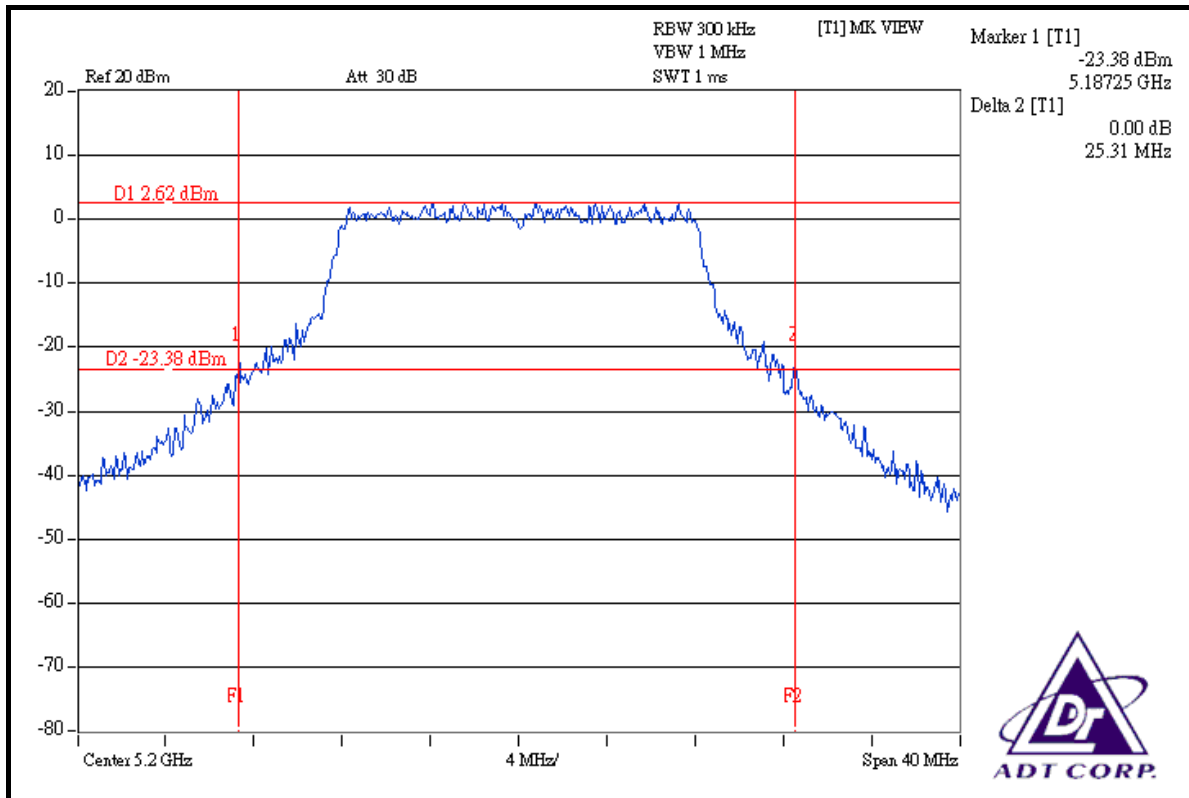

### CH 48

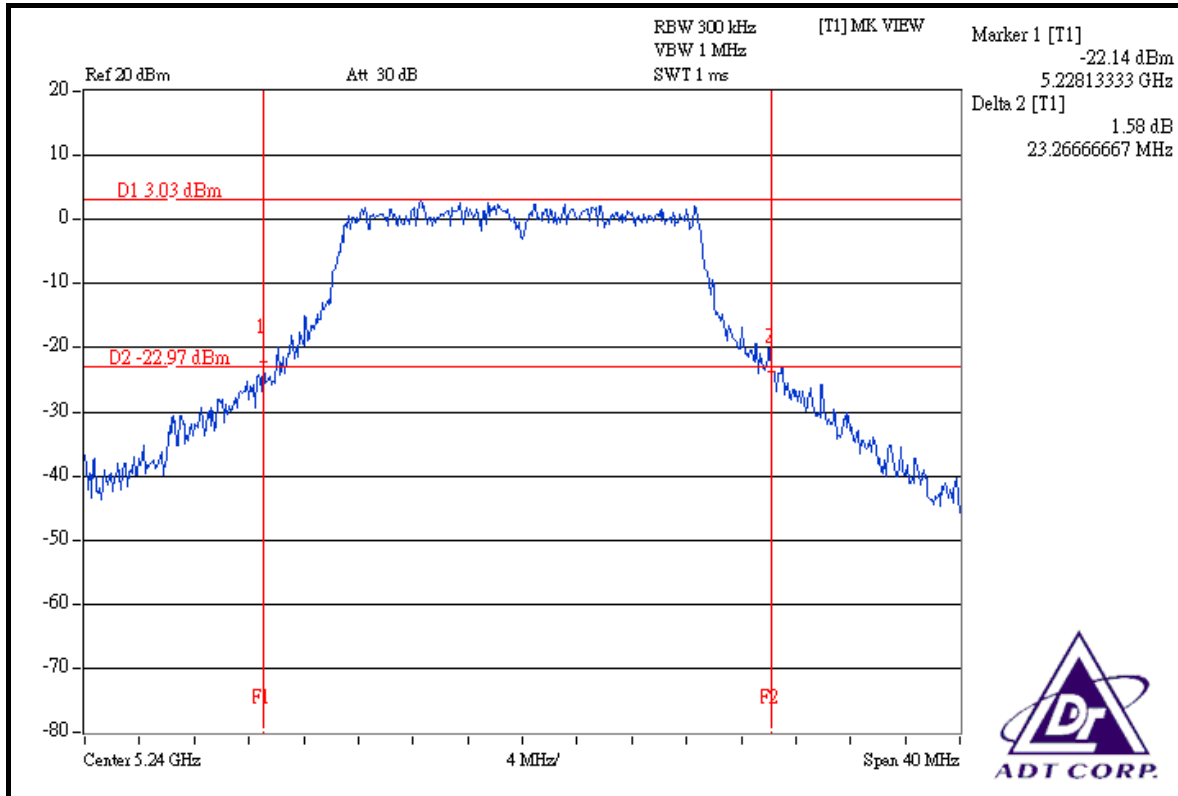



<b>MODULATION TYPE</b>	BPSK	<b>TRANSFER RATE</b>	6Mbps
<b>INPUT POWER (SYSTEM)</b>	120Vac, 60Hz	<b>ENVIRONMENTAL CONDITIONS</b>	25deg.C, 63%RH, 991hPa
<b>TEST MODE</b>	B	<b>TESTED BY</b>	Dean Wang

CHANNEL	CHANNEL FREQUENCY (MHz)	26dBc OCCUPIED BANDWIDTH (MHz)	PASS / FAIL
36	5180	22.93	PASS
40	5200	23.03	PASS
48	5240	23.33	PASS

**CH 36**

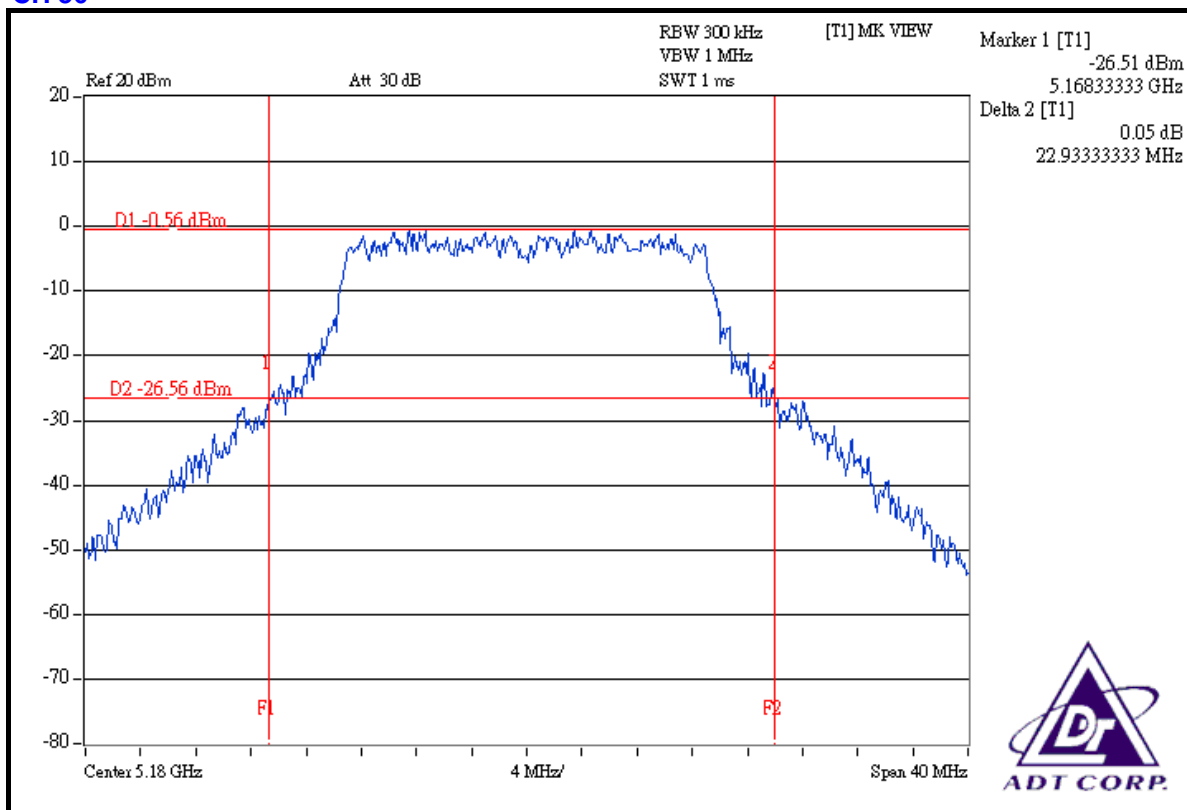



### CH 40

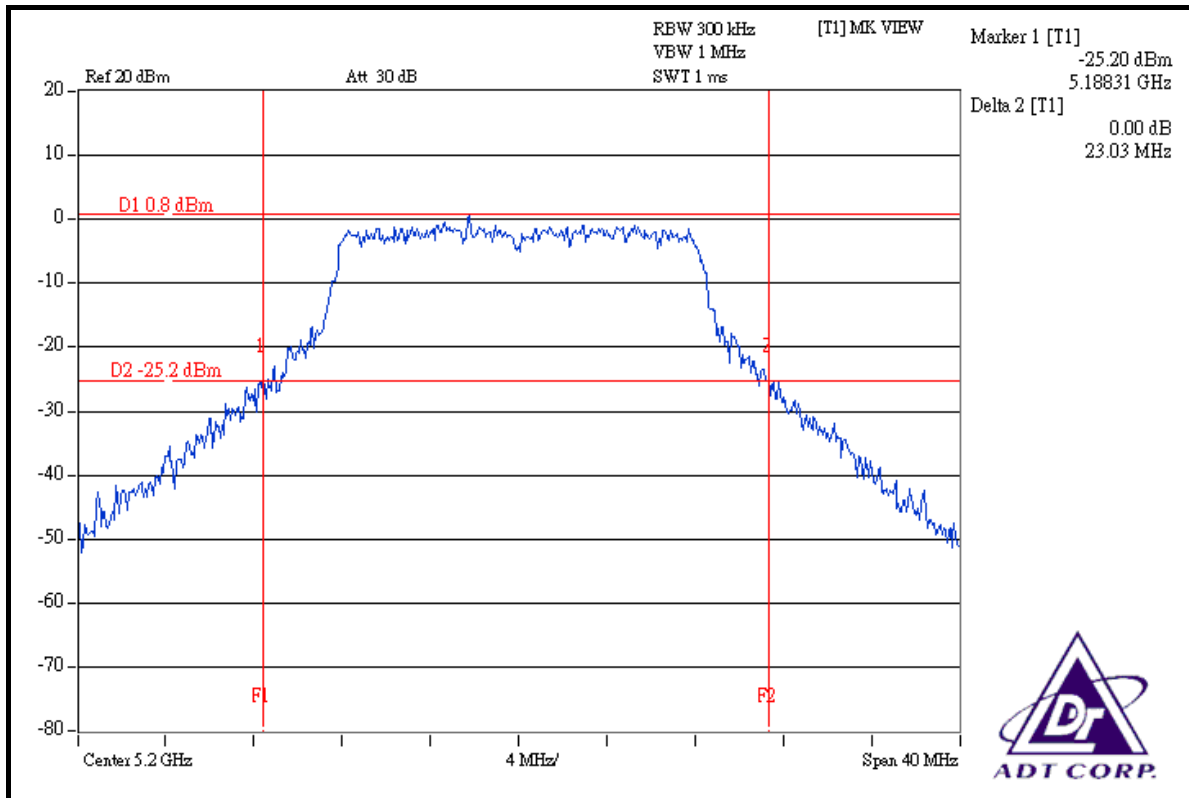

### CH 48

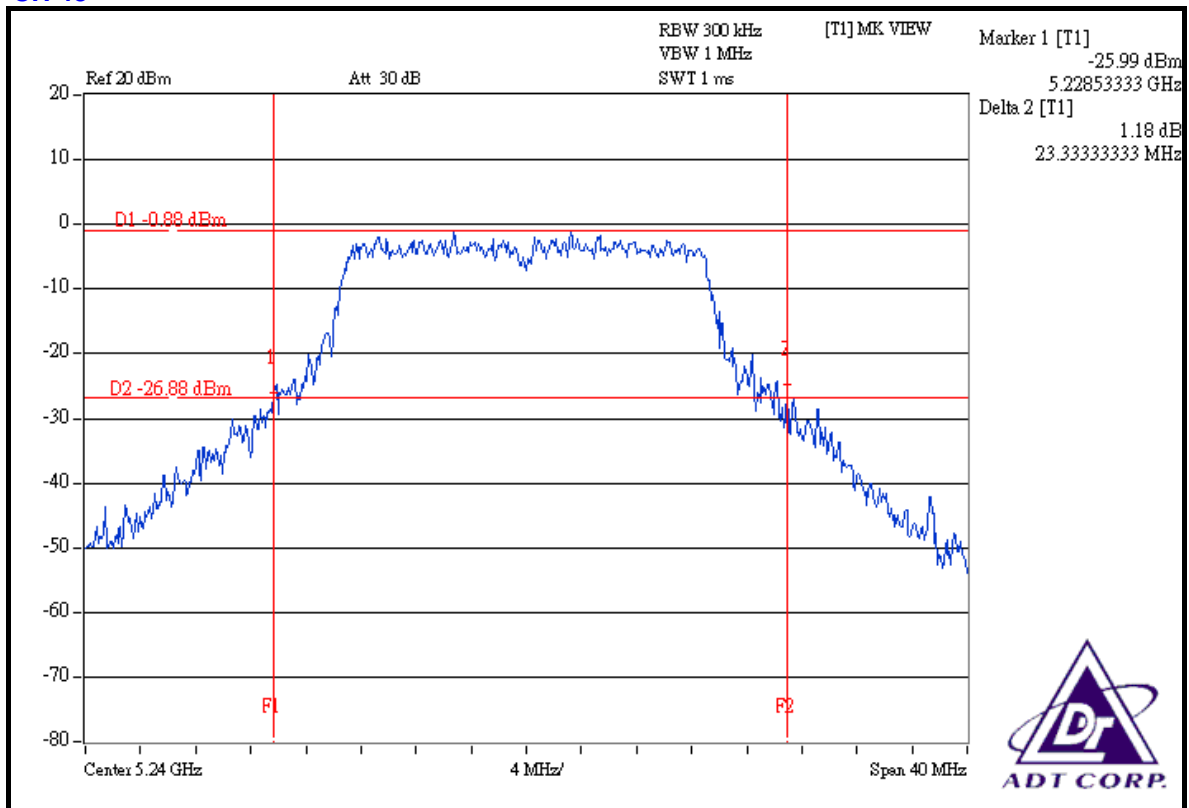



#### 4.4 PEAK POWER EXCURSION MEASUREMENT

##### 4.4.1 LIMITS OF PEAK POWER EXCURSION MEASUREMENT

Frequency Band	Limit
5.15 ~ 5.25 GHz	13dB
5.25 ~ 5.35 GHz	13dB
5.725 ~ 5.825 GHz	13dB

##### 4.4.2 TEST INSTRUMENTS

Description & Manufacturer	Model No.	Serial No.	Calibrated Until
SPECTRUM ANALYZER	FSP40	100040	Jun. 28, 2008

**NOTE:** The calibration interval of the above test instruments is 12 months and the calibrations are traceable to NML/ROC and NIST/USA.

#### 4.4.3 TEST PROCEDURE

1. The transmitter output was connected to the spectrum analyzer.
2. Set the spectrum bandwidth span to view the entire spectrum.
3. Using peak detector and Max-hold function for Trace 1 (RB=1MHz, VB=3MHz) and 2 (RB=1MHz, VB=300kHz).
4. The largest difference between Trace 1 and Trace 2 in any 1MHz band on any frequency was recorded.

#### 4.4.4 DEVIATION FROM TEST STANDARD

No deviation

#### 4.4.5 TEST SETUP

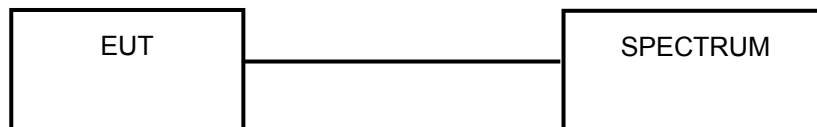

#### 4.4.6 EUT OPERATING CONDITIONS

The software provided by client to enable the EUT under transmission condition continuously at specific channel frequencies individually.





#### 4.4.7 TEST RESULTS

##### 802.11a OFDM modulation

<b>MODULATION TYPE</b>	BPSK	<b>TRANSFER RATE</b>	6Mbps
<b>INPUT POWER (SYSTEM)</b>	120Vac, 60 Hz	<b>ENVIRONMENTAL CONDITIONS</b>	25deg.C, 63%RH, 991hPa
<b>TEST MODE</b>	A	<b>TESTED BY</b>	Dean Wang

CHANNEL	CHANNEL FREQUENCY (MHz)	PEAK POWER EXCURSION (dB)	PEAK to AVERAGE EXCURSION LIMIT (dB)	PASS/FAIL
36	5180	9.34	13	PASS
40	5200	8.87	13	PASS
48	5240	8.52	13	PASS

##### CH 36

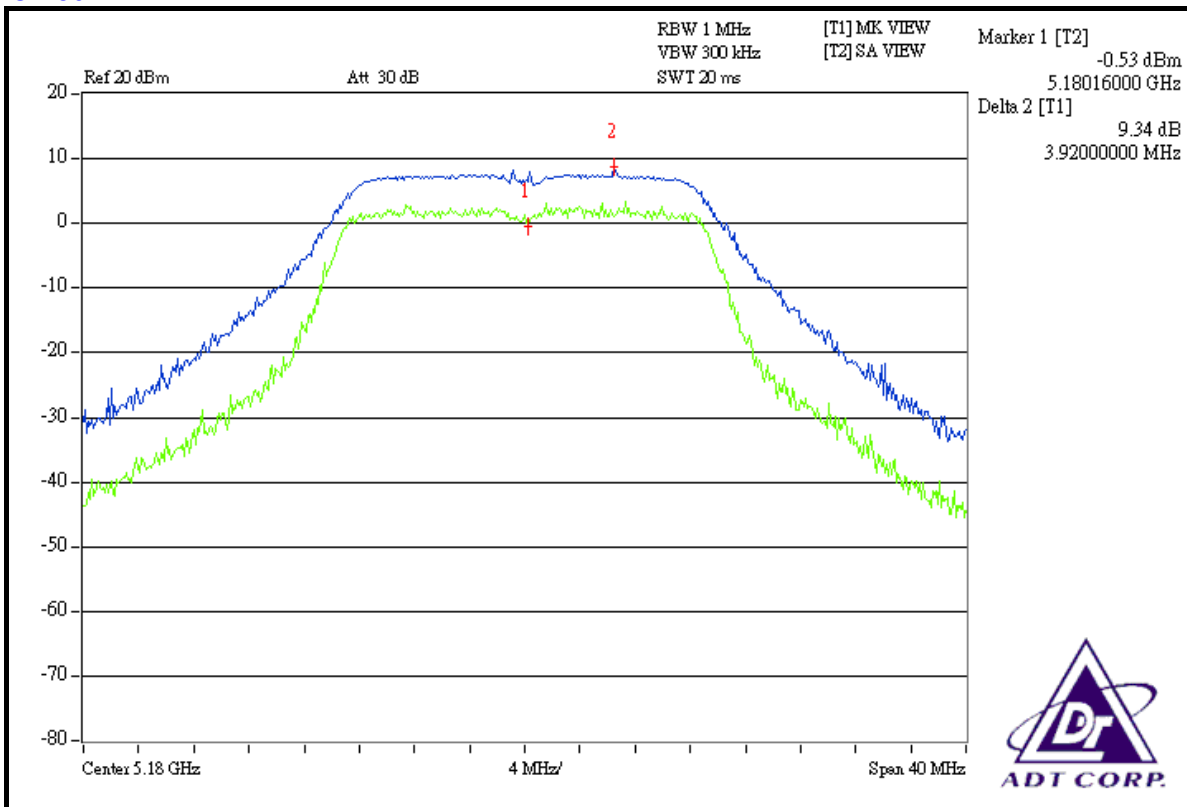



### CH 40

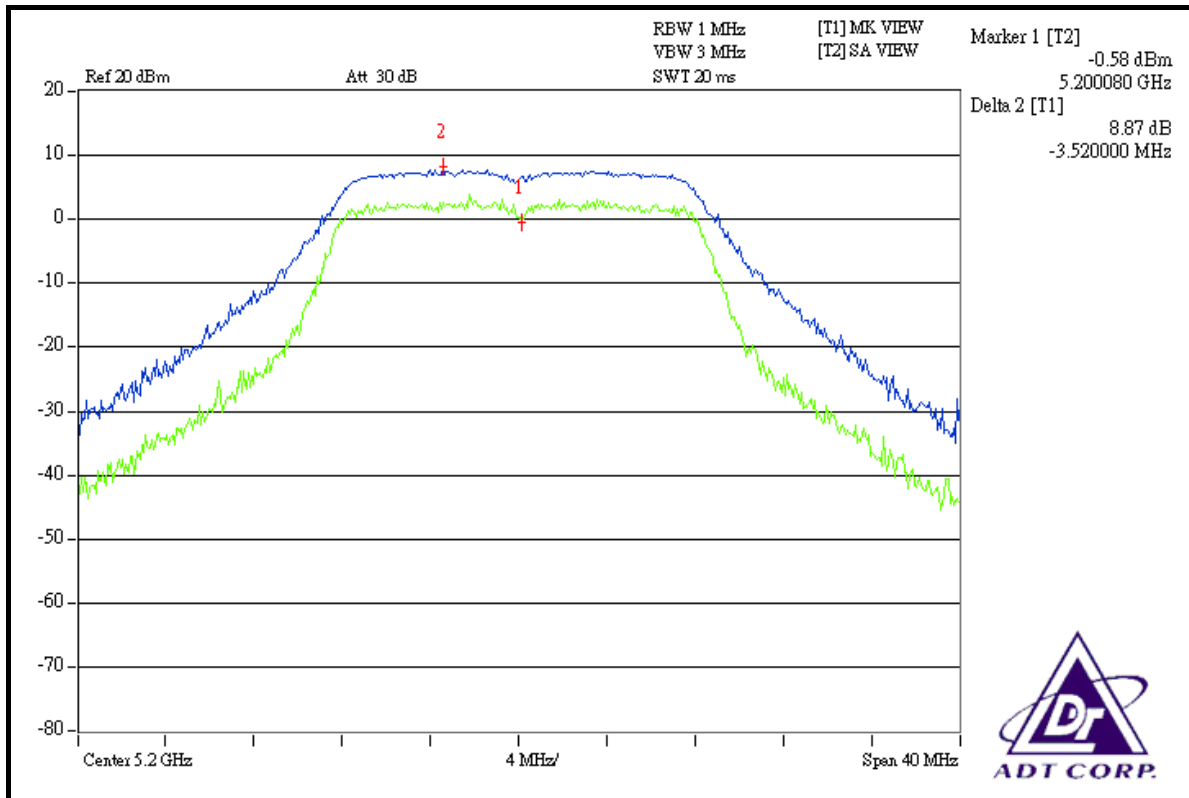

### CH 48

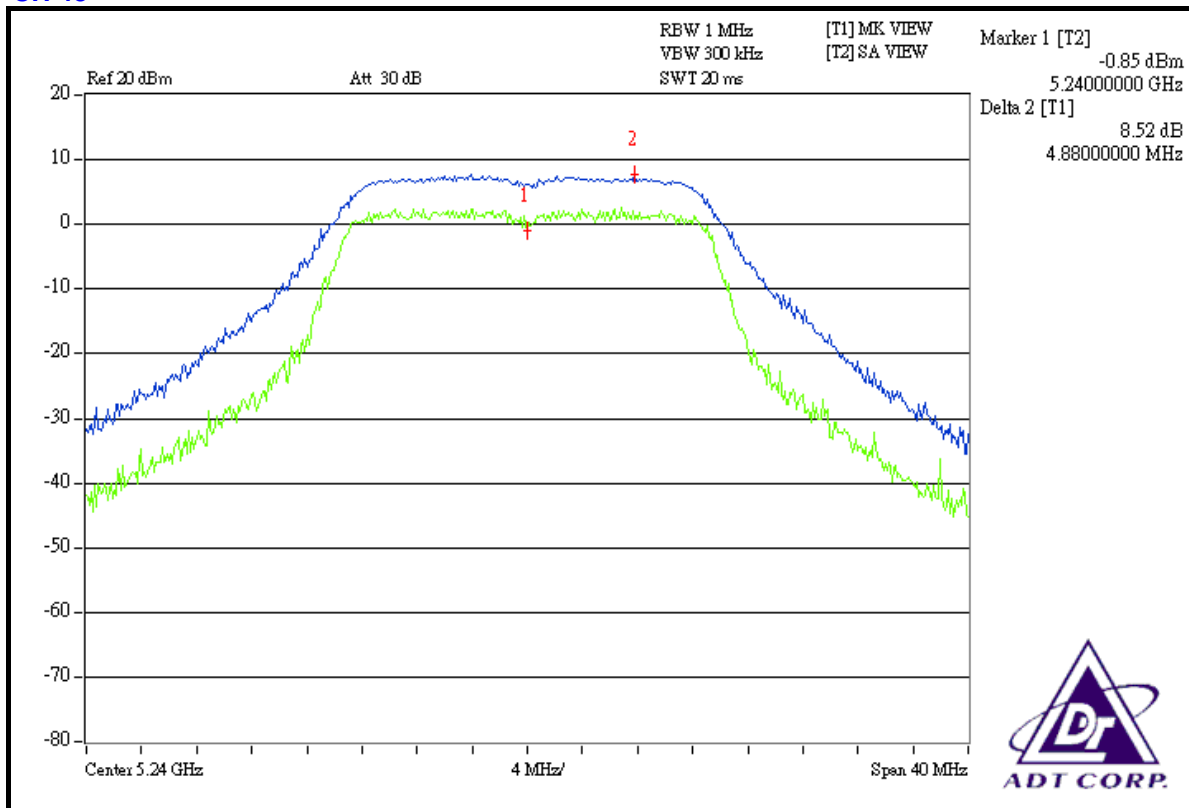



<b>MODULATION TYPE</b>	BPSK	<b>TRANSFER RATE</b>	6Mbps
<b>INPUT POWER (SYSTEM)</b>	120Vac, 60 Hz	<b>ENVIRONMENTAL CONDITIONS</b>	25deg.C, 63%RH, 991hPa
<b>TEST MODE</b>	B	<b>TESTED BY</b>	Dean Wang

CHANNEL	CHANNEL FREQUENCY (MHz)	PEAK POWER EXCURSION (dB)	PEAK to AVERAGE EXCURSION LIMIT (dB)	PASS/FAIL
36	5180	8.34	13	PASS
40	5200	8.26	13	PASS
48	5240	8.39	13	PASS

**CH 36**

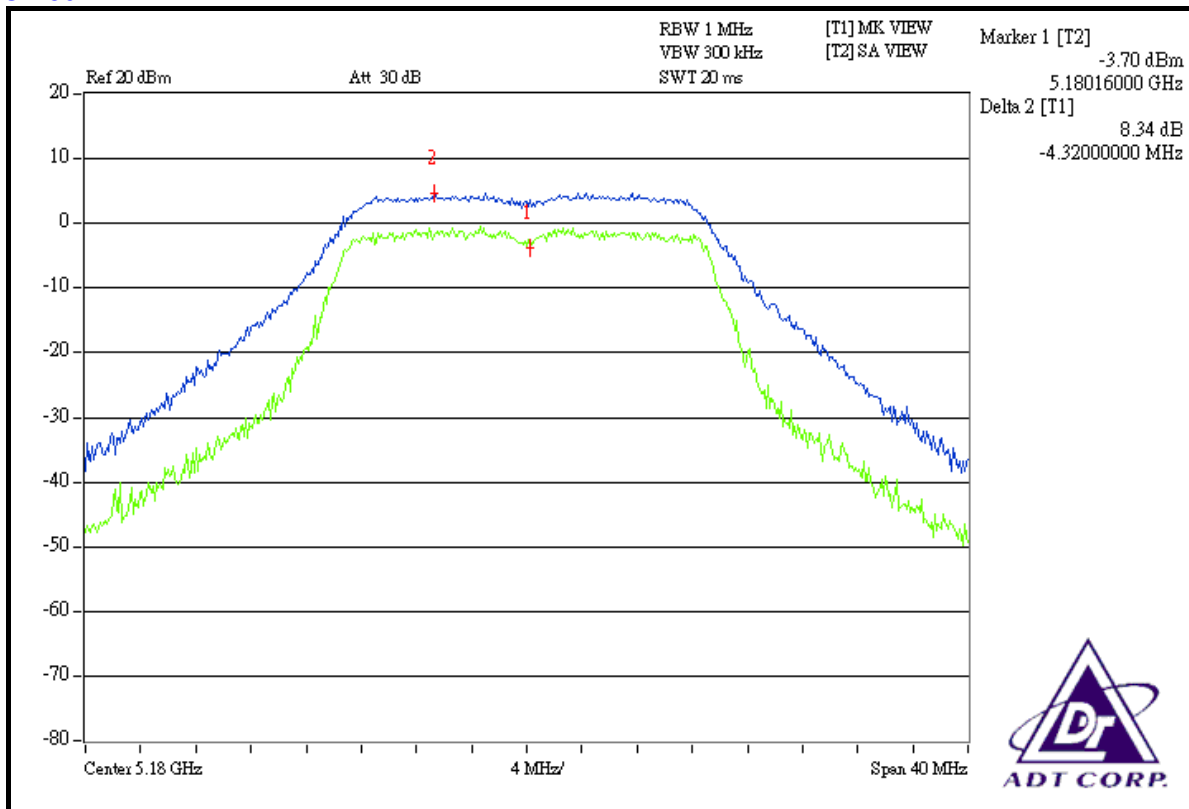



### CH 40

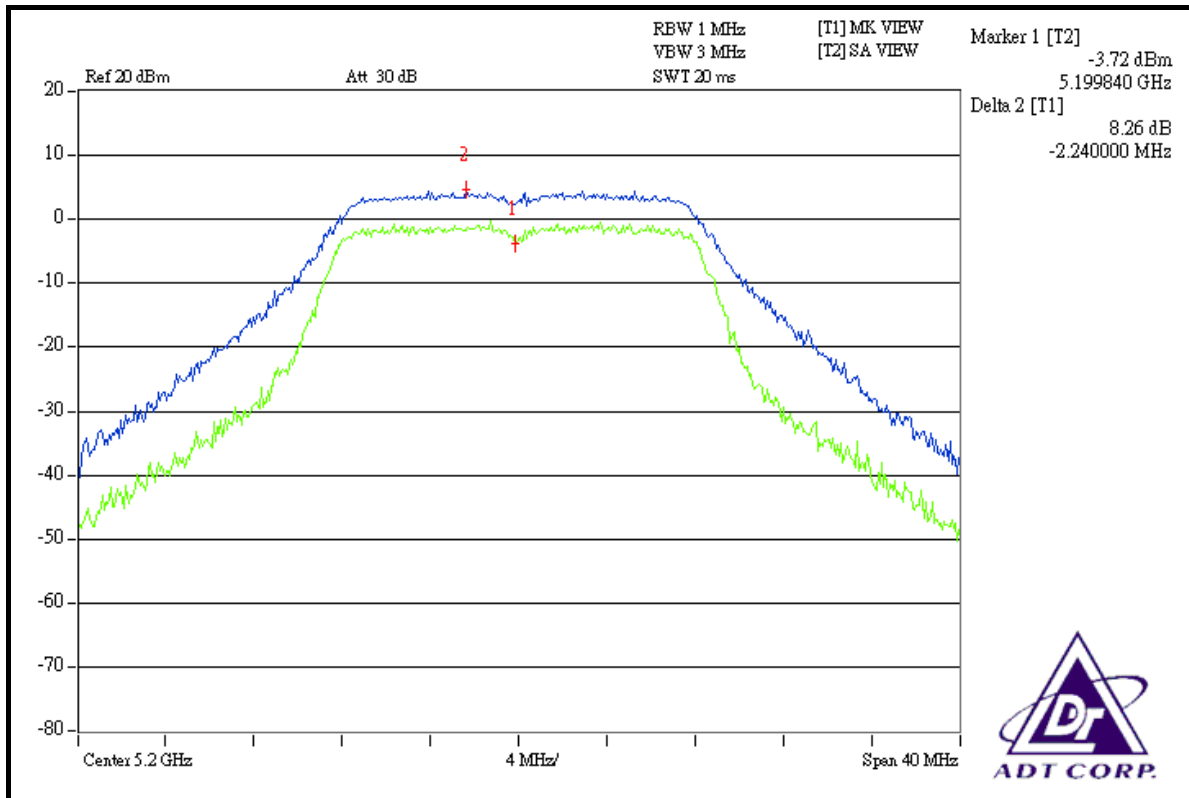

### CH 48

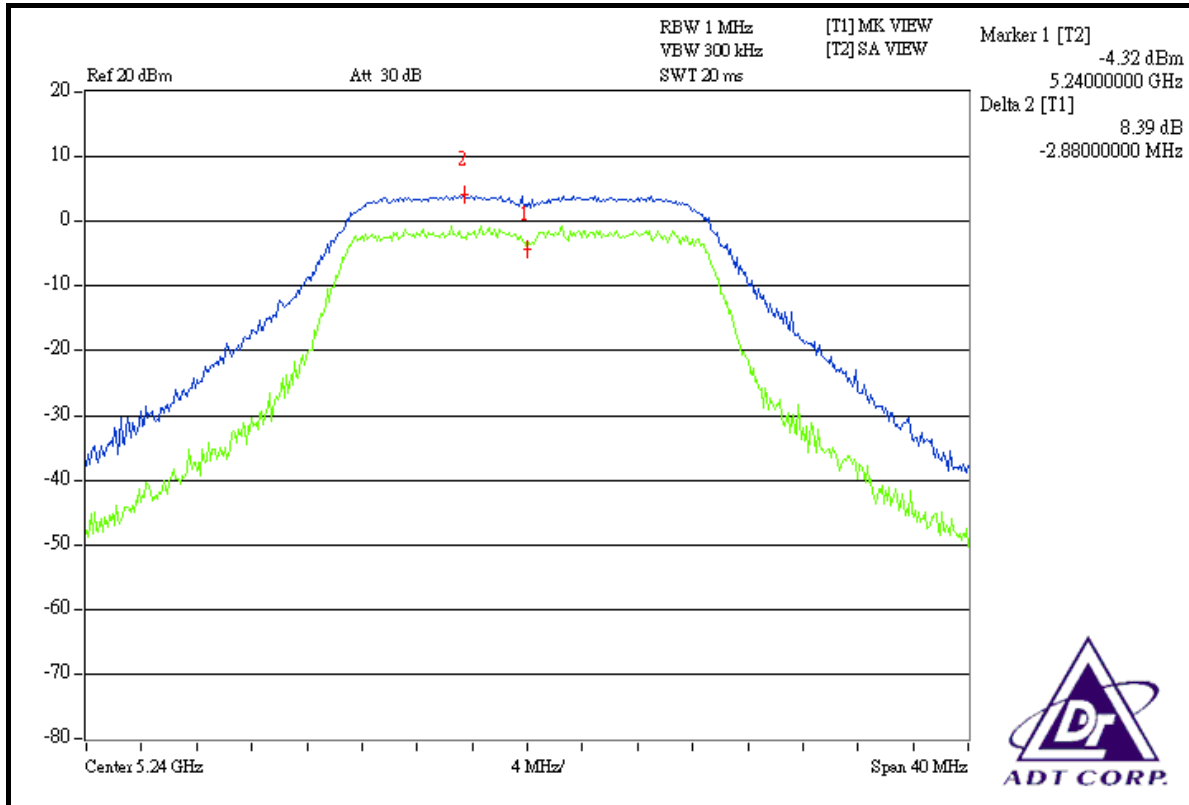



## 4.5 PEAK POWER SPECTRAL DENSITY MEASUREMENT

### 4.5.1 LIMITS OF PEAK POWER SPECTRAL DENSITY MEASUREMENT

Frequency Band	Limit
5.15 ~ 5.25GHz	4dBm
5.25 ~ 5.35GHz	11dBm
5.725 ~ 5.825GHz	17dBm

### 4.5.2 TEST INSTRUMENTS

Description & Manufacturer	Model No.	Serial No.	Calibrated Until
SPECTRUM ANALYZER	FSP40	100040	Jun. 28, 2008

**NOTE:** The calibration interval of the above test instruments is 12 months and the calibrations are traceable to NML/ROC and NIST/USA.

#### 4.5.3 TEST PROCEDURES

1. The transmitter output was connected to the spectrum analyzer.
2. Set RBW=1MHz, VBW=3MHz. The PPSD is the highest level found across the emission in any 1MHz band.

#### 4.5.4 DEVIATION FROM TEST STANDARD

No deviation

#### 4.5.5 TEST SETUP

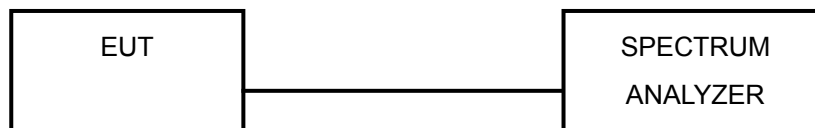

#### 4.5.6 EUT OPERATING CONDITIONS

Same as 5.3.6

## 4.5.7 TEST RESULTS

### 802.11a OFDM modulation

<b>MODULATION TYPE</b>	BPSK	<b>TRANSFER RATE</b>	6Mbps
<b>INPUT POWER (SYSTEM)</b>	120Vac, 60 Hz	<b>ENVIRONMENTAL CONDITIONS</b>	25deg.C, 63%RH, 991hPa
<b>TEST MODE</b>	A	<b>TESTED BY</b>	Dean Wang

CHANNEL	CHANNEL FREQUENCY (MHz)	RF POWER LEVEL IN 1MHz BW (dBm)	MAXIMUM LIMIT (dBm)	PASS/FAIL
36	5180	-3.04	4	PASS
40	5200	-2.88	4	PASS
48	5240	-3.14	4	PASS

### CH 36

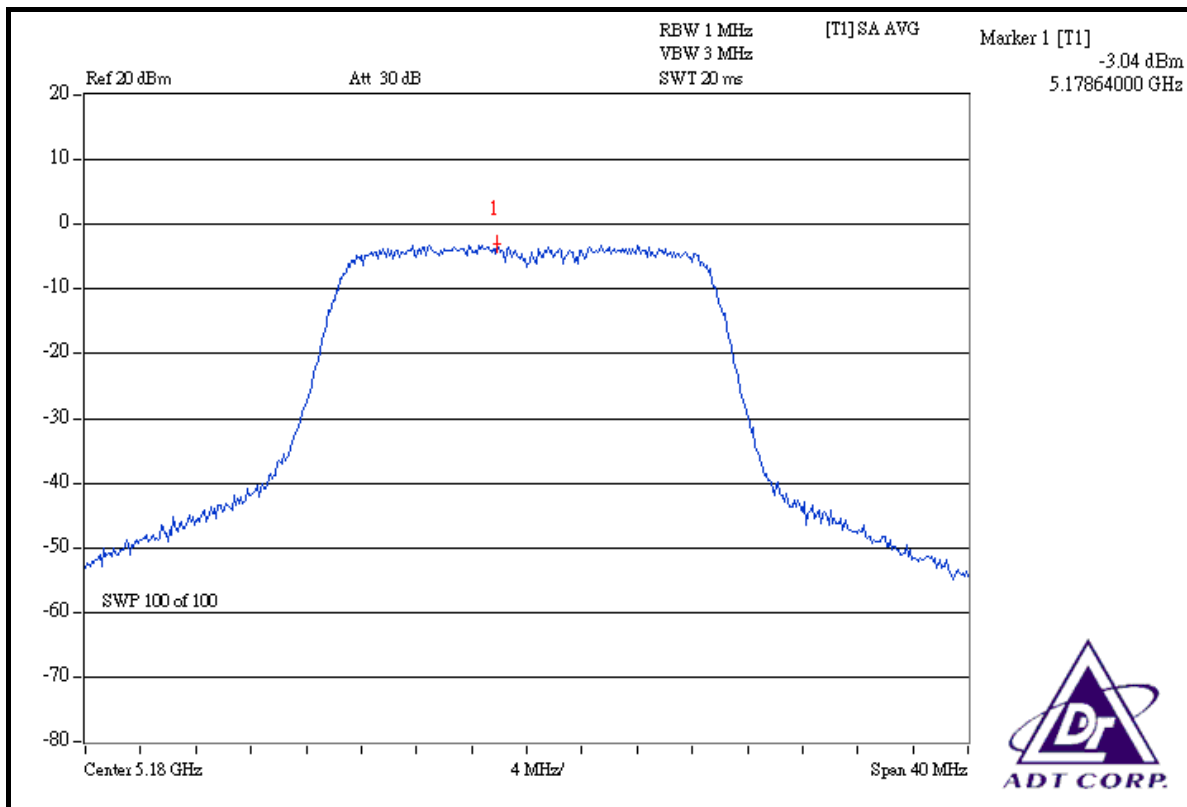



### CH 40

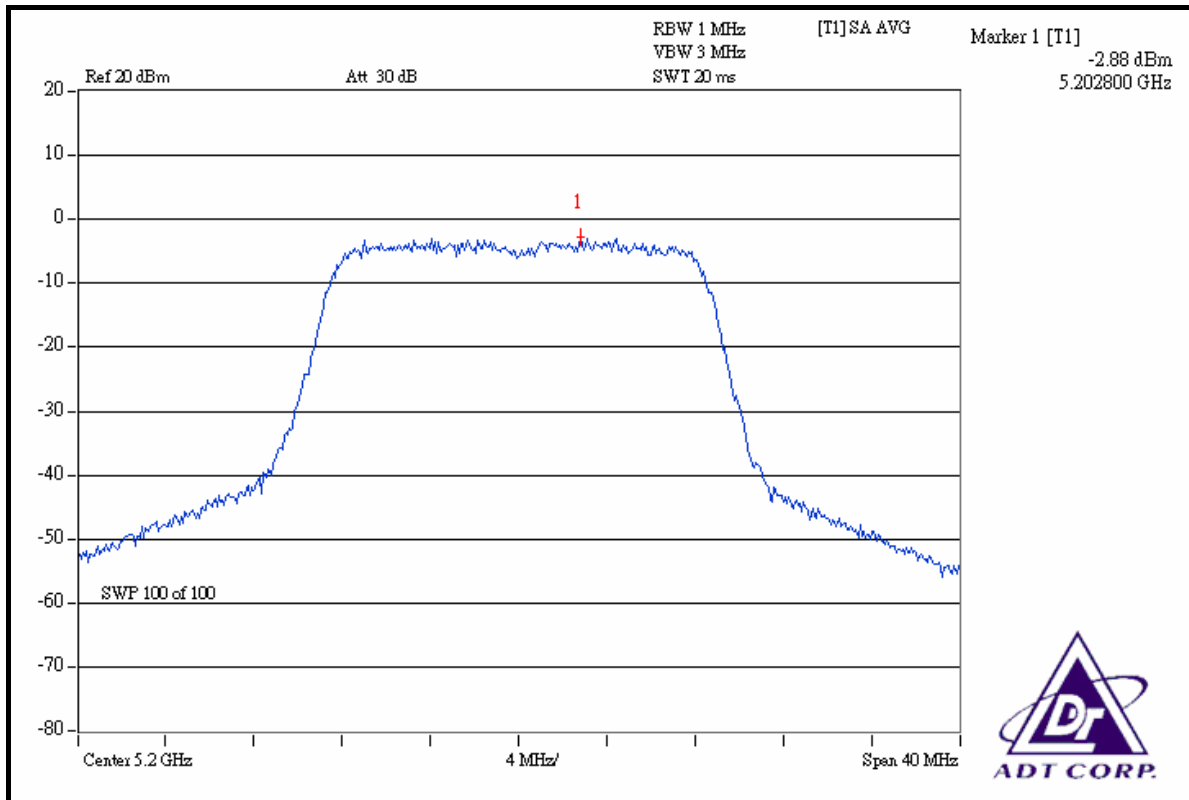

### CH 48

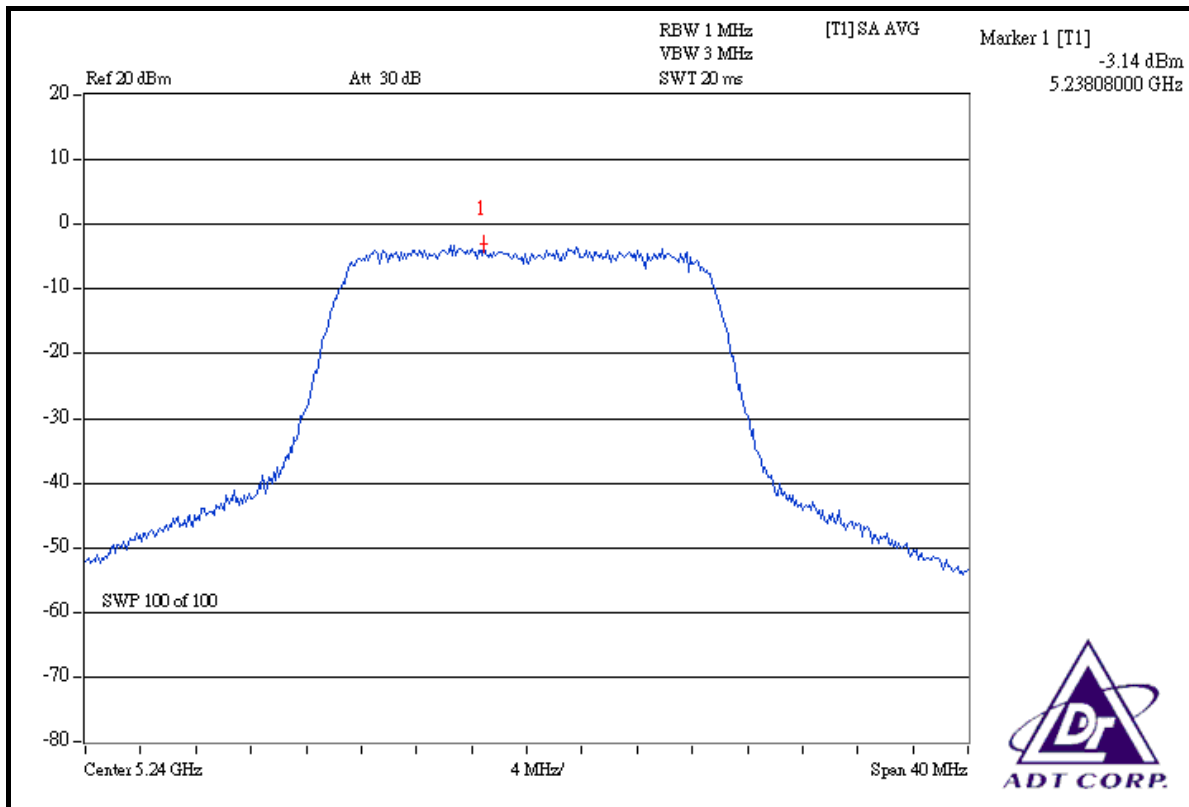



<b>MODULATION TYPE</b>	BPSK	<b>TRANSFER RATE</b>	6Mbps
<b>INPUT POWER (SYSTEM)</b>	120Vac, 60 Hz	<b>ENVIRONMENTAL CONDITIONS</b>	25deg.C, 63%RH, 991hPa
<b>TEST MODE</b>	B	<b>TESTED BY</b>	Dean Wang

CHANNEL	CHANNEL FREQUENCY (MHz)	RF POWER LEVEL IN 1MHz BW (dBm)	MAXIMUM LIMIT (dBm)	PASS/FAIL
36	5180	-6.40	-4	PASS
40	5200	-6.50	-4	PASS
48	5240	-6.63	-4	PASS

**NOTE:** According to 15.407(a)(1)(2), the maximum antenna gain 14dBi is higher than 6dBi, so the limit of peak power shall be reduced by 8dB.

### CH 36

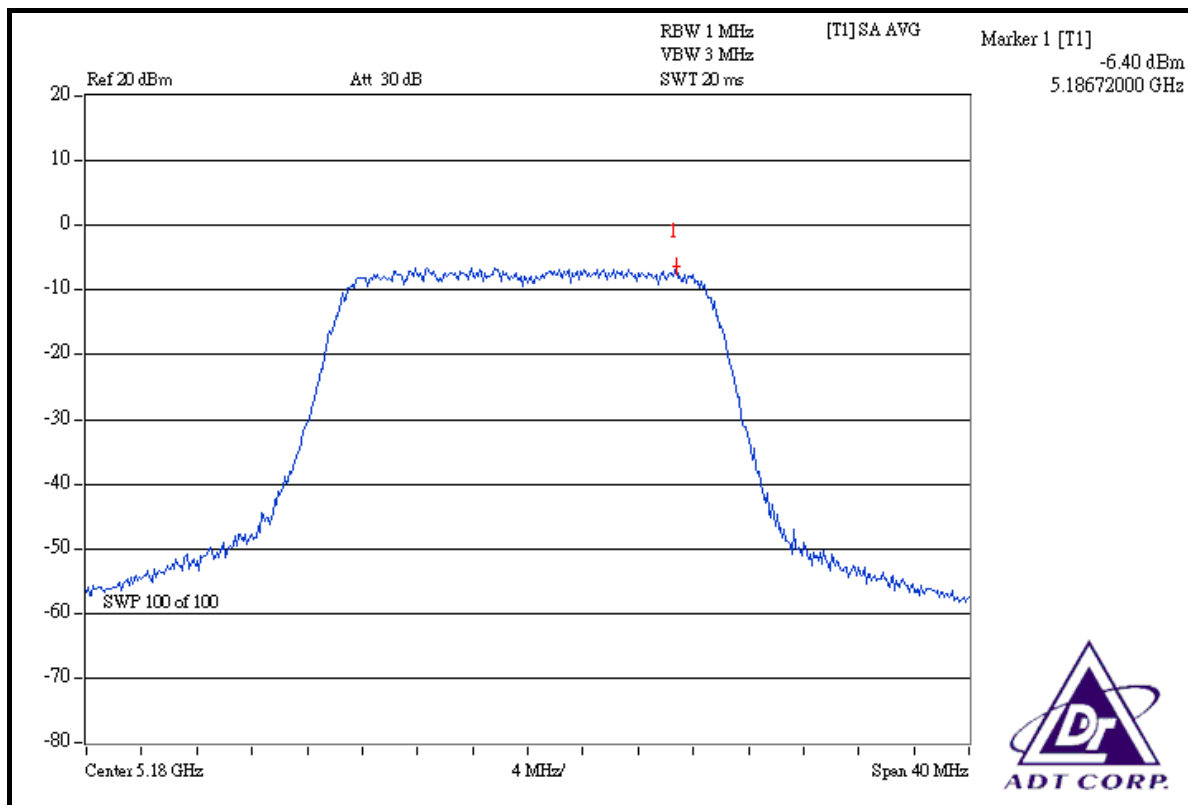



## 4.6 FREQUENCY STABILITY

### 4.6.1 LIMITS OF FREQUENCY STABILITY MEASUREMENT

The frequency tolerance of the carrier signal shall be maintained within +/- 0.02% of the operating frequency over a temperature variation of -30 degrees to 50 degrees C at normal supply voltage, and for a variation in the primary supply voltage from 85% to 115% of the rated supply voltage at a temperature of 20 degrees C.

### 4.6.2 TEST INSTRUMENTS

Description & Manufacturer	Model No.	Serial No.	Calibrated Until
ANRITSU SPECTRUM ANALYZER	MS2667C	M10281	Nov. 21, 2008
WIT STANDARD TEMPERATURE AND HUMIDITY CHAMBER	TH-4S-C	W981030	Jun. 28, 2008

**NOTE:** The calibration interval of the above test instruments is 12 months and the calibrations are traceable to NML/ROC and NIST/USA.

### 4.6.3 TEST PROCEDURE

1. The EUT was placed inside the environmental test chamber and powered by nominal DC voltage.
2. Turn the EUT on and couple its output to a spectrum analyzer.
3. Turn the EUT off and set the chamber to the highest temperature specified.
4. Allow sufficient time (approximately 30 min) for the temperature of the chamber to stabilize, turn the EUT on and measure the operating frequency after 2, 5, and 10 minutes.
5. Repeat step 2 and 3 with the temperature chamber set to the lowest temperature.
6. The test chamber was allowed to stabilize at +20 degree C for a minimum of 30 minutes. The supply voltage was then adjusted on the EUT from 85% to 115% and the frequency record.

#### 4.6.4 DEVIATION FROM TEST STANDARD

No deviation

#### 4.6.5 TEST SETUP

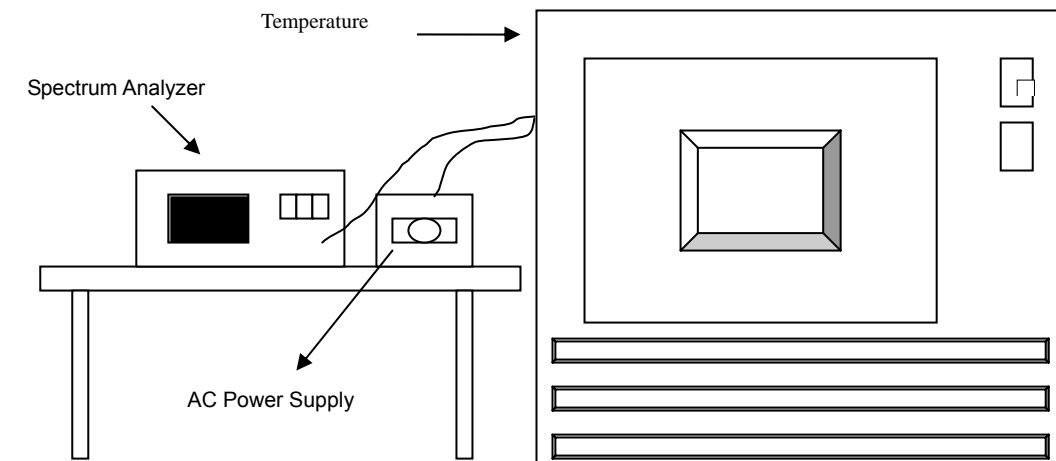

#### 4.6.6 EUT OPERATING CONDITION

Same as Item 4.1.7

#### 4.6.7 TEST RESULTS

		Operating frequency: 5200MHz				Limit : ± 0.01%			
Temp. (°C)	Power supply (Vac)	0 minute		2 minute		5 minute		10 minute	
		(MHz)	(%)	(MHz)	(%)	(MHz)	(%)	(MHz)	(%)
50	126.5	5199.902228	-0.0018802	5199.904108	-0.0018441	5199.907552	-0.0017778	5199.907982	-0.0017696
	110.0	5199.912872	-0.0016755	5199.914869	-0.0016371	5199.910858	-0.0017143	5199.912252	-0.0016875
	93.5	5199.921208	-0.0015152	5199.925745	-0.0014280	5199.926340	-0.0014165	5199.928856	-0.0013682
40	126.5	5199.919992	-0.0015386	5199.930333	-0.0013397	5199.933083	-0.0012869	5199.952938	-0.0009050
	110.0	5199.929562	-0.0013546	5199.941437	-0.0011262	5199.957184	-0.0008234	5199.957830	-0.0008110
	93.5	5199.942178	-0.0011120	5199.949242	-0.0009761	5199.959752	-0.0007740	5199.964849	-0.0006760
30	126.5	5199.924106	-0.0014595	5199.938449	-0.0011837	5199.957784	-0.0008118	5199.959869	-0.0007717
	110.0	5199.930357	-0.0013393	5199.954119	-0.0008823	5199.965377	-0.0006658	5199.959313	-0.0007824
	93.5	5199.947787	-0.0010041	5199.962712	-0.0007171	5199.966325	-0.0006476	5199.968853	-0.0005990
20	126.5	5199.932216	-0.0013035	5199.942573	-0.0011044	5199.961404	-0.0007422	5199.964189	-0.0006887
	110.0	5199.933173	-0.0012851	5199.959844	-0.0007722	5199.969008	-0.0005960	5199.968437	-0.0006070
	93.5	5199.956064	-0.0008449	5199.970767	-0.0005622	5199.970357	-0.0005701	5199.972046	-0.0005376
10	126.5	5199.938142	-0.0011896	5199.952988	-0.0009041	5199.968403	-0.0006076	5199.970861	-0.0005604
	110.0	5199.947454	-0.0010105	5199.963991	-0.0006925	5199.971023	-0.0005572	5199.972165	-0.0005353
	93.5	5199.962661	-0.0007181	5199.975735	-0.0004666	5199.978477	-0.0004139	5199.982246	-0.0003414
0	126.5	5199.942377	-0.0011081	5199.959946	-0.0007703	5199.972088	-0.0005368	5199.977094	-0.0004405
	110.0	5199.959371	-0.0007813	5199.969522	-0.0005861	5199.978700	-0.0004096	5199.978769	-0.0004083
	93.5	5199.968511	-0.0006056	5199.978747	-0.0004087	5199.980650	-0.0003721	5199.986182	-0.0002657
-10	126.5	5199.955124	-0.0008630	5199.965603	-0.0006615	5199.978818	-0.0004073	5199.983628	-0.0003148
	110.0	5199.961410	-0.0007421	5199.975736	-0.0004666	5199.981992	-0.0003463	5199.986207	-0.0002653
	93.5	5199.976429	-0.0004533	5199.982125	-0.0003437	5199.985832	-0.0002725	5199.989217	-0.0002074
-20	126.5	5199.958999	-0.0007885	5199.971849	-0.0005414	5199.982219	-0.0003419	5199.987360	-0.0002431
	110.0	5199.965981	-0.0006542	5199.980047	-0.0003837	5199.988766	-0.0002160	5199.985571	-0.0002775
	93.5	5199.979940	-0.0003858	5199.989329	-0.0002052	5199.989764	-0.0001968	5199.998487	-0.0000291
-30	126.5	5199.964618	-0.0006804	5199.978717	-0.0004093	5199.988700	-0.0002173	5199.986946	-0.0002510
	110.0	5199.979129	-0.0004014	5199.984849	-0.0002914	5199.991117	-0.0001708	5199.996501	-0.0000673
	93.5	5199.981899	-0.0003481	5199.994770	-0.0001006	5199.995086	-0.0000945	5199.995668	-0.0000833



## 4.7 BAND EDGES MEASUREMENT

### 4.7.1 TEST INSTRUMENTS

Description & Manufacturer	Model No.	Serial No.	Calibrated Until
SPECTRUM ANALYZER	FSP40	100040	Jun. 28, 2008

**NOTE:** The calibration interval of the above test instruments is 12 months and the calibrations are traceable to NML/ROC and NIST/USA.

### 4.7.2 TEST PROCEDURE

The transmitter output was connected to the spectrum analyzer via a low loss cable. Set both RBW and VBW of spectrum analyzer to 1MHz with suitable frequency span including 100 MHz bandwidth from band edge. The band edges was measured and recorded.

### 4.7.3 EUT OPERATING CONDITION

The software provided by client to enable the EUT under transmission condition continuously at specific channel frequencies individually.

### 4.7.4 TEST RESULTS

For signals in the restricted bands above and below the 5.15 to 5.35GHz allocated band a measurement was made of the amplitude of the spurious emissions with respect to the intentional signals. The relative amplitude, in dBc, was applied to the average and peak field strength of the intentional signal made on the OATS to calculate the field strength of the unintentional signals.

The spectrum plots (Peak RBW=1MHz, VBW=3MHz; Average RBW=1MHz, VBW=10MHz) are attached on the following pages.



#### TEST MODE A:

##### Channel 36 (5180MHz)

The band edge emission plot on the next page shows 52.73dBc between carrier maximum power and local maximum emission in restrict band. The emission of carrier strength list in the test result of channel 36 is 112.06dBuV/m (Peak), so the maximum field strength in restrict band is  $112.06 - 52.73 = 59.33$ dBuV/m which is under 74dBuV/m limit.

The band edge emission plot on the next page shows 50.82dBc between carrier maximum power and local maximum emission in restrict band. The emission of carrier strength list in the test result of channel 36 is 101.11dBuV/m (Average), so the maximum field strength in restrict band is  $101.11 - 50.82 = 50.29$ dBuV/m which is under 54dBuV/m limit.

##### Channel 48 (5240MHz)

The band edge emission plot on the next second page shows 55.95dBc between carrier maximum power and local maximum emission in restrict band. The emission of carrier strength list in the test result of channel 48 is 112.36dBuV/m (Peak), so the maximum field strength in restrict band is  $112.36 - 55.95 = 56.41$ dBuV/m which is under 74dBuV/m limit.

The band edge emission plot on the next third page shows 57.88dBc between carrier maximum power and local maximum emission in restrict band. The emission of carrier strength list in the test result of channel 48 is 102.25dBuV/m (Average), so the maximum field strength in restrict band is  $102.25 - 57.88 = 44.37$ dBuV/m which is under 54dBuV/m limit.

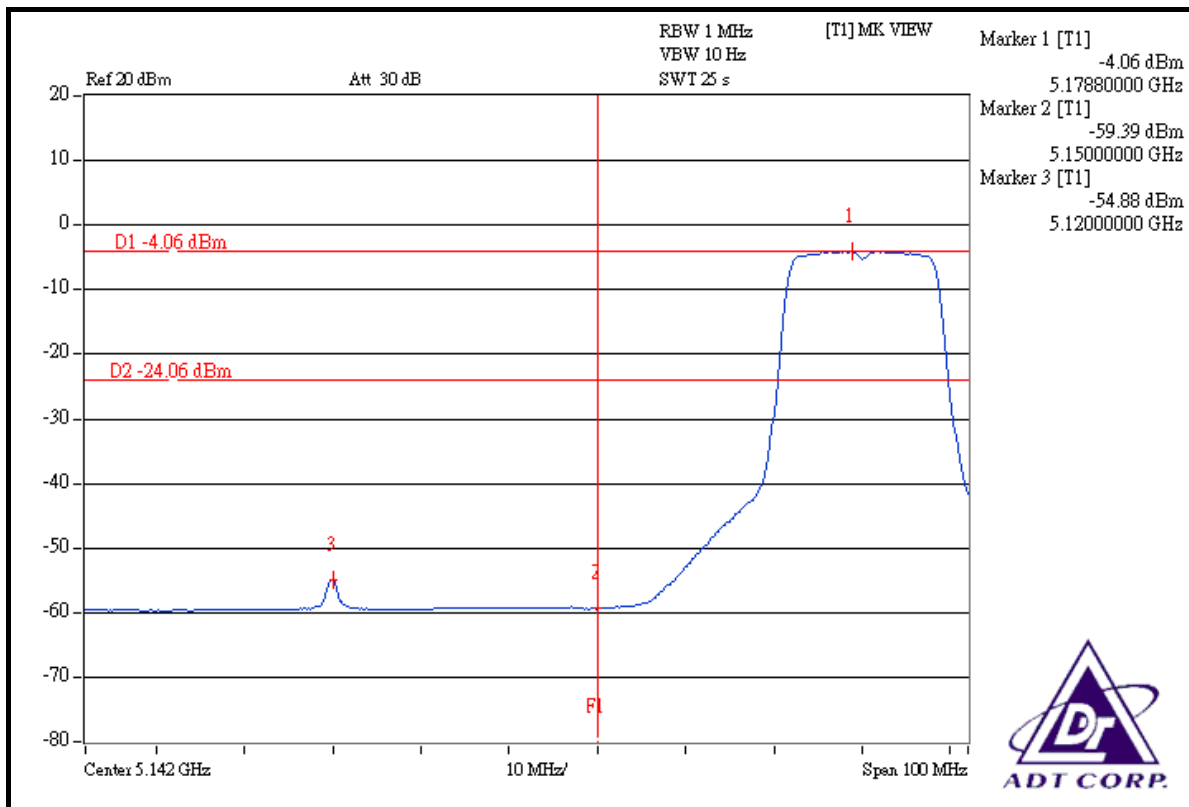
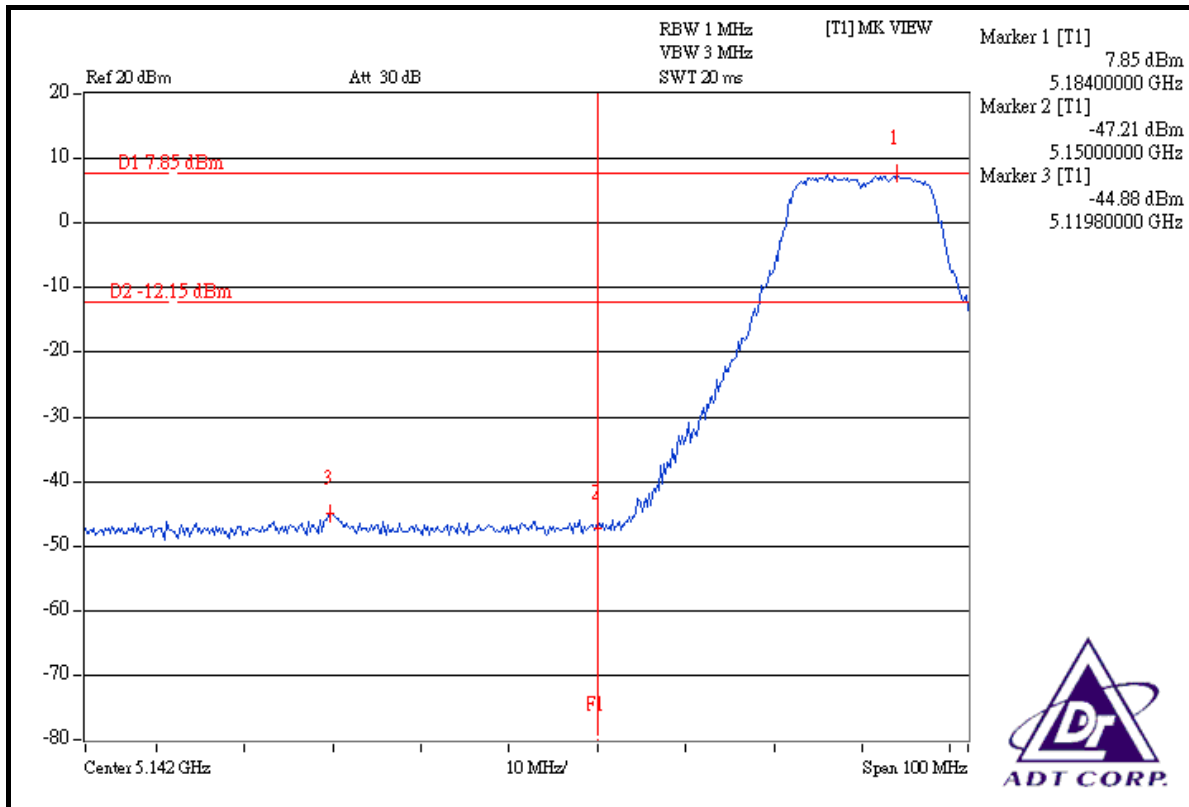



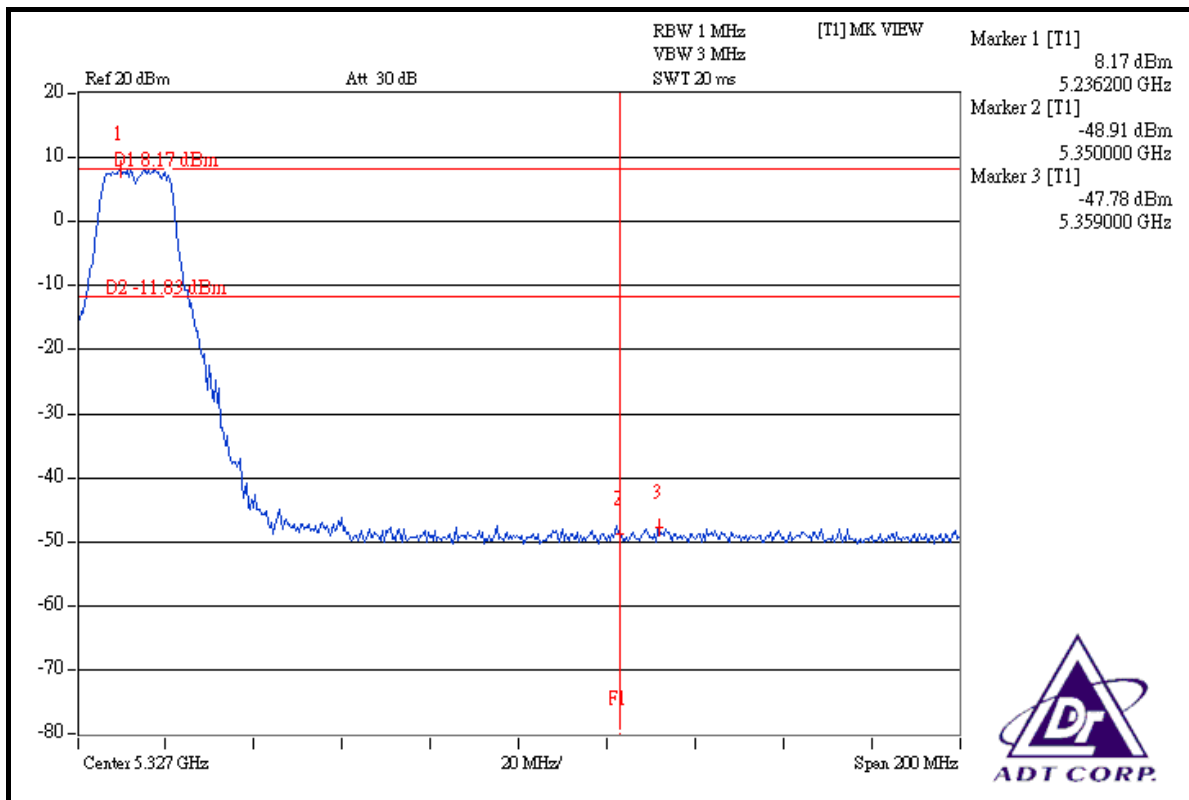
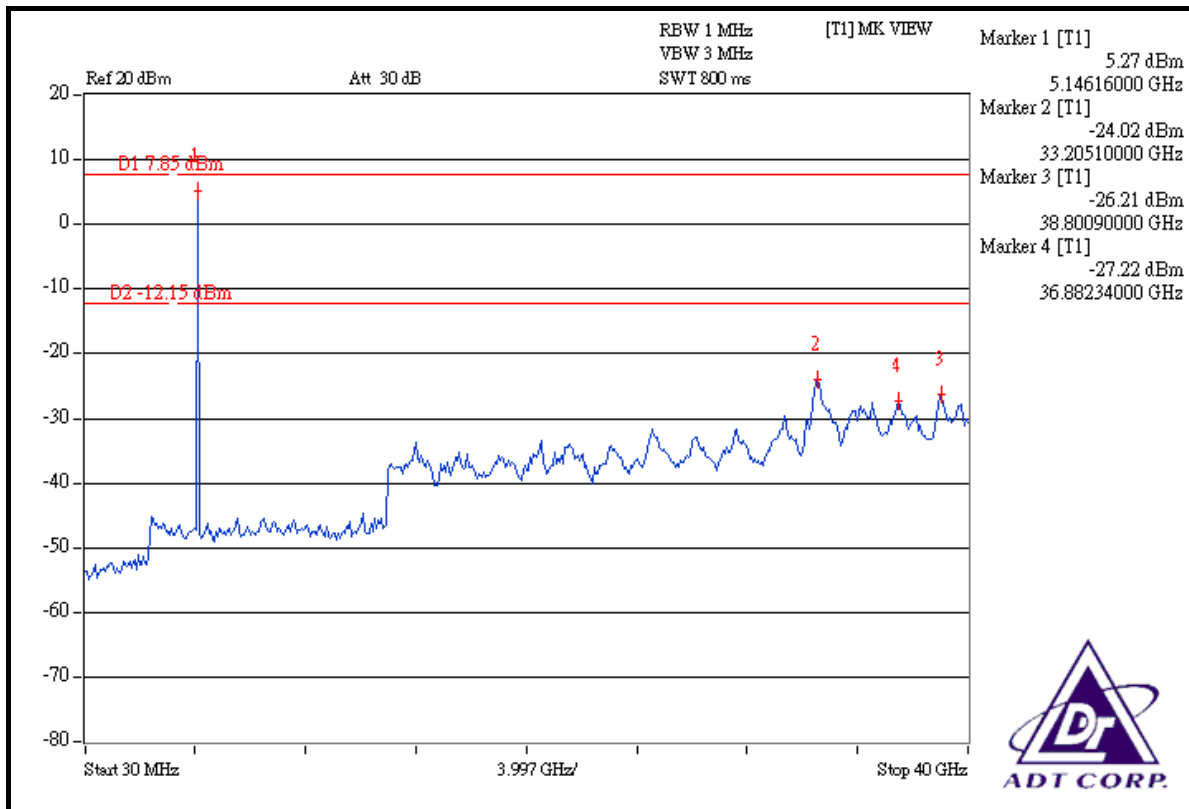

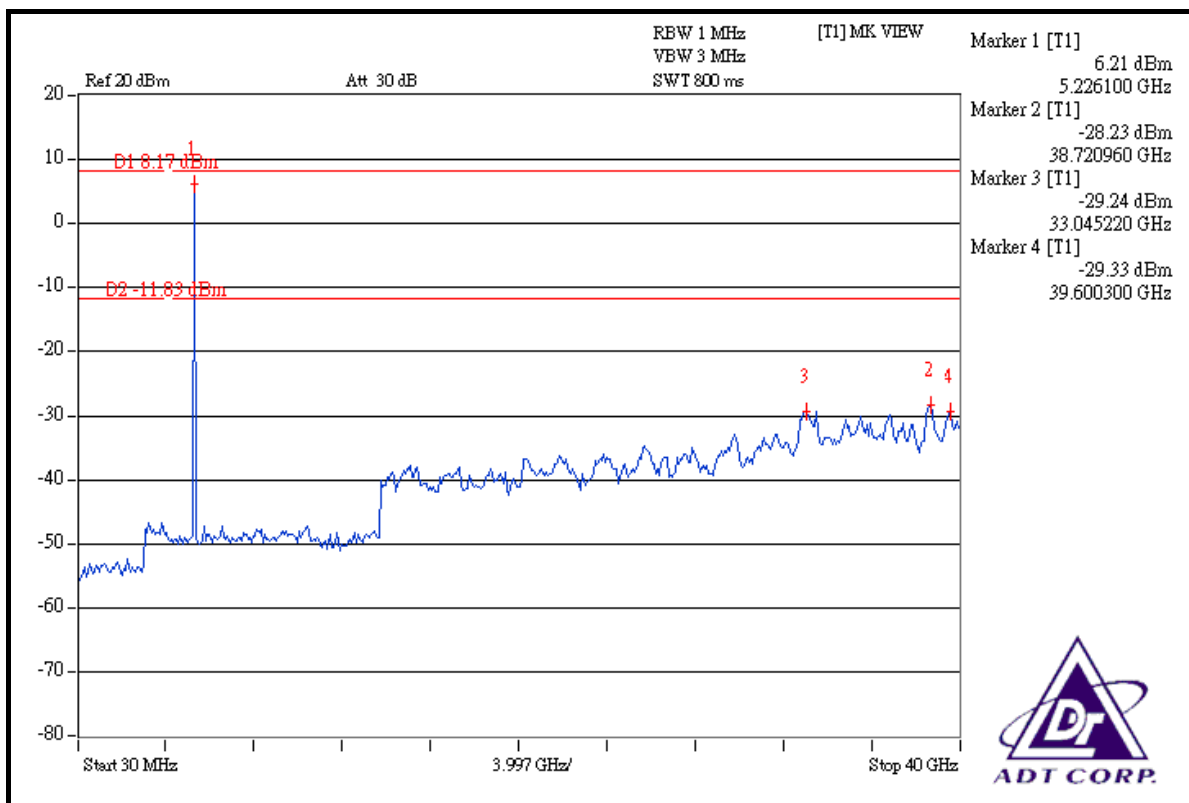
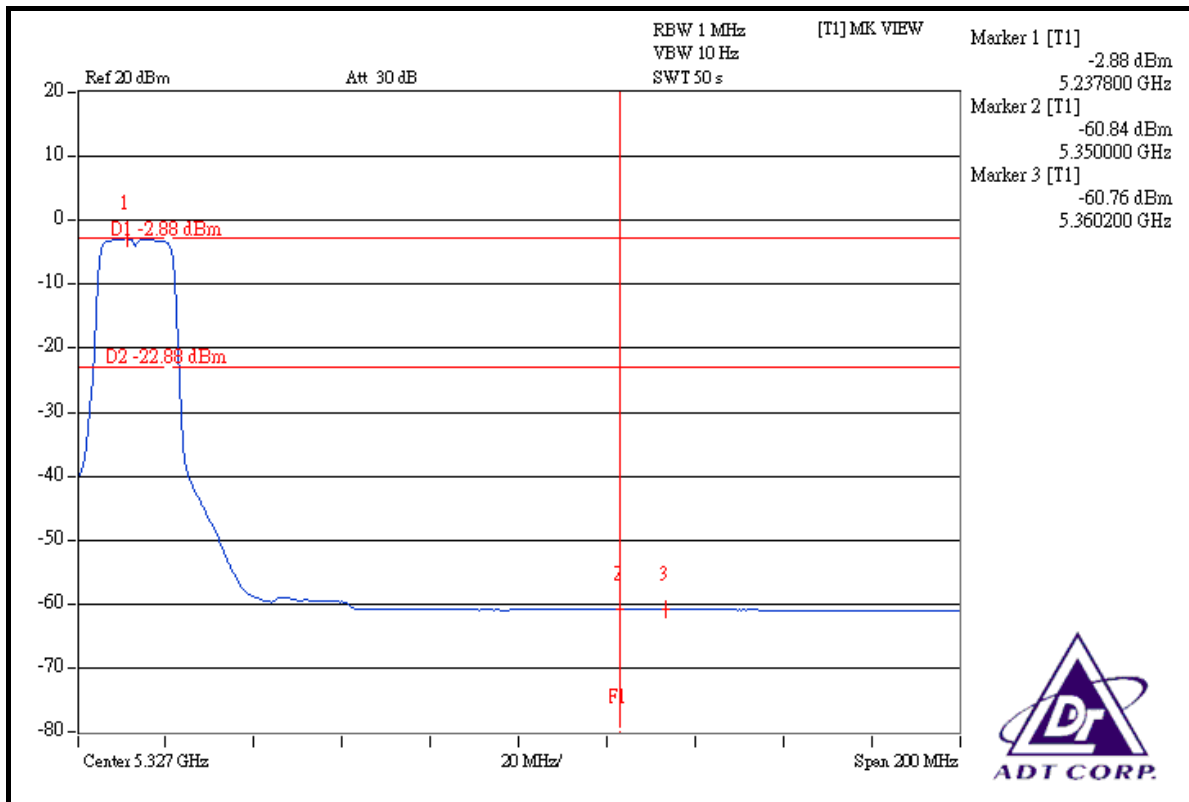



#### TEST MODE B:

##### Channel 36 (5180MHz)

The band edge emission plot on the next page shows 49.94dBc between carrier maximum power and local maximum emission in restrict band. The emission of carrier strength list in the test result of channel 36 is 116.63dBuV/m (Peak), so the maximum field strength in restrict band is  $116.63-49.94=66.69$ dBuV/m which is under 74dBuV/m limit.

The band edge emission plot on the next page shows 52.90dBc between carrier maximum power and local maximum emission in restrict band. The emission of carrier strength list in the test result of channel 36 is 105.87dBuV/m (Average), so the maximum field strength in restrict band is  $105.87-52.90=52.97$ dBuV/m which is under 54dBuV/m limit.

##### Channel 48 (5240MHz)

The band edge emission plot on the next second page shows 50.98dBc between carrier maximum power and local maximum emission in restrict band. The emission of carrier strength list in the test result of channel 48 is 116.51dBuV/m (Peak), so the maximum field strength in restrict band is  $116.51-50.98=65.53$ dBuV/m which is under 74dBuV/m limit.

The band edge emission plot on the next third page shows 53.61dBc between carrier maximum power and local maximum emission in restrict band. The emission of carrier strength list in the test result of channel 48 is 105.71dBuV/m (Average), so the maximum field strength in restrict band is  $105.71-53.61=52.10$ dBuV/m which is under 54dBuV/m limit.

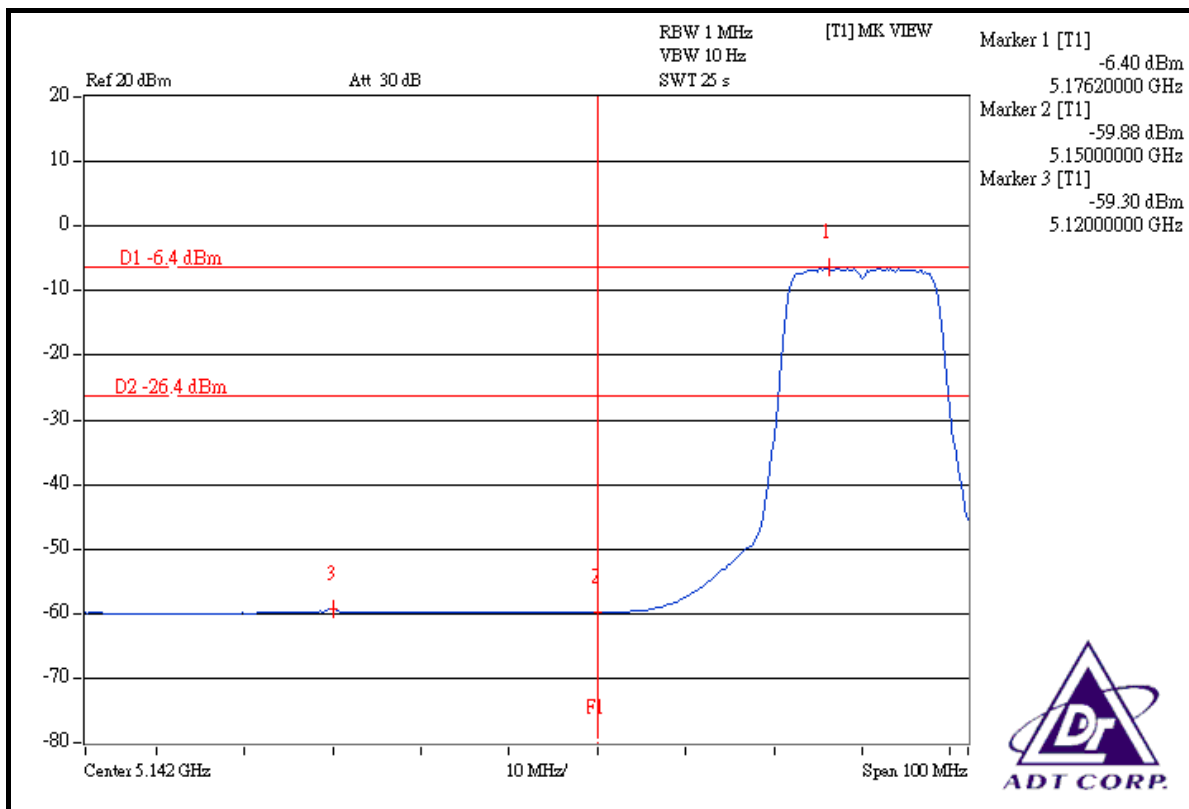
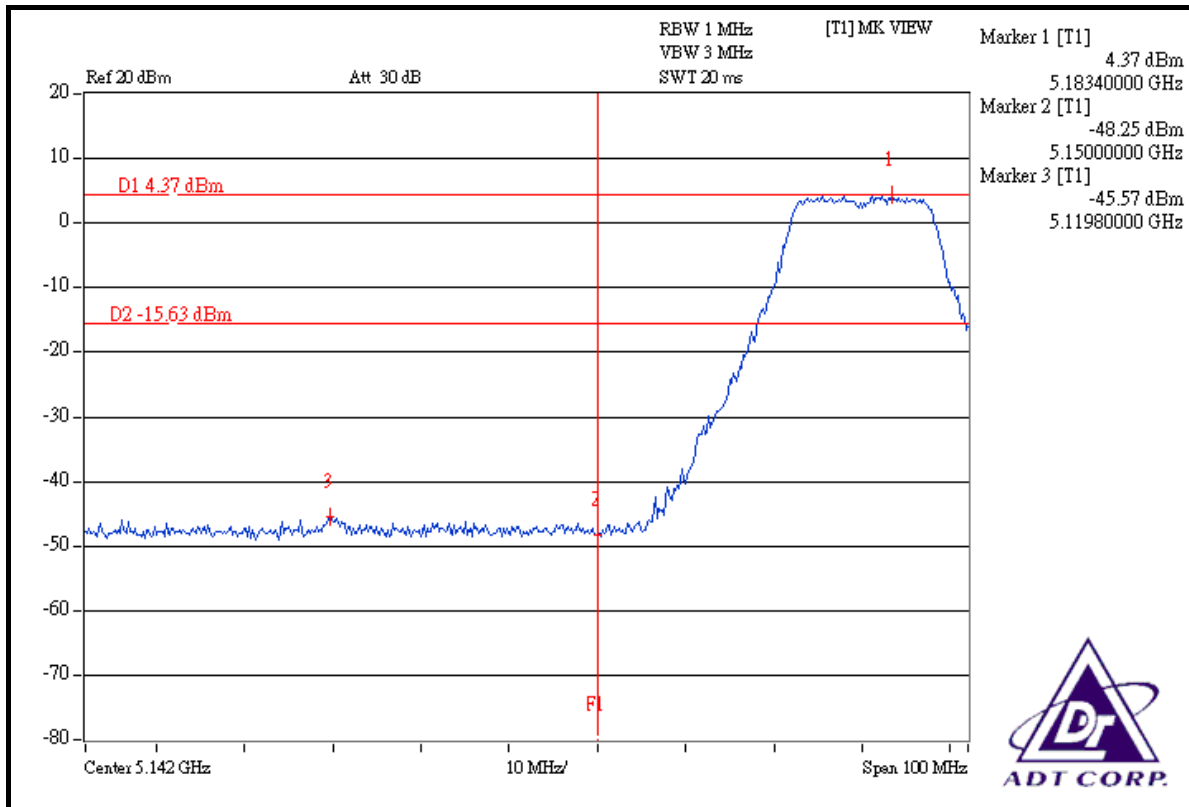

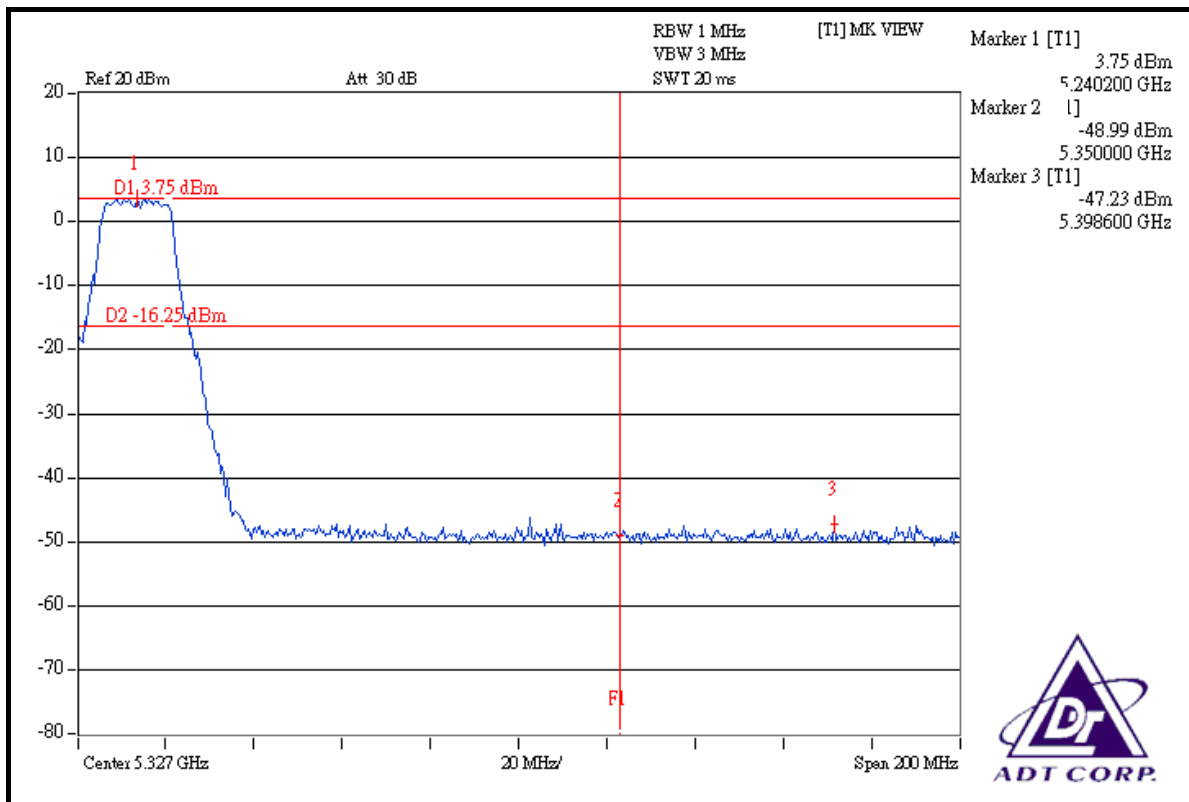
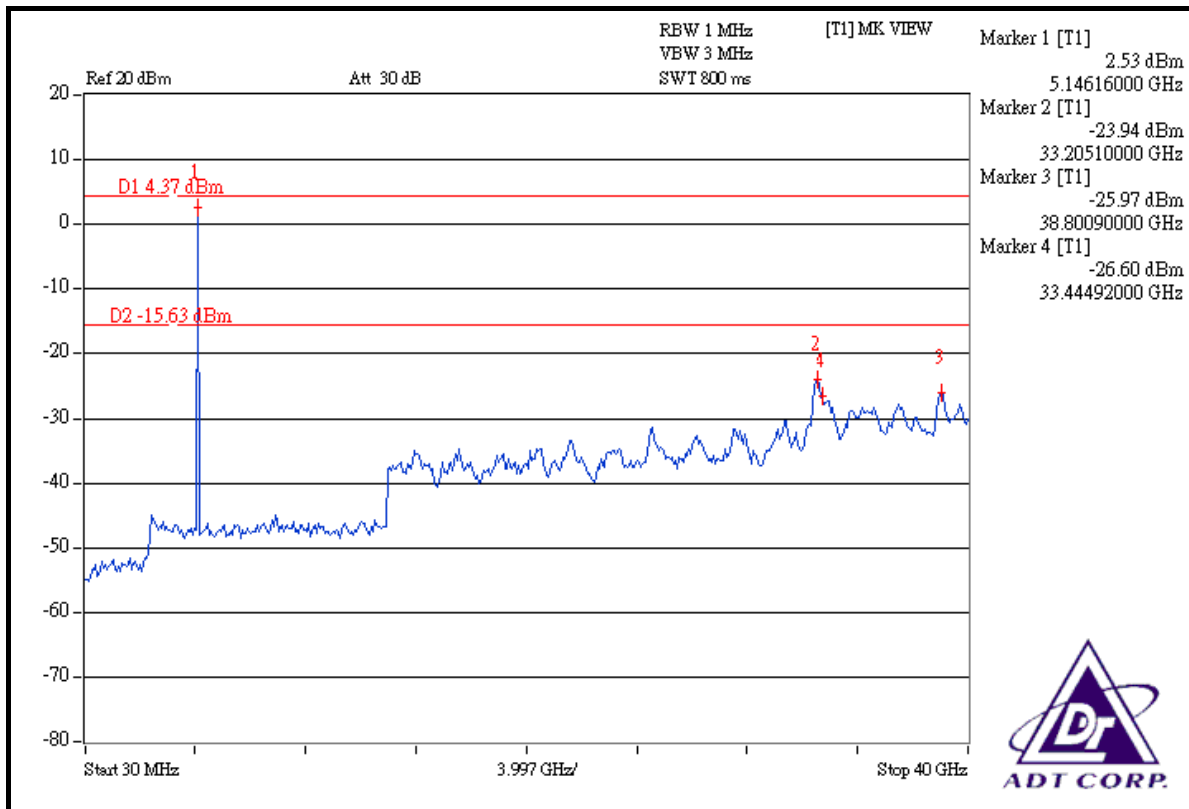

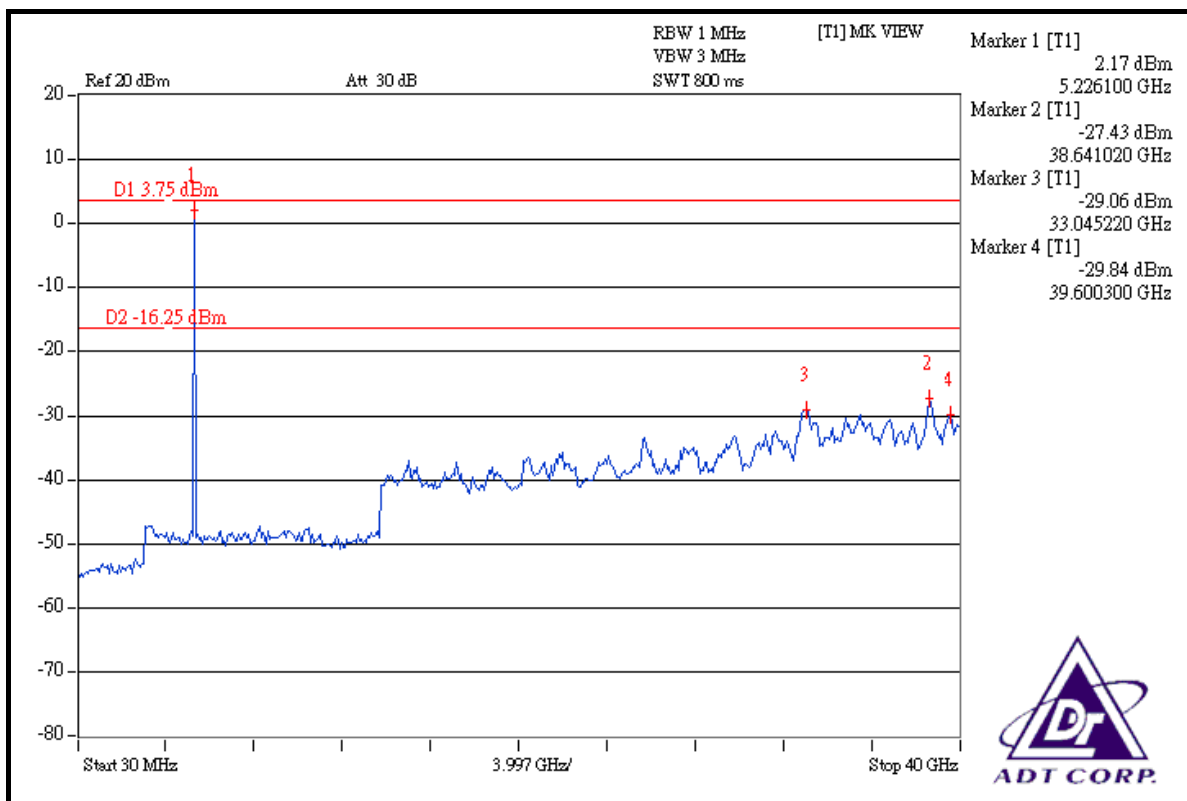
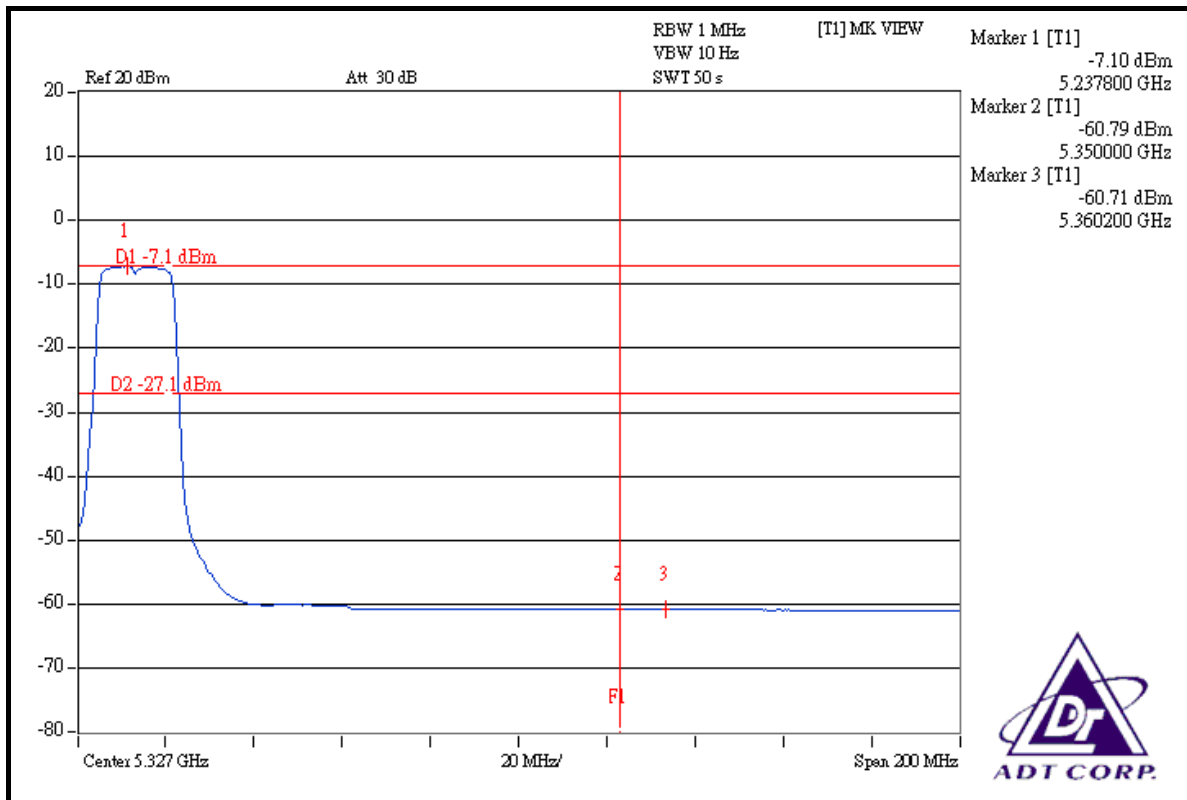



## **4.8 ANTENNA REQUIREMENT**

### **4.8.1 STANDARD APPLICABLE**

For intentional device, according to FCC 47 CFR Section 15.203, an intentional radiator shall be designed to ensure that no antenna other than that furnished by the responsible party shall be used with the device.

And according to FCC 47 CFR Section 15.407(a), if transmitting antennas of directional gain greater than 6dBi are used, the power shall be reduced by the amount in dB that the directional gain of the antenna exceeds 6dBi.

### **4.8.2 ANTENNA CONNECTED CONSTRUCTION**

The antennas used in this product are Dipole antenna with Reverse SMA connector and Patch antenna with UFL connector. The maximum Gain of the antenna is 14dBi.



## 5. PHOTOGRAPHS OF THE TEST CONFIGURATION

Please refer to the attached file (Test Setup Photo).





## 6. INFORMATION ON THE TESTING LABORATORIES

We, ADT Corp., were founded in 1988 to provide our best service in EMC, Radio, Telecom and Safety consultation. Our laboratories are accredited and approved by the following approval agencies according to ISO/IEC 17025.

<b>USA</b>	FCC, UL, A2LA
<b>Germany</b>	TUV Rheinland
<b>Japan</b>	VCCI
<b>Norway</b>	NEMKO
<b>Canada</b>	INDUSTRY CANADA , CSA
<b>R.O.C.</b>	CNLA, BSMI, NCC
<b>Netherlands</b>	Telefication
<b>Singapore</b>	PSB , GOST-ASIA(MOU)
<b>Russia</b>	CERTIS(MOU)

Copies of accreditation certificates of our laboratories obtained from approval agencies can be downloaded from our web site:

[www.adt.com.tw/index.5/phtml](http://www.adt.com.tw/index.5/phtml). If you have any comments, please feel free to contact us at the following:

**Linko EMC/RF Lab:**

Tel: 886-2-26052180  
Fax: 886-2-26051924

**Hsin Chu EMC/RF Lab:**

Tel: 886-3-5935343  
Fax: 886-3-5935342

**Hwa Ya EMC/RF/Safety Telecom Lab:**

Tel: 886-3-3183232  
Fax: 886-3-3185050

**Linko RF Lab.**

Tel: 886-3-3270910  
Fax: 886-3-3270892

**Web Site:** [www.adt.com.tw](http://www.adt.com.tw)

The address and road map of all our labs can be found in our web site also.

## **7. APPENDIX A - MODIFICATIONS RECORDERS FOR ENGINEERING CHANGES TO THE EUT BY THE LAB**

No any modifications are made to the EUT by the lab during the test.