

FCC TEST REPORT (15.247)

REPORT NO.: RF960129L09A
MODEL NO.: NOC-8610 EXT
(refer to item 3.1 for more details)
RECEIVED: Apr. 16, 2007
TESTED: May 24 ~ May 27, 2008
ISSUED: May 28, 2008

APPLICANT: SENA0 Networks CO., LTD.

ADDRESS: 3F, No. 529, Chung Cheng Rd., Hsintien, Taipei,
Taiwan, R.O.C.

ISSUED BY: Advance Data Technology Corporation

LAB ADDRESS: No. 47, 14th Ling, Chia Pau Tsuen, Lin Kou
Hsiang 244, Taipei Hsien, Taiwan, R.O.C.

TEST LOCATION: No. 19, Hwa Ya 2nd Rd., Wen Hwa Tsuen, Kwei
Shan Hsiang, Taoyuan Hsien 333, Taiwan,
R.O.C.

This test report consists of 103 pages in total. It may be duplicated completely for legal use with the approval of the applicant. It should not be reproduced except in full, without the written approval of our laboratory. The client should not use it to claim product endorsement by TAF, A2LA or any government agencies. The test results in the report only apply to the tested sample.



Testing Laboratory
0528

ACCREDITED
TESTING CERT # 2177-01

Table of Contents

1.	CERTIFICATION.....	5
2.	SUMMARY OF TEST RESULTS	6
2.1	MEASUREMENT UNCERTAINTY	6
3.	GENERAL INFORMATION.....	7
3.1	GENERAL DESCRIPTION OF EUT	7
3.2	DESCRIPTION OF TEST MODES	9
3.2.1	CONFIGURATION OF SYSTEM UNDER TEST	9
3.2.2	TEST MODE APPLICABILITY AND TESTED CHANNEL DETAIL	10
3.3	GENERAL DESCRIPTION OF APPLIED STANDARDS	14
3.4	DESCRIPTION OF SUPPORT UNITS	14
4.	TEST TYPES AND RESULTS (FOR 802.11b & g 2412~2462MHz BAND).....	15
4.1	RADIATED EMISSION MEASUREMENT	15
4.1.1	LIMITS OF RADIATED EMISSION MEASUREMENT	15
4.1.2	TEST INSTRUMENTS.....	16
4.1.3	TEST PROCEDURES	17
4.1.4	DEVIATION FROM TEST STANDARD.....	17
4.1.5	TEST SETUP.....	18
4.1.6	EUT OPERATING CONDITIONS	18
4.1.7	TEST RESULTS	19
4.2	CONDUCTED EMISSION MEASUREMENT	26
4.2.1	LIMITS OF CONDUCTED EMISSION MEASUREMENT	26
4.2.2	TEST INSTRUMENTS.....	26
4.2.3	TEST PROCEDURES	27
4.2.4	DEVIATION FROM TEST STANDARD.....	27
4.2.5	TEST SETUP.....	28
4.2.6	EUT OPERATING CONDITIONS	28
4.2.7	TEST RESULTS	29
4.3	6dB BANDWIDTH MEASUREMENT.....	35
4.3.1	LIMITS OF 6dB BANDWIDTH MEASUREMENT	35
4.3.2	TEST INSTRUMENTS.....	35
4.3.3	TEST PROCEDURE.....	36
4.3.4	DEVIATION FROM TEST STANDARD.....	36
4.3.5	TEST SETUP.....	36
4.3.6	EUT OPERATING CONDITIONS	36
4.3.7	TEST RESULTS	37
4.4	MAXIMUM PEAK OUTPUT POWER.....	41
4.4.1	LIMITS OF MAXIMUM PEAK OUTPUT POWER MEASUREMENT	41
4.4.2	INSTRUMENTS.....	41
4.4.1	TEST PROCEDURES	42
4.4.2	DEVIATION FROM TEST STANDARD.....	42
4.4.3	TEST SETUP.....	42
4.4.4	EUT OPERATING CONDITIONS	42
4.4.3	TEST RESULTS	43
4.5	POWER SPECTRAL DENSITY MEASUREMENT	44
4.5.1	LIMITS OF POWER SPECTRAL DENSITY MEASUREMENT	44
4.5.2	TEST INSTRUMENTS.....	44



4.5.3	TEST PROCEDURE.....	45
4.5.4	DEVIATION FROM TEST STANDARD.....	45
4.5.5	TEST SETUP.....	45
4.5.6	EUT OPERATING CONDITION.....	45
4.5.7	TEST RESULTS	46
4.6	BAND EDGES MEASUREMENT	50
4.6.1	LIMITS OF BAND EDGES MEASUREMENT.....	50
4.6.2	TEST INSTRUMENTS.....	50
4.6.3	TEST PROCEDURE.....	50
4.6.4	DEVIATION FROM TEST STANDARD.....	50
4.6.5	EUT OPERATING CONDITION.....	50
4.6.6	TEST RESULTS	51
4.7	ANTENNA REQUIREMENT	59
4.7.1	STANDARD APPLICABLE	59
4.7.2	ANTENNA CONNECTED CONSTRUCTION	59
5.	TEST TYPES AND RESULTS (FOR 802.11a 5745~5825MHz Band).....	60
5.1	RADIATED EMISSION MEASUREMENT	60
5.1.1	LIMITS OF RADIATED EMISSION MEASUREMENT.....	60
5.1.2	TEST INSTRUMENTS.....	61
5.1.3	TEST PROCEDURES	62
5.1.4	DEVIATION FROM TEST STANDARD.....	62
5.1.5	TEST SETUP.....	63
5.1.6	EUT OPERATING CONDITIONS	63
5.1.7	TEST RESULTS	64
5.2	CONDUCTED EMISSION MEASUREMENT	72
5.2.1	LIMITS OF CONDUCTED EMISSION MEASUREMENT.....	72
5.2.2	TEST INSTRUMENTS.....	72
5.2.3	TEST PROCEDURES	73
5.2.4	DEVIATION FROM TEST STANDARD.....	73
5.2.5	TEST SETUP.....	74
5.2.6	EUT OPERATING CONDITIONS	74
5.2.7	TEST RESULTS	75
5.3	6dB BANDWIDTH MEASUREMENT.....	77
5.3.1	LIMITS OF 6dB BANDWIDTH MEASUREMENT	77
5.3.2	TEST INSTRUMENTS.....	77
5.3.3	TEST PROCEDURE.....	78
5.3.4	DEVIATION FROM TEST STANDARD.....	78
5.3.5	TEST SETUP.....	78
5.3.6	EUT OPERATING CONDITIONS	78
5.3.7	TEST RESULTS	79
5.4	MAXIMUM PEAK OUTPUT POWER.....	83
5.4.1	LIMITS OF MAXIMUM PEAK OUTPUT POWER MEASUREMENT	83
5.4.2	INSTRUMENTS.....	83
5.4.3	TEST PROCEDURES	84
5.4.4	DEVIATION FROM TEST STANDARD.....	84
5.4.5	TEST SETUP.....	84
5.4.6	EUT OPERATING CONDITIONS	84
5.4.7	TEST RESULTS	85
5.5	POWER SPECTRAL DENSITY MEASUREMENT.....	86
5.5.1	LIMITS OF POWER SPECTRAL DENSITY MEASUREMENT	86
5.5.2	TEST INSTRUMENTS.....	86



5.5.3	TEST PROCEDURE.....	87
5.5.4	DEVIATION FROM TEST STANDARD.....	87
5.5.5	TEST SETUP.....	87
5.5.6	EUT OPERATING CONDITION.....	87
5.5.7	TEST RESULTS	88
5.6	BAND EDGES MEASUREMENT	92
5.6.1	LIMITS OF BAND EDGES MEASUREMENT.....	92
5.6.2	TEST INSTRUMENTS.....	92
5.6.3	TEST PROCEDURE.....	92
5.6.4	DEVIATION FROM TEST STANDARD.....	92
5.6.5	EUT OPERATING CONDITION.....	93
5.6.6	TEST RESULTS	93
5.7	ANTENNA REQUIREMENT	100
5.7.1	STANDARD APPLICABLE	100
5.7.2	ANTENNA CONNECTED CONSTRUCTION	100
6.	PHOTOGRAPHS OF THE TEST CONFIGURATION.....	101
7.	INFORMATION ON THE TESTING LABORATORIES	102
8.	APPENDIX A - MODIFICATIONS RECORDERS FOR ENGINEERING CHANGES TO THE EUT BY THE LAB.....	103



1. CERTIFICATION

PRODUCT: Wireless-A/G
MODEL: NOC-8610 EXT (refer to item 3.1 for more details)
BRAND: Senao (refer to item 3.1 for more details)
APPLICANT: SENA0 Networks CO., LTD.
TEST SAMPLE: ENGINEERING SAMPLE
TESTED: May 24 ~ May 27, 2008
STANDARDS: **FCC Part 15, Subpart C (Section 15.247),**
ANSI C63.4-2003

The above equipment (Model: NOC-8610 EXT, NOC-8610 PLUS) has been tested by **Advance Data Technology Corporation**, and found compliance with the requirement of the above standards. The test record, data evaluation & Equipment Under Test (EUT) configurations represented herein are true and accurate accounts of the measurements of the sample's EMC characteristics under the conditions specified in this report.

PREPARED BY : Andrea Hsia , **DATE:** May 28, 2008
Andrea Hsia / Specialist

TECHNICAL ACCEPTANCE : Long Chen , **DATE:** May 28, 2008
Responsible for RF Long Chen / Senior Engineer

APPROVED BY : Gary Chang , **DATE:** May 28, 2008
Gary Chang / Supervisor

2. SUMMARY OF TEST RESULTS

The EUT has been tested according to the following specifications:

APPLIED STANDARD: FCC Part 15, Subpart C (Section 15.247)			
Standard Section	Test Type and Limit	Result	Remark
15.207	AC Power Conducted Emission	PASS	Meet the requirement of limit. Minimum passing margin is -11.52dB at 19.707MHz
15.247(a)(2)	Spectrum Bandwidth of a Direct Sequence Spread Spectrum System Limit: min. 500kHz	PASS	Meet the requirement of limit.
15.247(b)	Maximum Peak Output Power Limit: max. 30dBm	PASS	Meet the requirement of limit.
15.247(d)	Radiated Emissions Limit: Table 15.209	PASS	Meet the requirement of limit. Minimum passing margin is -1.05dB at 4874.00MHz
15.247(e)	Power Spectral Density Limit: max. 8dBm	PASS	Meet the requirement of limit.
15.247(d)	Band Edge Measurement Limit: 20dB less than the peak value of fundamental frequency	PASS	Meet the requirement of limit.

2.1 MEASUREMENT UNCERTAINTY

Where relevant, the following measurement uncertainty levels have been estimated for tests performed on the EUT as specified in CISPR 16-4-2:

MEASUREMENT	FREQUENCY	UNCERTAINTY
Conducted emissions	9kHz~30MHz	2.44 dB
Radiated emissions	30MHz ~ 200MHz	3.34 dB
	200MHz ~1000MHz	3.35 dB
	1GHz ~ 18GHz	2.26 dB
	18GHz ~ 40GHz	1.94 dB

This uncertainty represents an expanded uncertainty expressed at approximately the 95% confidence level using a coverage factor of k=2.

3. GENERAL INFORMATION

3.1 GENERAL DESCRIPTION OF EUT

EUT	Wireless-A/G
MODEL NO.	NOC-8610 EXT (refer to note as below)
FCC ID	U2M-OC86107001
POWER SUPPLY	48Vdc from Adapter
MODULATION TYPE	CCK, DQPSK, DBPSK for DSSS 64QAM, 16QAM, QPSK, BPSK for OFDM
MODULATION TECHNOLOGY	DSSS, OFDM
TRANSFER RATE	802.11b: 11/5.5/2/1Mbps 802.11g: 54/48/36/24/18/12/9/6Mbps 802.11a: 54/48/36/24/18/12/9/6Mbps
FREQUENCY RANGE	802.11b & 802.11g: 2.400 ~ 2.483.5GHz 802.11a: 5.150 ~ 5.250GHz, 5.725 ~ 5.850GHz
NUMBER OF CHANNEL	802.11b & 802.11g: 11 802.11a: 5.150 ~ 5.250GHz: 4 5.725 ~ 5.850GHz: 5
CHANNEL SPACING	802.11b & 802.11g: 5MHz 802.11a: 20MHz
OUTPUT POWER	56.885mW for 802.11b 184.077mW for 802.11g 16.255mW for 5.150 ~ 5.250GHz 26.002mW for 5.725 ~ 5.850GHz
ANTENNA TYPE	Dipole antenna with 4dBi gain for 2.4GHz & 5GHz Patch antenna with 14dBi gain for 5GHz
DATA CABLE	NA
I/O PORTS	RJ45
ACCESSORY DEVICES	Adapter, POE

NOTE:

- The details of model no. listed as below:

Brand	Model	REMARK
Senao	NOC-8610 EXT	Dipole antenna
Senao	NOC-8610 PLUS	Patch antenna
EnGenius	EOC-8610 EXT	Dipole antenna
EnGenius	EOC-8610 PLUS	Patch antenna
Senao	SOC-8610 EXT	Dipole antenna
Senao	SOC-8610 PLUS	Patch antenna

2. The EUT were operated with following adapter and POE.

ADAPTER	
BRAND:	MW
MODEL:	ES18U48-480
INPUT:	100-240Vac, 50-60Hz, 0.5A
OUTPUT:	48Vdc, 0.375A, 18W Max.
POWER LINE:	1.8m non-shielded cable with one core

POE	
MODEL:	NPE-4818
OUTPUT:	48Vdc, 0.375A

NOTE: The EUT was power from adapter via POE. The POE & adapter were not work alone.

3. The EUT operates in both the 5GHz and 2.4GHz Bands and compatibility with 802.11a and 802.11b, 802.11g technology.
4. The above EUT information was declared by the manufacturer and for more detailed features description, please refer to the manufacturer's specifications or User's Manual.

3.2 DESCRIPTION OF TEST MODES

Operated in 2400 ~ 2483.5MHz band:

11 channels are provided to the EUT

CHANNEL	FREQUENCY	CHANNEL	FREQUENCY
1	2412 MHz	7	2442 MHz
2	2417 MHz	8	2447 MHz
3	2422 MHz	9	2452 MHz
4	2427 MHz	10	2457 MHz
5	2432 MHz	11	2462 MHz
6	2437 MHz		

Operated in 5745 ~ 5825MHz band:

5 channels are provided to this EUT

CHANNEL	FREQUENCY	CHANNEL	FREQUENCY
149	5745MHz	161	5805MHz
153	5765MHz	165	5825MHz
157	5785MHz		

3.2.1 CONFIGURATION OF SYSTEM UNDER TEST

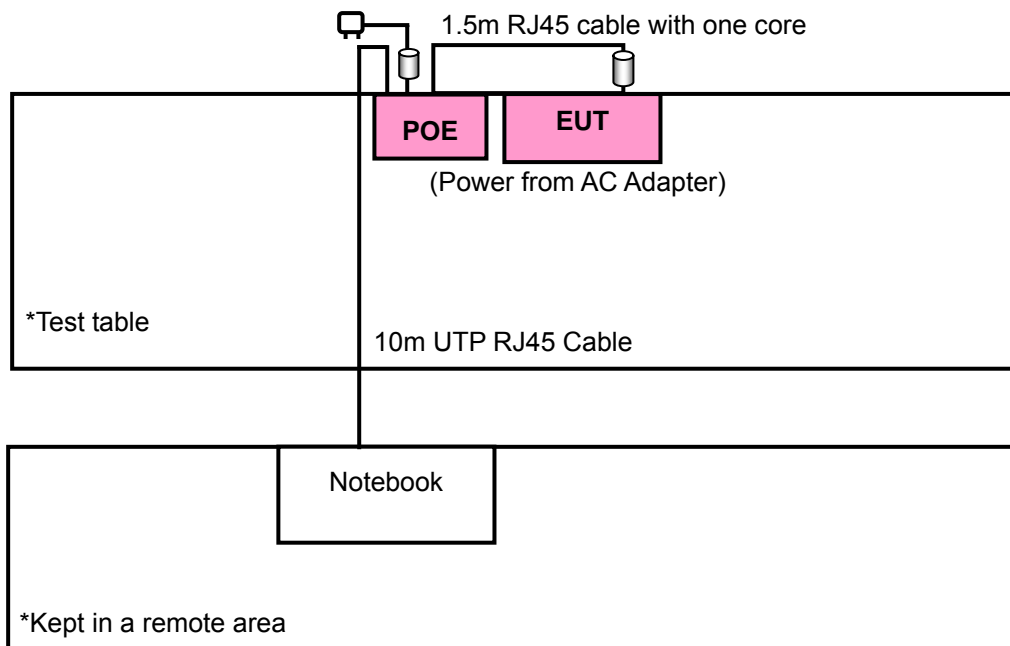

3.2.2 TEST MODE APPLICABILITY AND TESTED CHANNEL DETAIL

For 802.11b/g:

EUT configure mode	Applicable to				Description
	RE \geq 1G	RE<1G	PLC	APCM	
-	√	√	√	√	-

Where **PLC**: Power Line Conducted Emission
RE \geq 1G: Radiated Emission above 1GHz

RE<1G: Radiated Emission below 1GHz
APCM: Antenna Port Conducted Measurement

RADIATED EMISSION TEST (ABOVE 1 GHz):

- Pre-Scan has been conducted to determine the worst-case mode from all possible combinations between available modulations, data rates and antenna ports (if EUT with antenna diversity architecture).
- Following channel(s) was (were) selected for the final test as listed below.

MODE	AVAILABLE CHANNEL	TESTED CHANNEL	MODULATION TECHNOLOGY	MODULATION TYPE	DATA RATE (Mbps)	AXIS
802.11b	1 to 11	1, 6, 11	DSSS	DBPSK	1	Z
802.11g	1 to 11	1, 6, 11	OFDM	BPSK	6	Z

RADIATED EMISSION TEST (BELOW 1 GHz):

- Pre-Scan has been conducted to determine the worst-case mode from all possible combinations between available modulations, data rates, antenna ports (if EUT with antenna diversity architecture) and X, Y and Z Axis.
- Following channel(s) was (were) selected for the final test as listed below.

MODE	AVAILABLE CHANNEL	TESTED CHANNEL	MODULATION TECHNOLOGY	MODULATION TYPE	DATA RATE (Mbps)	AXIS
802.11g	1 to 11	11	OFDM	BPSK	6	Z

POWER LINE CONDUCTED EMISSION TEST:

- Pre-Scan has been conducted to determine the worst-case mode from all possible combinations between available modulations, data rates and antenna ports (if EUT with antenna diversity architecture).
- Following channel(s) was (were) selected for the final test as listed below.

MODE	AVAILABLE CHANNEL	TESTED CHANNEL	MODULATION TECHNOLOGY	MODULATION TYPE	DATA RATE (Mbps)
802.11g	1 to 11	1, 6, 11	OFDM	BPSK	6

BANDEDGE MEASUREMENT:

- Pre-Scan has been conducted to determine the worst-case mode from all possible combinations between available modulations, data rates and antenna ports (if EUT with antenna diversity architecture).
- Following channel(s) was (were) selected for the final test as listed below.

MODE	AVAILABLE CHANNEL	TESTED CHANNEL	MODULATION TECHNOLOGY	MODULATION TYPE	DATA RATE (Mbps)
802.11b	1 to 11	1, 11	DSSS	DBPSK	1
802.11g	1 to 11	1, 11	OFDM	BPSK	6

ANTENNA PORT CONDUCTED MEASUREMENT:

- Pre-Scan has been conducted to determine the worst-case mode from all possible combinations between available modulations, data rates and antenna ports (if EUT with antenna diversity architecture).
- Following channel(s) was (were) selected for the final test as listed below.

MODE	AVAILABLE CHANNEL	TESTED CHANNEL	MODULATION TECHNOLOGY	MODULATION TYPE	DATA RATE (Mbps)
802.11b	1 to 11	1, 6, 11	DSSS	DBPSK	1
802.11g	1 to 11	1, 6, 11	OFDM	BPSK	6

For 802.11a:

EUT configure mode	Applicable to				Description
	RE≥1G	RE<1G	PLC	APCM	
A	√	√	√	√	Dipole Antenna
B	√	√	-	√	Patch Antenna

Where **PLC**: Power Line Conducted Emission **RE<1G**: Radiated Emission below 1GHz
RE≥1G: Radiated Emission above 1GHz **APCM**: Antenna Port Conducted Measurement
NOTE: "-" means no effect.

RADIATED EMISSION TEST (ABOVE 1 GHz):

- Pre-Scan has been conducted to determine the worst-case mode from all possible combinations between available modulations, data rates, antenna ports (if EUT with antenna diversity architecture) and X, Y and Z Axis.
- Following channel(s) was (were) selected for the final test as listed below.

EUT CONFIGURE MODE	MODE	AVAILABLE CHANNEL	TESTED CHANNEL	MODULATION TECHNOLOGY	MODULATION TYPE	DATA RATE (Mbps)	AXIS
A	802.11a	149 to 165	149, 157, 165	OFDM	BPSK	6	Z
B	802.11a	149 to 165	149, 157, 165	OFDM	BPSK	6	Z

RADIATED EMISSION TEST (BELOW 1 GHz):

- Pre-Scan has been conducted to determine the worst-case mode from all possible combinations between available modulations, data rates, antenna ports (if EUT with antenna diversity architecture) and X, Y and Z Axis.
- Following channel(s) was (were) selected for the final test as listed below.

EUT CONFIGURE MODE	MODE	AVAILABLE CHANNEL	TESTED CHANNEL	MODULATION TECHNOLOGY	MODULATION TYPE	DATA RATE (Mbps)	AXIS
A	802.11a	149 to 165	165	OFDM	BPSK	6	Z
B	802.11a	149 to 165	165	OFDM	BPSK	6	Z

POWER LINE CONDUCTED EMISSION TEST:

- Pre-Scan has been conducted to determine the worst-case mode from all possible combinations between available modulations, data rates and antenna ports (if EUT with antenna diversity architecture).
- Following channel(s) was (were) selected for the final test as listed below.

EUT CONFIGURE MODE	MODE	AVAILABLE CHANNEL	TESTED CHANNEL	MODULATION TECHNOLOGY	MODULATION TYPE	DATA RATE (Mbps)
A	802.11a	149 to 165	165	OFDM	BPSK	6

BANDEDGE MEASUREMENT:

- Pre-Scan has been conducted to determine the worst-case mode from all possible combinations between available modulations, data rates and antenna ports (if EUT with antenna diversity architecture).
- Following channel(s) was (were) selected for the final test as listed below.

EUT CONFIGURE MODE	MODE	AVAILABLE CHANNEL	TESTED CHANNEL	MODULATION TECHNOLOGY	MODULATION TYPE	DATA RATE (Mbps)
A	802.11a	149 to 165	149, 165	OFDM	BPSK	6
B	802.11a	149 to 165	149, 165	OFDM	BPSK	6

ANTENNA PORT CONDUCTED MEASUREMENT:

- Pre-Scan has been conducted to determine the worst-case mode from all possible combinations between available modulations, data rates and antenna ports (if EUT with antenna diversity architecture).
- Following channel(s) was (were) selected for the final test as listed below.

EUT CONFIGURE MODE	MODE	AVAILABLE CHANNEL	TESTED CHANNEL	MODULATION TECHNOLOGY	MODULATION TYPE	DATA RATE (Mbps)
A	802.11a	149 to 165	149, 157, 165	OFDM	BPSK	6
B	802.11a	149 to 165	149, 157, 165	OFDM	BPSK	6



3.3 GENERAL DESCRIPTION OF APPLIED STANDARDS

The EUT is a RF Product. According to the specifications of the manufacturer, it must comply with the requirements of the following standards:

FCC Part 15, Subpart C. (15.247)

ANSI C63.4-2003

All test items have been performed and recorded as per the above standards.

NOTE: The EUT is also considered as a kind of computer peripheral, because the connection to computer is necessary for typical use. It has been verified to comply with the requirements of FCC Part 15, Subpart B, Class B (DoC). The test report has been issued separately.

3.4 DESCRIPTION OF SUPPORT UNITS

The EUT has been tested as an independent unit together with other necessary accessories or support units. The following support units or accessories were used to form a representative test configuration during the tests.

NO.	PRODUCT	BRAND	MODEL NO.	SERIAL NO.	FCC ID
1	NOTEBOOK COMPUTER	DELL	PP05L	12130898320	E2K24CLNS

NO.	SIGNAL CABLE DESCRIPTION OF THE ABOVE SUPPORT UNITS
1	1.5m RJ45 non-shielded cable with one core

NOTE: All power cords of the above support units are non shielded (1.8m).

4. TEST TYPES AND RESULTS (FOR 802.11b & g 2412~2462MHz BAND)

4.1 RADIATED EMISSION MEASUREMENT

4.1.1 LIMITS OF RADIATED EMISSION MEASUREMENT

Emissions radiated outside of the specified bands, shall be according to the general radiated limits in 15.209 as following:

Frequencies (MHz)	Field strength (microvolts/meter)	Measurement distance (meters)
0.009-0.490	2400/F(kHz)	300
0.490-1.705	24000/F(kHz)	30
1.705-30.0	30	30
30-88	100	3
88-216	150	3
216-960	200	3
Above 960	500	3

NOTE:

1. The lower limit shall apply at the transition frequencies.
2. Emission level (dBuV/m) = 20 log Emission level (uV/m).
3. As shown in 15.35(b), for frequencies above 1000MHz, the field strength limits are based on average detector, however, the peak field strength of any emission shall not exceed the maximum permitted average limits, specified above by more than 20dB under any condition of modulation.



4.1.2 TEST INSTRUMENTS

DESCRIPTION & MANUFACTURER	MODEL NO.	SERIAL NO.	CALIBRATED UNTIL
Test Receiver ROHDE & SCHWARZ	ESCI	100424	Jul. 27, 2008
Spectrum Analyzer Agilent	E4446A	MY44360128	Dec. 06, 2008
BILOG Antenna SCHWARZBECK	VULB9168	9168-160	May 31, 2008
HORN Antenna SCHWARZBECK	9120D	9120D-209	Jun. 28, 2008
HORN Antenna SCHWARZBECK	BBHA 9170	BBHA9170243	Dec. 24, 2008
Preamplifier Agilent	8447D	2944A10633	Oct. 28, 2008
Preamplifier Agilent	8449B	3008A01964	Oct. 23, 2008
RF signal cable HUBER+SUHNNER	SUCOFLEX 104	283402/4	Dec. 06, 2008
RF signal cable HUBER+SUHNNER	SUCOFLEX 104	251644/4	Dec. 06, 2008
Software ADT.	ADT_Radiated_V7.6	NA	NA
Antenna Tower inn-co GmbH	MA 4000	013303	NA
Antenna Tower Controller inn-co GmbH	CO2000	017303	NA
Turn Table ADT.	TT100.	TT93021703	NA
Turn Table Controller ADT.	SC100.	SC93021703	NA

- NOTE:**
1. The calibration interval of the above test instruments is 12 months and the calibrations are traceable to NML/ROC and NIST/USA.
 2. The test was performed in HwaYa Chamber 3.
 3. The horn antenna and HP preamplifier (model: 8449B) are used only for the measurement of emission frequency above 1GHz if tested.
 4. The FCC Site Registration No. is 988962.
 5. The IC Site Registration No. is IC3789B-3.

4.1.3 TEST PROCEDURES

- a. The EUT was placed on the top of a rotating table 0.8 meters above the ground at a 3 meters semi-anechoic chamber. The table was rotated 360 degrees to determine the position of the highest radiation.
- b. The EUT was set 3 meters away from the interference-receiving antenna, which was mounted on the top of a variable-height antenna tower.
- c. The antenna is a broadband antenna, and its height is varied from one meter to four meters above the ground to determine the maximum value of the field strength. Both horizontal and vertical polarizations of the antenna are set to make the measurement.
- d. For each suspected emission, the EUT was arranged to its worst case and then the antenna was tuned to heights from 1 meter to 4 meters and the rotatable table was turned from 0 degrees to 360 degrees to find the maximum reading.
- e. The test-receiver system was set to Peak Detect Function and Specified Bandwidth with Maximum Hold Mode.
- f. If the emission level of the EUT in peak mode was lower than the limit specified, then testing could be stopped and the peak values of the EUT would be reported. Otherwise the emissions would be re-tested one by one using peak, quasi-peak or average method as specified and then reported in a data sheet.

NOTE:

1. The resolution bandwidth and video bandwidth of test receiver/spectrum analyzer is 120kHz for Quasi-peak detection at frequency below 1GHz.
2. The resolution bandwidth of test receiver/spectrum analyzer is 1 MHz and video bandwidth is 3MHz for Peak detection at frequency above 1GHz.
3. The resolution bandwidth of test receiver/spectrum analyzer is 1 MHz and the video bandwidth is 10Hz for Average detection (AV) at frequency above 1GHz.
4. All modes of operation were investigated and the worst-case emissions are reported.

4.1.4 DEVIATION FROM TEST STANDARD

No deviation

4.1.5 TEST SETUP

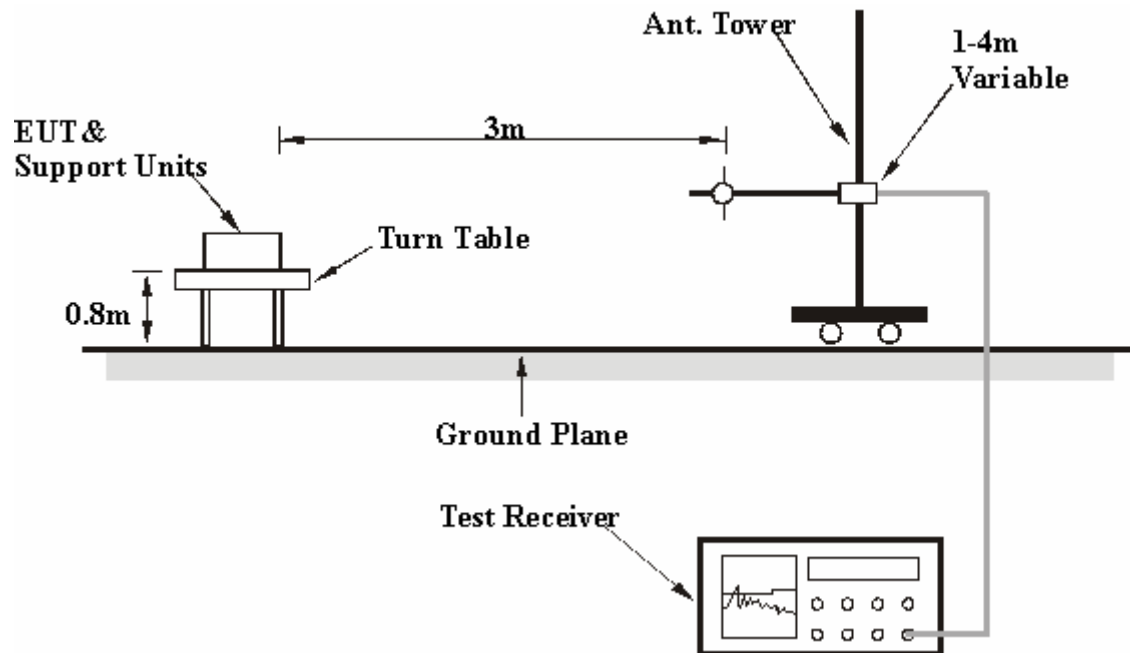

For the actual test configuration, please refer to the attached file (Test Setup Photo).

4.1.6 EUT OPERATING CONDITIONS

- Placed the EUT on a testing table.
- Prepared a notebook computer and placed it outside of testing area to act as communication partner for EUT.
- The EUT ran a test program (provided by manufacturer) to enable all functions under transmission condition continuously at specific channel frequency.
- The necessary accessories enable the EUT in full functions.

4.1.7 TEST RESULTS

802.11b DSSS modulation

EUT TEST CONDITION		MEASUREMENT DETAIL	
CHANNEL	Channel 1	FREQUENCY RANGE	1 ~ 25GHz
MODULATION TYPE	DBPSK	DETECTOR FUNCTION	Peak(PK) Average (AV)
TRANSFER RATE	1Mbps	ENVIRONMENTAL CONDITIONS	25deg. C, 68%RH, 991hPa
INPUT POWER (SYSTEM)	120Vac, 60 Hz	TESTED BY	Dean Wang

ANTENNA POLARITY & TEST DISTANCE: HORIZONTAL AT 3 M								
No.	Freq. (MHz)	Emission Level (dBuV/m)	Limit (dBuV/m)	Margin (dB)	Antenna Height (m)	Table Angle (Degree)	Raw Value (dBuV)	Correction Factor (dB/m)
1	2390.00	52.89 PK	74.00	-21.11	1.07 H	98	20.56	32.33
2	2390.00	48.27 AV	54.00	-5.73	1.07 H	98	15.94	32.33
3	*2412.00	99.33 PK			1.08 H	98	66.90	32.43
4	*2412.00	95.25 AV			1.08 H	98	62.82	32.43
5	4824.00	54.96 PK	74.00	-19.04	1.36 H	159	16.20	38.76
6	4824.00	49.35 AV	54.00	-4.65	1.36 H	159	10.59	38.76
ANTENNA POLARITY & TEST DISTANCE: VERTICAL AT 3 M								
No.	Freq. (MHz)	Emission Level (dBuV/m)	Limit (dBuV/m)	Margin (dB)	Antenna Height (m)	Table Angle (Degree)	Raw Value (dBuV)	Correction Factor (dB/m)
1	2364.00	63.65 PK	74.00	-10.35	1.07 V	255	31.43	32.22
2	2364.00	51.89 AV	54.00	-2.11	1.07 V	255	19.67	32.22
3	2390.00	62.48 PK	74.00	-11.52	1.06 V	254	30.15	32.33
4	2390.00	51.47 AV	54.00	-2.53	1.06 V	254	19.14	32.33
5	*2412.00	108.65 PK			1.08 V	258	76.22	32.43
6	*2412.00	104.52 AV			1.08 V	258	72.09	32.43
7	4824.00	56.05 PK	74.00	-17.95	1.13 V	169	17.29	38.76
8	4824.00	52.83 AV	54.00	-1.17	1.13 V	169	14.07	38.76

- REMARKS:**
1. Emission level(dBuV/m)=Raw Value(dBuV) + Correction Factor(dB/m)
 2. Correction Factor(dB/m) = Antenna Factor (dB/m) + Cable Factor (dB)
 3. The other emission levels were very low against the limit.
 4. Margin value = Emission level – Limit value.
 5. “ * “ : Fundamental frequency.

EUT TEST CONDITION		MEASUREMENT DETAIL	
CHANNEL	Channel 6	FREQUENCY RANGE	1 ~ 25GHz
MODULATION TYPE	DBPSK	DETECTOR FUNCTION	Peak(PK) Average (AV)
TRANSFER RATE	1Mbps	ENVIRONMENTAL CONDITIONS	25deg. C, 68%RH, 991hPa
INPUT POWER (SYSTEM)	120Vac, 60 Hz	TESTED BY	Dean Wang

ANTENNA POLARITY & TEST DISTANCE: HORIZONTAL AT 3 M								
No.	Freq. (MHz)	Emission Level (dBuV/m)	Limit (dBuV/m)	Margin (dB)	Antenna Height (m)	Table Angle (Degree)	Raw Value (dBuV)	Correction Factor (dB/m)
1	*2437.00	98.51 PK			1.12 H	105	65.97	32.54
2	*2437.00	94.28 AV			1.12 H	105	61.74	32.54
3	4874.00	52.48 PK	74.00	-21.52	1.05 H	226	13.56	38.92
4	4874.00	47.69 AV	54.00	-6.31	1.05 H	226	8.77	38.92
ANTENNA POLARITY & TEST DISTANCE: VERTICAL AT 3 M								
No.	Freq. (MHz)	Emission Level (dBuV/m)	Limit (dBuV/m)	Margin (dB)	Antenna Height (m)	Table Angle (Degree)	Raw Value (dBuV)	Correction Factor (dB/m)
1	*2437.00	107.70 PK			1.08 V	20	75.16	32.54
2	*2437.00	103.48 AV			1.08 V	20	70.94	32.54
3	4874.00	57.41 PK	74.00	-16.59	1.13 V	121	18.49	38.92
4	4874.00	52.95 AV	54.00	-1.05	1.13 V	121	14.03	38.92

- REMARKS:**
1. Emission level(dBuV/m)=Raw Value(dBuV) + Correction Factor(dB/m)
 2. Correction Factor(dB/m) = Antenna Factor (dB/m) + Cable Factor (dB)
 3. The other emission levels were very low against the limit.
 4. Margin value = Emission level – Limit value.
 5. “ * “ : Fundamental frequency.

EUT TEST CONDITION		MEASUREMENT DETAIL	
CHANNEL	Channel 11	FREQUENCY RANGE	1 ~ 25GHz
MODULATION TYPE	DBPSK	DETECTOR FUNCTION	Peak(PK) Average (AV)
TRANSFER RATE	1Mbps	ENVIRONMENTAL CONDITIONS	25deg. C, 68%RH, 991hPa
INPUT POWER (SYSTEM)	120Vac, 60 Hz	TESTED BY	Dean Wang

ANTENNA POLARITY & TEST DISTANCE: HORIZONTAL AT 3 M								
No.	Freq. (MHz)	Emission Level (dBuV/m)	Limit (dBuV/m)	Margin (dB)	Antenna Height (m)	Table Angle (Degree)	Raw Value (dBuV)	Correction Factor (dB/m)
1	*2462.00	93.86 PK			1.06 H	13	61.20	32.66
2	*2462.00	89.42 AV			1.06 H	13	56.76	32.66
3	2483.50	59.22 PK	74.00	-14.78	1.05 H	20	26.47	32.75
4	2483.50	48.43 AV	54.00	-5.57	1.05 H	20	15.68	32.75
5	4924.00	54.72 PK	74.00	-19.28	1.02 H	116	15.66	39.06
6	4924.00	48.54 AV	54.00	-5.46	1.02 H	116	9.48	39.06
ANTENNA POLARITY & TEST DISTANCE: VERTICAL AT 3 M								
No.	Freq. (MHz)	Emission Level (dBuV/m)	Limit (dBuV/m)	Margin (dB)	Antenna Height (m)	Table Angle (Degree)	Raw Value (dBuV)	Correction Factor (dB/m)
1	*2462.00	103.27 PK			1.07 V	9	70.61	32.66
2	*2462.00	98.82 AV			1.07 V	9	66.16	32.66
3	2483.50	62.29 PK	74.00	-11.71	1.07 V	9	29.54	32.75
4	2483.50	51.70 AV	54.00	-2.30	1.07 V	9	18.95	32.75
5	4924.00	56.13 PK	74.00	-17.87	1.05 V	138	17.07	39.06
6	4924.00	52.26 AV	54.00	-1.74	1.05 V	138	13.20	39.06

- REMARKS:**
1. Emission level(dBuV/m)=Raw Value(dBuV) + Correction Factor(dB/m)
 2. Correction Factor(dB/m) = Antenna Factor (dB/m) + Cable Factor (dB)
 3. The other emission levels were very low against the limit.
 4. Margin value = Emission level – Limit value.
 5. " * " : Fundamental frequency.

802.11g OFDM modulation

EUT TEST CONDITION		MEASUREMENT DETAIL	
CHANNEL	Channel 1	FREQUENCY RANGE	1 ~ 25GHz
MODULATION TYPE	BPSK	DETECTOR FUNCTION	Peak(PK) Average (AV)
TRANSFER RATE	6Mbps	ENVIRONMENTAL CONDITIONS	25deg. C, 68%RH, 991hPa
INPUT POWER (SYSTEM)	120Vac, 60 Hz	TESTED BY	Dean Wang

ANTENNA POLARITY & TEST DISTANCE: HORIZONTAL AT 3 M								
No.	Freq. (MHz)	Emission Level (dBuV/m)	Limit (dBuV/m)	Margin (dB)	Antenna Height (m)	Table Angle (Degree)	Raw Value (dBuV)	Correction Factor (dB/m)
1	2390.00	61.27 PK	74.00	-12.73	1.00 H	295	28.94	32.33
2	2390.00	48.91 AV	54.00	-5.09	1.00 H	295	16.58	32.33
3	*2412.00	100.30 PK			1.00 H	298	67.87	32.43
4	*2412.00	90.26 AV			1.00 H	298	57.83	32.43
5	4824.00	51.31 PK	74.00	-22.69	1.08 H	157	12.55	38.76
6	4824.00	38.68 AV	54.00	-15.32	1.08 H	157	-0.08	38.76
ANTENNA POLARITY & TEST DISTANCE: VERTICAL AT 3 M								
No.	Freq. (MHz)	Emission Level (dBuV/m)	Limit (dBuV/m)	Margin (dB)	Antenna Height (m)	Table Angle (Degree)	Raw Value (dBuV)	Correction Factor (dB/m)
1	2390.00	66.95 PK	74.00	-7.05	1.00 V	147	34.62	32.33
2	2390.00	52.53 AV	54.00	-1.47	1.00 V	147	20.20	32.33
3	*2412.00	109.02 PK			1.00 V	177	76.59	32.43
4	*2412.00	99.39 AV			1.00 V	177	66.96	32.43
5	4824.00	53.77 PK	74.00	-20.23	1.27 V	168	15.01	38.76
6	4824.00	42.37 AV	54.00	-11.63	1.27 V	168	3.61	38.76

- REMARKS:**
1. Emission level(dBuV/m)=Raw Value(dBuV) + Correction Factor(dB/m)
 2. Correction Factor(dB/m) = Antenna Factor (dB/m) + Cable Factor (dB)
 3. The other emission levels were very low against the limit.
 4. Margin value = Emission level – Limit value.
 5. “ * ” : Fundamental frequency.

EUT TEST CONDITION		MEASUREMENT DETAIL	
CHANNEL	Channel 6	FREQUENCY RANGE	1 ~ 25GHz
MODULATION TYPE	BPSK	DETECTOR FUNCTION	Peak(PK) Average (AV)
TRANSFER RATE	6Mbps	ENVIRONMENTAL CONDITIONS	25deg. C, 68%RH, 991hPa
INPUT POWER (SYSTEM)	120Vac, 60 Hz	TESTED BY	Dean Wang

ANTENNA POLARITY & TEST DISTANCE: HORIZONTAL AT 3 M								
No.	Freq. (MHz)	Emission Level (dBuV/m)	Limit (dBuV/m)	Margin (dB)	Antenna Height (m)	Table Angle (Degree)	Raw Value (dBuV)	Correction Factor (dB/m)
1	*2437.00	102.96 PK			1.08 H	112	70.42	32.54
2	*2437.00	93.45 AV			1.08 H	112	60.91	32.54
3	4874.00	54.19 PK	74.00	-19.81	1.06 H	205	15.27	38.92
4	4874.00	41.30 AV	54.00	-12.70	1.06 H	205	2.38	38.92
ANTENNA POLARITY & TEST DISTANCE: VERTICAL AT 3 M								
No.	Freq. (MHz)	Emission Level (dBuV/m)	Limit (dBuV/m)	Margin (dB)	Antenna Height (m)	Table Angle (Degree)	Raw Value (dBuV)	Correction Factor (dB/m)
1	*2437.00	112.45 PK			1.00 V	113	79.91	32.54
2	*2437.00	102.13 AV			1.00 V	113	69.59	32.54
3	4874.00	58.49 PK	74.00	-15.51	1.26 V	176	19.57	38.92
4	4874.00	45.92 AV	54.00	-8.08	1.26 V	176	7.00	38.92

- REMARKS:**
1. Emission level(dBuV/m)=Raw Value(dBuV) + Correction Factor(dB/m)
 2. Correction Factor(dB/m) = Antenna Factor (dB/m) + Cable Factor (dB)
 3. The other emission levels were very low against the limit.
 4. Margin value = Emission level – Limit value.
 5. " * " : Fundamental frequency.

EUT TEST CONDITION		MEASUREMENT DETAIL	
CHANNEL	Channel 11	FREQUENCY RANGE	1 ~ 25GHz
MODULATION TYPE	BPSK	DETECTOR FUNCTION	Peak(PK) Average (AV)
TRANSFER RATE	6Mbps	ENVIRONMENTAL CONDITIONS	25deg. C, 68%RH, 991hPa
INPUT POWER (SYSTEM)	120Vac, 60 Hz	TESTED BY	Dean Wang

ANTENNA POLARITY & TEST DISTANCE: HORIZONTAL AT 3 M								
No.	Freq. (MHz)	Emission Level (dBuV/m)	Limit (dBuV/m)	Margin (dB)	Antenna Height (m)	Table Angle (Degree)	Raw Value (dBuV)	Correction Factor (dB/m)
1	*2462.00	101.21 PK			1.06 H	174	68.55	32.66
2	*2462.00	91.43 AV			1.06 H	174	58.77	32.66
3	2483.50	62.54 PK	74.00	-11.46	1.00 H	126	29.79	32.75
4	2483.50	48.61 AV	54.00	-5.39	1.00 H	126	15.86	32.75
5	4924.00	53.81 PK	74.00	-20.19	1.00 H	213	14.75	39.06
6	4924.00	42.35 AV	54.00	-11.65	1.00 H	213	3.29	39.06
ANTENNA POLARITY & TEST DISTANCE: VERTICAL AT 3 M								
No.	Freq. (MHz)	Emission Level (dBuV/m)	Limit (dBuV/m)	Margin (dB)	Antenna Height (m)	Table Angle (Degree)	Raw Value (dBuV)	Correction Factor (dB/m)
1	*2462.00	109.66 PK			1.09 V	186	77.00	32.66
2	*2462.00	99.76 AV			1.09 V	186	67.10	32.66
3	2483.50	67.26 PK	74.00	-6.74	1.10 V	130	34.51	32.75
4	2483.50	52.87 AV	54.00	-1.13	1.10 V	130	20.12	32.75
5	4924.00	57.67 PK	74.00	-16.33	1.04 V	140	18.61	39.06
6	4924.00	46.00 AV	54.00	-8.00	1.04 V	140	6.94	39.06

- REMARKS:**
1. Emission level(dBuV/m)=Raw Value(dBuV) + Correction Factor(dB/m)
 2. Correction Factor(dB/m) = Antenna Factor (dB/m) + Cable Factor (dB)
 3. The other emission levels were very low against the limit.
 4. Margin value = Emission level – Limit value.
 5. “ * “ : Fundamental frequency.

Below 1GHz Worst-Case Data

EUT TEST CONDITION		MEASUREMENT DETAIL	
CHANNEL	Channel 11	FREQUENCY RANGE	Below 1000MHz
MODULATION TYPE	BPSK	DETECTOR FUNCTION	Quasi-Peak
TRANSFER RATE	6Mbps	ENVIRONMENTAL CONDITIONS	25deg. C, 65%RH, 991hPa
INPUT POWER (SYSTEM)	120Vac, 60 Hz	TESTED BY	Dean Wang

ANTENNA POLARITY & TEST DISTANCE: HORIZONTAL AT 3 M								
No.	Freq. (MHz)	Emission Level (dBuV/m)	Limit (dBuV/m)	Margin (dB)	Antenna Height (m)	Table Angle (Degree)	Raw Value (dBuV)	Correction Factor (dB/m)
1	47.81	38.36 QP	40.00	-1.64	1.97 H	289	23.78	14.58
2	199.05	41.62 QP	43.50	-1.88	1.50 H	337	30.27	11.34
3	250.01	44.75 QP	46.00	-1.25	1.00 H	337	31.26	13.49
4	300.16	38.35 QP	46.00	-7.65	1.00 H	202	23.21	15.14
5	500.42	38.34 QP	46.00	-7.66	2.00 H	187	18.04	20.29
6	626.80	36.78 QP	46.00	-9.22	1.00 H	100	13.72	23.06
7	753.18	44.22 QP	46.00	-1.78	1.00 H	355	18.55	25.66
ANTENNA POLARITY & TEST DISTANCE: VERTICAL AT 3 M								
No.	Freq. (MHz)	Emission Level (dBuV/m)	Limit (dBuV/m)	Margin (dB)	Antenna Height (m)	Table Angle (Degree)	Raw Value (dBuV)	Correction Factor (dB/m)
1	47.40	34.58 QP	40.00	-5.42	1.00 V	235	20.06	14.52
2	64.90	34.63 QP	40.00	-5.37	1.00 V	79	21.28	13.35
3	199.05	38.74 QP	43.50	-4.76	1.00 V	340	27.40	11.34
4	249.60	43.93 QP	46.00	-2.07	1.50 V	10	30.46	13.47
5	350.71	37.98 QP	46.00	-8.02	1.50 V	118	21.49	16.49
6	500.42	33.11 QP	46.00	-12.89	2.00 V	349	12.82	20.29
7	601.52	34.52 QP	46.00	-11.48	1.00 V	142	12.03	22.49
8	626.80	36.71 QP	46.00	-9.29	1.50 V	4	13.65	23.06
9	753.18	39.40 QP	46.00	-6.60	1.50 V	43	13.74	25.66

- REMARKS:**
1. Emission level(dBuV/m)=Raw Value(dBuV) + Correction Factor(dB/m)
 2. Correction Factor(dB/m) = Antenna Factor (dB/m) + Cable Factor (dB)
 3. The other emission levels were very low against the limit.
 4. Margin value = Emission level – Limit value.



4.2 CONDUCTED EMISSION MEASUREMENT

4.2.1 LIMITS OF CONDUCTED EMISSION MEASUREMENT

FREQUENCY OF EMISSION (MHz)	CONDUCTED LIMIT (dB μ V)	
	Quasi-peak	Average
0.15-0.5	66 to 56	56 to 46
0.5-5	56	46
5-30	60	50

- NOTE:**
1. The lower limit shall apply at the transition frequencies.
 2. The limit decreases in line with the logarithm of the frequency in the range of 0.15 to 0.50 MHz.
 3. All emanations from a class A/B digital device or system, including any network of conductors and apparatus connected thereto, shall not exceed the level of field strengths specified above.

4.2.2 TEST INSTRUMENTS

DESCRIPTION & MANUFACTURER	MODEL NO.	SERIAL NO.	CALIBRATED UNTIL
Test Receiver ROHDE & SCHWARZ	ESCS30	100288	Sep. 21, 2008
RF signal cable Woken	5D-FB	Cable-HYCO3-01	Jan. 06, 2009
LISN ROHDE & SCHWARZ	ESH2-Z5	100100	Jan. 09, 2009
LISN SCHWARZBECK	ESH3-Z5	100311	Jan. 21, 2009
Software ADT	ADT_Cond_V3	NA	NA

- NOTE:**
1. The calibration interval of the above test instruments is 12 months and the calibrations are traceable to NML/ROC and NIST/USA.
 2. The test was performed in HwaYa Shielded Room 2.
 3. The VCCI Site Registration No. is C-2047.

4.2.3 TEST PROCEDURES

- a. The EUT was placed 0.4 meters from the conducting wall of the shielded room with EUT being connected to the power mains through a line impedance stabilization network (LISN). Other support units were connected to the power mains through another LISN. The two LISNs provide 50 ohm/ 50uH of coupling impedance for the measuring instrument.
- b. Both lines of the power mains connected to the EUT were checked for maximum conducted interference.
- c. The frequency range from 150kHz to 30MHz was searched. Emission levels under (Limit - 20dB) was not recorded.

NOTE: All modes of operation were investigated and the worst-case emissions are reported.

4.2.4 DEVIATION FROM TEST STANDARD

No deviation

4.2.5 TEST SETUP

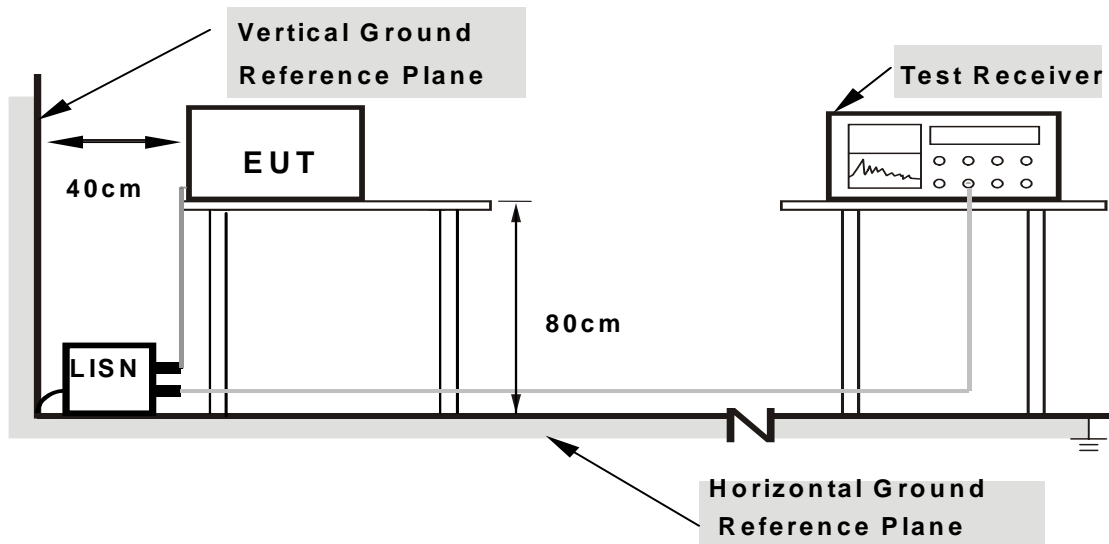

- Note:**
1. Support units were connected to second LISN.
 2. Both of LISNs (AMN) are 80 cm from EUT and at least 80 from other units and other metal planes

For the actual test configuration, please refer to the attached file (Test Setup Photo).

4.2.6 EUT OPERATING CONDITIONS

Same as 4.1.6

4.2.7 TEST RESULTS

Conducted Worst-Case Data

EUT TEST CONDITION		MEASUREMENT DETAIL	
CHANNEL	Channel 1	PHASE	Line 1
MODULATION TYPE	BPSK	6dB BANDWIDTH	9 kHz
TRANSFER RATE	6Mbps	ENVIRONMENTAL CONDITIONS	20deg. C, 60%RH, 991hPa
INPUT POWER (SYSTEM)	120Vac, 60 Hz	TESTED BY	Match Tsui

No	Freq. [MHz]	Corr. Factor (dB)	Reading Value [dB (uV)]		Emission Level [dB (uV)]		Limit [dB (uV)]		Margin (dB)	
			Q.P.	AV.	Q.P.	AV.	Q.P.	AV.	Q.P.	AV.
1	0.177	0.10	42.45	-	42.55	-	64.61	54.61	-22.06	-
2	0.552	0.10	36.65	-	36.75	-	56.00	46.00	-19.25	-
3	1.184	0.13	30.83	-	30.96	-	56.00	46.00	-25.04	-
4	1.980	0.22	31.38	-	31.60	-	56.00	46.00	-24.40	-
5	8.309	0.32	43.61	-	43.93	-	60.00	50.00	-16.07	-
6	18.406	0.54	41.81	-	42.35	-	60.00	50.00	-17.65	-

- REMARKS:**
1. Q.P. and AV. are abbreviations of quasi-peak and average individually.
 2. "-": The Quasi-peak reading value also meets average limit and measurement with the average detector is unnecessary.
 3. The emission levels of other frequencies were very low against the limit.
 4. Margin value = Emission level - Limit value
 5. Correction factor = Insertion loss + Cable loss
 6. Emission Level = Correction Factor + Reading Value.

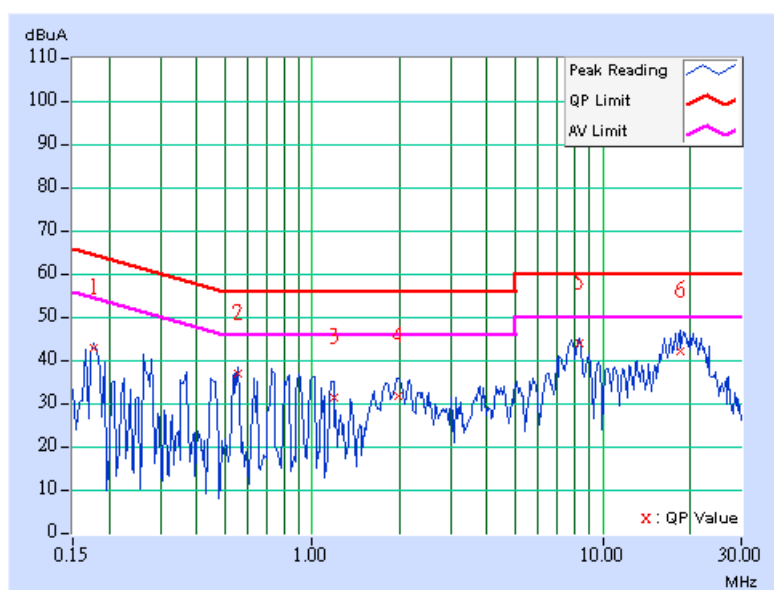

EUT TEST CONDITION		MEASUREMENT DETAIL	
CHANNEL	Channel 1	PHASE	Line 2
MODULATION TYPE	BPSK	6dB BANDWIDTH	9 kHz
TRANSFER RATE	6Mbps	ENVIRONMENTAL CONDITIONS	20deg. C, 60%RH, 991hPa
INPUT POWER (SYSTEM)	120Vac, 60 Hz	TESTED BY	Match Tsui

No	Freq. [MHz]	Corr. Factor [dB]	Reading Value [dB (uV)]		Emission Level [dB (uV)]		Limit [dB (uV)]		Margin (dB)	
			Q.P.	AV.	Q.P.	AV.	Q.P.	AV.	Q.P.	AV.
1	0.177	0.10	40.97	-	41.07	-	64.61	54.61	-23.54	-
2	0.547	0.13	34.92	-	35.05	-	56.00	46.00	-20.95	-
3	1.157	0.21	32.74	-	32.95	-	56.00	46.00	-23.05	-
4	1.949	0.22	35.15	-	35.37	-	56.00	46.00	-20.63	-
5	8.203	0.39	42.52	-	42.91	-	60.00	50.00	-17.09	-
6	18.305	0.54	43.02	-	43.56	-	60.00	50.00	-16.44	-

- REMARKS:**
1. Q.P. and AV. are abbreviations of quasi-peak and average individually.
 2. "-": The Quasi-peak reading value also meets average limit and measurement with the average detector is unnecessary.
 3. The emission levels of other frequencies were very low against the limit.
 4. Margin value = Emission level - Limit value
 5. Correction factor = Insertion loss + Cable loss
 6. Emission Level = Correction Factor + Reading Value.

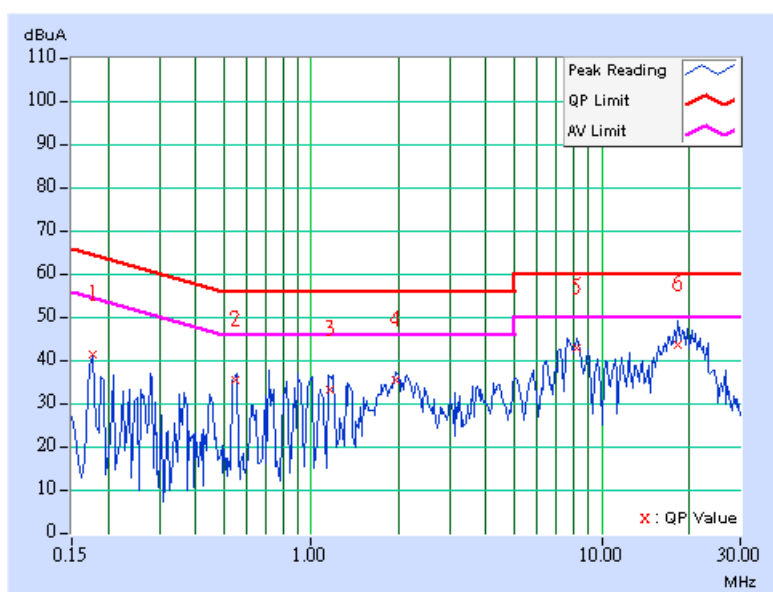

EUT TEST CONDITION		MEASUREMENT DETAIL	
CHANNEL	Channel 6	PHASE	Line 1
MODULATION TYPE	BPSK	6dB BANDWIDTH	9 kHz
TRANSFER RATE	6Mbps	ENVIRONMENTAL CONDITIONS	20deg. C, 60%RH, 991hPa
INPUT POWER (SYSTEM)	120Vac, 60 Hz	TESTED BY	Match Tsui

No	Freq. [MHz]	Corr. Factor [dB]	Reading Value [dB (uV)]		Emission Level [dB (uV)]		Limit [dB (uV)]		Margin (dB)	
			Q.P.	AV.	Q.P.	AV.	Q.P.	AV.	Q.P.	AV.
1	0.185	0.10	42.56	-	42.66	-	64.25	54.25	-21.59	-
2	0.548	0.10	36.41	-	36.51	-	56.00	46.00	-19.49	-
3	0.736	0.11	36.58	-	36.69	-	56.00	46.00	-19.31	-
4	1.961	0.22	33.85	-	34.07	-	56.00	46.00	-21.93	-
5	8.305	0.32	43.61	-	43.93	-	60.00	50.00	-16.07	-
6	19.176	0.56	44.04	-	44.60	-	60.00	50.00	-15.40	-

- REMARKS:**
1. Q.P. and AV. are abbreviations of quasi-peak and average individually.
 2. "-": The Quasi-peak reading value also meets average limit and measurement with the average detector is unnecessary.
 3. The emission levels of other frequencies were very low against the limit.
 4. Margin value = Emission level - Limit value
 5. Correction factor = Insertion loss + Cable loss
 6. Emission Level = Correction Factor + Reading Value.

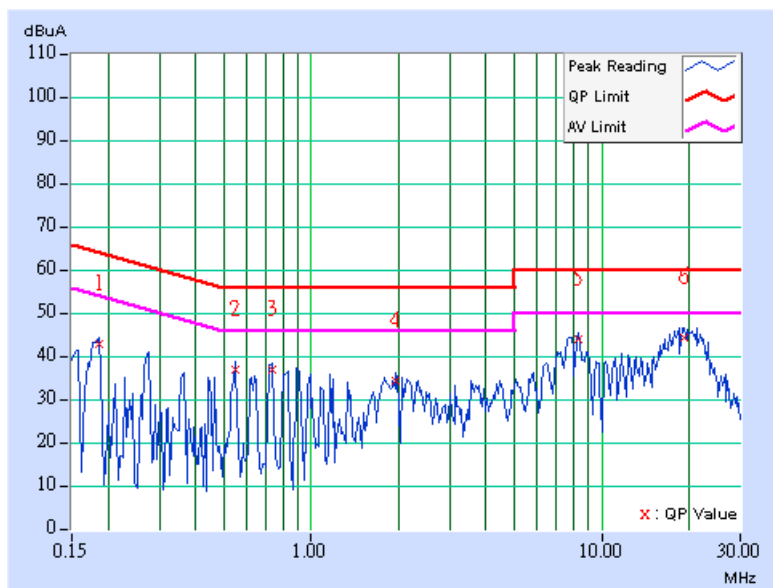

EUT TEST CONDITION		MEASUREMENT DETAIL	
CHANNEL	Channel 6	PHASE	Line 2
MODULATION TYPE	BPSK	6dB BANDWIDTH	9 kHz
TRANSFER RATE	6Mbps	ENVIRONMENTAL CONDITIONS	20deg. C, 60%RH, 991hPa
INPUT POWER (SYSTEM)	120Vac, 60 Hz	TESTED BY	Match Tsui

No	Freq. [MHz]	Corr. Factor (dB)	Reading Value [dB (uV)]		Emission Level [dB (uV)]		Limit [dB (uV)]		Margin (dB)	
			Q.P.	AV.	Q.P.	AV.	Q.P.	AV.	Q.P.	AV.
1	0.150	0.10	35.96	-	36.06	-	66.00	56.00	-29.94	-
2	0.545	0.13	34.48	-	34.61	-	56.00	46.00	-21.39	-
3	0.730	0.16	35.37	-	35.53	-	56.00	46.00	-20.47	-
4	1.930	0.22	34.69	-	34.91	-	56.00	46.00	-21.09	-
5	7.750	0.37	44.18	-	44.55	-	60.00	50.00	-15.45	-
6	19.180	0.56	44.68	-	45.24	-	60.00	50.00	-14.76	-

- REMARKS:**
1. Q.P. and AV. are abbreviations of quasi-peak and average individually.
 2. "-": The Quasi-peak reading value also meets average limit and measurement with the average detector is unnecessary.
 3. The emission levels of other frequencies were very low against the limit.
 4. Margin value = Emission level - Limit value
 5. Correction factor = Insertion loss + Cable loss
 6. Emission Level = Correction Factor + Reading Value.

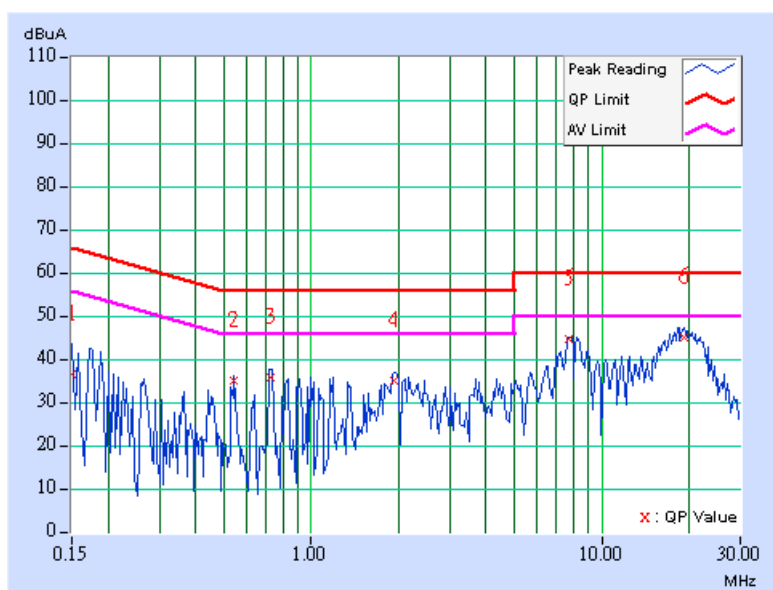

EUT TEST CONDITION		MEASUREMENT DETAIL	
CHANNEL	Channel 11	PHASE	Line 1
MODULATION TYPE	BPSK	6dB BANDWIDTH	9 kHz
TRANSFER RATE	6Mbps	ENVIRONMENTAL CONDITIONS	20deg. C, 60%RH, 991hPa
INPUT POWER (SYSTEM)	120Vac, 60 Hz	TESTED BY	Match Tsui

No	Freq. [MHz]	Corr. Factor [dB]	Reading Value [dB (uV)]		Emission Level [dB (uV)]		Limit [dB (uV)]		Margin (dB)	
			Q.P.	AV.	Q.P.	AV.	Q.P.	AV.	Q.P.	AV.
1	0.181	0.10	42.42	-	42.52	-	64.43	54.43	-21.91	-
2	0.548	0.10	36.75	-	36.85	-	56.00	46.00	-19.15	-
3	0.826	0.11	35.55	-	35.66	-	56.00	46.00	-20.34	-
4	1.992	0.22	30.59	-	30.81	-	56.00	46.00	-25.19	-
5	7.746	0.31	43.42	-	43.73	-	60.00	50.00	-16.27	-
6	19.164	0.55	45.37	-	45.92	-	60.00	50.00	-14.08	-

- REMARKS:**
1. Q.P. and AV. are abbreviations of quasi-peak and average individually.
 2. "-": The Quasi-peak reading value also meets average limit and measurement with the average detector is unnecessary.
 3. The emission levels of other frequencies were very low against the limit.
 4. Margin value = Emission level - Limit value
 5. Correction factor = Insertion loss + Cable loss
 6. Emission Level = Correction Factor + Reading Value.

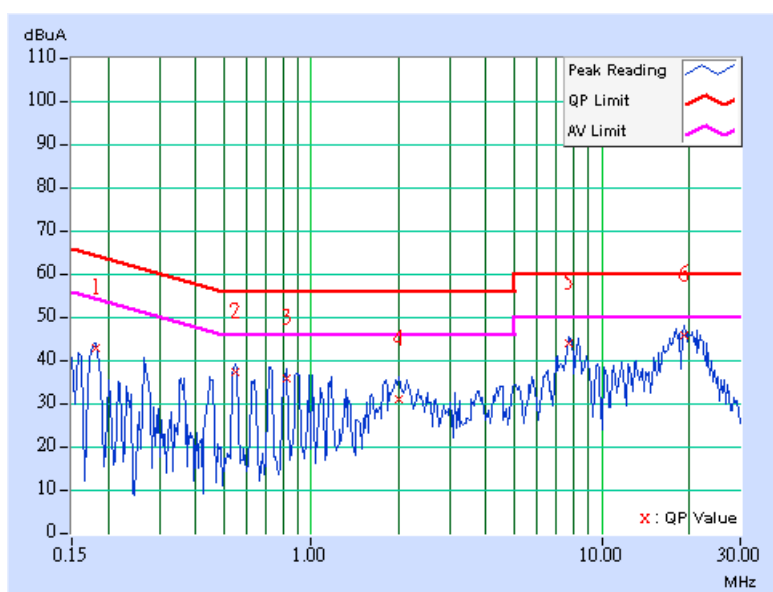

EUT TEST CONDITION		MEASUREMENT DETAIL	
CHANNEL	Channel 11	PHASE	Line 2
MODULATION TYPE	BPSK	6dB BANDWIDTH	9 kHz
TRANSFER RATE	6Mbps	ENVIRONMENTAL CONDITIONS	20deg. C, 60%RH, 991hPa
INPUT POWER (SYSTEM)	120Vac, 60 Hz	TESTED BY	Match Tsui

No	Freq. [MHz]	Corr. Factor (dB)	Reading Value [dB (uV)]		Emission Level [dB (uV)]		Limit [dB (uV)]		Margin (dB)	
			Q.P.	AV.	Q.P.	AV.	Q.P.	AV.	Q.P.	AV.
1	0.185	0.10	38.95	-	39.05	-	64.25	54.25	-25.20	-
2	0.548	0.13	35.52	-	35.65	-	56.00	46.00	-20.35	-
3	1.195	0.21	34.62	-	34.83	-	56.00	46.00	-21.17	-
4	1.930	0.22	34.96	-	35.18	-	56.00	46.00	-20.82	-
5	8.191	0.38	43.90	-	44.28	-	60.00	50.00	-15.72	-
6	19.059	0.55	45.17	-	45.72	-	60.00	50.00	-14.28	-

- REMARKS:**
1. Q.P. and AV. are abbreviations of quasi-peak and average individually.
 2. "-": The Quasi-peak reading value also meets average limit and measurement with the average detector is unnecessary.
 3. The emission levels of other frequencies were very low against the limit.
 4. Margin value = Emission level - Limit value
 5. Correction factor = Insertion loss + Cable loss
 6. Emission Level = Correction Factor + Reading Value.

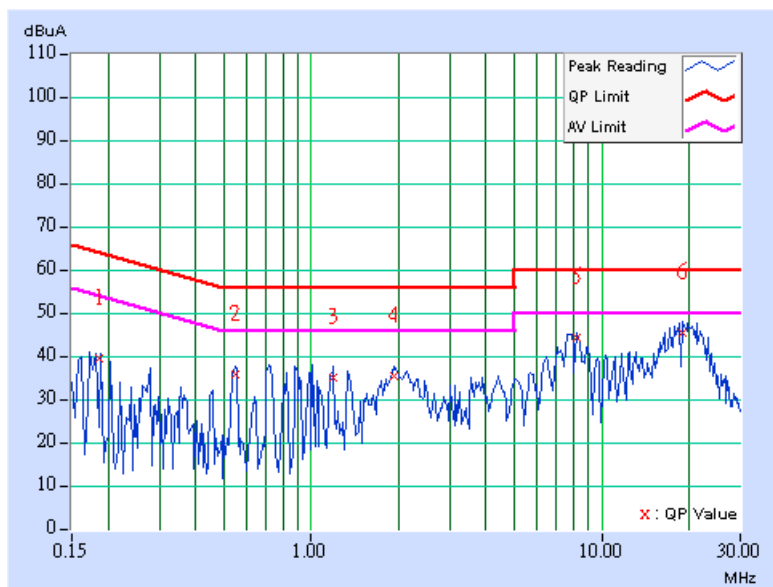



4.3 6dB BANDWIDTH MEASUREMENT

4.3.1 LIMITS OF 6dB BANDWIDTH MEASUREMENT

The minimum of 6dB Bandwidth Measurement is 0.5 MHz.

4.3.2 TEST INSTRUMENTS

Description & Manufacturer	Model No.	Serial No.	Calibrated Until
SPECTRUM ANALYZER	FSP40	100040	Jun. 28, 2008

NOTE: The calibration interval of the above test instruments is 12 months and the calibrations are traceable to NML/ROC and NIST/USA.

4.3.3 TEST PROCEDURE

The transmitter output was connected to the spectrum analyzer through an attenuator. The bandwidth of the fundamental frequency was measured by spectrum analyzer with 100kHz RBW and 100kHz VBW. The 6dB bandwidth is defined as the total spectrum the power of which is higher than peak power minus 6dB.

4.3.4 DEVIATION FROM TEST STANDARD

No deviation

4.3.5 TEST SETUP

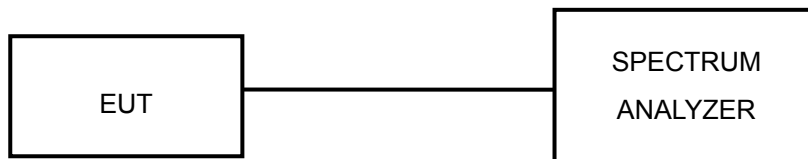

4.3.6 EUT OPERATING CONDITIONS

The software provided by client to enable the EUT under transmission condition continuously at lowest, middle and highest channel frequencies individually.



4.3.7 TEST RESULTS

802.11b DSSS modulation

MODULATION TYPE	DBPSK	TRANSFER RATE	1Mbps
INPUT POWER (SYSTEM)	120Vac, 60 Hz	ENVIRONMENTAL CONDITIONS	23deg.C, 63%RH, 991hPa
TESTED BY	Morgan Chen		

CHANNEL	CHANNEL FREQUENCY (MHz)	6dB BANDWIDTH (MHz)	MINIMUM LIMIT (MHz)	PASS/FAIL
1	2412	12.12	0.5	PASS
6	2437	12.04	0.5	PASS
11	2462	10.16	0.5	PASS

CH 1

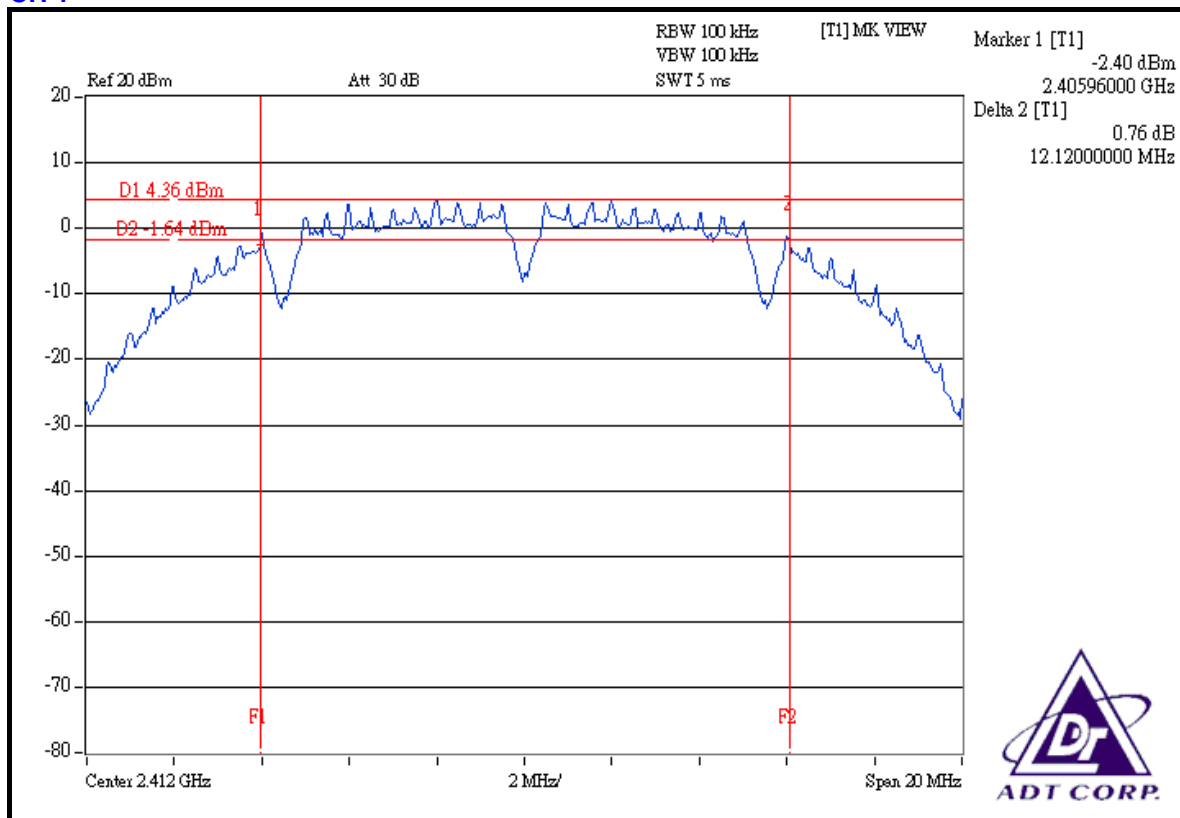

CH 6

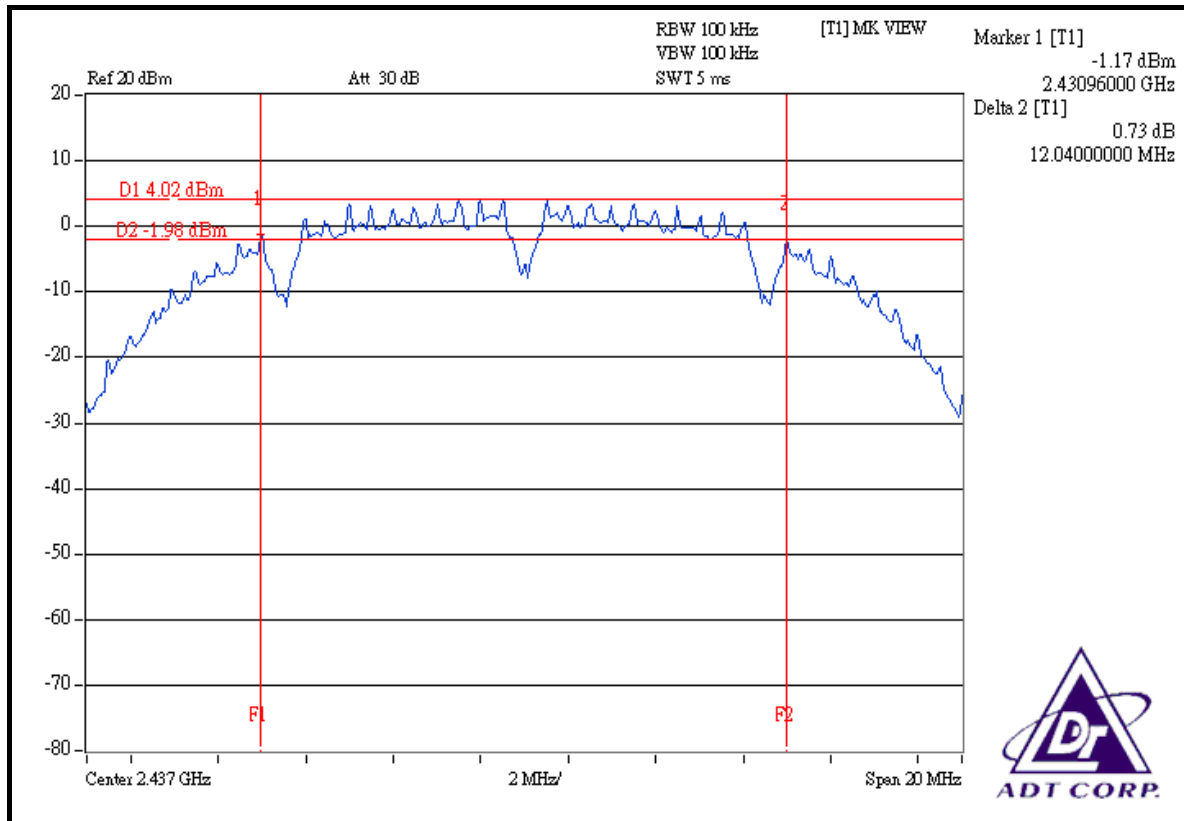

CH 11

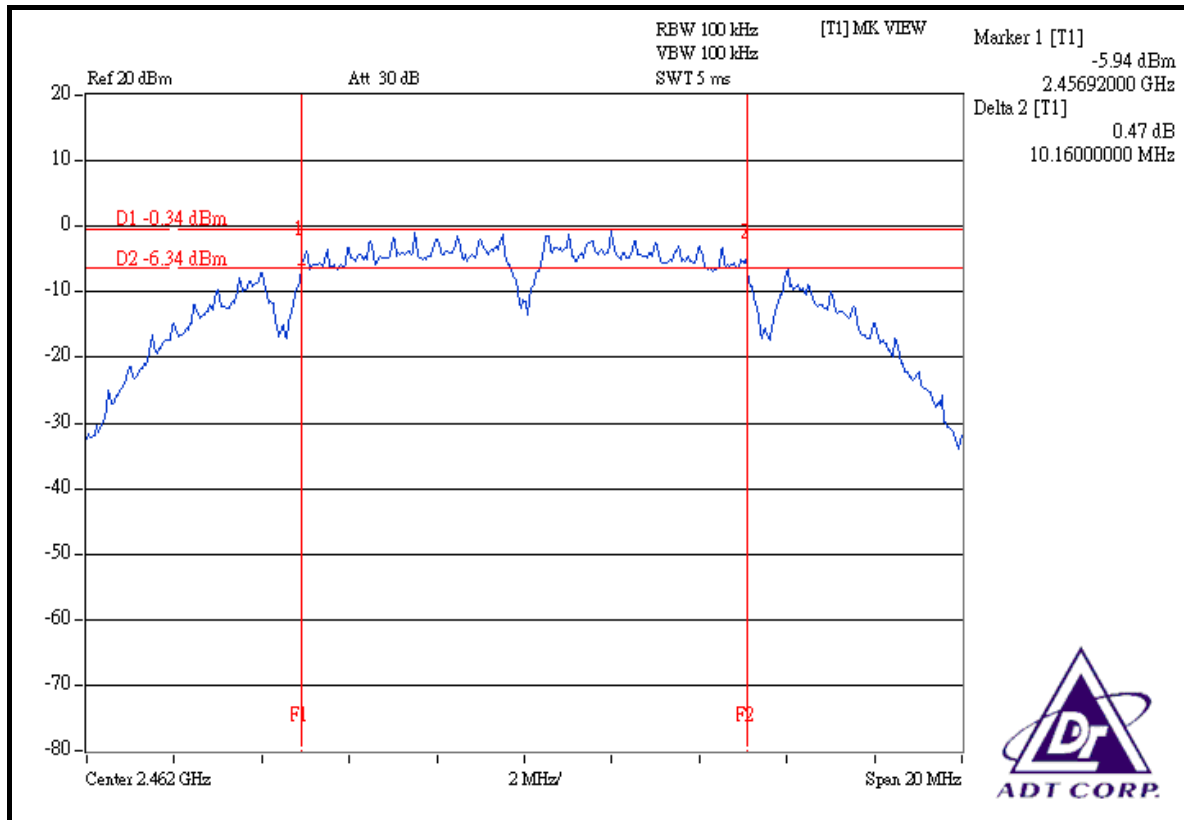



802.11g OFDM modulation

MODULATION TYPE	BPSK	TRANSFER RATE	6Mbps
INPUT POWER (SYSTEM)	120Vac, 60 Hz	ENVIRONMENTAL CONDITIONS	23deg.C, 63%RH, 991hPa
TESTED BY	Morgan Chen		

CHANNEL	CHANNEL FREQUENCY (MHz)	6dB BANDWIDTH (MHz)	MINIMUM LIMIT (MHz)	PASS/FAIL
1	2412	16.48	0.5	PASS
6	2437	16.44	0.5	PASS
11	2462	16.48	0.5	PASS

CH 1

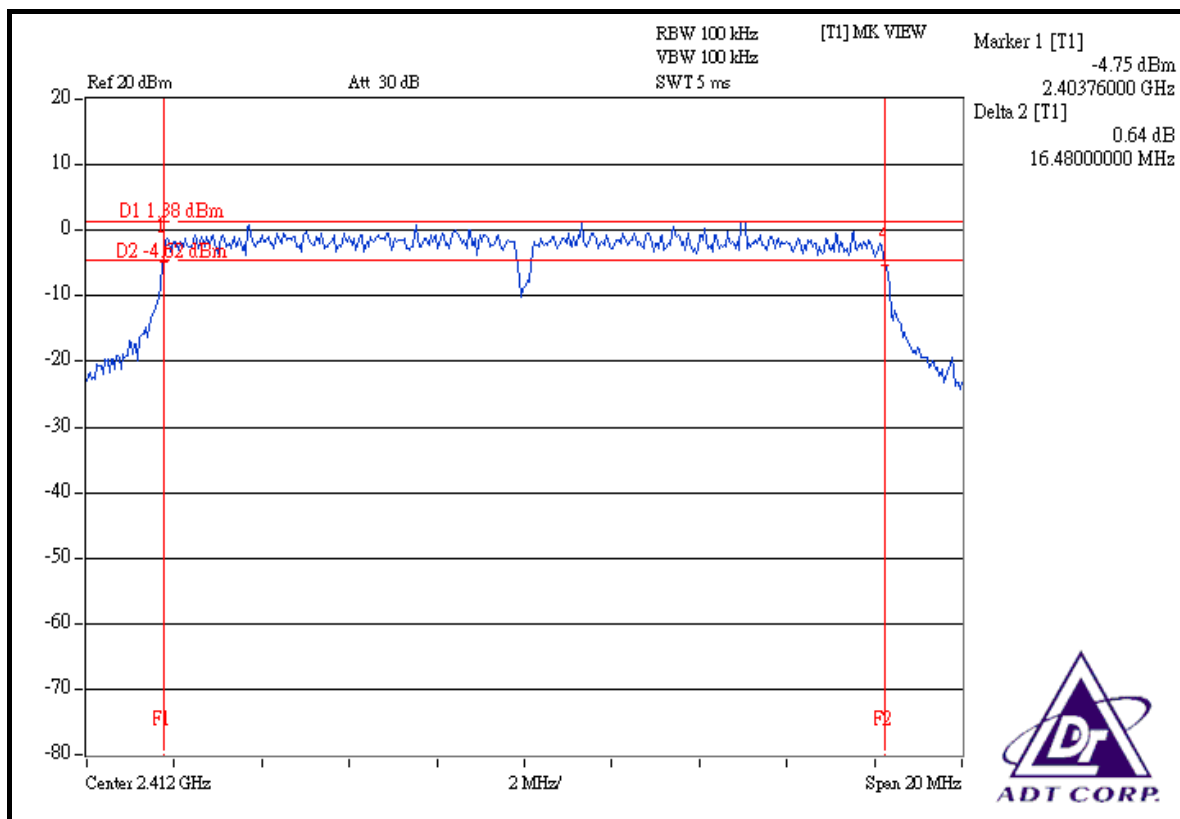

CH 6

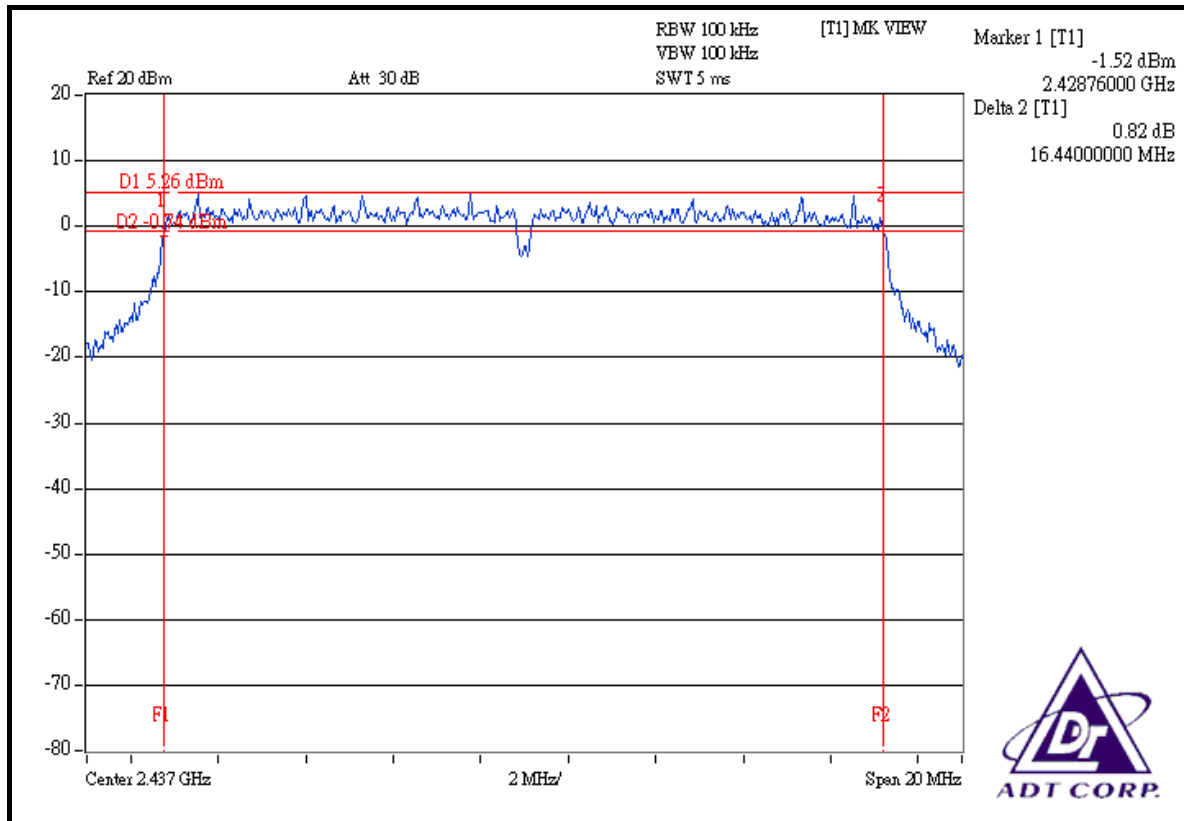

CH 11

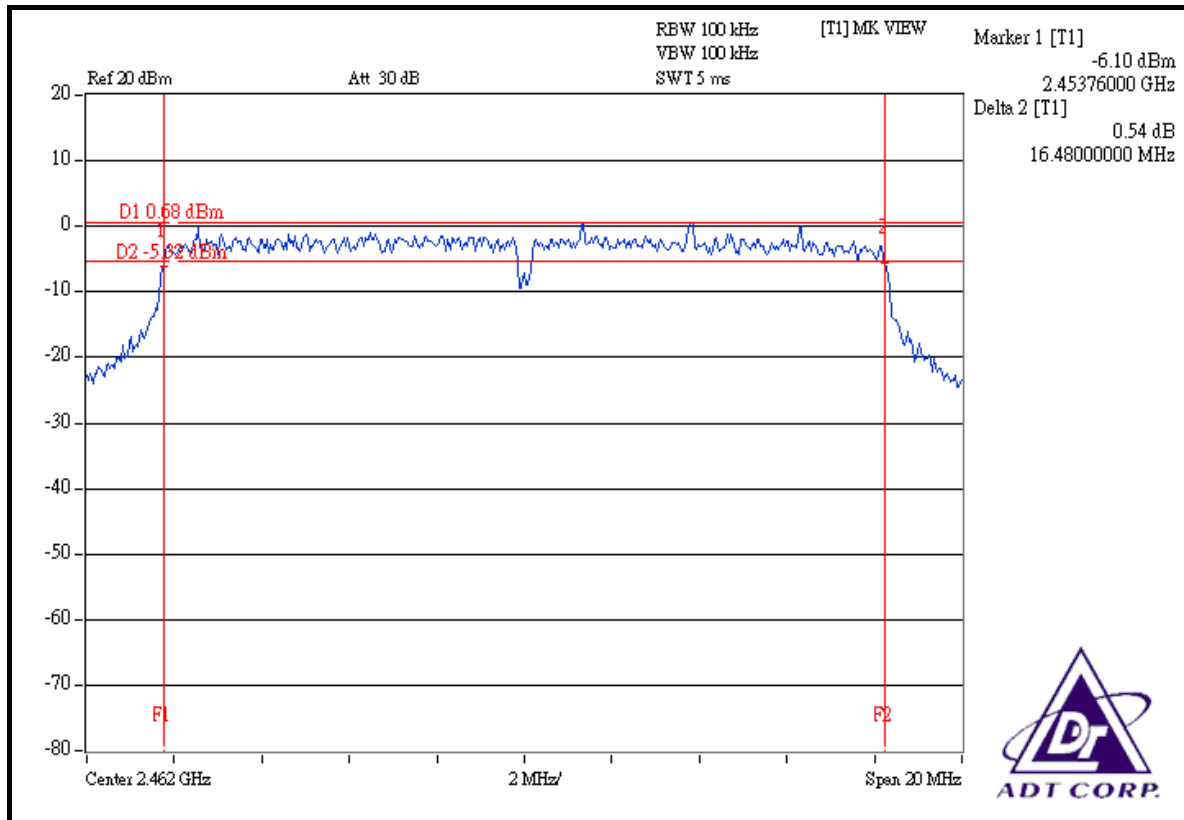



4.4 MAXIMUM PEAK OUTPUT POWER

4.4.1 LIMITS OF MAXIMUM PEAK OUTPUT POWER MEASUREMENT

The Maximum Peak Output Power Measurement is 30dBm.

4.4.2 INSTRUMENTS

Description & Manufacturer	Model No.	Serial No.	Calibrated Until
R&S SPECTRUM ANALYZER	FSP40	100040	Jun. 28, 2008
AGILENT SYNTHESIZED SIGNAL GENERATOR	E8257C	MY43320668	Dec. 25, 2008
DIGITAL RT OSCILLOSCOPE	TDS1012	C037299	Nov. 21, 2008
NARDA DETECTOR	4503A	FSCM99899	NA

NOTE:

The calibration interval of the above test instruments is 12 months and the calibrations are traceable to NML/ROC and NIST/USA.

4.4.1 TEST PROCEDURES

1. A detector was used on the output port of the EUT. An oscilloscope was used to read the response of the detector.
2. Replaced the EUT by the signal generator. The center frequency of the S.G was adjusted to the center frequency of the measured channel.
3. Adjusted the power to have the same reading on oscilloscope. Record the power level.

4.4.2 DEVIATION FROM TEST STANDARD

No deviation

4.4.3 TEST SETUP



4.4.4 EUT OPERATING CONDITIONS

Same as Item 4.3.6



4.4.3 TEST RESULTS

802.11b DSSS modulation

MODULATION TYPE	DBPSK	TRANSFER RATE	1Mbps
INPUT POWER (SYSTEM)	120Vac, 60 Hz	ENVIRONMENTAL CONDITIONS	23deg.C, 63%RH, 991hPa
TESTED BY	Morgan Chen		

CHANNEL	CHANNEL FREQUENCY (MHz)	PEAK POWER OUTPUT (mW)	PEAK POWER OUTPUT (dBm)	PEAK POWER LIMIT (dBm)	PASS/FAIL
1	2412	56.885	17.55	30	PASS
6	2437	56.885	17.55	30	PASS
11	2462	16.218	12.10	30	PASS

802.11g OFDM modulation

MODULATION TYPE	BPSK	TRANSFER RATE	6Mbps
INPUT POWER (SYSTEM)	120Vac, 60 Hz	ENVIRONMENTAL CONDITIONS	23deg.C, 63%RH, 991hPa
TESTED BY	Morgan Chen		

CHANNEL	CHANNEL FREQUENCY (MHz)	PEAK POWER OUTPUT (mW)	PEAK POWER OUTPUT (dBm)	PEAK POWER LIMIT (dBm)	PASS/FAIL
1	2412	90.782	19.58	30	PASS
6	2437	184.077	22.65	30	PASS
11	2462	71.614	18.55	30	PASS



4.5 POWER SPECTRAL DENSITY MEASUREMENT

4.5.1 LIMITS OF POWER SPECTRAL DENSITY MEASUREMENT

The Maximum of Power Spectral Density Measurement is 8dBm.

4.5.2 TEST INSTRUMENTS

Description & Manufacturer	Model No.	Serial No.	Calibrated Until
SPECTRUM ANALYZER	FSP40	100040	Jun. 28, 2008

NOTE:

The calibration interval of the above test instruments is 12 months and the calibrations are traceable to NML/ROC and NIST/USA.

4.5.3 TEST PROCEDURE

The transmitter output was connected to the spectrum analyzer through an attenuator, the bandwidth of the fundamental frequency was measured with the spectrum analyzer using 3kHz RBW and 30kHz VBW, set sweep time = span/3kHz. The power spectral density was measured and recorded. The sweep time is allowed to be longer than span/3kHz for a full response of the mixer in the spectrum analyzer.

4.5.4 DEVIATION FROM TEST STANDARD

No deviation

4.5.5 TEST SETUP

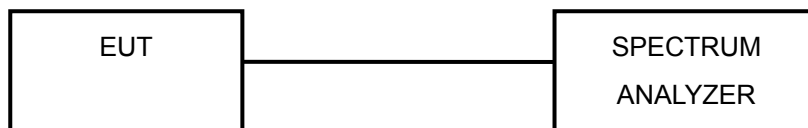

4.5.6 EUT OPERATING CONDITION

Same as Item 4.3.6



4.5.7 TEST RESULTS

802.11b DSSS modulation

MODULATION TYPE	DBPSK	TRANSFER RATE	1Mbps
INPUT POWER (SYSTEM)	120Vac, 60 Hz	ENVIRONMENTAL CONDITIONS	23deg.C, 63%RH, 991hPa
TESTED BY	Morgan Chen		

CHANNEL	CHANNEL FREQUENCY (MHz)	RF POWER LEVEL IN 3kHz BW (dBm)	MAXIMUM LIMIT (dBm)	PASS/FAIL
1	2412	-8.97	8	PASS
6	2437	-8.87	8	PASS
11	2462	-14.12	8	PASS

CH 1

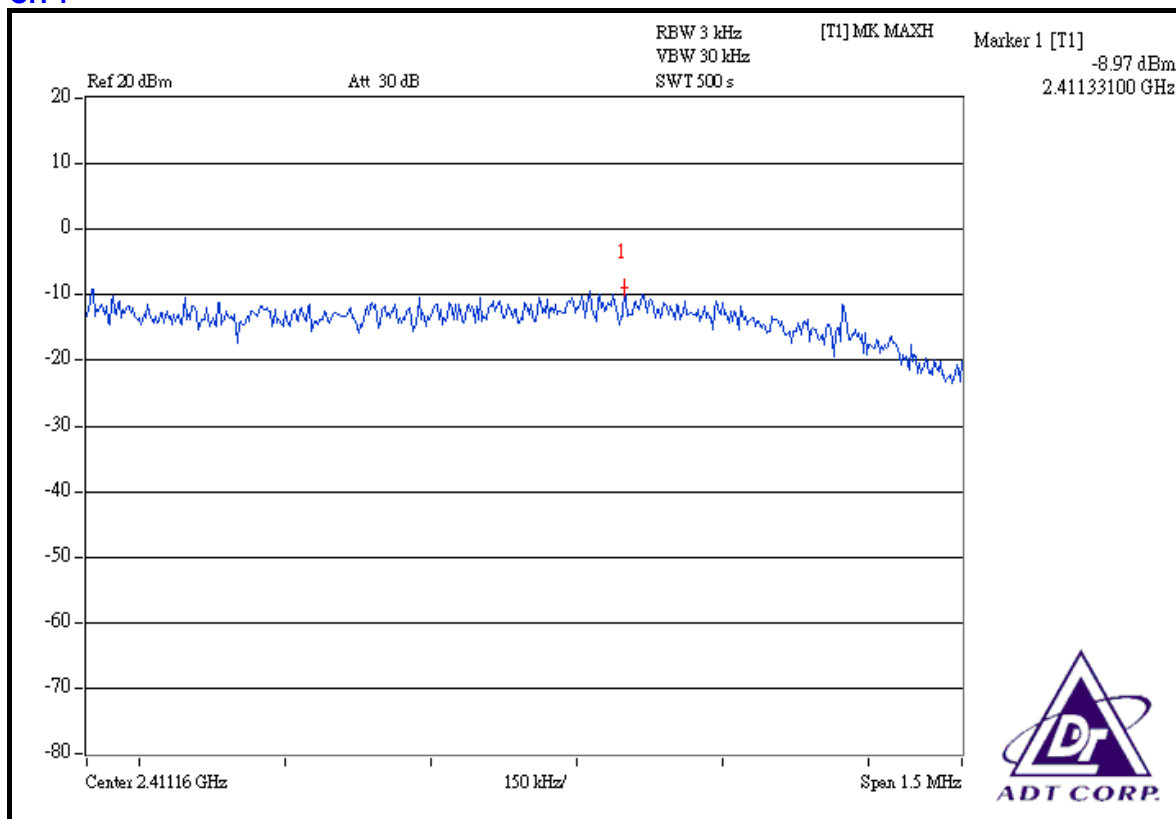



CH 6

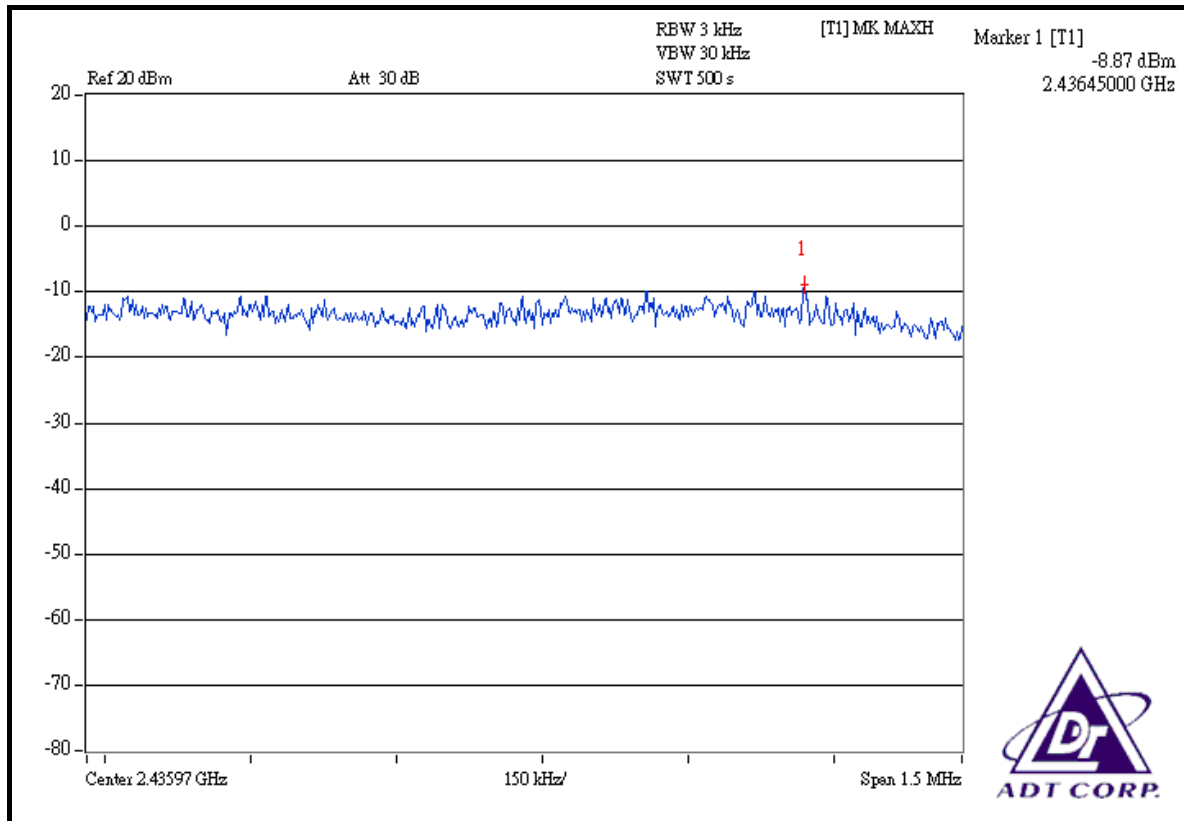

CH 11

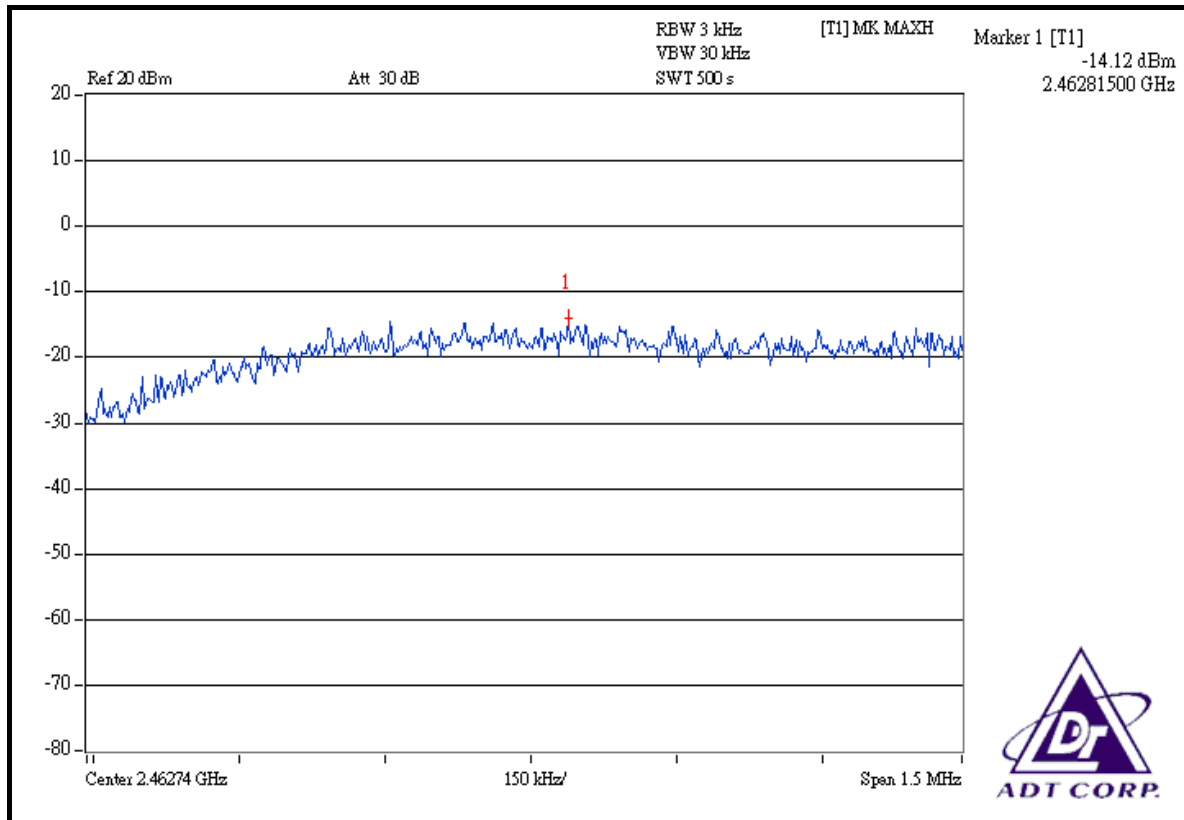



802.11g OFDM modulation

MODULATION TYPE	BPSK	TRANSFER RATE	6Mbps
INPUT POWER (SYSTEM)	120Vac, 60 Hz	ENVIRONMENTAL CONDITIONS	23deg.C, 63%RH, 991hPa
TESTED BY	Morgan Chen		

CHANNEL	CHANNEL FREQUENCY (MHz)	RF POWER LEVEL IN 3kHz BW (dBm)	MAXIMUM LIMIT (dBm)	PASS/FAIL
1	2412	-11.10	8	PASS
6	2437	-7.86	8	PASS
11	2462	-11.91	8	PASS

CH 1

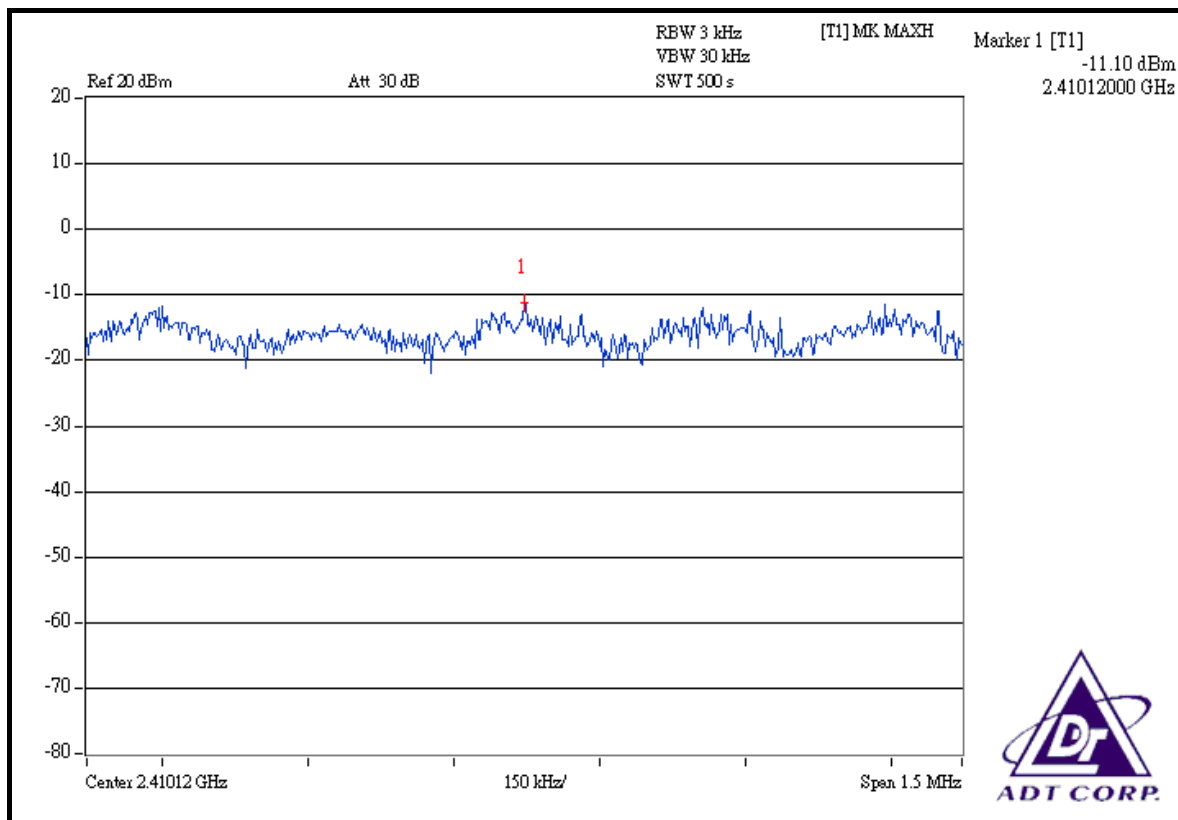



CH 6

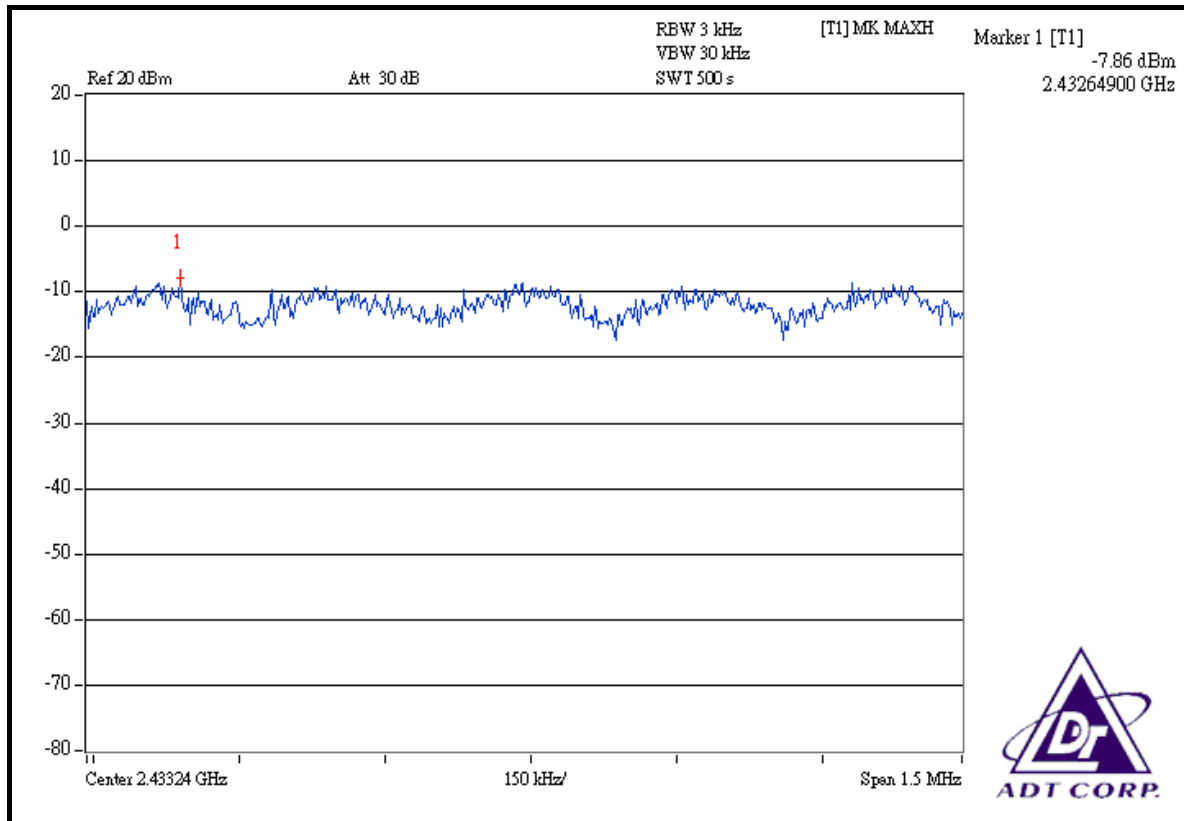

CH 11

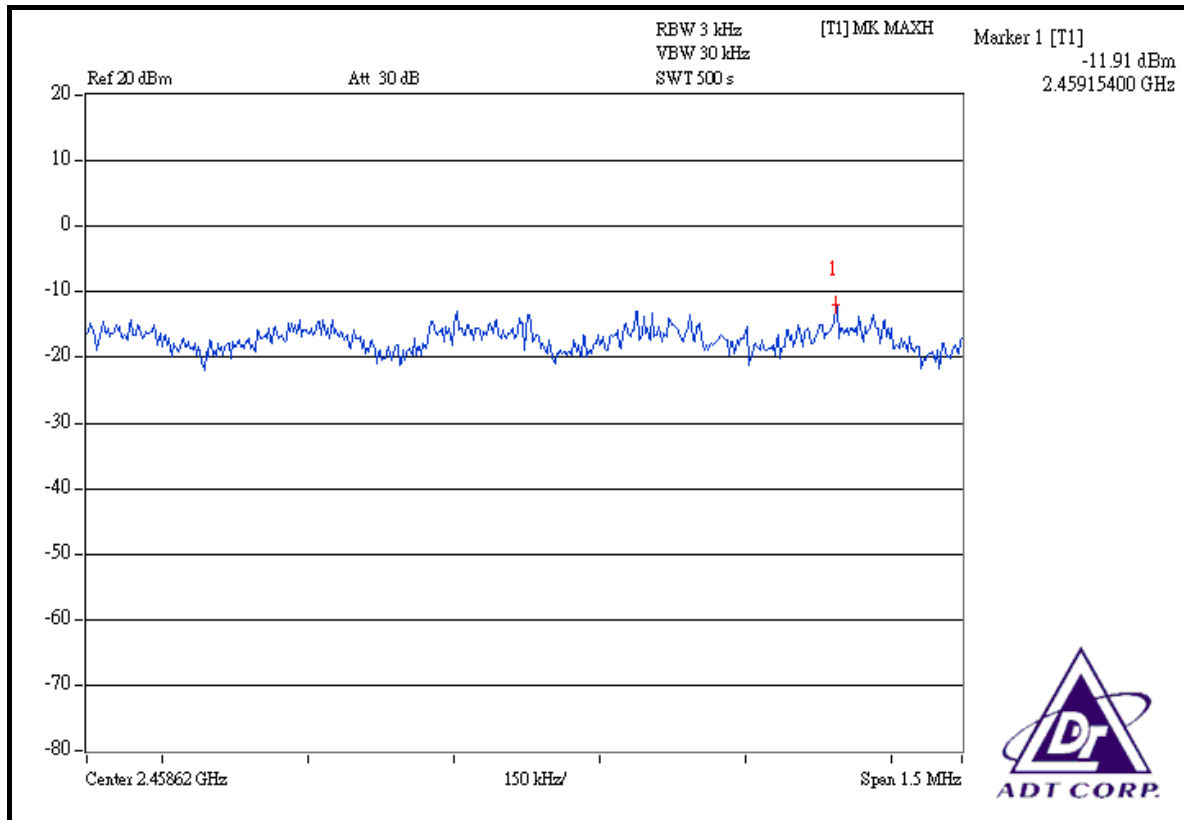



4.6 BAND EDGES MEASUREMENT

4.6.1 LIMITS OF BAND EDGES MEASUREMENT

Below -20dB of the highest emission level of operating band (in 100kHz Resolution Bandwidth).

4.6.2 TEST INSTRUMENTS

Description & Manufacturer	Model No.	Serial No.	Calibrated Until
SPECTRUM ANALYZER	FSP40	100040	Jun. 28, 2008

NOTE: The calibration interval of the above test instruments is 12 months and the calibrations are traceable to NML/ROC and NIST/USA.

4.6.3 TEST PROCEDURE

The transmitter output was connected to the spectrum analyzer via a low loss cable. Set both RBW and VBW of spectrum analyzer to 100kHz with suitable frequency span including 100MHz bandwidth from band edge. The band edges was measured and recorded.

The spectrum plots (Peak RBW=VBW=100kHz; Average RBW=1MHz, VBW= 10Hz) are attached on the following pages.

4.6.4 DEVIATION FROM TEST STANDARD

No deviation

4.6.5 EUT OPERATING CONDITION

Same as Item 4.3.6

4.6.6 TEST RESULTS

The spectrum plots are attached on the following 12 images. D1 line indicates the highest level, and D2 line indicates the 20dB offset below D1. It shows compliance with the requirement in part 15.247(d).

802.11b DSSS modulation

NOTE 1: The band edge emission plot on the next page shows 49.79dBc between carrier maximum power and local maximum emission in restrict band (2.3600GHz). The emission of carrier strength list in the test result of channel 1 at the item 4.2.7 is 108.65dBuV/m (Peak), so the maximum field strength in restrict band is $108.65 - 49.79 = 58.86$ dBuV/m which is under 74dBuV/m limit.

The band edge emission plot of on the next page shows 53.03dBc between carrier maximum power and local maximum emission in restrict band (2.3852GHz). The emission of carrier strength list in the test result of channel 1 at the item 4.2.7 is 104.52dBuV/m (Average), so the maximum field strength in restrict band is $104.52 - 53.03 = 51.49$ dBuV/m which is under 54dBuV/m limit.

NOTE 2: The band edge emission plot on the next second page shows 48.30dBc between carrier maximum power and local maximum emission in restrict band (2.4910GHz). The emission of carrier strength list in the test result of channel 11 at the item 4.2.7 is 103.27dBuV/m (Peak), so the maximum field strength in restrict band is $103.27 - 48.30 = 54.97$ dBuV/m which is under 74dBuV/m limit.

The band edge emission plot on the next third page shows 56.16dBc between carrier maximum power and local maximum emission in restrict band (2.4874GHz). The emission of carrier strength list in the test result of channel 11 at the item 4.2.7 is 98.82dBuV/m (Average), so the maximum field strength in restrict band is $98.82 - 56.16 = 42.66$ dBuV/m which is under 54dBuV/m limit.

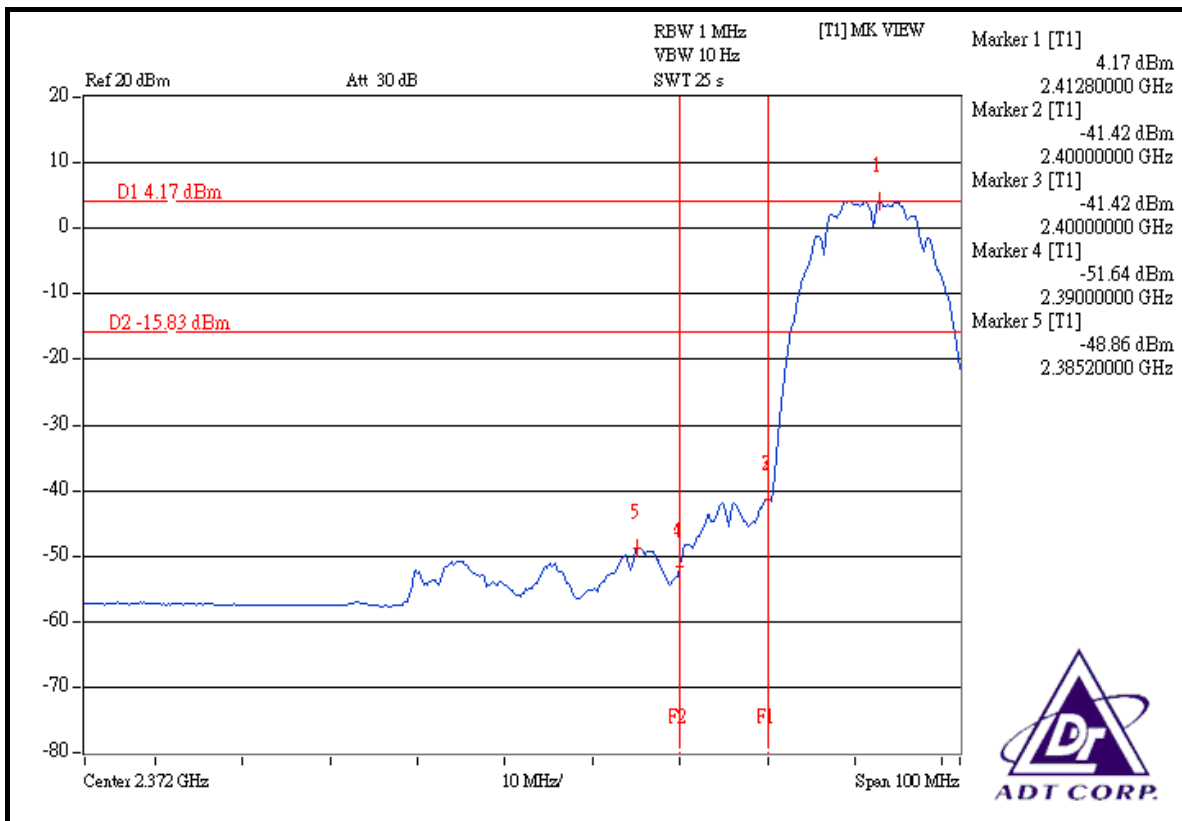
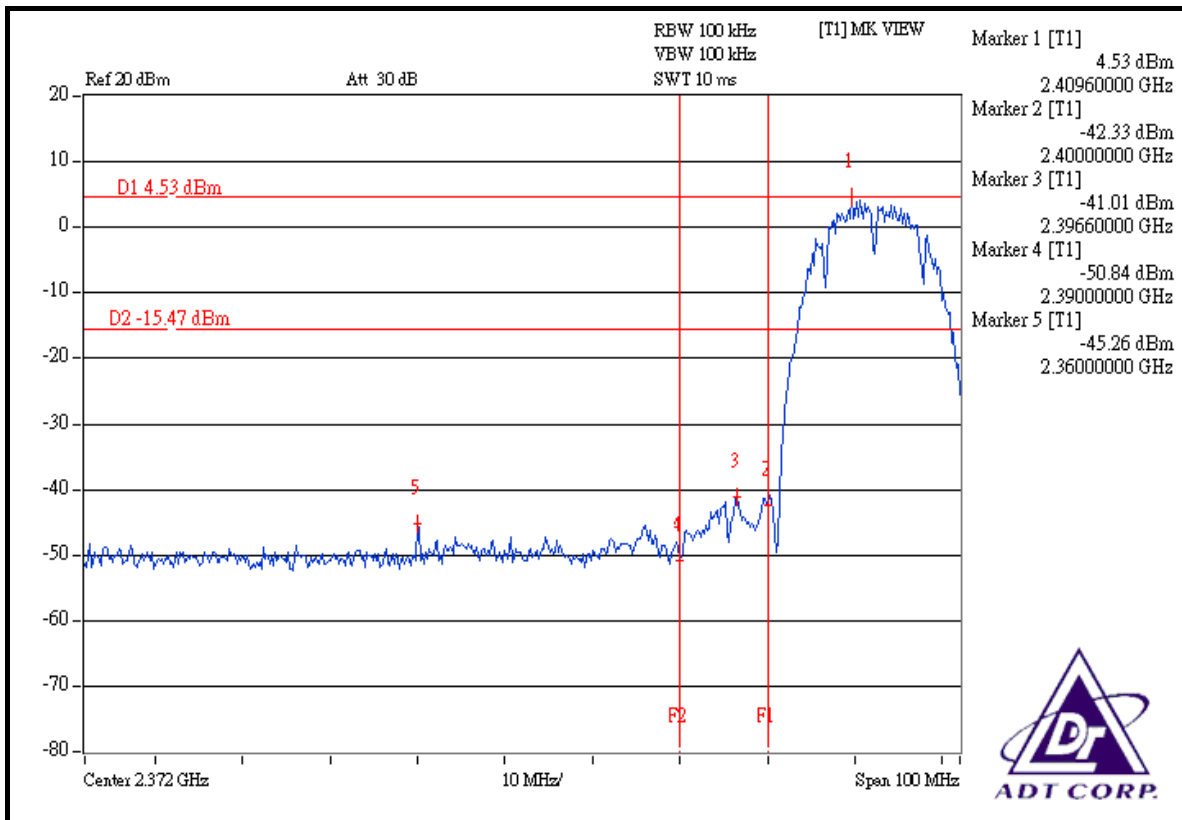

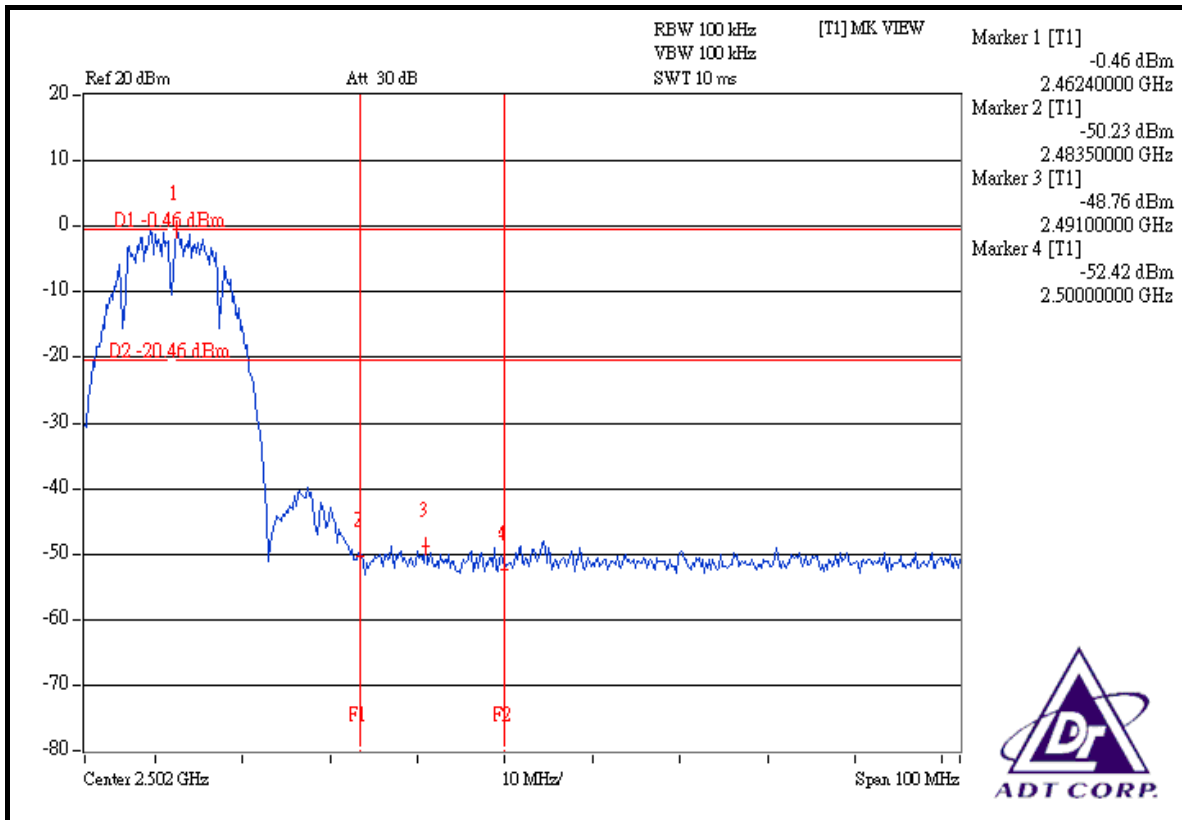
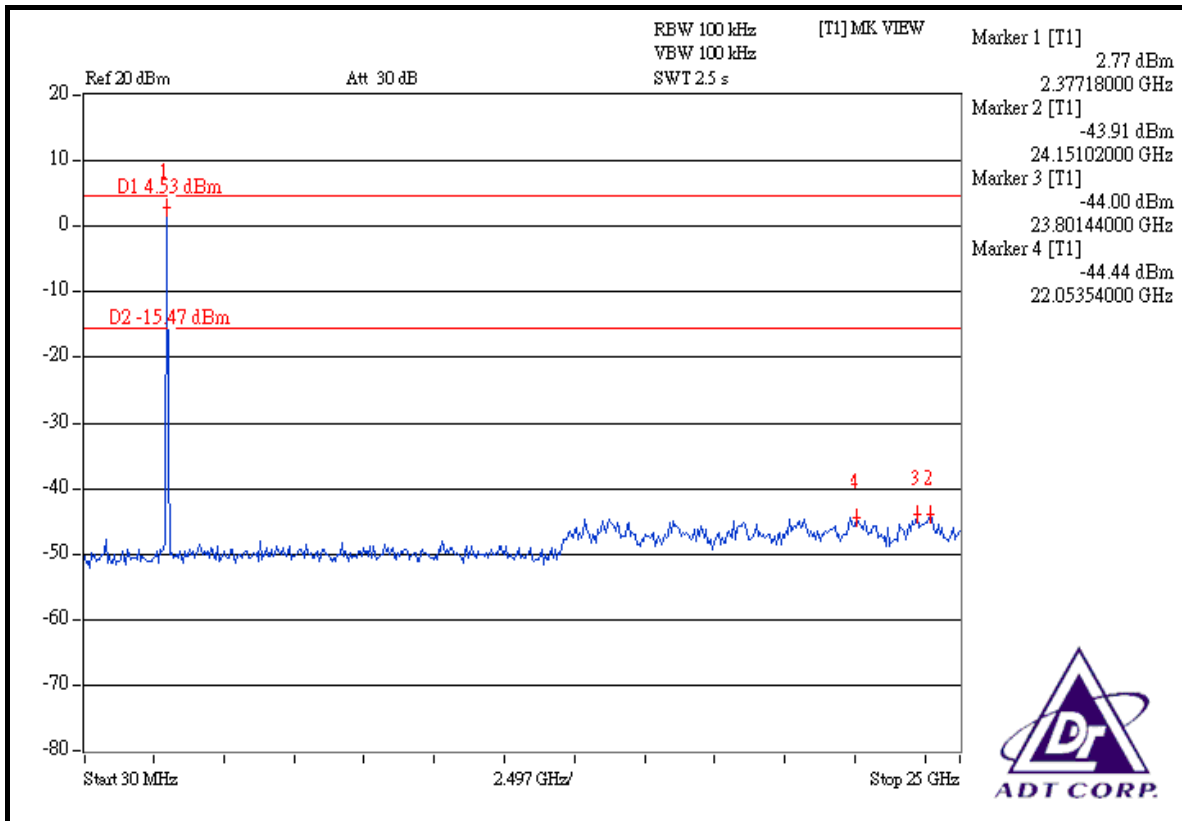

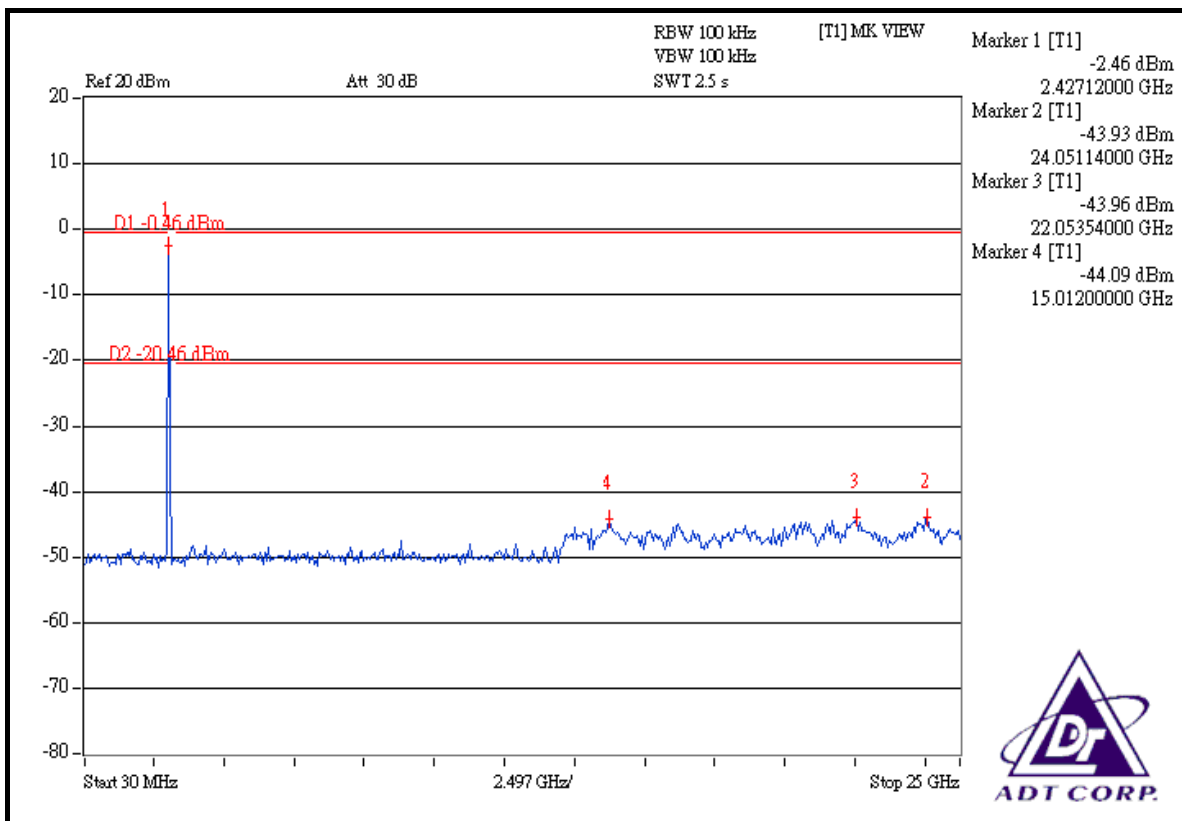
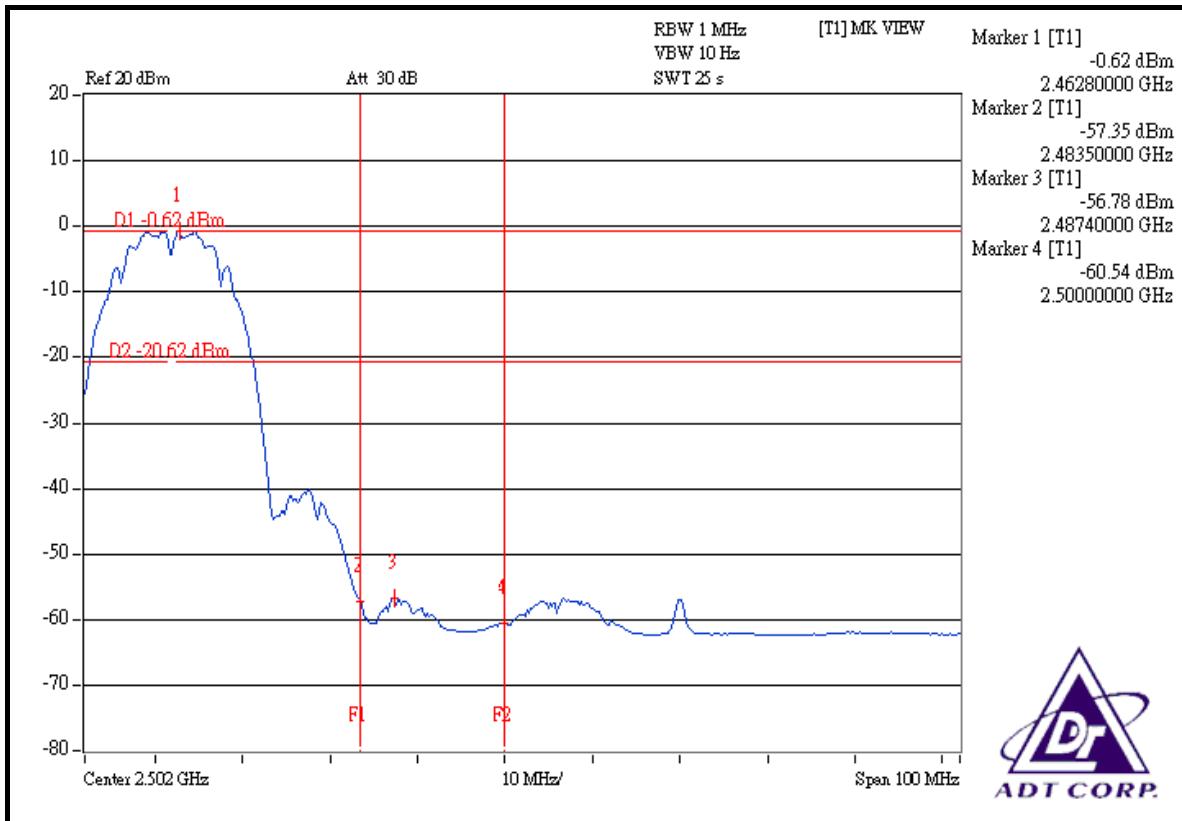

802.11g OFDM modulation

NOTE 1: The band edge emission plot on the next page shows 46.33dBc between carrier maximum power and local maximum emission in restrict band (2.3896GHz). The emission of carrier strength list in the test result of channel 1 at the item 4.2.7 is 109.02dBuV/m (Peak), so the maximum field strength in restrict band is $109.02 - 46.33 = 62.69$ dBuV/m which is under 74dBuV/m limit.

The band edge emission plot of on the next page shows 48.90dBc between carrier maximum power and local maximum emission in restrict band (2.3900GHz). The emission of carrier strength list in the test result of channel 1 at the item 4.2.7 is 99.39dBuV/m (Average), so the maximum field strength in restrict band is $99.39 - 48.90 = 50.49$ dBuV/m which is under 54dBuV/m limit.

NOTE 2: The band edge emission plot on the next second page shows 44.48dBc between carrier maximum power and local maximum emission in restrict band (2.4842GHz). The emission of carrier strength list in the test result of channel 11 at the item 4.2.7 is 109.66dBuV/m (Peak), so the maximum field strength in restrict band is $109.66 - 44.48 = 65.18$ dBuV/m which is under 74dBuV/m limit.

The band edge emission plot on the next third page shows 47.14dBc between carrier maximum power and local maximum emission in restrict band (2.4835GHz). The emission of carrier strength list in the test result of channel 11 at the item 4.2.7 is 99.76dBuV/m (Average), so the maximum field strength in restrict band is $99.76 - 47.14 = 52.62$ dBuV/m which is under 54dBuV/m limit.

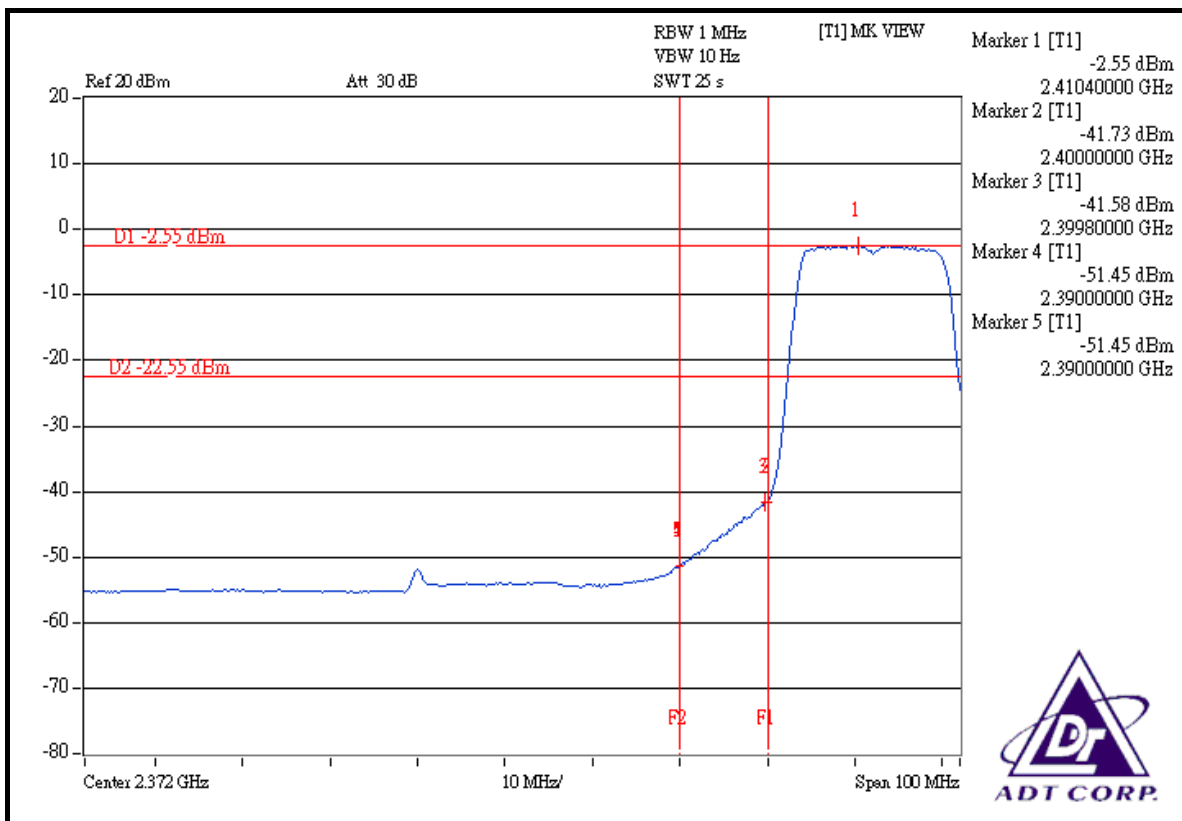
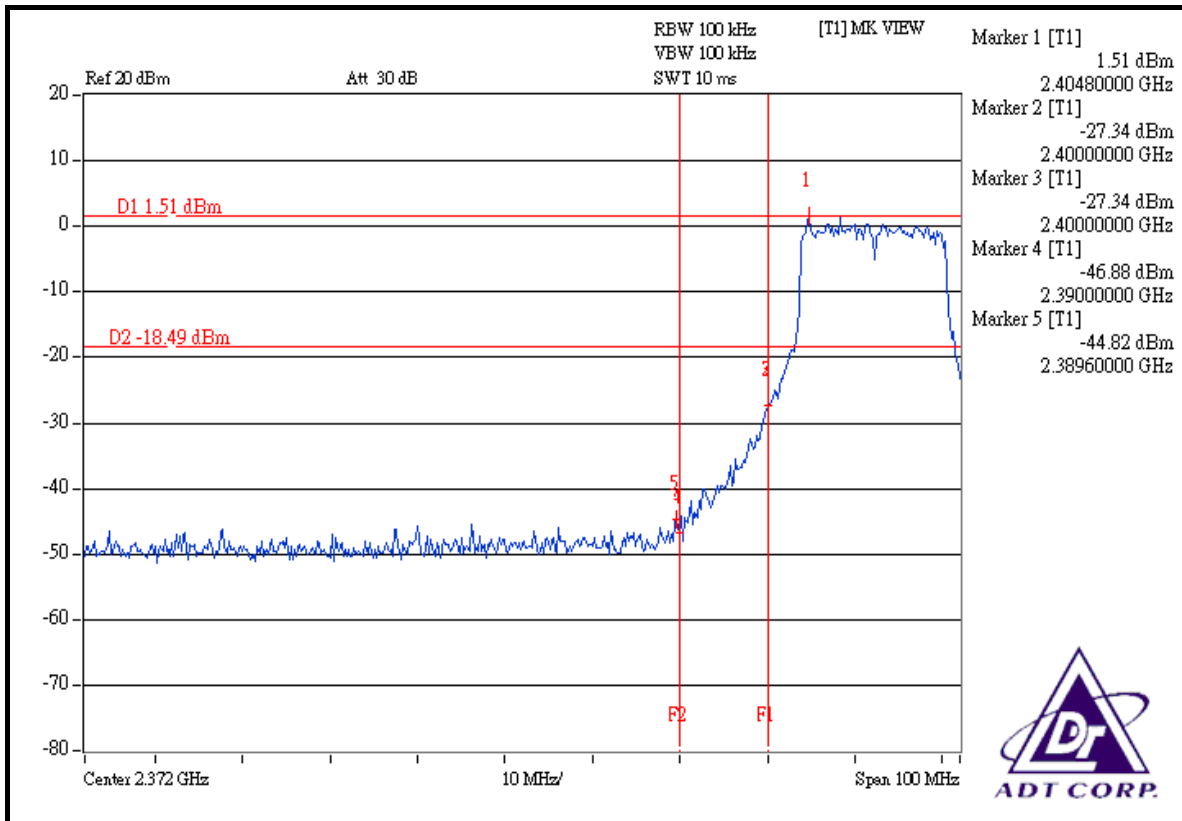

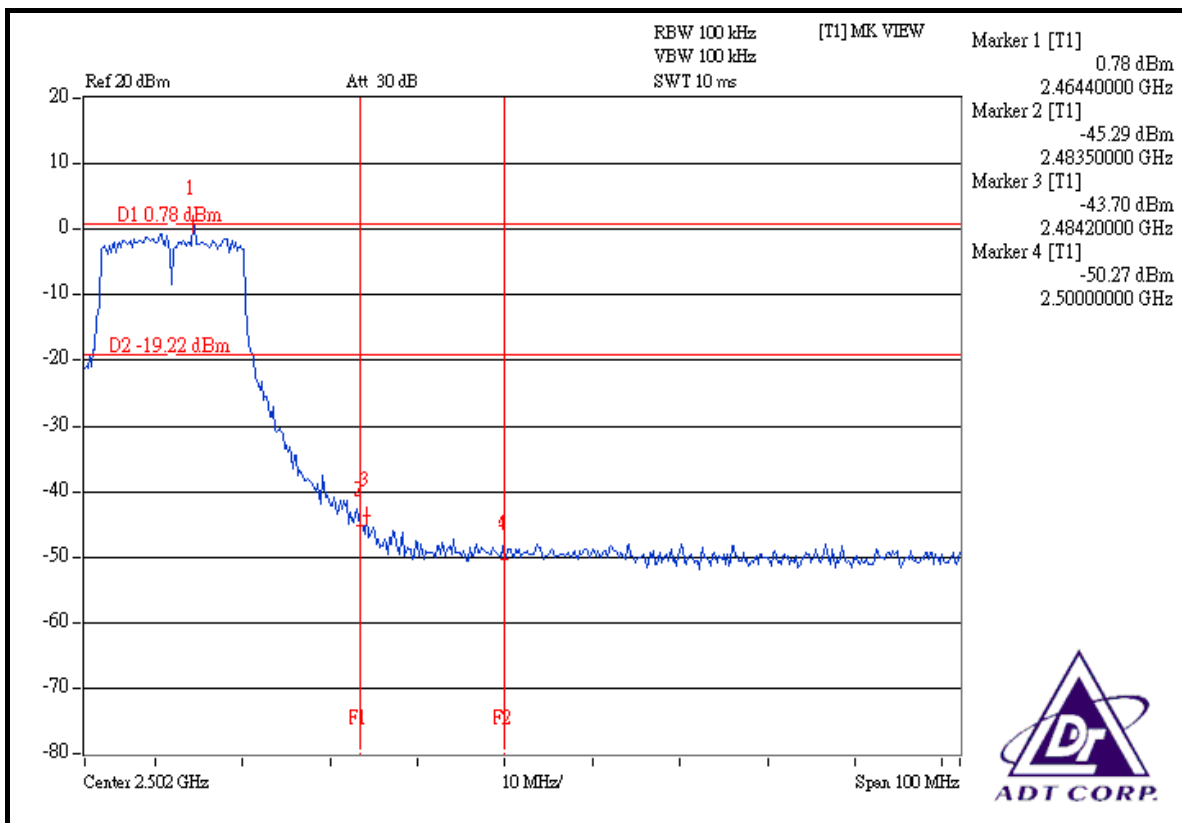
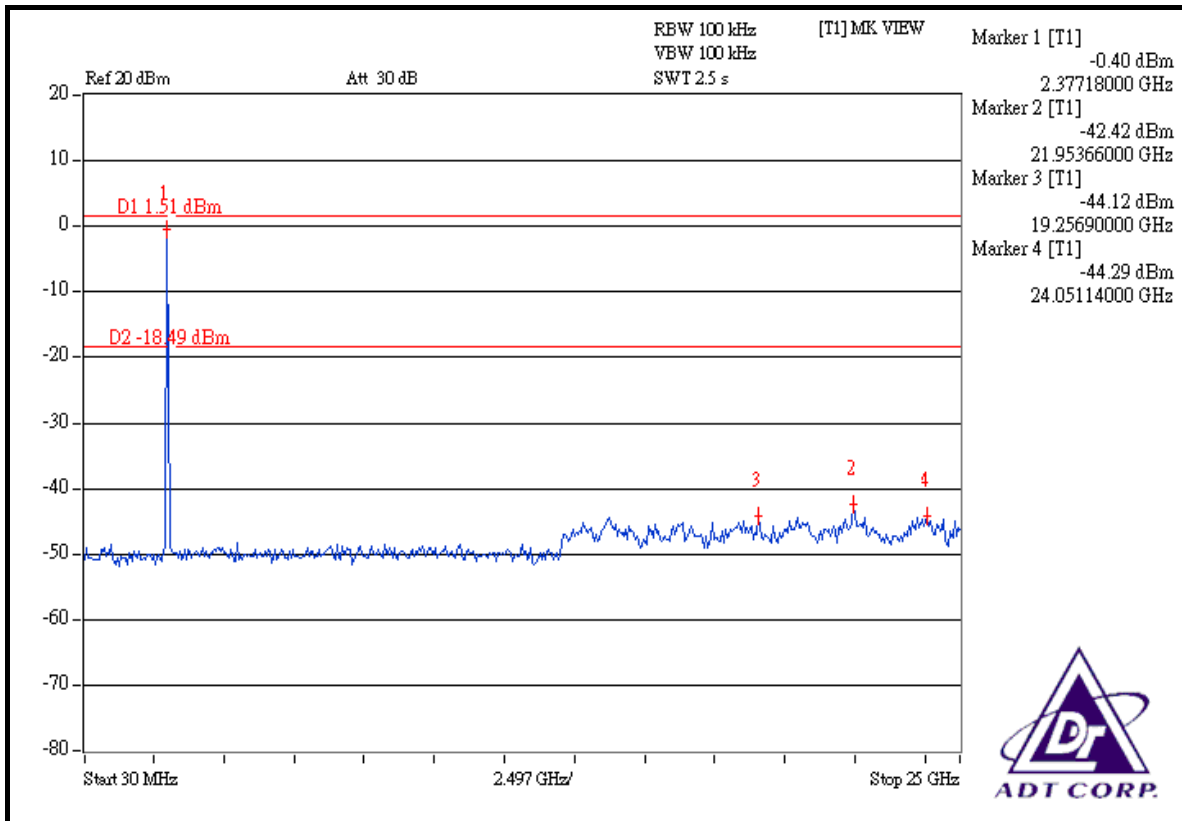

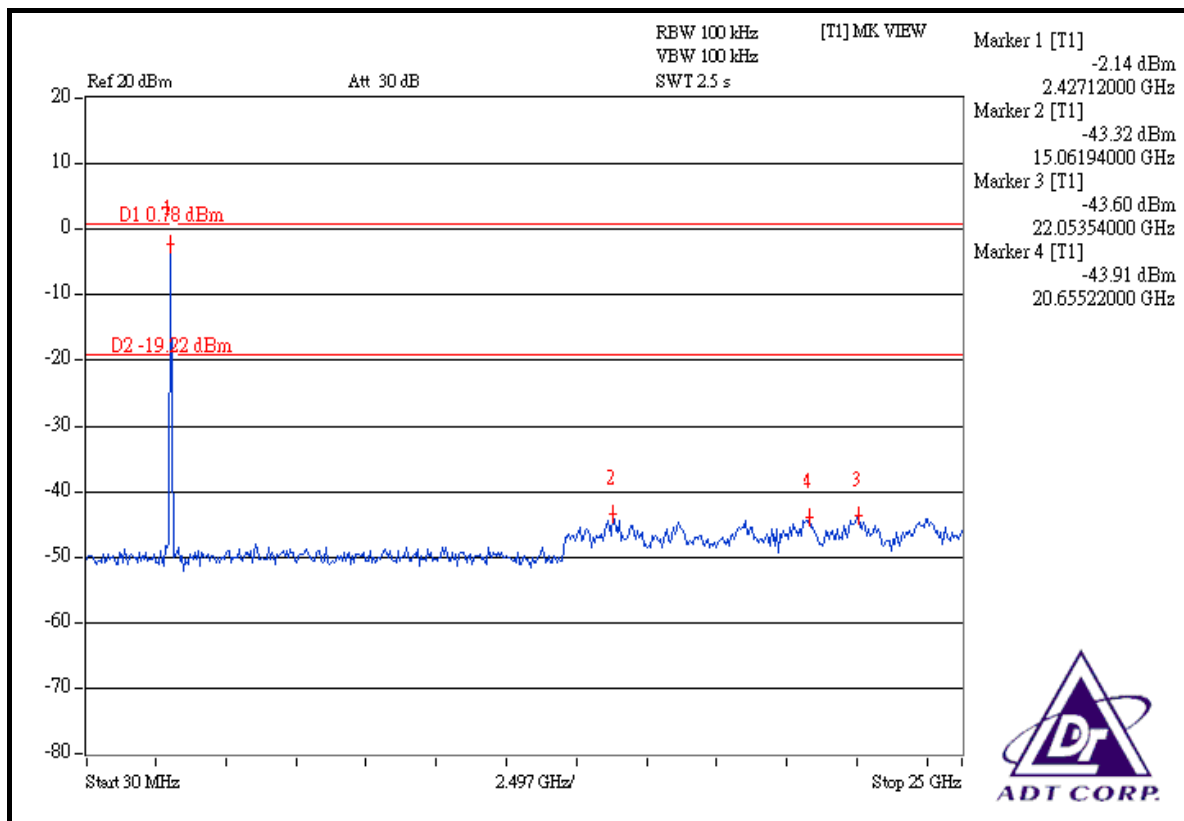
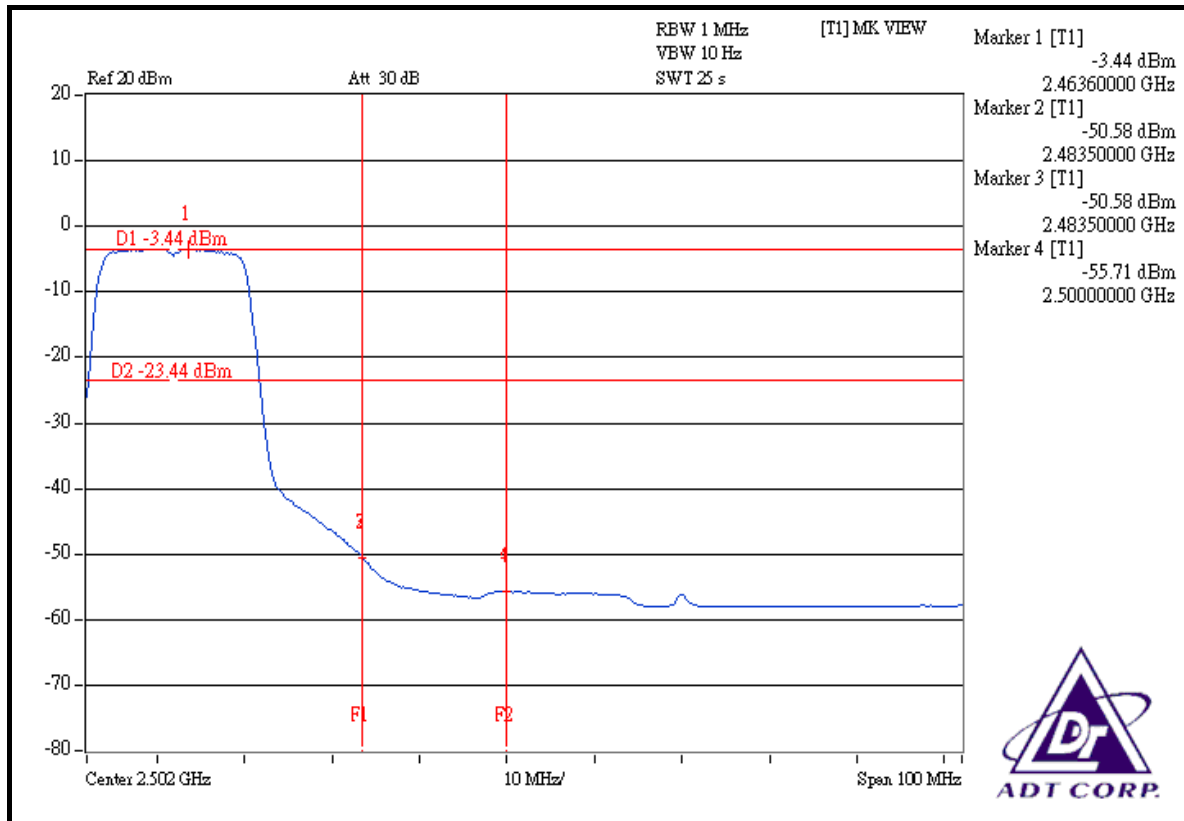



4.7 ANTENNA REQUIREMENT

4.7.1 STANDARD APPLICABLE

For intentional device, according to FCC 47 CFR Section 15.203, an intentional radiator shall be designed to ensure that no antenna other than that furnished by the responsible party shall be used with the device. And according to FCC 47 CFR Section 15.247 (b), if transmitting antennas of directional gain greater than 6dBi are used, the power shall be reduced by the amount in dB that the directional gain of the antenna exceeds 6dBi.

4.7.2 ANTENNA CONNECTED CONSTRUCTION

The antenna used in this product is Dipole antenna with Reverse SMA connector. The maximum Gain of the antenna is 4.0dBi.

5. TEST TYPES AND RESULTS (FOR 802.11a 5745~5825MHz Band)

5.1 RADIATED EMISSION MEASUREMENT

5.1.1 LIMITS OF RADIATED EMISSION MEASUREMENT

Emissions radiated outside of the specified bands, shall be according to the general radiated limits in 15.209 as following:

Frequencies (MHz)	Field strength (microvolts/meter)	Measurement distance (meters)
0.009-0.490	2400/F(kHz)	300
0.490-1.705	24000/F(kHz)	30
1.705-30.0	30	30
30-88	100	3
88-216	150	3
216-960	200	3
Above 960	500	3

NOTE:

1. The lower limit shall apply at the transition frequencies.
2. Emission level (dBuV/m) = 20 log Emission level (uV/m).
3. As shown in 15.35(b), for frequencies above 1000MHz, the field strength limits are based on average detector, however, the peak field strength of any emission shall not exceed the maximum permitted average limits, specified above by more than 20dB under any condition of modulation.



5.1.2 TEST INSTRUMENTS

DESCRIPTION & MANUFACTURER	MODEL NO.	SERIAL NO.	CALIBRATED UNTIL
Test Receiver ROHDE & SCHWARZ	ESCI	100424	Jul. 27, 2008
Spectrum Analyzer Agilent	E4446A	MY44360128	Dec. 06, 2008
BILOG Antenna SCHWARZBECK	VULB9168	9168-160	May 31, 2008
HORN Antenna SCHWARZBECK	9120D	9120D-209	Jun. 28, 2008
HORN Antenna SCHWARZBECK	BBHA 9170	BBHA9170243	Dec. 24, 2008
Preamplifier Agilent	8447D	2944A10633	Oct. 28, 2008
Preamplifier Agilent	8449B	3008A01964	Oct. 23, 2008
RF signal cable HUBER+SUHNNER	SUCOFLEX 104	283402/4	Dec. 06, 2008
RF signal cable HUBER+SUHNNER	SUCOFLEX 104	251644/4	Dec. 06, 2008
Software ADT.	ADT_Radiated_V7.6	NA	NA
Antenna Tower inn-co GmbH	MA 4000	013303	NA
Antenna Tower Controller inn-co GmbH	CO2000	017303	NA
Turn Table ADT.	TT100.	TT93021703	NA
Turn Table Controller ADT.	SC100.	SC93021703	NA

- NOTE:**
1. The calibration interval of the above test instruments is 12 months and the calibrations are traceable to NML/ROC and NIST/USA.
 2. The test was performed in HwaYa Chamber 3.
 3. The horn antenna and HP preamplifier (model: 8449B) are used only for the measurement of emission frequency above 1GHz if tested.
 4. The FCC Site Registration No. is 988962.
 5. The IC Site Registration No. is IC3789B-3.

5.1.3 TEST PROCEDURES

- a. The EUT was placed on the top of a rotating table 0.8 meters above the ground at a 3 meters semi-anechoic chamber. The table was rotated 360 degrees to determine the position of the highest radiation.
- b. The EUT was set 3 meters away from the interference-receiving antenna, which was mounted on the top of a variable-height antenna tower.
- c. The antenna is a broadband antenna, and its height is varied from one meter to four meters above the ground to determine the maximum value of the field strength. Both horizontal and vertical polarizations of the antenna are set to make the measurement.
- d. For each suspected emission, the EUT was arranged to its worst case and then the antenna was tuned to heights from 1 meter to 4 meters and the rotatable table was turned from 0 degrees to 360 degrees to find the maximum reading.
- e. The test-receiver system was set to Peak Detect Function and Specified Bandwidth with Maximum Hold Mode.
- f. If the emission level of the EUT in peak mode was lower than the limit specified, then testing could be stopped and the peak values of the EUT would be reported. Otherwise the emissions would be re-tested one by one using peak, quasi-peak or average method as specified and then reported in a data sheet.

NOTE:

1. The resolution bandwidth and video bandwidth of test receiver/spectrum analyzer is 120kHz for Peak detection (PK) and Quasi-peak detection (QP) at frequency below 1GHz.
2. The resolution bandwidth of test receiver/spectrum analyzer is 1 MHz and video bandwidth is 3MHz for Peak detection at frequency above 1GHz.
3. The resolution bandwidth of test receiver/spectrum analyzer is 1 MHz and the video bandwidth is 10kHz for Average detection (AV) at frequency above 1GHz.
4. All modes of operation were investigated and the worst-case emissions are reported.

5.1.4 DEVIATION FROM TEST STANDARD

No deviation

5.1.5 TEST SETUP

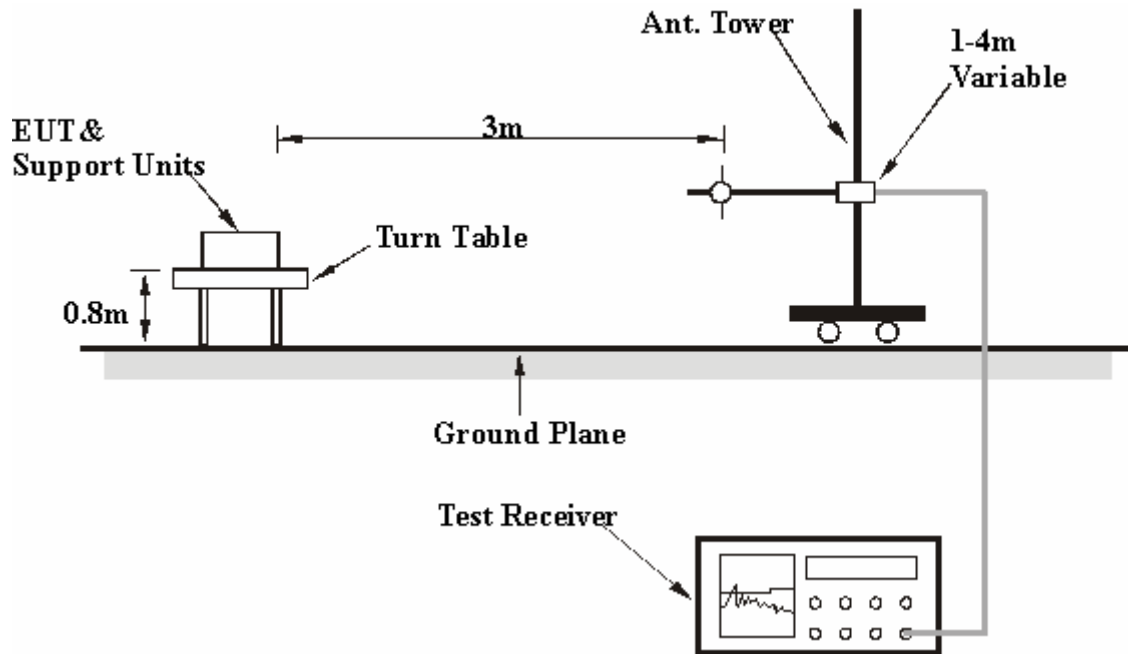

For the actual test configuration, please refer to the attached file (Test Setup Photo).

5.1.6 EUT OPERATING CONDITIONS

Same as 4.1.6

5.1.7 TEST RESULTS

802.11a OFDM modulation

EUT TEST CONDITION		MEASUREMENT DETAIL	
CHANNEL	Channel 149	FREQUENCY RANGE	1 ~ 40 GHz
MODULATION TYPE	BPSK	DETECTOR FUNCTION	Peak(PK) Average (AV)
TRANSFER RATE	6Mbps	ENVIRONMENTAL CONDITIONS	25deg. C, 68%RH, 991hPa
INPUT POWER (SYSTEM)	120Vac, 60 Hz	TEST MODE	A
TESTED BY	Dean Wang		

ANTENNA POLARITY & TEST DISTANCE: HORIZONTAL AT 3 M								
No.	Freq. (MHz)	Emission Level (dBuV/m)	Limit (dBuV/m)	Margin (dB)	Antenna Height (m)	Table Angle (Degree)	Raw Value (dBuV)	Correction Factor (dB/m)
1	5725.00	62.25 PK	77.57	-15.32	1.02 H	114	21.61	40.64
2	5725.00	43.58 AV	67.49	-23.91	1.02 H	114	2.94	40.64
3	*5745.00	97.57 PK			1.03 H	264	56.88	40.69
4	*5745.00	87.49 AV			1.03 H	264	46.80	40.69
5	#11490.00	63.49 PK	74.00	-10.51	1.03 H	168	11.63	51.86
6	#11490.00	49.57 AV	54.00	-4.43	1.03 H	168	-2.29	51.86
ANTENNA POLARITY & TEST DISTANCE: VERTICAL AT 3 M								
No.	Freq. (MHz)	Emission Level (dBuV/m)	Limit (dBuV/m)	Margin (dB)	Antenna Height (m)	Table Angle (Degree)	Raw Value (dBuV)	Correction Factor (dB/m)
1	5725.00	68.31 PK	87.86	-19.55	1.05 V	15	27.68	40.64
2	5725.00	49.95 AV	77.71	-27.76	1.05 V	15	9.31	40.64
3	*5745.00	107.86 PK			1.04 V	15	67.17	40.69
4	*5745.00	97.71 AV			1.04 V	15	57.02	40.69
5	#11490.00	66.74 PK	74.00	-7.26	1.07 V	167	14.87	51.86
6	#11490.00	52.73 AV	54.00	-1.27	1.07 V	167	0.86	51.86

- NOTE:**
1. Emission level(dBuV/m)=Raw Value(dBuV) + Correction Factor(dB/m)
 2. Correction Factor(dB/m) = Antenna Factor (dB/m) + Cable Factor (dB)
 3. The other emission levels were very low against the limit.
 4. Margin value = Emission level – Limit value
 5. "*" : Fundamental frequency
 6. "#"The radiated frequency falling in the restricted band.
 7. The limit value is defined as per 15.247

EUT TEST CONDITION		MEASUREMENT DETAIL	
CHANNEL	Channel 157	FREQUENCY RANGE	1 ~ 40 GHz
MODULATION TYPE	BPSK	DETECTOR FUNCTION	Peak(PK) Average (AV)
TRANSFER RATE	6Mbps	ENVIRONMENTAL CONDITIONS	25deg. C, 68%RH, 991hPa
INPUT POWER (SYSTEM)	120Vac, 60 Hz	TEST MODE	A
TESTED BY	Dean Wang		

ANTENNA POLARITY & TEST DISTANCE: HORIZONTAL AT 3 M								
No.	Freq. (MHz)	Emission Level (dBuV/m)	Limit (dBuV/m)	Margin (dB)	Antenna Height (m)	Table Angle (Degree)	Raw Value (dBuV)	Correction Factor (dB/m)
1	*5785.00	97.28 PK			1.05 H	116	56.49	40.79
2	*5785.00	87.16 AV			1.05 H	116	46.37	40.79
3	#11570.00	63.21 PK	74.00	-10.79	1.02 H	175	11.61	51.60
4	#11570.00	49.72 AV	54.00	-4.28	1.02 H	175	-1.88	51.60
ANTENNA POLARITY & TEST DISTANCE: VERTICAL AT 3 M								
No.	Freq. (MHz)	Emission Level (dBuV/m)	Limit (dBuV/m)	Margin (dB)	Antenna Height (m)	Table Angle (Degree)	Raw Value (dBuV)	Correction Factor (dB/m)
1	*5785.00	107.35 PK			1.02 V	116	66.56	40.79
2	*5785.00	97.38 AV			1.02 V	116	56.59	40.79
3	#11570.00	66.49 PK	74.00	-7.51	1.02 V	186	14.89	51.60
4	#11570.00	52.59 AV	54.00	-1.41	1.02 V	186	0.99	51.60

- NOTE:**
1. Emission level(dBuV/m)=Raw Value(dBuV) + Correction Factor(dB/m)
 2. Correction Factor(dB/m) = Antenna Factor (dB/m) + Cable Factor (dB)
 3. The other emission levels were very low against the limit.
 4. Margin value = Emission level – Limit value
 5. "*" : Fundamental frequency
 6. "#"The radiated frequency falling in the restricted band.
 7. The limit value is defined as per 15.247

EUT TEST CONDITION		MEASUREMENT DETAIL	
CHANNEL	Channel 165	FREQUENCY RANGE	1 ~ 40 GHz
MODULATION TYPE	BPSK	DETECTOR FUNCTION	Peak(PK) Average (AV)
TRANSFER RATE	6Mbps	ENVIRONMENTAL CONDITIONS	25deg. C, 68%RH, 991hPa
INPUT POWER (SYSTEM)	120Vac, 60 Hz	TEST MODE	A
TESTED BY	Dean Wang		

ANTENNA POLARITY & TEST DISTANCE: HORIZONTAL AT 3 M								
No.	Freq. (MHz)	Emission Level (dBuV/m)	Limit (dBuV/m)	Margin (dB)	Antenna Height (m)	Table Angle (Degree)	Raw Value (dBuV)	Correction Factor (dB/m)
1	*5825.00	97.28 PK			1.02 H	31	56.42	40.86
2	*5825.00	87.19 AV			1.02 H	31	46.33	40.86
3	5850.00	52.29 PK	77.28	-24.99	1.02 H	116	11.41	40.88
4	5850.00	39.87 AV	67.19	-27.32	1.02 H	116	-1.01	40.88
5	#11650.00	63.19 PK	74.00	-10.81	1.02 H	146	11.45	51.74
6	#11650.00	49.93 AV	54.00	-4.07	1.02 H	146	-1.81	51.74
ANTENNA POLARITY & TEST DISTANCE: VERTICAL AT 3 M								
No.	Freq. (MHz)	Emission Level (dBuV/m)	Limit (dBuV/m)	Margin (dB)	Antenna Height (m)	Table Angle (Degree)	Raw Value (dBuV)	Correction Factor (dB/m)
1	*5825.00	107.04 PK			1.12 V	0	66.18	40.86
2	*5825.00	96.74 AV			1.12 V	0	55.88	40.86
3	5850.00	54.83 PK	87.04	-32.21	1.02 V	11	13.95	40.88
4	5850.00	41.57 AV	76.74	-35.17	1.02 V	11	0.69	40.88
5	#11650.00	66.12 PK	74.00	-7.88	1.06 V	172	14.38	51.74
6	#11650.00	52.62 AV	54.00	-1.38	1.06 V	172	0.88	51.74

- NOTE:**
1. Emission level(dBuV/m)=Raw Value(dBuV) + Correction Factor(dB/m)
 2. Correction Factor(dB/m) = Antenna Factor (dB/m) + Cable Factor (dB)
 3. The other emission levels were very low against the limit.
 4. Margin value = Emission level – Limit value
 5. "*" : Fundamental frequency
 6. "#"The radiated frequency falling in the restricted band.
 7. The limit value is defined as per 15.247



EUT TEST CONDITION		MEASUREMENT DETAIL	
CHANNEL	Channel 149	FREQUENCY RANGE	1 ~ 40 GHz
MODULATION TYPE	BPSK	DETECTOR FUNCTION	Peak(PK) Average (AV)
TRANSFER RATE	6Mbps	ENVIRONMENTAL CONDITIONS	25deg. C, 68%RH, 991hPa
INPUT POWER (SYSTEM)	120Vac, 60 Hz	TEST MODE	B
TESTED BY	Dean Wang		

ANTENNA POLARITY & TEST DISTANCE: HORIZONTAL AT 3 M								
No.	Freq. (MHz)	Emission Level (dBuV/m)	Limit (dBuV/m)	Margin (dB)	Antenna Height (m)	Table Angle (Degree)	Raw Value (dBuV)	Correction Factor (dB/m)
1	5725.00	61.23 PK	78.69	-17.46	1.02 H	164	20.59	40.64
2	5725.00	44.28 AV	67.35	-23.07	1.02 H	164	3.64	40.64
3	*5745.00	98.69 PK			1.00 H	178	58.00	40.69
4	*5745.00	87.35 AV			1.00 H	178	46.66	40.69
5	#11490.00	60.58 PK	74.00	-13.42	1.02 H	155	8.72	51.86
6	#11490.00	48.11 AV	54.00	-5.89	1.02 H	155	-3.75	51.86
ANTENNA POLARITY & TEST DISTANCE: VERTICAL AT 3 M								
No.	Freq. (MHz)	Emission Level (dBuV/m)	Limit (dBuV/m)	Margin (dB)	Antenna Height (m)	Table Angle (Degree)	Raw Value (dBuV)	Correction Factor (dB/m)
1	#5120.00	62.43 PK	74.00	-11.57	1.02 V	179	23.08	39.35
2	#5120.00	52.59 AV	54.00	-1.41	1.02 V	179	13.24	39.35
3	5725.00	69.81 PK	94.28	-24.47	1.15 V	172	29.17	40.64
4	5725.00	52.74 AV	83.60	-30.86	1.15 V	172	12.10	40.64
5	*5745.00	114.28 PK			1.30 V	173	73.59	40.69
6	*5745.00	103.60 AV			1.30 V	173	62.91	40.69
7	#11490.00	62.89 PK	74.00	-11.11	1.00 V	126	11.02	51.86
8	#11490.00	49.75 AV	54.00	-4.25	1.00 V	126	-2.12	51.86

- NOTE:**
1. Emission level(dBuV/m)=Raw Value(dBuV) + Correction Factor(dB/m)
 2. Correction Factor(dB/m) = Antenna Factor (dB/m) + Cable Factor (dB)
 3. The other emission levels were very low against the limit.
 4. Margin value = Emission level – Limit value
 5. "*" : Fundamental frequency
 6. "#”The radiated frequency falling in the restricted band.
 7. The limit value is defined as per 15.247

EUT TEST CONDITION		MEASUREMENT DETAIL	
CHANNEL	Channel 157	FREQUENCY RANGE	1 ~ 40 GHz
MODULATION TYPE	BPSK	DETECTOR FUNCTION	Peak(PK) Average (AV)
TRANSFER RATE	6Mbps	ENVIRONMENTAL CONDITIONS	25deg. C, 68%RH, 991hPa
INPUT POWER (SYSTEM)	120Vac, 60 Hz	TEST MODE	B
TESTED BY	Dean Wang		

ANTENNA POLARITY & TEST DISTANCE: HORIZONTAL AT 3 M								
No.	Freq. (MHz)	Emission Level (dBuV/m)	Limit (dBuV/m)	Margin (dB)	Antenna Height (m)	Table Angle (Degree)	Raw Value (dBuV)	Correction Factor (dB/m)
1	*5785.00	98.26 PK			1.02 H	168	57.47	40.79
2	*5785.00	88.37 AV			1.02 H	168	47.58	40.79
3	#11570.00	60.85 PK	74.00	-13.15	1.02 H	138	9.25	51.60
4	#11570.00	48.96 AV	54.00	-5.04	1.02 H	138	-2.64	51.60
ANTENNA POLARITY & TEST DISTANCE: VERTICAL AT 3 M								
No.	Freq. (MHz)	Emission Level (dBuV/m)	Limit (dBuV/m)	Margin (dB)	Antenna Height (m)	Table Angle (Degree)	Raw Value (dBuV)	Correction Factor (dB/m)
1	#5120.00	62.58 PK	74.00	-11.42	1.02 V	175	23.23	39.35
2	#5120.00	52.59 AV	54.00	-1.41	1.02 V	175	13.24	39.35
3	*5785.00	113.28 PK			1.02 V	169	72.49	40.79
4	*5785.00	102.96 AV			1.02 V	169	62.17	40.79
5	#11570.00	63.97 PK	74.00	-10.03	1.02 V	136	12.37	51.60
6	#11570.00	50.75 AV	54.00	-3.25	1.02 V	136	-0.85	51.60

- NOTE:**
1. Emission level(dBuV/m)=Raw Value(dBuV) + Correction Factor(dB/m)
 2. Correction Factor(dB/m) = Antenna Factor (dB/m) + Cable Factor (dB)
 3. The other emission levels were very low against the limit.
 4. Margin value = Emission level – Limit value
 5. "*" : Fundamental frequency
 6. "#"The radiated frequency falling in the restricted band.
 7. The limit value is defined as per 15.247



EUT TEST CONDITION		MEASUREMENT DETAIL	
CHANNEL	Channel 165	FREQUENCY RANGE	1 ~ 40 GHz
MODULATION TYPE	BPSK	DETECTOR FUNCTION	Peak(PK) Average (AV)
TRANSFER RATE	6Mbps	ENVIRONMENTAL CONDITIONS	25deg. C, 68%RH, 991hPa
INPUT POWER (SYSTEM)	120Vac, 60 Hz	TEST MODE	B
TESTED BY	Dean Wang		

ANTENNA POLARITY & TEST DISTANCE: HORIZONTAL AT 3 M								
No.	Freq. (MHz)	Emission Level (dBuV/m)	Limit (dBuV/m)	Margin (dB)	Antenna Height (m)	Table Angle (Degree)	Raw Value (dBuV)	Correction Factor (dB/m)
1	*5825.00	97.58 PK			1.00 H	168	56.72	40.86
2	*5825.00	87.96 AV			1.00 H	168	47.10	40.86
3	5850.00	56.12 PK	77.58	-21.46	1.02 H	158	15.24	40.88
4	5850.00	40.55 AV	67.96	-27.41	1.02 H	158	-0.33	40.88
5	#11650.00	61.25 PK	74.00	-12.75	1.02 H	221	9.51	51.74
6	#11650.00	48.65 AV	54.00	-5.35	1.02 H	221	-3.09	51.74
ANTENNA POLARITY & TEST DISTANCE: VERTICAL AT 3 M								
No.	Freq. (MHz)	Emission Level (dBuV/m)	Limit (dBuV/m)	Margin (dB)	Antenna Height (m)	Table Angle (Degree)	Raw Value (dBuV)	Correction Factor (dB/m)
1	#5120.00	62.70 PK	74.00	-11.30	1.02 V	174	23.35	39.35
2	#5120.00	52.66 AV	54.00	-1.34	1.02 V	174	13.31	39.35
3	*5825.00	112.90 PK			1.31 V	174	72.04	40.86
4	*5825.00	102.63 AV			1.31 V	174	61.77	40.86
5	5850.00	59.29 PK	92.90	-33.61	1.29 V	174	18.41	40.88
6	5850.00	44.39 AV	82.63	-38.24	1.29 V	174	3.51	40.88
7	#11650.00	63.63 PK	74.00	-10.37	1.02 V	115	11.89	51.74
8	#11650.00	50.32 AV	54.00	-3.68	1.02 V	115	-1.42	51.74

- NOTE:**
1. Emission level(dBuV/m)=Raw Value(dBuV) + Correction Factor(dB/m)
 2. Correction Factor(dB/m) = Antenna Factor (dB/m) + Cable Factor (dB)
 3. The other emission levels were very low against the limit.
 4. Margin value = Emission level – Limit value
 5. "*" : Fundamental frequency
 6. "#"The radiated frequency falling in the restricted band.
 7. The limit value is defined as per 15.247



Below 1GHz Worst-Case Data

EUT TEST CONDITION		MEASUREMENT DETAIL	
CHANNEL	Channel 165	FREQUENCY RANGE	Below 1000MHz
MODULATION TYPE	BPSK	DETECTOR FUNCTION	Quasi-Peak
TRANSFER RATE	6Mbps	ENVIRONMENTAL CONDITIONS	25deg. C, 65%RH, 991hPa
INPUT POWER (SYSTEM)	120Vac, 60 Hz	TEST MODE	A
TESTED BY	Dean Wang		

ANTENNA POLARITY & TEST DISTANCE: HORIZONTAL AT 3 M								
No.	Freq. (MHz)	Emission Level (dBuV/m)	Limit (dBuV/m)	Margin (dB)	Antenna Height (m)	Table Angle (Degree)	Raw Value (dBuV)	Correction Factor (dB/m)
1	35.73	33.17 QP	40.00	-6.83	1.50 H	145	19.19	13.97
2	105.73	36.14 QP	43.50	-7.36	2.00 H	358	25.25	10.89
3	199.05	41.71 QP	43.50	-1.79	1.50 H	103	30.37	11.34
4	249.60	43.37 QP	46.00	-2.63	1.00 H	133	29.90	13.47
5	434.31	36.69 QP	46.00	-9.31	1.50 H	172	17.84	18.85
6	558.75	36.95 QP	46.00	-9.05	1.50 H	331	15.49	21.46
7	751.23	41.20 QP	46.00	-4.80	1.00 H	172	15.55	25.65

ANTENNA POLARITY & TEST DISTANCE: VERTICAL AT 3 M								
No.	Freq. (MHz)	Emission Level (dBuV/m)	Limit (dBuV/m)	Margin (dB)	Antenna Height (m)	Table Angle (Degree)	Raw Value (dBuV)	Correction Factor (dB/m)
1	55.18	38.21 QP	40.00	-1.79	1.00 V	142	23.78	14.42
2	105.73	37.44 QP	43.50	-6.06	1.50 V	217	26.55	10.89
3	199.05	37.21 QP	43.50	-6.29	1.00 V	94	25.87	11.34
4	500.42	37.21 QP	46.00	-8.79	1.00 V	250	16.91	20.29
5	558.75	40.12 QP	46.00	-5.88	2.00 V	31	18.66	21.46
6	683.18	42.01 QP	46.00	-3.99	1.50 V	205	18.02	23.99
7	751.23	43.85 QP	46.00	-2.15	1.50 V	199	18.20	25.65

- REMARKS:**
1. Emission level(dBuV/m)=Raw Value(dBuV) + Correction Factor(dB/m)
 2. Correction Factor(dB/m) = Antenna Factor (dB/m) + Cable Factor (dB)
 3. The other emission levels were very low against the limit.
 4. Margin value = Emission level – Limit value.



EUT TEST CONDITION		MEASUREMENT DETAIL	
CHANNEL	Channel 165	FREQUENCY RANGE	Below 1000MHz
MODULATION TYPE	BPSK	DETECTOR FUNCTION	Quasi-Peak
TRANSFER RATE	6Mbps	ENVIRONMENTAL CONDITIONS	25deg. C, 65%RH, 991hPa
INPUT POWER (SYSTEM)	120Vac, 60 Hz	TEST MODE	B
TESTED BY	Dean Wang		

ANTENNA POLARITY & TEST DISTANCE: HORIZONTAL AT 3 M								
No.	Freq. (MHz)	Emission Level (dBuV/m)	Limit (dBuV/m)	Margin (dB)	Antenna Height (m)	Table Angle (Degree)	Raw Value (dBuV)	Correction Factor (dB/m)
1	107.67	35.12 QP	43.50	-8.38	1.50 H	154	23.99	11.13
2	249.60	40.78 QP	46.00	-5.22	1.00 H	124	27.31	13.47
3	300.16	42.05 QP	46.00	-3.95	1.00 H	7	26.90	15.14
4	434.31	36.57 QP	46.00	-9.43	1.50 H	172	17.72	18.85
5	500.42	37.53 QP	46.00	-8.47	1.50 H	349	17.24	20.29
6	683.18	38.45 QP	46.00	-7.55	1.00 H	178	14.46	23.99
7	751.23	41.04 QP	46.00	-4.96	1.00 H	223	15.38	25.65
8	807.62	38.60 QP	46.00	-7.40	1.00 H	160	12.56	26.05
ANTENNA POLARITY & TEST DISTANCE: VERTICAL AT 3 M								
No.	Freq. (MHz)	Emission Level (dBuV/m)	Limit (dBuV/m)	Margin (dB)	Antenna Height (m)	Table Angle (Degree)	Raw Value (dBuV)	Correction Factor (dB/m)
1	55.18	36.63 QP	40.00	-3.37	1.00 V	91	22.21	14.42
2	105.73	36.83 QP	43.50	-6.67	1.00 V	208	25.94	10.89
3	199.05	31.27 QP	43.50	-12.23	1.50 V	97	19.93	11.34
4	249.60	35.09 QP	46.00	-10.91	1.50 V	43	21.62	13.47
5	300.16	36.56 QP	46.00	-9.44	1.50 V	343	21.42	15.14
6	558.75	39.69 QP	46.00	-6.31	1.50 V	37	18.23	21.46
7	683.18	41.50 QP	46.00	-4.50	1.50 V	187	17.51	23.99
8	751.23	43.96 QP	46.00	-2.04	1.50 V	202	18.31	25.65

- REMARKS:**
1. Emission level(dBuV/m)=Raw Value(dBuV) + Correction Factor(dB/m)
 2. Correction Factor(dB/m) = Antenna Factor (dB/m) + Cable Factor (dB)
 3. The other emission levels were very low against the limit.
 4. Margin value = Emission level – Limit value.



5.2 CONDUCTED EMISSION MEASUREMENT

5.2.1 LIMITS OF CONDUCTED EMISSION MEASUREMENT

FREQUENCY OF EMISSION (MHz)	CONDUCTED LIMIT (dB μ V)	
	Quasi-peak	Average
0.15-0.5	66 to 56	56 to 46
0.5-5	56	46
5-30	60	50

- NOTE:**
1. The lower limit shall apply at the transition frequencies.
 2. The limit decreases in line with the logarithm of the frequency in the range of 0.15 to 0.50 MHz.
 3. All emanations from a class A/B digital device or system, including any network of conductors and apparatus connected thereto, shall not exceed the level of field strengths specified above.

5.2.2 TEST INSTRUMENTS

DESCRIPTION & MANUFACTURER	MODEL NO.	SERIAL NO.	CALIBRATED UNTIL
Test Receiver ROHDE & SCHWARZ	ESCS30	100288	Sep. 21, 2008
RF signal cable Woken	5D-FB	Cable-HYCO3-01	Jan. 06, 2009
LISN ROHDE & SCHWARZ	ESH2-Z5	100100	Jan. 09, 2009
LISN SCHWARZBECK	ESH3-Z5	100311	Jan. 21, 2009
Software ADT	ADT_Cond_V3	NA	NA

- NOTE:**
1. The calibration interval of the above test instruments is 12 months and the calibrations are traceable to NML/ROC and NIST/USA.
 2. The test was performed in HwaYa Shielded Room 2.
 3. The VCCI Site Registration No. is C-2047.

5.2.3 TEST PROCEDURES

- a. The EUT was placed 0.4 meters from the conducting wall of the shielded room with EUT being connected to the power mains through a line impedance stabilization network (LISN). Other support units were connected to the power mains through another LISN. The two LISNs provide 50 ohm/ 50uH of coupling impedance for the measuring instrument.
- b. Both lines of the power mains connected to the EUT were checked for maximum conducted interference.
- c. The frequency range from 150kHz to 30MHz was searched. Emission levels under (Limit – 20dB) was not recorded.

NOTE: All modes of operation were investigated and the worst-case emissions are reported.

5.2.4 DEVIATION FROM TEST STANDARD

No deviation

5.2.5 TEST SETUP

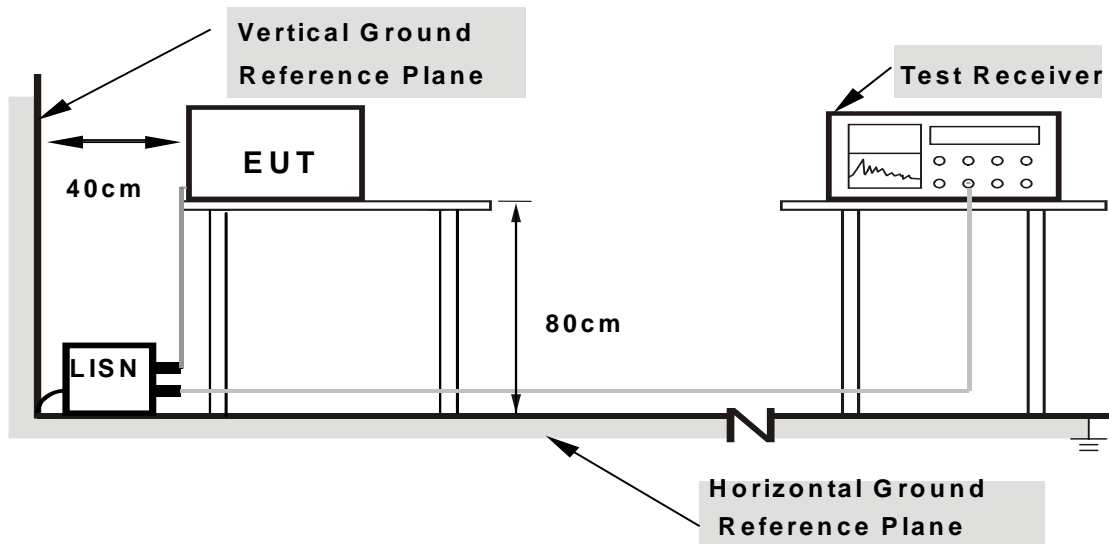

Note: 1.Support units were connected to second LISN.

2.Both of LISNs (AMN) are 80 cm from EUT and at least 80 from other units and other metal planes

For the actual test configuration, please refer to the attached file (Test Setup Photo).

5.2.6 EUT OPERATING CONDITIONS

Same as 4.1.6

5.2.7 TEST RESULTS

Conducted Worst-Case Data

EUT TEST CONDITION		MEASUREMENT DETAIL	
CHANNEL	Channel 165	PHASE	Line 1
MODULATION TYPE	BPSK	6dB BANDWIDTH	9 kHz
TRANSFER RATE	6Mbps	ENVIRONMENTAL CONDITIONS	20deg. C, 60%RH, 991hPa
INPUT POWER (SYSTEM)	120Vac, 60 Hz	TEST MODE	A
TESTED BY	Match Tsui		

No	Freq. [MHz]	Corr. Factor [dB]	Reading Value [dB (uV)]		Emission Level [dB (uV)]		Limit [dB (uV)]		Margin (dB)	
			Q.P.	AV.	Q.P.	AV.	Q.P.	AV.	Q.P.	AV.
1	0.181	0.10	42.32	-	42.42	-	64.43	54.43	-22.01	-
2	0.548	0.10	37.66	-	37.76	-	56.00	46.00	-18.24	-
3	0.732	0.11	37.49	-	37.60	-	56.00	46.00	-18.40	-
4	1.969	0.22	32.49	-	32.71	-	56.00	46.00	-23.29	-
5	8.293	0.32	43.28	-	43.60	-	60.00	50.00	-16.40	-
6	19.707	0.56	47.36	-	47.92	-	60.00	50.00	-12.08	-

- REMARKS:**
1. Q.P. and AV. are abbreviations of quasi-peak and average individually.
 2. "-": The Quasi-peak reading value also meets average limit and measurement with the average detector is unnecessary.
 3. The emission levels of other frequencies were very low against the limit.
 4. Margin value = Emission level - Limit value
 5. Correction factor = Insertion loss + Cable loss
 6. Emission Level = Correction Factor + Reading Value.

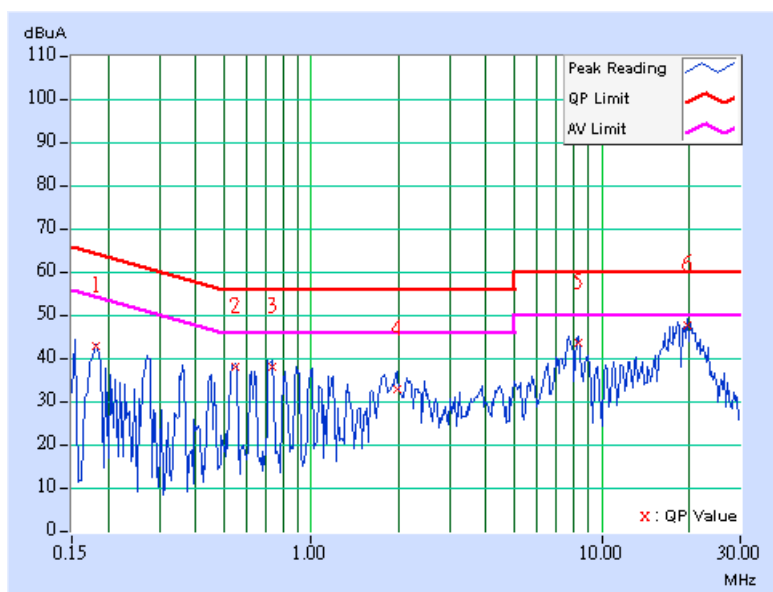

EUT TEST CONDITION		MEASUREMENT DETAIL	
CHANNEL	Channel 165	PHASE	Line 2
MODULATION TYPE	BPSK	6dB BANDWIDTH	9 kHz
TRANSFER RATE	6Mbps	ENVIRONMENTAL CONDITIONS	20deg. C, 60%RH, 991hPa
INPUT POWER (SYSTEM)	120Vac, 60 Hz	TEST MODE	A
TESTED BY	Match Tsui		

No	Freq. [MHz]	Corr. Factor [dB]	Reading Value [dB (uV)]		Emission Level [dB (uV)]		Limit [dB (uV)]		Margin (dB)	
			Q.P.	AV.	Q.P.	AV.	Q.P.	AV.	Q.P.	AV.
1	0.185	0.10	37.84	-	37.94	-	64.25	54.25	-26.31	-
2	0.552	0.13	36.49	-	36.62	-	56.00	46.00	-19.38	-
3	0.732	0.16	36.87	-	37.03	-	56.00	46.00	-18.97	-
4	1.921	0.22	34.45	-	34.67	-	56.00	46.00	-21.33	-
5	7.734	0.37	42.82	-	43.19	-	60.00	50.00	-16.81	-
6	19.707	0.56	47.92	-	48.48	-	60.00	50.00	-11.52	-

- REMARKS:**
1. Q.P. and AV. are abbreviations of quasi-peak and average individually.
 2. "-": The Quasi-peak reading value also meets average limit and measurement with the average detector is unnecessary.
 3. The emission levels of other frequencies were very low against the limit.
 4. Margin value = Emission level - Limit value
 5. Correction factor = Insertion loss + Cable loss
 6. Emission Level = Correction Factor + Reading Value.

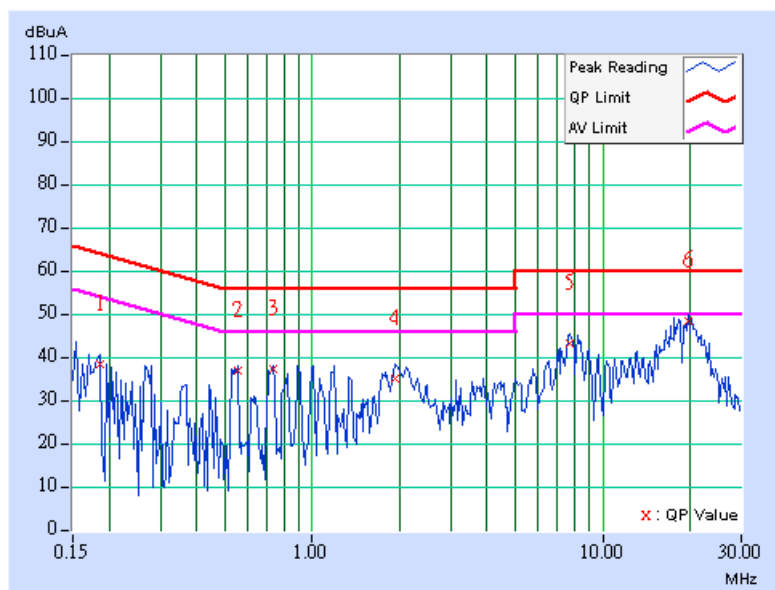



5.3 6dB BANDWIDTH MEASUREMENT

5.3.1 LIMITS OF 6dB BANDWIDTH MEASUREMENT

The minimum of 6dB Bandwidth Measurement is 0.5 MHz.

5.3.2 TEST INSTRUMENTS

Description & Manufacturer	Model No.	Serial No.	Calibrated Until
SPECTRUM ANALYZER	FSP40	100040	Jun. 28, 2008

NOTES: The calibration interval of the above test instruments is 12 months and the calibrations are traceable to NML/ROC and NIST/USA.

5.3.3 TEST PROCEDURE

The transmitter output was connected to the spectrum analyzer through an attenuator. The bandwidth of the fundamental frequency was measured by spectrum analyzer with 100kHz RBW and 100kHz VBW. The 6dB bandwidth is defined as the total spectrum the power of which is higher than peak power minus 6dB.

5.3.4 DEVIATION FROM TEST STANDARD

No deviation

5.3.5 TEST SETUP

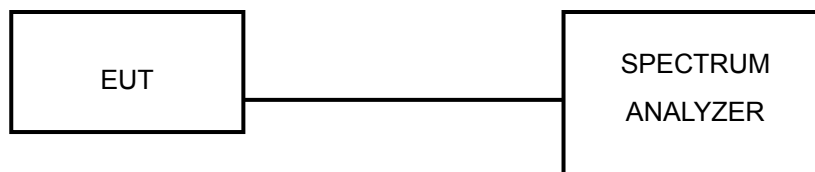

5.3.6 EUT OPERATING CONDITIONS

The software provided by client to enable the EUT under transmission condition continuously at lowest, middle and highest channel frequencies individually.

5.3.7 TEST RESULTS

802.11a OFDM modulation

MODULATION TYPE	BPSK	TRANSFER RATE	6Mbps
INPUT POWER (SYSTEM)	120Vac, 60 Hz	ENVIRONMENTAL CONDITIONS	23deg.C, 63%RH, 991hPa
TEST MODE	A	TESTED BY	Morgan Chen

CHANNEL	CHANNEL FREQUENCY (MHz)	6dB BANDWIDTH (MHz)	MINIMUM LIMIT (MHz)	PASS/FAIL
149	5745	16.40	0.5	PASS
157	5785	16.44	0.5	PASS
165	5825	16.40	0.5	PASS

CH 149

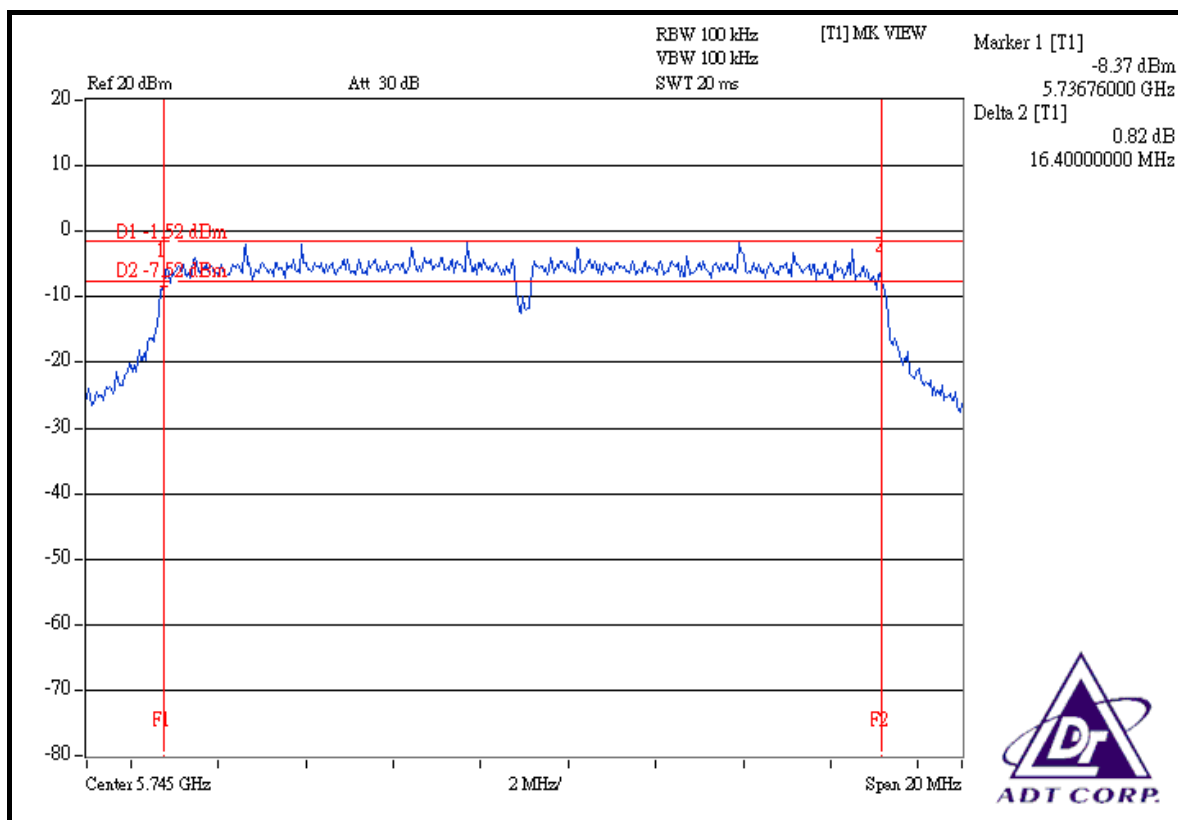

CH 157

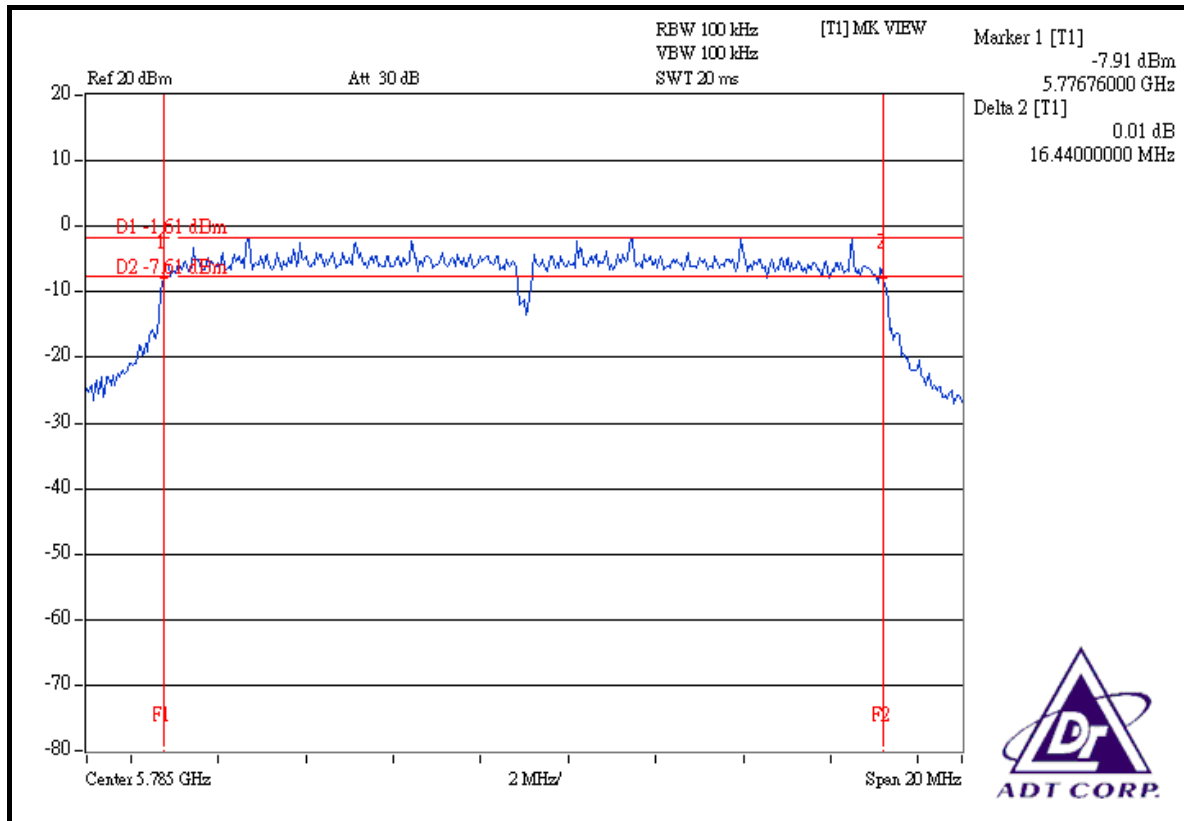

CH 165

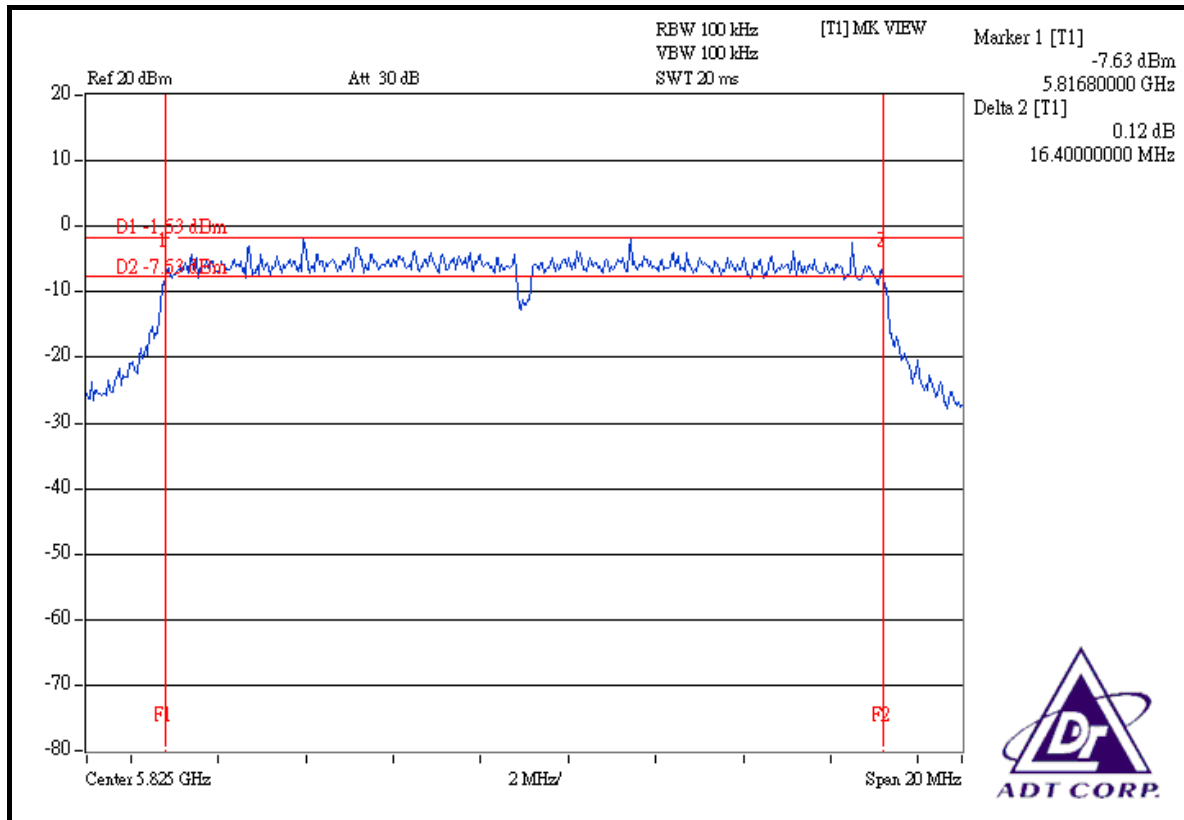



802.11a OFDM modulation

MODULATION TYPE	BPSK	TRANSFER RATE	6Mbps
INPUT POWER (SYSTEM)	120Vac, 60 Hz	ENVIRONMENTAL CONDITIONS	23deg.C, 63%RH, 991hPa
TEST MODE	B	TESTED BY	Morgan Chen

CHANNEL	CHANNEL FREQUENCY (MHz)	6dB BANDWIDTH (MHz)	MINIMUM LIMIT (MHz)	PASS/FAIL
149	5745	16.40	0.5	PASS
157	5785	16.40	0.5	PASS
165	5825	16.40	0.5	PASS

CH 149

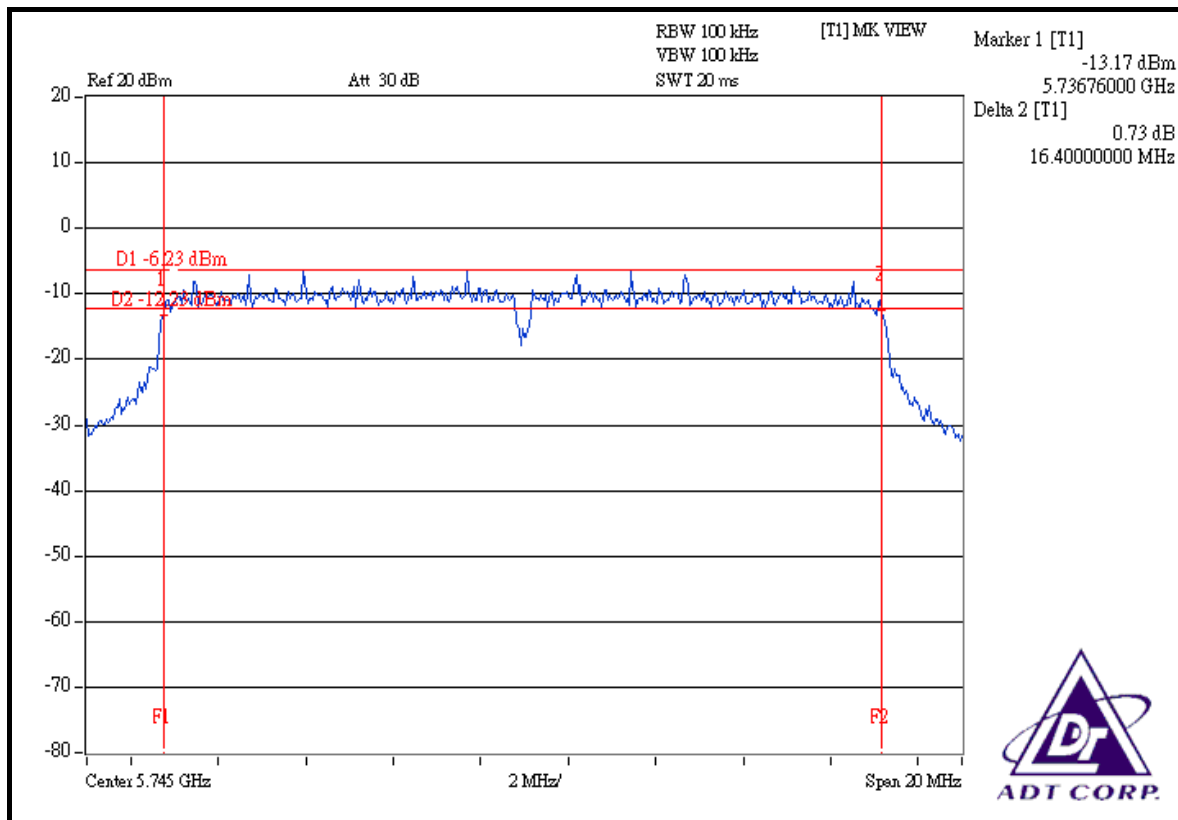

CH 157

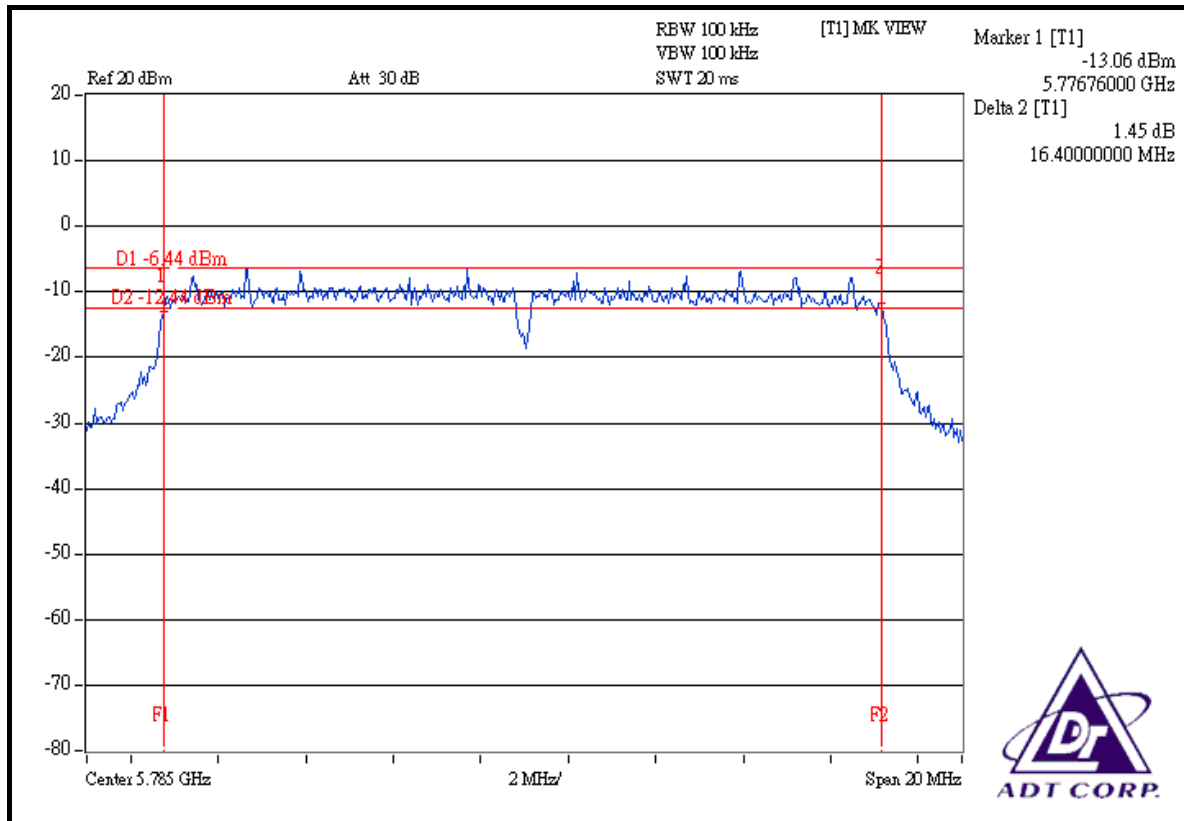

CH 165

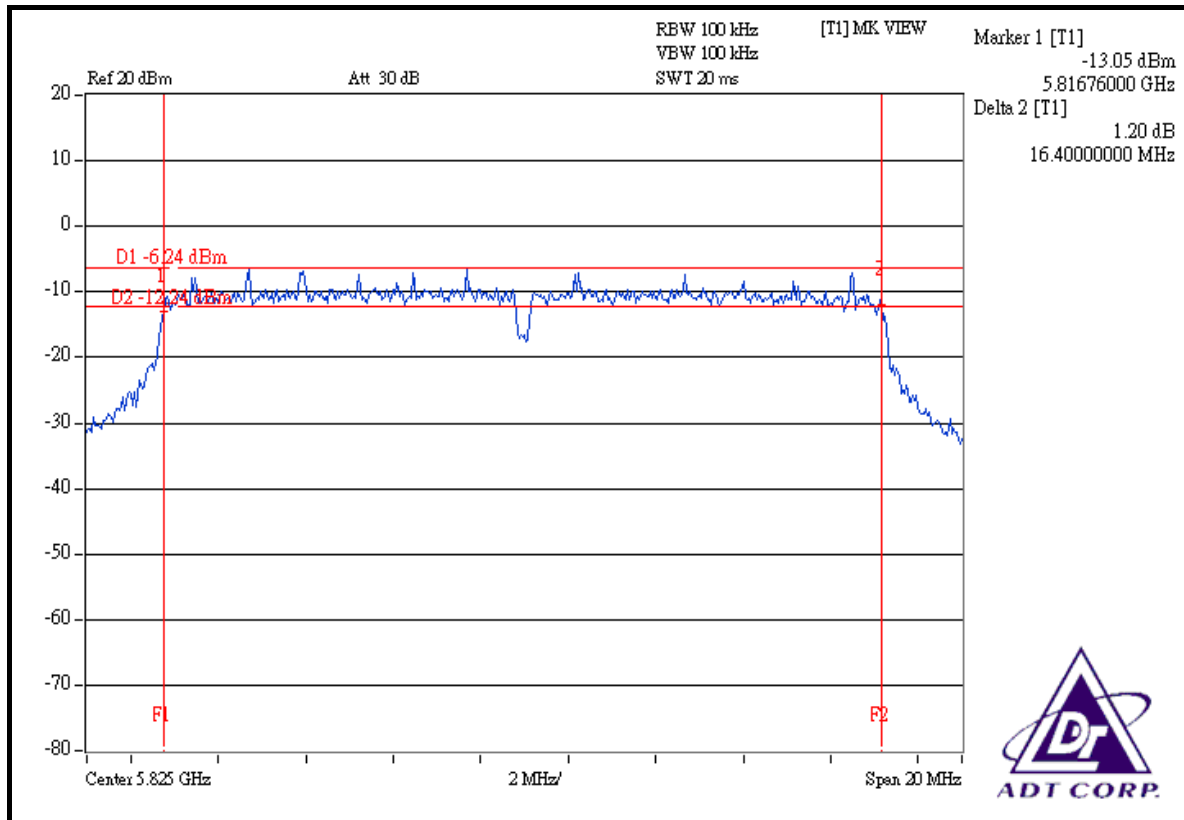



5.4 MAXIMUM PEAK OUTPUT POWER

5.4.1 LIMITS OF MAXIMUM PEAK OUTPUT POWER MEASUREMENT

The Maximum Peak Output Power Measurement is 30dBm.

5.4.2 INSTRUMENTS

Description & Manufacturer	Model No.	Serial No.	Calibrated Until
SPECTRUM ANALYZER	FSP40	100040	Jun. 28, 2008
AGILENT SIGNAL GENERATOR	E8257C	MY43320668	Dec. 28, 2007
DIGITAL RT OSCILLOSCOPE	TDS1012	C037299	Nov. 27, 2007
NARDA DETECTOR	4503A	FSCM99899	NA

NOTE:

The calibration interval of the above test instruments is 12 months and the calibrations are traceable to NML/ROC and NIST/USA.

5.4.3 TEST PROCEDURES

1. A detector was used on the output port of the EUT. An oscilloscope was used to read the response of the detector.
2. Replaced the EUT by the signal generator . The center frequency of the S.G was adjusted to the center frequency of the measured channel.
3. Adjusted the power to have the same reading on oscilloscope. Record the power level.

5.4.4 DEVIATION FROM TEST STANDARD

No deviation

5.4.5 TEST SETUP



5.4.6 EUT OPERATING CONDITIONS

Same as Item 5.3.6

5.4.7 TEST RESULTS

802.11a OFDM modulation

MODULATION TYPE	BPSK	TRANSFER RATE	6Mbps
INPUT POWER (SYSTEM)	120Vac, 60 Hz	ENVIRONMENTAL CONDITIONS	23deg.C, 63%RH, 991hPa
TEST MODE	A	TESTED BY	Morgan Chen

CHANNEL	CHANNEL FREQUENCY (MHz)	PEAK POWER OUTPUT (mW)	PEAK POWER OUTPUT (dBm)	PEAK POWER LIMIT (dBm)	PASS/FAIL
149	5745	26.002	14.15	30	PASS
157	5785	25.527	14.07	30	PASS
165	5825	25.645	14.09	30	PASS

MODULATION TYPE	BPSK	TRANSFER RATE	6Mbps
INPUT POWER (SYSTEM)	120Vac, 60 Hz	ENVIRONMENTAL CONDITIONS	23deg.C, 63%RH, 991hPa
TEST MODE	B	TESTED BY	Morgan Chen

CHANNEL	CHANNEL FREQUENCY (MHz)	PEAK POWER OUTPUT (mW)	PEAK POWER OUTPUT (dBm)	PEAK POWER LIMIT (dBm)	PASS/FAIL
149	5745	5.035	7.02	22	PASS
157	5785	5.058	7.04	22	PASS
165	5825	5.129	7.10	22	PASS

NOTE: According to 15.247(b)(4), the maximum antenna gain 14dBi is higher than 6dBi, so the limit of peak power shall be reduced by 8dB.



5.5 POWER SPECTRAL DENSITY MEASUREMENT

5.5.1 LIMITS OF POWER SPECTRAL DENSITY MEASUREMENT

The Maximum of Power Spectral Density Measurement is 8dBm.

5.5.2 TEST INSTRUMENTS

Description & Manufacturer	Model No.	Serial No.	Calibrated Until
SPECTRUM ANALYZER	FSP40	100040	Jun. 28, 2008

NOTES:

The calibration interval of the above test instruments is 12 months and the calibrations are traceable to NML/ROC and NIST/USA.

5.5.3 TEST PROCEDURE

The transmitter output was connected to the spectrum analyzer through an attenuator, the bandwidth of the fundamental frequency was measured with the spectrum analyzer using 3 kHz RBW and 30 kHz VBW, set sweep time = span/3 kHz. The power spectral density was measured and recorded.

The sweep time is allowed to be longer than span/3 kHz for a full response of the mixer in the spectrum analyzer.

5.5.4 DEVIATION FROM TEST STANDARD

No deviation

5.5.5 TEST SETUP

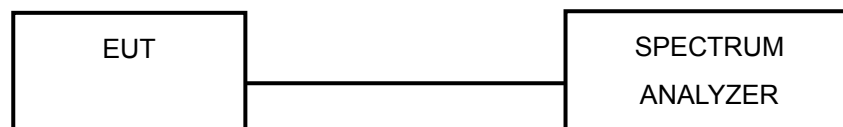

5.5.6 EUT OPERATING CONDITION

Same as Item 5.3.6



5.5.7 TEST RESULTS

802.11a OFDM modulation

MODULATION TYPE	BPSK	TRANSFER RATE	6Mbps
INPUT POWER (SYSTEM)	120Vac, 60 Hz	ENVIRONMENTAL CONDITIONS	23deg.C, 63%RH, 991hPa
TEST MODE	A	TESTED BY	Morgan Chen

CHANNEL	CHANNEL FREQUENCY (MHz)	RF POWER LEVEL IN 3 kHz BW (dBm)	MAXIMUM LIMIT (dBm)	PASS/FAIL
149	5745	-14.25	8	PASS
157	5785	-14.46	8	PASS
165	5825	-14.49	8	PASS

CH 149

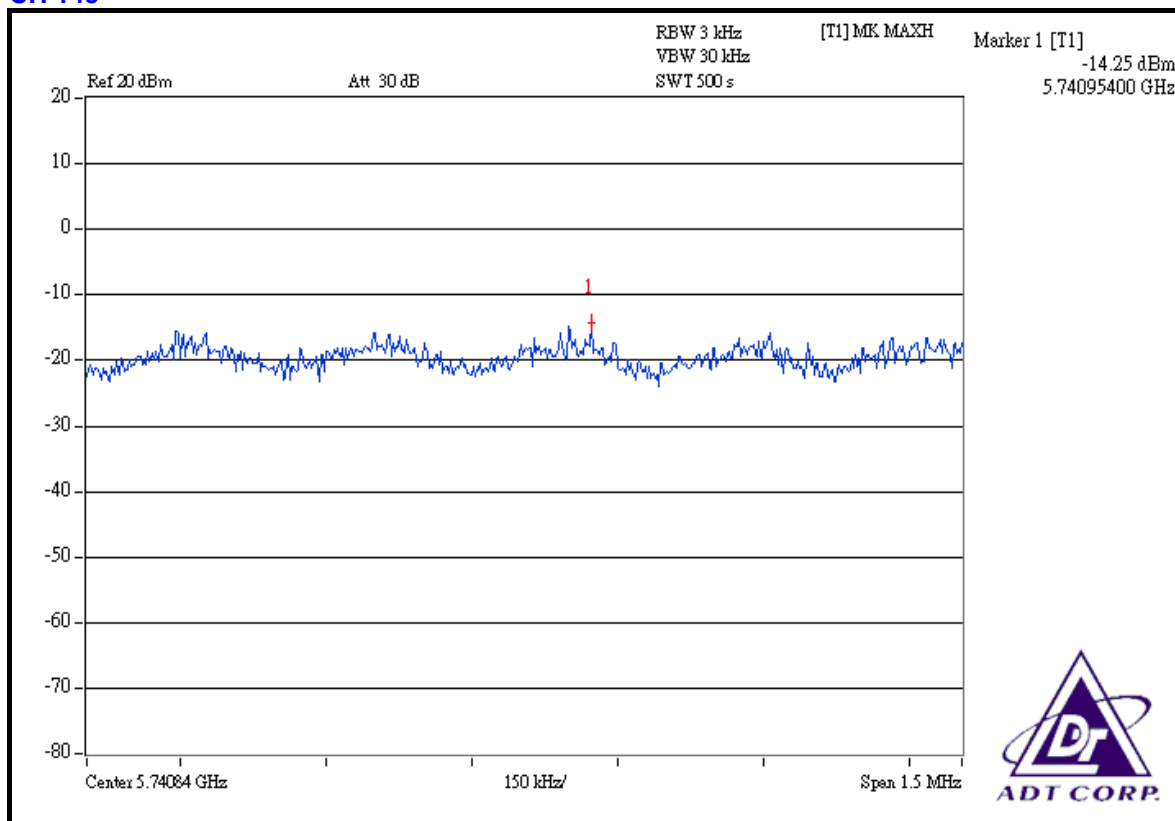



CH 157

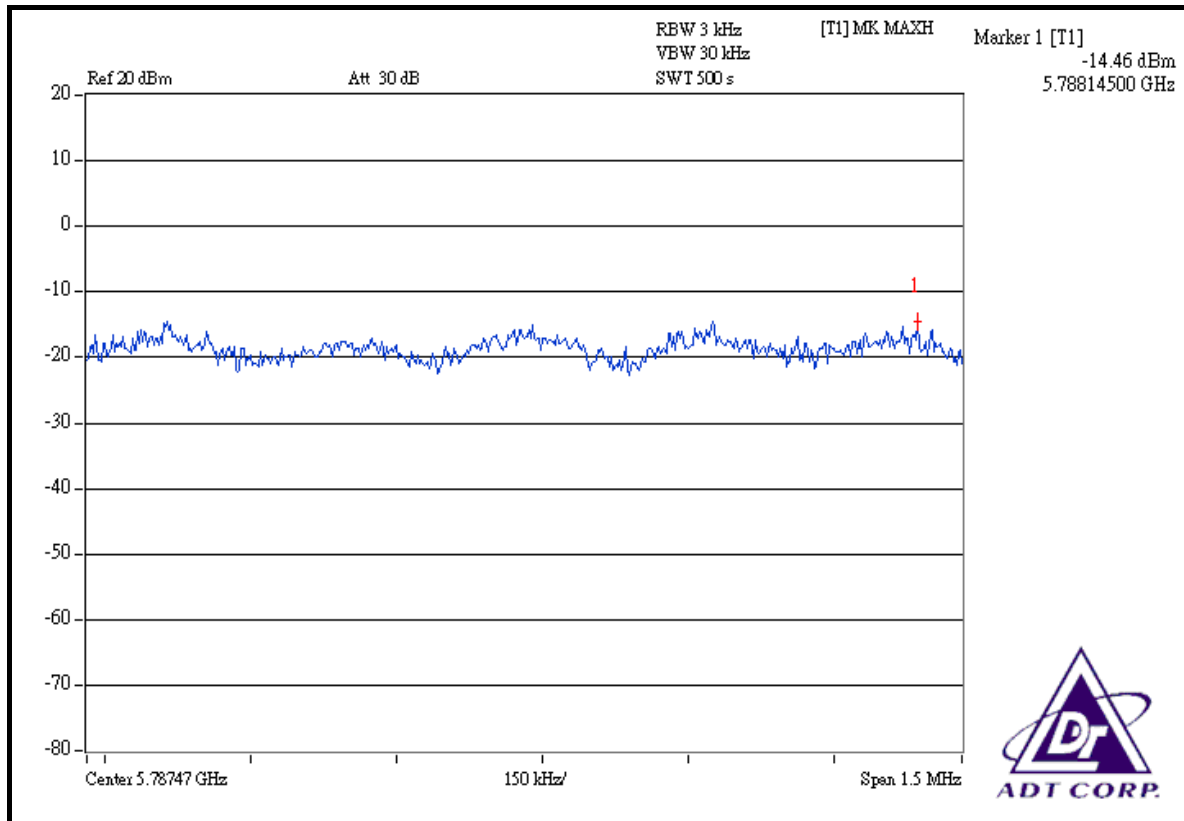

CH 165

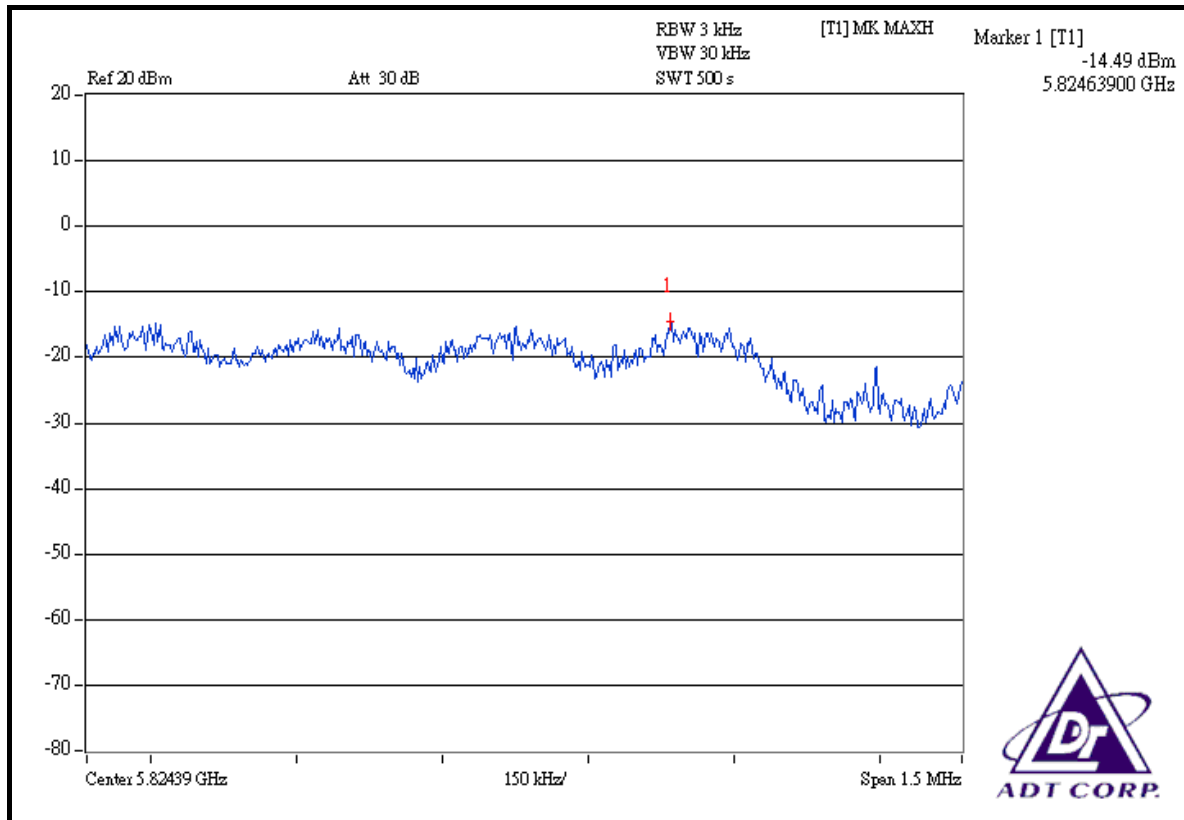



MODULATION TYPE	BPSK	TRANSFER RATE	6Mbps
INPUT POWER (SYSTEM)	120Vac, 60 Hz	ENVIRONMENTAL CONDITIONS	23deg.C, 63%RH, 991hPa
TEST MODE	B	TESTED BY	Morgan Chen

CHANNEL	CHANNEL FREQUENCY (MHz)	RF POWER LEVEL IN 3 kHz BW (dBm)	MAXIMUM LIMIT (dBm)	PASS/FAIL
149	5745	-19.33	0	PASS
157	5785	-19.38	0	PASS
165	5825	-19.29	0	PASS

NOTE: According to 15.247(b)(4), the maximum antenna gain 14dBi is higher than 6dBi, so the limit of peak power shall be reduced by 8dB.

CH 149

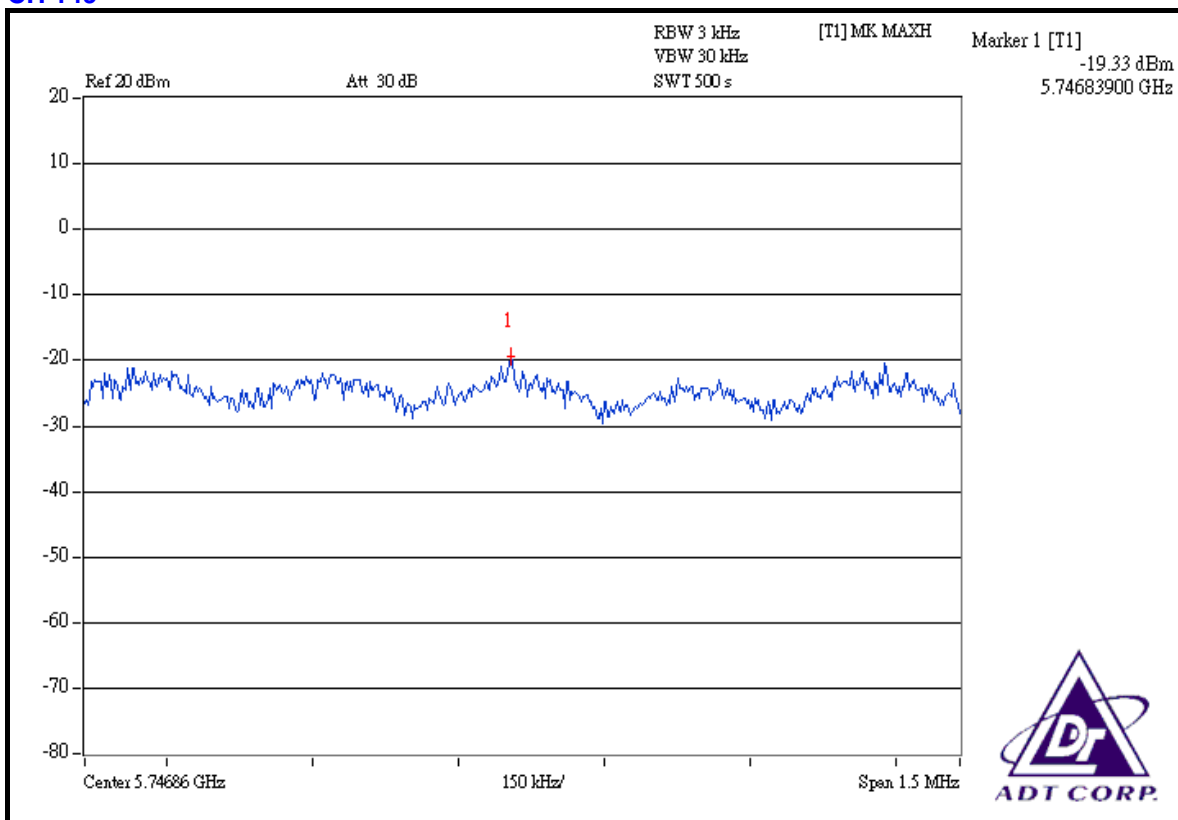



CH 157

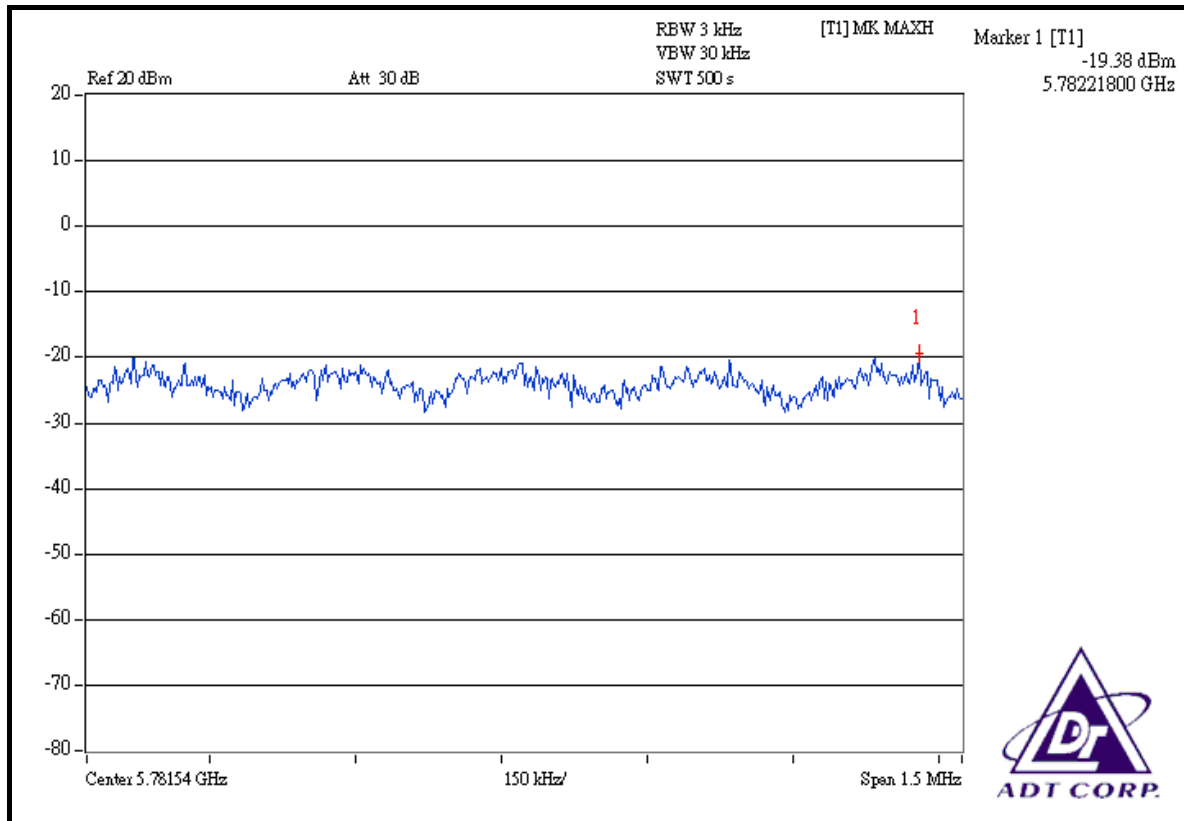

CH 165

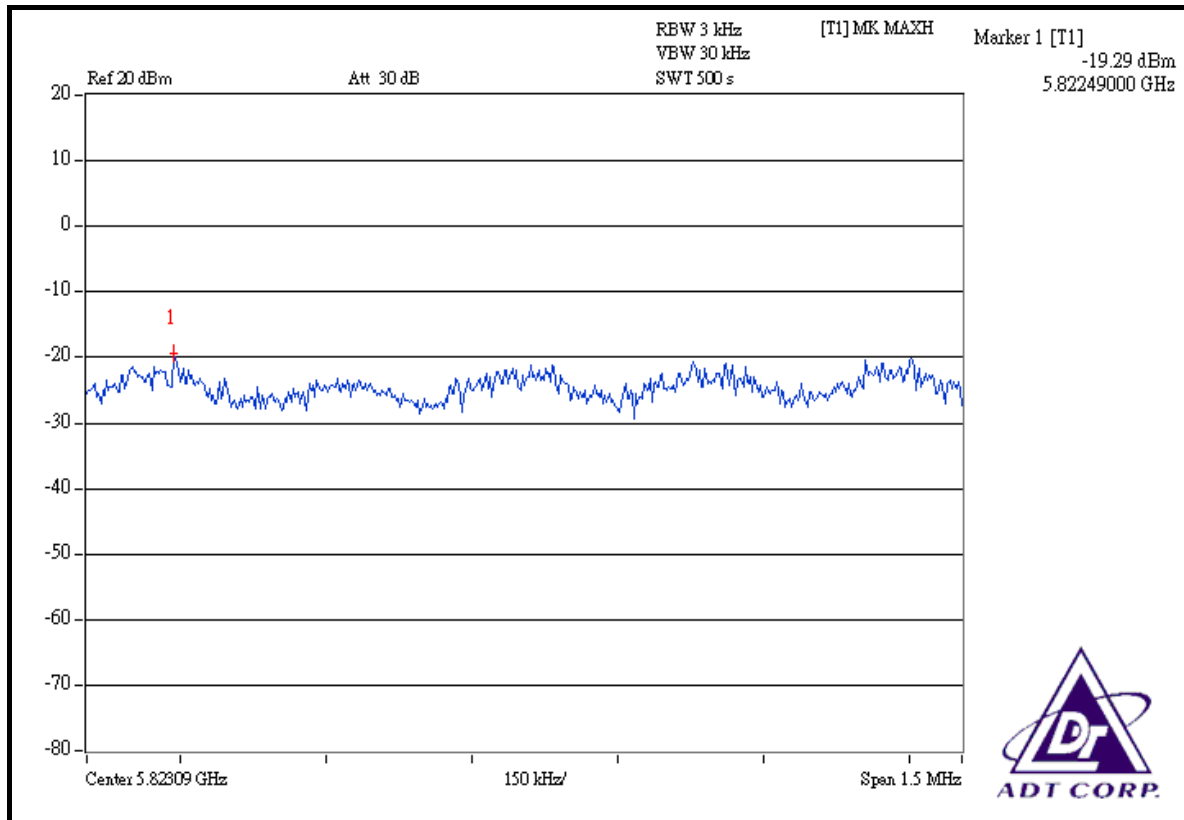



5.6 BAND EDGES MEASUREMENT

5.6.1 LIMITS OF BAND EDGES MEASUREMENT

Below -20dB of the highest emission level of operating band (in 100kHz Resolution Bandwidth).

5.6.2 TEST INSTRUMENTS

Description & Manufacturer	Model No.	Serial No.	Calibrated Until
SPECTRUM ANALYZER	FSP40	100040	Jun. 28, 2008

NOTES:

The calibration interval of the above test instruments is 12 months and the calibrations are traceable to NML/ROC and NIST/USA.

5.6.3 TEST PROCEDURE

The transmitter output was connected to the spectrum analyzer via a low loss cable. Set both RBW and VBW of spectrum analyzer to 100 kHz with suitable frequency span including 100 MHz bandwidth from band edge. The band edges was measured and recorded.

5.6.4 DEVIATION FROM TEST STANDARD

No deviation

5.6.5 EUT OPERATING CONDITION

Same as Item 5.9.6

5.6.6 TEST RESULTS

The spectrum plots are attached on the following pages. D1 line indicates the highest level, D2 line indicates the 20dB offset below D1. It shows compliance with the requirement in part 15.247(d).



TEST MODE A

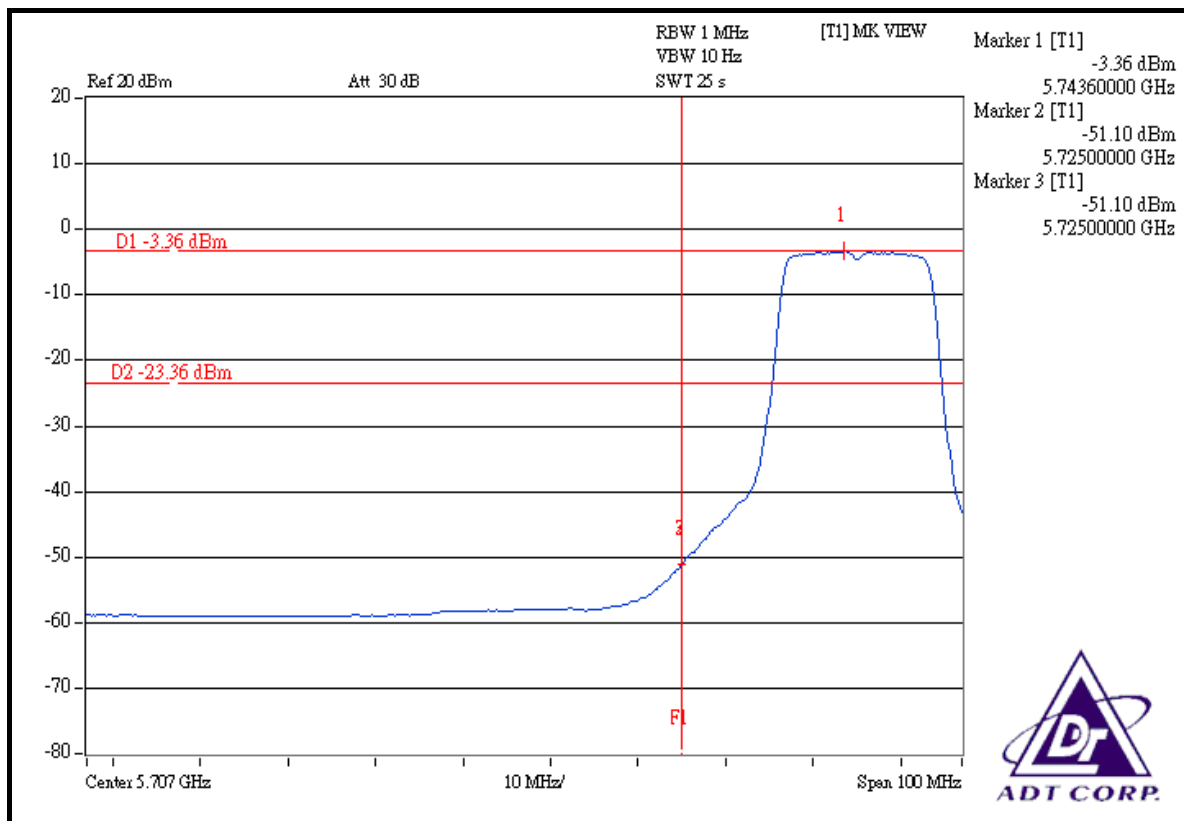
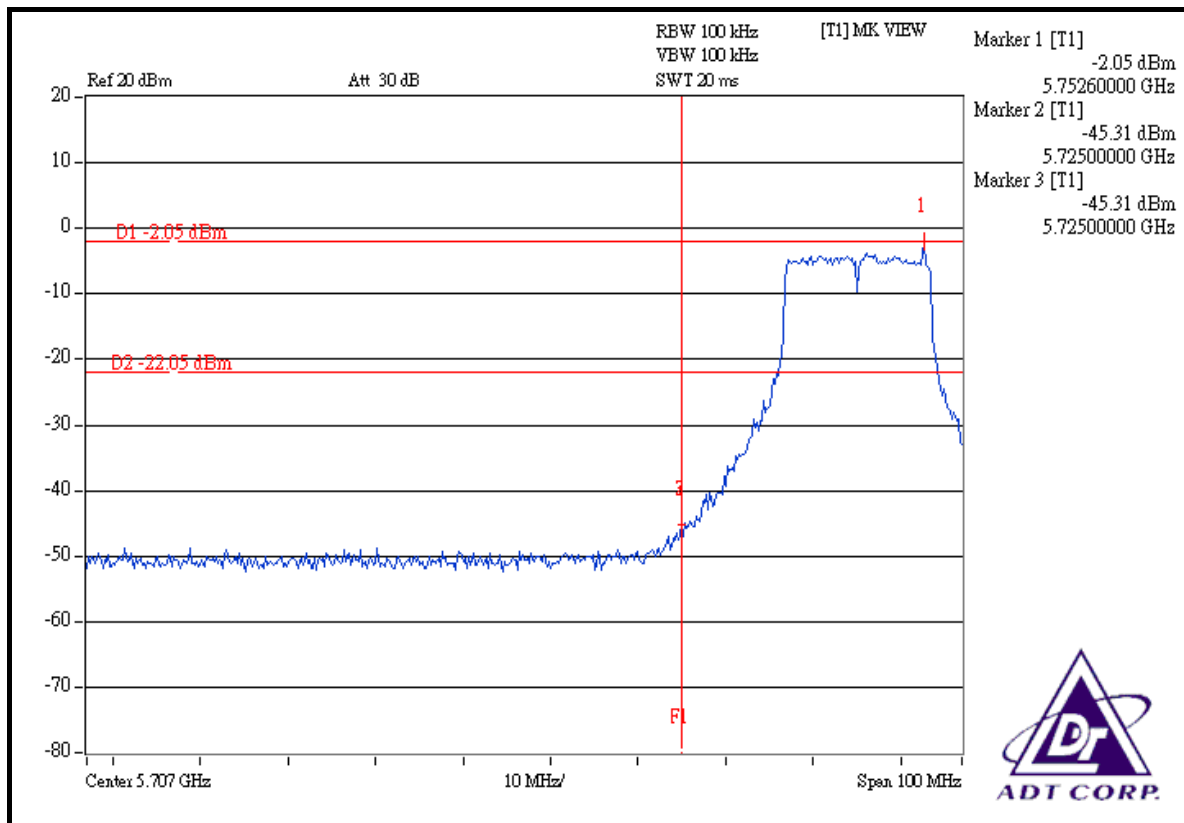

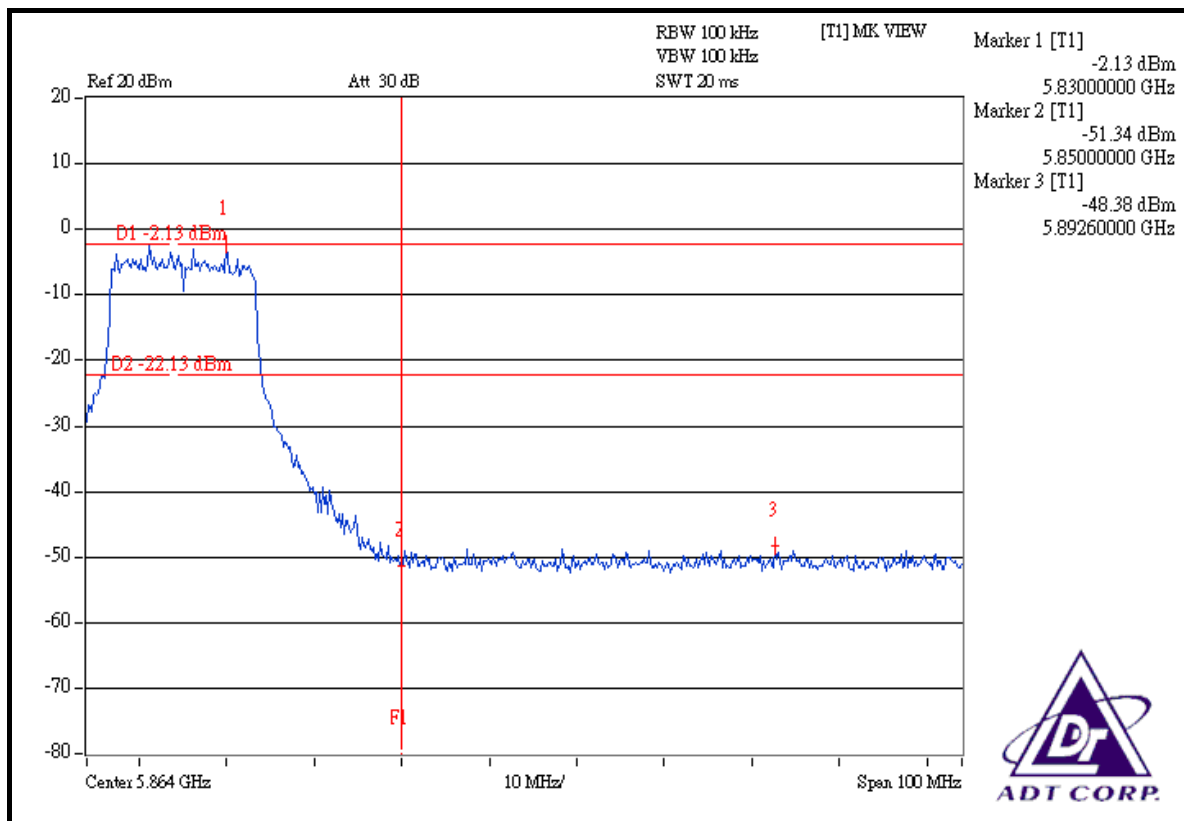
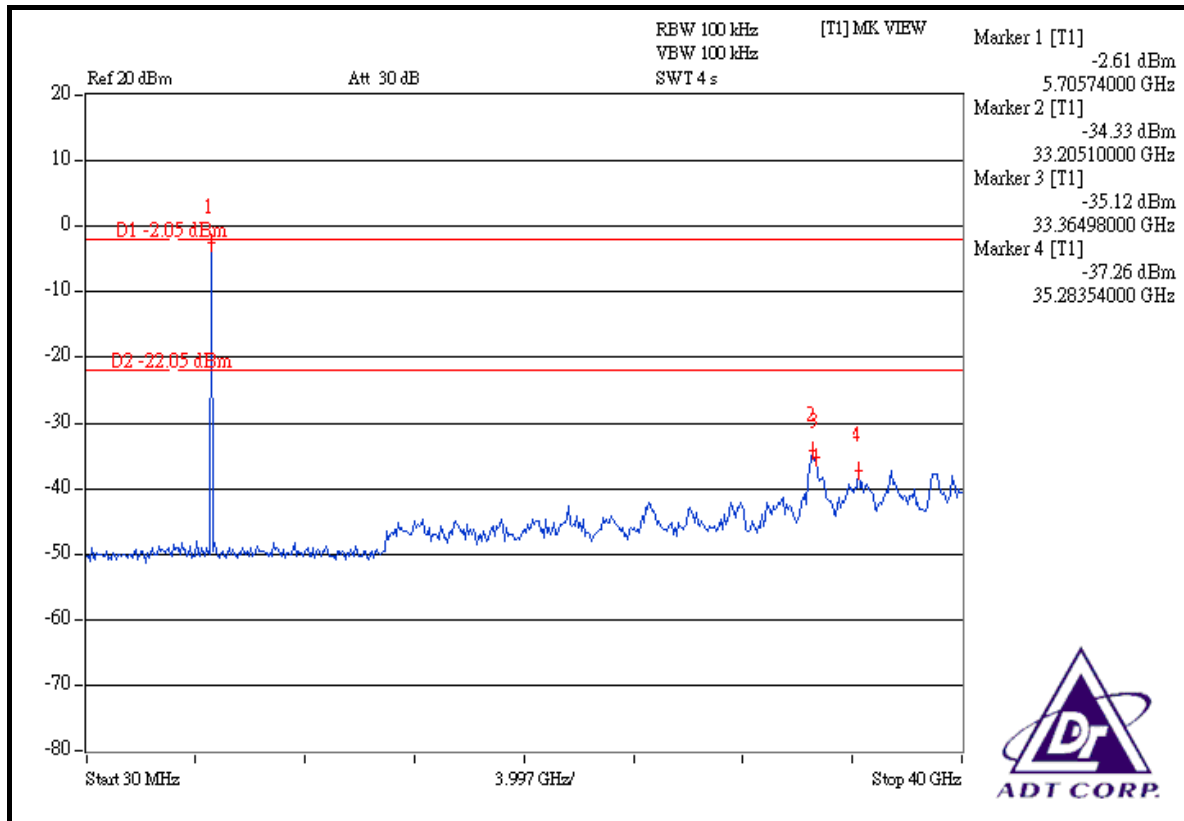

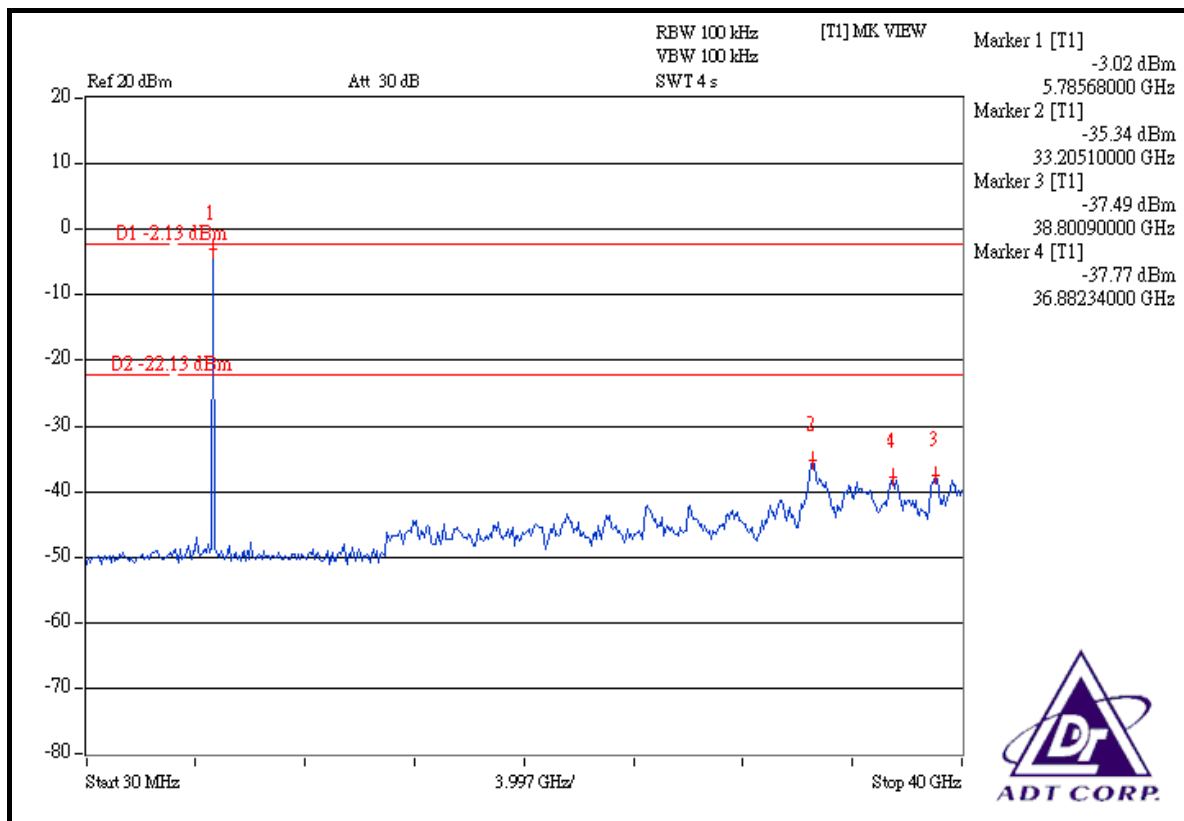
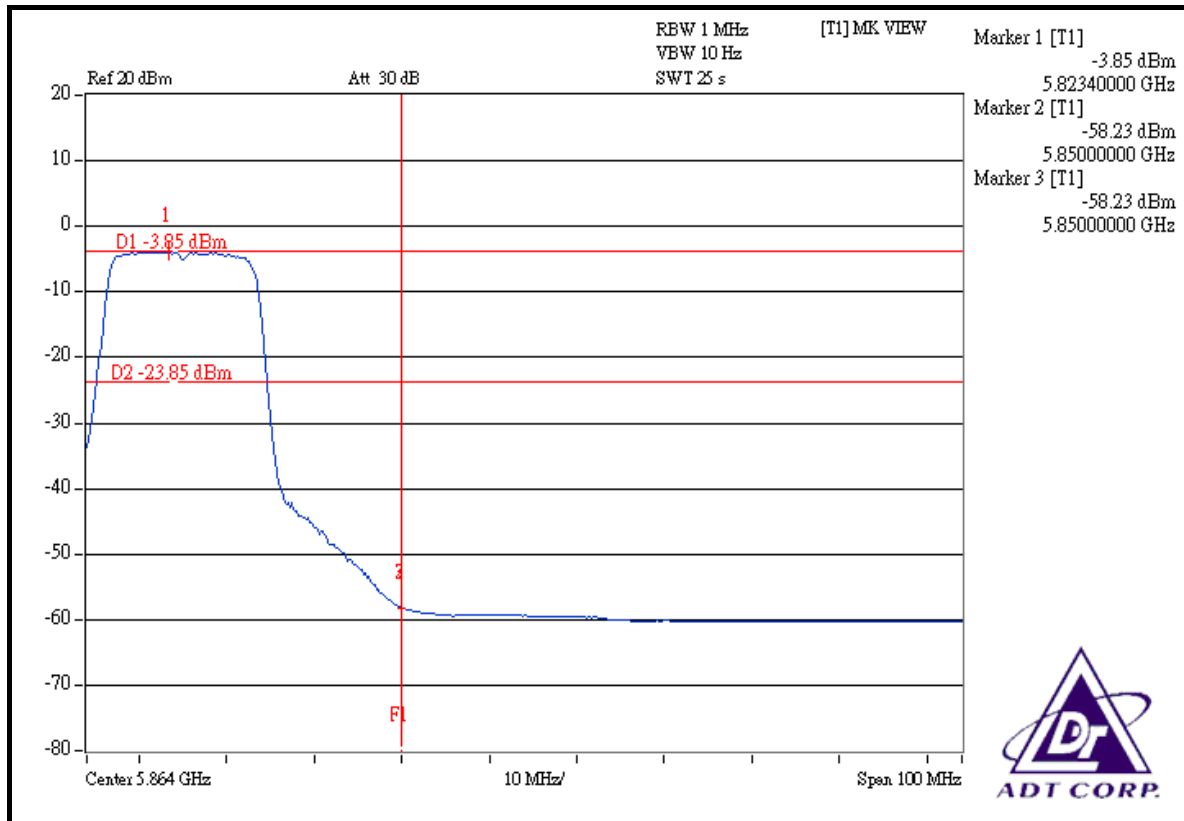



TEST MODE B

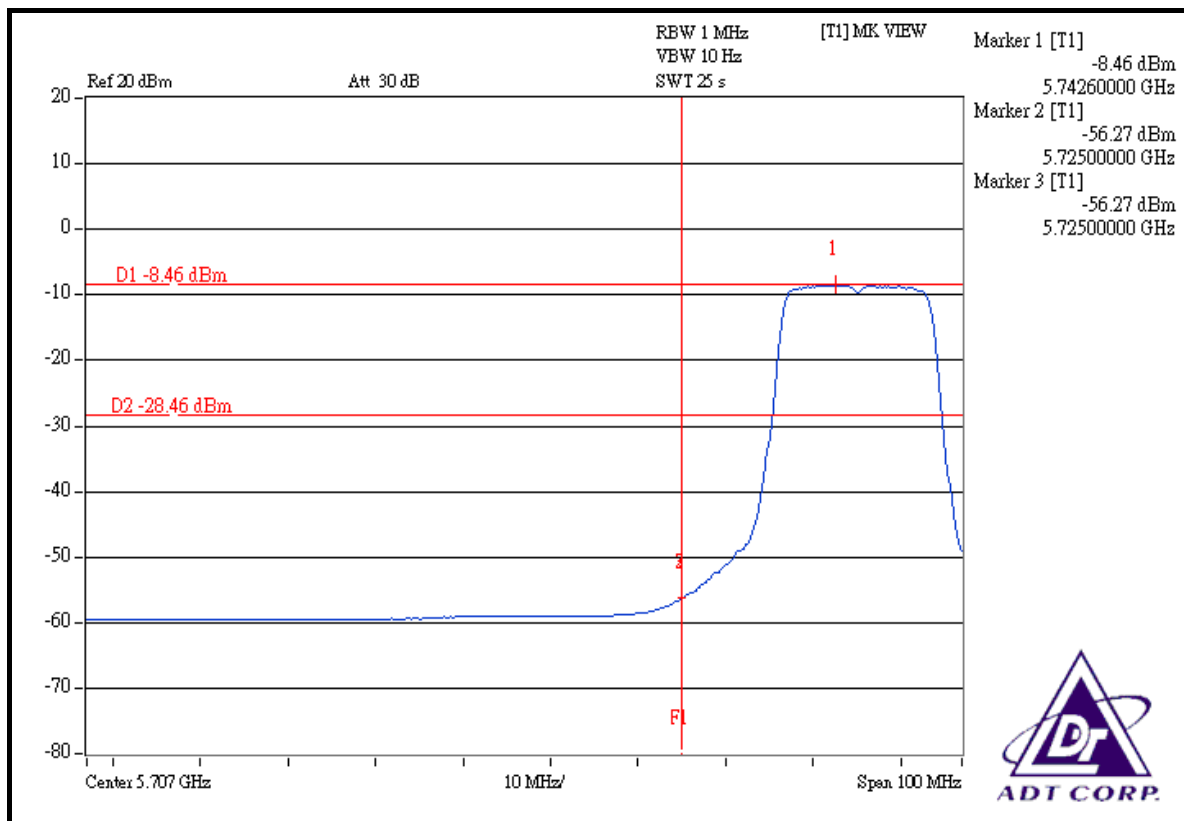
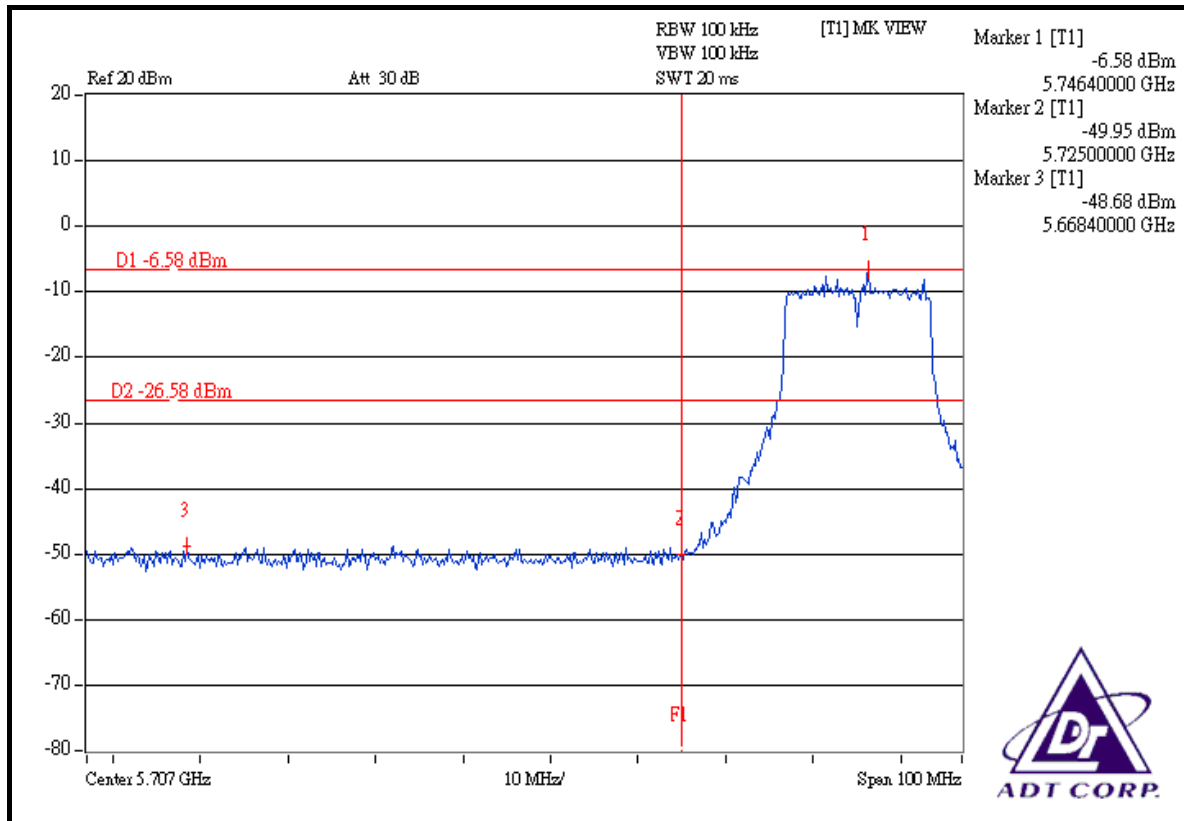

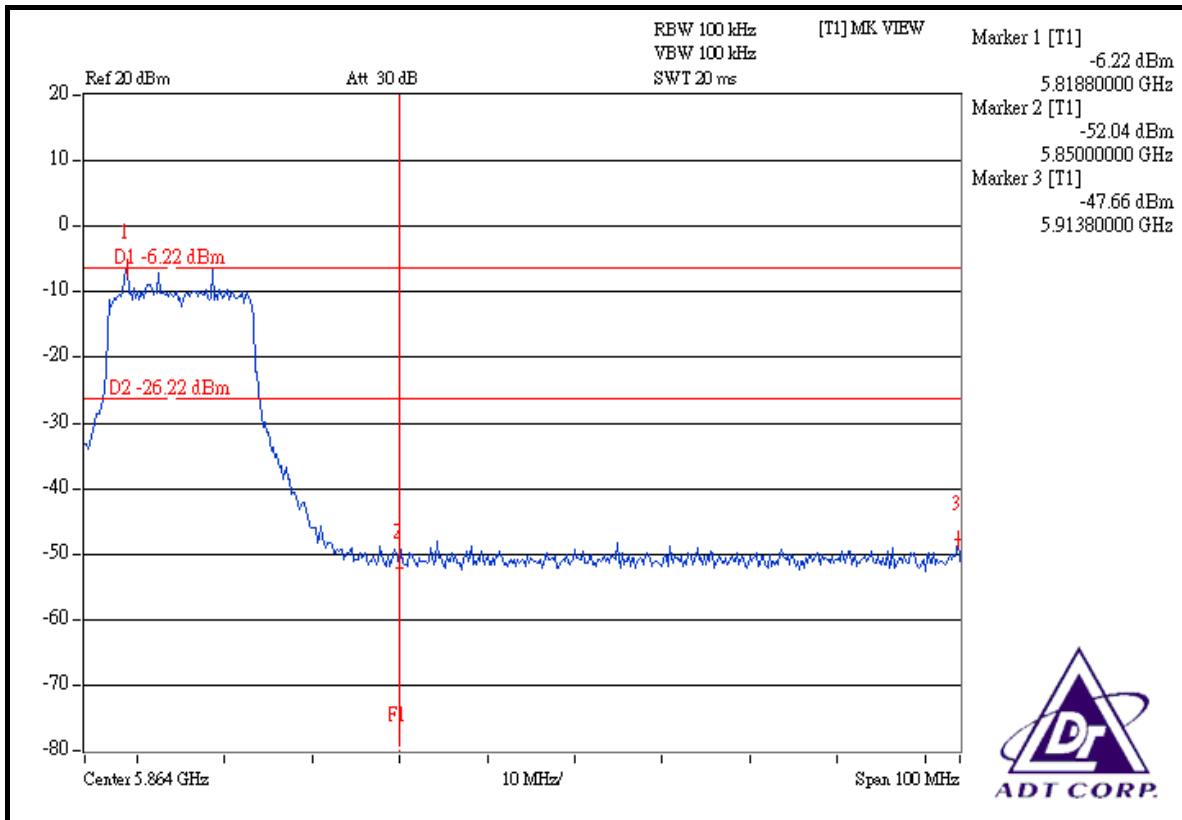
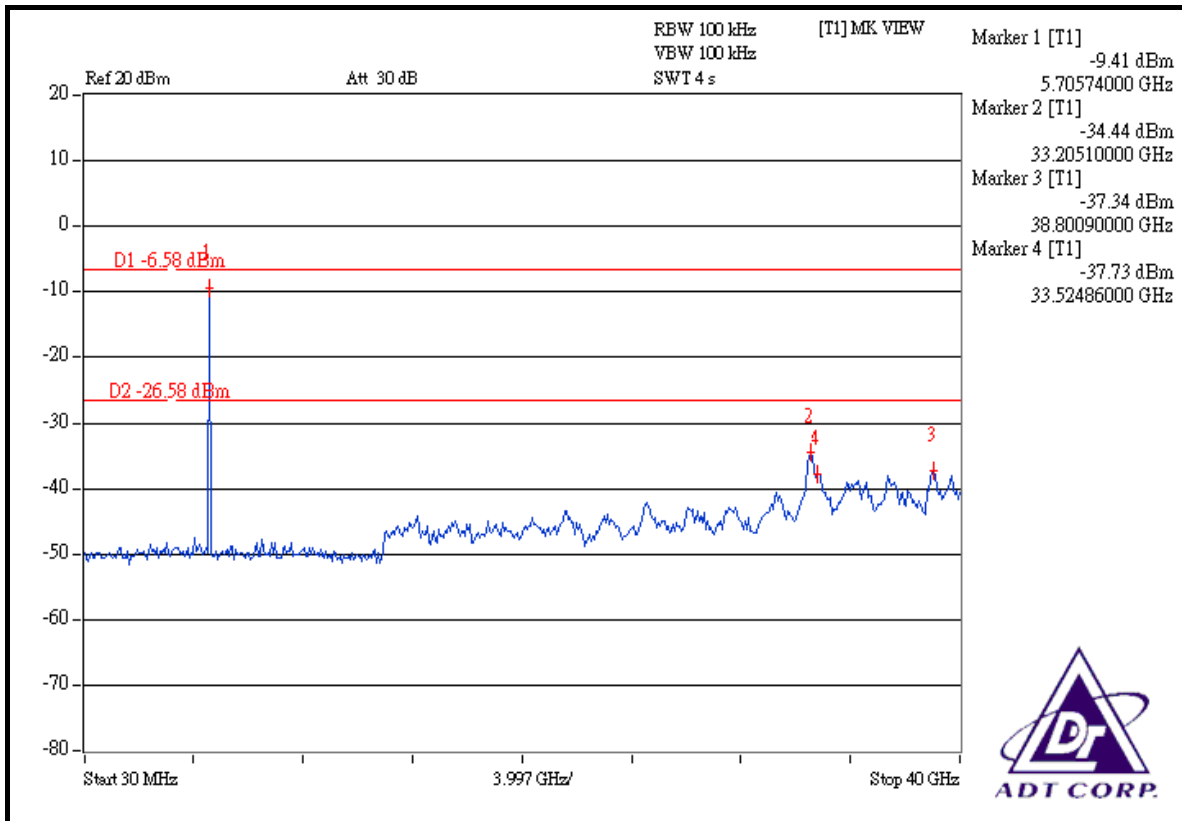

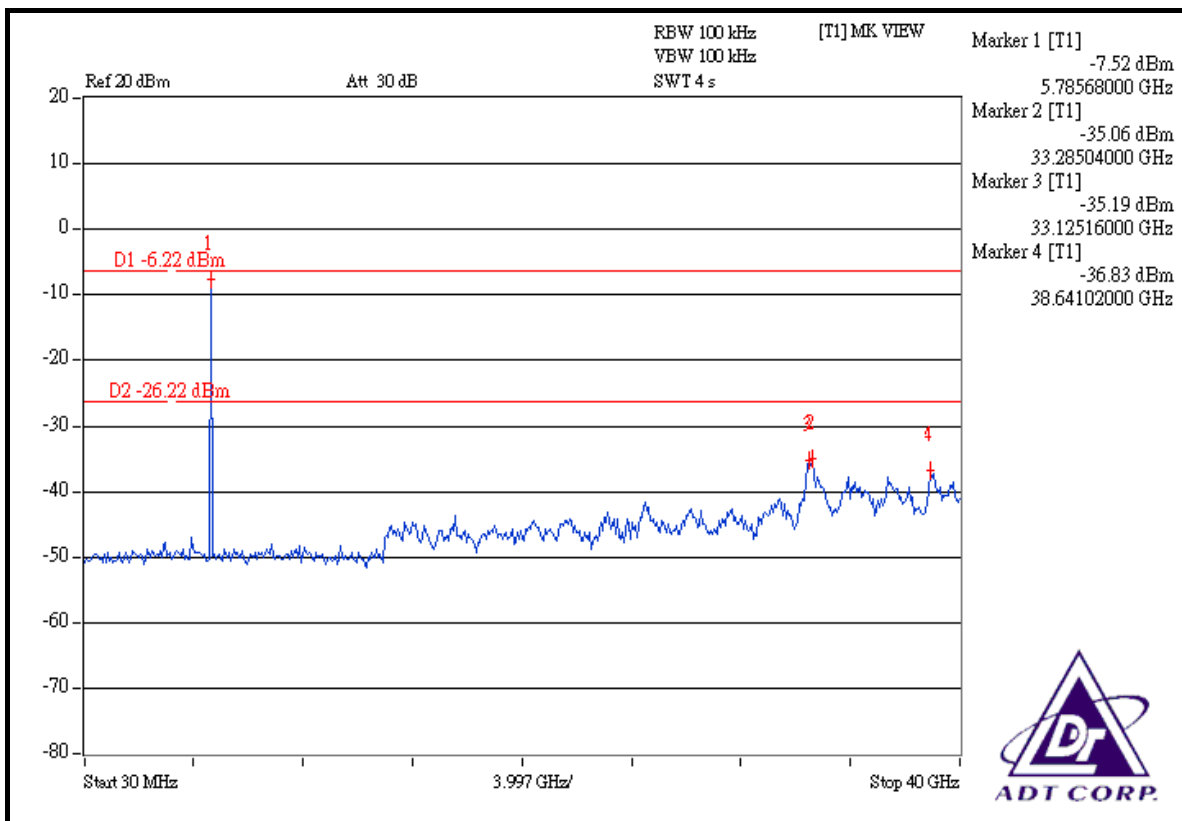
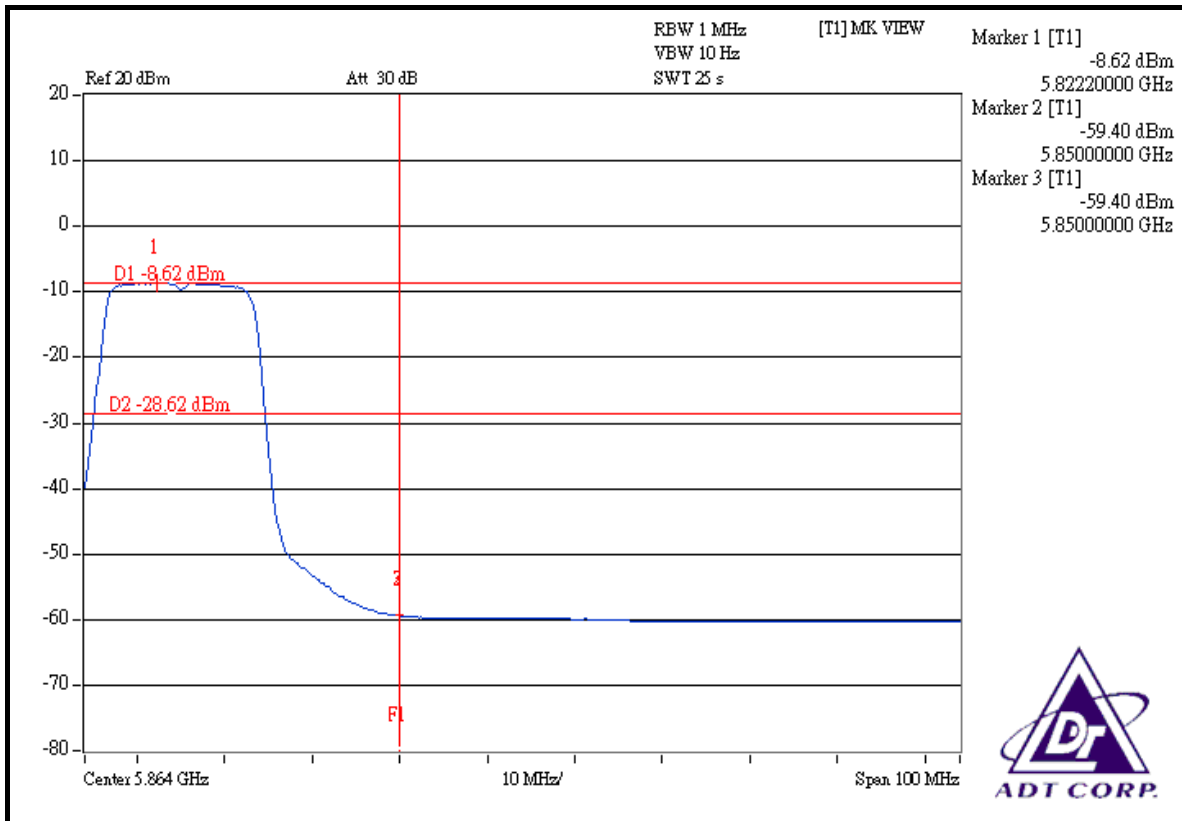

5.7 ANTENNA REQUIREMENT

5.7.1 STANDARD APPLICABLE

For intentional device, according to FCC 47 CFR Section 15.203, an intentional radiator shall be designed to ensure that no antenna other than that furnished by the responsible party shall be used with the device.

And according to FCC 47 CFR Section 15.247(a), if transmitting antennas of directional gain greater than 6dBi are used, the power shall be reduced by the amount in dB that the directional gain of the antenna exceeds 6dBi.

5.7.2 ANTENNA CONNECTED CONSTRUCTION

The antenna used in this product are Dipole antenna with Reverse SMA connector and Patch antenna with UFL connector. The maximum Gain of the antenna is 14dBi.



6. PHOTOGRAPHS OF THE TEST CONFIGURATION

Please refer to the attached file (Test Setup Photo).



7. INFORMATION ON THE TESTING LABORATORIES

We, ADT Corp., were founded in 1988 to provide our best service in EMC, Radio, Telecom and Safety consultation. Our laboratories are accredited and approved by the following approval agencies according to ISO/IEC 17025.

USA	FCC, UL, A2LA
Germany	TUV Rheinland
Japan	VCCI
Norway	NEMKO
Canada	INDUSTRY CANADA , CSA
R.O.C.	CNLA, BSMI, NCC
Netherlands	Telefication
Singapore	PSB , GOST-ASIA(MOU)
Russia	CERTIS(MOU)

Copies of accreditation certificates of our laboratories obtained from approval agencies can be downloaded from our web site:

www.adt.com.tw/index.5/phtml. If you have any comments, please feel free to contact us at the following:

Linko EMC/RF Lab:

Tel: 886-2-26052180

Fax: 886-2-26051924

Hsin Chu EMC/RF Lab:

Tel: 886-3-5935343

Fax: 886-3-5935342

Hwa Ya EMC/RF/Safety Telecom Lab:

Tel: 886-3-3183232

Fax: 886-3-3185050

Web Site: www.adt.com.tw

The address and road map of all our labs can be found in our web site also.

8. APPENDIX A - MODIFICATIONS RECORDERS FOR ENGINEERING CHANGES TO THE EUT BY THE LAB

No any modifications are made to the EUT by the lab during the test.