



FCC TEST REPORT

REPORT NO.: RF971103L12

MODEL NO.: ZF2741

RECEIVED: Nov. 03, 2008

TESTED: Nov. 05 ~ Nov. 17, 2008

ISSUED: Nov. 17, 2008

Applicant's Company	Senao Networks, Inc.
Applicant Address	3F, No. 529, Chung Cheng Rd., Hsintien, Taipei, Taiwan
FCC ID	U2M-OC36600802
Manufacturer's Company	Senao Networks, Inc.
Manufacturer Address	3F, No. 529, Chung Cheng Rd., Hsintien, Taipei, Taiwan

ISSUED BY: Advance Data Technology Corporation

LAB ADDRESS: No. 47, 14th Ling, Chia Pau Tsuen, Lin Kou Hsiang, Taipei Hsien 244, Taiwan, R.O.C.

TEST LOCATION: No. 19, Hwa Ya 2nd Rd, Wen Hwa Tsuen, Kwei Shan Hsiang, Taoyuan Hsien 333, Taiwan, R.O.C.

This test report consists of 86 pages in total. It may be duplicated completely for legal use with the approval of the applicant. It should not be reproduced except in full, without the written approval of our laboratory. The client should not use it to claim product endorsement by TAF or any government agencies. The test results in the report only apply to the tested sample.



Table of Contents

1	CERTIFICATION.....	4
2	SUMMARY OF TEST RESULTS	5
2.1	MEASUREMENT UNCERTAINTY.....	5
3	GENERAL INFORMATION.....	6
3.1	GENERAL DESCRIPTION OF EUT	6
3.2	DESCRIPTION OF TEST MODES	7
3.2.1	CONFIGURATION OF SYSTEM UNDER TEST	7
3.2.2	TEST MODE APPLICABILITY AND TESTED CHANNEL DETAIL	9
3.3	GENERAL DESCRIPTION OF APPLIED STANDARDS	11
3.4	DESCRIPTION OF SUPPORT UNITS	11
4	TEST TYPES AND RESULTS	12
4.1	RADIATED EMISSION MEASUREMENT	12
4.1.1	LIMITS OF RADIATED EMISSION MEASUREMENT	12
4.1.2	TEST INSTRUMENTS.....	13
4.1.3	TEST PROCEDURES	14
4.1.4	DEVIATION FROM TEST STANDARD.....	14
4.1.5	TEST SETUP	15
4.1.6	EUT OPERATING CONDITIONS	15
4.1.7	TEST RESULTS	16
4.2	CONDUCTED EMISSION MEASUREMENT	32
4.2.1	LIMITS OF CONDUCTED EMISSION MEASUREMENT	32
4.2.2	TEST INSTRUMENTS.....	32
4.2.3	TEST PROCEDURES	33
4.2.4	DEVIATION FROM TEST STANDARD.....	33
4.2.5	TEST SETUP	34
4.2.6	EUT OPERATING CONDITIONS	34
4.2.7	TEST RESULTS	35
4.3	6dB BANDWIDTH MEASUREMENT.....	43
4.3.1	LIMITS OF 6dB BANDWIDTH MEASUREMENT	43
4.3.2	TEST INSTRUMENTS.....	43
4.3.3	TEST PROCEDURE.....	43
4.3.4	DEVIATION FROM TEST STANDARD.....	43
4.3.5	TEST SETUP	44
4.3.6	EUT OPERATING CONDITIONS	44
4.3.7	TEST RESULTS	45
4.4	MAXIMUM PEAK OUTPUT POWER.....	53



4.4.1	LIMITS OF MAXIMUM PEAK OUTPUT POWER MEASUREMENT	53
4.4.2	TEST INSTRUMENTS.....	53
4.4.3	TEST PROCEDURES	54
4.4.4	DEVIATION FROM TEST STANDARD.....	54
4.4.5	TEST SETUP	54
4.4.6	EUT OPERATING CONDITIONS	54
4.4.7	TEST RESULTS	55
4.5	POWER SPECTRAL DENSITY MEASUREMENT	57
4.5.1	LIMITS OF POWER SPECTRAL DENSITY MEASUREMENT	57
4.5.2	TEST INSTRUMENTS.....	57
4.5.3	TEST PROCEDURE.....	57
4.5.4	DEVIATION FROM TEST STANDARD.....	57
4.5.5	TEST SETUP	57
4.5.6	EUT OPERATING CONDITIONS	57
4.5.7	TEST RESULTS	58
4.6	BAND EDGES MEASUREMENT	66
4.6.1	LIMITS OF BAND EDGES MEASUREMENT	66
4.6.2	TEST INSTRUMENTS.....	66
4.6.3	TEST PROCEDURE.....	66
4.6.4	DEVIATION FROM TEST STANDARD.....	66
4.6.5	EUT OPERATING CONDITION.....	66
4.6.6	TEST RESULTS	67
4.7	ANTENNA REQUIREMENT	83
4.7.1	STANDARD APPLICABLE	83
4.7.2	ANTENNA CONNECTED CONSTRUCTION	83
5	PHOTOGRAPHS OF THE TEST CONFIGURATION.....	84
6	INFORMATION ON THE TESTING LABORATORIES	85
7	APPENDIX A – MODIFICATIONS RECORDERS FOR ENGINEERING CHANGES TO THE EUT BY THE LAB.....	86



1 CERTIFICATION

PRODUCT: ZoneFlex 2741 802.11b/g Outdoor Access Point

MODEL: ZF2741

BRAND: Ruckus

APPLICANT: Senao Networks, Inc.

TESTED: Nov. 05 ~ Nov. 17, 2008

TEST SAMPLE: R&D SAMPLE

STANDARDS: **FCC Part 15, Subpart C (Section 15.247)**

ANSI C63.4-2003

The above equipment (model: ZF2741) has been tested by **Advance Data Technology Corporation**, and found compliance with the requirement of the above standards. The test record, data evaluation & Equipment Under Test (EUT) configurations represented herein are true and accurate accounts of the measurements of the sample's EMC characteristics under the conditions specified in this report.

PREPARED BY :  , **DATE** : Nov. 17, 2008
Joanna Wang / Senior Specialist

TECHNICAL ACCEPTANCE :  , **DATE** : Nov. 17, 2008
Responsible for RF Long Chen / Senior Engineer

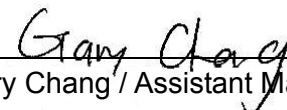
APPROVED BY :  , **DATE** : Nov. 17, 2008
Gary Chang / Assistant Manager

2 SUMMARY OF TEST RESULTS

The EUT has been tested according to the following specifications:

APPLIED STANDARD: FCC Part 15, Subpart C			
Standard Section	Test Type and Limit	Result	Remark
15.207	AC Power Conducted Emission	PASS	Meet the requirement of limit. Minimum passing margin is -6.07dB at 0.249MHz.
15.247(a)(2)	Spectrum Bandwidth of a Direct Sequence Spread Spectrum System Limit: min. 500kHz	PASS	Meet the requirement of limit.
15.247(b)	Maximum Peak Output Power Limit: max. 30dBm	PASS	Meet the requirement of limit.
15.247(d)	Radiated Emissions Limit: Table 15.209	PASS	Meet the requirement of limit. Minimum passing margin is -1.08dB at 4874.000MHz.
15.247(e)	Power Spectral Density Limit: max. 8dBm	PASS	Meet the requirement of limit.
15.247(d)	Band Edge Measurement Limit: 20dB less than the peak value of fundamental frequency	PASS	Meet the requirement of limit.

2.1 MEASUREMENT UNCERTAINTY

Where relevant, the following measurement uncertainty levels have been estimated for tests performed on the EUT as specified in CISPR 16-4-2:

MEASUREMENT	FREQUENCY	UNCERTAINTY
Conducted emissions	9kHz ~ 30MHz	2.44 dB
Radiated emissions	30MHz ~ 200MHz	3.34 dB
	200MHz ~ 1000MHz	3.35 dB
	1GHz ~ 18GHz	2.26 dB
	18GHz ~ 40GHz	1.94 dB

This uncertainty represents an expanded uncertainty expressed at approximately the 95% confidence level using a coverage factor of k=2.



3 GENERAL INFORMATION

3.1 GENERAL DESCRIPTION OF EUT

PRODUCT	ZoneFlex 2741 802.11b/g Outdoor Access Point
MODEL NO.	ZF2741
FCC ID	U2M-OC36600802
POWER SUPPLY	12Vdc from DC power supply 48Vdc from PoE
MODULATION TYPE	CCK, DQPSK, DBPSK for DSSS 64QAM, 16QAM, QPSK, BPSK for OFDM
MODULATION TECHNOLOGY	DSSS, OFDM
TRANSFER RATE	802.11b: 11/5.5/2/1Mbps 802.11g: 54/48/36/24/18/12/9/6Mbps
FREQUENCY RANGE	2412MHz ~ 2462MHz
NUMBER OF CHANNEL	11
MAXIMUM OUTPUT POWER	504.661mW
ANTENNA TYPE	Internal antenna with 5dBi gain External antenna with 9dBi gain (Option)
DATA CABLE	NA
I/O PORTS	RJ45
ACCESSORY DEVICES	PoE, adapter(for PoE use)

NOTE:

1. The EUT was operated with following PoE:

BRAND:	Ruckus
MODEL:	EPE-1212
P/N:	740-64127-001

The adapter of PoE:

BRAND:	Ruckus
MODEL:	8A-201WU48
INPUT:	100-240Vac, 50-60Hz, 0.7A
OUTPUT:	48Vdc, 0.42A
POWER LINE:	1.8m non-shielded cable without core

2. The internal and external works separately. In user FW, when external antenna plug in, the major transmission would program from external antenna. Two antennas will not transmit simultaneously. It was controlled by user FW.
3. The EUT, operates in the 2.4GHz frequency range, lets you connect IEEE 802.11g or IEEE 802.11b devices to the network. With its high-speed data transmissions of up to 54Mbps.
4. The above EUT information was declared by manufacturer and for more detailed features description, please refer to the manufacturer's specifications or User's Manual.

3.2 DESCRIPTION OF TEST MODES

Eleven channels are provided to this EUT.

CHANNEL	FREQUENCY	CHANNEL	FREQUENCY
1	2412 MHz	7	2442 MHz
2	2417 MHz	8	2447 MHz
3	2422 MHz	9	2452 MHz
4	2427 MHz	10	2457 MHz
5	2432 MHz	11	2462 MHz
6	2437 MHz		

3.2.1 CONFIGURATION OF SYSTEM UNDER TEST

TEST MODE A, C

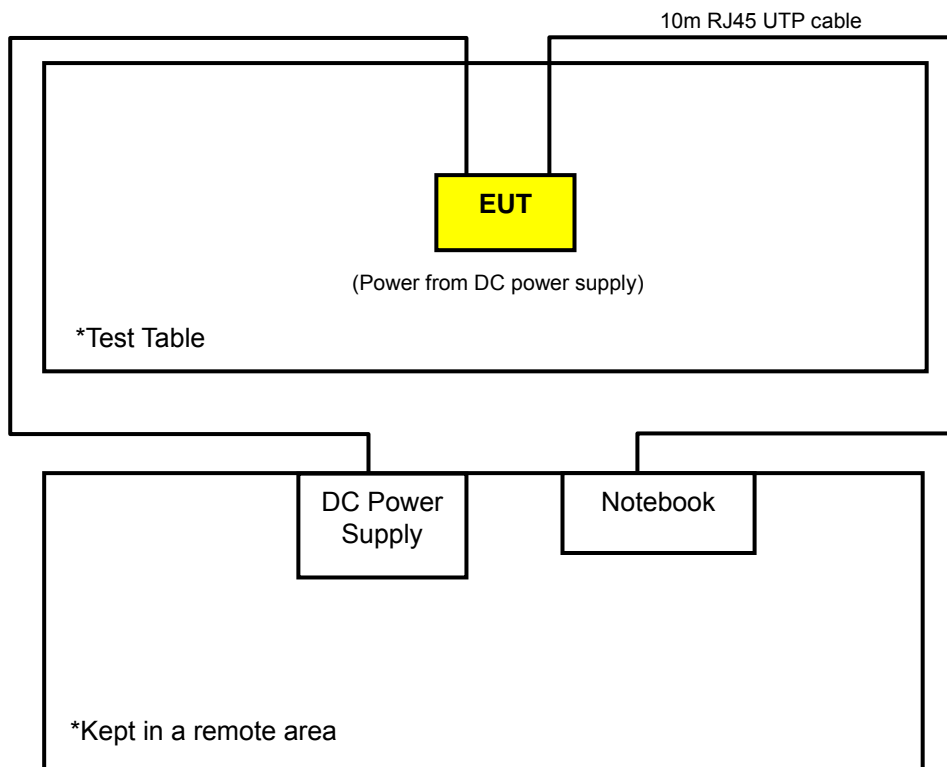

TEST MODE B, D

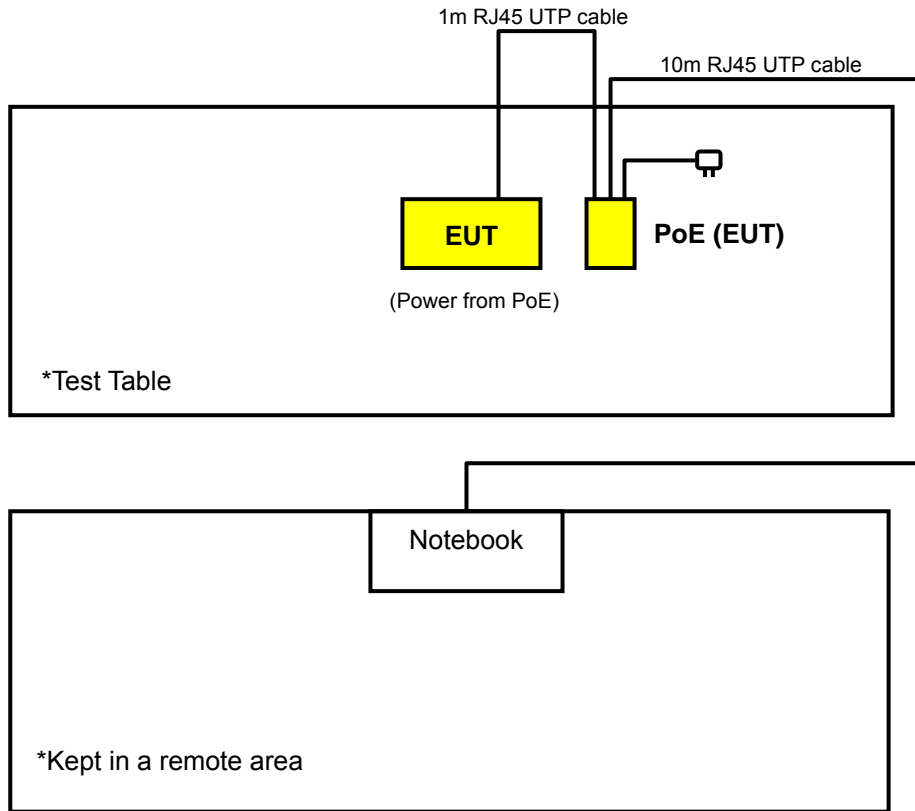

3.2.2 TEST MODE APPLICABILITY AND TESTED CHANNEL DETAIL

EUT Configure Mode	Applicable to				Description	
	RE \geq 1G	RE<1G	PLC	APCM	Antenna	Power Source
A	-	√	√	-	Internal	Power from DC power supply
B	√	√	√	√		Power from PoE
C	-	√	√	-	External	Power from DC power supply
D	√	√	√	√		Power from PoE

Where **PLC**: Power Line Conducted Emission **RE<1G**: Radiated Emission below 1GHz
RE \geq 1G: Radiated Emission above 1GHz **APCM**: Antenna Port Conducted Measurement

NOTE: "-" means no effect

RADIATED EMISSION TEST (ABOVE 1 GHz):

- Pre-Scan has been conducted to determine the worst-case mode from all possible combinations between available modulations, data rates, XYZ Axis and antenna ports (if EUT with antenna diversity architecture).
- Following channel(s) was (were) selected for the final test as listed below.

EUT Configure Mode	Mode	Available Channel	Tested Channel	Modulation Technology	Modulation Type	Data Rate (Mbps)	Axis
B, D	802.11b	1 to 11	1, 6, 11	DSSS	DBPSK	1	Z
	802.11g	1 to 11	1, 6, 11	OFDM	BPSK	6	

RADIATED EMISSION TEST (BELOW 1 GHz):

- Pre-Scan has been conducted to determine the worst-case mode from all possible combinations between available modulations, data rates, XYZ Axis and antenna ports (if EUT with antenna diversity architecture).
- Following channel(s) was (were) selected for the final test as listed below.

EUT Configure Mode	Mode	Available Channel	Tested Channel	Modulation Technology	Modulation Type	Data Rate (Mbps)	Axis
A, B	802.11b	1 to 11	6	DSSS	DBPSK	1	Z
C, D	802.11g	1 to 11	1	OFDM	BPSK	6	



POWER LINE CONDUCTED EMISSION TEST:

- Pre-Scan has been conducted to determine the worst-case mode from all possible combinations between available modulations, data rates and antenna ports (if EUT with antenna diversity architecture).
- Following channel(s) was (were) selected for the final test as listed below.

EUT Configure Mode	Mode	Available Channel	Tested Channel	Modulation Technology	Modulation Type	Data Rate (Mbps)
A, B	802.11b	1 to 11	6	DSSS	DBPSK	1
C, D	802.11g	1 to 11	1	OFDM	BPSK	6

BANDEDGE MEASUREMENT:

- Pre-Scan has been conducted to determine the worst-case mode from all possible combinations between available modulations, data rates and antenna ports (if EUT with antenna diversity architecture).
- Following channel(s) was (were) selected for the final test as listed below.

EUT Configure Mode	Mode	Available Channel	Tested Channel	Modulation Technology	Modulation Type	Data Rate (Mbps)
B, D	802.11b	1 to 11	1, 11	DSSS	DBPSK	1
	802.11g	1 to 11	1, 11	OFDM	BPSK	6

ANTENNA PORT CONDUCTED MEASUREMENT:

- Pre-Scan has been conducted to determine the worst-case mode from all possible combinations between available modulations, data rates and antenna ports (if EUT with antenna diversity architecture).
- Following channel(s) was (were) selected for the final test as listed below.

EUT Configure Mode	Mode	Available Channel	Tested Channel	Modulation Technology	Modulation Type	Data Rate (Mbps)
B, D	802.11b	1 to 11	1, 6, 11	DSSS	DBPSK	1
	802.11g	1 to 11	1, 6, 11	OFDM	BPSK	6



3.3 GENERAL DESCRIPTION OF APPLIED STANDARDS

The EUT is a RF product. According to the specifications of the manufacturer, it must comply with the requirements of the following standards:

FCC Part 15, Subpart C (15.247)

ANSI C63.4- 2003

All test items have been performed and recorded as per the above standards.

NOTE: The EUT is also considered as a kind of computer peripheral, because the connection to computer is necessary for typical use. It has been verified to comply with the requirements of FCC Part 15, Subpart B, Class B (DoC). The test report has been issued separately.

3.4 DESCRIPTION OF SUPPORT UNITS

The EUT has been tested as an independent unit together with other necessary accessories or support units. The following support units or accessories were used to form a representative test configuration during the tests.

NO.	PRODUCT	BRAND	MODEL NO.	SERIAL NO.	FCC ID
1	DC POWER SUPPLY	Topward	6603D	700637	NA
2	NOTEBOOK COMPUTER	DELL	PP05L	12130898320	E2K24CLNS

NO.	SIGNAL CABLE DESCRIPTION OF THE ABOVE SUPPORT UNITS
1	NA
2	10m RJ45 UTP cable

NOTE:

1. All power cords of the above support units are non shielded (1.8m).
2. Item 1-2 acted as a communication partners to transfer data.
3. Item 1 was only for test mode A, C.

4 TEST TYPES AND RESULTS

4.1 RADIATED EMISSION MEASUREMENT

4.1.1 LIMITS OF RADIATED EMISSION MEASUREMENT

Emissions radiated outside of the specified bands, shall be according to the general radiated limits in 15.209 as following:

Frequencies (MHz)	Field strength (microvolts/meter)	Measurement distance (meters)
0.009-0.490	2400/F(kHz)	300
0.490-1.705	24000/F(kHz)	30
1.705-30.0	30	30
30-88	100	3
88-216	150	3
216-960	200	3
Above 960	500	3

NOTE:

1. The lower limit shall apply at the transition frequencies.
2. Emission level (dBuV/m) = 20 log Emission level (uV/m).
3. As shown in 15.35(b), for frequencies above 1000MHz, the field strength limits are based on average detector, however, the peak field strength of any emission shall not exceed the maximum permitted average limits, specified above by more than 20dB under any condition of modulation.



4.1.2 TEST INSTRUMENTS

DESCRIPTION & MANUFACTURER	MODEL NO.	SERIAL NO.	DATE OF CALIBRATION	DUE DATE OF CALIBRATION
Test Receiver ROHDE & SCHWARZ	ESI7	100033	Jun. 30, 2008	Jun. 29, 2009
Spectrum Analyzer ROHDE & SCHWARZ	FSP40	100041	Apr. 22, 2008	Apr. 21, 2009
BILOG Antenna SCHWARZBECK	VULB9168	9168-160	May 02, 2008	May 01, 2009
HORN Antenna SCHWARZBECK	9120D	9120D-209	Jun. 24, 2008	Jun. 23, 2009
HORN Antenna SCHWARZBECK	BBHA 9170	BBHA9170243	Dec. 25, 2007	Dec. 24, 2008
Preamplifier Agilent	8447D	2944A10633	Nov. 03, 2008	Nov. 02, 2009
Preamplifier Agilent	8449B	3008A01964	Oct. 23, 2008	Oct. 22, 2009
RF signal cable HUBER+SUHNNER	SUCOFLEX 104	283402/4	Dec. 07, 2007	Dec. 06, 2008
RF signal cable HUBER+SUHNNER	SUCOFLEX 104	251644/4	Dec. 07, 2007	Dec. 06, 2008
Software ADT.	ADT_Radiated_V7.6	NA	NA	NA
Antenna Tower inn-co GmbH	MA 4000	013303	NA	NA
Antenna Tower Controller inn-co GmbH	CO2000	017303	NA	NA
Turn Table ADT.	TT100.	TT93021703	NA	NA
Turn Table Controller ADT.	SC100.	SC93021703	NA	NA

- NOTE:**
1. The calibration interval of the above test instruments is 12 months and the calibrations are traceable to NML/ROC and NIST/USA.
 2. The test was performed in HwaYa Chamber 3.
 3. The horn antenna and HP preamplifier (model: 8449B) are used only for the measurement of emission frequency above 1GHz if tested.
 4. The FCC Site Registration No. is 988962.
 5. The IC Site Registration No. is IC3789B-3.

4.1.3 TEST PROCEDURES

- a. The EUT was placed on the top of a rotating table 0.8 meters above the ground at a 3 meters semi-anechoic chamber. The table was rotated 360 degrees to determine the position of the highest radiation.
- b. The EUT was set 3 meters away from the interference-receiving antenna, which was mounted on the top of a variable-height antenna tower.
- c. The antenna is a broadband antenna, and its height is varied from one meter to four meters above the ground to determine the maximum value of the field strength. Both horizontal and vertical polarizations of the antenna are set to make the measurement.
- d. For each suspected emission, the EUT was arranged to its worst case and then the antenna was tuned to heights from 1 meter to 4 meters and the rotatable table was turned from 0 degrees to 360 degrees to find the maximum reading.
- e. The test-receiver system was set to Peak Detect Function and Specified Bandwidth with Maximum Hold Mode.
- f. If the emission level of the EUT in peak mode was lower than the limit specified, then testing could be stopped and the peak values of the EUT would be reported. Otherwise the emissions would be re-tested one by one using peak, quasi-peak method or average method as specified and then reported in data sheet.

NOTE:

1. The resolution bandwidth and video bandwidth of test receiver/spectrum analyzer is 120kHz for Peak detection (PK) and Quasi-peak detection (QP) at frequency below 1GHz.
2. The resolution bandwidth of test receiver/spectrum analyzer is 1 MHz and video bandwidth is 3MHz for Peak detection at frequency above 1GHz.
3. The resolution bandwidth of test receiver/spectrum analyzer is 1 MHz and the video bandwidth is 10 Hz for Average detection (AV) at frequency above 1GHz.
4. All modes of operation were investigated and the worst-case emissions are reported.

4.1.4 DEVIATION FROM TEST STANDARD

No deviation.

4.1.5 TEST SETUP

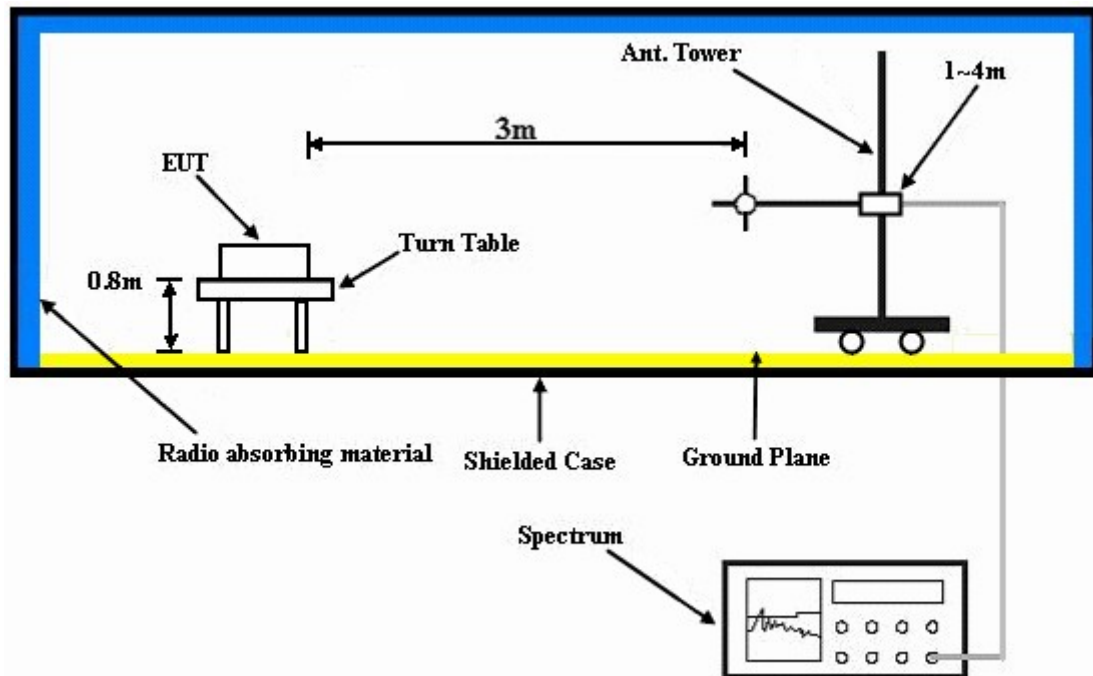

For the actual test configuration, please refer to the attached file (Test Setup Photo).

4.1.6 EUT OPERATING CONDITIONS

- a. Placed the EUT on the testing table.
- b. Prepared a notebook system to act as a communication partner and placed it outside of testing area.
- c. The communication partner run a test program (provided by manufacturer) to enable EUT under transmission condition continuously at specific channel frequency via RJ45 cable.
- d. The communication partner sent data to EUT by command "PING".

4.1.7 TEST RESULTS

802.11b DSSS MODULATION

EUT TEST CONDITION		MEASUREMENT DETAIL	
CHANNEL	Channel 1	FREQUENCY RANGE	1 ~ 25GHz
INPUT POWER	120Vac, 60 Hz	DETECTOR FUNCTION	Peak (PK) Average (AV)
ENVIRONMENTAL CONDITIONS	23deg. C, 67%RH 1014hPa	TEST MODE	B
TESTED BY	Match Tsui		

ANTENNA POLARITY & TEST DISTANCE: HORIZONTAL AT 3 M								
NO.	FREQ. (MHz)	EMISSION LEVEL (dBuV/m)	LIMIT (dBuV/m)	MARGIN (dB)	ANTENNA HEIGHT (m)	TABLE ANGLE (Degree)	RAW VALUE (dBuV)	CORRECTION FACTOR (dB/m)
1	2385.00	60.63 PK	74.00	-13.37	1.17 H	174	28.21	32.42
2	2385.00	52.50 AV	54.00	-1.50	1.17 H	174	20.08	32.42
3	*2412.00	115.77 PK			1.16 H	164	83.25	32.52
4	*2412.00	111.09 AV			1.16 H	164	78.57	32.52
5	4824.00	54.08 PK	74.00	-19.92	1.42 H	216	15.78	38.30
6	4824.00	49.20 AV	54.00	-4.80	1.42 H	216	10.90	38.30
ANTENNA POLARITY & TEST DISTANCE: VERTICAL AT 3 M								
NO.	FREQ. (MHz)	EMISSION LEVEL (dBuV/m)	LIMIT (dBuV/m)	MARGIN (dB)	ANTENNA HEIGHT (m)	TABLE ANGLE (Degree)	RAW VALUE (dBuV)	CORRECTION FACTOR (dB/m)
1	2385.00	57.70 PK	74.00	-16.30	1.62 V	184	25.28	32.42
2	2385.00	47.85 AV	54.00	-6.15	1.62 V	184	15.43	32.42
3	*2412.00	109.38 PK			1.64 V	184	76.86	32.52
4	*2412.00	105.33 AV			1.64 V	184	72.81	32.52
5	4824.00	54.73 PK	74.00	-19.27	1.03 V	222	16.43	38.30
6	4824.00	50.18 AV	54.00	-3.82	1.03 V	222	11.88	38.30

- REMARKS:**
1. Emission level (dBuV/m) = Raw Value (dBuV) + Correction Factor (dB/m).
 2. Correction Factor (dB/m) = Antenna Factor (dB/m) + Cable Factor (dB).
 3. The other emission levels were very low against the limit.
 4. Margin value = Emission level – Limit value.
 5. “ * “: Fundamental frequency.

EUT TEST CONDITION		MEASUREMENT DETAIL	
CHANNEL	Channel 6	FREQUENCY RANGE	1 ~ 25GHz
INPUT POWER	120Vac, 60 Hz	DETECTOR FUNCTION	Peak (PK) Average (AV)
ENVIRONMENTAL CONDITIONS	23deg. C, 67%RH 1014hPa	TEST MODE	B
TESTED BY	Match Tsui		

ANTENNA POLARITY & TEST DISTANCE: HORIZONTAL AT 3 M								
NO.	FREQ. (MHz)	EMISSION LEVEL (dBuV/m)	LIMIT (dBuV/m)	MARGIN (dB)	ANTENNA HEIGHT (m)	TABLE ANGLE (Degree)	RAW VALUE (dBuV)	CORRECTION FACTOR (dB/m)
1	2390.00	57.82 PK	74.00	-16.18	1.15 H	156	25.38	32.44
2	2390.00	46.26 AV	54.00	-7.74	1.15 H	156	13.82	32.44
3	*2437.00	118.30 PK			1.15 H	160	85.70	32.60
4	*2437.00	113.79 AV			1.15 H	160	81.19	32.60
5	2483.50	58.25 PK	74.00	-15.75	1.15 H	156	25.49	32.76
6	2483.50	46.09 AV	54.00	-7.91	1.15 H	156	13.33	32.76
7	4874.00	54.88 PK	74.00	-19.12	1.38 H	196	16.38	38.50
8	4874.00	51.20 AV	54.00	-2.80	1.38 H	196	12.70	38.50
9	7311.00	59.72 PK	74.00	-14.28	1.21 H	217	15.24	44.48
10	7311.00	51.10 AV	54.00	-2.90	1.21 H	217	6.62	44.48
11	#9748.00	66.74 PK	98.30	-31.56	1.24 H	236	18.34	48.40
12	#9748.00	63.44 AV	93.79	-30.35	1.24 H	236	15.04	48.40

ANTENNA POLARITY & TEST DISTANCE: VERTICAL AT 3 M								
NO.	FREQ. (MHz)	EMISSION LEVEL (dBuV/m)	LIMIT (dBuV/m)	MARGIN (dB)	ANTENNA HEIGHT (m)	TABLE ANGLE (Degree)	RAW VALUE (dBuV)	CORRECTION FACTOR (dB/m)
1	*2437.00	112.31 PK			1.59 V	190	79.71	32.60
2	*2437.00	108.42 AV			1.59 V	190	75.82	32.60
3	4874.00	56.16 PK	74.00	-17.84	1.27 V	220	17.66	38.50
4	4874.00	52.92 AV	54.00	-1.08	1.27 V	220	14.42	38.50
5	7311.00	58.49 PK	74.00	-15.51	1.28 V	227	14.01	44.48
6	7311.00	50.09 AV	54.00	-3.91	1.28 V	227	5.61	44.48
7	#9748.00	64.57 PK	92.31	-27.74	1.09 V	152	16.17	48.40
8	#9748.00	60.38 AV	88.42	-28.04	1.09 V	152	11.98	48.40

- REMARKS:**
1. Emission level (dBuV/m) = Raw Value (dBuV) + Correction Factor (dB/m).
 2. Correction Factor (dB/m) = Antenna Factor (dB/m) + Cable Factor (dB).
 3. The other emission levels were very low against the limit.
 4. Margin value = Emission level – Limit value.
 5. “ * “: Fundamental frequency.
 6. “#”: The radiated frequency is out the restricted band.

EUT TEST CONDITION		MEASUREMENT DETAIL	
CHANNEL	Channel 11	FREQUENCY RANGE	1 ~ 25GHz
INPUT POWER	120Vac, 60 Hz	DETECTOR FUNCTION	Peak (PK) Average (AV)
ENVIRONMENTAL CONDITIONS	23deg. C, 67%RH 1014hPa	TEST MODE	B
TESTED BY	Match Tsui		

ANTENNA POLARITY & TEST DISTANCE: HORIZONTAL AT 3 M								
NO.	FREQ. (MHz)	EMISSION LEVEL (dBuV/m)	LIMIT (dBuV/m)	MARGIN (dB)	ANTENNA HEIGHT (m)	TABLE ANGLE (Degree)	RAW VALUE (dBuV)	CORRECTION FACTOR (dB/m)
1	*2462.00	114.03 PK			1.11 H	160	81.35	32.68
2	*2462.00	109.70 AV			1.11 H	160	77.02	32.68
3	2488.00	60.26 PK	74.00	-13.74	1.11 H	159	27.49	32.77
4	2488.00	52.29 AV	54.00	-1.71	1.11 H	159	19.52	32.77
5	4924.00	50.83 PK	74.00	-23.17	1.01 H	252	12.19	38.64
6	4924.00	41.52 AV	54.00	-12.48	1.01 H	252	2.88	38.64
ANTENNA POLARITY & TEST DISTANCE: VERTICAL AT 3 M								
NO.	FREQ. (MHz)	EMISSION LEVEL (dBuV/m)	LIMIT (dBuV/m)	MARGIN (dB)	ANTENNA HEIGHT (m)	TABLE ANGLE (Degree)	RAW VALUE (dBuV)	CORRECTION FACTOR (dB/m)
1	*2462.00	109.97 PK			1.38 V	186	77.29	32.68
2	*2462.00	105.72 AV			1.38 V	186	73.04	32.68
3	2488.00	57.08 PK	74.00	-16.92	1.38 V	186	24.31	32.77
4	2488.00	49.25 AV	54.00	-4.75	1.38 V	186	16.48	32.77
5	4924.00	50.49 PK	74.00	-23.51	1.10 V	18	11.85	38.64
6	4924.00	40.60 AV	54.00	-13.40	1.10 V	18	1.96	38.64

- REMARKS:**
1. Emission level (dBuV/m) = Raw Value (dBuV) + Correction Factor (dB/m).
 2. Correction Factor (dB/m) = Antenna Factor (dB/m) + Cable Factor (dB).
 3. The other emission levels were very low against the limit.
 4. Margin value = Emission level – Limit value.
 5. “ * “: Fundamental frequency.

EUT TEST CONDITION		MEASUREMENT DETAIL	
CHANNEL	Channel 1	FREQUENCY RANGE	1 ~ 25GHz
INPUT POWER	120Vac, 60 Hz	DETECTOR FUNCTION	Peak (PK) Average (AV)
ENVIRONMENTAL CONDITIONS	24deg. C, 64%RH 1018hPa	TEST MODE	D
TESTED BY	Match Tsui		

ANTENNA POLARITY & TEST DISTANCE: HORIZONTAL AT 3 M								
NO.	FREQ. (MHz)	EMISSION LEVEL (dBuV/m)	LIMIT (dBuV/m)	MARGIN (dB)	ANTENNA HEIGHT (m)	TABLE ANGLE (Degree)	RAW VALUE (dBuV)	CORRECTION FACTOR (dB/m)
1	2386.00	56.84 PK	74.00	-17.16	1.50 H	19	24.41	32.43
2	2386.00	46.21 AV	54.00	-7.79	1.50 H	19	13.78	32.43
3	*2412.00	102.17 PK			1.50 H	19	69.65	32.52
4	*2412.00	97.57 AV			1.50 H	19	65.05	32.52
5	4824.00	50.79 PK	74.00	-23.21	1.28 H	320	12.49	38.30
6	4824.00	40.79 AV	54.00	-13.21	1.28 H	320	2.49	38.30
ANTENNA POLARITY & TEST DISTANCE: VERTICAL AT 3 M								
NO.	FREQ. (MHz)	EMISSION LEVEL (dBuV/m)	LIMIT (dBuV/m)	MARGIN (dB)	ANTENNA HEIGHT (m)	TABLE ANGLE (Degree)	RAW VALUE (dBuV)	CORRECTION FACTOR (dB/m)
1	2386.00	61.17 PK	74.00	-12.83	1.15 V	357	28.74	32.43
2	2386.00	52.61 AV	54.00	-1.39	1.15 V	357	20.18	32.43
3	*2412.00	115.50 PK			1.12 V	0	82.98	32.52
4	*2412.00	111.24 AV			1.12 V	0	78.72	32.52
5	4824.00	50.83 PK	74.00	-23.17	1.00 V	301	12.53	38.30
6	4824.00	41.89 AV	54.00	-12.11	1.00 V	301	3.59	38.30

- REMARKS:**
1. Emission level (dBuV/m) = Raw Value (dBuV) + Correction Factor (dB/m).
 2. Correction Factor (dB/m) = Antenna Factor (dB/m) + Cable Factor (dB).
 3. The other emission levels were very low against the limit.
 4. Margin value = Emission level – Limit value.
 5. “ * ”: Fundamental frequency.

EUT TEST CONDITION		MEASUREMENT DETAIL	
CHANNEL	Channel 6	FREQUENCY RANGE	1 ~ 25GHz
INPUT POWER	120Vac, 60 Hz	DETECTOR FUNCTION	Peak (PK) Average (AV)
ENVIRONMENTAL CONDITIONS	24deg. C, 64%RH 1018hPa	TEST MODE	D
TESTED BY	Match Tsui		

ANTENNA POLARITY & TEST DISTANCE: HORIZONTAL AT 3 M								
NO.	FREQ. (MHz)	EMISSION LEVEL (dBuV/m)	LIMIT (dBuV/m)	MARGIN (dB)	ANTENNA HEIGHT (m)	TABLE ANGLE (Degree)	RAW VALUE (dBuV)	CORRECTION FACTOR (dB/m)
1	2390.00	54.77 PK	74.00	-19.23	1.00 H	17	22.33	32.44
2	2390.00	45.44 AV	54.00	-8.56	1.00 H	17	13.00	32.44
3	*2437.00	104.06 PK			1.00 H	17	71.46	32.60
4	*2437.00	99.56 AV			1.00 H	17	66.96	32.60
5	2483.50	55.68 PK	74.00	-18.32	1.00 H	17	22.92	32.76
6	2483.50	45.79 AV	54.00	-8.21	1.00 H	17	13.03	32.76
7	4874.00	53.57 PK	74.00	-20.43	1.04 H	326	15.07	38.50
8	4874.00	49.46 AV	54.00	-4.54	1.04 H	326	10.96	38.50
ANTENNA POLARITY & TEST DISTANCE: VERTICAL AT 3 M								
NO.	FREQ. (MHz)	EMISSION LEVEL (dBuV/m)	LIMIT (dBuV/m)	MARGIN (dB)	ANTENNA HEIGHT (m)	TABLE ANGLE (Degree)	RAW VALUE (dBuV)	CORRECTION FACTOR (dB/m)
1	2390.00	56.99 PK	74.00	-17.01	1.10 V	358	24.55	32.44
2	2390.00	46.73 AV	54.00	-7.27	1.10 V	358	14.29	32.44
3	*2437.00	117.19 PK			1.10 V	358	84.59	32.60
4	*2437.00	112.69 AV			1.10 V	358	80.09	32.60
5	2483.50	54.94 PK	74.00	-19.06	1.10 V	358	22.18	32.76
6	2483.50	46.09 AV	54.00	-7.91	1.10 V	358	13.33	32.76
7	4874.00	53.42 PK	74.00	-20.58	1.44 V	24	14.92	38.50
8	4874.00	49.54 AV	54.00	-4.46	1.44 V	24	11.04	38.50

- REMARKS:**
1. Emission level (dBuV/m) = Raw Value (dBuV) + Correction Factor (dB/m).
 2. Correction Factor (dB/m) = Antenna Factor (dB/m) + Cable Factor (dB).
 3. The other emission levels were very low against the limit.
 4. Margin value = Emission level – Limit value.
 5. “ * “: Fundamental frequency.

EUT TEST CONDITION		MEASUREMENT DETAIL	
CHANNEL	Channel 11	FREQUENCY RANGE	1 ~ 25GHz
INPUT POWER	120Vac, 60 Hz	DETECTOR FUNCTION	Peak (PK) Average (AV)
ENVIRONMENTAL CONDITIONS	24deg. C, 64%RH 1018hPa	TEST MODE	D
TESTED BY	Match Tsui		

ANTENNA POLARITY & TEST DISTANCE: HORIZONTAL AT 3 M								
NO.	FREQ. (MHz)	EMISSION LEVEL (dBuV/m)	LIMIT (dBuV/m)	MARGIN (dB)	ANTENNA HEIGHT (m)	TABLE ANGLE (Degree)	RAW VALUE (dBuV)	CORRECTION FACTOR (dB/m)
1	*2462.00	102.88 PK			1.00 H	18	70.20	32.68
2	*2462.00	98.29 AV			1.00 H	18	65.61	32.68
3	2483.50	55.44 PK	74.00	-18.56	1.00 H	18	22.68	32.76
4	2483.50	46.32 AV	54.00	-7.68	1.00 H	18	13.56	32.76
5	4924.00	51.81 PK	74.00	-22.19	1.14 H	324	13.17	38.64
6	4924.00	45.39 AV	54.00	-8.61	1.14 H	324	6.75	38.64
ANTENNA POLARITY & TEST DISTANCE: VERTICAL AT 3 M								
NO.	FREQ. (MHz)	EMISSION LEVEL (dBuV/m)	LIMIT (dBuV/m)	MARGIN (dB)	ANTENNA HEIGHT (m)	TABLE ANGLE (Degree)	RAW VALUE (dBuV)	CORRECTION FACTOR (dB/m)
1	*2462.00	115.75 PK			1.10 V	0	83.07	32.68
2	*2462.00	111.23 AV			1.10 V	0	78.55	32.68
3	2483.50	60.42 PK	74.00	-13.58	1.10 V	0	27.66	32.76
4	2483.50	52.65 AV	54.00	-1.35	1.10 V	0	19.89	32.76
5	4924.00	52.52 PK	74.00	-21.48	1.27 V	36	13.88	38.64
6	4924.00	46.78 AV	54.00	-7.22	1.27 V	36	8.14	38.64

- REMARKS:**
1. Emission level (dBuV/m) = Raw Value (dBuV) + Correction Factor (dB/m).
 2. Correction Factor (dB/m) = Antenna Factor (dB/m) + Cable Factor (dB).
 3. The other emission levels were very low against the limit.
 4. Margin value = Emission level – Limit value.
 5. “ * “: Fundamental frequency.

802.11g OFDM MODULATION

EUT TEST CONDITION		MEASUREMENT DETAIL	
CHANNEL	Channel 1	FREQUENCY RANGE	1 ~ 25GHz
INPUT POWER	120Vac, 60 Hz	DETECTOR FUNCTION	Peak (PK) Average (AV)
ENVIRONMENTAL CONDITIONS	23deg. C, 67%RH 1014hPa	TEST MODE	B
TESTED BY	Match Tsui		

ANTENNA POLARITY & TEST DISTANCE: HORIZONTAL AT 3 M								
NO.	FREQ. (MHz)	EMISSION LEVEL (dBuV/m)	LIMIT (dBuV/m)	MARGIN (dB)	ANTENNA HEIGHT (m)	TABLE ANGLE (Degree)	RAW VALUE (dBuV)	CORRECTION FACTOR (dB/m)
1	2390.00	63.67 PK	74.00	-10.33	1.20 H	175	31.23	32.44
2	2390.00	48.87 AV	54.00	-5.13	1.20 H	175	16.43	32.44
3	*2412.00	113.06 PK			1.17 H	179	80.54	32.52
4	*2412.00	101.45 AV			1.17 H	179	68.93	32.52
5	4824.00	49.87 PK	74.00	-24.13	1.20 H	0	11.57	38.30
6	4824.00	35.67 AV	54.00	-18.33	1.20 H	0	-2.63	38.30
ANTENNA POLARITY & TEST DISTANCE: VERTICAL AT 3 M								
NO.	FREQ. (MHz)	EMISSION LEVEL (dBuV/m)	LIMIT (dBuV/m)	MARGIN (dB)	ANTENNA HEIGHT (m)	TABLE ANGLE (Degree)	RAW VALUE (dBuV)	CORRECTION FACTOR (dB/m)
1	2390.00	56.13 PK	74.00	-17.87	1.35 V	211	23.69	32.44
2	2390.00	45.99 AV	54.00	-8.01	1.35 V	211	13.55	32.44
3	*2412.00	106.11 PK			1.35 V	211	73.59	32.52
4	*2412.00	95.34 AV			1.35 V	211	62.82	32.52
5	4824.00	50.47 PK	74.00	-23.53	1.20 V	360	12.17	38.30
6	4824.00	35.34 AV	54.00	-18.66	1.20 V	360	-2.96	38.30

- REMARKS:**
1. Emission level (dBuV/m) = Raw Value (dBuV) + Correction Factor (dB/m).
 2. Correction Factor (dB/m) = Antenna Factor (dB/m) + Cable Factor (dB).
 3. The other emission levels were very low against the limit.
 4. Margin value = Emission level – Limit value.
 5. “ * “: Fundamental frequency.

EUT TEST CONDITION		MEASUREMENT DETAIL	
CHANNEL	Channel 6	FREQUENCY RANGE	1 ~ 25GHz
INPUT POWER	120Vac, 60 Hz	DETECTOR FUNCTION	Peak (PK) Average (AV)
ENVIRONMENTAL CONDITIONS	23deg. C, 67%RH 1014hPa	TEST MODE	B
TESTED BY	Match Tsui		

ANTENNA POLARITY & TEST DISTANCE: HORIZONTAL AT 3 M								
NO.	FREQ. (MHz)	EMISSION LEVEL (dBuV/m)	LIMIT (dBuV/m)	MARGIN (dB)	ANTENNA HEIGHT (m)	TABLE ANGLE (Degree)	RAW VALUE (dBuV)	CORRECTION FACTOR (dB/m)
1	2390.00	56.46 PK	74.00	-17.54	1.13 H	178	24.02	32.44
2	2390.00	45.70 AV	54.00	-8.30	1.13 H	178	13.26	32.44
3	*2437.00	113.65 PK			1.13 H	178	81.05	32.60
4	*2437.00	102.71 AV			1.13 H	178	70.11	32.60
5	2483.50	55.30 PK	74.00	-18.70	1.13 H	178	22.54	32.76
6	2483.50	45.93 AV	54.00	-8.07	1.13 H	178	13.17	32.76
7	4874.00	48.45 PK	74.00	-25.55	1.13 H	360	9.95	38.50
8	4874.00	35.66 AV	54.00	-18.34	1.13 H	360	-2.84	38.50
ANTENNA POLARITY & TEST DISTANCE: VERTICAL AT 3 M								
NO.	FREQ. (MHz)	EMISSION LEVEL (dBuV/m)	LIMIT (dBuV/m)	MARGIN (dB)	ANTENNA HEIGHT (m)	TABLE ANGLE (Degree)	RAW VALUE (dBuV)	CORRECTION FACTOR (dB/m)
1	*2437.00	106.98 PK			1.37 V	190	74.38	32.60
2	*2437.00	96.06 AV			1.37 V	190	63.46	32.60
3	4874.00	48.79 PK	74.00	-25.21	1.16 V	230	10.29	38.50
4	4874.00	35.83 AV	54.00	-18.17	1.16 V	230	-2.67	38.50

- REMARKS:**
1. Emission level (dBuV/m) = Raw Value (dBuV) + Correction Factor (dB/m).
 2. Correction Factor (dB/m) = Antenna Factor (dB/m) + Cable Factor (dB).
 3. The other emission levels were very low against the limit.
 4. Margin value = Emission level – Limit value.
 5. “ * “: Fundamental frequency.

EUT TEST CONDITION		MEASUREMENT DETAIL	
CHANNEL	Channel 11	FREQUENCY RANGE	1 ~ 25GHz
INPUT POWER	120Vac, 60 Hz	DETECTOR FUNCTION	Peak (PK) Average (AV)
ENVIRONMENTAL CONDITIONS	23deg. C, 67%RH 1014hPa	TEST MODE	B
TESTED BY	Match Tsui		

ANTENNA POLARITY & TEST DISTANCE: HORIZONTAL AT 3 M								
NO.	FREQ. (MHz)	EMISSION LEVEL (dBuV/m)	LIMIT (dBuV/m)	MARGIN (dB)	ANTENNA HEIGHT (m)	TABLE ANGLE (Degree)	RAW VALUE (dBuV)	CORRECTION FACTOR (dB/m)
1	*2462.00	112.94 PK			1.12 H	165	80.26	32.68
2	*2462.00	101.94 AV			1.12 H	165	69.26	32.68
3	2483.50	62.97 PK	74.00	-11.03	1.11 H	161	30.21	32.76
4	2483.50	49.08 AV	54.00	-4.92	1.11 H	161	16.32	32.76
5	4924.00	50.30 PK	74.00	-23.70	1.11 H	360	11.66	38.64
6	4924.00	35.68 AV	54.00	-18.32	1.11 H	360	-2.96	38.64
ANTENNA POLARITY & TEST DISTANCE: VERTICAL AT 3 M								
NO.	FREQ. (MHz)	EMISSION LEVEL (dBuV/m)	LIMIT (dBuV/m)	MARGIN (dB)	ANTENNA HEIGHT (m)	TABLE ANGLE (Degree)	RAW VALUE (dBuV)	CORRECTION FACTOR (dB/m)
1	*2462.00	106.34 PK			1.35 V	190	73.66	32.68
2	*2462.00	95.29 AV			1.35 V	190	62.61	32.68
3	2483.50	57.47 PK	74.00	-16.53	1.35 V	190	24.71	32.76
4	2483.50	47.51 AV	54.00	-6.49	1.35 V	190	14.75	32.76
5	4924.00	49.35 PK	74.00	-24.65	1.30 V	360	10.71	38.64
6	4924.00	35.28 AV	54.00	-18.72	1.30 V	360	-3.36	38.64

- REMARKS:**
1. Emission level (dBuV/m) = Raw Value (dBuV) + Correction Factor (dB/m).
 2. Correction Factor (dB/m) = Antenna Factor (dB/m) + Cable Factor (dB).
 3. The other emission levels were very low against the limit.
 4. Margin value = Emission level – Limit value.
 5. “ * “: Fundamental frequency.

EUT TEST CONDITION		MEASUREMENT DETAIL	
CHANNEL	Channel 1	FREQUENCY RANGE	1 ~ 25GHz
INPUT POWER	120Vac, 60 Hz	DETECTOR FUNCTION	Peak (PK) Average (AV)
ENVIRONMENTAL CONDITIONS	24deg. C, 64%RH 1018hPa	TEST MODE	D
TESTED BY	Match Tsui		

ANTENNA POLARITY & TEST DISTANCE: HORIZONTAL AT 3 M								
NO.	FREQ. (MHz)	EMISSION LEVEL (dBuV/m)	LIMIT (dBuV/m)	MARGIN (dB)	ANTENNA HEIGHT (m)	TABLE ANGLE (Degree)	RAW VALUE (dBuV)	CORRECTION FACTOR (dB/m)
1	2390.00	57.58 PK	74.00	-16.42	1.00 H	360	25.14	32.44
2	2390.00	46.51 AV	54.00	-7.49	1.00 H	360	14.07	32.44
3	*2412.00	106.26 PK			1.00 H	360	73.74	32.52
4	*2412.00	94.68 AV			1.00 H	360	62.16	32.52
5	4824.00	48.51 PK	74.00	-25.49	1.10 H	360	10.21	38.30
6	4824.00	35.67 AV	54.00	-18.33	1.10 H	360	-2.63	38.30
ANTENNA POLARITY & TEST DISTANCE: VERTICAL AT 3 M								
NO.	FREQ. (MHz)	EMISSION LEVEL (dBuV/m)	LIMIT (dBuV/m)	MARGIN (dB)	ANTENNA HEIGHT (m)	TABLE ANGLE (Degree)	RAW VALUE (dBuV)	CORRECTION FACTOR (dB/m)
1	2390.00	68.97 PK	74.00	-5.03	1.13 V	352	36.53	32.44
2	2390.00	51.77 AV	54.00	-2.23	1.13 V	352	19.33	32.44
3	*2412.00	118.65 PK			1.13 V	355	86.13	32.52
4	*2412.00	107.94 AV			1.13 V	355	75.42	32.52
5	4824.00	49.06 PK	74.00	-24.94	1.13 V	180	10.76	38.30
6	4824.00	36.27 AV	54.00	-17.73	1.13 V	180	-2.03	38.30

- REMARKS:**
1. Emission level (dBuV/m) = Raw Value (dBuV) + Correction Factor (dB/m).
 2. Correction Factor (dB/m) = Antenna Factor (dB/m) + Cable Factor (dB).
 3. The other emission levels were very low against the limit.
 4. Margin value = Emission level – Limit value.
 5. “ * ”: Fundamental frequency.

EUT TEST CONDITION		MEASUREMENT DETAIL	
CHANNEL	Channel 6	FREQUENCY RANGE	1 ~ 25GHz
INPUT POWER	120Vac, 60 Hz	DETECTOR FUNCTION	Peak (PK) Average (AV)
ENVIRONMENTAL CONDITIONS	24deg. C, 64%RH 1018hPa	TEST MODE	D
TESTED BY	Match Tsui		

ANTENNA POLARITY & TEST DISTANCE: HORIZONTAL AT 3 M								
NO.	FREQ. (MHz)	EMISSION LEVEL (dBuV/m)	LIMIT (dBuV/m)	MARGIN (dB)	ANTENNA HEIGHT (m)	TABLE ANGLE (Degree)	RAW VALUE (dBuV)	CORRECTION FACTOR (dB/m)
1	*2437.00	106.04 PK			1.00 H	1	73.44	32.60
2	*2437.00	94.37 AV			1.00 H	1	61.77	32.60
3	4874.00	48.73 PK	74.00	-25.27	1.07 H	360	10.23	38.50
4	4874.00	35.92 AV	54.00	-18.08	1.07 H	360	-2.58	38.50

ANTENNA POLARITY & TEST DISTANCE: VERTICAL AT 3 M								
NO.	FREQ. (MHz)	EMISSION LEVEL (dBuV/m)	LIMIT (dBuV/m)	MARGIN (dB)	ANTENNA HEIGHT (m)	TABLE ANGLE (Degree)	RAW VALUE (dBuV)	CORRECTION FACTOR (dB/m)
1	2390.00	54.59 PK	74.00	-19.41	1.11 V	1	22.15	32.44
2	2390.00	45.75 AV	54.00	-8.25	1.11 V	1	13.31	32.44
3	*2437.00	118.25 PK			1.11 V	1	85.65	32.60
4	*2437.00	107.73 AV			1.11 V	1	75.13	32.60
5	2483.50	55.21 PK	74.00	-18.79	1.11 V	1	22.45	32.76
6	2483.50	46.12 AV	54.00	-7.88	1.11 V	1	13.36	32.76
7	4874.00	49.03 PK	74.00	-24.97	1.11 V	177	10.53	38.50
8	4874.00	36.86 AV	54.00	-17.14	1.11 V	177	-1.64	38.50

- REMARKS:**
1. Emission level (dBuV/m) = Raw Value (dBuV) + Correction Factor (dB/m).
 2. Correction Factor (dB/m) = Antenna Factor (dB/m) + Cable Factor (dB).
 3. The other emission levels were very low against the limit.
 4. Margin value = Emission level – Limit value.
 5. “ * “: Fundamental frequency.

EUT TEST CONDITION		MEASUREMENT DETAIL	
CHANNEL	Channel 11	FREQUENCY RANGE	1 ~ 25GHz
INPUT POWER	120Vac, 60 Hz	DETECTOR FUNCTION	Peak (PK) Average (AV)
ENVIRONMENTAL CONDITIONS	24deg. C, 64%RH 1018hPa	TEST MODE	D
TESTED BY	Match Tsui		

ANTENNA POLARITY & TEST DISTANCE: HORIZONTAL AT 3 M								
NO.	FREQ. (MHz)	EMISSION LEVEL (dBuV/m)	LIMIT (dBuV/m)	MARGIN (dB)	ANTENNA HEIGHT (m)	TABLE ANGLE (Degree)	RAW VALUE (dBuV)	CORRECTION FACTOR (dB/m)
1	*2462.00	103.10 PK			1.00 H	17	70.42	32.68
2	*2462.00	92.26 AV			1.00 H	17	59.58	32.68
3	2483.50	55.18 PK	74.00	-18.82	1.00 H	17	22.42	32.76
4	2483.50	46.95 AV	54.00	-7.05	1.00 H	17	14.19	32.76
5	4924.00	49.19 PK	74.00	-24.81	1.10 H	360	10.55	38.64
6	4924.00	36.18 AV	54.00	-17.82	1.10 H	360	-2.46	38.64
ANTENNA POLARITY & TEST DISTANCE: VERTICAL AT 3 M								
NO.	FREQ. (MHz)	EMISSION LEVEL (dBuV/m)	LIMIT (dBuV/m)	MARGIN (dB)	ANTENNA HEIGHT (m)	TABLE ANGLE (Degree)	RAW VALUE (dBuV)	CORRECTION FACTOR (dB/m)
1	*2462.00	117.04 PK			1.12 V	355	84.36	32.68
2	*2462.00	106.09 AV			1.12 V	355	73.41	32.68
3	2483.50	69.79 PK	74.00	-4.21	1.08 V	349	37.03	32.76
4	2483.50	52.74 AV	54.00	-1.26	1.08 V	349	19.98	32.76
5	4924.00	49.18 PK	74.00	-24.82	1.08 V	198	10.54	38.64
6	4924.00	36.75 AV	54.00	-17.25	1.08 V	198	-1.89	38.64

- REMARKS:**
1. Emission level (dBuV/m) = Raw Value (dBuV) + Correction Factor (dB/m).
 2. Correction Factor (dB/m) = Antenna Factor (dB/m) + Cable Factor (dB).
 3. The other emission levels were very low against the limit.
 4. Margin value = Emission level – Limit value.
 5. “ * “: Fundamental frequency.

**BELOW 1GHz WORST-CASE DATA :
802.11b DSSS MODULATION**

EUT TEST CONDITION		MEASUREMENT DETAIL	
CHANNEL	Channel 6	FREQUENCY RANGE	Below 1000MHz
INPUT POWER	120Vac, 60 Hz	DETECTOR FUNCTION	Quasi-Peak
ENVIRONMENTAL CONDITIONS	23deg. C, 67%RH 1014hPa	TEST MODE	A
TESTED BY	Match Tsui		

ANTENNA POLARITY & TEST DISTANCE: HORIZONTAL AT 3 M								
NO.	FREQ. (MHz)	EMISSION LEVEL (dBuV/m)	LIMIT (dBuV/m)	MARGIN (dB)	ANTENNA HEIGHT (m)	TABLE ANGLE (Degree)	RAW VALUE (dBuV)	CORRECTION FACTOR (dB/m)
1	101.84	35.69 QP	43.50	-7.81	2.50 H	40	23.73	11.96
2	162.11	34.86 QP	43.50	-8.64	1.50 H	301	20.15	14.71
3	249.60	37.91 QP	46.00	-8.09	1.25 H	229	23.51	14.40
4	274.88	40.81 QP	46.00	-5.19	1.00 H	10	26.39	14.42
5	368.21	37.29 QP	46.00	-8.71	1.00 H	253	19.76	17.53
6	459.59	39.31 QP	46.00	-6.69	1.50 H	154	18.92	20.39
7	500.42	40.87 QP	46.00	-5.13	1.50 H	214	19.39	21.48
8	552.91	39.08 QP	46.00	-6.92	1.50 H	265	16.43	22.64
9	607.35	39.80 QP	46.00	-6.20	1.25 H	214	15.93	23.87
10	829.00	37.15 QP	46.00	-8.85	1.50 H	55	8.92	28.23

ANTENNA POLARITY & TEST DISTANCE: VERTICAL AT 3 M								
NO.	FREQ. (MHz)	EMISSION LEVEL (dBuV/m)	LIMIT (dBuV/m)	MARGIN (dB)	ANTENNA HEIGHT (m)	TABLE ANGLE (Degree)	RAW VALUE (dBuV)	CORRECTION FACTOR (dB/m)
1	43.51	32.64 QP	40.00	-7.36	1.50 V	118	17.89	14.75
2	249.60	35.20 QP	46.00	-10.80	1.00 V	10	20.79	14.40
3	368.21	35.51 QP	46.00	-10.49	1.25 V	271	17.98	17.53
4	459.59	38.62 QP	46.00	-7.38	1.25 V	103	18.23	20.39
5	500.42	39.84 QP	46.00	-6.16	1.00 V	106	18.36	21.48
6	552.91	40.64 QP	46.00	-5.36	1.00 V	19	17.99	22.64
7	595.69	39.08 QP	46.00	-6.92	1.50 V	94	15.51	23.57
8	735.68	35.35 QP	46.00	-10.65	1.50 V	112	8.46	26.89
9	875.67	35.28 QP	46.00	-10.72	1.00 V	304	5.95	29.33

- REMARKS:**
1. Emission level (dBuV/m) = Raw Value (dBuV) + Correction Factor (dB/m).
 2. Correction Factor (dB/m) = Antenna Factor (dB/m) + Cable Factor (dB).
 3. The other emission levels were very low against the limit.
 4. Margin value = Emission level – Limit value.

EUT TEST CONDITION		MEASUREMENT DETAIL	
CHANNEL	Channel 6	FREQUENCY RANGE	Below 1000MHz
INPUT POWER	120Vac, 60 Hz	DETECTOR FUNCTION	Quasi-Peak
ENVIRONMENTAL CONDITIONS	23deg. C, 67%RH 1014hPa	TEST MODE	B
TESTED BY	Match Tsui		

ANTENNA POLARITY & TEST DISTANCE: HORIZONTAL AT 3 M								
NO.	FREQ. (MHz)	EMISSION LEVEL (dBuV/m)	LIMIT (dBuV/m)	MARGIN (dB)	ANTENNA HEIGHT (m)	TABLE ANGLE (Degree)	RAW VALUE (dBuV)	CORRECTION FACTOR (dB/m)
1	38.98	38.85 QP	40.00	-1.15	1.49 H	107	23.68	15.17
2	94.06	35.87 QP	43.50	-7.63	2.50 H	253	26.08	9.78
3	125.17	38.71 QP	43.50	-4.79	1.25 H	67	26.51	12.20
4	167.94	36.66 QP	43.50	-6.84	1.50 H	94	22.30	14.36
5	249.60	40.41 QP	46.00	-5.59	1.00 H	289	26.00	14.40
6	368.21	37.13 QP	46.00	-8.87	1.00 H	331	19.60	17.53
7	500.42	37.42 QP	46.00	-8.58	1.50 H	205	15.95	21.48
8	552.91	39.75 QP	46.00	-6.25	1.50 H	295	17.10	22.64
9	603.47	38.97 QP	46.00	-7.03	1.00 H	178	15.22	23.76
10	751.23	41.71 QP	46.00	-4.29	1.00 H	256	14.66	27.06
ANTENNA POLARITY & TEST DISTANCE: VERTICAL AT 3 M								
NO.	FREQ. (MHz)	EMISSION LEVEL (dBuV/m)	LIMIT (dBuV/m)	MARGIN (dB)	ANTENNA HEIGHT (m)	TABLE ANGLE (Degree)	RAW VALUE (dBuV)	CORRECTION FACTOR (dB/m)
1	35.73	38.11 QP	40.00	-1.89	2.00 V	316	23.57	14.54
2	68.79	30.77 QP	40.00	-9.23	1.50 V	19	17.19	13.58
3	249.60	36.64 QP	46.00	-9.36	1.00 V	238	22.24	14.40
4	459.59	37.45 QP	46.00	-8.55	1.00 V	130	17.06	20.39
5	500.42	41.12 QP	46.00	-4.88	1.00 V	268	19.65	21.48
6	552.91	35.94 QP	46.00	-10.06	2.00 V	61	13.30	22.64
7	587.91	35.96 QP	46.00	-10.04	1.25 V	100	12.56	23.40
8	595.69	44.67 QP	46.00	-1.33	1.00 V	109	21.11	23.57
9	751.23	42.75 QP	46.00	-3.25	1.00 V	172	15.70	27.06
10	875.67	35.73 QP	46.00	-10.27	1.00 V	10	6.39	29.33

- REMARKS:**
1. Emission level (dBuV/m) = Raw Value (dBuV) + Correction Factor (dB/m).
 2. Correction Factor (dB/m) = Antenna Factor (dB/m) + Cable Factor (dB).
 3. The other emission levels were very low against the limit.
 4. Margin value = Emission level – Limit value.

802.11g OFDM MODULATION

EUT TEST CONDITION		MEASUREMENT DETAIL	
CHANNEL	Channel 1	FREQUENCY RANGE	Below 1000MHz
INPUT POWER	120Vac, 60 Hz	DETECTOR FUNCTION	Quasi-Peak
ENVIRONMENTAL CONDITIONS	24deg. C, 64%RH 1016hPa	TEST MODE	C
TESTED BY	Match Tsui		

ANTENNA POLARITY & TEST DISTANCE: HORIZONTAL AT 3 M								
NO.	FREQ. (MHz)	EMISSION LEVEL (dBuV/m)	LIMIT (dBuV/m)	MARGIN (dB)	ANTENNA HEIGHT (m)	TABLE ANGLE (Degree)	RAW VALUE (dBuV)	CORRECTION FACTOR (dB/m)
1	125.17	36.50 QP	43.50	-7.00	2.00 H	292	24.30	12.20
2	154.33	38.13 QP	43.50	-5.37	1.00 H	286	23.47	14.66
3	162.11	37.29 QP	43.50	-6.21	1.50 H	295	22.58	14.71
4	249.60	36.84 QP	46.00	-9.16	1.25 H	64	22.44	14.40
5	317.65	37.05 QP	46.00	-8.95	1.00 H	250	21.82	15.23
6	368.21	38.70 QP	46.00	-7.30	1.00 H	88	21.17	17.53
7	500.42	40.31 QP	46.00	-5.69	1.25 H	286	18.84	21.48
8	552.91	37.76 QP	46.00	-8.24	1.50 H	304	15.11	22.64
9	607.35	36.24 QP	46.00	-9.76	1.25 H	268	12.38	23.87

ANTENNA POLARITY & TEST DISTANCE: VERTICAL AT 3 M								
NO.	FREQ. (MHz)	EMISSION LEVEL (dBuV/m)	LIMIT (dBuV/m)	MARGIN (dB)	ANTENNA HEIGHT (m)	TABLE ANGLE (Degree)	RAW VALUE (dBuV)	CORRECTION FACTOR (dB/m)
1	33.79	30.75 QP	40.00	-9.25	1.50 V	265	16.77	13.97
2	68.79	32.33 QP	40.00	-7.67	2.00 V	25	18.75	13.58
3	156.28	35.08 QP	43.50	-8.42	1.50 V	100	20.35	14.72
4	368.21	38.92 QP	46.00	-7.08	1.25 V	226	21.39	17.53
5	552.91	38.77 QP	46.00	-7.23	1.00 V	298	16.13	22.64
6	595.69	36.04 QP	46.00	-9.96	1.50 V	208	12.47	23.57

- REMARKS:**
1. Emission level (dBuV/m) = Raw Value (dBuV) + Correction Factor (dB/m).
 2. Correction Factor (dB/m) = Antenna Factor (dB/m) + Cable Factor (dB).
 3. The other emission levels were very low against the limit.
 4. Margin value = Emission level – Limit value.

EUT TEST CONDITION		MEASUREMENT DETAIL	
CHANNEL	Channel 1	FREQUENCY RANGE	Below 1000MHz
INPUT POWER	120Vac, 60 Hz	DETECTOR FUNCTION	Quasi-Peak
ENVIRONMENTAL CONDITIONS	24deg. C, 64%RH 1016hPa	TEST MODE	D
TESTED BY	Match Tsui		

ANTENNA POLARITY & TEST DISTANCE: HORIZONTAL AT 3 M								
NO.	FREQ. (MHz)	EMISSION LEVEL (dBuV/m)	LIMIT (dBuV/m)	MARGIN (dB)	ANTENNA HEIGHT (m)	TABLE ANGLE (Degree)	RAW VALUE (dBuV)	CORRECTION FACTOR (dB/m)
1	33.79	37.69 QP	40.00	-2.31	1.00 H	16	23.72	13.97
2	101.84	35.71 QP	43.50	-7.79	1.50 H	301	23.75	11.96
3	162.11	37.00 QP	43.50	-6.50	1.50 H	223	22.28	14.71
4	249.60	42.86 QP	46.00	-3.14	1.00 H	214	28.46	14.40
5	368.21	38.09 QP	46.00	-7.91	1.00 H	28	20.57	17.53
6	500.42	38.87 QP	46.00	-7.13	1.25 H	256	17.39	21.48
7	751.23	38.66 QP	46.00	-7.34	1.25 H	10	11.60	27.06
ANTENNA POLARITY & TEST DISTANCE: VERTICAL AT 3 M								
NO.	FREQ. (MHz)	EMISSION LEVEL (dBuV/m)	LIMIT (dBuV/m)	MARGIN (dB)	ANTENNA HEIGHT (m)	TABLE ANGLE (Degree)	RAW VALUE (dBuV)	CORRECTION FACTOR (dB/m)
1	33.79	38.24 QP	40.00	-1.76	1.25 V	136	24.27	13.97
2	64.90	38.13 QP	40.00	-1.87	1.00 V	10	24.71	13.42
3	101.84	41.87 QP	43.50	-1.63	1.25 V	208	29.91	11.96
4	146.56	38.02 QP	43.50	-5.48	1.00 V	10	23.88	14.14
5	249.60	38.08 QP	46.00	-7.92	1.00 V	124	23.68	14.40
6	500.42	40.55 QP	46.00	-5.45	1.00 V	349	19.07	21.48
7	751.23	38.21 QP	46.00	-7.79	1.25 V	1	11.15	27.06

- REMARKS:**
1. Emission level (dBuV/m) = Raw Value (dBuV) + Correction Factor (dB/m).
 2. Correction Factor (dB/m) = Antenna Factor (dB/m) + Cable Factor (dB).
 3. The other emission levels were very low against the limit.
 4. Margin value = Emission level – Limit value.

4.2 CONDUCTED EMISSION MEASUREMENT

4.2.1 LIMITS OF CONDUCTED EMISSION MEASUREMENT

FREQUENCY OF EMISSION (MHz)	CONDUCTED LIMIT (dB μ V)	
	Quasi-peak	Average
0.15 ~ 0.5	66 to 56	56 to 46
0.5 ~ 5	56	46
5 ~ 30	60	50

- NOTE:**
1. The lower limit shall apply at the transition frequencies.
 2. The limit decreases in line with the logarithm of the frequency in the range of 0.15 to 0.50 MHz.
 3. All emanations from a class A/B digital device or system, including any network of conductors and apparatus connected thereto, shall not exceed the level of field strengths specified above.

4.2.2 TEST INSTRUMENTS

DESCRIPTION & MANUFACTURER	MODEL NO.	SERIAL NO.	DATE OF CALIBRATION	DUE DATE OF CALIBRATION
Test Receiver ROHDE & SCHWARZ	ESCS30	100288	Sep. 22, 2008	Sep. 21, 2009
RF signal cable Woken	5D-FB	Cable-HYCO2-01	Jan. 04, 2008	Jan. 03, 2009
LISN ROHDE & SCHWARZ	ESH2-Z5	100100	Jan. 10, 2008	Jan. 09, 2009
LISN ROHDE & SCHWARZ	ESH3-Z5	100311	Jul. 30, 2008	Jul. 29, 2009
Software ADT	ADT_Cond_V3	NA	NA	NA

- NOTE:**
1. The calibration interval of the above test instruments is 12 months and the calibrations are traceable to NML/ROC and NIST/USA.
 2. The test was performed in HwaYa Shielded Room 2.
 3. The VCCI Site Registration No. is C-2047.

4.2.3 TEST PROCEDURES

- a. The EUT was placed 0.4 meters from the conducting wall of the shielded room with EUT being connected to the power mains through a line impedance stabilization network (LISN). Other support units were connected to the power mains through another LISN. The two LISNs provide 50 ohm/ 50uH of coupling impedance for the measuring instrument.
- b. Both lines of the power mains connected to the EUT were checked for maximum conducted interference.
- c. The frequency range from 150kHz to 30MHz was searched. Emission levels under (Limit - 20dB) was not recorded.

NOTE: All modes of operation were investigated and the worst-case emissions are reported.

4.2.4 DEVIATION FROM TEST STANDARD

No deviation.

4.2.5 TEST SETUP

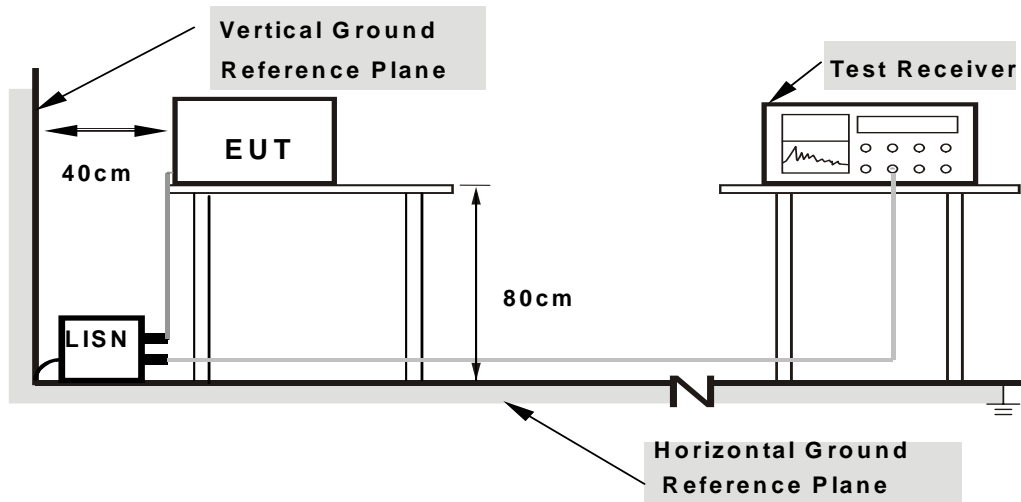

Note: 1.Support units were connected to second LISN.

2.Both of LISNs (AMN) are 80 cm from EUT and at least 80 cm from other units and other metal planes

For the actual test configuration, please refer to the attached file (Test Setup Photo).

4.2.6 EUT OPERATING CONDITIONS

Same as 4.1.6.

4.2.7 TEST RESULTS

CONDUCTED WORST-CASE DATA : 802.11b DSSS MODULATION

EUT TEST CONDITION		MEASUREMENT DETAIL	
CHANNEL	Channel 6	PHASE	Line 1
MODULATION TYPE	DBPSK	6dB BANDWIDTH	9 kHz
TRANSFER RATE	1Mbps	ENVIRONMENTAL CONDITIONS	20deg. C, 60%RH, 1013hPa
INPUT POWER	120Vac, 60 Hz	TEST MODE	A
TESTED BY	Match Tsui		

No	Freq. [MHz]	Corr. Factor (dB)	Reading Value [dB (uV)]		Emission Level [dB (uV)]		Limit [dB (uV)]		Margin (dB)	
			Q.P.	AV.	Q.P.	AV.	Q.P.	AV.	Q.P.	AV.
1	0.158	0.13	52.74	-	52.87	-	65.58	55.58	-12.71	-
2	0.505	0.15	22.11	-	22.26	-	56.00	46.00	-33.74	-
3	4.148	0.44	31.13	-	31.57	-	56.00	46.00	-24.43	-
4	5.613	0.49	26.40	-	26.89	-	60.00	50.00	-33.11	-
5	6.727	0.52	23.33	-	23.85	-	60.00	50.00	-36.15	-
6	17.695	1.11	38.57	-	39.68	-	60.00	50.00	-20.32	-

- REMARKS:**
1. Q.P. and AV. are abbreviations of quasi-peak and average individually.
 2. "-": The Quasi-peak reading value also meets average limit and measurement with the average detector is unnecessary.
 3. The emission levels of other frequencies were very low against the limit.
 4. Margin value = Emission level - Limit value
 5. Correction factor = Insertion loss + Cable loss
 6. Emission Level = Correction Factor + Reading Value.

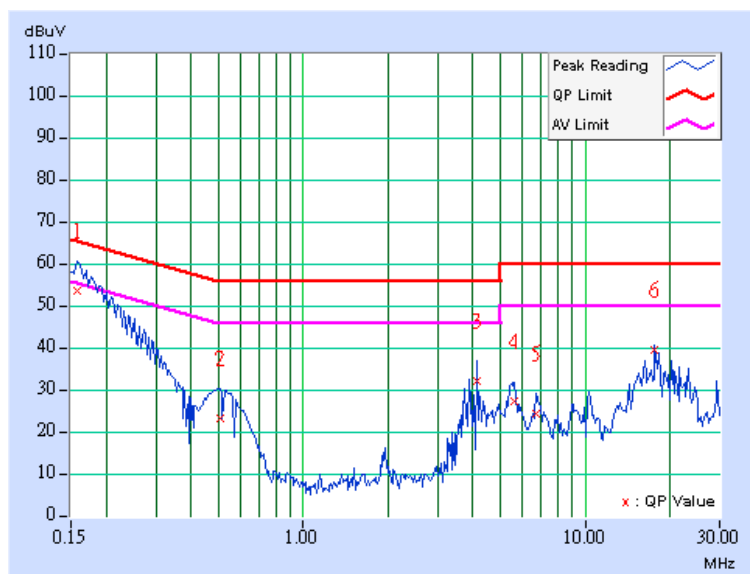

EUT TEST CONDITION		MEASUREMENT DETAIL	
CHANNEL	Channel 6	PHASE	Line 2
MODULATION TYPE	DBPSK	6dB BANDWIDTH	9 kHz
TRANSFER RATE	1Mbps	ENVIRONMENTAL CONDITIONS	20deg. C, 60%RH, 1013hPa
INPUT POWER	120Vac, 60 Hz	TEST MODE	A
TESTED BY	Match Tsui		

No	Freq. [MHz]	Corr. Factor (dB)	Reading Value [dB (uV)]		Emission Level [dB (uV)]		Limit [dB (uV)]		Margin (dB)	
			Q.P.	AV.	Q.P.	AV.	Q.P.	AV.	Q.P.	AV.
1	0.158	0.14	52.52	-	52.66	-	65.58	55.58	-12.92	-
2	0.486	0.15	22.35	-	22.50	-	56.24	46.24	-33.73	-
3	4.059	0.43	23.41	-	23.84	-	56.00	46.00	-32.16	-
4	5.719	0.47	24.72	-	25.19	-	60.00	50.00	-34.81	-
5	10.418	0.58	22.64	-	23.22	-	60.00	50.00	-36.78	-
6	18.246	0.88	41.69	-	42.57	-	60.00	50.00	-17.43	-

- REMARKS:**
1. Q.P. and AV. are abbreviations of quasi-peak and average individually.
 2. "-": The Quasi-peak reading value also meets average limit and measurement with the average detector is unnecessary.
 3. The emission levels of other frequencies were very low against the limit.
 4. Margin value = Emission level - Limit value
 5. Correction factor = Insertion loss + Cable loss
 6. Emission Level = Correction Factor + Reading Value.

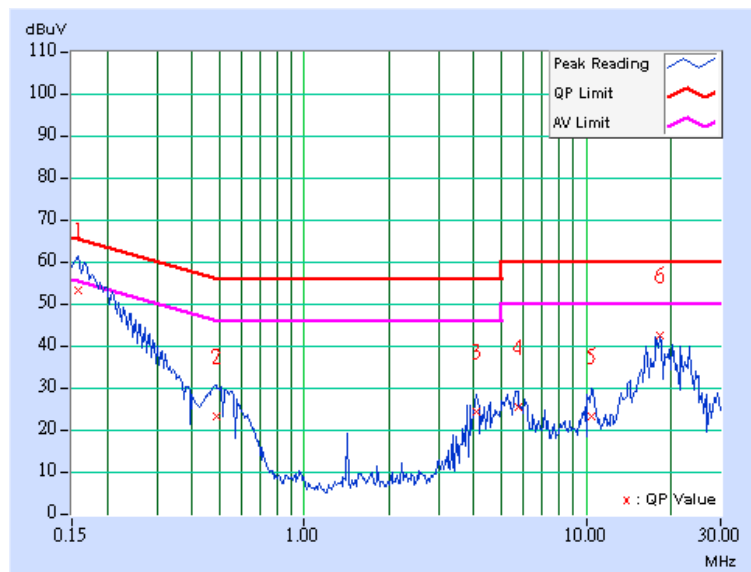

EUT TEST CONDITION		MEASUREMENT DETAIL	
CHANNEL	Channel 6	PHASE	Line 1
MODULATION TYPE	DBPSK	6dB BANDWIDTH	9 kHz
TRANSFER RATE	1Mbps	ENVIRONMENTAL CONDITIONS	20deg. C, 60%RH, 1013hPa
INPUT POWER	120Vac, 60 Hz	TEST MODE	B
TESTED BY	Match Tsui		

No	Freq. [MHz]	Corr. Factor (dB)	Reading Value [dB (uV)]		Emission Level [dB (uV)]		Limit [dB (uV)]		Margin (dB)	
			Q.P.	AV.	Q.P.	AV.	Q.P.	AV.	Q.P.	AV.
			1	0.154	0.13	53.24	-	53.37	-	65.79
2	0.248	0.13	51.24	-	51.37	-	61.84	51.84	-10.46	-
3	0.388	0.14	47.59	-	47.73	-	58.10	48.10	-10.37	-
4	0.724	0.16	45.19	-	45.35	-	56.00	46.00	-10.65	-
5	1.789	0.24	44.83	-	45.07	-	56.00	46.00	-10.93	-
6	5.660	0.49	41.33	-	41.82	-	60.00	50.00	-18.18	-

- REMARKS:**
1. Q.P. and AV. are abbreviations of quasi-peak and average individually.
 2. "-": The Quasi-peak reading value also meets average limit and measurement with the average detector is unnecessary.
 3. The emission levels of other frequencies were very low against the limit.
 4. Margin value = Emission level - Limit value
 5. Correction factor = Insertion loss + Cable loss
 6. Emission Level = Correction Factor + Reading Value.

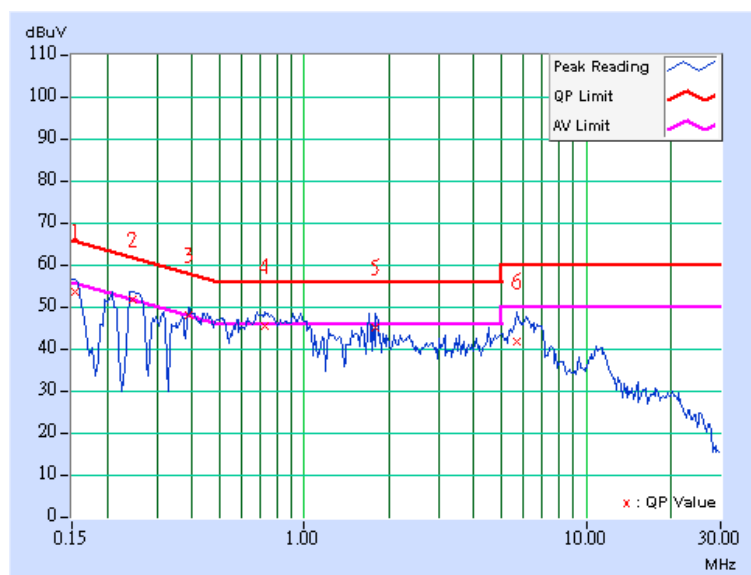

EUT TEST CONDITION		MEASUREMENT DETAIL	
CHANNEL	Channel 6	PHASE	Line 2
MODULATION TYPE	DBPSK	6dB BANDWIDTH	9 kHz
TRANSFER RATE	1Mbps	ENVIRONMENTAL CONDITIONS	20deg. C, 60%RH, 1013hPa
INPUT POWER	120Vac, 60 Hz	TEST MODE	B
TESTED BY	Match Tsui		

No	Freq. [MHz]	Corr. Factor (dB)	Reading Value [dB (uV)]		Emission Level [dB (uV)]		Limit [dB (uV)]		Margin (dB)	
			Q.P.	AV.	Q.P.	AV.	Q.P.	AV.	Q.P.	AV.
			1	0.150	0.14	52.85	-	52.99	-	66.00
2	0.259	0.14	50.89	-	51.03	-	61.45	51.45	-10.42	-
3	0.677	0.16	47.08	36.95	47.24	37.11	56.00	46.00	-8.76	-8.89
4	0.966	0.18	46.31	35.69	46.49	35.87	56.00	46.00	-9.51	-10.13
5	1.758	0.24	47.17	36.39	47.41	36.63	56.00	46.00	-8.59	-9.37
6	6.098	0.48	43.19	-	43.67	-	60.00	50.00	-16.33	-

- REMARKS:**
1. Q.P. and AV. are abbreviations of quasi-peak and average individually.
 2. "-": The Quasi-peak reading value also meets average limit and measurement with the average detector is unnecessary.
 3. The emission levels of other frequencies were very low against the limit.
 4. Margin value = Emission level - Limit value
 5. Correction factor = Insertion loss + Cable loss
 6. Emission Level = Correction Factor + Reading Value.

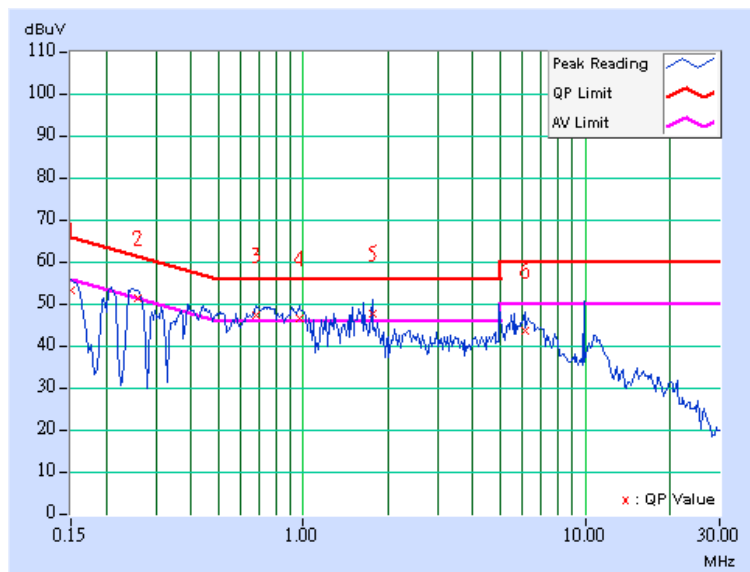

802.11g OFDM MODULATION

EUT TEST CONDITION		MEASUREMENT DETAIL	
CHANNEL	Channel 1	PHASE	Line 1
MODULATION TYPE	BPSK	6dB BANDWIDTH	9 kHz
TRANSFER RATE	6Mbps	ENVIRONMENTAL CONDITIONS	20deg. C, 60%RH, 1016hPa
INPUT POWER	120Vac, 60 Hz	TEST MODE	C
TESTED BY	Match Tsui		

No	Freq. [MHz]	Corr. Factor (dB)	Reading Value [dB (uV)]		Emission Level [dB (uV)]		Limit [dB (uV)]		Margin (dB)	
			Q.P.	AV.	Q.P.	AV.	Q.P.	AV.	Q.P.	AV.
1	0.159	0.13	53.44	-	53.57	-	65.53	55.53	-11.97	-
2	0.507	0.15	21.47	-	21.62	-	56.00	46.00	-34.38	-
3	4.150	0.44	32.54	-	32.98	-	56.00	46.00	-23.02	-
4	5.614	0.49	26.40	-	26.89	-	60.00	50.00	-33.11	-
5	6.728	0.52	24.24	-	24.76	-	60.00	50.00	-35.24	-
6	17.697	1.11	39.54	-	40.65	-	60.00	50.00	-19.35	-

- REMARKS:**
1. Q.P. and AV. are abbreviations of quasi-peak and average individually.
 2. "-": The Quasi-peak reading value also meets average limit and measurement with the average detector is unnecessary.
 3. The emission levels of other frequencies were very low against the limit.
 4. Margin value = Emission level - Limit value
 5. Correction factor = Insertion loss + Cable loss
 6. Emission Level = Correction Factor + Reading Value.

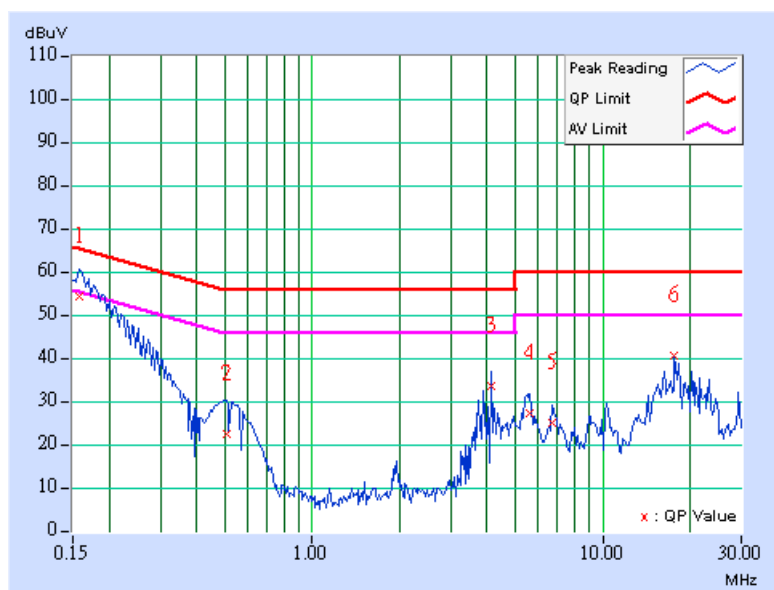

EUT TEST CONDITION		MEASUREMENT DETAIL	
CHANNEL	Channel 1	PHASE	Line 2
MODULATION TYPE	BPSK	6dB BANDWIDTH	9 kHz
TRANSFER RATE	6Mbps	ENVIRONMENTAL CONDITIONS	20deg. C, 60%RH, 1016hPa
INPUT POWER	120Vac, 60 Hz	TEST MODE	C
TESTED BY	Match Tsui		

No	Freq. [MHz]	Corr. Factor (dB)	Reading Value [dB (uV)]		Emission Level [dB (uV)]		Limit [dB (uV)]		Margin (dB)	
			Q.P.	AV.	Q.P.	AV.	Q.P.	AV.	Q.P.	AV.
			1	0.160	0.14	51.60	-	51.74	-	65.48
2	0.487	0.15	21.54	-	21.69	-	56.22	46.22	-34.53	-
3	4.060	0.43	22.52	-	22.95	-	56.00	46.00	-33.05	-
4	5.719	0.47	23.58	-	24.05	-	60.00	50.00	-35.95	-
5	10.425	0.58	21.54	-	22.12	-	60.00	50.00	-37.88	-
6	18.248	0.88	42.80	-	43.68	-	60.00	50.00	-16.32	-

- REMARKS:**
1. Q.P. and AV. are abbreviations of quasi-peak and average individually.
 2. "-": The Quasi-peak reading value also meets average limit and measurement with the average detector is unnecessary.
 3. The emission levels of other frequencies were very low against the limit.
 4. Margin value = Emission level - Limit value
 5. Correction factor = Insertion loss + Cable loss
 6. Emission Level = Correction Factor + Reading Value.

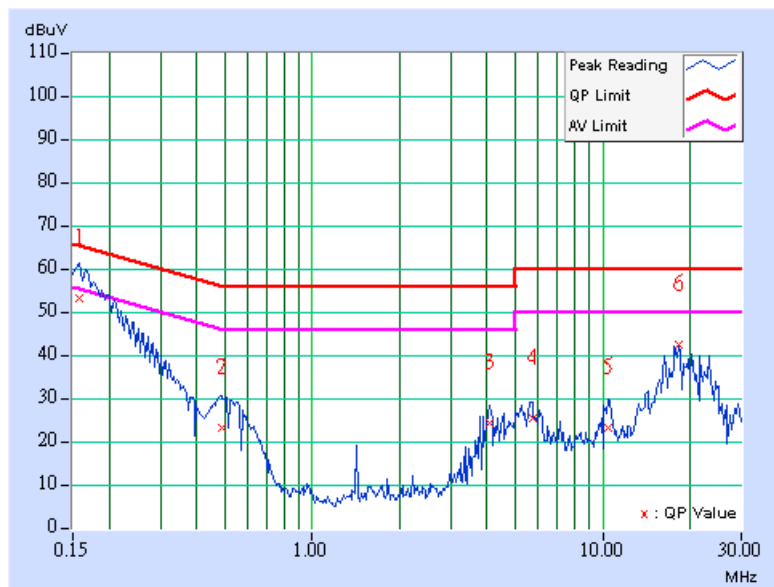

EUT TEST CONDITION		MEASUREMENT DETAIL	
CHANNEL	Channel 1	PHASE	Line 1
MODULATION TYPE	BPSK	6dB BANDWIDTH	9 kHz
TRANSFER RATE	6Mbps	ENVIRONMENTAL CONDITIONS	20deg. C, 60%RH, 1016hPa
INPUT POWER	120Vac, 60 Hz	TEST MODE	D
TESTED BY	Match Tsui		

No	Freq. [MHz]	Corr. Factor (dB)	Reading Value [dB (uV)]		Emission Level [dB (uV)]		Limit [dB (uV)]		Margin (dB)	
			Q.P.	AV.	Q.P.	AV.	Q.P.	AV.	Q.P.	AV.
			1	0.155	0.13	52.96	-	53.09	-	65.74
2	0.249	0.13	52.54	45.60	52.67	45.73	61.80	51.80	-9.13	-6.07
3	0.390	0.14	48.65	37.27	48.79	37.41	58.07	48.07	-9.28	-10.66
4	0.726	0.16	44.85	-	45.01	-	56.00	46.00	-10.99	-
5	1.790	0.24	45.81	35.63	46.05	35.87	56.00	46.00	-9.95	-10.13
6	5.665	0.49	42.40	-	42.89	-	60.00	50.00	-17.11	-

- REMARKS:**
1. Q.P. and AV. are abbreviations of quasi-peak and average individually.
 2. "-": The Quasi-peak reading value also meets average limit and measurement with the average detector is unnecessary.
 3. The emission levels of other frequencies were very low against the limit.
 4. Margin value = Emission level - Limit value
 5. Correction factor = Insertion loss + Cable loss
 6. Emission Level = Correction Factor + Reading Value.

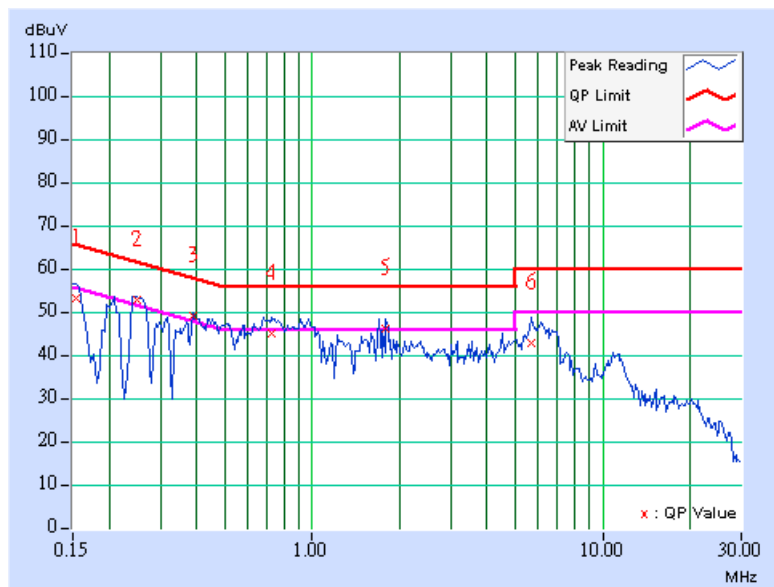

EUT TEST CONDITION		MEASUREMENT DETAIL	
CHANNEL	Channel 1	PHASE	Line 2
MODULATION TYPE	BPSK	6dB BANDWIDTH	9 kHz
TRANSFER RATE	6Mbps	ENVIRONMENTAL CONDITIONS	20deg. C, 60%RH, 1016hPa
INPUT POWER	120Vac, 60 Hz	TEST MODE	D
TESTED BY	Match Tsui		

No	Freq. [MHz]	Corr. Factor (dB)	Reading Value [dB (uV)]		Emission Level [dB (uV)]		Limit [dB (uV)]		Margin (dB)	
			Q.P.	AV.	Q.P.	AV.	Q.P.	AV.	Q.P.	AV.
			1	0.150	0.14	51.69	-	51.83	-	66.00
2	0.260	0.14	49.35	-	49.49	-	61.44	51.44	-11.94	-
3	0.679	0.16	46.57	35.54	46.73	35.70	56.00	46.00	-9.27	-10.30
4	0.968	0.18	45.10	-	45.28	-	56.00	46.00	-10.72	-
5	1.760	0.24	46.46	35.96	46.70	36.20	56.00	46.00	-9.30	-9.80
6	6.098	0.48	42.77	-	43.25	-	60.00	50.00	-16.75	-

- REMARKS:**
1. Q.P. and AV. are abbreviations of quasi-peak and average individually.
 2. "-": The Quasi-peak reading value also meets average limit and measurement with the average detector is unnecessary.
 3. The emission levels of other frequencies were very low against the limit.
 4. Margin value = Emission level - Limit value
 5. Correction factor = Insertion loss + Cable loss
 6. Emission Level = Correction Factor + Reading Value.

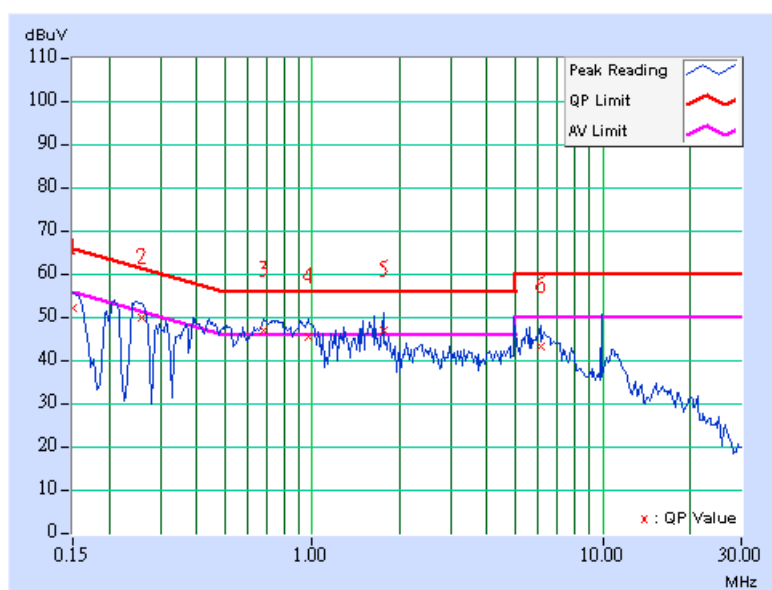



4.3 6dB BANDWIDTH MEASUREMENT

4.3.1 LIMITS OF 6dB BANDWIDTH MEASUREMENT

The minimum of 6dB Bandwidth Measurement is 0.5 MHz.

4.3.2 TEST INSTRUMENTS

DESCRIPTION & MANUFACTURER	MODEL NO.	SERIAL NO.	CALIBRATED UNTIL
SPECTRUM ANALYZER	FSP 40	100041	Apr. 21, 2009

NOTE: The calibration interval of the above test instruments is 12 months and the calibrations are traceable to NML/ROC and NIST/USA.

4.3.3 TEST PROCEDURE

The transmitter output was connected to the spectrum analyzer through an attenuator. The bandwidth of the fundamental frequency was measured by spectrum analyzer with 100 kHz RBW and 300kHz VBW. The 6dB bandwidth is defined as the total spectrum the power of which is higher than peak power minus 6dB.

4.3.4 DEVIATION FROM TEST STANDARD

No deviation.

4.3.5 TEST SETUP

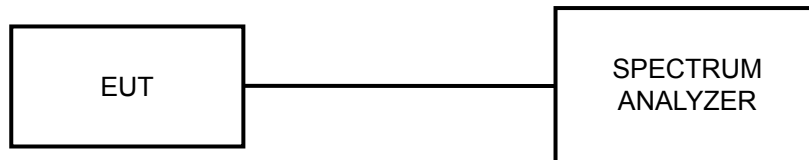

For the actual test configuration, please refer to the related Item – Photographs of the Test Configuration.

4.3.6 EUT OPERATING CONDITIONS

The software provided by client to enable the EUT under transmission condition continuously at lowest, middle and highest channel frequencies individually.

4.3.7 TEST RESULTS

802.11b DSSS MODULATION

MODULATION TYPE	DBPSK	TRANSFER RATE	1Mbps
INPUT POWER	120Vac, 60 Hz	ENVIRONMENTAL CONDITIONS	24deg. C, 64%RH, 1013hPa
TEST MODE	B	TESTED BY	Match Tsui

CHANNEL	CHANNEL FREQUENCY (MHz)	6dB BANDWIDTH (MHz)	MINIMUM LIMIT (MHz)	PASS/FAIL
1	2412	11.09	0.5	PASS
6	2437	12.08	0.5	PASS
11	2462	11.11	0.5	PASS

CH 1

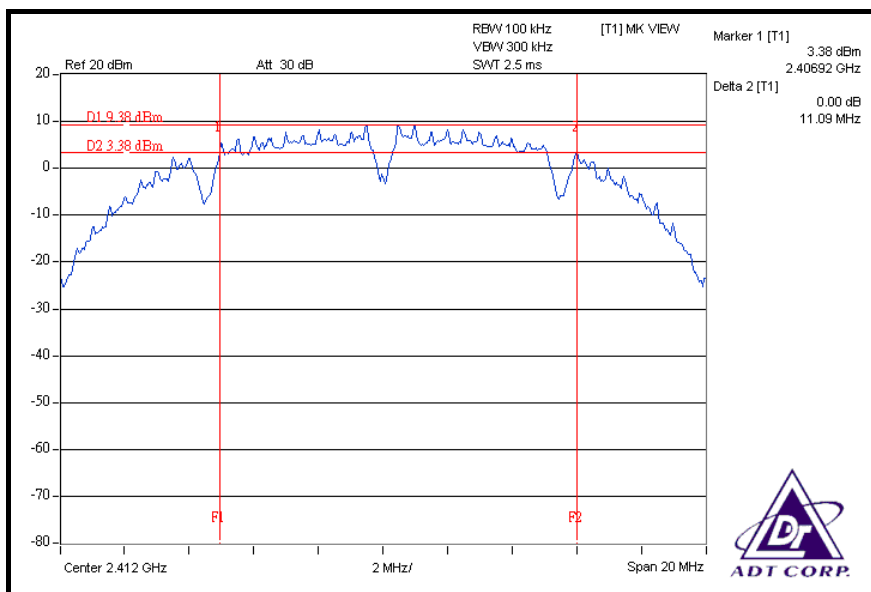

CH 6

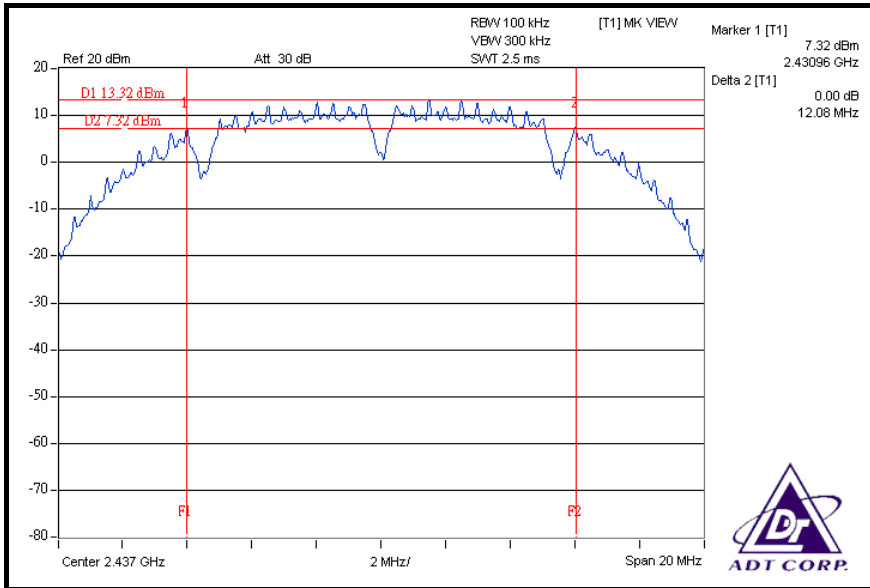

CH 11

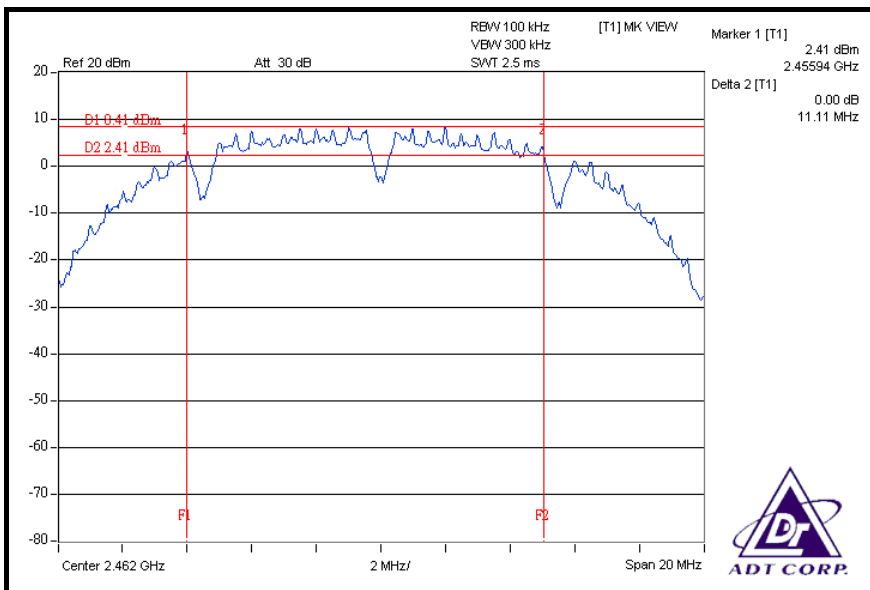

MODULATION TYPE	DBPSK	TRANSFER RATE	1Mbps
INPUT POWER	120Vac, 60 Hz	ENVIRONMENTAL CONDITIONS	24deg. C, 64%RH, 1013hPa
TEST MODE	D	TESTED BY	Match Tsui

CHANNEL	CHANNEL FREQUENCY (MHz)	6dB BANDWIDTH (MHz)	MINIMUM LIMIT (MHz)	PASS/FAIL
1	2412	10.16	0.5	PASS
6	2437	11.11	0.5	PASS
11	2462	11.10	0.5	PASS

CH 1

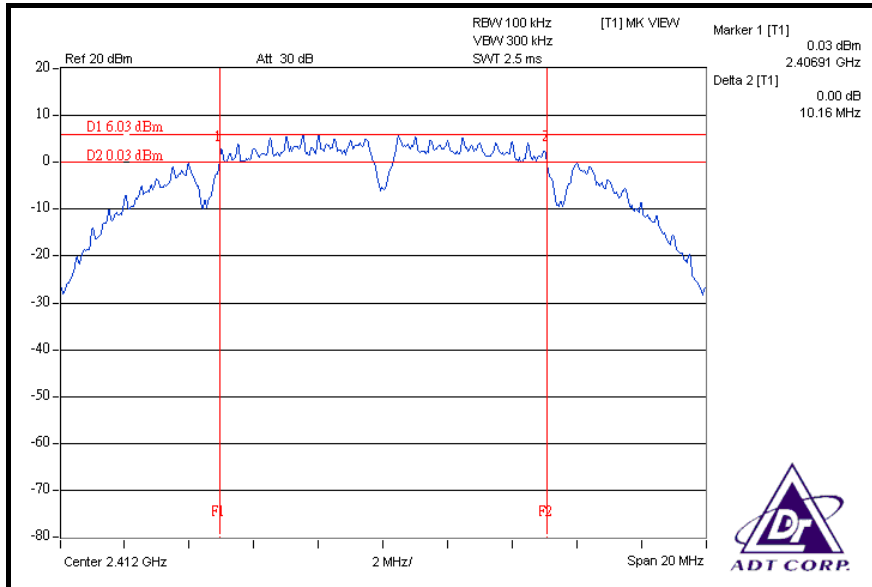

CH 6

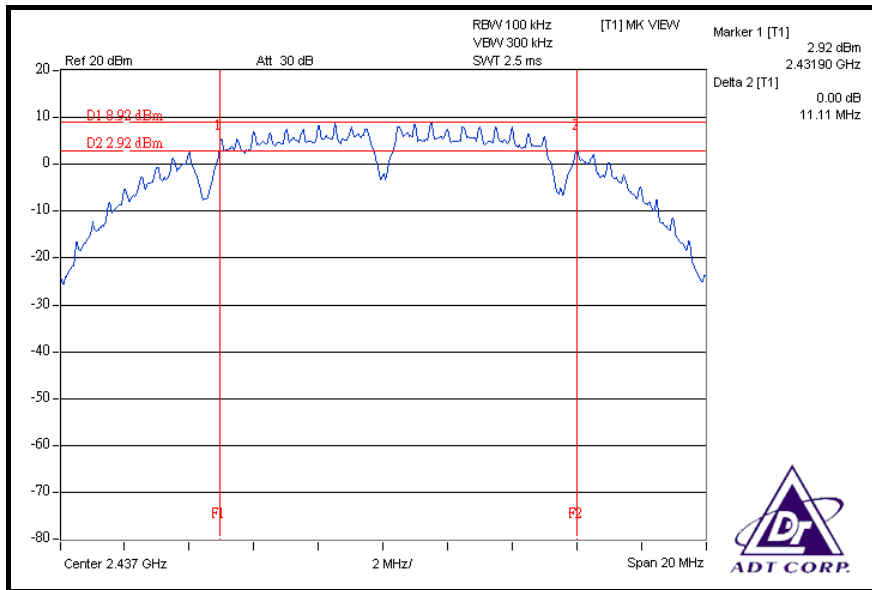

CH 11

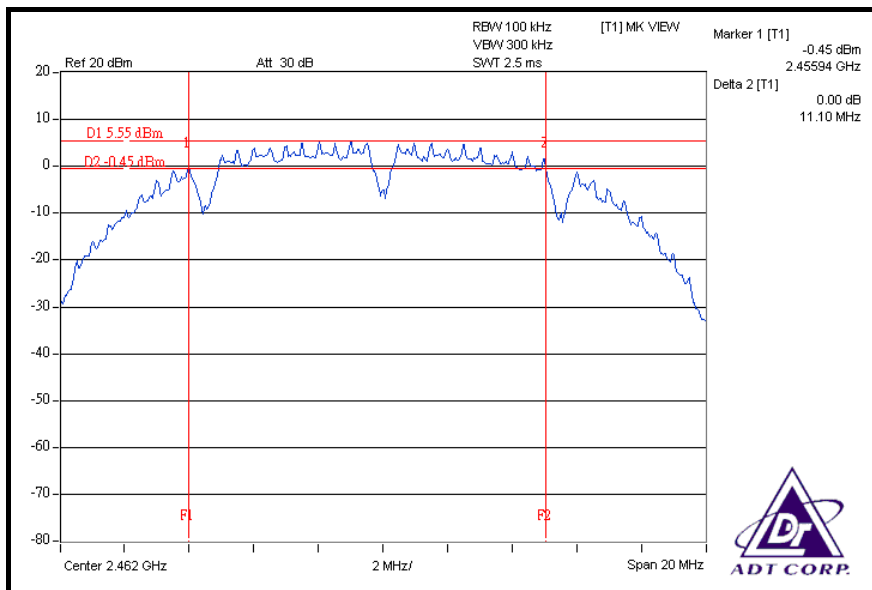



802.11g OFDM MODULATION

MODULATION TYPE	BPSK	TRANSFER RATE	6Mbps
INPUT POWER	120Vac, 60 Hz	ENVIRONMENTAL CONDITIONS	24deg. C, 64%RH, 1013hPa
TEST MODE	B	TESTED BY	Match Tsui

CHANNEL	CHANNEL FREQUENCY (MHz)	6dB BANDWIDTH (MHz)	MINIMUM LIMIT (MHz)	PASS/FAIL
1	2412	16.43	0.5	PASS
6	2437	16.46	0.5	PASS
11	2462	16.40	0.5	PASS

CH 1

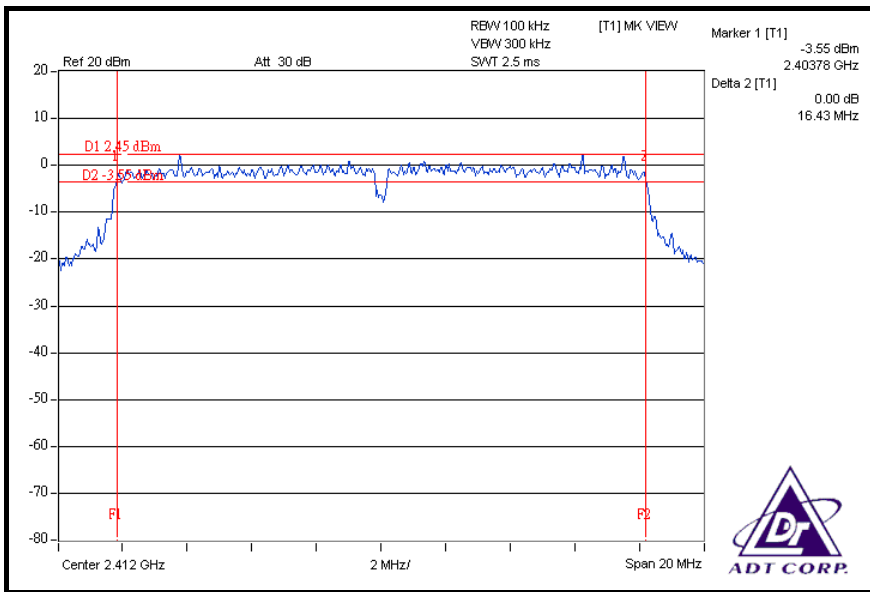

CH 6

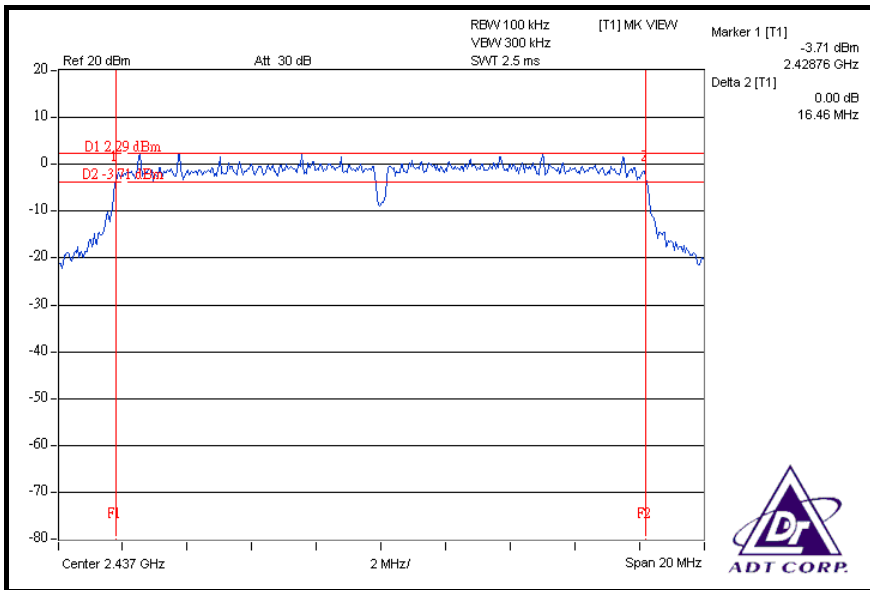

CH 11

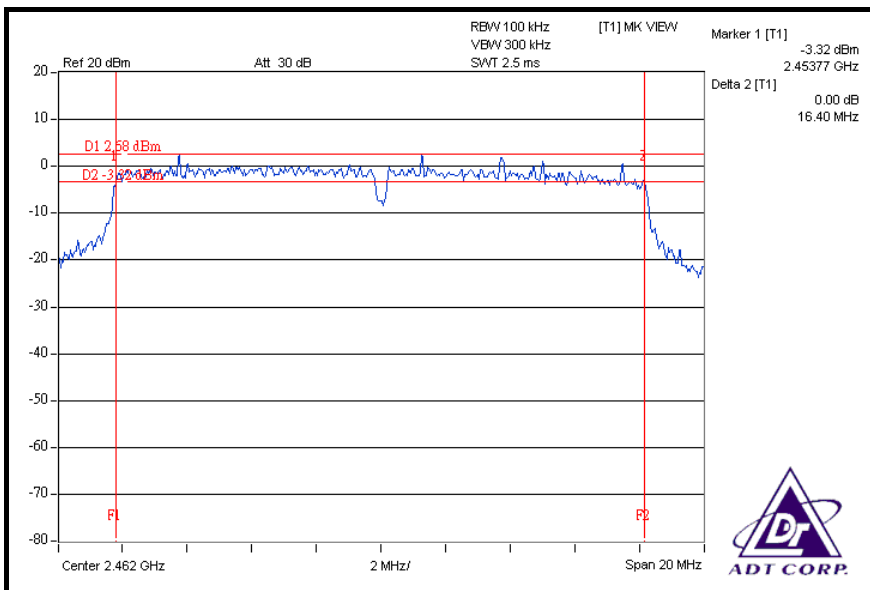



MODULATION TYPE	BPSK	TRANSFER RATE	6Mbps
INPUT POWER	120Vac, 60 Hz	ENVIRONMENTAL CONDITIONS	24deg. C, 64%RH, 1013hPa
TEST MODE	D	TESTED BY	Match Tsui

CHANNEL	CHANNEL FREQUENCY (MHz)	6dB BANDWIDTH (MHz)	MINIMUM LIMIT (MHz)	PASS/FAIL
1	2412	16.42	0.5	PASS
6	2437	16.42	0.5	PASS
11	2462	16.06	0.5	PASS

CH 1

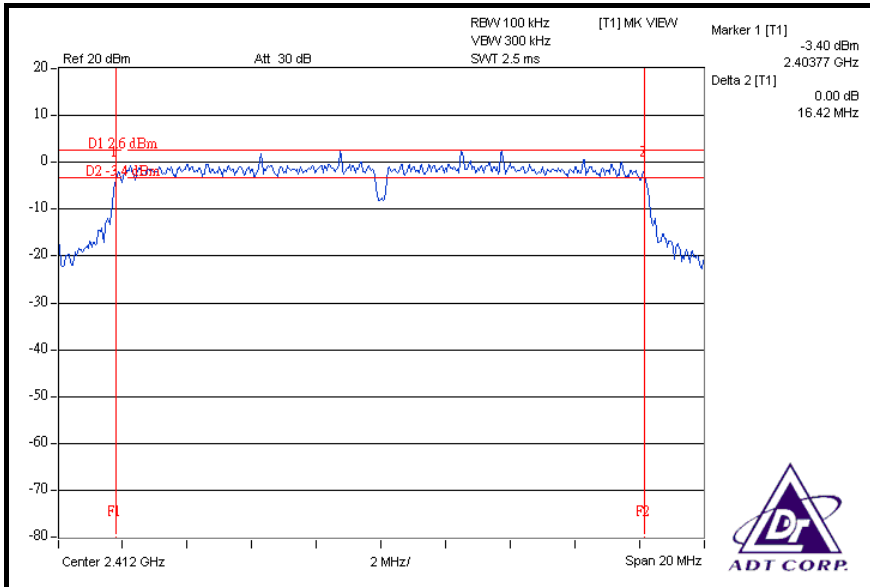

CH 6

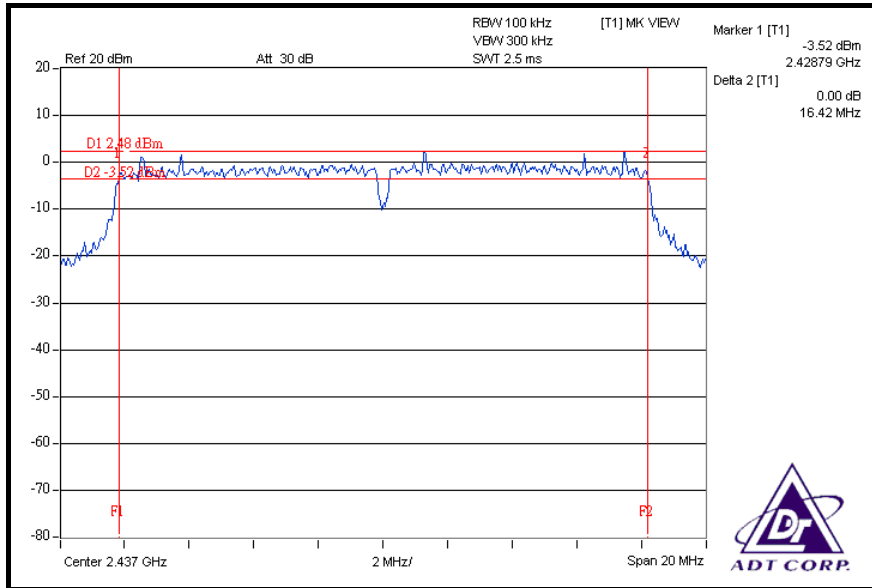

CH 11

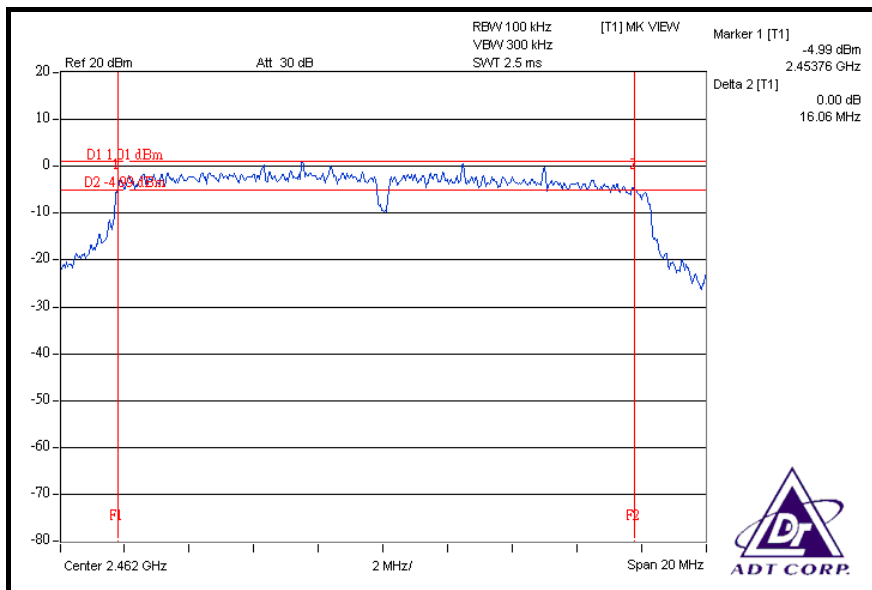



4.4 MAXIMUM PEAK OUTPUT POWER

4.4.1 LIMITS OF MAXIMUM PEAK OUTPUT POWER MEASUREMENT

The Maximum Peak Output Power Measurement is 30dBm.

4.4.2 TEST INSTRUMENTS

DESCRIPTION & MANUFACTURER	MODEL NO.	SERIAL NO.	CALIBRATED UNTIL
HIGH SPEED PEAK POWER METER	ML2495A	0824012	Aug. 03, 2009
POWER SENSOR	MA2444B	0738138	Aug. 03, 2009

NOTE:

1. The calibration interval of the above test instruments is 12 months and the calibrations are traceable to NML/ROC and NIST/USA.
2. Measurement Bandwidth of ML2495A is 65MHz greater than 6dB bandwidth of emission.

4.4.3 TEST PROCEDURES

A power sensor was used on the output port of the EUT. A power meter was used to read the response of the power sensor. Record the power level.

4.4.4 DEVIATION FROM TEST STANDARD

No deviation.

4.4.5 TEST SETUP

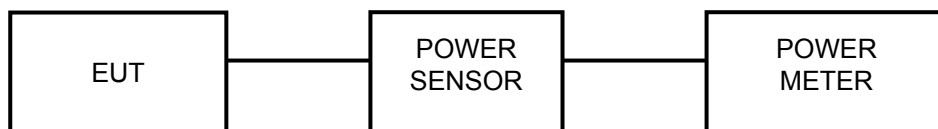

4.4.6 EUT OPERATING CONDITIONS

Same as 4.3.6.

4.4.7 TEST RESULTS

802.11b DSSS MODULATION

MODULATION TYPE	DBPSK	TRANSFER RATE	1Mbps
INPUT POWER	120Vac, 60 Hz	ENVIRONMENTAL CONDITIONS	24deg. C, 64%RH, 1013hPa
TEST MODE	B	TESTED BY	Match Tsui

CHANNEL	CHANNEL FREQUENCY (MHz)	PEAK POWER OUTPUT (mW)	PEAK POWER OUTPUT (dBm)	PEAK POWER LIMIT (dBm)	PASS/FAIL
1	2412	202.768	23.07	30	PASS
6	2437	504.661	27.03	30	PASS
11	2462	161.808	22.09	30	PASS

MODULATION TYPE	DBPSK	TRANSFER RATE	1Mbps
INPUT POWER	120Vac, 60 Hz	ENVIRONMENTAL CONDITIONS	24deg. C, 64%RH, 1013hPa
TEST MODE	D	TESTED BY	Match Tsui

CHANNEL	CHANNEL FREQUENCY (MHz)	PEAK POWER OUTPUT (mW)	PEAK POWER OUTPUT (dBm)	PEAK POWER LIMIT (dBm)	PASS/FAIL
1	2412	101.158	20.05	27	PASS
6	2437	201.372	23.04	27	PASS
11	2462	90.782	19.58	27	PASS

NOTE: According to 15.247 (b) (4), the maximum antenna gain 9dBi is higher than 6dBi, so the limit of peak power shall be reduced by 3dBm.

802.11g OFDM MODULATION

MODULATION TYPE	BPSK	TRANSFER RATE	6Mbps
INPUT POWER	120Vac, 60 Hz	ENVIRONMENTAL CONDITIONS	24deg. C, 64%RH, 1013hPa
TEST MODE	B	TESTED BY	Match Tsui

CHANNEL	CHANNEL FREQUENCY (MHz)	PEAK POWER OUTPUT (mW)	PEAK POWER OUTPUT (dBm)	PEAK POWER LIMIT (dBm)	PASS/FAIL
1	2412	402.717	26.05	30	PASS
6	2437	405.509	26.08	30	PASS
11	2462	401.791	26.04	30	PASS

MODULATION TYPE	BPSK	TRANSFER RATE	6Mbps
INPUT POWER	120Vac, 60 Hz	ENVIRONMENTAL CONDITIONS	24deg. C, 64%RH, 1013hPa
TEST MODE	D	TESTED BY	Match Tsui

CHANNEL	CHANNEL FREQUENCY (MHz)	PEAK POWER OUTPUT (mW)	PEAK POWER OUTPUT (dBm)	PEAK POWER LIMIT (dBm)	PASS/FAIL
1	2412	360.579	25.57	27	PASS
6	2437	357.273	25.53	27	PASS
11	2462	255.859	24.08	27	PASS

NOTE: According to 15.247 (b) (4), the maximum antenna gain 9dBi is higher than 6dBi, so the limit of peak power shall be reduced by 3dBm.

4.5 POWER SPECTRAL DENSITY MEASUREMENT

4.5.1 LIMITS OF POWER SPECTRAL DENSITY MEASUREMENT

The Maximum of Power Spectral Density Measurement is 8dBm.

4.5.2 TEST INSTRUMENTS

DESCRIPTION & MANUFACTURER	MODEL NO.	SERIAL NO.	CALIBRATED UNTIL
R&S SPECTRUM ANALYZER	FSP 40	100041	Apr. 21, 2009

NOTE: The calibration interval of the above test instruments is 12 months and the calibrations are traceable to NML/ROC and NIST/USA.

4.5.3 TEST PROCEDURE

The transmitter output was connected to the spectrum analyzer through an attenuator, the bandwidth of the fundamental frequency was measured with the spectrum analyzer using 3kHz RBW and 30kHz VBW, set sweep time = span/3kHz. The power spectral density was measured and recorded.

The sweep time is allowed to be longer than span/3kHz for a full response of the mixer in the spectrum analyzer.

4.5.4 DEVIATION FROM TEST STANDARD

No deviation.

4.5.5 TEST SETUP

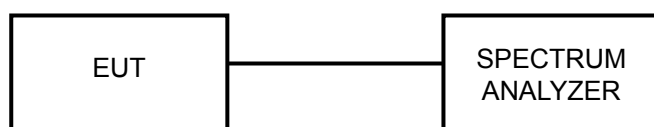

4.5.6 EUT OPERATING CONDITIONS

Same as 4.3.6.

4.5.7 TEST RESULTS

802.11b DSSS MODULATION

MODULATION TYPE	DBPSK	TRANSFER RATE	1Mbps
INPUT POWER	120Vac, 60 Hz	ENVIRONMENTAL CONDITIONS	24deg. C, 64%RH, 1013hPa
TEST MODE	B	TESTED BY	Match Tsui

CHANNEL	CHANNEL FREQUENCY (MHz)	RF POWER LEVEL IN 3 kHz BW (dBm)	MAXIMUM LIMIT (dBm)	PASS/FAIL
1	2412	-3.90	8	PASS
6	2437	0.10	8	PASS
11	2462	-4.98	8	PASS

CH 1

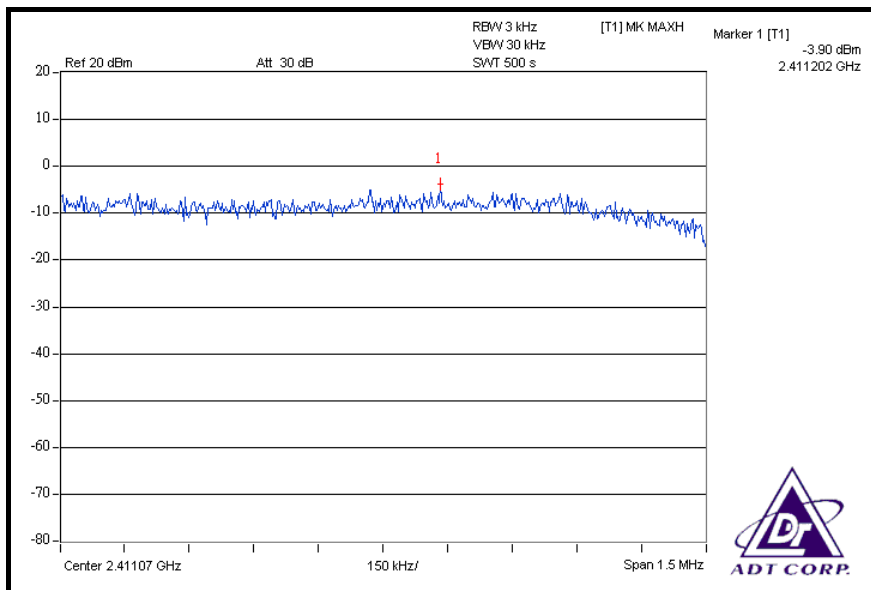

CH 6

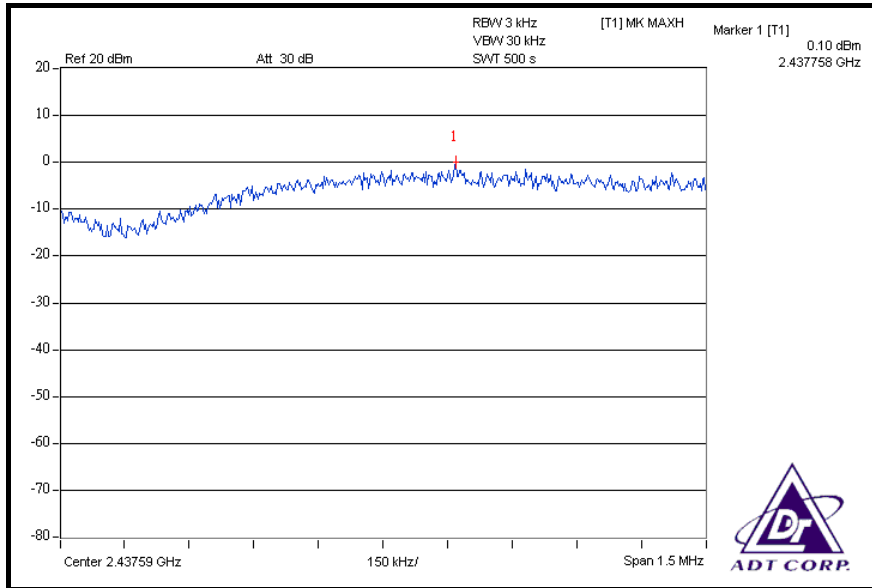

CH 11

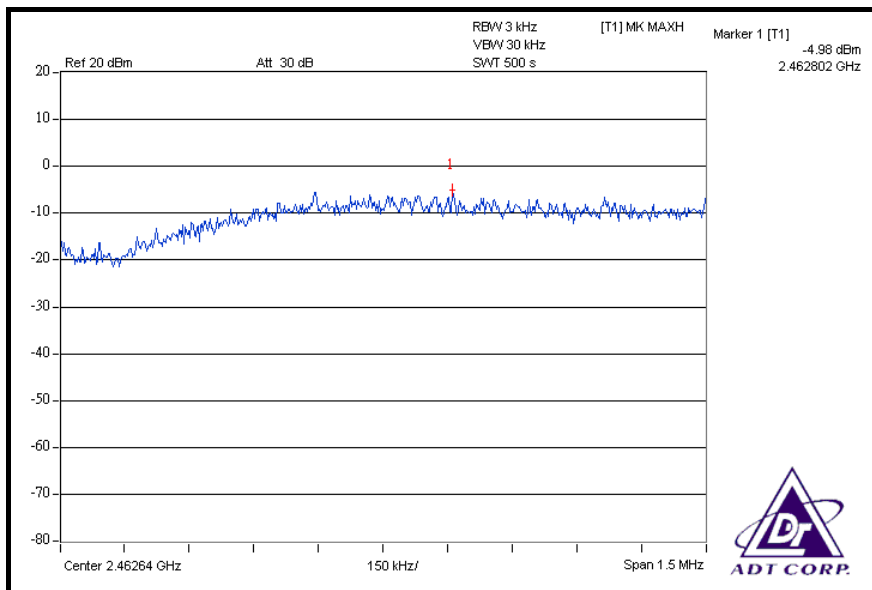

MODULATION TYPE	DBPSK	TRANSFER RATE	1Mbps
INPUT POWER	120Vac, 60 Hz	ENVIRONMENTAL CONDITIONS	24deg. C, 64%RH, 1013hPa
TEST MODE	D	TESTED BY	Match Tsui

CHANNEL	CHANNEL FREQUENCY (MHz)	RF POWER LEVEL IN 3 kHz BW (dBm)	MAXIMUM LIMIT (dBm)	PASS/FAIL
1	2412	-6.99	8	PASS
6	2437	-3.84	8	PASS
11	2462	-7.56	8	PASS

CH 1

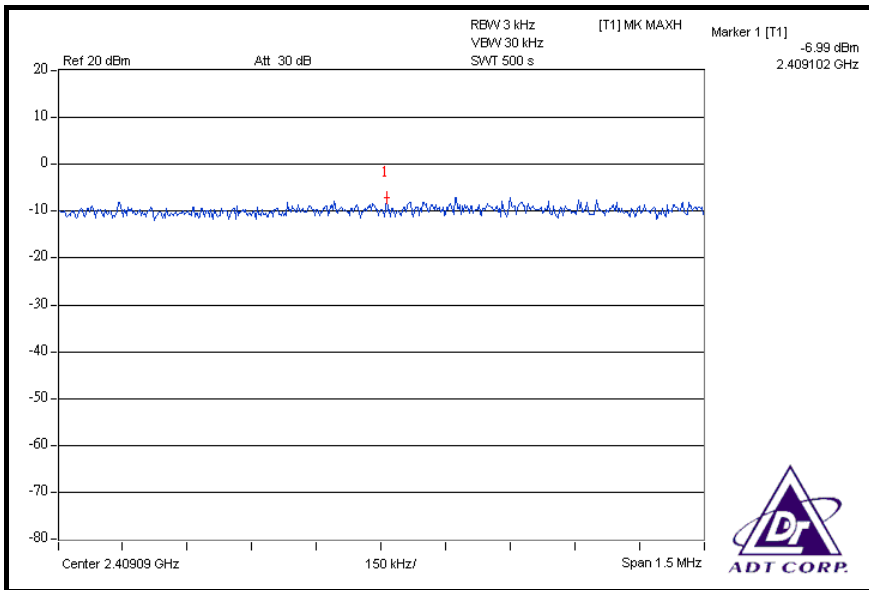

CH 6

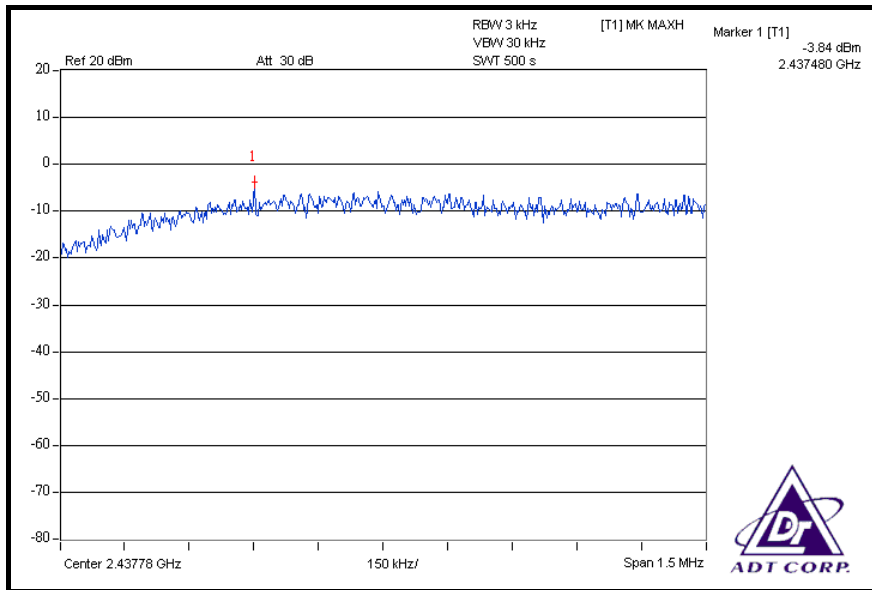

CH 11

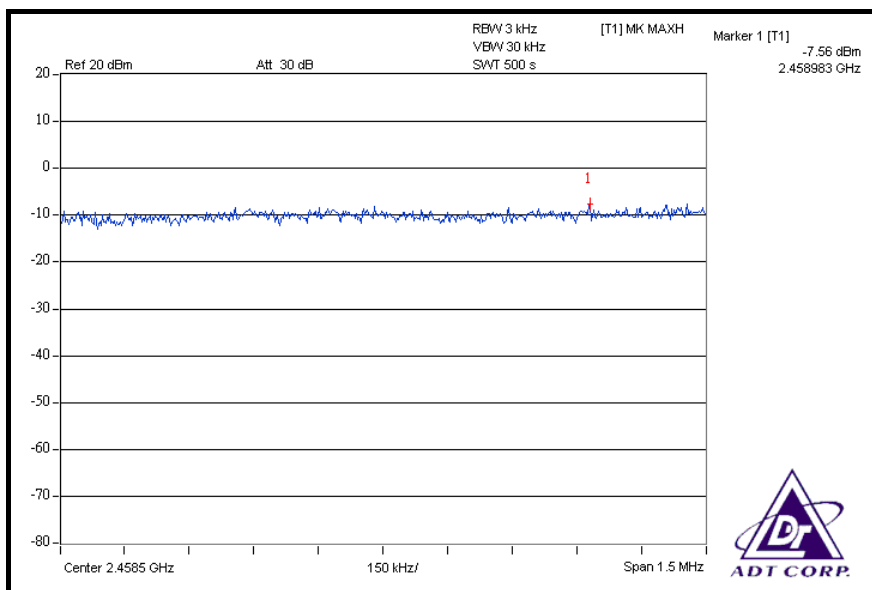



802.11g OFDM MODULATION

MODULATION TYPE	BPSK	TRANSFER RATE	6Mbps
INPUT POWER	120Vac, 60 Hz	ENVIRONMENTAL CONDITIONS	24deg. C, 64%RH, 1013hPa
TEST MODE	B	TESTED BY	Match Tsui

CHANNEL	CHANNEL FREQUENCY (MHz)	RF POWER LEVEL IN 3 kHz BW (dBm)	MAXIMUM LIMIT (dBm)	PASS/FAIL
1	2412	-10.30	8	PASS
6	2437	-10.36	8	PASS
11	2462	-10.39	8	PASS

CH 1

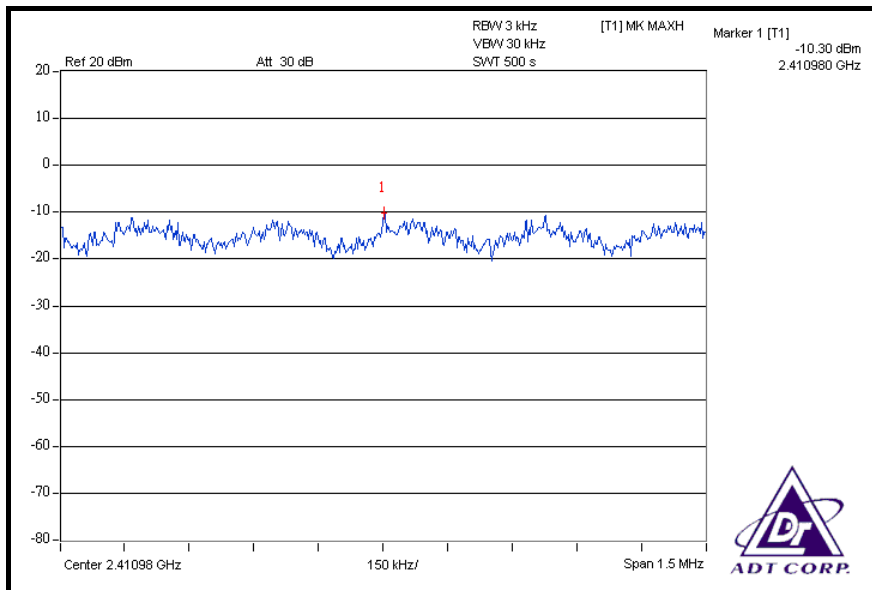

CH 6

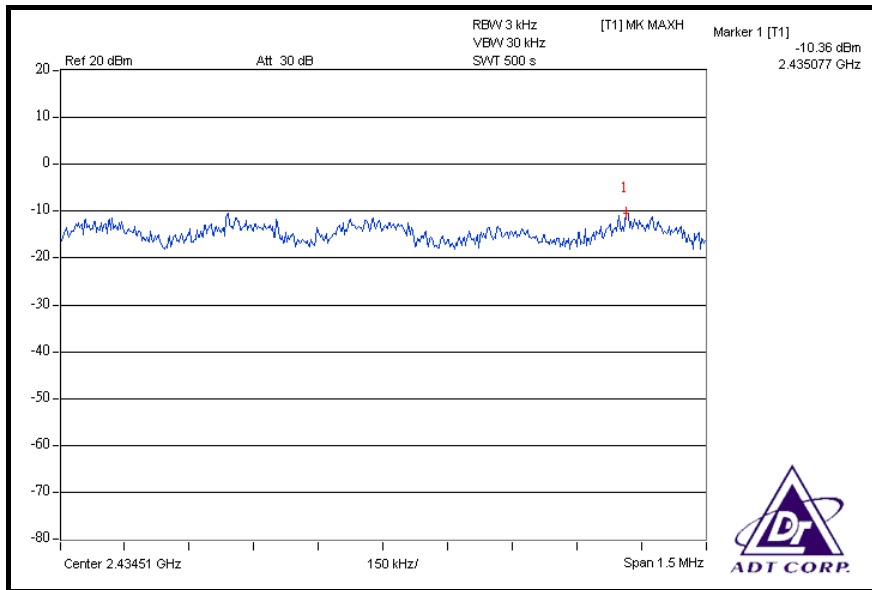

CH 11

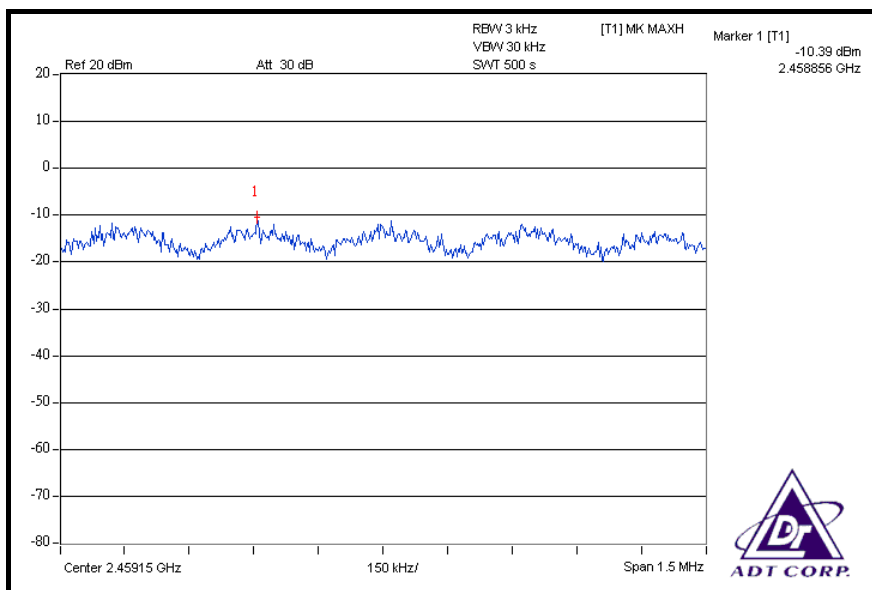



MODULATION TYPE	BPSK	TRANSFER RATE	6Mbps
INPUT POWER	120Vac, 60 Hz	ENVIRONMENTAL CONDITIONS	24deg. C, 64%RH, 1013hPa
TEST MODE	D	TESTED BY	Match Tsui

CHANNEL	CHANNEL FREQUENCY (MHz)	RF POWER LEVEL IN 3 kHz BW (dBm)	MAXIMUM LIMIT (dBm)	PASS/FAIL
1	2412	-10.71	8	PASS
6	2437	-10.50	8	PASS
11	2462	-12.24	8	PASS

CH 1

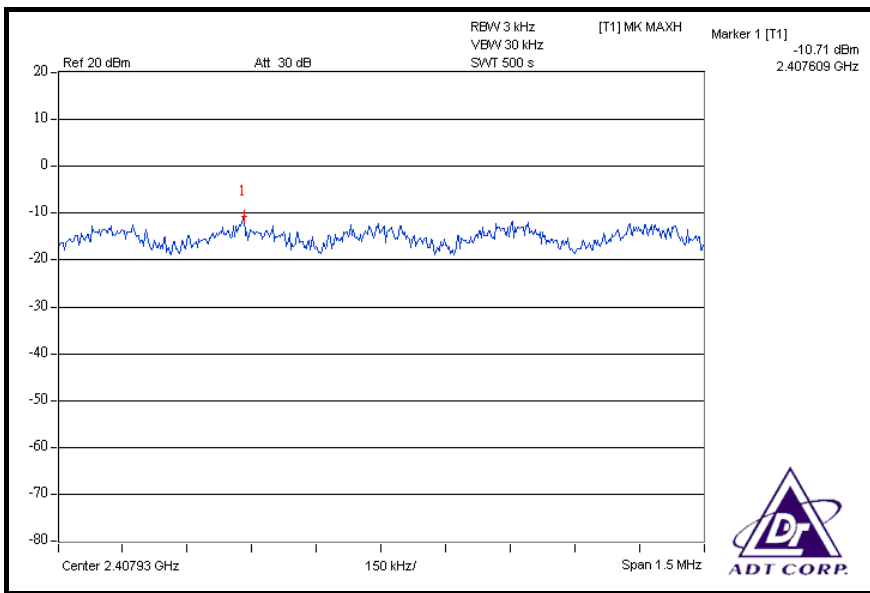

CH 6

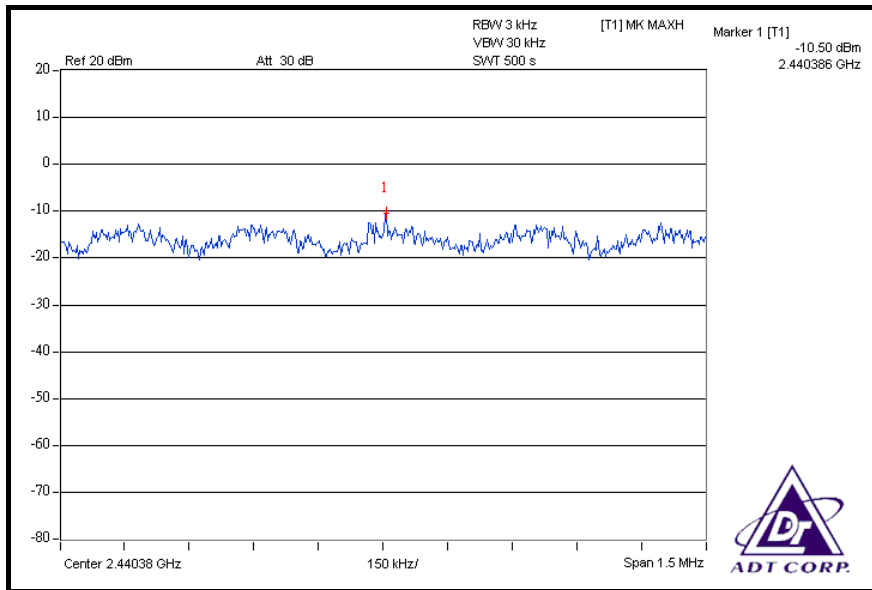

CH 11

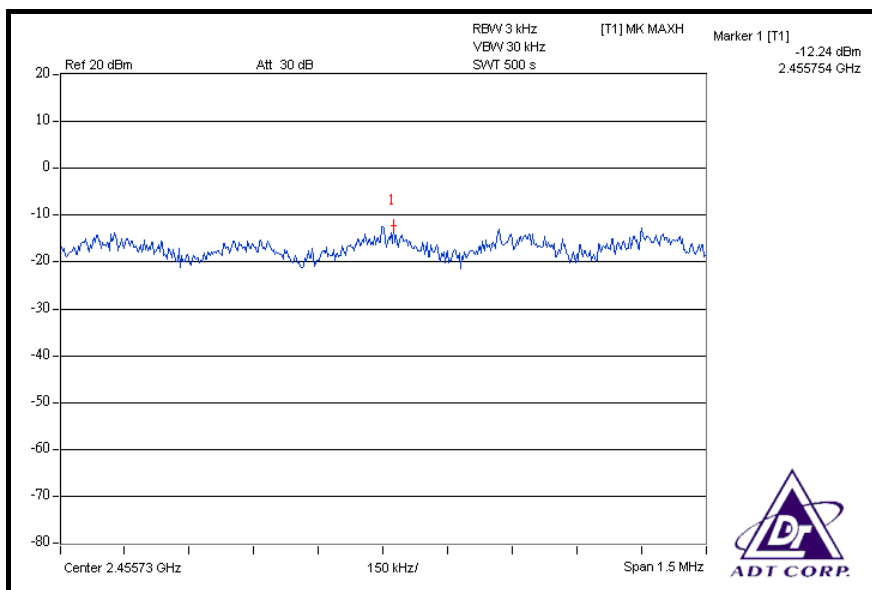



4.6 BAND EDGES MEASUREMENT

4.6.1 LIMITS OF BAND EDGES MEASUREMENT

Below -20dB of the highest emission level of operating band (in 100kHz Resolution Bandwidth).

4.6.2 TEST INSTRUMENTS

DESCRIPTION & MANUFACTURER	MODEL NO.	SERIAL NO.	CALIBRATED UNTIL
R&S SPECTRUM ANALYZER	FSP 40	100041	Apr. 21, 2009

NOTE: The calibration interval of the above test instruments is 12 months and the calibrations are traceable to NML/ROC and NIST/USA.

4.6.3 TEST PROCEDURE

The transmitter output was connected to the spectrum analyzer via a low loss cable. Set both RBW and VBW of spectrum analyzer to 100kHz and 300kHz with suitable frequency span including 100MHz bandwidth from band edge. The band edges was measured and recorded.

The spectrum plots (Peak RBW=100kHz, VBW=300kHz; Average RBW=1MHz, VBW= 10Hz are attached on the following pages.

4.6.4 DEVIATION FROM TEST STANDARD

No deviation.

4.6.5 EUT OPERATING CONDITION

Same as 4.3.6.

4.6.6 TEST RESULTS

The spectrum plots are attached on the following 24 images. D1 line indicates the highest level, and D2 line indicates the 20dB offset below D1. It shows compliance with the requirement in part 15.247(d).

802.11b DSSS MODULATION TEST MODE B

NOTE 1: The band edge emission plot on the next page shows 55.91dBc between carrier maximum power and local maximum emission in restrict band (2.38300GHz). The emission of carrier strength list in the test result of channel 1 at the item 4.1.7 is 115.77dBuV/m (Peak), so the maximum field strength in restrict band is $115.77 - 55.91 = 59.86$ dBuV/m which is under 74dBuV/m limit.

The band edge emission plot on the next page shows 59.44dBc between carrier maximum power and local maximum emission in restrict band (2.38540GHz). The emission of carrier strength list in the test result of channel 1 at the item 4.1.7 is 111.09dBuV/m (Average), so the maximum field strength in restrict band is $111.09 - 59.44 = 51.65$ dBuV/m which is under 54dBuV/m limit.

NOTE 2: The band edge emission plot on the next second page shows 54.48dBc between carrier maximum power and local maximum emission in restrict band (2.48740GHz). The emission of carrier strength list in the test result of channel 11 at the item 4.1.7 is 114.03dBuV/m (Peak), so the maximum field strength in restrict band is $114.03 - 54.48 = 59.55$ dBuV/m which is under 74dBuV/m limit.

The band edge emission plot on the next third page shows 57.55dBc between carrier maximum power and local maximum emission in restrict band (2.48860GHz). The emission of carrier strength list in the test result of channel 11 at the item 4.1.7 is 109.70dBuV/m (Average), so the maximum field strength in restrict band is $109.70 - 57.55 = 52.15$ dBuV/m which is under 54dBuV/m limit.

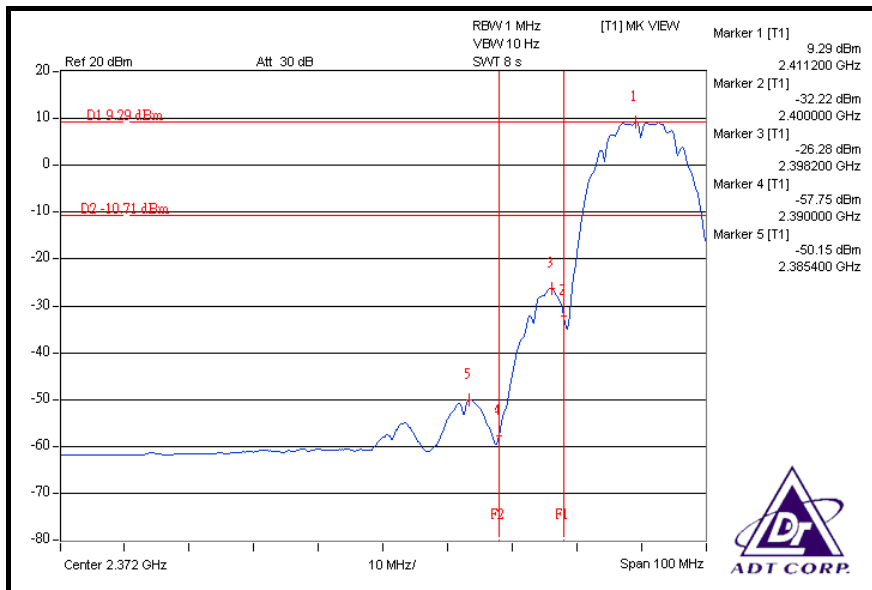
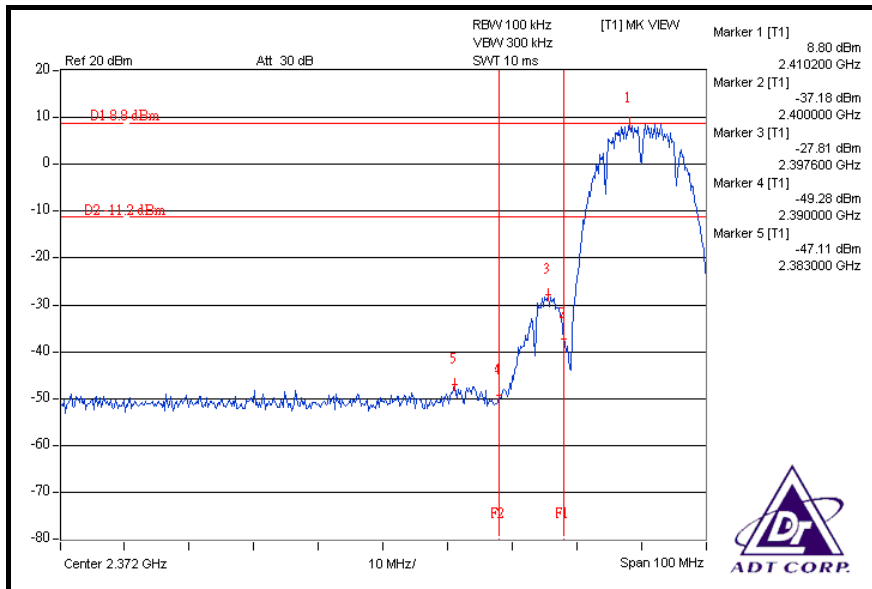

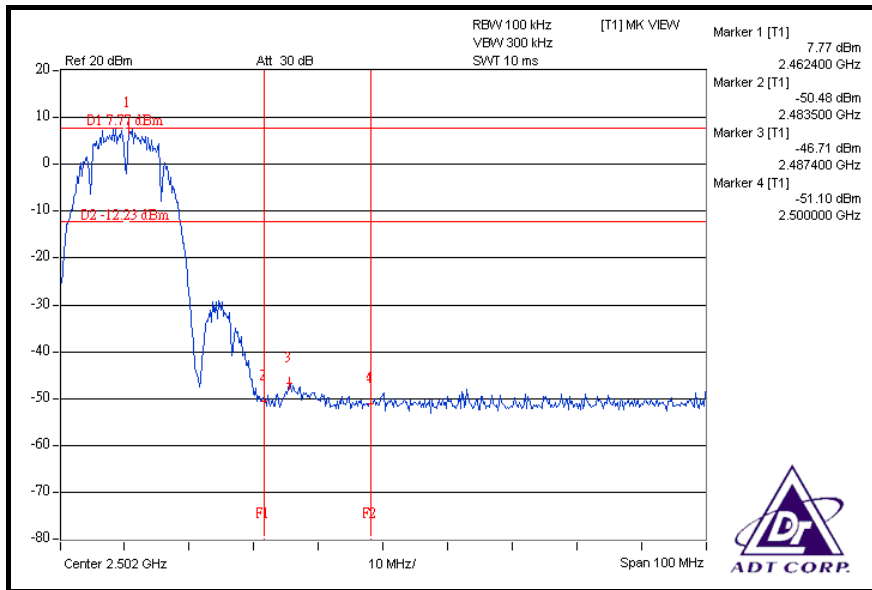
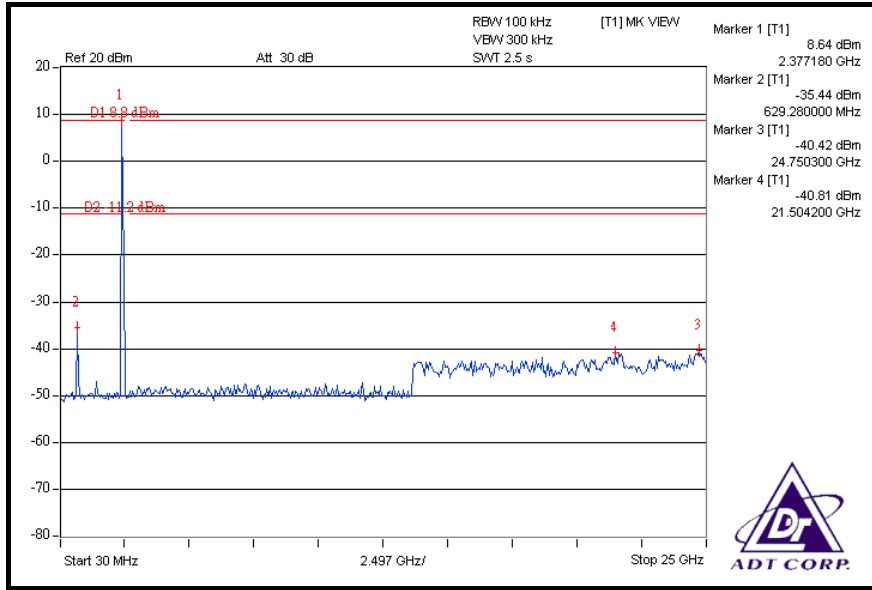

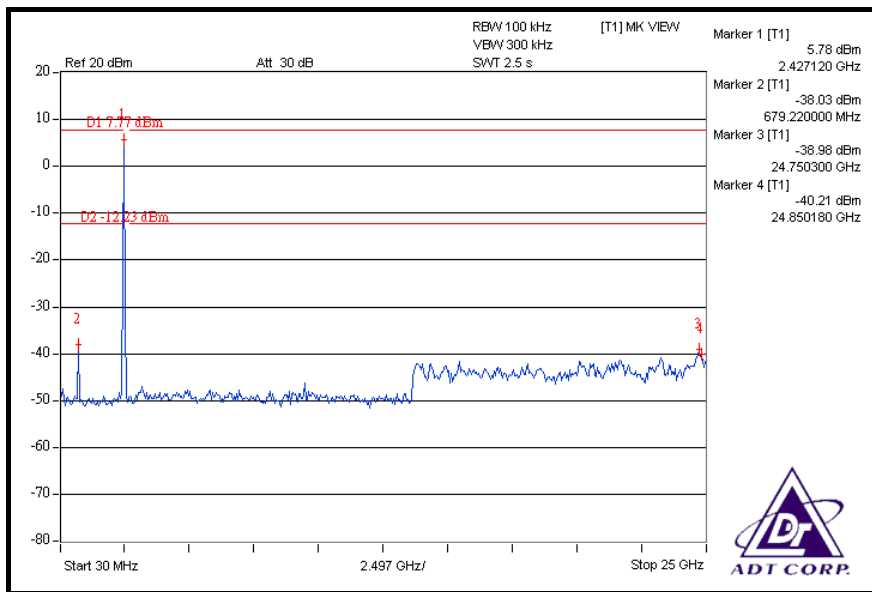
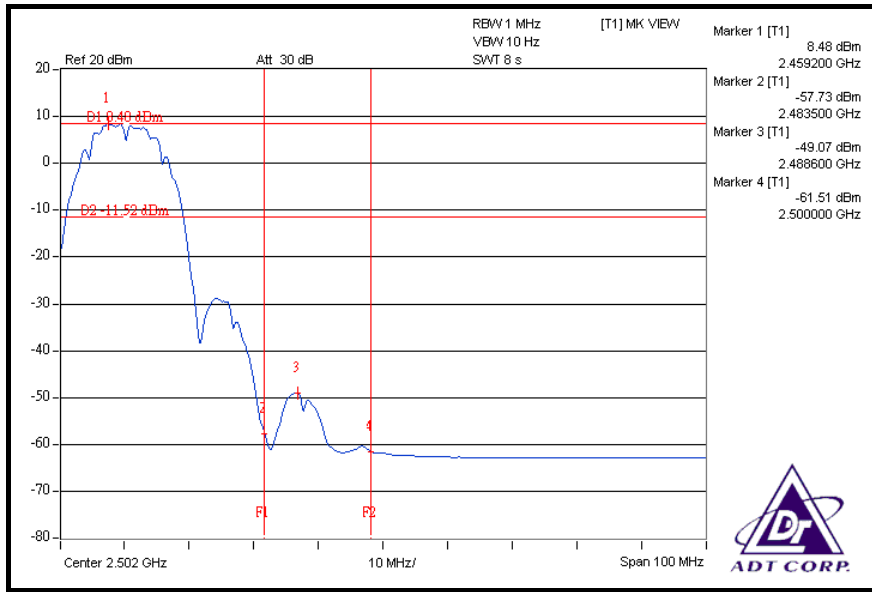

TEST MODE D

NOTE 1: The band edge emission plot on the next page shows 53.57dBc between carrier maximum power and local maximum emission in restrict band (2.38540GHz). The emission of carrier strength list in the test result of channel 1 at the item 4.1.7 is 115.50dBuV/m (Peak), so the maximum field strength in restrict band is $115.50 - 53.57 = 61.93$ dBuV/m which is under 74dBuV/m limit.

The band edge emission plot on the next page shows 60.10dBc between carrier maximum power and local maximum emission in restrict band (2.38540GHz). The emission of carrier strength list in the test result of channel 1 at the item 4.1.7 is 111.24dBuV/m (Average), so the maximum field strength in restrict band is $111.24 - 60.10 = 51.14$ dBuV/m which is under 54dBuV/m limit.

NOTE 2: The band edge emission plot on the next second page shows 53.76dBc between carrier maximum power and local maximum emission in restrict band (2.48860GHz). The emission of carrier strength list in the test result of channel 11 at the item 4.1.7 is 115.75dBuV/m (Peak), so the maximum field strength in restrict band is $115.75 - 53.76 = 61.99$ dBuV/m which is under 74dBuV/m limit.

The band edge emission plot on the next third page shows 60.01dBc between carrier maximum power and local maximum emission in restrict band (2.48820GHz). The emission of carrier strength list in the test result of channel 11 at the item 4.1.7 is 111.23dBuV/m (Average), so the maximum field strength in restrict band is $111.23 - 60.01 = 51.22$ dBuV/m which is under 54dBuV/m limit.

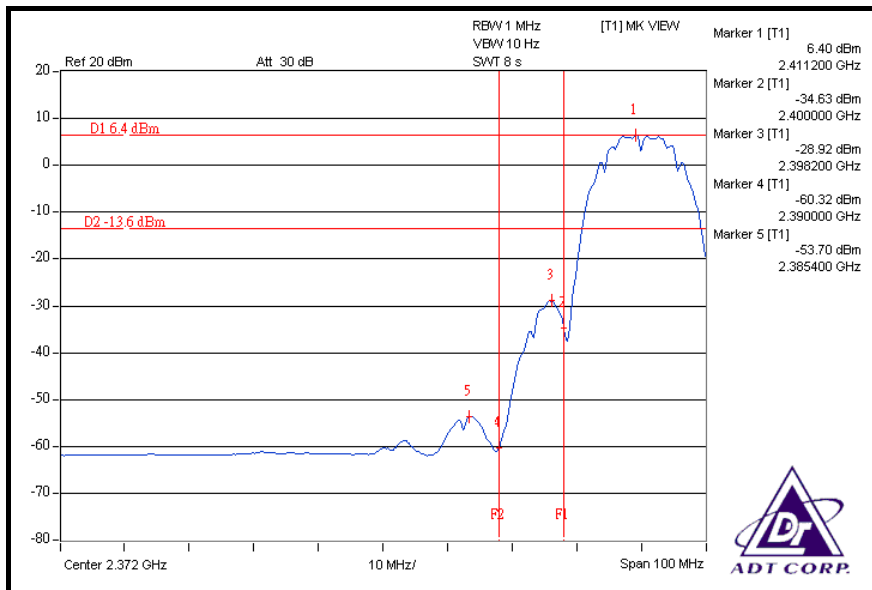
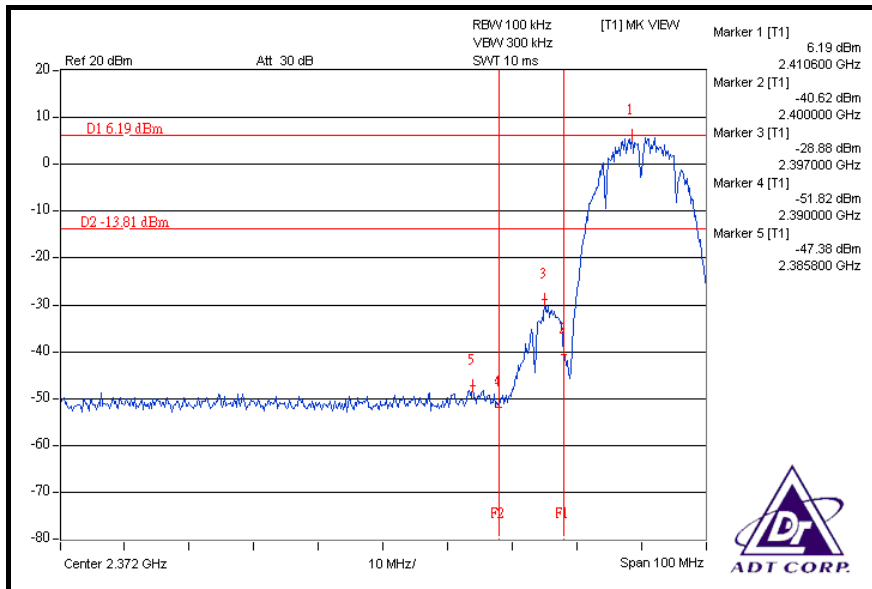

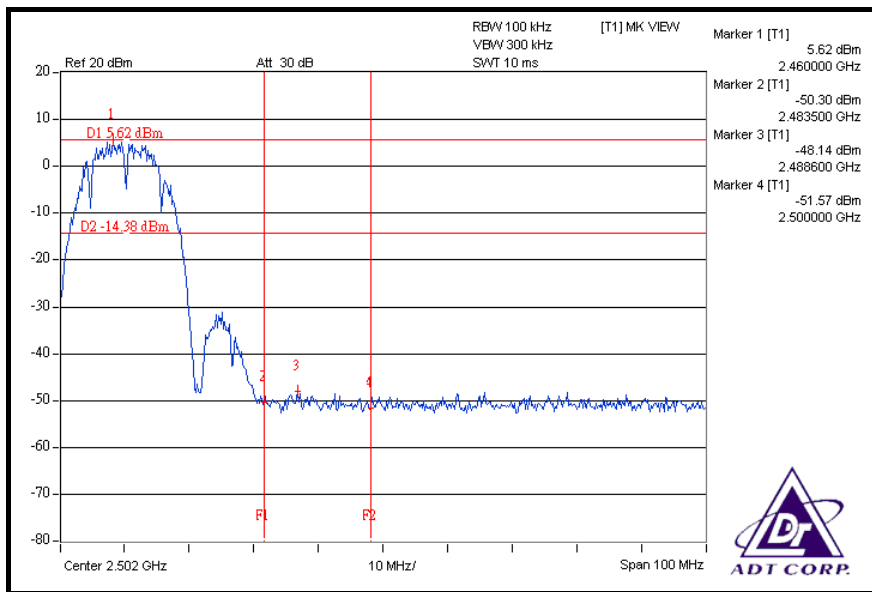
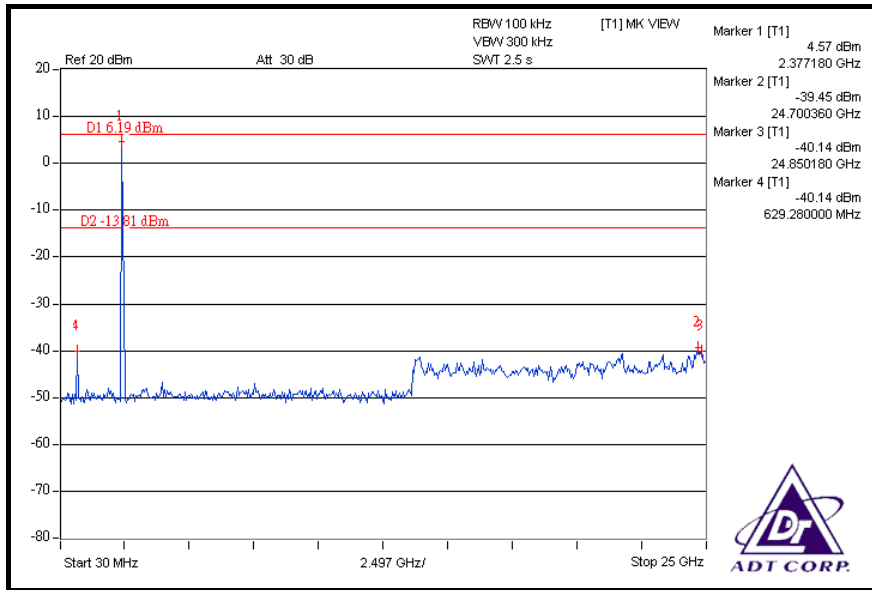

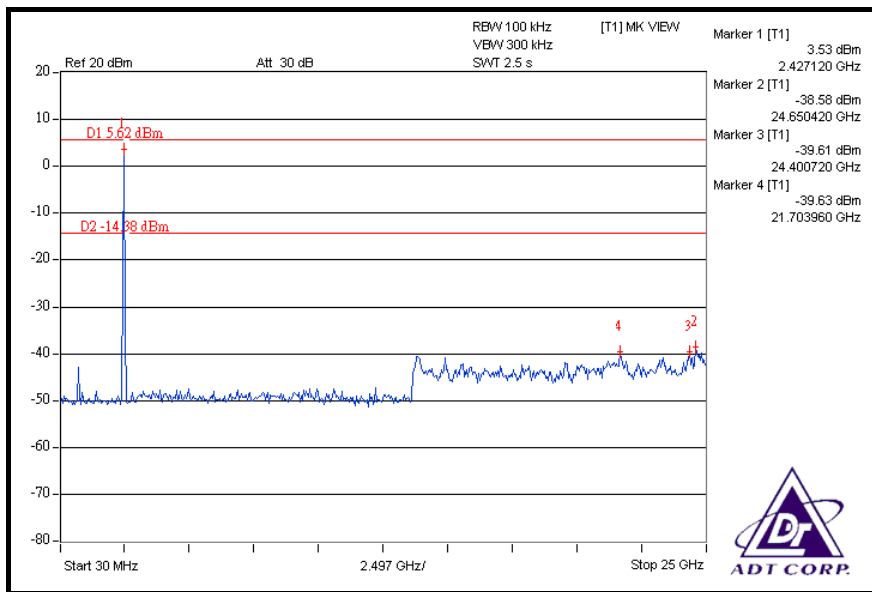
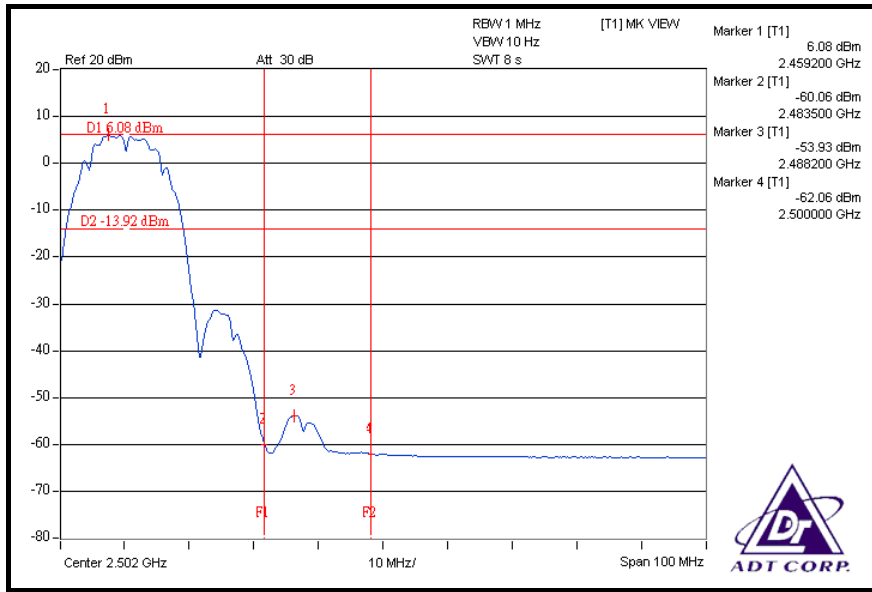

802.11g OFDM MODULATION TEST MODE B

NOTE 1: The band edge emission plot on the next page shows 49.95dBc between carrier maximum power and local maximum emission in restrict band (2.38300GHz). The emission of carrier strength list in the test result of channel 1 at the item 4.1.7 is 113.06dBuV/m (Peak), so the maximum field strength in restrict band is $113.06 - 49.95 = 63.11$ dBuV/m which is under 74dBuV/m limit.

The band edge emission plot on the next page shows 56.37dBc between carrier maximum power and local maximum emission in restrict band (2.39000GHz). The emission of carrier strength list in the test result of channel 1 at the item 4.1.7 is 101.45dBuV/m (Average), so the maximum field strength in restrict band is $101.45 - 56.37 = 45.08$ dBuV/m which is under 54dBuV/m limit.

NOTE 2: The band edge emission plot on the next second page shows 50.77dBc between carrier maximum power and local maximum emission in restrict band (2.49240GHz). The emission of carrier strength list in the test result of channel 11 at the item 4.1.7 is 112.94dBuV/m (Peak), so the maximum field strength in restrict band is $112.94 - 50.77 = 62.17$ dBuV/m which is under 74dBuV/m limit.

The band edge emission plot on the next third page shows 56.37dBc between carrier maximum power and local maximum emission in restrict band (2.48350GHz). The emission of carrier strength list in the test result of channel 11 at the item 4.1.7 is 101.94dBuV/m (Average), so the maximum field strength in restrict band is $101.94 - 56.37 = 45.57$ dBuV/m which is under 54dBuV/m limit.

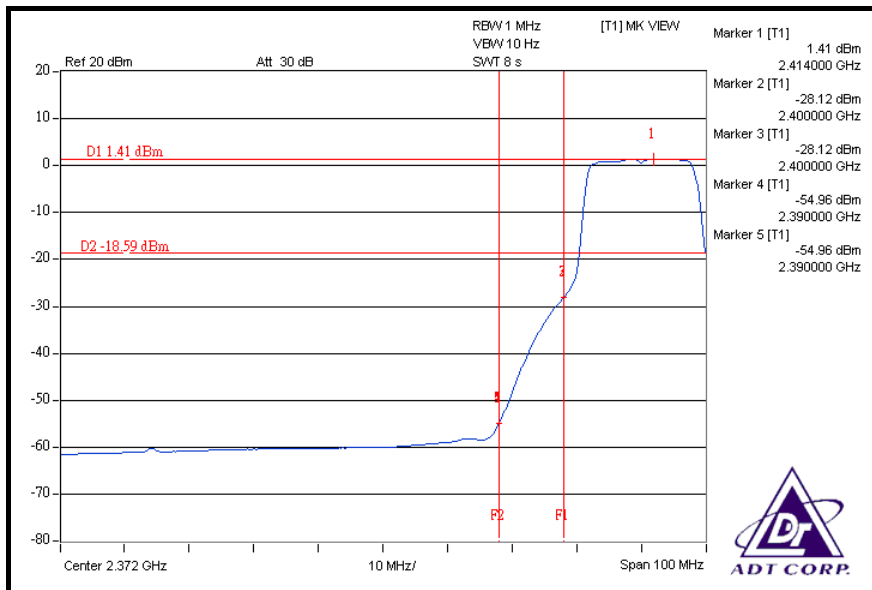
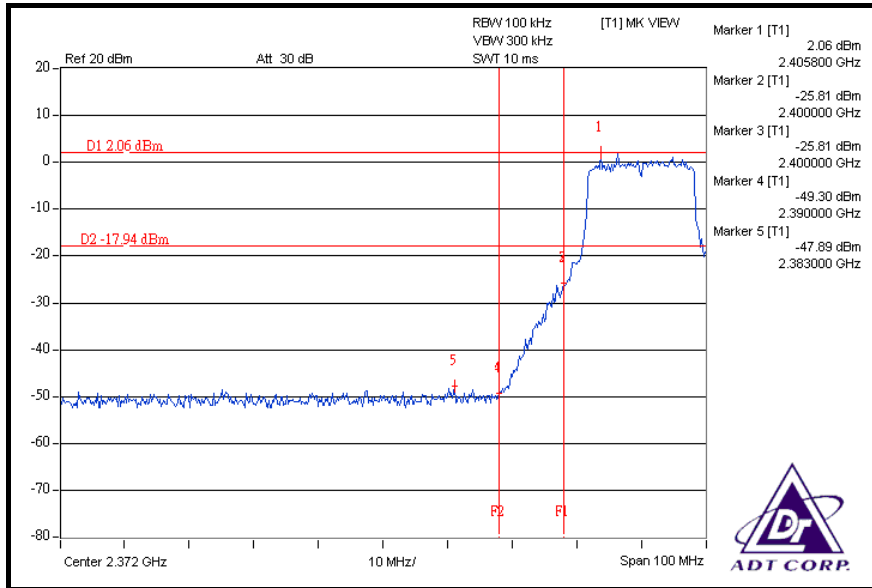

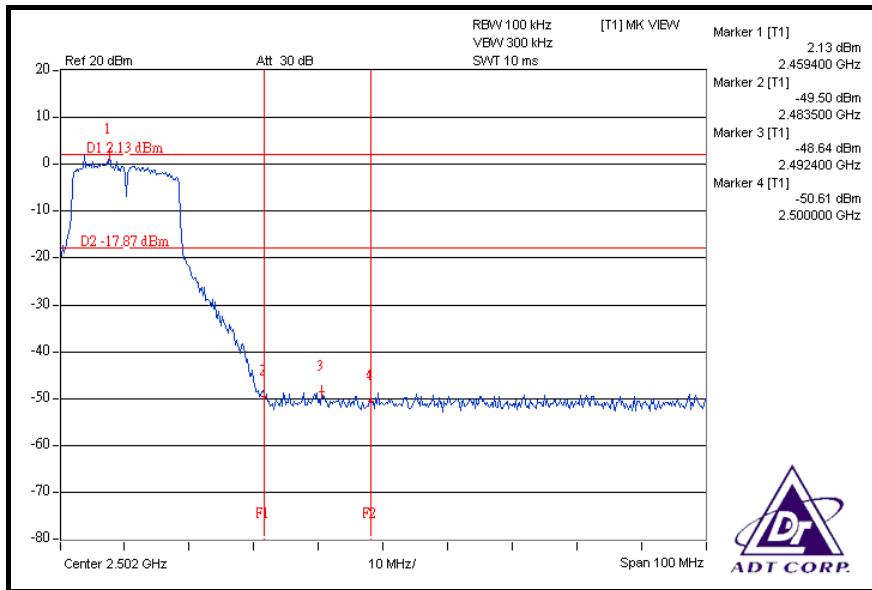
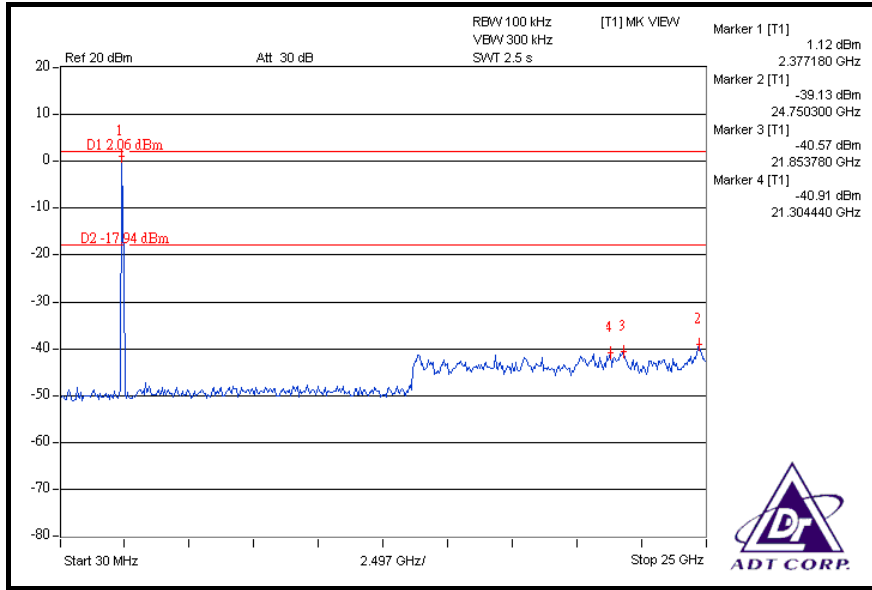

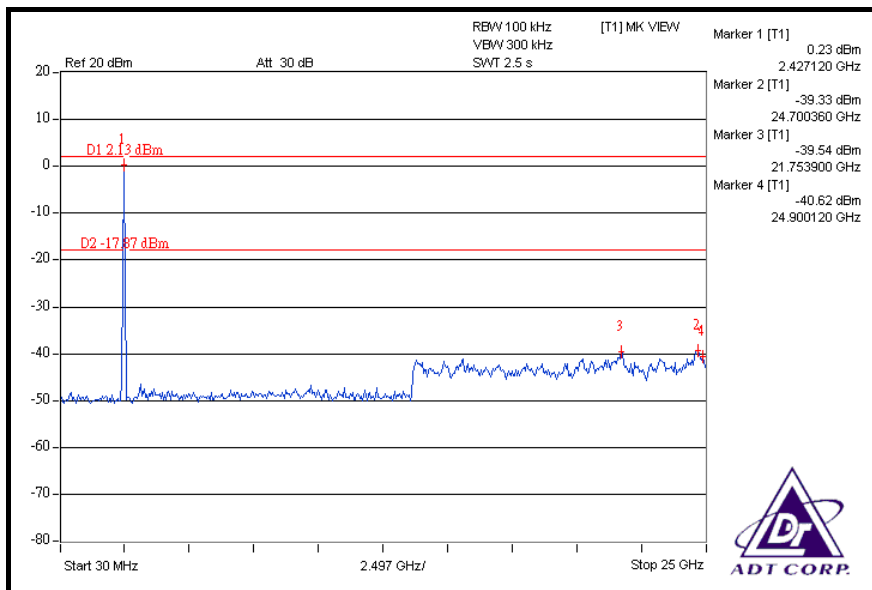
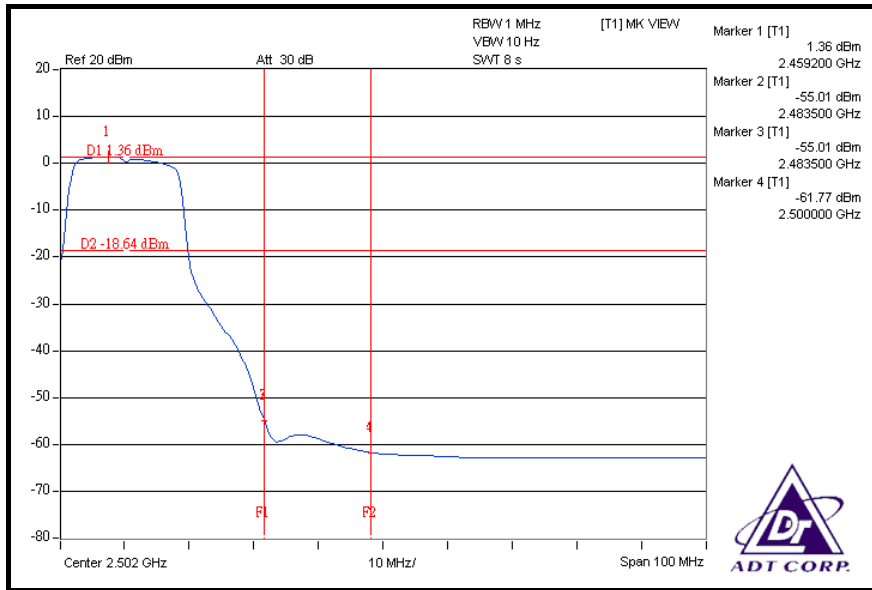

TEST MODE D

NOTE 1: The band edge emission plot on the next page shows 50.13dBc between carrier maximum power and local maximum emission in restrict band (2.35380GHz). The emission of carrier strength list in the test result of channel 1 at the item 4.1.7 is 118.65dBuV/m (Peak), so the maximum field strength in restrict band is $118.65 - 50.13 = 68.52$ dBuV/m which is under 74dBuV/m limit.

The band edge emission plot on the next page shows 56.19dBc between carrier maximum power and local maximum emission in restrict band (2.39000GHz). The emission of carrier strength list in the test result of channel 1 at the item 4.1.7 is 107.94dBuV/m (Average), so the maximum field strength in restrict band is $107.94 - 56.19 = 51.75$ dBuV/m which is under 54dBuV/m limit.

NOTE 2: The band edge emission plot on the next second page shows 48.32dBc between carrier maximum power and local maximum emission in restrict band (2.49520GHz). The emission of carrier strength list in the test result of channel 11 at the item 4.1.7 is 117.04dBuV/m (Peak), so the maximum field strength in restrict band is $117.04 - 48.32 = 68.72$ dBuV/m which is under 74dBuV/m limit.

The band edge emission plot on the next third page shows 56.16dBc between carrier maximum power and local maximum emission in restrict band (2.48350GHz). The emission of carrier strength list in the test result of channel 11 at the item 4.1.7 is 106.09dBuV/m (Average), so the maximum field strength in restrict band is $106.09 - 56.16 = 49.93$ dBuV/m which is under 54dBuV/m limit.

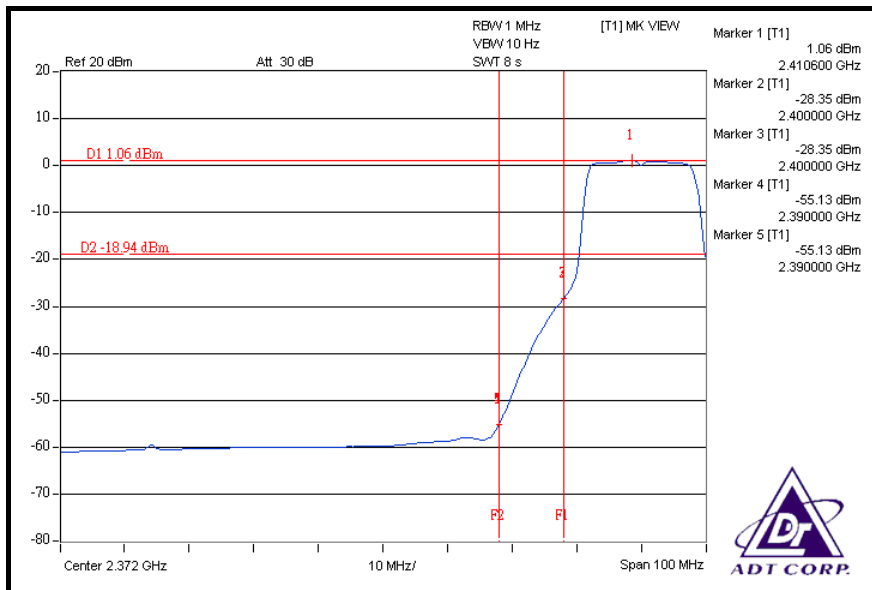
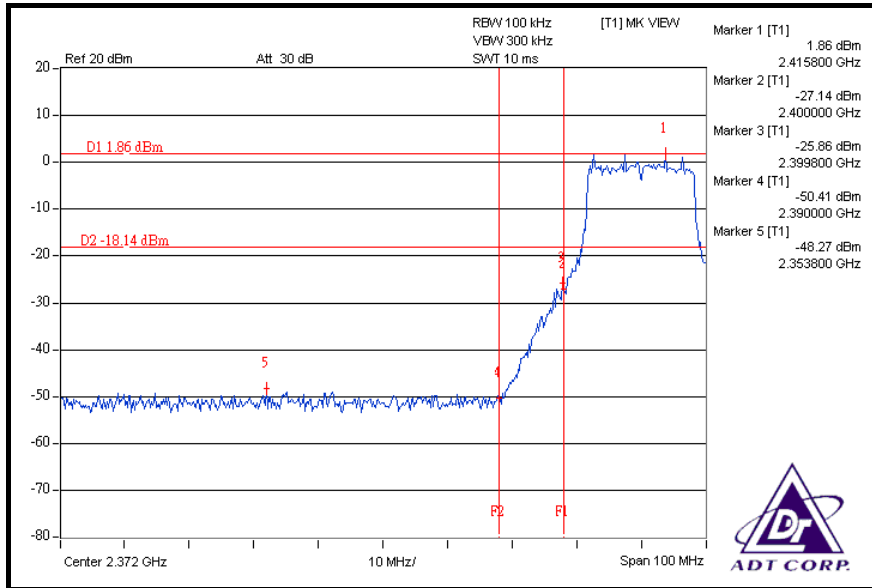

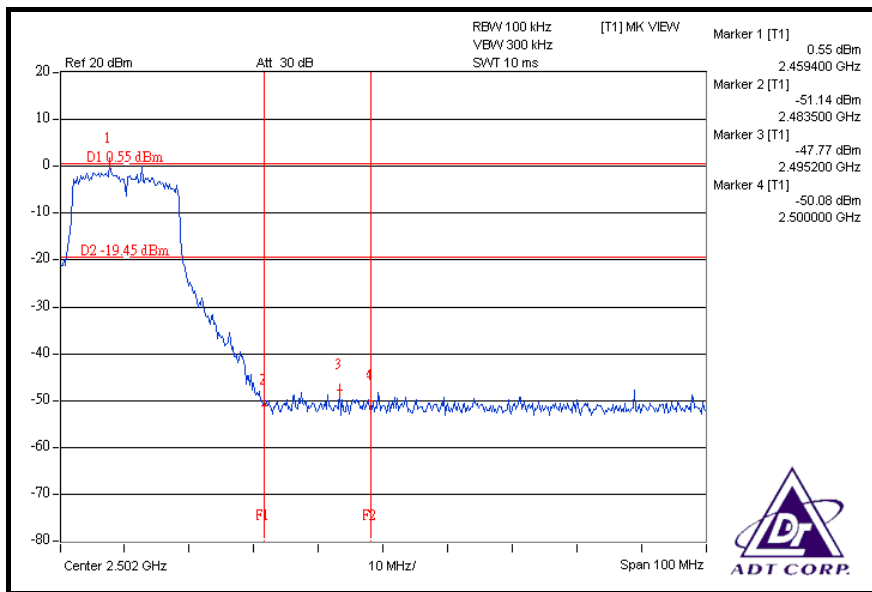
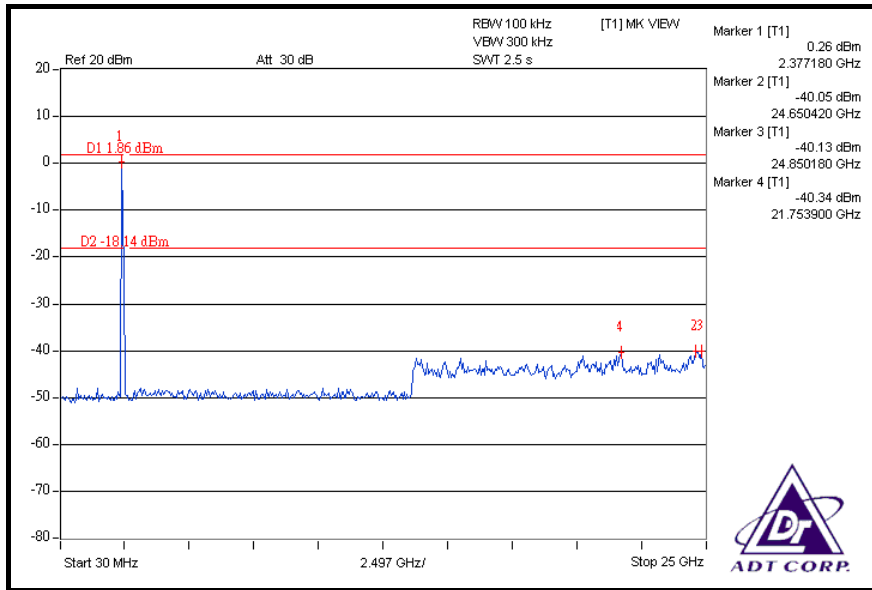

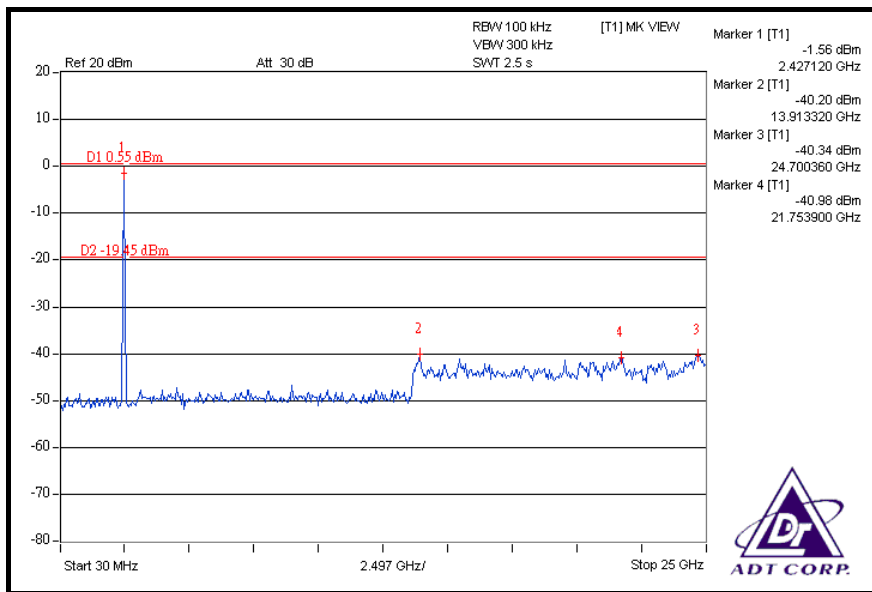
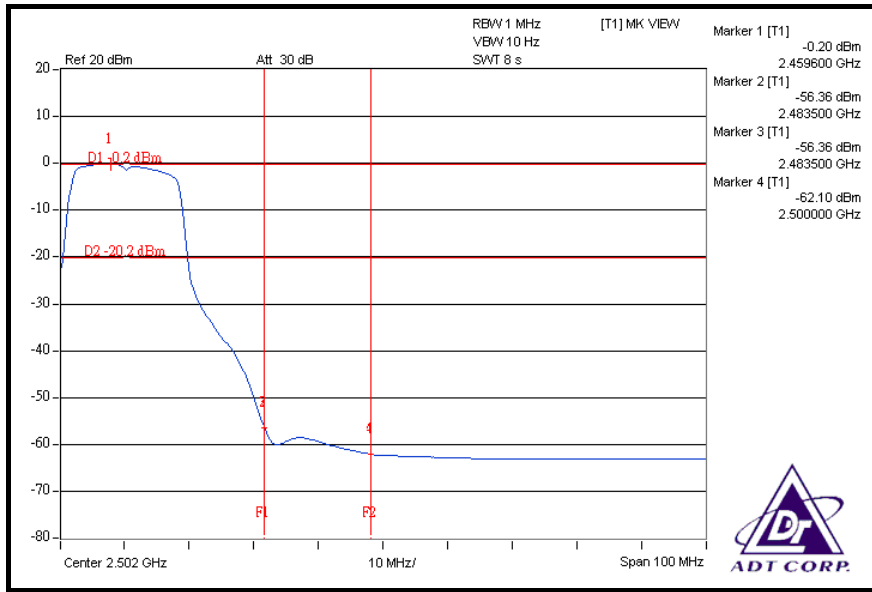

4.7 ANTENNA REQUIREMENT

4.7.1 STANDARD APPLICABLE

For intentional device, according to FCC 47 CFR Section 15.203, an intentional radiator shall be designed to ensure that no antenna other than that furnished by the responsible party shall be used with the device.

And according to FCC 47 CFR Section 15.247 (b), if transmitting antennas of directional gain greater than 6dBi are used, the power shall be reduced by the amount in dB that the directional gain of the antenna exceeds 6dBi.

4.7.2 ANTENNA CONNECTED CONSTRUCTION

The antenna used in this product are Internal antenna with I-PEX antenna connector and External antenna with N-Type antenna connector. The maximum Gain of the antenna is 9dBi.



5 PHOTOGRAPHS OF THE TEST CONFIGURATION

Please refer to the attached file (Test Setup Photo).



6 INFORMATION ON THE TESTING LABORATORIES

We, ADT Corp., were founded in 1988 to provide our best service in EMC, Radio, Telecom and Safety consultation. Our laboratories are accredited and approved by the following approval agencies according to ISO/IEC 17025.

USA	FCC, UL
Germany	TUV Rheinland
Japan	VCCI
Norway	NEMKO
Canada	INDUSTRY CANADA , CSA
R.O.C.	TAF, BSMI, NCC
Netherlands	Telefication
Singapore	GOST-ASIA(MOU)
Russia	CERTIS(MOU)

Copies of accreditation certificates of our laboratories obtained from approval agencies can be downloaded from our web site: www.adt.com.tw/index.5/phtml. If you have any comments, please feel free to contact us at the following:

Linko EMC/RF Lab

Tel: 886-2-26052180
Fax: 886-2-26051924

Hsin Chu EMC/RF Lab

Tel: 886-3-5935343
Fax: 886-3-5935342

Hwa Ya EMC/RF/Safety/Telecom Lab

Tel: 886-3-3183232
Fax: 886-3-3185050

Web Site: www.adt.com.tw

The address and road map of all our labs can be found in our web site also.

7 APPENDIX A – MODIFICATIONS RECORDERS FOR ENGINEERING CHANGES TO THE EUT BY THE LAB

No any modifications are made to the EUT by the lab during the test.

---END---