

## FCC Test Report

**Report No.:** RF150716C07D-1

**FCC ID:** U2M-OAP7250AG

**Test Model:** OAP7250AG

**Received Date:** Aug. 27, 2015

**Test Date:** Sep. 05 ~ Sep. 18, 2015

**Issued Date:** Sep. 25, 2015

**Applicant:** Senao Networks, Inc.

**Address:** 3F, No. 529, Chung Cheng Rd., Hsintien, New Taipei City, R.O.C

**Issued By:** Bureau Veritas Consumer Products Services (H.K.) Ltd., Taoyuan Branch

**Lab Address:** No. 47-2, 14th Ling, Chia Pau Vil., Lin Kou Dist., New Taipei City, Taiwan, R.O.C.

**Lab Address:** No.19, Hwa Ya 2nd Rd., Wen Hwa Vil., Kwei Shan Dist., Taoyuan City 33383, TAIWAN (R.O.C.)



This report is for your exclusive use. Any copying or replication of this report to or for any other person or entity, or use of our name or trademark, is permitted only with our prior written permission. This report sets forth our findings solely with respect to the test samples identified herein. The results set forth in this report are not indicative or representative of the quality or characteristics of the lot from which a test sample was taken or any similar or identical product specifically and expressly noted. Our report includes all of the tests requested by you and the results thereof based upon the information that you provided to us. You have 60 days from date of issuance of this report to notify us of any material error or omission caused by our negligence, provided, however, that such notice shall be in writing and shall specifically address the issue you wish to raise. A failure to raise such issue within the prescribed time shall constitute your unqualified acceptance of the completeness of this report, the tests conducted and the correctness of the report contents. Unless specific mention, the uncertainty of measurement has been explicitly taken into account to declare the compliance or non-compliance to the specification. The report must not be used by the client to claim product certification, approval, or endorsement by TAF or any government agencies.



## Table of Contents

<b>Release Control Record</b> .....	<b>4</b>
<b>1 Certificate of Conformity</b> .....	<b>5</b>
<b>2 Summary of Test Results</b> .....	<b>6</b>
2.1 Measurement Uncertainty .....	6
2.2 Modification Record .....	6
<b>3 General Information</b> .....	<b>7</b>
3.1 General Description of EUT .....	7
3.2 Description of Test Modes .....	8
3.2.1 Test Mode Applicability and Tested Channel Detail.....	9
3.3 Duty Cycle of Test Signal .....	11
3.4 Description of Support Units .....	12
3.4.1 Configuration of System under Test .....	12
3.5 General Description of Applied Standards .....	13
<b>4 Test Types and Results</b> .....	<b>14</b>
4.1 Radiated Emission and Bandedge Measurement.....	14
4.1.1 Limits of Radiated Emission and Bandedge Measurement .....	14
4.1.2 Test Instruments .....	15
4.1.3 Test Procedures.....	16
4.1.4 Deviation from Test Standard .....	16
4.1.5 Test Set Up .....	17
4.1.6 EUT Operating Conditions.....	17
4.1.7 Test Results .....	18
4.2 Conducted Emission Measurement .....	37
4.2.1 Limits of Conducted Emission Measurement .....	37
4.2.2 Test Instruments .....	37
4.2.3 Test Procedures.....	38
4.2.4 Deviation from Test Standard .....	38
4.2.5 Test Setup.....	38
4.2.6 EUT Operating Conditions.....	38
4.2.7 Test Results .....	39
4.3 Transmit Power Measurement .....	41
4.3.1 Limits of Transmit Power Measurement .....	41
4.3.2 Test Setup.....	41
4.3.3 Test Instruments .....	41
4.3.4 Test Procedure .....	42
4.3.5 Deviation from Test Standard .....	42
4.3.6 EUT Operating Conditions.....	42
4.3.7 Test Result.....	43
4.4 Peak Power Spectral Density Measurement .....	50
4.4.1 Limits of Peak Power Spectral Density Measurement .....	50
4.4.2 Test Setup.....	50
4.4.3 Test Instruments .....	50
4.4.4 Test Procedures.....	50
4.4.5 Deviation from Test Standard .....	51
4.4.6 EUT Operating Conditions.....	51
4.4.7 Test Results .....	52
4.5 Frequency Stability.....	57
4.5.1 Limits of Frequency Stability Measurement .....	57
4.5.2 Test Setup.....	57
4.5.3 Test Instruments .....	57
4.5.4 Test Procedure .....	57
4.5.5 Deviation from Test Standard .....	57
4.5.6 EUT Operating Condition .....	57



4.5.7 Test Results .....	58
4.6 6dB Bandwidth Measurement .....	59
4.6.1 Limits of 6dB Bandwidth Measurement .....	59
4.6.2 Test Setup .....	59
4.6.3 Test Instruments .....	59
4.6.4 Test Procedure .....	59
4.6.5 Deviation from Test Standard .....	59
4.6.6 EUT Operating Condition .....	59
4.6.7 Test Results .....	60
<b>5 Pictures of Test Arrangements .....</b>	<b>62</b>
<b>Appendix – Information on the Testing Laboratories .....</b>	<b>63</b>



A D T

### Release Control Record

Issue No.	Description	Date Issued
RF150716C07D-1	Original release	Sep. 25, 2015

## 1 Certificate of Conformity

**Product:** Wireless 802.11ac/b/g/n access point  
**Brand:** Senao Networks  
**Test Model:** OAP7250AG  
**Sample Status:** Engineering Sample  
**Applicant:** Senao Networks, Inc.  
**Test Date:** Sep. 05 ~ Sep. 18, 2015  
**Standards:** 47 CFR FCC Part 15, Subpart E (Section 15.407)  
ANSI C63.10:2013

The above equipment has been tested by **Bureau Veritas Consumer Products Services (H.K.) Ltd., Taoyuan Branch**, and found compliance with the requirement of the above standards. The test record, data evaluation & Equipment Under Test (EUT) configurations represented herein are true and accurate accounts of the measurements of the sample's EMC characteristics under the conditions specified in this report.

**Prepared by :** Celine Chou , **Date:** Sep. 25, 2015  
Celine Chou / Specialist

**Approved by :** Ken Liu , **Date:** Sep. 25, 2015  
Ken Liu / Senior Manager

## 2 Summary of Test Results

47 CFR FCC Part 15, Subpart E (Section 15.407)			
FCC Clause	Test Item	Result	Remarks
15.207 15.407(b)(6)	AC Power Conducted Emissions	Pass	Meet the requirement of limit. Minimum passing margin is -11.00dB at 0.48669MHz.
15.407(b) (1/2/3/4/6)	Radiated Emissions & Band Edge Measurement	Pass	Meet the requirement of limit. Minimum passing margin is -1.0dB at 11650.00MHz and 11570.00MHz.
15.407(a)(1/2 /3)	Max Average Transmit Power	Pass	Meet the requirement of limit.
15.407(a)(1/2 /3)	Peak Power Spectral Density	Pass	Meet the requirement of limit.
15.407(e)	6dB bandwidth	Pass	Meet the requirement of limit. (U-NII-3 Band only)
15.407(g)	Frequency Stability	Pass	Meet the requirement of limit.
15.203	Antenna Requirement	Pass	Antenna connector is N-Type. (The device is professionally installed)

### 2.1 Measurement Uncertainty

Where relevant, the following measurement uncertainty levels have been estimated for tests performed on the EUT as specified in CISPR 16-4-2:

Measurement	Frequency	Expanded Uncertainty (k=2) (±)
Conducted Emissions at mains ports0	150kHz ~ 30MHz	2.44 dB
Radiated Emissions up to 1 GHz	30MHz ~ 200MHz	3.86 dB
	200MHz ~1000MHz	3.87 dB
Radiated Emissions above 1 GHz	1GHz ~ 18GHz	2.29 dB
	18GHz ~ 40GHz	2.29 dB

### 2.2 Modification Record

There were no modifications required for compliance.

### 3 General Information

#### 3.1 General Description of EUT

Product	Wireless 802.11ac/b/g/n access point
Brand	Senao Networks
Test Model	OAP7250AG
Status of EUT	Engineering Sample
Power Supply Rating	48Vdc (POE)
Modulation Type	256QAM, 64QAM, 16QAM, QPSK, BPSK for OFDM
Modulation Technology	OFDM
Transfer Rate	802.11a: 54.0/ 48.0/ 36.0/ 24.0/ 18.0/ 12.0/ 9.0/ 6.0Mbps 802.11n: up to 450Mbps 802.11ac: up to 1300Mbps
Operating Frequency	5180 ~ 5240MHz, 5745 ~ 5825MHz
Number of Channel	5180 ~ 5240MHz: 4 for 802.11a, 802.11n (HT20), 802.11ac (VHT20) 2 for 802.11n (HT40), 802.11ac (VHT40) 1 for 802.11ac (VHT80) 5745 ~ 5825MHz: 5 for 802.11a, 802.11n (HT20), 802.11ac (VHT20) 2 for 802.11n (HT40), 802.11ac (VHT40) 1 for 802.11ac (VHT80)
Output Power	5180 ~ 5240MHz: 205.555mW 5745 ~ 5825MHz: 173.702mW
Antenna Type	5180 ~ 5240MHz: Dipole antenna with -2.33dBi gain 5745 ~ 5825MHz: Dipole antenna with 6.03dBi gain
Antenna Connector	N-Type (The device is professionally installed)
Accessory Device	PoE, Adapter of PoE
Data Cable Supplied	N/A

Note:

- The EUT incorporates a MIMO function. Physically, the EUT provides 3 completed transmitters and 3 receivers.

Modulation Mode	TX Function
802.11a	3TX
802.11n (HT20)	3TX
802.11n (HT40)	3TX
802.11ac (VHT80)	3TX

\* The modulation and bandwidth are similar for 802.11n mode for 20MHz/40MHz and 802.11ac mode for 20MHz/40MHz, therefore investigated worst case to representative mode in test report. (Final test mode refer section 3.2.1)

2. The EUT consumes power from the following PoE.

PoE	
Brand	EnGenius
Model	EPE-48GP
Rating	48Vdc, 0.8A, 38.4W Max

Adapter of PoE	
Brand	Powertron Electronics Corp.
Model	PA1040-480IB080
Input Power	100-240Vac~50-60Hz 1.5A
Output Power	48Vdc / 0.8A 38.4W Max
Power Line	1.55m power cable with 1 core attached on adapter

### 3.2 Description of Test Modes

#### For 5180 ~ 5240MHz

4 channels are provided for 802.11a, 802.11n (HT20), 802.11ac (VHT20):

Channel	Frequency	Channel	Frequency
36	5180 MHz	44	5220 MHz
40	5200 MHz	48	5240 MHz

2 channels are provided for 802.11n (HT40), 802.11ac (VHT40):

Channel	Frequency	Channel	Frequency
38	5190 MHz	46	5230 MHz

1 channel is provided for 802.11ac (VHT80):

Channel	Frequency
42	5210MHz

#### For 5745 ~ 5825MHz:

5 channels are provided for 802.11a, 802.11n (HT20), 802.11ac (VHT20):

Channel	Frequency	Channel	Frequency
149	5745MHz	161	5805MHz
153	5765MHz	165	5825MHz
157	5785MHz		

2 channels are provided for 802.11n (HT40), 802.11ac (VHT40):

Channel	Frequency	Channel	Frequency
151	5755MHz	159	5795MHz

1 channel is provided for 802.11ac (VHT80):

Channel	Frequency
155	5775MHz



### 3.2.1 Test Mode Applicability and Tested Channel Detail

EUT CONFIGURE MODE	APPLICABLE TO				DESCRIPTION
	RE $\geq$ 1G	RE<1G	PLC	APCM	
-	√	√	√	√	-

Where **RE $\geq$ 1G**: Radiated Emission above 1GHz & Bandedge Measurement  
**RE<1G**: Radiated Emission below 1GHz  
**PLC**: Power Line Conducted Emission  
**APCM**: Antenna Port Conducted Measurement

Note: The EUT had been pre-tested on the positioned of each 3 axis. The worst case was found when positioned on **Z-plane**.

#### Radiated Emission Test (Above 1GHz):

- Pre-Scan has been conducted to determine the worst-case mode from all possible combinations between available modulations, data rates and antenna ports (if EUT with antenna diversity architecture).
- Following channel(s) was (were) selected for the final test as listed below.

EUT CONFIGURE MODE	MODE	FREQ. BAND (MHz)	AVAILABLE CHANNEL	TESTED CHANNEL	MODULATION TECHNOLOGY	MODULATION TYPE	DATA RATE (Mbps)
-	802.11a	5180-5240	36 to 48	36, 40, 48	OFDM	BPSK	6.0
-	802.11n (HT20)		36 to 48	36, 40, 48	OFDM	BPSK	7.2
-	802.11n (HT40)		38 to 46	38, 46	OFDM	BPSK	15.0
-	802.11ac (VHT80)		42	42	OFDM	BPSK	97.5
-	802.11a	5745-5825	149 to 165	149, 157, 165	OFDM	BPSK	6.0
-	802.11n (HT20)		149 to 165	149, 157, 165	OFDM	BPSK	7.2
-	802.11n (HT40)		151 to 159	151, 159	OFDM	BPSK	15.0
-	802.11ac (VHT80)		155	155	OFDM	BPSK	97.5

#### Radiated Emission Test (Below 1GHz):

- Pre-Scan has been conducted to determine the worst-case mode from all possible combinations between available modulations, data rates and antenna ports (if EUT with antenna diversity architecture).
- Following channel(s) was (were) selected for the final test as listed below.

EUT CONFIGURE MODE	MODE	FREQ. BAND (MHz)	AVAILABLE CHANNEL	TESTED CHANNEL	MODULATION TECHNOLOGY	MODULATION TYPE	DATA RATE (Mbps)
-	802.11a	5180-5240	36 to 48	36	OFDM	BPSK	6.0
	802.11a	5745-5825	149 to 165		OFDM	BPSK	6.0

**Power Line Conducted Emission Test:**

- Pre-Scan has been conducted to determine the worst-case mode from all possible combinations between available modulations, data rates and antenna ports (if EUT with antenna diversity architecture).
- Following channel(s) was (were) selected for the final test as listed below.

EUT CONFIGURE MODE	MODE	FREQ. BAND (MHz)	AVAILABLE CHANNEL	TESTED CHANNEL	MODULATION TECHNOLOGY	MODULATION TYPE	DATA RATE (Mbps)
-	802.11a	5180-5240	36 to 48	36	OFDM	BPSK	6.0
	802.11a	5745-5825	149 to 165		OFDM	BPSK	6.0

**Antenna Port Conducted Measurement:**

- This item includes all test value of each mode, but only includes spectrum plot of worst value of each mode.
- Pre-Scan has been conducted to determine the worst-case mode from all possible combinations between available modulations, data rates and antenna ports (if EUT with antenna diversity architecture).
- Following channel(s) was (were) selected for the final test as listed below.

EUT CONFIGURE MODE	MODE	FREQ. BAND (MHz)	AVAILABLE CHANNEL	TESTED CHANNEL	MODULATION TECHNOLOGY	MODULATION TYPE	DATA RATE (Mbps)
-	802.11a	5180-5240	36 to 48	36, 40, 48	OFDM	BPSK	6.0
-	802.11n (HT20)		36 to 48	36, 40, 48	OFDM	BPSK	7.2
-	802.11n (HT40)		38 to 46	38, 46	OFDM	BPSK	15.0
-	802.11ac (VHT80)		42	42	OFDM	BPSK	97.5
-	802.11a	5745-5825	149 to 165	149, 157, 165	OFDM	BPSK	6.0
-	802.11n (HT20)		149 to 165	149, 157, 165	OFDM	BPSK	7.2
-	802.11n (HT40)		151 to 159	151, 159	OFDM	BPSK	15.0
-	802.11ac (VHT80)		155	155	OFDM	BPSK	97.5

**Test Condition:**

APPLICABLE TO	ENVIRONMENTAL CONDITIONS	INPUT POWER	TESTED BY
RE $\geq$ 1G	18deg. C, 70%RH	120Vac, 60Hz	Nick Hsu
RE $<$ 1G	18deg. C, 70%RH	120Vac, 60Hz	Nick Hsu
PLC	18deg. C, 70%RH	120Vac, 60Hz	Nick Hsu
APCM	25deg. C, 60%RH	120Vac, 60Hz	Nick Hsu

### 3.3 Duty Cycle of Test Signal

Duty cycle of test signal is < 98 %, duty factor is required.

802.11a: Duty cycle = 2.002/2.102 = 0.952, Duty factor =  $10 \cdot \log(1/0.952) = 0.21$

802.11n (HT20): Duty cycle = 1.877/1.965 = 0.955, Duty factor =  $10 \cdot \log(1/0.955) = 0.20$

802.11n (HT40): Duty cycle = 0.912/0.997 = 0.915, Duty factor =  $10 \cdot \log(1/0.915) = 0.39$

802.11ac (VHT80): Duty cycle = 4.135/4.235 = 0.976, Duty factor =  $10 \cdot \log(1/0.976) = 0.10$

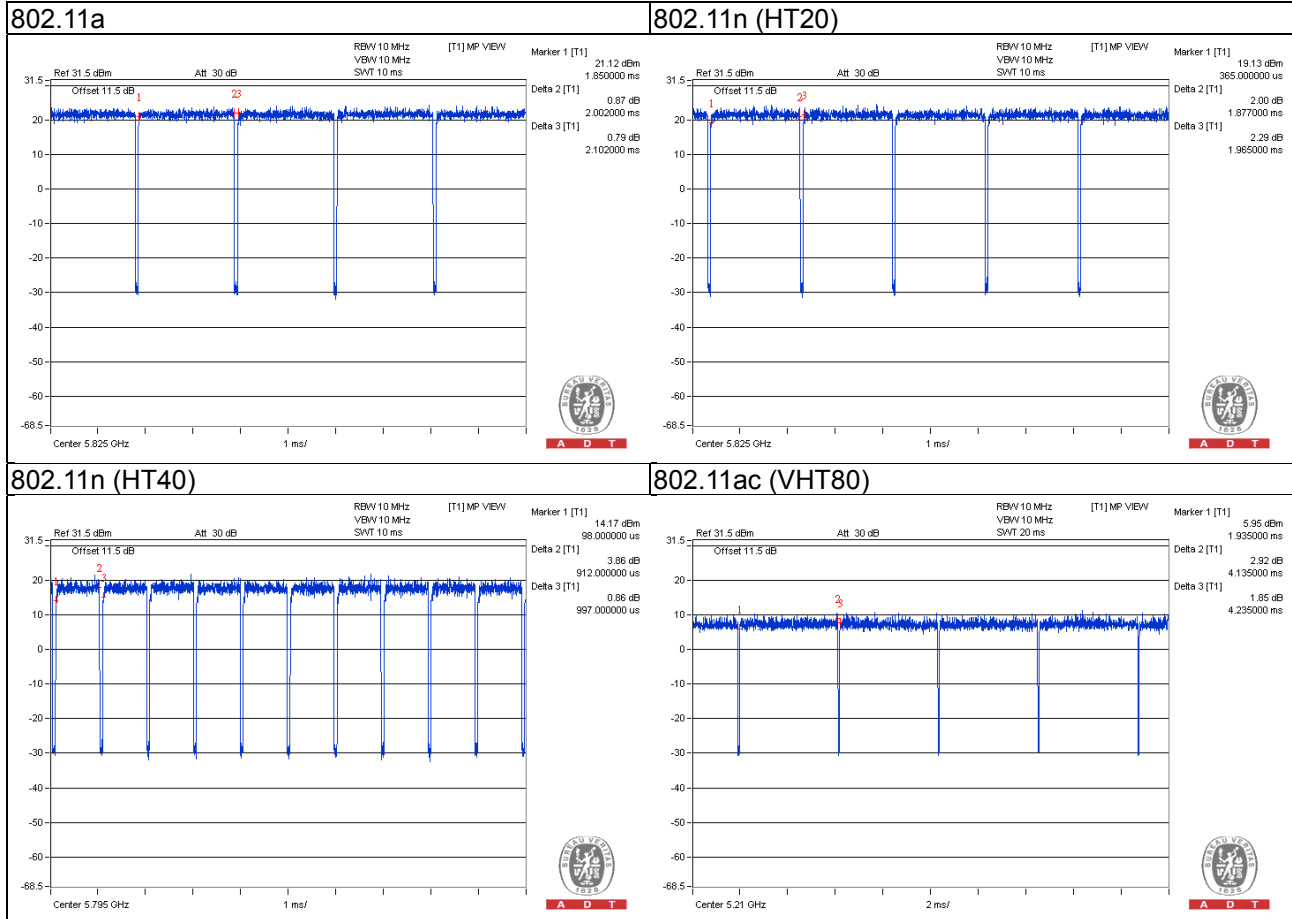

### 3.4 Description of Support Units

The EUT has been tested as an independent unit together with other necessary accessories or support units. The following support units or accessories were used to form a representative test configuration during the tests.

ID	Product	Brand	Model No.	Serial No.	FCC ID	Remarks
A.	Notebook	DELL	E5410	1HC2XM1	FCC DoC Approved	-
B.	Load	NA	NA	NA	NA	-

Note:

1. All power cords of the above support units are non-shielded (1.8m).
2. Items A acted as communication partners to transfer data.

ID	Descriptions	Qty.	Length (m)	Shielding (Yes/No)	Cores (Qty.)	Remarks
1.	Cat5e cable	1	1.8	N	0	-
2.	Cat5e cable	1	1.8	N	0	-
3.	Cat5e cable	1	10	N	0	-

#### 3.4.1 Configuration of System under Test

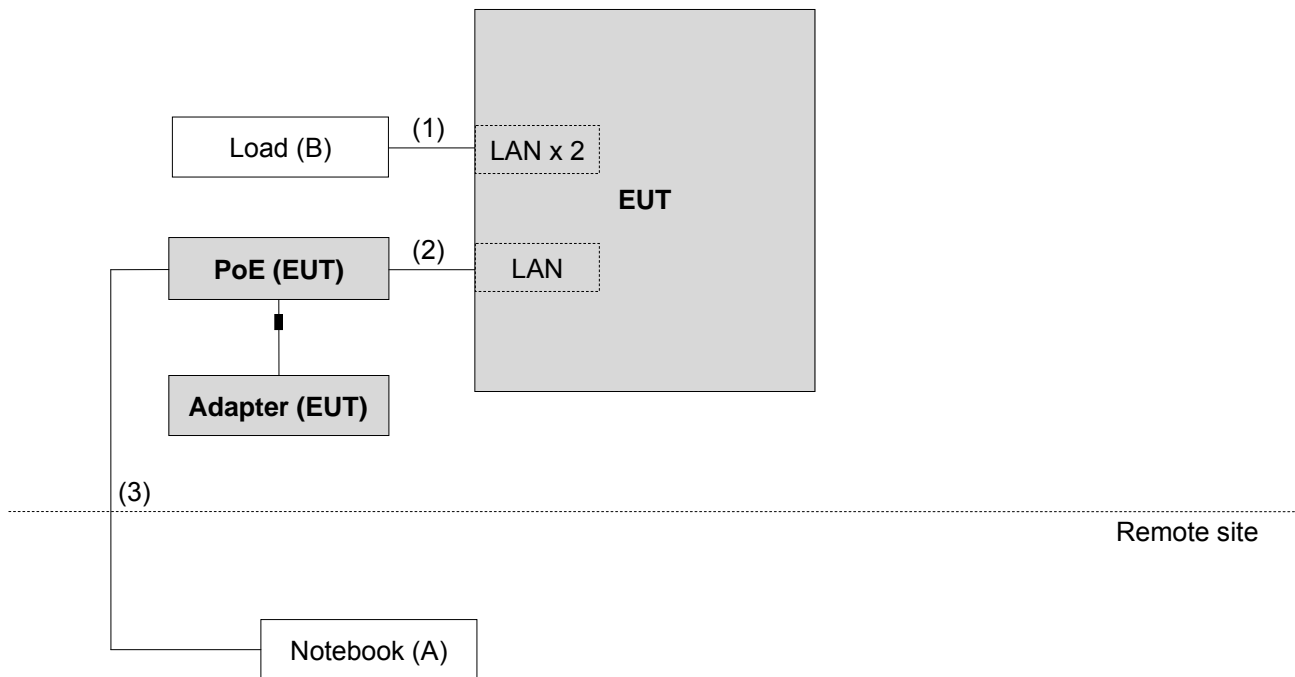

### 3.5 General Description of Applied Standards

The EUT is a RF Product. According to the specifications of the manufacturer, it must comply with the requirements of the following standards:

**FCC Part 15, Subpart E (15.407)**

**789033 D02 General UNII Test Procedures New Rules v01**

**662911 D01 Multiple Transmitter Output v02r01**

ANSI C63.10-2013

All test items have been performed and recorded as per the above standards.

Note: The EUT is also considered as a kind of computer peripheral, because the connection to computer is necessary for typical use. It has been verified to comply with the requirements of FCC Part 15, Subpart B, Class B (DoC). The test report has been issued separately.

## 4 Test Types and Results

### 4.1 Radiated Emission and Bandedge Measurement

#### 4.1.1 Limits of Radiated Emission and Bandedge Measurement

Radiated emissions which fall in the restricted bands must comply with the radiated emission limits specified as below table.

Frequencies (MHz)	Field Strength (microvolts/meter)	Measurement Distance (meters)
0.009 ~ 0.490	2400/F(kHz)	300
0.490 ~ 1.705	24000/F(kHz)	30
1.705 ~ 30.0	30	30
30 ~ 88	100	3
88 ~ 216	150	3
216 ~ 960	200	3
Above 960	500	3

#### NOTE:

1. The lower limit shall apply at the transition frequencies.
2. Emission level (dBuV/m) = 20 log Emission level (uV/m).
3. For frequencies above 1000MHz, the field strength limits are based on average detector, however, the peak field strength of any emission shall not exceed the maximum permitted average limits, specified above by more than 20dB under any condition of modulation.

#### LIMITS OF UNWANTED EMISSION OUT OF THE RESTRICTED BANDS

APPLICABLE TO	LIMIT	
789033 D02 General UNII Test Procedures New Rules v01	FIELD STRENGTH AT 3m	
	PK:74 (dBµV/m)	AV:54 (dBµV/m)
APPLICABLE TO	EIRP LIMIT	EQUIVALENT FIELD STRENGTH AT 3m
15.407(b)(1)	PK:-27 (dBm/MHz)	PK:68.2(dBµV/m)
15.407(b)(2)		
15.407(b)(3)		
15.407(b)(4)	PK:-27 (dBm/MHz) <sup>*1</sup> PK:-17 (dBm/MHz) <sup>*2</sup>	PK: 68.2(dBµV/m) <sup>*1</sup> PK:78.2 (dBµV/m) <sup>*2</sup>

**NOTE:** <sup>\*1</sup> beyond 10MHz of the band edge <sup>\*2</sup> within 10 MHz of band edge

The following formula is used to convert the equipment isotropic radiated power (eirp) to field strength:

$$E = \frac{1000000 \sqrt{30P}}{3} \mu\text{V/m, where P is the eirp (Watts).}$$



A D T

#### 4.1.2 Test Instruments

Description & Manufacturer	Model No.	Serial No.	Cal. Date	Cal. Due
Test Receiver ROHDE & SCHWARZ	ESIB7	100187	Apr. 10, 2015	Apr. 09, 2016
Spectrum Analyzer ROHDE & SCHWARZ	FSP40	100041	Sep. 02, 2015	Sep. 01, 2016
BILOG Antenna SCHWARZBECK	VULB9168	9168-160	Feb. 05, 2015	Feb. 04, 2016
HORN Antenna SCHWARZBECK	9120D	209	Feb. 09, 2015	Feb. 08, 2016
HORN Antenna SCHWARZBECK	BBHA 9170	BBHA9170241	Feb. 09, 2015	Feb. 08, 2016
Preamplifier Agilent	8447D	2944A10738	Oct. 18, 2014	Oct. 17, 2015
Preamplifier Agilent	8449B	3008A01964	Aug. 22, 2015	Aug. 21, 2016
RF signal cable HUBER+SUHNER	SUCOFLEX 104	Cable-CH3-03(214378)	Aug. 22, 2015	Aug. 21, 2016
RF signal cable HUBER+SUHNER	SUCOFLEX 106	Cable-CH3-03(309224+ 12738)	Aug. 22, 2015	Aug. 21, 2016
Software BV ADT	ADT_Radiated_ V7.6.15.9.4	NA	NA	NA
Antenna Tower inn-co GmbH	MA 4000	013303	NA	NA
Antenna Tower Controller BV ADT	AT100	AT93021702	NA	NA
Turn Table BV ADT	TT100	TT93021702	NA	NA
Turn Table Controller BV ADT	SC100	SC93021702	NA	NA
26GHz ~ 40GHz Amplifier	EM26400	815221	Oct. 18, 2014	Oct. 17, 2015
High Speed Peak Power Meter	ML2495A	0824011	Jul. 09, 2015	Jul. 08, 2016
Power Sensor	MA2411B	0738171	Jul. 09, 2015	Jul. 08, 2016
WIT Standard Temperature And Humidity Chamber	TH-4S-C	W981030	Jun. 08, 2015	Jun. 07, 2016

- Note: 1. The calibration interval of the above test instruments is 12 months and the calibrations are traceable to NML/ROC and NIST/USA.  
2. The test was performed in HwaYa Chamber 3.  
3. The horn antenna and preamplifier (model: 8449B) are used only for the measurement of emission frequency above 1GHz if tested.  
4. The FCC Site Registration No. is 988962.  
5. The IC Site Registration No. is IC 7450F-3.

#### 4.1.3 Test Procedures

- a. The EUT was placed on the top of a rotating table 0.8 meters (for below 1GHz) / 1.5 meters (for above 1GHz) above the ground at 3 meter chamber room for test. The table was rotated 360 degrees to determine the position of the highest radiation.
- b. The EUT was set 3 meters away from the interference-receiving antenna, which was mounted on the top of a variable-height antenna tower.
- c. The height of antenna is varied from one meter to four meters above the ground to determine the maximum value of the field strength. Both horizontal and vertical polarizations of the antenna are set to make the measurement.
- d. For each suspected emission, the EUT was arranged to its worst case and then the antenna was tuned to heights from 1 meter to 4 meters and the rotatable table was turned from 0 degrees to 360 degrees to find the maximum reading.
- e. The test-receiver system was set to quasi-peak detect function and specified bandwidth with maximum hold mode when the test frequency is below 1 GHz.
- f. The test-receiver system was set to peak and average detect function and specified bandwidth with maximum hold mode when the test frequency is above 1 GHz. If the peak reading value also meets average limit, measurement with the average detector is unnecessary.

**Note:**

1. The resolution bandwidth and video bandwidth of test receiver/spectrum analyzer is 120kHz for Quasi-peak detection (QP) at frequency below 1GHz.
2. The resolution bandwidth of test receiver/spectrum analyzer is 1 MHz and the video bandwidth is 3 MHz for Peak detection (PK) at frequency above 1GHz.
3. The resolution bandwidth of test receiver/spectrum analyzer is 1MHz and the video bandwidth is 3MHz for RMS Average (Duty cycle < 98%) for Average detection (AV) at frequency above 1GHz, then the measurement results was added to a correction factor ( $10 \log(1/\text{duty cycle})$ ).
4. The resolution bandwidth of test receiver/spectrum analyzer is 1MHz and the video bandwidth is 10Hz (Duty cycle  $\geq 98\%$ ) for Average detection (AV) at frequency above 1GHz.
5. All modes of operation were investigated and the worst-case emissions are reported.

#### 4.1.4 Deviation from Test Standard

No deviation.



#### 4.1.5 Test Set Up

##### <Frequency Range below 1GHz>

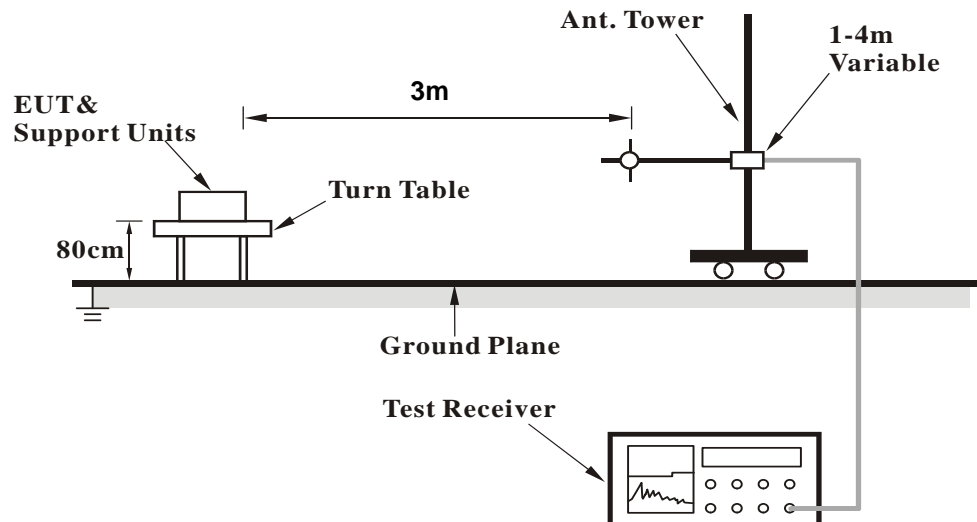

##### <Frequency Range above 1GHz>

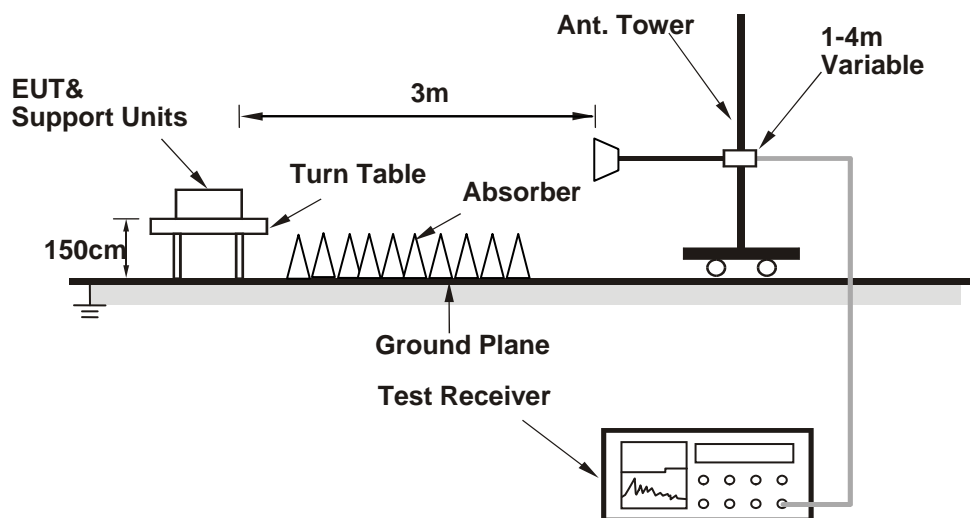

For the actual test configuration, please refer to the attached file (Test Setup Photo)

#### 4.1.6 EUT Operating Conditions

- Placed the EUT on the testing table.
- Prepared notebook to act as communication partner and placed it outside of testing area.
- The communication partner connected with EUT via a RJ45 cable and ran a test program (provided by manufacturer) to enable EUT under transmission condition continuously at specific channel frequency.
- The communication partner sent data to EUT by command "PING".
- The necessary accessories enable the system in full functions.

#### 4.1.7 Test Results

Above 1GHz Worst-Case Data:

802.11a

CHANNEL	TX Channel 36	DETECTOR FUNCTION	Peak (PK)
FREQUENCY RANGE	1GHz ~ 40GHz		Average (AV)

#### ANTENNA POLARITY & TEST DISTANCE: HORIZONTAL AT 3 M

NO.	FREQ. (MHz)	EMISSION LEVEL (dBuV/m)	LIMIT (dBuV/m)	MARGIN (dB)	ANTENNA HEIGHT (m)	TABLE ANGLE (Degree)	RAW VALUE (dBuV)	CORRECTION FACTOR (dB/m)
1	5150.00	56.9 PK	74.0	-17.1	1.23 H	200	50.70	6.20
2	5150.00	44.4 AV	54.0	-9.6	1.23 H	200	38.20	6.20
3	*5180.00	103.7 PK			1.40 H	186	64.20	39.50
4	*5180.00	93.8 AV			1.40 H	186	54.30	39.50
5	#10360.00	58.6 PK	74.0	-15.4	1.15 H	241	41.60	17.00
6	#10360.00	45.8 AV	54.0	-8.2	1.15 H	241	28.80	17.00

#### ANTENNA POLARITY & TEST DISTANCE: VERTICAL AT 3 M

NO.	FREQ. (MHz)	EMISSION LEVEL (dBuV/m)	LIMIT (dBuV/m)	MARGIN (dB)	ANTENNA HEIGHT (m)	TABLE ANGLE (Degree)	RAW VALUE (dBuV)	CORRECTION FACTOR (dB/m)
1	5150.00	68.2 PK	74.0	-5.8	1.82 V	107	62.00	6.20
2	5150.00	52.4 AV	54.0	-1.6	1.82 V	107	46.20	6.20
3	*5180.00	118.7 PK			1.85 V	8	79.20	39.50
4	*5180.00	108.7 AV			1.85 V	8	69.20	39.50
5	#10360.00	58.5 PK	74.0	-15.5	1.51 V	207	41.50	17.00
6	#10360.00	45.9 AV	54.0	-8.1	1.51 V	207	28.90	17.00

Remarks:

1. Emission Level(dBuV/m) = Raw Value(dBuV) + Correction Factor(dB/m)
2. Correction Factor(dB/m) = Antenna Factor(dB/m) + Cable Factor(dB)
3. The other emission levels were very low against the limit.
4. Margin value = Emission Level – Limit value
5. " \* ": Fundamental frequency.
6. " # ": The radiated frequency is out of the restricted band.

CHANNEL	TX Channel 40	DETECTOR	Peak (PK)
FREQUENCY RANGE	1GHz ~ 40GHz	FUNCTION	Average (AV)

**ANTENNA POLARITY & TEST DISTANCE: HORIZONTAL AT 3 M**

NO.	FREQ. (MHz)	EMISSION LEVEL (dBuV/m)	LIMIT (dBuV/m)	MARGIN (dB)	ANTENNA HEIGHT (m)	TABLE ANGLE (Degree)	RAW VALUE (dBuV)	CORRECTION FACTOR (dB/m)
1	*5200.00	102.8 PK			1.09 H	188	63.20	39.60
2	*5200.00	92.7 AV			1.09 H	188	53.10	39.60
3	#10400.00	58.6 PK	74.0	-15.4	1.06 H	61	41.60	17.00
4	#10400.00	45.9 AV	54.0	-8.1	1.06 H	61	28.90	17.00

**ANTENNA POLARITY & TEST DISTANCE: VERTICAL AT 3 M**

NO.	FREQ. (MHz)	EMISSION LEVEL (dBuV/m)	LIMIT (dBuV/m)	MARGIN (dB)	ANTENNA HEIGHT (m)	TABLE ANGLE (Degree)	RAW VALUE (dBuV)	CORRECTION FACTOR (dB/m)
1	*5200.00	119.3 PK			1.63 V	323	79.70	39.60
2	*5200.00	109.2 AV			1.63 V	323	69.60	39.60
3	#10400.00	58.5 PK	74.0	-15.5	1.41 V	324	41.50	17.00
4	#10400.00	45.6 AV	54.0	-8.4	1.41 V	324	28.60	17.00

**Remarks:**

1. Emission Level(dBuV/m) = Raw Value(dBuV) + Correction Factor(dB/m)
2. Correction Factor(dB/m) = Antenna Factor(dB/m) + Cable Factor(dB)
3. The other emission levels were very low against the limit.
4. Margin value = Emission Level – Limit value
5. " \* ": Fundamental frequency.
6. " # ": The radiated frequency is out of the restricted band.

CHANNEL	TX Channel 48	DETECTOR FUNCTION	Peak (PK)
FREQUENCY RANGE	1GHz ~ 40GHz		Average (AV)

ANTENNA POLARITY & TEST DISTANCE: HORIZONTAL AT 3 M								
NO.	FREQ. (MHz)	EMISSION LEVEL (dBuV/m)	LIMIT (dBuV/m)	MARGIN (dB)	ANTENNA HEIGHT (m)	TABLE ANGLE (Degree)	RAW VALUE (dBuV)	CORRECTION FACTOR (dB/m)
1	5088.00	56.1 PK	74.0	-17.9	1.12 H	152	50.10	6.00
2	5088.00	44.4 AV	54.0	-9.6	1.12 H	152	38.40	6.00
3	*5240.00	102.7 PK			1.14 H	187	63.10	39.60
4	*5240.00	92.7 AV			1.14 H	187	53.10	39.60
5	#10480.00	58.8 PK	74.0	-15.2	1.39 H	251	40.80	18.00
6	#10480.00	46.3 AV	54.0	-7.7	1.39 H	251	28.30	18.00
ANTENNA POLARITY & TEST DISTANCE: VERTICAL AT 3 M								
NO.	FREQ. (MHz)	EMISSION LEVEL (dBuV/m)	LIMIT (dBuV/m)	MARGIN (dB)	ANTENNA HEIGHT (m)	TABLE ANGLE (Degree)	RAW VALUE (dBuV)	CORRECTION FACTOR (dB/m)
1	5088.00	60.4 PK	74.0	-13.6	2.05 V	136	54.40	6.00
2	5088.00	49.3 AV	54.0	-4.7	2.05 V	136	43.30	6.00
3	*5240.00	120.3 PK			2.00 V	274	80.70	39.60
4	*5240.00	109.9 AV			2.00 V	274	70.30	39.60
5	#10480.00	59.1 PK	74.0	-14.9	1.34 V	195	41.10	18.00
6	#10480.00	46.4 AV	54.0	-7.6	1.34 V	195	28.40	18.00

**Remarks:**

1. Emission Level(dBuV/m) = Raw Value(dBuV) + Correction Factor(dB/m)
2. Correction Factor(dB/m) = Antenna Factor(dB/m) + Cable Factor(dB)
3. The other emission levels were very low against the limit.
4. Margin value = Emission Level – Limit value
5. " \* ": Fundamental frequency.
6. " # ": The radiated frequency is out of the restricted band.

CHANNEL	TX Channel 149	DETECTOR FUNCTION	Peak (PK)
FREQUENCY RANGE	1GHz ~ 40GHz		Average (AV)

**ANTENNA POLARITY & TEST DISTANCE: HORIZONTAL AT 3 M**

NO.	FREQ. (MHz)	EMISSION LEVEL (dBuV/m)	LIMIT (dBuV/m)	MARGIN (dB)	ANTENNA HEIGHT (m)	TABLE ANGLE (Degree)	RAW VALUE (dBuV)	CORRECTION FACTOR (dB/m)
1	#5714.90	58.1 PK	74.0	-15.9	1.15 H	302	50.90	7.20
2	#5714.90	47.2 AV	54.0	-6.8	1.15 H	302	40.00	7.20
3	#5722.90	58.4 PK	78.2	-19.8	1.01 H	265	51.20	7.20
4	#5725.00	44.7 PK	78.2	-33.5	1.11 H	315	37.50	7.20
5	*5745.00	102.9 PK			1.02 H	150	62.50	40.40
6	*5745.00	93.5 AV			1.02 H	150	53.10	40.40
7	11490.00	58.5 PK	74.0	-15.5	4.00 H	153	40.20	18.30
8	11490.00	48.0 AV	54.0	-6.0	4.00 H	153	29.70	18.30

**ANTENNA POLARITY & TEST DISTANCE: VERTICAL AT 3 M**

NO.	FREQ. (MHz)	EMISSION LEVEL (dBuV/m)	LIMIT (dBuV/m)	MARGIN (dB)	ANTENNA HEIGHT (m)	TABLE ANGLE (Degree)	RAW VALUE (dBuV)	CORRECTION FACTOR (dB/m)
1	#5714.90	67.6 PK	74.0	-6.4	1.69 V	334	60.40	7.20
2	#5714.90	52.4 AV	54.0	-1.6	1.69 V	334	45.20	7.20
3	#5722.90	73.1 PK	78.2	-5.1	1.24 V	347	65.90	7.20
4	#5725.00	55.7 PK	78.2	-22.5	1.24 V	359	48.50	7.20
5	*5745.00	116.9 PK			1.59 V	177	76.50	40.40
6	*5745.00	107.5 AV			1.59 V	177	67.10	40.40
7	11490.00	59.9 PK	74.0	-14.1	1.65 V	184	41.60	18.30
8	11490.00	50.7 AV	54.0	-3.3	1.65 V	184	32.40	18.30

**Remarks:**

1. Emission Level(dBuV/m) = Raw Value(dBuV) + Correction Factor(dB/m)
2. Correction Factor(dB/m) = Antenna Factor(dB/m) + Cable Factor(dB)
3. The other emission levels were very low against the limit.
4. Margin value = Emission Level – Limit value
5. " \* ": Fundamental frequency.
6. " # ": The radiated frequency is out of the restricted band.

CHANNEL	TX Channel 157	DETECTOR FUNCTION	Peak (PK)
FREQUENCY RANGE	1GHz ~ 40GHz		Average (AV)

**ANTENNA POLARITY & TEST DISTANCE: HORIZONTAL AT 3 M**

NO.	FREQ. (MHz)	EMISSION LEVEL (dBuV/m)	LIMIT (dBuV/m)	MARGIN (dB)	ANTENNA HEIGHT (m)	TABLE ANGLE (Degree)	RAW VALUE (dBuV)	CORRECTION FACTOR (dB/m)
1	*5785.00	101.6 PK			1.00 H	135	61.10	40.50
2	*5785.00	92.7 AV			1.00 H	135	52.20	40.50
3	11570.00	59.6 PK	74.0	-14.4	1.15 H	161	41.40	18.20
4	11570.00	47.5 AV	54.0	-6.5	1.15 H	161	29.30	18.20

**ANTENNA POLARITY & TEST DISTANCE: VERTICAL AT 3 M**

NO.	FREQ. (MHz)	EMISSION LEVEL (dBuV/m)	LIMIT (dBuV/m)	MARGIN (dB)	ANTENNA HEIGHT (m)	TABLE ANGLE (Degree)	RAW VALUE (dBuV)	CORRECTION FACTOR (dB/m)
1	*5785.00	117.8 PK			1.27 V	151	77.30	40.50
2	*5785.00	108.3 AV			1.27 V	151	67.80	40.50
3	11570.00	62.6 PK	74.0	-11.4	1.49 V	353	44.40	18.20
4	11570.00	52.9 AV	54.0	-1.1	1.49 V	353	34.70	18.20

**Remarks:**

1. Emission Level(dBuV/m) = Raw Value(dBuV) + Correction Factor(dB/m)
2. Correction Factor(dB/m) = Antenna Factor(dB/m) + Cable Factor(dB)
3. The other emission levels were very low against the limit.
4. Margin value = Emission Level – Limit value
5. " \* ": Fundamental frequency.

CHANNEL	TX Channel 165	DETECTOR FUNCTION	Peak (PK)
FREQUENCY RANGE	1GHz ~ 40GHz		Average (AV)

ANTENNA POLARITY & TEST DISTANCE: HORIZONTAL AT 3 M								
NO.	FREQ. (MHz)	EMISSION LEVEL (dBuV/m)	LIMIT (dBuV/m)	MARGIN (dB)	ANTENNA HEIGHT (m)	TABLE ANGLE (Degree)	RAW VALUE (dBuV)	CORRECTION FACTOR (dB/m)
1	*5825.00	102.2 PK			1.26 H	191	61.70	40.50
2	*5825.00	92.3 AV			1.26 H	191	51.80	40.50
3	#5850.00	43.0 PK	78.2	-35.2	1.30 H	148	35.50	7.50
4	#5852.10	58.2 PK	78.2	-20.0	1.14 H	113	50.60	7.60
5	#5860.10	58.9 PK	74.0	-15.1	1.03 H	74	51.30	7.60
6	#5860.10	47.1 AV	54.0	-6.9	1.03 H	74	39.50	7.60
7	11650.00	59.0 PK	74.0	-15.0	1.02 H	148	40.30	18.70
8	11650.00	48.0 AV	54.0	-6.0	1.02 H	148	29.30	18.70

ANTENNA POLARITY & TEST DISTANCE: VERTICAL AT 3 M								
NO.	FREQ. (MHz)	EMISSION LEVEL (dBuV/m)	LIMIT (dBuV/m)	MARGIN (dB)	ANTENNA HEIGHT (m)	TABLE ANGLE (Degree)	RAW VALUE (dBuV)	CORRECTION FACTOR (dB/m)
1	*5825.00	116.3 PK			1.38 V	151	75.80	40.50
2	*5825.00	107.2 AV			1.38 V	151	66.70	40.50
3	#5850.00	50.0 PK	78.2	-28.2	1.43 V	128	42.50	7.50
4	#5852.10	69.5 PK	78.2	-8.7	1.26 V	127	61.90	7.60
5	#5860.10	68.2 PK	74.0	-5.8	1.11 V	177	60.60	7.60
6	#5860.10	50.0 AV	54.0	-4.0	1.11 V	177	42.40	7.60
7	11650.00	64.0 PK	74.0	-10.0	1.28 V	330	45.30	18.70
<b>8</b>	<b>11650.00</b>	<b>53.0 AV</b>	<b>54.0</b>	<b>-1.0</b>	<b>1.28 V</b>	<b>330</b>	<b>34.30</b>	<b>18.70</b>

Remarks:

1. Emission Level(dBuV/m) = Raw Value(dBuV) + Correction Factor(dB/m)
2. Correction Factor(dB/m) = Antenna Factor(dB/m) + Cable Factor(dB)
3. The other emission levels were very low against the limit.
4. Margin value = Emission Level – Limit value
5. " \* ": Fundamental frequency.
6. " # ": The radiated frequency is out of the restricted band.

**802.11n (HT20)**

CHANNEL	TX Channel 36	DETECTOR FUNCTION	Peak (PK)
FREQUENCY RANGE	1GHz ~ 40GHz		Average (AV)

**ANTENNA POLARITY & TEST DISTANCE: HORIZONTAL AT 3 M**

NO.	FREQ. (MHz)	EMISSION LEVEL (dBuV/m)	LIMIT (dBuV/m)	MARGIN (dB)	ANTENNA HEIGHT (m)	TABLE ANGLE (Degree)	RAW VALUE (dBuV)	CORRECTION FACTOR (dB/m)
1	5150.00	57.5 PK	74.0	-16.5	1.17 H	193	51.30	6.20
2	5150.00	44.2 AV	54.0	-9.8	1.17 H	193	38.00	6.20
3	*5180.00	102.0 PK			1.00 H	187	62.50	39.50
4	*5180.00	92.6 AV			1.00 H	187	53.10	39.50
5	#10360.00	58.4 PK	74.0	-15.6	1.08 H	264	41.40	17.00
6	#10360.00	45.8 AV	54.0	-8.2	1.08 H	264	28.80	17.00

**ANTENNA POLARITY & TEST DISTANCE: VERTICAL AT 3 M**

NO.	FREQ. (MHz)	EMISSION LEVEL (dBuV/m)	LIMIT (dBuV/m)	MARGIN (dB)	ANTENNA HEIGHT (m)	TABLE ANGLE (Degree)	RAW VALUE (dBuV)	CORRECTION FACTOR (dB/m)
1	5150.00	66.5 PK	74.0	-7.5	2.25 V	292	60.30	6.20
2	5150.00	52.7 AV	54.0	-1.3	2.25 V	292	46.50	6.20
3	*5180.00	118.6 PK			1.90 V	3	79.10	39.50
4	*5180.00	108.3 AV			1.90 V	3	68.80	39.50
5	#10360.00	58.4 PK	74.0	-15.6	1.56 V	77	41.40	17.00
6	#10360.00	45.8 AV	54.0	-8.2	1.56 V	77	28.80	17.00

**Remarks:**

1. Emission Level(dBuV/m) = Raw Value(dBuV) + Correction Factor(dB/m)
2. Correction Factor(dB/m) = Antenna Factor(dB/m) + Cable Factor(dB)
3. The other emission levels were very low against the limit.
4. Margin value = Emission Level – Limit value
5. " \* ": Fundamental frequency.
6. " # ": The radiated frequency is out of the restricted band.



CHANNEL	TX Channel 40	DETECTOR FUNCTION	Peak (PK)
FREQUENCY RANGE	1GHz ~ 40GHz		Average (AV)

**ANTENNA POLARITY & TEST DISTANCE: HORIZONTAL AT 3 M**

NO.	FREQ. (MHz)	EMISSION LEVEL (dBuV/m)	LIMIT (dBuV/m)	MARGIN (dB)	ANTENNA HEIGHT (m)	TABLE ANGLE (Degree)	RAW VALUE (dBuV)	CORRECTION FACTOR (dB/m)
1	*5200.00	102.3 PK			1.10 H	191	62.70	39.60
2	*5200.00	92.2 AV			1.10 H	191	52.60	39.60
3	#10400.00	58.5 PK	74.0	-15.5	1.01 H	243	41.50	17.00
4	#10400.00	45.7 AV	54.0	-8.3	1.01 H	243	28.70	17.00

**ANTENNA POLARITY & TEST DISTANCE: VERTICAL AT 3 M**

NO.	FREQ. (MHz)	EMISSION LEVEL (dBuV/m)	LIMIT (dBuV/m)	MARGIN (dB)	ANTENNA HEIGHT (m)	TABLE ANGLE (Degree)	RAW VALUE (dBuV)	CORRECTION FACTOR (dB/m)
1	*5200.00	119.9 PK			1.87 V	321	80.30	39.60
2	*5200.00	110.0 AV			1.87 V	321	70.40	39.60
3	#10400.00	59.0 PK	74.0	-15.0	1.66 V	215	42.00	17.00
4	#10400.00	45.7 AV	54.0	-8.3	1.66 V	215	28.70	17.00

Remarks:

1. Emission Level(dBuV/m) = Raw Value(dBuV) + Correction Factor(dB/m)
2. Correction Factor(dB/m) = Antenna Factor(dB/m) + Cable Factor(dB)
3. The other emission levels were very low against the limit.
4. Margin value = Emission Level – Limit value
5. " \* ": Fundamental frequency.
6. " # ": The radiated frequency is out of the restricted band.

CHANNEL	TX Channel 48	DETECTOR FUNCTION	Peak (PK)
FREQUENCY RANGE	1GHz ~ 40GHz		Average (AV)

ANTENNA POLARITY & TEST DISTANCE: HORIZONTAL AT 3 M								
NO.	FREQ. (MHz)	EMISSION LEVEL (dBuV/m)	LIMIT (dBuV/m)	MARGIN (dB)	ANTENNA HEIGHT (m)	TABLE ANGLE (Degree)	RAW VALUE (dBuV)	CORRECTION FACTOR (dB/m)
1	5080.00	56.5 PK	74.0	-17.5	1.06 H	201	50.50	6.00
2	5080.00	44.1 AV	54.0	-9.9	1.06 H	201	38.10	6.00
3	*5240.00	102.3 PK			1.22 H	185	62.70	39.60
4	*5240.00	92.4 AV			1.22 H	185	52.80	39.60
5	#10480.00	59.4 PK	74.0	-14.6	1.06 H	139	41.40	18.00
6	#10480.00	46.5 AV	54.0	-7.5	1.06 H	139	28.50	18.00
ANTENNA POLARITY & TEST DISTANCE: VERTICAL AT 3 M								
NO.	FREQ. (MHz)	EMISSION LEVEL (dBuV/m)	LIMIT (dBuV/m)	MARGIN (dB)	ANTENNA HEIGHT (m)	TABLE ANGLE (Degree)	RAW VALUE (dBuV)	CORRECTION FACTOR (dB/m)
1	5080.00	60.2 PK	74.0	-13.8	1.82 V	121	54.20	6.00
2	5080.00	48.7 AV	54.0	-5.3	1.82 V	121	42.70	6.00
3	*5240.00	120.2 PK			1.80 V	150	80.60	39.60
4	*5240.00	110.1 AV			1.80 V	150	70.50	39.60
5	#10480.00	59.1 PK	74.0	-14.9	1.46 V	59	41.10	18.00
6	#10480.00	46.6 AV	54.0	-7.4	1.46 V	59	28.60	18.00

**Remarks:**

1. Emission Level(dBuV/m) = Raw Value(dBuV) + Correction Factor(dB/m)
2. Correction Factor(dB/m) = Antenna Factor(dB/m) + Cable Factor(dB)
3. The other emission levels were very low against the limit.
4. Margin value = Emission Level – Limit value
5. " \* ": Fundamental frequency.
6. " # ": The radiated frequency is out of the restricted band.

CHANNEL	TX Channel 149	DETECTOR FUNCTION	Peak (PK)
FREQUENCY RANGE	1GHz ~ 40GHz		Average (AV)

**ANTENNA POLARITY & TEST DISTANCE: HORIZONTAL AT 3 M**

NO.	FREQ. (MHz)	EMISSION LEVEL (dBuV/m)	LIMIT (dBuV/m)	MARGIN (dB)	ANTENNA HEIGHT (m)	TABLE ANGLE (Degree)	RAW VALUE (dBuV)	CORRECTION FACTOR (dB/m)
1	#5714.00	59.3 PK	74.0	-14.7	1.11 H	187	52.10	7.20
2	#5714.00	47.6 AV	54.0	-6.4	1.11 H	187	40.40	7.20
3	#5722.00	62.2 PK	78.2	-16.0	1.05 H	201	55.00	7.20
4	#5725.00	59.1 PK	78.2	-19.1	1.05 H	201	51.90	7.20
5	*5745.00	101.9 PK			1.00 H	195	61.50	40.40
6	*5745.00	92.7 AV			1.00 H	195	52.30	40.40
7	11490.00	61.3 PK	74.0	-12.7	1.25 H	191	43.00	18.30
8	11490.00	48.3 AV	54.0	-5.7	1.25 H	191	30.00	18.30

**ANTENNA POLARITY & TEST DISTANCE: VERTICAL AT 3 M**

NO.	FREQ. (MHz)	EMISSION LEVEL (dBuV/m)	LIMIT (dBuV/m)	MARGIN (dB)	ANTENNA HEIGHT (m)	TABLE ANGLE (Degree)	RAW VALUE (dBuV)	CORRECTION FACTOR (dB/m)
1	#5714.00	65.5 PK	74.0	-8.5	1.69 V	305	58.30	7.20
2	#5714.00	52.6 AV	54.0	-1.4	1.69 V	305	45.40	7.20
3	#5722.00	61.7 PK	78.2	-16.5	1.54 V	175	54.50	7.20
4	#5725.00	61.3 PK	78.2	-16.9	1.54 V	175	54.10	7.20
5	*5745.00	117.9 PK			1.48 V	171	77.50	40.40
6	*5745.00	108.3 AV			1.48 V	171	67.90	40.40
7	11490.00	63.2 PK	74.0	-10.8	1.46 V	49	44.90	18.30
8	11490.00	51.2 AV	54.0	-2.8	1.46 V	49	32.90	18.30

**Remarks:**

1. Emission Level(dBuV/m) = Raw Value(dBuV) + Correction Factor(dB/m)
2. Correction Factor(dB/m) = Antenna Factor(dB/m) + Cable Factor(dB)
3. The other emission levels were very low against the limit.
4. Margin value = Emission Level – Limit value
5. " \* ": Fundamental frequency.
6. " # ": The radiated frequency is out of the restricted band.

CHANNEL	TX Channel 157	DETECTOR FUNCTION	Peak (PK)
FREQUENCY RANGE	1GHz ~ 40GHz		Average (AV)

**ANTENNA POLARITY & TEST DISTANCE: HORIZONTAL AT 3 M**

NO.	FREQ. (MHz)	EMISSION LEVEL (dBuV/m)	LIMIT (dBuV/m)	MARGIN (dB)	ANTENNA HEIGHT (m)	TABLE ANGLE (Degree)	RAW VALUE (dBuV)	CORRECTION FACTOR (dB/m)
1	*5785.00	100.3 PK			1.00 H	197	59.80	40.50
2	*5785.00	91.1 AV			1.00 H	197	50.60	40.50
3	11570.00	61.3 PK	74.0	-12.7	1.20 H	217	43.10	18.20
4	11570.00	48.5 AV	54.0	-5.5	1.20 H	217	30.30	18.20

**ANTENNA POLARITY & TEST DISTANCE: VERTICAL AT 3 M**

NO.	FREQ. (MHz)	EMISSION LEVEL (dBuV/m)	LIMIT (dBuV/m)	MARGIN (dB)	ANTENNA HEIGHT (m)	TABLE ANGLE (Degree)	RAW VALUE (dBuV)	CORRECTION FACTOR (dB/m)
1	*5785.00	118.3 PK			1.32 V	172	77.80	40.50
2	*5785.00	109.2 AV			1.32 V	172	68.70	40.50
3	11570.00	63.9 PK	74.0	-10.1	1.50 V	41	45.70	18.20
<b>4</b>	<b>11570.00</b>	<b>53.0 AV</b>	<b>54.0</b>	<b>-1.0</b>	<b>1.50 V</b>	<b>41</b>	<b>34.80</b>	<b>18.20</b>

**Remarks:**

1. Emission Level(dBuV/m) = Raw Value(dBuV) + Correction Factor(dB/m)
2. Correction Factor(dB/m) = Antenna Factor(dB/m) + Cable Factor(dB)
3. The other emission levels were very low against the limit.
4. Margin value = Emission Level – Limit value
5. " \* ": Fundamental frequency.
6. " # ": The radiated frequency is out of the restricted band.

CHANNEL	TX Channel 165	DETECTOR FUNCTION	Peak (PK)
FREQUENCY RANGE	1GHz ~ 40GHz		Average (AV)

**ANTENNA POLARITY & TEST DISTANCE: HORIZONTAL AT 3 M**

NO.	FREQ. (MHz)	EMISSION LEVEL (dBuV/m)	LIMIT (dBuV/m)	MARGIN (dB)	ANTENNA HEIGHT (m)	TABLE ANGLE (Degree)	RAW VALUE (dBuV)	CORRECTION FACTOR (dB/m)
1	*5825.00	102.8 PK			1.00 H	193	62.30	40.50
2	*5825.00	93.5 AV			1.00 H	193	53.00	40.50
3	#5850.00	60.9 PK	78.2	-17.3	1.26 H	109	53.40	7.50
4	#5853.00	61.9 PK	78.2	-16.3	1.26 H	109	54.30	7.60
5	#5861.00	59.7 PK	74.0	-14.3	1.21 H	136	52.10	7.60
6	#5861.00	47.9 AV	54.0	-6.1	1.21 H	136	40.30	7.60
7	11650.00	61.5 PK	74.0	-12.5	1.30 H	222	42.80	18.70
8	11650.00	48.6 AV	54.0	-5.4	1.30 H	222	29.90	18.70

**ANTENNA POLARITY & TEST DISTANCE: VERTICAL AT 3 M**

NO.	FREQ. (MHz)	EMISSION LEVEL (dBuV/m)	LIMIT (dBuV/m)	MARGIN (dB)	ANTENNA HEIGHT (m)	TABLE ANGLE (Degree)	RAW VALUE (dBuV)	CORRECTION FACTOR (dB/m)
1	*5825.00	117.8 PK			1.27 V	150	77.30	40.50
2	*5825.00	108.2 AV			1.27 V	150	67.70	40.50
3	#5850.00	62.8 PK	78.2	-15.4	1.38 V	150	55.30	7.50
4	#5853.00	73.3 PK	78.2	-4.9	1.38 V	15	65.70	7.60
5	#5861.00	61.2 PK	74.0	-12.8	1.69 V	164	53.60	7.60
6	#5861.00	49.5 AV	54.0	-4.5	1.69 V	164	41.90	7.60
7	11650.00	63.7 PK	74.0	-10.3	1.59 V	205	45.00	18.70
8	11650.00	52.4 AV	54.0	-1.6	1.59 V	205	33.70	18.70

**Remarks:**

1. Emission Level(dBuV/m) = Raw Value(dBuV) + Correction Factor(dB/m)
2. Correction Factor(dB/m) = Antenna Factor(dB/m) + Cable Factor(dB)
3. The other emission levels were very low against the limit.
4. Margin value = Emission Level – Limit value
5. " \* ": Fundamental frequency.
6. " # ": The radiated frequency is out of the restricted band.

**802.11n (HT40)**

CHANNEL	TX Channel 38	DETECTOR FUNCTION	Peak (PK)
FREQUENCY RANGE	1GHz ~ 40GHz		Average (AV)

**ANTENNA POLARITY & TEST DISTANCE: HORIZONTAL AT 3 M**

NO.	FREQ. (MHz)	EMISSION LEVEL (dBuV/m)	LIMIT (dBuV/m)	MARGIN (dB)	ANTENNA HEIGHT (m)	TABLE ANGLE (Degree)	RAW VALUE (dBuV)	CORRECTION FACTOR (dB/m)
1	5150.00	56.4 PK	74.0	-17.6	1.04 H	211	50.20	6.20
2	5150.00	44.7 AV	54.0	-9.3	1.04 H	211	38.50	6.20
3	*5190.00	95.9 PK			1.21 H	186	56.40	39.50
4	*5190.00	86.7 AV			1.21 H	186	47.20	39.50
5	#10380.00	58.0 PK	74.0	-16.0	1.06 H	142	41.00	17.00
6	#10380.00	46.3 AV	54.0	-7.7	1.06 H	142	29.30	17.00

**ANTENNA POLARITY & TEST DISTANCE: VERTICAL AT 3 M**

NO.	FREQ. (MHz)	EMISSION LEVEL (dBuV/m)	LIMIT (dBuV/m)	MARGIN (dB)	ANTENNA HEIGHT (m)	TABLE ANGLE (Degree)	RAW VALUE (dBuV)	CORRECTION FACTOR (dB/m)
1	5150.00	64.6 PK	74.0	-9.4	1.59 V	6	58.40	6.20
2	5150.00	52.7 AV	54.0	-1.3	1.59 V	6	46.50	6.20
3	*5190.00	112.1 PK			1.89 V	192	72.60	39.50
4	*5190.00	102.8 AV			1.89 V	192	63.30	39.50
5	#10380.00	58.4 PK	74.0	-15.6	1.47 V	135	41.40	17.00
6	#10380.00	46.4 AV	54.0	-7.6	1.47 V	135	29.40	17.00

**Remarks:**

1. Emission Level(dBuV/m) = Raw Value(dBuV) + Correction Factor(dB/m)
2. Correction Factor(dB/m) = Antenna Factor(dB/m) + Cable Factor(dB)
3. The other emission levels were very low against the limit.
4. Margin value = Emission Level – Limit value
5. " \* ": Fundamental frequency.
6. " # ": The radiated frequency is out of the restricted band.

CHANNEL	TX Channel 46	DETECTOR FUNCTION	Peak (PK)
FREQUENCY RANGE	1GHz ~ 40GHz		Average (AV)

**ANTENNA POLARITY & TEST DISTANCE: HORIZONTAL AT 3 M**

NO.	FREQ. (MHz)	EMISSION LEVEL (dBuV/m)	LIMIT (dBuV/m)	MARGIN (dB)	ANTENNA HEIGHT (m)	TABLE ANGLE (Degree)	RAW VALUE (dBuV)	CORRECTION FACTOR (dB/m)
1	5150.00	56.8 PK	74.0	-17.2	1.12 H	192	50.60	6.20
2	5150.00	45.3 AV	54.0	-8.7	1.12 H	192	39.10	6.20
3	*5230.00	100.2 PK			1.33 H	187	60.60	39.60
4	*5230.00	90.6 AV			1.33 H	187	51.00	39.60
5	#10460.00	59.0 PK	74.0	-15.0	1.06 H	54	41.20	17.80
6	#10460.00	46.2 AV	54.0	-7.8	1.06 H	54	28.40	17.80

**ANTENNA POLARITY & TEST DISTANCE: VERTICAL AT 3 M**

NO.	FREQ. (MHz)	EMISSION LEVEL (dBuV/m)	LIMIT (dBuV/m)	MARGIN (dB)	ANTENNA HEIGHT (m)	TABLE ANGLE (Degree)	RAW VALUE (dBuV)	CORRECTION FACTOR (dB/m)
1	5150.00	58.4 PK	74.0	-15.6	1.87 V	324	52.20	6.20
2	5150.00	47.4 AV	54.0	-6.6	1.87 V	324	41.20	6.20
3	*5230.00	117.3 PK			1.83 V	322	77.70	39.60
4	*5230.00	108.0 AV			1.83 V	322	68.40	39.60
5	#10460.00	59.2 PK	74.0	-14.8	1.37 V	331	41.40	17.80
6	#10460.00	47.2 AV	54.0	-6.8	1.37 V	331	29.40	17.80

**Remarks:**

1. Emission Level(dBuV/m) = Raw Value(dBuV) + Correction Factor(dB/m)
2. Correction Factor(dB/m) = Antenna Factor(dB/m) + Cable Factor(dB)
3. The other emission levels were very low against the limit.
4. Margin value = Emission Level – Limit value
5. " \* ": Fundamental frequency.
6. " # ": The radiated frequency is out of the restricted band.

CHANNEL	TX Channel 151	DETECTOR FUNCTION	Peak (PK)
FREQUENCY RANGE	1GHz ~ 40GHz		Average (AV)

**ANTENNA POLARITY & TEST DISTANCE: HORIZONTAL AT 3 M**

NO.	FREQ. (MHz)	EMISSION LEVEL (dBuV/m)	LIMIT (dBuV/m)	MARGIN (dB)	ANTENNA HEIGHT (m)	TABLE ANGLE (Degree)	RAW VALUE (dBuV)	CORRECTION FACTOR (dB/m)
1	#5714.00	59.1 PK	74.0	-14.9	1.11 H	159	51.90	7.20
2	#5714.00	47.3 AV	54.0	-6.7	1.11 H	159	40.10	7.20
3	#5722.00	60.8 PK	78.2	-17.4	1.11 H	133	53.60	7.20
4	#5725.00	58.5 PK	78.2	-19.7	1.10 H	133	51.30	7.20
5	*5755.00	95.6 PK			1.09 H	195	55.10	40.50
6	*5755.00	86.8 AV			1.09 H	195	46.30	40.50
7	11510.00	61.1 PK	74.0	-12.9	1.22 H	255	42.90	18.20
8	11510.00	47.9 AV	54.0	-6.1	1.22 H	255	29.70	18.20

**ANTENNA POLARITY & TEST DISTANCE: VERTICAL AT 3 M**

NO.	FREQ. (MHz)	EMISSION LEVEL (dBuV/m)	LIMIT (dBuV/m)	MARGIN (dB)	ANTENNA HEIGHT (m)	TABLE ANGLE (Degree)	RAW VALUE (dBuV)	CORRECTION FACTOR (dB/m)
1	#5714.00	64.9 PK	74.0	-9.1	1.55 V	186	57.70	7.20
2	#5714.00	52.8 AV	54.0	-1.2	1.55 V	183	45.60	7.20
3	#5722.00	72.5 PK	78.2	-5.7	1.41 V	177	65.30	7.20
4	#5725.00	58.1 PK	78.2	-20.1	1.41 V	177	50.90	7.20
5	*5755.00	111.2 PK			1.47 V	173	70.70	40.50
6	*5755.00	101.6 AV			1.47 V	173	61.10	40.50
7	11510.00	61.0 PK	74.0	-13.0	1.40 V	38	42.80	18.20
8	11510.00	48.2 AV	54.0	-5.8	1.40 V	38	30.00	18.20

**Remarks:**

1. Emission Level(dBuV/m) = Raw Value(dBuV) + Correction Factor(dB/m)
2. Correction Factor(dB/m) = Antenna Factor(dB/m) + Cable Factor(dB)
3. The other emission levels were very low against the limit.
4. Margin value = Emission Level – Limit value
5. " \* ": Fundamental frequency.
6. " # ": The radiated frequency is out of the restricted band.



CHANNEL	TX Channel 159	DETECTOR FUNCTION	Peak (PK)
FREQUENCY RANGE	1GHz ~ 40GHz		Average (AV)

**ANTENNA POLARITY & TEST DISTANCE: HORIZONTAL AT 3 M**

NO.	FREQ. (MHz)	EMISSION LEVEL (dBuV/m)	LIMIT (dBuV/m)	MARGIN (dB)	ANTENNA HEIGHT (m)	TABLE ANGLE (Degree)	RAW VALUE (dBuV)	CORRECTION FACTOR (dB/m)
1	*5795.00	97.1 PK			1.18 H	149	56.60	40.50
2	*5795.00	88.1 AV			1.18 H	149	47.60	40.50
3	11590.00	61.0 PK	74.0	-13.0	1.26 H	188	42.70	18.30
4	11590.00	47.9 AV	54.0	-6.1	1.26 H	188	29.60	18.30

**ANTENNA POLARITY & TEST DISTANCE: VERTICAL AT 3 M**

NO.	FREQ. (MHz)	EMISSION LEVEL (dBuV/m)	LIMIT (dBuV/m)	MARGIN (dB)	ANTENNA HEIGHT (m)	TABLE ANGLE (Degree)	RAW VALUE (dBuV)	CORRECTION FACTOR (dB/m)
1	*5795.00	114.3 PK			1.53 V	172	73.80	40.50
2	*5795.00	104.8 AV			1.53 V	172	64.30	40.50
3	11590.00	62.7 PK	74.0	-11.3	1.48 V	41	44.40	18.30
4	11590.00	52.1 AV	54.0	-1.9	1.48 V	41	33.80	18.30

**Remarks:**

1. Emission Level(dBuV/m) = Raw Value(dBuV) + Correction Factor(dB/m)
2. Correction Factor(dB/m) = Antenna Factor(dB/m) + Cable Factor(dB)
3. The other emission levels were very low against the limit.
4. Margin value = Emission Level – Limit value
5. " \* ": Fundamental frequency.
6. " # ": The radiated frequency is out of the restricted band.

**802.11ac (VHT80)**

CHANNEL	TX Channel 42	DETECTOR FUNCTION	Peak (PK)
FREQUENCY RANGE	1GHz ~ 40GHz		Average (AV)

**ANTENNA POLARITY & TEST DISTANCE: HORIZONTAL AT 3 M**

NO.	FREQ. (MHz)	EMISSION LEVEL (dBuV/m)	LIMIT (dBuV/m)	MARGIN (dB)	ANTENNA HEIGHT (m)	TABLE ANGLE (Degree)	RAW VALUE (dBuV)	CORRECTION FACTOR (dB/m)
1	5150.00	56.6 PK	74.0	-17.4	1.21 H	206	50.40	6.20
2	5150.00	44.6 AV	54.0	-9.4	1.21 H	206	38.40	6.20
3	*5210.00	88.3 PK			1.38 H	186	48.70	39.60
4	*5210.00	78.4 AV			1.38 H	186	38.80	39.60
5	#10420.00	58.5 PK	74.0	-15.5	1.06 H	86	41.30	17.20
6	#10420.00	46.6 AV	54.0	-7.4	1.06 H	86	29.40	17.20

**ANTENNA POLARITY & TEST DISTANCE: VERTICAL AT 3 M**

NO.	FREQ. (MHz)	EMISSION LEVEL (dBuV/m)	LIMIT (dBuV/m)	MARGIN (dB)	ANTENNA HEIGHT (m)	TABLE ANGLE (Degree)	RAW VALUE (dBuV)	CORRECTION FACTOR (dB/m)
1	5150.00	68.2 PK	74.0	-5.8	1.96 V	143	62.00	6.20
2	5150.00	52.9 AV	54.0	-1.1	1.96 V	143	46.70	6.20
3	*5210.00	104.2 PK			1.87 V	12	64.60	39.60
4	*5210.00	94.2 AV			1.87 V	12	54.60	39.60
5	#10420.00	58.4 PK	74.0	-15.6	1.46 V	294	41.20	17.20
6	#10420.00	46.6 AV	54.0	-7.4	1.46 V	294	29.40	17.20

**Remarks:**

1. Emission Level(dBuV/m) = Raw Value(dBuV) + Correction Factor(dB/m)
2. Correction Factor(dB/m) = Antenna Factor(dB/m) + Cable Factor(dB)
3. The other emission levels were very low against the limit.
4. Margin value = Emission Level – Limit value
5. " \* ": Fundamental frequency.
6. " # ": The radiated frequency is out of the restricted band.

CHANNEL	TX Channel 155	DETECTOR FUNCTION	Peak (PK)
FREQUENCY RANGE	1GHz ~ 40GHz		Average (AV)

**ANTENNA POLARITY & TEST DISTANCE: HORIZONTAL AT 3 M**

NO.	FREQ. (MHz)	EMISSION LEVEL (dBuV/m)	LIMIT (dBuV/m)	MARGIN (dB)	ANTENNA HEIGHT (m)	TABLE ANGLE (Degree)	RAW VALUE (dBuV)	CORRECTION FACTOR (dB/m)
1	#5714.00	58.0 PK	74.0	-16.0	1.19 H	191	50.80	7.20
2	#5714.00	47.1 AV	54.0	-6.9	1.19 H	191	39.90	7.20
3	#5722.00	60.8 PK	78.2	-17.4	1.23 H	220	53.60	7.20
4	#5725.00	57.1 PK	78.2	-21.1	1.23 H	220	49.90	7.20
5	*5775.00	90.2 PK			1.19 H	191	49.70	40.50
6	*5775.00	80.1 AV			1.19 H	191	39.60	40.50
7	11550.00	60.2 PK	74.0	-13.8	1.11 H	310	42.00	18.20
8	11550.00	47.0 AV	54.0	-7.0	1.11 H	310	28.80	18.20

**ANTENNA POLARITY & TEST DISTANCE: VERTICAL AT 3 M**

NO.	FREQ. (MHz)	EMISSION LEVEL (dBuV/m)	LIMIT (dBuV/m)	MARGIN (dB)	ANTENNA HEIGHT (m)	TABLE ANGLE (Degree)	RAW VALUE (dBuV)	CORRECTION FACTOR (dB/m)
1	#5714.00	65.3 PK	74.0	-8.7	1.56 V	165	58.10	7.20
2	#5714.00	52.7 AV	54.0	-1.3	1.56 V	165	45.50	7.20
3	#5722.00	70.7 PK	78.2	-7.5	1.54 V	310	63.50	7.20
4	#5725.00	58.8 PK	78.2	-19.4	1.54 V	310	51.60	7.20
5	*5775.00	103.3 PK			1.63 V	171	62.80	40.50
6	*5775.00	94.6 AV			1.63 V	171	54.10	40.50
7	11550.00	60.4 PK	74.0	-13.6	1.60 V	21	42.20	18.20
8	11550.00	47.3 AV	54.0	-6.7	1.60 V	21	29.10	18.20

**Remarks:**

1. Emission Level(dBuV/m) = Raw Value(dBuV) + Correction Factor(dB/m)
2. Correction Factor(dB/m) = Antenna Factor(dB/m) + Cable Factor(dB)
3. The other emission levels were very low against the limit.
4. Margin value = Emission Level – Limit value
5. " \* ": Fundamental frequency.
6. " # ": The radiated frequency is out of the restricted band.

Below 1GHz Worst-Case Data: 802.11a

CHANNEL	TX Channel 36	DETECTOR FUNCTION	Quasi-Peak (QP)
FREQUENCY RANGE	30MHz ~ 1GHz		

ANTENNA POLARITY & TEST DISTANCE: HORIZONTAL AT 3 M								
NO.	FREQ. (MHz)	EMISSION LEVEL (dBuV/m)	LIMIT (dBuV/m)	MARGIN (dB)	ANTENNA HEIGHT (m)	TABLE ANGLE (Degree)	RAW VALUE (dBuV)	CORRECTION FACTOR (dB/m)
1	57.12	32.5 QP	40.0	-7.5	2.00 H	255	47.30	-14.80
2	136.84	34.9 QP	43.5	-8.6	2.00 H	208	49.90	-15.00
3	167.94	37.1 QP	43.5	-6.4	1.50 H	209	51.40	-14.30
4	214.61	35.0 QP	43.5	-8.5	1.00 H	206	51.70	-16.70
5	374.04	36.1 QP	46.0	-9.9	1.00 H	106	47.10	-11.00
6	500.42	37.1 QP	46.0	-8.9	1.50 H	213	45.40	-8.30
ANTENNA POLARITY & TEST DISTANCE: VERTICAL AT 3 M								
NO.	FREQ. (MHz)	EMISSION LEVEL (dBuV/m)	LIMIT (dBuV/m)	MARGIN (dB)	ANTENNA HEIGHT (m)	TABLE ANGLE (Degree)	RAW VALUE (dBuV)	CORRECTION FACTOR (dB/m)
1	30.00	37.3 QP	40.0	-2.7	1.00 V	315	53.40	-16.10
2	55.18	38.6 QP	40.0	-1.4	1.00 V	5	53.20	-14.60
3	142.67	33.2 QP	43.5	-10.3	1.00 V	279	47.60	-14.40
4	164.06	34.2 QP	43.5	-9.3	1.00 V	45	48.20	-14.00
5	374.04	35.6 QP	46.0	-10.4	1.00 V	169	46.60	-11.00
6	500.42	37.0 QP	46.0	-9.0	1.00 V	319	45.30	-8.30

Remarks:

1. Emission Level(dBuV/m) = Raw Value(dBuV) + Correction Factor(dB/m)
2. Correction Factor(dB/m) = Antenna Factor(dB/m) + Cable Factor(dB)
3. The other emission levels were very low against the limit.
4. Margin value = Emission Level – Limit value

## 4.2 Conducted Emission Measurement

### 4.2.1 Limits of Conducted Emission Measurement

Frequency (MHz)	Conducted Limit (dBuV)	
	Quasi-peak	Average
0.15 - 0.5	66 - 56	56 - 46
0.50 - 5.0	56	46
5.0 - 30.0	60	50

- Note:** 1. The lower limit shall apply at the transition frequencies.  
 2. The limit decreases in line with the logarithm of the frequency in the range of 0.15 to 0.50MHz.

### 4.2.2 Test Instruments

Description & Manufacturer	Model No.	Serial No.	Cal. Date	Cal. Due
Test Receiver ROHDE & SCHWARZ	ESCS 30	100288	Apr. 27, 2015	Apr. 26, 2016
RF signal cable (with 10dB PAD) Woken	5D-FB	Cable-cond2-01	Dec. 26, 2014	Dec. 25, 2015
LISN ROHDE & SCHWARZ (EUT)	ESH2-Z5	100100	Dec. 30, 2014	Dec. 29, 2015
LISN ROHDE & SCHWARZ (Peripheral)	ESH3-Z5	100312	Jul. 21, 2015	Jul. 20, 2016
Software ADT	BV ADT_Cond_ V7.3.7.3	NA	NA	NA

- Note:** 1. The calibration interval of the above test instruments is 12 months and the calibrations are traceable to NML/ROC and NIST/USA.  
 2. The test was performed in HwaYa Shielded Room 2.  
 3. The VCCI Site Registration No. is C-2047.

### 4.2.3 Test Procedures

- The EUT was placed 0.4 meters from the conducting wall of the shielded room with EUT being connected to the power mains through a line impedance stabilization network (LISN). Other support units were connected to the power mains through another LISN. The two LISNs provide 50 ohm/ 50uH of coupling impedance for the measuring instrument.
- Both lines of the power mains connected to the EUT were checked for maximum conducted interference.
- The frequency range from 150kHz to 30MHz was searched. Emission levels under (Limit - 20dB) was not recorded.

**NOTE:** The resolution bandwidth and video bandwidth of test receiver is 9kHz for quasi-peak detection (QP) and average detection (AV) at frequency 0.15MHz-30MHz.

### 4.2.4 Deviation from Test Standard

No deviation.

### 4.2.5 Test Setup

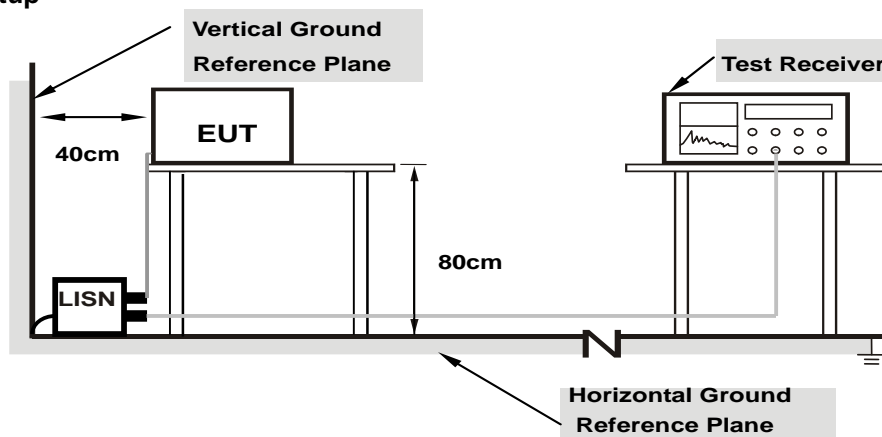

**Note:** 1.Support units were connected to second LISN.

For the actual test configuration, please refer to the attached file (Test Setup Photo).

### 4.2.6 EUT Operating Conditions

Same as 4.1.6.

### 4.2.7 Test Results

Phase	Line (L)	Detector Function	Quasi-Peak (QP) / Average (AV)
-------	----------	-------------------	--------------------------------

No	Freq. [MHz]	Corr. Factor (dB)	Reading Value [dB (uV)]		Emission Level [dB (uV)]		Limit [dB (uV)]		Margin (dB)	
			Q.P.	AV.	Q.P.	AV.	Q.P.	AV.	Q.P.	AV.
			<b>1</b>	<b>0.48669</b>	<b>9.97</b>	<b>34.77</b>	<b>25.26</b>	<b>44.74</b>	<b>35.23</b>	<b>56.22</b>
2	0.81406	10.03	31.16	21.62	41.19	31.65	56.00	46.00	-14.81	-14.35
3	1.04688	10.07	31.21	22.68	41.28	32.75	56.00	46.00	-14.72	-13.25
4	1.44531	10.11	30.52	22.48	40.63	32.59	56.00	46.00	-15.37	-13.41
5	1.85547	10.14	29.90	22.58	40.04	32.72	56.00	46.00	-15.96	-13.28
6	2.76953	10.20	27.69	21.19	37.89	31.39	56.00	46.00	-18.11	-14.61

Remarks:

1. Q.P. and AV. are abbreviations of quasi-peak and average individually.
2. The emission levels of other frequencies were very low against the limit.
3. Margin value = Emission level - Limit value
4. Correction factor = Insertion loss + Cable loss
5. Emission Level = Correction Factor + Reading Value.

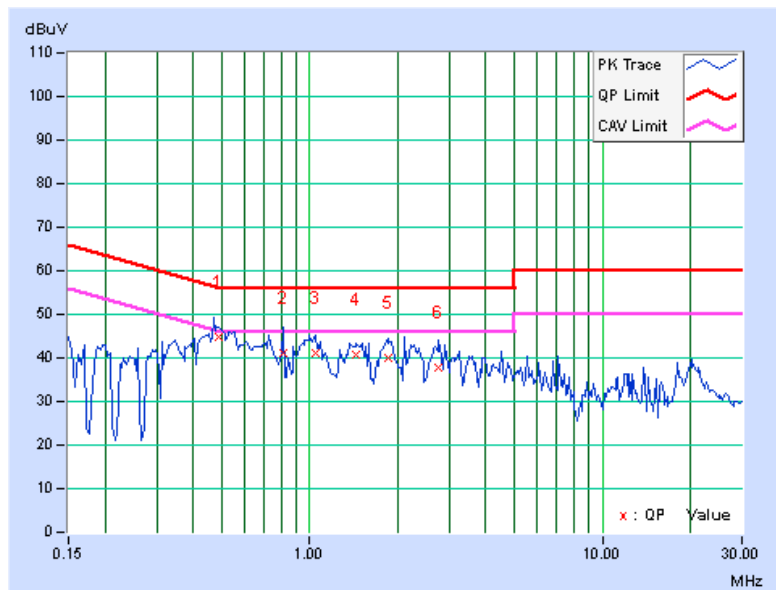

Phase	Neutral (N)	Detector Function	Quasi-Peak (QP) / Average (AV)
-------	-------------	-------------------	--------------------------------

No	Freq. [MHz]	Corr. Factor (dB)	Reading Value [dB (uV)]		Emission Level [dB (uV)]		Limit [dB (uV)]		Margin (dB)	
			Q.P.	AV.	Q.P.	AV.	Q.P.	AV.	Q.P.	AV.
			1	0.48203	10.01	31.92	21.72	41.93	31.73	56.30
2	0.81797	10.05	25.33	12.49	35.38	22.54	56.00	46.00	-20.62	-23.46
3	1.22656	10.10	26.09	16.35	36.19	26.45	56.00	46.00	-19.81	-19.55
4	2.14063	10.20	27.53	17.21	37.73	27.41	56.00	46.00	-18.27	-18.59
5	4.69922	10.32	20.31	13.83	30.63	24.15	56.00	46.00	-25.37	-21.85
6	20.78125	10.83	21.02	13.55	31.85	24.38	60.00	50.00	-28.15	-25.62

Remarks:

1. Q.P. and AV. are abbreviations of quasi-peak and average individually.
2. The emission levels of other frequencies were very low against the limit.
3. Margin value = Emission level - Limit value
4. Correction factor = Insertion loss + Cable loss
5. Emission Level = Correction Factor + Reading Value.

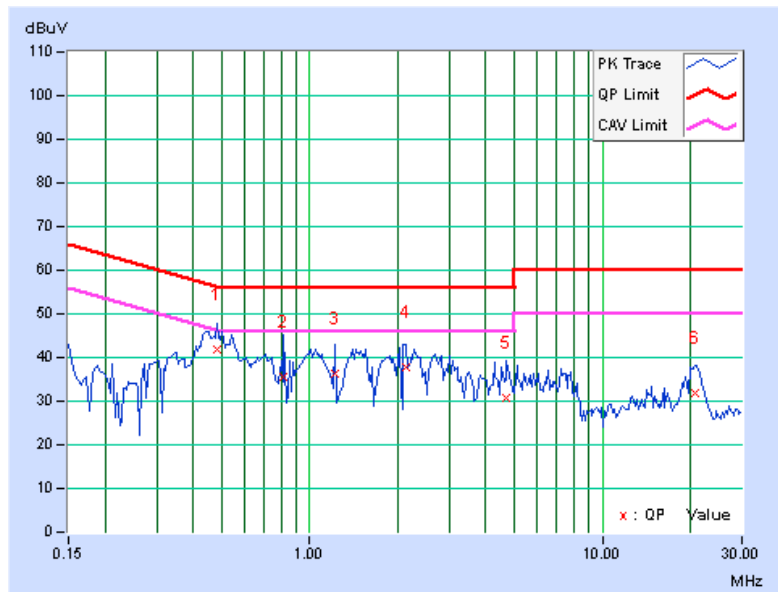



### 4.3 Transmit Power Measurement

#### 4.3.1 Limits of Transmit Power Measurement

Operation Band	EUT Category		LIMIT
U-NII-1	√	Outdoor Access Point	1 Watt (30 dBm) (Max. e.i.r.p ≤ 125mW(21 dBm) at any elevation angle above 30 degrees as measured from the horizon)
		Fixed point-to-point Access Point	1 Watt (30 dBm)
		Indoor Access Point	1 Watt (30 dBm)
		Mobile and Portable client device	250mW (24 dBm)
U-NII-2A	---		250mW (24 dBm) or 11 dBm+10 log B*
U-NII-2C	---		250mW (24 dBm) or 11 dBm+10 log B*
U-NII-3	√		1 Watt (30 dBm)

\*B is the 26 dB emission bandwidth in megahertz

Per KDB 662911 Method of conducted output power measurement on IEEE 802.11 devices,

Array Gain = 0 dB (i.e., no array gain) for  $N_{ANT} \leq 4$ ;

Array Gain = 0 dB (i.e., no array gain) for channel widths  $\geq 40$  MHz for any  $N_{ANT}$ ;

Array Gain =  $5 \log(N_{ANT}/N_{SS})$  dB or 3 dB, whichever is less for 20-MHz channel widths with  $N_{ANT} \geq 5$ .

For power measurements on all other devices: Array Gain =  $10 \log(N_{ANT}/N_{SS})$  dB.

#### 4.3.2 Test Setup

For 802.11a, 802.11n (HT20), 802.11n (HT40), 802.11ac (VHT20), 802.11ac (VHT40)

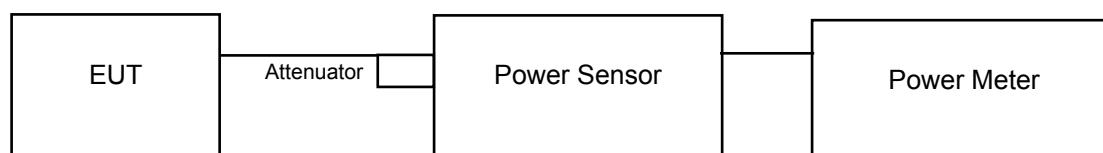

For 802.11ac (VHT80)

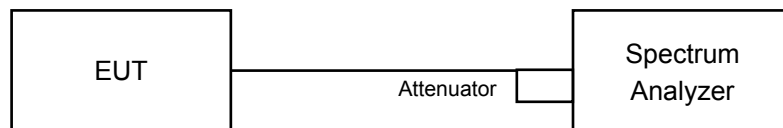

#### 4.3.3 Test Instruments

Refer to section 4.1.2 to get information of above instrument.

#### 4.3.4 Test Procedure

##### For Average Power Measurement

##### For 802.11a, 802.11n (HT20), 802.11n (HT40), 802.11ac (VHT20), 802.11ac (VHT40)

Method PM is used to perform output power measurement, trigger and gating function of wide band power meter is enabled to measure max output power of TX on burst. Duty factor is not added to measured value.

##### For 802.11ac (VHT80)

- a. Set span to encompass the entire 26 dB EBW (or, alternatively, the entire 99% occupied bandwidth) of the signal.
- b. Set sweep trigger to “free run”.
- c. Set RBW = 1 MHz.
- d. Set VBW  $\geq$  3 MHz
- e. Number of points in sweep  $\geq$  2 Span / RBW.
- f. Sweep time  $\leq$  (number of points in sweep) \* T
- g. Using emission bandwidth to determine the frequency span for integration the channel bandwidth.
- h. Detector = RMS.
- i. Trace mode = max hold.
- j. Allow max hold to run for at least 60 seconds, or longer as needed to allow the trace to stabilize.

#### 4.3.5 Deviation from Test Standard

No deviation.

#### 4.3.6 EUT Operating Conditions

The software provided by client to enable the EUT under transmission condition continuously at lowest, middle and highest channel frequencies individually.

### 4.3.7 Test Result

#### Power Output:

#### 802.11a

Chan.	Chan. Freq. (MHz)	Maximum Conducted Power (dBm)			Total Power (mW)	Total Power (dBm)	Power Limit (dBm)	Pass / Fail
		Chain 0	Chain 1	Chain 2				
36	5180	18.87	18.36	17.11	197.043	22.95	30.00	Pass
40	5200	19.03	18.32	17.38	202.605	23.07	30.00	Pass
48	5240	18.23	18.08	17.29	184.376	22.66	30.00	Pass
149	5745	18.12	16.14	15.81	144.085	21.59	29.97	Pass
157	5785	18.01	17.09	17.73	<b>173.702</b>	22.40	29.97	Pass
165	5825	18.09	17.33	17.12	170.015	22.30	29.97	Pass

Note: for U-NII-3 Band: Antenna gain = 6.03dBi > 6dBi, so the conducted power limit shall be reduced to  $30-(6.03-6) = 29.97$ dBm.

#### 802.11n (HT20)

Chan.	Chan. Freq. (MHz)	Maximum Conducted Power (dBm)			Total Power (mW)	Total Power (dBm)	Power Limit (dBm)	Pass / Fail
		Chain 0	Chain 1	Chain 2				
36	5180	18.80	18.12	17.18	192.961	22.85	30.00	Pass
40	5200	19.08	18.24	17.28	201.047	23.03	30.00	Pass
48	5240	19.44	18.05	17.31	<b>205.555</b>	23.13	30.00	Pass
149	5745	18.08	15.95	15.88	142.350	21.53	29.97	Pass
157	5785	17.91	16.77	17.85	170.290	22.31	29.97	Pass
165	5825	18.09	17.41	17.02	169.848	22.30	29.97	Pass

Note: for U-NII-3 Band: Antenna gain = 6.03dBi > 6dBi, so the conducted power limit shall be reduced to  $30-(6.03-6) = 29.97$ dBm.

#### 802.11n (HT40)

Chan.	Chan. Freq. (MHz)	Maximum Conducted Power (dBm)			Total Power (mW)	Total Power (dBm)	Power Limit (dBm)	Pass / Fail
		Chain 0	Chain 1	Chain 2				
38	5190	14.37	13.77	12.74	69.969	18.45	30.00	Pass
46	5230	19.06	17.95	17.42	198.119	22.97	30.00	Pass
151	5755	13.92	12.27	12.25	58.314	17.66	29.97	Pass
159	5795	17.31	16.51	16.61	144.412	21.60	29.97	Pass

Note: for U-NII-3 Band: Antenna gain = 6.03dBi > 6dBi, so the conducted power limit shall be reduced to  $30-(6.03-6) = 29.97$ dBm.

## 802.11ac (VHT80)

Chan.	Chan. Freq. (MHz)	Maximum Conducted Power (dBm)			Total Power (mW)	Total Power (dBm)	Power Limit (dBm)	Pass / Fail
		Chain 0	Chain 1	Chain 2				
42	5210	10.26	9.44	8.65	26.735	14.27	30.00	Pass
155	5775	9.00	8.19	7.75	20.492	13.12	29.97	Pass

Note: for U-NII-3 Band: Antenna gain = 6.03dBi > 6dBi, so the conducted power limit shall be reduced to  $30 - (6.03 - 6) = 29.97$ dBm.

For U-NII-1 Band (Outdoor Access Point)

EIRP Power:

802.11a

Chan.	Chan. Freq. (MHz)	Conducted Power (dBm)	Ant. Gain (dBi)	EIRP (dBm)	Power Limit (dBm)	Pass / Fail
36	5180	22.95	-2.33	20.62	21	Pass
40	5200	23.07	-2.33	20.74	21	Pass
48	5240	22.66	-2.33	20.33	21	Pass

802.11n (HT20)

Chan.	Chan. Freq. (MHz)	Conducted Power (dBm)	Ant. Gain (dBi)	EIRP (dBm)	Power Limit (dBm)	Pass / Fail
36	5180	22.85	-2.33	20.52	21	Pass
40	5200	23.03	-2.33	20.70	21	Pass
48	5240	23.13	-2.33	20.80	21	Pass

802.11n (HT40)

Chan.	Chan. Freq. (MHz)	Conducted Power (dBm)	Ant. Gain (dBi)	EIRP (dBm)	Power Limit (dBm)	Pass / Fail
38	5190	18.45	-2.33	16.12	21	Pass
46	5230	22.97	-2.33	20.64	21	Pass

802.11ac (VHT80)

Chan.	Chan. Freq. (MHz)	Conducted Power (dBm)	Ant. Gain (dBi)	EIRP (dBm)	Power Limit (dBm)	Pass / Fail
42	5210	14.27	-2.33	11.94	21	Pass

## 26dB Bandwidth:

## 802.11a

Channel	Channel Frequency (MHz)	26dBc Bandwidth (MHz)			Pass / Fail
		Chain 0	Chain 1	Chain 2	
36	5180	22.48	21.82	21.61	Pass
40	5200	22.33	21.98	21.43	Pass
48	5240	21.96	21.96	22.04	Pass

## 802.11n (HT20)

Channel	Channel Frequency (MHz)	26dBc Bandwidth (MHz)			Pass / Fail
		Chain 0	Chain 1	Chain 2	
36	5180	23.21	22.93	22.46	Pass
40	5200	23.35	23.51	22.32	Pass
48	5240	22.83	22.55	22.75	Pass

## 802.11n (HT40)

Channel	Channel Frequency (MHz)	26dBc Bandwidth (MHz)			Pass / Fail
		Chain 0	Chain 1	Chain 2	
38	5190	45.48	44.82	44.43	Pass
46	5230	45.39	46.37	45.56	Pass

## 802.11ac (VHT80)

Channel	Channel Frequency (MHz)	26dBc Bandwidth (MHz)			Pass / Fail
		Chain 0	Chain 1	Chain 2	
42	5210	91.61	87.35	87.51	Pass

Spectrum Plot of Worst Value

802.11a

802.11n (HT20)

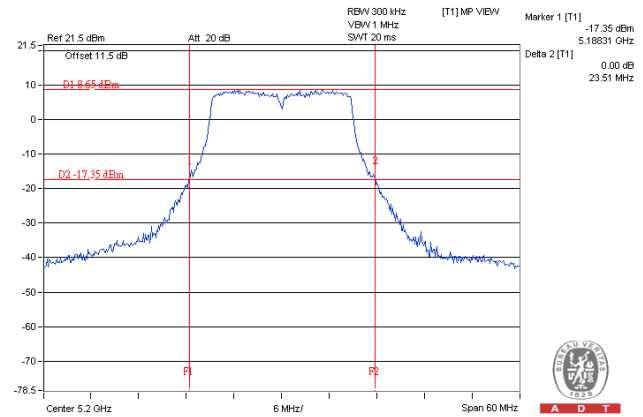
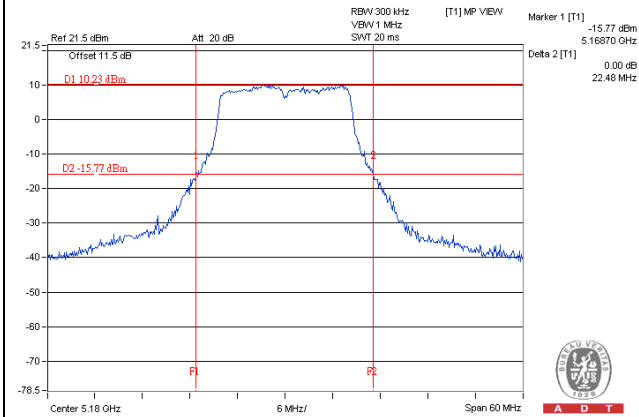

802.11n (HT40)

802.11ac (VHT80)

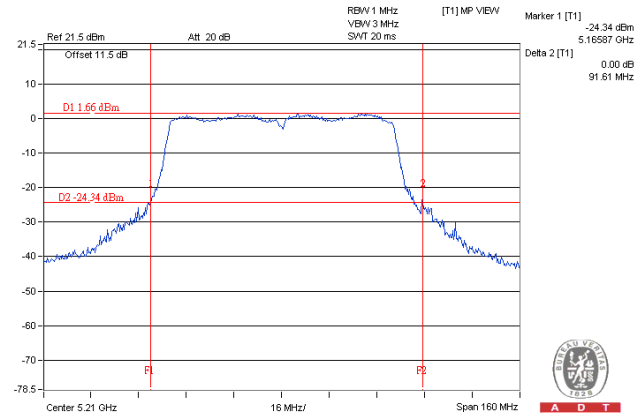
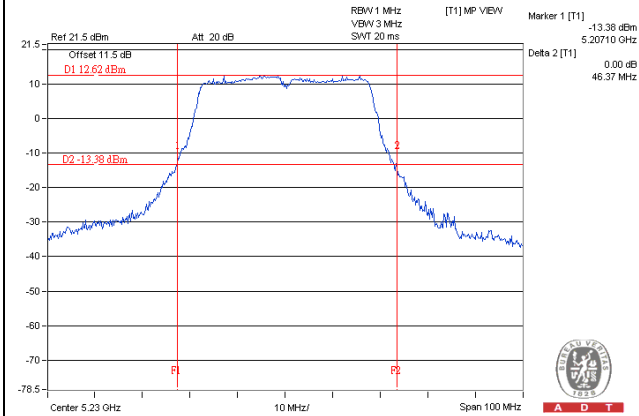

**Occupied Bandwidth:**
**802.11a**

Channel	Channel Frequency (MHz)	Occupied Bandwidth (MHz)		
		Chain 0	Chain 1	Chain 2
36	5180	16.80	16.68	16.68
40	5200	16.80	16.80	16.68
48	5240	16.80	16.68	16.56
149	5745	16.78	16.87	16.61
157	5785	16.92	16.68	16.68
165	5825	16.80	16.80	16.68

**802.11n (HT20)**

Channel	Channel Frequency (MHz)	Occupied Bandwidth (MHz)		
		Chain 0	Chain 1	Chain 2
36	5180	18.00	17.88	17.88
40	5200	18.12	18.12	17.88
48	5240	18.00	17.88	17.88
149	5745	17.88	17.88	17.88
157	5785	18.00	17.88	17.76
165	5825	17.88	17.88	17.88

**802.11n (HT40)**

Channel	Channel Frequency (MHz)	Occupied Bandwidth (MHz)		
		Chain 0	Chain 1	Chain 2
38	5190	36.96	36.72	36.84
46	5230	36.72	37.08	36.84
151	5755	36.96	37.08	36.72
159	5795	36.96	36.84	36.72

**802.11ac (VHT80)**

Channel	Channel Frequency (MHz)	Occupied Bandwidth (MHz)		
		Chain 0	Chain 1	Chain 2
42	5210	75.88	76.16	76.16
155	5775	76.16	75.88	75.88



**Spectrum Plot of Worst Value**

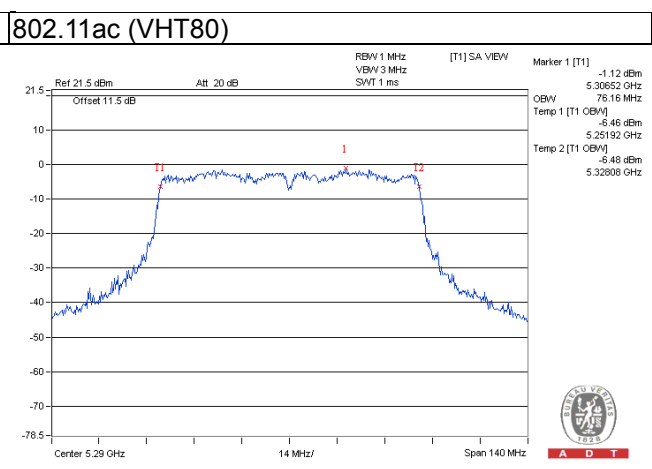
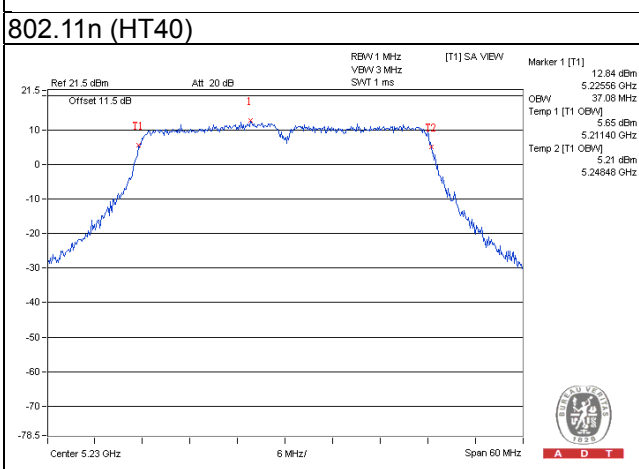
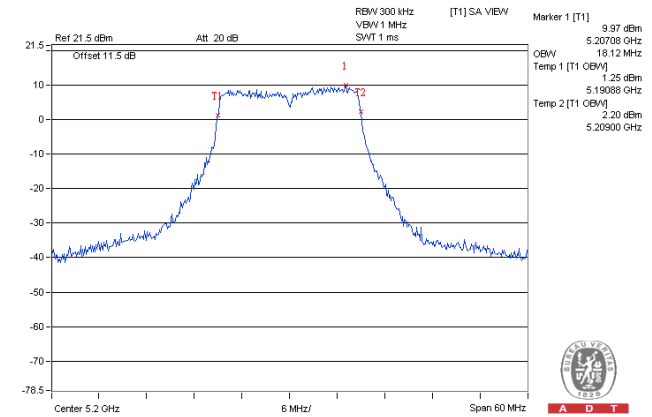
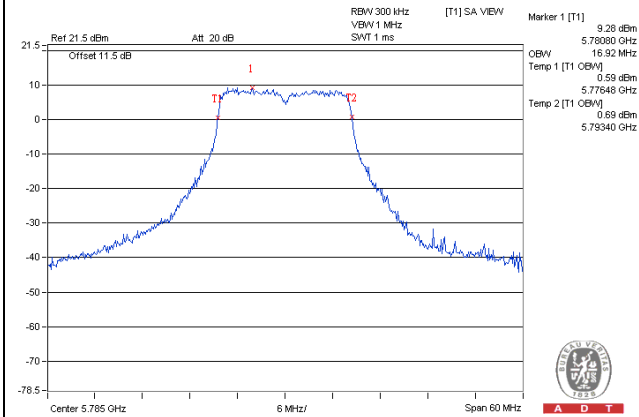

## 4.4 Peak Power Spectral Density Measurement

### 4.4.1 Limits of Peak Power Spectral Density Measurement

Operation Band	EUT Category		LIMIT
U-NII-1	√	Outdoor Access Point	17dBm/ MHz
		Fixed point-to-point Access Point	
		Indoor Access Point	11dBm/ MHz
		Mobile and Portable client device	
U-NII-2A	---		11dBm/ MHz
U-NII-2C	---		11dBm/ MHz
U-NII-3	√		30dBm/ 500kHz

### 4.4.2 Test Setup



### 4.4.3 Test Instruments

Refer to section 4.1.2 to get information of above instrument.

### 4.4.4 Test Procedures

#### For U-NII-1 band:

Using method SA-2

- Set span to encompass the entire emission bandwidth (EBW) of the signal.
- Set RBW = 1 MHz, Set VBW ≥ 3 MHz, Detector = RMS
- Sweep time = auto, trigger set to “free run”.
- Trace average at least 100 traces in power averaging mode.
- Record the max value and add 10 log (1/duty cycle)

#### For U-NII-3 band:

- Set span to encompass the entire emission bandwidth (EBW) of the signal.
- Set RBW = 300 kHz, Set VBW ≥ 1 MHz, Detector = RMS
- Use the peak marker function to determine the maximum power level in any 300 kHz band segment within the fundamental EBW.
- Scale the observed power level to an equivalent value in 500 kHz by adjusting (reducing) the measured power by a bandwidth correction factor (BWCF) where  $BWCF = 10\log(500\text{ kHz}/300\text{kHz})$
- Sweep time = auto, trigger set to “free run”.
- Trace average at least 100 traces in power averaging mode.
- Record the max value and add 10 log (1/duty cycle)

#### 4.4.5 Deviation from Test Standard

No deviation.

#### 4.4.6 EUT Operating Conditions

Same as Item 4.3.6.

#### 4.4.7 Test Results

For U-NII-1 Band

802.11a

Chan.	Freq. (MHz)	PSD (dBm)			Total PSD w/o duty factor (dBm)	Duty factor	Total PSD with duty factor (dBm)	Max. Limit (dBm)	Pass / Fail
		Chain 0	Chain 1	Chain 2					
36	5180	5.71	4.55	3.51	9.46	0.21	9.67	17.00	Pass
40	5200	5.88	4.78	3.87	9.70	0.21	9.91	17.00	Pass
48	5240	5.71	4.38	4.54	9.69	0.21	9.90	17.00	Pass

Note:

1. Method 1 of power density measurement of KDB 662911 is using for calculating total power density. Total power density is summing entire spectra across corresponding frequency bins on the various outputs by computer.
2. Directional gain =  $-2.33\text{dBi} + 10\log(3) = 2.44\text{dBi} < 6\text{dBi}$  , so the power density limit no need to reduced.
3. Refer to section 3.3 for duty cycle spectrum plot.

802.11n (HT20)

Chan.	Freq. (MHz)	PSD (dBm)			Total PSD w/o duty factor (dBm)	Duty factor	Total PSD with duty factor (dBm)	Max. Limit (dBm)	Pass / Fail
		Chain 0	Chain 1	Chain 2					
36	5180	5.71	3.86	3.07	9.13	0.20	9.33	17.00	Pass
40	5200	5.80	4.10	3.85	9.44	0.20	9.64	17.00	Pass
48	5240	6.11	3.34	3.77	9.36	0.20	9.56	17.00	Pass

Note:

1. Method 1 of power density measurement of KDB 662911 is using for calculating total power density. Total power density is summing entire spectra across corresponding frequency bins on the various outputs by computer.
2. Directional gain =  $-2.33\text{dBi} + 10\log(3) = 2.44\text{dBi} < 6\text{dBi}$  , so the power density limit no need to reduced.
3. Refer to section 3.3 for duty cycle spectrum plot.

802.11n (HT40)

Chan.	Freq. (MHz)	PSD (dBm)			Total PSD w/o duty factor (dBm)	Duty factor	Total PSD with duty factor (dBm)	Max. Limit (dBm)	Pass / Fail
		Chain 0	Chain 1	Chain 2					
38	5190	-2.08	-3.40	-4.31	1.60	0.39	1.99	17.00	Pass
46	5230	3.30	0.74	1.49	6.75	0.39	7.14	17.00	Pass

Note:

1. Method 1 of power density measurement of KDB 662911 is using for calculating total power density. Total power density is summing entire spectra across corresponding frequency bins on the various outputs by computer.
2. Directional gain =  $-2.33\text{dBi} + 10\log(3) = 2.44\text{dBi} < 6\text{dBi}$  , so the power density limit no need to reduced.
3. Refer to section 3.3 for duty cycle spectrum plot.

802.11ac (VHT80)

Chan.	Freq. (MHz)	PSD (dBm)			Total PSD w/o duty factor (dBm)	Duty factor	Total PSD with duty factor (dBm)	Max. Limit (dBm)	Pass / Fail
		Chain 0	Chain 1	Chain 2					
42	5210	-8.81	-10.35	-11.26	-5.24	0.10	-5.14	17.00	Pass

Note:

1. Method 1 of power density measurement of KDB 662911 is using for calculating total power density. Total power density is summing entire spectra across corresponding frequency bins on the various outputs by computer.
2. Directional gain =  $-2.33\text{dBi} + 10\log(3) = 2.44\text{dBi} < 6\text{dBi}$ , so the power density limit no need to reduced.
3. Refer to section 3.3 for duty cycle spectrum plot.

**Spectrum Plot of Worst Value**

802.11a / Chain 0 / CH 40

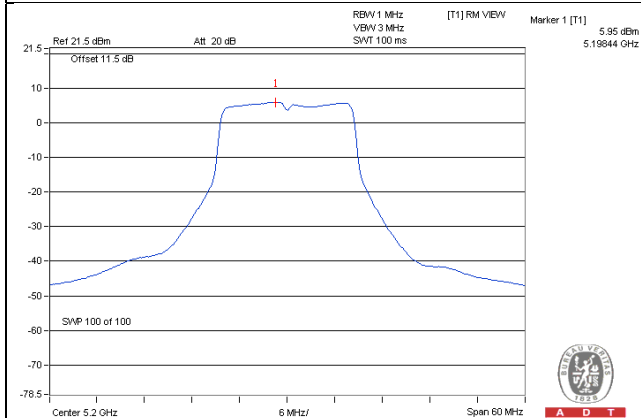

802.11n (HT20) / Chain 0 / CH 48

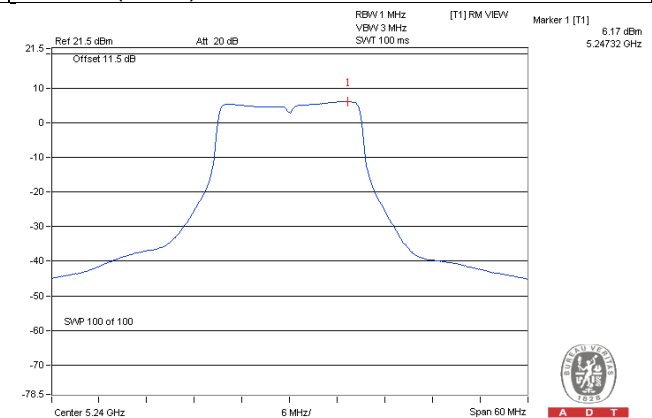

802.11n (HT40) / Chain 0 / CH 46

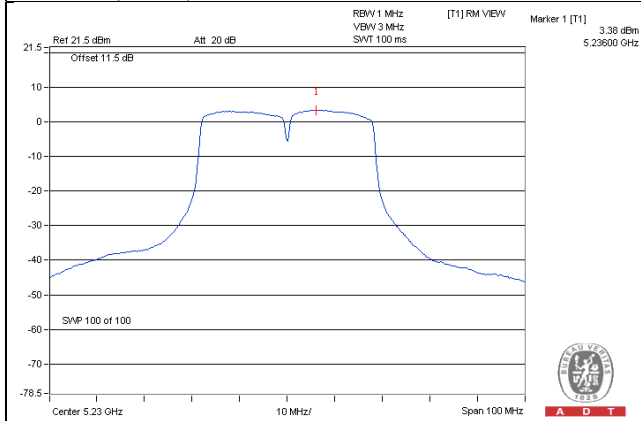

802.11ac (VHT80) / Chain 0 / CH 42

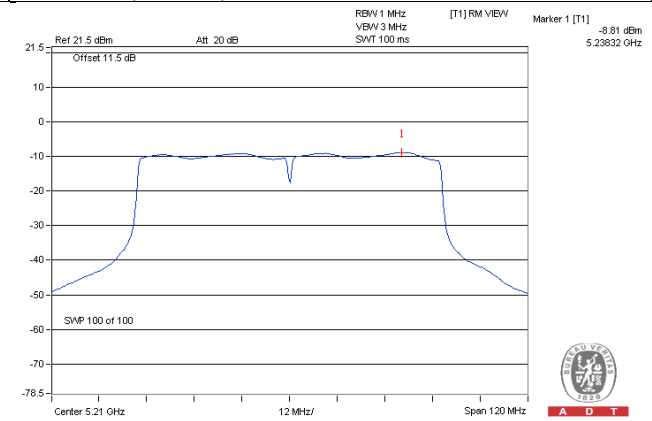

**For U-NII-3 Band**
**802.11a**

TX chain	Channel	Freq. (MHz)	PSD (dBm/300 kHz)	PSD (dBm/500 kHz)	10 log (N=3) dB	Duty factor	Total PSD (dBm/500 kHz)	Limit (dBm/500 kHz)	Pass / Fail
0	149	5745	-3.57	-1.35	4.77	0.21	3.63	25.20	Pass
	157	5785	-3.42	-1.20	4.77	0.21	3.78	25.20	Pass
	165	5825	-3.02	-0.80	4.77	0.21	4.18	25.20	Pass
1	149	5745	-5.67	-3.45	4.77	0.21	1.53	25.20	Pass
	157	5785	-4.42	-2.20	4.77	0.21	2.78	25.20	Pass
	165	5825	-3.22	-1.00	4.77	0.21	3.98	25.20	Pass
2	149	5745	-5.48	-3.26	4.77	0.21	1.72	25.20	Pass
	157	5785	-4.87	-2.65	4.77	0.21	2.33	25.20	Pass
	165	5825	-4.10	-1.88	4.77	0.21	3.10	25.20	Pass

**Note:**

- Method 1 of power density measurement of KDB 662911 is using for calculating total power density. Total power density is summing entire spectra across corresponding frequency bins on the various outputs by computer.
- Directional gain = 6.03dBi + 10log(3) = 10.80dBi > 6dBi , so the power density limit shall be reduced to 30-(10.80-6) = 25.20dBm.
- Refer to section 3.3 for duty cycle spectrum plot.

**802.11n (HT20)**

TX chain	Channel	Freq. (MHz)	PSD (dBm/300 kHz)	PSD (dBm/500 kHz)	10 log (N=3) dB	Duty factor	Total PSD (dBm/500 kHz)	Limit (dBm/500 kHz)	Pass / Fail
0	149	5745	-3.49	-1.27	4.77	0.20	3.70	25.20	Pass
	157	5785	-4.58	-2.36	4.77	0.20	2.61	25.20	Pass
	165	5825	-3.45	-1.23	4.77	0.20	3.74	25.20	Pass
1	149	5745	-5.84	-3.62	4.77	0.20	1.35	25.20	Pass
	157	5785	-5.09	-2.87	4.77	0.20	2.10	25.20	Pass
	165	5825	-3.95	-1.73	4.77	0.20	3.24	25.20	Pass
2	149	5745	-6.02	-3.80	4.77	0.20	1.17	25.20	Pass
	157	5785	-3.80	-1.58	4.77	0.20	3.39	25.20	Pass
	165	5825	-4.55	-2.33	4.77	0.20	2.64	25.20	Pass

**Note:**

- Method 1 of power density measurement of KDB 662911 is using for calculating total power density. Total power density is summing entire spectra across corresponding frequency bins on the various outputs by computer.
- Directional gain = 6.03dBi + 10log(3) = 10.80dBi > 6dBi , so the power density limit shall be reduced to 30-(10.80-6) = 25.20dBm.
- Refer to section 3.3 for duty cycle spectrum plot.

**802.11n (HT40)**

TX chain	Channel	Freq. (MHz)	PSD (dBm/300 kHz)	PSD (dBm/500 kHz)	10 log (N=3) dB	Duty factor	Total PSD (dBm/500 kHz)	Limit (dBm/500 kHz)	Pass / Fail
0	151	5755	-11.09	-8.87	4.77	0.39	-3.71	25.20	Pass
	159	5795	-7.38	-5.16	4.77	0.39	0.00	25.20	Pass
1	151	5755	-12.57	-10.35	4.77	0.39	-5.19	25.20	Pass
	159	5795	-12.20	-9.98	4.77	0.39	-4.82	25.20	Pass
2	151	5755	-12.91	-10.69	4.77	0.39	-5.53	25.20	Pass
	159	5795	-8.26	-6.04	4.77	0.39	-0.88	25.20	Pass

Note:

- Method 1 of power density measurement of KDB 662911 is using for calculating total power density. Total power density is summing entire spectra across corresponding frequency bins on the various outputs by computer.
- Directional gain =  $6.03\text{dBi} + 10\log(3) = 10.80\text{dBi} > 6\text{dBi}$  , so the power density limit shall be reduced to  $30-(10.80-6) = 25.20\text{dBm}$ .
- Refer to section 3.3 for duty cycle spectrum plot.

**802.11ac (VHT80)**

TX chain	Channel	Freq. (MHz)	PSD (dBm/300 kHz)	PSD (dBm/500 kHz)	10 log (N=3) dB	Duty factor	Total PSD (dBm/500 kHz)	Limit (dBm/500 kHz)	Pass / Fail
0	155	5775	-18.71	-16.49	4.77	0.10	-11.62	25.20	Pass
1	155	5775	-19.51	-17.29	4.77	0.10	-12.42	25.20	Pass
2	155	5775	-19.88	-17.66	4.77	0.10	-12.79	25.20	Pass

Note:

- Method 1 of power density measurement of KDB 662911 is using for calculating total power density. Total power density is summing entire spectra across corresponding frequency bins on the various outputs by computer.
- Directional gain =  $6.03\text{dBi} + 10\log(3) = 10.80\text{dBi} > 6\text{dBi}$  , so the power density limit shall be reduced to  $30-(10.80-6) = 25.20\text{dBm}$ .
- Refer to section 3.3 for duty cycle spectrum plot.

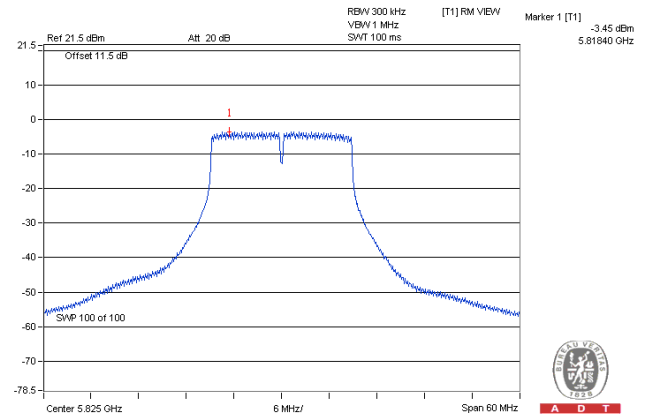
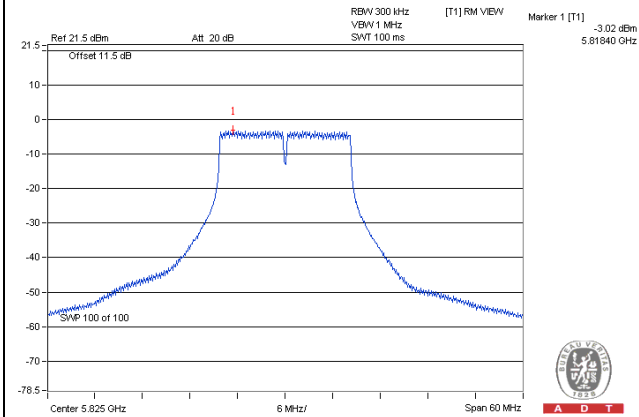
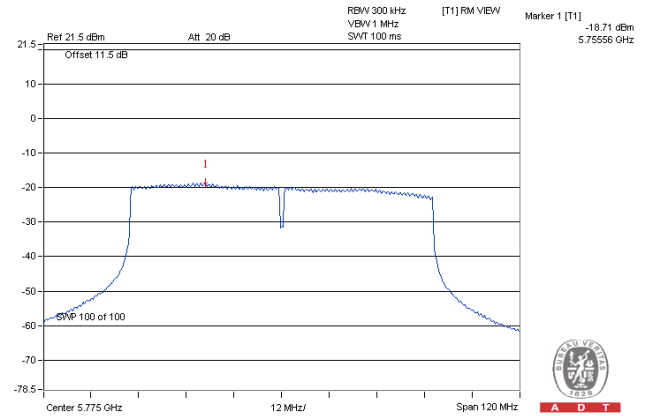
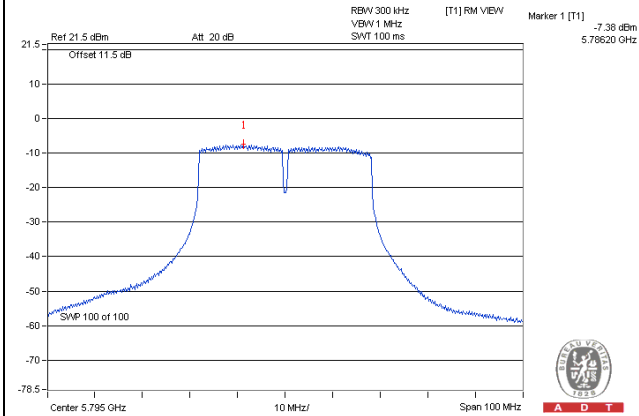
**Spectrum Plot of Worst Value****802.11a****802.11n (HT20)****802.11n (HT40)****802.11ac (VHT80)**



## 4.5 Frequency Stability

### 4.5.1 Limits of Frequency Stability Measurement

The frequency of the carrier signal shall be maintained within band of operation

### 4.5.2 Test Setup

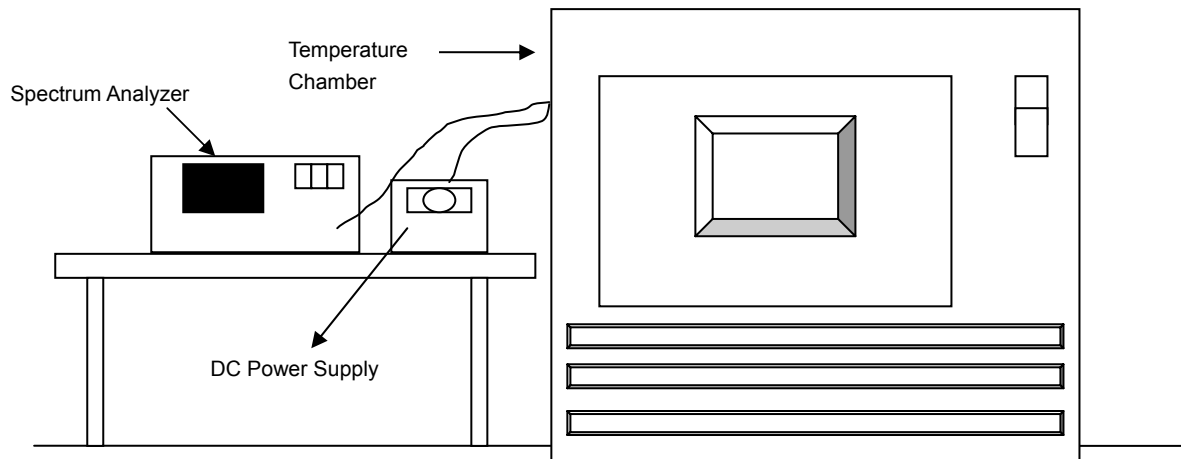

### 4.5.3 Test Instruments

Refer to section 4.1.2 to get information of above instrument.

### 4.5.4 Test Procedure

- a. The EUT was placed inside the environmental test chamber and powered by nominal DC voltage.
- b. Turn the EUT on and couple its output to a spectrum analyzer.
- c. Turn the EUT off and set the chamber to the highest temperature specified.
- d. Allow sufficient time (approximately 30 min) for the temperature of the chamber to stabilize, turn the EUT on and measure the operating frequency after 2, 5, and 10 minutes.
- e. Repeat step 2 and 3 with the temperature chamber set to the lowest temperature.
- f. The test chamber was allowed to stabilize at +20 degree C for a minimum of 30 minutes. The supply voltage was then adjusted on the EUT from 85% to 115% and the frequency record.

### 4.5.5 Deviation from Test Standard

No deviation.

### 4.5.6 EUT Operating Condition

Set the EUT transmit at un-modulation mode to test frequency stability.

#### 4.5.7 Test Results

Frequency Stability Versus Temp.									
Operating Frequency: 5180MHz									
Temp. (°C)	Power Supply (Vdc)	0 Minute		2 Minute		5 Minute		10 Minute	
		Measured Frequency (MHz)	Frequency Drift (%)	Measured Frequency (MHz)	Frequency Drift (%)	Measured Frequency (MHz)	Frequency Drift (%)	Measured Frequency (MHz)	Frequency Drift (%)
50	48	5180.0042	0.00008	5180.0059	0.00011	5180.0034	0.00007	5180.0019	0.00004
40	48	5179.9832	-0.00032	5179.9871	-0.00025	5179.988	-0.00023	5179.9838	-0.00031
30	48	5180.0061	0.00012	5180.0093	0.00018	5180.0095	0.00018	5180.0063	0.00012
20	48	5180.0185	0.00036	5180.0218	0.00042	5180.0201	0.00039	5180.0185	0.00036
10	48	5180.0075	0.00014	5180.0072	0.00014	5180.008	0.00015	5180.0089	0.00017
0	48	5180.0024	0.00005	5180.0011	0.00002	5179.999	-0.00002	5180.0025	0.00005
-10	48	5180.0032	0.00006	5180.0012	0.00002	5180.0038	0.00007	5180.0023	0.00004
-20	48	5179.978	-0.00042	5179.9774	-0.00044	5179.9752	-0.00048	5179.9752	-0.00048
-30	48	5180.0191	0.00037	5180.0186	0.00036	5180.02	0.00039	5180.0194	0.00037

Frequency Stability Versus Temp.									
Operating Frequency: 5180MHz									
Temp. (°C)	Power Supply (Vdc)	0 Minute		2 Minute		5 Minute		10 Minute	
		Measured Frequency (MHz)	Frequency Drift (%)	Measured Frequency (MHz)	Frequency Drift (%)	Measured Frequency (MHz)	Frequency Drift (%)	Measured Frequency (MHz)	Frequency Drift (%)
20	55.2	5180.0189	0.00036	5180.0226	0.00044	5180.0194	0.00037	5180.0186	0.00036
	48.0	5180.0185	0.00036	5180.0218	0.00042	5180.0201	0.00039	5180.0185	0.00036
	40.8	5180.019	0.00037	5180.0211	0.00041	5180.0206	0.00040	5180.0183	0.00035

## 4.6 6dB Bandwidth Measurement

### 4.6.1 Limits of 6dB Bandwidth Measurement

The minimum of 6dB Bandwidth Measurement is 0.5MHz.

### 4.6.2 Test Setup

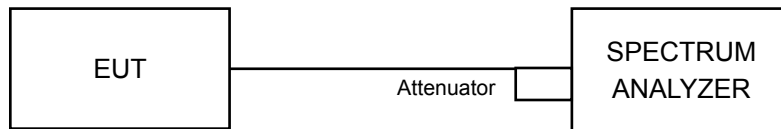

### 4.6.3 Test Instruments

Refer to section 4.1.2 to get information of above instrument.

### 4.6.4 Test Procedure

#### MEASUREMENT PROCEDURE REF

- Set resolution bandwidth (RBW) = 100kHz
- Set the video bandwidth (VBW)  $\geq 3 \times$  RBW, Detector = Peak.
- Trace mode = max hold.
- Sweep = auto couple.
- Measure the maximum width of the emission that is constrained by the frequencies associated with the two amplitude points (upper and lower) that are attenuated by 6 dB relative to the maximum level measured in the fundamental emission

### 4.6.5 Deviation from Test Standard

No deviation.

### 4.6.6 EUT Operating Condition

The software provided by client to enable the EUT under transmission condition continuously at lowest, middle and highest channel frequencies individually.

#### 4.6.7 Test Results

##### 802.11a

Channel	Frequency (MHz)	6dB Bandwidth (MHz)			Minimum Limit (MHz)	Pass / Fail
		Chain 0	Chain 1	Chain 2		
149	5745	16.41	16.43	16.41	0.5	Pass
157	5785	16.42	16.41	16.44	0.5	Pass
165	5825	16.44	16.43	16.46	0.5	Pass

##### 802.11n (HT20)

Channel	Frequency (MHz)	6dB Bandwidth (MHz)			Minimum Limit (MHz)	Pass / Fail
		Chain 0	Chain 1	Chain 2		
149	5745	17.63	17.65	17.65	0.5	Pass
157	5785	17.64	17.65	17.66	0.5	Pass
165	5825	17.65	17.64	17.67	0.5	Pass

##### 802.11n (HT40)

Channel	Frequency (MHz)	6dB Bandwidth (MHz)			Minimum Limit (MHz)	Pass / Fail
		Chain 0	Chain 1	Chain 2		
151	5755	36.37	35.89	36.15	0.5	Pass
159	5795	36.34	35.89	36.16	0.5	Pass

##### 802.11ac (VHT80)

Channel	Frequency (MHz)	6dB Bandwidth (MHz)			Minimum Limit (MHz)	Pass / Fail
		Chain 0	Chain 1	Chain 2		
155	5775	75.78	73.38	74.50	0.5	Pass

**Spectrum Plot of Worst Value**

**802.11a**

**802.11n (HT20)**

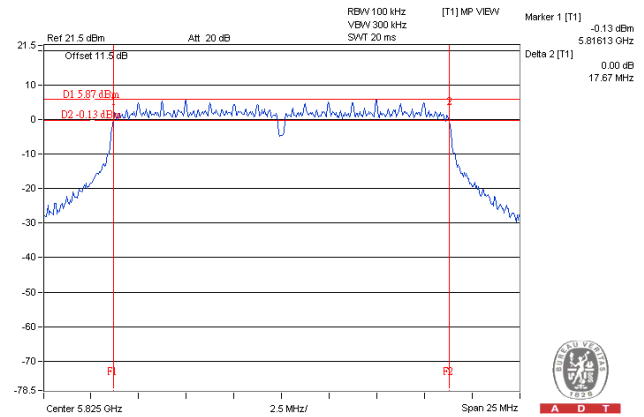
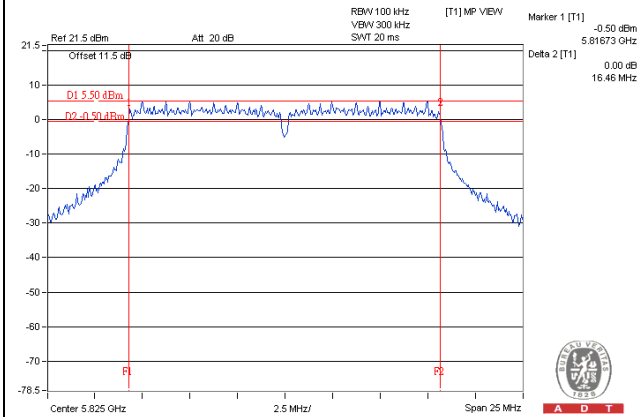

**802.11n (HT40)**

**802.11ac (VHT80)**

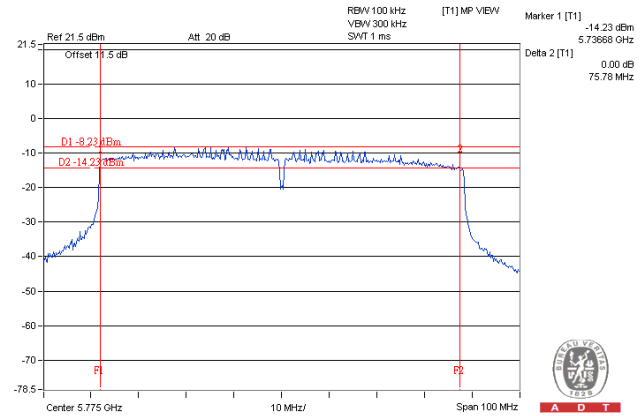
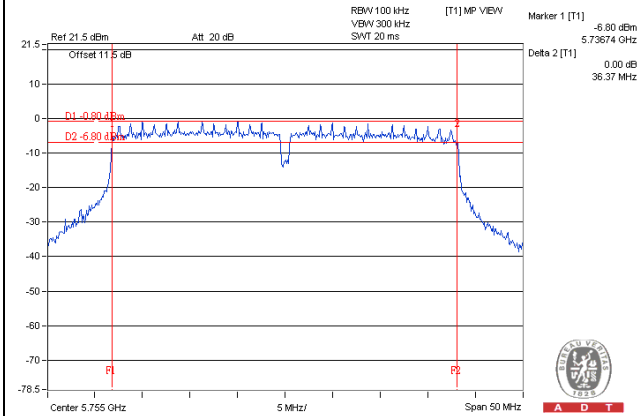

## **5 Pictures of Test Arrangements**

Please refer to the attached file (Test Setup Photo).

## Appendix – Information on the Testing Laboratories

We, Bureau Veritas Consumer Products Services (H.K.) Ltd., Taoyuan Branch, were founded in 1988 to provide our best service in EMC, Radio, Telecom and Safety consultation. Our laboratories are accredited and approved according to ISO/IEC 17025.

If you have any comments, please feel free to contact us at the following:

**Linko EMC/RF Lab**

Tel: 886-2-26052180

Fax: 886-2-26051924

**Hsin Chu EMC/RF/Telecom Lab**

Tel: 886-3-5935343

Fax: 886-3-5935342

**Hwa Ya EMC/RF/Safety Lab**

Tel: 886-3-3183232

Fax: 886-3-3270892

**Email:** [service.adt@tw.bureauveritas.com](mailto:service.adt@tw.bureauveritas.com)

**Web Site:** [www.bureauveritas-adt.com](http://www.bureauveritas-adt.com)

The address and road map of all our labs can be found in our web site also.

--- END ---