



FCC TEST REPORT (15.247)

REPORT NO.: RF970602L11

MODEL NO.: EOA-8670 (refer to item 3.1 for more detail)

RECEIVED: Jun. 02, 2008

TESTED: Jul. 12 ~ Oct. 06, 2008

ISSUED: Oct. 24, 2008

APPLICANT: Senao Networks Inc.

ADDRESS: 3F, No. 529, Chung Cheng Rd., Hsintien, Taipei,
Taiwan, R.O.C.

ISSUED BY: Advance Data Technology Corporation

LAB ADDRESS: No. 47, 14th Ling, Chia Pau Tsuen, Lin Kou
Hsiang, Taipei Hsien 244, Taiwan, R.O.C.

TEST LOCATION: No. 19, Hwa Ya 2nd Rd, Wen Hwa Tsuen, Kwei
Shan Hsiang, Taoyuan Hsien 333, Taiwan,
R.O.C.

This test report consists of 109 pages in total. It may be duplicated completely for legal use with the approval of the applicant. It should not be reproduced except in full, without the written approval of our laboratory. The client should not use it to claim product endorsement by TAF or any government agencies. The test results in the report only apply to the tested sample.



TABLE OF CONTENTS

1.	CERTIFICATION.....	5
2.	SUMMARY OF TEST RESULTS	6
2.1	MEASUREMENT UNCERTAINTY	6
3.	GENERAL INFORMATION.....	7
3.1	GENERAL DESCRIPTION OF EUT.....	7
3.2	DESCRIPTION OF TEST MODES.....	9
3.2.1	CONFIGURATION OF SYSTEM UNDER TEST.....	9
3.2.2	TEST MODE APPLICABILITY AND TESTED CHANNEL DETAIL.....	10
3.3	GENERAL DESCRIPTION OF APPLIED STANDARDS.....	14
3.4	DESCRIPTION OF SUPPORT UNITS.....	14
4.	TEST TYPES AND RESULTS (FOR 2.4GHz BAND).....	15
4.1	RADIATED EMISSION MEASUREMENT	15
4.1.1	LIMITS OF RADIATED EMISSION MEASUREMENT.....	15
4.1.2	TEST INSTRUMENTS	16
4.1.3	TEST PROCEDURES	18
4.1.4	DEVIATION FROM TEST STANDARD	18
4.1.5	TEST SETUP	19
4.1.6	EUT OPERATING CONDITIONS.....	19
4.1.7	TEST RESULTS	20
4.2	CONDUCTED EMISSION MEASUREMENT	36
4.2.1	LIMITS OF CONDUCTED EMISSION MEASUREMENT.....	36
4.2.2	TEST INSTRUMENTS	36
4.2.3	TEST PROCEDURES	37
4.2.4	DEVIATION FROM TEST STANDARD	37
4.2.5	TEST SETUP	38
4.2.6	EUT OPERATING CONDITIONS.....	38
4.2.7	TEST RESULTS	39
4.3	6dB BANDWIDTH MEASUREMENT	43
4.3.1	LIMITS OF 6dB BANDWIDTH MEASUREMENT.....	43
4.3.2	TEST INSTRUMENTS	43
4.3.3	TEST PROCEDURE	43
4.3.4	DEVIATION FROM TEST STANDARD	43
4.3.5	TEST SETUP	44
4.3.6	EUT OPERATING CONDITIONS.....	44
4.3.7	TEST RESULTS	45
4.4	MAXIMUM PEAK OUTPUT POWER	49
4.4.1	LIMITS OF MAXIMUM PEAK OUTPUT POWER MEASUREMENT.....	49
4.4.2	INSTRUMENTS.....	49
4.4.3	TEST PROCEDURES	49
4.4.4	DEVIATION FROM TEST STANDARD	50
4.4.5	TEST SETUP	50
4.4.6	EUT OPERATING CONDITIONS.....	50
4.4.7	TEST RESULTS	51
4.5	POWER SPECTRAL DENSITY MEASUREMENT.....	52
4.5.1	LIMITS OF POWER SPECTRAL DENSITY MEASUREMENT.....	52
4.5.2	TEST INSTRUMENTS	52
4.5.3	TEST PROCEDURE	52
4.5.4	DEVIATION FROM TEST STANDARD	53

4.5.5	TEST SETUP	53
4.5.6	EUT OPERATING CONDITION	53
4.5.7	TEST RESULTS	54
4.6	BAND EDGES MEASUREMENT	58
4.6.1	LIMITS OF BAND EDGES MEASUREMENT	58
4.6.2	TEST INSTRUMENTS	58
4.6.3	TEST PROCEDURE	58
4.6.4	DEVIATION FROM TEST STANDARD	58
4.6.5	EUT OPERATING CONDITION	58
4.6.6	TEST RESULTS	59
4.7	ANTENNA REQUIREMENT	69
4.7.1	STANDARD APPLICABLE	69
4.7.2	ANTENNA CONNECTED CONSTRUCTION	69
5.	TEST TYPES AND RESULTS (FOR 5.0GHz BAND)	70
5.1	RADIATED EMISSION MEASUREMENT	70
5.1.1	LIMITS OF RADIATED EMISSION MEASUREMENT	70
5.1.2	TEST INSTRUMENTS	71
5.1.3	TEST PROCEDURES	73
5.1.4	DEVIATION FROM TEST STANDARD	73
5.1.5	TEST SETUP	74
5.1.6	EUT OPERATING CONDITIONS	74
5.1.7	TEST RESULTS	75
5.2	CONDUCTED EMISSION MEASUREMENT	83
5.2.1	LIMITS OF CONDUCTED EMISSION MEASUREMENT	83
5.2.2	TEST INSTRUMENTS	83
5.2.3	TEST PROCEDURES	84
5.2.4	DEVIATION FROM TEST STANDARD	84
5.2.5	TEST SETUP	85
5.2.6	EUT OPERATING CONDITIONS	85
5.2.7	TEST RESULTS	86
5.3	6dB BANDWIDTH MEASUREMENT	90
5.3.1	LIMITS OF 6dB BANDWIDTH MEASUREMENT	90
5.3.2	TEST INSTRUMENTS	90
5.3.3	TEST PROCEDURE	90
5.3.4	DEVIATION FROM TEST STANDARD	91
5.3.5	TEST SETUP	91
5.3.6	EUT OPERATING CONDITIONS	91
5.3.7	TEST RESULTS	92
5.4	MAXIMUM PEAK OUTPUT POWER	94
5.4.1	LIMITS OF MAXIMUM PEAK OUTPUT POWER MEASUREMENT	94
5.4.2	INSTRUMENTS	94
5.4.3	TEST PROCEDURES	94
5.4.4	DEVIATION FROM TEST STANDARD	95
5.4.5	TEST SETUP	95
5.4.6	EUT OPERATING CONDITIONS	95
5.4.7	TEST RESULTS	96
5.5	POWER SPECTRAL DENSITY MEASUREMENT	97
5.5.1	LIMITS OF POWER SPECTRAL DENSITY MEASUREMENT	97
5.5.2	TEST INSTRUMENTS	97
5.5.3	TEST PROCEDURE	97
5.5.4	DEVIATION FROM TEST STANDARD	98



5.5.5	TEST SETUP	98
5.5.6	EUT OPERATING CONDITION.....	98
5.5.7	TEST RESULTS	99
5.6	BAND EDGES MEASUREMENT	101
5.6.1	LIMITS OF BAND EDGES MEASUREMENT	101
5.6.2	TEST INSTRUMENTS.....	101
5.6.3	TEST PROCEDURE.....	101
5.6.4	DEVIATION FROM TEST STANDARD	101
5.6.5	EUT OPERATING CONDITION.....	101
5.6.6	TEST RESULTS	102
5.7	ANTENNA REQUIREMENT	106
5.7.1	STANDARD APPLICABLE	106
5.7.2	ANTENNA CONNECTED CONSTRUCTION	106
6.	PHOTOGRAPHS OF THE TEST CONFIGURATION.....	107
7.	INFORMATION ON THE TESTING LABORATORIES	108
8.	APPENDIX A - MODIFICATIONS RECORDERS FOR ENGINEERING CHANGES TO THE EUT BY THE LAB.....	109



1. CERTIFICATION

PRODUCT: 802.11a/b/g Outdoor Layer-2 MESH AP

MODEL NO.: EOA-8670 (refer to item 3.1 for more detail)

BRAND: EnGenius

APPLICANT: Senao Networks Inc.

TEST SAMPLE: ENGINEERING SAMPLE

TESTED: Jul. 12 ~ Oct. 06, 2008

STANDARDS: FCC Part 15, Subpart C (Section 15.247)
ANSI C63.4-2003

The above equipment (Model: EOA-8670, EOM-8670) has been tested by **Advance Data Technology Corporation**, and found compliance with the requirement of the above standards. The test record, data evaluation & Equipment Under Test (EUT) configurations represented herein are true and accurate accounts of the measurements of the sample's EMC characteristics under the conditions specified in this report.

PREPARED BY : Andrea Hsia , **DATE:** Oct. 24, 2008
Andrea Hsia / Specialist

TECHNICAL ACCEPTANCE : Long Chen , **DATE:** Oct. 24, 2008
Responsible for RF Long Chen / Senior Engineer

APPROVED BY : Gary Chang , **DATE:** Oct. 24, 2008
Gary Chang / Assistant Manager

2. SUMMARY OF TEST RESULTS

The EUT has been tested according to the following specifications:

APPLIED STANDARD: FCC PART 15, SUBPART C (SECTION 15.247)			
STANDARD SECTION	TEST TYPE AND LIMIT	RESULT	REMARK
15.207	AC Power Conducted Emission	PASS	Meet the requirement of limit. Minimum passing margin is -17.20dB at 17.695MHz
15.247(a)(2)	Spectrum Bandwidth of a Direct Sequence Spread Spectrum System Limit: min. 500kHz	PASS	Meet the requirement of limit.
15.247(b)	Maximum Peak Output Power Limit: max. 30dBm	PASS	Meet the requirement of limit.
15.247(d)	Radiated Emissions Limit: Table 15.209	PASS	Meet the requirement of limit. Minimum passing margin is -1.00dB at 4924.00MHz
15.247(e)	Power Spectral Density Limit: max. 8dBm	PASS	Meet the requirement of limit.
15.247(d)	Band Edge Measurement Limit: 20dB less than the peak value of fundamental frequency	PASS	Meet the requirement of limit.

2.1 MEASUREMENT UNCERTAINTY

Where relevant, the following measurement uncertainty levels have been estimated for tests performed on the EUT as specified in CISPR 16-4-2:

MEASUREMENT	FREQUENCY	UNCERTAINTY
Conducted emissions	9kHz~30MHz	2.44dB
Radiated emissions	30MHz ~ 1GHz	4.03dB
	1GHz ~ 18GHz	2.26dB
	18GHz ~ 40GHz	1.94dB

This uncertainty represents an expanded uncertainty expressed at approximately the 95% confidence level using a coverage factor of $k = 2$.



3. GENERAL INFORMATION

3.1 GENERAL DESCRIPTION OF EUT

PRODUCT	802.11a/b/g Outdoor Layer-2 MESH AP
MODEL NO.	EOA-8670 (refer to note as below)
FCC ID	U2M-OA86708001
POWER SUPPLY	48Vdc from POE
MODULATION TYPE	CCK, DQPSK, DBPSK for DSSS 64QAM, 16QAM, QPSK, BPSK for OFDM
MODULATION TECHNOLOGY	DSSS, OFDM
TRANSFER RATE	802.11b: 11.0/ 5.5/ 2.0/ 1.0Mbps 802.11g: 54.0/ 48.0/ 36.0/ 24.0/ 18.0/ 12.0/ 9.0/ 6.0Mbps 802.11a: 54.0/ 48.0/ 36.0/ 24.0/ 18.0/ 12.0/ 9.0/ 6.0Mbps
FREQUENCY RANGE	2.4GHz: 2400.0 ~ 2483.5MHz 5.0GHz: 5150.0 ~ 5250.0MHz, 5725.0 ~ 5850.0MHz
NUMBER OF CHANNEL	802.11b & 802.11g: 11 802.11a: 9
CHANNEL SPACING	802.11b & 802.11g: 5MHz 802.11a: 20MHz
OUTPUT POWER	319.154mW for 2400.0 ~ 2483.5MHz 38.371mW for 5150.0 ~ 5250.0MHz 30.339mW for 5725.0 ~ 5850.0MHz
ANTENNA TYPE	Refer to note as below
DATA CABLE	NA
I/O PORTS	RJ45
ASSOCIATED DEVICES	Grounding cable (1.8m)

NOTE:

- The following models are provided to this EUT.

BRAND	MODEL NAME	REMARK
EnGenius	EOA-8670	For plastics housing
EnGenius	EOM-8670	For iron housing

- The following antennas were provided to this EUT.

Antenna Type	Gain (dBi)				Antenna connector
	2.4G		5.0G		
	Peak	Average	Peak	Average	
Omni-directional external	4.5	2.5	7.0	5.0	N-type



3. The EUT was operated with following POE.

BRAND:	EnGenius
MODEL:	NPE-4818
OUTPUT:	48Vdc, 0.375A

* The POE is for support unit only.

4. The POE was operated with following adapter.

BRAND:	MW
MODEL:	ES18U48-480
INPUT:	100-240Vac,50/60Hz, 0.5A
OUTPUT:	48Vdc, 0.375A

* The adapter is for support unit only.

5. The EUT is an 802.11a/b/g Outdoor Layer-2 MESH AP. The functions of EUT listed as below:

	TEST STANDARD	REFERENCE REPORT
WLAN 802.11b/g	FCC Part 15, Subpart C (Section 15.247)	RF970602L11
WLAN 802.11a (5725~5850 MHz)		
WLAN 802.11a (5150~ 5250MHz)	FCC Part 15, Subpart E (Section 15.407)	RF970602L11-1

6. The above EUT information was declared by manufacturer and for more detailed features description, please refer to the manufacturer's specifications or user's manual.

3.2 DESCRIPTION OF TEST MODES

FOR 2.4GHz:

11 channels are provided for 802.11b and 802.11g:

CHANNEL	FREQUENCY	CHANNEL	FREQUENCY
1	2412MHz	7	2442MHz
2	2417MHz	8	2447MHz
3	2422MHz	9	2452MHz
4	2427MHz	10	2457MHz
5	2432MHz	11	2462MHz
6	2437MHz		

FOR 5.0GHz (5725 ~ 5850MHz):

5 channels are provided for 802.11a:

CHANNEL	FREQUENCY	CHANNEL	FREQUENCY
149	5745MHz	161	5805MHz
153	5765MHz	165	5825MHz
157	5785MHz		

3.2.1 CONFIGURATION OF SYSTEM UNDER TEST

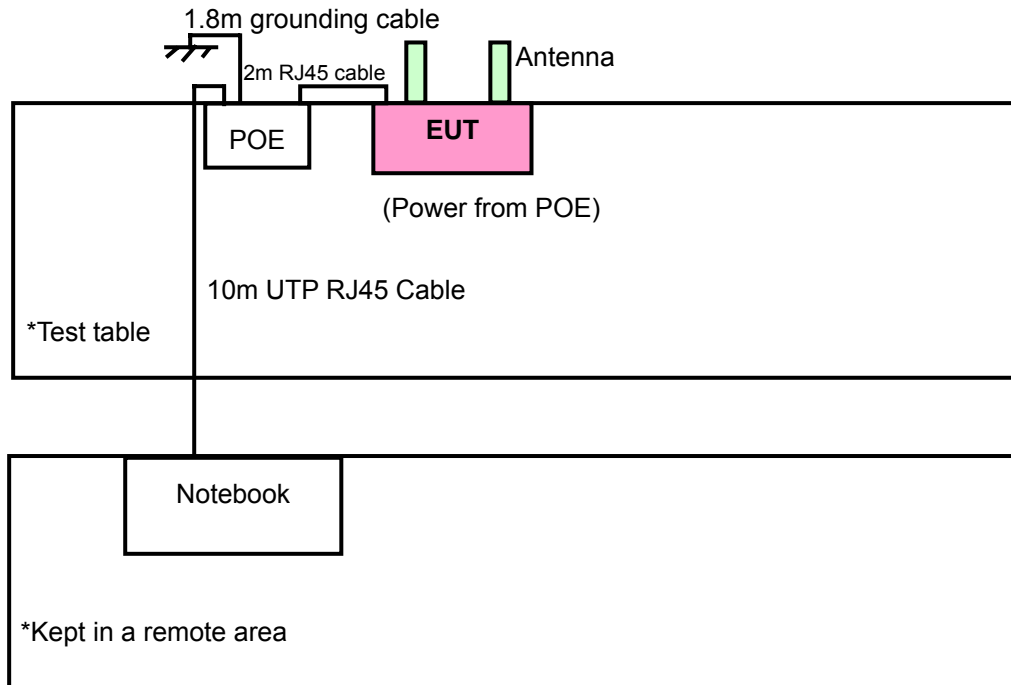

3.2.2 TEST MODE APPLICABILITY AND TESTED CHANNEL DETAIL

FOR 2.400 ~ 2.4835GHz:

EUT CONFIGURE MODE	APPLICABLE TO				DESCRIPTION
	RE \geq 1G	RE<1G	PLC	APCM	
A	√	√	√	-	For model: EOA-8670
B	√	√	√	√	For model: EOM-8670

Where **RE \geq 1G**: Radiated Emission above 1GHz

RE<1G: Radiated Emission below 1GHz

PLC: Power Line Conducted Emission

APCM: Antenna Port Conducted Measurement

NOTE: "-" means no effect

RADIATED EMISSION TEST (ABOVE 1GHz):

- Pre-Scan has been conducted to determine the worst-case mode from all possible combinations between available modulations, data rates, XYZ axis, antenna ports (if EUT with antenna diversity architecture) and packet type.
- Following channel(s) was (were) selected for the final test as listed below.

EUT CONFIGURE MODE	MODE	AVAILABLE CHANNEL	TESTED CHANNEL	MODULATION TECHNOLOGY	MODULATION TYPE	DATA RATE (Mbps)	AXIZ
A	802.11b	1 to 11	1, 6, 11	DSSS	DBPSK	1.0	Z
B	802.11b	1 to 11	1, 6, 11	DSSS	DBPSK	1.0	Z
A	802.11g	1 to 11	1, 6, 11	OFDM	BPSK	6.0	Z
B	802.11g	1 to 11	1, 6, 11	OFDM	BPSK	6.0	Z

RADIATED EMISSION TEST (BELOW 1GHz):

- Pre-Scan has been conducted to determine the worst-case mode from all possible combinations between available modulations, data rates, XYZ axis, antenna ports (if EUT with antenna diversity architecture) and packet type.
- Following channel(s) was (were) selected for the final test as listed below.

EUT CONFIGURE MODE	MODE	AVAILABLE CHANNEL	TESTED CHANNEL	MODULATION TECHNOLOGY	MODULATION TYPE	DATA RATE (Mbps)	AXIZ
A	802.11g	1 to 11	6	OFDM	BPSK	6.0	Z
B	802.11g	1 to 11	6	OFDM	BPSK	6.0	Z

POWER LINE CONDUCTED EMISSION TEST:

- Pre-Scan has been conducted to determine the worst-case mode from all possible combinations between available modulations, data rates and antenna ports (if EUT with antenna diversity architecture).
- Following channel(s) was (were) selected for the final test as listed below.

EUT CONFIGURE MODE	MODE	AVAILABLE CHANNEL	TESTED CHANNEL	MODULATION TECHNOLOGY	MODULATION TYPE	DATA RATE (Mbps)
A	802.11g	1 to 11	6	OFDM	BPSK	6.0
B	802.11g	1 to 11	6	OFDM	BPSK	6.0

BANDEDGE MEASUREMENT:

- Pre-Scan has been conducted to determine the worst-case mode from all possible combinations between available modulations, data rates, XYZ axis, antenna ports (if EUT with antenna diversity architecture) and packet type.
- Following channel(s) was (were) selected for the final test as listed below.

EUT CONFIGURE MODE	MODE	AVAILABLE CHANNEL	TESTED CHANNEL	MODULATION TECHNOLOGY	MODULATION TYPE	DATA RATE (Mbps)	AXIZ
A	802.11b	1 to 11	1, 11	DSSS	DBPSK	1.0	Z
B	802.11b	1 to 11	1, 11	OFDM	BPSK	1.0	Z
A	802.11g	1 to 11	1, 11	DSSS	DBPSK	6.0	Z
B	802.11g	1 to 11	1, 11	OFDM	BPSK	6.0	Z

ANTENNA PORT CONDUCTED MEASUREMENT:

- Pre-Scan has been conducted to determine the worst-case mode from all possible combinations between available modulations, data rates and antenna ports (if EUT with antenna diversity architecture).
- Following channel(s) was (were) selected for the final test as listed below.

EUT CONFIGURE MODE	MODE	AVAILABLE CHANNEL	TESTED CHANNEL	MODULATION TECHNOLOGY	MODULATION TYPE	DATA RATE (Mbps)
B	802.11b	1 to 11	1, 6, 11	DSSS	DBPSK	1.0
B	802.11g	1 to 11	1, 6, 11	OFDM	BPSK	6.0

FOR 5.725 ~ 5.850GHz:

EUT CONFIGURE MODE	APPLICABLE TO				DESCRIPTION
	PLC	RE<1G	RE≥1G	APCM	
A	√	√	√	-	For model: EOA-8670
B	√	√	√	√	For model: EOM-8670

Where **PLC**: Power Line Conducted Emission **RE<1G**: Radiated Emission below 1GHz
RE≥1G: Radiated Emission above 1GHz **APCM**: Antenna Port Conducted Measurement

NOTE: "-" means no effect

RADIATED EMISSION TEST (ABOVE 1GHz):

- Pre-Scan has been conducted to determine the worst-case mode from all possible combinations between available modulations, data rates, XYZ axis, antenna ports (if EUT with antenna diversity architecture) and packet type.
- Following channel(s) was (were) selected for the final test as listed below.

EUT CONFIGURE MODE	MODE	AVAILABLE CHANNEL	TESTED CHANNEL	MODULATION TECHNOLOGY	MODULATION TYPE	DATA RATE (Mbps)	AXIZ
A	802.11a	149 to 165	149, 157, 165	OFDM	BPSK	6.0	Z
B	802.11a	149 to 165	149, 157, 165	OFDM	BPSK	6.0	Z

RADIATED EMISSION TEST (BELOW 1GHz):

- Pre-Scan has been conducted to determine the worst-case mode from all possible combinations between available modulations, data rates, XYZ axis, antenna ports (if EUT with antenna diversity architecture) and packet type.
- Following channel(s) was (were) selected for the final test as listed below.

EUT CONFIGURE MODE	MODE	AVAILABLE CHANNEL	TESTED CHANNEL	MODULATION TECHNOLOGY	MODULATION TYPE	DATA RATE (Mbps)	AXIZ
A	802.11a	149 to 165	149	OFDM	BPSK	6.0	Z
B	802.11a	149 to 165	149	OFDM	BPSK	6.0	Z

POWER LINE CONDUCTED EMISSION TEST:

- Pre-Scan has been conducted to determine the worst-case mode from all possible combinations between available modulations, data rates and antenna ports (if EUT with antenna diversity architecture).
- Following channel(s) was (were) selected for the final test as listed below.

EUT CONFIGURE MODE	MODE	AVAILABLE CHANNEL	TESTED CHANNEL	MODULATION TECHNOLOGY	MODULATION TYPE	DATA RATE (Mbps)
A	802.11a	149 to 165	149	OFDM	BPSK	6.0
B	802.11a	149 to 165	149	OFDM	BPSK	6.0

BANDEDGE MEASUREMENT:

- Pre-Scan has been conducted to determine the worst-case mode from all possible combinations between available modulations, data rates, XYZ axis, antenna ports (if EUT with antenna diversity architecture) and packet type.
- Following channel(s) was (were) selected for the final test as listed below.

EUT CONFIGURE MODE	MODE	AVAILABLE CHANNEL	TESTED CHANNEL	MODULATION TECHNOLOGY	MODULATION TYPE	DATA RATE (Mbps)	AXIZ
A	802.11a	149 to 165	149, 165	OFDM	BPSK	6.0	Z
B	802.11a	149 to 165	149, 165	OFDM	BPSK	6.0	Z

ANTENNA PORT CONDUCTED MEASUREMENT:

- Pre-Scan has been conducted to determine the worst-case mode from all possible combinations between available modulations, data rates and antenna ports (if EUT with antenna diversity architecture).
- Following channel(s) was (were) selected for the final test as listed below.

EUT CONFIGURE MODE	MODE	AVAILABLE CHANNEL	TESTED CHANNEL	MODULATION TECHNOLOGY	MODULATION TYPE	DATA RATE (Mbps)
B	802.11a	149 to 165	149, 157, 165	OFDM	BPSK	6.0
B	802.11a	149 to 165	149, 157, 165	OFDM	BPSK	6.0



3.3 GENERAL DESCRIPTION OF APPLIED STANDARDS

The EUT is a RF Product. According to the specifications of the manufacturer, it must comply with the requirements of the following standards:

FCC Part 15, Subpart C (15.247)

ANSI C63.4-2003

All test items have been performed and recorded as per the above standards.

NOTE: The EUT is also considered as a kind of computer peripheral, because the connection to computer is necessary for typical use. It has been verified to comply with the requirements of FCC Part 15, Subpart B, Class B (DoC). The test report has been issued separately.

3.4 DESCRIPTION OF SUPPORT UNITS

The EUT has been tested as an independent unit together with other necessary accessories or support units. The following support units or accessories were used to form a representative test configuration during the tests.

NO.	PRODUCT	BRAND	MODEL NO.	SERIAL NO.	FCC ID
1	POE	EnGenius	NPE-4818	NA	NA
2	NOTEBOOK COMPUTER	DELL	PP05L	16484462992	E2K24CLNS

NO.	SIGNAL CABLE DESCRIPTION OF THE ABOVE SUPPORT UNITS
1	2m RJ45 cable; 1.8m grounding cable
2	NA

NOTE 1: All power cords of the above support units are non shielded (1.8m).

NOTE 2: Item 2 acted as communication partners to transfer data.

NOTE 3: Item 1 & 2m RJ 45 were supplied from client and only for test.

4. TEST TYPES AND RESULTS (FOR 2.4GHz BAND)

4.1 RADIATED EMISSION MEASUREMENT

4.1.1 LIMITS OF RADIATED EMISSION MEASUREMENT

Emissions radiated outside of the specified bands, shall be according to the general radiated limits in 15.209 as following:

FREQUENCIES (MHz)	FIELD STRENGTH (microvolts/meter)	MEASUREMENT DISTANCE (meters)
0.009 ~ 0.490	2400/F(kHz)	300
0.490 ~ 1.705	24000/F(kHz)	30
1.705 ~ 30.0	30	30
30 ~ 88	100	3
88 ~ 216	150	3
216 ~ 960	200	3
Above 960	500	3

NOTE:

1. The lower limit shall apply at the transition frequencies.
2. Emission level (dBuV/m) = 20 log Emission level (uV/m).
3. As shown in 15.35(b), for frequencies above 1000MHz, the field strength limits are based on average detector, however, the peak field strength of any emission shall not exceed the maximum permitted average limits, specified above by more than 20dB under any condition of modulation.



4.1.2 TEST INSTRUMENTS

Above 1GHz:

DESCRIPTION & MANUFACTURER	MODEL NO.	SERIAL NO.	DATE OF CALIBRATION	DUE DATE OF CALIBRATION
Test Receiver ROHDE & SCHWARZ	ESI7	100033	Jun. 30, 2008	Jun. 29, 2009
Spectrum Analyzer Agilent	FSP	100041	Apr. 22, 2008	Apr. 21, 2009
BILOG Antenna SCHWARZBECK	VULB9168	9168-160	May, 02, 2008	May, 01, 2009
HORN Antenna SCHWARZBECK	9120D	9120D-209	Jun. 24, 2008	Jun. 23, 2009
HORN Antenna SCHWARZBECK	BBHA 9170	BBHA9170243	Dec. 25, 2007	Dec. 24, 2008
Preamplifier Agilent	8447D	2944A10633	Oct. 29, 2007	Oct. 28, 2008
Preamplifier Agilent	8449B	3008A01964	Oct. 24, 2007	Oct. 23, 2008
RF signal cable HUBER+SUHNNER	SUCOFLEX 104	283402/4	Dec. 07, 2007	Dec. 06, 2008
RF signal cable HUBER+SUHNNER	SUCOFLEX 104	251644/4	Dec. 07, 2007	Dec. 06, 2008
Software ADT.	ADT_Radiated_V7.6	NA	NA	NA
Antenna Tower inn-co GmbH	MA 4000	013303	NA	NA
Antenna Tower Controller inn-co GmbH	CO2000	017303	NA	NA
Turn Table ADT.	TT100.	TT93021703	NA	NA
Turn Table Controller ADT.	SC100.	SC93021703	NA	NA

- NOTE:**
1. The calibration interval of the above test instruments is 12 months and the calibrations are traceable to NML/ROC and NIST/USA.
 2. The test was performed in HwaYa Chamber 3.
 3. The horn antenna and HP preamplifier (model: 8449B) are used only for the measurement of emission frequency above 1GHz if tested.
 4. The FCC Site Registration No. is 988962.
 5. The IC Site Registration No. is IC3789B-3.



Below 1GHz:

DESCRIPTION & MANUFACTURER	MODEL NO.	SERIAL NO.	CALIBRATED DATE	CALIBRATED UNTIL
ROHDE & SCHWARZ TEST RECEIVER	ESCI	100412	Jul. 22, 2008	Jul. 21, 2009
SCHAFFENR BILOG Antenna	CBL6111D	21872	Apr. 29, 2008	Apr. 28, 2009
ADT. Turn Table	TT100	0505	NA	NA
ADT. Tower	AT100	0505	NA	NA
Software	ADT_Radiated_V7.6.15	NA	NA	NA
ADT RF Switches BOX	EM-H-01-1	1002	Aug. 19, 2008	Aug. 18, 2009
TIMES RF cable	LMR-600	CABLE-ST5-01	Aug. 19, 2008	Aug. 18, 2009

- NOTE:**
1. The calibration interval of the above test instruments is 12 months. And the calibrations are traceable to NML/ROC and NIST/USA.
 2. The test was performed in Open Site No. 5.
 3. The VCCI Site Registration No. R-1039.
 4. The Industry Canada Reference No. IC 3789A-5

4.1.3 TEST PROCEDURES

- a. The EUT was placed on the top of a rotating table 0.8 meters above the ground at a 3 meters semi-anechoic chamber and open test area side. The table was rotated 360 degrees to determine the position of the highest radiation.
- b. The EUT was set 3 meters away from the interference-receiving antenna, which was mounted on the top of a variable-height antenna tower.
- c. The antenna is a broadband antenna, and its height is varied from one meter to four meters above the ground to determine the maximum value of the field strength. Both horizontal and vertical polarizations of the antenna are set to make the measurement.
- d. For each suspected emission, the EUT was arranged to its worst case and then the antenna was tuned to heights from 1 meter to 4 meters and the rotatable table was turned from 0 degrees to 360 degrees to find the maximum reading.
- e. The test-receiver system was set to Peak Detect Function and Specified Bandwidth with Maximum Hold Mode.
- f. If the emission level of the EUT in peak mode was lower than the limit specified, then testing could be stopped and the peak values of the EUT would be reported. Otherwise the emissions would be re-tested one by one using peak, quasi-peak or average method as specified and then reported in a data sheet.

NOTE:

1. The resolution bandwidth and video bandwidth of test receiver/spectrum analyzer is 120kHz for Quasi-peak detection at frequency below 1GHz.
2. The resolution bandwidth of test receiver/spectrum analyzer is 100kHz and video bandwidth is 300kHz for Peak detection at frequency above 1GHz.
3. The resolution bandwidth of test receiver/spectrum analyzer is 1MHz and the video bandwidth is 10Hz for Average detection (AV) at frequency above 1GHz.
4. All modes of operation were investigated and the worst-case emissions are reported.

4.1.4 DEVIATION FROM TEST STANDARD

No deviation

4.1.5 TEST SETUP

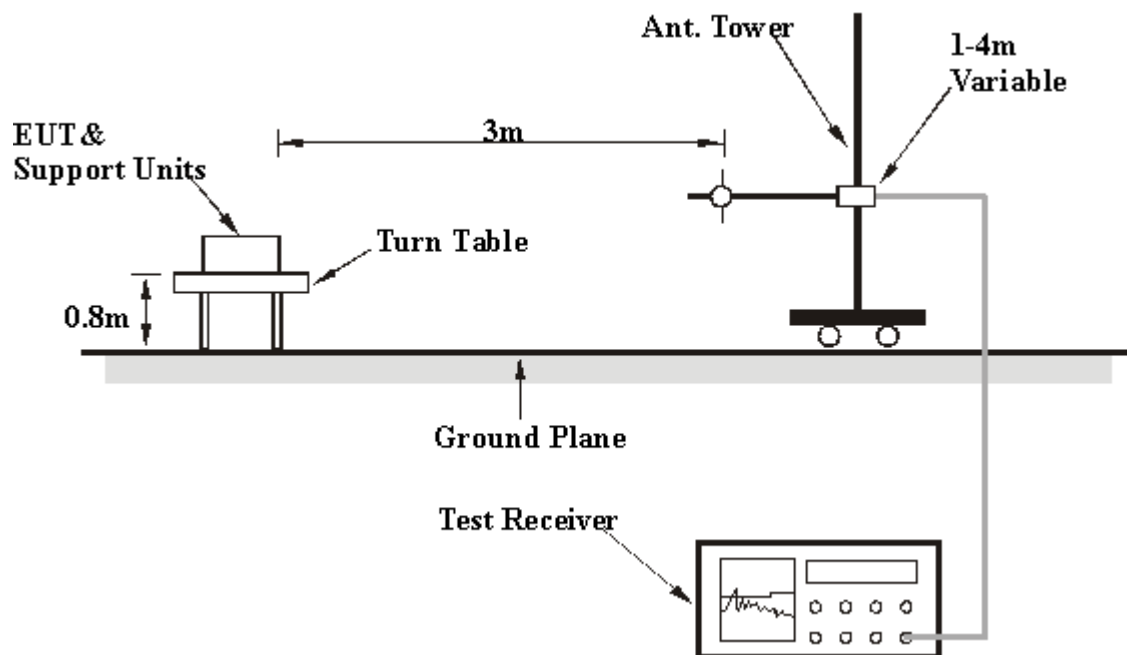

For the actual test configuration, please refer to the attached file (Test Setup Photo).

4.1.6 EUT OPERATING CONDITIONS

- a. Placed the EUT on a testing table.
- b. Prepared a notebook computer and placed it outside of testing area to act as communication partner for EUT.
- c. The EUT ran a test program (provided by manufacturer) to enable all functions under transmission condition continuously at specific channel frequency.
- d. The necessary accessories enable the EUT in full functions.

4.1.7 TEST RESULTS

802.11b DSSS MODULATION

EUT TEST CONDITION		MEASUREMENT DETAIL	
CHANNEL	Channel 1	FREQUENCY RANGE	1 ~ 25GHz
INPUT POWER (SYSTEM)	120Vac, 60 Hz	DETECTOR FUNCTION	Peak (PK) Average (AV)
ENVIRONMENTAL CONDITIONS	25deg. C, 65%RH 1000hPa	TEST MODE	A
TESTED BY	Match Tsui		

ANTENNA POLARITY & TEST DISTANCE: HORIZONTAL AT 3 M								
NO.	FREQ. (MHz)	EMISSION LEVEL (dBuV/m)	LIMIT (dBuV/m)	MARGIN (dB)	ANTENNA HEIGHT (m)	TABLE ANGLE (Degree)	RAW VALUE (dBuV)	CORRECTION FACTOR (dB/m)
1	2386.00	57.34 PK	74.00	-16.66	1.12 H	103	25.11	32.23
2	2386.00	47.41 AV	54.00	-6.59	1.12 H	103	15.18	32.23
3	*2412.00	99.63 PK			1.12 H	103	67.31	32.32
4	*2412.00	95.14 AV			1.12 H	103	62.82	32.32
5	4824.00	55.90 PK	74.00	-18.10	1.14 H	36	17.77	38.13
6	4824.00	52.42 AV	54.00	-1.58	1.14 H	36	14.29	38.13
ANTENNA POLARITY & TEST DISTANCE: VERTICAL AT 3 M								
NO.	FREQ. (MHz)	EMISSION LEVEL (dBuV/m)	LIMIT (dBuV/m)	MARGIN (dB)	ANTENNA HEIGHT (m)	TABLE ANGLE (Degree)	RAW VALUE (dBuV)	CORRECTION FACTOR (dB/m)
1	2386.00	62.47 PK	74.00	-11.53	1.19 V	124	30.24	32.23
2	2386.00	52.88 AV	54.00	-1.12	1.19 V	124	20.65	32.23
3	*2412.00	106.67 PK			1.43 V	106	74.35	32.32
4	*2412.00	101.93 AV			1.43 V	106	69.61	32.32
5	4824.00	56.47 PK	74.00	-17.53	1.04 V	1	18.34	38.13
6	4824.00	52.01 AV	54.00	-1.99	1.04 V	1	13.88	38.13

- REMARKS:**
1. Emission level (dBuV/m) = Raw Value (dBuV) + Correction Factor (dB/m).
 2. Correction Factor (dB/m) = Antenna Factor (dB/m) + Cable Factor (dB).
 3. The other emission levels were very low against the limit.
 4. Margin value = Emission level – Limit value.
 5. “ * “: Fundamental frequency.



EUT TEST CONDITION		MEASUREMENT DETAIL	
CHANNEL	Channel 6	FREQUENCY RANGE	1 ~ 25GHz
INPUT POWER (SYSTEM)	120Vac, 60 Hz	DETECTOR FUNCTION	Peak (PK) Average (AV)
ENVIRONMENTAL CONDITIONS	25deg. C, 65%RH 1000hPa	TEST MODE	A
TESTED BY	Match Tsui		

ANTENNA POLARITY & TEST DISTANCE: HORIZONTAL AT 3 M								
NO.	FREQ. (MHz)	EMISSION LEVEL (dBuV/m)	LIMIT (dBuV/m)	MARGIN (dB)	ANTENNA HEIGHT (m)	TABLE ANGLE (Degree)	RAW VALUE (dBuV)	CORRECTION FACTOR (dB/m)
1	*2437.00	100.08 PK			1.14 H	270	67.68	32.40
2	*2437.00	95.58 AV			1.14 H	270	63.18	32.40
3	4874.00	55.31 PK	74.00	-18.69	1.00 H	0	16.99	38.32
4	4874.00	52.22 AV	54.00	-1.78	1.00 H	0	13.90	38.32

ANTENNA POLARITY & TEST DISTANCE: VERTICAL AT 3 M								
NO.	FREQ. (MHz)	EMISSION LEVEL (dBuV/m)	LIMIT (dBuV/m)	MARGIN (dB)	ANTENNA HEIGHT (m)	TABLE ANGLE (Degree)	RAW VALUE (dBuV)	CORRECTION FACTOR (dB/m)
1	2390.00	56.89 PK	74.00	-17.11	1.29 V	360	24.65	32.24
2	2390.00	47.86 AV	54.00	-6.14	1.29 V	360	15.62	32.24
3	*2437.00	106.77 PK			1.48 V	360	74.37	32.40
4	*2437.00	102.07 AV			1.48 V	360	69.67	32.40
5	4874.00	55.49 PK	74.00	-18.51	1.43 V	323	17.17	38.32
6	4874.00	52.87 AV	54.00	-1.13	1.43 V	323	14.55	38.32

- REMARKS:**
1. Emission level (dBuV/m) = Raw Value (dBuV) + Correction Factor (dB/m).
 2. Correction Factor (dB/m) = Antenna Factor (dB/m) + Cable Factor (dB).
 3. The other emission levels were very low against the limit.
 4. Margin value = Emission level – Limit value.
 5. “ * “: Fundamental frequency.

EUT TEST CONDITION		MEASUREMENT DETAIL	
CHANNEL	Channel 11	FREQUENCY RANGE	1 ~ 25GHz
INPUT POWER (SYSTEM)	120Vac, 60 Hz	DETECTOR FUNCTION	Peak (PK) Average (AV)
ENVIRONMENTAL CONDITIONS	25deg. C, 65%RH 1000hPa	TEST MODE	A
TESTED BY	Match Tsui		

ANTENNA POLARITY & TEST DISTANCE: HORIZONTAL AT 3 M								
NO.	FREQ. (MHz)	EMISSION LEVEL (dBuV/m)	LIMIT (dBuV/m)	MARGIN (dB)	ANTENNA HEIGHT (m)	TABLE ANGLE (Degree)	RAW VALUE (dBuV)	CORRECTION FACTOR (dB/m)
1	*2462.00	99.96 PK			1.31 H	312	67.48	32.48
2	*2462.00	95.37 AV			1.31 H	312	62.89	32.48
3	2483.50	55.64 PK	74.00	-18.36	1.31 H	312	23.08	32.56
4	2483.50	46.65 AV	54.00	-7.35	1.31 H	312	14.09	32.56
5	4924.00	56.24 PK	74.00	-17.76	1.29 H	113	17.78	38.46
6	4924.00	52.10 AV	54.00	-1.90	1.29 H	113	13.64	38.46
ANTENNA POLARITY & TEST DISTANCE: VERTICAL AT 3 M								
NO.	FREQ. (MHz)	EMISSION LEVEL (dBuV/m)	LIMIT (dBuV/m)	MARGIN (dB)	ANTENNA HEIGHT (m)	TABLE ANGLE (Degree)	RAW VALUE (dBuV)	CORRECTION FACTOR (dB/m)
1	*2462.00	105.28 PK			1.30 V	201	72.80	32.48
2	*2462.00	100.46 AV			1.30 V	201	67.98	32.48
3	2487.00	58.98 PK	74.00	-15.02	1.27 V	210	26.41	32.57
4	2487.00	48.87 AV	54.00	-5.13	1.27 V	210	16.30	32.57
5	4924.00	56.80 PK	74.00	-17.20	1.00 V	166	18.34	38.46
6	4924.00	53.00 AV	54.00	-1.00	1.00 V	166	14.54	38.46

- REMARKS:**
1. Emission level (dBuV/m) = Raw Value (dBuV) + Correction Factor (dB/m).
 2. Correction Factor (dB/m) = Antenna Factor (dB/m) + Cable Factor (dB).
 3. The other emission levels were very low against the limit.
 4. Margin value = Emission level – Limit value.
 5. “ * ”: Fundamental frequency.

EUT TEST CONDITION		MEASUREMENT DETAIL	
CHANNEL	Channel 1	FREQUENCY RANGE	1 ~ 25GHz
INPUT POWER (SYSTEM)	120Vac, 60 Hz	DETECTOR FUNCTION	Peak (PK) Average (AV)
ENVIRONMENTAL CONDITIONS	24deg. C, 64%RH 1000hPa	TEST MODE	B
TESTED BY	Match Tsui		

ANTENNA POLARITY & TEST DISTANCE: HORIZONTAL AT 3 M								
NO.	FREQ. (MHz)	EMISSION LEVEL (dBuV/m)	LIMIT (dBuV/m)	MARGIN (dB)	ANTENNA HEIGHT (m)	TABLE ANGLE (Degree)	RAW VALUE (dBuV)	CORRECTION FACTOR (dB/m)
1	2386.00	57.95 PK	74.00	-16.05	1.27 H	222	25.72	32.23
2	2386.00	47.04 AV	54.00	-6.96	1.27 H	222	14.81	32.23
3	*2412.00	98.07 PK			1.27 H	222	65.75	32.32
4	*2412.00	93.71 AV			1.27 H	222	61.39	32.32
5	4824.00	49.16 PK	74.00	-24.84	1.28 H	67	11.03	38.13
6	4824.00	36.92 AV	54.00	-17.08	1.28 H	67	-1.21	38.13
ANTENNA POLARITY & TEST DISTANCE: VERTICAL AT 3 M								
NO.	FREQ. (MHz)	EMISSION LEVEL (dBuV/m)	LIMIT (dBuV/m)	MARGIN (dB)	ANTENNA HEIGHT (m)	TABLE ANGLE (Degree)	RAW VALUE (dBuV)	CORRECTION FACTOR (dB/m)
1	2386.00	61.86 PK	74.00	-12.14	1.15 V	16	29.63	32.23
2	2386.00	52.13 AV	54.00	-1.87	1.15 V	16	19.90	32.23
3	*2412.00	106.21 PK			1.14 V	21	73.89	32.32
4	*2412.00	101.77 AV			1.14 V	21	69.45	32.32
5	4824.00	49.40 PK	74.00	-24.60	1.21 V	360	11.27	38.13
6	4824.00	39.32 AV	54.00	-14.68	1.21 V	360	1.19	38.13

- REMARKS:**
1. Emission level (dBuV/m) = Raw Value (dBuV) + Correction Factor (dB/m).
 2. Correction Factor (dB/m) = Antenna Factor (dB/m) + Cable Factor (dB).
 3. The other emission levels were very low against the limit.
 4. Margin value = Emission level – Limit value.
 5. “ * “: Fundamental frequency.



EUT TEST CONDITION		MEASUREMENT DETAIL	
CHANNEL	Channel 6	FREQUENCY RANGE	1 ~ 25GHz
INPUT POWER (SYSTEM)	120Vac, 60 Hz	DETECTOR FUNCTION	Peak (PK) Average (AV)
ENVIRONMENTAL CONDITIONS	24deg. C, 64%RH 1000hPa	TEST MODE	B
TESTED BY	Match Tsui		

ANTENNA POLARITY & TEST DISTANCE: HORIZONTAL AT 3 M								
NO.	FREQ. (MHz)	EMISSION LEVEL (dBuV/m)	LIMIT (dBuV/m)	MARGIN (dB)	ANTENNA HEIGHT (m)	TABLE ANGLE (Degree)	RAW VALUE (dBuV)	CORRECTION FACTOR (dB/m)
1	*2437.00	99.04 PK			1.33 H	244	66.64	32.40
2	*2437.00	93.87 AV			1.33 H	244	61.47	32.40
3	4874.00	50.04 PK	74.00	-23.96	1.10 H	0	11.72	38.32
4	4874.00	36.98 AV	54.00	-17.02	1.10 H	0	-1.34	38.32
ANTENNA POLARITY & TEST DISTANCE: VERTICAL AT 3 M								
NO.	FREQ. (MHz)	EMISSION LEVEL (dBuV/m)	LIMIT (dBuV/m)	MARGIN (dB)	ANTENNA HEIGHT (m)	TABLE ANGLE (Degree)	RAW VALUE (dBuV)	CORRECTION FACTOR (dB/m)
1	*2437.00	106.47 PK			1.18 V	350	74.07	32.40
2	*2437.00	102.11 AV			1.18 V	350	69.71	32.40
3	4874.00	50.32 PK	74.00	-23.68	1.19 V	360	12.00	38.32
4	4874.00	39.67 AV	54.00	-14.33	1.19 V	360	1.35	38.32

- REMARKS:**
1. Emission level (dBuV/m) = Raw Value (dBuV) + Correction Factor (dB/m).
 2. Correction Factor (dB/m) = Antenna Factor (dB/m) + Cable Factor (dB).
 3. The other emission levels were very low against the limit.
 4. Margin value = Emission level – Limit value.
 5. “ * “: Fundamental frequency.

EUT TEST CONDITION		MEASUREMENT DETAIL	
CHANNEL	Channel 11	FREQUENCY RANGE	1 ~ 25GHz
INPUT POWER (SYSTEM)	120Vac, 60 Hz	DETECTOR FUNCTION	Peak (PK) Average (AV)
ENVIRONMENTAL CONDITIONS	24deg. C, 64%RH 1000hPa	TEST MODE	B
TESTED BY	Match Tsui		

ANTENNA POLARITY & TEST DISTANCE: HORIZONTAL AT 3 M								
NO.	FREQ. (MHz)	EMISSION LEVEL (dBuV/m)	LIMIT (dBuV/m)	MARGIN (dB)	ANTENNA HEIGHT (m)	TABLE ANGLE (Degree)	RAW VALUE (dBuV)	CORRECTION FACTOR (dB/m)
1	*2462.00	99.87 PK			1.30 H	300	67.39	32.48
2	*2462.00	95.41 AV			1.30 H	300	62.93	32.48
3	2483.50	54.17 PK	74.00	-19.83	1.30 H	300	21.61	32.56
4	2483.50	46.30 AV	54.00	-7.70	1.30 H	300	13.74	32.56
5	4924.00	49.24 PK	74.00	-24.76	1.00 H	360	10.78	38.46
6	4924.00	36.97 AV	54.00	-17.03	1.00 H	360	-1.49	38.46
ANTENNA POLARITY & TEST DISTANCE: VERTICAL AT 3 M								
NO.	FREQ. (MHz)	EMISSION LEVEL (dBuV/m)	LIMIT (dBuV/m)	MARGIN (dB)	ANTENNA HEIGHT (m)	TABLE ANGLE (Degree)	RAW VALUE (dBuV)	CORRECTION FACTOR (dB/m)
1	*2462.00	105.49 PK			1.15 V	180	73.01	32.48
2	*2462.00	100.72 AV			1.15 V	180	68.24	32.48
3	2487.00	59.14 PK	74.00	-14.86	1.15 V	180	26.57	32.57
4	2487.00	49.05 AV	54.00	-4.95	1.15 V	180	16.48	32.57
5	4924.00	50.63 PK	74.00	-23.37	1.15 V	360	12.17	38.46
6	4924.00	39.87 AV	54.00	-14.13	1.15 V	360	1.41	38.46

- REMARKS:**
1. Emission level (dBuV/m) = Raw Value (dBuV) + Correction Factor (dB/m).
 2. Correction Factor (dB/m) = Antenna Factor (dB/m) + Cable Factor (dB).
 3. The other emission levels were very low against the limit.
 4. Margin value = Emission level – Limit value.
 5. “ * “: Fundamental frequency.



802.11g OFDM MODULATION

EUT TEST CONDITION		MEASUREMENT DETAIL	
CHANNEL	Channel 1	FREQUENCY RANGE	1 ~ 25GHz
INPUT POWER (SYSTEM)	120Vac, 60 Hz	DETECTOR FUNCTION	Peak (PK) Average (AV)
ENVIRONMENTAL CONDITIONS	25deg. C, 65%RH 1000hPa	TEST MODE	A
TESTED BY	Match Tsui		

ANTENNA POLARITY & TEST DISTANCE: HORIZONTAL AT 3 M								
NO.	FREQ. (MHz)	EMISSION LEVEL (dBuV/m)	LIMIT (dBuV/m)	MARGIN (dB)	ANTENNA HEIGHT (m)	TABLE ANGLE (Degree)	RAW VALUE (dBuV)	CORRECTION FACTOR (dB/m)
1	2390.00	60.01 PK	74.00	-13.99	1.40 H	267	27.77	32.24
2	2390.00	48.93 AV	54.00	-5.07	1.40 H	267	16.69	32.24
3	*2412.00	104.05 PK			1.40 H	267	71.73	32.32
4	*2412.00	93.76 AV			1.40 H	267	61.44	32.32
5	4824.00	56.51 PK	74.00	-17.49	1.26 H	330	18.38	38.13
6	4824.00	42.52 AV	54.00	-11.48	1.26 H	330	4.39	38.13
ANTENNA POLARITY & TEST DISTANCE: VERTICAL AT 3 M								
NO.	FREQ. (MHz)	EMISSION LEVEL (dBuV/m)	LIMIT (dBuV/m)	MARGIN (dB)	ANTENNA HEIGHT (m)	TABLE ANGLE (Degree)	RAW VALUE (dBuV)	CORRECTION FACTOR (dB/m)
1	2390.00	68.32 PK	74.00	-5.68	1.32 V	75	36.08	32.24
2	2390.00	52.51 AV	54.00	-1.49	1.32 V	75	20.27	32.24
3	*2412.00	111.00 PK			1.25 V	87	78.68	32.32
4	*2412.00	100.68 AV			1.25 V	87	68.36	32.32
5	4824.00	55.76 PK	74.00	-18.24	1.20 V	25	17.63	38.13
6	4824.00	41.46 AV	54.00	-12.54	1.20 V	25	3.33	38.13

- REMARKS:**
1. Emission level (dBuV/m) = Raw Value (dBuV) + Correction Factor (dB/m).
 2. Correction Factor (dB/m) = Antenna Factor (dB/m) + Cable Factor (dB).
 3. The other emission levels were very low against the limit.
 4. Margin value = Emission level – Limit value.
 5. “ * “: Fundamental frequency.

EUT TEST CONDITION		MEASUREMENT DETAIL	
CHANNEL	Channel 6	FREQUENCY RANGE	1 ~ 25GHz
INPUT POWER (SYSTEM)	120Vac, 60 Hz	DETECTOR FUNCTION	Peak (PK) Average (AV)
ENVIRONMENTAL CONDITIONS	25deg. C, 65%RH 1000hPa	TEST MODE	A
TESTED BY	Match Tsui		

ANTENNA POLARITY & TEST DISTANCE: HORIZONTAL AT 3 M								
NO.	FREQ. (MHz)	EMISSION LEVEL (dBuV/m)	LIMIT (dBuV/m)	MARGIN (dB)	ANTENNA HEIGHT (m)	TABLE ANGLE (Degree)	RAW VALUE (dBuV)	CORRECTION FACTOR (dB/m)
1	*2437.00	109.23 PK			1.53 H	290	76.83	32.40
2	*2437.00	99.04 AV			1.53 H	290	66.64	32.40
3	4874.00	64.12 PK	74.00	-9.88	1.16 H	233	25.80	38.32
4	4874.00	50.31 AV	54.00	-3.69	1.16 H	233	11.99	38.32

ANTENNA POLARITY & TEST DISTANCE: VERTICAL AT 3 M								
NO.	FREQ. (MHz)	EMISSION LEVEL (dBuV/m)	LIMIT (dBuV/m)	MARGIN (dB)	ANTENNA HEIGHT (m)	TABLE ANGLE (Degree)	RAW VALUE (dBuV)	CORRECTION FACTOR (dB/m)
1	2390.00	65.29 PK	74.00	-8.71	1.12 V	197	33.05	32.24
2	2390.00	51.27 AV	54.00	-2.73	1.12 V	197	19.03	32.24
3	*2437.00	116.34 PK			1.11 V	195	83.94	32.40
4	*2437.00	105.08 AV			1.11 V	195	72.68	32.40
5	4874.00	63.74 PK	74.00	-10.26	1.07 V	196	25.42	38.32
6	4874.00	50.62 AV	54.00	-3.38	1.07 V	196	12.30	38.32

- REMARKS:**
1. Emission level (dBuV/m) = Raw Value (dBuV) + Correction Factor (dB/m).
 2. Correction Factor (dB/m) = Antenna Factor (dB/m) + Cable Factor (dB).
 3. The other emission levels were very low against the limit.
 4. Margin value = Emission level – Limit value.
 5. “ * “: Fundamental frequency.

EUT TEST CONDITION		MEASUREMENT DETAIL	
CHANNEL	Channel 11	FREQUENCY RANGE	1 ~ 25GHz
INPUT POWER (SYSTEM)	120Vac, 60 Hz	DETECTOR FUNCTION	Peak (PK) Average (AV)
ENVIRONMENTAL CONDITIONS	25deg. C, 65%RH 1000hPa	TEST MODE	A
TESTED BY	Match Tsui		

ANTENNA POLARITY & TEST DISTANCE: HORIZONTAL AT 3 M								
NO.	FREQ. (MHz)	EMISSION LEVEL (dBuV/m)	LIMIT (dBuV/m)	MARGIN (dB)	ANTENNA HEIGHT (m)	TABLE ANGLE (Degree)	RAW VALUE (dBuV)	CORRECTION FACTOR (dB/m)
1	*2462.00	104.57 PK			1.55 H	307	72.09	32.48
2	*2462.00	93.64 AV			1.55 H	307	61.16	32.48
3	2483.50	60.04 PK	74.00	-13.96	1.53 H	308	27.48	32.56
4	2483.50	49.03 AV	54.00	-4.97	1.53 H	308	16.47	32.56
5	4924.00	60.36 PK	74.00	-13.64	1.05 H	229	21.90	38.46
6	4924.00	45.51 AV	54.00	-8.49	1.05 H	229	7.05	38.46
ANTENNA POLARITY & TEST DISTANCE: VERTICAL AT 3 M								
NO.	FREQ. (MHz)	EMISSION LEVEL (dBuV/m)	LIMIT (dBuV/m)	MARGIN (dB)	ANTENNA HEIGHT (m)	TABLE ANGLE (Degree)	RAW VALUE (dBuV)	CORRECTION FACTOR (dB/m)
1	*2462.00	110.27 PK			1.07 V	192	77.79	32.48
2	*2462.00	99.41 AV			1.07 V	192	66.93	32.48
3	2483.50	67.98 PK	74.00	-6.02	1.28 V	201	35.42	32.56
4	2483.50	52.69 AV	54.00	-1.31	1.28 V	201	20.13	32.56
5	4924.00	59.92 PK	74.00	-14.08	1.08 V	193	21.46	38.46
6	4924.00	45.69 AV	54.00	-8.31	1.08 V	193	7.23	38.46

- REMARKS:**
1. Emission level (dBuV/m) = Raw Value (dBuV) + Correction Factor (dB/m).
 2. Correction Factor (dB/m) = Antenna Factor (dB/m) + Cable Factor (dB).
 3. The other emission levels were very low against the limit.
 4. Margin value = Emission level – Limit value.
 5. “ * “: Fundamental frequency.

EUT TEST CONDITION		MEASUREMENT DETAIL	
CHANNEL	Channel 1	FREQUENCY RANGE	1 ~ 25GHz
INPUT POWER (SYSTEM)	120Vac, 60 Hz	DETECTOR FUNCTION	Peak (PK) Average (AV)
ENVIRONMENTAL CONDITIONS	24deg. C, 64%RH 1000hPa	TEST MODE	B
TESTED BY	Match Tsui		

ANTENNA POLARITY & TEST DISTANCE: HORIZONTAL AT 3 M								
NO.	FREQ. (MHz)	EMISSION LEVEL (dBuV/m)	LIMIT (dBuV/m)	MARGIN (dB)	ANTENNA HEIGHT (m)	TABLE ANGLE (Degree)	RAW VALUE (dBuV)	CORRECTION FACTOR (dB/m)
1	2390.00	61.98 PK	74.00	-12.02	1.05 H	360	29.74	32.24
2	2390.00	47.97 AV	54.00	-6.03	1.05 H	360	15.73	32.24
3	*2412.00	102.73 PK			1.05 H	360	70.41	32.32
4	*2412.00	92.00 AV			1.05 H	360	59.68	32.32
5	4824.00	48.93 PK	74.00	-25.07	1.12 H	0	10.80	38.13
6	4824.00	35.62 AV	54.00	-18.38	1.12 H	0	-2.51	38.13
ANTENNA POLARITY & TEST DISTANCE: VERTICAL AT 3 M								
NO.	FREQ. (MHz)	EMISSION LEVEL (dBuV/m)	LIMIT (dBuV/m)	MARGIN (dB)	ANTENNA HEIGHT (m)	TABLE ANGLE (Degree)	RAW VALUE (dBuV)	CORRECTION FACTOR (dB/m)
1	2390.00	65.22 PK	74.00	-8.78	1.20 V	15	32.98	32.24
2	2390.00	52.18 AV	54.00	-1.82	1.20 V	15	19.94	32.24
3	*2412.00	109.87 PK			1.14 V	22	77.55	32.32
4	*2412.00	99.05 AV			1.14 V	22	66.73	32.32
5	4824.00	47.75 PK	74.00	-26.25	1.00 V	360	9.62	38.13
6	4824.00	35.95 AV	54.00	-18.05	1.00 V	360	-2.18	38.13

- REMARKS:**
1. Emission level (dBuV/m) = Raw Value (dBuV) + Correction Factor (dB/m).
 2. Correction Factor (dB/m) = Antenna Factor (dB/m) + Cable Factor (dB).
 3. The other emission levels were very low against the limit.
 4. Margin value = Emission level – Limit value.
 5. “ * ”: Fundamental frequency.

EUT TEST CONDITION		MEASUREMENT DETAIL	
CHANNEL	Channel 6	FREQUENCY RANGE	1 ~ 25GHz
INPUT POWER (SYSTEM)	120Vac, 60 Hz	DETECTOR FUNCTION	Peak (PK) Average (AV)
ENVIRONMENTAL CONDITIONS	24deg. C, 64%RH 1000hPa	TEST MODE	B
TESTED BY	Match Tsui		

ANTENNA POLARITY & TEST DISTANCE: HORIZONTAL AT 3 M								
NO.	FREQ. (MHz)	EMISSION LEVEL (dBuV/m)	LIMIT (dBuV/m)	MARGIN (dB)	ANTENNA HEIGHT (m)	TABLE ANGLE (Degree)	RAW VALUE (dBuV)	CORRECTION FACTOR (dB/m)
1	*2437.00	108.33 PK			1.03 H	345	75.93	32.40
2	*2437.00	98.11 AV			1.03 H	345	65.71	32.40
3	4874.00	50.31 PK	74.00	-23.69	1.11 H	0	11.99	38.32
4	4874.00	38.42 AV	54.00	-15.58	1.11 H	0	0.10	38.32

ANTENNA POLARITY & TEST DISTANCE: VERTICAL AT 3 M								
NO.	FREQ. (MHz)	EMISSION LEVEL (dBuV/m)	LIMIT (dBuV/m)	MARGIN (dB)	ANTENNA HEIGHT (m)	TABLE ANGLE (Degree)	RAW VALUE (dBuV)	CORRECTION FACTOR (dB/m)
1	2390.00	66.17 PK	74.00	-7.83	1.17 V	210	33.93	32.24
2	2390.00	51.62 AV	54.00	-2.38	1.17 V	210	19.38	32.24
3	*2437.00	115.53 PK			1.17 V	210	83.13	32.40
4	*2437.00	104.17 AV			1.17 V	210	71.77	32.40
5	4874.00	51.24 PK	74.00	-22.76	1.01 V	344	12.92	38.32
6	4874.00	39.74 AV	54.00	-14.26	1.01 V	344	1.42	38.32

- REMARKS:**
1. Emission level (dBuV/m) = Raw Value (dBuV) + Correction Factor (dB/m).
 2. Correction Factor (dB/m) = Antenna Factor (dB/m) + Cable Factor (dB).
 3. The other emission levels were very low against the limit.
 4. Margin value = Emission level – Limit value.
 5. “ * “: Fundamental frequency.

EUT TEST CONDITION		MEASUREMENT DETAIL	
CHANNEL	Channel 11	FREQUENCY RANGE	1 ~ 25GHz
INPUT POWER (SYSTEM)	120Vac, 60 Hz	DETECTOR FUNCTION	Peak (PK) Average (AV)
ENVIRONMENTAL CONDITIONS	24deg. C, 64%RH 1000hPa	TEST MODE	B
TESTED BY	Match Tsui		

ANTENNA POLARITY & TEST DISTANCE: HORIZONTAL AT 3 M								
NO.	FREQ. (MHz)	EMISSION LEVEL (dBuV/m)	LIMIT (dBuV/m)	MARGIN (dB)	ANTENNA HEIGHT (m)	TABLE ANGLE (Degree)	RAW VALUE (dBuV)	CORRECTION FACTOR (dB/m)
1	*2462.00	103.26 PK			1.06 H	10	70.78	32.48
2	*2462.00	92.41 AV			1.06 H	10	59.93	32.48
3	2483.50	60.41 PK	74.00	-13.59	1.06 H	10	27.85	32.56
4	2483.50	49.23 AV	54.00	-4.77	1.06 H	10	16.67	32.56
5	4924.00	49.11 PK	74.00	-24.89	1.06 H	0	10.65	38.46
6	4924.00	35.96 AV	54.00	-18.04	1.06 H	0	-2.50	38.46
ANTENNA POLARITY & TEST DISTANCE: VERTICAL AT 3 M								
NO.	FREQ. (MHz)	EMISSION LEVEL (dBuV/m)	LIMIT (dBuV/m)	MARGIN (dB)	ANTENNA HEIGHT (m)	TABLE ANGLE (Degree)	RAW VALUE (dBuV)	CORRECTION FACTOR (dB/m)
1	*2462.00	110.04 PK			1.19 V	300	77.56	32.48
2	*2462.00	99.31 AV			1.19 V	300	66.83	32.48
3	2483.50	68.12 PK	74.00	-5.88	1.19 V	0	35.56	32.56
4	2483.50	52.88 AV	54.00	-1.12	1.19 V	0	20.32	32.56
5	4924.00	47.59 PK	74.00	-26.41	1.10 V	0	9.13	38.46
6	4924.00	36.05 AV	54.00	-17.95	1.10 V	0	-2.41	38.46

- REMARKS:**
1. Emission level (dBuV/m) = Raw Value (dBuV) + Correction Factor (dB/m).
 2. Correction Factor (dB/m) = Antenna Factor (dB/m) + Cable Factor (dB).
 3. The other emission levels were very low against the limit.
 4. Margin value = Emission level – Limit value.
 5. “ * ”: Fundamental frequency.



BELOW 1GHz WORST-CASE DATA : 802.11g OFDM MODULATION

EUT TEST CONDITION		MEASUREMENT DETAIL	
CHANNEL	Channel 6	FREQUENCY RANGE	Below 1000MHz
INPUT POWER (SYSTEM)	120Vac, 60 Hz	DETECTOR FUNCTION	Quasi-Peak
ENVIRONMENTAL CONDITIONS	28deg. C, 63%RH 999hPa	TEST MODE	A
TESTED BY	Rober Tsai		

ANTENNA POLARITY & TEST DISTANCE: HORIZONTAL AT 3 M								
NO.	FREQ. (MHz)	EMISSION LEVEL (dBuV/m)	LIMIT (dBuV/m)	MARGIN (dB)	ANTENNA HEIGHT (m)	TABLE ANGLE (Degree)	RAW VALUE (dBuV)	CORRECTION FACTOR (dB/m)
1	74.60	29.95 QP	40.00	-10.05	1.98 H	291	21.71	8.24
2	108.54	37.18 QP	43.50	-6.32	2.00 H	156	25.36	11.82
3	111.42	31.94 QP	43.50	-11.56	2.00 H	336	19.79	12.15
4	124.92	30.44 QP	43.50	-13.06	2.00 H	261	17.29	13.15
5	130.86	31.62 QP	43.50	-11.88	1.53 H	18	18.46	13.16
6	165.24	29.78 QP	43.50	-13.72	2.00 H	205	17.15	12.63
7	198.13	29.34 QP	43.50	-14.16	1.08 H	5	18.90	10.44
8	231.71	36.05 QP	46.00	-9.95	2.44 H	225	22.61	13.44
9	250.00	39.68 QP	46.00	-6.32	1.96 H	122	24.48	15.20
10	352.01	31.76 QP	46.00	-14.24	2.50 H	216	14.75	17.01
11	500.03	41.35 QP	46.00	-4.65	2.32 H	255	20.77	20.58
12	525.03	32.09 QP	46.00	-13.91	2.00 H	216	10.66	21.43
13	600.04	29.24 QP	46.00	-16.76	1.00 H	20	5.42	23.82
14	625.00	31.14 QP	46.00	-14.86	2.10 H	353	7.09	24.05
15	750.00	31.28 QP	46.00	-14.72	1.00 H	309	5.72	25.56
16	933.02	32.32 QP	46.00	-13.68	2.07 H	310	5.24	27.08

- REMARKS:**
1. Emission level (dBuV/m) = Raw Value (dBuV) + Correction Factor (dB/m).
 2. Correction Factor (dB/m) = Antenna Factor (dB/m) + Cable Factor (dB).
 3. The other emission levels were very low against the limit.
 4. Margin value = Emission level – Limit value.

EUT TEST CONDITION		MEASUREMENT DETAIL	
CHANNEL	Channel 6	FREQUENCY RANGE	Below 1000MHz
INPUT POWER (SYSTEM)	120Vac, 60 Hz	DETECTOR FUNCTION	Quasi-Peak
ENVIRONMENTAL CONDITIONS	28deg. C, 63%RH 999hPa	TEST MODE	A
TESTED BY	Rober Tsai		

ANTENNA POLARITY & TEST DISTANCE: VERTICAL AT 3 M								
NO.	FREQ. (MHz)	EMISSION LEVEL (dBuV/m)	LIMIT (dBuV/m)	MARGIN (dB)	ANTENNA HEIGHT (m)	TABLE ANGLE (Degree)	RAW VALUE (dBuV)	CORRECTION FACTOR (dB/m)
1	38.95	37.38 QP	40.00	-2.62	1.78 V	180	22.41	14.97
2	39.48	37.83 QP	40.00	-2.17	1.00 V	204	23.14	14.69
3	58.73	35.51 QP	40.00	-4.49	1.72 V	168	29.00	6.51
4	66.30	36.70 QP	40.00	-3.30	1.34 V	134	29.65	7.05
5	86.07	37.20 QP	40.00	-2.80	1.44 V	89	27.52	9.68
6	87.67	37.70 QP	40.00	-2.30	1.00 V	14	27.84	9.86
7	108.74	40.82 QP	43.50	-2.68	2.00 V	157	28.97	11.85
8	125.02	39.34 QP	43.50	-4.16	1.54 V	16	26.19	13.15
9	143.39	40.02 QP	43.50	-3.48	1.00 V	358	26.89	13.13
10	151.43	39.89 QP	43.50	-3.61	1.57 V	114	26.80	13.09
11	155.55	37.45 QP	43.50	-6.05	1.99 V	12	24.24	13.21
12	162.90	35.90 QP	43.50	-7.60	1.00 V	201	22.95	12.95
13	229.88	32.49 QP	46.00	-13.51	1.00 V	116	19.22	13.27
14	250.01	40.16 QP	46.00	-5.84	1.00 V	19	24.96	15.20
15	500.00	41.94 QP	46.00	-4.06	1.60 V	91	21.36	20.58
16	529.00	36.09 QP	46.00	-9.91	1.51 V	142	14.53	21.56
17	575.04	34.22 QP	46.00	-11.78	1.54 V	45	11.17	23.05
18	600.01	35.19 QP	46.00	-10.81	1.99 V	9	11.37	23.82
19	625.05	31.75 QP	46.00	-14.25	1.51 V	321	7.69	24.06
20	667.70	33.68 QP	46.00	-12.32	1.62 V	210	9.26	24.42
21	750.90	30.12 QP	46.00	-15.88	2.05 V	103	4.55	25.57

- REMARKS:**
1. Emission level (dBuV/m) = Raw Value (dBuV) + Correction Factor (dB/m).
 2. Correction Factor (dB/m) = Antenna Factor (dB/m) + Cable Factor (dB).
 3. The other emission levels were very low against the limit.
 4. Margin value = Emission level – Limit value.



BELOW 1GHz WORST-CASE DATA : 802.11g OFDM MODULATION

EUT TEST CONDITION		MEASUREMENT DETAIL	
CHANNEL	Channel 6	FREQUENCY RANGE	Below 1000MHz
INPUT POWER (SYSTEM)	120Vac, 60 Hz	DETECTOR FUNCTION	Quasi-Peak
ENVIRONMENTAL CONDITIONS	28deg. C, 63%RH 999hPa	TEST MODE	B
TESTED BY	Rober Tsai		

ANTENNA POLARITY & TEST DISTANCE: HORIZONTAL AT 3 M								
NO.	FREQ. (MHz)	EMISSION LEVEL (dBuV/m)	LIMIT (dBuV/m)	MARGIN (dB)	ANTENNA HEIGHT (m)	TABLE ANGLE (Degree)	RAW VALUE (dBuV)	CORRECTION FACTOR (dB/m)
1	39.26	28.06 QP	40.00	-11.94	1.59 H	285	13.26	14.80
2	62.35	28.90 QP	40.00	-11.10	1.00 H	171	22.45	6.45
3	86.12	29.04 QP	40.00	-10.96	1.40 H	179	19.36	9.68
4	110.89	36.62 QP	43.50	-6.88	2.54 H	261	24.53	12.09
5	131.73	30.09 QP	43.50	-13.41	2.04 H	44	16.93	13.16
6	165.63	30.99 QP	43.50	-12.51	1.56 H	320	18.41	12.58
7	250.00	40.41 QP	46.00	-5.59	1.00 H	340	25.21	15.20
8	275.00	32.02 QP	46.00	-13.98	1.99 H	182	16.54	15.48
9	500.05	31.31 QP	46.00	-14.69	1.00 H	110	10.73	20.58
10	575.02	30.18 QP	46.00	-15.82	1.28 H	229	7.13	23.05
11	600.04	32.43 QP	46.00	-13.57	1.53 H	323	8.61	23.82
12	850.01	31.20 QP	46.00	-14.80	1.65 H	238	4.74	26.46

- REMARKS:**
1. Emission level (dBuV/m) = Raw Value (dBuV) + Correction Factor (dB/m).
 2. Correction Factor (dB/m) = Antenna Factor (dB/m) + Cable Factor (dB).
 3. The other emission levels were very low against the limit.
 4. Margin value = Emission level – Limit value.

EUT TEST CONDITION		MEASUREMENT DETAIL	
CHANNEL	Channel 6	FREQUENCY RANGE	Below 1000MHz
INPUT POWER (SYSTEM)	120Vac, 60 Hz	DETECTOR FUNCTION	Quasi-Peak
ENVIRONMENTAL CONDITIONS	28deg. C, 63%RH 999hPa	TEST MODE	B
TESTED BY	Rober Tsai		

ANTENNA POLARITY & TEST DISTANCE: VERTICAL AT 3 M								
NO.	FREQ. (MHz)	EMISSION LEVEL (dBuV/m)	LIMIT (dBuV/m)	MARGIN (dB)	ANTENNA HEIGHT (m)	TABLE ANGLE (Degree)	RAW VALUE (dBuV)	CORRECTION FACTOR (dB/m)
1	39.55	32.52 QP	40.00	-7.48	1.00 V	170	17.87	14.65
2	43.90	36.02 QP	40.00	-3.98	1.00 V	305	23.90	12.12
3	51.12	37.75 QP	40.00	-2.25	1.28 V	59	28.74	9.01
4	62.25	36.51 QP	40.00	-3.49	1.94 V	88	30.08	6.43
5	66.30	36.01 QP	40.00	-3.99	1.20 V	2	28.96	7.05
6	79.30	35.39 QP	40.00	-4.61	1.23 V	99	26.51	8.88
7	86.12	37.03 QP	40.00	-2.97	1.29 V	344	27.35	9.68
8	110.59	34.02 QP	43.50	-9.48	1.00 V	320	21.96	12.06
9	163.38	31.36 QP	43.50	-12.14	1.00 V	88	18.47	12.89
10	175.03	32.26 QP	43.50	-11.24	1.00 V	219	20.97	11.29
11	250.00	37.47 QP	46.00	-8.53	1.50 V	68	22.27	15.20
12	500.05	31.31 QP	46.00	-14.69	1.66 V	187	10.73	20.58
13	575.00	31.21 QP	46.00	-14.79	1.54 V	24	8.17	23.04
14	650.03	30.81 QP	46.00	-15.19	1.00 V	28	6.52	24.29
15	750.01	32.02 QP	46.00	-13.98	1.13 V	110	6.46	25.56
16	850.00	31.01 QP	46.00	-14.99	2.54 V	259	4.55	26.46

- REMARKS:**
1. Emission level (dBuV/m) = Raw Value (dBuV) + Correction Factor (dB/m).
 2. Correction Factor (dB/m) = Antenna Factor (dB/m) + Cable Factor (dB).
 3. The other emission levels were very low against the limit.
 4. Margin value = Emission level – Limit value.



4.2 CONDUCTED EMISSION MEASUREMENT

4.2.1 LIMITS OF CONDUCTED EMISSION MEASUREMENT

FREQUENCY OF EMISSION (MHz)	CONDUCTED LIMIT (dB μ V)	
	Quasi-peak	Average
0.15 ~ 0.5	66 to 56	56 to 46
0.5 ~ 5	56	46
5 ~ 30	60	50

- NOTE:** 1. The lower limit shall apply at the transition frequencies.
 2. The limit decreases in line with the logarithm of the frequency in the range of 0.15 to 0.50MHz.
 3. All emanations from a class A/B digital device or system, including any network of conductors and apparatus connected thereto, shall not exceed the level of field strengths specified above.

4.2.2 TEST INSTRUMENTS

DESCRIPTION & MANUFACTURER	MODEL NO.	SERIAL NO.	DATE OF CALIBRATION	DUE DATE OF CALIBRATION
Test Receiver ROHDE & SCHWARZ	ESCS30	100291	Nov. 22, 2007	Nov. 21, 2008
RF signal cable Woken	5D-FB	Cable-HYC01-01	Jan. 04, 2008	Jan. 03, 2009
LISN ROHDE & SCHWARZ	ESH3-Z5	100312	Jun. 13, 2008	Jun. 12, 2009
V-LISN SCHWARZBECK	NNBL 8226-2	8226-142	Jun. 10, 2008	Jun. 09, 2009
Software ADT	ADT_Cond_V3	NA	NA	NA

- NOTE:** 1. The calibration interval of the above test instruments is 12 months and the calibrations are traceable to NML/ROC and NIST/USA.
 2. The test was performed in HwaYa Shielded Room 1.
 3. The VCCI Site Registration No. is C-2040.

4.2.3 TEST PROCEDURES

- a. The EUT was placed 0.4 meters from the conducting wall of the shielded room with EUT being connected to the power mains through a line impedance stabilization network (LISN). Other support units were connected to the power mains through another LISN. The two LISNs provide 50 ohm/ 50uH of coupling impedance for the measuring instrument.
- b. Both lines of the power mains connected to the EUT were checked for maximum conducted interference.
- c. The frequency range from 150kHz to 30MHz was searched. Emission levels under (Limit - 20dB) was not recorded.

NOTE: All modes of operation were investigated and the worst-case emissions are reported.

4.2.4 DEVIATION FROM TEST STANDARD

No deviation

4.2.5 TEST SETUP

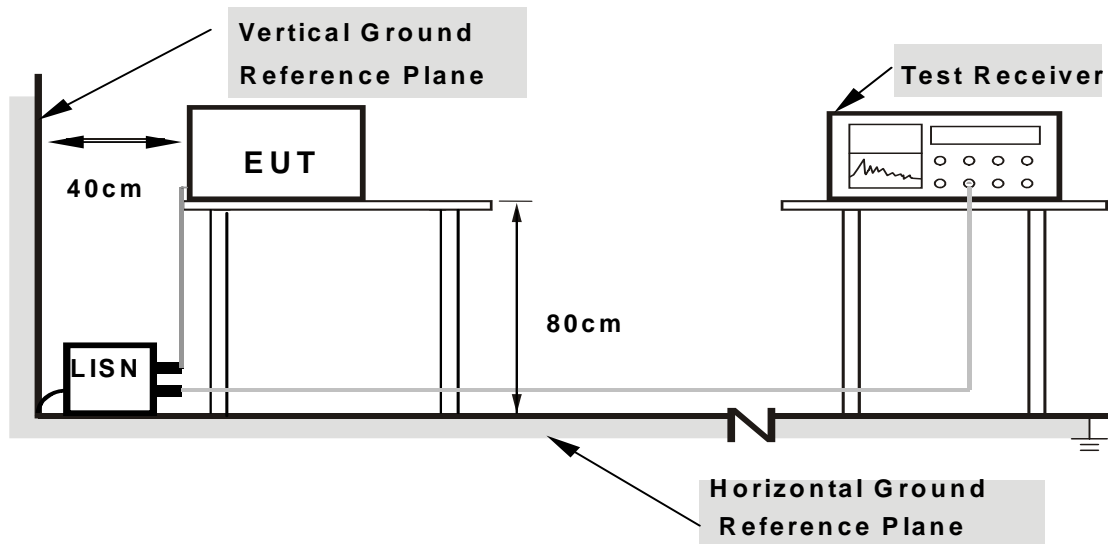

- Note:**
1. Support units were connected to second LISN.
 2. Both of LISNs (AMN) are 80 cm from EUT and at least 80 from other units and other metal planes

For the actual test configuration, please refer to the attached file (Test Setup Photo).

4.2.6 EUT OPERATING CONDITIONS

Same as 4.1.6.

4.2.7 TEST RESULTS

CONDUCTED WORST-CASE DATA : 802.11g OFDM MODULATION

EUT TEST CONDITION		MEASUREMENT DETAIL	
CHANNEL	Channel 6	PHASE	Line 1
MODULATION TYPE	BPSK	INPUT POWER (SYSTEM)	120Vac, 60Hz
TRANSFER RATE	6.0Mbps	6dB BANDWIDTH	9kHz
ENVIRONMENTAL CONDITIONS	20deg. C, 60%RH, 988hPa	TEST MODE	A
TESTED BY	Match Tsui		

No	Freq. [MHz]	Corr. Factor (dB)	Reading Value [dB (uV)]		Emission Level [dB (uV)]		Limit [dB (uV)]		Margin (dB)	
			Q.P.	AV.	Q.P.	AV.	Q.P.	AV.	Q.P.	AV.
1	0.150	0.06	46.71	-	46.77	-	66.00	56.00	-19.23	-
2	0.224	0.06	39.40	-	39.46	-	62.66	52.66	-23.20	-
3	0.435	0.07	37.21	-	37.28	-	57.15	47.15	-19.87	-
4	1.441	0.10	34.08	-	34.18	-	56.00	46.00	-21.82	-
5	2.035	0.12	33.62	-	33.74	-	56.00	46.00	-22.26	-
6	16.227	1.38	37.04	-	38.42	-	60.00	50.00	-21.58	-

- REMARKS:**
1. Q.P. and AV. are abbreviations of quasi-peak and average individually.
 2. "-": The Quasi-peak reading value also meets average limit and measurement with the average detector is unnecessary.
 3. The emission levels of other frequencies were very low against the limit.
 4. Margin value = Emission level - Limit value
 5. Correction factor = Insertion loss + Cable loss
 6. Emission Level = Correction Factor + Reading Value.

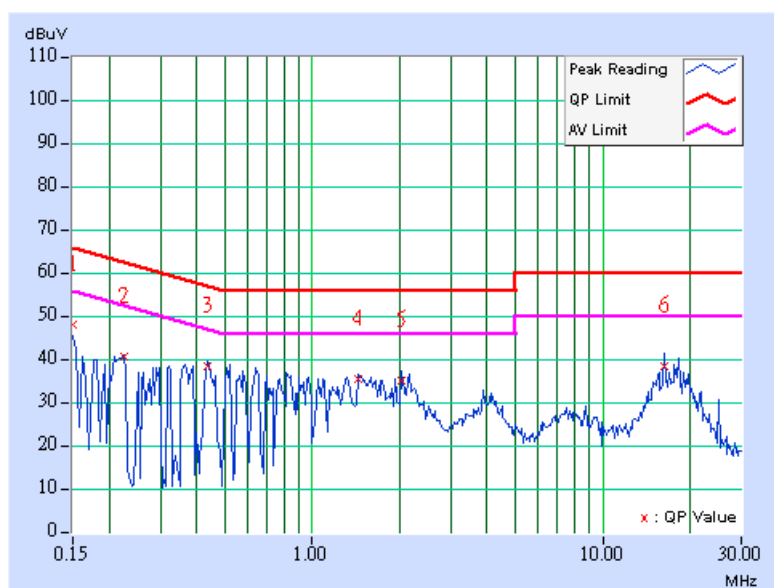

EUT TEST CONDITION		MEASUREMENT DETAIL	
CHANNEL	Channel 6	PHASE	Line 2
MODULATION TYPE	BPSK	INPUT POWER (SYSTEM)	120Vac, 60Hz
TRANSFER RATE	6.0Mbps	6dB BANDWIDTH	9kHz
ENVIRONMENTAL CONDITIONS	20deg. C, 60%RH, 988hPa	TEST MODE	A
TESTED BY	Match Tsui		

No	Freq. [MHz]	Corr. Factor (dB)	Reading Value [dB (uV)]		Emission Level [dB (uV)]		Limit [dB (uV)]		Margin (dB)	
			Q.P.	AV.	Q.P.	AV.	Q.P.	AV.	Q.P.	AV.
1	0.154	0.08	42.17	-	42.25	-	65.79	55.79	-23.54	-
2	0.205	0.08	41.75	-	41.83	-	63.42	53.42	-21.59	-
3	0.287	0.08	38.63	-	38.71	-	60.62	50.62	-21.90	-
4	0.939	0.11	35.93	-	36.04	-	56.00	46.00	-19.96	-
5	1.930	0.13	34.46	-	34.59	-	56.00	46.00	-21.41	-
6	16.230	0.98	37.85	-	38.83	-	60.00	50.00	-21.17	-

- REMARKS:**
1. Q.P. and AV. are abbreviations of quasi-peak and average individually.
 2. "-": The Quasi-peak reading value also meets average limit and measurement with the average detector is unnecessary.
 3. The emission levels of other frequencies were very low against the limit.
 4. Margin value = Emission level - Limit value
 5. Correction factor = Insertion loss + Cable loss
 6. Emission Level = Correction Factor + Reading Value.

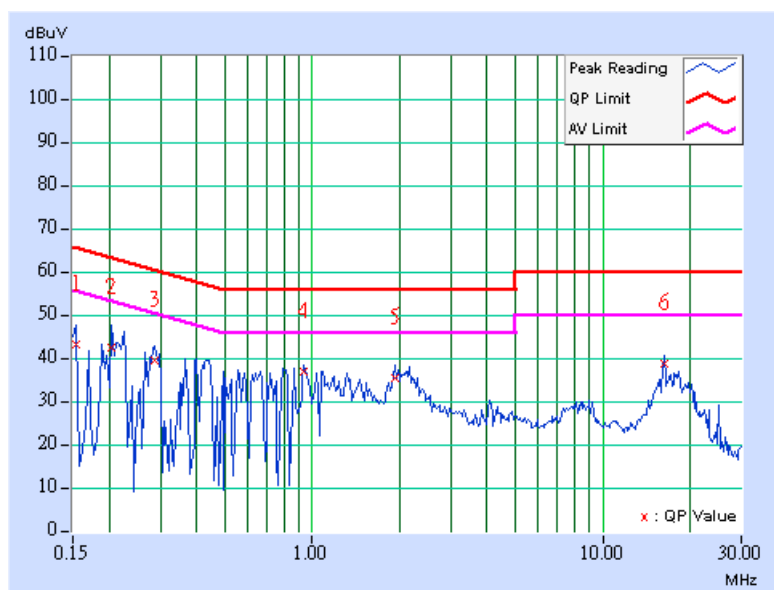

EUT TEST CONDITION		MEASUREMENT DETAIL	
CHANNEL	Channel 6	PHASE	Line 1
MODULATION TYPE	BPSK	INPUT POWER (SYSTEM)	120Vac, 60Hz
TRANSFER RATE	6.0Mbps	6dB BANDWIDTH	9kHz
ENVIRONMENTAL CONDITIONS	20deg. C, 60%RH, 988hPa	TEST MODE	B
TESTED BY	Match Tsui		

No	Freq. [MHz]	Corr. Factor (dB)	Reading Value [dB (uV)]		Emission Level [dB (uV)]		Limit [dB (uV)]		Margin (dB)	
			Q.P.	AV.	Q.P.	AV.	Q.P.	AV.	Q.P.	AV.
1	0.150	0.20	44.16	-	44.36	-	66.00	56.00	-21.64	-
2	0.271	0.20	31.75	-	31.95	-	61.08	51.08	-29.13	-
3	0.447	0.20	33.33	-	33.53	-	56.93	46.93	-23.40	-
4	1.449	0.20	32.19	-	32.39	-	56.00	46.00	-23.61	-
5	2.113	0.21	30.36	-	30.57	-	56.00	46.00	-25.43	-
6	17.691	0.91	40.95	-	41.86	-	60.00	50.00	-18.14	-

- REMARKS:**
1. Q.P. and AV. are abbreviations of quasi-peak and average individually.
 2. "-": The Quasi-peak reading value also meets average limit and measurement with the average detector is unnecessary.
 3. The emission levels of other frequencies were very low against the limit.
 4. Margin value = Emission level - Limit value
 5. Correction factor = Insertion loss + Cable loss
 6. Emission Level = Correction Factor + Reading Value.

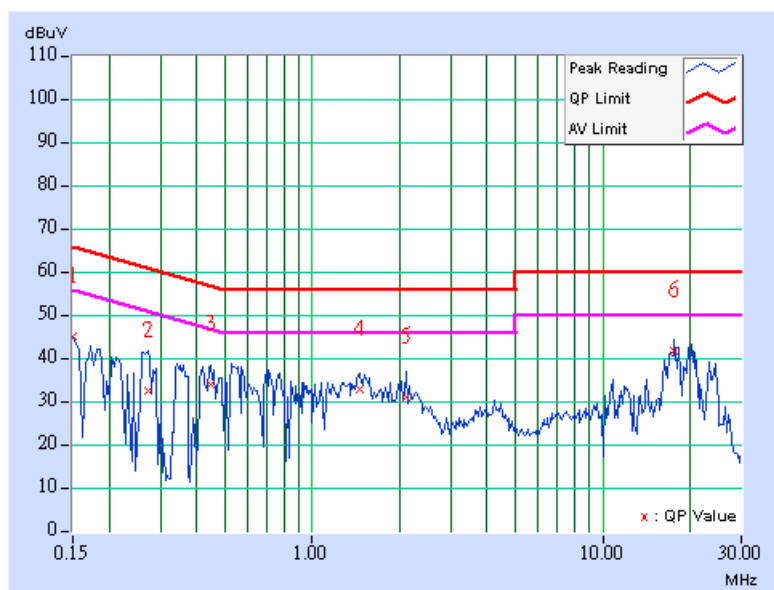

EUT TEST CONDITION		MEASUREMENT DETAIL	
CHANNEL	Channel 6	PHASE	Line 2
MODULATION TYPE	BPSK	INPUT POWER (SYSTEM)	120Vac, 60Hz
TRANSFER RATE	6.0Mbps	6dB BANDWIDTH	9kHz
ENVIRONMENTAL CONDITIONS	20deg. C, 60%RH, 988hPa	TEST MODE	B
TESTED BY	Match Tsui		

No	Freq. [MHz]	Corr. Factor (dB)	Reading Value [dB (uV)]		Emission Level [dB (uV)]		Limit [dB (uV)]		Margin (dB)	
			Q.P.	AV.	Q.P.	AV.	Q.P.	AV.	Q.P.	AV.
1	0.150	0.20	46.00	-	46.20	-	66.00	56.00	-19.80	-
2	0.193	0.20	44.51	-	44.71	-	63.91	53.91	-19.20	-
3	0.287	0.20	38.72	-	38.92	-	60.62	50.62	-21.70	-
4	1.020	0.20	30.65	-	30.85	-	56.00	46.00	-25.15	-
5	2.117	0.21	32.51	-	32.72	-	56.00	46.00	-23.28	-
6	17.694	0.51	41.83	-	42.34	-	60.00	50.00	-17.66	-

- REMARKS:**
1. Q.P. and AV. are abbreviations of quasi-peak and average individually.
 2. "-": The Quasi-peak reading value also meets average limit and measurement with the average detector is unnecessary.
 3. The emission levels of other frequencies were very low against the limit.
 4. Margin value = Emission level - Limit value
 5. Correction factor = Insertion loss + Cable loss
 6. Emission Level = Correction Factor + Reading Value.

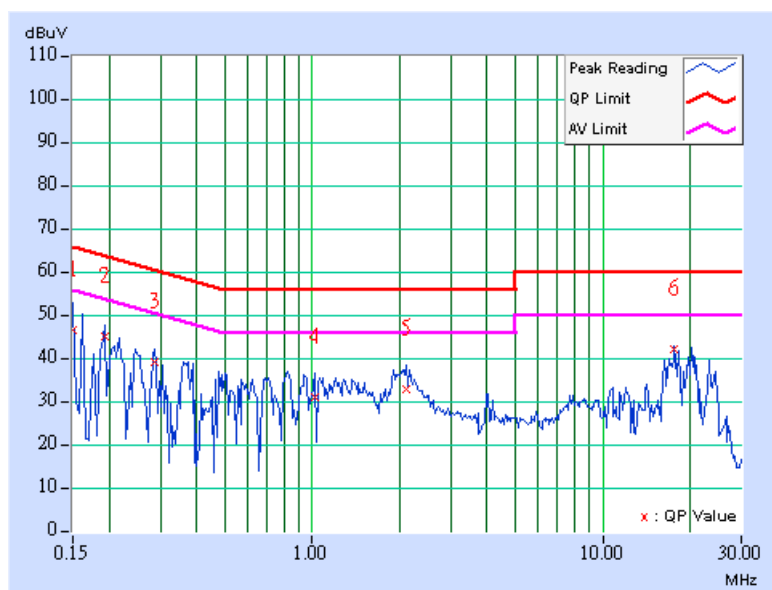



4.3 6dB BANDWIDTH MEASUREMENT

4.3.1 LIMITS OF 6dB BANDWIDTH MEASUREMENT

The minimum of 6dB Bandwidth Measurement is 0.5 MHz.

4.3.2 TEST INSTRUMENTS

DESCRIPTION & MANUFACTURER	MODEL NO.	SERIAL NO.	DATE OF CALIBRATION	CALIBRATED UNTIL
R&S SPECTRUM ANALYZER	FSP40	100041	Apr. 22, 2008	Apr. 21, 2009

NOTE: The calibration interval of the above test instruments is 12 months and the calibrations are traceable to NML/ROC and NIST/USA.

4.3.3 TEST PROCEDURE

The transmitter output was connected to the spectrum analyzer through an attenuator. The bandwidth of the fundamental frequency was measured by spectrum analyzer with 100kHz RBW and 300kHz VBW. The 6dB bandwidth is defined as the total spectrum the power of which is higher than peak power minus 6dB.

4.3.4 DEVIATION FROM TEST STANDARD

No deviation

4.3.5 TEST SETUP

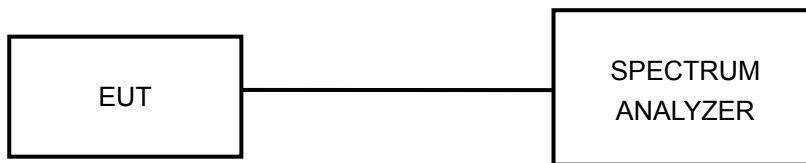

4.3.6 EUT OPERATING CONDITIONS

The software provided by client to enable the EUT under transmission condition continuously at lowest, middle and highest channel frequencies individually.

4.3.7 TEST RESULTS

802.11b DSSS MODULATION

MODULATION TYPE	DBPSK	TRANSFER RATE	1.0Mbps
INPUT POWER (SYSTEM)	120Vac, 60Hz	ENVIRONMENTAL CONDITIONS	27deg.C, 66%RH, 991hPa
TESTED BY	Dean Wang		

CHANNEL	CHANNEL FREQUENCY (MHz)	6dB BANDWIDTH (MHz)	MINIMUM LIMIT (MHz)	PASS / FAIL
1	2412	10.20	0.5	PASS
6	2437	12.07	0.5	PASS
11	2462	12.10	0.5	PASS

CH 1

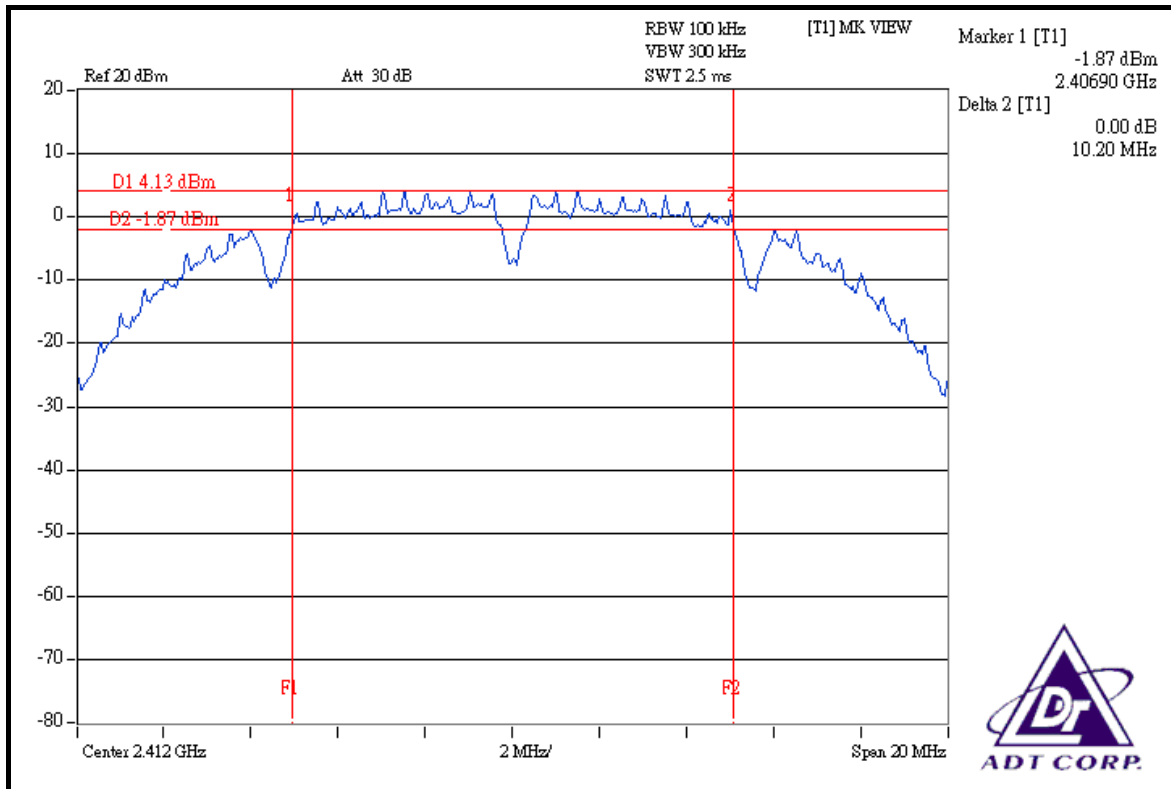



CH 6

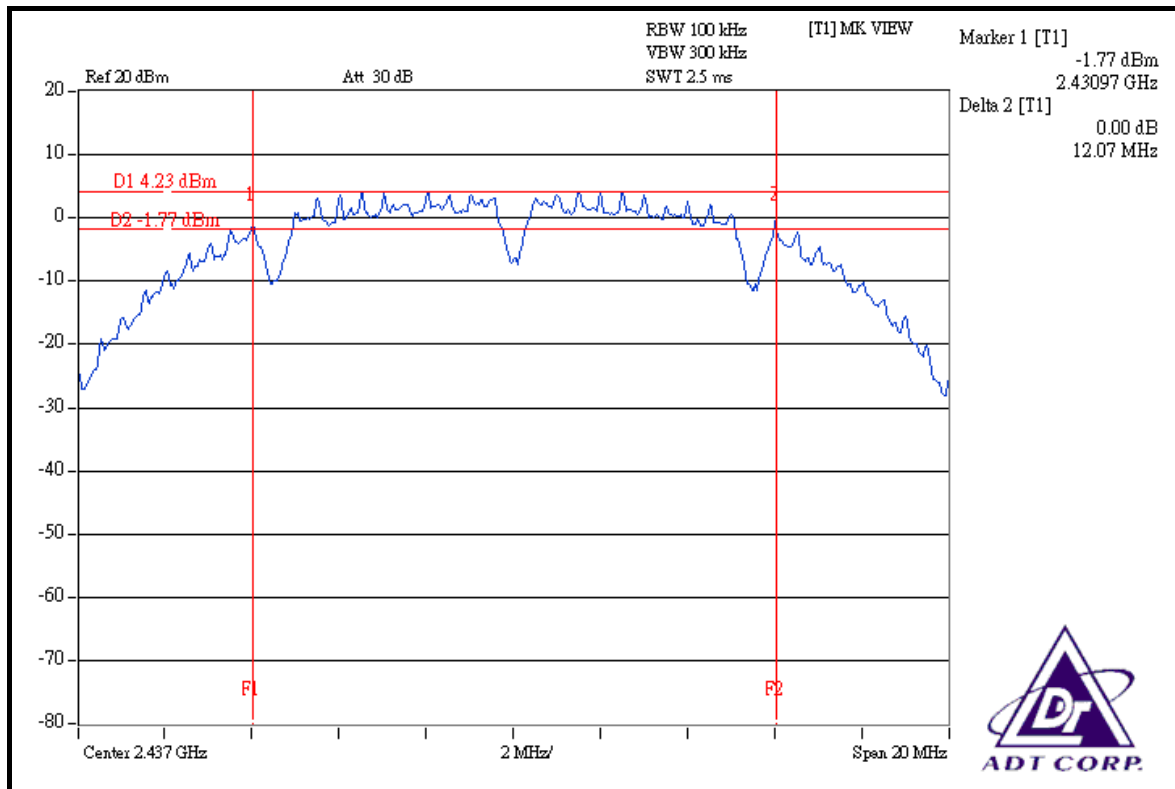

CH 11

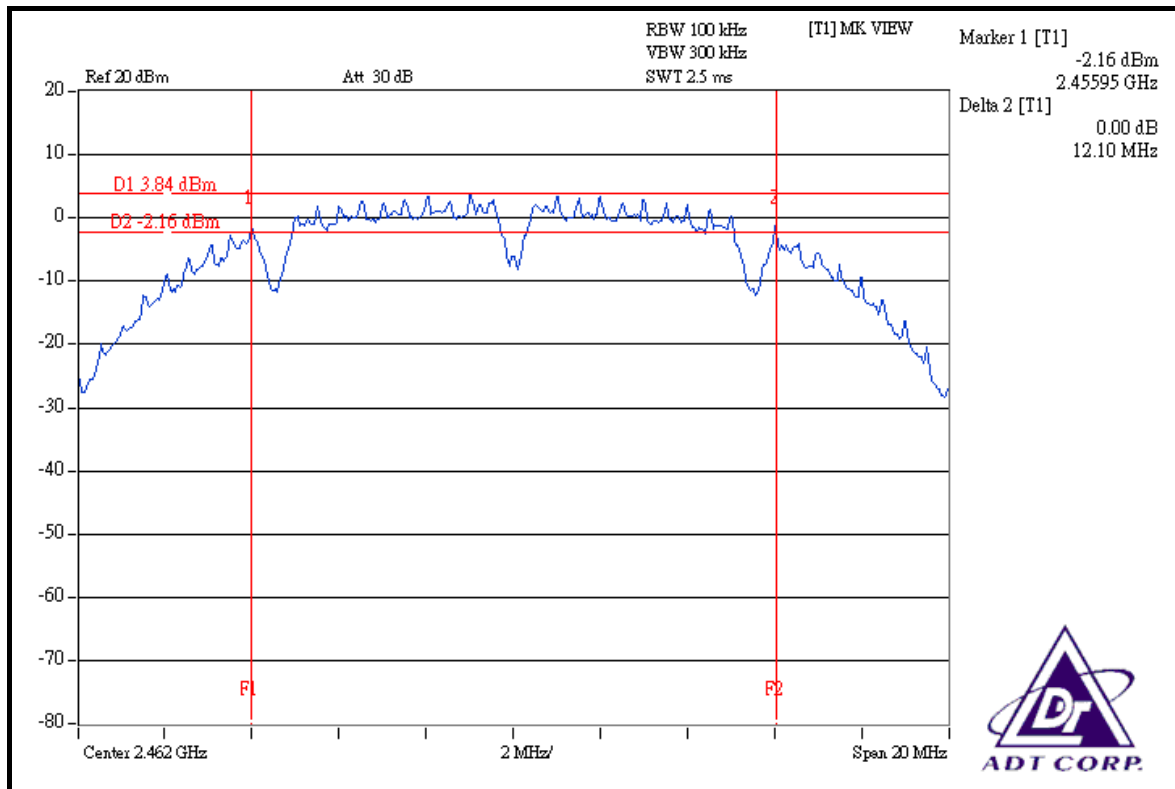



802.11g OFDM MODULATION

MODULATION TYPE	BPSK	TRANSFER RATE	6.0Mbps
INPUT POWER (SYSTEM)	120Vac, 60Hz	ENVIRONMENTAL CONDITIONS	27deg.C, 66%RH, 991hPa
TESTED BY	Dean Wang		

CHANNEL	CHANNEL FREQUENCY (MHz)	6dB BANDWIDTH (MHz)	MINIMUM LIMIT (MHz)	PASS / FAIL
1	2412	16.40	0.5	PASS
6	2437	16.47	0.5	PASS
11	2462	16.56	0.5	PASS

CH 1

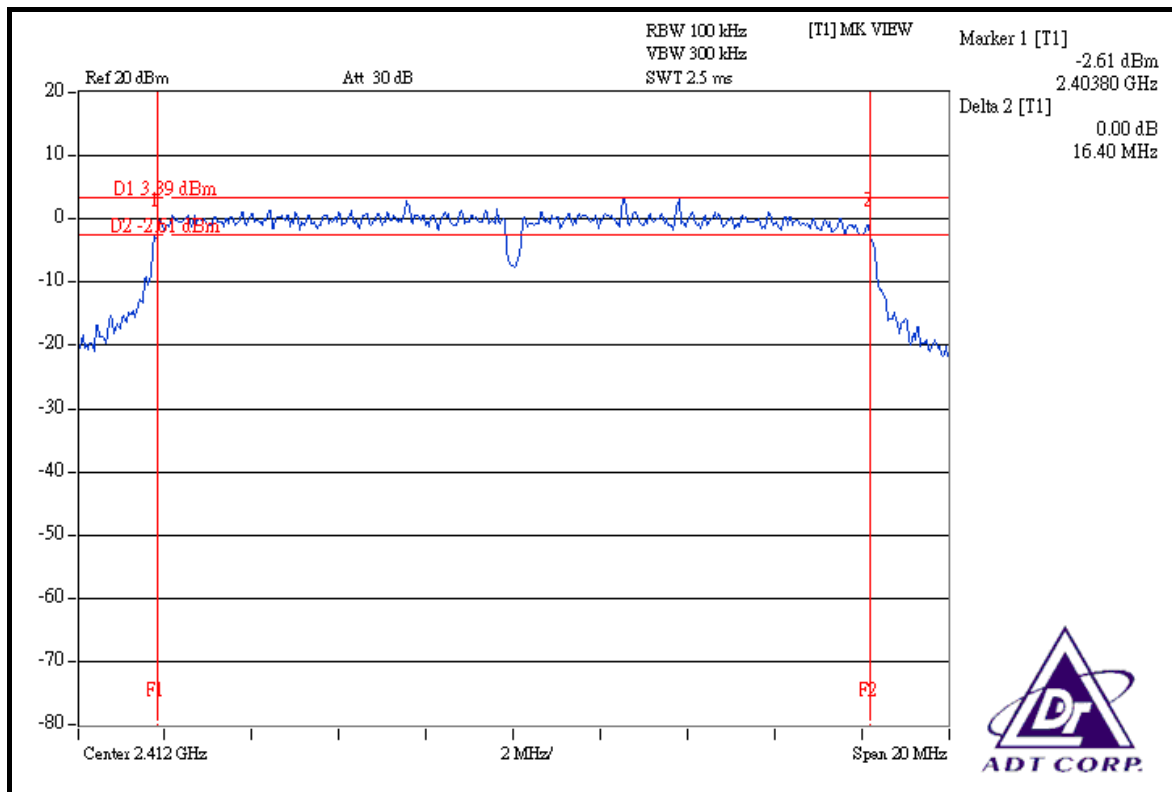

CH 6

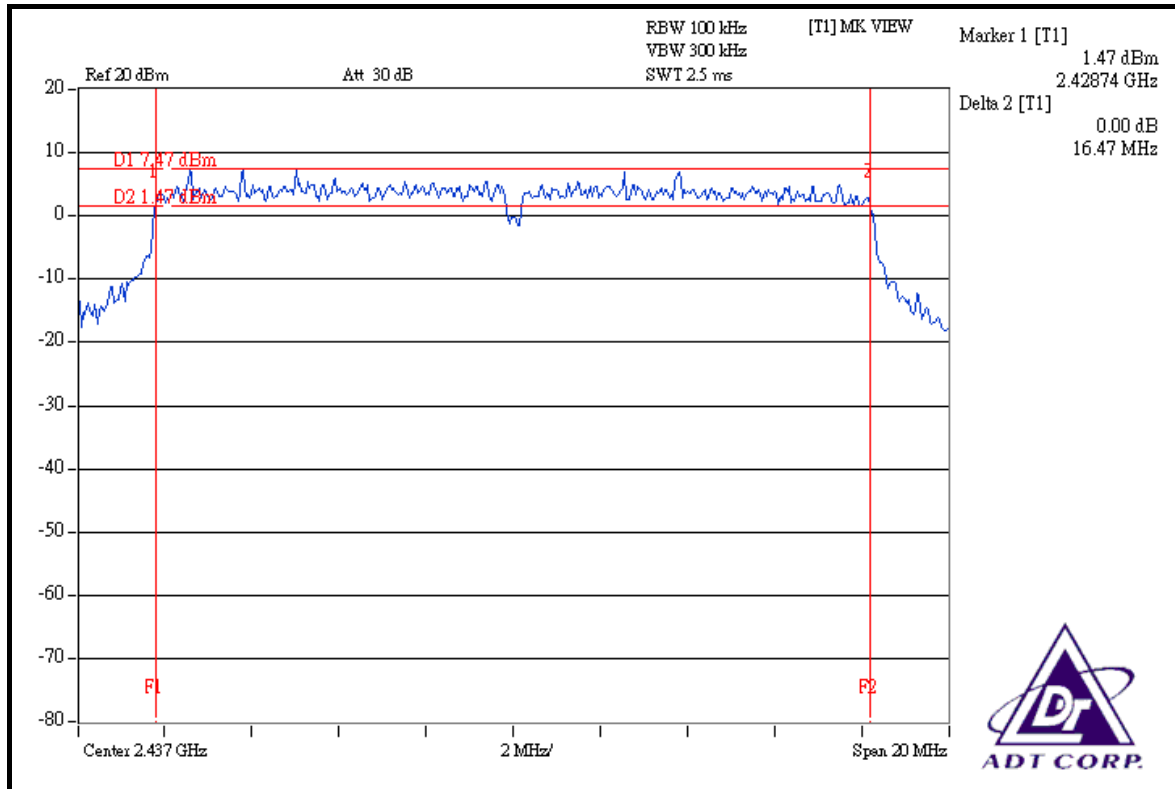

CH 11

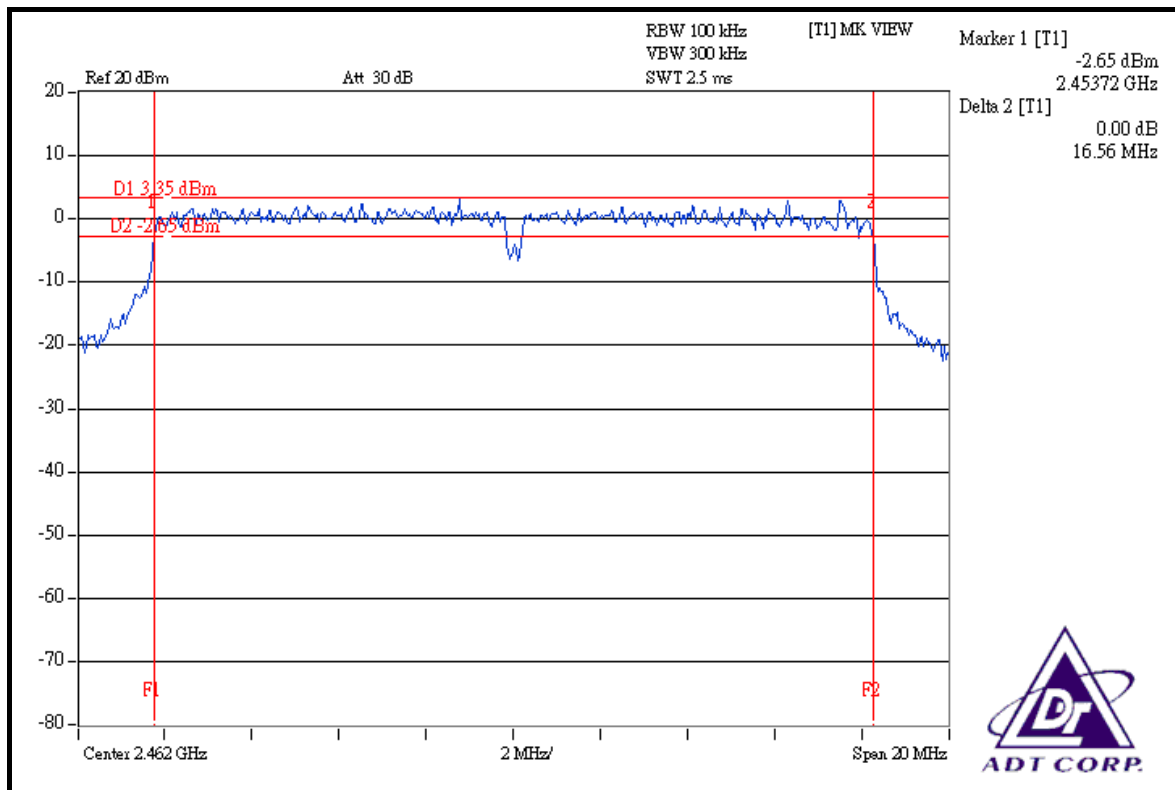



4.4 MAXIMUM PEAK OUTPUT POWER

4.4.1 LIMITS OF MAXIMUM PEAK OUTPUT POWER MEASUREMENT

The Maximum Peak Output Power Measurement is 30dBm.

4.4.2 INSTRUMENTS

DESCRIPTION & MANUFACTURER	MODEL NO.	SERIAL NO.	DATE OF CALIBRATION	CALIBRATED UNTIL
R&S SPECTRUM ANALYZER	FSP40	100041	Apr. 22, 2008	Apr. 21, 2009
AGILENT SYNTHESIZED SIGNAL GENERATOR	E8257C	MY43320668	Dec. 26, 2007	Dec. 25, 2008
DIGITAL RT OSCILLOSCOPE	TDS1012	C037299	Nov. 22, 2007	Nov. 21, 2008
NARDA DETECTOR	4503A	FSCM99899	NA	NA

NOTE: The calibration interval of the above test instruments is 12 months and the calibrations are traceable to NML/ROC and NIST/USA.

4.4.3 TEST PROCEDURES

- a. A detector was used on the output port of the EUT. An oscilloscope was used to read the response of the detector.
- b. Replaced the EUT by the signal generator. The center frequency of the S.G was adjusted to the center frequency of the measured channel.
- c. Adjusted the power to have the same reading on oscilloscope. Record the power level.

4.4.4 DEVIATION FROM TEST STANDARD

No deviation

4.4.5 TEST SETUP



4.4.6 EUT OPERATING CONDITIONS

Same as Item 5.3.6



4.4.7 TEST RESULTS

802.11b DSSS MODULATION

MODULATION TYPE	DBPSK	TRANSFER RATE	1.0Mbps
INPUT POWER (SYSTEM)	120Vac, 60Hz	ENVIRONMENTAL CONDITIONS	27deg.C, 66%RH, 991hPa
TESTED BY	Dean Wang		

CHANNEL	CHANNEL FREQUENCY (MHz)	PEAK POWER OUTPUT (mW)	PEAK POWER OUTPUT (dBm)	PEAK POWER LIMIT (dBm)	PASS / FAIL
1	2412	51.050	17.08	30	PASS
6	2437	50.816	17.06	30	PASS
11	2462	45.709	16.60	30	PASS

802.11g OFDM MODULATION

MODULATION TYPE	BPSK	TRANSFER RATE	6.0Mbps
INPUT POWER (SYSTEM)	120Vac, 60Hz	ENVIRONMENTAL CONDITIONS	25 deg.C, 65 %RH, 991hPa
TESTED BY	Dean Wang		

CHANNEL	CHANNEL FREQUENCY (MHz)	PEAK POWER OUTPUT (mW)	PEAK POWER OUTPUT (dBm)	PEAK POWER LIMIT (dBm)	PASS / FAIL
1	2412	126.474	21.02	30	PASS
6	2437	319.154	25.04	30	PASS
11	2462	129.122	21.11	30	PASS



4.5 POWER SPECTRAL DENSITY MEASUREMENT

4.5.1 LIMITS OF POWER SPECTRAL DENSITY MEASUREMENT

The Maximum of Power Spectral Density Measurement is 8dBm.

4.5.2 TEST INSTRUMENTS

DESCRIPTION & MANUFACTURER	MODEL NO.	SERIAL NO.	DATE OF CALIBRATION	CALIBRATED UNTIL
R&S SPECTRUM ANALYZER	FSP40	100041	Apr. 22, 2008	Apr. 21, 2009

NOTE: The calibration interval of the above test instruments is 12 months and the calibrations are traceable to NML/ROC and NIST/USA.

4.5.3 TEST PROCEDURE

The transmitter output was connected to the spectrum analyzer through an attenuator, the bandwidth of the fundamental frequency was measured with the spectrum analyzer using 3kHz RBW and 30kHz VBW, set sweep time = span/3kHz. The power spectral density was measured and recorded.

The sweep time is allowed to be longer than span/3kHz for a full response of the mixer in the spectrum analyzer.

4.5.4 DEVIATION FROM TEST STANDARD

No deviation

4.5.5 TEST SETUP

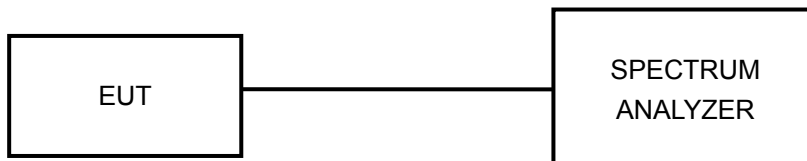

4.5.6 EUT OPERATING CONDITION

Same as Item 4.3.6



4.5.7 TEST RESULTS

802.11b DSSS MODULATION

MODULATION TYPE	DBPSK	TRANSFER RATE	1.0Mbps
INPUT POWER (SYSTEM)	120Vac, 60Hz	ENVIRONMENTAL CONDITIONS	27deg.C, 66%RH, 991hPa
TESTED BY	Dean Wang		

CHANNEL	CHANNEL FREQUENCY (MHz)	RF POWER LEVEL IN 3kHz BW (dBm)	MAXIMUM LIMIT (dBm)	PASS / FAIL
1	2412	-9.24	8	PASS
6	2437	-9.18	8	PASS
11	2462	-9.58	8	PASS

CH 1

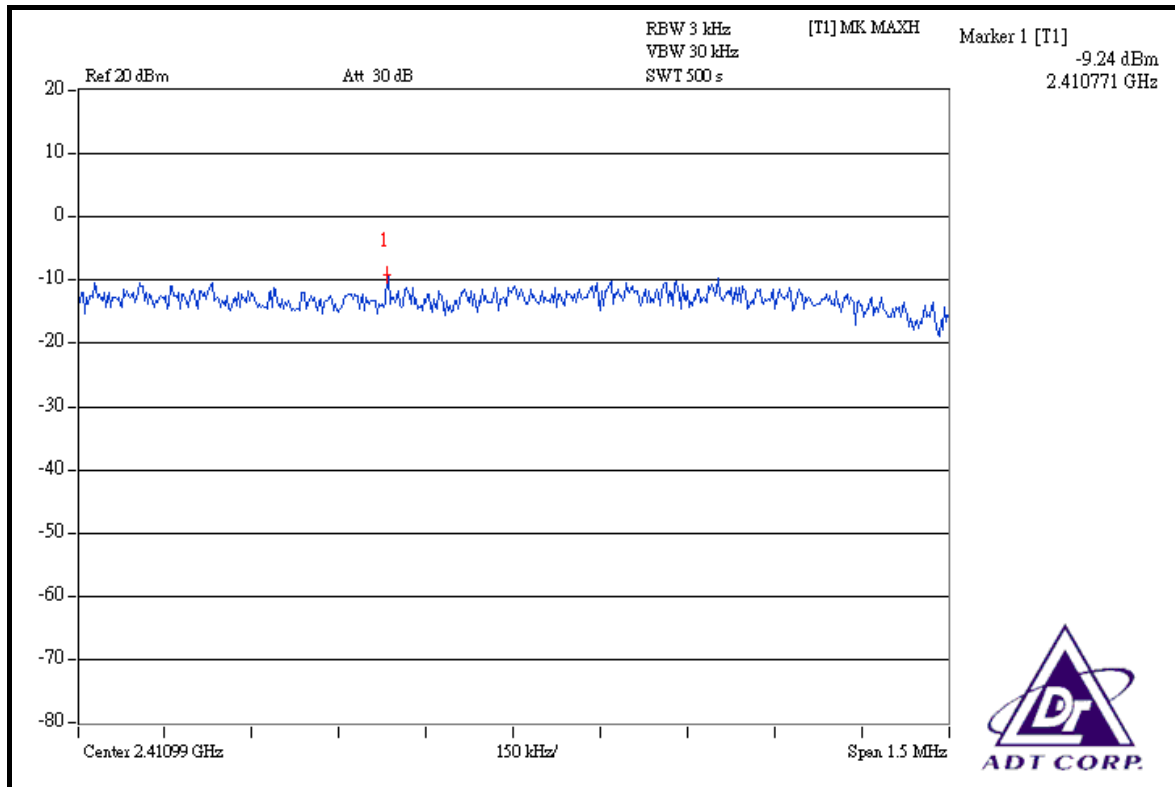



CH 6

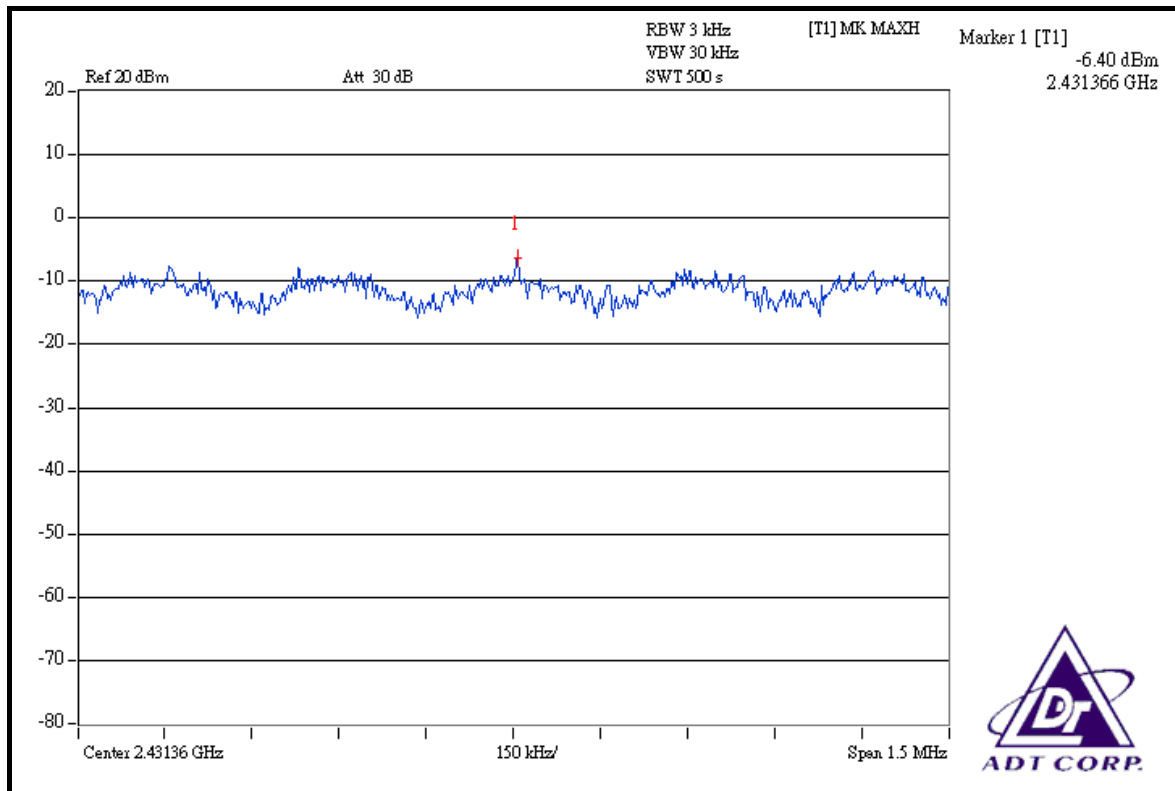

CH 11

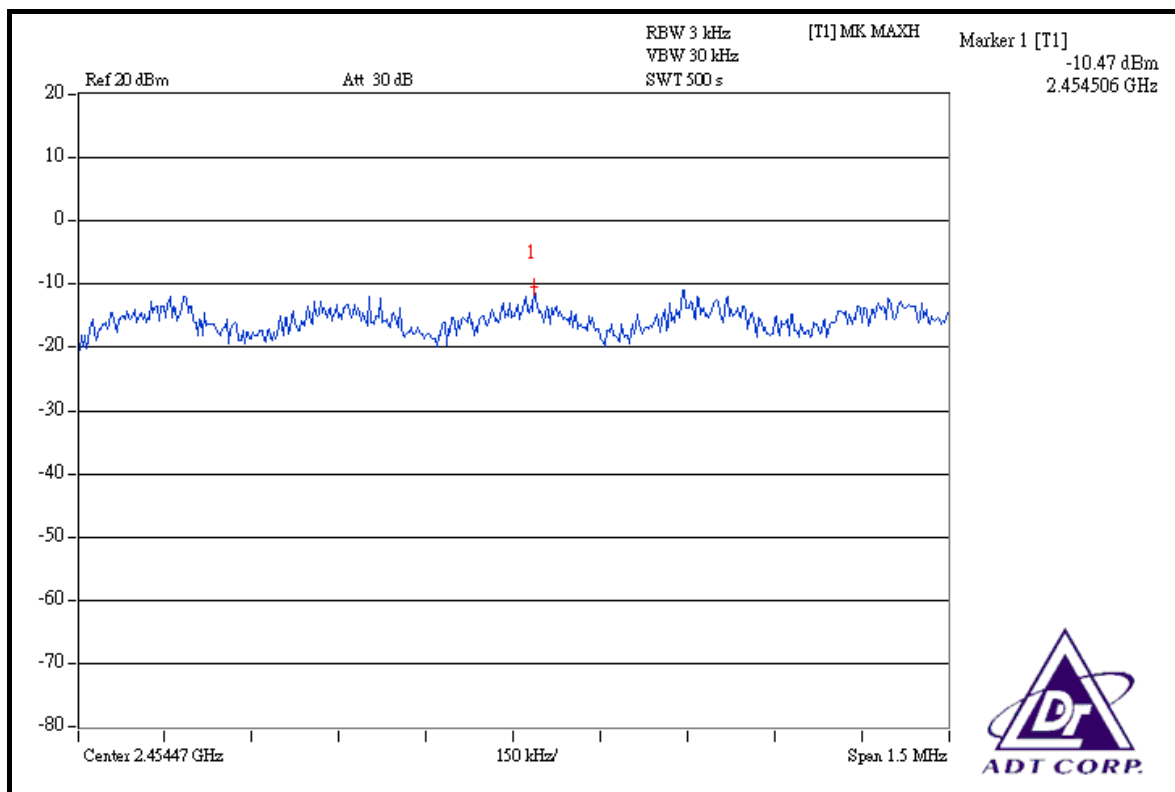



4.6 BAND EDGES MEASUREMENT

4.6.1 LIMITS OF BAND EDGES MEASUREMENT

Below -20dB of the highest emission level of operating band (in 100kHz Resolution Bandwidth).

4.6.2 TEST INSTRUMENTS

DESCRIPTION & MANUFACTURER	MODEL NO.	SERIAL NO.	DATE OF CALIBRATION	CALIBRATED UNTIL
R&S SPECTRUM ANALYZER	FSP40	100041	Apr. 22, 2008	Apr. 21, 2009

NOTE: The calibration interval of the above test instruments is 12 months and the calibrations are traceable to NML/ROC and NIST/USA.

4.6.3 TEST PROCEDURE

The transmitter output was connected to the spectrum analyzer via a low lose cable. Set both RBW and VBW of spectrum analyzer to 100kHz and 300kHz with suitable frequency span including 100MHz bandwidth from band edge. The band edges was measured and recorded.

The spectrum plots (Peak RBW=100kHz, VBW=300kHz; Average RBW=1MHz, VBW= 10Hz are attached on the following pages.

4.6.4 DEVIATION FROM TEST STANDARD

No deviation

4.6.5 EUT OPERATING CONDITION

Same as Item 4.3.6

4.6.6 TEST RESULTS

The spectrum plots are attached on the following pages. D1 line indicates the highest level, and D2 line indicates the 20dB offset below D1. It shows compliance with the requirement in part 15.247(d).

802.11b DSSS MODULATION

TEST MODE A

NOTE 1: The band edge emission plot on the next second page shows 46.32dBc between carrier maximum power and local maximum emission in restrict band (2.3866GHz). The emission of carrier strength list in the test result of channel 1 at the item 4.1.7 is 106.67dBuV/m (Peak), so the maximum field strength in restrict band is $106.67 - 46.32 = 60.35$ dBuV/m which is under 74dBuV/m limit.

The band edge emission plot of on the next second page shows 49.43dBc between carrier maximum power and local maximum emission in restrict band (2.3866GHz). The emission of carrier strength list in the test result of channel 1 at the item 4.1.7 is 101.93dBuV/m (Average), so the maximum field strength in restrict band is $101.93 - 49.43 = 52.50$ dBuV/m which is under 54dBuV/m limit.

NOTE 2: The band edge emission plot on the next third page shows 50.53dBc between carrier maximum power and local maximum emission in restrict band (2.4878GHz). The emission of carrier strength list in the test result of channel 11 at the item 4.1.7 is 105.28dBuV/m (Peak), so the maximum field strength in restrict band is $105.28 - 50.53 = 54.75$ dBuV/m which is under 74dBuV/m limit.

The band edge emission plot on the next fourth page shows 53.47dBc between carrier maximum power and local maximum emission in restrict band (2.4884GHz). The emission of carrier strength list in the test result of channel 11 at the item 4.1.7 is 100.46dBuV/m (Average), so the maximum field strength in restrict band is $100.46 - 53.47 = 46.99$ dBuV/m which is under 54dBuV/m limit.

TEST MODE B

NOTE 1: The band edge emission plot on the next page shows 46.32dBc between carrier maximum power and local maximum emission in restrict band (2.3866GHz). The emission of carrier strength list in the test result of channel 1 at the item 4.1.7 is 106.21dBuV/m (Peak), so the maximum field strength in restrict band is $106.21 - 46.32 = 59.89$ dBuV/m which is under 74dBuV/m limit.

The band edge emission plot of on the next page shows 49.43dBc between carrier maximum power and local maximum emission in restrict band (2.3866GHz). The emission of carrier strength list in the test result of channel 1 at the item 4.1.7 is 101.77dBuV/m (Average), so the maximum field strength in restrict band is $101.77 - 49.43 = 52.34$ dBuV/m which is under 54dBuV/m limit.

NOTE 2: The band edge emission plot on the next second page shows 50.53dBc between carrier maximum power and local maximum emission in restrict band (2.4878GHz). The emission of carrier strength list in the test result of channel 11 at the item 4.1.7 is 105.49dBuV/m (Peak), so the maximum field strength in restrict band is $105.49 - 50.53 = 54.96$ dBuV/m which is under 74dBuV/m limit.

The band edge emission plot on the next third page shows 53.47dBc between carrier maximum power and local maximum emission in restrict band (2.4884GHz). The emission of carrier strength list in the test result of channel 11 at the item 4.1.7 is 100.72dBuV/m (Average), so the maximum field strength in restrict band is $100.72 - 53.47 = 47.25$ dBuV/m which is under 54dBuV/m limit.

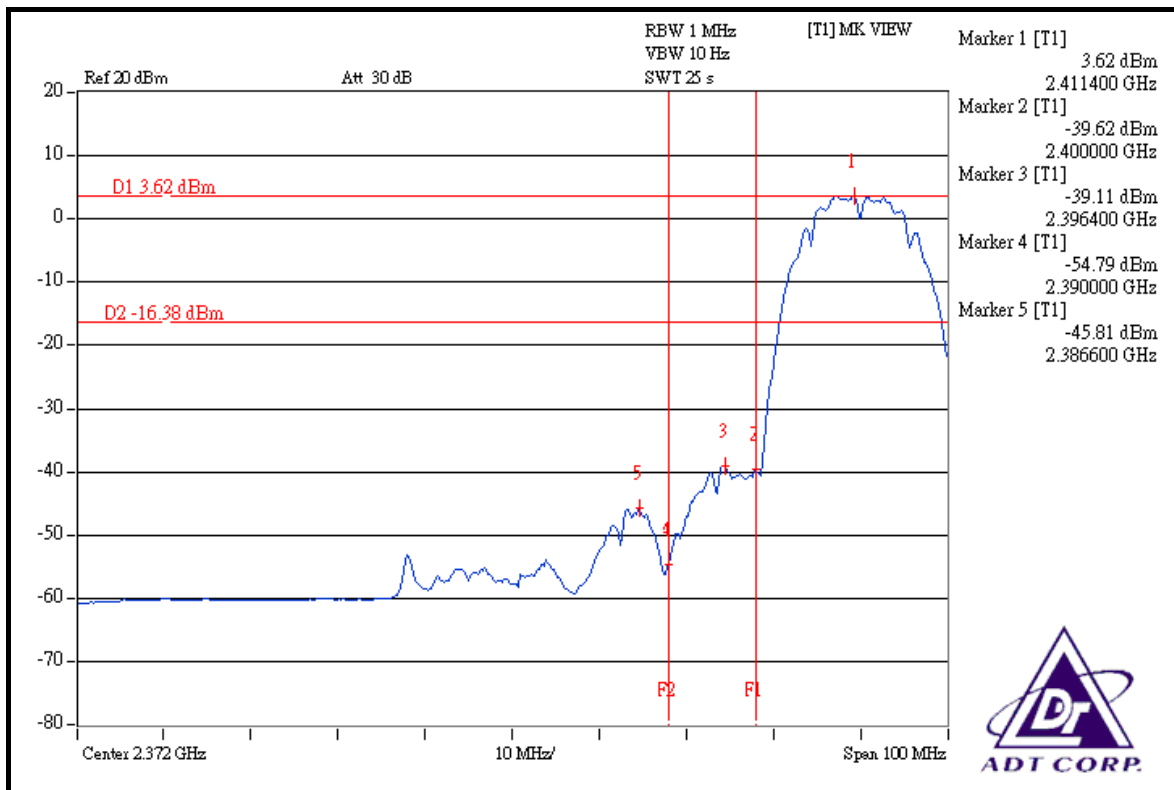
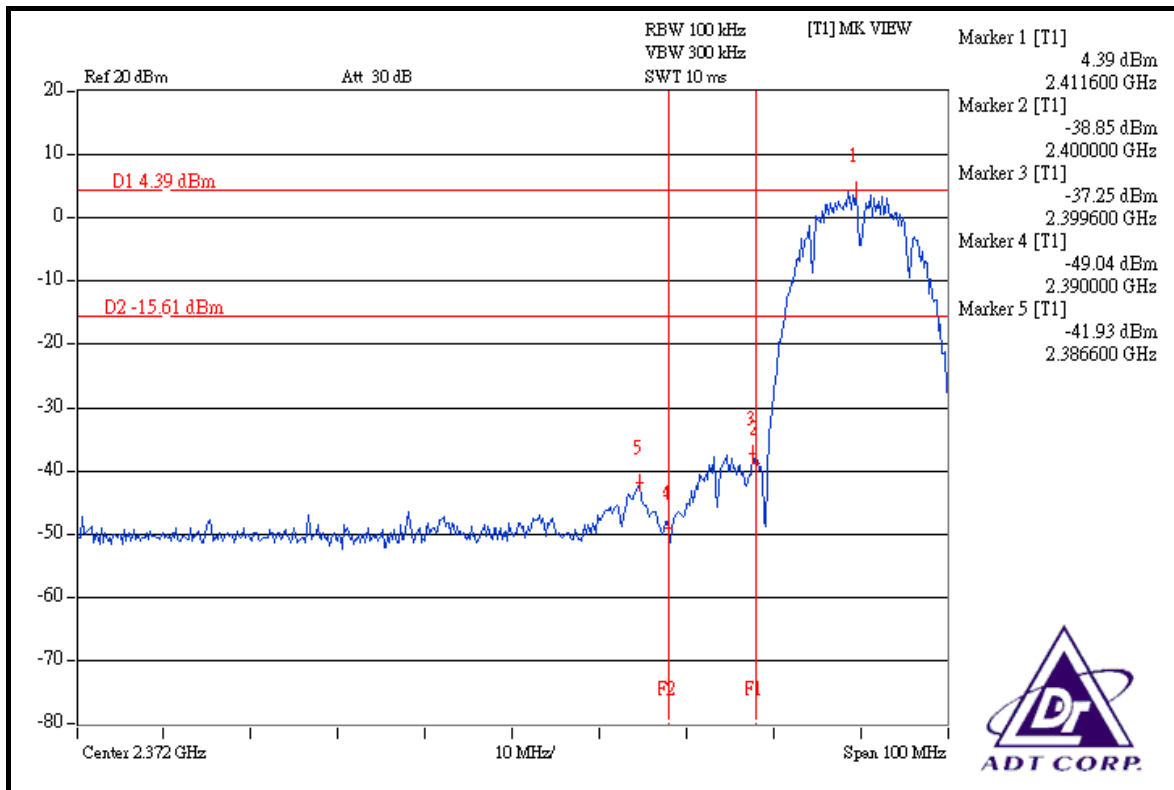

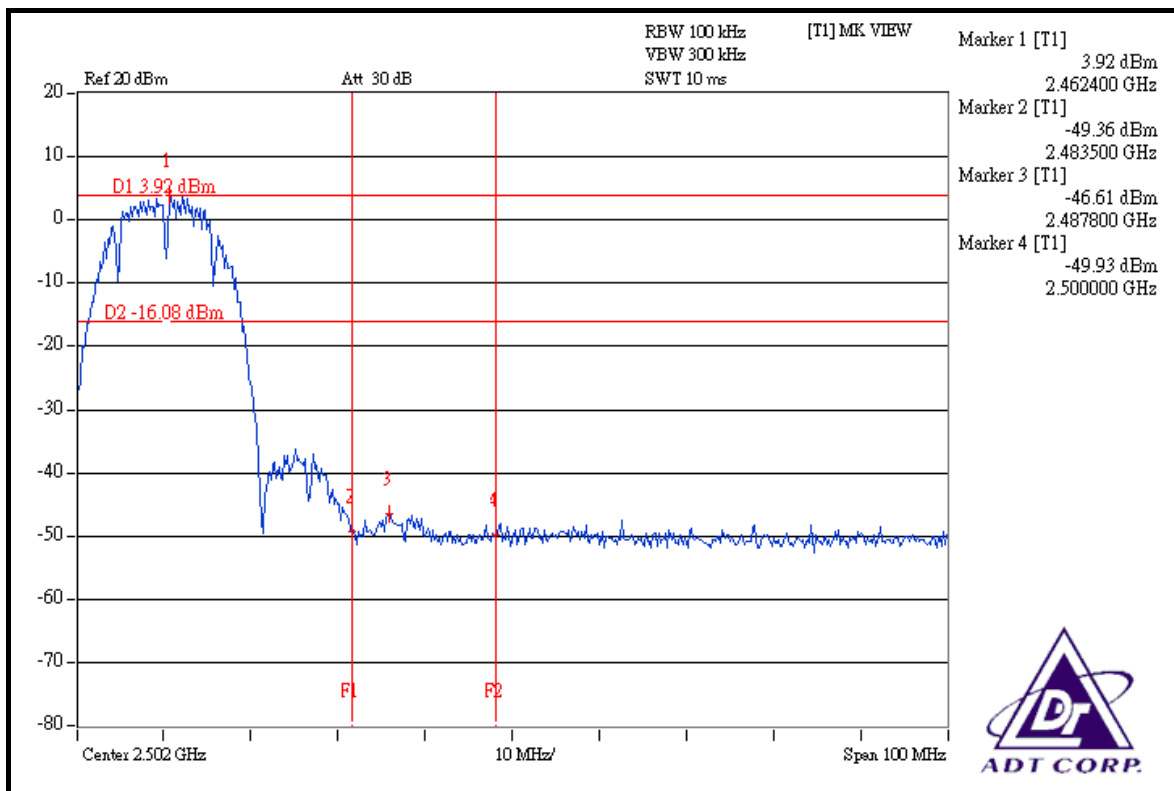
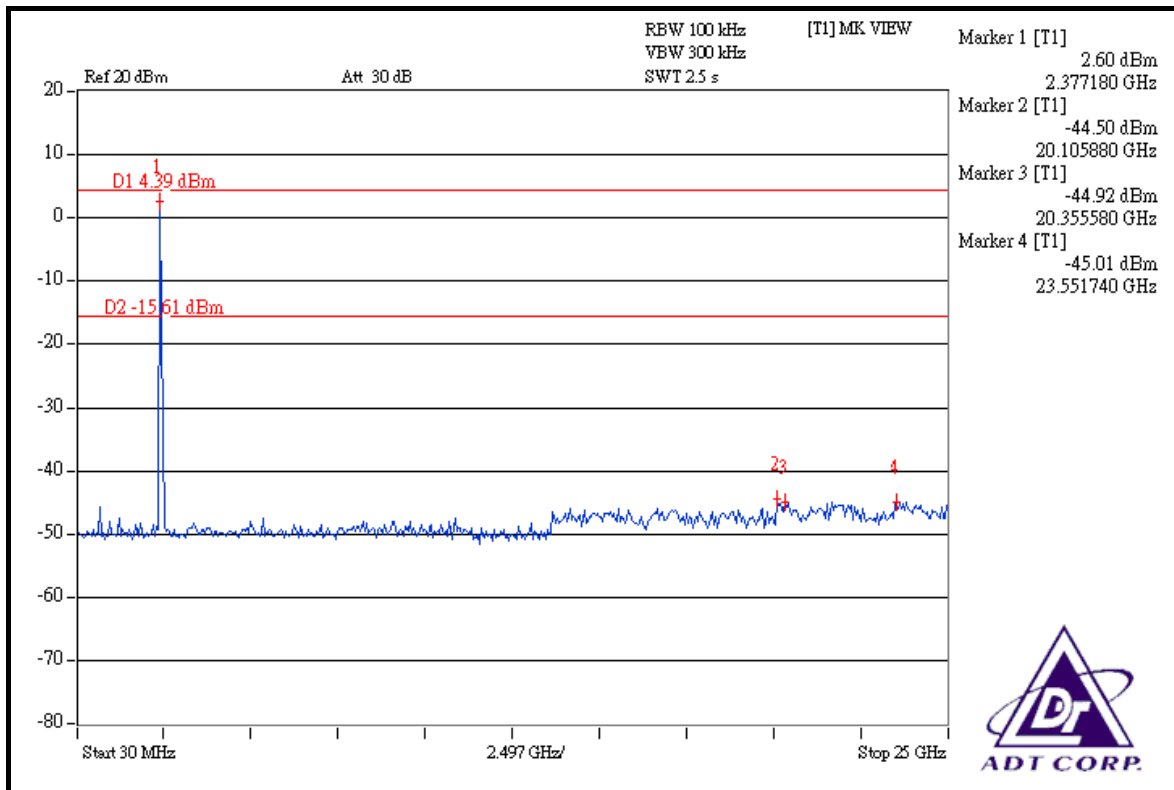

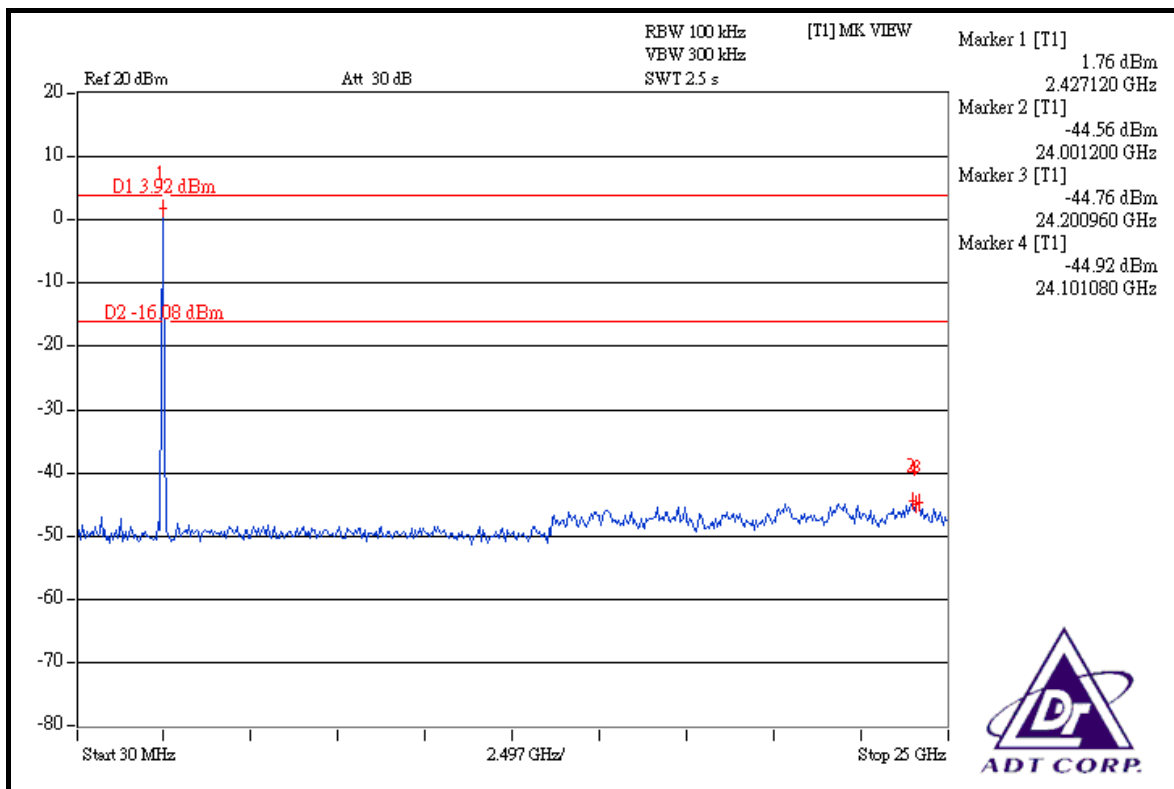
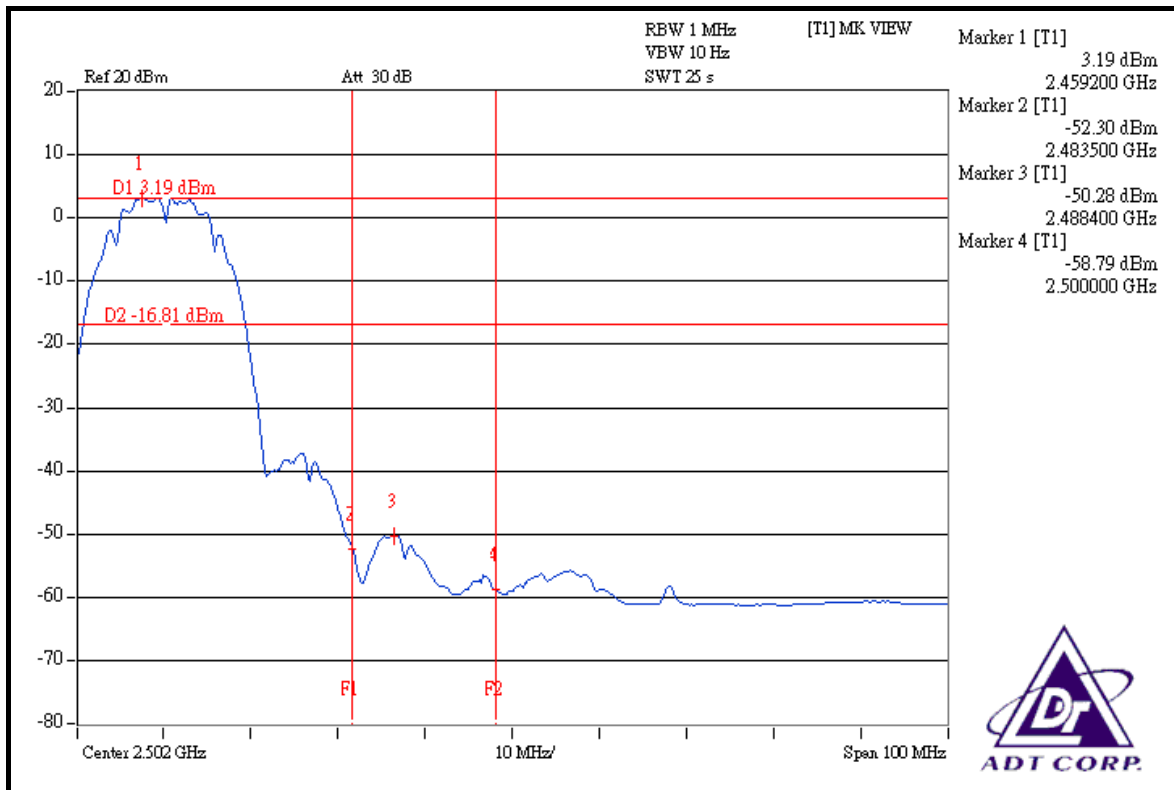

802.11g OFDM MODULATION

TEST MODE A

NOTE 1: The band edge emission plot on the next second page shows 44.75dBc between carrier maximum power and local maximum emission in restrict band (2.3896GHz). The emission of carrier strength list in the test result of channel 1 at the item 4.1.7 is 111.00dBuV/m (Peak), so the maximum field strength in restrict band is $111.00 - 44.75 = 66.25$ dBuV/m which is under 74dBuV/m limit.

The band edge emission plot of on the next second page shows 47.05dBc between carrier maximum power and local maximum emission in restrict band (2.3900GHz). The emission of carrier strength list in the test result of channel 1 at the item 4.1.7 is 100.68dBuV/m (Average), so the maximum field strength in restrict band is $100.68 - 47.05 = 53.63$ dBuV/m which is under 54dBuV/m limit.

NOTE 2: The band edge emission plot on the next third page shows 43.92dBc between carrier maximum power and local maximum emission in restrict band (2.4836GHz). The emission of carrier strength list in the test result of channel 11 at the item 4.1.7 is 110.27dBuV/m (Peak), so the maximum field strength in restrict band is $110.27 - 43.92 = 66.35$ dBuV/m which is under 74dBuV/m limit.

The band edge emission plot on the next fourth page shows 46.49dBc between carrier maximum power and local maximum emission in restrict band (2.4835GHz). The emission of carrier strength list in the test result of channel 11 at the item 4.1.7 is 99.41dBuV/m (Average), so the maximum field strength in restrict band is $99.41 - 46.49 = 52.92$ dBuV/m which is under 54dBuV/m limit.

TEST MODE B

NOTE 1: The band edge emission plot on the next page shows 44.75dBc between carrier maximum power and local maximum emission in restrict band (2.3896GHz). The emission of carrier strength list in the test result of channel 1 at the item 4.1.7 is 109.87dBuV/m (Peak), so the maximum field strength in restrict band is $109.87 - 44.75 = 65.12$ dBuV/m which is under 74dBuV/m limit.

The band edge emission plot of on the next page shows 47.05dBc between carrier maximum power and local maximum emission in restrict band (2.3900GHz). The emission of carrier strength list in the test result of channel 1 at the item 4.1.7 is 99.05dBuV/m (Average), so the maximum field strength in restrict band is $99.05 - 47.05 = 52.00$ dBuV/m which is under 54dBuV/m limit.

NOTE 2: The band edge emission plot on the next second page shows 43.92dBc between carrier maximum power and local maximum emission in restrict band (2.4836GHz). The emission of carrier strength list in the test result of channel 11 at the item 4.1.7 is 110.04dBuV/m (Peak), so the maximum field strength in restrict band is $110.04 - 43.92 = 66.12$ dBuV/m which is under 74dBuV/m limit.

The band edge emission plot on the next third page shows 46.49dBc between carrier maximum power and local maximum emission in restrict band (2.4835GHz). The emission of carrier strength list in the test result of channel 11 at the item 4.1.7 is 99.31dBuV/m (Average), so the maximum field strength in restrict band is $99.31 - 46.49 = 52.82$ dBuV/m which is under 54dBuV/m limit.

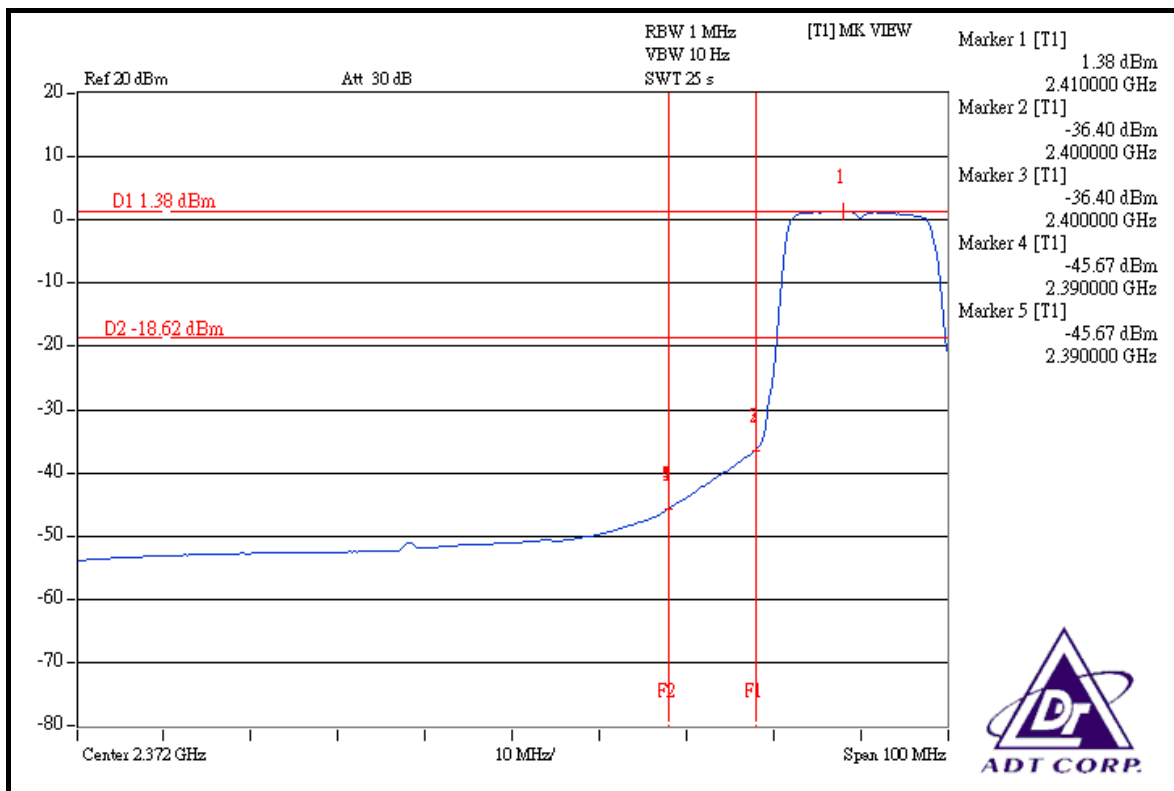
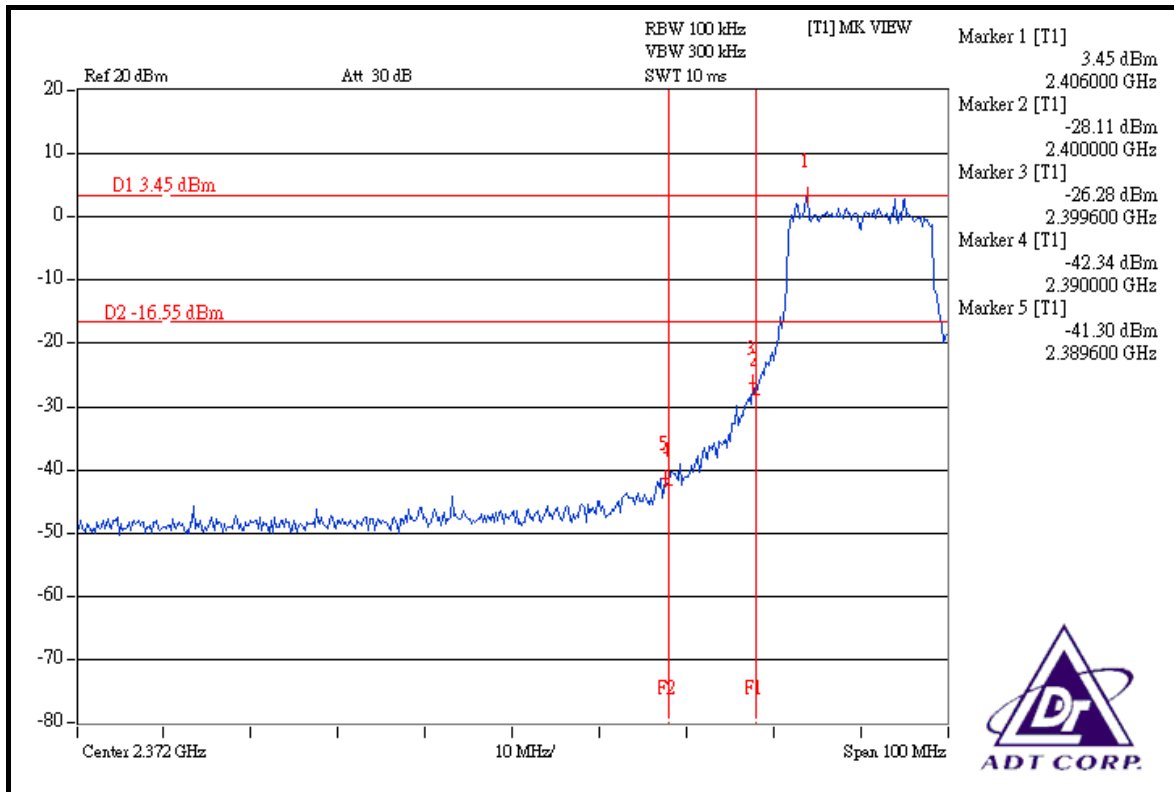

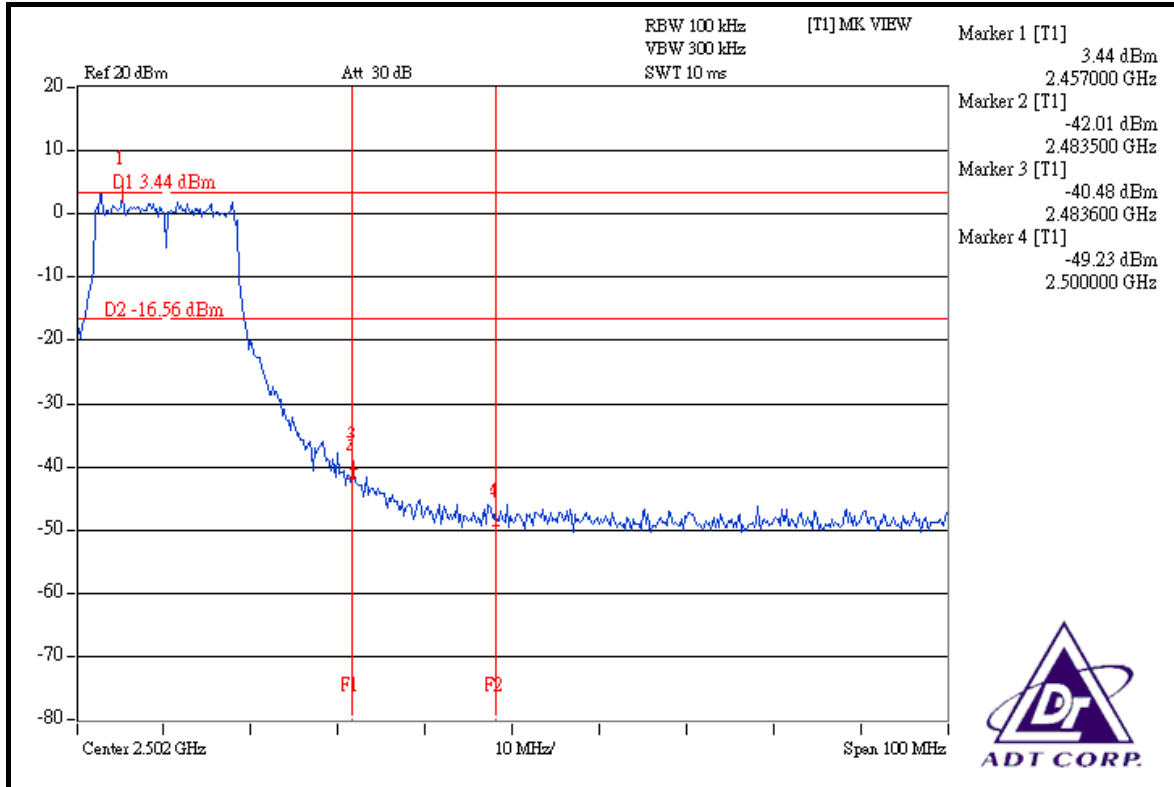
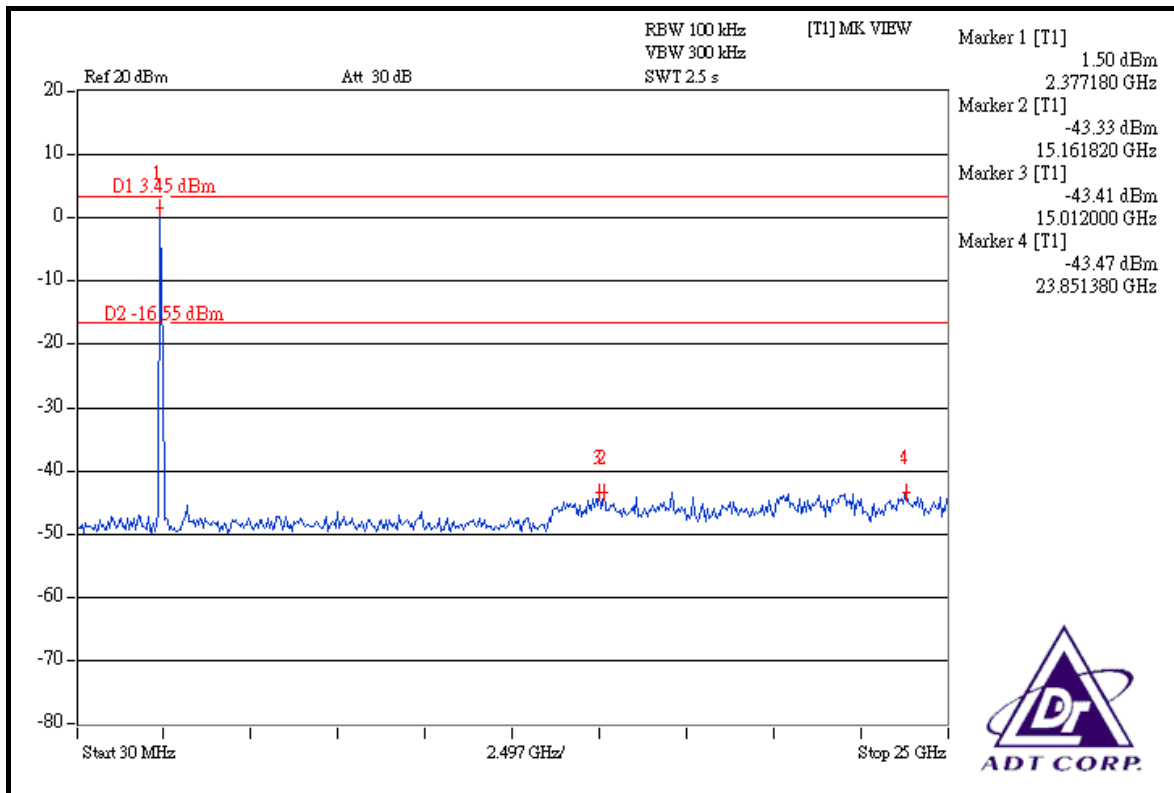

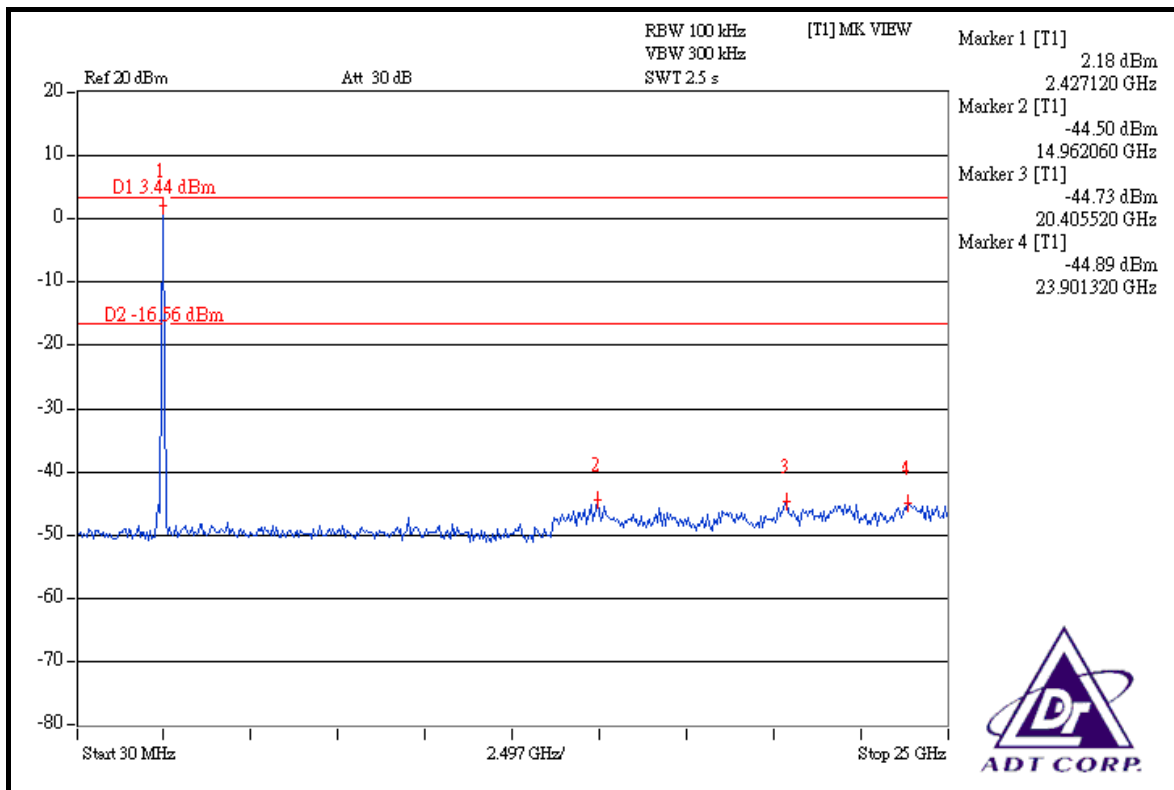
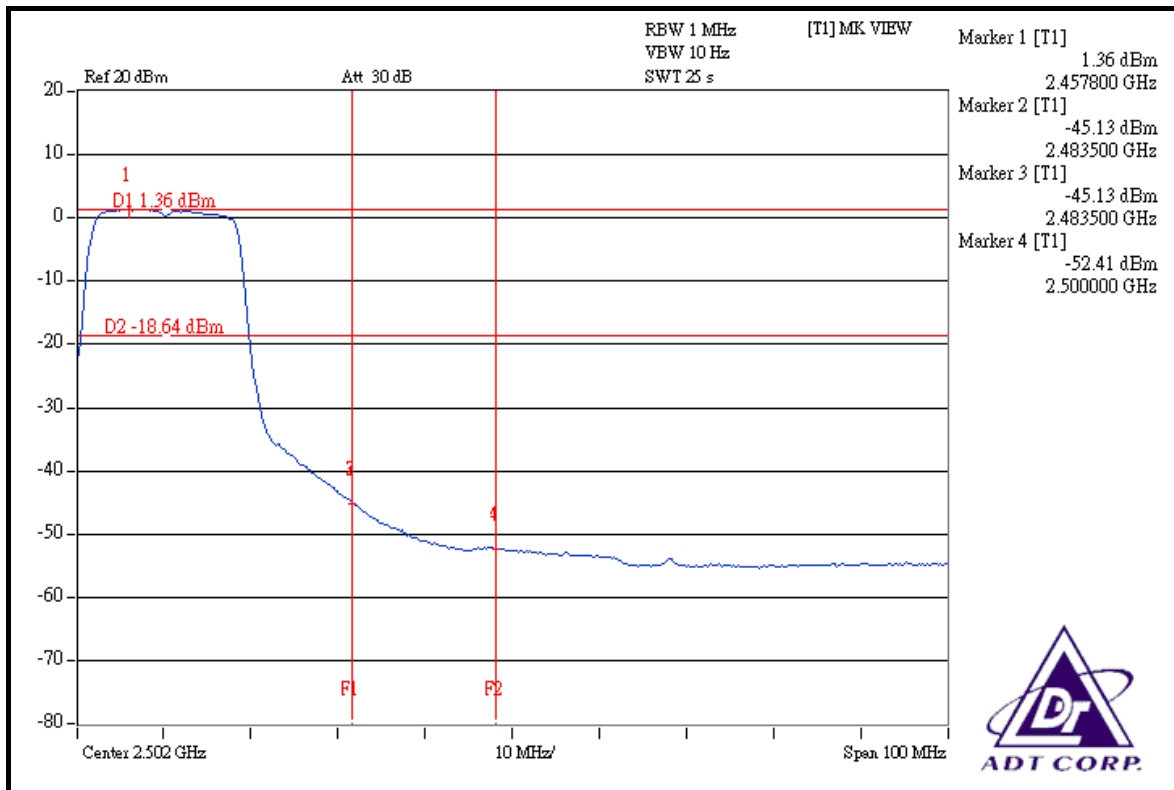



4.7 ANTENNA REQUIREMENT

4.7.1 STANDARD APPLICABLE

For intentional device, according to FCC 47 CFR Section 15.203, an intentional radiator shall be designed to ensure that no antenna other than that furnished by the responsible party shall be used with the device.

And according to FCC 47 CFR Section 15.247 (b), if transmitting antennas of directional gain greater than 6dBi are used, the power shall be reduced by the amount in dB that the directional gain of the antenna exceeds 6dBi.

4.7.2 ANTENNA CONNECTED CONSTRUCTION

The antenna used in this product is Omni-directional external with N type connector. The maximum Gain of the antenna is 4.5dBi.

5. TEST TYPES AND RESULTS (FOR 5.0GHz BAND)

5.1 RADIATED EMISSION MEASUREMENT

5.1.1 LIMITS OF RADIATED EMISSION MEASUREMENT

Emissions radiated outside of the specified bands, shall be according to the general radiated limits in 15.209 as following:

FREQUENCIES (MHz)	FIELD STRENGTH (microvolts/meter)	MEASUREMENT DISTANCE (meters)
0.009 ~ 0.490	2400/F(kHz)	300
0.490 ~ 1.705	24000/F(kHz)	30
1.705 ~ 30.0	30	30
30 ~ 88	100	3
88 ~ 216	150	3
216 ~ 960	200	3
Above 960	500	3

NOTE:

1. The lower limit shall apply at the transition frequencies.
2. Emission level (dBuV/m) = 20 log Emission level (uV/m).
3. As shown in 15.35(b), for frequencies above 1000MHz, the field strength limits are based on average detector, however, the peak field strength of any emission shall not exceed the maximum permitted average limits, specified above by more than 20dB under any condition of modulation.



5.1.2 TEST INSTRUMENTS

Above 1GHz:

DESCRIPTION & MANUFACTURER	MODEL NO.	SERIAL NO.	DATE OF CALIBRATION	DUE DATE OF CALIBRATION
Test Receiver ROHDE & SCHWARZ	ESI7	100033	Jun. 30, 2008	Jun. 29, 2009
Spectrum Analyzer Agilent	FSP	100041	Apr. 22, 2008	Apr. 21, 2009
BILOG Antenna SCHWARZBECK	VULB9168	9168-160	May, 02, 2008	May, 01, 2009
HORN Antenna SCHWARZBECK	9120D	9120D-209	Jun. 24, 2008	Jun. 23, 2009
HORN Antenna SCHWARZBECK	BBHA 9170	BBHA9170243	Dec. 25, 2007	Dec. 24, 2008
Preamplifier Agilent	8447D	2944A10633	Oct. 29, 2007	Oct. 28, 2008
Preamplifier Agilent	8449B	3008A01964	Oct. 24, 2007	Oct. 23, 2008
RF signal cable HUBER+SUHNNER	SUCOFLEX 104	283402/4	Dec. 07, 2007	Dec. 06, 2008
RF signal cable HUBER+SUHNNER	SUCOFLEX 104	251644/4	Dec. 07, 2007	Dec. 06, 2008
Software ADT.	ADT_Radiated_V7.6	NA	NA	NA
Antenna Tower inn-co GmbH	MA 4000	013303	NA	NA
Antenna Tower Controller inn-co GmbH	CO2000	017303	NA	NA
Turn Table ADT.	TT100.	TT93021703	NA	NA
Turn Table Controller ADT.	SC100.	SC93021703	NA	NA

- NOTE:**
1. The calibration interval of the above test instruments is 12 months and the calibrations are traceable to NML/ROC and NIST/USA.
 2. The test was performed in HwaYa Chamber 3.
 3. The horn antenna and HP preamplifier (model: 8449B) are used only for the measurement of emission frequency above 1GHz if tested.
 4. The FCC Site Registration No. is 988962.
 5. The IC Site Registration No. is IC3789B-3.



Below 1GHz:

DESCRIPTION & MANUFACTURER	MODEL NO.	SERIAL NO.	CALIBRATED DATE	CALIBRATED UNTIL
ROHDE & SCHWARZ TEST RECEIVER	ESCI	100412	Jul. 22, 2008	Jul. 21, 2009
SCHAFFENR BILOG Antenna	CBL6111D	21872	Apr. 29, 2008	Apr. 28, 2009
ADT. Turn Table	TT100	0505	NA	NA
ADT. Tower	AT100	0505	NA	NA
Software	ADT_Radiated_V7.6.15	NA	NA	NA
ADT RF Switches BOX	EM-H-01-1	1002	Aug. 19, 2008	Aug. 18, 2009
TIMES RF cable	LMR-600	CABLE-ST5-01	Aug. 19, 2008	Aug. 18, 2009

- NOTE:** 1. The calibration interval of the above test instruments is 12 months. And the calibrations are traceable to NML/ROC and NIST/USA.
2. The test was performed in Open Site No. 5.
3. The VCCI Site Registration No. R-1039.
4. The Industry Canada Reference No. IC 3789A-5

5.1.3 TEST PROCEDURES

- a. The EUT was placed on the top of a rotating table 0.8 meters above the ground at a 3 meters semi-anechoic chamber and open test area side. The table was rotated 360 degrees to determine the position of the highest radiation.
- b. The EUT was set 3 meters away from the interference-receiving antenna, which was mounted on the top of a variable-height antenna tower.
- c. The antenna is a broadband antenna, and its height is varied from one meter to four meters above the ground to determine the maximum value of the field strength. Both horizontal and vertical polarizations of the antenna are set to make the measurement.
- d. For each suspected emission, the EUT was arranged to its worst case and then the antenna was tuned to heights from 1 meter to 4 meters and the rotatable table was turned from 0 degrees to 360 degrees to find the maximum reading.
- e. The test-receiver system was set to Peak Detect Function and Specified Bandwidth with Maximum Hold Mode.
- f. If the emission level of the EUT in peak mode was lower than the limit specified, then testing could be stopped and the peak values of the EUT would be reported. Otherwise the emissions would be re-tested one by one using peak, quasi-peak or average method as specified and then reported in a data sheet.

NOTE:

1. The resolution bandwidth and video bandwidth of test receiver/spectrum analyzer is 120kHz for Quasi-peak detection at frequency below 1GHz.
2. The resolution bandwidth of test receiver/spectrum analyzer is 100kHz and video bandwidth is 300kHz for Peak detection at frequency above 1GHz.
3. The resolution bandwidth of test receiver/spectrum analyzer is 1MHz and the video bandwidth is 10Hz for Average detection (AV) at frequency above 1GHz.
4. All modes of operation were investigated and the worst-case emissions are reported.

5.1.4 DEVIATION FROM TEST STANDARD

No deviation

5.1.5 TEST SETUP

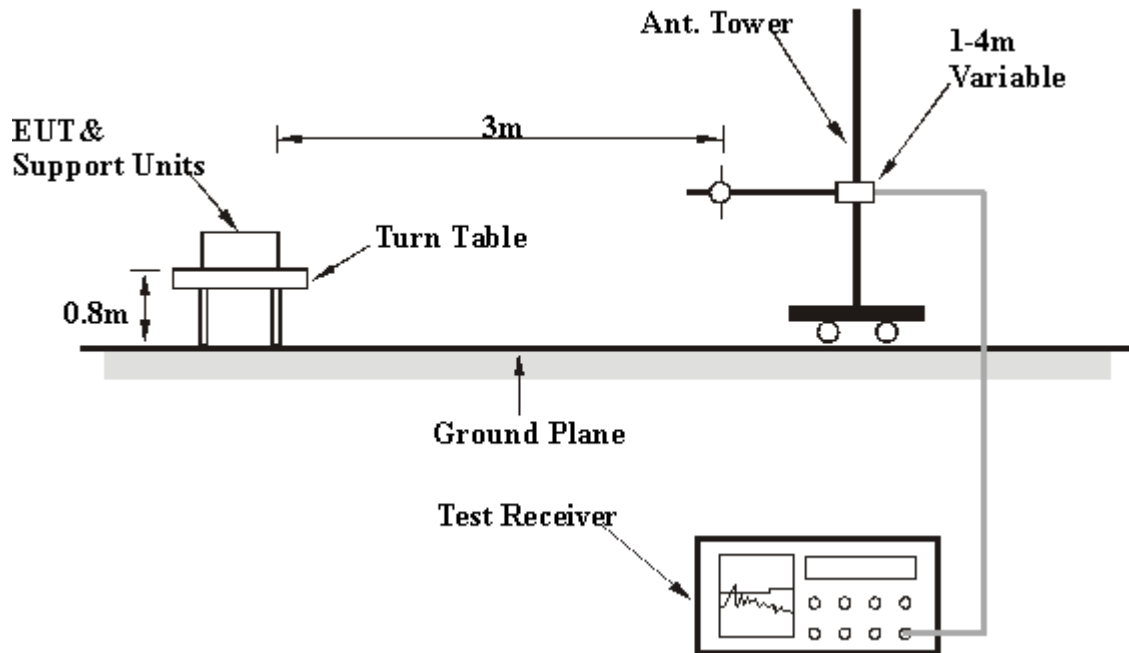

For the actual test configuration, please refer to the attached file (Test Setup Photo).

5.1.6 EUT OPERATING CONDITIONS

Same as 4.1.6

5.1.7 TEST RESULTS

802.11a OFDM MODULATION

EUT TEST CONDITION		MEASUREMENT DETAIL	
CHANNEL	Channel 149	FREQUENCY RANGE	1 ~ 40GHz
INPUT POWER (SYSTEM)	120Vac, 60 Hz	DETECTOR FUNCTION	Peak (PK) Average (AV)
ENVIRONMENTAL CONDITIONS	24deg. C, 64%RH 1000hPa	TEST MODE	A
TESTED BY	Match Tsui		

ANTENNA POLARITY & TEST DISTANCE: HORIZONTAL AT 3 M								
NO.	FREQ. (MHz)	EMISSION LEVEL (dBuV/m)	LIMIT (dBuV/m)	MARGIN (dB)	ANTENNA HEIGHT (m)	TABLE ANGLE (Degree)	RAW VALUE (dBuV)	CORRECTION FACTOR (dB/m)
1	3830.00	53.45 PK	74.00	-20.55	1.00 H	196	17.63	35.81
2	3830.00	49.86 AV	54.00	-4.14	1.00 H	196	14.04	35.81
3	#5725.00	65.26 PK	81.67	-16.41	1.10 H	187	25.42	39.84
4	#5725.00	43.72 AV	69.98	-26.26	1.10 H	187	3.88	39.84
5	*5745.00	101.67 PK			1.10 H	187	61.80	39.87
6	*5745.00	89.98 AV			1.10 H	187	50.11	39.87
7	11490.00	60.77 PK	74.00	-13.23	1.12 H	99	10.77	50.00
8	11490.00	48.63 AV	54.00	-5.37	1.12 H	99	-1.37	50.00
ANTENNA POLARITY & TEST DISTANCE: VERTICAL AT 3 M								
NO.	FREQ. (MHz)	EMISSION LEVEL (dBuV/m)	LIMIT (dBuV/m)	MARGIN (dB)	ANTENNA HEIGHT (m)	TABLE ANGLE (Degree)	RAW VALUE (dBuV)	CORRECTION FACTOR (dB/m)
1	3830.00	54.70 PK	74.00	-19.30	1.34 V	154	18.88	35.81
2	3830.00	50.90 AV	54.00	-3.10	1.34 V	154	15.08	35.81
3	#5725.00	73.50 PK	91.81	-18.31	1.51 V	159	33.66	39.84
4	#5725.00	59.39 AV	81.30	-21.91	1.51 V	159	19.55	39.84
5	*5745.00	111.81 PK			1.51 V	160	71.94	39.87
6	*5745.00	101.30 AV			1.51 V	160	61.43	39.87
7	7660.00	56.60 PK	74.00	-17.40	1.05 V	168	11.34	45.26
8	7660.00	48.30 AV	54.00	-5.70	1.05 V	168	3.04	45.26
9	11490.00	65.71 PK	74.00	-8.29	1.37 V	214	15.71	50.00
10	11490.00	52.21 AV	54.00	-1.79	1.37 V	214	2.21	50.00

- REMARKS:**
1. Emission level (dBuV/m) = Raw Value (dBuV) + Correction Factor (dB/m).
 2. Correction Factor (dB/m) = Antenna Factor (dB/m) + Cable Factor (dB).
 3. The other emission levels were very low against the limit.
 4. Margin value = Emission level – Limit value.
 5. “ * “: Fundamental frequency.
 6. The limit value is defined as per 15.247.
 7. "#":The radiated frequency is out the restricted band.

EUT TEST CONDITION		MEASUREMENT DETAIL	
CHANNEL	Channel 157	FREQUENCY RANGE	1 ~ 40GHz
INPUT POWER (SYSTEM)	120Vac, 60 Hz	DETECTOR FUNCTION	Peak (PK) Average (AV)
ENVIRONMENTAL CONDITIONS	24deg. C, 64%RH 1000hPa	TEST MODE	A
TESTED BY	Match Tsui		

ANTENNA POLARITY & TEST DISTANCE: HORIZONTAL AT 3 M								
NO.	FREQ. (MHz)	EMISSION LEVEL (dBuV/m)	LIMIT (dBuV/m)	MARGIN (dB)	ANTENNA HEIGHT (m)	TABLE ANGLE (Degree)	RAW VALUE (dBuV)	CORRECTION FACTOR (dB/m)
1	3856.00	52.42 PK	74.00	-21.58	1.00 H	138	16.52	35.89
2	3856.00	48.10 AV	54.00	-5.90	1.00 H	138	12.20	35.89
3	*5785.00	100.56 PK			1.17 H	196	60.63	39.93
4	*5785.00	90.25 AV			1.17 H	196	50.32	39.93
5	11570.00	61.24 PK	74.00	-12.76	1.55 H	104	11.34	49.89
6	11570.00	48.86 AV	54.00	-5.14	1.55 H	104	-1.04	49.89
ANTENNA POLARITY & TEST DISTANCE: VERTICAL AT 3 M								
NO.	FREQ. (MHz)	EMISSION LEVEL (dBuV/m)	LIMIT (dBuV/m)	MARGIN (dB)	ANTENNA HEIGHT (m)	TABLE ANGLE (Degree)	RAW VALUE (dBuV)	CORRECTION FACTOR (dB/m)
1	3856.00	54.38 PK	74.00	-19.62	1.18 V	154	18.48	35.89
2	3856.00	50.98 AV	54.00	-3.02	1.18 V	154	15.08	35.89
3	*5785.00	111.27 PK			1.41 V	132	71.34	39.93
4	*5785.00	100.69 AV			1.41 V	132	60.76	39.93
5	11570.00	64.81 PK	74.00	-9.19	1.00 V	202	14.91	49.89
6	11570.00	51.73 AV	54.00	-2.27	1.00 V	202	1.83	49.89

- REMARKS:**
1. Emission level (dBuV/m) = Raw Value (dBuV) + Correction Factor (dB/m).
 2. Correction Factor (dB/m) = Antenna Factor (dB/m) + Cable Factor (dB).
 3. The other emission levels were very low against the limit.
 4. Margin value = Emission level – Limit value.
 5. “ * “: Fundamental frequency.
 6. The limit value is defined as per 15.247.

EUT TEST CONDITION		MEASUREMENT DETAIL	
CHANNEL	Channel 165	FREQUENCY RANGE	1 ~ 40GHz
INPUT POWER (SYSTEM)	120Vac, 60 Hz	DETECTOR FUNCTION	Peak (PK) Average (AV)
ENVIRONMENTAL CONDITIONS	24deg. C, 64%RH 1000hPa	TEST MODE	A
TESTED BY	Match Tsui		

ANTENNA POLARITY & TEST DISTANCE: HORIZONTAL AT 3 M								
NO.	FREQ. (MHz)	EMISSION LEVEL (dBuV/m)	LIMIT (dBuV/m)	MARGIN (dB)	ANTENNA HEIGHT (m)	TABLE ANGLE (Degree)	RAW VALUE (dBuV)	CORRECTION FACTOR (dB/m)
1	3883.00	52.82 PK	74.00	-21.18	1.00 H	139	16.84	35.98
2	3883.00	48.59 AV	54.00	-5.41	1.00 H	139	12.61	35.98
3	*5825.00	99.56 PK			1.19 H	188	59.53	40.03
4	*5825.00	89.69 AV			1.19 H	188	49.66	40.03
5	#5850.00	50.42 PK	79.56	-29.14	1.19 H	188	10.32	40.10
6	#5850.00	38.01 AV	69.69	-31.68	1.19 H	188	-2.09	40.10
7	11650.00	61.20 PK	74.00	-12.80	1.00 H	211	11.36	49.84
8	11650.00	48.04 AV	54.00	-5.96	1.00 H	211	-1.80	49.84
ANTENNA POLARITY & TEST DISTANCE: VERTICAL AT 3 M								
NO.	FREQ. (MHz)	EMISSION LEVEL (dBuV/m)	LIMIT (dBuV/m)	MARGIN (dB)	ANTENNA HEIGHT (m)	TABLE ANGLE (Degree)	RAW VALUE (dBuV)	CORRECTION FACTOR (dB/m)
1	3883.00	55.12 PK	74.00	-18.88	1.32 V	148	19.14	35.98
2	3883.00	51.70 AV	54.00	-2.30	1.32 V	148	15.72	35.98
3	*5825.00	110.95 PK			1.40 V	129	70.92	40.03
4	*5825.00	100.45 AV			1.40 V	129	60.42	40.03
5	#5850.00	62.88 PK	90.95	-28.07	1.40 V	119	22.78	40.10
6	#5850.00	41.07 AV	80.45	-39.38	1.40 V	119	0.97	40.10
7	11650.00	65.58 PK	74.00	-8.42	1.35 V	217	15.74	49.84
8	11650.00	51.08 AV	54.00	-2.92	1.35 V	217	1.24	49.84

- REMARKS:**
1. Emission level (dBuV/m) = Raw Value (dBuV) + Correction Factor (dB/m).
 2. Correction Factor (dB/m) = Antenna Factor (dB/m) + Cable Factor (dB).
 3. The other emission levels were very low against the limit.
 4. Margin value = Emission level – Limit value.
 5. “ * “: Fundamental frequency.
 6. The limit value is defined as per 15.247.
 7. “#“: The radiated frequency is out the restricted band.

EUT TEST CONDITION		MEASUREMENT DETAIL	
CHANNEL	Channel 149	FREQUENCY RANGE	1 ~ 40GHz
INPUT POWER (SYSTEM)	120Vac, 60 Hz	DETECTOR FUNCTION	Peak (PK) Average (AV)
ENVIRONMENTAL CONDITIONS	25deg. C, 65%RH 1000hPa	TEST MODE	B
TESTED BY	Kevin Liang		

ANTENNA POLARITY & TEST DISTANCE: HORIZONTAL AT 3 M								
NO.	FREQ. (MHz)	EMISSION LEVEL (dBuV/m)	LIMIT (dBuV/m)	MARGIN (dB)	ANTENNA HEIGHT (m)	TABLE ANGLE (Degree)	RAW VALUE (dBuV)	CORRECTION FACTOR (dB/m)
1	3830.00	50.44 PK	74.00	-23.56	1.30 H	219	14.62	35.81
2	3830.00	45.80 AV	54.00	-8.20	1.30 H	219	9.99	35.81
3	#5725.00	69.94 PK	81.53	-11.59	1.08 H	217	30.10	39.84
4	#5725.00	46.45 AV	69.80	-23.35	1.08 H	217	6.61	39.84
5	*5745.00	101.53 PK			1.08 H	217	61.66	39.87
6	*5745.00	89.80 AV			1.08 H	217	49.93	39.87
7	11490.00	61.30 PK	74.00	-12.70	1.03 H	17	11.30	50.00
8	11490.00	48.39 AV	54.00	-5.61	1.03 H	17	-1.61	50.00
ANTENNA POLARITY & TEST DISTANCE: VERTICAL AT 3 M								
NO.	FREQ. (MHz)	EMISSION LEVEL (dBuV/m)	LIMIT (dBuV/m)	MARGIN (dB)	ANTENNA HEIGHT (m)	TABLE ANGLE (Degree)	RAW VALUE (dBuV)	CORRECTION FACTOR (dB/m)
1	3830.00	50.45 PK	74.00	-23.55	1.32 V	279	14.63	35.81
2	3830.00	43.73 AV	54.00	-10.27	1.32 V	279	7.91	35.81
3	#5725.00	78.57 PK	91.69	-13.12	1.18 V	75	38.73	39.84
4	#5725.00	57.75 AV	81.08	-23.33	1.18 V	75	17.91	39.84
5	*5745.00	111.69 PK			1.18 V	75	71.82	39.87
6	*5745.00	101.08 AV			1.18 V	75	61.21	39.87
7	11490.00	62.41 PK	74.00	-11.59	1.08 V	186	12.41	50.00
8	11490.00	49.07 AV	54.00	-4.93	1.08 V	186	-0.93	50.00

- REMARKS:**
1. Emission level (dBuV/m) = Raw Value (dBuV) + Correction Factor (dB/m).
 2. Correction Factor (dB/m) = Antenna Factor (dB/m) + Cable Factor (dB).
 3. The other emission levels were very low against the limit.
 4. Margin value = Emission level – Limit value.
 5. “ * “: Fundamental frequency.
 6. The limit value is defined as per 15.247.
 7. “#“: The radiated frequency is out the restricted band.

EUT TEST CONDITION		MEASUREMENT DETAIL	
CHANNEL	Channel 157	FREQUENCY RANGE	1 ~ 40GHz
INPUT POWER (SYSTEM)	120Vac, 60 Hz	DETECTOR FUNCTION	Peak (PK) Average (AV)
ENVIRONMENTAL CONDITIONS	25deg. C, 65%RH 1000hPa	TEST MODE	B
TESTED BY	Kevin Liang		

ANTENNA POLARITY & TEST DISTANCE: HORIZONTAL AT 3 M								
NO.	FREQ. (MHz)	EMISSION LEVEL (dBuV/m)	LIMIT (dBuV/m)	MARGIN (dB)	ANTENNA HEIGHT (m)	TABLE ANGLE (Degree)	RAW VALUE (dBuV)	CORRECTION FACTOR (dB/m)
1	3856.00	52.45 PK	74.00	-21.55	1.35 H	174	16.55	35.89
2	3856.00	46.98 AV	54.00	-7.02	1.35 H	174	11.08	35.89
3	*5785.00	100.44 PK			1.06 H	215	60.51	39.93
4	*5785.00	90.07 AV			1.06 H	215	50.14	39.93
5	11570.00	61.22 PK	74.00	-12.78	1.04 H	12	11.33	49.89
6	11570.00	48.34 AV	54.00	-5.66	1.04 H	12	-1.55	49.89
ANTENNA POLARITY & TEST DISTANCE: VERTICAL AT 3 M								
NO.	FREQ. (MHz)	EMISSION LEVEL (dBuV/m)	LIMIT (dBuV/m)	MARGIN (dB)	ANTENNA HEIGHT (m)	TABLE ANGLE (Degree)	RAW VALUE (dBuV)	CORRECTION FACTOR (dB/m)
1	3856.00	50.87 PK	74.00	-23.13	1.29 V	280	14.97	35.89
2	3856.00	44.78 AV	54.00	-9.22	1.29 V	280	8.88	35.89
3	*5785.00	111.16 PK			1.17 V	80	71.23	39.93
4	*5785.00	100.48 AV			1.17 V	80	60.55	39.93
5	11570.00	62.34 PK	74.00	-11.66	1.10 V	183	12.45	49.89
6	11570.00	48.95 AV	54.00	-5.05	1.10 V	183	-0.94	49.89

- REMARKS:**
1. Emission level (dBuV/m) = Raw Value (dBuV) + Correction Factor (dB/m).
 2. Correction Factor (dB/m) = Antenna Factor (dB/m) + Cable Factor (dB).
 3. The other emission levels were very low against the limit.
 4. Margin value = Emission level – Limit value.
 5. “ * “: Fundamental frequency.
 6. The limit value is defined as per 15.247.



EUT TEST CONDITION		MEASUREMENT DETAIL	
CHANNEL	Channel 165	FREQUENCY RANGE	1 ~ 40GHz
INPUT POWER (SYSTEM)	120Vac, 60 Hz	DETECTOR FUNCTION	Peak (PK) Average (AV)
ENVIRONMENTAL CONDITIONS	25deg. C, 65%RH 1000hPa	TEST MODE	B
TESTED BY	Kevin Liang		

ANTENNA POLARITY & TEST DISTANCE: HORIZONTAL AT 3 M								
NO.	FREQ. (MHz)	EMISSION LEVEL (dBuV/m)	LIMIT (dBuV/m)	MARGIN (dB)	ANTENNA HEIGHT (m)	TABLE ANGLE (Degree)	RAW VALUE (dBuV)	CORRECTION FACTOR (dB/m)
1	3883.00	51.12 PK	74.00	-22.88	1.33 H	176	15.14	35.98
2	3883.00	44.45 AV	54.00	-9.55	1.33 H	176	8.47	35.98
3	*5825.00	99.75 PK			1.07 H	217	59.72	40.03
4	*5825.00	89.87 AV			1.07 H	217	49.84	40.03
5	#5850.00	58.35 PK	79.75	-21.40	1.07 H	217	18.25	40.10
6	#5850.00	39.57 AV	69.87	-30.30	1.07 H	217	-0.53	40.10
7	11650.00	60.96 PK	74.00	-13.04	1.05 H	8	11.12	49.84
8	11650.00	48.25 AV	54.00	-5.75	1.05 H	8	-1.59	49.84
ANTENNA POLARITY & TEST DISTANCE: VERTICAL AT 3 M								
NO.	FREQ. (MHz)	EMISSION LEVEL (dBuV/m)	LIMIT (dBuV/m)	MARGIN (dB)	ANTENNA HEIGHT (m)	TABLE ANGLE (Degree)	RAW VALUE (dBuV)	CORRECTION FACTOR (dB/m)
1	3883.00	49.89 PK	74.00	-24.11	1.29 V	338	13.91	35.98
2	3883.00	41.38 AV	54.00	-12.62	1.29 V	338	5.40	35.98
3	*5825.00	111.07 PK			1.25 V	82	71.04	40.03
4	*5825.00	100.55 AV			1.25 V	82	60.52	40.03
5	#5850.00	66.34 PK	91.07	-24.73	1.25 V	83	26.24	40.10
6	#5850.00	44.78 AV	80.55	-35.77	1.25 V	83	4.68	40.10
7	11650.00	62.00 PK	74.00	-12.00	1.09 V	182	12.16	49.84
8	11650.00	48.87 AV	54.00	-5.13	1.09 V	182	-0.97	49.84

- REMARKS:**
1. Emission level (dBuV/m) = Raw Value (dBuV) + Correction Factor (dB/m).
 2. Correction Factor (dB/m) = Antenna Factor (dB/m) + Cable Factor (dB).
 3. The other emission levels were very low against the limit.
 4. Margin value = Emission level – Limit value.
 5. “ * “: Fundamental frequency.
 6. The limit value is defined as per 15.247.
 7. “#“: The radiated frequency is out the restricted band.

BELOW 1GHz WORST-CASE DATA : 802.11a OFDM MODULATION

EUT TEST CONDITION		MEASUREMENT DETAIL	
CHANNEL	Channel 149	FREQUENCY RANGE	Below 1000MHz
INPUT POWER (SYSTEM)	120Vac, 60 Hz	DETECTOR FUNCTION	Quasi-Peak
ENVIRONMENTAL CONDITIONS	28deg. C, 63%RH 999hPa	TEST MODE	A
TESTED BY	Rober Tsai		

ANTENNA POLARITY & TEST DISTANCE: HORIZONTAL AT 3 M								
NO.	FREQ. (MHz)	EMISSION LEVEL (dBuV/m)	LIMIT (dBuV/m)	MARGIN (dB)	ANTENNA HEIGHT (m)	TABLE ANGLE (Degree)	RAW VALUE (dBuV)	CORRECTION FACTOR (dB/m)
1	108.81	36.46 QP	43.50	-7.04	1.48 H	189	24.61	11.85
2	131.63	34.11 QP	43.50	-9.39	2.00 H	105	20.95	13.16
3	166.13	36.29 QP	43.50	-7.21	1.89 H	348	23.78	12.51
4	250.01	43.91 QP	46.00	-2.09	1.34 H	242	28.71	15.20
5	500.05	37.22 QP	46.00	-8.78	1.00 H	202	16.64	20.58
6	600.03	30.61 QP	46.00	-15.39	1.00 H	144	6.79	23.82
7	625.04	32.56 QP	46.00	-13.44	1.00 H	13	8.50	24.06
8	669.32	35.69 QP	46.00	-10.31	1.94 H	92	11.25	24.44
9	750.00	32.75 QP	46.00	-13.25	1.50 H	211	7.19	25.56
10	934.14	31.61 QP	46.00	-14.39	2.04 H	76	4.51	27.10

ANTENNA POLARITY & TEST DISTANCE: VERTICAL AT 3 M								
NO.	FREQ. (MHz)	EMISSION LEVEL (dBuV/m)	LIMIT (dBuV/m)	MARGIN (dB)	ANTENNA HEIGHT (m)	TABLE ANGLE (Degree)	RAW VALUE (dBuV)	CORRECTION FACTOR (dB/m)
1	39.47	37.51 QP	40.00	-2.49	1.05 V	231	22.81	14.70
2	58.74	36.02 QP	40.00	-3.98	1.78 V	170	29.52	6.50
3	66.29	33.54 QP	40.00	-6.46	1.20 V	43	26.49	7.05
4	86.10	36.33 QP	40.00	-3.67	1.00 V	299	26.65	9.68
5	108.63	41.24 QP	43.50	-2.26	2.08 V	255	29.41	11.83
6	125.01	40.73 QP	43.50	-2.77	1.00 V	87	27.58	13.15
7	131.88	34.30 QP	43.50	-9.20	1.00 V	74	21.14	13.16
8	145.25	32.63 QP	43.50	-10.87	1.00 V	211	19.53	13.10
9	165.00	32.05 QP	43.50	-11.45	1.00 V	23	19.38	12.66
10	250.00	38.05 QP	46.00	-7.95	2.05 V	44	22.85	15.20
11	375.01	33.12 QP	46.00	-12.88	1.00 V	190	15.45	17.67
12	500.05	35.26 QP	46.00	-10.74	2.04 V	90	14.68	20.58
13	528.00	37.59 QP	46.00	-8.41	1.11 V	319	16.06	21.53
14	600.04	32.82 QP	46.00	-13.18	1.70 V	258	9.00	23.82
15	625.00	36.92 QP	46.00	-9.08	1.00 V	111	12.87	24.05
16	750.02	32.21 QP	46.00	-13.79	2.04 V	223	6.65	25.56

- REMARKS:**
1. Emission level (dBuV/m) = Raw Value (dBuV) + Correction Factor (dB/m).
 2. Correction Factor (dB/m) = Antenna Factor (dB/m) + Cable Factor (dB).
 3. The other emission levels were very low against the limit.
 4. Margin value = Emission level – Limit value.



EUT TEST CONDITION		MEASUREMENT DETAIL	
CHANNEL	Channel 149	FREQUENCY RANGE	Below 1000MHz
INPUT POWER (SYSTEM)	120Vac, 60 Hz	DETECTOR FUNCTION	Quasi-Peak
ENVIRONMENTAL CONDITIONS	24deg. C, 64%RH 1000hPa	TEST MODE	B
TESTED BY	Kevin Liang		

ANTENNA POLARITY & TEST DISTANCE: HORIZONTAL AT 3 M								
NO.	FREQ. (MHz)	EMISSION LEVEL (dBuV/m)	LIMIT (dBuV/m)	MARGIN (dB)	ANTENNA HEIGHT (m)	TABLE ANGLE (Degree)	RAW VALUE (dBuV)	CORRECTION FACTOR (dB/m)
1	111.36	34.27 QP	43.50	-9.23	1.49 H	286	22.12	12.15
2	132.47	31.08 QP	43.50	-12.42	1.84 H	159	17.92	13.16
3	143.70	28.70 QP	43.50	-14.80	2.11 H	82	15.58	13.12
4	164.63	29.24 QP	43.50	-14.26	1.62 H	230	16.52	12.72
5	250.00	40.22 QP	46.00	-5.78	1.00 H	66	25.02	15.20
6	275.00	33.05 QP	46.00	-12.95	1.39 H	346	17.57	15.48
7	500.05	31.64 QP	46.00	-14.36	1.00 H	330	11.06	20.58
8	575.00	30.61 QP	46.00	-15.39	2.51 H	332	7.57	23.04
9	600.04	30.76 QP	46.00	-15.24	1.62 H	124	6.94	23.82
10	850.02	28.26 QP	46.00	-17.74	2.47 H	110	1.80	26.46

ANTENNA POLARITY & TEST DISTANCE: VERTICAL AT 3 M								
NO.	FREQ. (MHz)	EMISSION LEVEL (dBuV/m)	LIMIT (dBuV/m)	MARGIN (dB)	ANTENNA HEIGHT (m)	TABLE ANGLE (Degree)	RAW VALUE (dBuV)	CORRECTION FACTOR (dB/m)
1	43.75	35.44 QP	40.00	-4.56	1.00 V	328	23.23	12.21
2	50.48	37.51 QP	40.00	-2.49	1.00 V	288	28.29	9.22
3	62.08	36.87 QP	40.00	-3.13	1.00 V	127	30.46	6.41
4	77.98	34.06 QP	40.00	-5.94	1.00 V	201	25.36	8.70
5	86.17	37.37 QP	40.00	-2.63	1.42 V	2	27.68	9.69
6	110.73	38.09 QP	43.50	-5.41	2.51 V	69	26.02	12.07
7	132.36	34.03 QP	43.50	-9.47	1.57 V	55	20.87	13.16
8	165.13	34.20 QP	43.50	-9.30	1.00 V	147	21.55	12.65
9	250.00	37.52 QP	46.00	-8.48	2.02 V	258	22.32	15.20
10	275.00	30.85 QP	46.00	-15.15	2.13 V	214	15.37	15.48
11	500.05	32.04 QP	46.00	-13.96	1.62 V	169	11.46	20.58
12	525.03	29.77 QP	46.00	-16.23	1.60 V	173	8.34	21.43
13	575.06	31.67 QP	46.00	-14.33	1.00 V	40	8.62	23.05
14	600.05	30.90 QP	46.00	-15.10	1.00 V	260	7.08	23.82
15	750.01	29.97 QP	46.00	-16.03	2.01 V	126	4.41	25.56
16	850.00	28.87 QP	46.00	-17.13	1.00 V	19	2.41	26.46

- REMARKS:**
1. Emission level (dBuV/m) = Raw Value (dBuV) + Correction Factor (dB/m).
 2. Correction Factor (dB/m) = Antenna Factor (dB/m) + Cable Factor (dB).
 3. The other emission levels were very low against the limit.
 4. Margin value = Emission level – Limit value.

5.2 CONDUCTED EMISSION MEASUREMENT

5.2.1 LIMITS OF CONDUCTED EMISSION MEASUREMENT

FREQUENCY OF EMISSION (MHz)	CONDUCTED LIMIT (dB μ V)	
	Quasi-peak	Average
0.15 ~ 0.5	66 to 56	56 to 46
0.5 ~ 5	56	46
5 ~ 30	60	50

- NOTE:** 1. The lower limit shall apply at the transition frequencies.
2. The limit decreases in line with the logarithm of the frequency in the range of 0.15 to 0.50MHz.
3. All emanations from a class A/B digital device or system, including any network of conductors and apparatus connected thereto, shall not exceed the level of field strengths specified above.

5.2.2 TEST INSTRUMENTS

DESCRIPTION & MANUFACTURER	MODEL NO.	SERIAL NO.	DATE OF CALIBRATION	DUE DATE OF CALIBRATION
Test Receiver ROHDE & SCHWARZ	ESCS30	100291	Nov. 22, 2007	Nov. 21, 2008
RF signal cable Woken	5D-FB	Cable-HYC01-01	Jan. 04, 2008	Jan. 03, 2009
LISN ROHDE & SCHWARZ	ESH3-Z5	100312	Jun. 13, 2008	Jun. 12, 2009
V-LISN SCHWARZBECK	NNBL 8226-2	8226-142	Jun. 10, 2008	Jun. 09, 2009
Software ADT	ADT_Cond_V3	NA	NA	NA

- NOTE:** 1. The calibration interval of the above test instruments is 12 months and the calibrations are traceable to NML/ROC and NIST/USA.
2. The test was performed in HwaYa Shielded Room 1.
3. The VCCI Site Registration No. is C-2040.

5.2.3 TEST PROCEDURES

- a. The EUT was placed 0.4 meters from the conducting wall of the shielded room with EUT being connected to the power mains through a line impedance stabilization network (LISN). Other support units were connected to the power mains through another LISN. The two LISNs provide 50 ohm/ 50uH of coupling impedance for the measuring instrument.
- b. Both lines of the power mains connected to the EUT were checked for maximum conducted interference.
- c. The frequency range from 150kHz to 30MHz was searched. Emission levels under (Limit - 20dB) was not recorded.

5.2.4 DEVIATION FROM TEST STANDARD

No deviation

5.2.5 TEST SETUP

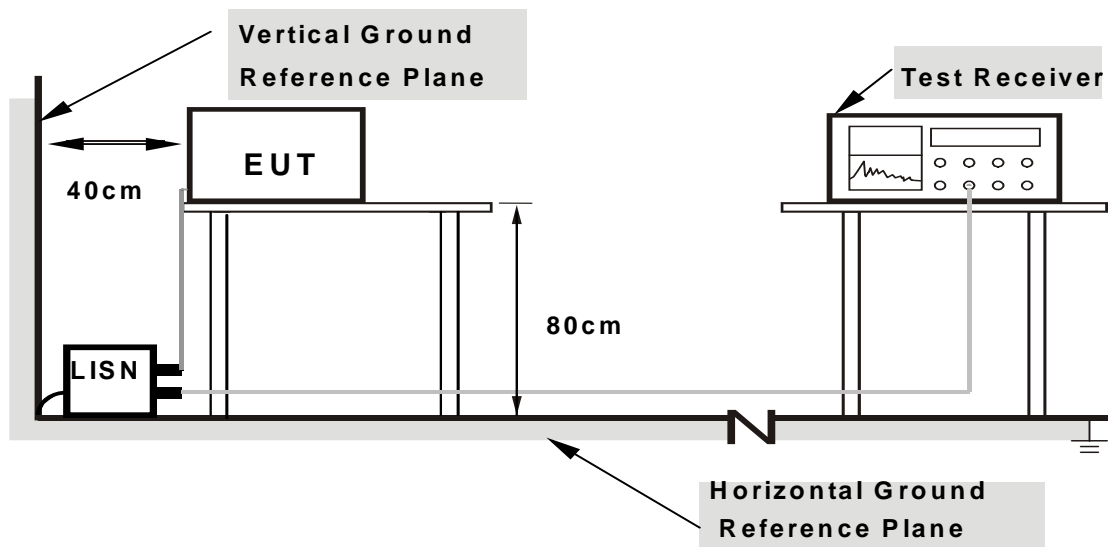

Note: 1. Support units were connected to second LISN.

2. Both of LISNs (AMN) are 80 cm from EUT and at least 80 from other units and other metal planes

For the actual test configuration, please refer to the attached file (Test Setup Photo).

5.2.6 EUT OPERATING CONDITIONS

Same as 4.1.6

5.2.7 TEST RESULTS

CONDUCTED WORST-CASE DATA : 802.11a OFDM MODULATION

EUT TEST CONDITION		MEASUREMENT DETAIL	
CHANNEL	Channel 149	PHASE	Line 1
MODULATION TYPE	BPSK	INPUT POWER (SYSTEM)	120Vac, 60Hz
TRANSFER RATE	6.0Mbps	6dB BANDWIDTH	9kHz
ENVIRONMENTAL CONDITIONS	20deg. C, 60%RH, 988hPa	TEST MODE	A
TESTED BY	Match Tsui		

No	Freq. [MHz]	Corr. Factor [dB]	Reading Value [dB (uV)]		Emission Level [dB (uV)]		Limit [dB (uV)]		Margin (dB)	
			Q.P.	AV.	Q.P.	AV.	Q.P.	AV.	Q.P.	AV.
			1	0.150	0.20	44.56	-	44.76	-	66.00
2	0.216	0.20	39.53	-	39.73	-	62.96	52.96	-23.23	-
3	0.439	0.20	35.86	-	36.06	-	57.08	47.08	-21.02	-
4	1.469	0.20	33.09	-	33.29	-	56.00	46.00	-22.71	-
5	1.957	0.20	33.23	-	33.43	-	56.00	46.00	-22.57	-
6	16.230	0.85	38.56	-	39.41	-	60.00	50.00	-20.59	-

- REMARKS:**
1. Q.P. and AV. are abbreviations of quasi-peak and average individually.
 2. "-": The Quasi-peak reading value also meets average limit and measurement with the average detector is unnecessary.
 3. The emission levels of other frequencies were very low against the limit.
 4. Margin value = Emission level - Limit value
 5. Correction factor = Insertion loss + Cable loss
 6. Emission Level = Correction Factor + Reading Value.

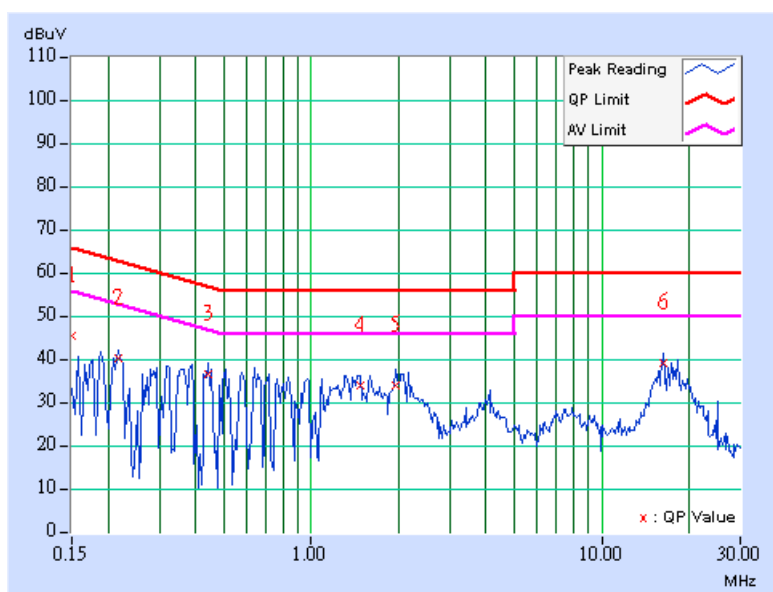

EUT TEST CONDITION		MEASUREMENT DETAIL	
CHANNEL	Channel 149	PHASE	Line 2
MODULATION TYPE	BPSK	INPUT POWER (SYSTEM)	120Vac, 60Hz
TRANSFER RATE	6.0Mbps	6dB BANDWIDTH	9kHz
ENVIRONMENTAL CONDITIONS	20deg. C, 60%RH, 988hPa	TEST MODE	A
TESTED BY	Match Tsui		

No	Freq. [MHz]	Corr. Factor (dB)	Reading Value [dB (uV)]		Emission Level [dB (uV)]		Limit [dB (uV)]		Margin (dB)	
			Q.P.	AV.	Q.P.	AV.	Q.P.	AV.	Q.P.	AV.
1	0.150	0.20	48.07	-	48.27	-	66.00	56.00	-17.73	-
2	0.216	0.20	43.07	-	43.27	-	62.96	52.96	-19.69	-
3	0.298	0.20	40.37	-	40.57	-	60.29	50.29	-19.72	-
4	0.771	0.20	32.64	-	32.84	-	56.00	46.00	-23.16	-
5	1.996	0.20	32.23	-	32.43	-	56.00	46.00	-23.57	-
6	16.230	0.50	38.38	-	38.88	-	60.00	50.00	-21.12	-

- REMARKS:**
1. Q.P. and AV. are abbreviations of quasi-peak and average individually.
 2. "-": The Quasi-peak reading value also meets average limit and measurement with the average detector is unnecessary.
 3. The emission levels of other frequencies were very low against the limit.
 4. Margin value = Emission level - Limit value
 5. Correction factor = Insertion loss + Cable loss
 6. Emission Level = Correction Factor + Reading Value.

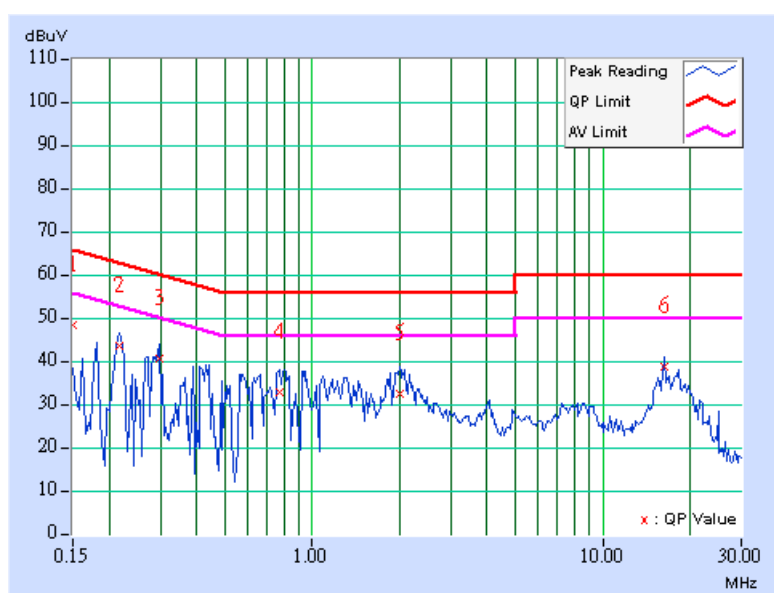

EUT TEST CONDITION		MEASUREMENT DETAIL	
CHANNEL	Channel 149	PHASE	Line 1
MODULATION TYPE	BPSK	INPUT POWER (SYSTEM)	120Vac, 60Hz
TRANSFER RATE	6.0Mbps	6dB BANDWIDTH	9kHz
ENVIRONMENTAL CONDITIONS	20deg. C, 60%RH, 988hPa	TEST MODE	B
TESTED BY	Match Tsui		

No	Freq. [MHz]	Corr. Factor (dB)	Reading Value [dB (uV)]		Emission Level [dB (uV)]		Limit [dB (uV)]		Margin (dB)	
			Q.P.	AV.	Q.P.	AV.	Q.P.	AV.	Q.P.	AV.
1	0.150	0.20	43.44	-	43.64	-	66.00	56.00	-22.36	-
2	0.220	0.20	40.56	-	40.76	-	62.81	52.81	-22.05	-
3	0.357	0.20	35.99	-	36.19	-	58.80	48.80	-22.61	-
4	1.434	0.20	33.18	-	33.38	-	56.00	46.00	-22.62	-
5	2.047	0.20	32.81	-	33.01	-	56.00	46.00	-22.99	-
6	17.695	0.91	41.89	-	42.80	-	60.00	50.00	-17.20	-

- REMARKS:**
1. Q.P. and AV. are abbreviations of quasi-peak and average individually.
 2. "-": The Quasi-peak reading value also meets average limit and measurement with the average detector is unnecessary.
 3. The emission levels of other frequencies were very low against the limit.
 4. Margin value = Emission level - Limit value
 5. Correction factor = Insertion loss + Cable loss
 6. Emission Level = Correction Factor + Reading Value.

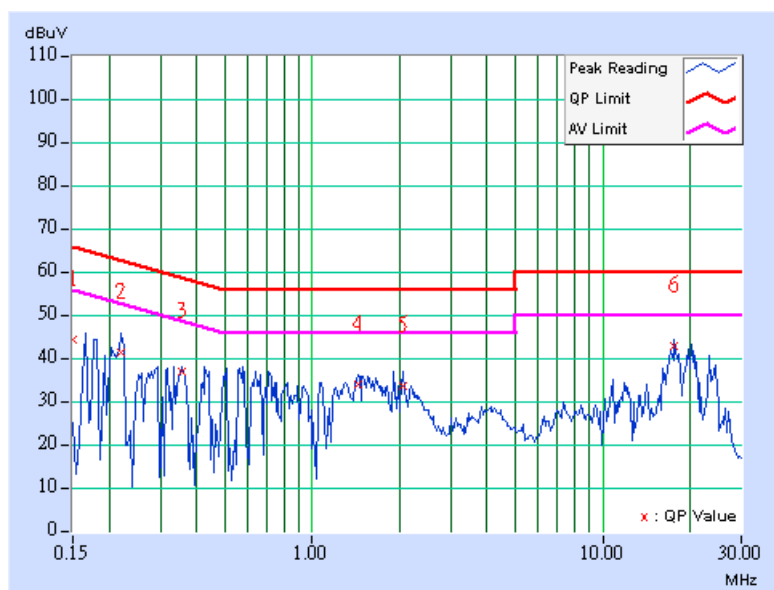

EUT TEST CONDITION		MEASUREMENT DETAIL	
CHANNEL	Channel 149	PHASE	Line 2
MODULATION TYPE	BPSK	INPUT POWER (SYSTEM)	120Vac, 60Hz
TRANSFER RATE	6.0Mbps	6dB BANDWIDTH	9kHz
ENVIRONMENTAL CONDITIONS	20deg. C, 60%RH, 988hPa	TEST MODE	B
TESTED BY	Match Tsui		

No	Freq. [MHz]	Corr. Factor (dB)	Reading Value [dB (uV)]		Emission Level [dB (uV)]		Limit [dB (uV)]		Margin (dB)	
			Q.P.	AV.	Q.P.	AV.	Q.P.	AV.	Q.P.	AV.
1	0.150	0.20	45.19	-	45.39	-	66.00	56.00	-20.61	-
2	0.177	0.20	43.02	-	43.22	-	64.61	54.61	-21.39	-
3	0.388	0.20	37.22	-	37.42	-	58.10	48.10	-20.68	-
4	1.059	0.20	33.17	-	33.37	-	56.00	46.00	-22.63	-
5	2.047	0.20	34.19	-	34.39	-	56.00	46.00	-21.61	-
6	17.695	0.51	41.62	-	42.13	-	60.00	50.00	-17.87	-

- REMARKS:**
1. Q.P. and AV. are abbreviations of quasi-peak and average individually.
 2. "-": The Quasi-peak reading value also meets average limit and measurement with the average detector is unnecessary.
 3. The emission levels of other frequencies were very low against the limit.
 4. Margin value = Emission level - Limit value
 5. Correction factor = Insertion loss + Cable loss
 6. Emission Level = Correction Factor + Reading Value.

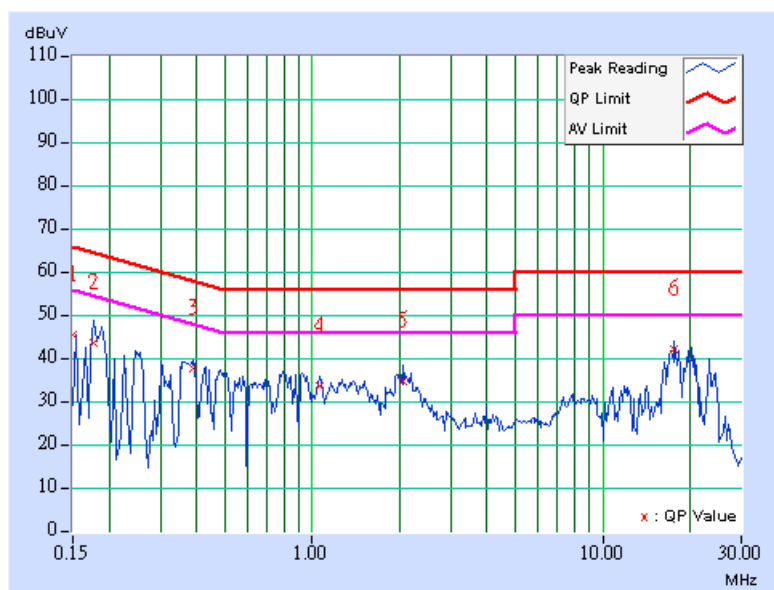



5.3 6dB BANDWIDTH MEASUREMENT

5.3.1 LIMITS OF 6dB BANDWIDTH MEASUREMENT

The minimum of 6dB Bandwidth Measurement is 0.5MHz.

5.3.2 TEST INSTRUMENTS

DESCRIPTION & MANUFACTURER	MODEL NO.	SERIAL NO.	DATE OF CALIBRATION	CALIBRATED UNTIL
R&S SPECTRUM ANALYZER	FSP40	100041	Apr. 22, 2008	Apr. 21, 2009

NOTE: The calibration interval of the above test instruments is 12 months and the calibrations are traceable to NML/ROC and NIST/USA.

5.3.3 TEST PROCEDURE

The transmitter output was connected to the spectrum analyzer through an attenuator. The bandwidth of the fundamental frequency was measured by spectrum analyzer with 100kHz RBW and 300kHz VBW. The 6dB bandwidth is defined as the total spectrum the power of which is higher than peak power minus 6dB.

5.3.4 DEVIATION FROM TEST STANDARD

No deviation

5.3.5 TEST SETUP

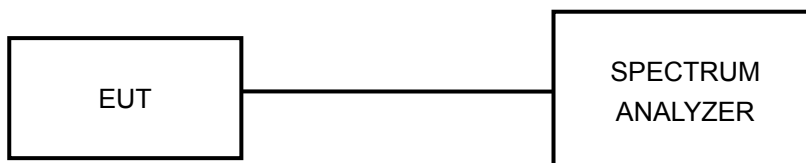

5.3.6 EUT OPERATING CONDITIONS

The software provided by client to enable the EUT under transmission condition continuously at lowest, middle and highest channel frequencies individually.

5.3.7 TEST RESULTS

802.11a OFDM MODULATION

MODULATION TYPE	BPSK	TRANSFER RATE	6.0Mbps
INPUT POWER (SYSTEM)	120Vac, 60Hz	ENVIRONMENTAL CONDITIONS	27deg.C, 66%RH, 991hPa
TESTED BY	Dean Wang		

CHANNEL	CHANNEL FREQUENCY (MHz)	6dB BANDWIDTH (MHz)	MINIMUM LIMIT (MHz)	PASS / FAIL
149	5745	16.40	0.5	PASS
157	5785	16.40	0.5	PASS
165	5825	16.42	0.5	PASS

CH 149

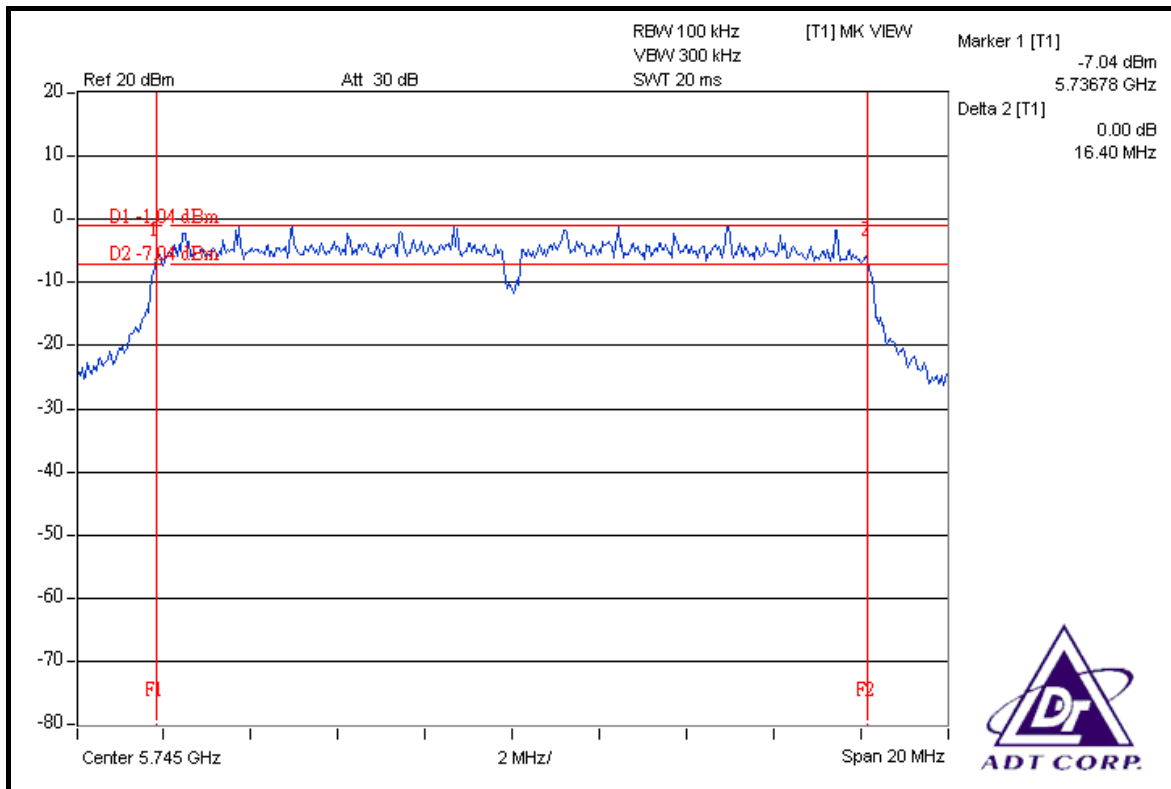

CH 157

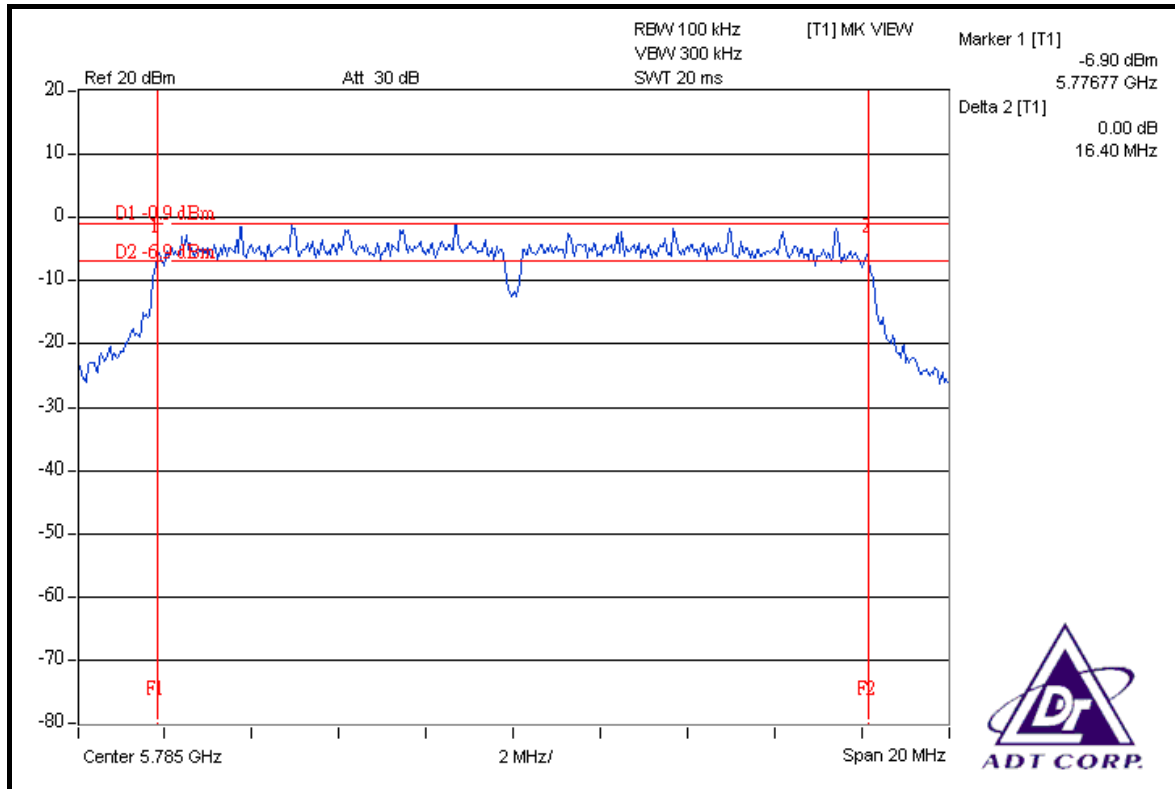

CH 165

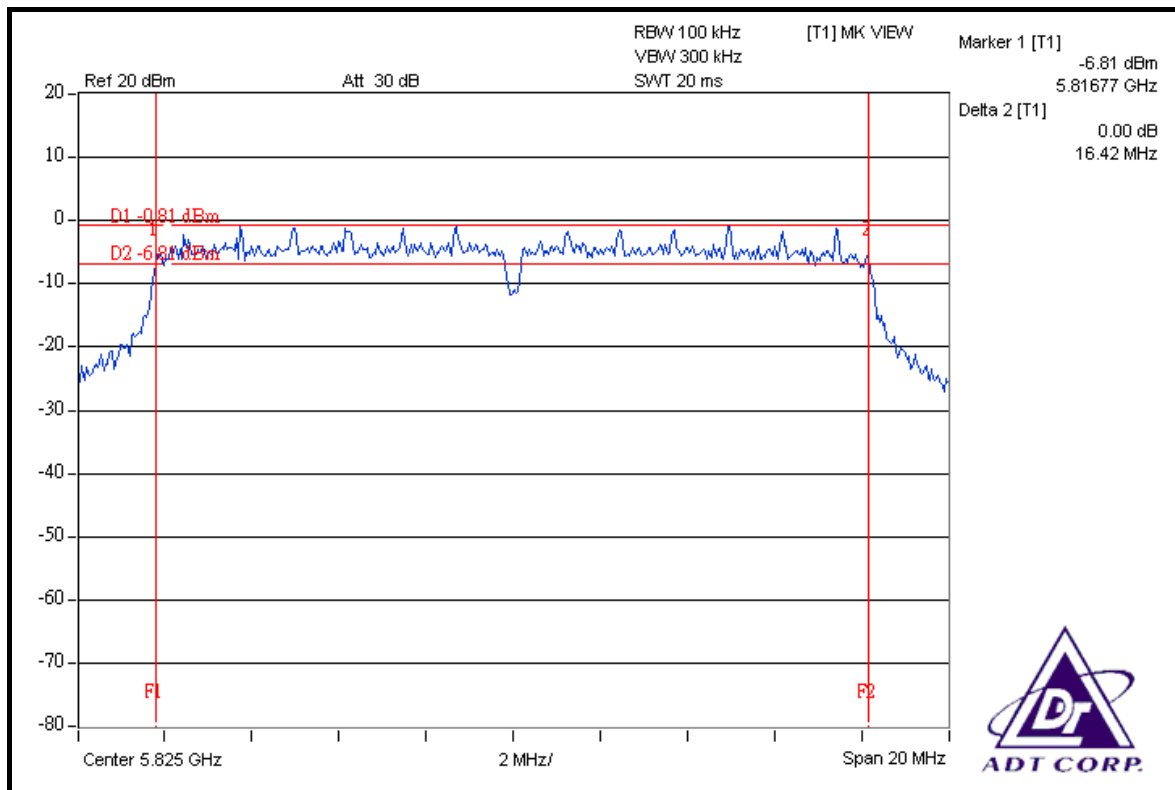



5.4 MAXIMUM PEAK OUTPUT POWER

5.4.1 LIMITS OF MAXIMUM PEAK OUTPUT POWER MEASUREMENT

The Maximum Peak Output Power Measurement is 30dBm.

5.4.2 INSTRUMENTS

DESCRIPTION & MANUFACTURER	MODEL NO.	SERIAL NO.	DATE OF CALIBRATION	CALIBRATED UNTIL
R&S SPECTRUM ANALYZER	FSP40	100041	Apr. 22, 2008	Apr. 21, 2009
AGILENT SYNTHESIZED SIGNAL GENERATOR	E8257C	MY43320668	Dec. 26, 2007	Dec. 25, 2008
DIGITAL RT OSCILLOSCOPE	TDS1012	C037299	Nov. 22, 2007	Nov. 21, 2008
NARDA DETECTOR	4503A	FSCM99899	NA	NA

NOTE: The calibration interval of the above test instruments is 12 months and the calibrations are traceable to NML/ROC and NIST/USA.

5.4.3 TEST PROCEDURES

- d. A detector was used on the output port of the EUT. An oscilloscope was used to read the response of the detector.
- e. Replaced the EUT by the signal generator. The center frequency of the S.G was adjusted to the center frequency of the measured channel.
- f. Adjusted the power to have the same reading on oscilloscope. Record the power level.

5.4.4 DEVIATION FROM TEST STANDARD

No deviation

5.4.5 TEST SETUP



5.4.6 EUT OPERATING CONDITIONS

Same as Item 5.3.6



5.4.7 TEST RESULTS

802.11a OFDM MODULATION

MODULATION TYPE	BPSK	TRANSFER RATE	6.0Mbps
INPUT POWER (SYSTEM)	120Vac, 60Hz	ENVIRONMENTAL CONDITIONS	27deg.C, 66%RH, 991hPa
TESTED BY	Dean Wang		

CHANNEL	CHANNEL FREQUENCY (MHz)	PEAK POWER OUTPUT (mW)	PEAK POWER OUTPUT (dBm)	PEAK POWER LIMIT (dBm)	PASS / FAIL
149	5745	30.339	14.82	29	PASS
157	5785	29.923	14.76	29	PASS
165	5825	29.785	14.74	29	PASS

NOTE: According to 15.247(b)(4), the maximum antenna gain 7.0dBi is higher than 6dBi, so the limit of peak power shall be reduced by 1dB.



5.5 POWER SPECTRAL DENSITY MEASUREMENT

5.5.1 LIMITS OF POWER SPECTRAL DENSITY MEASUREMENT

The Maximum of Power Spectral Density Measurement is 8dBm.

5.5.2 TEST INSTRUMENTS

DESCRIPTION & MANUFACTURER	MODEL NO.	SERIAL NO.	DATE OF CALIBRATION	CALIBRATED UNTIL
R&S SPECTRUM ANALYZER	FSP40	100041	Apr. 22, 2008	Apr. 21, 2009

NOTE: The calibration interval of the above test instruments is 12 months and the calibrations are traceable to NML/ROC and NIST/USA.

5.5.3 TEST PROCEDURE

The transmitter output was connected to the spectrum analyzer through an attenuator, the bandwidth of the fundamental frequency was measured with the spectrum analyzer using 3kHz RBW and 30kHz VBW, set sweep time = span/3kHz. The power spectral density was measured and recorded.

The sweep time is allowed to be longer than span/3kHz for a full response of the mixer in the spectrum analyzer.

5.5.4 DEVIATION FROM TEST STANDARD

No deviation

5.5.5 TEST SETUP

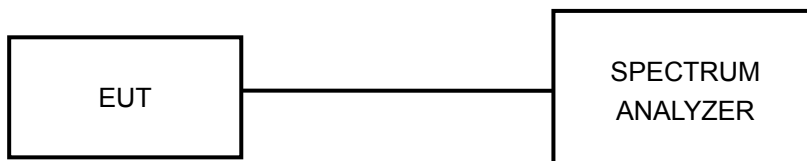

5.5.6 EUT OPERATING CONDITION

Same as Item 5.3.6

5.5.7 TEST RESULTS

802.11a OFDM MODULATION

MODULATION TYPE	BPSK	TRANSFER RATE	6.0Mbps
INPUT POWER (SYSTEM)	120Vac, 60Hz	ENVIRONMENTAL CONDITIONS	27deg.C, 66%RH, 991hPa
TESTED BY	Dean Wang		

CHANNEL	CHANNEL FREQUENCY (MHz)	RF POWER LEVEL IN 3kHz BW (dBm)	MAXIMUM LIMIT (dBm)	PASS / FAIL
149	5745	-14.58	7	PASS
157	5785	-14.53	7	PASS
165	5825	-14.71	7	PASS

NOTE: According to 15.247(b)(4), the maximum antenna gain 7.0dBi is higher than 6dBi, so the limit of peak power shall be reduced by 1dB.

CH 149

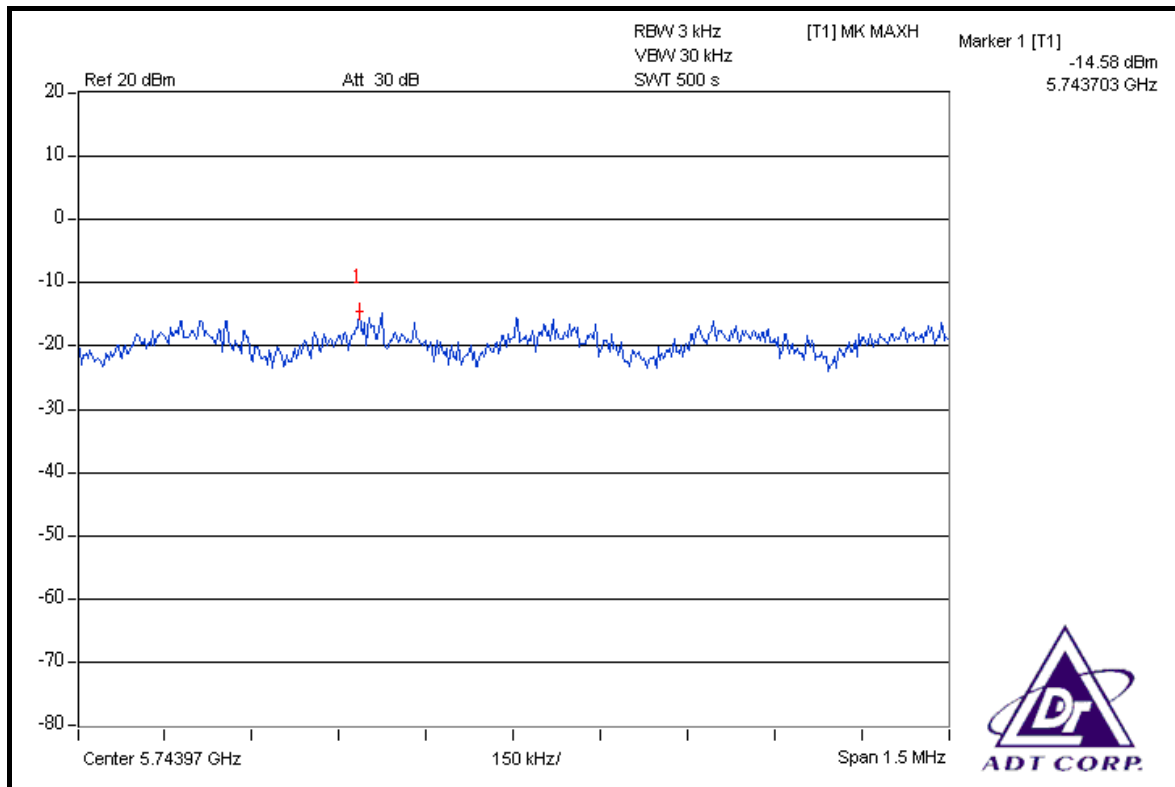



CH 157

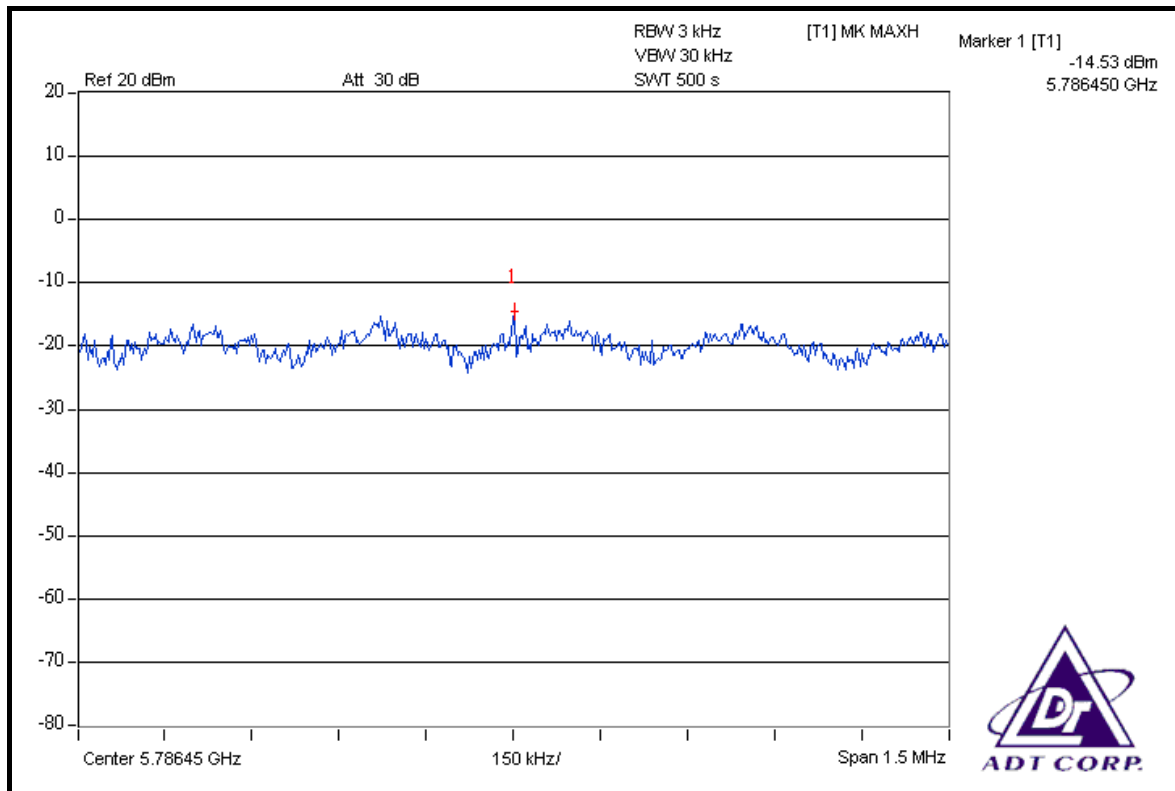

CH 165

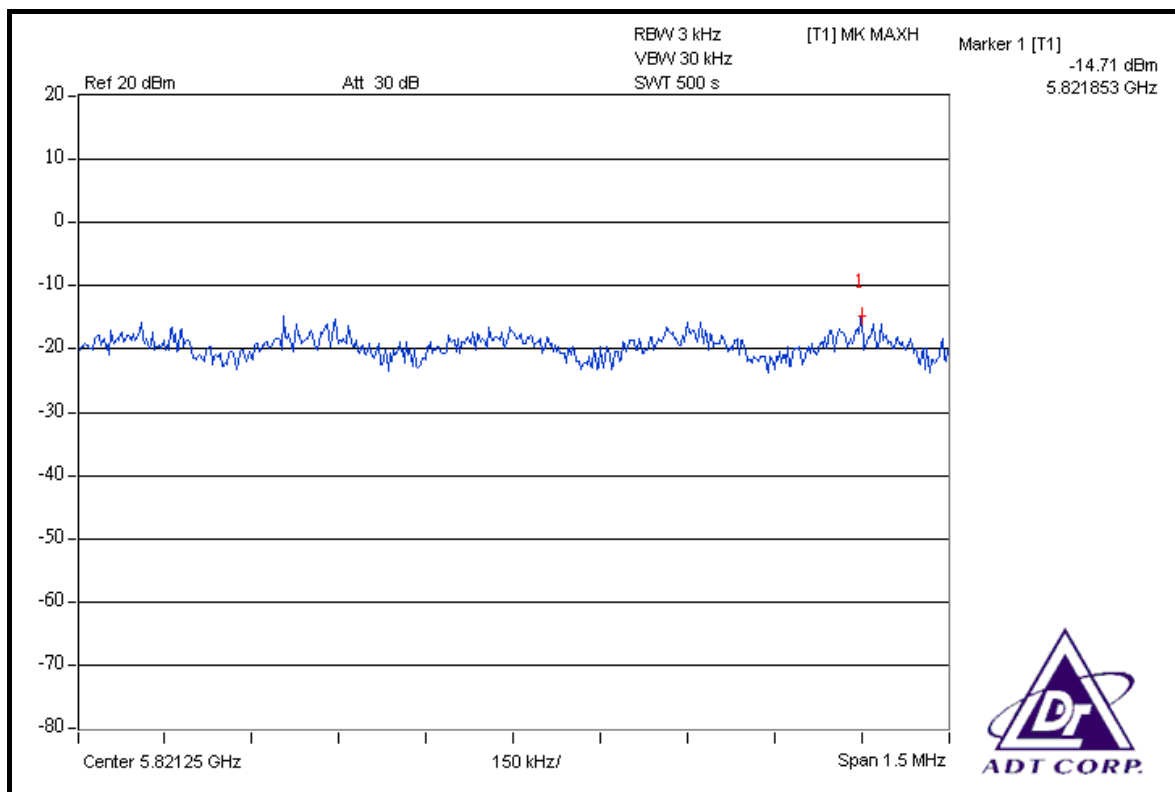



5.6 BAND EDGES MEASUREMENT

5.6.1 LIMITS OF BAND EDGES MEASUREMENT

Below -20dB of the highest emission level of operating band (in 100kHz Resolution Bandwidth).

5.6.2 TEST INSTRUMENTS

DESCRIPTION & MANUFACTURER	MODEL NO.	SERIAL NO.	DATE OF CALIBRATION	CALIBRATED UNTIL
R&S SPECTRUM ANALYZER	FSP40	100041	Apr. 22, 2008	Apr. 21, 2009

NOTE: The calibration interval of the above test instruments is 12 months and the calibrations are traceable to NML/ROC and NIST/USA.

5.6.3 TEST PROCEDURE

The transmitter output was connected to the spectrum analyzer via a low lose cable. Set both RBW and VBW of spectrum analyzer to 100kHz and 300kHz with suitable frequency span including 100MHz bandwidth from band edge. The band edges was measured and recorded.

The spectrum plots (Peak RBW=100kHz, VBW=300kHz; Average RBW=1MHz, VBW= 10Hz are attached on the following pages.

5.6.4 DEVIATION FROM TEST STANDARD

No deviation

5.6.5 EUT OPERATING CONDITION

Same as Item 5.3.6



5.6.6 TEST RESULTS

The spectrum plots are attached on the following pages. D1 line indicates the highest level, D2 line indicates the 20dB offset below D1. It shows compliance with the requirement in part 15.247(d).

802.11a OFDM MODULATION

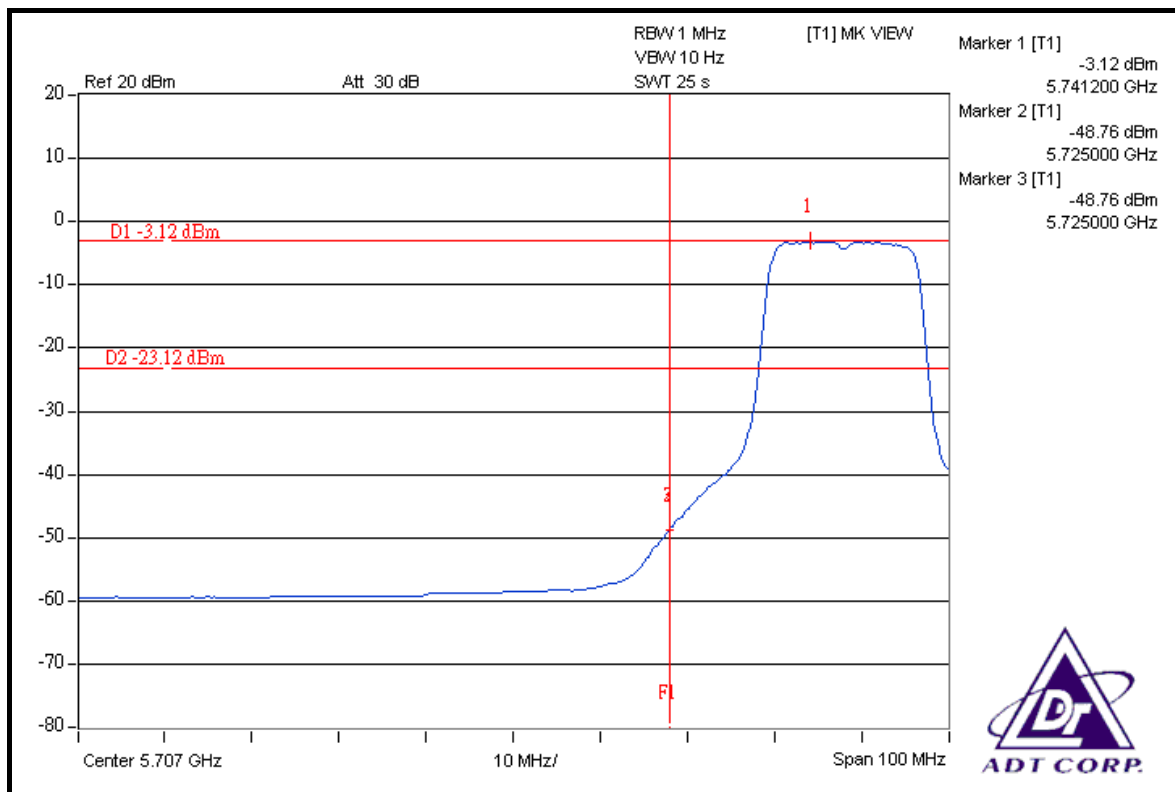
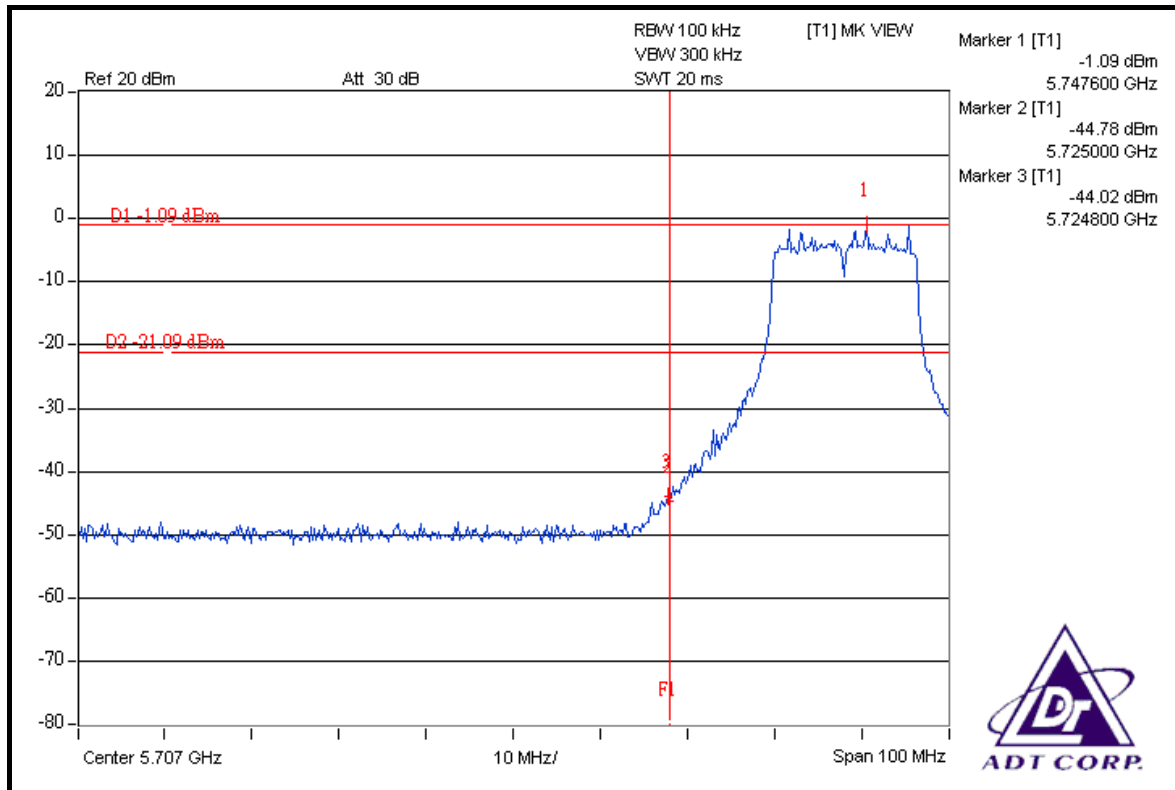

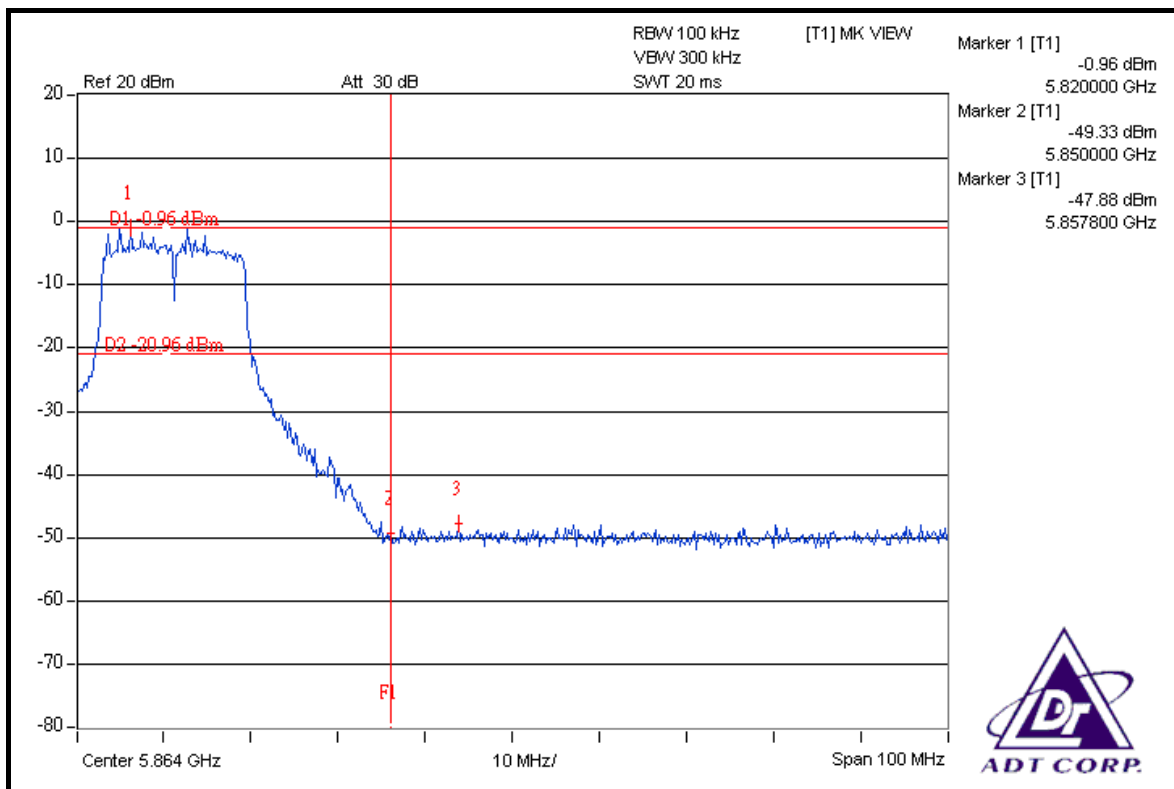
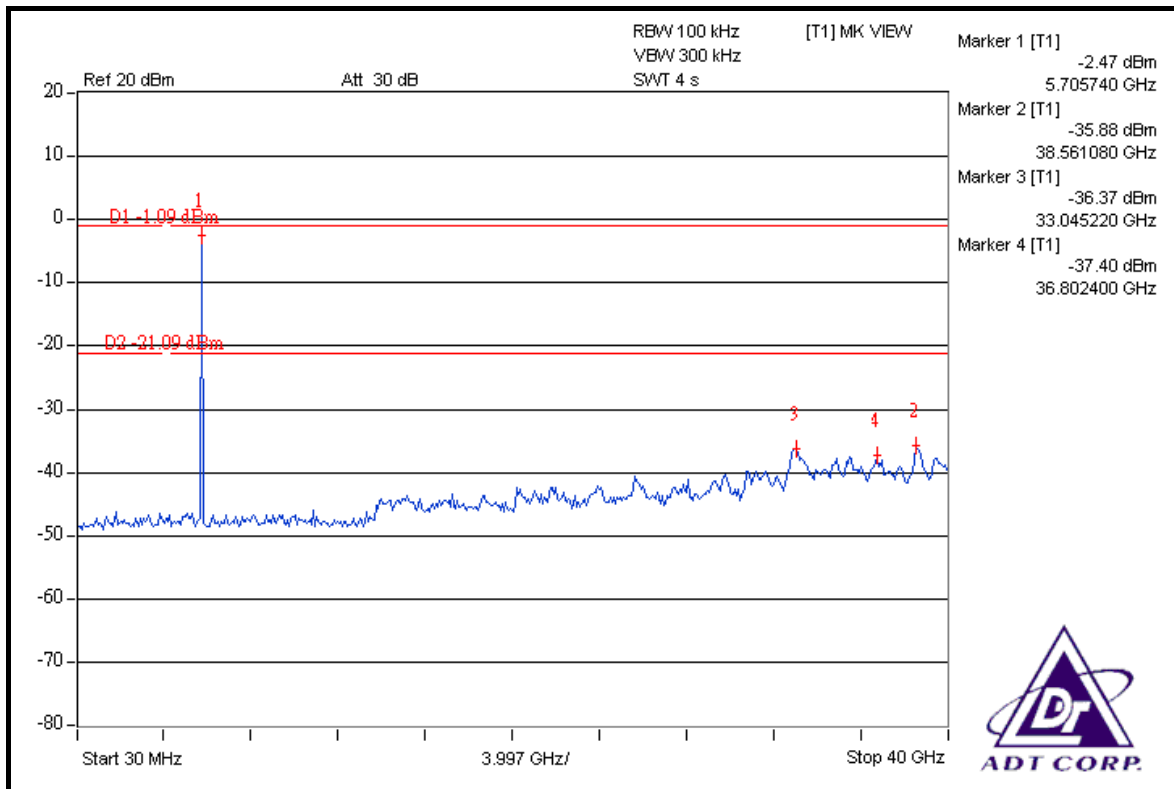

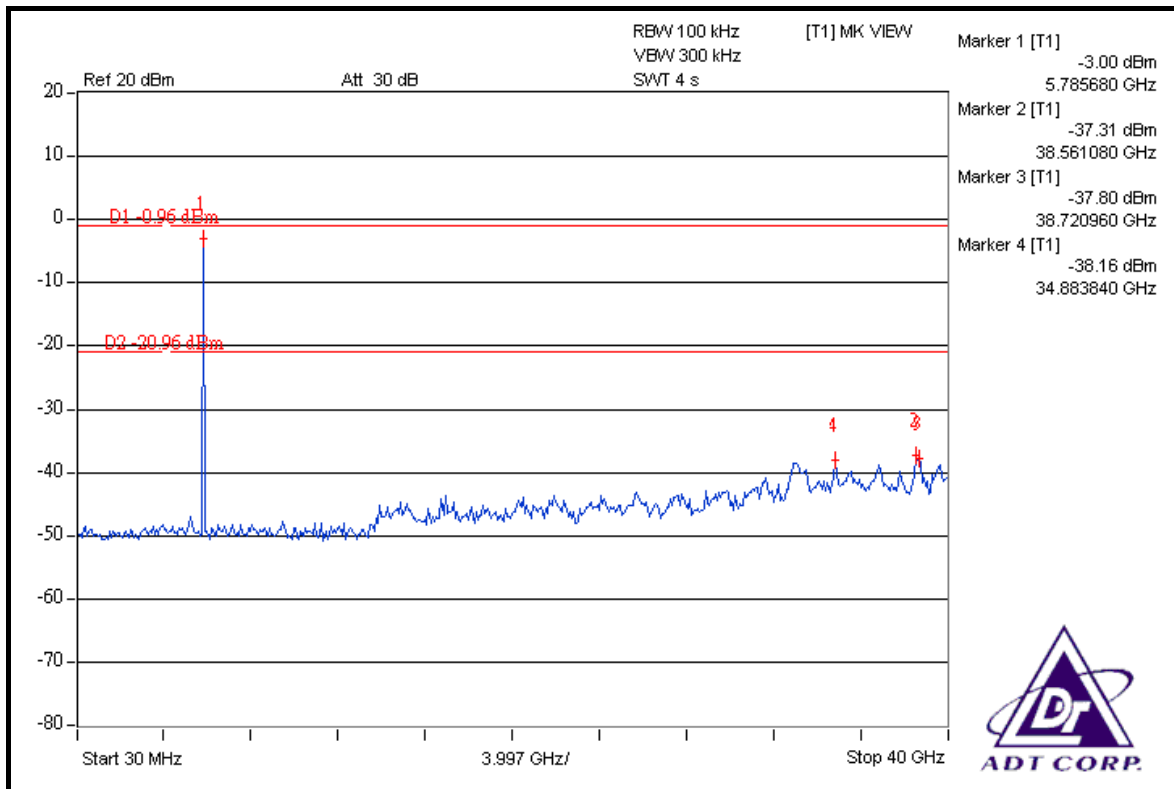
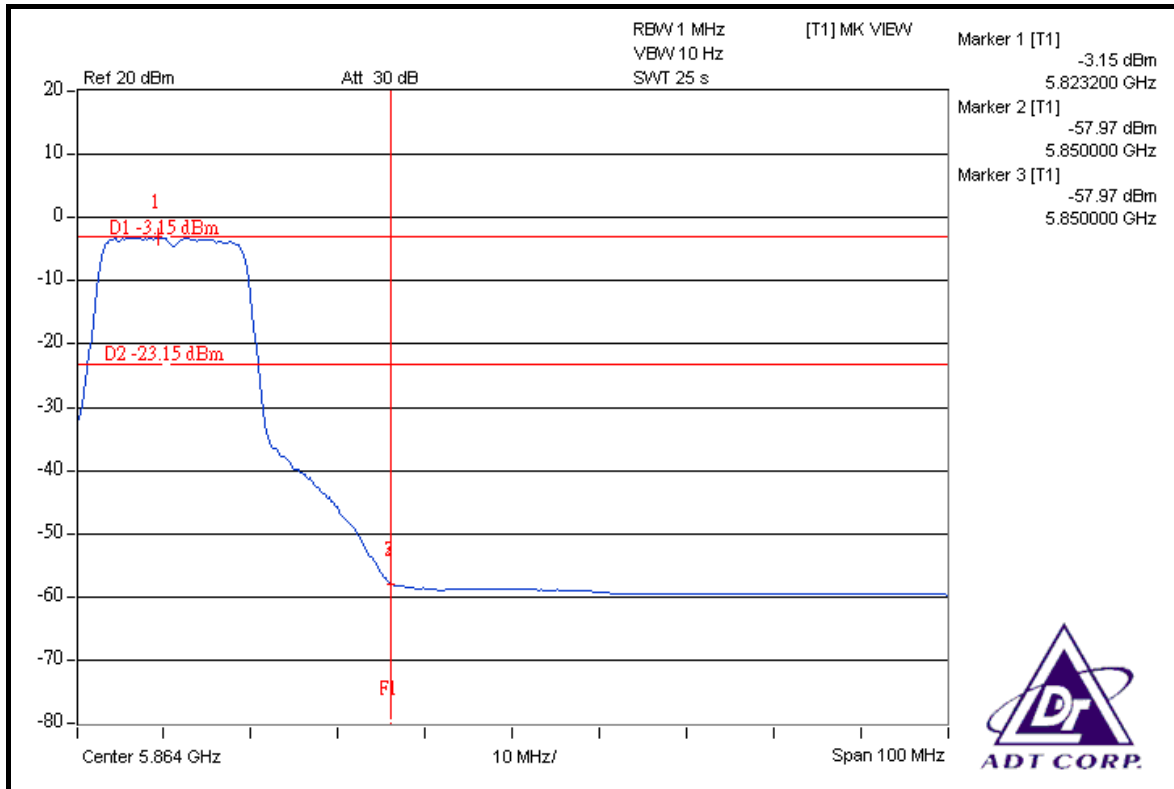



5.7 ANTENNA REQUIREMENT

5.7.1 STANDARD APPLICABLE

For intentional device, according to FCC 47 CFR Section 15.203, an intentional radiator shall be designed to ensure that no antenna other than that furnished by the responsible party shall be used with the device.

And according to FCC 47 CFR Section 15.247(a), if transmitting antennas of directional gain greater than 6dBi are used, the power shall be reduced by the amount in dB that the directional gain of the antenna exceeds 6dBi.

5.7.2 ANTENNA CONNECTED CONSTRUCTION

The antenna used in this product is Omni-directional external with N type connector. The maximum Gain of the antenna is 7.0dBi.

6. PHOTOGRAPHS OF THE TEST CONFIGURATION

Please refer to the attached file (Test Setup Photo).



7. INFORMATION ON THE TESTING LABORATORIES

We, ADT Corp., were founded in 1988 to provide our best service in EMC, Radio, Telecom and Safety consultation. Our laboratories are accredited and approved by the following approval agencies according to ISO/IEC 17025.

USA	FCC, UL
Germany	TUV Rheinland
Japan	VCCI
Norway	NEMKO
Canada	INDUSTRY CANADA , CSA
R.O.C.	TAF, BSMI, NCC
Netherlands	Telefication
Singapore	GOST-ASIA(MOU)
Russia	CERTIS(MOU)

Copies of accreditation certificates of our laboratories obtained from approval agencies can be downloaded from our web site:
www.adt.com.tw/index.5/phtml. If you have any comments, please feel free to contact us at the following:

Linko EMC/RF Lab:
Tel: 886-2-26052180
Fax: 886-2-26051924

Hsin Chu EMC/RF Lab:
Tel: 886-3-5935343
Fax: 886-3-5935342

Hwa Ya EMC/RF/Safety Telecom Lab:
Tel: 886-3-3183232
Fax: 886-3-3185050

Web Site: www.adt.com.tw

The address and road map of all our labs can be found in our web site also.

8. APPENDIX A - MODIFICATIONS RECORDERS FOR ENGINEERING CHANGES TO THE EUT BY THE LAB

No any modifications are made to the EUT by the lab during the test.

---END---