



FCC TEST REPORT

REPORT NO.: RF970818L12

MODEL NO.: EMP-9602

(refer to item 3.1 for more details)

RECEIVED: Aug. 18, 2008

TESTED: Aug. 19 ~ Aug. 22, 2008

ISSUED: Aug. 29, 2008

APPLICANT: Senao Networks Inc.

ADDRESS: 3F, No. 529, Chung Cheng Rd., Hsintien, Taipei,
Taiwan, R.O.C.

ISSUED BY: Advance Data Technology Corporation

LAB ADDRESS: No. 47, 14th Ling, Chia Pau Tsuen, Lin Kou
Hsiang, Taipei Hsien 244, Taiwan, R.O.C.

TEST LOCATION: No. 19, Hwa Ya 2nd Rd, Wen Hwa Tsuen, Kwei
Shan Hsiang, Taoyuan Hsien 333, Taiwan,
R.O.C.

This test report consists of 92 pages in total. It may be duplicated completely for legal use with the approval of the applicant. It should not be reproduced except in full, without the written approval of our laboratory. The client should not use it to claim product endorsement by TAF or any government agencies. The test results in the report only apply to the tested sample.





TABLE OF CONTENTS

1.	CERTIFICATION	4
2.	SUMMARY OF TEST RESULTS	5
2.1	MEASUREMENT UNCERTAINTY	5
3.	GENERAL INFORMATION	6
3.1	GENERAL DESCRIPTION OF EUT	6
3.2	DESCRIPTION OF TEST MODES	7
3.2.1	CONFIGURATION OF SYSTEM UNDER TEST	7
3.2.2	TEST MODE APPLICABILITY AND TESTED CHANNEL DETAIL	8
3.3	GENERAL DESCRIPTION OF APPLIED STANDARDS	10
3.4	DESCRIPTION OF SUPPORT UNITS	10
4.	TEST TYPES AND RESULTS	11
4.1	RADIATED EMISSION MEASUREMENT	11
4.1.1	LIMITS OF RADIATED EMISSION MEASUREMENT	11
4.1.2	TEST INSTRUMENTS	12
4.1.3	TEST PROCEDURES	13
4.1.4	DEVIATION FROM TEST STANDARD	13
4.1.5	TEST SETUP	14
4.1.6	EUT OPERATING CONDITIONS	14
4.1.7	TEST RESULTS	15
4.2	CONDUCTED EMISSION MEASUREMENT	30
4.2.1	LIMITS OF CONDUCTED EMISSION MEASUREMENT	30
4.2.2	TEST INSTRUMENTS	30
4.2.3	TEST PROCEDURES	31
4.2.4	DEVIATION FROM TEST STANDARD	31
4.2.5	TEST SETUP	32
4.2.6	EUT OPERATING CONDITIONS	32
4.2.7	TEST RESULTS	33
4.3	6dB BANDWIDTH MEASUREMENT	35
4.3.1	LIMITS OF 6dB BANDWIDTH MEASUREMENT	35
4.3.2	TEST INSTRUMENTS	35
4.3.3	TEST PROCEDURE	35
4.3.4	DEVIATION FROM TEST STANDARD	35
4.3.5	TEST SETUP	36
4.3.6	EUT OPERATING CONDITIONS	36
4.3.7	TEST RESULTS	37
4.4	MAXIMUM PEAK OUTPUT POWER	51
4.4.1	LIMITS OF MAXIMUM PEAK OUTPUT POWER MEASUREMENT	51
4.4.2	INSTRUMENTS	51
4.4.3	TEST PROCEDURES	51
4.4.4	DEVIATION FROM TEST STANDARD	51
4.4.5	TEST SETUP	52
4.4.6	EUT OPERATING CONDITIONS	52
4.4.7	TEST RESULTS	53
4.5	POWER SPECTRAL DENSITY MEASUREMENT	55
4.5.1	LIMITS OF POWER SPECTRAL DENSITY MEASUREMENT	55
4.5.2	TEST INSTRUMENTS	55
4.5.3	TEST PROCEDURE	55
4.5.4	DEVIATION FROM TEST STANDARD	55
4.5.5	TEST SETUP	56



4.5.6	EUT OPERATING CONDITION	56
4.5.7	TEST RESULTS	57
4.6	BAND EDGES MEASUREMENT	71
4.6.1	LIMITS OF BAND EDGES MEASUREMENT	71
4.6.2	TEST INSTRUMENTS	71
4.6.3	TEST PROCEDURE	72
4.6.4	DEVIATION FROM TEST STANDARD	72
4.6.5	EUT OPERATING CONDITION	73
4.6.6	TEST RESULTS	73
4.7	ANTENNA REQUIREMENT	89
4.7.1	STANDARD APPLICABLE	89
4.7.2	ANTENNA CONNECTED CONSTRUCTION.....	89
5.	PHOTOGRAPHS OF THE TEST CONFIGURATION	90
6.	INFORMATION ON THE TESTING LABORATORIES.....	91
7.	APPENDIX A - MODIFICATIONS RECORDERS FOR ENGINEERING CHANGES TO THE EUT BY THE LAB.....	92



1. CERTIFICATION

PRODUCT: 802.11b/g/n miniPCI
MODEL: EMP-9602 (refer to item 3.1 for more details)
BRAND: EnGenius / Senao
APPLICANT: Senao Networks Inc.
TESTED: Aug. 19 ~ Aug. 22, 2008
TEST SAMPLE: ENGINEERING SAMPLE
STANDARDS: FCC Part 15, Subpart C (Section 15.247)
ANSI C63.4-2003

The above equipment (model: EMP-9602) has been tested by **Advance Data Technology Corporation**, and found compliance with the requirement of the above standards. The test record, data evaluation & Equipment Under Test (EUT) configurations represented herein are true and accurate accounts of the measurements of the sample's EMC characteristics under the conditions specified in this report.

PREPARED BY : Wendy Liao , **DATE:** Aug. 29, 2008
Wendy Liao / Senior Specialist

TECHNICAL ACCEPTANCE : Long Chen , **DATE:** Aug. 29, 2008
Responsible for RF
Long Chen / Senior Engineer

APPROVED BY : Gary Chang , **DATE:** Aug. 29, 2008
Gary Chang / Assistant Manager

2. SUMMARY OF TEST RESULTS

The EUT has been tested according to the following specifications:

APPLIED STANDARD: FCC Part 15, Subpart C			
Standard Section	Test Type and Limit	Result	Remark
15.207	AC Power Conducted Emission	PASS	Meet the requirement of limit. Minimum passing margin is -15.54dB at 0.173MHz.
15.247(a)(2)	Spectrum Bandwidth of a Direct Sequence Spread Spectrum System Limit: min. 500kHz	PASS	Meet the requirement of limit.
15.247(b)	Maximum Peak Output Power Limit: max. 30dBm	PASS	Meet the requirement of limit.
15.247(d)	Radiated Emissions Limit: Table 15.209	PASS	Meet the requirement of limit. Minimum passing margin is -1.00dB at 99.89 or 152.39MHz.
15.247(e)	Power Spectral Density Limit: max. 8dBm	PASS	Meet the requirement of limit.
15.247(d)	Band Edge Measurement Limit: 20dB less than the peak value of fundamental frequency	PASS	Meet the requirement of limit.

2.1 MEASUREMENT UNCERTAINTY

Where relevant, the following measurement uncertainty levels have been estimated for tests performed on the EUT as specified in CISPR 16-4-2:

MEASUREMENT	FREQUENCY	UNCERTAINTY
Conducted emissions	9kHz ~ 30MHz	2.44 dB
Radiated emissions	30MHz ~ 200MHz	3.19 dB
	200MHz ~ 1000MHz	3.21 dB
	1GHz ~ 18GHz	2.26 dB
	18GHz ~ 40GHz	1.94 dB

This uncertainty represents an expanded uncertainty expressed at approximately the 95% confidence level using a coverage factor of k=2.

3. GENERAL INFORMATION

3.1 GENERAL DESCRIPTION OF EUT

PRODUCT	802.11b/g/n miniPCI
MODEL NO.	EMP-9602 (refer to NOTE for more details)
FCC ID	U2M-MP9600801
POWER SUPPLY	3.3Vdc from host equipment
MODULATION TYPE	CCK, DQPSK, DBPSK for DSSS 64QAM, 16QAM, QPSK, BPSK for OFDM
MODULATION TECHNOLOGY	DSSS, OFDM
TRANSFER RATE	802.11b: 11.0/ 5.5/ 2.0/ 1.0Mbps 802.11g: 54.0/ 48.0/ 36.0/ 24.0/ 18.0/ 12.0/ 9.0/ 6.0Mbps Draft 802.11n: up to 300Mbps
FREQUENCY RANGE	2412MHz ~ 2472MHz
NUMBER OF CHANNEL	11 for 802.11b, 802.11g, draft 802.11n (20MHz) 7 for draft 802.11n (40MHz)
MAXIMUM OUTPUT POWER	251.523mW
ANTENNA TYPE	Dipole antenna with 5dBi gain (black) Dipole antenna with 3dBi gain (white)
DATA CABLE	NA
I/O PORTS	NA
ACCESSORY DEVICES	NA

NOTE:

- The models are identical to each other except their model designation due to marketing requirement.

BRAND	MODEL	REMARK
EnGenius / Senao	EMP-9602	Marketing requirement
	NMP-9602	

- The EUT incorporates a MIMO function. Physically, the EUT provides three completed transmitter and three receivers.

MODULATION MODE	TX FUNCTION
802.11b	1TX
802.11g	1TX
Draft 802.11n (20MHz)	3TX
Draft 802.11n (40MHz)	3TX

- Two antennas were same type, the one with highest gain will be the worst case, therefore only tested for final.
- The above EUT information was declared by manufacturer and for more detailed features description, please refer to the manufacturer's specifications or user's manual.

3.2 DESCRIPTION OF TEST MODES

Eleven channels are provided for 802.11b, 802.11g and draft 802.11n (20MHz):

CHANNEL	FREQUENCY	CHANNEL	FREQUENCY
1	2412MHz	7	2442MHz
2	2417MHz	8	2447MHz
3	2422MHz	9	2452MHz
4	2427MHz	10	2457MHz
5	2432MHz	11	2462MHz
6	2437MHz		

Seven channels are provided for draft 802.11n (40MHz):

CHANNEL	FREQUENCY	CHANNEL	FREQUENCY
1	2422MHz	5	2442MHz
2	2427MHz	6	2447MHz
3	2432MHz	7	2452MHz
4	2437MHz		

3.2.1 CONFIGURATION OF SYSTEM UNDER TEST

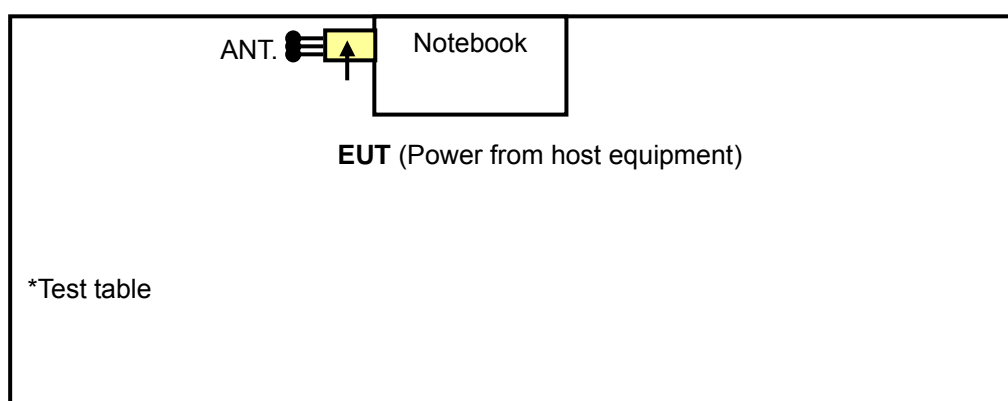

3.2.2 TEST MODE APPLICABILITY AND TESTED CHANNEL DETAIL

EUT CONFIGURE MODE	APPLICABLE TO				DESCRIPTION
	RE \geq 1G	RE<1G	PLC	APCM	
-	√	√	√	√	-

Where **PLC**: Power Line Conducted Emission **RE<1G**: Radiated Emission below 1GHz
RE \geq 1G: Radiated Emission above 1GHz **APCM**: Antenna Port Conducted Measurement

RADIATED EMISSION TEST (ABOVE 1 GHz):

- Pre-Scan has been conducted to determine the worst-case mode from all possible combinations between available modulations, data rates and antenna ports (if EUT with antenna diversity architecture).
- Following channel(s) was (were) selected for the final test as listed below.

MODE	AVAILABLE CHANNEL	TESTED CHANNEL	MODULATION TECHNOLOGY	MODULATION TYPE	DATA RATE (Mbps)
802.11b	1 to 11	1, 6, 11	DSSS	DBPSK	1
802.11g	1 to 11	1, 6, 11	OFDM	BPSK	6
Draft 802.11n (20MHz)	1 to 11	1, 6, 11	OFDM	BPSK	7.2
Draft 802.11n (40MHz)	1 to 7	1, 4, 7	OFDM	BPSK	15.0

RADIATED EMISSION TEST (BELOW 1 GHz):

- Pre-Scan has been conducted to determine the worst-case mode from all possible combinations between available modulations, data rates and antenna ports (if EUT with antenna diversity architecture).
- Following channel(s) was (were) selected for the final test as listed below.

MODE	AVAILABLE CHANNEL	TESTED CHANNEL	MODULATION TECHNOLOGY	MODULATION TYPE	DATA RATE (Mbps)
Draft 802.11n (20MHz)	1 to 11	6	OFDM	BPSK	7.2

POWER LINE CONDUCTED EMISSION TEST:

- Pre-Scan has been conducted to determine the worst-case mode from all possible combinations between available modulations, data rates, and antenna ports (if EUT with antenna diversity architecture).
- Following channel(s) was (were) selected for the final test as listed below.

MODE	AVAILABLE CHANNEL	TESTED CHANNEL	MODULATION TECHNOLOGY	MODULATION TYPE	DATA RATE (Mbps)
Draft 802.11n (20MHz)	1 to 11	6	OFDM	BPSK	7.2

BANDEDGE MEASUREMENT:

- Pre-Scan has been conducted to determine the worst-case mode from all possible combinations between available modulations, data rates and antenna ports (if EUT with antenna diversity architecture).
- Follow channel(s) was (were) selected for the final test as listed below.

MODE	AVAILABLE CHANNEL	TESTED CHANNEL	MODULATION TECHNOLOGY	MODULATION TYPE	DATA RATE (Mbps)
802.11b	1 to 11	1, 11	DSSS	DBPSK	1
802.11g	1 to 11	1, 11	OFDM	BPSK	6
Draft 802.11n (20MHz)	1 to 11	1, 11	OFDM	BPSK	7.2
Draft 802.11n (40MHz)	1 to 7	1, 7	OFDM	BPSK	15.0

ANTENNA PORT CONDUCTED MEASUREMENT:

- Pre-Scan has been conducted to determine the worst-case mode from all possible combinations between available modulations, data rates, and antenna ports (if EUT with antenna diversity architecture).
- Following channel(s) was (were) selected for the final test as listed below.

MODE	AVAILABLE CHANNEL	TESTED CHANNEL	MODULATION TECHNOLOGY	MODULATION TYPE	DATA RATE (Mbps)
802.11b	1 to 11	1, 6, 11	DSSS	DBPSK	1
802.11g	1 to 11	1, 6, 11	OFDM	BPSK	6
Draft 802.11n (20MHz)	1 to 11	1, 6, 11	OFDM	BPSK	7.2
Draft 802.11n (40MHz)	1 to 7	1, 4, 7	OFDM	BPSK	15.0



3.3 GENERAL DESCRIPTION OF APPLIED STANDARDS

The EUT is a RF product. According to the specifications of the manufacturer, it must comply with the requirements of the following standards:

FCC Part 15, Subpart C (15.247)

ANSI C63.4-2003

All test items have been performed and recorded as per the above standards.

NOTE: The EUT is also considered as a kind of computer peripheral, because the connection to computer is necessary for typical use. It has been verified to comply with the requirements of FCC Part 15, Subpart B, Class B (DoC). The test report has been issued separately.

3.4 DESCRIPTION OF SUPPORT UNITS

The EUT has been tested as an independent unit together with other necessary accessories or support units. The following support units or accessories were used to form a representative test configuration during the tests.

NO.	PRODUCT	BRAND	MODEL NO.	SERIAL NO.	FCC ID
1	NOTEBOOK COMPUTER	DELL	PP05L	16484462992	E2K24CLNS

NO.	SIGNAL CABLE DESCRIPTION OF THE ABOVE SUPPORT UNITS
1	NA

NOTE: All power cords of the above support units are non shielded (1.8m).

4. TEST TYPES AND RESULTS

4.1 RADIATED EMISSION MEASUREMENT

4.1.1 LIMITS OF RADIATED EMISSION MEASUREMENT

Emissions radiated outside of the specified bands, shall be according to the general radiated limits in 15.209 as following:

FREQUENCIES (MHz)	FIELD STRENGTH (microvolts/meter)	MEASUREMENT DISTANCE (meters)
0.009 ~ 0.490	2400 / F(kHz)	300
0.490 ~ 1.705	24000 / F(kHz)	30
1.705 ~ 30.0	30	30
30 ~ 88	100	3
88 ~ 216	150	3
216 ~ 960	200	3
Above 960	500	3

NOTE:

1. The lower limit shall apply at the transition frequencies.
2. Emission level (dBuV/m) = 20 log Emission level (uV/m).
3. As shown in 15.35(b), for frequencies above 1000MHz, the field strength limits are based on average detector, however, the peak field strength of any emission shall not exceed the maximum permitted average limits, specified above by more than 20dB under any condition of modulation.



4.1.2 TEST INSTRUMENTS

DESCRIPTION & MANUFACTURER	MODEL NO.	SERIAL NO.	DATE OF CALIBRATION	DUE DATE OF CALIBRATION
Test Receiver ROHDE & SCHWARZ	ESI7	838496/016	Dec. 26, 2007	Dec. 25, 2008
Spectrum Analyzer ROHDE & SCHWARZ	FSP40	100039	Dec. 03, 2007	Dec. 02, 2008
BILOG Antenna SCHWARZBECK	VULB9168	9168-155	Apr. 30, 2008	Apr. 29, 2009
HORN Antenna SCHWARZBECK	BBHA 9120D	9120D-408	Jan. 22, 2008	Jan. 21, 2009
HORN Antenna SCHWARZBECK	BBHA 9170	BBHA9170242	Jan. 07, 2008	Jan. 06, 2009
Preamplifier Agilent	8449B	3008A01960	Oct. 31, 2007	Oct. 30, 2008
Preamplifier Agilent	8447D	2944A10631	Nov. 01, 2007	Oct. 31, 2008
RF signal cable HUBER+SUHNNER	SUCOFLEX 104	274397/4	Nov. 08, 2007	Nov. 07, 2008
RF signal cable HUBER+SUHNNER	SUCOFLEX 104	283401/4	Nov. 08, 2007	Nov. 07, 2008
Software ADT.	ADT_Radiated_V7.6	NA	NA	NA
Antenna Tower inn-co GmbH	MA 4000	010303	NA	NA
Antenna Tower Controller inn-co GmbH	CO2000	019303	NA	NA
Turn Table ADT.	TT100.	TT93021704	NA	NA
Turn Table Controller ADT.	SC100.	SC93021704	NA	NA

- NOTE:**
1. The calibration interval of the above test instruments is 12 months and the calibrations are traceable to NML/ROC and NIST/USA.
 2. The test was performed in HwaYa Chamber 4.
 3. The horn antenna and HP preamplifier (model: 8449B) are used only for the measurement of emission frequency above 1GHz if tested.
 4. The FCC Site Registration No. is 460141.
 5. The IC Site Registration No. is IC3789B-4.

4.1.3 TEST PROCEDURES

- a. The EUT was placed on the top of a rotating table 0.8 meters above the ground at a 3 meters semi-anechoic chamber. The table was rotated 360 degrees to determine the position of the highest radiation.
- b. The EUT was set 3 meters away from the interference-receiving antenna, which was mounted on the top of a variable-height antenna tower.
- c. The antenna is a broadband antenna, and its height is varied from one meter to four meters above the ground to determine the maximum value of the field strength. Both horizontal and vertical polarizations of the antenna are set to make the measurement.
- d. For each suspected emission, the EUT was arranged to its worst case and then the antenna was tuned to heights from 1 meter to 4 meters and the rotatable table was turned from 0 degrees to 360 degrees to find the maximum reading.
- e. The test-receiver system was set to Peak Detect Function and Specified Bandwidth with Maximum Hold Mode.
- f. If the emission level of the EUT in peak mode was lower than the limit specified, then testing could be stopped and the peak values of the EUT would be reported. Otherwise the emissions would be re-tested one by one using peak, quasi-peak or average method as specified and then reported in a data sheet.

NOTE:

1. The resolution bandwidth and video bandwidth of test receiver/spectrum analyzer is 120kHz for Peak detection (PK) and Quasi-peak detection (QP) at frequency below 1GHz.
2. The resolution bandwidth of test receiver/spectrum analyzer is 1 MHz and video bandwidth is 3MHz for Peak detection at frequency above 1GHz.
3. The resolution bandwidth of test receiver/spectrum analyzer is 1MHz and the video bandwidth is 10Hz for Average detection (AV) at frequency above 1GHz.
4. All modes of operation were investigated and the worst-case emissions are reported.

4.1.4 DEVIATION FROM TEST STANDARD

No deviation.

4.1.5 TEST SETUP

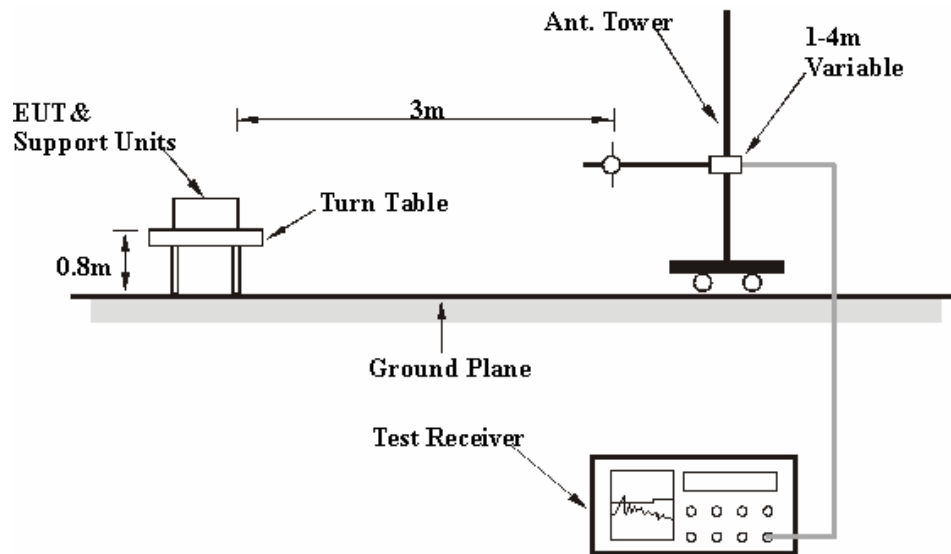

For the actual test configuration, please refer to the attached file (Test Setup Photo)

4.1.6 EUT OPERATING CONDITIONS

- Connected the EUT into the notebook system via extend card and placed on a testing table.
- The EUT ran a test program (provided by manufacturer) to enable all functions under transmission condition continuously at specific channel frequency.
- The necessary accessories enable the EUT in full functions.



4.1.7 TEST RESULTS

802.11b DSSS MODULATION

EUT TEST CONDITION		MEASUREMENT DETAIL	
CHANNEL	Channel 1	FREQUENCY RANGE	1 ~ 25GHz
INPUT POWER (SYSTEM)	120Vac, 60 Hz	DETECTOR FUNCTION	Peak (PK) Average (AV)
ENVIRONMENTAL CONDITIONS	24deg. C, 64%RH 999hPa	TESTED BY	Mark Liao

ANTENNA POLARITY & TEST DISTANCE: HORIZONTAL AT 3 M								
NO.	FREQ. (MHz)	EMISSION LEVEL (dBuV/m)	LIMIT (dBuV/m)	MARGIN (dB)	ANTENNA HEIGHT (m)	TABLE ANGLE (Degree)	RAW VALUE (dBuV)	CORRECTION FACTOR (dB/m)
1	2386.00	58.18 PK	74.00	-15.82	1.46 H	2	26.46	31.72
2	2386.00	45.77 AV	54.00	-8.23	1.46 H	2	14.05	31.72
3	*2412.00	100.73 PK			1.46 H	2	68.92	31.81
4	*2412.00	96.16 AV			1.46 H	2	64.35	31.81
5	4824.00	52.76 PK	74.00	-21.24	1.59 H	23	14.67	38.09
6	4824.00	47.57 AV	54.00	-6.43	1.59 H	23	9.48	38.09
7	#7238.00	54.93 PK	80.73	-25.80	1.53 H	11	10.42	44.51
8	#7238.00	43.79 AV	76.16	-32.37	1.53 H	11	-0.72	44.51
9	#9648.00	57.40 PK	80.73	-23.33	1.38 H	35	9.67	47.73
10	#9648.00	45.72 AV	76.16	-30.44	1.38 H	35	-2.01	47.73

- REMARKS:**
1. Emission level (dBuV/m) = Raw Value (dBuV) + Correction Factor (dB/m).
 2. Correction Factor (dB/m) = Antenna Factor (dB/m) + Cable Factor (dB).
 3. The other emission levels were very low against the limit.
 4. Margin value = Emission level – Limit value.
 5. “ * “: Fundamental frequency.
 6. “#”:The radiated frequency is out the restricted band.



EUT TEST CONDITION		MEASUREMENT DETAIL	
CHANNEL	Channel 1	FREQUENCY RANGE	1 ~ 25GHz
INPUT POWER (SYSTEM)	120Vac, 60 Hz	DETECTOR FUNCTION	Peak (PK) Average (AV)
ENVIRONMENTAL CONDITIONS	24deg. C, 64%RH 999hPa	TESTED BY	Mark Liao

ANTENNA POLARITY & TEST DISTANCE: VERTICAL AT 3 M								
NO.	FREQ. (MHz)	EMISSION LEVEL (dBuV/m)	LIMIT (dBuV/m)	MARGIN (dB)	ANTENNA HEIGHT (m)	TABLE ANGLE (Degree)	RAW VALUE (dBuV)	CORRECTION FACTOR (dB/m)
1	2386.00	60.33 PK	74.00	-13.67	1.45 V	272	28.61	31.72
2	2386.00	48.93 AV	54.00	-5.07	1.45 V	272	17.21	31.72
3	*2412.00	110.73 PK			1.45 V	272	78.92	31.81
4	*2412.00	106.08 AV			1.45 V	272	74.27	31.81
5	4824.00	54.89 PK	74.00	-19.11	1.00 V	68	16.80	38.09
6	4824.00	51.65 AV	54.00	-2.35	1.00 V	68	13.56	38.09
7	#7238.00	58.72 PK	90.73	-32.01	1.59 V	100	14.21	44.51
8	#7238.00	49.98 AV	86.08	-36.10	1.59 V	100	5.47	44.51
9	#9648.00	56.89 PK	90.73	-33.84	1.47 V	224	9.16	47.73
10	#9648.00	46.22 AV	86.08	-39.86	1.47 V	224	-1.51	47.73

- REMARKS:**
1. Emission level (dBuV/m) = Raw Value (dBuV) + Correction Factor (dB/m).
 2. Correction Factor (dB/m) = Antenna Factor (dB/m) + Cable Factor (dB).
 3. The other emission levels were very low against the limit.
 4. Margin value = Emission level – Limit value.
 5. “ * “: Fundamental frequency.
 6. “#”:The radiated frequency is out the restricted band.

EUT TEST CONDITION		MEASUREMENT DETAIL	
CHANNEL	Channel 6	FREQUENCY RANGE	1 ~ 25GHz
INPUT POWER (SYSTEM)	120Vac, 60 Hz	DETECTOR FUNCTION	Peak (PK) Average (AV)
ENVIRONMENTAL CONDITIONS	24deg. C, 64%RH 999hPa	TESTED BY	Mark Liao

ANTENNA POLARITY & TEST DISTANCE: HORIZONTAL AT 3 M								
NO.	FREQ. (MHz)	EMISSION LEVEL (dBuV/m)	LIMIT (dBuV/m)	MARGIN (dB)	ANTENNA HEIGHT (m)	TABLE ANGLE (Degree)	RAW VALUE (dBuV)	CORRECTION FACTOR (dB/m)
1	*2437.00	100.09 PK			1.40 H	23	68.19	31.90
2	*2437.00	95.52 AV			1.40 H	23	63.62	31.90
3	4874.00	51.92 PK	74.00	-22.08	1.57 H	24	13.70	38.22
4	4874.00	45.45 AV	54.00	-8.55	1.57 H	24	7.23	38.22
5	7311.00	55.47 PK	74.00	-18.53	1.57 H	30	10.78	44.69
6	7311.00	44.41 AV	54.00	-9.59	1.57 H	30	-0.28	44.69
7	#9748.00	59.14 PK	80.09	-20.95	1.32 H	68	11.25	47.89
8	#9748.00	49.21 AV	75.52	-26.31	1.32 H	68	1.32	47.89
ANTENNA POLARITY & TEST DISTANCE: VERTICAL AT 3 M								
NO.	FREQ. (MHz)	EMISSION LEVEL (dBuV/m)	LIMIT (dBuV/m)	MARGIN (dB)	ANTENNA HEIGHT (m)	TABLE ANGLE (Degree)	RAW VALUE (dBuV)	CORRECTION FACTOR (dB/m)
1	*2437.00	110.62 PK			1.40 V	280	78.72	31.90
2	*2437.00	106.10 AV			1.40 V	280	74.20	31.90
3	4874.00	53.25 PK	74.00	-20.75	1.00 V	47	15.03	38.22
4	4874.00	49.30 AV	54.00	-4.70	1.00 V	47	11.08	38.22
5	7311.00	59.39 PK	74.00	-14.61	1.57 V	269	14.70	44.69
6	7311.00	51.58 AV	54.00	-2.42	1.57 V	269	6.89	44.69
7	#9748.00	59.58 PK	90.62	-31.04	1.80 V	219	11.69	47.89
8	#9748.00	50.99 AV	86.10	-35.11	1.80 V	219	3.10	47.89

- REMARKS:**
1. Emission level (dBuV/m) = Raw Value (dBuV) + Correction Factor (dB/m).
 2. Correction Factor (dB/m) = Antenna Factor (dB/m) + Cable Factor (dB).
 3. The other emission levels were very low against the limit.
 4. Margin value = Emission level – Limit value.
 5. “ * “: Fundamental frequency.
 6. “#“: The radiated frequency is out the restricted band.



EUT TEST CONDITION		MEASUREMENT DETAIL	
CHANNEL	Channel 11	FREQUENCY RANGE	1 ~ 25GHz
INPUT POWER (SYSTEM)	120Vac, 60 Hz	DETECTOR FUNCTION	Peak (PK) Average (AV)
ENVIRONMENTAL CONDITIONS	24deg. C, 64%RH 999hPa	TESTED BY	Mark Liao

ANTENNA POLARITY & TEST DISTANCE: HORIZONTAL AT 3 M								
NO.	FREQ. (MHz)	EMISSION LEVEL (dBuV/m)	LIMIT (dBuV/m)	MARGIN (dB)	ANTENNA HEIGHT (m)	TABLE ANGLE (Degree)	RAW VALUE (dBuV)	CORRECTION FACTOR (dB/m)
1	*2462.00	100.06 PK			1.41 H	2	68.07	31.99
2	*2462.00	95.53 AV			1.41 H	2	63.54	31.99
3	2487.50	58.11 PK	74.00	-15.89	1.41 H	2	26.02	32.09
4	2487.50	46.21 AV	54.00	-7.79	1.41 H	2	14.12	32.09
5	4924.00	50.47 PK	74.00	-23.53	1.71 H	25	12.12	38.35
6	4924.00	43.20 AV	54.00	-10.80	1.71 H	25	4.85	38.35
7	7386.00	56.68 PK	74.00	-17.32	1.70 H	342	11.80	44.87
8	7386.00	45.94 AV	54.00	-8.06	1.70 H	342	1.06	44.87
9	#9848.00	58.60 PK	80.06	-21.46	1.48 H	14	10.55	48.05
10	#9848.00	47.46 AV	75.53	-28.07	1.48 H	14	-0.59	48.05

- REMARKS:**
1. Emission level (dBuV/m) = Raw Value (dBuV) + Correction Factor (dB/m).
 2. Correction Factor (dB/m) = Antenna Factor (dB/m) + Cable Factor (dB).
 3. The other emission levels were very low against the limit.
 4. Margin value = Emission level – Limit value.
 5. “ * “: Fundamental frequency.
 6. “#”:The radiated frequency is out the restricted band.

EUT TEST CONDITION		MEASUREMENT DETAIL	
CHANNEL	Channel 11	FREQUENCY RANGE	1 ~ 25GHz
INPUT POWER (SYSTEM)	120Vac, 60 Hz	DETECTOR FUNCTION	Peak (PK) Average (AV)
ENVIRONMENTAL CONDITIONS	24deg. C, 64%RH 999hPa	TESTED BY	Mark Liao

ANTENNA POLARITY & TEST DISTANCE: VERTICAL AT 3 M								
NO.	FREQ. (MHz)	EMISSION LEVEL (dBuV/m)	LIMIT (dBuV/m)	MARGIN (dB)	ANTENNA HEIGHT (m)	TABLE ANGLE (Degree)	RAW VALUE (dBuV)	CORRECTION FACTOR (dB/m)
1	*2462.00	111.11 PK			1.70 V	275	79.12	31.99
2	*2462.00	106.48 AV			1.70 V	275	74.49	31.99
3	2487.50	61.64 PK	74.00	-12.36	1.42 V	288	29.55	32.09
4	2487.50	51.53 AV	54.00	-2.47	1.42 V	288	19.44	32.09
5	4924.00	51.80 PK	74.00	-22.20	1.40 V	47	13.45	38.35
6	4924.00	46.78 AV	54.00	-7.22	1.40 V	47	8.43	38.35
7	7386.00	59.25 PK	74.00	-14.75	1.54 V	106	14.37	44.87
8	7386.00	52.28 AV	54.00	-1.72	1.54 V	106	7.40	44.87
9	#9848.00	58.27 PK	91.11	-32.84	1.76 V	27	10.22	48.05
10	#9848.00	50.55 AV	86.48	-35.93	1.76 V	27	2.50	48.05

- REMARKS:**
1. Emission level (dBuV/m) = Raw Value (dBuV) + Correction Factor (dB/m).
 2. Correction Factor (dB/m) = Antenna Factor (dB/m) + Cable Factor (dB).
 3. The other emission levels were very low against the limit.
 4. Margin value = Emission level – Limit value.
 5. “ * “: Fundamental frequency.
 6. “#”:The radiated frequency is out the restricted band.



802.11g OFDM MODULATION

EUT TEST CONDITION		MEASUREMENT DETAIL	
CHANNEL	Channel 1	FREQUENCY RANGE	1 ~ 25GHz
INPUT POWER (SYSTEM)	120Vac, 60 Hz	DETECTOR FUNCTION	Peak (PK) Average (AV)
ENVIRONMENTAL CONDITIONS	24deg. C, 64%RH 999hPa	TESTED BY	Mark Liao

ANTENNA POLARITY & TEST DISTANCE: HORIZONTAL AT 3 M								
NO.	FREQ. (MHz)	EMISSION LEVEL (dBuV/m)	LIMIT (dBuV/m)	MARGIN (dB)	ANTENNA HEIGHT (m)	TABLE ANGLE (Degree)	RAW VALUE (dBuV)	CORRECTION FACTOR (dB/m)
1	2390.00	58.13 PK	74.00	-15.87	1.20 H	214	26.40	31.73
2	2390.00	45.74 AV	54.00	-8.26	1.20 H	214	14.01	31.73
3	*2412.00	94.06 PK			1.20 H	214	62.25	31.81
4	*2412.00	83.96 AV			1.20 H	214	52.15	31.81
5	4824.00	47.13 PK	74.00	-26.87	1.23 H	142	9.04	38.09
6	4824.00	34.16 AV	54.00	-19.84	1.23 H	142	-3.93	38.09
ANTENNA POLARITY & TEST DISTANCE: VERTICAL AT 3 M								
NO.	FREQ. (MHz)	EMISSION LEVEL (dBuV/m)	LIMIT (dBuV/m)	MARGIN (dB)	ANTENNA HEIGHT (m)	TABLE ANGLE (Degree)	RAW VALUE (dBuV)	CORRECTION FACTOR (dB/m)
1	2390.00	58.33 PK	74.00	-15.67	1.46 V	273	26.60	31.73
2	2390.00	46.78 AV	54.00	-7.22	1.46 V	273	15.05	31.73
3	*2412.00	105.71 PK			1.46 V	273	73.90	31.81
4	*2412.00	95.42 AV			1.46 V	273	63.61	31.81
5	4824.00	47.47 PK	74.00	-26.53	1.36 V	45	9.38	38.09
6	4824.00	34.35 AV	54.00	-19.65	1.36 V	45	-3.74	38.09

- REMARKS:**
1. Emission level (dBuV/m) = Raw Value (dBuV) + Correction Factor (dB/m).
 2. Correction Factor (dB/m) = Antenna Factor (dB/m) + Cable Factor (dB).
 3. The other emission levels were very low against the limit.
 4. Margin value = Emission level – Limit value.
 5. “*”: Fundamental frequency.



EUT TEST CONDITION		MEASUREMENT DETAIL	
CHANNEL	Channel 6	FREQUENCY RANGE	1 ~ 25GHz
INPUT POWER (SYSTEM)	120Vac, 60 Hz	DETECTOR FUNCTION	Peak (PK) Average (AV)
ENVIRONMENTAL CONDITIONS	24deg. C, 64%RH 999hPa	TESTED BY	Mark Liao

ANTENNA POLARITY & TEST DISTANCE: HORIZONTAL AT 3 M								
NO.	FREQ. (MHz)	EMISSION LEVEL (dBuV/m)	LIMIT (dBuV/m)	MARGIN (dB)	ANTENNA HEIGHT (m)	TABLE ANGLE (Degree)	RAW VALUE (dBuV)	CORRECTION FACTOR (dB/m)
1	*2437.00	94.79 PK			1.18 H	214	62.89	31.90
2	*2437.00	84.39 AV			1.18 H	214	52.49	31.90
3	4874.00	47.95 PK	74.00	-26.05	1.09 H	32	9.73	38.22
4	4874.00	34.74 AV	54.00	-19.26	1.09 H	32	-3.48	38.22
ANTENNA POLARITY & TEST DISTANCE: VERTICAL AT 3 M								
NO.	FREQ. (MHz)	EMISSION LEVEL (dBuV/m)	LIMIT (dBuV/m)	MARGIN (dB)	ANTENNA HEIGHT (m)	TABLE ANGLE (Degree)	RAW VALUE (dBuV)	CORRECTION FACTOR (dB/m)
1	*2437.00	106.45 PK			1.34 V	198	74.55	31.90
2	*2437.00	95.87 AV			1.34 V	198	63.97	31.90
3	4874.00	48.32 PK	74.00	-25.68	1.31 V	88	10.10	38.22
4	4874.00	35.40 AV	54.00	-18.60	1.31 V	88	-2.82	38.22

- REMARKS:**
1. Emission level (dBuV/m) = Raw Value (dBuV) + Correction Factor (dB/m).
 2. Correction Factor (dB/m) = Antenna Factor (dB/m) + Cable Factor (dB).
 3. The other emission levels were very low against the limit.
 4. Margin value = Emission level – Limit value.
 5. “ * “: Fundamental frequency.



EUT TEST CONDITION		MEASUREMENT DETAIL	
CHANNEL	Channel 11	FREQUENCY RANGE	1 ~ 25GHz
INPUT POWER (SYSTEM)	120Vac, 60 Hz	DETECTOR FUNCTION	Peak (PK) Average (AV)
ENVIRONMENTAL CONDITIONS	24deg. C, 64%RH 999hPa	TESTED BY	Mark Liao

ANTENNA POLARITY & TEST DISTANCE: HORIZONTAL AT 3 M								
NO.	FREQ. (MHz)	EMISSION LEVEL (dBuV/m)	LIMIT (dBuV/m)	MARGIN (dB)	ANTENNA HEIGHT (m)	TABLE ANGLE (Degree)	RAW VALUE (dBuV)	CORRECTION FACTOR (dB/m)
1	*2462.00	95.27 PK			1.30 H	229	63.28	31.99
2	*2462.00	85.27 AV			1.30 H	229	53.28	31.99
3	2483.50	58.10 PK	74.00	-15.90	1.30 H	229	26.03	32.07
4	2483.50	45.97 AV	54.00	-8.03	1.30 H	229	13.90	32.07
5	4924.00	47.33 PK	74.00	-26.67	1.16 H	143	8.98	38.35
6	4924.00	34.29 AV	54.00	-19.71	1.16 H	143	-4.06	38.35
ANTENNA POLARITY & TEST DISTANCE: VERTICAL AT 3 M								
NO.	FREQ. (MHz)	EMISSION LEVEL (dBuV/m)	LIMIT (dBuV/m)	MARGIN (dB)	ANTENNA HEIGHT (m)	TABLE ANGLE (Degree)	RAW VALUE (dBuV)	CORRECTION FACTOR (dB/m)
1	*2462.00	105.48 PK			1.32 V	171	73.49	31.99
2	*2462.00	95.97 AV			1.32 V	171	63.98	31.99
3	2483.50	60.02 PK	74.00	-13.98	1.32 V	171	27.95	32.07
4	2483.50	47.83 AV	54.00	-6.17	1.32 V	171	15.76	32.07
5	4924.00	48.26 PK	74.00	-25.74	1.28 V	86	9.91	38.35
6	4924.00	35.11 AV	54.00	-18.89	1.28 V	86	-3.24	38.35

- REMARKS:**
1. Emission level (dBuV/m) = Raw Value (dBuV) + Correction Factor (dB/m).
 2. Correction Factor (dB/m) = Antenna Factor (dB/m) + Cable Factor (dB).
 3. The other emission levels were very low against the limit.
 4. Margin value = Emission level – Limit value.
 5. “* “: Fundamental frequency.

DRAFT 802.11n (20MHz) OFDM MODULATION

EUT TEST CONDITION		MEASUREMENT DETAIL	
CHANNEL	Channel 1	FREQUENCY RANGE	1 ~ 25GHz
INPUT POWER (SYSTEM)	120Vac, 60 Hz	DETECTOR FUNCTION	Peak (PK) Average (AV)
ENVIRONMENTAL CONDITIONS	24deg. C, 64%RH 999hPa	TESTED BY	Mark Liao

ANTENNA POLARITY & TEST DISTANCE: HORIZONTAL AT 3 M								
NO.	FREQ. (MHz)	EMISSION LEVEL (dBuV/m)	LIMIT (dBuV/m)	MARGIN (dB)	ANTENNA HEIGHT (m)	TABLE ANGLE (Degree)	RAW VALUE (dBuV)	CORRECTION FACTOR (dB/m)
1	2390.00	63.28 PK	74.00	-10.72	1.97 H	274	31.55	31.73
2	2390.00	47.59 AV	54.00	-6.41	1.97 H	274	15.86	31.73
3	*2412.00	100.46 PK			1.97 H	274	68.65	31.81
4	*2412.00	87.59 AV			1.97 H	274	55.78	31.81
5	4824.00	52.58 PK	74.00	-21.42	1.61 H	32	14.49	38.09
6	4824.00	38.68 AV	54.00	-15.32	1.61 H	32	0.59	38.09

ANTENNA POLARITY & TEST DISTANCE: VERTICAL AT 3 M								
NO.	FREQ. (MHz)	EMISSION LEVEL (dBuV/m)	LIMIT (dBuV/m)	MARGIN (dB)	ANTENNA HEIGHT (m)	TABLE ANGLE (Degree)	RAW VALUE (dBuV)	CORRECTION FACTOR (dB/m)
1	2390.00	64.06 PK	74.00	-9.94	1.15 V	183	32.33	31.73
2	2390.00	49.31 AV	54.00	-4.69	1.15 V	183	17.58	31.73
3	*2412.00	112.14 PK			1.15 V	183	80.33	31.81
4	*2412.00	99.05 AV			1.15 V	183	67.24	31.81
5	4824.00	55.74 PK	74.00	-18.26	1.28 V	63	17.65	38.09
6	4824.00	41.94 AV	54.00	-12.06	1.28 V	63	3.85	38.09

- REMARKS:**
1. Emission level (dBuV/m) = Raw Value (dBuV) + Correction Factor (dB/m).
 2. Correction Factor (dB/m) = Antenna Factor (dB/m) + Cable Factor (dB).
 3. The other emission levels were very low against the limit.
 4. Margin value = Emission level – Limit value.
 5. “ * “: Fundamental frequency.



EUT TEST CONDITION		MEASUREMENT DETAIL	
CHANNEL	Channel 6	FREQUENCY RANGE	1 ~ 25GHz
INPUT POWER (SYSTEM)	120Vac, 60 Hz	DETECTOR FUNCTION	Peak (PK) Average (AV)
ENVIRONMENTAL CONDITIONS	24deg. C, 64%RH 999hPa	TESTED BY	Mark Liao

ANTENNA POLARITY & TEST DISTANCE: HORIZONTAL AT 3 M								
NO.	FREQ. (MHz)	EMISSION LEVEL (dBuV/m)	LIMIT (dBuV/m)	MARGIN (dB)	ANTENNA HEIGHT (m)	TABLE ANGLE (Degree)	RAW VALUE (dBuV)	CORRECTION FACTOR (dB/m)
1	*2437.00	100.76 PK			1.97 H	303	68.86	31.90
2	*2437.00	88.49 AV			1.97 H	303	56.59	31.90
3	4874.00	52.04 PK	74.00	-21.96	1.61 H	25	13.82	38.22
4	4874.00	37.96 AV	54.00	-16.04	1.61 H	25	-0.26	38.22
ANTENNA POLARITY & TEST DISTANCE: VERTICAL AT 3 M								
NO.	FREQ. (MHz)	EMISSION LEVEL (dBuV/m)	LIMIT (dBuV/m)	MARGIN (dB)	ANTENNA HEIGHT (m)	TABLE ANGLE (Degree)	RAW VALUE (dBuV)	CORRECTION FACTOR (dB/m)
1	*2437.00	112.88 PK			1.42 V	274	80.98	31.90
2	*2437.00	99.26 AV			1.42 V	274	67.36	31.90
3	4874.00	52.44 PK	74.00	-21.56	1.46 V	75	14.22	38.22
4	4874.00	39.30 AV	54.00	-14.70	1.46 V	75	1.08	38.22

- REMARKS:**
1. Emission level (dBuV/m) = Raw Value (dBuV) + Correction Factor (dB/m).
 2. Correction Factor (dB/m) = Antenna Factor (dB/m) + Cable Factor (dB).
 3. The other emission levels were very low against the limit.
 4. Margin value = Emission level – Limit value.
 5. “ * “: Fundamental frequency.



EUT TEST CONDITION		MEASUREMENT DETAIL	
CHANNEL	Channel 11	FREQUENCY RANGE	1 ~ 25GHz
INPUT POWER (SYSTEM)	120Vac, 60 Hz	DETECTOR FUNCTION	Peak (PK) Average (AV)
ENVIRONMENTAL CONDITIONS	24deg. C, 64%RH 999hPa	TESTED BY	Mark Liao

ANTENNA POLARITY & TEST DISTANCE: HORIZONTAL AT 3 M								
NO.	FREQ. (MHz)	EMISSION LEVEL (dBuV/m)	LIMIT (dBuV/m)	MARGIN (dB)	ANTENNA HEIGHT (m)	TABLE ANGLE (Degree)	RAW VALUE (dBuV)	CORRECTION FACTOR (dB/m)
1	*2462.00	101.78 PK			1.13 H	15	69.79	31.99
2	*2462.00	89.35 AV			1.13 H	15	57.36	31.99
3	2483.50	59.32 PK	74.00	-14.68	1.13 H	15	27.25	32.07
4	2483.50	46.61 AV	54.00	-7.39	1.13 H	15	14.54	32.07
5	4924.00	49.32 PK	74.00	-24.68	1.09 H	23	10.97	38.35
6	4924.00	37.47 AV	54.00	-16.53	1.09 H	23	-0.88	38.35
ANTENNA POLARITY & TEST DISTANCE: VERTICAL AT 3 M								
NO.	FREQ. (MHz)	EMISSION LEVEL (dBuV/m)	LIMIT (dBuV/m)	MARGIN (dB)	ANTENNA HEIGHT (m)	TABLE ANGLE (Degree)	RAW VALUE (dBuV)	CORRECTION FACTOR (dB/m)
1	*2462.00	113.56 PK			1.39 V	268	81.57	31.99
2	*2462.00	99.92 AV			1.39 V	268	67.93	31.99
3	2483.50	67.43 PK	74.00	-6.57	1.39 V	268	35.36	32.07
4	2483.50	50.24 AV	54.00	-3.76	1.39 V	268	18.17	32.07
5	4924.00	52.05 PK	74.00	-21.95	1.26 V	47	13.70	38.35
6	4924.00	38.83 AV	54.00	-15.17	1.26 V	47	0.48	38.35

- REMARKS:**
1. Emission level (dBuV/m) = Raw Value (dBuV) + Correction Factor (dB/m).
 2. Correction Factor (dB/m) = Antenna Factor (dB/m) + Cable Factor (dB).
 3. The other emission levels were very low against the limit.
 4. Margin value = Emission level – Limit value.
 5. “ * “: Fundamental frequency.



DRAFT 802.11n (40MHz) OFDM MODULATION

EUT TEST CONDITION		MEASUREMENT DETAIL	
CHANNEL	Channel 1	FREQUENCY RANGE	1 ~ 25GHz
INPUT POWER (SYSTEM)	120Vac, 60 Hz	DETECTOR FUNCTION	Peak (PK) Average (AV)
ENVIRONMENTAL CONDITIONS	24deg. C, 64%RH 999hPa	TESTED BY	Mark Liao

ANTENNA POLARITY & TEST DISTANCE: HORIZONTAL AT 3 M								
NO.	FREQ. (MHz)	EMISSION LEVEL (dBuV/m)	LIMIT (dBuV/m)	MARGIN (dB)	ANTENNA HEIGHT (m)	TABLE ANGLE (Degree)	RAW VALUE (dBuV)	CORRECTION FACTOR (dB/m)
1	2382.00	57.31 PK	74.00	-16.69	1.39 H	6	25.60	31.71
2	2382.00	46.49 AV	54.00	-7.51	1.39 H	6	14.78	31.71
3	*2422.00	95.63 PK			1.39 H	6	63.78	31.85
4	*2422.00	81.21 AV			1.39 H	6	49.36	31.85
5	4844.00	47.63 PK	74.00	-26.37	1.39 H	118	9.49	38.14
6	4844.00	35.75 AV	54.00	-18.25	1.39 H	118	-2.39	38.14
ANTENNA POLARITY & TEST DISTANCE: VERTICAL AT 3 M								
NO.	FREQ. (MHz)	EMISSION LEVEL (dBuV/m)	LIMIT (dBuV/m)	MARGIN (dB)	ANTENNA HEIGHT (m)	TABLE ANGLE (Degree)	RAW VALUE (dBuV)	CORRECTION FACTOR (dB/m)
1	2382.00	69.70 PK	74.00	-4.30	1.11 V	86	37.99	31.71
2	2382.00	52.06 AV	54.00	-1.94	1.11 V	86	20.35	31.71
3	*2422.00	108.99 PK			1.05 V	86	77.14	31.85
4	*2422.00	94.12 AV			1.05 V	86	62.27	31.85
5	4844.00	48.60 PK	74.00	-25.40	1.47 V	79	10.46	38.14
6	4844.00	36.11 AV	54.00	-17.89	1.47 V	79	-2.03	38.14

- REMARKS:**
1. Emission level (dBuV/m) = Raw Value (dBuV) + Correction Factor (dB/m).
 2. Correction Factor (dB/m) = Antenna Factor (dB/m) + Cable Factor (dB).
 3. The other emission levels were very low against the limit.
 4. Margin value = Emission level – Limit value.
 5. “ * “: Fundamental frequency.

EUT TEST CONDITION		MEASUREMENT DETAIL	
CHANNEL	Channel 4	FREQUENCY RANGE	1 ~ 25GHz
INPUT POWER (SYSTEM)	120Vac, 60 Hz	DETECTOR FUNCTION	Peak (PK) Average (AV)
ENVIRONMENTAL CONDITIONS	24deg. C, 64%RH 999hPa	TESTED BY	Mark Liao

ANTENNA POLARITY & TEST DISTANCE: HORIZONTAL AT 3 M								
NO.	FREQ. (MHz)	EMISSION LEVEL (dBuV/m)	LIMIT (dBuV/m)	MARGIN (dB)	ANTENNA HEIGHT (m)	TABLE ANGLE (Degree)	RAW VALUE (dBuV)	CORRECTION FACTOR (dB/m)
1	2390.00	57.75 PK	74.00	-16.25	1.41 H	5	26.02	31.73
2	2390.00	45.95 AV	54.00	-8.05	1.41 H	5	14.22	31.73
3	*2437.00	97.27 PK			1.41 H	5	65.37	31.90
4	*2437.00	82.51 AV			1.41 H	5	50.61	31.90
5	2483.50	57.68 PK	74.00	-16.32	1.41 H	5	25.61	32.07
6	2483.50	46.30 AV	54.00	-7.70	1.41 H	5	14.23	32.07
7	4874.00	48.93 PK	74.00	-25.07	1.36 H	25	10.71	38.22
8	4874.00	36.04 AV	54.00	-17.96	1.36 H	25	-2.18	38.22
ANTENNA POLARITY & TEST DISTANCE: VERTICAL AT 3 M								
NO.	FREQ. (MHz)	EMISSION LEVEL (dBuV/m)	LIMIT (dBuV/m)	MARGIN (dB)	ANTENNA HEIGHT (m)	TABLE ANGLE (Degree)	RAW VALUE (dBuV)	CORRECTION FACTOR (dB/m)
1	2390.00	63.00 PK	74.00	-11.00	1.12 V	238	31.27	31.73
2	2390.00	49.11 AV	54.00	-4.89	1.12 V	238	17.38	31.73
3	*2437.00	110.51 PK			1.12 V	238	78.61	31.90
4	*2437.00	95.36 AV			1.12 V	238	63.46	31.90
5	2483.50	62.91 PK	74.00	-11.09	1.12 V	238	30.84	32.07
6	2483.50	50.40 AV	54.00	-3.60	1.12 V	238	18.33	32.07
7	4874.00	51.33 PK	74.00	-22.67	1.01 V	68	13.11	38.22
8	4874.00	37.10 AV	54.00	-16.90	1.01 V	68	-1.12	38.22

- REMARKS:**
1. Emission level (dBuV/m) = Raw Value (dBuV) + Correction Factor (dB/m).
 2. Correction Factor (dB/m) = Antenna Factor (dB/m) + Cable Factor (dB).
 3. The other emission levels were very low against the limit.
 4. Margin value = Emission level – Limit value.
 5. “ * “: Fundamental frequency.



EUT TEST CONDITION		MEASUREMENT DETAIL	
CHANNEL	Channel 7	FREQUENCY RANGE	1 ~ 25GHz
INPUT POWER (SYSTEM)	120Vac, 60 Hz	DETECTOR FUNCTION	Peak (PK) Average (AV)
ENVIRONMENTAL CONDITIONS	24deg. C, 64%RH 999hPa	TESTED BY	Mark Liao

ANTENNA POLARITY & TEST DISTANCE: HORIZONTAL AT 3 M								
NO.	FREQ. (MHz)	EMISSION LEVEL (dBuV/m)	LIMIT (dBuV/m)	MARGIN (dB)	ANTENNA HEIGHT (m)	TABLE ANGLE (Degree)	RAW VALUE (dBuV)	CORRECTION FACTOR (dB/m)
1	*2452.00	96.32 PK			1.24 H	313	64.36	31.96
2	*2452.00	81.35 AV			1.24 H	313	49.39	31.96
3	2492.00	58.13 PK	74.00	-15.87	1.24 H	313	26.03	32.10
4	2492.00	46.37 AV	54.00	-7.63	1.24 H	313	14.27	32.10
5	4904.00	47.11 PK	74.00	-26.89	1.26 H	52	8.81	38.30
6	4904.00	34.69 AV	54.00	-19.31	1.26 H	52	-3.61	38.30
ANTENNA POLARITY & TEST DISTANCE: VERTICAL AT 3 M								
NO.	FREQ. (MHz)	EMISSION LEVEL (dBuV/m)	LIMIT (dBuV/m)	MARGIN (dB)	ANTENNA HEIGHT (m)	TABLE ANGLE (Degree)	RAW VALUE (dBuV)	CORRECTION FACTOR (dB/m)
1	*2452.00	110.04 PK			1.74 V	267	78.08	31.96
2	*2452.00	94.82 AV			1.74 V	267	62.86	31.96
3	2492.00	70.43 PK	74.00	-3.57	1.14 V	271	38.33	32.10
4	2492.00	52.30 AV	54.00	-1.70	1.14 V	271	20.20	32.10
5	4904.00	48.11 PK	74.00	-25.89	1.39 V	52	9.81	38.30
6	4904.00	35.85 AV	54.00	-18.15	1.39 V	52	-2.45	38.30

- REMARKS:**
1. Emission level (dBuV/m) = Raw Value (dBuV) + Correction Factor (dB/m).
 2. Correction Factor (dB/m) = Antenna Factor (dB/m) + Cable Factor (dB).
 3. The other emission levels were very low against the limit.
 4. Margin value = Emission level – Limit value.
 5. “ * “: Fundamental frequency.



BELOW 1GHz WORST-CASE DATA : DRAFT 802.11n (20MHz) OFDM MODULATION

EUT TEST CONDITION		MEASUREMENT DETAIL	
CHANNEL	Channel 6	FREQUENCY RANGE	Below 1000MHz
INPUT POWER (SYSTEM)	120Vac, 60 Hz	DETECTOR FUNCTION	Quasi-Peak
ENVIRONMENTAL CONDITIONS	24deg. C, 64%RH 999hPa	TESTED BY	Match Tsui

ANTENNA POLARITY & TEST DISTANCE: HORIZONTAL AT 3 M								
NO.	FREQ. (MHz)	EMISSION LEVEL (dBuV/m)	LIMIT (dBuV/m)	MARGIN (dB)	ANTENNA HEIGHT (m)	TABLE ANGLE (Degree)	RAW VALUE (dBuV)	CORRECTION FACTOR (dB/m)
1	92.12	34.41 QP	43.50	-9.09	2.00 H	160	25.35	9.06
2	99.89	42.50 QP	43.50	-1.00	2.00 H	166	30.56	11.94
3	152.39	42.50 QP	43.50	-1.00	2.00 H	82	27.90	14.60
4	162.11	41.79 QP	43.50	-1.71	1.50 H	91	27.08	14.71
5	199.05	40.07 QP	43.50	-3.43	1.25 H	145	28.99	11.08
6	232.11	35.05 QP	46.00	-10.95	1.50 H	16	21.84	13.21
7	265.16	38.05 QP	46.00	-7.95	1.50 H	334	23.63	14.42
8	333.21	37.99 QP	46.00	-8.01	1.25 H	19	22.05	15.94
9	366.26	36.39 QP	46.00	-9.61	1.00 H	115	18.95	17.44
10	395.43	36.04 QP	46.00	-9.96	2.00 H	103	17.31	18.74
11	601.52	37.23 QP	46.00	-8.77	1.25 H	100	13.53	23.70
12	665.68	36.20 QP	46.00	-9.80	2.00 H	214	10.68	25.52

ANTENNA POLARITY & TEST DISTANCE: VERTICAL AT 3 M								
NO.	FREQ. (MHz)	EMISSION LEVEL (dBuV/m)	LIMIT (dBuV/m)	MARGIN (dB)	ANTENNA HEIGHT (m)	TABLE ANGLE (Degree)	RAW VALUE (dBuV)	CORRECTION FACTOR (dB/m)
1	31.84	33.66 QP	40.00	-6.34	1.00 V	172	20.37	13.29
2	64.90	35.16 QP	40.00	-4.84	1.00 V	10	21.74	13.42
3	121.28	36.64 QP	43.50	-6.86	1.00 V	145	24.76	11.88
4	150.45	42.10 QP	43.50	-1.40	2.00 V	124	27.55	14.54
5	162.11	38.80 QP	43.50	-4.70	1.00 V	61	24.08	14.71
6	846.50	38.78 QP	46.00	-7.22	2.00 V	271	10.13	28.65

- REMARKS:**
1. Emission level (dBuV/m) = Raw Value (dBuV) + Correction Factor (dB/m).
 2. Correction Factor (dB/m) = Antenna Factor (dB/m) + Cable Factor (dB).
 3. The other emission levels were very low against the limit.
 4. Margin value = Emission level – Limit value.

4.2 CONDUCTED EMISSION MEASUREMENT

4.2.1 LIMITS OF CONDUCTED EMISSION MEASUREMENT

FREQUENCY OF EMISSION (MHz)	CONDUCTED LIMIT (dB μ V)	
	Quasi-peak	Average
0.15-0.5	66 to 56	56 to 46
0.5-5	56	46
5-30	60	50

- NOTE:**
1. The lower limit shall apply at the transition frequencies.
 2. The limit decreases in line with the logarithm of the frequency in the range of 0.15 to 0.50 MHz.
 3. All emanations from a class A/B digital device or system, including any network of conductors and apparatus connected thereto, shall not exceed the level of field strengths specified above.

4.2.2 TEST INSTRUMENTS

DESCRIPTION & MANUFACTURER	MODEL NO.	SERIAL NO.	DATE OF CALIBRATION	DUE DATE OF CALIBRATION
Test Receiver ROHDE & SCHWARZ	ESCS30	100291	Nov. 22, 2007	Nov. 21, 2008
RF signal cable Woken	5D-FB	Cable-HYC01-01	Jan. 04, 2008	Jan. 03, 2009
LISN ROHDE & SCHWARZ	ESH3-Z5	100312	Jun. 13, 2008	Jun. 12, 2009
LISN ROHDE & SCHWARZ	ESH2-Z5	100104	Sep. 12, 2007	Sep. 11, 2008
Software ADT	ADT_Cond_V3	NA	NA	NA

- NOTE:**
1. The calibration interval of the above test instruments is 12 months and the calibrations are traceable to NML/ROC and NIST/USA.
 2. The test was performed in HwaYa Shielded Room 1.
 3. The VCCI Site Registration No. is C-2040.

4.2.3 TEST PROCEDURES

- a. The EUT was placed 0.4 meters from the conducting wall of the shielded room with EUT being connected to the power mains through a line impedance stabilization network (LISN). Other support units were connected to the power mains through another LISN. The two LISNs provide 50 ohm/ 50uH of coupling impedance for the measuring instrument.
- b. Both lines of the power mains connected to the EUT were checked for maximum conducted interference.
- c. The frequency range from 150kHz to 30MHz was searched. Emission levels under (Limit - 20dB) was not recorded.

NOTE: All modes of operation were investigated and the worst-case emissions are reported.

4.2.4 DEVIATION FROM TEST STANDARD

No deviation.

4.2.5 TEST SETUP

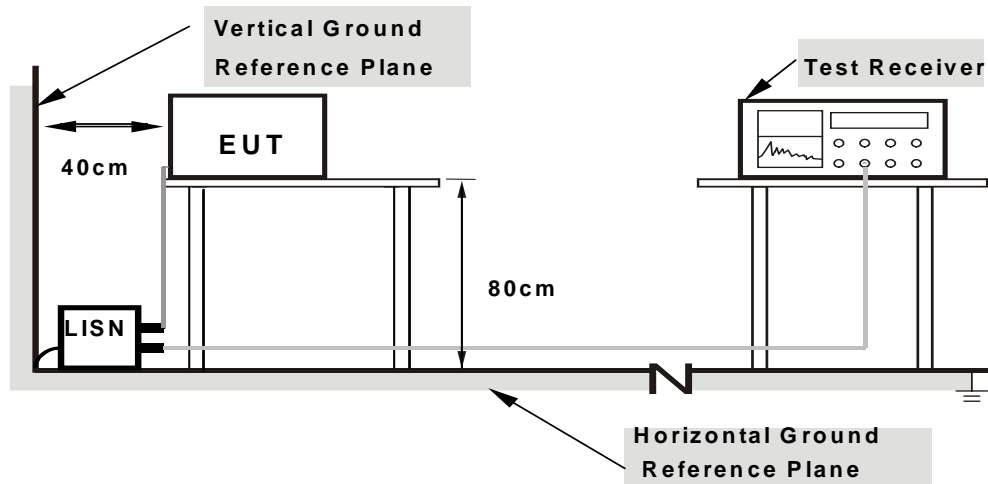

- Note:**
1. Support units were connected to second LISN.
 2. Both of LISNs (AMN) are 80 cm from EUT and at least 80 cm from other units and other metal planes

For the actual test configuration, please refer to the attached file (Test Setup Photo).

4.2.6 EUT OPERATING CONDITIONS

Same as 4.1.6.

4.2.7 TEST RESULTS

CONDUCTED WORST-CASE DATA: 802.11n (20MHz) OFDM MODULATION

EUT TEST CONDITION		MEASUREMENT DETAIL	
CHANNEL	Channel 6	PHASE	Line 1
MODULATION TYPE	BPSK	6dB BANDWIDTH	9 kHz
INPUT POWER (SYSTEM)	120Vac, 60 Hz	ENVIRONMENTAL CONDITIONS	25deg. C, 63%RH, 1016hPa
TESTED BY	Kevin Liang		

No	Freq. [MHz]	Corr. Factor [dB]	Reading Value [dB (uV)]		Emission Level [dB (uV)]		Limit [dB (uV)]		Margin (dB)	
			Q.P.	AV.	Q.P.	AV.	Q.P.	AV.	Q.P.	AV.
1	0.173	0.20	49.03	-	49.23	-	64.79	54.79	-15.56	-
2	0.232	0.20	42.97	-	43.17	-	62.38	52.38	-19.21	-
3	0.287	0.20	38.21	-	38.41	-	60.62	50.62	-22.21	-
4	2.018	0.20	35.57	-	35.77	-	56.00	46.00	-20.23	-
5	3.859	0.39	33.92	-	34.31	-	56.00	46.00	-21.69	-
6	10.156	0.54	28.55	-	29.09	-	60.00	50.00	-30.91	-

- REMARKS:**
1. Q.P. and AV. are abbreviations of quasi-peak and average individually.
 2. "-": The Quasi-peak reading value also meets average limit and measurement with the average detector is unnecessary.
 3. The emission levels of other frequencies were very low against the limit.
 4. Margin value = Emission level - Limit value
 5. Correction factor = Insertion loss + Cable loss
 6. Emission Level = Correction Factor + Reading Value.

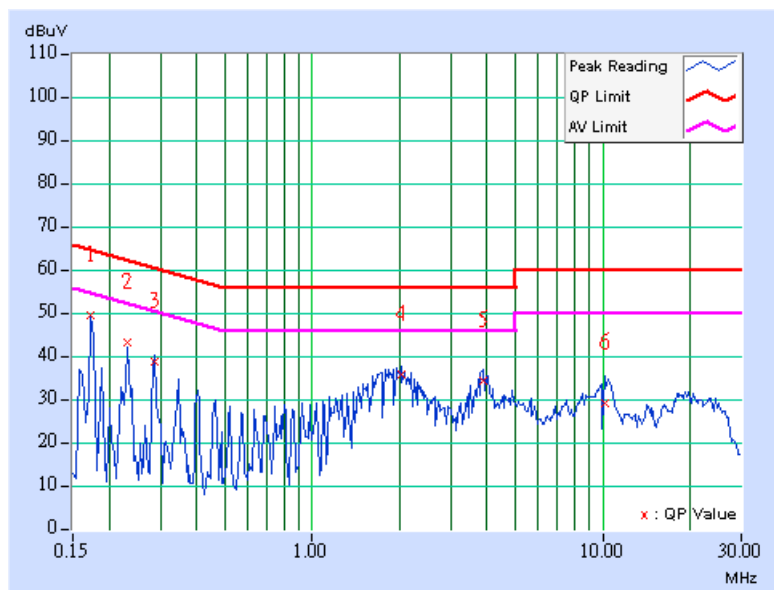

EUT TEST CONDITION		MEASUREMENT DETAIL	
CHANNEL	Channel 6	PHASE	Line 2
MODULATION TYPE	BPSK	6dB BANDWIDTH	9 kHz
INPUT POWER (SYSTEM)	120Vac, 60 Hz	ENVIRONMENTAL CONDITIONS	25deg. C, 63%RH, 1016hPa
TESTED BY	Kevin Liang		

No	Freq. [MHz]	Corr. Factor [dB]	Reading Value [dB (uV)]		Emission Level [dB (uV)]		Limit [dB (uV)]		Margin (dB)	
			Q.P.	AV.	Q.P.	AV.	Q.P.	AV.	Q.P.	AV.
1	0.173	0.20	49.05	-	49.25	-	64.79	54.79	-15.54	-
2	0.232	0.20	41.04	-	41.24	-	62.38	52.38	-21.14	-
3	0.287	0.20	38.45	-	38.65	-	60.62	50.62	-21.97	-
4	1.844	0.20	35.00	-	35.20	-	56.00	46.00	-20.80	-
5	4.039	0.40	30.10	-	30.50	-	56.00	46.00	-25.50	-
6	20.121	0.51	26.79	-	27.30	-	60.00	50.00	-32.70	-

- REMARKS:**
1. Q.P. and AV. are abbreviations of quasi-peak and average individually.
 2. "-": The Quasi-peak reading value also meets average limit and measurement with the average detector is unnecessary.
 3. The emission levels of other frequencies were very low against the limit.
 4. Margin value = Emission level - Limit value
 5. Correction factor = Insertion loss + Cable loss
 6. Emission Level = Correction Factor + Reading Value.

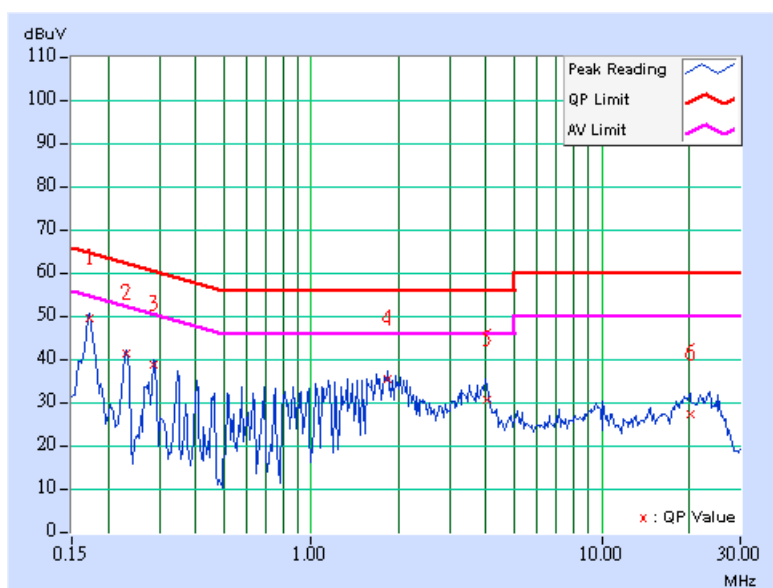



4.3 6dB BANDWIDTH MEASUREMENT

4.3.1 LIMITS OF 6dB BANDWIDTH MEASUREMENT

The minimum of 6dB Bandwidth Measurement is 0.5 MHz.

4.3.2 TEST INSTRUMENTS

DESCRIPTION & MANUFACTURER	MODEL NO.	SERIAL NO.	DATE OF CALIBRATION	DUE DATE OF CALIBRATION
SPECTRUM ANALYZER	FSP 40	100041	Apr. 22, 2008	Apr. 21, 2009

NOTE: The calibration interval of the above test instruments is 12 months and the calibrations are traceable to NML/ROC and NIST/USA.

4.3.3 TEST PROCEDURE

The transmitter output was connected to the spectrum analyzer through an attenuator. The bandwidth of the fundamental frequency was measured by spectrum analyzer with 100kHz RBW and 100kHz VBW. The 6dB bandwidth is defined as the total spectrum the power of which is higher than peak power minus 6dB.

4.3.4 DEVIATION FROM TEST STANDARD

No deviation.

4.3.5 TEST SETUP

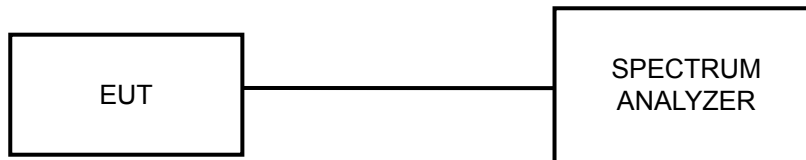

4.3.6 EUT OPERATING CONDITIONS

The software provided by client to enable the EUT under transmission condition continuously at lowest, middle and highest channel frequencies individually.

4.3.7 TEST RESULTS

802.11b DSSS MODULATION

MODULATION TYPE	DBPSK	TRANSFER RATE	1.0Mbps
INPUT POWER (SYSTEM)	120Vac, 60 Hz	ENVIRONMENTAL CONDITIONS	25deg.C, 65%RH, 991hPa
TESTED BY	Brad Wu		

CHANNEL	CHANNEL FREQUENCY (MHz)	6dB BANDWIDTH (MHz)	MINIMUM LIMIT (MHz)	PASS / FAIL
1	2412	11.13	0.5	PASS
6	2437	12.09	0.5	PASS
11	2462	11.11	0.5	PASS

CH 1

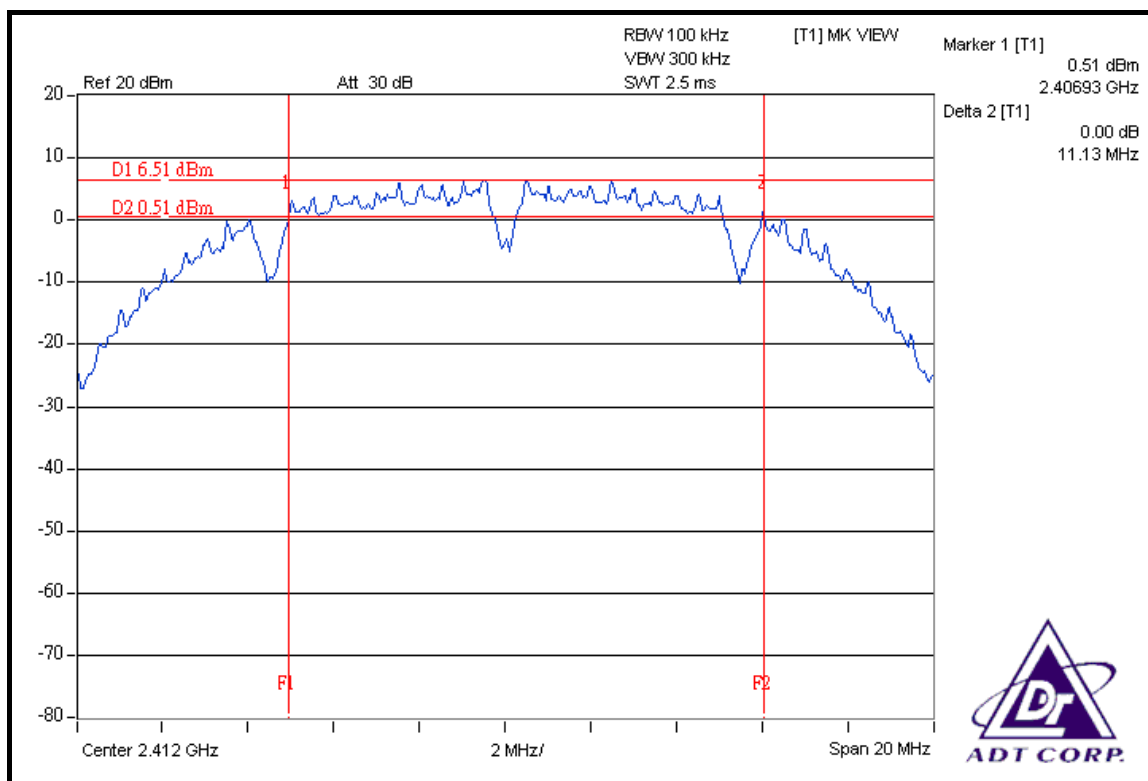

CH 6

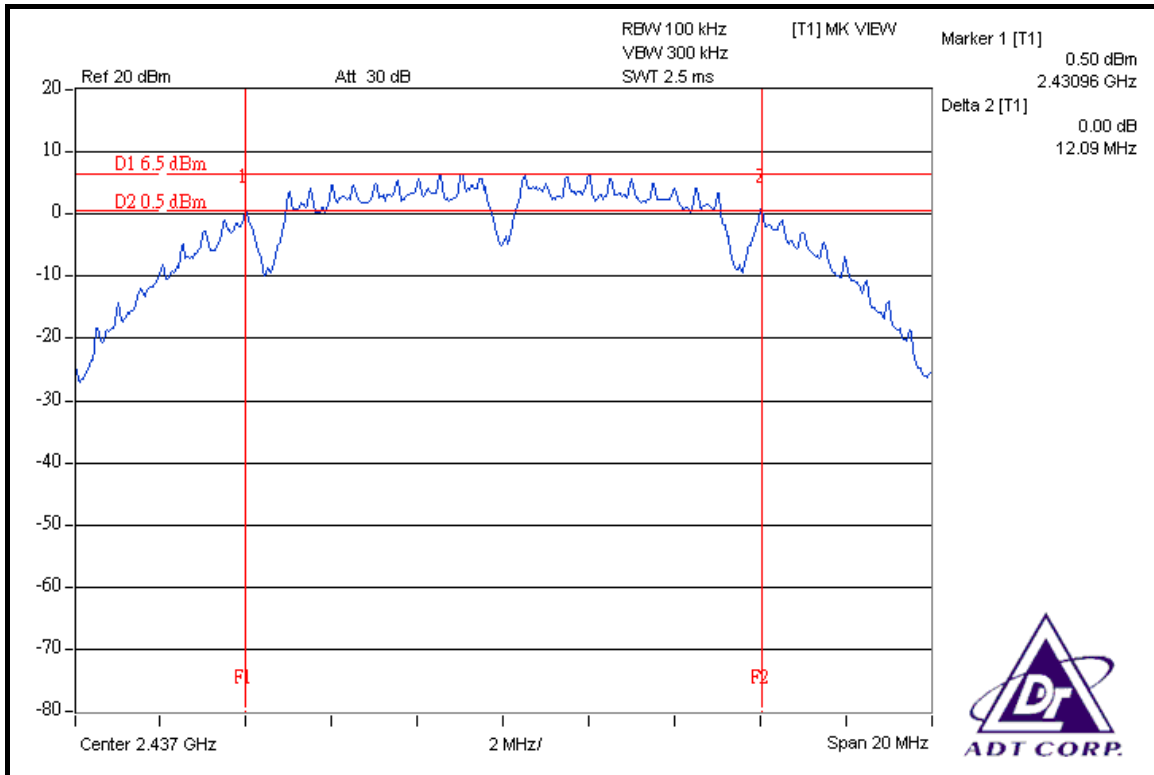

CH 11

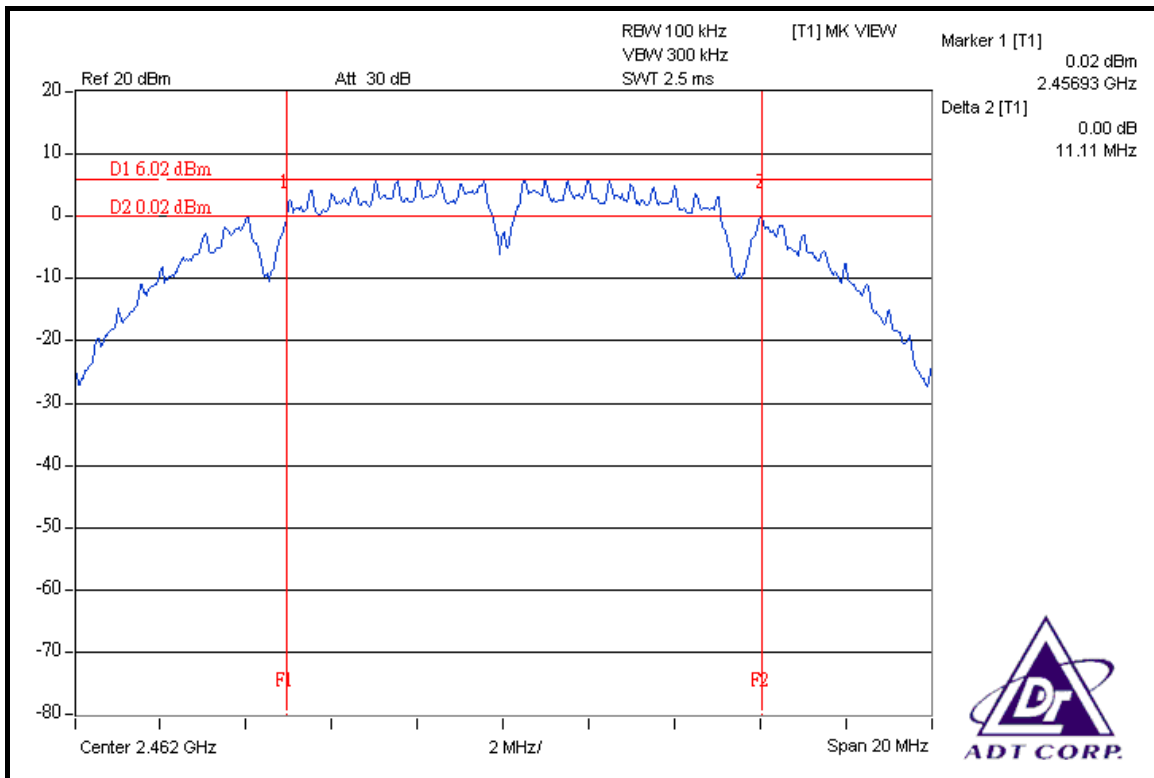



802.11g OFDM MODULATION

MODULATION TYPE	BPSK	TRANSFER RATE	6.0Mbps
INPUT POWER (SYSTEM)	120Vac, 60 Hz	ENVIRONMENTAL CONDITIONS	25deg.C, 65%RH, 991hPa
TESTED BY	Brad Wu		

CHANNEL	CHANNEL FREQUENCY (MHz)	6dB BANDWIDTH (MHz)	MINIMUM LIMIT (MHz)	PASS / FAIL
1	2412	16.41	0.5	PASS
6	2437	16.42	0.5	PASS
11	2462	16.40	0.5	PASS

CH 1

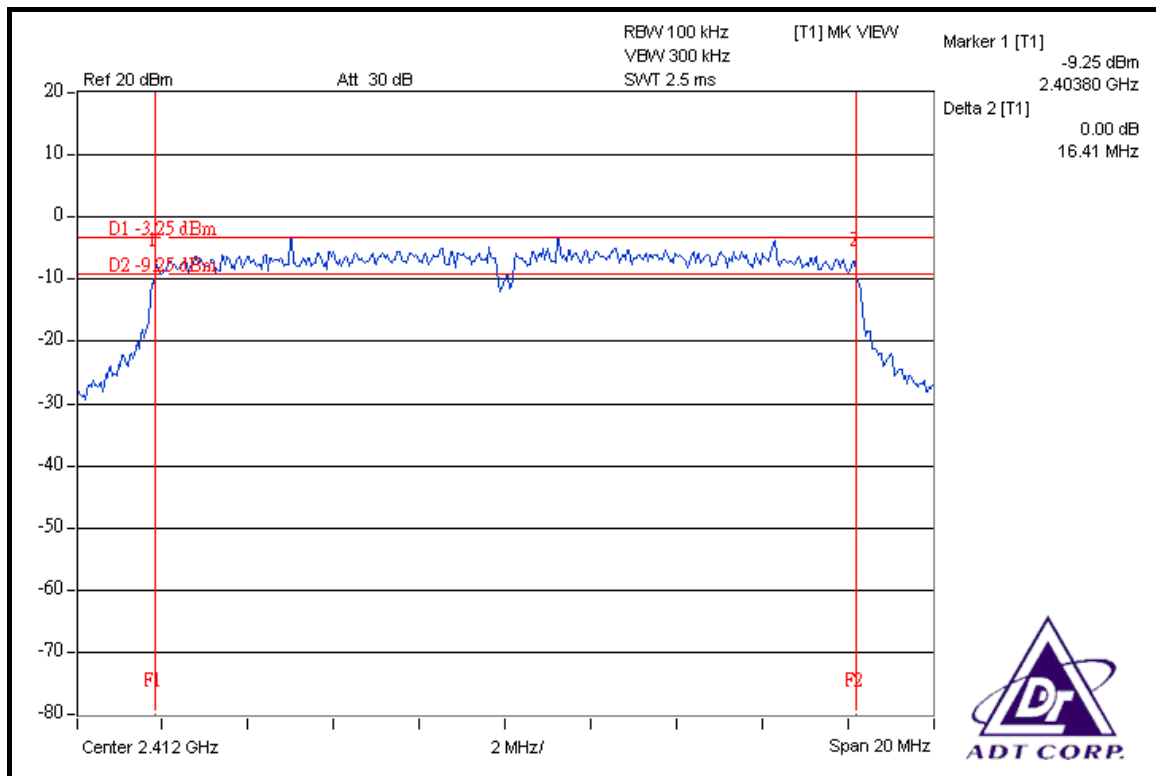

CH 6

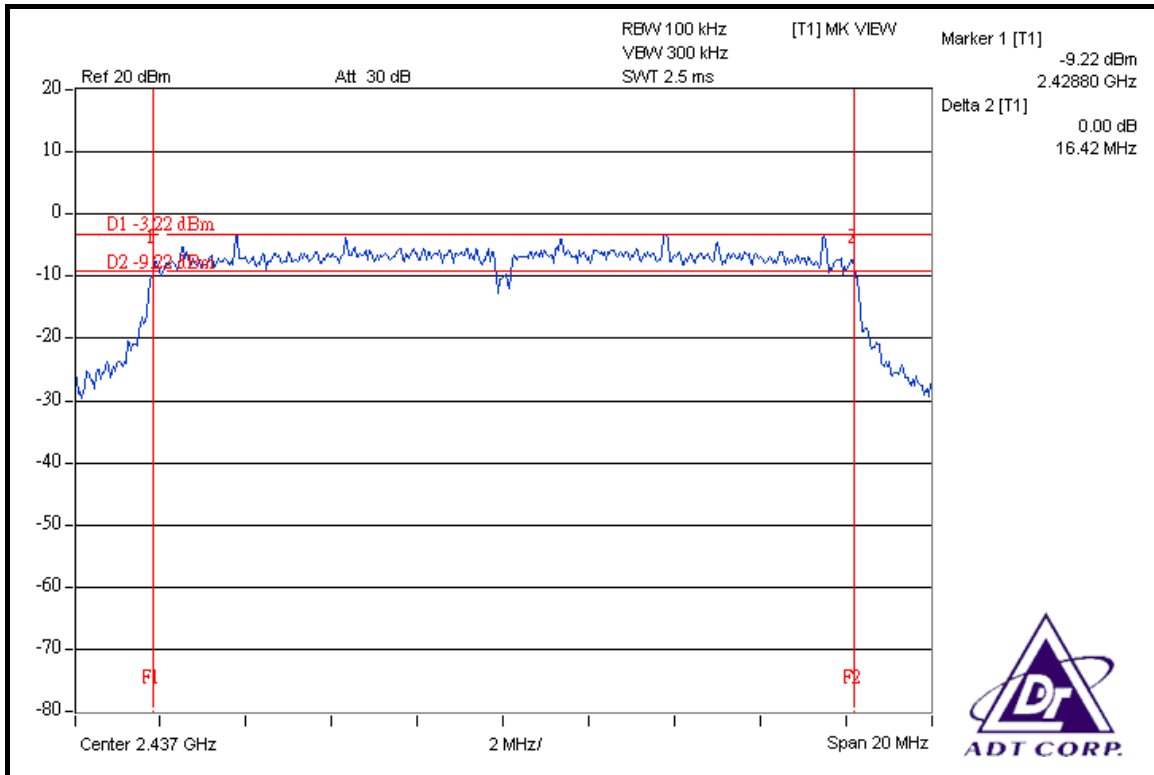

CH 11

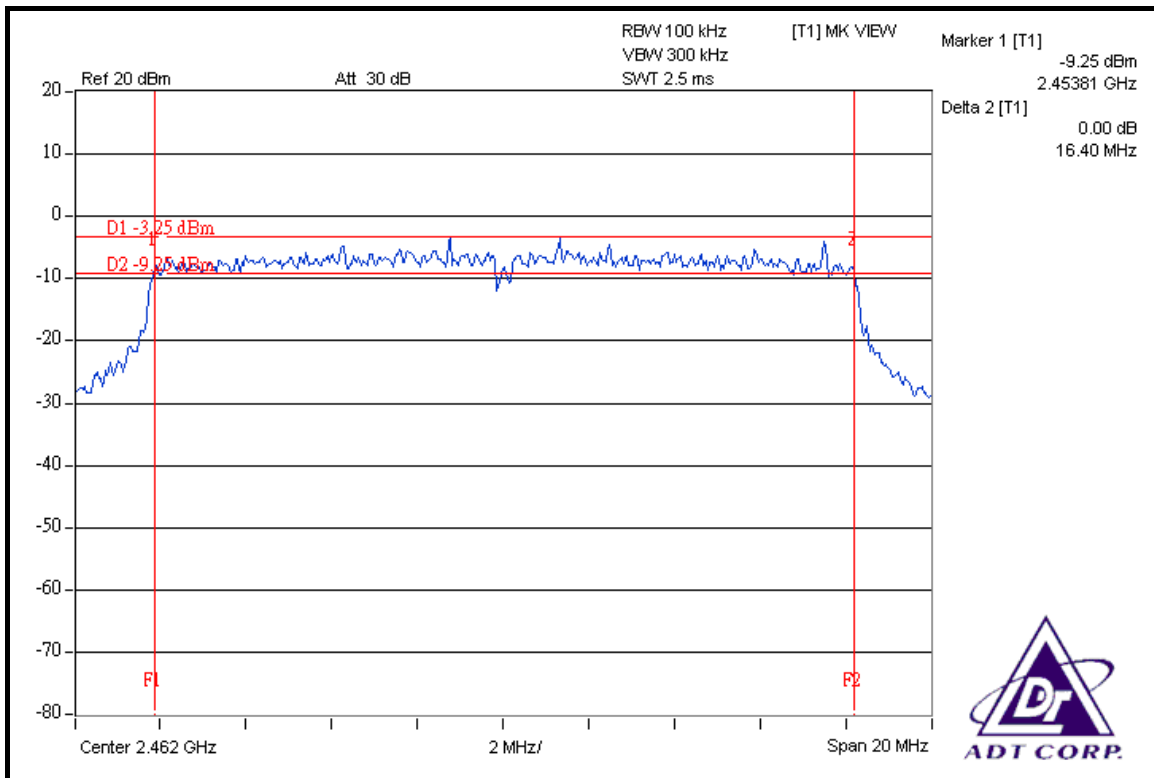



DRAFT 802.11n (20MHz) OFDM MODULATION

MODULATION TYPE	BPSK	TRANSFER RATE	7.2Mbps
INPUT POWER (SYSTEM)	120Vac, 60 Hz	ENVIRONMENTAL CONDITIONS	25deg.C, 65%RH, 991hPa
TESTED BY	Brad Wu		

CHANNEL	CHANNEL FREQUENCY (MHz)	6dB BANDWIDTH (MHz)			MINIMUM LIMIT (MHz)	PASS / FAIL
		CHAIN 0	CHAIN 1	CHAIN 2		
1	2412	17.58	17.34	17.64	0.5	PASS
6	2437	17.62	17.61	17.62	0.5	PASS
11	2462	17.38	17.63	17.62	0.5	PASS

FOR CHAIN 0: CH 1

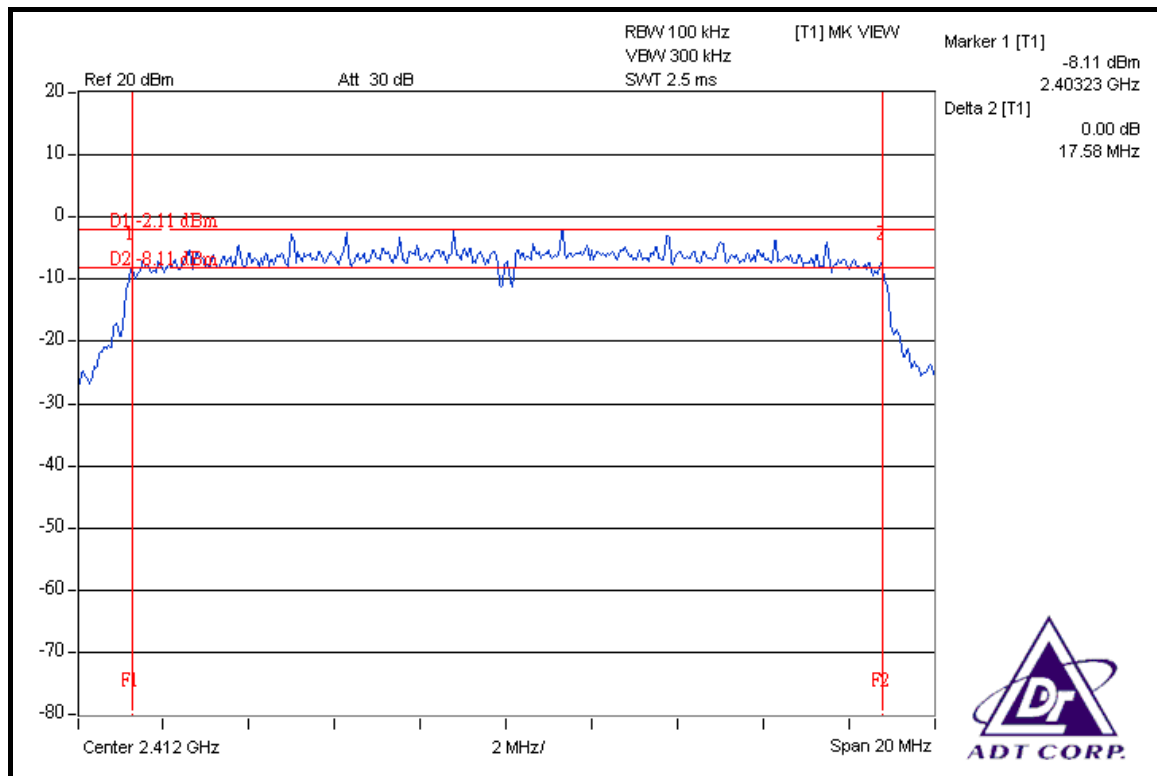

CH 6

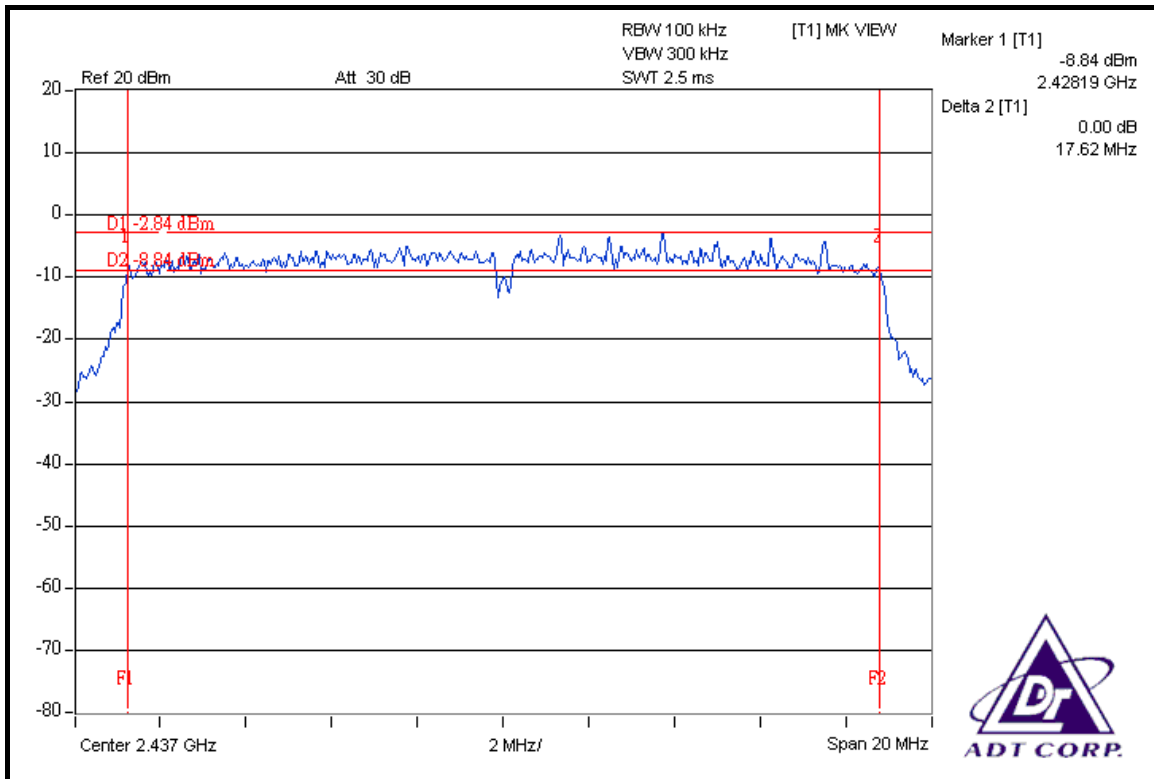

CH 11

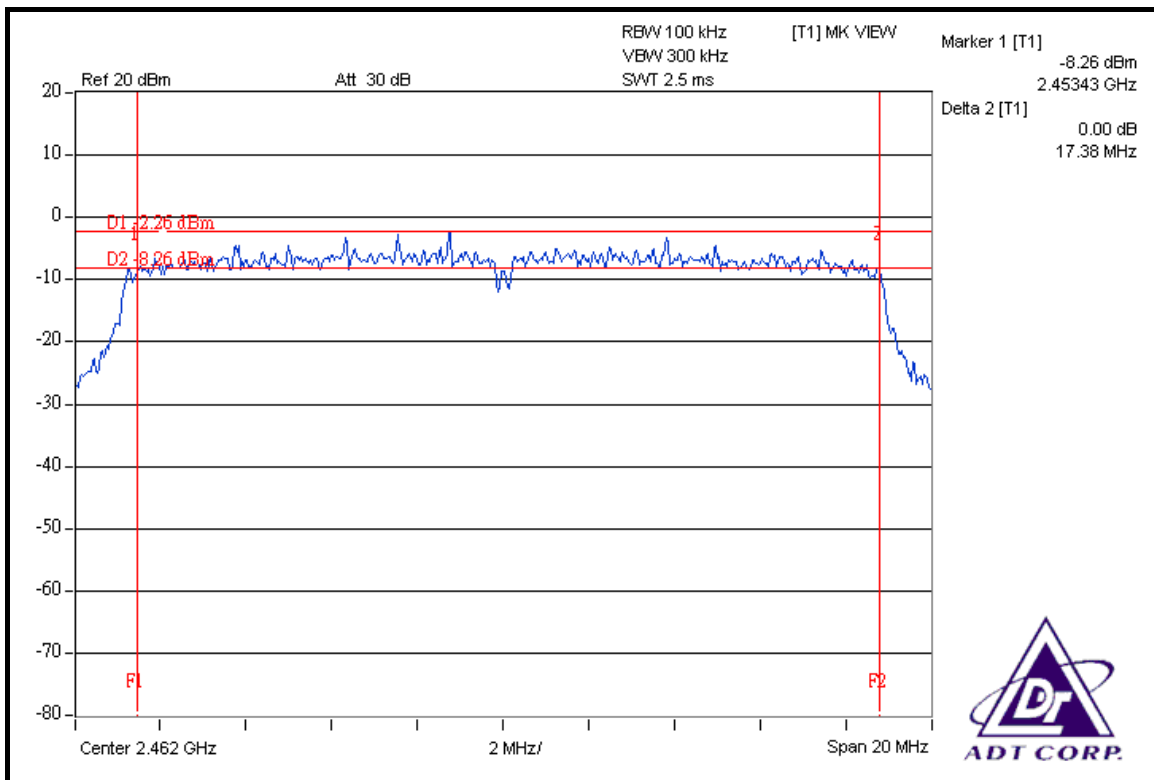

FOR CHAIN 1: CH 1

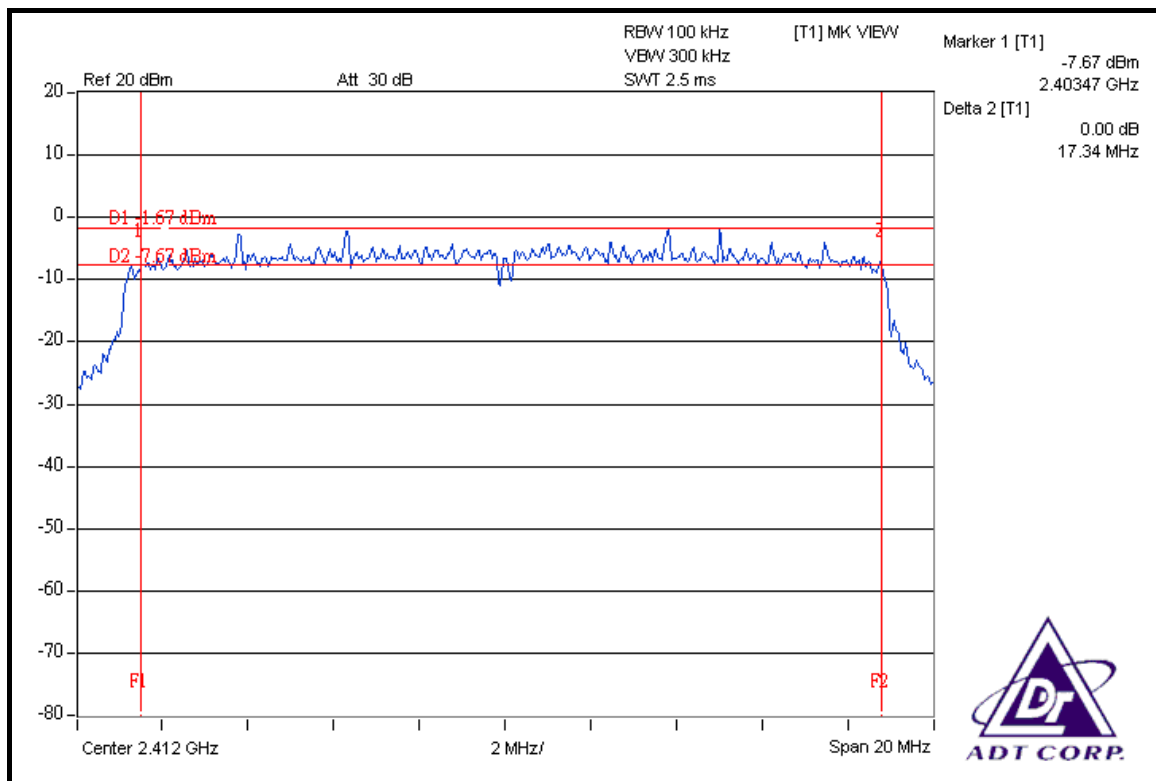

CH 6

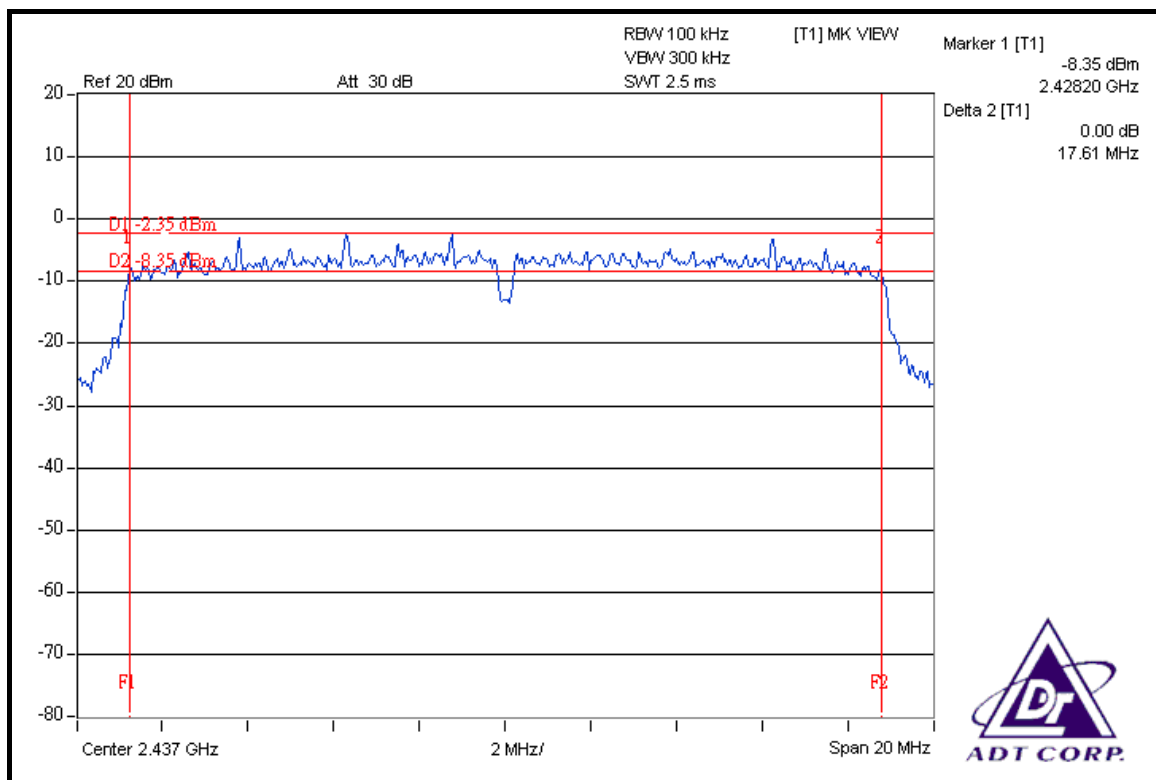

CH 11

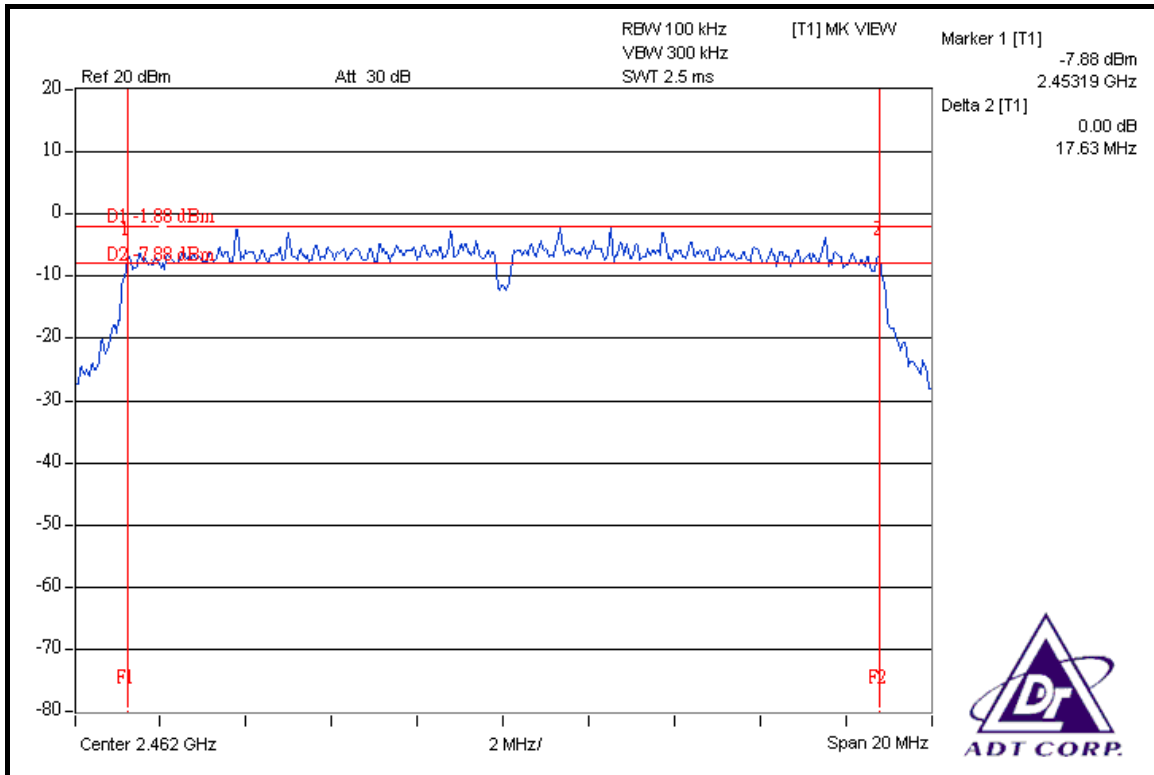

FOR CHAIN 2: CH 1

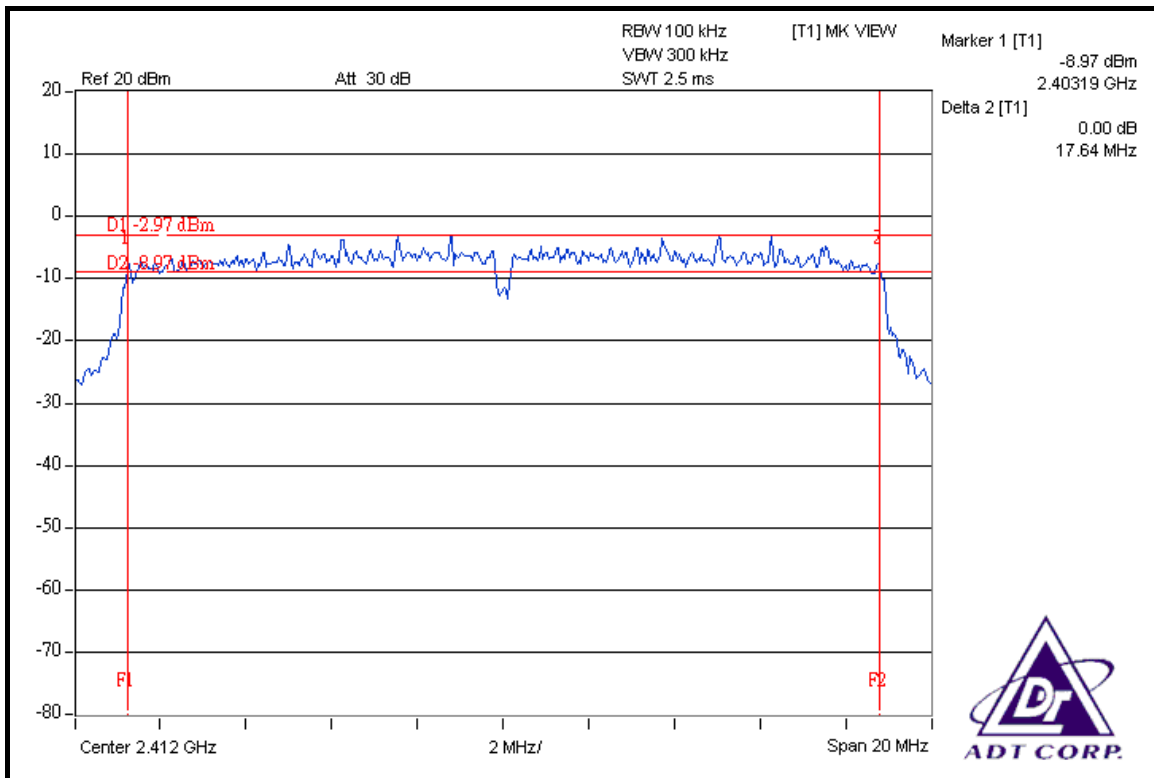

CH 6

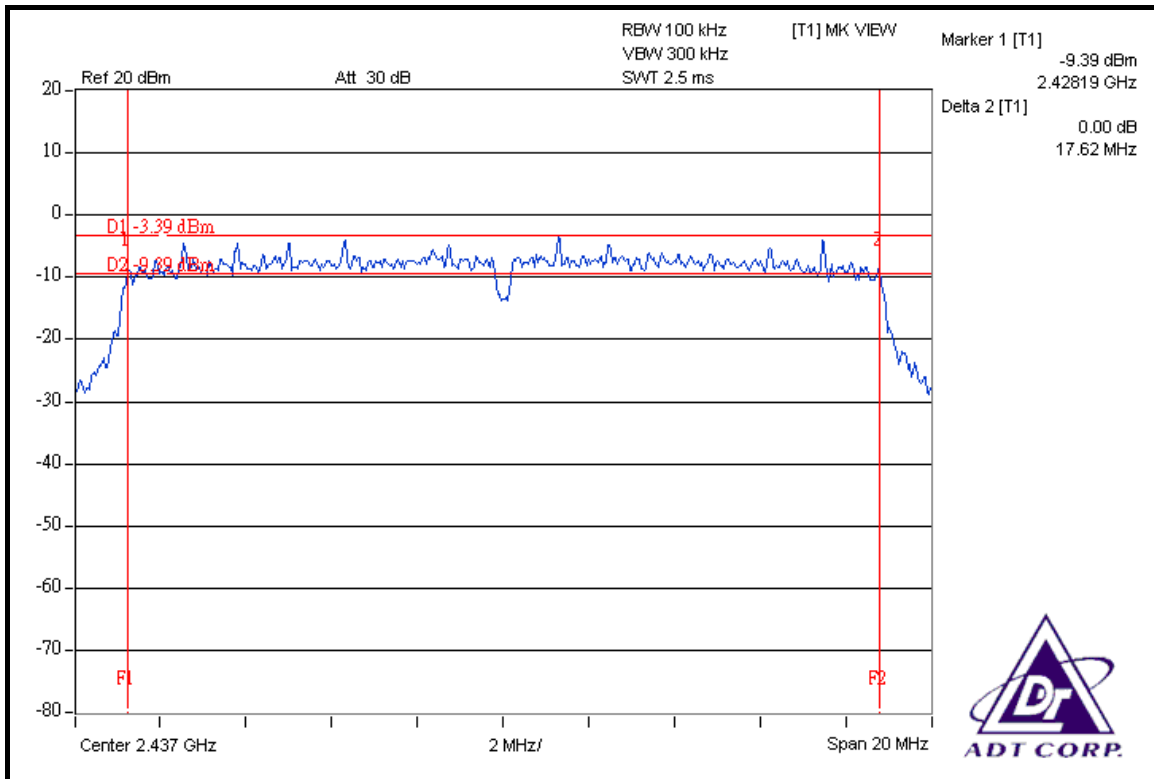

CH 11

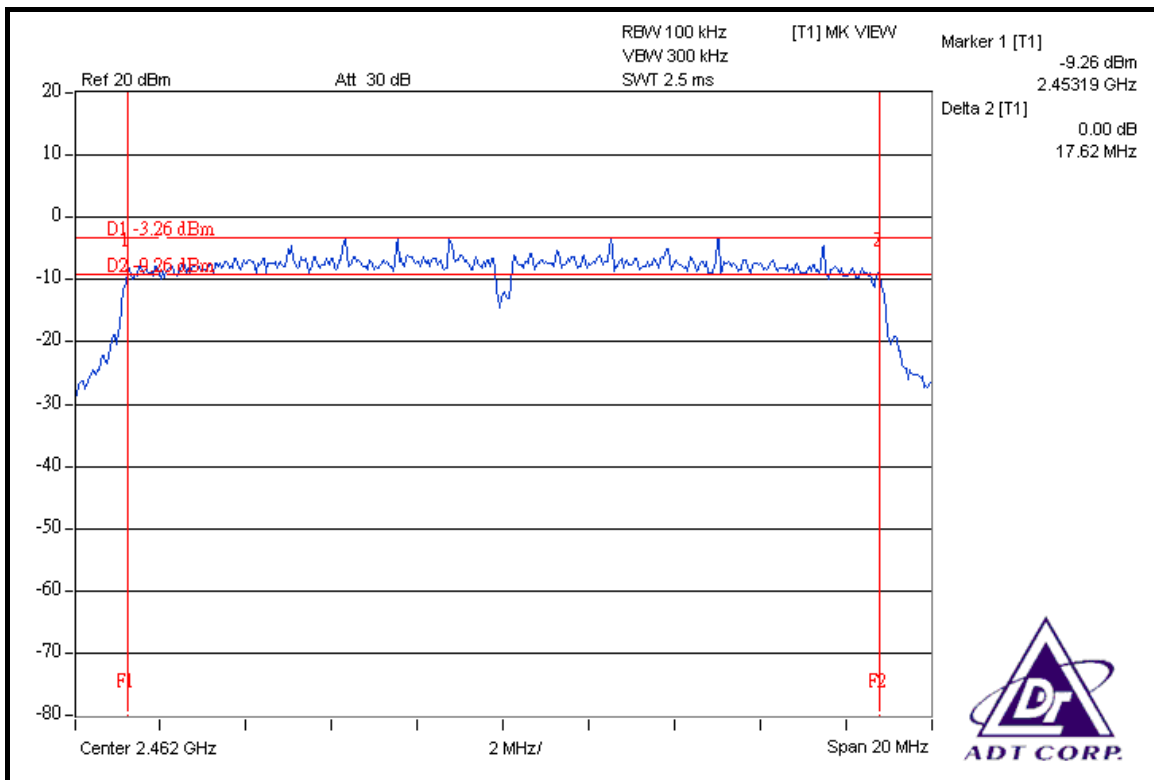



DRAFT 802.11n (40MHz) OFDM MODULATION

MODULATION TYPE	BPSK	TRANSFER RATE	15.0Mbps
INPUT POWER (SYSTEM)	120Vac, 60 Hz	ENVIRONMENTAL CONDITIONS	25deg.C, 65%RH, 991hPa
TESTED BY	Brad Wu		

CHANNEL	CHANNEL FREQUENCY (MHz)	6dB BANDWIDTH (MHz)			MINIMUM LIMIT (MHz)	PASS / FAIL
		CHAIN 0	CHAIN 1	CHAIN 2		
1	2422	36.40	36.44	36.43	0.5	PASS
4	2437	36.39	36.42	36.43	0.5	PASS
7	2452	36.50	36.51	36.47	0.5	PASS

FOR CHAIN 0: CH 1

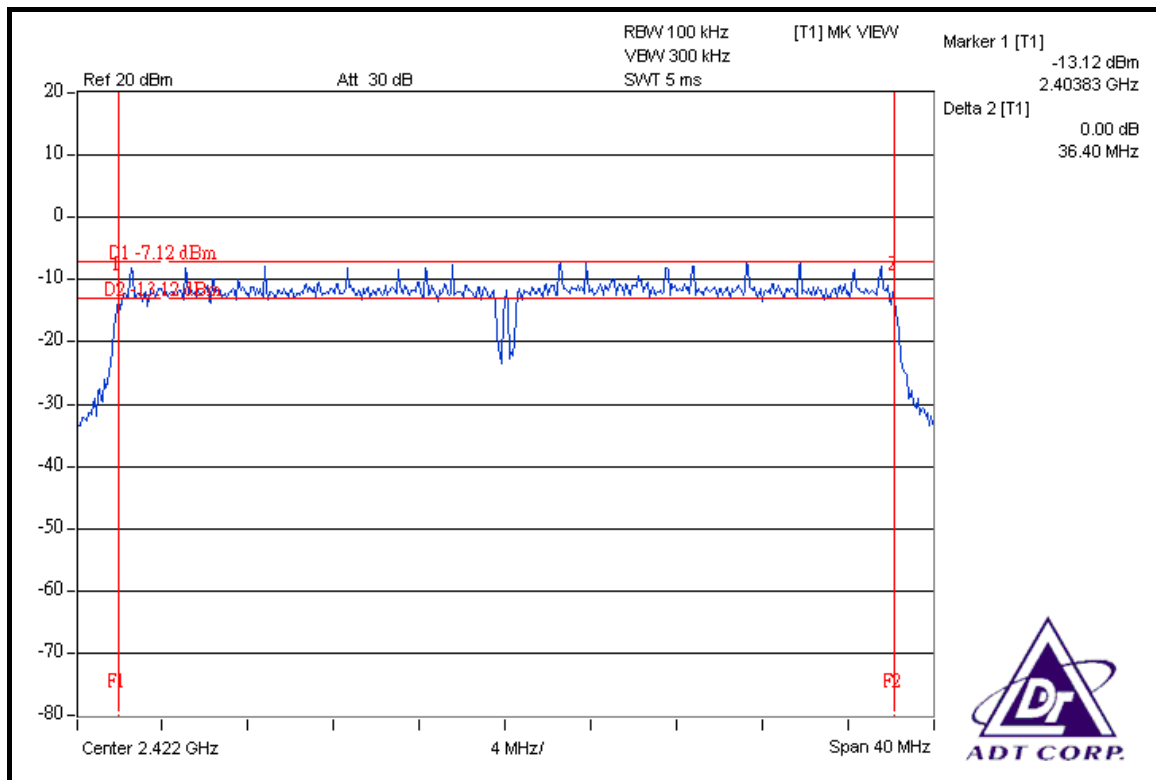

CH 4

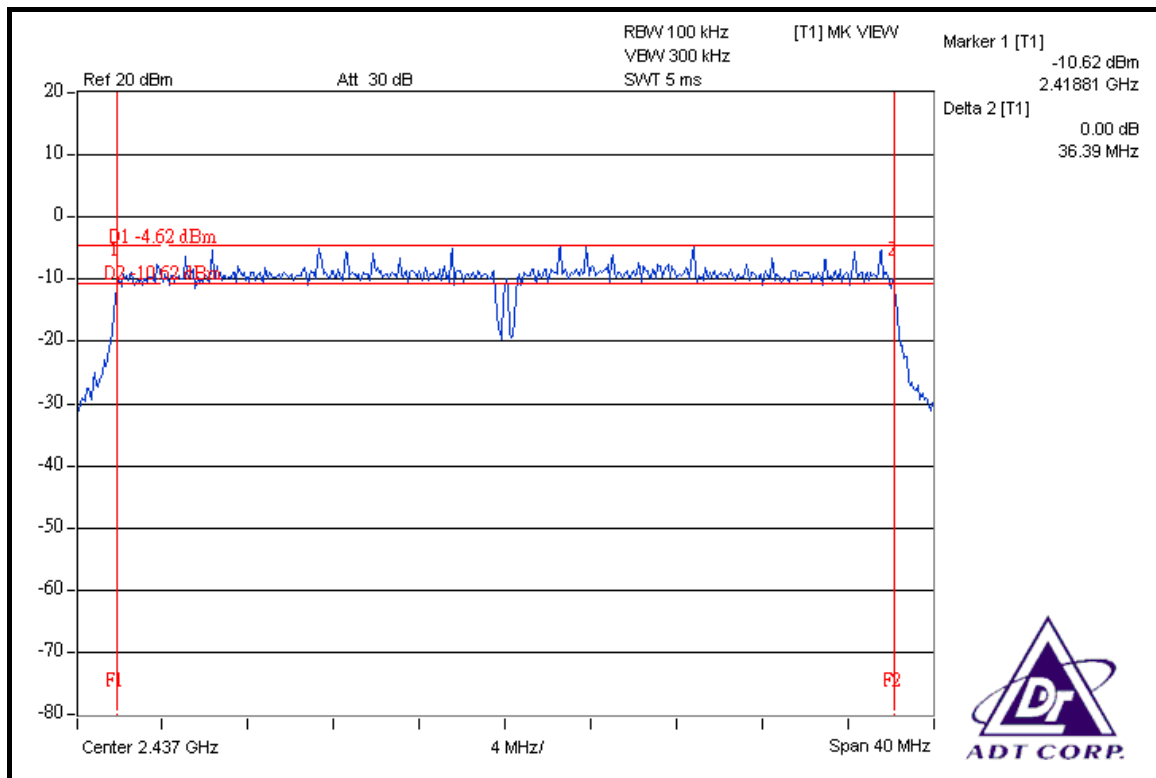

CH 7

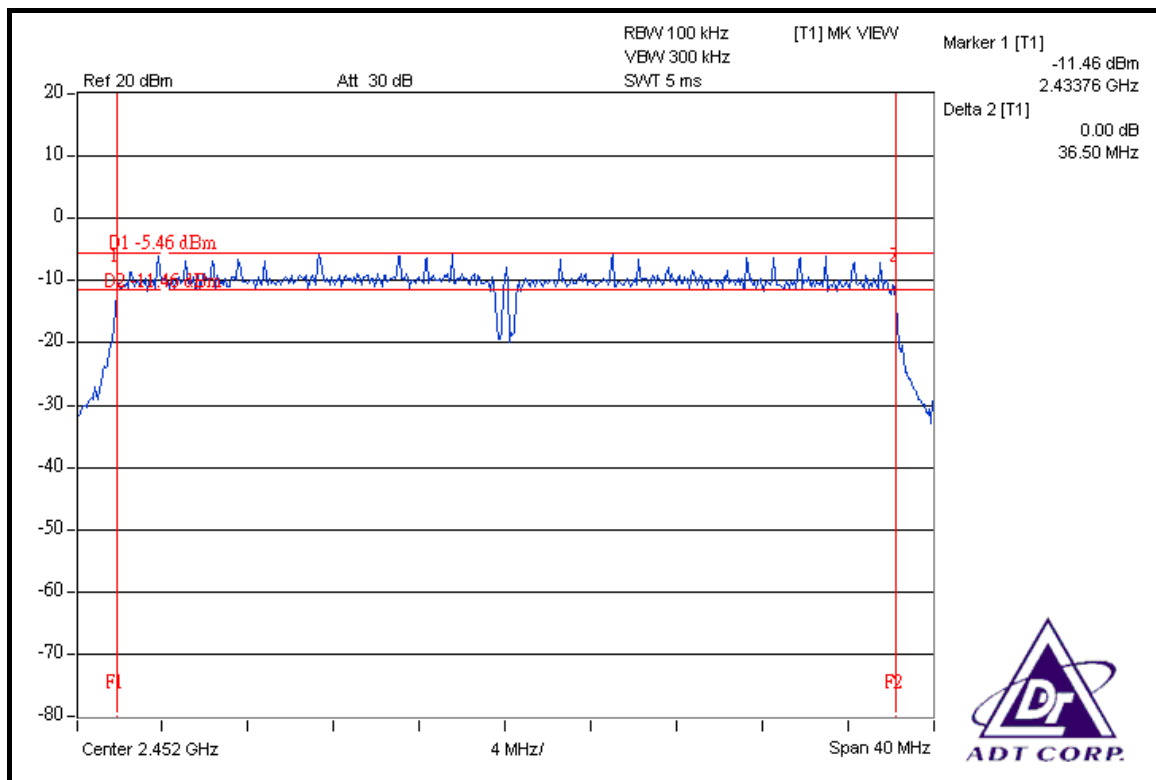

FOR CHAIN 1: CH 1

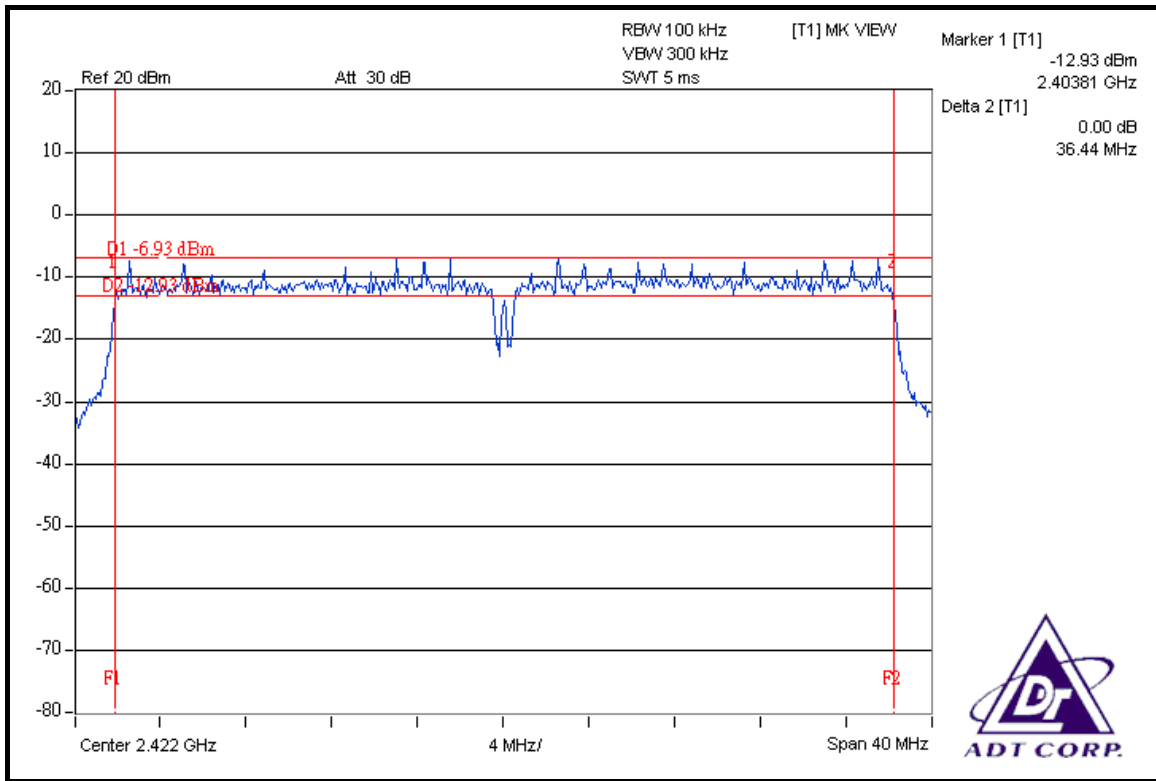

CH 4

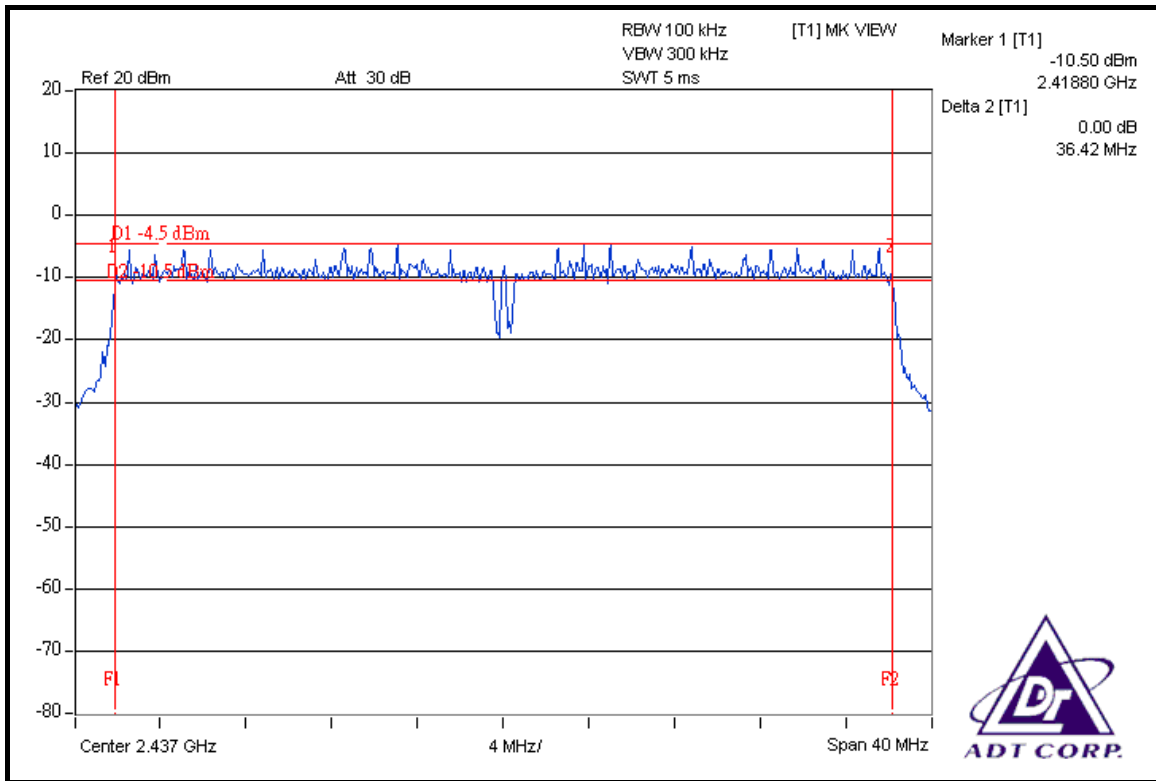

CH 7

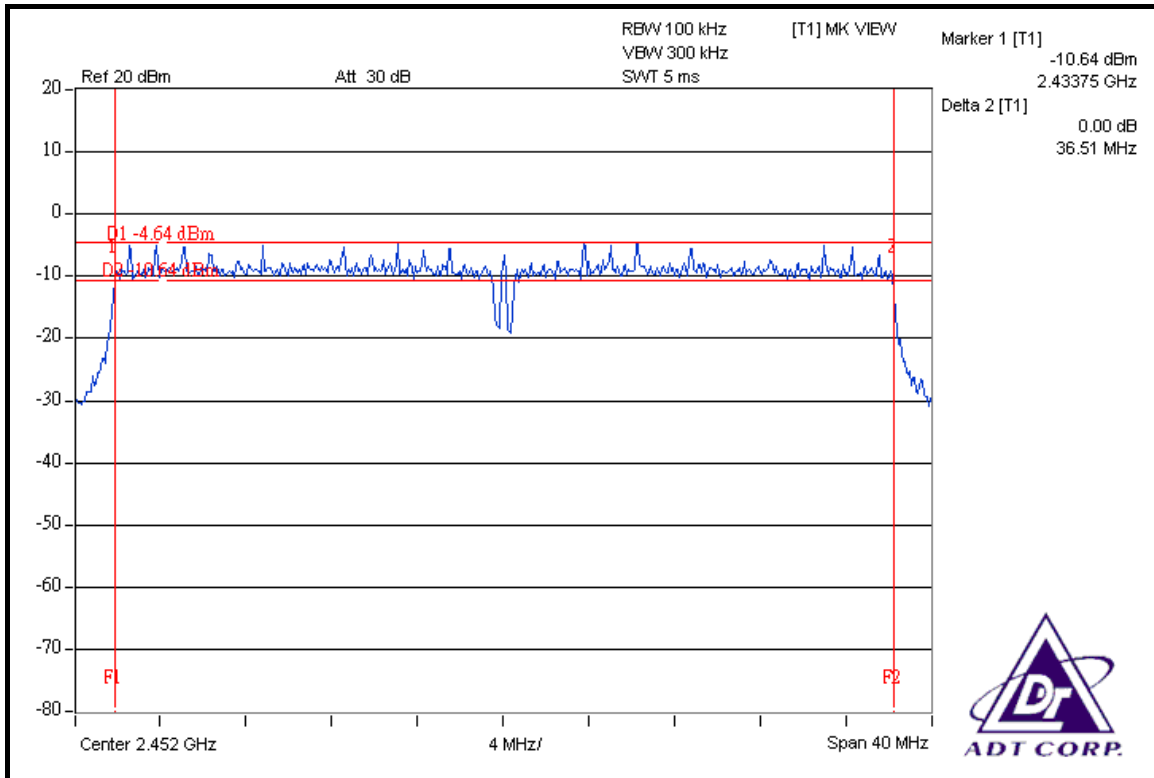

FOR CHAIN 2: CH 1

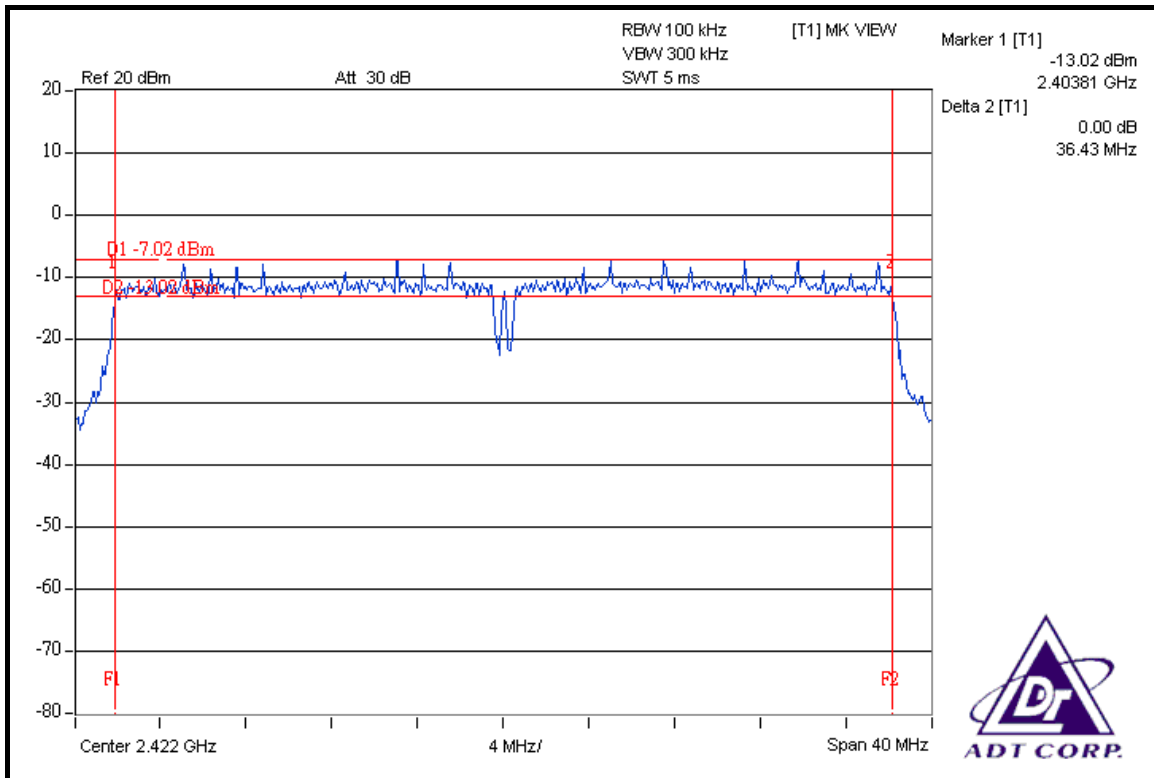

CH 4

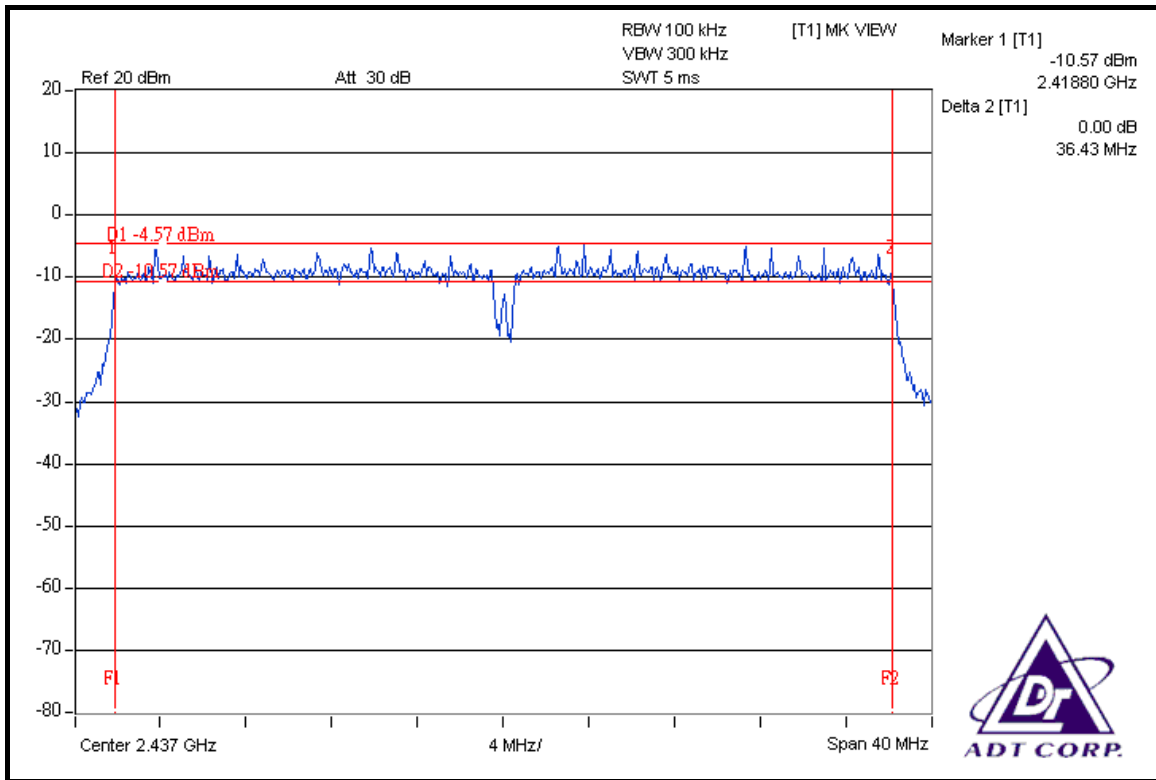

CH 7

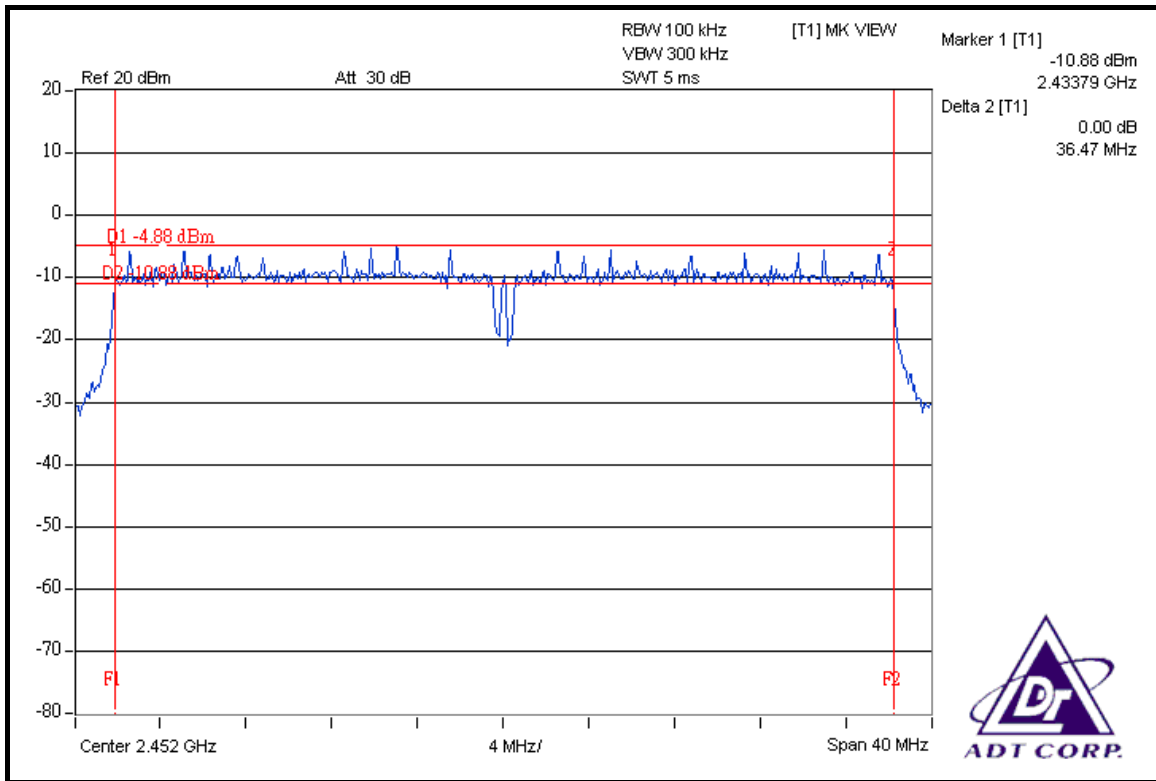



4.4 MAXIMUM PEAK OUTPUT POWER

4.4.1 LIMITS OF MAXIMUM PEAK OUTPUT POWER MEASUREMENT

The Maximum Peak Output Power Measurement is 30dBm.

4.4.2 INSTRUMENTS

DESCRIPTION & MANUFACTURER	MODEL NO.	SERIAL NO.	DATE OF CALIBRATION	DUE DATE OF CALIBRATION
HIGH SPEED PEAK POWER METER	ML2495A	0824012	Aug. 04, 2008	Aug. 03, 2009
POWER SENSOR	MA2444B	0738138	Aug. 04, 2008	Aug. 03, 2009

NOTE:

1. The calibration interval of the above test instruments is 12 months and the calibrations are traceable to NML/ROC and NIST/USA.
2. Measurement Bandwidth of ML2495A is 65MHz greater than 6dB bandwidth of emission.

4.4.3 TEST PROCEDURES

A power sensor was used on the output port of the EUT. A power meter was used to read the response of the power sensor. Record the power level.

4.4.4 DEVIATION FROM TEST STANDARD

No deviation.

4.4.5 TEST SETUP

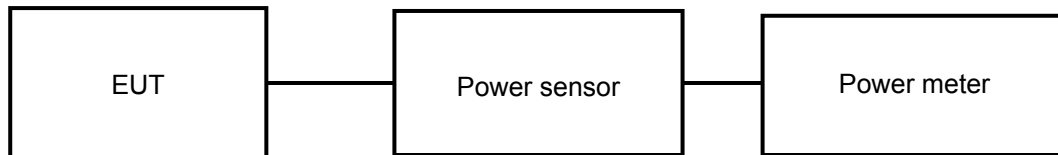

4.4.6 EUT OPERATING CONDITIONS

Same as Item 4.3.6.



4.4.7 TEST RESULTS

802.11b DSSS MODULATION

MODULATION TYPE	DBPSK	TRANSFER RATE	1.0Mbps
INPUT POWER (SYSTEM)	120Vac, 60 Hz	ENVIRONMENTAL CONDITIONS	25deg.C, 65%RH, 991hPa
TESTED BY	Brad Wu		

CHAN	CHANNEL FREQUENCY (MHz)	PEAK POWER OUTPUT (mW)	PEAK POWER OUTPUT (dBm)	PEAK POWER LIMIT (dBm)	PASS/FAIL
1	2412	101.625	20.07	30	PASS
6	2437	101.391	20.06	30	PASS
11	2462	91.201	19.60	30	PASS

802.11g OFDM MODULATION

MODULATION TYPE	BPSK	TRANSFER RATE	6.0Mbps
INPUT POWER (SYSTEM)	120Vac, 60 Hz	ENVIRONMENTAL CONDITIONS	25deg.C, 65%RH, 991hPa
TESTED BY	Brad Wu		

CHAN	CHANNEL FREQUENCY (MHz)	PEAK POWER OUTPUT (mW)	PEAK POWER OUTPUT (dBm)	PEAK POWER LIMIT (dBm)	PASS/FAIL
1	2412	80.724	19.07	30	PASS
6	2437	81.096	19.09	30	PASS
11	2462	81.658	19.12	30	PASS



DRAFT 802.11n (20MHz) OFDM MODULATION

MODULATION TYPE	BPSK	TRANSFER RATE	7.2Mbps
INPUT POWER (SYSTEM)	120Vac, 60 Hz	ENVIRONMENTAL CONDITIONS	25deg.C, 65%RH, 991hPa
TESTED BY	Brad Wu		

CHAN.	CHANNEL FREQUENCY (MHz)	PEAK POWER OUTPUT (dBm)			TOTAL PEAK POWER (mW)	TOTAL PEAK POWER (dBm)	PEAK POWER LIMIT (dBm)	PASS / FAIL
		CHAIN 0	CHAIN 1	CHAIN 2				
1	2412	19.08	19.10	19.51	251.523	24.01	30	PASS
6	2437	18.56	18.56	19.07	224.282	23.51	30	PASS
11	2462	19.02	19.09	19.06	241.433	23.83	30	PASS

DRAFT 802.11n (40MHz) OFDM MODULATION

MODULATION TYPE	BPSK	TRANSFER RATE	15.0Mbps
INPUT POWER (SYSTEM)	120Vac, 60 Hz	ENVIRONMENTAL CONDITIONS	25deg.C, 65%RH, 991hPa
TESTED BY	Brad Wu		

CHAN.	CHANNEL FREQUENCY (MHz)	PEAK POWER OUTPUT (dBm)			TOTAL PEAK POWER (mW)	TOTAL PEAK POWER (dBm)	PEAK POWER LIMIT (dBm)	PASS / FAIL
		CHAIN 0	CHAIN 1	CHAIN 2				
1	2422	16.55	16.05	16.63	131.483	21.19	30	PASS
4	2437	19.05	18.51	19.05	231.663	23.65	30	PASS
7	2452	18.07	18.59	18.58	208.509	23.19	30	PASS



4.5 POWER SPECTRAL DENSITY MEASUREMENT

4.5.1 LIMITS OF POWER SPECTRAL DENSITY MEASUREMENT

The Maximum of Power Spectral Density Measurement is 8dBm.

4.5.2 TEST INSTRUMENTS

DESCRIPTION & MANUFACTURER	MODEL NO.	SERIAL NO.	DATE OF CALIBRATION	DUE DATE OF CALIBRATION
SPECTRUM ANALYZER	FSP 40	100041	Apr. 22, 2008	Apr. 21, 2009

NOTE: The calibration interval of the above test instruments is 12 months and the calibrations are traceable to NML/ROC and NIST/USA.

4.5.3 TEST PROCEDURE

The transmitter output was connected to the spectrum analyzer through an attenuator, the bandwidth of the fundamental frequency was measured with the spectrum analyzer using 3kHz RBW and 30kHz VBW, set sweep time = span/3kHz. The power spectral density was measured and recorded.

The sweep time is allowed to be longer than span/3kHz for a full response of the mixer in the spectrum analyzer.

4.5.4 DEVIATION FROM TEST STANDARD

No deviation.

4.5.5 TEST SETUP

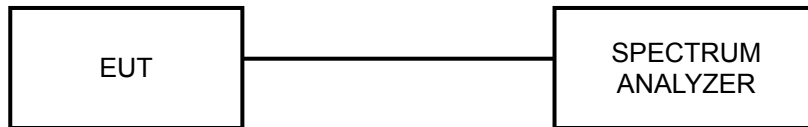

4.5.6 EUT OPERATING CONDITION

Same as Item 4.3.6.



CH 6

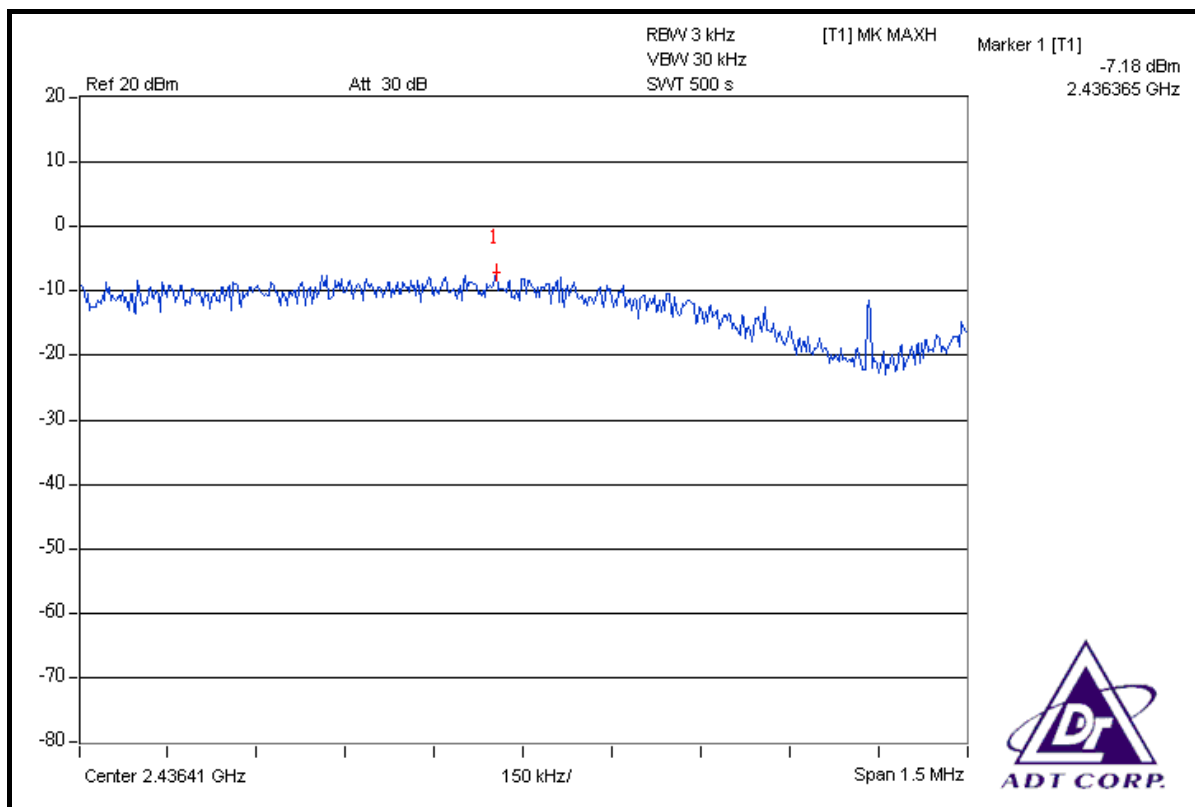

CH 11

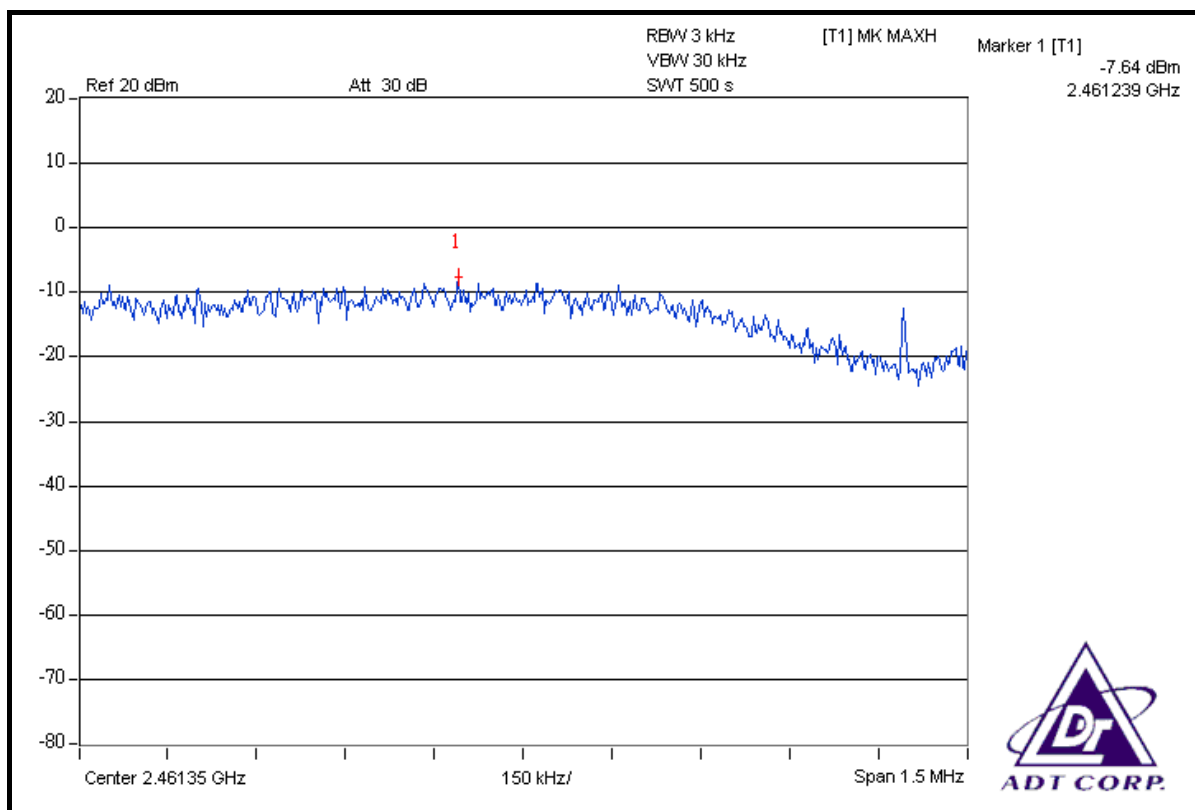



802.11g OFDM MODULATION

MODULATION TYPE	BPSK	TRANSFER RATE	6.0Mbps
INPUT POWER (SYSTEM)	120Vac, 60 Hz	ENVIRONMENTAL CONDITIONS	25deg.C, 65%RH, 991hPa
TESTED BY	Brad Wu		

CHANNEL	CHANNEL FREQUENCY (MHz)	RF POWER LEVEL IN 3 kHz BW (dBm)	MAXIMUM LIMIT (dBm)	PASS/FAIL
1	2412	-13.13	8	PASS
6	2437	-13.16	8	PASS
11	2462	-12.98	8	PASS

CH 1

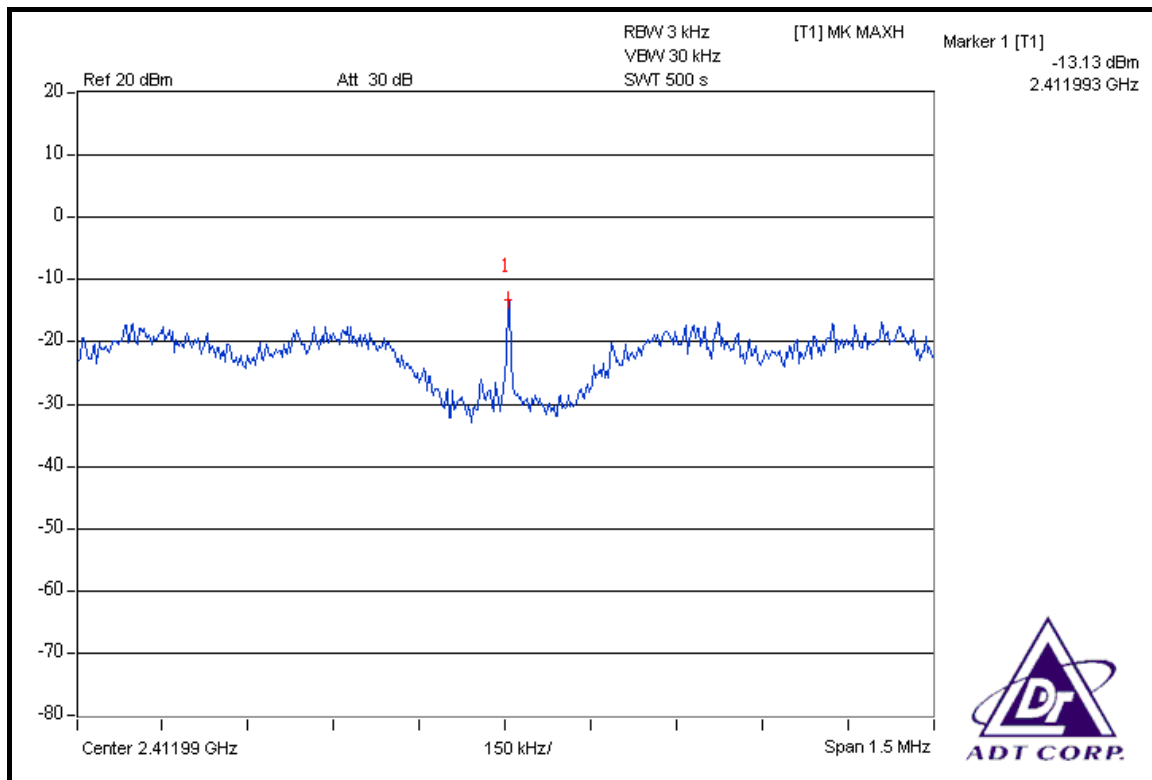

CH 6

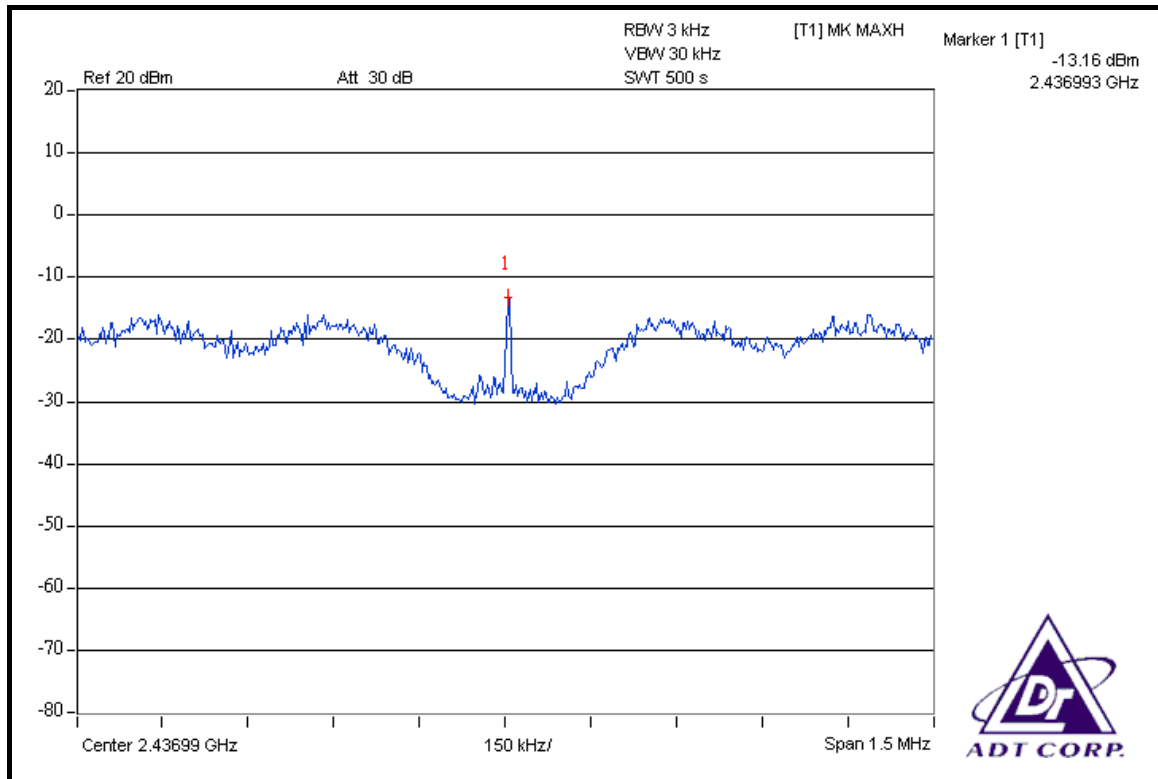

CH 11

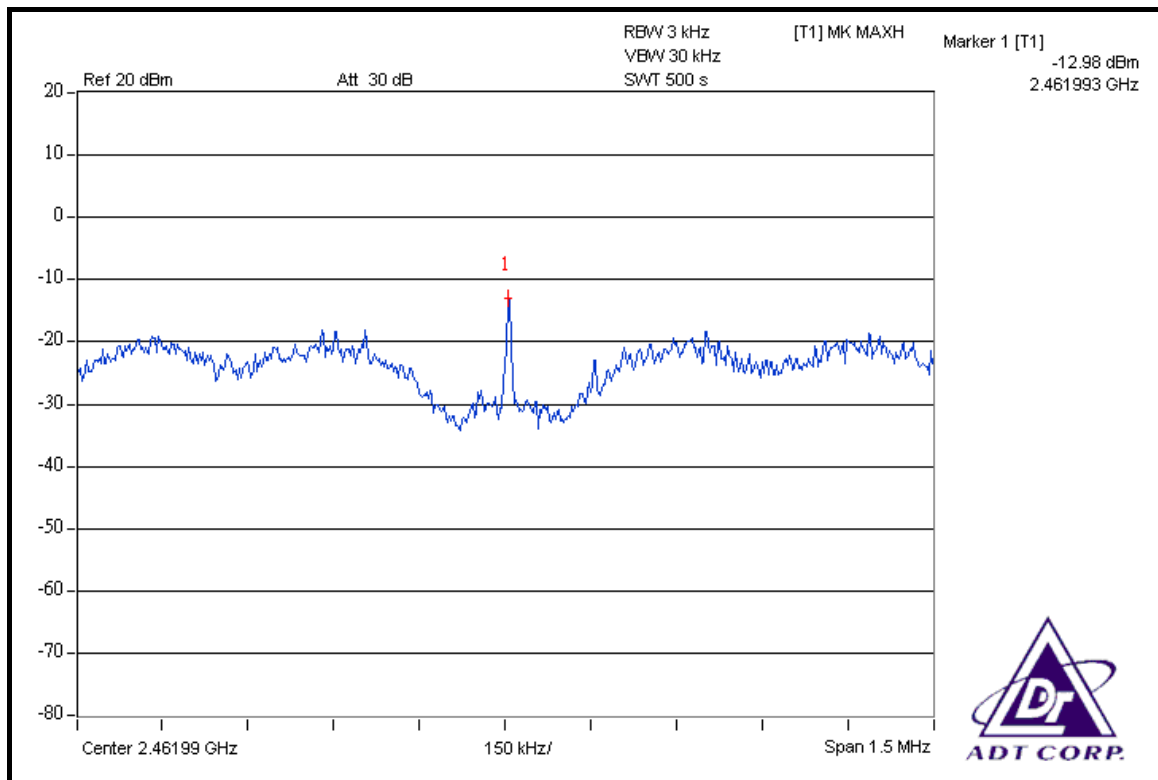



DRAFT 802.11n (20MHz) OFDM MODULATION

MODULATION TYPE	BPSK	TRANSFER RATE	7.2Mbps
INPUT POWER (SYSTEM)	120Vac, 60 Hz	ENVIRONMENTAL CONDITIONS	25deg.C, 65%RH, 991hPa
TESTED BY	Brad Wu		

CHANNEL	CHANNEL FREQUENCY (MHz)	RF POWER LEVEL IN 3kHz BW (dBm)			TOTAL POWER DENSITY (mW)	TOTAL POWER DENSITY (dBm)	MAX. LIMIT (dBm)	PASS / FAIL
		CHAIN 0	CHAIN 1	CHAIN 2				
1	2412	-11.24	-9.45	-12.34	0.247	-6.07	8	PASS
6	2437	-11.54	-9.96	-12.67	0.225	-6.48	8	PASS
11	2462	-11.00	-9.27	-12.64	0.052	-5.98	8	PASS

FOR CHAIN 0: CH 1

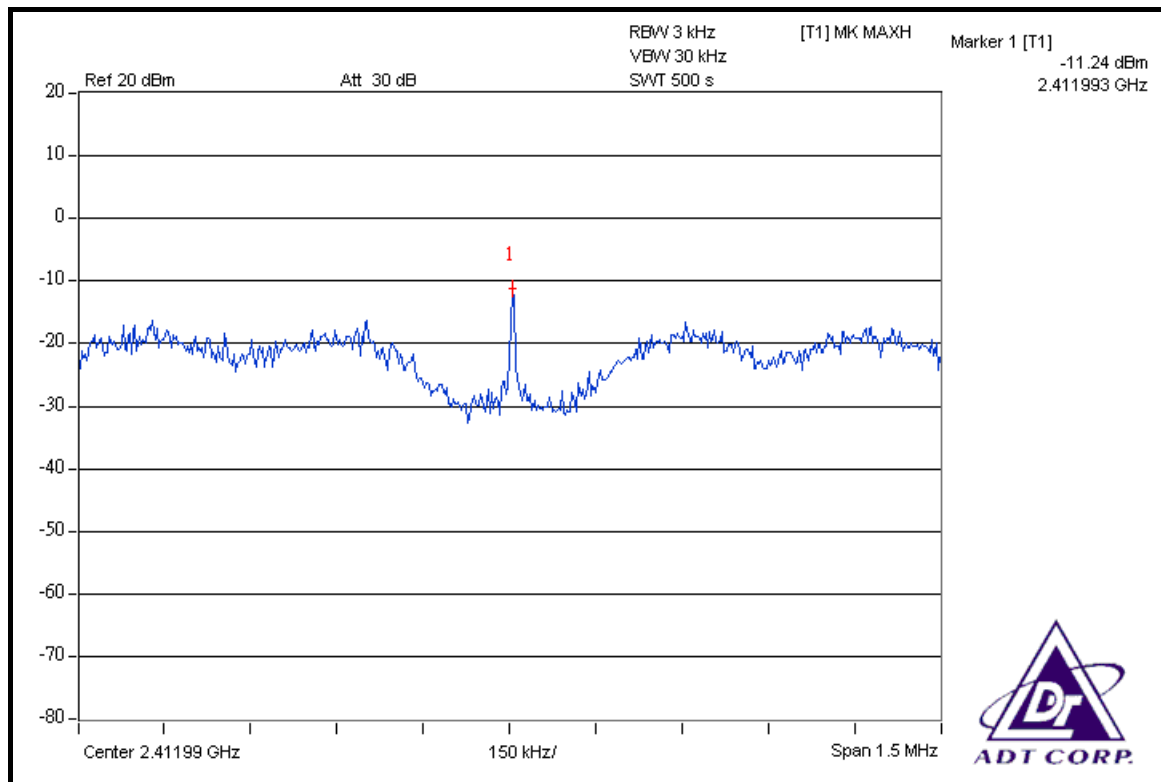



CH 6

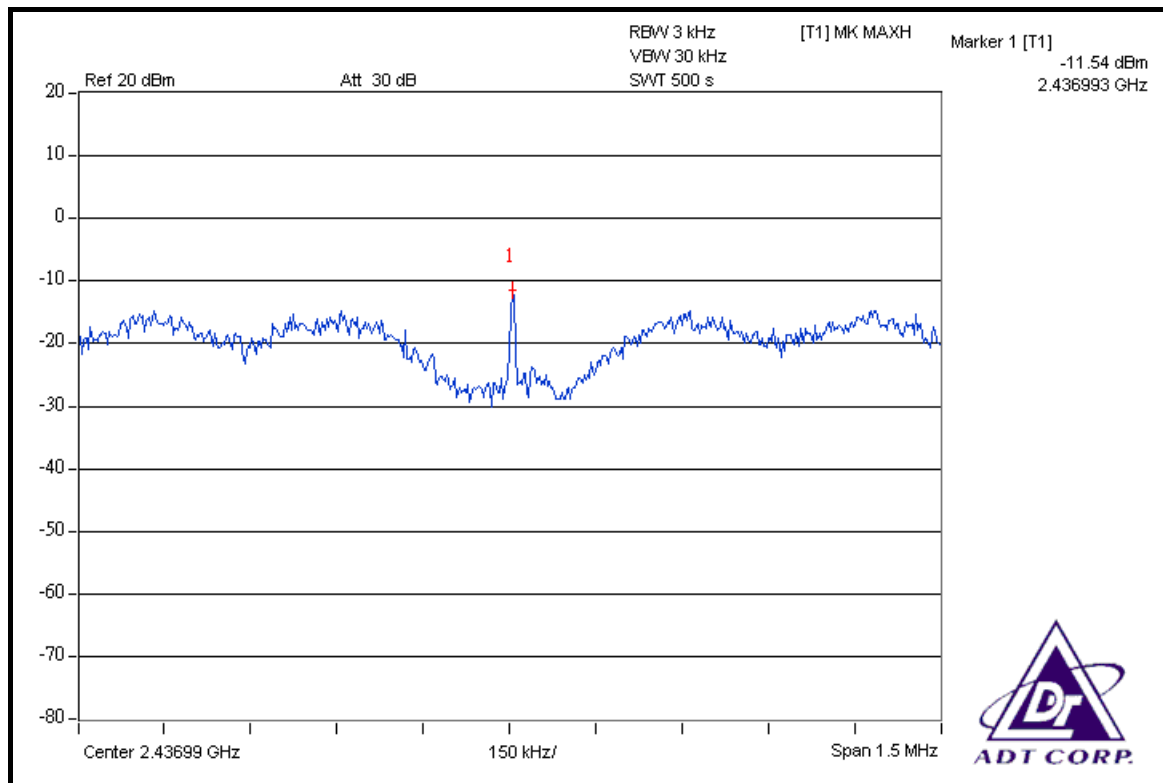

CH 11

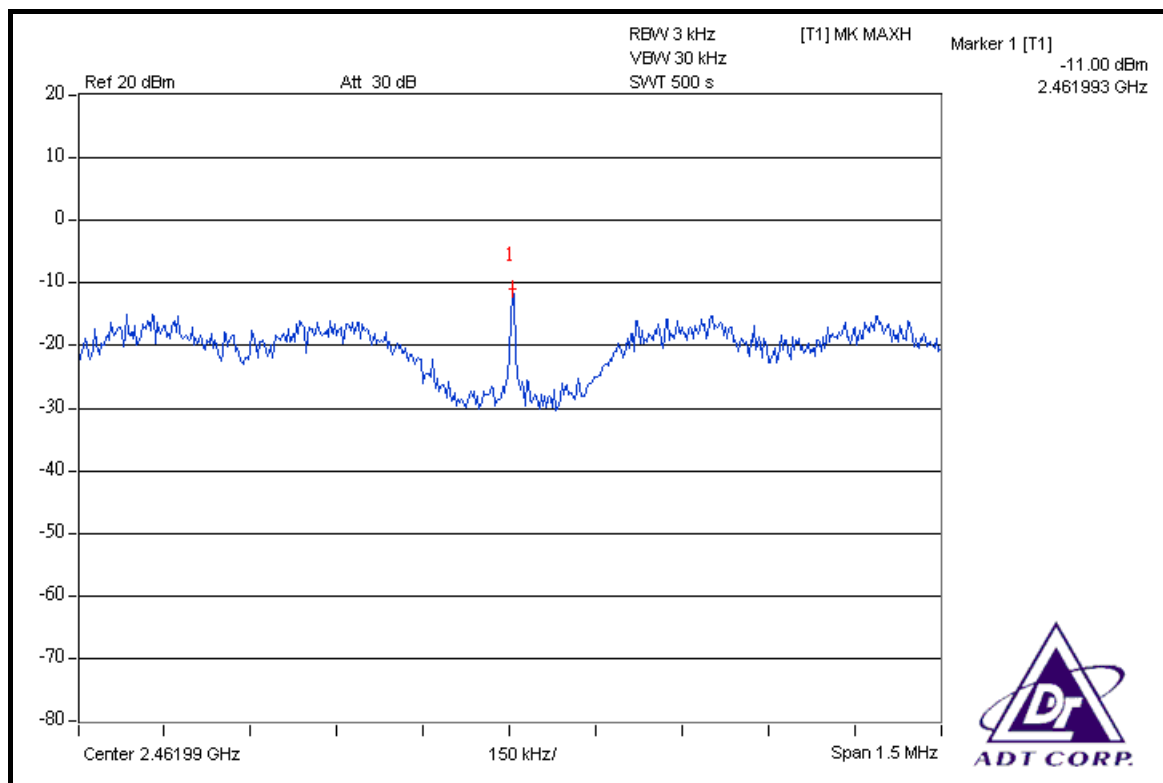



FOR CHAIN 1: CH 1

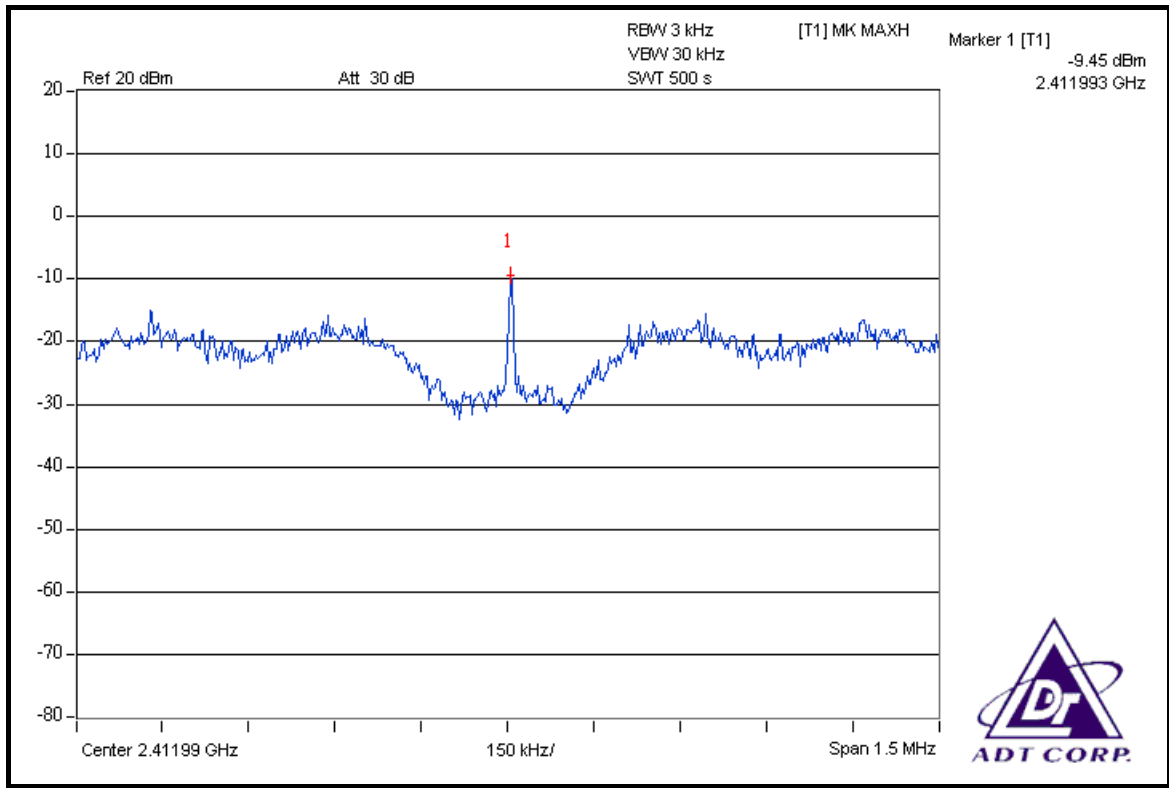

CH 6

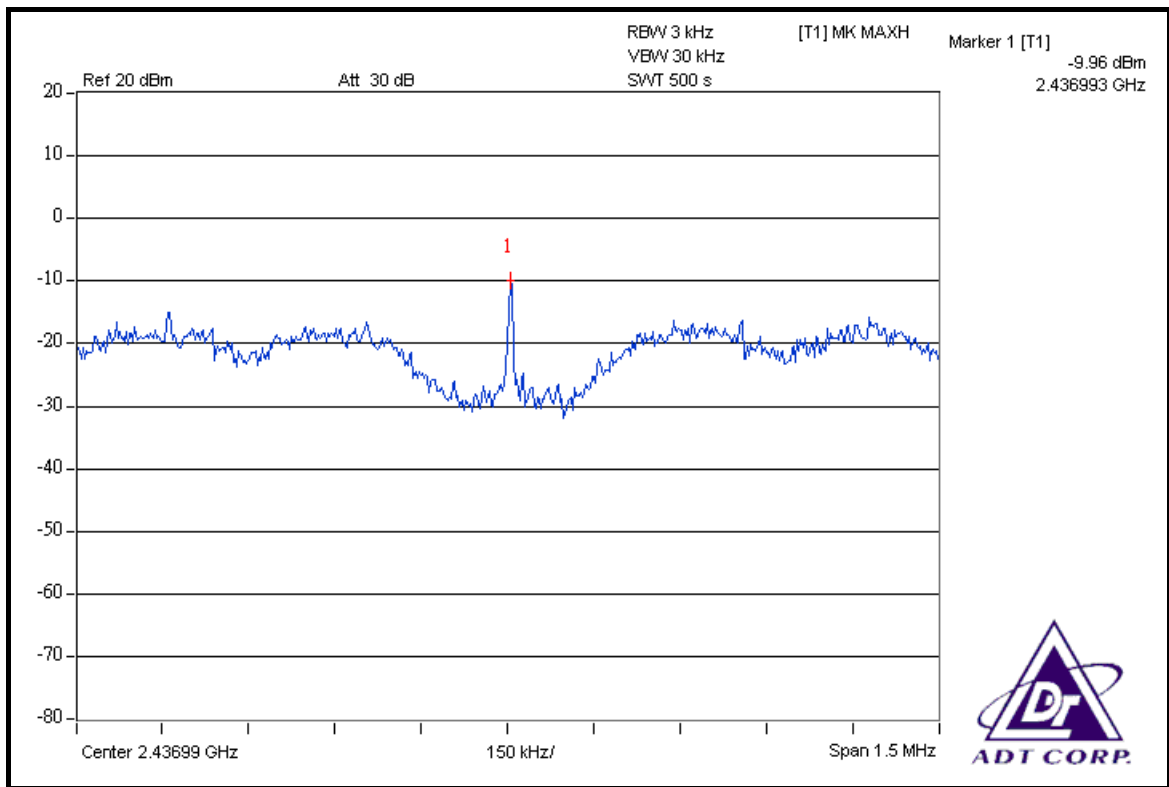



CH 11

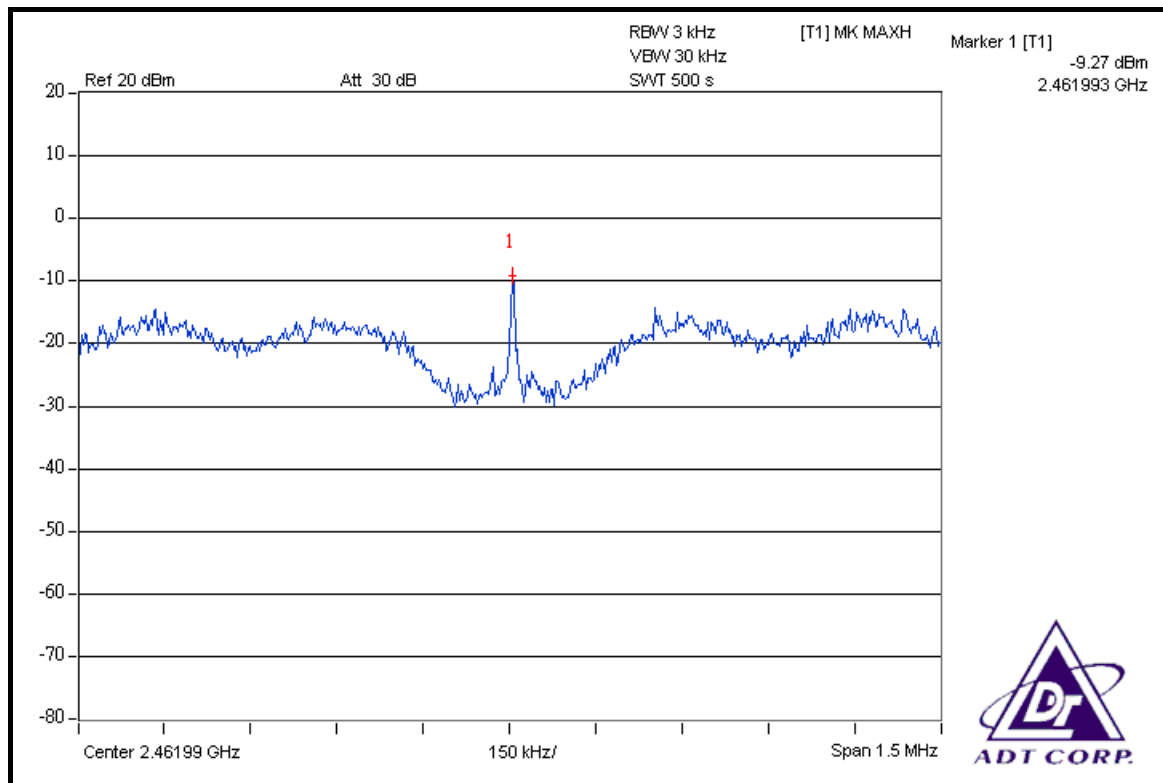

FOR CHAIN 2: CH 1

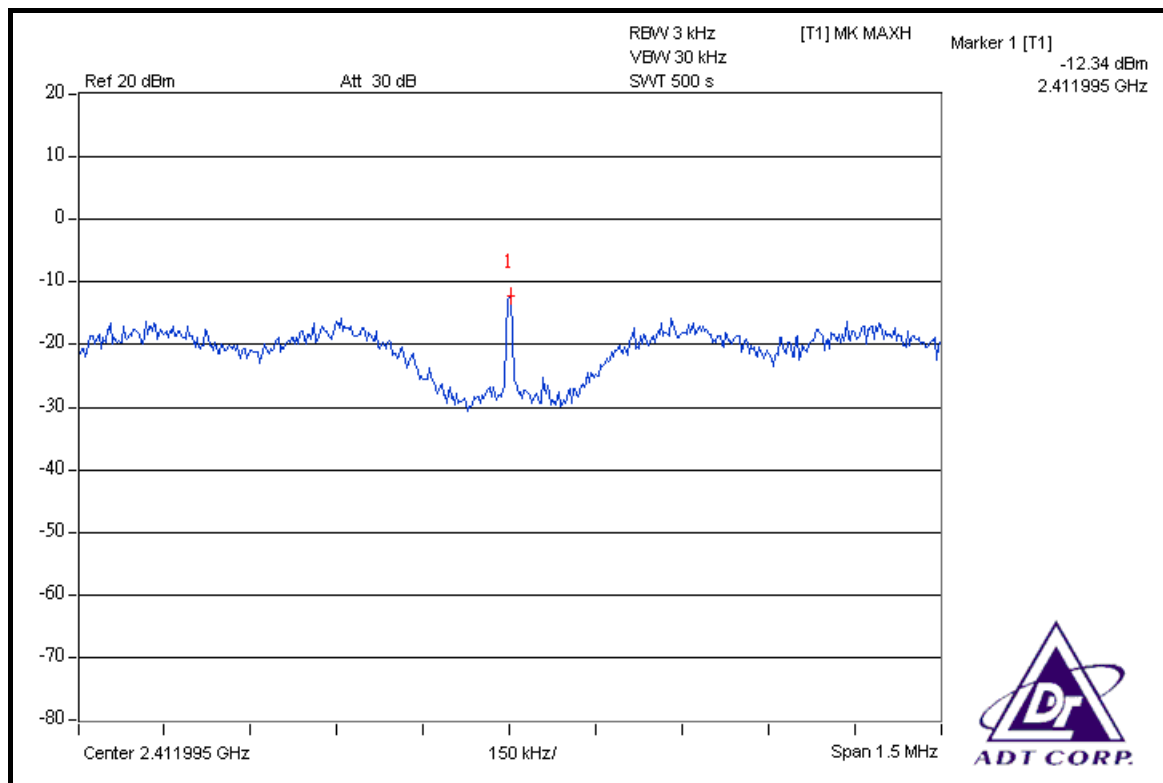



CH 6

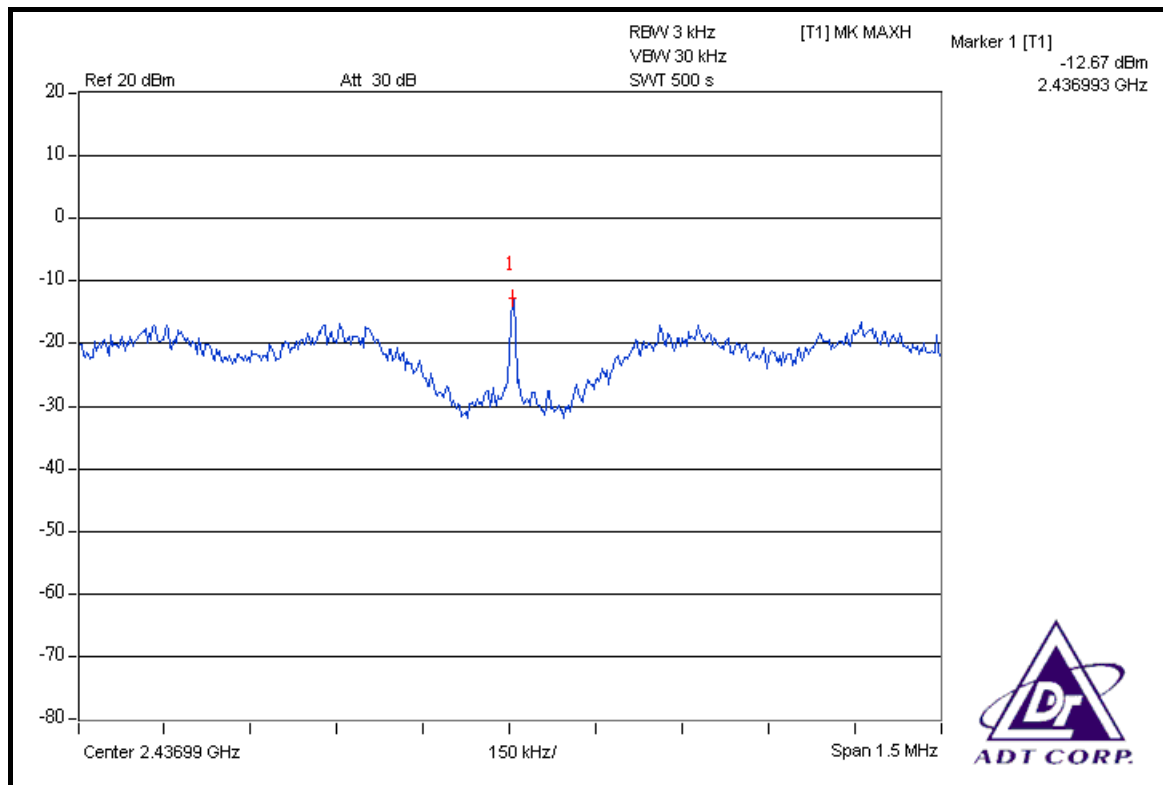

CH 11

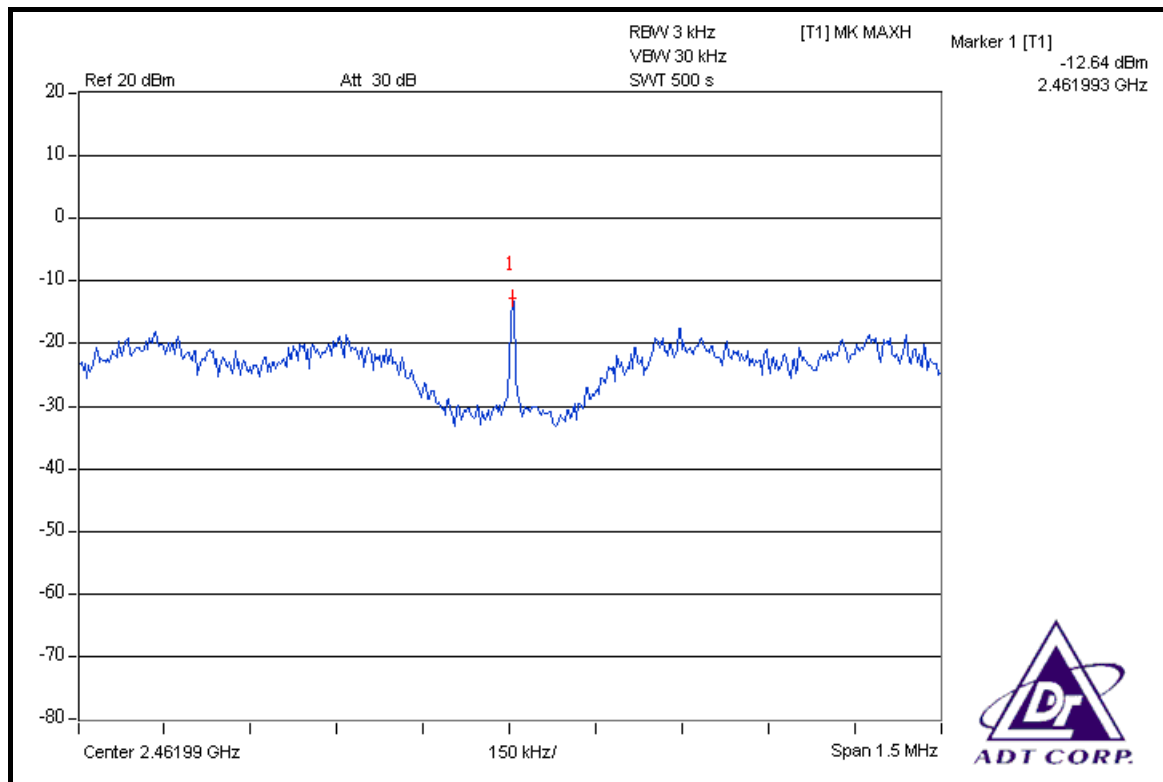

CH 4

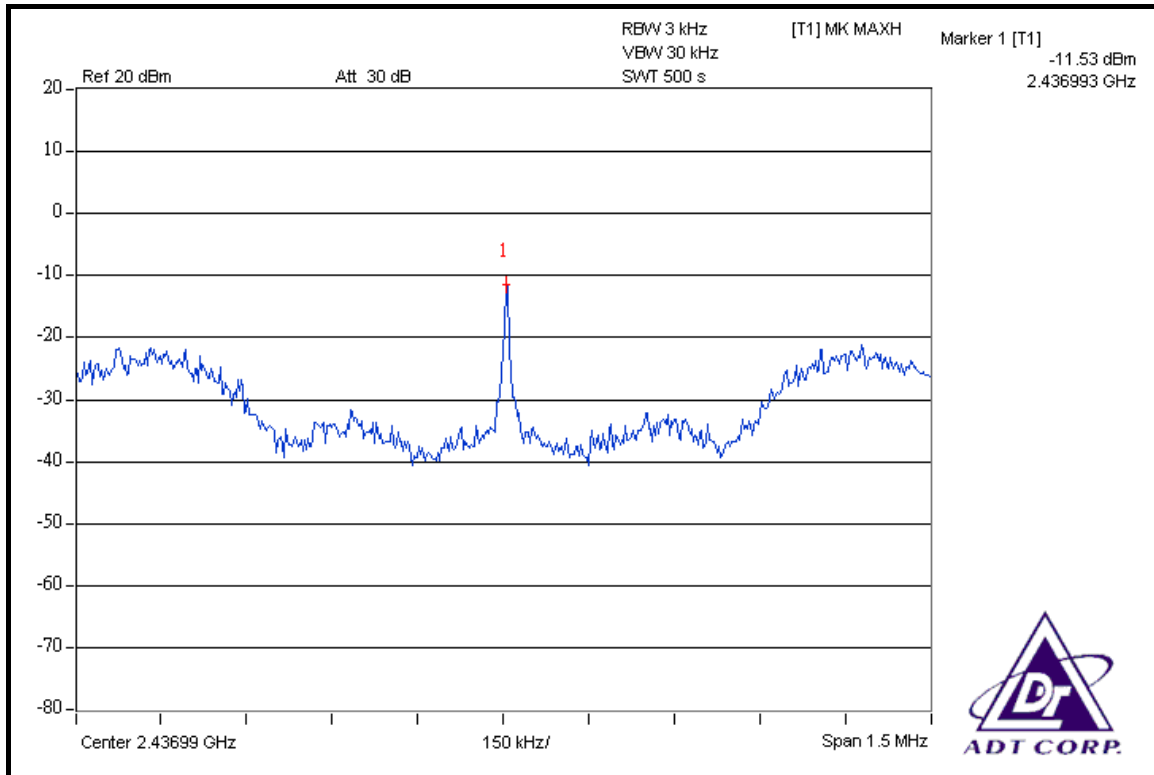

CH 7

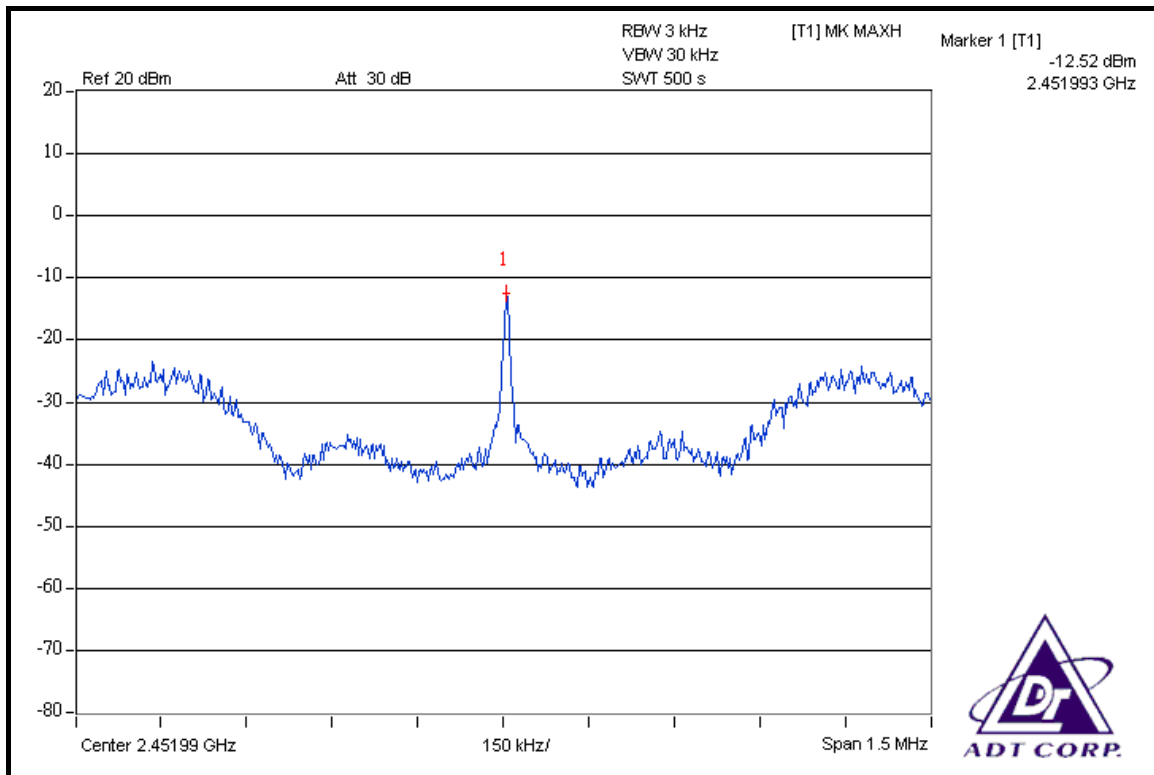



FOR CHAIN 1: CH 1

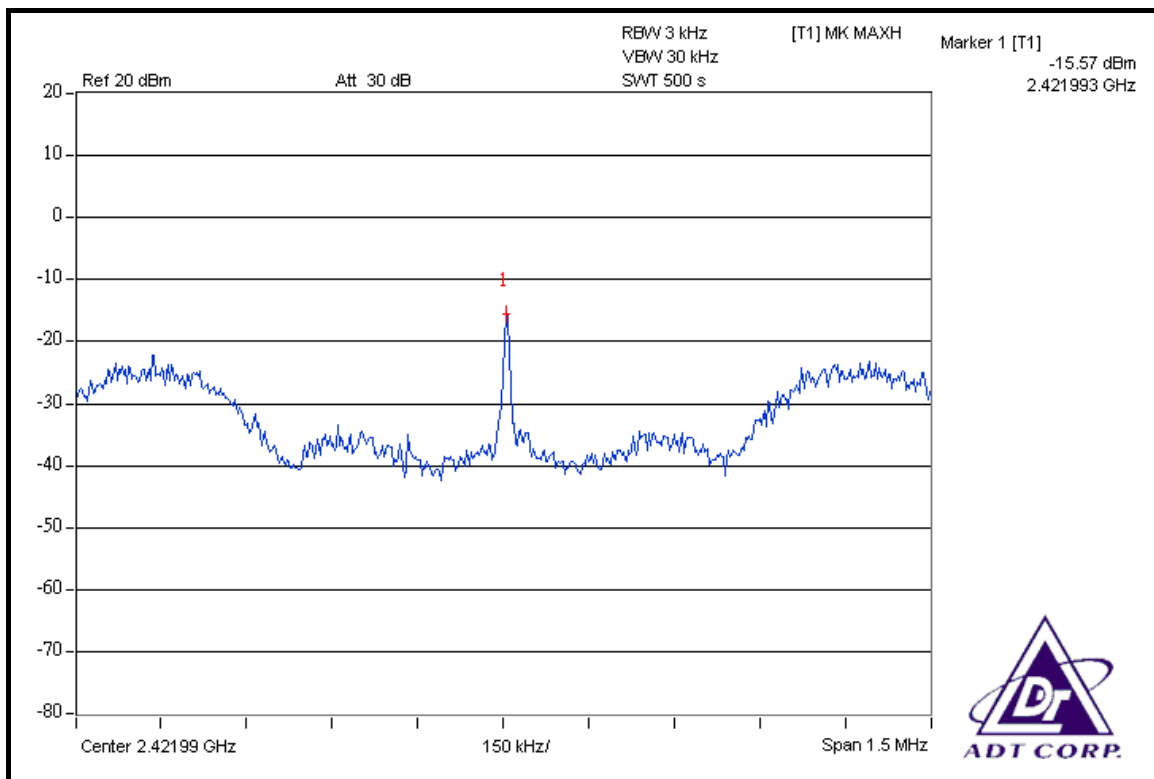

CH 4

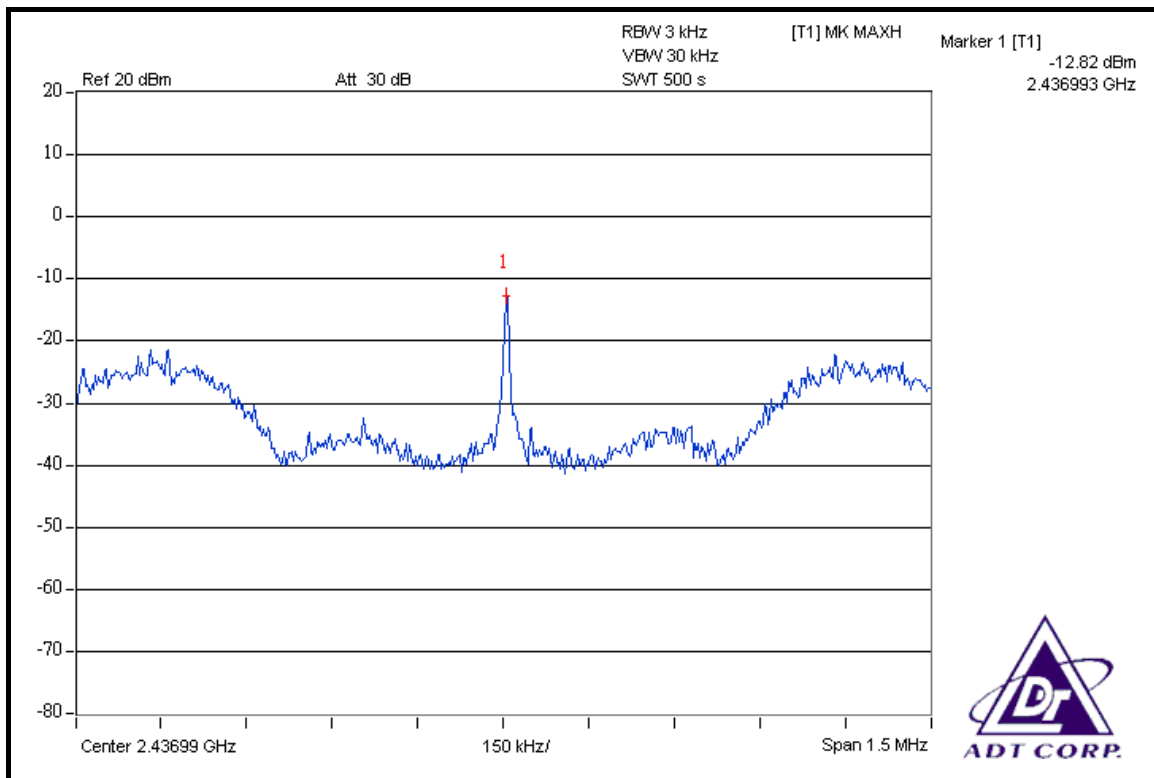



CH 7

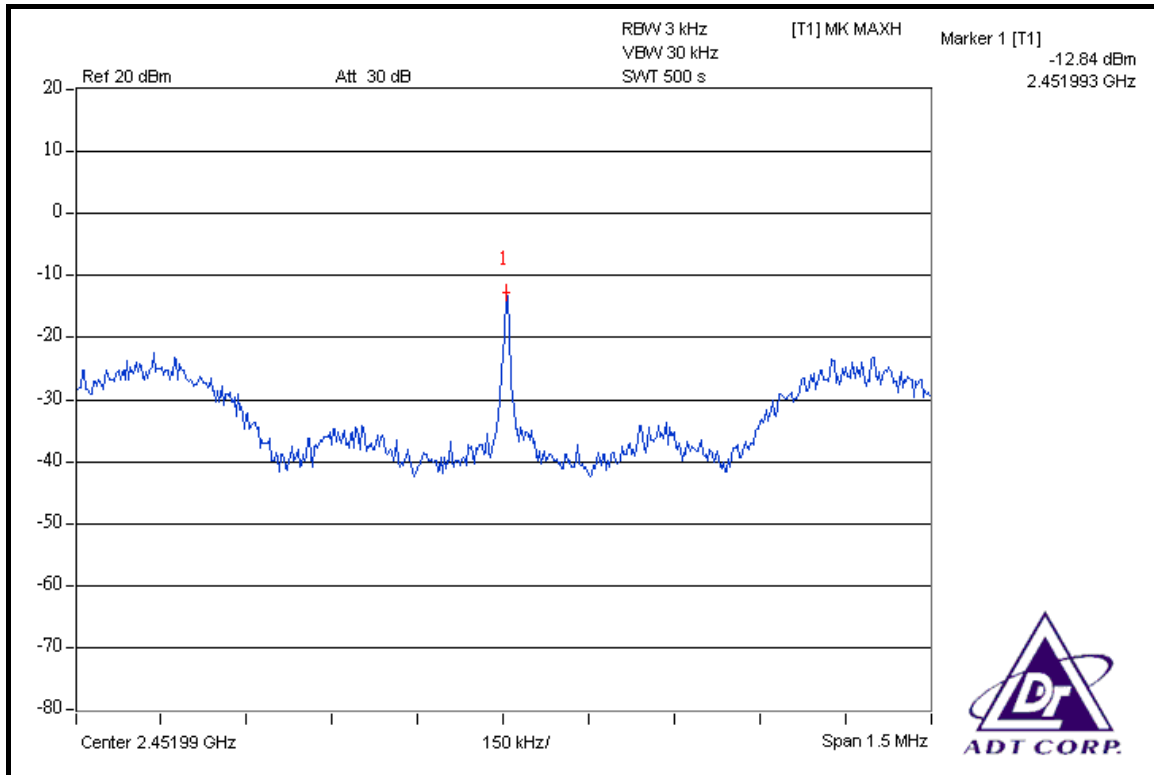

FOR CHAIN 2: CH 1

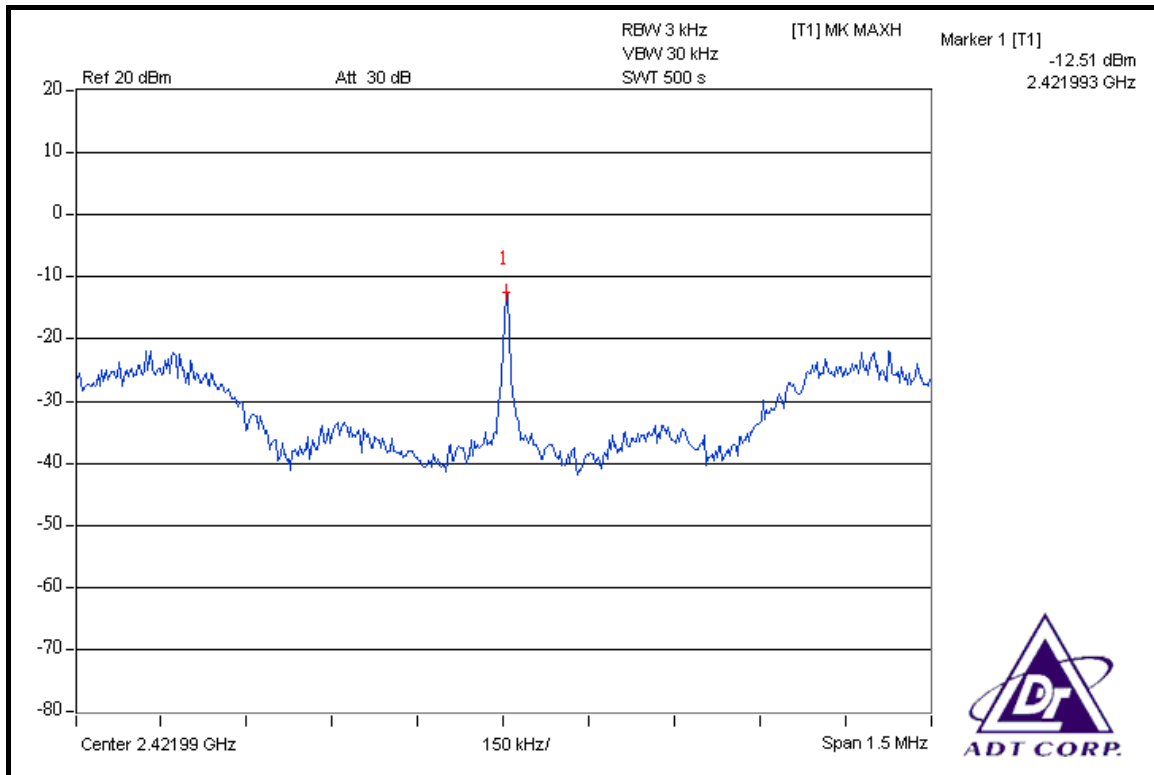

CH 4

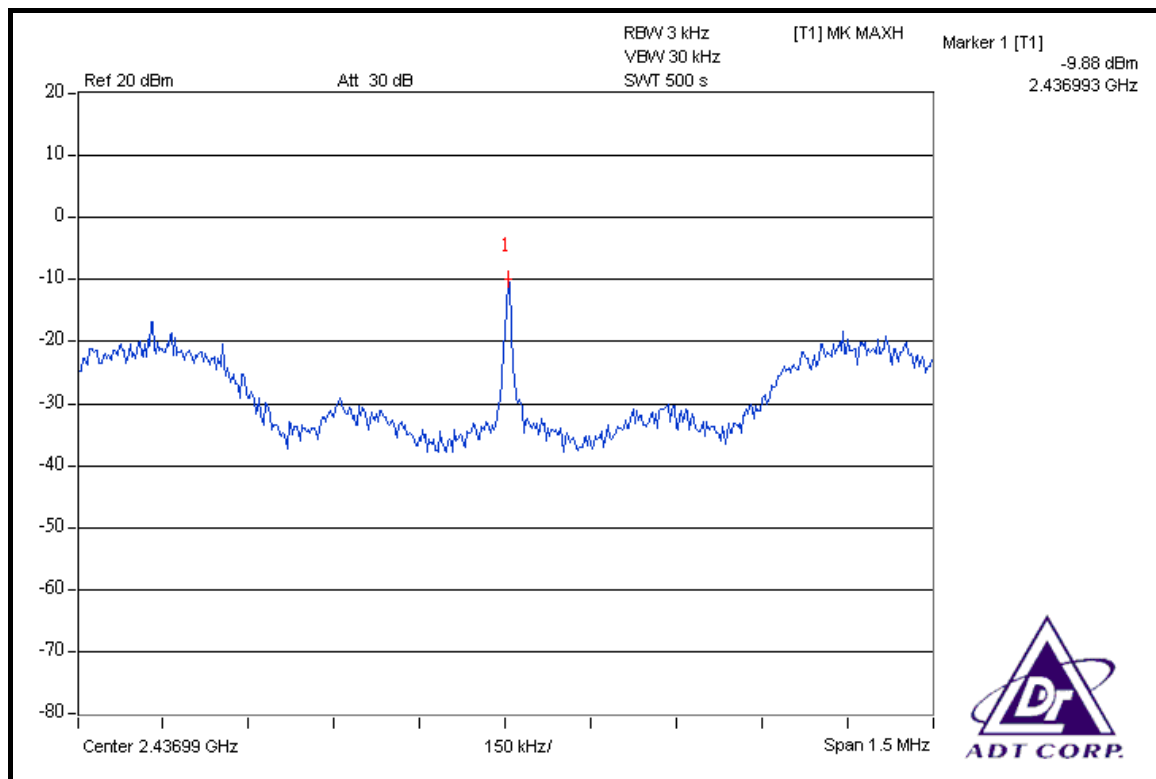

CH 7

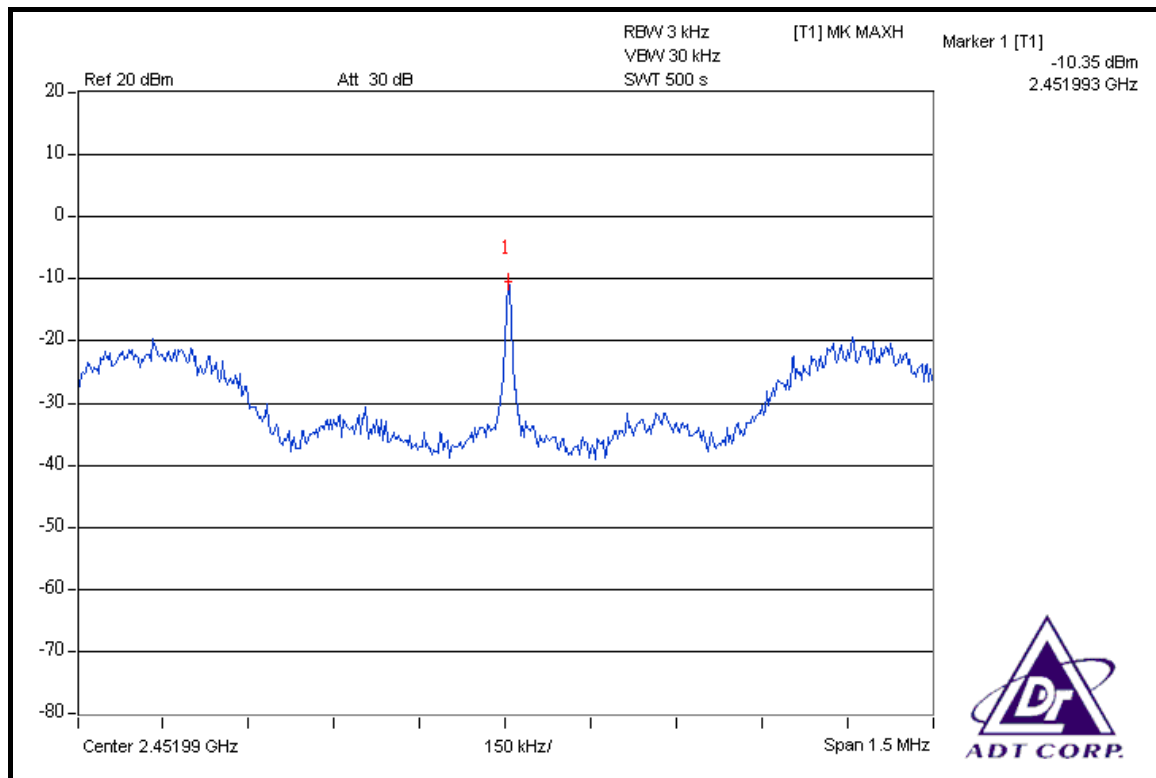



4.6 BAND EDGES MEASUREMENT

4.6.1 LIMITS OF BAND EDGES MEASUREMENT

Below –20dB of the highest emission level of operating band (in 100kHz Resolution Bandwidth).

4.6.2 TEST INSTRUMENTS

DESCRIPTION & MANUFACTURER	MODEL NO.	SERIAL NO.	DATE OF CALIBRATION	DUE DATE OF CALIBRATION
FOR CONDUCTED MEASUREMENT				
SPECTRUM ANALYZER	FSP 40	100041	Apr. 22, 2008	Apr. 21, 2009
FOR RADIATED MEASUREMENT				
Test Receiver ROHDE & SCHWARZ	ESI7	838496/016	Dec. 26, 2007	Dec. 25, 2008
Spectrum Analyzer ROHDE & SCHWARZ	FSP40	100039	Dec. 03, 2007	Dec. 02, 2008
BILOG Antenna SCHWARZBECK	VULB9168	9168-155	Apr. 30, 2008	Apr. 29, 2009
HORN Antenna SCHWARZBECK	BBHA 9120D	9120D-408	Jan. 22, 2008	Jan. 21, 2009
HORN Antenna SCHWARZBECK	BBHA 9170	BBHA9170242	Jan. 07, 2008	Jan. 06, 2009
Preamplifier Agilent	8449B	3008A01960	Oct. 31, 2007	Oct. 30, 2008
Preamplifier Agilent	8447D	2944A10631	Nov. 01, 2007	Oct. 31, 2008
RF signal cable HUBER+SUHNNER	SUCOFLEX 104	274397/4	Nov. 08, 2007	Nov. 07, 2008
RF signal cable HUBER+SUHNNER	SUCOFLEX 104	283401/4	Nov. 08, 2007	Nov. 07, 2008
Software ADT.	ADT_Radiated_V7.6	NA	NA	NA
Antenna Tower inn-co GmbH	MA 4000	010303	NA	NA
Antenna Tower Controller inn-co GmbH	CO2000	019303	NA	NA
Turn Table ADT.	TT100.	TT93021704	NA	NA
Turn Table Controller ADT.	SC100.	SC93021704	NA	NA

NOTE: The calibration interval of the above test instruments is 12 months and the calibrations are traceable to NML/ROC and NIST/USA.

4.6.3 TEST PROCEDURE

FOR CONDUCTED MEASUREMENT

The transmitter output was connected to the spectrum analyzer via a low lose cable. Set both RBW and VBW of spectrum analyzer to 100kHz and 300kHz with suitable frequency span including 100MHz bandwidth from band edge. The band edges was measured and recorded.

The spectrum plots (Peak RBW = 100kHz, VBW = 300kHz; Average RBW = 1MHz, VBW = 10Hz) are attached on the following pages.

FOR RADIATED MEASUREMENT

- a. The EUT was placed on the top of a rotating table 0.8 meters above the ground at a 3 meter semi-anechoic chamber. The table was rotated 360 degrees to determine the position of the highest radiation.
- b. The EUT was set 3 meters away from the interference-receiving antenna, which was mounted on the top of a variable-height antenna tower.
- c. The antenna is a broadband antenna, and its height is varied from one meter to four meters above the ground to determine the maximum value of the field strength. Both horizontal and vertical polarizations of the antenna are set to make the measurement.
- d. For each suspected emission, the EUT was arranged to its worst case and then the antenna was tuned to heights from 1 meter to 4 meters and the rotatable table was turned from 0 degrees to 360 degrees to find the maximum reading.
- e. Set both RBW and VBW of spectrum analyzer to 100kHz with suitable frequency span including 100MHz bandwidth from band edge. The band edges was measured and recorded.

The spectrum plots (Peak RBW = 100kHz, VBW = 300kHz; Average RBW = 1MHz, VBW = 10Hz)

4.6.4 DEVIATION FROM TEST STANDARD

No deviation.

4.6.5 EUT OPERATING CONDITION

Same as Item 4.3.6.

4.6.6 TEST RESULTS

The spectrum plots are attached on the following 24 images. D1 line indicates the highest level, and D2 line indicates the 20dB offset below D1. It shows compliance with the requirement in part 15.247(d).

802.11b DSSS MODULATION: 1TX

NOTE 1: The band edge emission plot on the next page shows 53.23dBc between carrier maximum power and local maximum emission in restrict band (2.3850GHz). The emission of carrier strength list in the test result of channel 1 at the item 4.2.7 is 110.73dBuV/m (Peak), so the maximum field strength in restrict band is $110.73 - 53.23 = 57.50$ dBuV/m which is under 74dBuV/m limit.

The band edge emission plot on the next page shows 59.54dBc between carrier maximum power and local maximum emission in restrict band (2.3868GHz). The emission of carrier strength list in the test result of channel 1 at the item 4.2.7 is 106.08dBuV/m (Average), so the maximum field strength in restrict band is $106.08 - 59.54 = 46.54$ dBuV/m which is under 54dBuV/m limit.

NOTE 2: The band edge emission plot on the next second page shows 53.85dBc between carrier maximum power and local maximum emission in restrict band (2.4950GHz). The emission of carrier strength list in the test result of channel 11 at the item 4.2.7 is 111.11dBuV/m (Peak), so the maximum field strength in restrict band is $111.11 - 53.85 = 57.26$ dBuV/m which is under 74dBuV/m limit.

The band edge emission plot on the next third page shows 59.88dBc between carrier maximum power and local maximum emission in restrict band (2.4876GHz). The emission of carrier strength list in the test result of channel 11 at the item 4.2.7 is 106.48dBuV/m (Average), so the maximum field strength in restrict band is $106.48 - 59.88 = 46.60$ dBuV/m which is under 54dBuV/m limit.

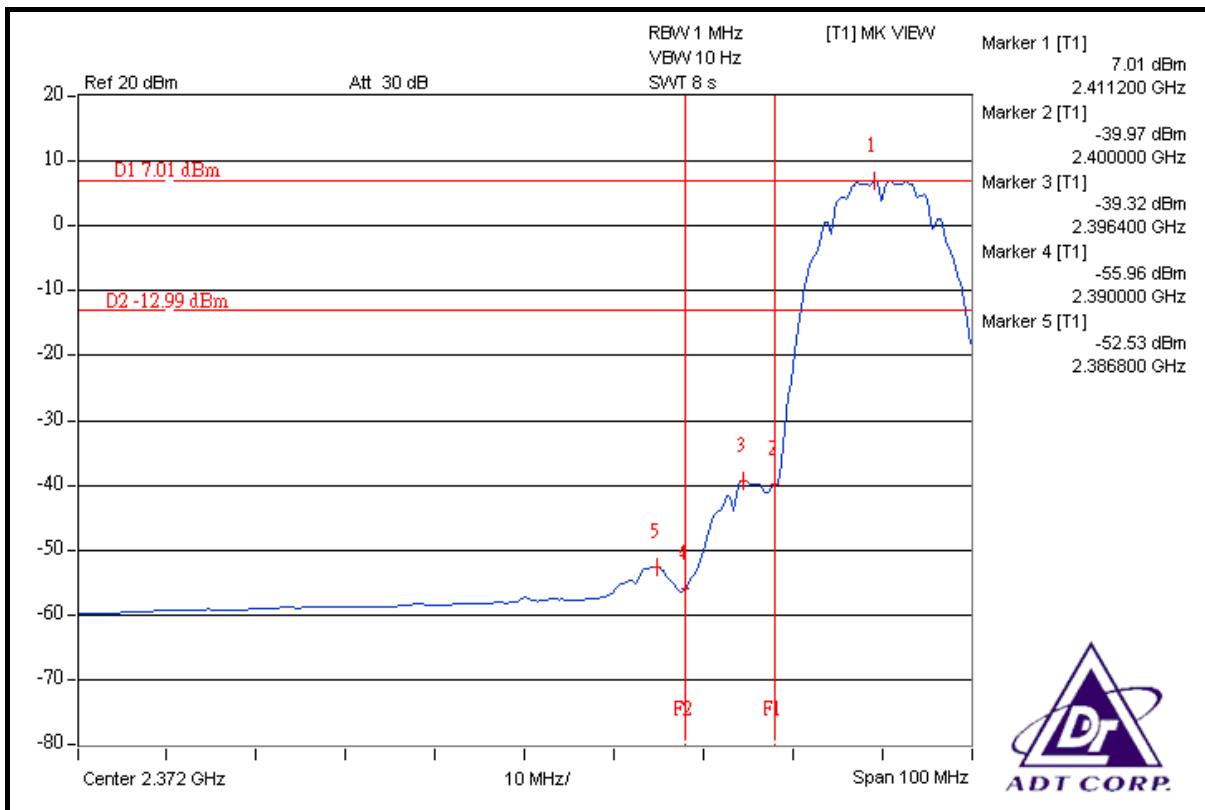
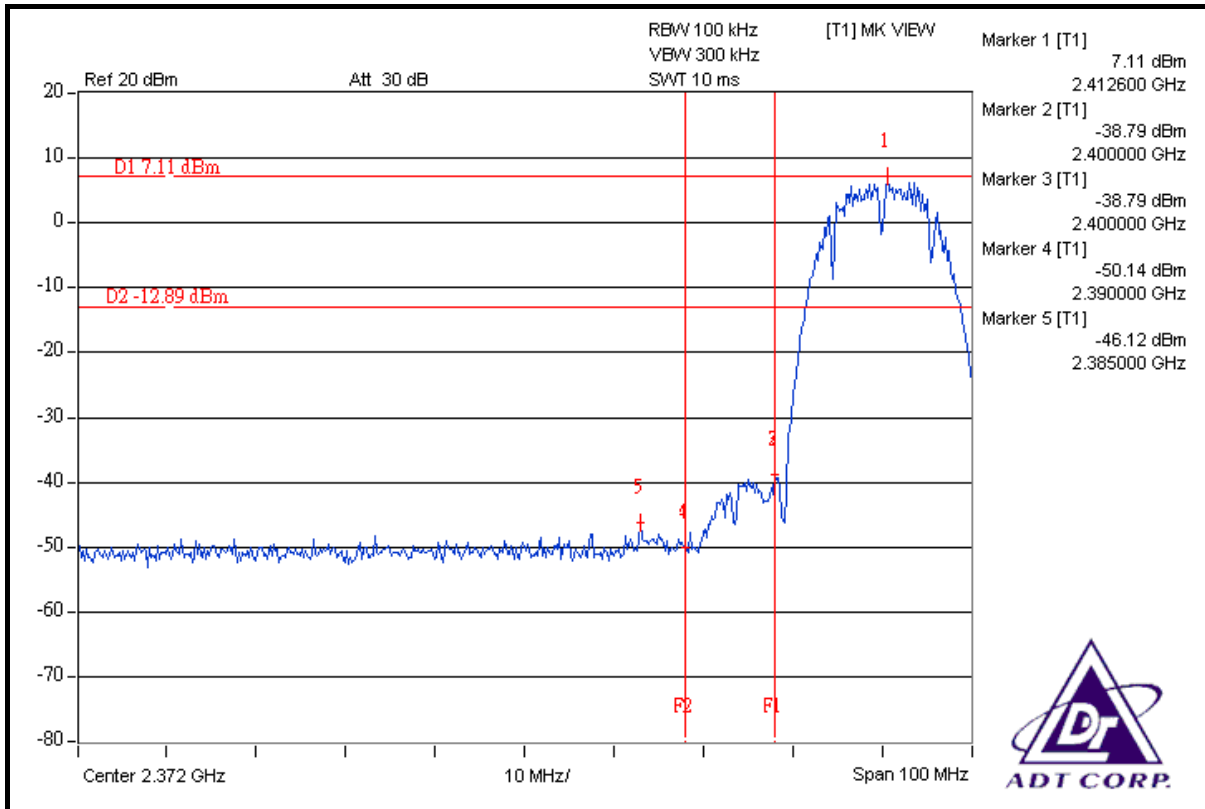

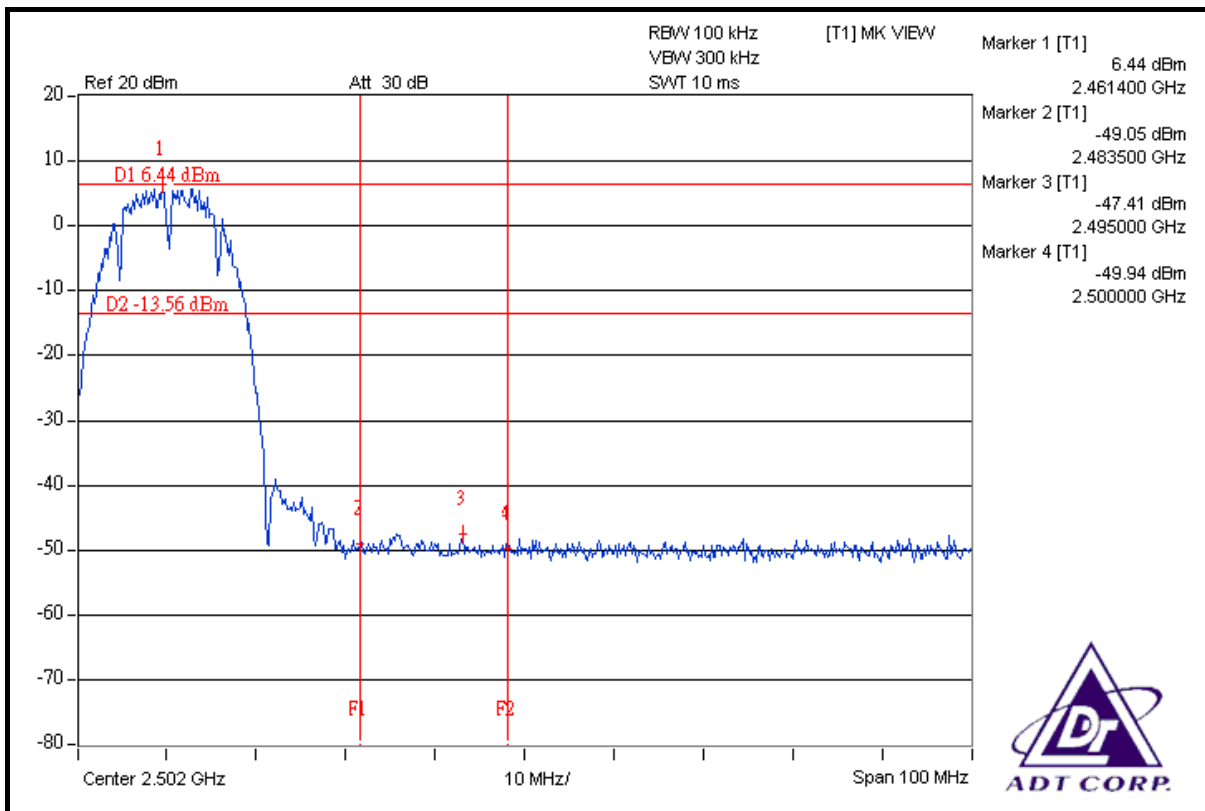
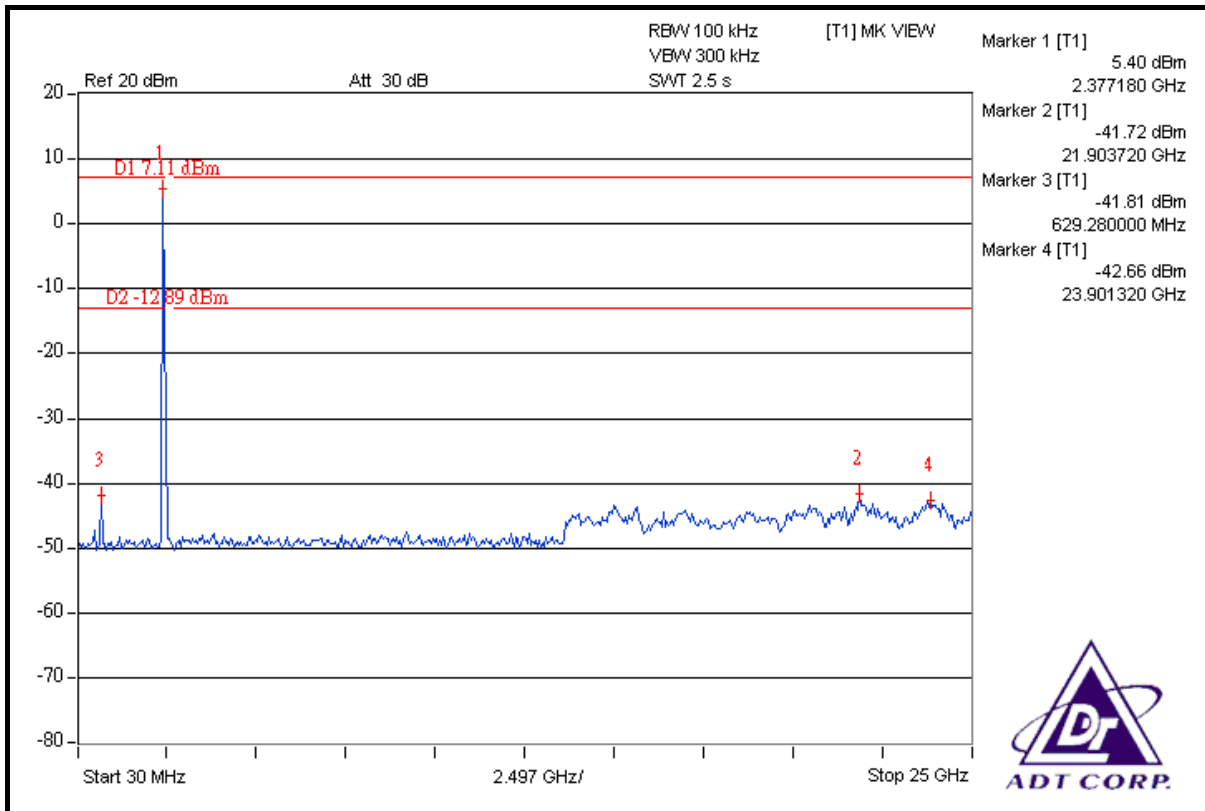

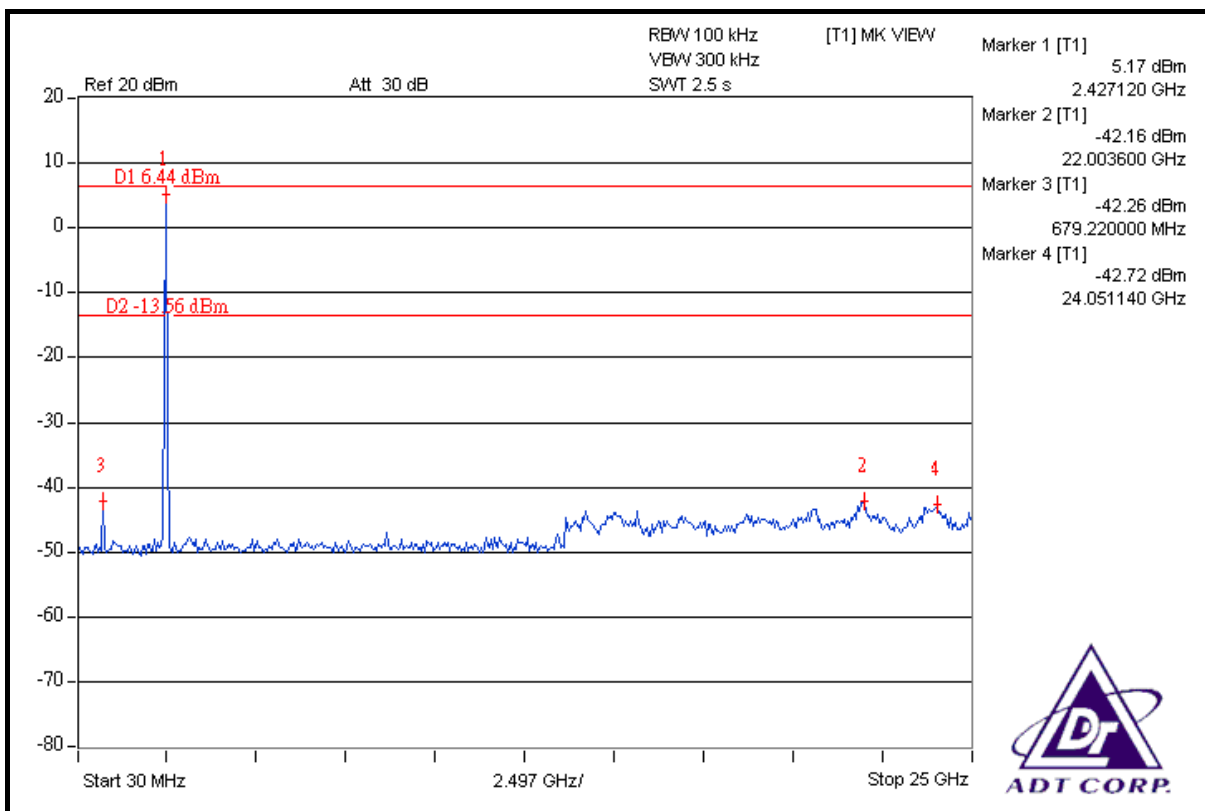
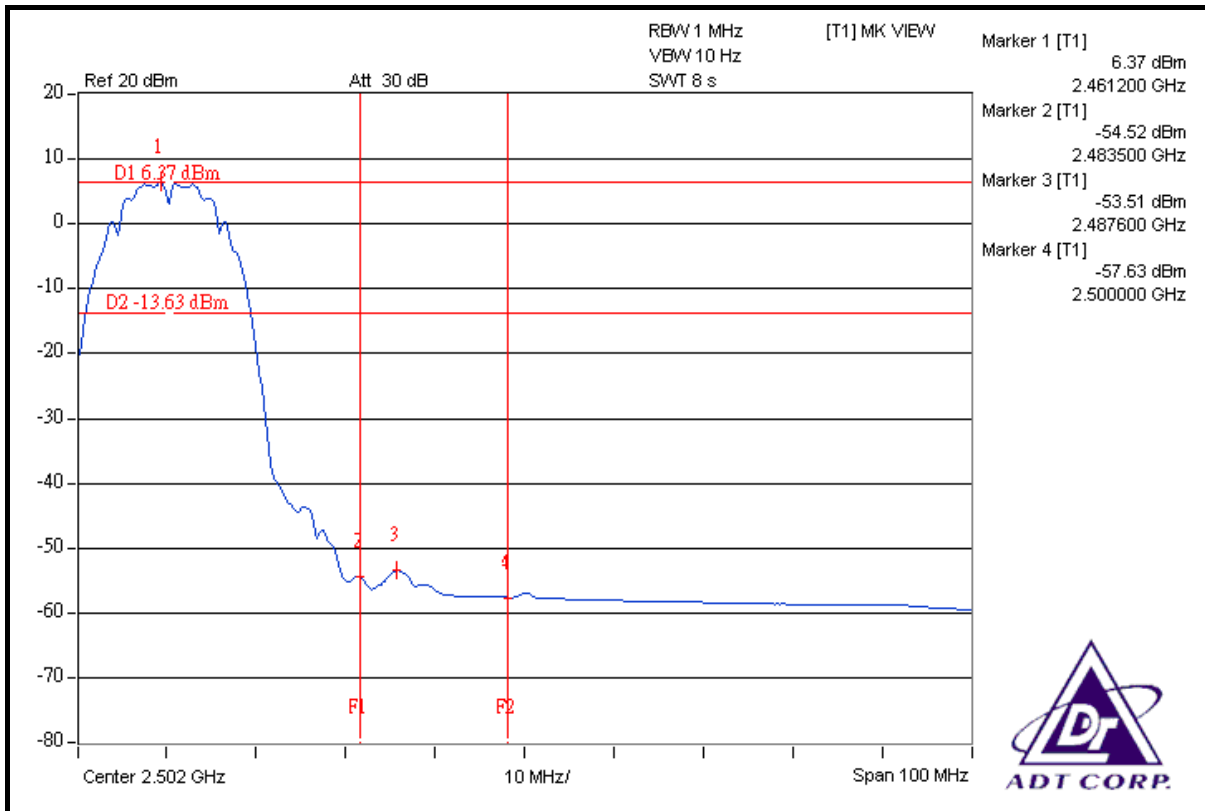

802.11g OFDM MODULATION: 1TX

NOTE 1: The band edge emission plot on the next page shows 46.27dBc between carrier maximum power and local maximum emission in restrict band (2.3340GHz). The emission of carrier strength list in the test result of channel 1 at the item 4.2.7 is 105.71dBuV/m (Peak), so the maximum field strength in restrict band is $105.71 - 46.27 = 59.44$ dBuV/m which is under 74dBuV/m limit.

The band edge emission plot on the next page shows 52.33dBc between carrier maximum power and local maximum emission in restrict band (2.3900GHz). The emission of carrier strength list in the test result of channel 1 at the item 4.2.7 is 95.42dBuV/m (Average), so the maximum field strength in restrict band is $95.42 - 52.33 = 43.09$ dBuV/m which is under 54dBuV/m limit.

NOTE 2: The band edge emission plot on the next second page shows 45.47dBc between carrier maximum power and local maximum emission in restrict band (2.4916GHz). The emission of carrier strength list in the test result of channel 11 at the item 4.2.7 is 105.48dBuV/m (Peak), so the maximum field strength in restrict band is $105.48 - 45.47 = 60.01$ dBuV/m which is under 74dBuV/m limit.

The band edge emission plot on the next third page shows 51.77dBc between carrier maximum power and local maximum emission in restrict band (2.4835GHz). The emission of carrier strength list in the test result of channel 11 at the item 4.2.7 is 95.97dBuV/m (Average), so the maximum field strength in restrict band is $95.97 - 51.77 = 44.20$ dBuV/m which is under 54dBuV/m limit.

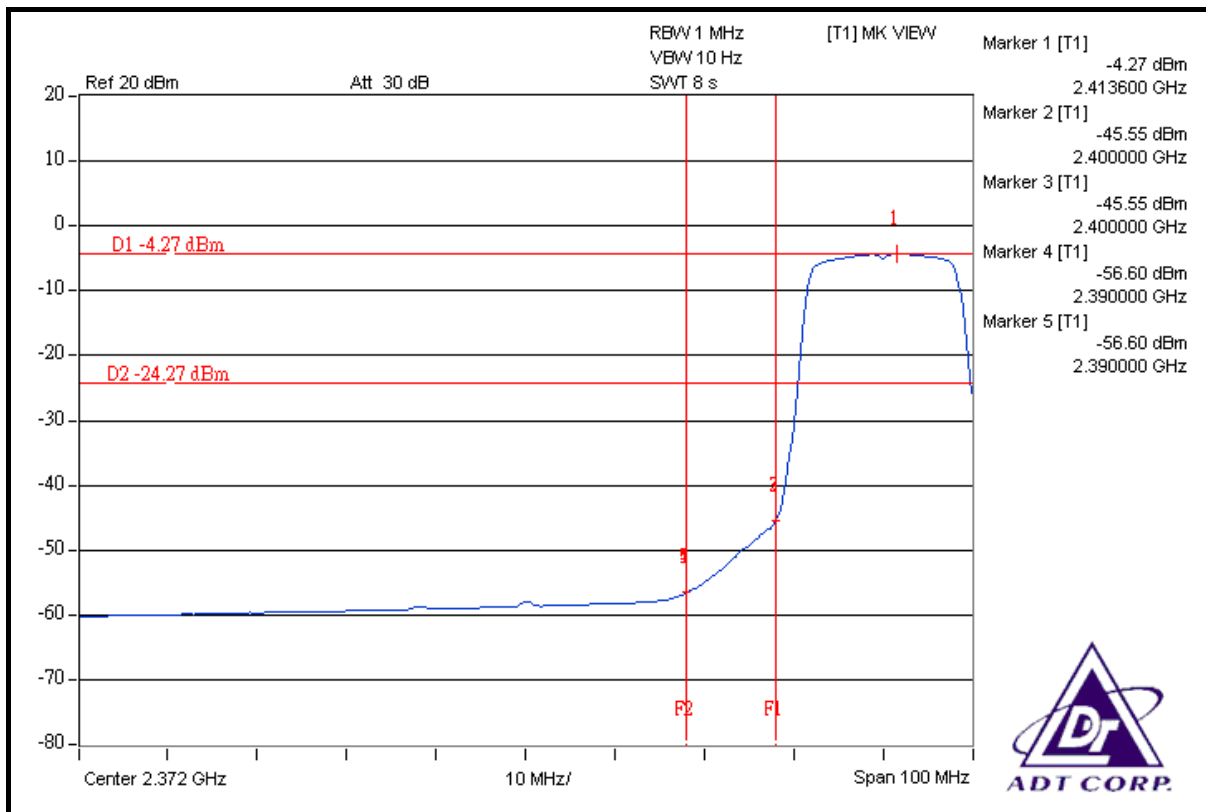
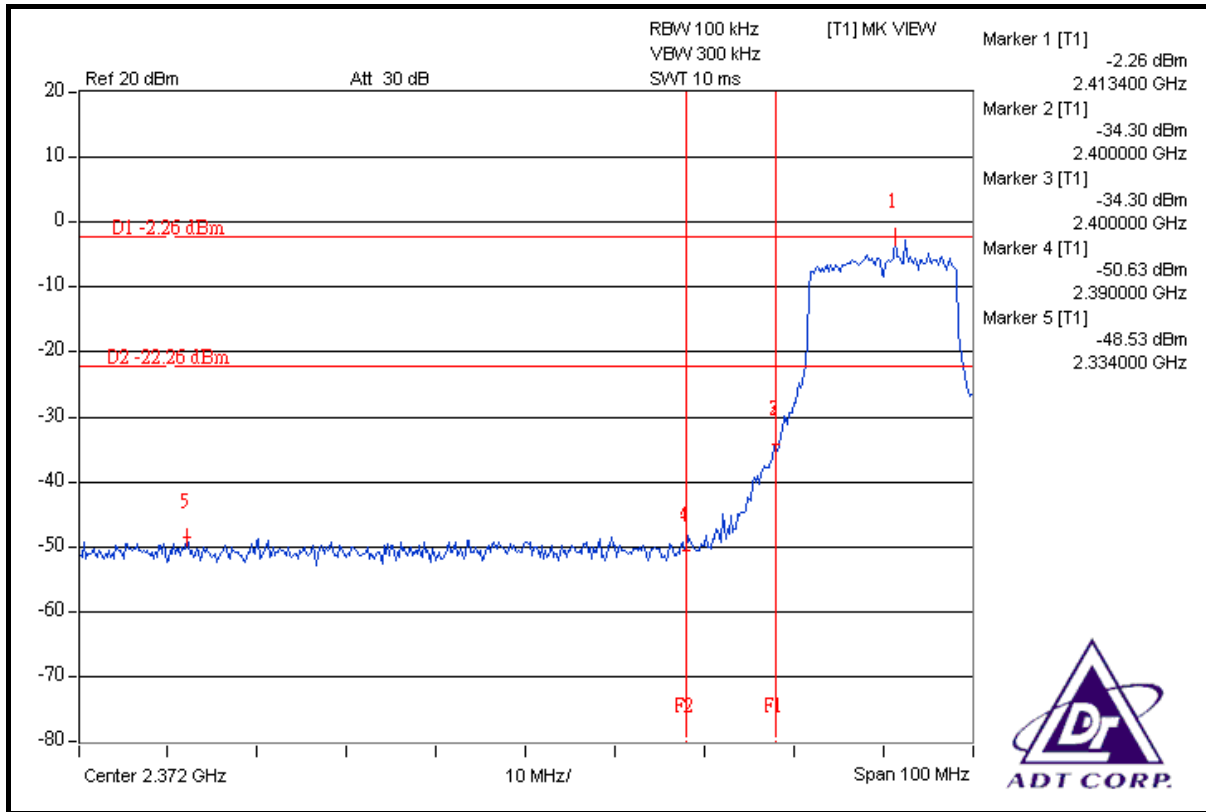

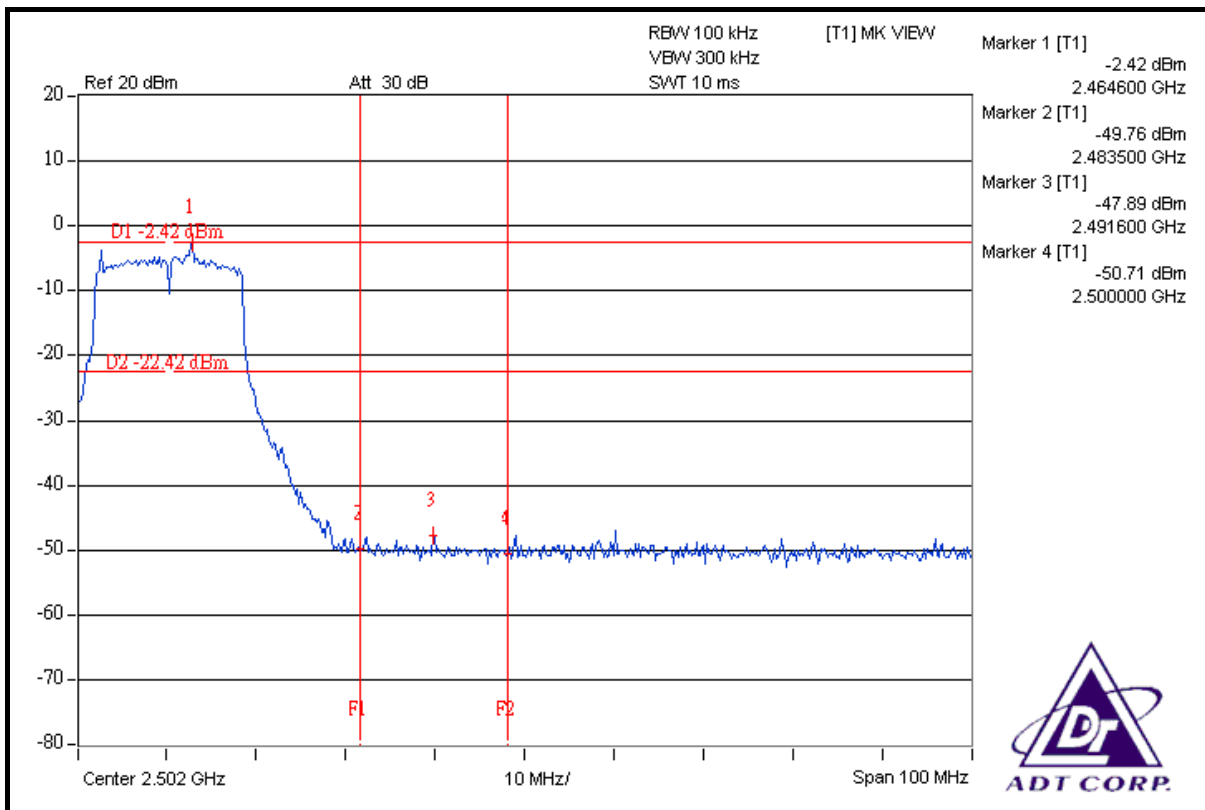
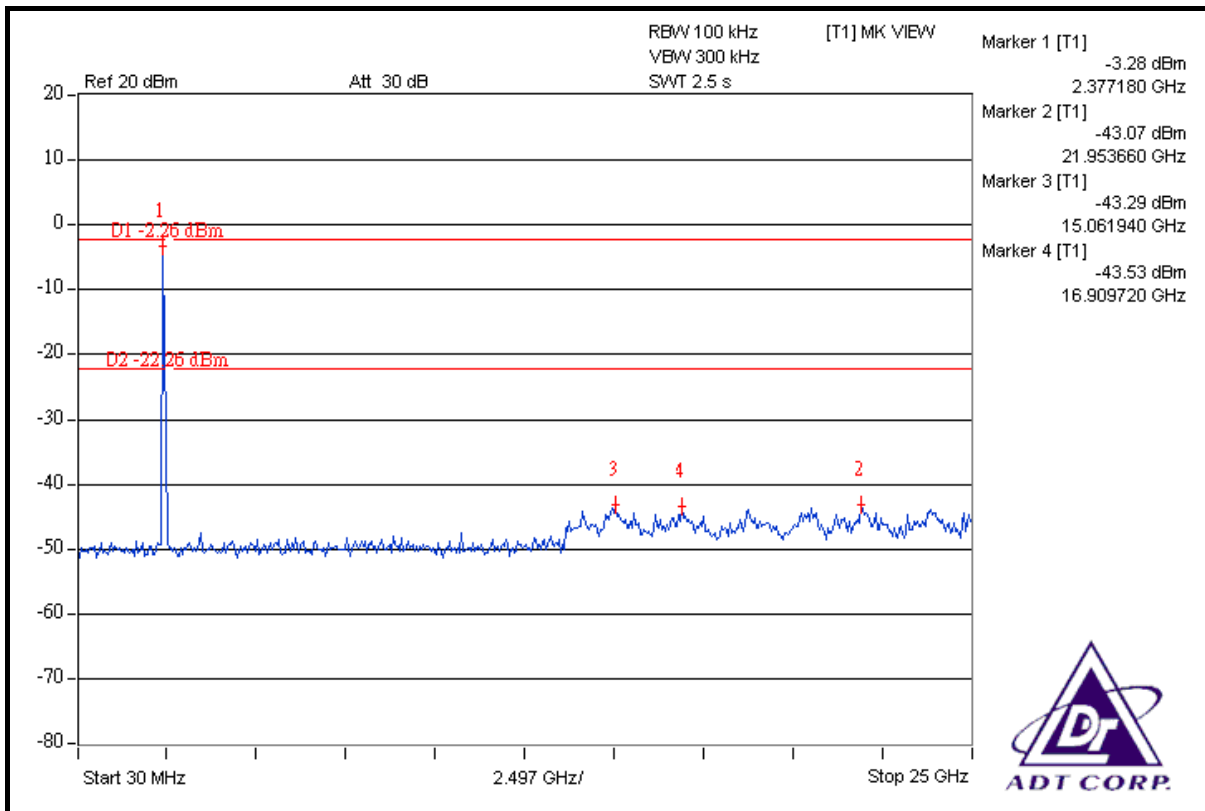

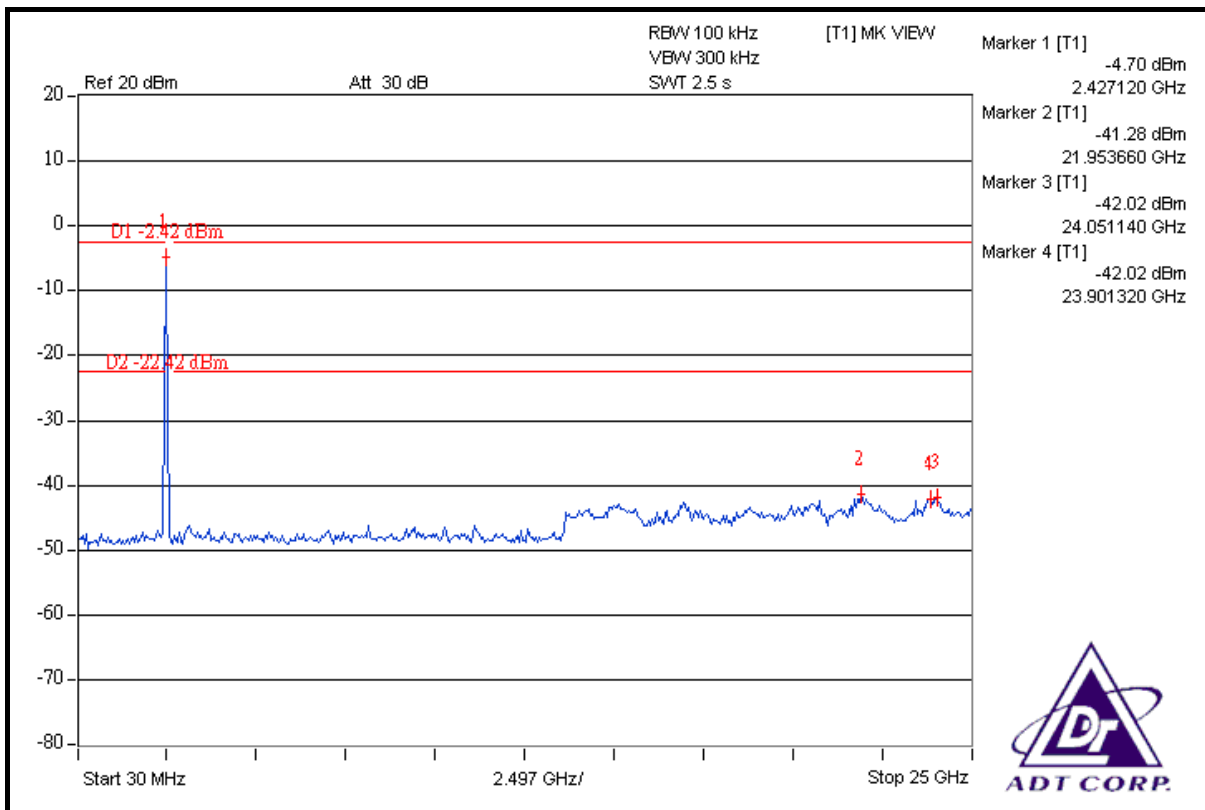
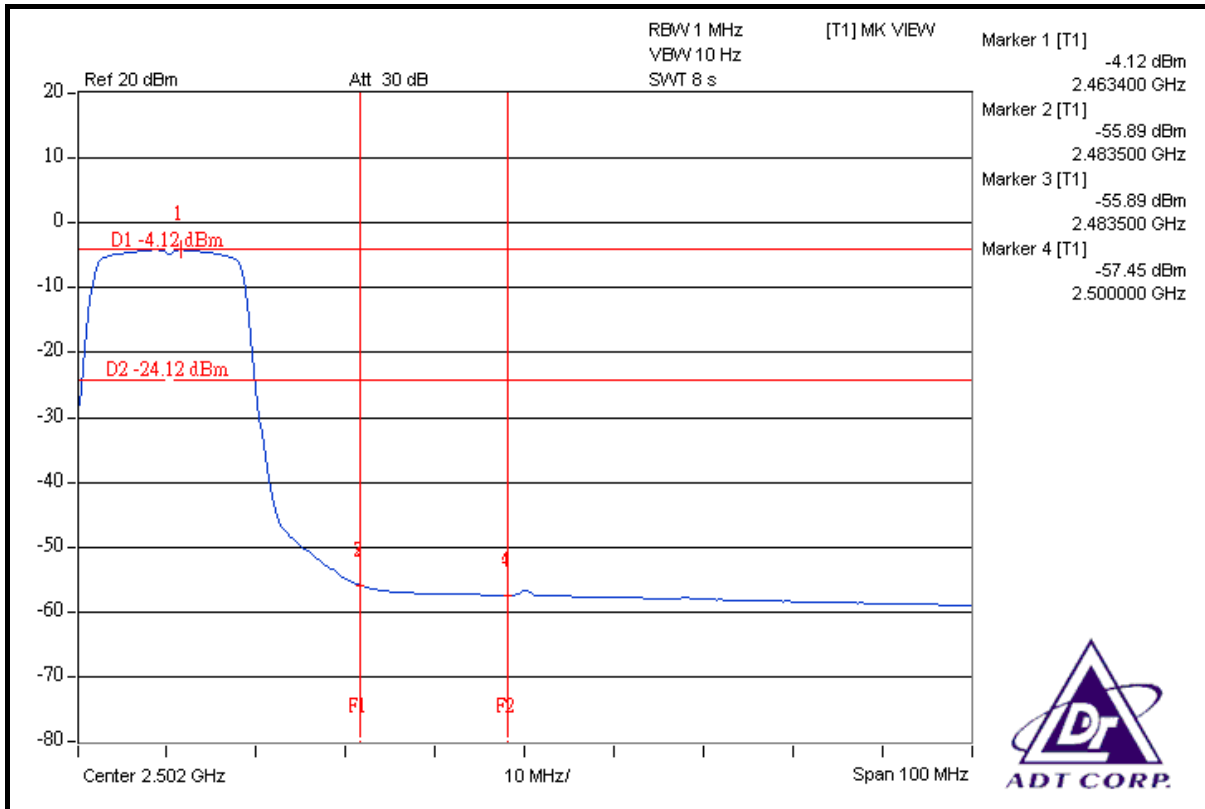

DRAFT 802.11n (20MHz) OFDM MODULATION: 3TX

NOTE 1: The band edge emission plot on the next page shows 46.71dBc between carrier maximum power and local maximum emission in restrict band (2.3896GHz). The emission of carrier strength list in the test result of channel 1 at the item 4.2.7 is 112.14dBuV/m (Peak), so the maximum field strength in restrict band is $112.14 - 46.71 = 65.43$ dBuV/m which is under 74dBuV/m limit.

The band edge emission plot on the next page shows 49.79dBc between carrier maximum power and local maximum emission in restrict band (2.3900GHz). The emission of carrier strength list in the test result of channel 1 at the item 4.2.7 is 99.05dBuV/m (Average), so the maximum field strength in restrict band is $99.05 - 49.79 = 49.26$ dBuV/m which is under 54dBuV/m limit.

NOTE 2: The band edge emission plot on the next second page shows 50.03dBc between carrier maximum power and local maximum emission in restrict band (2.4840GHz). The emission of carrier strength list in the test result of channel 11 at the item 4.2.7 is 113.56dBuV/m (Peak), so the maximum field strength in restrict band is $113.56 - 50.03 = 63.53$ dBuV/m which is under 74dBuV/m limit.

The band edge emission plot on the next third page shows 50.77dBc between carrier maximum power and local maximum emission in restrict band (2.4835GHz). The emission of carrier strength list in the test result of channel 11 at the item 4.2.7 is 99.92dBuV/m (Average), so the maximum field strength in restrict band is $99.92 - 50.77 = 49.15$ dBuV/m which is under 54dBuV/m limit.

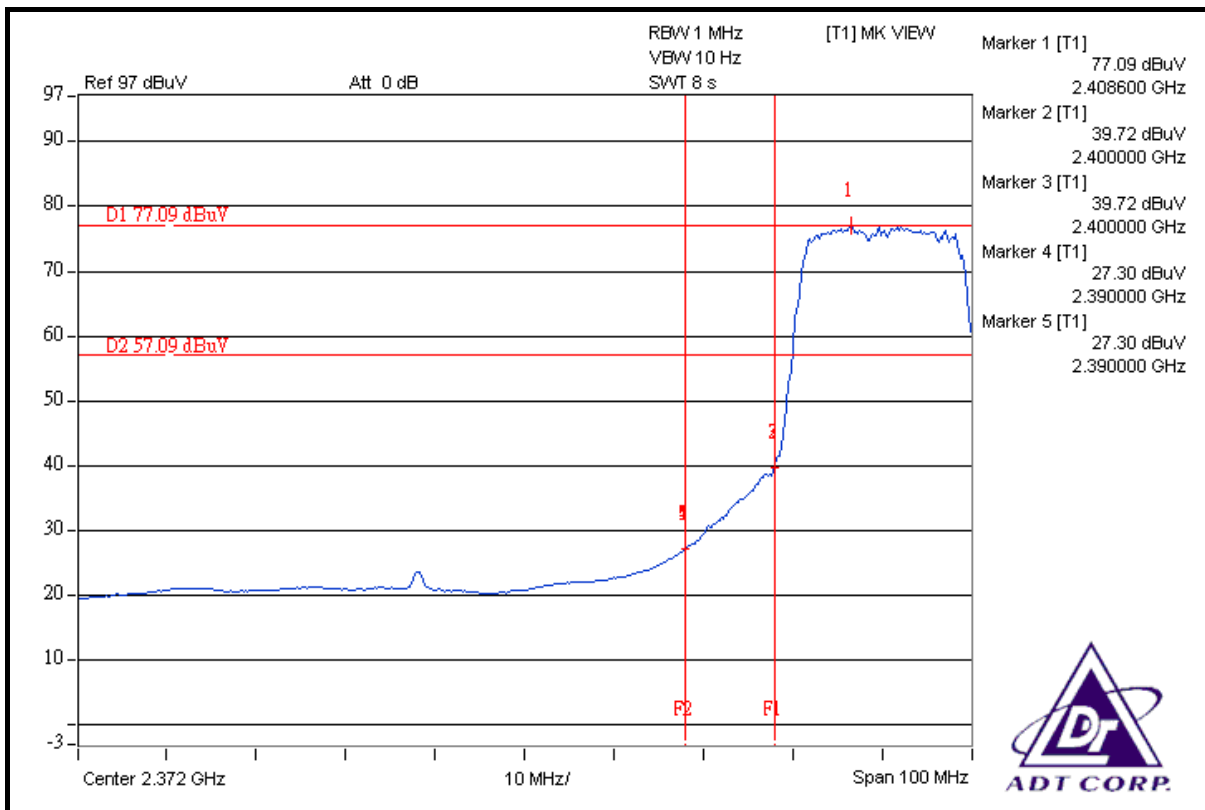
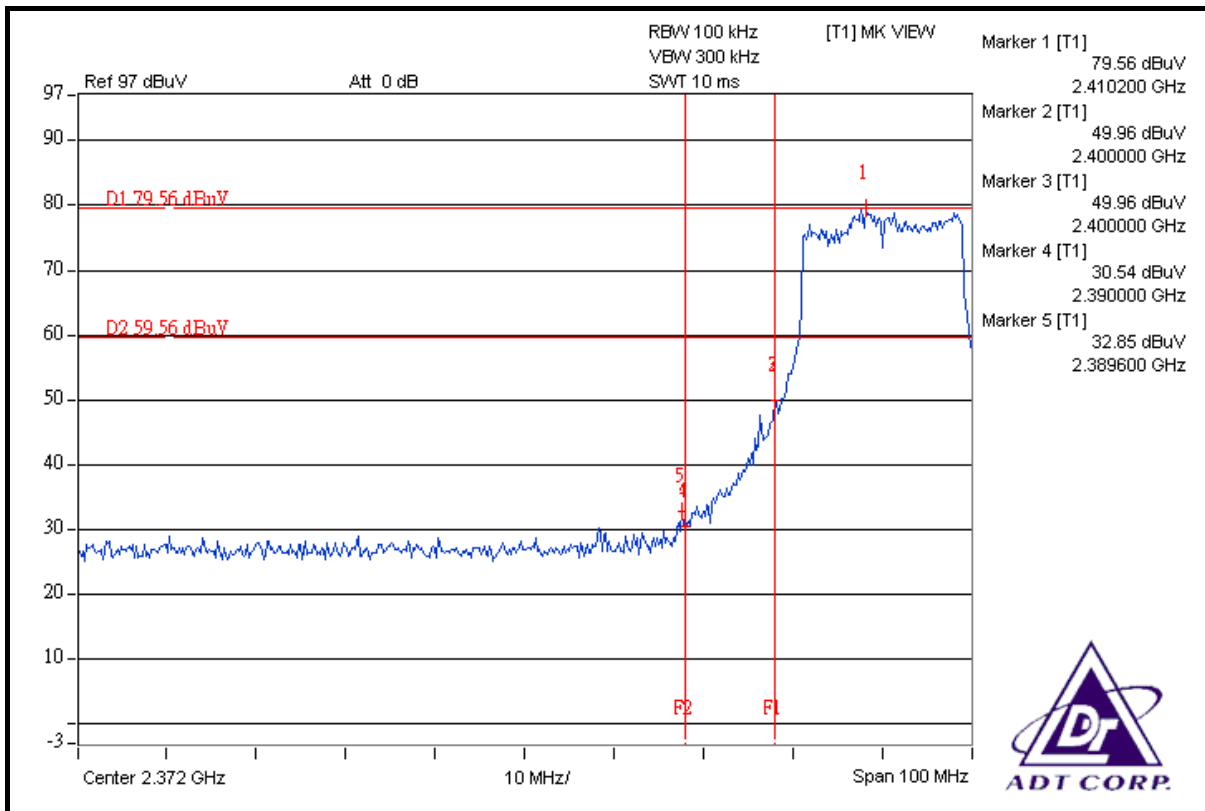

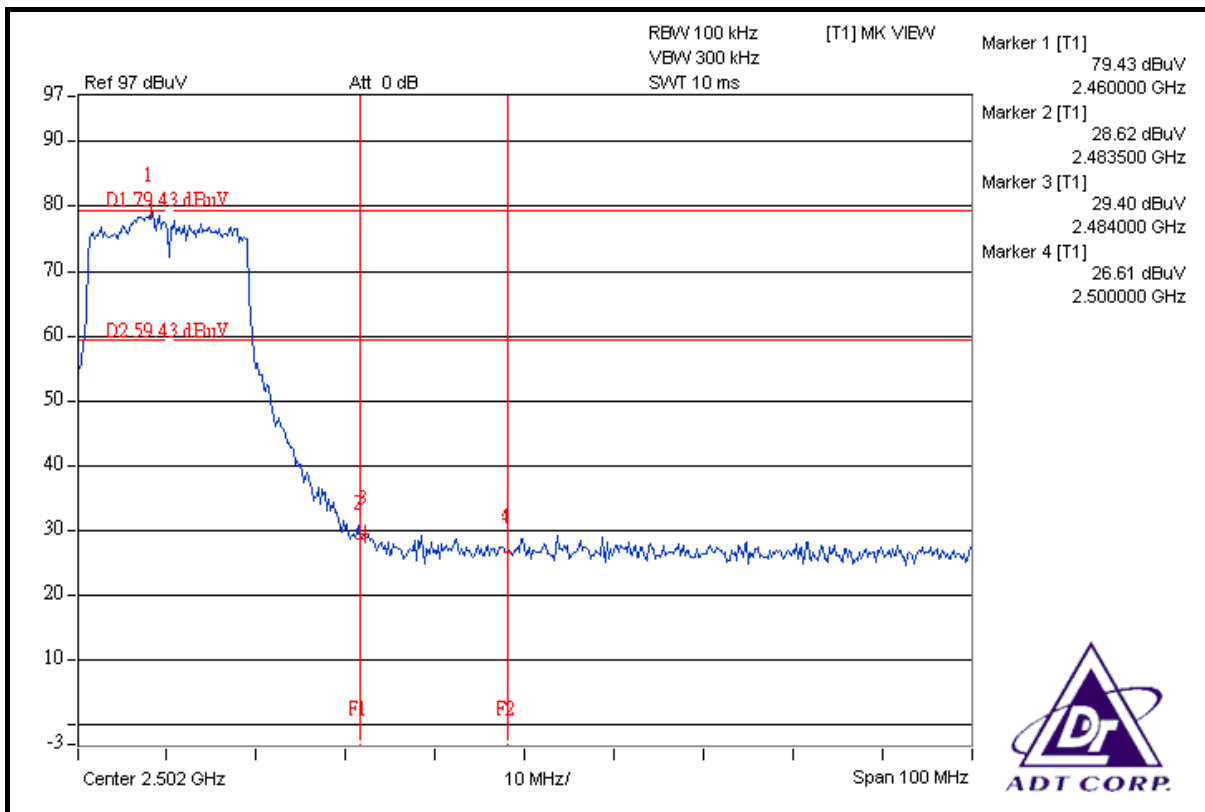
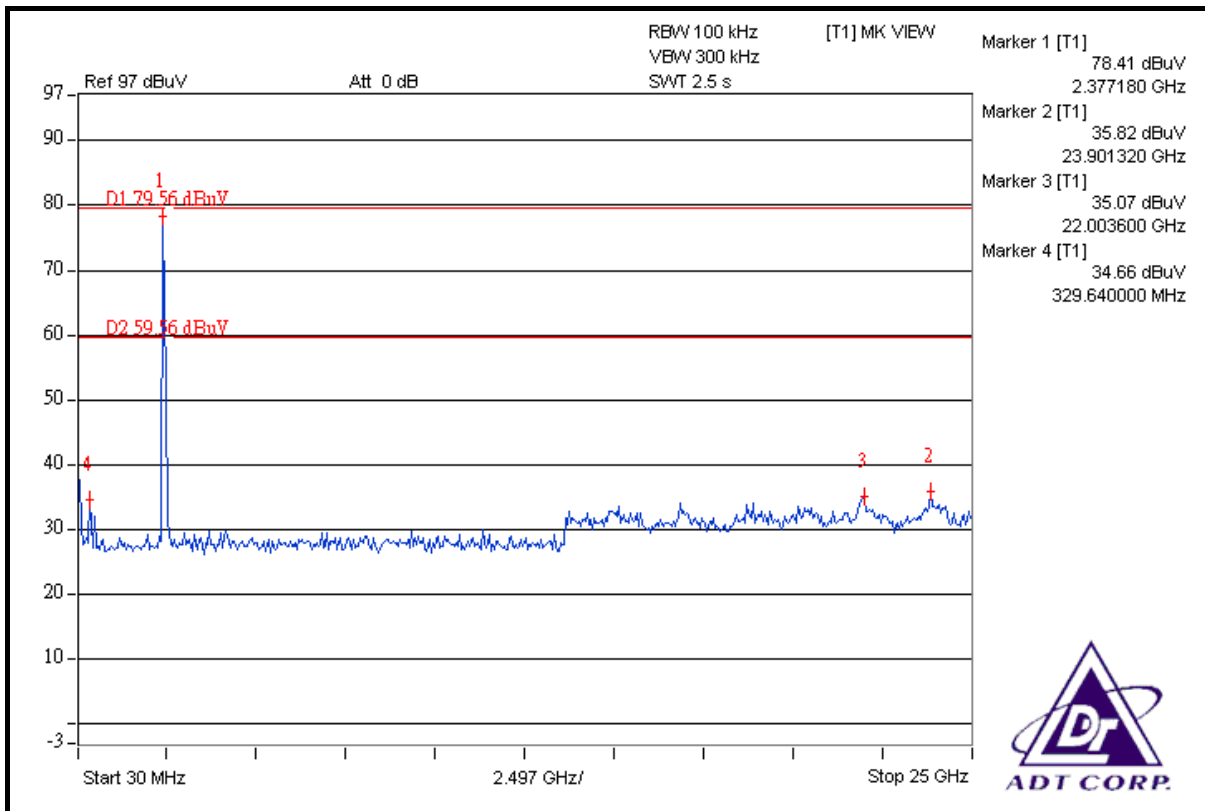

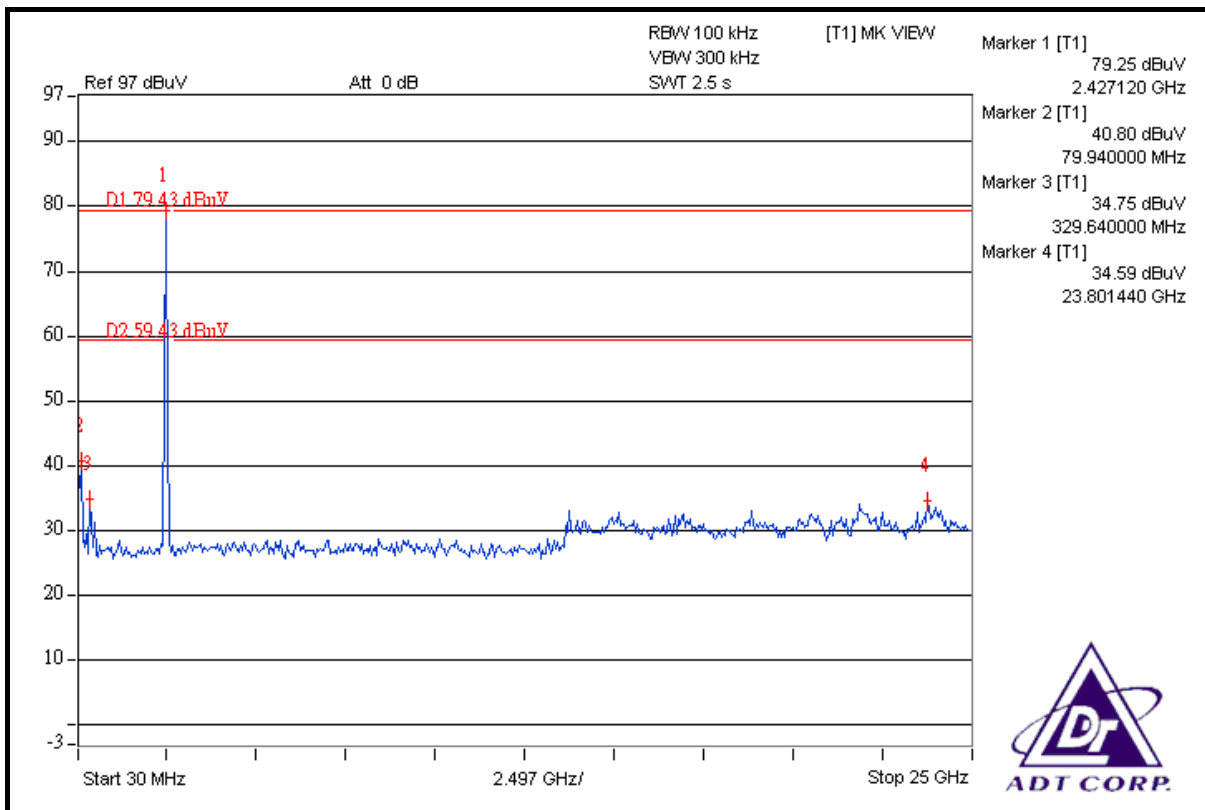
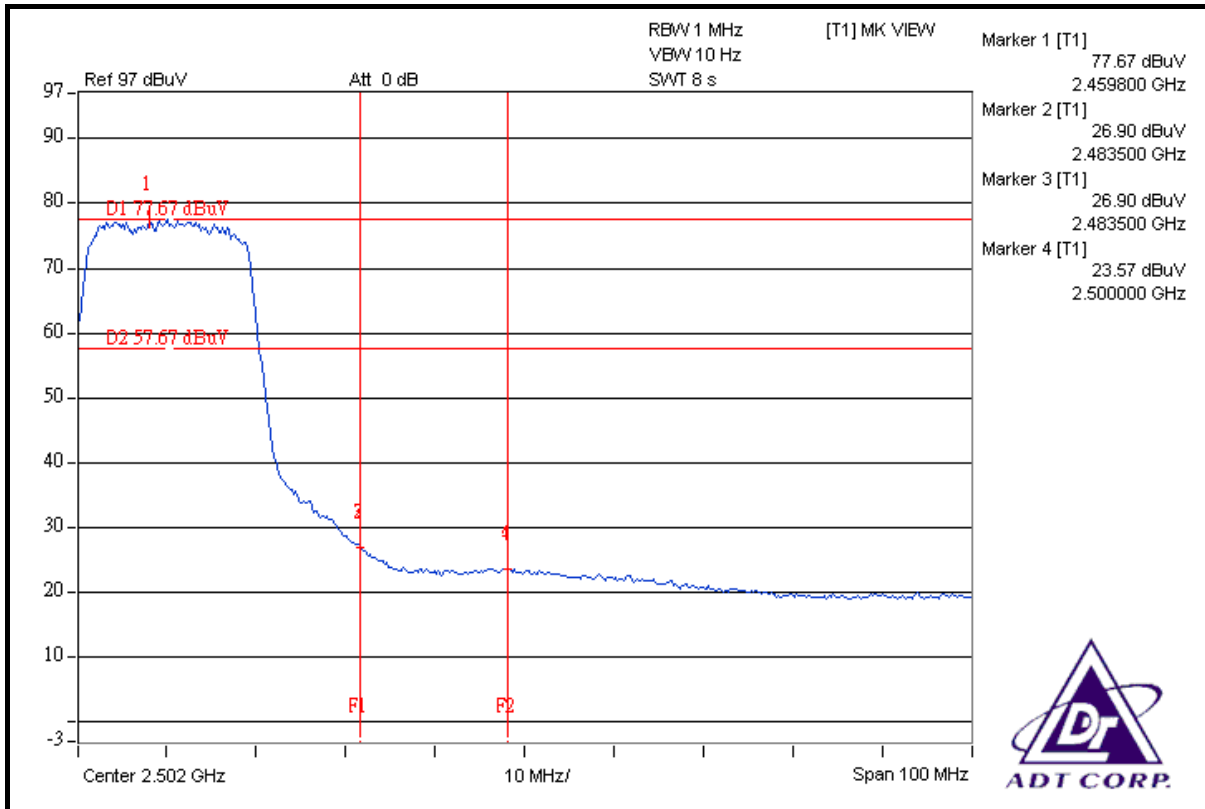

DRAFT 802.11n (40MHz) OFDM MODULATION: 3TX

NOTE 1: The band edge emission plot on the next page shows 41.74dBc between carrier maximum power and local maximum emission in restrict band (2.3896GHz). The emission of carrier strength list in the test result of channel 1 at the item 4.2.7 is 108.99dBuV/m (Peak), so the maximum field strength in restrict band is $108.99 - 41.74 = 67.25$ dBuV/m which is under 74dBuV/m limit.

The band edge emission plot on the next page shows 43.45dBc between carrier maximum power and local maximum emission in restrict band (2.3900GHz). The emission of carrier strength list in the test result of channel 1 at the item 4.2.7 is 94.12dBuV/m (Average), so the maximum field strength in restrict band is $94.12 - 43.45 = 50.67$ dBuV/m which is under 54dBuV/m limit.

NOTE 2: The band edge emission plot on the next second page shows 43.02dBc between carrier maximum power and local maximum emission in restrict band (2.4856GHz). The emission of carrier strength list in the test result of channel 7 at the item 4.2.7 is 110.04dBuV/m (Peak), so the maximum field strength in restrict band is $110.04 - 43.02 = 67.02$ dBuV/m which is under 74dBuV/m limit.

The band edge emission plot on the next third page shows 44.61dBc between carrier maximum power and local maximum emission in restrict band (2.4835GHz). The emission of carrier strength list in the test result of channel 7 at the item 4.2.7 is 94.82dBuV/m (Average), so the maximum field strength in restrict band is $94.82 - 44.61 = 50.21$ dBuV/m which is under 54dBuV/m limit.

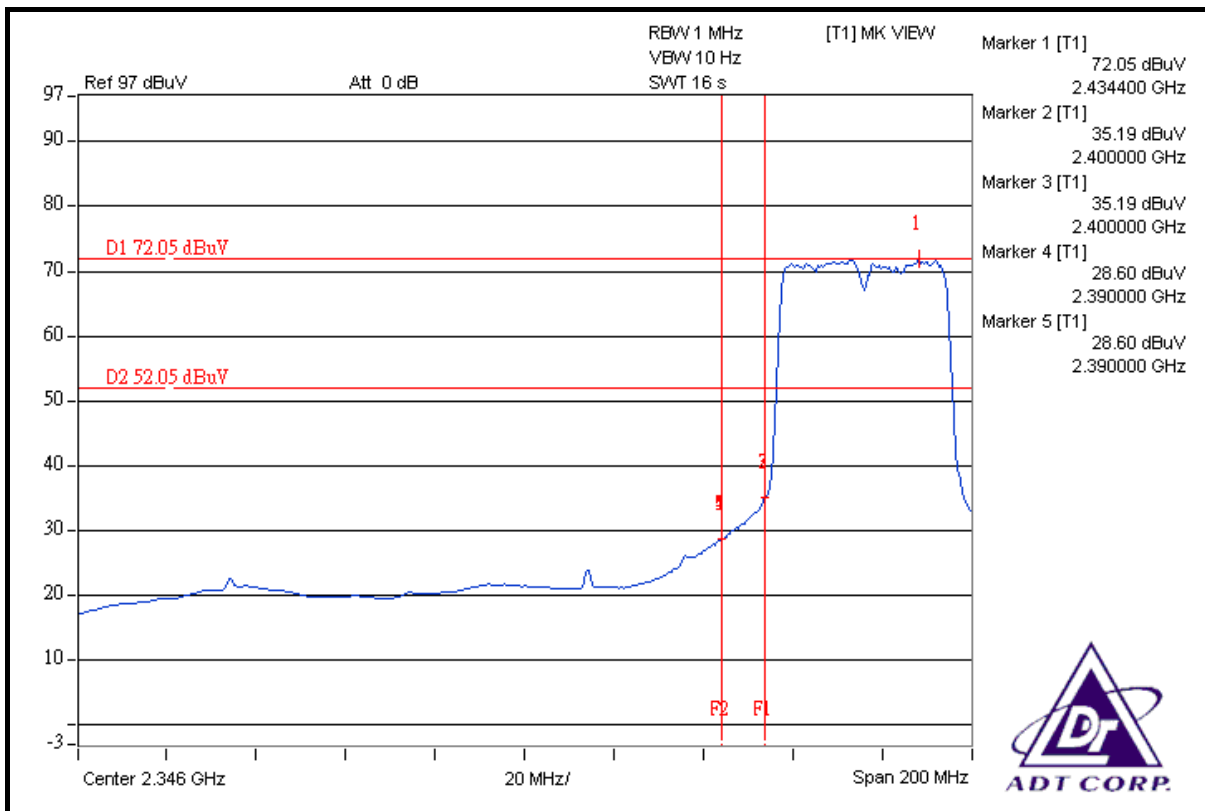
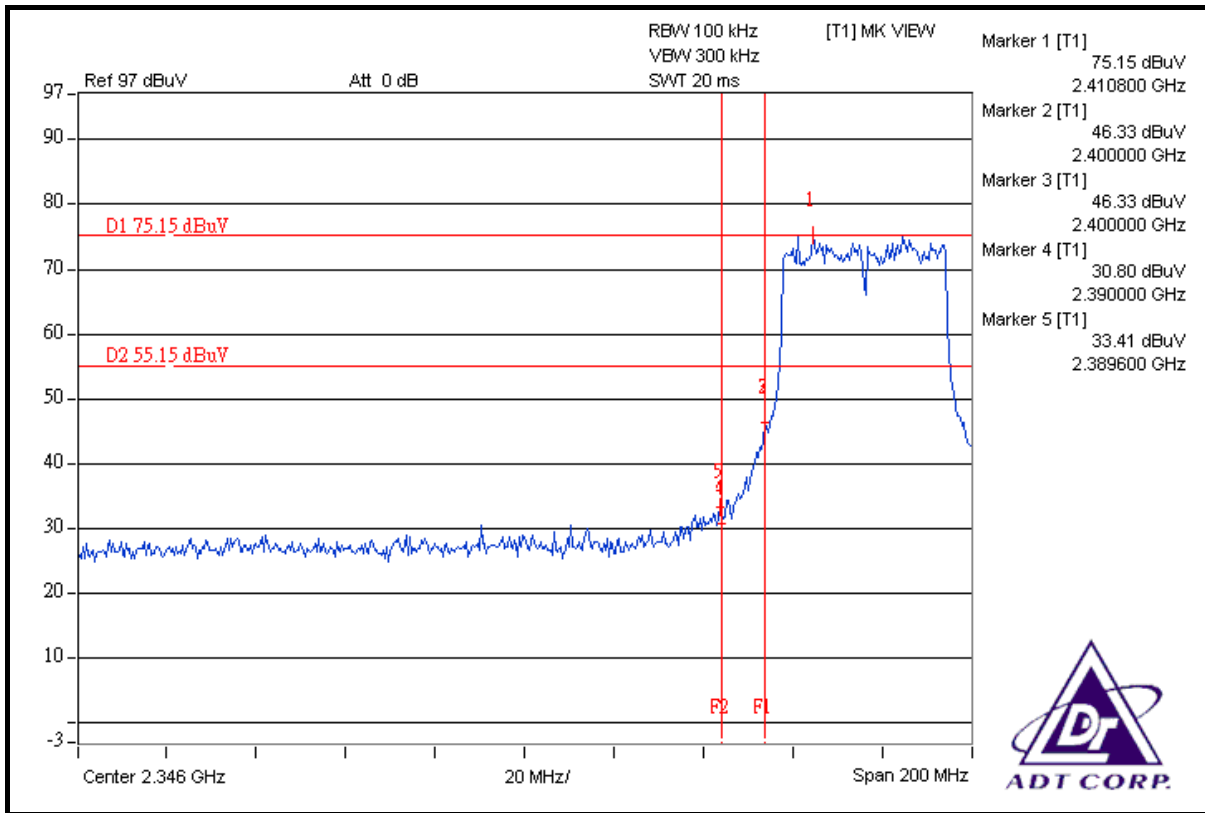

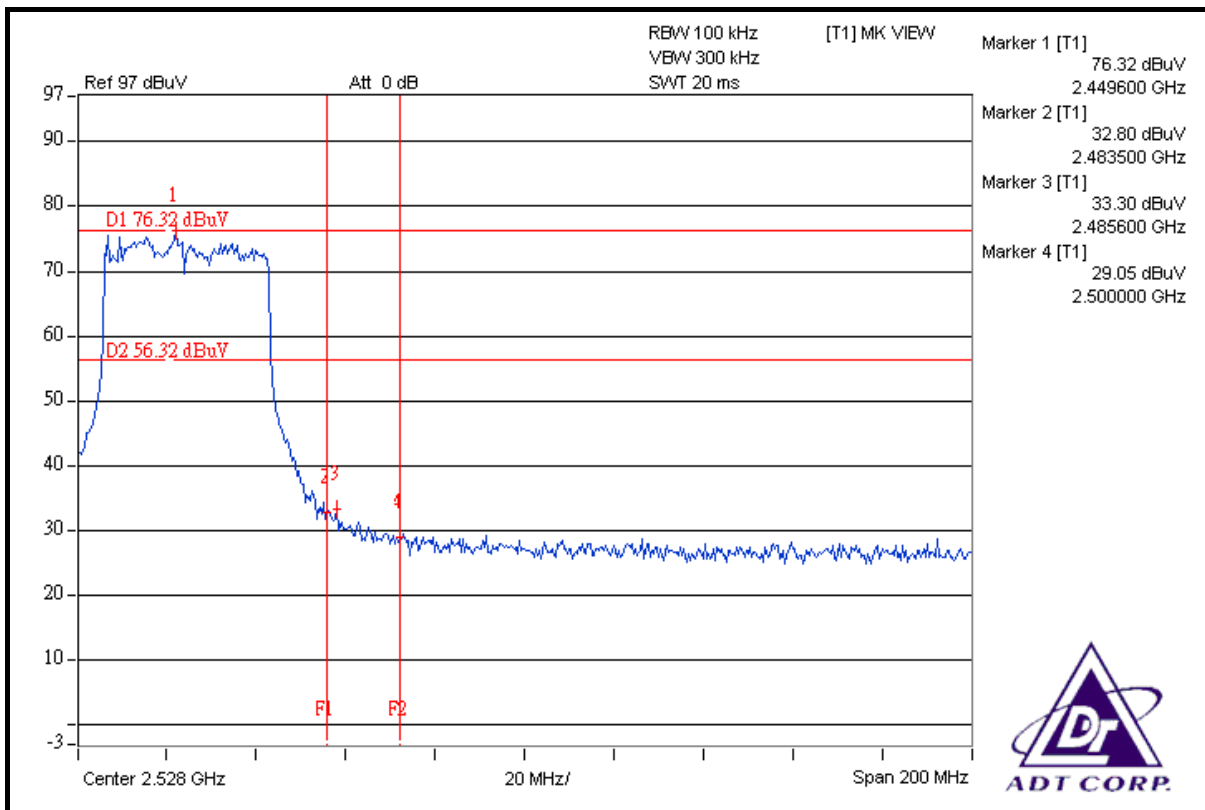
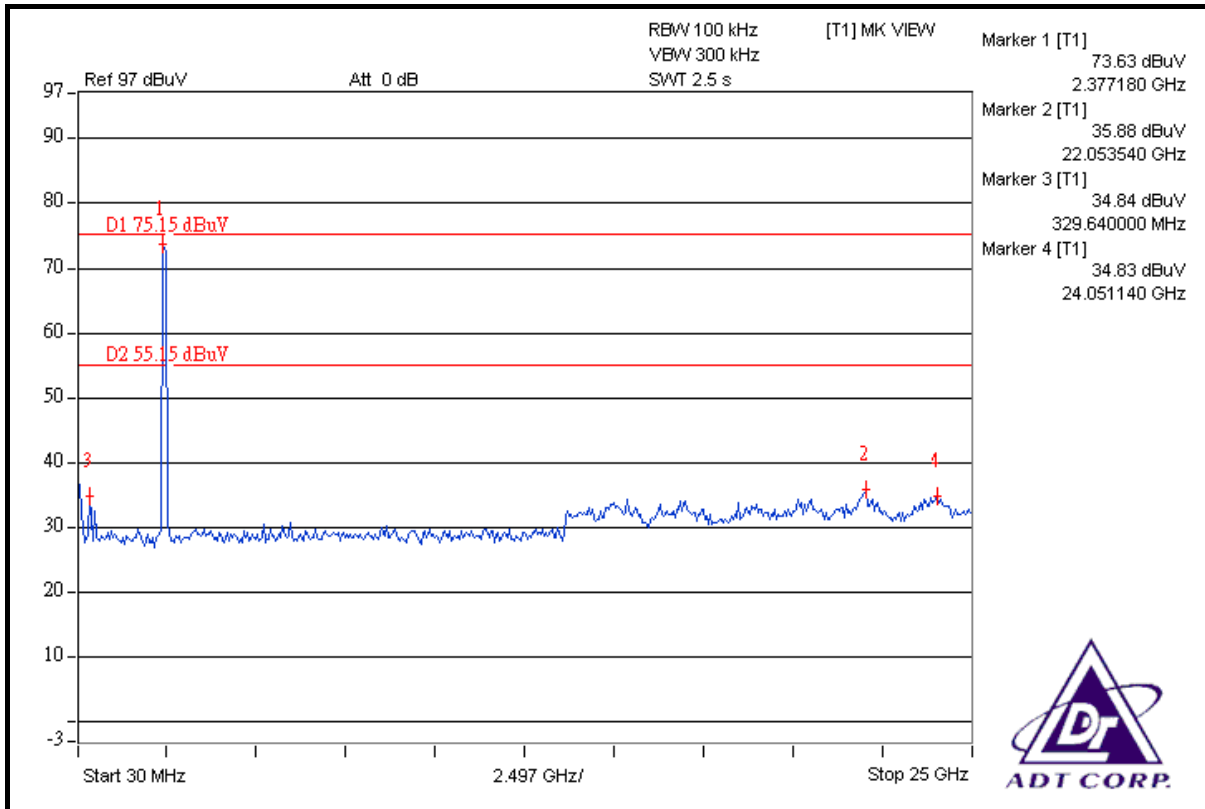

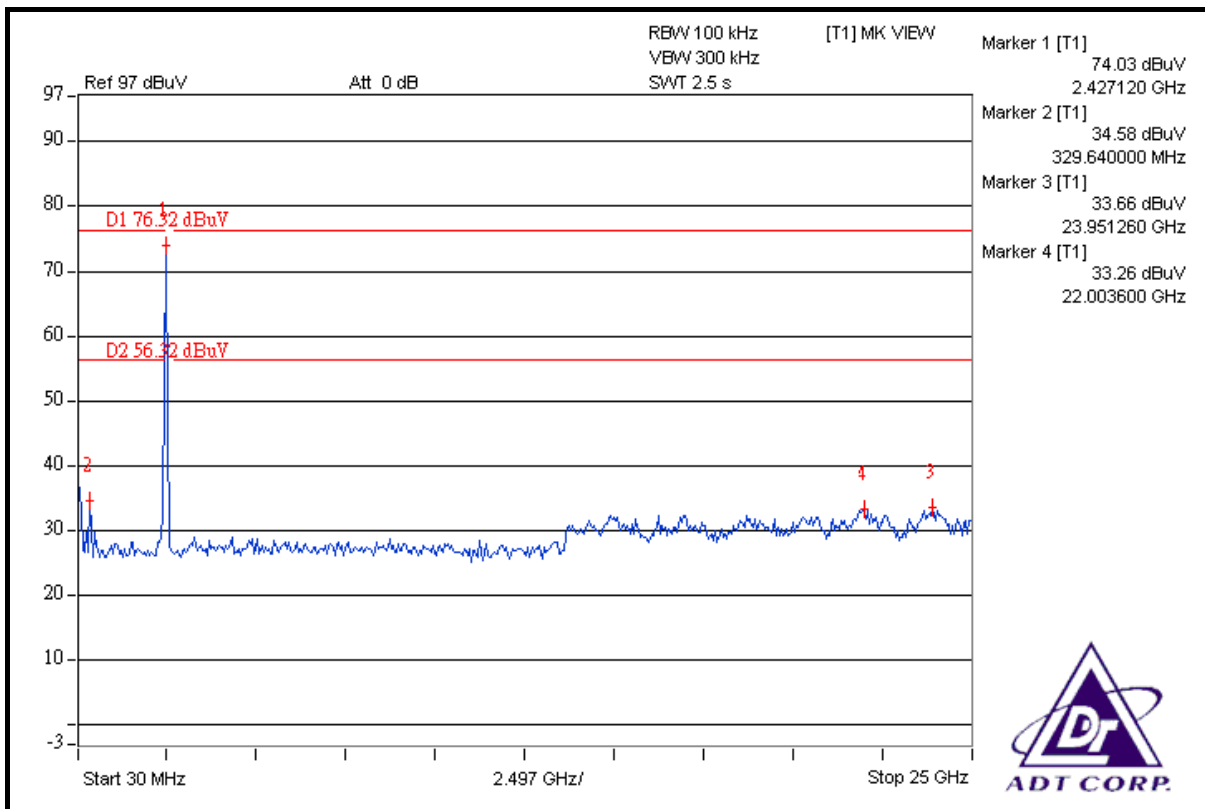
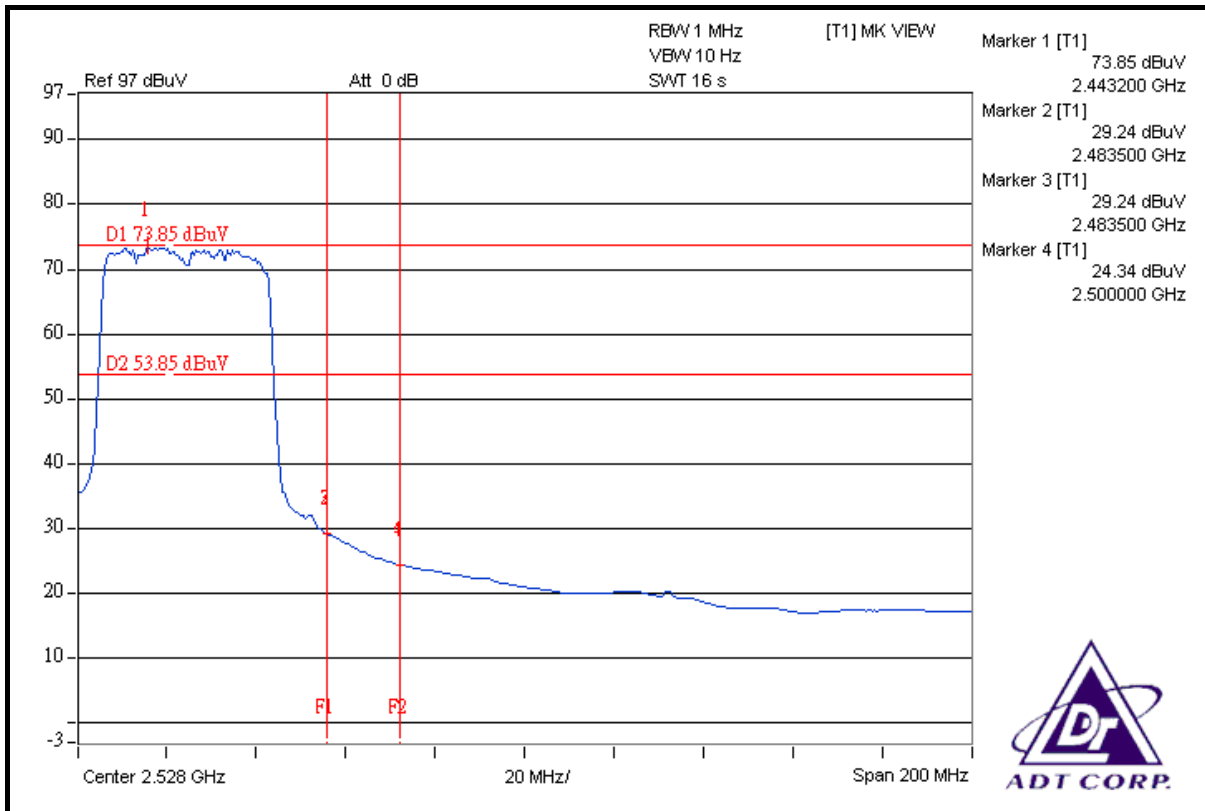



4.7 ANTENNA REQUIREMENT

4.7.1 STANDARD APPLICABLE

For intentional device, according to FCC 47 CFR Section 15.203, an intentional radiator shall be designed to ensure that no antenna other than that furnished by the responsible party shall be used with the device. And according to FCC 47 CFR Section 15.247 (b), if transmitting antennas of directional gain greater than 6dBi are used, the power shall be reduced by the amount in dB that the directional gain of the antenna exceeds 6dBi.

4.7.2 ANTENNA CONNECTED CONSTRUCTION

The antenna used in this product is Dipole antennas with RTNC antenna connectors. The maximum Gain of the antenna is 5dBi.



5. PHOTOGRAPHS OF THE TEST CONFIGURATION

Please refer to the attached file (Test Setup Photo).



6. INFORMATION ON THE TESTING LABORATORIES

We, ADT Corp., were founded in 1988 to provide our best service in EMC, Radio, Telecom and Safety consultation. Our laboratories are accredited and approved by the following approval agencies according to ISO/IEC 17025.

USA	FCC, UL
Germany	TUV Rheinland
Japan	VCCI
Norway	NEMKO
Canada	INDUSTRY CANADA , CSA
R.O.C.	TAF, BSMI, NCC
Netherlands	Telefication
Singapore	GOST-ASIA(MOU)
Russia	CERTIS(MOU)

Copies of accreditation certificates of our laboratories obtained from approval agencies can be downloaded from our web site:

www.adt.com.tw/index.5/phtml. If you have any comments, please feel free to contact us at the following:

Linko EMC/RF Lab:

Tel: 886-2-26052180

Fax: 886-2-26051924

Hsin Chu EMC/RF Lab:

Tel: 886-3-5935343

Fax: 886-3-5935342

Hwa Ya EMC/RF/Safety Telecom Lab:

Tel: 886-3-3183232

Fax: 886-3-3185050

Web Site: www.adt.com.tw

The address and road map of all our labs can be found in our web site also.



7. APPENDIX A - MODIFICATIONS RECORDERS FOR ENGINEERING CHANGES TO THE EUT BY THE LAB

No any modifications are made to the EUT by the lab during the test.

--- END ---