



# FCC TEST REPORT (15.247)

**REPORT NO.:** RF970819L02

**MODEL NO.:** EMP-7601 (refer to item 3.1 for more detail)

**RECEIVED:** Aug. 19, 2008

**TESTED:** Aug. 19 ~ Aug. 26, 2008

**ISSUED:** Aug. 29, 2008

**APPLICANT:** Senao Networks Inc.

**ADDRESS:** 3F, No. 529, Chung Cheng Rd., Hsintien, Taipei,  
Taiwan, R.O.C.

**ISSUED BY:** Advance Data Technology Corporation

**LAB ADDRESS:** No. 47, 14th Ling, Chia Pau Tsuen, Lin Kou  
Hsiang, Taipei Hsien 244, Taiwan, R.O.C.

**TEST LOCATION:** No. 19, Hwa Ya 2nd Rd, Wen Hwa Tsuen, Kwei  
Shan Hsiang, Taoyuan Hsien 333, Taiwan,  
R.O.C.

This test report consists of 155 pages in total. It may be duplicated completely for legal use with the approval of the applicant. It should not be reproduced except in full, without the written approval of our laboratory. The client should not use it to claim product endorsement by TAF or any government agencies. The test results in the report only apply to the tested sample.





## TABLE OF CONTENTS

1.	CERTIFICATION.....	5
2.	SUMMARY OF TEST RESULTS .....	6
2.1	MEASUREMENT UNCERTAINTY.....	6
3.	GENERAL INFORMATION.....	7
3.1	GENERAL DESCRIPTION OF EUT .....	7
3.2	DESCRIPTION OF TEST MODES.....	9
3.2.1	CONFIGURATION OF SYSTEM UNDER TEST .....	9
3.2.2	TEST MODE APPLICABILITY AND TESTED CHANNEL DETAIL .....	10
3.3	GENERAL DESCRIPTION OF APPLIED STANDARDS .....	14
3.4	DESCRIPTION OF SUPPORT UNITS .....	14
4.	TEST TYPES AND RESULTS (FOR 2.4GHz BAND).....	15
4.1	RADIATED EMISSION MEASUREMENT .....	15
4.1.1	LIMITS OF RADIATED EMISSION MEASUREMENT.....	15
4.1.2	TEST INSTRUMENTS.....	16
4.1.3	TEST PROCEDURES .....	17
4.1.4	DEVIATION FROM TEST STANDARD.....	17
4.1.5	TEST SETUP.....	18
4.1.6	EUT OPERATING CONDITIONS .....	18
4.1.7	TEST RESULTS .....	19
4.2	CONDUCTED EMISSION MEASUREMENT .....	32
4.2.1	LIMITS OF CONDUCTED EMISSION MEASUREMENT.....	32
4.2.2	TEST INSTRUMENTS.....	32
4.2.3	TEST PROCEDURES .....	33
4.2.4	DEVIATION FROM TEST STANDARD.....	33
4.2.5	TEST SETUP.....	34
4.2.6	EUT OPERATING CONDITIONS .....	34
4.2.7	TEST RESULTS .....	35
4.3	6dB BANDWIDTH MEASUREMENT.....	37
4.3.1	LIMITS OF 6dB BANDWIDTH MEASUREMENT .....	37
4.3.2	TEST INSTRUMENTS.....	37
4.3.3	TEST PROCEDURE.....	37
4.3.4	DEVIATION FROM TEST STANDARD.....	37
4.3.5	TEST SETUP.....	38
4.3.6	EUT OPERATING CONDITIONS .....	38
4.3.7	TEST RESULTS .....	39
4.4	MAXIMUM PEAK OUTPUT POWER.....	53
4.4.1	LIMITS OF MAXIMUM PEAK OUTPUT POWER MEASUREMENT .....	53
4.4.2	INSTRUMENTS.....	53
4.4.3	TEST PROCEDURES .....	53
4.4.4	DEVIATION FROM TEST STANDARD.....	54
4.4.5	TEST SETUP.....	54
4.4.6	EUT OPERATING CONDITIONS .....	54
4.4.7	TEST RESULTS .....	55
4.5	POWER SPECTRAL DENSITY MEASUREMENT .....	57
4.5.1	LIMITS OF POWER SPECTRAL DENSITY MEASUREMENT .....	57
4.5.2	TEST INSTRUMENTS.....	57
4.5.3	TEST PROCEDURE.....	57
4.5.4	DEVIATION FROM TEST STANDARD.....	58



4.5.5	TEST SETUP.....	58
4.5.6	EUT OPERATING CONDITION.....	58
4.5.7	TEST RESULTS .....	59
4.6	BAND EDGES MEASUREMENT .....	73
4.6.1	LIMITS OF BAND EDGES MEASUREMENT.....	73
4.6.2	TEST INSTRUMENTS.....	73
4.6.3	TEST PROCEDURE.....	74
4.6.4	DEVIATION FROM TEST STANDARD.....	74
4.6.5	EUT OPERATING CONDITION.....	74
4.6.6	TEST RESULTS .....	75
4.7	ANTENNA REQUIREMENT .....	91
4.7.1	STANDARD APPLICABLE .....	91
4.7.2	ANTENNA CONNECTED CONSTRUCTION .....	91
5.	TEST TYPES AND RESULTS (FOR 5.0GHz BAND).....	92
5.1	RADIATED EMISSION MEASUREMENT .....	92
5.1.1	LIMITS OF RADIATED EMISSION MEASUREMENT.....	92
5.1.2	TEST INSTRUMENTS.....	93
5.1.3	TEST PROCEDURES .....	94
5.1.4	DEVIATION FROM TEST STANDARD.....	94
5.1.5	TEST SETUP.....	95
5.1.6	EUT OPERATING CONDITIONS .....	95
5.1.7	TEST RESULTS .....	96
5.2	CONDUCTED EMISSION MEASUREMENT .....	105
5.2.1	LIMITS OF CONDUCTED EMISSION MEASUREMENT.....	105
5.2.2	TEST INSTRUMENTS.....	105
5.2.3	TEST PROCEDURES .....	106
5.2.4	DEVIATION FROM TEST STANDARD.....	106
5.2.5	TEST SETUP.....	107
5.2.6	EUT OPERATING CONDITIONS .....	107
5.2.7	TEST RESULTS .....	108
5.3	6dB BANDWIDTH MEASUREMENT.....	110
5.3.1	LIMITS OF 6dB BANDWIDTH MEASUREMENT .....	110
5.3.2	TEST INSTRUMENTS.....	110
5.3.3	TEST PROCEDURE.....	110
5.3.4	DEVIATION FROM TEST STANDARD.....	111
5.3.5	TEST SETUP.....	111
5.3.6	EUT OPERATING CONDITIONS .....	111
5.3.7	TEST RESULTS .....	112
5.4	MAXIMUM PEAK OUTPUT POWER.....	123
5.4.1	LIMITS OF MAXIMUM PEAK OUTPUT POWER MEASUREMENT .....	123
5.4.2	INSTRUMENTS.....	123
5.4.3	TEST PROCEDURES .....	123
5.4.4	DEVIATION FROM TEST STANDARD.....	124
5.4.5	TEST SETUP.....	124
5.4.6	EUT OPERATING CONDITIONS .....	124
5.4.7	TEST RESULTS .....	125
5.5	POWER SPECTRAL DENSITY MEASUREMENT.....	127
5.5.1	LIMITS OF POWER SPECTRAL DENSITY MEASUREMENT .....	127
5.5.2	TEST INSTRUMENTS.....	127
5.5.3	TEST PROCEDURE.....	127
5.5.4	DEVIATION FROM TEST STANDARD.....	128



5.5.5	TEST SETUP .....	128
5.5.6	EUT OPERATING CONDITION.....	128
5.5.7	TEST RESULTS .....	129
5.6	BAND EDGES MEASUREMENT .....	140
5.6.1	LIMITS OF BAND EDGES MEASUREMENT .....	140
5.6.2	TEST INSTRUMENTS.....	140
5.6.3	TEST PROCEDURE.....	140
5.6.4	DEVIATION FROM TEST STANDARD.....	142
5.6.5	EUT OPERATING CONDITION.....	142
5.6.6	TEST RESULTS .....	142
5.7	ANTENNA REQUIREMENT .....	152
5.7.1	STANDARD APPLICABLE .....	152
5.7.2	ANTENNA CONNECTED CONSTRUCTION .....	152
6.	PHOTOGRAPHS OF THE TEST CONFIGURATION.....	153
7.	INFORMATION ON THE TESTING LABORATORIES .....	154
8.	APPENDIX A - MODIFICATIONS RECORDERS FOR ENGINEERING CHANGES TO THE EUT BY THE LAB.....	155



# 1. CERTIFICATION

**PRODUCT:** 802.11 a/b/g/n miniPCI

**MODEL NO.:** EMP-7601 (refer to item 3.1 for more detail)

**BRAND:** Senao (refer to item 3.1 for more detail)

**APPLICANT:** Senao Networks Inc.

**TEST SAMPLE:** ENGINEERING SAMPLE

**TESTED:** Aug. 19 ~ Aug. 26, 2008

**STANDARDS: FCC Part 15, Subpart C (Section 15.247)**

ANSI C63.4-2003

The above equipment (Model: EMP-7601) has been tested by **Advance Data Technology Corporation**, and found compliance with the requirement of the above standards. The test record, data evaluation & Equipment Under Test (EUT) configurations represented herein are true and accurate accounts of the measurements of the sample's EMC characteristics under the conditions specified in this report.

**PREPARED BY** : Andrea Hsia , **DATE:** Aug. 29, 2008  
Andrea Hsia / Specialist

**TECHNICAL ACCEPTANCE** : Long Chen , **DATE:** Aug. 29, 2008  
Responsible for RF Long Chen / Senior Engineer

**APPROVED BY** : Gary Chang , **DATE:** Aug. 29, 2008  
Gary Chang / Assistant Manager

## 2. SUMMARY OF TEST RESULTS

The EUT has been tested according to the following specifications:

APPLIED STANDARD: FCC PART 15, SUBPART C (SECTION 15.247)			
STANDARD SECTION	TEST TYPE AND LIMIT	RESULT	REMARK
15.207	AC Power Conducted Emission	PASS	Meet the requirement of limit. Minimum passing margin is -14.42dB at 0.174MHz
15.247(a)(2)	Spectrum Bandwidth of a Direct Sequence Spread Spectrum System Limit: min. 500kHz	PASS	Meet the requirement of limit.
15.247(b)	Maximum Peak Output Power Limit: max. 30dBm	PASS	Meet the requirement of limit.
15.247(d)	Radiated Emissions Limit: Table 15.209	PASS	Meet the requirement of limit. Minimum passing margin is -1.00dB at 138.78MHz
15.247(e)	Power Spectral Density Limit: max. 8dBm	PASS	Meet the requirement of limit.
15.247(d)	Band Edge Measurement Limit: 20dB less than the peak value of fundamental frequency	PASS	Meet the requirement of limit.

### 2.1 MEASUREMENT UNCERTAINTY

Where relevant, the following measurement uncertainty levels have been estimated for tests performed on the EUT as specified in CISPR 16-4-2:

MEASUREMENT	FREQUENCY	UNCERTAINTY
Conducted emissions	9kHz~30MHz	2.44 dB
Radiated emissions	30MHz ~ 200MHz	3.34 dB
	200MHz ~1000MHz	3.35 dB
	1GHz ~ 18GHz	2.26 dB
	18GHz ~ 40GHz	1.94 dB

This uncertainty represents an expanded uncertainty expressed at approximately the 95% confidence level using a coverage factor of  $k = 2$ .

### 3. GENERAL INFORMATION

#### 3.1 GENERAL DESCRIPTION OF EUT

<b>PRODUCT</b>	802.11 a/b/g/n miniPCI
<b>MODEL NO.</b>	EMP-7601 (refer to note as below)
<b>FCC ID</b>	U2M-MP7600801
<b>POWER SUPPLY</b>	3.3Vdc from host equipment
<b>MODULATION TYPE</b>	CCK, DQPSK, DBPSK for DSSS 64QAM, 16QAM, QPSK, BPSK for OFDM
<b>MODULATION TECHNOLOGY</b>	DSSS, OFDM
<b>TRANSFER RATE</b>	802.11b:11.0/ 5.5/ 2.0/ 1.0Mbps 802.11g: 54.0/ 48.0/ 36.0/ 24.0/ 18.0/ 12.0/ 9.0/ 6.0Mbps 802.11a: 54.0/ 48.0/ 36.0/ 24.0/ 18.0/ 12.0/ 9.0/ 6.0Mbps Draft 802.11n: up to 300.0Mbps
<b>FREQUENCY RANGE</b>	2.4GHz: 2400.0 ~ 2483.5MHz 5.0GHz: 5150.0 ~ 5250.0MHz, 5725.0 ~ 5850.0MHz
<b>NUMBER OF CHANNEL</b>	2.4GHz: 11 for 802.11b, 802.11g, draft 802.11n (20MHz) 7 for draft 802.11n (40MHz) 5.0GHz: 9 for 802.11a, draft 802.11n (20MHz) 4 for draft 802.11n (40MHz)
<b>OUTPUT POWER</b>	253.161mW for 2400.0 ~ 2483.5MHz 45.032mW for 5150.0 ~ 5250.0MHz 267.225mW for 5725.0 ~ 5850.0MHz
<b>ANTENNA TYPE</b>	2.4GHz: Dipole antenna with 3.0dBi gain 5.0GHz: Dipole antenna with 4.0dBi gain
<b>DATA CABLE</b>	NA
<b>I/O PORTS</b>	NA
<b>ASSOCIATED DEVICES</b>	NA

**NOTE:**

1. The following models are provided to this EUT.

BRAND	MODEL NAME	REMARK
EnGenius / Senao	EMP-7601	For marketing different
EnGenius / Senao	NMP-7601	For marketing different

2. The EUT is an 802.11 a/b/g/n miniPCI. The functions of EUT listed as below:

	TEST STANDARD	REFERENCE REPORT
WLAN 802.11b/g, draft 802.11n	FCC Part 15, Subpart C (Section 15.247)	RF970819L02
WLAN 802.11a, draft 802.11n (5725~5850 MHz)		
WLAN 802.11a, draft 802.11n (5150~ 5250MHz)	FCC Part 15, Subpart E (Section 15.407)	RF970819L02-1

3. The frequency bands used in this EUT are listed as follows:

Frequency Band (MHz)	2400~2483.5	5150~5250	5725~5850
802.11b	√		
802.11g	√		
802.11a		√	√
Draft 802.11n (20MHz)	√	√	√
Draft 802.11n (40MHz)	√	√	√

4. The EUT incorporates a MIMO function. Physically, the EUT provides three completed transmitters and three receivers.

MODULATION MODE	TX FUNCTION
802.11b	1TX
802.11g	1TX
802.11a	1TX
Draft 802.11n (20MHz)	3TX
Draft 802.11n (40MHz)	3TX

5. The above EUT information was declared by manufacturer and for more detailed features description, please refer to the manufacturer's specifications or user's manual.



### 3.2 DESCRIPTION OF TEST MODES

#### FOR 2.4GHz:

11 channels are provided for 802.11b, 802.11g and draft 802.11n (20MHz):

CHANNEL	FREQUENCY	CHANNEL	FREQUENCY
1	2412MHz	7	2442MHz
2	2417MHz	8	2447MHz
3	2422MHz	9	2452MHz
4	2427MHz	10	2457MHz
5	2432MHz	11	2462MHz
6	2437MHz		

7 channels are provided for draft 802.11n (40MHz):

CHANNEL	FREQUENCY	CHANNEL	FREQUENCY
1	2422MHz	5	2442MHz
2	2427MHz	6	2447MHz
3	2432MHz	7	2452MHz
4	2437MHz		

#### FOR 5.0GHz (5725 ~ 5850MHz):

5 channels are provided for 802.11a, draft 802.11n (20MHz):

CHANNEL	FREQUENCY	CHANNEL	FREQUENCY
149	5745MHz	161	5805MHz
153	5765MHz	165	5825MHz
157	5785MHz		

2 channels are provided for draft 802.11n (40MHz):

CHANNEL	FREQUENCY	CHANNEL	FREQUENCY
151	5755MHz	159	5795MHz

#### 3.2.1 CONFIGURATION OF SYSTEM UNDER TEST

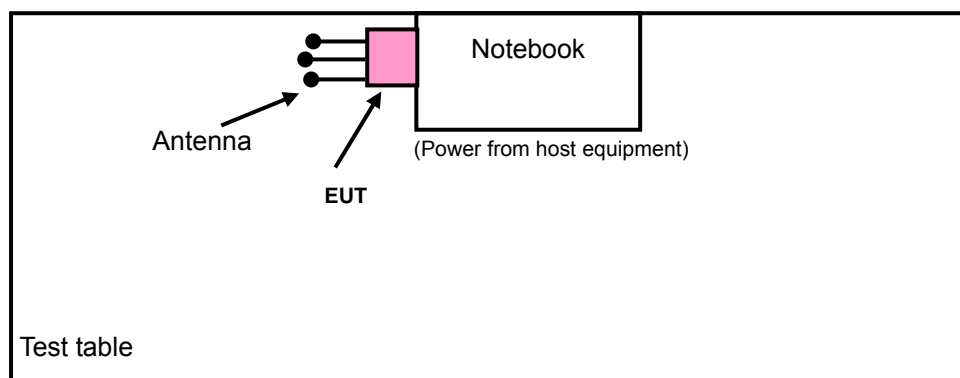

### 3.2.2 TEST MODE APPLICABILITY AND TESTED CHANNEL DETAIL

#### FOR 2.400 ~ 2.4835GHz:

EUT CONFIGURE MODE	APPLICABLE TO				DESCRIPTION
	RE≥1G	RE<1G	PLC	APCM	
-	√	√	√	√	-

Where **RE≥1G**: Radiated Emission above 1GHz      **RE<1G**: Radiated Emission below 1GHz  
**PLC**: Power Line Conducted Emission      **APCM**: Antenna Port Conducted Measurement

#### **RADIATED EMISSION TEST (ABOVE 1GHz):**

- Pre-Scan has been conducted to determine the worst-case mode from all possible combinations between available modulations, data rates and antenna ports (if EUT with antenna diversity architecture).
- Following channel(s) was (were) selected for the final test as listed below.

MODE	AVAILABLE CHANNEL	TESTED CHANNEL	MODULATION TECHNOLOGY	MODULATION TYPE	DATA RATE (Mbps)
802.11b	1 to 11	1, 6, 11	DSSS	DBPSK	1.0
802.11g	1 to 11	1, 6, 11	OFDM	BPSK	6.0
Draft 802.11n (20MHz)	1 to 11	1, 6, 11	OFDM	BPSK	7.2
Draft 802.11n (40MHz)	1 to 7	1, 4, 7	OFDM	BPSK	15.0

#### **RADIATED EMISSION TEST (BELOW 1GHz):**

- Pre-Scan has been conducted to determine the worst-case mode from all possible combinations between available modulations, data rates and antenna ports (if EUT with antenna diversity architecture).
- Following channel(s) was (were) selected for the final test as listed below.

MODE	AVAILABLE CHANNEL	TESTED CHANNEL	MODULATION TECHNOLOGY	MODULATION TYPE	DATA RATE (Mbps)
Draft 802.11n (20MHz)	1 to 11	11	OFDM	BPSK	7.2

#### **POWER LINE CONDUCTED EMISSION TEST:**

- Pre-Scan has been conducted to determine the worst-case mode from all possible combinations between available modulations, data rates and antenna ports (if EUT with antenna diversity architecture).
- Following channel(s) was (were) selected for the final test as listed below.

MODE	AVAILABLE CHANNEL	TESTED CHANNEL	MODULATION TECHNOLOGY	MODULATION TYPE	DATA RATE (Mbps)
Draft 802.11n (20MHz)	1 to 11	11	OFDM	BPSK	7.2

**BANDEDGE MEASUREMENT:**

- Pre-Scan has been conducted to determine the worst-case mode from all possible combinations between available modulations, data rates and antenna ports (if EUT with antenna diversity architecture).
- Following channel(s) was (were) selected for the final test as listed below.

MODE	AVAILABLE CHANNEL	TESTED CHANNEL	MODULATION TECHNOLOGY	MODULATION TYPE	DATA RATE (Mbps)
802.11b	1 to 11	1, 11	DSSS	DBPSK	1.0
802.11g	1 to 11	1, 11	OFDM	BPSK	6.0
Draft 802.11n (20MHz)	1 to 11	1, 11	OFDM	BPSK	7.2
Draft 802.11n (40MHz)	1 to 7	1, 7	OFDM	BPSK	15.0

**ANTENNA PORT CONDUCTED MEASUREMENT:**

- Pre-Scan has been conducted to determine the worst-case mode from all possible combinations between available modulations, data rates and antenna ports (if EUT with antenna diversity architecture).
- Following channel(s) was (were) selected for the final test as listed below.

MODE	AVAILABLE CHANNEL	TESTED CHANNEL	MODULATION TECHNOLOGY	MODULATION TYPE	DATA RATE (Mbps)
802.11b	1 to 11	1, 6, 11	DSSS	DBPSK	1.0
802.11g	1 to 11	1, 6, 11	OFDM	BPSK	6.0
Draft 802.11n (20MHz)	1 to 11	1, 6, 11	OFDM	BPSK	7.2
Draft 802.11n (40MHz)	1 to 7	1, 4, 7	OFDM	BPSK	15.0



**FOR 5.725 ~ 5.850GHz:**

EUT CONFIGURE MODE	APPLICABLE TO				DESCRIPTION
	PLC	RE<1G	RE≥1G	APCM	
-	√	√	√	√	-

Where **PLC:** Power Line Conducted Emission      **RE<1G:** Radiated Emission below 1GHz  
**RE≥1G:** Radiated Emission above 1GHz      **APCM:** Antenna Port Conducted Measurement

**RADIATED EMISSION TEST (ABOVE 1GHz):**

- Pre-Scan has been conducted to determine the worst-case mode from all possible combinations between available modulations, data rates and antenna ports (if EUT with antenna diversity architecture).
- Following channel(s) was (were) selected for the final test as listed below.

MODE	AVAILABLE CHANNEL	TESTED CHANNEL	MODULATION TECHNOLOGY	MODULATION TYPE	DATA RATE (Mbps)
802.11a	149 to 165	149, 157, 165	OFDM	BPSK	6.0
Draft 802.11n (20MHz)	149 to 165	149, 157, 165	OFDM	BPSK	7.2
Draft 802.11n (40MHz)	151 to 159	151, 159	OFDM	BPSK	15.0

**RADIATED EMISSION TEST (BELOW 1GHz):**

- Pre-Scan has been conducted to determine the worst-case mode from all possible combinations between available modulations, data rates and antenna ports (if EUT with antenna diversity architecture).
- Following channel(s) was (were) selected for the final test as listed below.

MODE	AVAILABLE CHANNEL	TESTED CHANNEL	MODULATION TECHNOLOGY	MODULATION TYPE	DATA RATE (Mbps)
Draft 802.11n (20MHz)	149 to 165	165	OFDM	BPSK	7.2

**POWER LINE CONDUCTED EMISSION TEST:**

- Pre-Scan has been conducted to determine the worst-case mode from all possible combinations between available modulations, data rates and antenna ports (if EUT with antenna diversity architecture).
- Following channel(s) was (were) selected for the final test as listed below.

MODE	AVAILABLE CHANNEL	TESTED CHANNEL	MODULATION TECHNOLOGY	MODULATION TYPE	DATA RATE (Mbps)
Draft 802.11n (20MHz)	149 to 165	165	OFDM	BPSK	7.2

**BANDEDGE MEASUREMENT:**

- Pre-Scan has been conducted to determine the worst-case mode from all possible combinations between available modulations, data rates and antenna ports (if EUT with antenna diversity architecture).
- Following channel(s) was (were) selected for the final test as listed below.

MODE	AVAILABLE CHANNEL	TESTED CHANNEL	MODULATION TECHNOLOGY	MODULATION TYPE	DATA RATE (Mbps)
802.11a	149 to 165	149, 165	OFDM	BPSK	6.0
Draft 802.11n (20MHz)	149 to 165	149, 165	OFDM	BPSK	7.2
Draft 802.11n (40MHz)	151 to 159	151, 159	OFDM	BPSK	15.0

**ANTENNA PORT CONDUCTED MEASUREMENT:**

- Pre-Scan has been conducted to determine the worst-case mode from all possible combinations between available modulations, data rates and antenna ports (if EUT with antenna diversity architecture).
- Following channel(s) was (were) selected for the final test as listed below.

MODE	AVAILABLE CHANNEL	TESTED CHANNEL	MODULATION TECHNOLOGY	MODULATION TYPE	DATA RATE (Mbps)
802.11a	149 to 165	149, 157, 165	OFDM	BPSK	6.0
Draft 802.11n (20MHz)	149 to 165	149, 157, 165	OFDM	BPSK	7.2
Draft 802.11n (40MHz)	151 to 159	151, 159	OFDM	BPSK	15.0



### 3.3 GENERAL DESCRIPTION OF APPLIED STANDARDS

The EUT is a RF Product. According to the specifications of the manufacturer, it must comply with the requirements of the following standards:

**FCC Part 15, Subpart C (15.247)**

**ANSI C63.4-2003**

All test items have been performed and recorded as per the above standards.

**NOTE:** The EUT is also considered as a kind of computer peripheral, because the connection to computer is necessary for typical use. It has been verified to comply with the requirements of FCC Part 15, Subpart B, Class B (DoC). The test report has been issued separately.

### 3.4 DESCRIPTION OF SUPPORT UNITS

The EUT has been tested as an independent unit together with other necessary accessories or support units. The following support units or accessories were used to form a representative test configuration during the tests.

NO.	PRODUCT	BRAND	MODEL NO.	SERIAL NO.	FCC ID
1	NOTEBOOK COMPUTER	DELL	PP05L	16484462992	E2K24CLNS

NO.	SIGNAL CABLE DESCRIPTION OF THE ABOVE SUPPORT UNITS
1	NA

**NOTE:** All power cords of the above support units are non shielded (1.8m).

## 4. TEST TYPES AND RESULTS (FOR 2.4GHZ BAND)

### 4.1 RADIATED EMISSION MEASUREMENT

#### 4.1.1 LIMITS OF RADIATED EMISSION MEASUREMENT

Emissions radiated outside of the specified bands, shall be according to the general radiated limits in 15.209 as following:

FREQUENCIES (MHz)	FIELD STRENGTH (microvolts/meter)	MEASUREMENT DISTANCE (meters)
0.009 ~ 0.490	2400/F(kHz)	300
0.490 ~ 1.705	24000/F(kHz)	30
1.705 ~ 30.0	30	30
30 ~ 88	100	3
88 ~ 216	150	3
216 ~ 960	200	3
Above 960	500	3

**NOTE:**

1. The lower limit shall apply at the transition frequencies.
2. Emission level (dBuV/m) = 20 log Emission level (uV/m).
3. As shown in 15.35(b), for frequencies above 1000MHz, the field strength limits are based on average detector, however, the peak field strength of any emission shall not exceed the maximum permitted average limits, specified above by more than 20dB under any condition of modulation.



#### 4.1.2 TEST INSTRUMENTS

DESCRIPTION & MANUFACTURER	MODEL NO.	SERIAL NO.	DATE OF CALIBRATION	DUE DATE OF CALIBRATION
Test Receiver ROHDE & SCHWARZ	ESI7	100033	Jun. 30, 2008	Jun. 29, 2009
Spectrum Analyzer Agilent	FSP	100041	Apr. 22, 2008	Apr. 21, 2009
BILOG Antenna SCHWARZBECK	VULB9168	9168-160	May, 02, 2008	May, 01, 2009
HORN Antenna SCHWARZBECK	9120D	9120D-209	Jun. 24, 2008	Jun. 23, 2009
HORN Antenna SCHWARZBECK	BBHA 9170	BBHA9170243	Dec. 25, 2007	Dec. 24, 2008
Preamplifier Agilent	8447D	2944A10633	Oct. 29, 2007	Oct. 28, 2008
Preamplifier Agilent	8449B	3008A01964	Oct. 24, 2007	Oct. 23, 2008
RF signal cable HUBER+SUHNNER	SUCOFLEX 104	283402/4	Dec. 07, 2007	Dec. 06, 2008
RF signal cable HUBER+SUHNNER	SUCOFLEX 104	251644/4	Dec. 07, 2007	Dec. 06, 2008
Software ADT.	ADT_Radiated_V7.6	NA	NA	NA
Antenna Tower inn-co GmbH	MA 4000	013303	NA	NA
Antenna Tower Controller inn-co GmbH	CO2000	017303	NA	NA
Turn Table ADT.	TT100.	TT93021703	NA	NA
Turn Table Controller ADT.	SC100.	SC93021703	NA	NA

- NOTE:**
1. The calibration interval of the above test instruments is 12 months and the calibrations are traceable to NML/ROC and NIST/USA.
  2. The test was performed in HwaYa Chamber 3.
  3. The horn antenna and HP preamplifier (model: 8449B) are used only for the measurement of emission frequency above 1GHz if tested.
  4. The FCC Site Registration No. is 988962.
  5. The IC Site Registration No. is IC3789B-3.



#### 4.1.3 TEST PROCEDURES

- a. The EUT was placed on the top of a rotating table 0.8 meters above the ground at a 3 meters semi-anechoic chamber. The table was rotated 360 degrees to determine the position of the highest radiation.
- b. The EUT was set 3 meters away from the interference-receiving antenna, which was mounted on the top of a variable-height antenna tower.
- c. The antenna is a broadband antenna, and its height is varied from one meter to four meters above the ground to determine the maximum value of the field strength. Both horizontal and vertical polarizations of the antenna are set to make the measurement.
- d. For each suspected emission, the EUT was arranged to its worst case and then the antenna was tuned to heights from 1 meter to 4 meters and the rotatable table was turned from 0 degrees to 360 degrees to find the maximum reading.
- e. The test-receiver system was set to Peak Detect Function and Specified Bandwidth with Maximum Hold Mode.
- f. If the emission level of the EUT in peak mode was lower than the limit specified, then testing could be stopped and the peak values of the EUT would be reported. Otherwise the emissions would be re-tested one by one using peak, quasi-peak or average method as specified and then reported in a data sheet.

**NOTE:**

1. The resolution bandwidth and video bandwidth of test receiver/spectrum analyzer is 120kHz for Quasi-peak detection at frequency below 1GHz.
2. The resolution bandwidth of test receiver/spectrum analyzer is 100kHz and video bandwidth is 300kHz for Peak detection at frequency above 1GHz.
3. The resolution bandwidth of test receiver/spectrum analyzer is 1MHz and the video bandwidth is 10Hz for Average detection (AV) at frequency above 1GHz.
4. All modes of operation were investigated and the worst-case emissions are reported.

#### 4.1.4 DEVIATION FROM TEST STANDARD

No deviation

#### 4.1.5 TEST SETUP

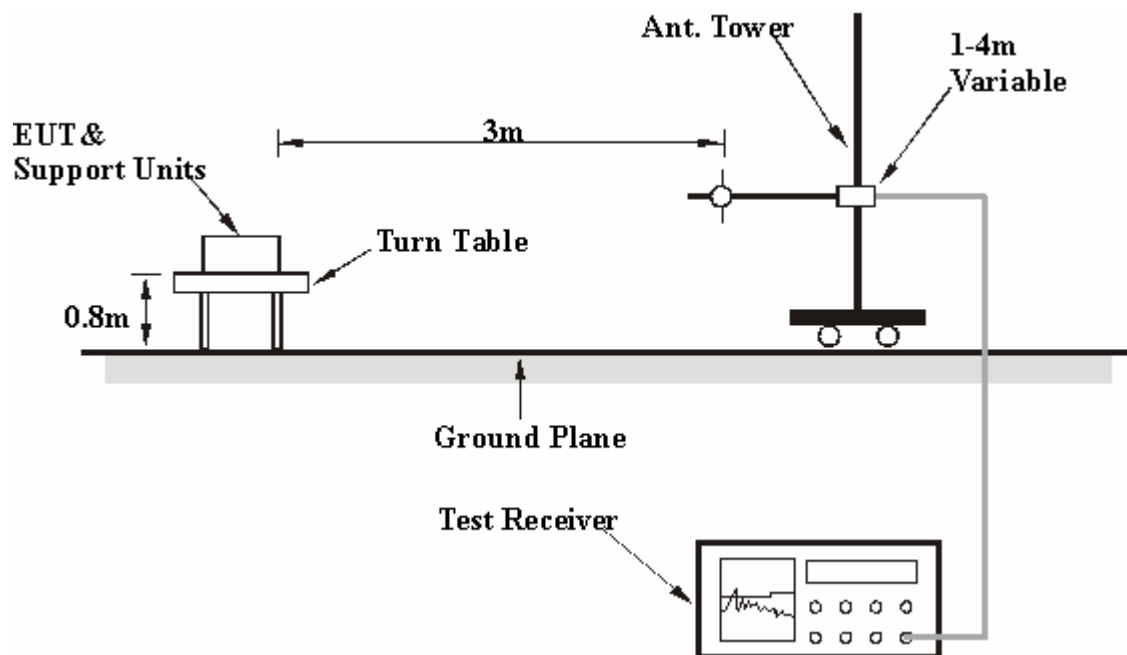

For the actual test configuration, please refer to the attached file (Test Setup Photo).

#### 4.1.6 EUT OPERATING CONDITIONS

- a. Connected the EUT into the notebook system and placed on a testing table.
- b. The EUT ran a test program (provided by manufacturer) to enable all functions under transmission condition continuously at specific channel frequency.
- c. The necessary accessories enable the EUT in full functions.

#### 4.1.7 TEST RESULTS

##### 802.11b DSSS MODULATION

EUT TEST CONDITION		MEASUREMENT DETAIL	
CHANNEL	Channel 1	FREQUENCY RANGE	1 ~ 25GHz
INPUT POWER (SYSTEM)	120Vac, 60 Hz	DETECTOR FUNCTION	Peak (PK) Average (AV)
ENVIRONMENTAL CONDITIONS	24deg. C, 64%RH 999hPa	TESTED BY	Kevin Liang

ANTENNA POLARITY & TEST DISTANCE: HORIZONTAL AT 3 M								
NO.	FREQ. (MHz)	EMISSION LEVEL (dBuV/m)	LIMIT (dBuV/m)	MARGIN (dB)	ANTENNA HEIGHT (m)	TABLE ANGLE (Degree)	RAW VALUE (dBuV)	CORRECTION FACTOR (dB/m)
1	2390.00	55.78 PK	74.00	-18.22	1.13 H	9	23.34	32.44
2	2390.00	46.14 AV	54.00	-7.86	1.13 H	9	13.70	32.44
3	*2412.00	101.14 PK			1.13 H	9	68.62	32.52
4	*2412.00	96.47 AV			1.13 H	9	63.95	32.52
5	4824.00	50.58 PK	74.00	-23.42	1.13 H	359	12.28	38.30
6	4824.00	39.46 AV	54.00	-14.54	1.13 H	359	1.16	38.30
ANTENNA POLARITY & TEST DISTANCE: VERTICAL AT 3 M								
NO.	FREQ. (MHz)	EMISSION LEVEL (dBuV/m)	LIMIT (dBuV/m)	MARGIN (dB)	ANTENNA HEIGHT (m)	TABLE ANGLE (Degree)	RAW VALUE (dBuV)	CORRECTION FACTOR (dB/m)
1	2390.00	57.64 PK	74.00	-16.36	1.17 V	307	25.20	32.44
2	2390.00	48.04 AV	54.00	-5.96	1.17 V	307	15.60	32.44
3	*2412.00	112.40 PK			1.17 V	303	79.88	32.52
4	*2412.00	107.63 AV			1.17 V	303	75.11	32.52
5	4824.00	54.33 PK	74.00	-19.67	1.17 V	288	16.03	38.30
6	4824.00	49.99 AV	54.00	-4.01	1.17 V	288	11.69	38.30

- REMARKS:**
1. Emission level (dBuV/m) = Raw Value (dBuV) + Correction Factor (dB/m).
  2. Correction Factor (dB/m) = Antenna Factor (dB/m) + Cable Factor (dB).
  3. The other emission levels were very low against the limit.
  4. Margin value = Emission level – Limit value.
  5. “ \* “: Fundamental frequency.



EUT TEST CONDITION		MEASUREMENT DETAIL	
CHANNEL	Channel 6	FREQUENCY RANGE	1 ~ 25GHz
INPUT POWER (SYSTEM)	120Vac, 60 Hz	DETECTOR FUNCTION	Peak (PK) Average (AV)
ENVIRONMENTAL CONDITIONS	24deg. C, 64%RH 999hPa	TESTED BY	Kevin Liang

ANTENNA POLARITY & TEST DISTANCE: HORIZONTAL AT 3 M								
NO.	FREQ. (MHz)	EMISSION LEVEL (dBuV/m)	LIMIT (dBuV/m)	MARGIN (dB)	ANTENNA HEIGHT (m)	TABLE ANGLE (Degree)	RAW VALUE (dBuV)	CORRECTION FACTOR (dB/m)
1	*2437.00	101.43 PK			1.11 H	10	68.83	32.60
2	*2437.00	96.65 AV			1.11 H	10	64.05	32.60
3	4874.00	51.28 PK	74.00	-22.72	1.05 H	295	12.78	38.50
4	4874.00	44.50 AV	54.00	-9.50	1.05 H	295	6.00	38.50
ANTENNA POLARITY & TEST DISTANCE: VERTICAL AT 3 M								
NO.	FREQ. (MHz)	EMISSION LEVEL (dBuV/m)	LIMIT (dBuV/m)	MARGIN (dB)	ANTENNA HEIGHT (m)	TABLE ANGLE (Degree)	RAW VALUE (dBuV)	CORRECTION FACTOR (dB/m)
1	*2437.00	111.98 PK			1.41 V	286	79.38	32.60
2	*2437.00	106.98 AV			1.41 V	286	74.38	32.60
3	4874.00	54.51 PK	74.00	-19.49	1.35 V	272	16.01	38.50
4	4874.00	50.84 AV	54.00	-3.16	1.35 V	272	12.34	38.50

- REMARKS:**
1. Emission level (dBuV/m) = Raw Value (dBuV) + Correction Factor (dB/m).
  2. Correction Factor (dB/m) = Antenna Factor (dB/m) + Cable Factor (dB).
  3. The other emission levels were very low against the limit.
  4. Margin value = Emission level – Limit value.
  5. “ \* “: Fundamental frequency.



EUT TEST CONDITION		MEASUREMENT DETAIL	
CHANNEL	Channel 11	FREQUENCY RANGE	1 ~ 25GHz
INPUT POWER (SYSTEM)	120Vac, 60 Hz	DETECTOR FUNCTION	Peak (PK) Average (AV)
ENVIRONMENTAL CONDITIONS	24deg. C, 64%RH 999hPa	TESTED BY	Kevin Liang

ANTENNA POLARITY & TEST DISTANCE: HORIZONTAL AT 3 M								
NO.	FREQ. (MHz)	EMISSION LEVEL (dBuV/m)	LIMIT (dBuV/m)	MARGIN (dB)	ANTENNA HEIGHT (m)	TABLE ANGLE (Degree)	RAW VALUE (dBuV)	CORRECTION FACTOR (dB/m)
1	*2462.00	102.58 PK			1.12 H	12	69.90	32.68
2	*2462.00	98.02 AV			1.12 H	12	65.34	32.68
3	2483.50	58.50 PK	74.00	-15.50	1.12 H	12	25.74	32.76
4	2483.50	46.20 AV	54.00	-7.80	1.12 H	12	13.44	32.76
5	4924.00	51.34 PK	74.00	-22.66	1.07 H	292	12.70	38.64
6	4924.00	44.59 AV	54.00	-9.41	1.07 H	292	5.95	38.64
ANTENNA POLARITY & TEST DISTANCE: VERTICAL AT 3 M								
NO.	FREQ. (MHz)	EMISSION LEVEL (dBuV/m)	LIMIT (dBuV/m)	MARGIN (dB)	ANTENNA HEIGHT (m)	TABLE ANGLE (Degree)	RAW VALUE (dBuV)	CORRECTION FACTOR (dB/m)
1	*2462.00	111.73 PK			1.36 V	276	79.05	32.68
2	*2462.00	107.07 AV			1.36 V	276	74.39	32.68
3	2483.50	59.33 PK	74.00	-14.67	1.36 V	276	26.57	32.76
4	2483.50	48.05 AV	54.00	-5.95	1.36 V	276	15.29	32.76
5	4924.00	56.27 PK	74.00	-17.73	1.32 V	277	17.63	38.64
6	4924.00	52.12 AV	54.00	-1.88	1.32 V	277	13.48	38.64

- REMARKS:**
1. Emission level (dBuV/m) = Raw Value (dBuV) + Correction Factor (dB/m).
  2. Correction Factor (dB/m) = Antenna Factor (dB/m) + Cable Factor (dB).
  3. The other emission levels were very low against the limit.
  4. Margin value = Emission level – Limit value.
  5. “ \* “: Fundamental frequency.



**802.11g OFDM MODULATION**

EUT TEST CONDITION		MEASUREMENT DETAIL	
CHANNEL	Channel 1	FREQUENCY RANGE	1 ~ 25GHz
INPUT POWER (SYSTEM)	120Vac, 60 Hz	DETECTOR FUNCTION	Peak (PK) Average (AV)
ENVIRONMENTAL CONDITIONS	24deg. C, 64%RH 999hPa	TESTED BY	Kevin Liang

ANTENNA POLARITY & TEST DISTANCE: HORIZONTAL AT 3 M								
NO.	FREQ. (MHz)	EMISSION LEVEL (dBuV/m)	LIMIT (dBuV/m)	MARGIN (dB)	ANTENNA HEIGHT (m)	TABLE ANGLE (Degree)	RAW VALUE (dBuV)	CORRECTION FACTOR (dB/m)
1	2390.00	57.79 PK	74.00	-16.21	1.14 H	9	25.35	32.44
2	2390.00	45.88 AV	54.00	-8.12	1.14 H	9	13.44	32.44
3	*2412.00	96.94 PK			1.14 H	9	64.42	32.52
4	*2412.00	85.83 AV			1.14 H	9	53.31	32.52
5	4824.00	47.77 PK	74.00	-26.23	1.06 H	320	9.47	38.30
6	4824.00	35.11 AV	54.00	-18.89	1.06 H	320	-3.19	38.30
ANTENNA POLARITY & TEST DISTANCE: VERTICAL AT 3 M								
NO.	FREQ. (MHz)	EMISSION LEVEL (dBuV/m)	LIMIT (dBuV/m)	MARGIN (dB)	ANTENNA HEIGHT (m)	TABLE ANGLE (Degree)	RAW VALUE (dBuV)	CORRECTION FACTOR (dB/m)
1	2390.00	60.11 PK	74.00	-13.89	1.17 V	299	27.67	32.44
2	2390.00	47.12 AV	54.00	-6.88	1.17 V	299	14.68	32.44
3	*2412.00	106.90 PK			1.17 V	299	74.38	32.52
4	*2412.00	95.74 AV			1.17 V	299	63.22	32.52
5	4824.00	48.79 PK	74.00	-25.21	1.30 V	9	10.49	38.30
6	4824.00	36.49 AV	54.00	-17.51	1.30 V	9	-1.81	38.30

- REMARKS:**
1. Emission level (dBuV/m) = Raw Value (dBuV) + Correction Factor (dB/m).
  2. Correction Factor (dB/m) = Antenna Factor (dB/m) + Cable Factor (dB).
  3. The other emission levels were very low against the limit.
  4. Margin value = Emission level – Limit value.
  5. “ \* “: Fundamental frequency.



EUT TEST CONDITION		MEASUREMENT DETAIL	
CHANNEL	Channel 6	FREQUENCY RANGE	1 ~ 25GHz
INPUT POWER (SYSTEM)	120Vac, 60 Hz	DETECTOR FUNCTION	Peak (PK) Average (AV)
ENVIRONMENTAL CONDITIONS	24deg. C, 64%RH 999hPa	TESTED BY	Kevin Liang

ANTENNA POLARITY & TEST DISTANCE: HORIZONTAL AT 3 M								
NO.	FREQ. (MHz)	EMISSION LEVEL (dBuV/m)	LIMIT (dBuV/m)	MARGIN (dB)	ANTENNA HEIGHT (m)	TABLE ANGLE (Degree)	RAW VALUE (dBuV)	CORRECTION FACTOR (dB/m)
1	*2437.00	96.36 PK			1.11 H	10	63.76	32.60
2	*2437.00	84.95 AV			1.11 H	10	52.35	32.60
3	4874.00	52.28 PK	74.00	-21.72	1.08 H	315	13.78	38.50
4	4874.00	39.71 AV	54.00	-14.29	1.08 H	315	1.21	38.50
ANTENNA POLARITY & TEST DISTANCE: VERTICAL AT 3 M								
NO.	FREQ. (MHz)	EMISSION LEVEL (dBuV/m)	LIMIT (dBuV/m)	MARGIN (dB)	ANTENNA HEIGHT (m)	TABLE ANGLE (Degree)	RAW VALUE (dBuV)	CORRECTION FACTOR (dB/m)
1	*2437.00	107.04 PK			1.17 V	256	74.44	32.60
2	*2437.00	95.86 AV			1.17 V	256	63.26	32.60
3	4874.00	48.52 PK	74.00	-25.48	1.31 V	12	10.02	38.50
4	4874.00	36.34 AV	54.00	-17.66	1.31 V	12	-2.16	38.50

- REMARKS:**
1. Emission level (dBuV/m) = Raw Value (dBuV) + Correction Factor (dB/m).
  2. Correction Factor (dB/m) = Antenna Factor (dB/m) + Cable Factor (dB).
  3. The other emission levels were very low against the limit.
  4. Margin value = Emission level – Limit value.
  5. “ \* “: Fundamental frequency.



EUT TEST CONDITION		MEASUREMENT DETAIL	
CHANNEL	Channel 11	FREQUENCY RANGE	1 ~ 25GHz
INPUT POWER (SYSTEM)	120Vac, 60 Hz	DETECTOR FUNCTION	Peak (PK) Average (AV)
ENVIRONMENTAL CONDITIONS	24deg. C, 64%RH 999hPa	TESTED BY	Kevin Liang

ANTENNA POLARITY & TEST DISTANCE: HORIZONTAL AT 3 M								
NO.	FREQ. (MHz)	EMISSION LEVEL (dBuV/m)	LIMIT (dBuV/m)	MARGIN (dB)	ANTENNA HEIGHT (m)	TABLE ANGLE (Degree)	RAW VALUE (dBuV)	CORRECTION FACTOR (dB/m)
1	*2462.00	96.69 PK			1.10 H	10	64.01	32.68
2	*2462.00	85.74 AV			1.10 H	10	53.06	32.68
3	2483.50	57.98 PK	74.00	-16.02	1.10 H	9	25.22	32.76
4	2483.50	46.23 AV	54.00	-7.77	1.10 H	9	13.47	32.76
5	4924.00	47.58 PK	74.00	-26.42	1.04 H	339	8.94	38.64
6	4924.00	35.04 AV	54.00	-18.96	1.04 H	339	-3.60	38.64
ANTENNA POLARITY & TEST DISTANCE: VERTICAL AT 3 M								
NO.	FREQ. (MHz)	EMISSION LEVEL (dBuV/m)	LIMIT (dBuV/m)	MARGIN (dB)	ANTENNA HEIGHT (m)	TABLE ANGLE (Degree)	RAW VALUE (dBuV)	CORRECTION FACTOR (dB/m)
1	*2462.00	107.43 PK			1.17 V	257	74.75	32.68
2	*2462.00	96.52 AV			1.17 V	257	63.84	32.68
3	2483.50	60.34 PK	74.00	-13.66	1.17 V	257	27.58	32.76
4	2483.50	48.02 AV	54.00	-5.98	1.17 V	257	15.26	32.76
5	4924.00	48.65 PK	74.00	-25.35	1.32 V	15	10.01	38.64
6	4924.00	36.23 AV	54.00	-17.77	1.32 V	15	-2.41	38.64

- REMARKS:**
1. Emission level (dBuV/m) = Raw Value (dBuV) + Correction Factor (dB/m).
  2. Correction Factor (dB/m) = Antenna Factor (dB/m) + Cable Factor (dB).
  3. The other emission levels were very low against the limit.
  4. Margin value = Emission level – Limit value.
  5. “ \* “: Fundamental frequency.



### DRAFT 802.11n (20MHz) OFDM MODULATION

EUT TEST CONDITION		MEASUREMENT DETAIL	
CHANNEL	Channel 1	FREQUENCY RANGE	1 ~ 25GHz
INPUT POWER (SYSTEM)	120Vac, 60 Hz	DETECTOR FUNCTION	Peak (PK) Average (AV)
ENVIRONMENTAL CONDITIONS	24deg. C, 64%RH 999hPa	TESTED BY	Kevin Liang

ANTENNA POLARITY & TEST DISTANCE: HORIZONTAL AT 3 M								
NO.	FREQ. (MHz)	EMISSION LEVEL (dBuV/m)	LIMIT (dBuV/m)	MARGIN (dB)	ANTENNA HEIGHT (m)	TABLE ANGLE (Degree)	RAW VALUE (dBuV)	CORRECTION FACTOR (dB/m)
1	2390.00	58.21 PK	74.00	-15.79	1.46 H	321	25.77	32.44
2	2390.00	46.31 AV	54.00	-7.69	1.46 H	321	13.87	32.44
3	*2412.00	101.73 PK			1.46 H	321	69.21	32.52
4	*2412.00	87.29 AV			1.46 H	321	54.77	32.52
5	4824.00	47.58 PK	74.00	-26.42	1.10 H	256	9.28	38.30
6	4824.00	35.08 AV	54.00	-18.92	1.10 H	256	-3.22	38.30
ANTENNA POLARITY & TEST DISTANCE: VERTICAL AT 3 M								
NO.	FREQ. (MHz)	EMISSION LEVEL (dBuV/m)	LIMIT (dBuV/m)	MARGIN (dB)	ANTENNA HEIGHT (m)	TABLE ANGLE (Degree)	RAW VALUE (dBuV)	CORRECTION FACTOR (dB/m)
1	2390.00	64.67 PK	74.00	-9.33	1.00 V	189	32.23	32.44
2	2390.00	48.23 AV	54.00	-5.77	1.00 V	189	15.79	32.44
3	*2412.00	113.13 PK			1.00 V	189	80.61	32.52
4	*2412.00	99.20 AV			1.00 V	189	66.68	32.52
5	4824.00	48.68 PK	74.00	-25.32	1.27 V	162	10.38	38.30
6	4824.00	35.64 AV	54.00	-18.36	1.27 V	162	-2.66	38.30

- REMARKS:**
1. Emission level (dBuV/m) = Raw Value (dBuV) + Correction Factor (dB/m).
  2. Correction Factor (dB/m) = Antenna Factor (dB/m) + Cable Factor (dB).
  3. The other emission levels were very low against the limit.
  4. Margin value = Emission level – Limit value.
  5. “ \* “: Fundamental frequency.

EUT TEST CONDITION		MEASUREMENT DETAIL	
CHANNEL	Channel 6	FREQUENCY RANGE	1 ~ 25GHz
INPUT POWER (SYSTEM)	120Vac, 60 Hz	DETECTOR FUNCTION	Peak (PK) Average (AV)
ENVIRONMENTAL CONDITIONS	24deg. C, 64%RH 999hPa	TESTED BY	Kevin Liang

ANTENNA POLARITY & TEST DISTANCE: HORIZONTAL AT 3 M								
NO.	FREQ. (MHz)	EMISSION LEVEL (dBuV/m)	LIMIT (dBuV/m)	MARGIN (dB)	ANTENNA HEIGHT (m)	TABLE ANGLE (Degree)	RAW VALUE (dBuV)	CORRECTION FACTOR (dB/m)
1	*2437.00	101.93 PK			1.14 H	322	69.33	32.60
2	*2437.00	88.64 AV			1.14 H	322	56.04	32.60
3	4874.00	47.53 PK	74.00	-26.47	1.12 H	252	9.03	38.50
4	4874.00	34.97 AV	54.00	-19.03	1.12 H	252	-3.53	38.50
ANTENNA POLARITY & TEST DISTANCE: VERTICAL AT 3 M								
NO.	FREQ. (MHz)	EMISSION LEVEL (dBuV/m)	LIMIT (dBuV/m)	MARGIN (dB)	ANTENNA HEIGHT (m)	TABLE ANGLE (Degree)	RAW VALUE (dBuV)	CORRECTION FACTOR (dB/m)
1	*2437.00	112.99 PK			1.45 V	191	80.39	32.60
2	*2437.00	99.56 AV			1.45 V	191	66.96	32.60
3	4874.00	48.77 PK	74.00	-25.23	1.29 V	152	10.27	38.50
4	4874.00	35.89 AV	54.00	-18.11	1.29 V	152	-2.61	38.50

- REMARKS:**
1. Emission level (dBuV/m) = Raw Value (dBuV) + Correction Factor (dB/m).
  2. Correction Factor (dB/m) = Antenna Factor (dB/m) + Cable Factor (dB).
  3. The other emission levels were very low against the limit.
  4. Margin value = Emission level – Limit value.
  5. “ \* “: Fundamental frequency.

EUT TEST CONDITION		MEASUREMENT DETAIL	
CHANNEL	Channel 11	FREQUENCY RANGE	1 ~ 25GHz
INPUT POWER (SYSTEM)	120Vac, 60 Hz	DETECTOR FUNCTION	Peak (PK) Average (AV)
ENVIRONMENTAL CONDITIONS	24deg. C, 64%RH 999hPa	TESTED BY	Kevin Liang

ANTENNA POLARITY & TEST DISTANCE: HORIZONTAL AT 3 M								
NO.	FREQ. (MHz)	EMISSION LEVEL (dBuV/m)	LIMIT (dBuV/m)	MARGIN (dB)	ANTENNA HEIGHT (m)	TABLE ANGLE (Degree)	RAW VALUE (dBuV)	CORRECTION FACTOR (dB/m)
1	*2462.00	102.70 PK			1.44 H	325	70.02	32.68
2	*2462.00	90.18 AV			1.44 H	325	57.50	32.68
3	2483.50	58.79 PK	74.00	-15.21	1.44 H	325	26.03	32.76
4	2483.50	47.23 AV	54.00	-6.77	1.44 H	325	14.47	32.76
5	4924.00	47.70 PK	74.00	-26.30	1.12 H	251	9.06	38.64
6	4924.00	35.27 AV	54.00	-18.73	1.12 H	251	-3.37	38.64
ANTENNA POLARITY & TEST DISTANCE: VERTICAL AT 3 M								
NO.	FREQ. (MHz)	EMISSION LEVEL (dBuV/m)	LIMIT (dBuV/m)	MARGIN (dB)	ANTENNA HEIGHT (m)	TABLE ANGLE (Degree)	RAW VALUE (dBuV)	CORRECTION FACTOR (dB/m)
1	*2462.00	113.73 PK			1.17 V	219	81.05	32.68
2	*2462.00	100.23 AV			1.17 V	219	67.55	32.68
3	2483.50	68.43 PK	74.00	-5.57	1.17 V	219	35.67	32.76
4	2483.50	49.77 AV	54.00	-4.23	1.17 V	219	17.01	32.76
5	4924.00	48.95 PK	74.00	-25.05	1.24 V	158	10.31	38.64
6	4924.00	35.85 AV	54.00	-18.15	1.24 V	158	-2.79	38.64

- REMARKS:**
1. Emission level (dBuV/m) = Raw Value (dBuV) + Correction Factor (dB/m).
  2. Correction Factor (dB/m) = Antenna Factor (dB/m) + Cable Factor (dB).
  3. The other emission levels were very low against the limit.
  4. Margin value = Emission level – Limit value.
  5. “ \* “: Fundamental frequency.

### DRAFT 802.11n (40MHz) OFDM MODULATION

EUT TEST CONDITION		MEASUREMENT DETAIL	
CHANNEL	Channel 1	FREQUENCY RANGE	1 ~ 25GHz
INPUT POWER (SYSTEM)	120Vac, 60 Hz	DETECTOR FUNCTION	Peak (PK) Average (AV)
ENVIRONMENTAL CONDITIONS	24deg. C, 64%RH 999hPa	TESTED BY	Kevin Liang

ANTENNA POLARITY & TEST DISTANCE: HORIZONTAL AT 3 M								
NO.	FREQ. (MHz)	EMISSION LEVEL (dBuV/m)	LIMIT (dBuV/m)	MARGIN (dB)	ANTENNA HEIGHT (m)	TABLE ANGLE (Degree)	RAW VALUE (dBuV)	CORRECTION FACTOR (dB/m)
1	2390.00	60.18 PK	74.00	-13.82	1.44 H	332	27.74	32.44
2	2390.00	47.16 AV	54.00	-6.84	1.44 H	332	14.72	32.44
3	*2422.00	99.83 PK			1.44 H	332	67.28	32.55
4	*2422.00	84.37 AV			1.44 H	332	51.82	32.55
5	4844.00	47.32 PK	74.00	-26.68	1.14 H	329	8.94	38.38
6	4844.00	34.81 AV	54.00	-19.19	1.14 H	329	-3.57	38.38
ANTENNA POLARITY & TEST DISTANCE: VERTICAL AT 3 M								
NO.	FREQ. (MHz)	EMISSION LEVEL (dBuV/m)	LIMIT (dBuV/m)	MARGIN (dB)	ANTENNA HEIGHT (m)	TABLE ANGLE (Degree)	RAW VALUE (dBuV)	CORRECTION FACTOR (dB/m)
1	2390.00	72.21 PK	74.00	-1.79	1.20 V	263	39.77	32.44
2	2390.00	52.85 AV	54.00	-1.15	1.20 V	263	20.41	32.44
3	*2422.00	111.28 PK			1.20 V	263	78.73	32.55
4	*2422.00	96.68 AV			1.20 V	263	64.13	32.55
5	4844.00	48.94 PK	74.00	-25.06	1.21 V	188	10.57	38.38
6	4844.00	36.29 AV	54.00	-17.71	1.21 V	188	-2.08	38.38

- REMARKS:**
1. Emission level (dBuV/m) = Raw Value (dBuV) + Correction Factor (dB/m).
  2. Correction Factor (dB/m) = Antenna Factor (dB/m) + Cable Factor (dB).
  3. The other emission levels were very low against the limit.
  4. Margin value = Emission level – Limit value.
  5. “ \* “: Fundamental frequency.



EUT TEST CONDITION		MEASUREMENT DETAIL	
CHANNEL	Channel 4	FREQUENCY RANGE	1 ~ 25GHz
INPUT POWER (SYSTEM)	120Vac, 60 Hz	DETECTOR FUNCTION	Peak (PK) Average (AV)
ENVIRONMENTAL CONDITIONS	24deg. C, 64%RH 999hPa	TESTED BY	Kevin Liang

ANTENNA POLARITY & TEST DISTANCE: HORIZONTAL AT 3 M								
NO.	FREQ. (MHz)	EMISSION LEVEL (dBuV/m)	LIMIT (dBuV/m)	MARGIN (dB)	ANTENNA HEIGHT (m)	TABLE ANGLE (Degree)	RAW VALUE (dBuV)	CORRECTION FACTOR (dB/m)
1	*2437.00	99.40 PK			1.44 H	327	66.80	32.60
2	*2437.00	85.34 AV			1.44 H	327	52.74	32.60
3	4874.00	47.55 PK	74.00	-26.45	1.15 H	320	9.05	38.50
4	4874.00	34.96 AV	54.00	-19.04	1.15 H	320	-3.54	38.50
ANTENNA POLARITY & TEST DISTANCE: VERTICAL AT 3 M								
NO.	FREQ. (MHz)	EMISSION LEVEL (dBuV/m)	LIMIT (dBuV/m)	MARGIN (dB)	ANTENNA HEIGHT (m)	TABLE ANGLE (Degree)	RAW VALUE (dBuV)	CORRECTION FACTOR (dB/m)
1	*2437.00	110.84 PK			1.16 V	260	78.24	32.60
2	*2437.00	96.61 AV			1.16 V	260	64.01	32.60
3	4874.00	48.87 PK	74.00	-25.13	1.25 V	193	10.37	38.50
4	4874.00	36.24 AV	54.00	-17.76	1.25 V	193	-2.26	38.50

- REMARKS:**
1. Emission level (dBuV/m) = Raw Value (dBuV) + Correction Factor (dB/m).
  2. Correction Factor (dB/m) = Antenna Factor (dB/m) + Cable Factor (dB).
  3. The other emission levels were very low against the limit.
  4. Margin value = Emission level – Limit value.
  5. “ \* “: Fundamental frequency.

EUT TEST CONDITION		MEASUREMENT DETAIL	
CHANNEL	Channel 7	FREQUENCY RANGE	1 ~ 25GHz
INPUT POWER (SYSTEM)	120Vac, 60 Hz	DETECTOR FUNCTION	Peak (PK) Average (AV)
ENVIRONMENTAL CONDITIONS	24deg. C, 64%RH 999hPa	TESTED BY	Kevin Liang

ANTENNA POLARITY & TEST DISTANCE: HORIZONTAL AT 3 M								
NO.	FREQ. (MHz)	EMISSION LEVEL (dBuV/m)	LIMIT (dBuV/m)	MARGIN (dB)	ANTENNA HEIGHT (m)	TABLE ANGLE (Degree)	RAW VALUE (dBuV)	CORRECTION FACTOR (dB/m)
1	*2452.00	100.53 PK			1.16 H	330	67.88	32.65
2	*2452.00	84.82 AV			1.16 H	330	52.17	32.65
3	2483.50	60.60 PK	74.00	-13.40	1.16 H	330	27.84	32.76
4	2483.50	47.34 AV	54.00	-6.66	1.16 H	330	14.58	32.76
5	4904.00	47.42 PK	74.00	-26.58	1.10 H	318	8.81	38.61
6	4904.00	34.86 AV	54.00	-19.14	1.10 H	318	-3.75	38.61
ANTENNA POLARITY & TEST DISTANCE: VERTICAL AT 3 M								
NO.	FREQ. (MHz)	EMISSION LEVEL (dBuV/m)	LIMIT (dBuV/m)	MARGIN (dB)	ANTENNA HEIGHT (m)	TABLE ANGLE (Degree)	RAW VALUE (dBuV)	CORRECTION FACTOR (dB/m)
1	*2452.00	111.05 PK			1.12 V	236	78.40	32.65
2	*2452.00	96.89 AV			1.12 V	236	64.24	32.65
3	2483.50	72.82 PK	74.00	-1.18	1.12 V	236	40.06	32.76
4	2483.50	52.88 AV	54.00	-1.12	1.12 V	236	20.12	32.76
5	4904.00	49.05 PK	74.00	-24.95	1.25 V	196	10.44	38.61
6	4904.00	36.41 AV	54.00	-17.59	1.25 V	196	-2.20	38.61

- REMARKS:**
1. Emission level (dBuV/m) = Raw Value (dBuV) + Correction Factor (dB/m).
  2. Correction Factor (dB/m) = Antenna Factor (dB/m) + Cable Factor (dB).
  3. The other emission levels were very low against the limit.
  4. Margin value = Emission level – Limit value.
  5. “ \* “: Fundamental frequency.

**BELOW 1GHz WORST-CASE DATA : DRAFT 802.11n (20MHz) OFDM MODULATION**

EUT TEST CONDITION		MEASUREMENT DETAIL	
CHANNEL	Channel 11	FREQUENCY RANGE	Below 1000MHz
INPUT POWER (SYSTEM)	120Vac, 60 Hz	DETECTOR FUNCTION	Quasi-Peak
ENVIRONMENTAL CONDITIONS	24deg. C, 64%RH 999hPa	TESTED BY	Match Tsui

ANTENNA POLARITY & TEST DISTANCE: HORIZONTAL AT 3 M								
NO.	FREQ. (MHz)	EMISSION LEVEL (dBuV/m)	LIMIT (dBuV/m)	MARGIN (dB)	ANTENNA HEIGHT (m)	TABLE ANGLE (Degree)	RAW VALUE (dBuV)	CORRECTION FACTOR (dB/m)
1	125.17	40.83 QP	43.50	-2.67	1.50 H	103	28.63	12.20
2	<b>138.78</b>	<b>42.50 QP</b>	<b>43.50</b>	<b>-1.00</b>	<b>1.25 H</b>	<b>109</b>	<b>29.19</b>	<b>13.31</b>
3	166.00	42.04 QP	43.50	-1.46	2.00 H	10	27.56	14.48
4	199.05	41.73 QP	43.50	-1.77	1.00 H	10	30.65	11.08
5	232.11	41.51 QP	46.00	-4.49	2.00 H	355	28.29	13.21
6	265.16	44.98 QP	46.00	-1.02	1.00 H	10	30.56	14.42
7	333.21	40.65 QP	46.00	-5.35	1.00 H	10	24.70	15.94
ANTENNA POLARITY & TEST DISTANCE: VERTICAL AT 3 M								
NO.	FREQ. (MHz)	EMISSION LEVEL (dBuV/m)	LIMIT (dBuV/m)	MARGIN (dB)	ANTENNA HEIGHT (m)	TABLE ANGLE (Degree)	RAW VALUE (dBuV)	CORRECTION FACTOR (dB/m)
1	31.84	34.44 QP	40.00	-5.56	1.00 V	220	21.15	13.29
2	64.90	32.46 QP	40.00	-7.54	1.00 V	40	19.03	13.42
3	99.89	32.97 QP	43.50	-10.53	1.25 V	295	21.03	11.94
4	150.45	42.14 QP	43.50	-1.36	1.00 V	88	27.60	14.54
5	162.11	42.40 QP	43.50	-1.10	1.00 V	304	27.69	14.71
6	199.05	32.97 QP	43.50	-10.53	1.50 V	280	21.89	11.08
7	265.16	37.48 QP	46.00	-8.52	1.00 V	79	23.05	14.42

- REMARKS:**
1. Emission level (dBuV/m) = Raw Value (dBuV) + Correction Factor (dB/m).
  2. Correction Factor (dB/m) = Antenna Factor (dB/m) + Cable Factor (dB).
  3. The other emission levels were very low against the limit.
  4. Margin value = Emission level – Limit value.

## 4.2 CONDUCTED EMISSION MEASUREMENT

### 4.2.1 LIMITS OF CONDUCTED EMISSION MEASUREMENT

FREQUENCY OF EMISSION (MHz)	CONDUCTED LIMIT (dB $\mu$ V)	
	Quasi-peak	Average
0.15 ~ 0.5	66 to 56	56 to 46
0.5 ~ 5	56	46
5 ~ 30	60	50

- NOTE:** 1. The lower limit shall apply at the transition frequencies.
2. The limit decreases in line with the logarithm of the frequency in the range of 0.15 to 0.50MHz.
3. All emanations from a class A/B digital device or system, including any network of conductors and apparatus connected thereto, shall not exceed the level of field strengths specified above.

### 4.2.2 TEST INSTRUMENTS

DESCRIPTION & MANUFACTURER	MODEL NO.	SERIAL NO.	DATE OF CALIBRATION	DUE DATE OF CALIBRATION
Test Receiver ROHDE & SCHWARZ	ESCS30	100291	Nov. 22, 2007	Nov. 21, 2008
RF signal cable Woken	5D-FB	Cable-HYC01-01	Jan. 04, 2008	Jan. 03, 2009
LISN ROHDE & SCHWARZ	ESH3-Z5	100312	Jun. 13, 2008	Jun. 12, 2009
LISN ROHDE & SCHWARZ	ESH2-Z5	100104	Sep. 12, 2007	Sep. 11, 2008
Software ADT	ADT_Cond_V3	NA	NA	NA

- NOTE:** 1. The calibration interval of the above test instruments is 12 months and the calibrations are traceable to NML/ROC and NIST/USA.
2. The test was performed in HwaYa Shielded Room 1.
3. The VCCI Site Registration No. is C-2040.



#### 4.2.3 TEST PROCEDURES

- a. The EUT was placed 0.4 meters from the conducting wall of the shielded room with EUT being connected to the power mains through a line impedance stabilization network (LISN). Other support units were connected to the power mains through another LISN. The two LISNs provide 50 ohm/ 50uH of coupling impedance for the measuring instrument.
- b. Both lines of the power mains connected to the EUT were checked for maximum conducted interference.
- c. The frequency range from 150kHz to 30MHz was searched. Emission levels under (Limit - 20dB) was not recorded.

**NOTE:** All modes of operation were investigated and the worst-case emissions are reported.

#### 4.2.4 DEVIATION FROM TEST STANDARD

No deviation

#### 4.2.5 TEST SETUP

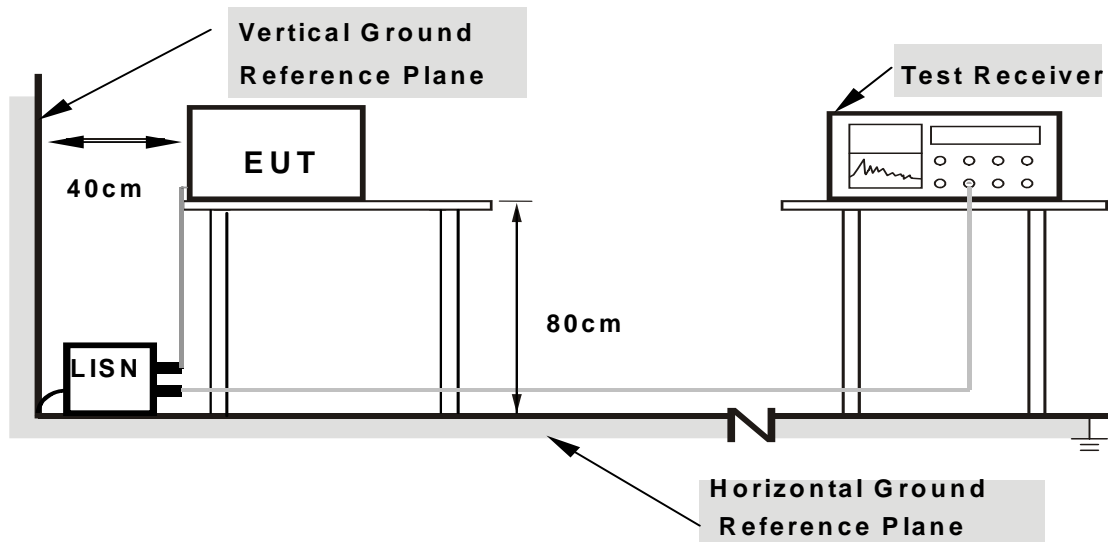

- Note:**
1. Support units were connected to second LISN.
  2. Both of LISNs (AMN) are 80 cm from EUT and at least 80 from other units and other metal planes

For the actual test configuration, please refer to the attached file (Test Setup Photo).

#### 4.2.6 EUT OPERATING CONDITIONS

Same as 4.1.6.

#### 4.2.7 TEST RESULTS

##### CONDUCTED WORST-CASE DATA : DRAFT 802.11n (20MHz) OFDM MODULATION

EUT TEST CONDITION		MEASUREMENT DETAIL	
CHANNEL	Channel 11	PHASE	Line 1
MODULATION TYPE	BPSK	INPUT POWER (SYSTEM)	120Vac, 60Hz
TRANSFER RATE	7.2Mbps	6dB BANDWIDTH	9kHz
ENVIRONMENTAL CONDITIONS	25deg. C, 63%RH, 988hPa	TESTED BY	Kevin Liang

No	Freq. [MHz]	Corr. Factor (dB)	Reading Value [dB (uV)]		Emission Level [dB (uV)]		Limit [dB (uV)]		Margin (dB)	
			Q.P.	AV.	Q.P.	AV.	Q.P.	AV.	Q.P.	AV.
			1	0.173	0.20	49.97	-	50.17	-	64.79
2	0.291	0.20	38.87	-	39.07	-	60.51	50.51	-21.44	-
3	1.969	0.20	34.87	-	35.07	-	56.00	46.00	-20.93	-
4	3.820	0.38	33.67	-	34.05	-	56.00	46.00	-21.95	-
5	10.387	0.55	25.85	-	26.40	-	60.00	50.00	-33.60	-
6	19.723	1.00	24.70	-	25.70	-	60.00	50.00	-34.30	-

- REMARKS:**
1. Q.P. and AV. are abbreviations of quasi-peak and average individually.
  2. "-": The Quasi-peak reading value also meets average limit and measurement with the average detector is unnecessary.
  3. The emission levels of other frequencies were very low against the limit.
  4. Margin value = Emission level - Limit value
  5. Correction factor = Insertion loss + Cable loss
  6. Emission Level = Correction Factor + Reading Value.

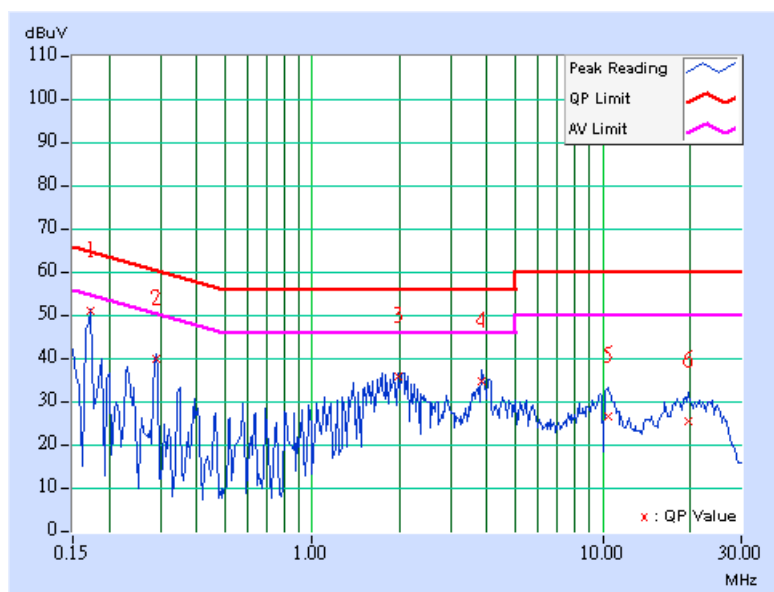

EUT TEST CONDITION		MEASUREMENT DETAIL	
CHANNEL	Channel 11	PHASE	Line 2
MODULATION TYPE	BPSK	INPUT POWER (SYSTEM)	120Vac, 60Hz
TRANSFER RATE	7.2Mbps	6dB BANDWIDTH	9kHz
ENVIRONMENTAL CONDITIONS	25deg. C, 63%RH, 988hPa	TESTED BY	Kevin Liang

No	Freq. [MHz]	Corr. Factor (dB)	Reading Value [dB (uV)]		Emission Level [dB (uV)]		Limit [dB (uV)]		Margin (dB)	
			Q.P.	AV.	Q.P.	AV.	Q.P.	AV.	Q.P.	AV.
1	0.174	0.20	50.17	-	50.37	-	64.79	54.79	-14.42	-
2	0.229	0.20	41.04	-	41.24	-	62.47	52.47	-21.23	-
3	0.291	0.20	38.91	-	39.11	-	60.51	50.51	-21.40	-
4	0.463	0.20	31.76	-	31.96	-	56.65	46.65	-24.69	-
5	1.738	0.20	32.98	-	33.18	-	56.00	46.00	-22.82	-
6	3.702	0.37	31.71	-	32.08	-	56.00	46.00	-23.92	-

- REMARKS:**
1. Q.P. and AV. are abbreviations of quasi-peak and average individually.
  2. "-": The Quasi-peak reading value also meets average limit and measurement with the average detector is unnecessary.
  3. The emission levels of other frequencies were very low against the limit.
  4. Margin value = Emission level - Limit value
  5. Correction factor = Insertion loss + Cable loss
  6. Emission Level = Correction Factor + Reading Value.

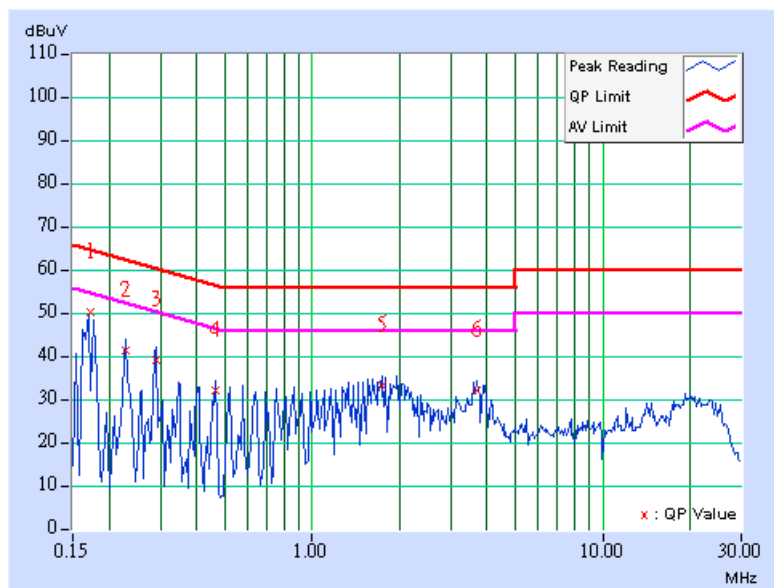



### 4.3 6dB BANDWIDTH MEASUREMENT

#### 4.3.1 LIMITS OF 6dB BANDWIDTH MEASUREMENT

The minimum of 6dB Bandwidth Measurement is 0.5 MHz.

#### 4.3.2 TEST INSTRUMENTS

DESCRIPTION & MANUFACTURER	MODEL NO.	SERIAL NO.	DATE OF CALIBRATION	CALIBRATED UNTIL
R&S SPECTRUM ANALYZER	FSP40	100041	Apr. 22, 2008	Apr. 21, 2009

**NOTE:** The calibration interval of the above test instruments is 12 months and the calibrations are traceable to NML/ROC and NIST/USA.

#### 4.3.3 TEST PROCEDURE

The transmitter output was connected to the spectrum analyzer through an attenuator. The bandwidth of the fundamental frequency was measured by spectrum analyzer with 100kHz RBW and 300kHz VBW. The 6dB bandwidth is defined as the total spectrum the power of which is higher than peak power minus 6dB.

#### 4.3.4 DEVIATION FROM TEST STANDARD

No deviation

#### 4.3.5 TEST SETUP

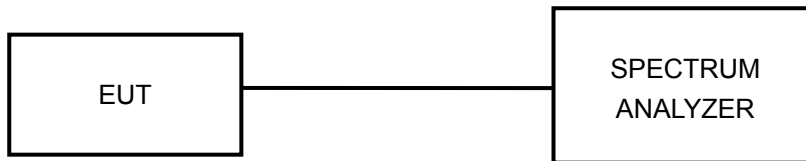

#### 4.3.6 EUT OPERATING CONDITIONS

The software provided by client to enable the EUT under transmission condition continuously at lowest, middle and highest channel frequencies individually.

### 4.3.7 TEST RESULTS

#### 802.11b DSSS MODULATION

<b>MODULATION TYPE</b>	DBPSK	<b>TRANSFER RATE</b>	1.0Mbps
<b>INPUT POWER (SYSTEM)</b>	120Vac, 60Hz	<b>ENVIRONMENTAL CONDITIONS</b>	25deg.C, 63%RH, 991hPa
<b>TESTED BY</b>	Dean Wang		

CHANNEL	CHANNEL FREQUENCY (MHz)	6dB BANDWIDTH (MHz)	MINIMUM LIMIT (MHz)	PASS / FAIL
1	2412	11.11	0.5	PASS
6	2437	10.12	0.5	PASS
11	2462	11.09	0.5	PASS

#### CH 1

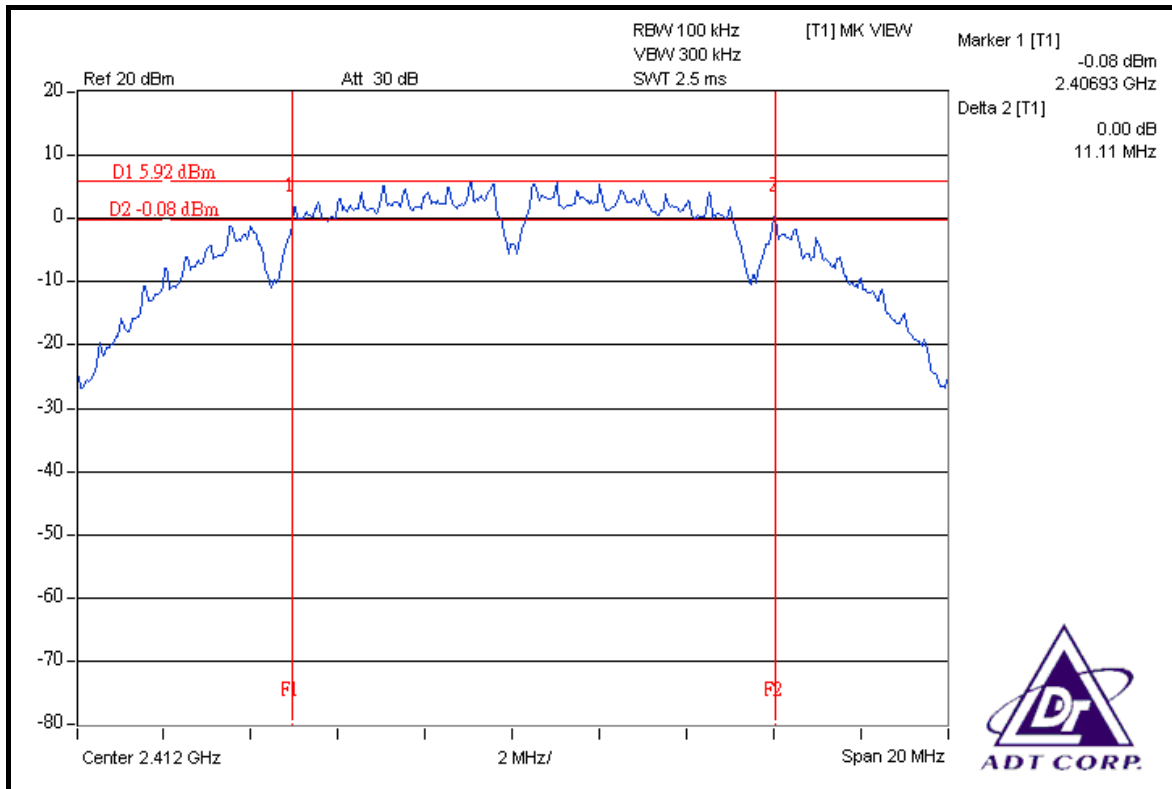

### CH 6

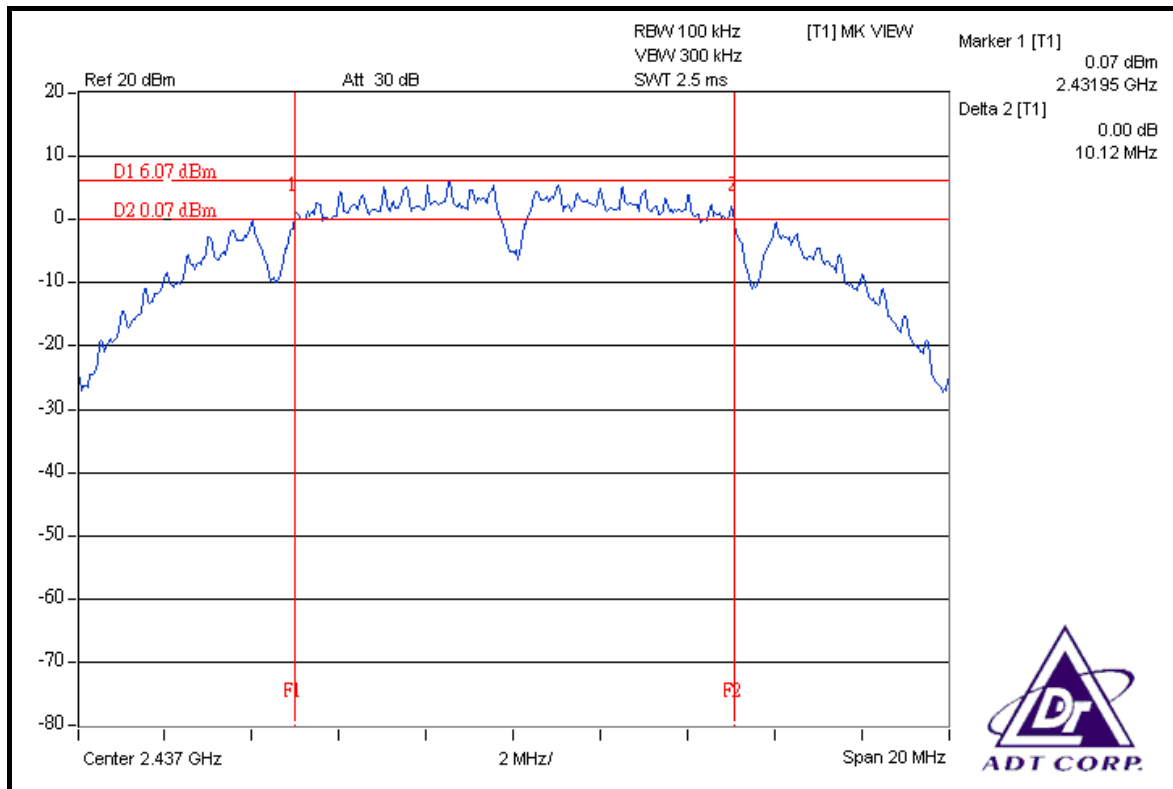

### CH 11

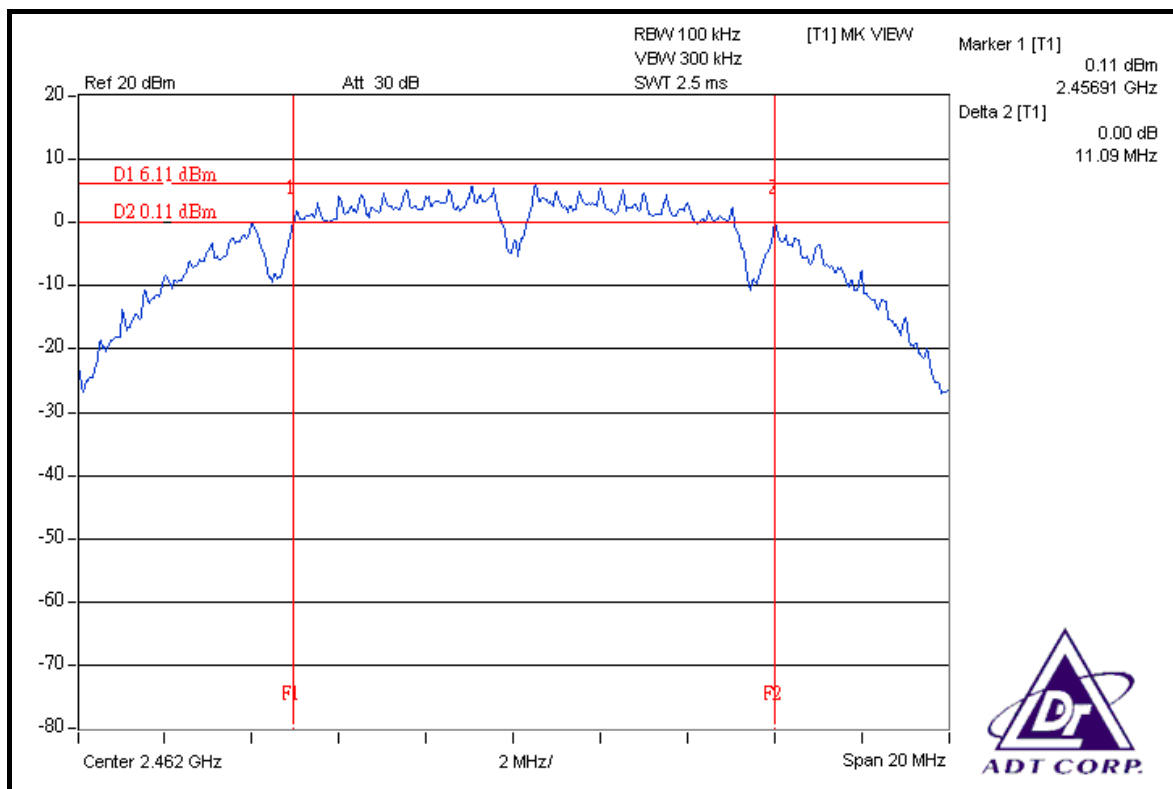





### 802.11g OFDM MODULATION

<b>MODULATION TYPE</b>	BPSK	<b>TRANSFER RATE</b>	6.0Mbps
<b>INPUT POWER (SYSTEM)</b>	120Vac, 60Hz	<b>ENVIRONMENTAL CONDITIONS</b>	25deg.C, 63%RH, 991hPa
<b>TESTED BY</b>	Dean Wang		

CHANNEL	CHANNEL FREQUENCY (MHz)	6dB BANDWIDTH (MHz)	MINIMUM LIMIT (MHz)	PASS / FAIL
1	2412	16.38	0.5	PASS
6	2437	16.42	0.5	PASS
11	2462	16.42	0.5	PASS

### CH 1

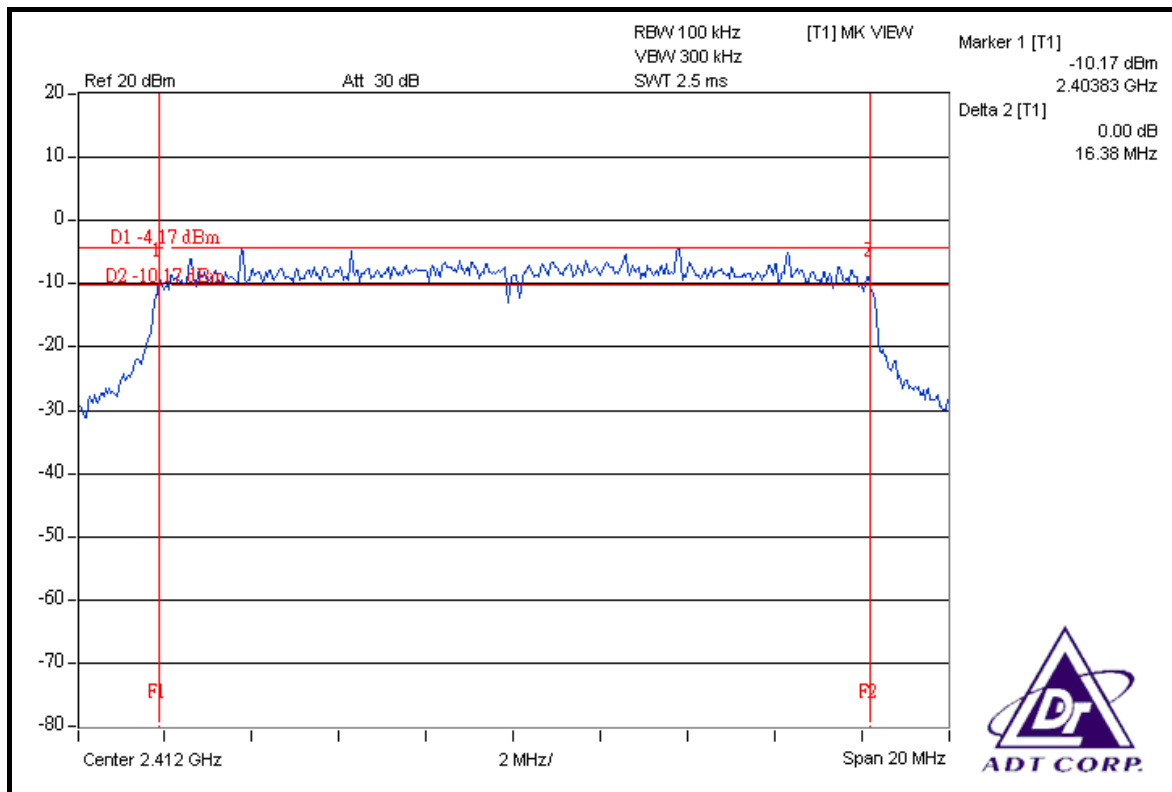

### CH 6

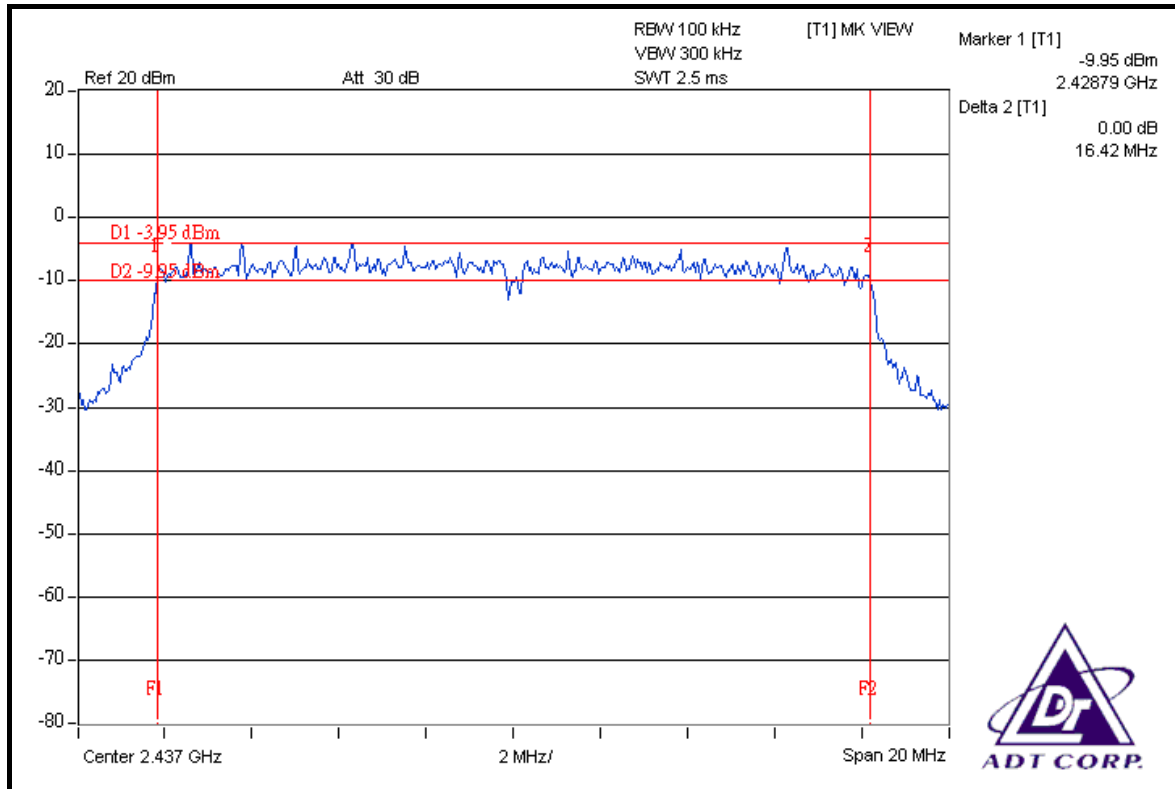

### CH 11

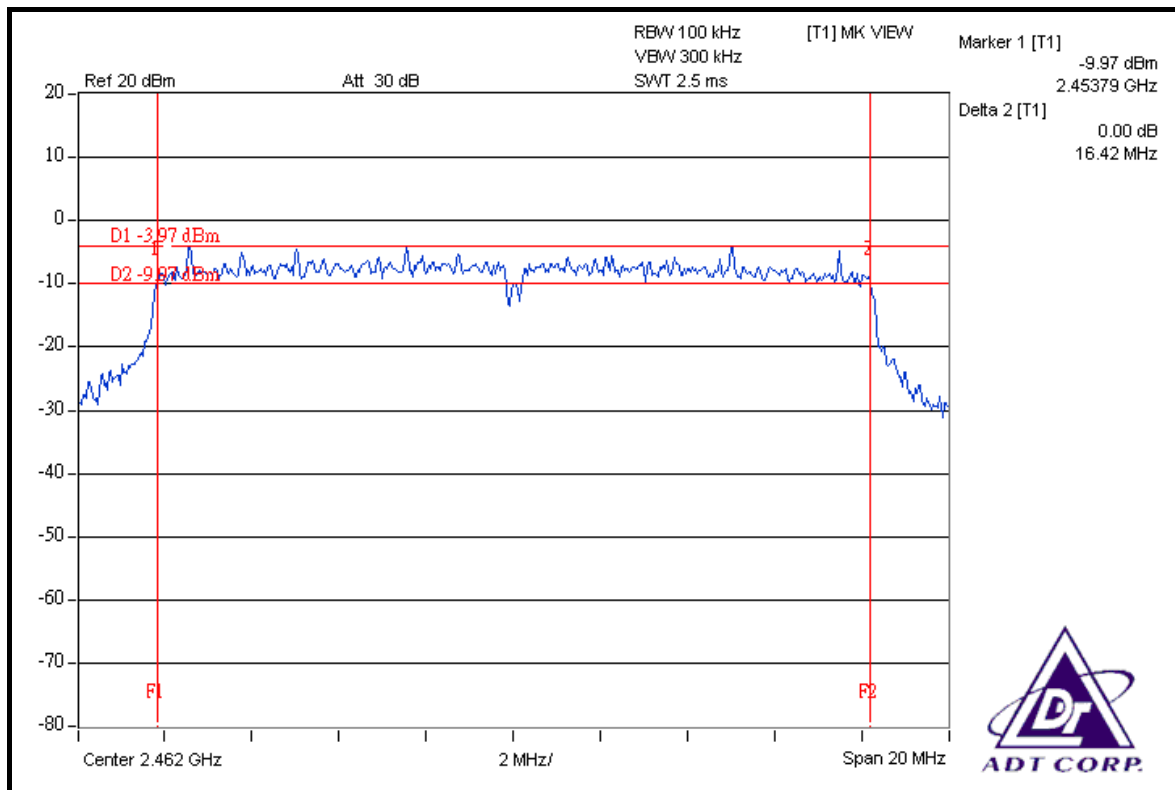



**DRAFT 802.11n (20MHz) OFDM MODULATION**

<b>MODULATION TYPE</b>	BPSK	<b>TRANSFER RATE</b>	7.2Mbps
<b>INPUT POWER (SYSTEM)</b>	120Vac, 60Hz	<b>ENVIRONMENTAL CONDITIONS</b>	25deg.C, 63%RH, 991hPa
<b>TESTED BY</b>	Dean Wang		

CHANNEL	CHANNEL FREQUENCY (MHz)	6dB BANDWIDTH (MHz)			MINIMUM LIMIT (MHz)	PASS / FAIL
		CHAIN 0	CHAIN 1	CHAIN 2		
1	2412	16.47	17.37	17.33	0.5	PASS
6	2437	16.58	17.63	17.34	0.5	PASS
11	2462	16.47	17.66	16.41	0.5	PASS

**FOR CHAIN 0: CH 1**

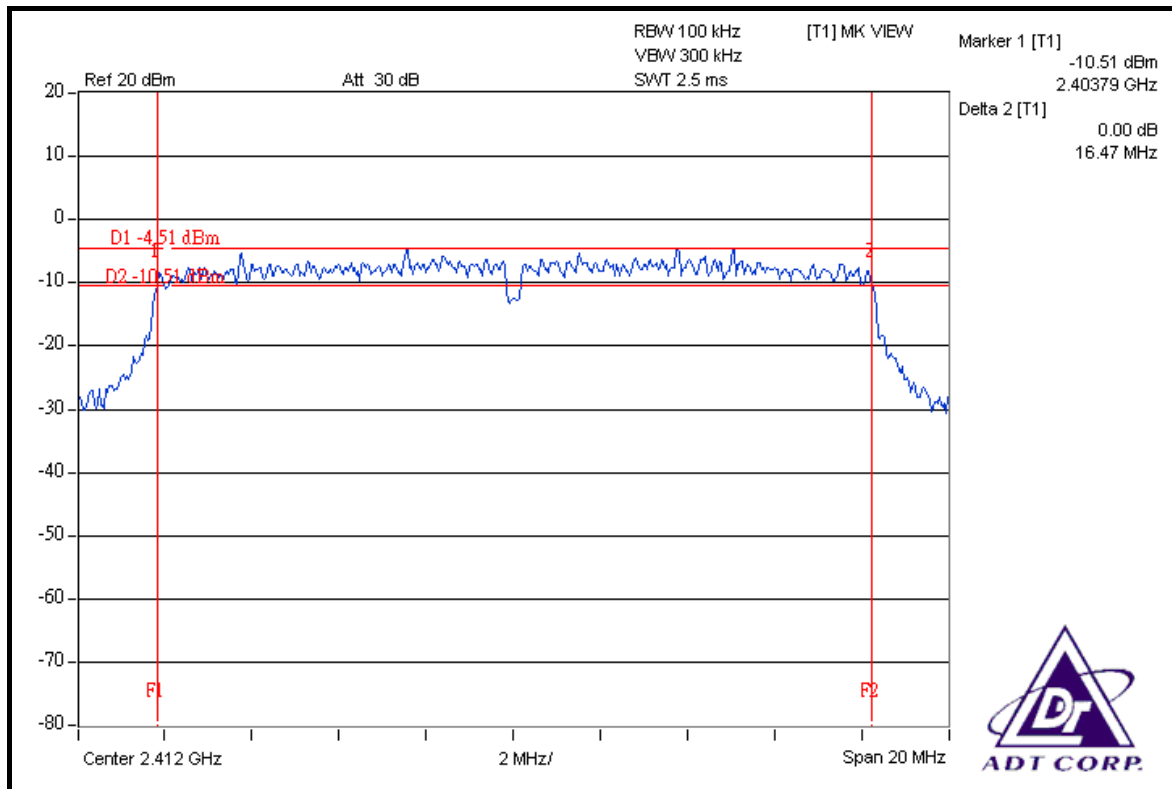

### CH 6

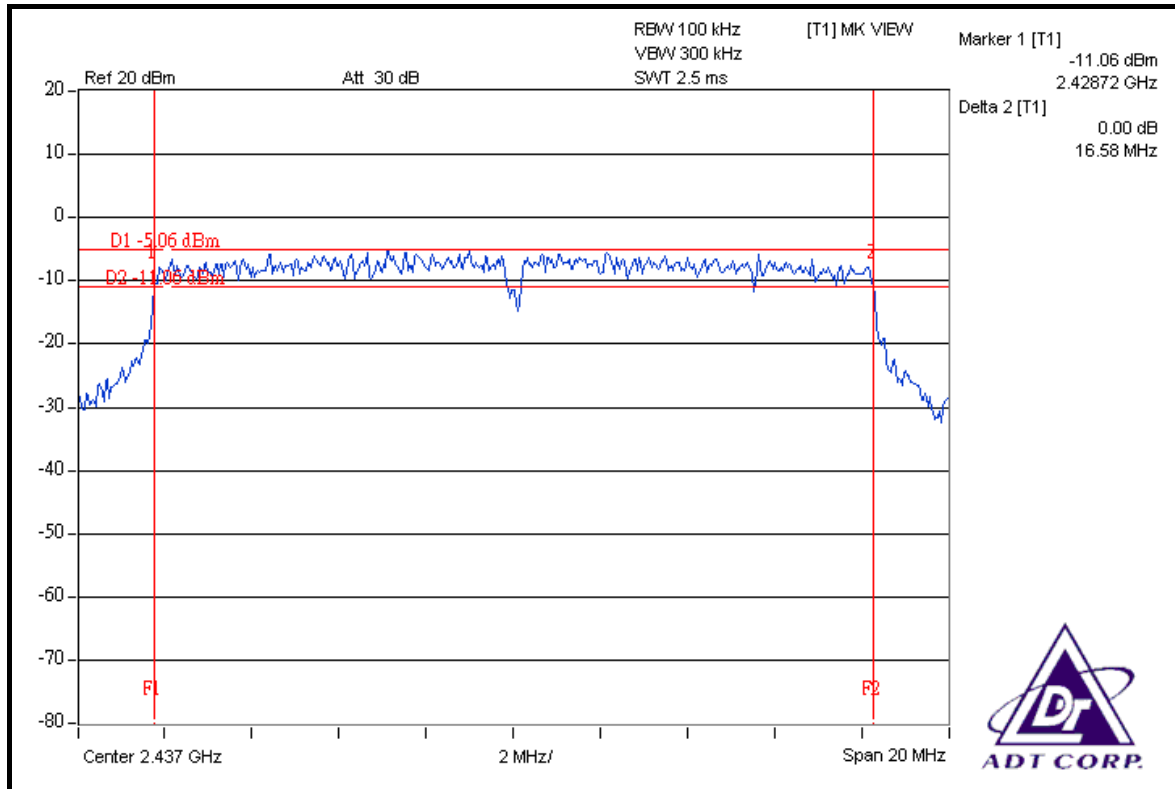

### CH 11

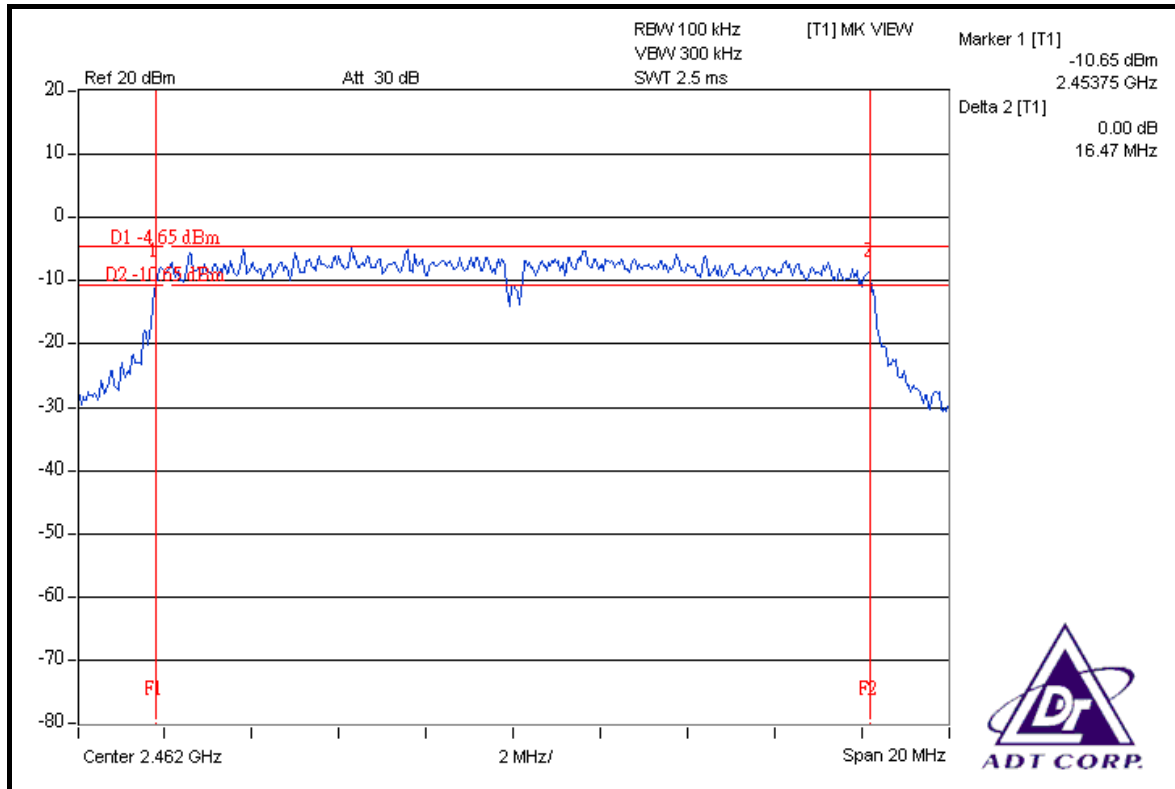

### FOR CHAIN 1: CH 1

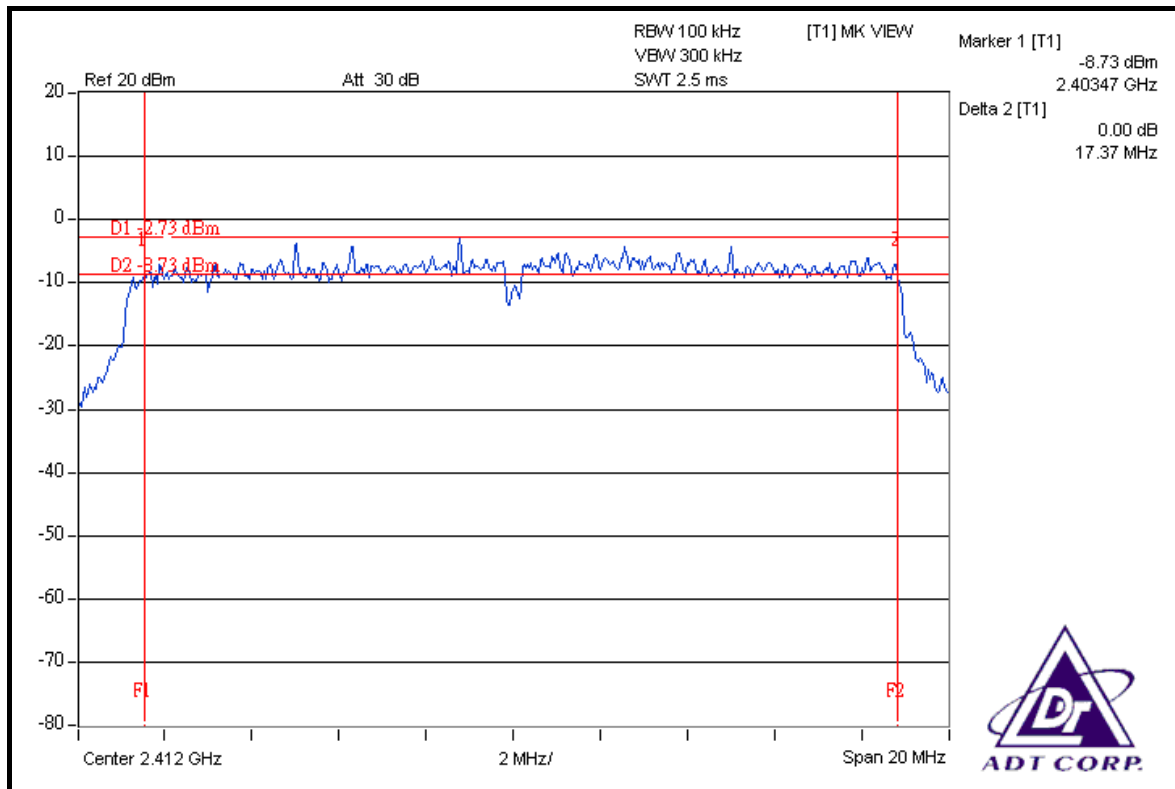

### CH 6

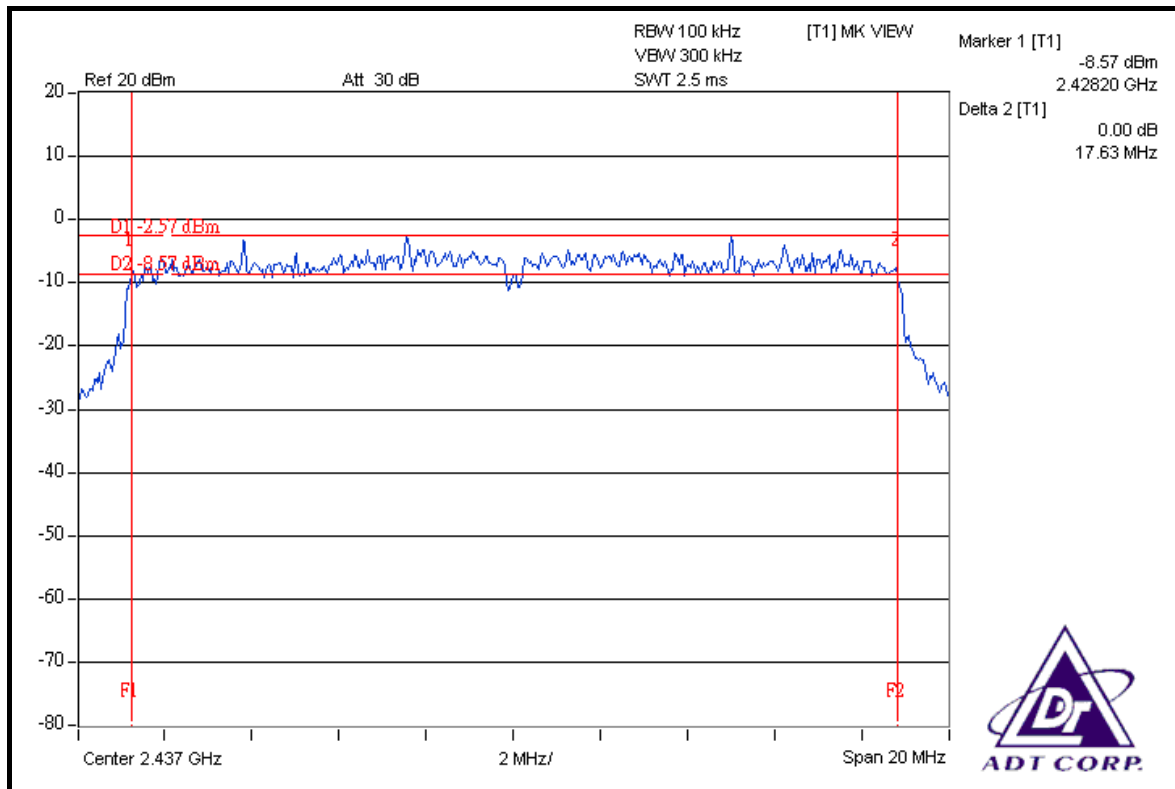

### CH 11

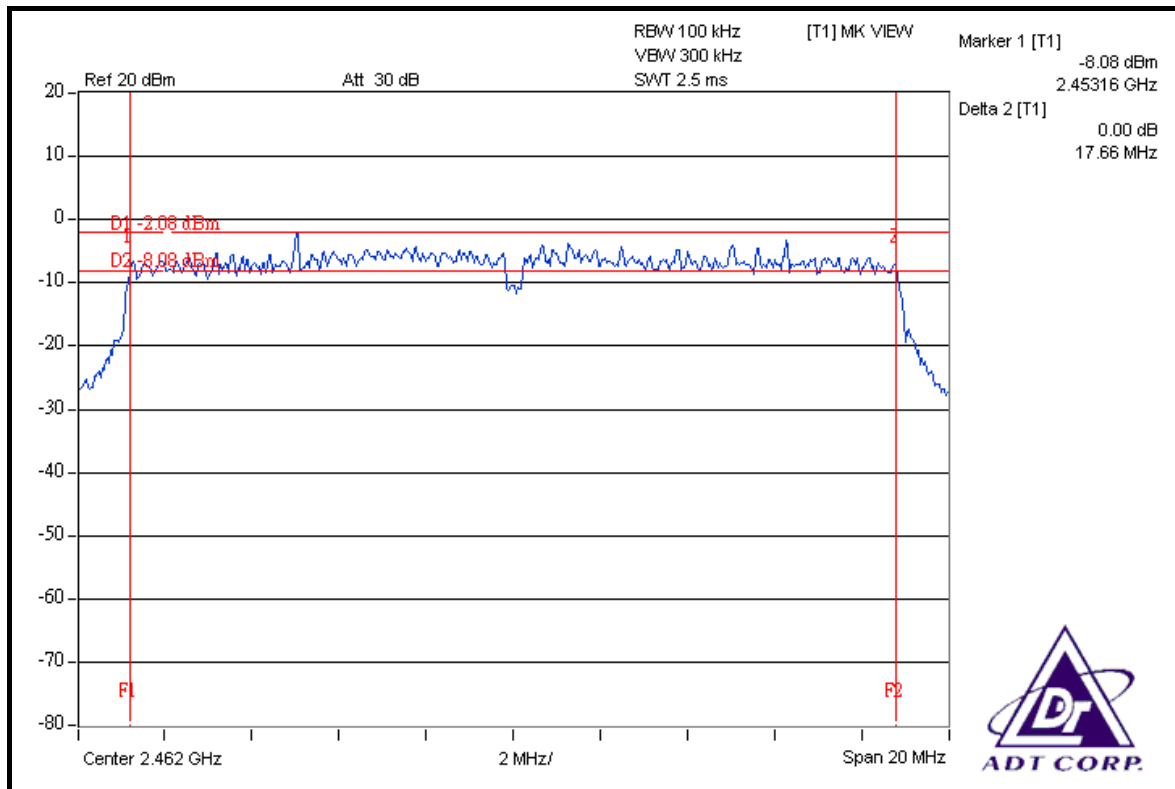

### FOR CHAIN 2: CH 1

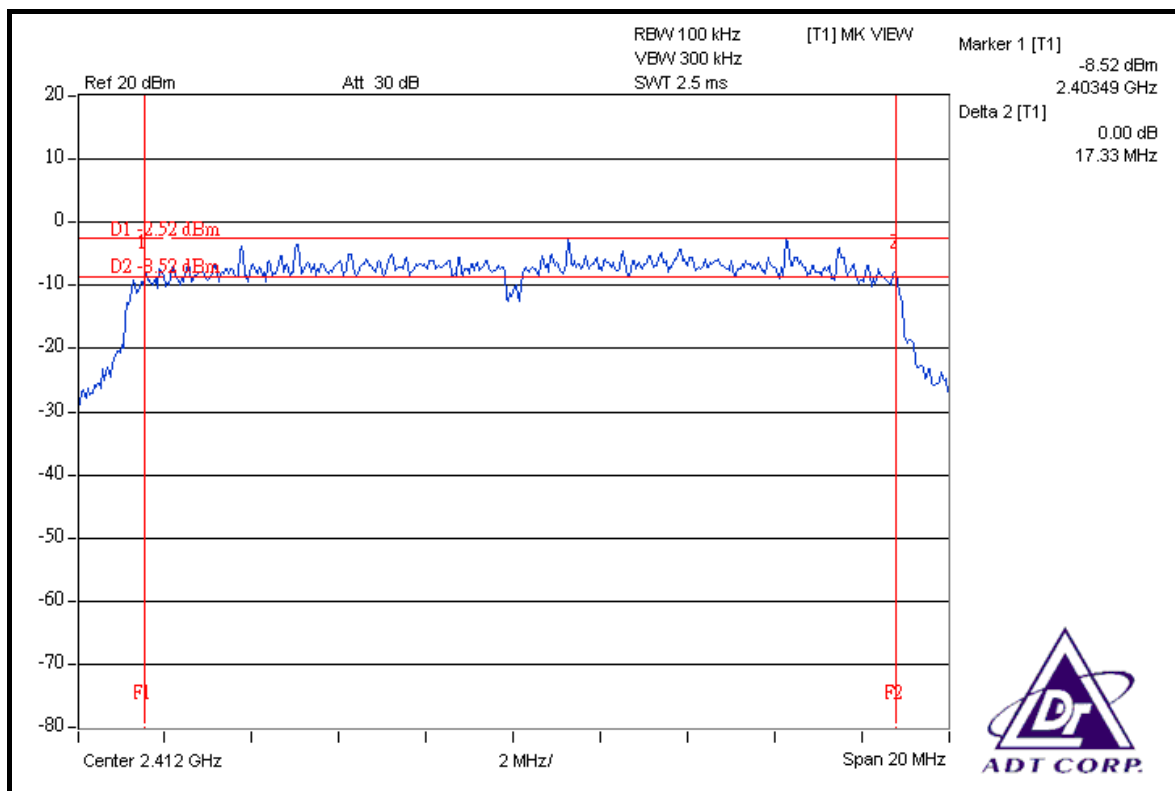

### CH 6

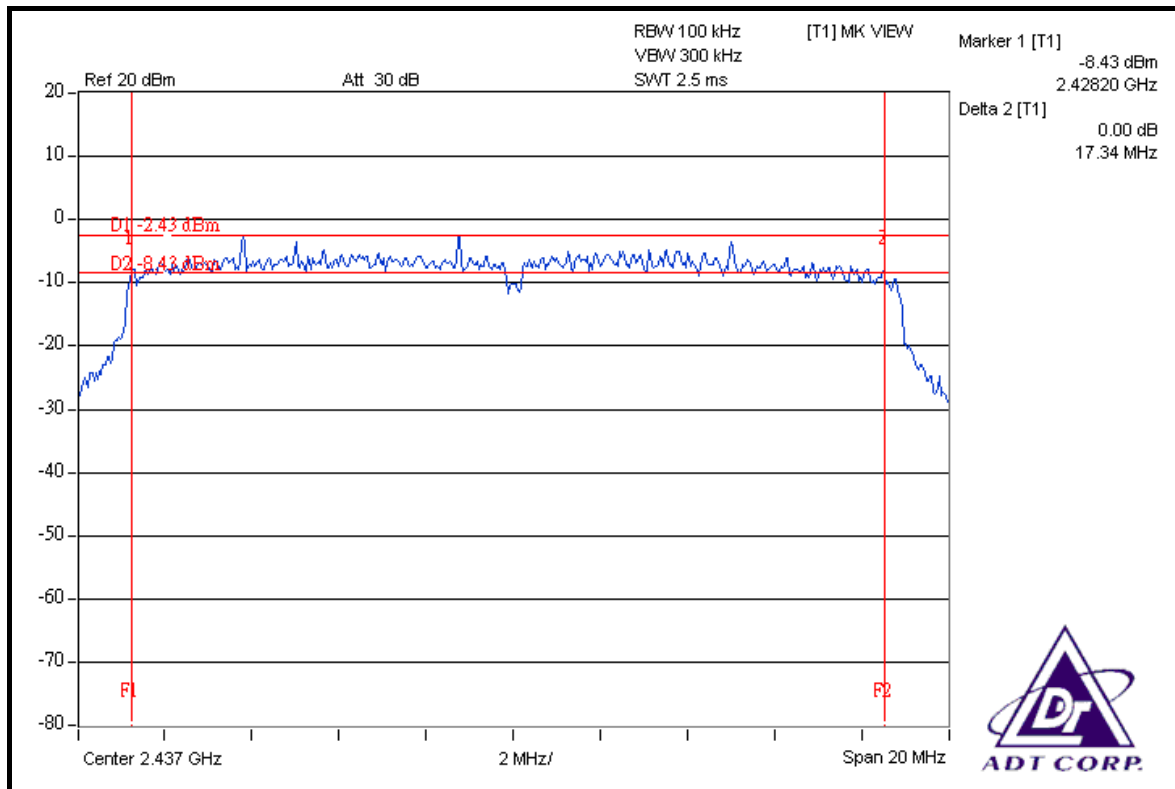

### CH 11

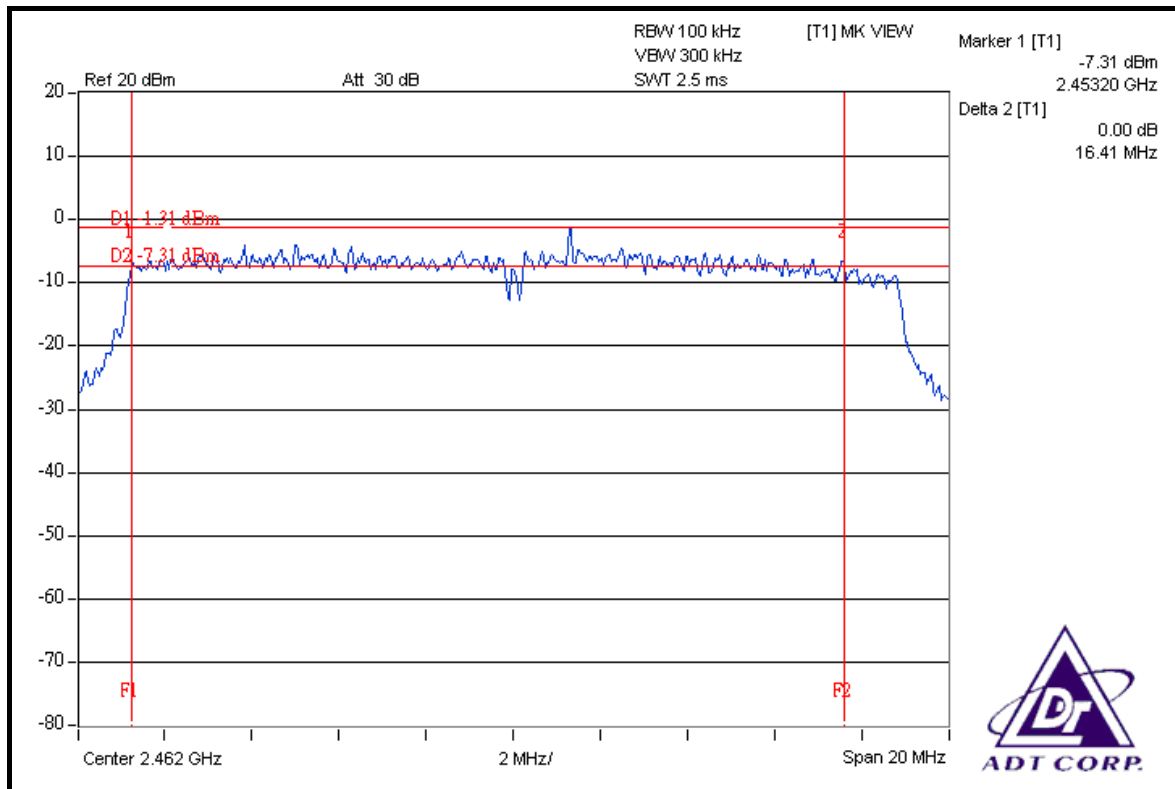



**DRAFT 802.11n (40MHz) OFDM MODULATION**

<b>MODULATION TYPE</b>	BPSK	<b>TRANSFER RATE</b>	15Mbps
<b>INPUT POWER (SYSTEM)</b>	120Vac, 60Hz	<b>ENVIRONMENTAL CONDITIONS</b>	25deg.C, 63%RH, 991hPa
<b>TESTED BY</b>	Dean Wang		

CHANNEL	CHANNEL FREQUENCY (MHz)	6dB BANDWIDTH (MHz)			MINIMUM LIMIT (MHz)	PASS / FAIL
		CHAIN 0	CHAIN 1	CHAIN 2		
1	2422	36.35	35.83	36.19	0.5	PASS
4	2437	36.37	36.51	35.81	0.5	PASS
7	2452	36.51	36.51	35.87	0.5	PASS

**FOR CHAIN 0: CH 1**

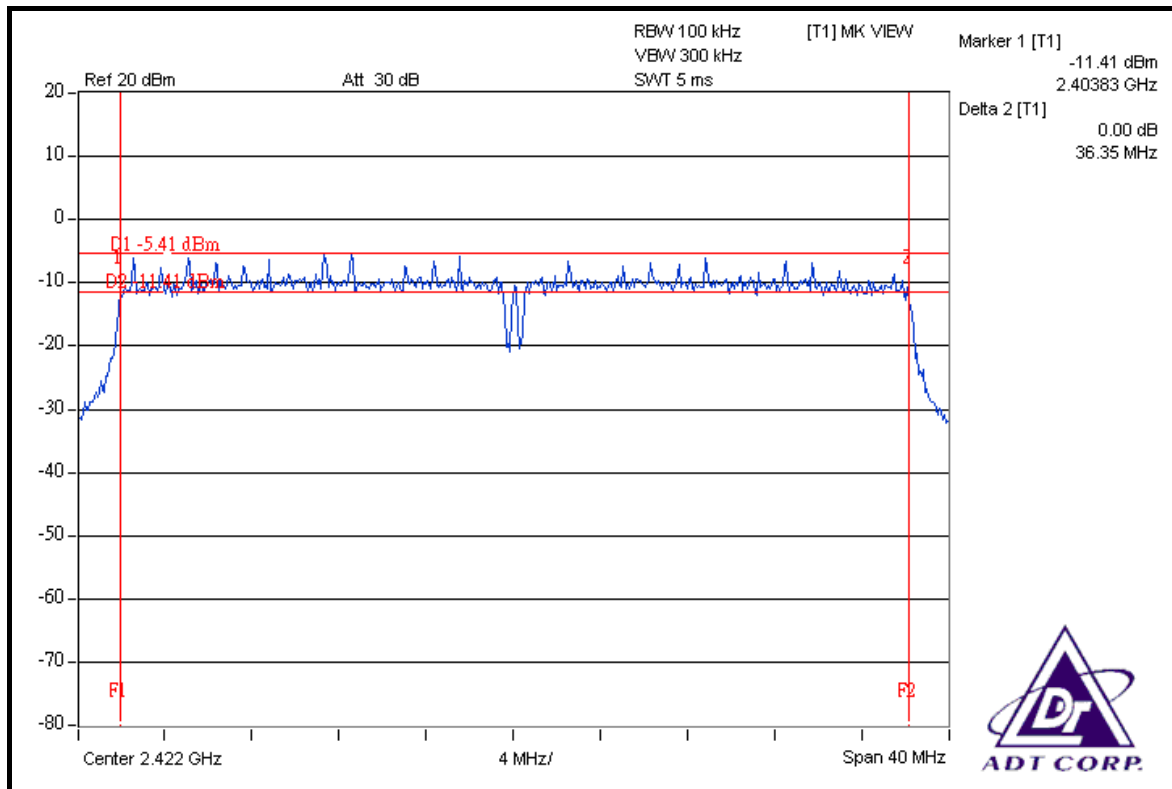



### CH 4

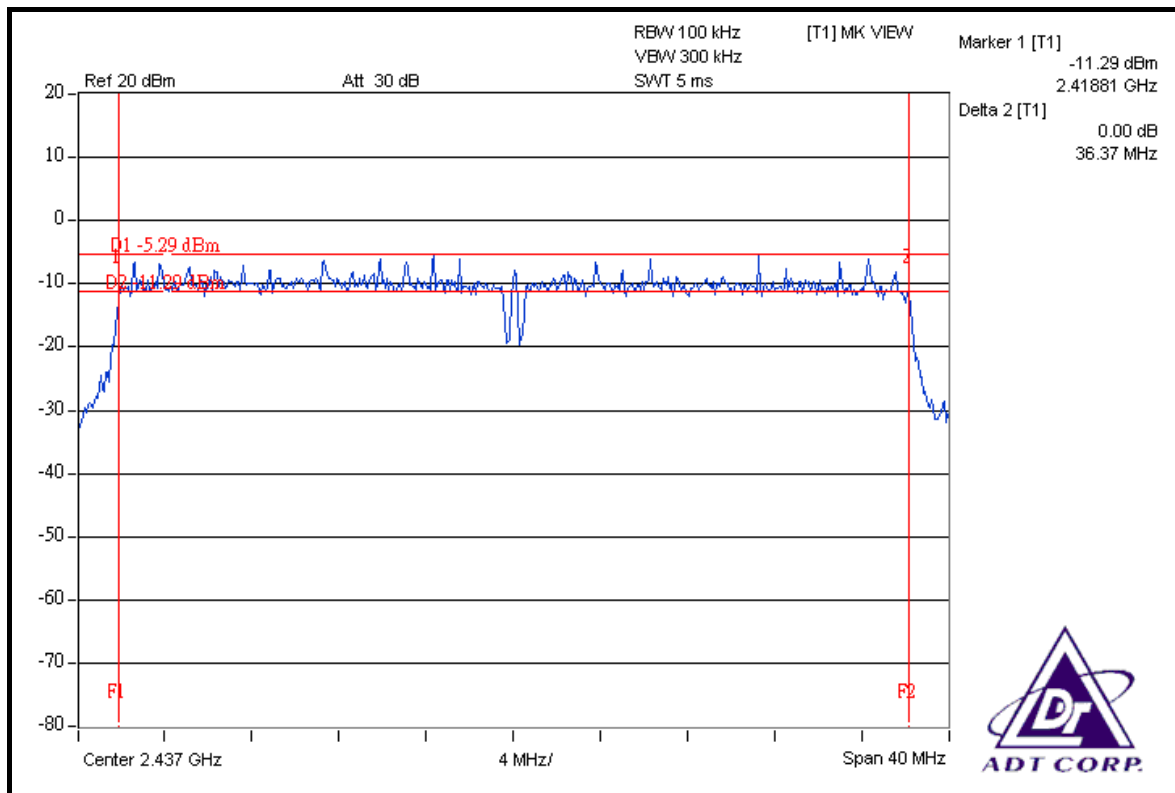

### CH 7

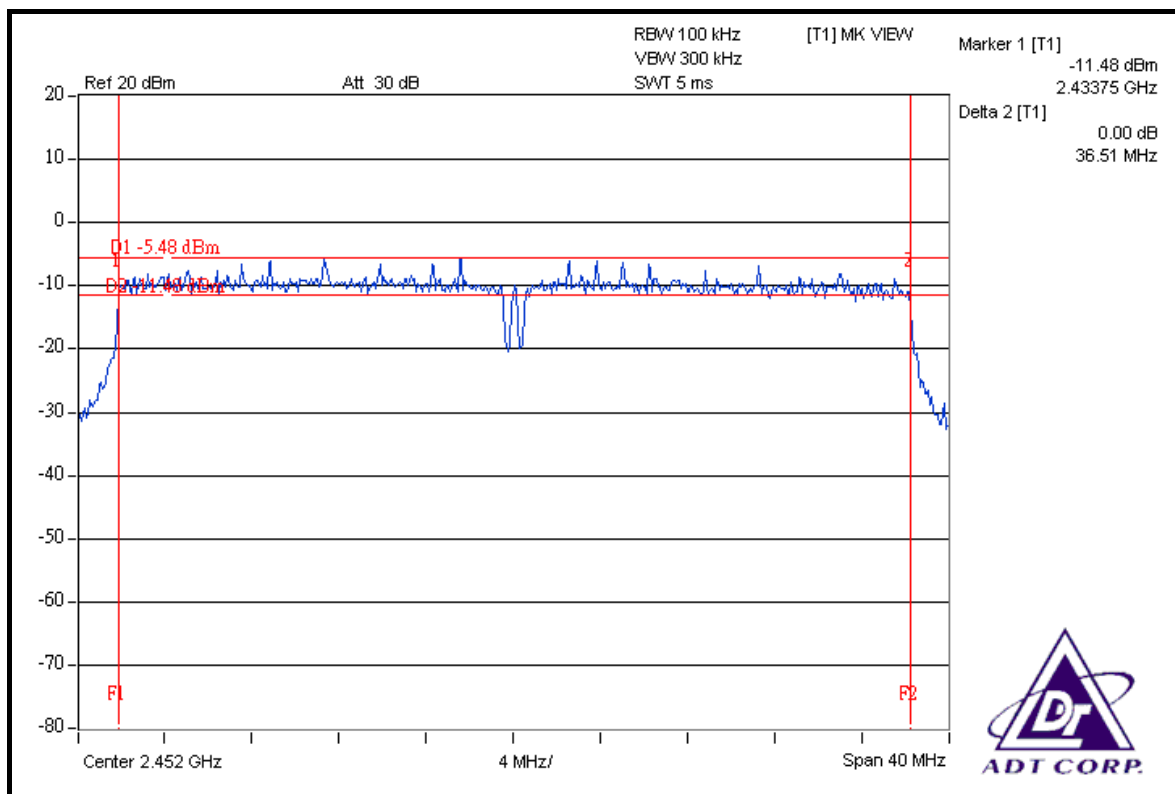



### FOR CHAIN 1: CH 1

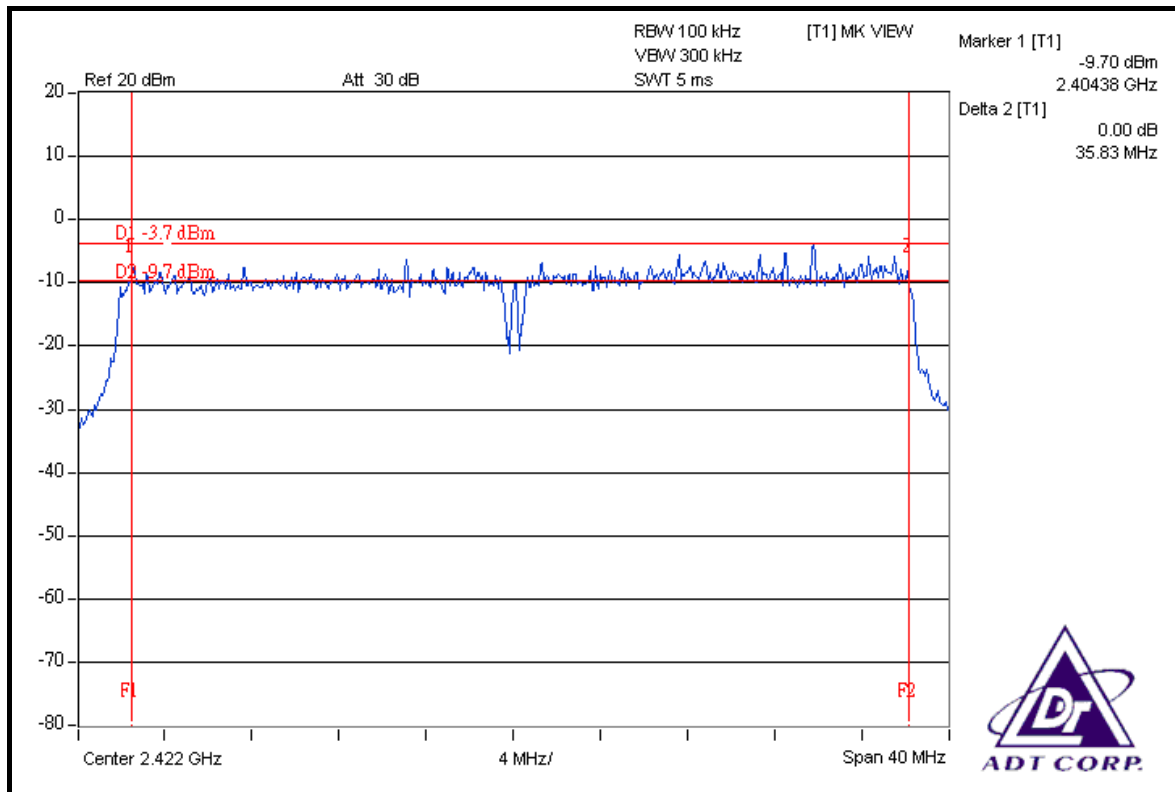

### CH 4

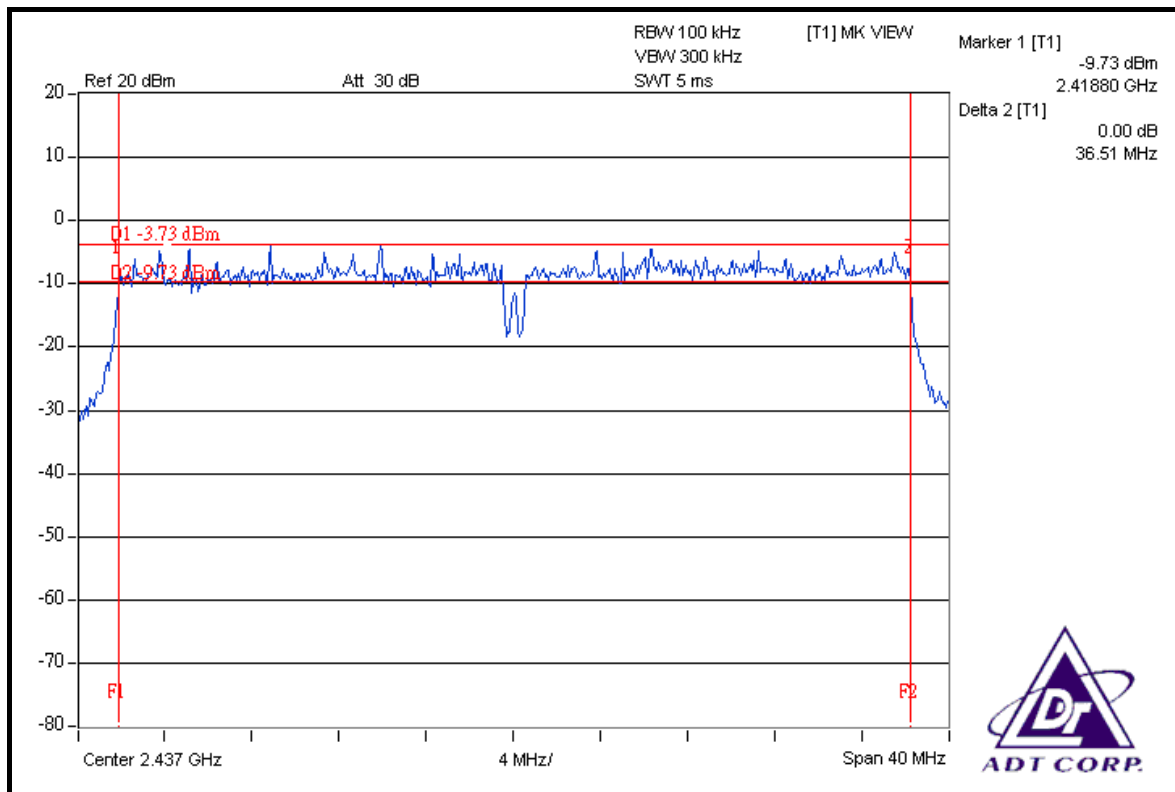



### CH 7

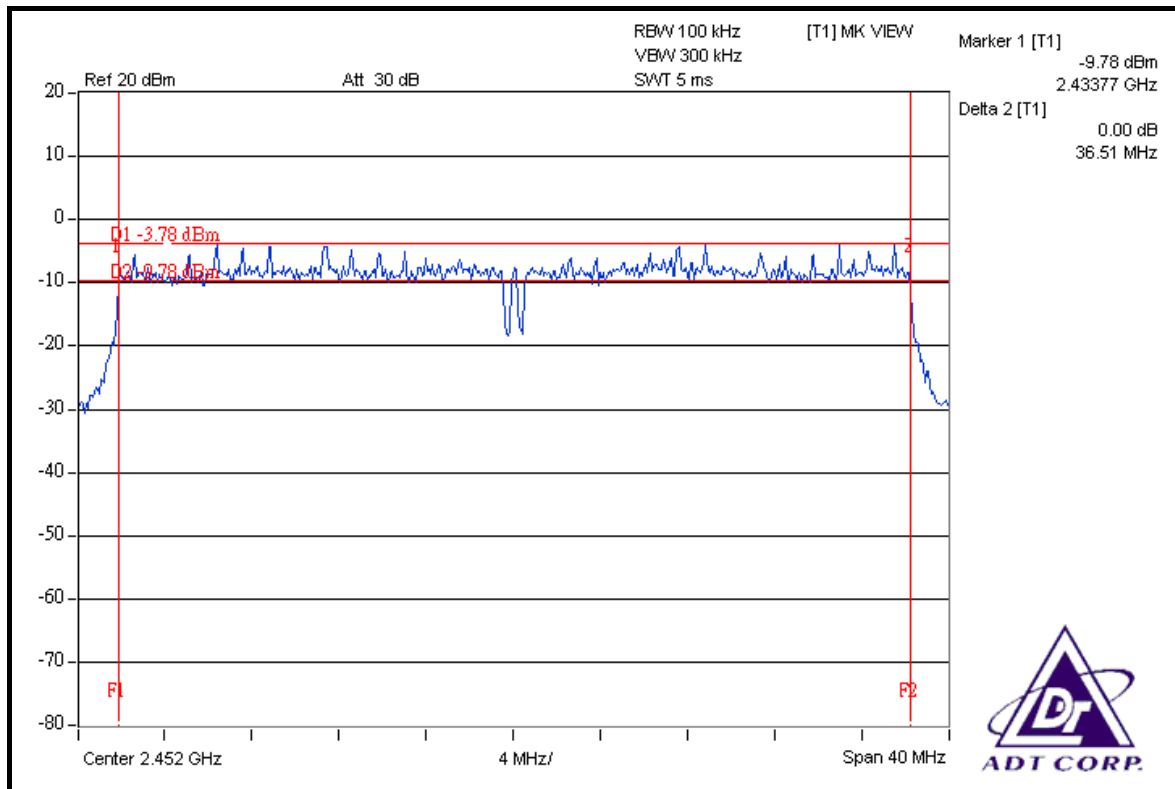

### FOR CHAIN 2: CH 1

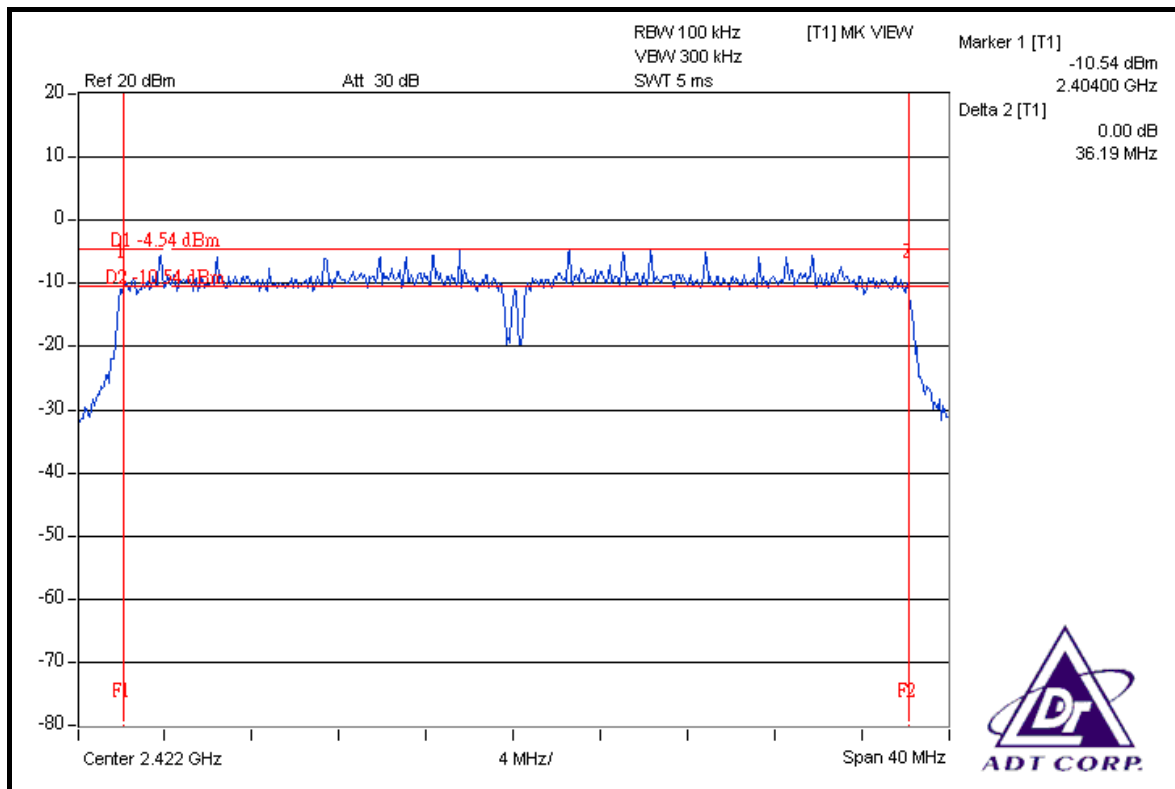

### CH 4

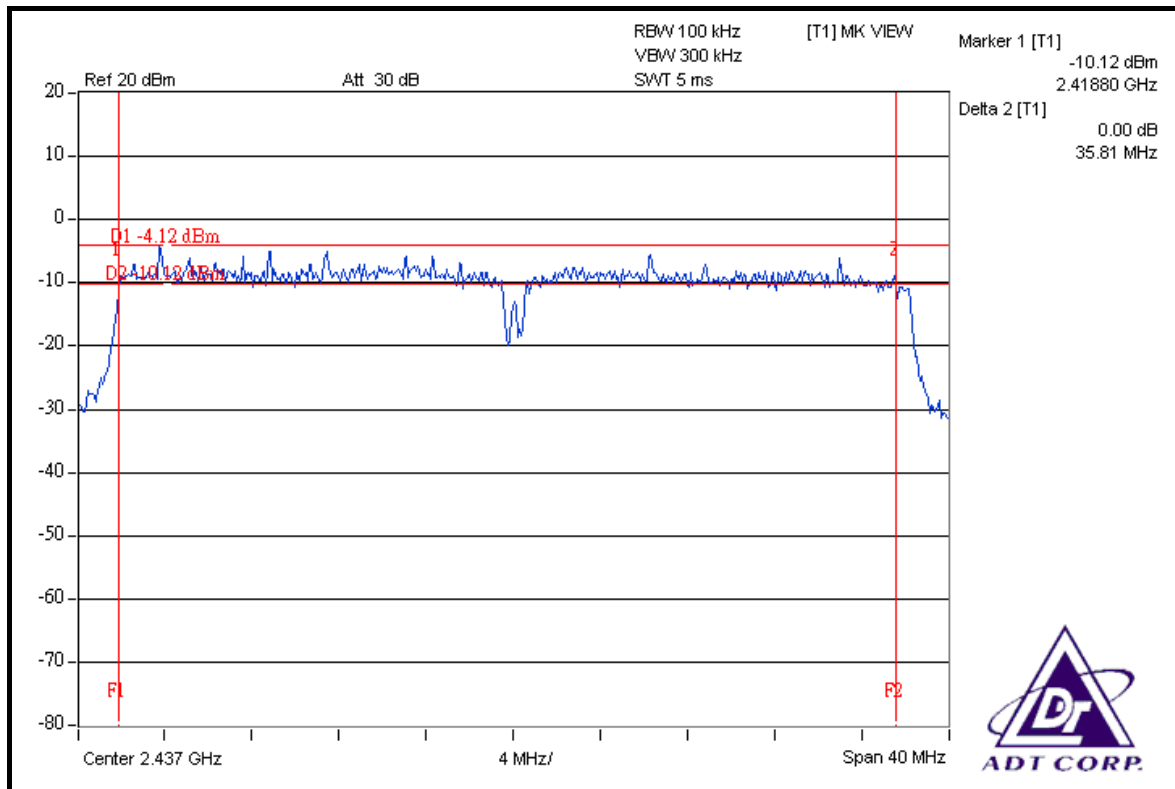

### CH 7

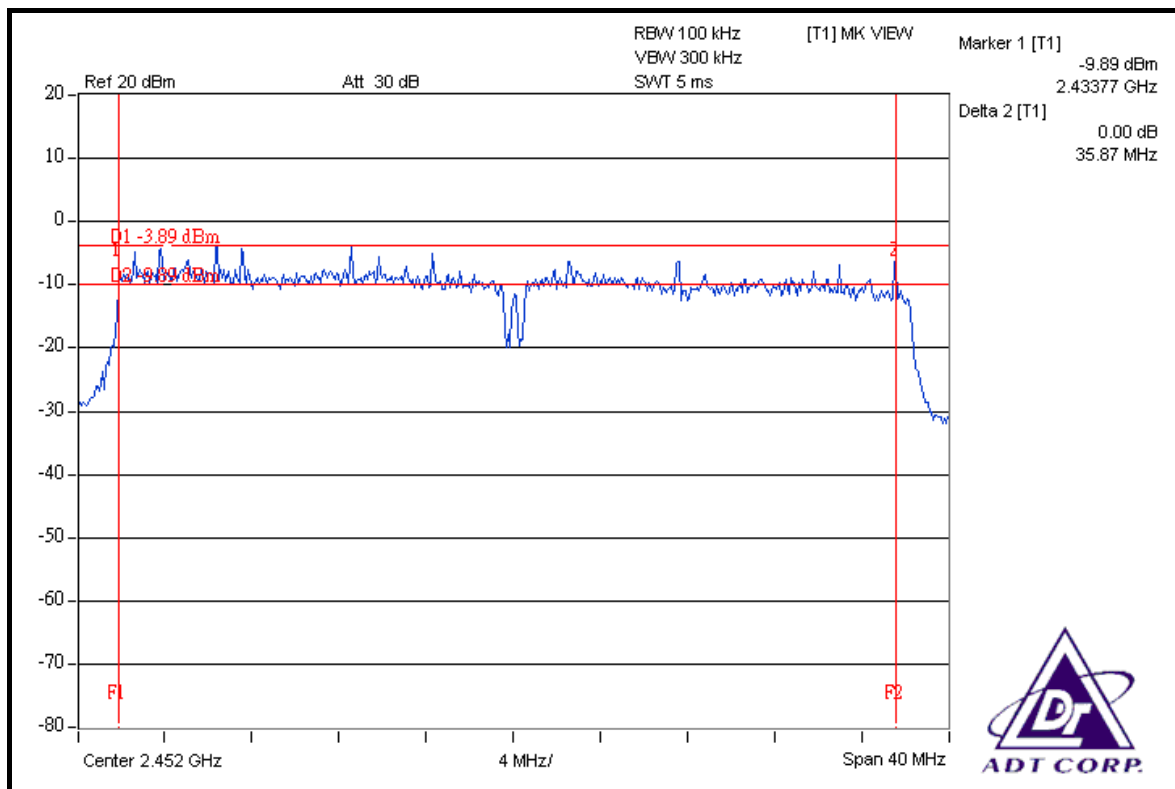



#### 4.4 MAXIMUM PEAK OUTPUT POWER

##### 4.4.1 LIMITS OF MAXIMUM PEAK OUTPUT POWER MEASUREMENT

The Maximum Peak Output Power Measurement is 30dBm.

##### 4.4.2 INSTRUMENTS

DESCRIPTION & MANUFACTURER	MODEL NO.	SERIAL NO.	DATE OF CALIBRATION	CALIBRATED UNTIL
High Speed Peak Power Meter	ML2495A	0824012	Aug. 04, 2008	Aug. 03, 2009
Power Sensor	MA2444B	0738138	Aug. 04, 2008	Aug. 03, 2009

**Note:**

1. The calibration interval of the above test instruments is 12 months and the calibrations are traceable to NML/ROC and NIST/USA.
2. Measurement Bandwidth of ML2495A is 65MHz greater than 6dB bandwidth of emission.

##### 4.4.3 TEST PROCEDURES

A power sensor was used on the output port of the EUT. A power meter was used to read the response of the power sensor. Record the power level.

#### 4.4.4 DEVIATION FROM TEST STANDARD

No deviation

#### 4.4.5 TEST SETUP

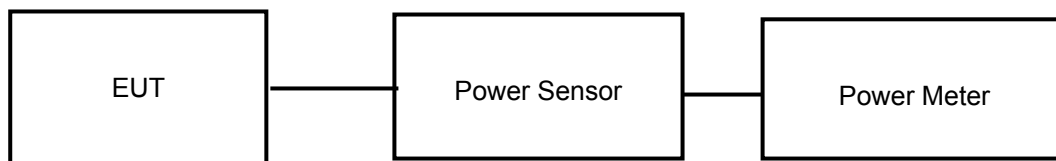

#### 4.4.6 EUT OPERATING CONDITIONS

Same as Item 4.3.6



#### 4.4.7 TEST RESULTS

##### 802.11b DSSS MODULATION

<b>MODULATION TYPE</b>	DBPSK	<b>TRANSFER RATE</b>	1.0Mbps
<b>INPUT POWER (SYSTEM)</b>	120Vac, 60Hz	<b>ENVIRONMENTAL CONDITIONS</b>	25deg.C, 63%RH, 991hPa
<b>TESTED BY</b>	Dean Wang		

CHANNEL	CHANNEL FREQUENCY (MHz)	PEAK POWER OUTPUT (mW)	PEAK POWER OUTPUT (dBm)	PEAK POWER LIMIT (dBm)	PASS / FAIL
1	2412	100.693	20.03	30	PASS
6	2437	101.859	20.08	30	PASS
11	2462	101.158	20.05	30	PASS

##### 802.11g OFDM MODULATION

<b>MODULATION TYPE</b>	BPSK	<b>TRANSFER RATE</b>	6.0Mbps
<b>INPUT POWER (SYSTEM)</b>	120Vac, 60Hz	<b>ENVIRONMENTAL CONDITIONS</b>	25 deg.C, 65 %RH, 991hPa
<b>TESTED BY</b>	Dean Wang		

CHANNEL	CHANNEL FREQUENCY (MHz)	PEAK POWER OUTPUT (mW)	PEAK POWER OUTPUT (dBm)	PEAK POWER LIMIT (dBm)	PASS / FAIL
1	2412	79.983	19.03	30	PASS
6	2437	80.353	19.05	30	PASS
11	2462	81.096	19.09	30	PASS



### DRAFT 802.11n (20MHz) OFDM MODULATION

<b>MODULATION TYPE</b>	BPSK	<b>TRANSFER RATE</b>	7.2Mbps
<b>INPUT POWER (SYSTEM)</b>	120Vac, 60Hz	<b>ENVIRONMENTAL CONDITIONS</b>	25 deg.C, 65 %RH, 991hPa
<b>TESTED BY</b>	Dean Wang		

CHAN.	CHAN. FREQ. (MHz)	PEAK POWER OUTPUT (dBm)			TOTAL PEAK POWER (mW)	TOTAL PEAK POWER (dBm)	PEAK POWER LIMIT (dBm)	PASS / FAIL
		CHAIN 0	CHAIN 1	CHAIN 2				
1	2412	19.05	18.56	18.53	223.417	23.49	30	PASS
6	2437	18.54	18.59	18.56	215.506	23.33	30	PASS
11	2462	19.09	19.10	19.58	253.161	24.03	30	PASS

### DRAFT 802.11n (40MHz) OFDM MODULATION:

<b>MODULATION TYPE</b>	BPSK	<b>TRANSFER RATE</b>	15Mbps
<b>INPUT POWER (SYSTEM)</b>	120Vac, 60Hz	<b>ENVIRONMENTAL CONDITIONS</b>	25deg.C, 63%RH, 991hPa
<b>TESTED BY</b>	Dean Wang		

CHAN.	CHAN. FREQ. (MHz)	PEAK POWER OUTPUT (dBm)			TOTAL PEAK POWER (mW)	TOTAL PEAK POWER (dBm)	PEAK POWER LIMIT (dBm)	PASS / FAIL
		CHAIN 0	CHAIN 1	CHAIN 2				
1	2422	19.11	19.08	18.61	234.991	23.71	30	PASS
4	2437	19.06	19.04	19.07	241.429	23.83	30	PASS
7	2452	19.08	19.02	19.11	242.179	23.84	30	PASS





## 4.5 POWER SPECTRAL DENSITY MEASUREMENT

### 4.5.1 LIMITS OF POWER SPECTRAL DENSITY MEASUREMENT

The Maximum of Power Spectral Density Measurement is 8dBm.

### 4.5.2 TEST INSTRUMENTS

DESCRIPTION & MANUFACTURER	MODEL NO.	SERIAL NO.	DATE OF CALIBRATION	CALIBRATED UNTIL
R&S SPECTRUM ANALYZER	FSP40	100041	Apr. 22, 2008	Apr. 21, 2009

**NOTE:** The calibration interval of the above test instruments is 12 months and the calibrations are traceable to NML/ROC and NIST/USA.

### 4.5.3 TEST PROCEDURE

The transmitter output was connected to the spectrum analyzer through an attenuator, the bandwidth of the fundamental frequency was measured with the spectrum analyzer using 3kHz RBW and 30kHz VBW, set sweep time = span/3kHz. The power spectral density was measured and recorded.

The sweep time is allowed to be longer than span/3kHz for a full response of the mixer in the spectrum analyzer.

#### 4.5.4 DEVIATION FROM TEST STANDARD

No deviation

#### 4.5.5 TEST SETUP

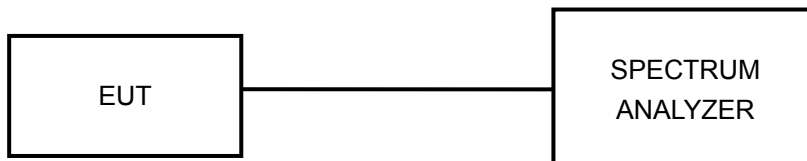

#### 4.5.6 EUT OPERATING CONDITION

Same as Item 4.3.6



### 4.5.7 TEST RESULTS

#### 802.11b DSSS MODULATION

<b>MODULATION TYPE</b>	DBPSK	<b>TRANSFER RATE</b>	1.0Mbps
<b>INPUT POWER (SYSTEM)</b>	120Vac, 60Hz	<b>ENVIRONMENTAL CONDITIONS</b>	25deg.C, 63%RH, 991hPa
<b>TESTED BY</b>	Dean Wang		

CHANNEL	CHANNEL FREQUENCY (MHz)	RF POWER LEVEL IN 3kHz BW (dBm)	MAXIMUM LIMIT (dBm)	PASS / FAIL
1	2412	-8.46	8	PASS
6	2437	-8.60	8	PASS
11	2462	-8.31	8	PASS

#### CH 1

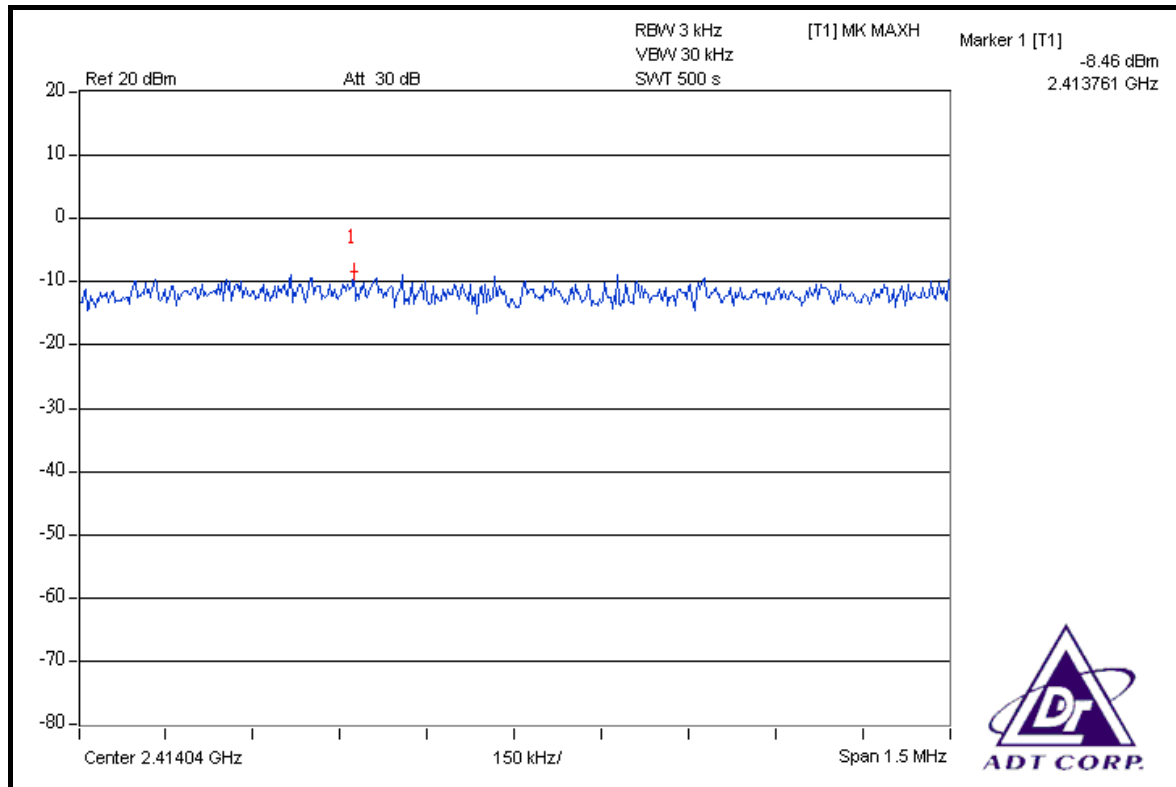

### CH 6

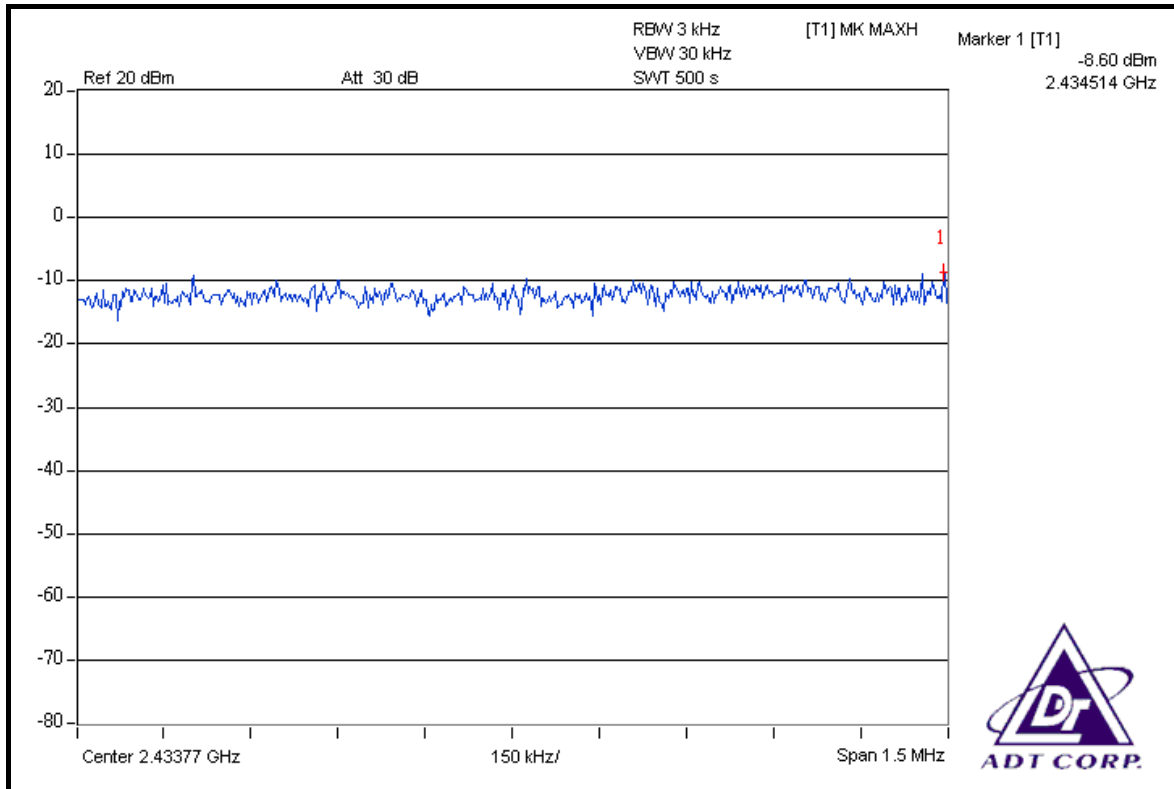

### CH 11

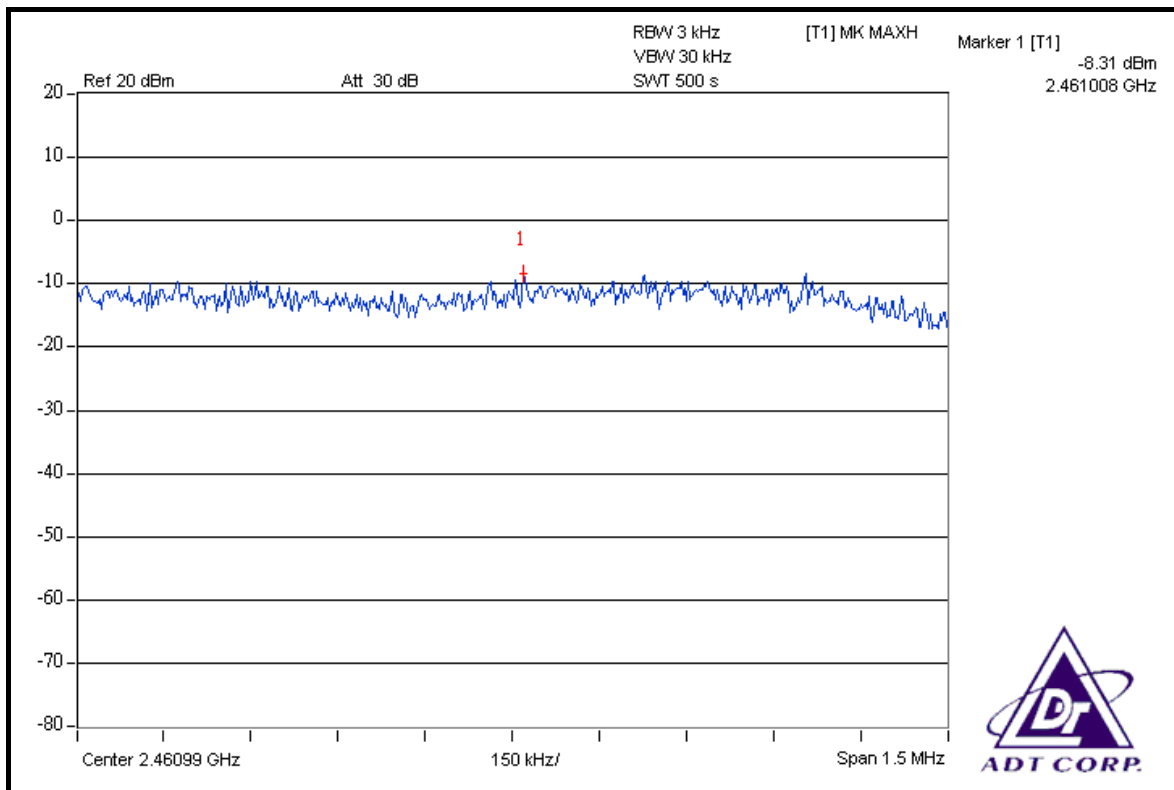



**802.11g OFDM MODULATION**

<b>MODULATION TYPE</b>	BPSK	<b>TRANSFER RATE</b>	6.0Mbps
<b>INPUT POWER (SYSTEM)</b>	120Vac, 60Hz	<b>ENVIRONMENTAL CONDITIONS</b>	25deg.C, 63%RH, 991hPa
<b>TESTED BY</b>	Long Chen		

CHANNEL	CHANNEL FREQUENCY (MHz)	RF POWER LEVEL IN 3kHz BW (dBm)	MAXIMUM LIMIT (dBm)	PASS / FAIL
1	2412	-11.31	8	PASS
6	2437	-11.38	8	PASS
11	2462	-11.38	8	PASS

**CH 1**

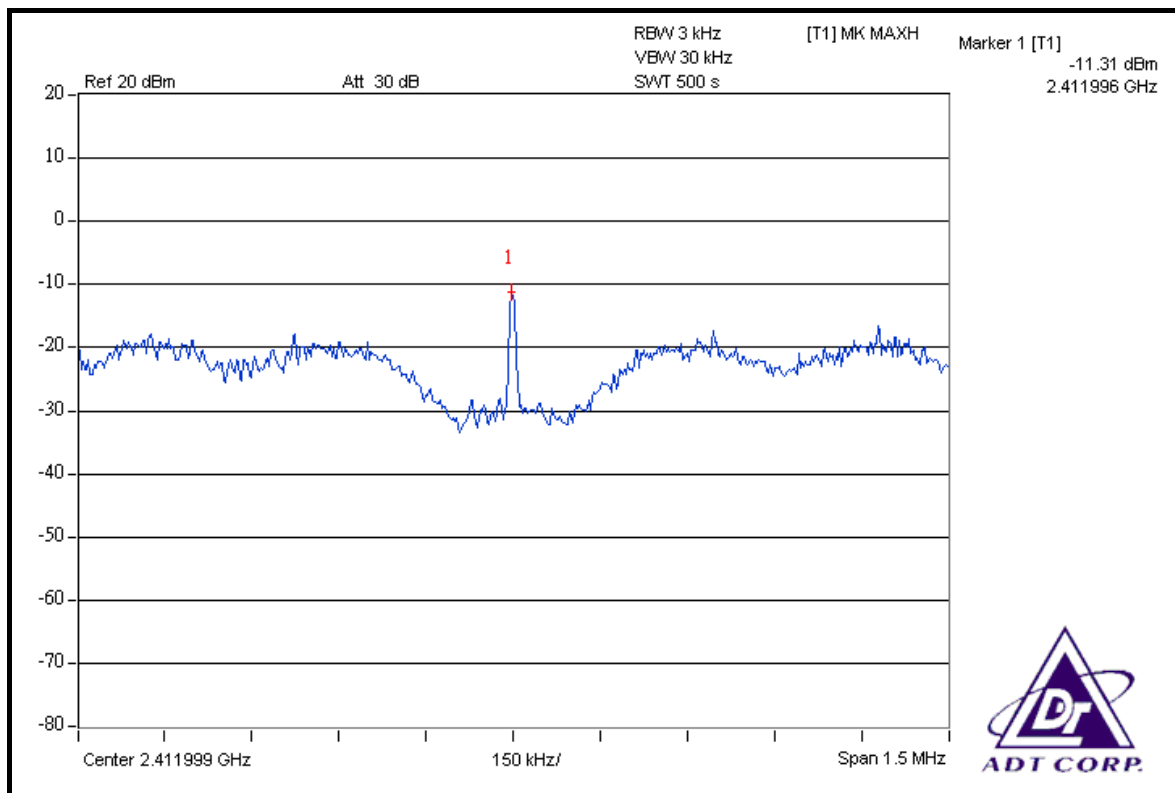

### CH 6

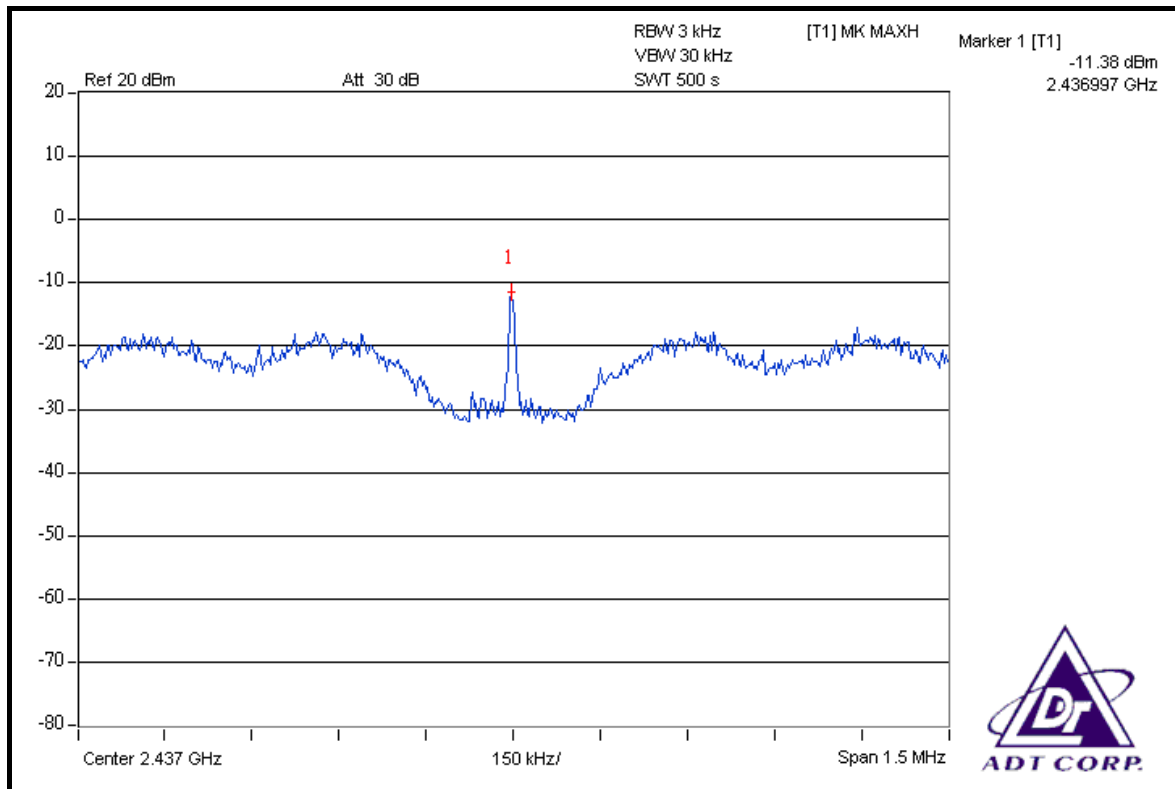

### CH 11

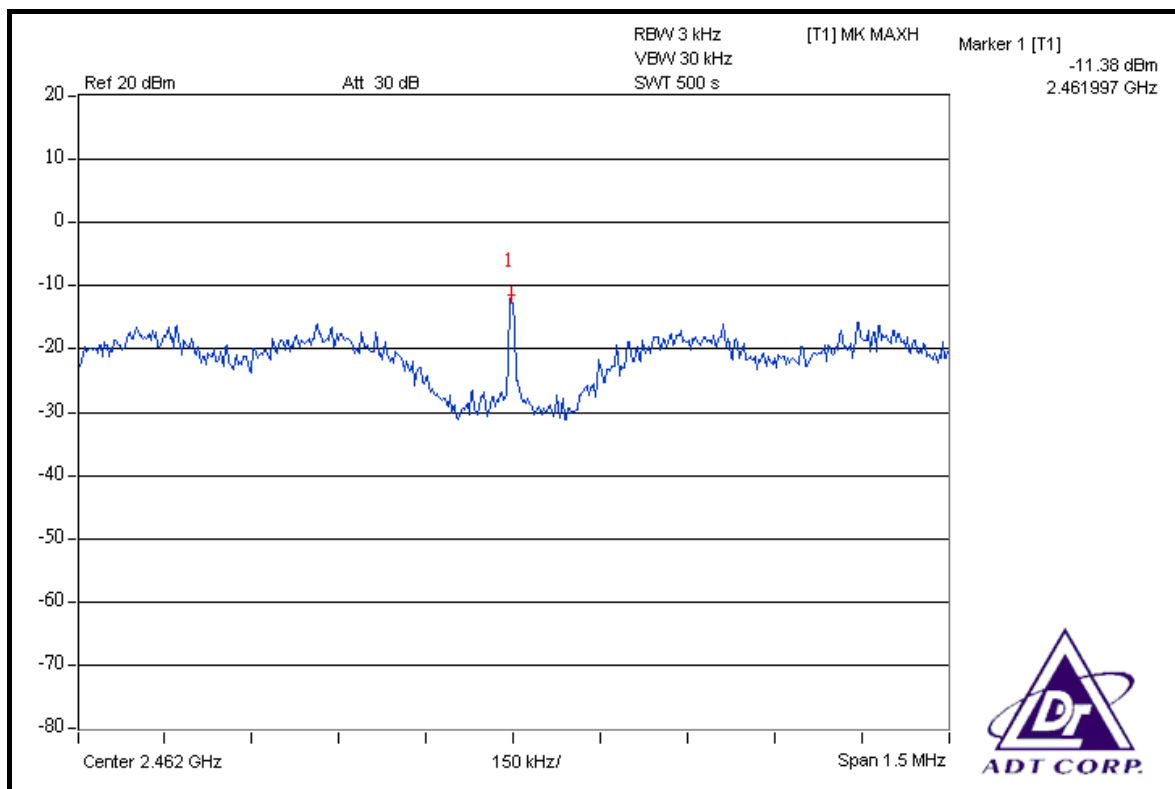



**DRAFT 802.11n (20MHz) OFDM MODULATION**

<b>MODULATION TYPE</b>	BPSK	<b>TRANSFER RATE</b>	7.2Mbps
<b>INPUT POWER (SYSTEM)</b>	120Vac, 60Hz	<b>ENVIRONMENTAL CONDITIONS</b>	25deg.C, 63%RH, 991hPa
<b>TESTED BY</b>	Dean Wang		

CHAN.	CHAN. FREQ. (MHz)	RF POWER LEVEL IN 3kHz BW (dBm)			TOTAL POWER DENSITY (mW)	TOTAL POWER DENSITY (dBm)	MAX. LIMIT (dBm)	PASS / FAIL
		CHAIN 0	CHAIN 1	CHAIN 2				
1	2412	-11.53	-12.35	-13.81	0.170	-7.69	8	PASS
6	2437	-11.82	-12.17	-13.60	0.170	-7.69	8	PASS
11	2462	-11.30	-11.64	-13.04	0.192	-7.16	8	PASS

**FOR CHAIN 0: CH 1**

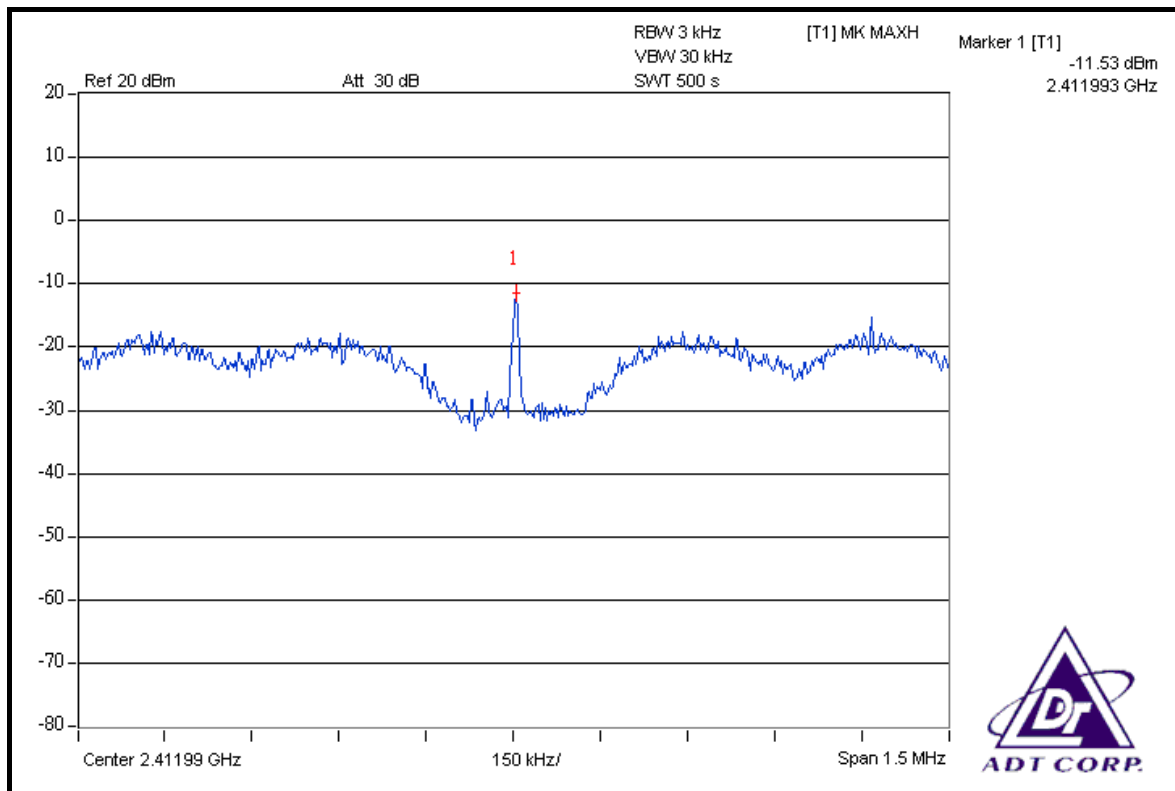

### CH 6

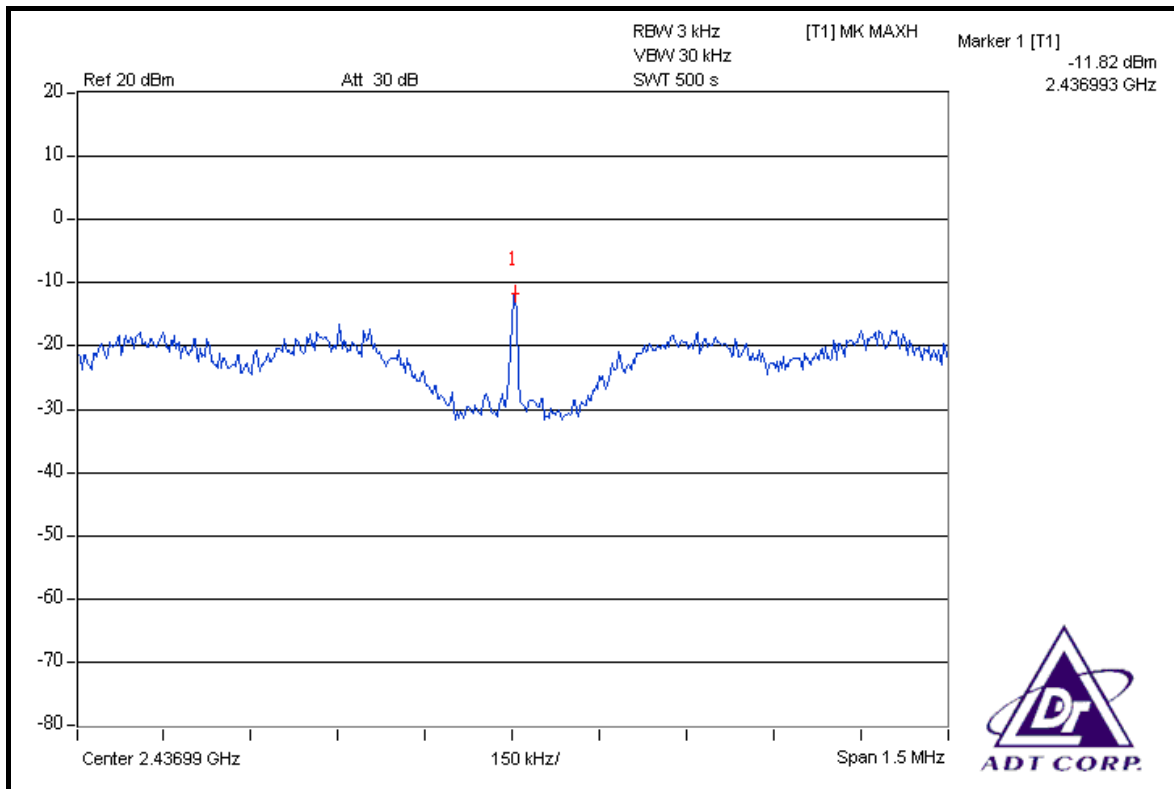

### CH 11

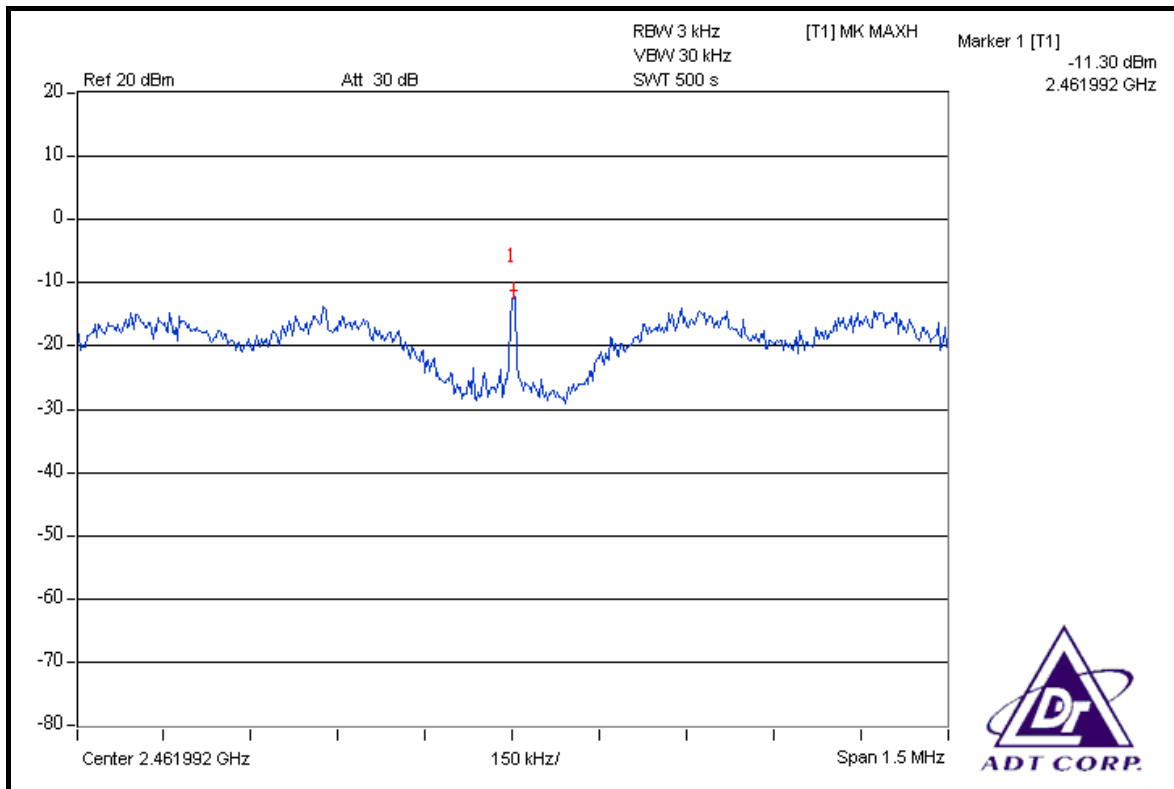





### FOR CHAIN 1: CH 1

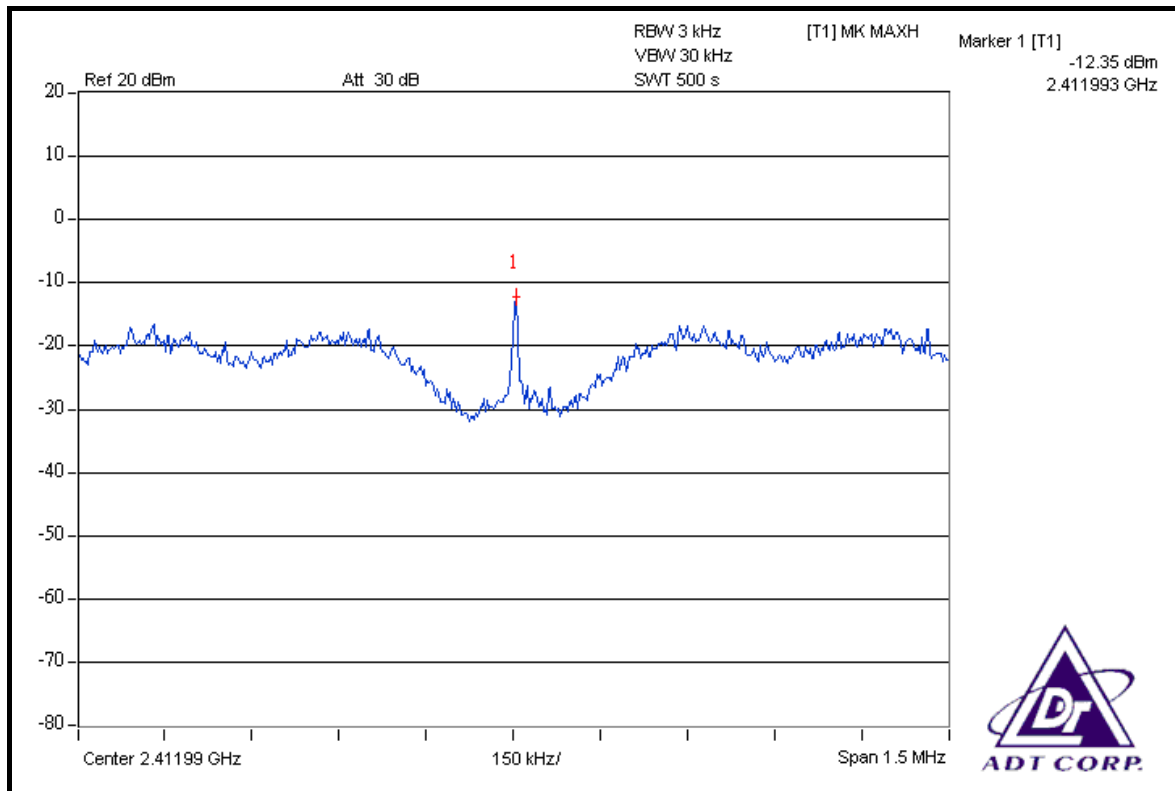

### CH 6

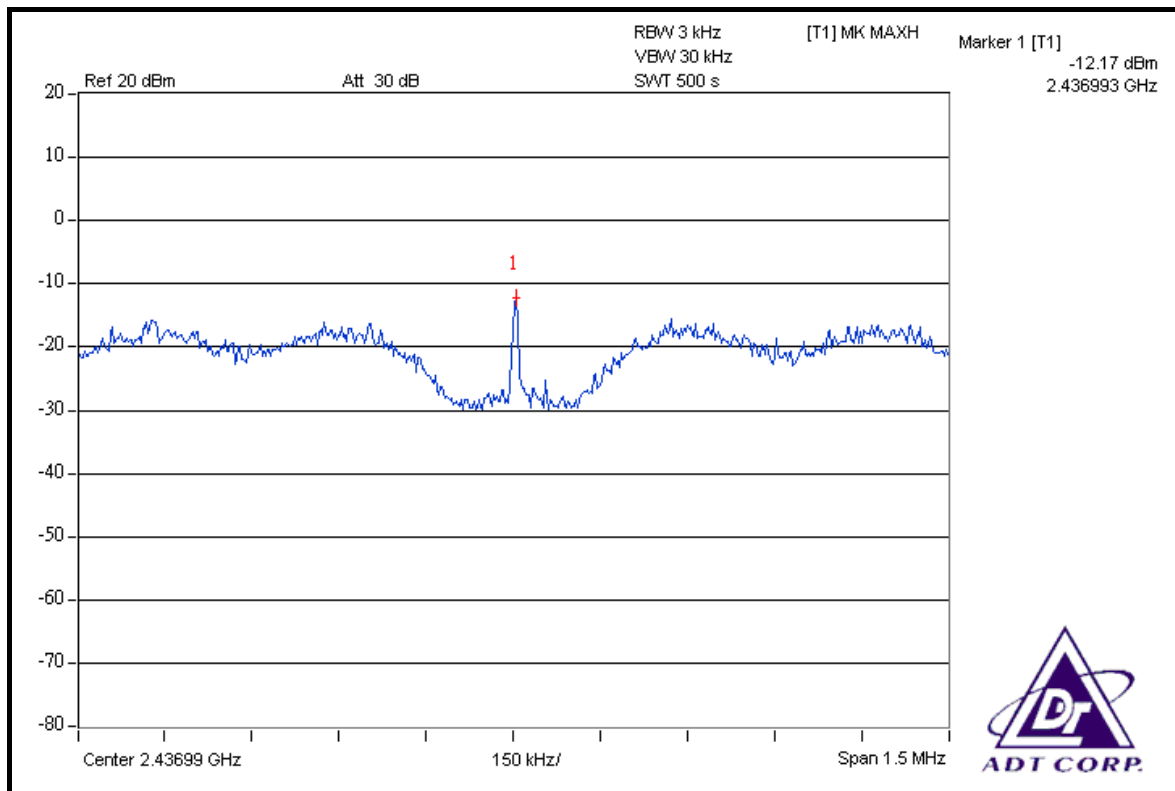



### CH 11

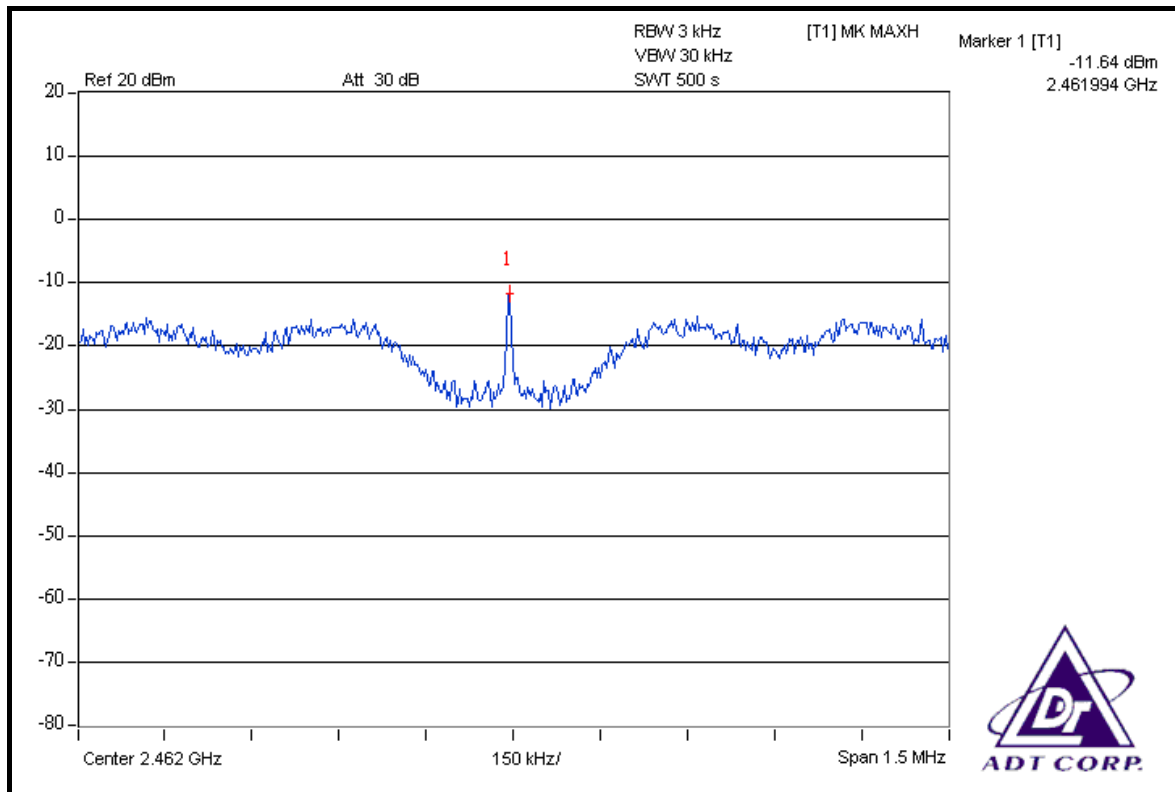

### FOR CHAIN 2: CH 1

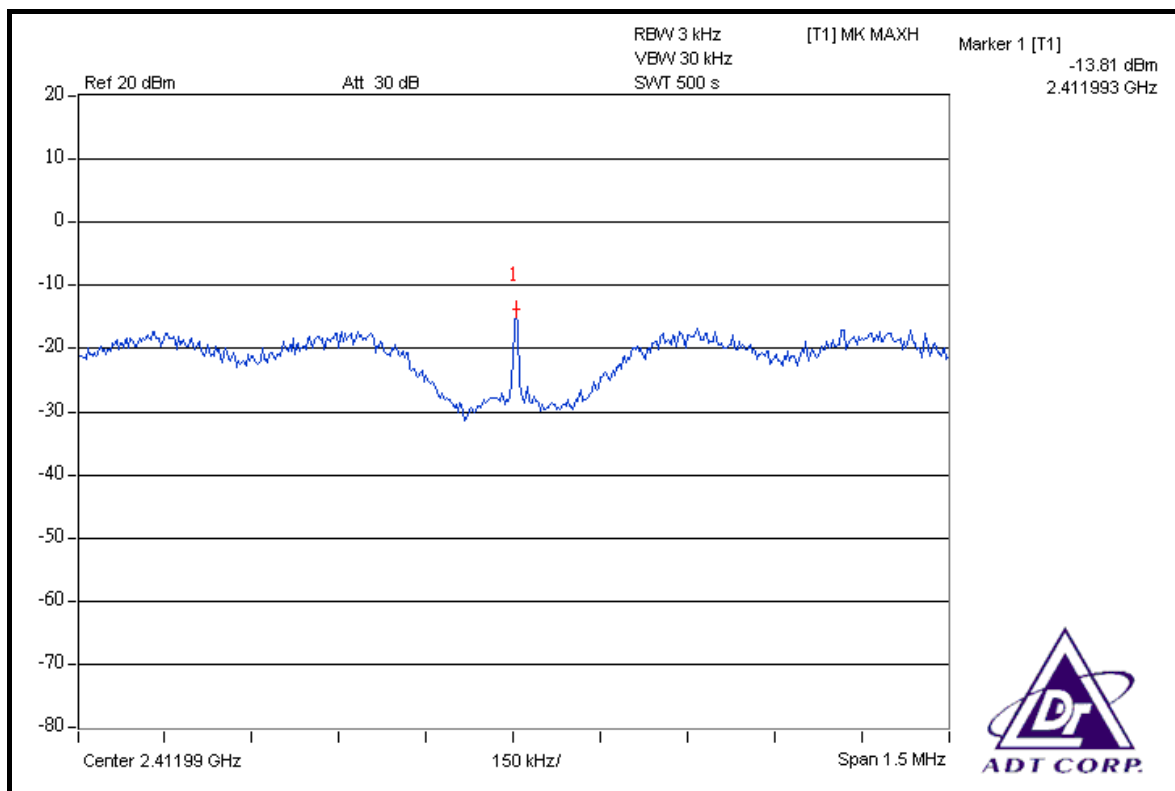



### CH 6

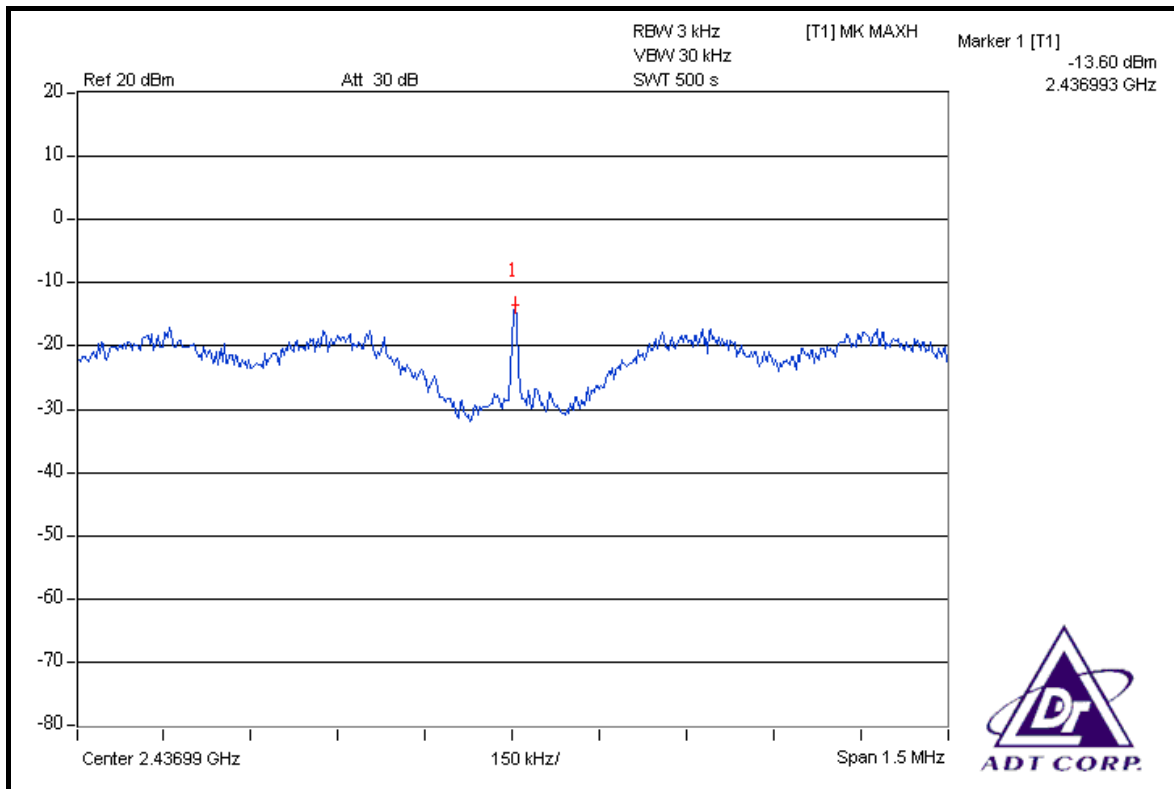

### CH 11

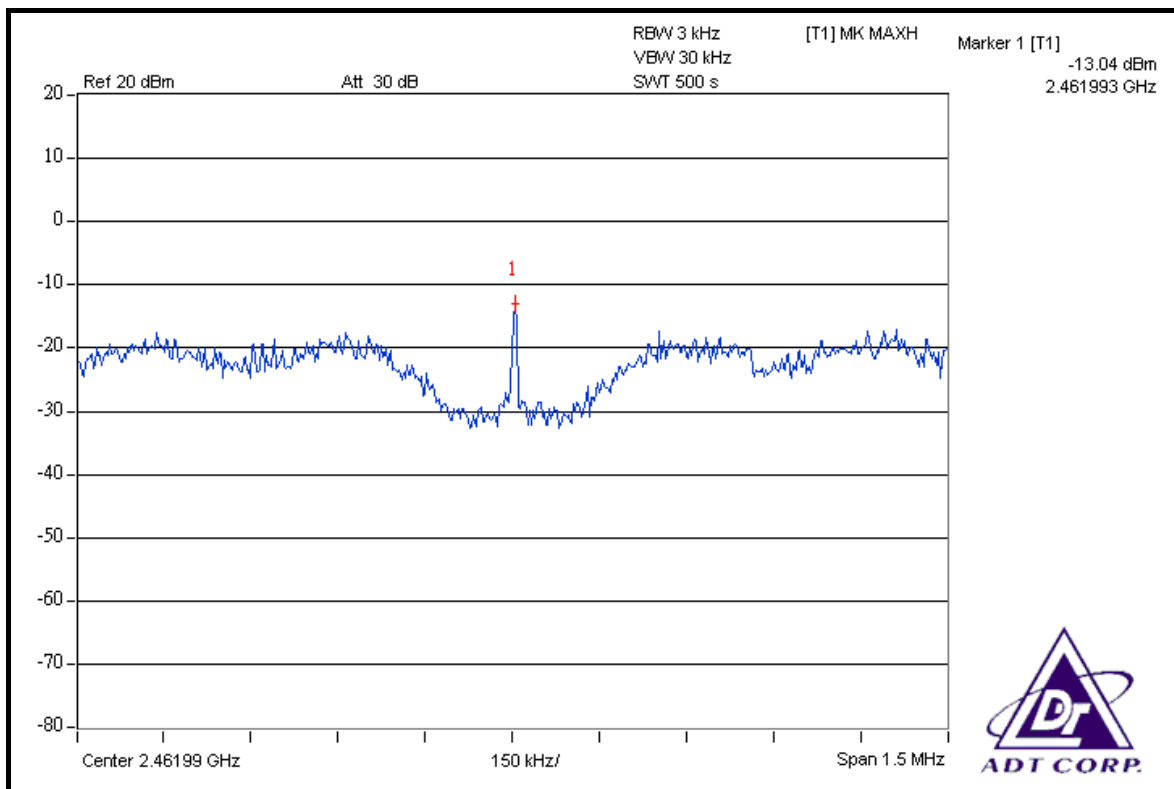



**DRAFT 802.11n (40MHz) OFDM MODULATION**

<b>MODULATION TYPE</b>	BPSK	<b>TRANSFER RATE</b>	15Mbps
<b>INPUT POWER (SYSTEM)</b>	120Vac, 60Hz	<b>ENVIRONMENTAL CONDITIONS</b>	25 deg.C, 65 %RH, 991hPa
<b>TESTED BY</b>	Dean Wang		

CHAN.	CHAN. FREQ. (MHz)	RF POWER LEVEL IN 3kHz BW (dBm)			TOTAL POWER DENSITY (mW)	TOTAL POWER DENSITY (dBm)	MAX. LIMIT (dBm)	PASS / FAIL
		CHAIN 0	CHAIN 1	CHAIN 2				
1	2422	-7.20	-9.90	-9.84	0.397	-4.02	8	PASS
4	2437	-7.02	-9.71	-9.10	0.429	-3.68	8	PASS
7	2452	-7.04	-9.65	-9.13	0.428	-3.68	8	PASS

**FOR CHAIN 0: CH 1**

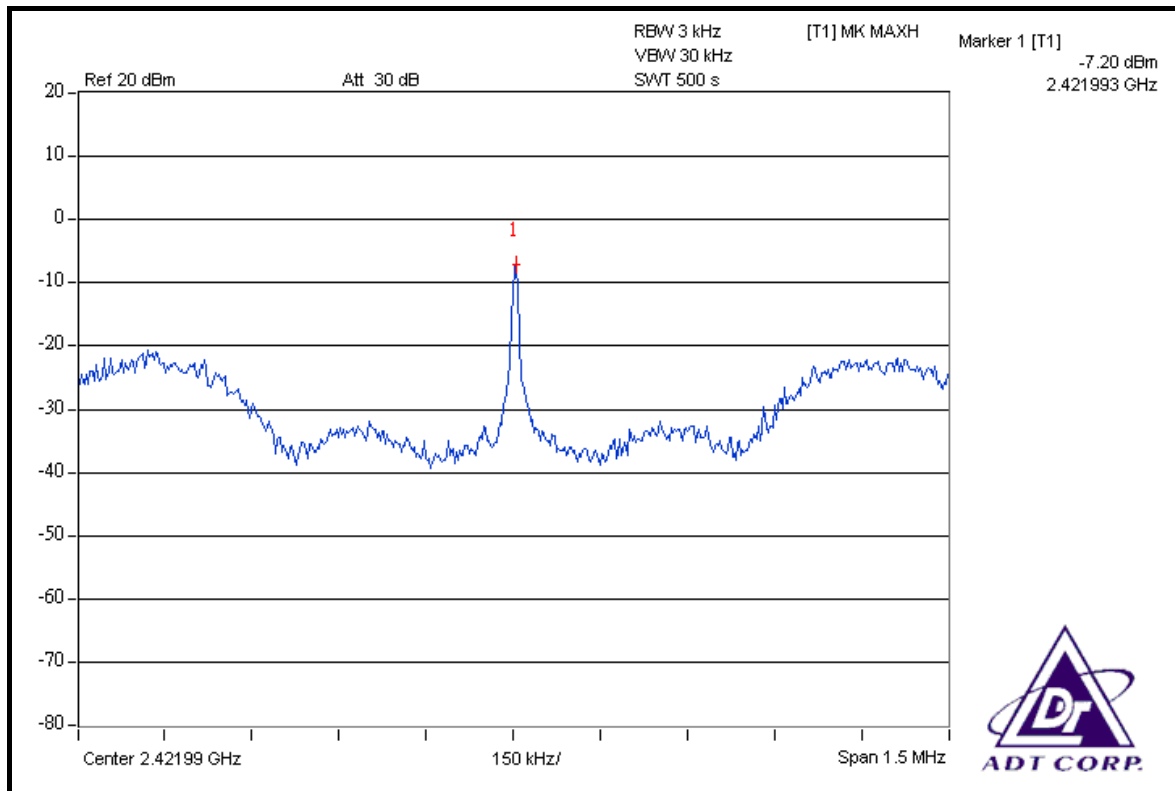

### CH 4

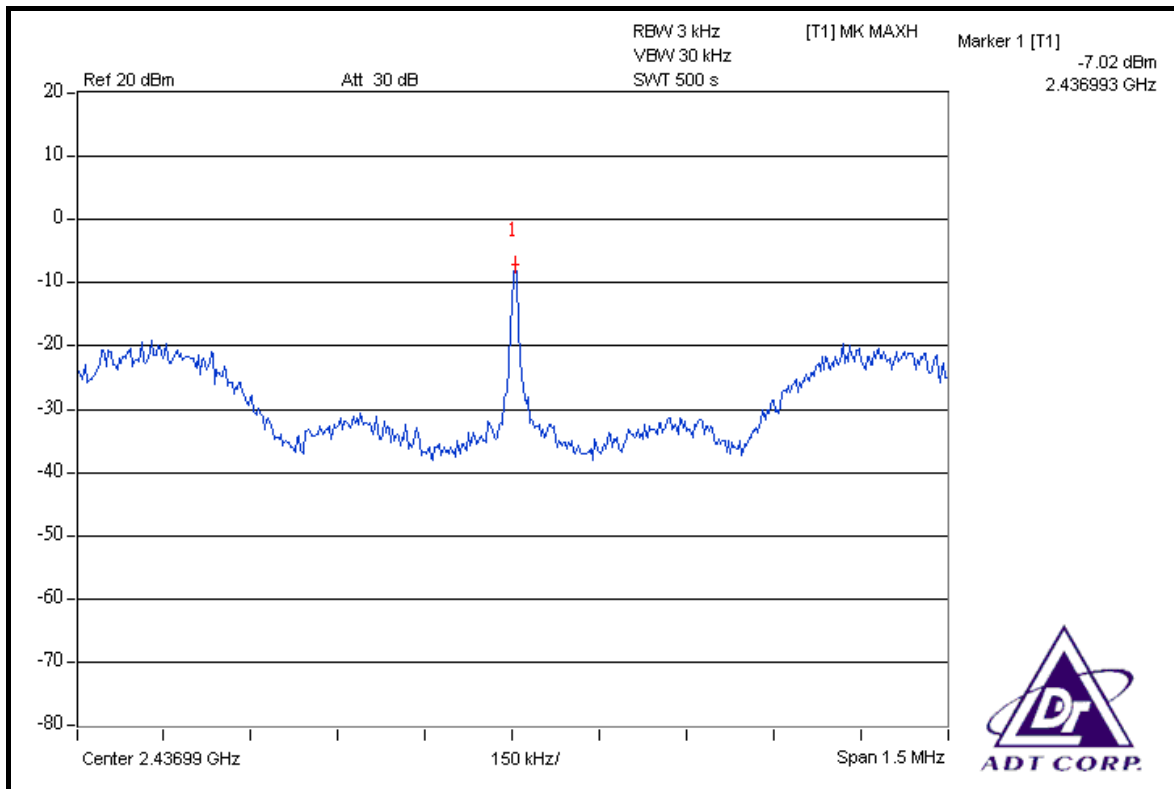

### CH 7

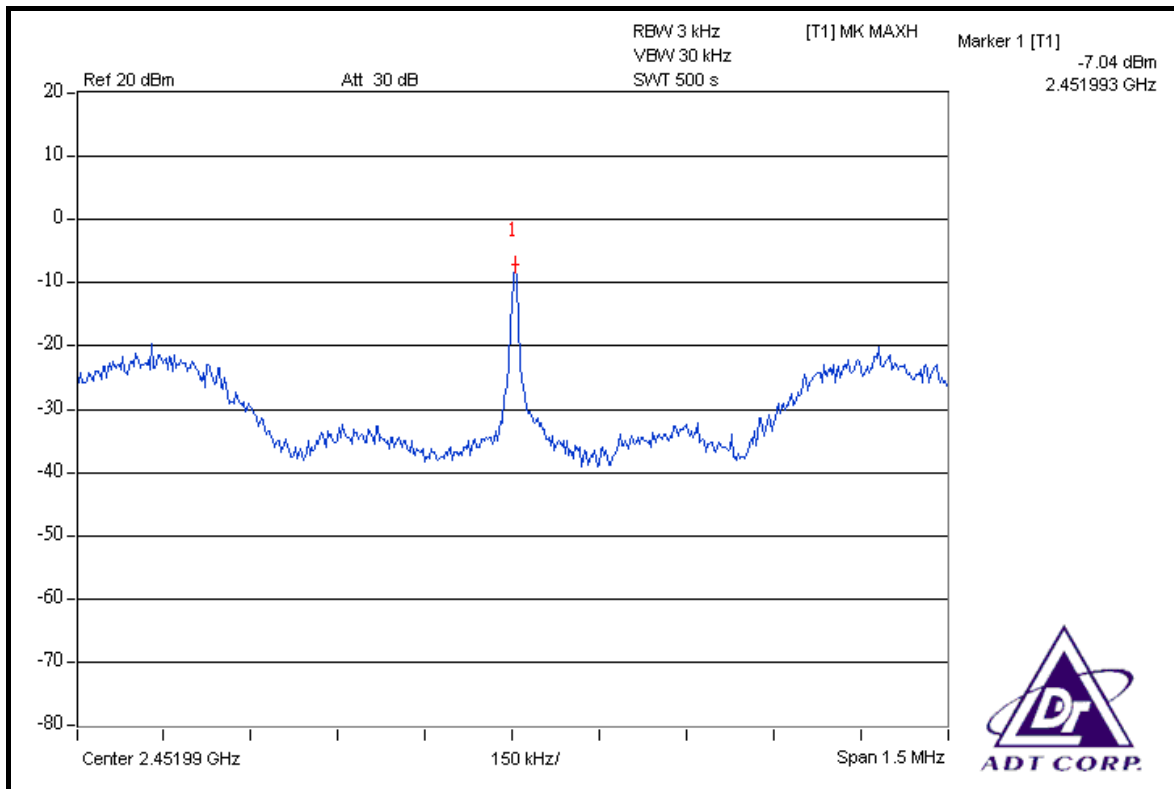



### FOR CHAIN 1: CH 1

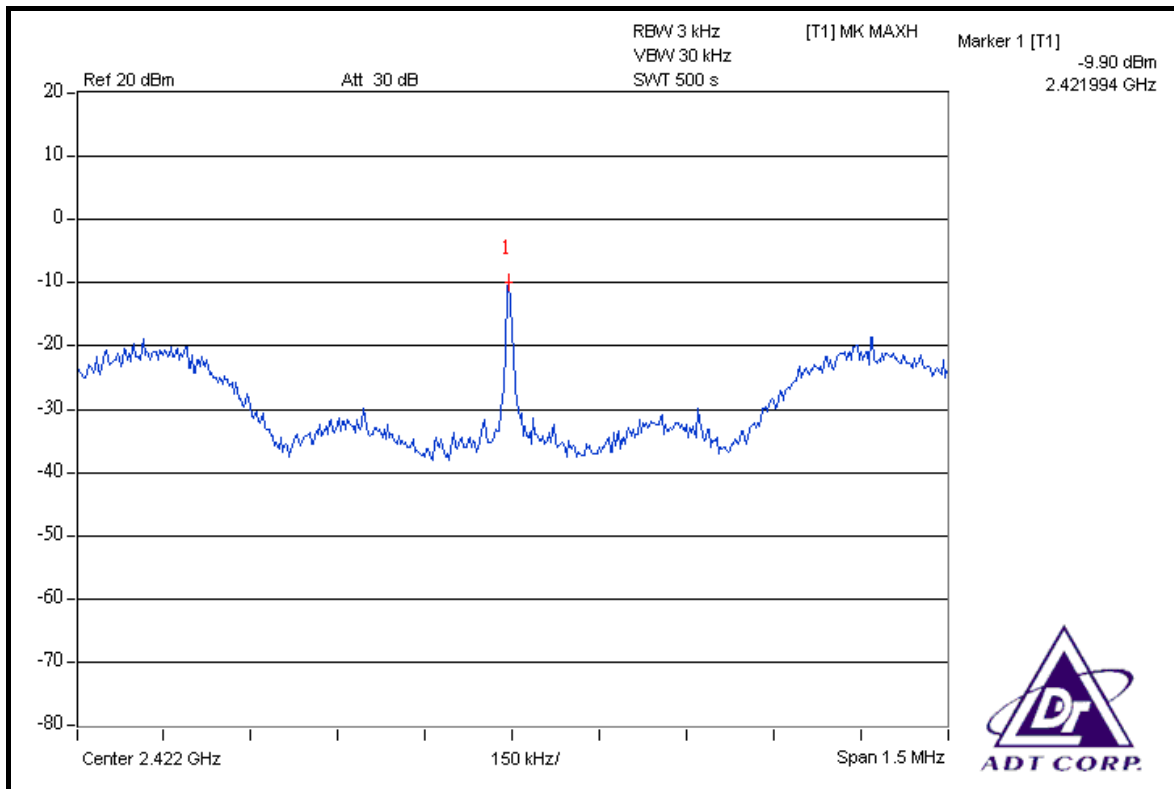

### CH 4

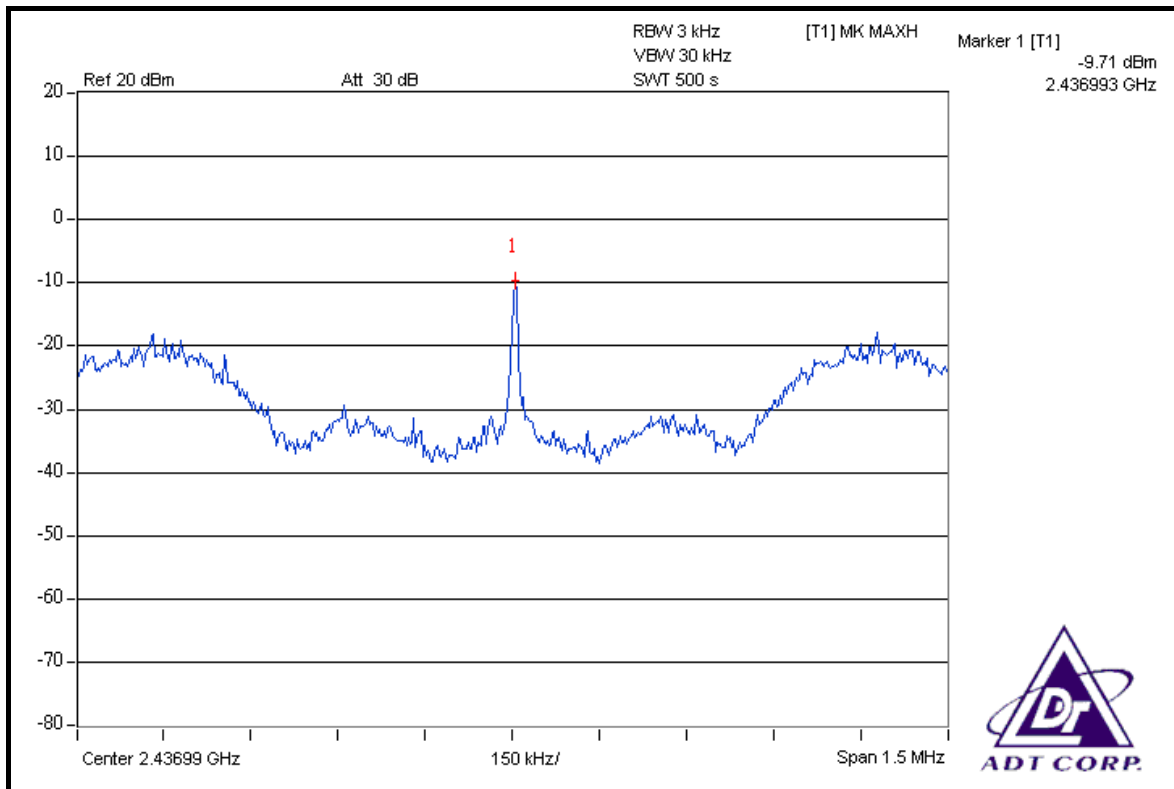



### CH 7

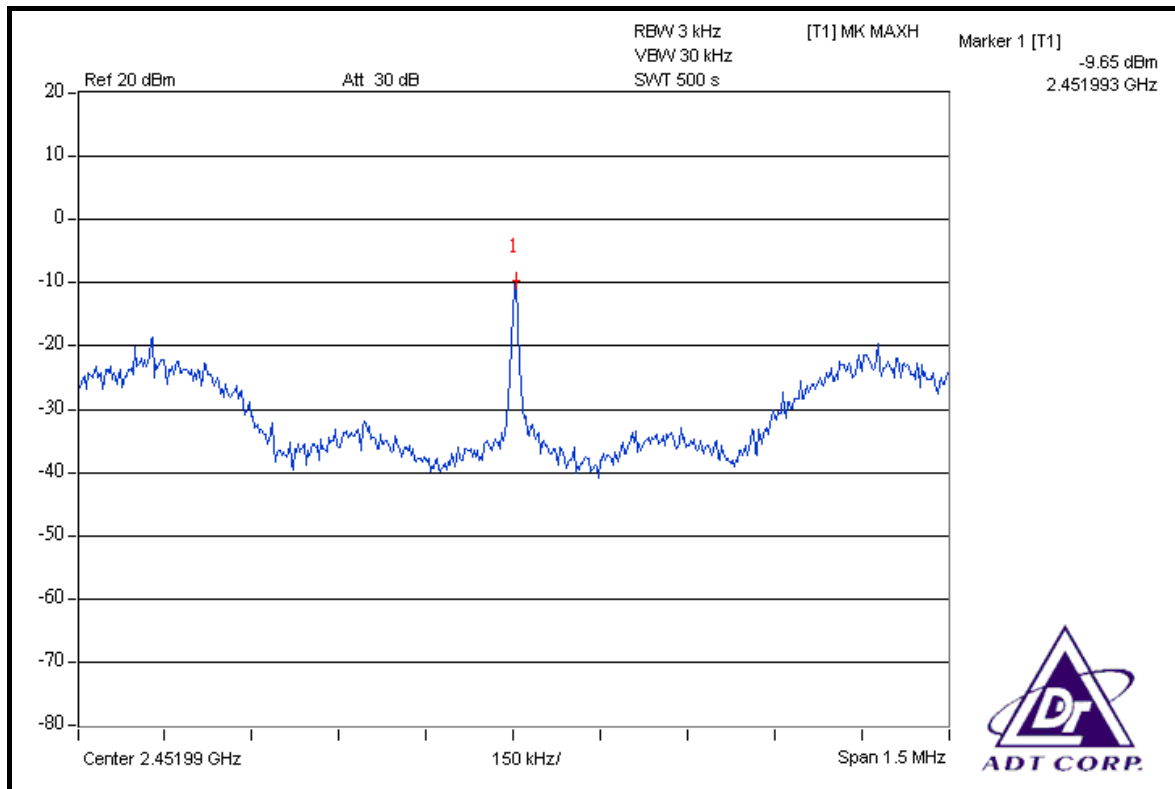

### FOR CHAIN 2: CH 1

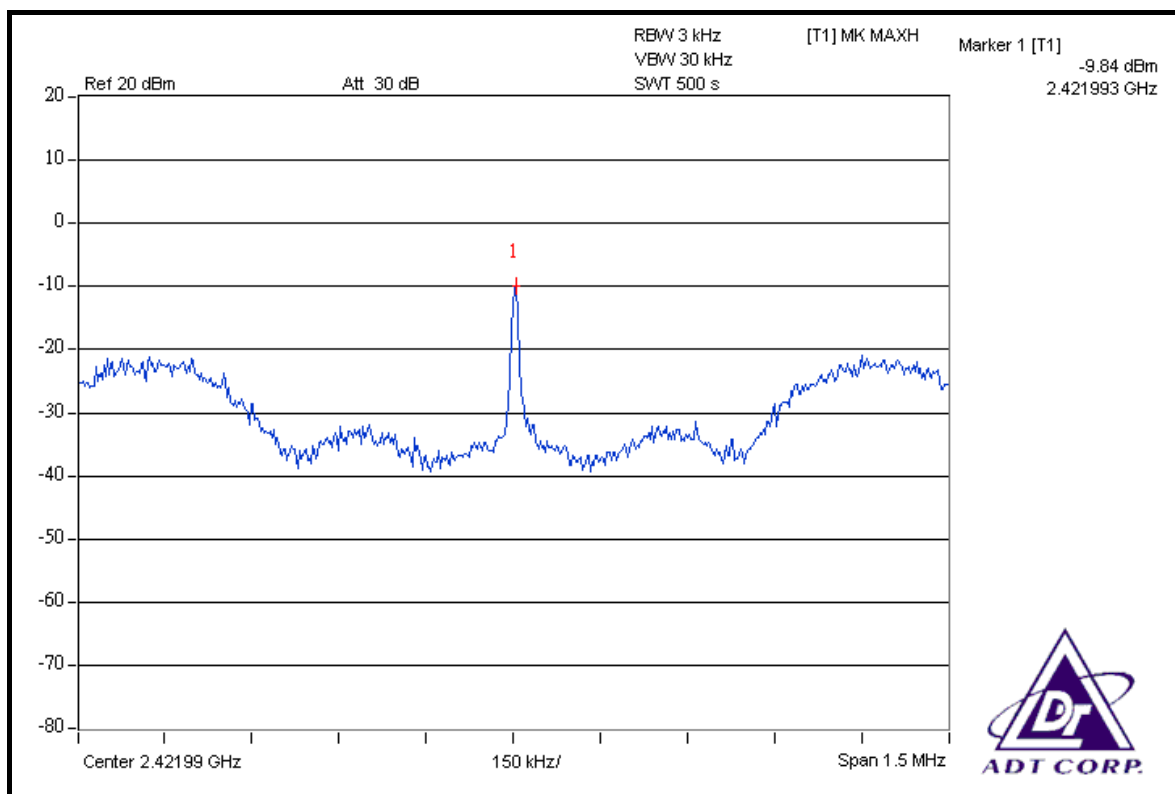

CH 4

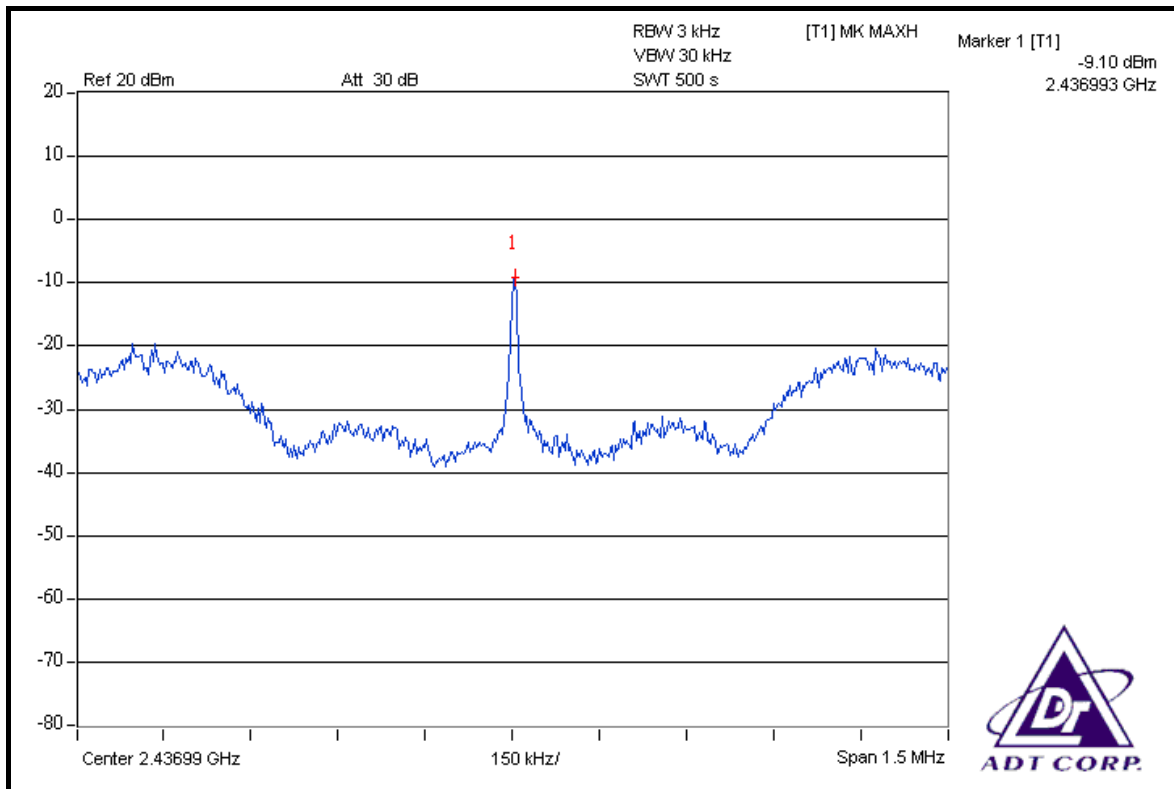

CH 7

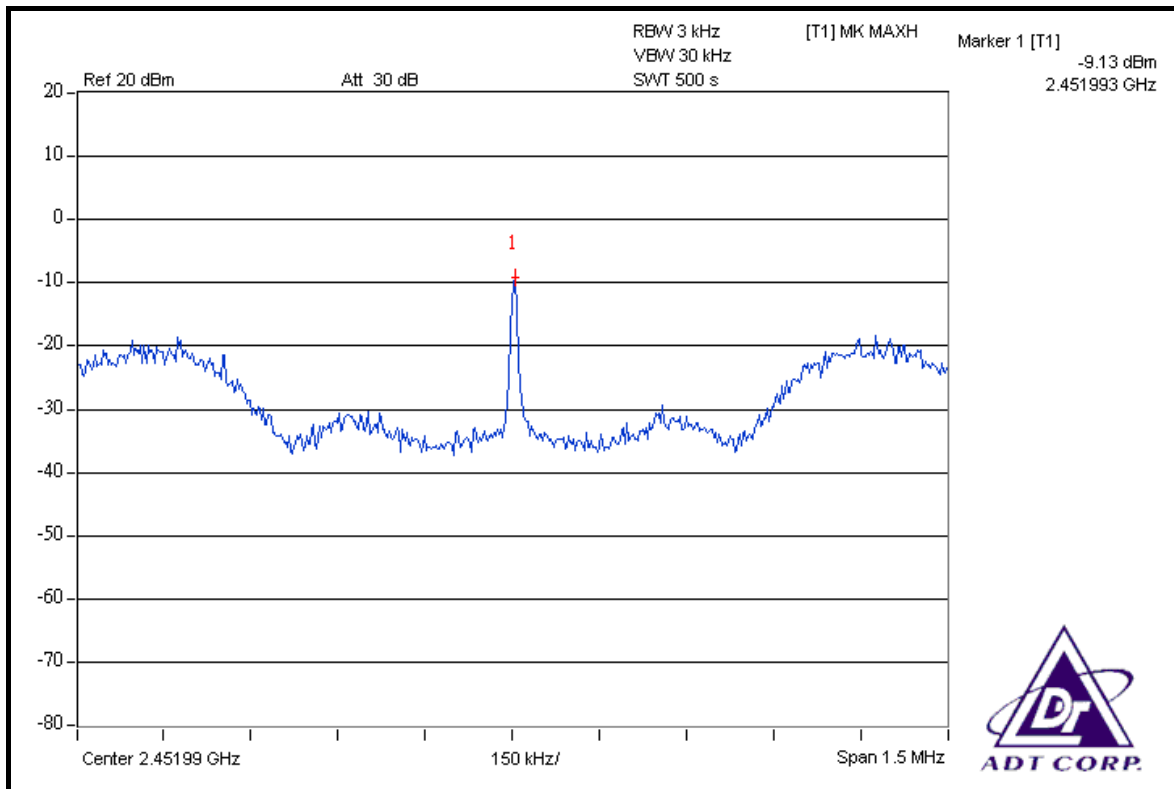





## 4.6 BAND EDGES MEASUREMENT

### 4.6.1 LIMITS OF BAND EDGES MEASUREMENT

Below -20dB of the highest emission level of operating band (in 100kHz Resolution Bandwidth).

### 4.6.2 TEST INSTRUMENTS

DESCRIPTION & MANUFACTURER	MODEL NO.	SERIAL NO.	DATE OF CALIBRATION	CALIBRATED UNTIL
<b>FOR CONDUCTED MEASUREMENT:</b>				
R&S SPECTRUM ANALYZER	FSP40	100041	Apr. 22, 2008	Apr. 21, 2009
<b>FOR RADIATED MEASUREMENT:</b>				
Test Receiver ROHDE & SCHWARZ	ESI7	100033	Jun. 30, 2008	Jun. 29, 2009
Spectrum Analyzer Agilent	FSP	100041	Apr. 22, 2008	Apr. 21, 2009
BILOG Antenna SCHWARZBECK	VULB9168	9168-160	May, 02, 2008	May, 01, 2009
HORN Antenna SCHWARZBECK	9120D	9120D-209	Jun. 24, 2008	Jun. 23, 2009
HORN Antenna SCHWARZBECK	BBHA 9170	BBHA9170243	Dec. 25, 2007	Dec. 24, 2008
Preamplifier Agilent	8447D	2944A10633	Oct. 29, 2007	Oct. 28, 2008
Preamplifier Agilent	8449B	3008A01964	Oct. 24, 2007	Oct. 23, 2008
RF signal cable HUBER+SUHNNER	SUCOFLEX 104	283402/4	Dec. 07, 2007	Dec. 06, 2008
RF signal cable HUBER+SUHNNER	SUCOFLEX 104	251644/4	Dec. 07, 2007	Dec. 06, 2008
Software ADT.	ADT_Radiated_V7.6	NA	NA	NA
Antenna Tower inn-co GmbH	MA 4000	013303	NA	NA
Antenna Tower Controller inn-co GmbH	CO2000	017303	NA	NA
Turn Table ADT.	TT100.	TT93021703	NA	NA
Turn Table Controller ADT.	SC100.	SC93021703	NA	NA

**NOTE:** The calibration interval of the above test instruments is 12 months and the calibrations are traceable to NML/ROC and NIST/USA.

#### 4.6.3 TEST PROCEDURE

##### FOR CONDUCTED MEASUREMENT:

The transmitter output was connected to the spectrum analyzer via a low lose cable. Set both RBW and VBW of spectrum analyzer to 100kHz and 300kHz with suitable frequency span including 100MHz bandwidth from band edge. The band edges was measured and recorded.

The spectrum plots (Peak RBW = 100kHz, VBW = 300kHz) are attached on the following pages.

##### FOR RADIATED MEASUREMENT:

- a. The EUT was placed on the top of a rotating table 0.8 meters above the ground at a 3 meter semi-anechoic chamber. The table was rotated 360 degrees to determine the position of the highest radiation.
- b. The EUT was set 3 meters away from the interference-receiving antenna, which was mounted on the top of a variable-height antenna tower.
- c. The antenna is a broadband antenna, and its height is varied from one meter to four meters above the ground to determine the maximum value of the field strength. Both horizontal and vertical polarizations of the antenna are set to make the measurement.
- d. For each suspected emission, the EUT was arranged to its worst case and then the antenna was tuned to heights from 1 meter to 4 meters and the rotatable table was turned from 0 degrees to 360 degrees to find the maximum reading.
- e. Set both RBW and VBW of spectrum analyzer to 100kHz and 300kHz with suitable frequency span including 100MHz bandwidth from band edge. The band edges was measured and recorded.

The spectrum plots (Peak RBW = 100kHz, VBW = 300kHz) are attached on the following pages.

**NOTE:** The resolution bandwidth of test receiver/spectrum analyzer is 1MHz and the video bandwidth is 10Hz for Average detection (AV) at frequency above 1GHz.

#### 4.6.4 DEVIATION FROM TEST STANDARD

No deviation

#### 4.6.5 EUT OPERATING CONDITION

Same as Item 4.3.6

#### 4.6.6 TEST RESULTS

The spectrum plots are attached on the following pages. D1 line indicates the highest level, and D2 line indicates the 20dB offset below D1. It shows compliance with the requirement in part 15.247(d).

#### 802.11b DSSS MODULATION

**NOTE 1:** The band edge emission plot on the next page shows 53.40dBc between carrier maximum power and local maximum emission in restrict band (2.3564GHz). The emission of carrier strength list in the test result of channel 1 at the item 4.2.7 is 112.40dBuV/m (Peak), so the maximum field strength in restrict band is  $112.40 - 53.40 = 59.00$ dBuV/m which is under 74dBuV/m limit.

The band edge emission plot of on the next page shows 62.70dBc between carrier maximum power and local maximum emission in restrict band (2.3874GHz). The emission of carrier strength list in the test result of channel 1 at the item 4.2.7 is 107.63dBuV/m (Average), so the maximum field strength in restrict band is  $107.63 - 62.70 = 44.93$ dBuV/m which is under 54dBuV/m limit.

**NOTE 2:** The band edge emission plot on the next second page shows 53.80dBc between carrier maximum power and local maximum emission in restrict band (2.4940GHz). The emission of carrier strength list in the test result of channel 11 at the item 4.2.7 is 111.73dBuV/m (Peak), so the maximum field strength in restrict band is  $111.73 - 53.80 = 57.93$ dBuV/m which is under 74dBuV/m limit.

The band edge emission plot on the next third page shows 62.81dBc between carrier maximum power and local maximum emission in restrict band (2.4986GHz). The emission of carrier strength list in the test result of channel 11 at the item 4.2.7 is 107.07dBuV/m (Average), so the maximum field strength in restrict band is  $107.07 - 62.81 = 44.26$ dBuV/m which is under 54dBuV/m limit.

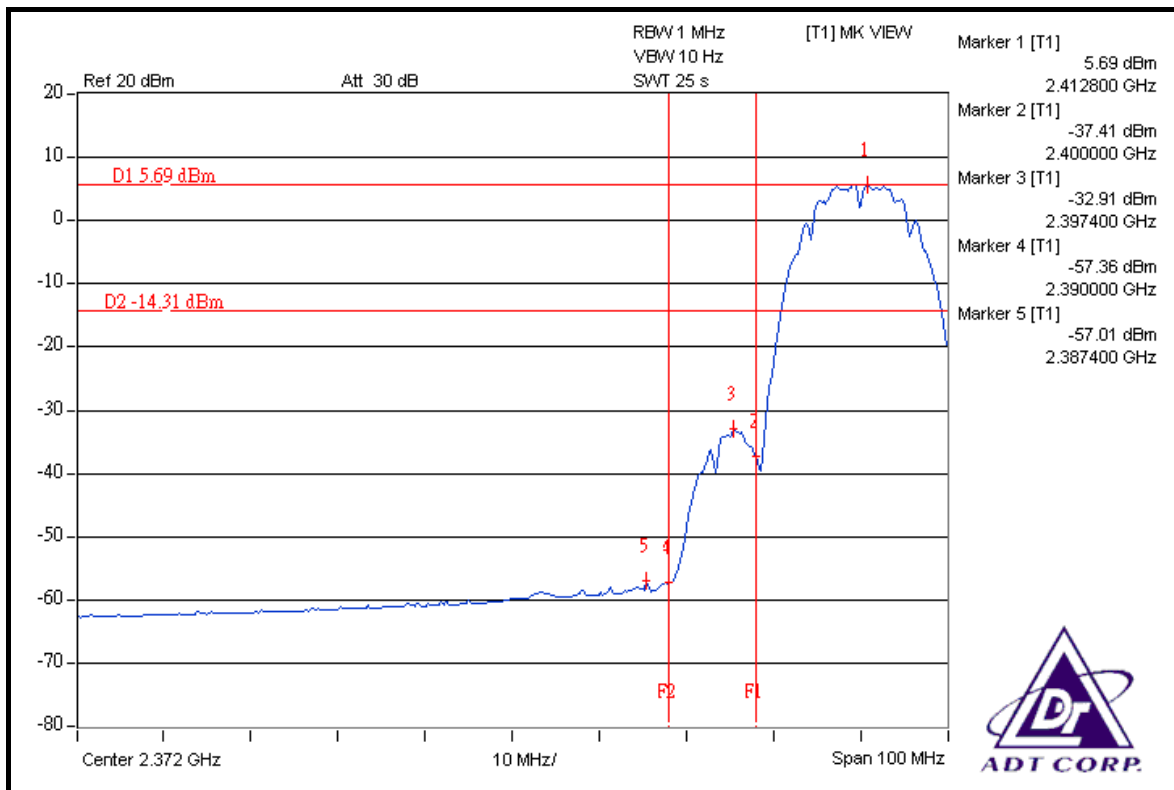
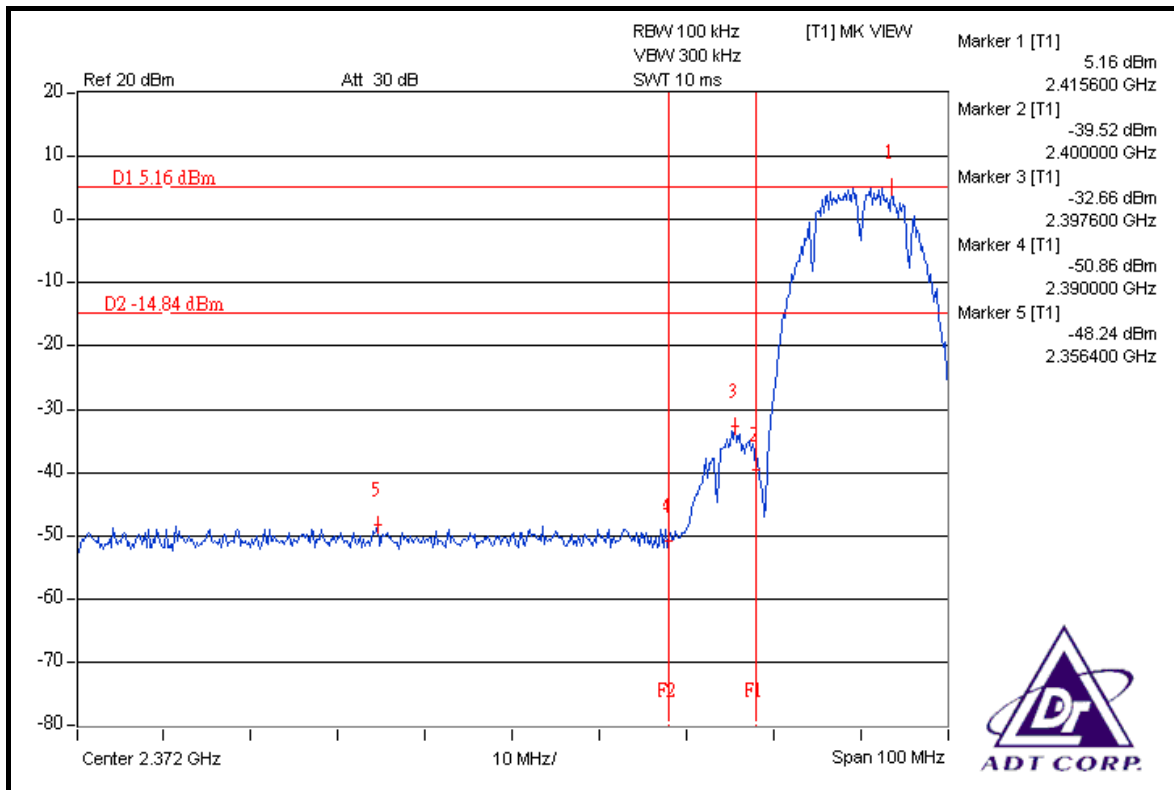

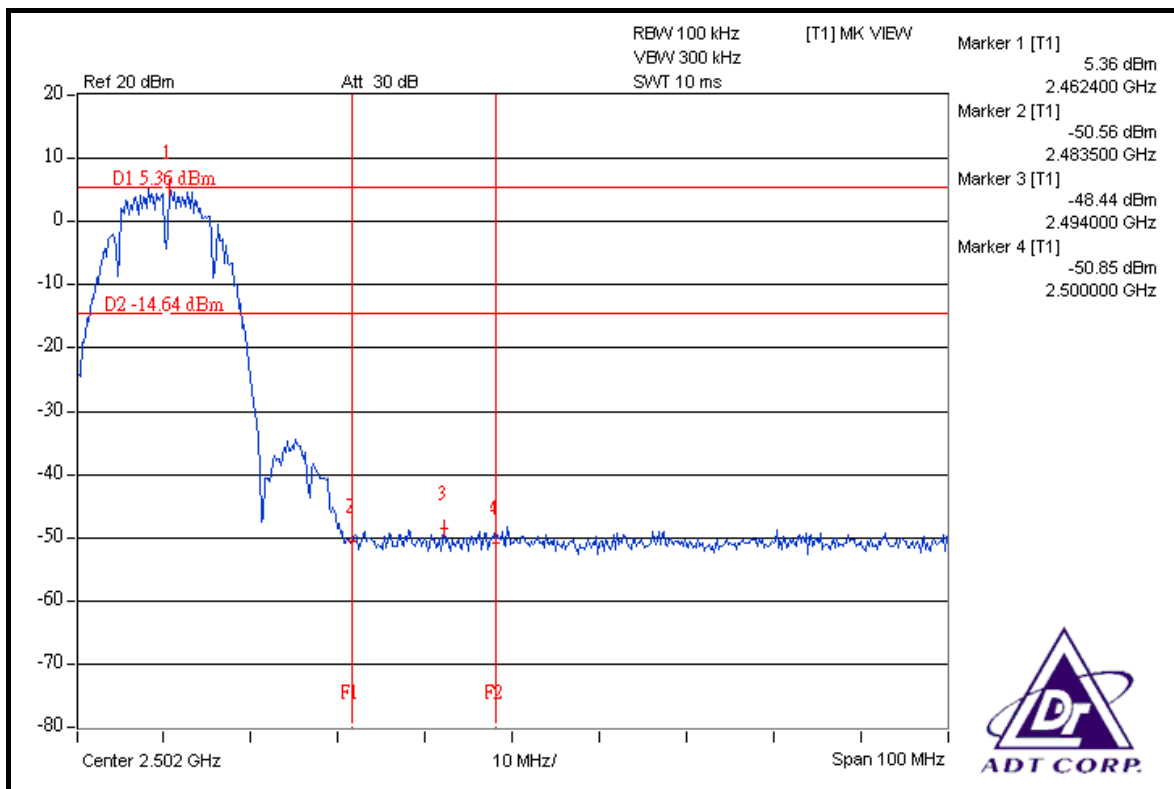
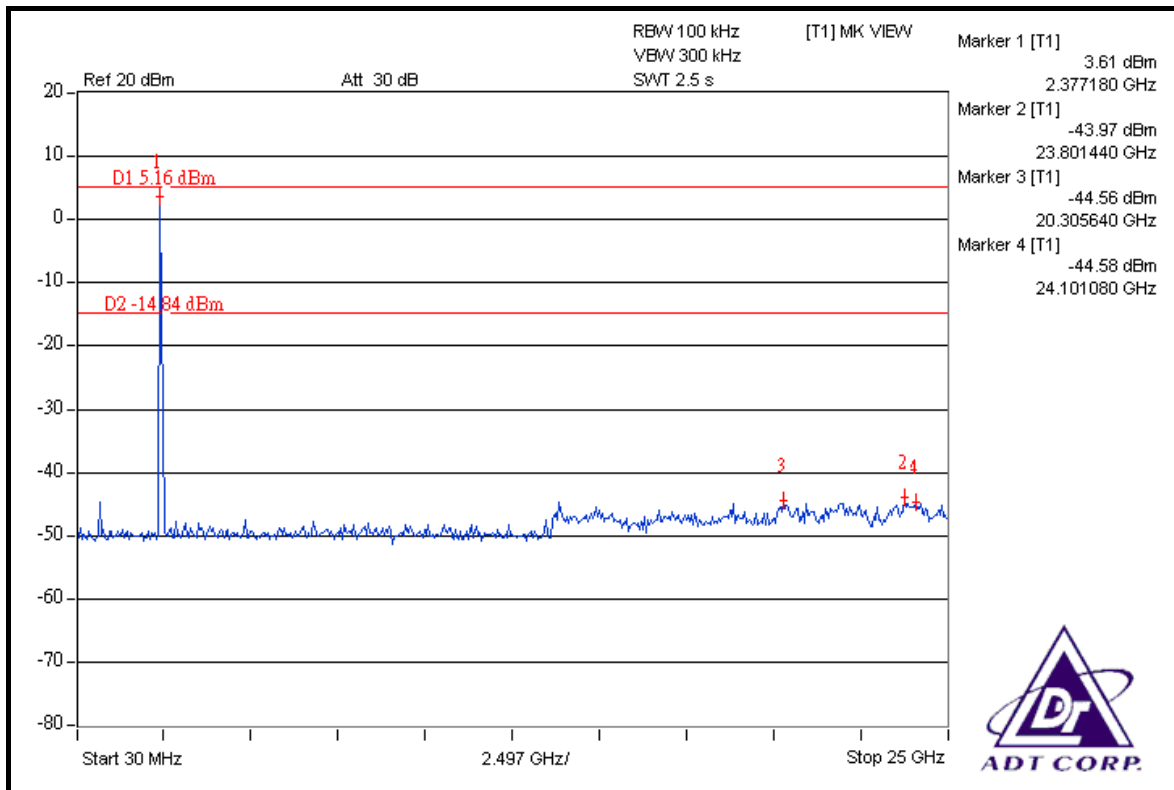

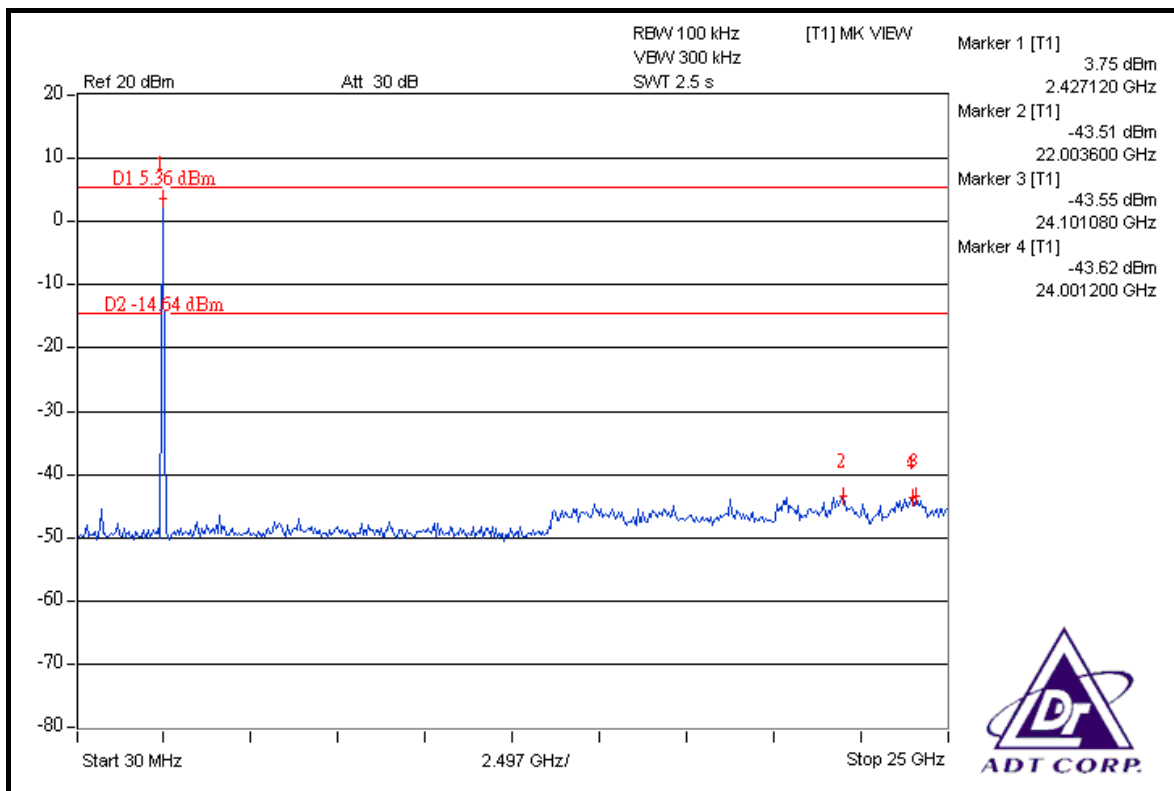
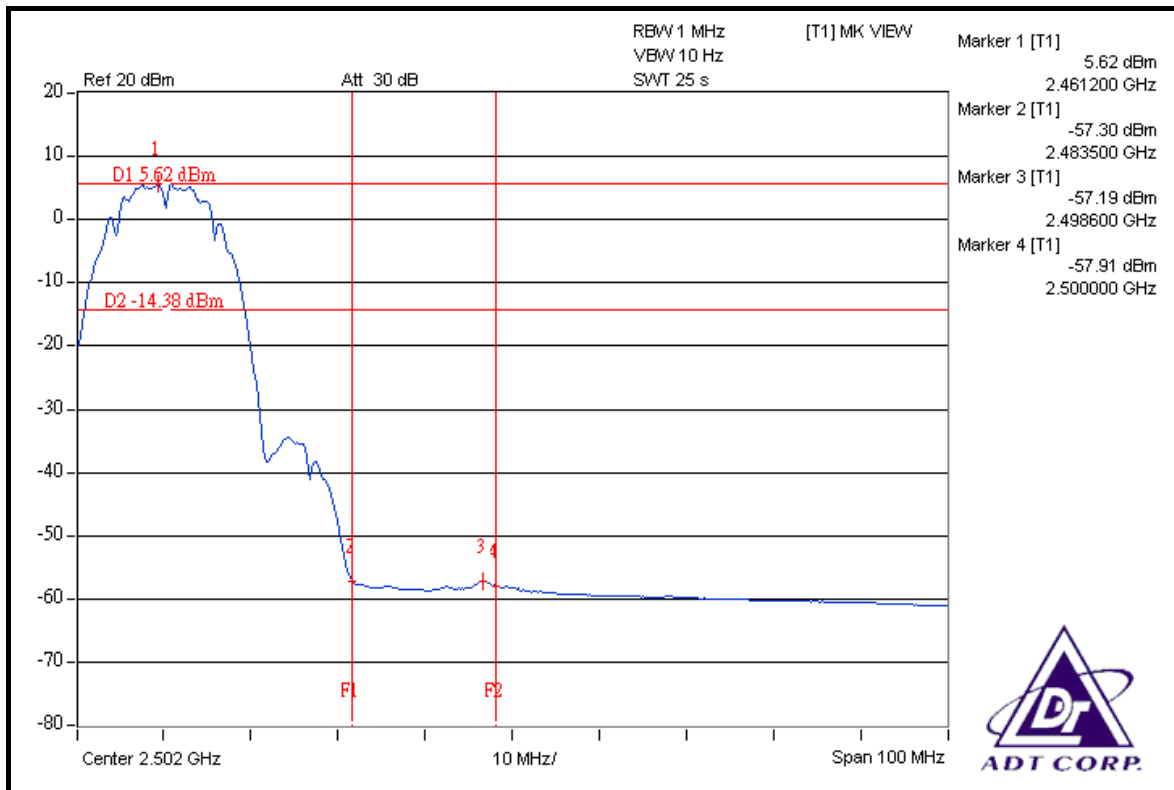

## 802.11g OFDM MODULATION

**NOTE 1:** The band edge emission plot on the next page shows 41.31dBc between carrier maximum power and local maximum emission in restrict band (2.3890GHz). The emission of carrier strength list in the test result of channel 1 at the item 4.2.7 is 106.90dBuV/m (Peak), so the maximum field strength in restrict band is  $106.90 - 41.31 = 65.59$ dBuV/m which is under 74dBuV/m limit.

The band edge emission plot of on the next page shows 52.00dBc between carrier maximum power and local maximum emission in restrict band (2.3900GHz). The emission of carrier strength list in the test result of channel 1 at the item 4.2.7 is 95.74dBuV/m (Average), so the maximum field strength in restrict band is  $95.74 - 52.00 = 43.74$ dBuV/m which is under 54dBuV/m limit.

**NOTE 2:** The band edge emission plot on the next second page shows 43.40dBc between carrier maximum power and local maximum emission in restrict band (2.4942GHz). The emission of carrier strength list in the test result of channel 11 at the item 4.2.7 is 107.43dBuV/m (Peak), so the maximum field strength in restrict band is  $107.43 - 43.40 = 64.03$ dBuV/m which is under 74dBuV/m limit.

The band edge emission plot on the next third page shows 51.73dBc between carrier maximum power and local maximum emission in restrict band (2.4835GHz). The emission of carrier strength list in the test result of channel 11 at the item 4.2.7 is 96.52dBuV/m (Average), so the maximum field strength in restrict band is  $96.52 - 51.73 = 44.79$ dBuV/m which is under 54dBuV/m limit.

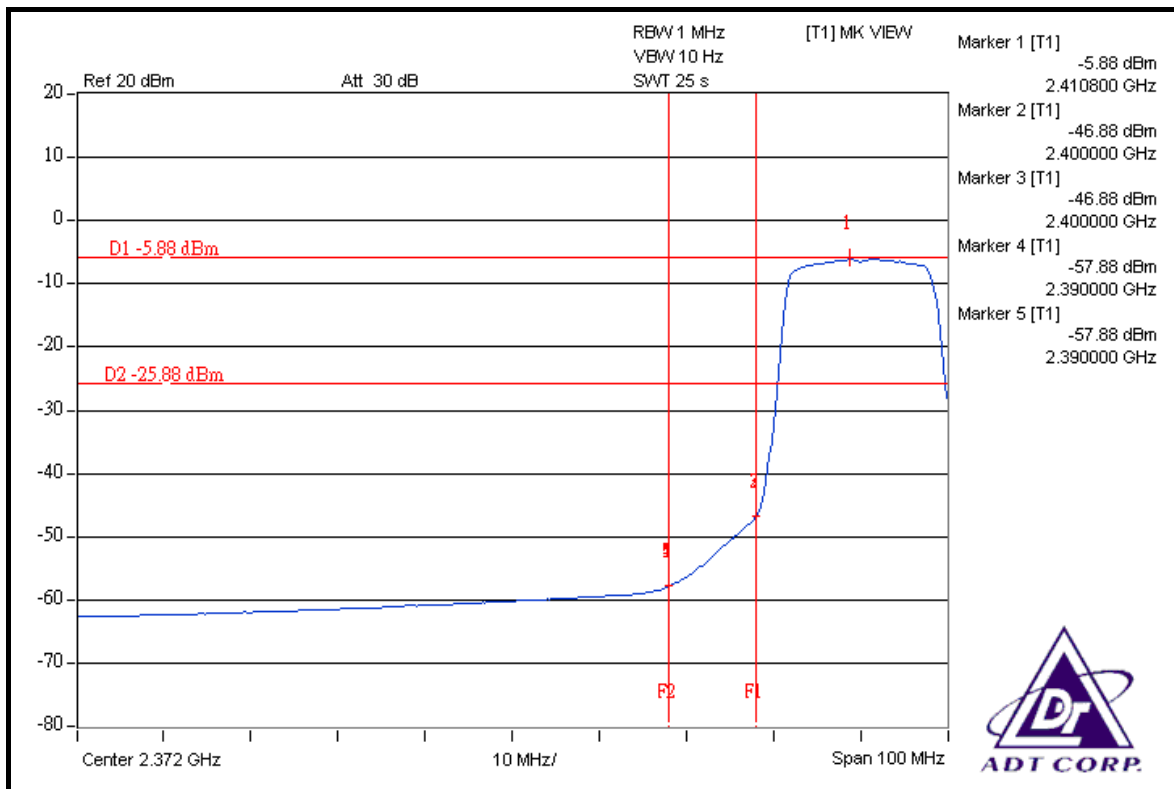
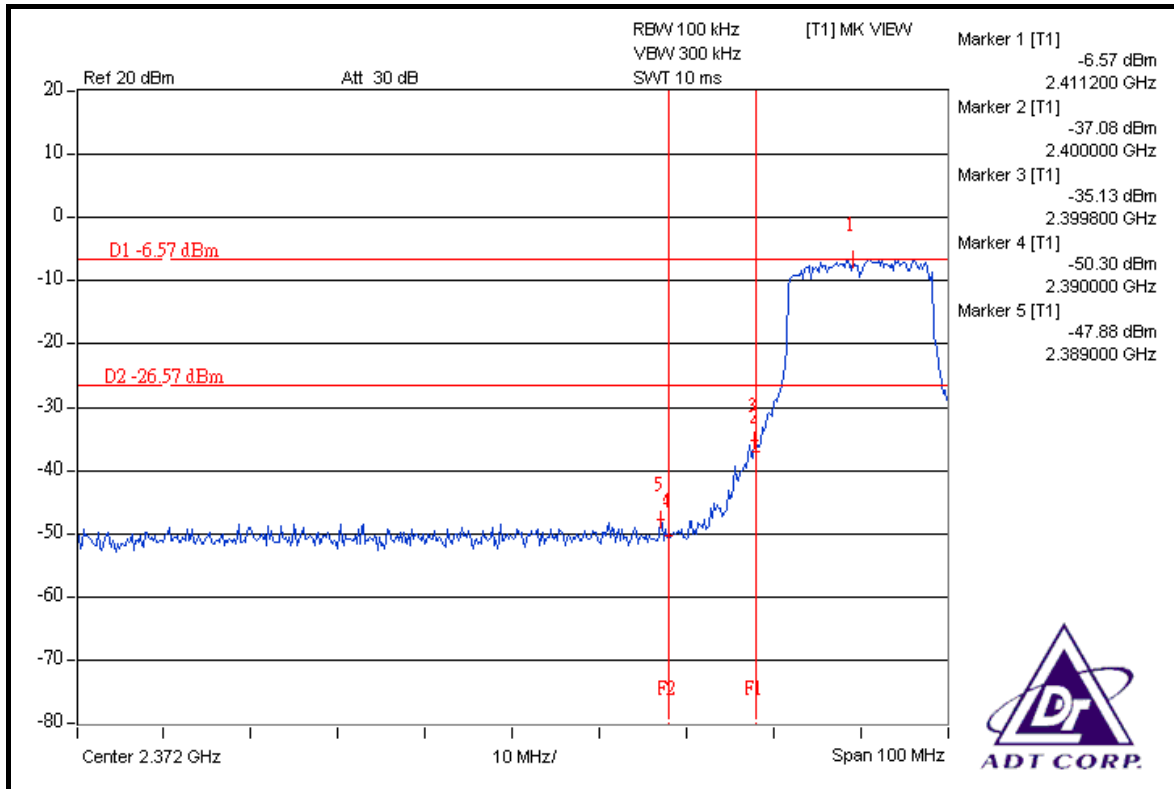



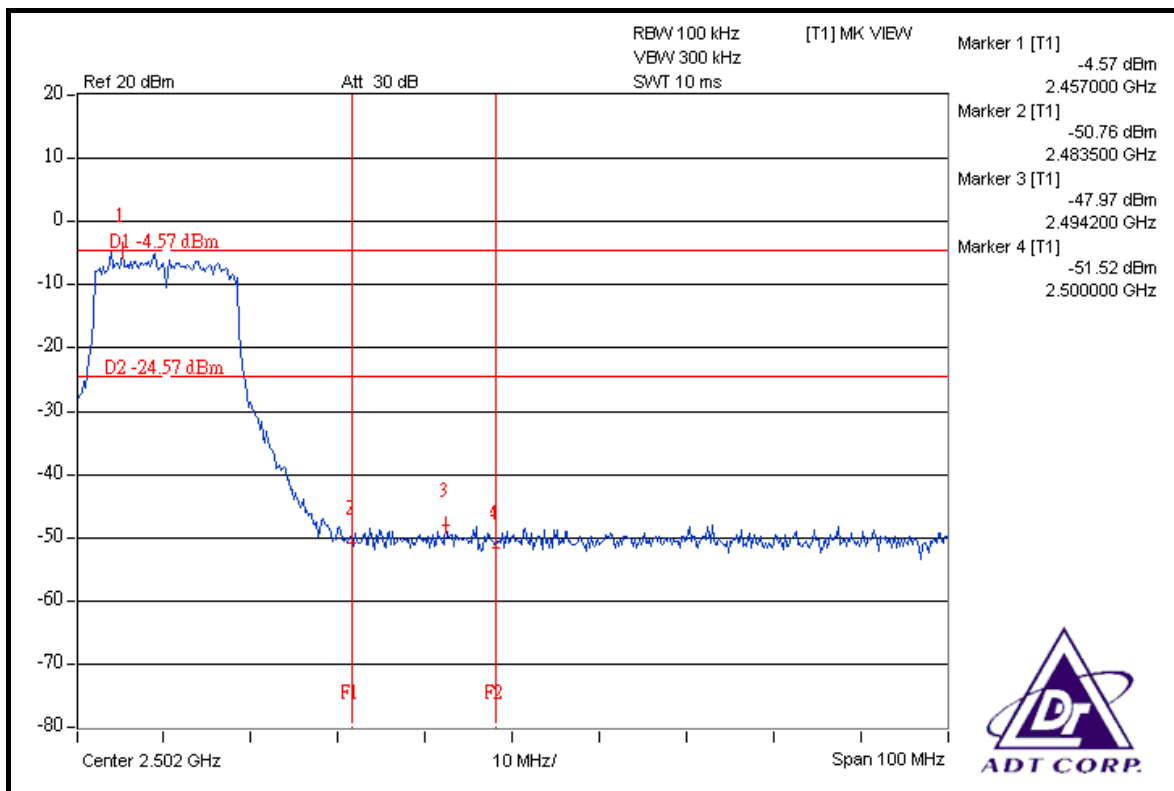
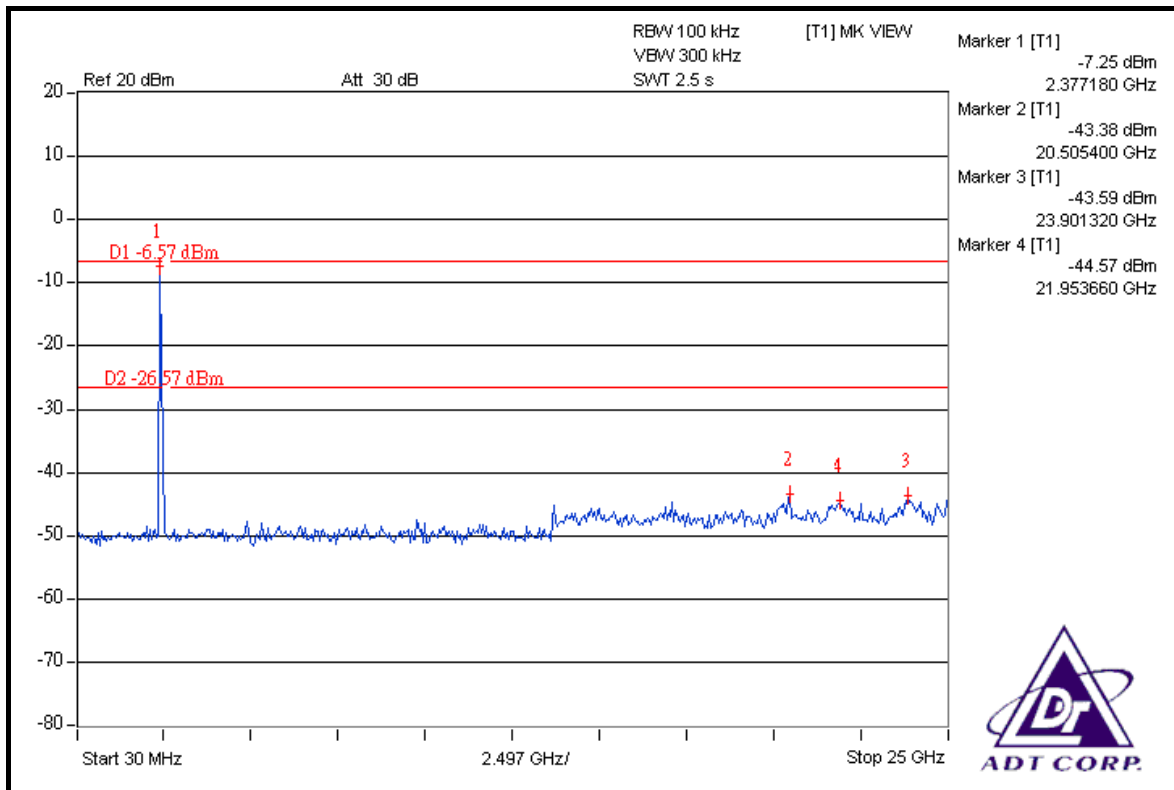

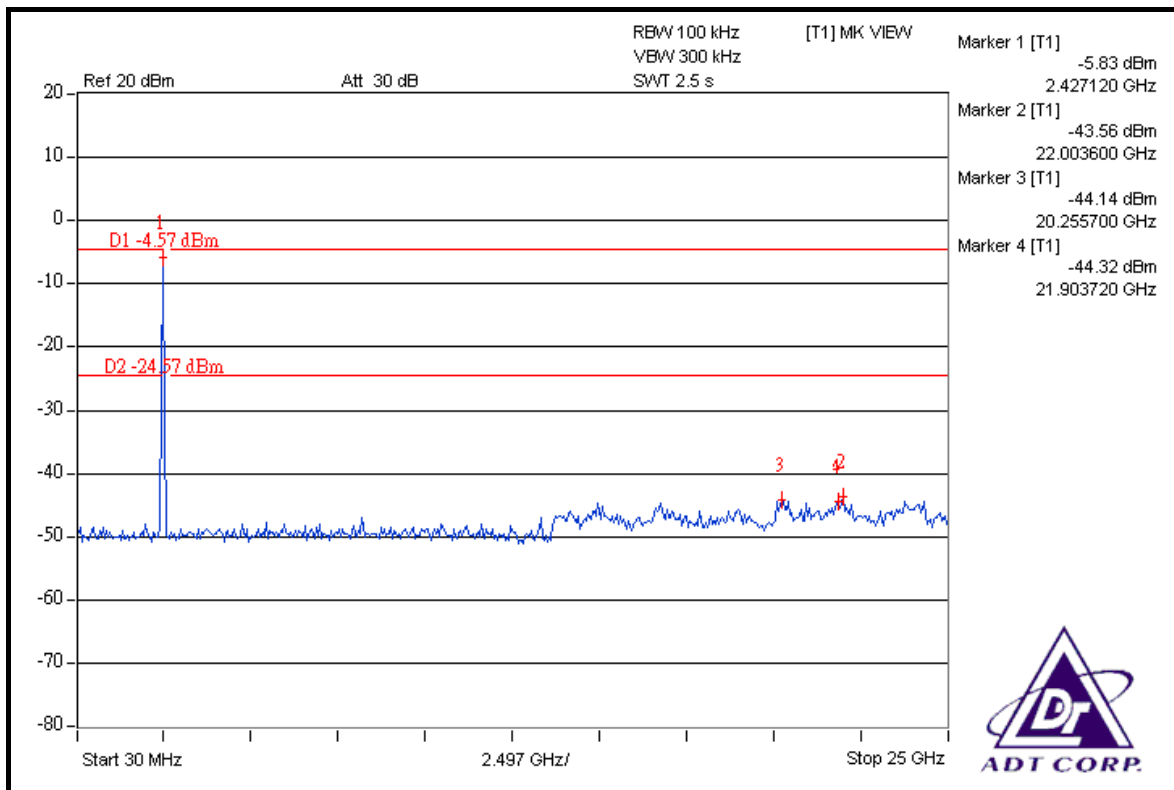
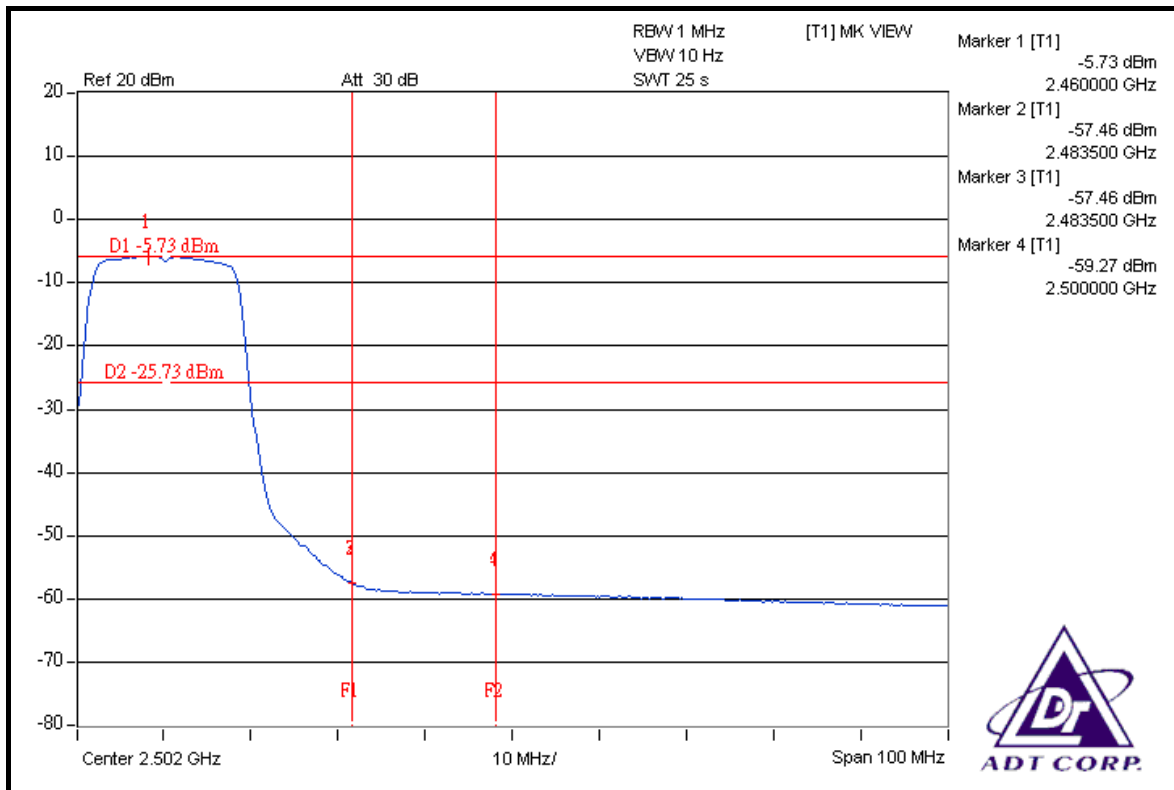

## DRAFT 802.11n (20MHz) OFDM MODULATION

**NOTE 1:** The band edge emission plot on the next page shows 50.34dBc between carrier maximum power and local maximum emission in restrict band (2.3428GHz). The emission of carrier strength list in the test result of channel 1 at the item 4.2.7 is 113.13dBuV/m (Peak), so the maximum field strength in restrict band is  $113.13 - 50.34 = 62.79$ dBuV/m which is under 74dBuV/m limit.

The band edge emission plot of on the next page shows 55.59dBc between carrier maximum power and local maximum emission in restrict band (2.3900GHz). The emission of carrier strength list in the test result of channel 1 at the item 4.2.7 is 99.20dBuV/m (Average), so the maximum field strength in restrict band is  $99.20 - 55.59 = 43.61$ dBuV/m which is under 54dBuV/m limit.

**NOTE 2:** The band edge emission plot on the next second page shows 48.53dBc between carrier maximum power and local maximum emission in restrict band (2.4882GHz). The emission of carrier strength list in the test result of channel 11 at the item 4.2.7 is 113.73dBuV/m (Peak), so the maximum field strength in restrict band is  $113.73 - 48.53 = 65.20$ dBuV/m which is under 74dBuV/m limit.

The band edge emission plot on the next third page shows 54.54dBc between carrier maximum power and local maximum emission in restrict band (2.4835GHz). The emission of carrier strength list in the test result of channel 11 at the item 4.2.7 is 100.23dBuV/m (Average), so the maximum field strength in restrict band is  $100.23 - 54.54 = 45.69$ dBuV/m which is under 54dBuV/m limit.

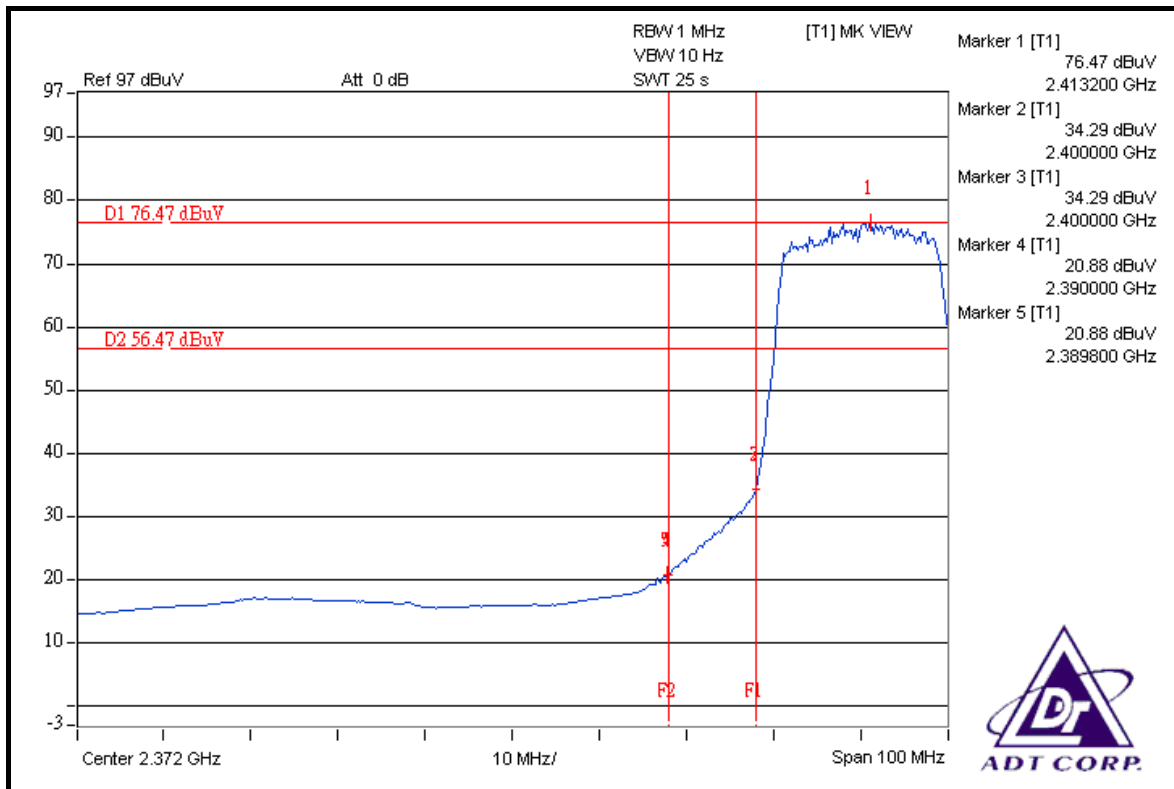
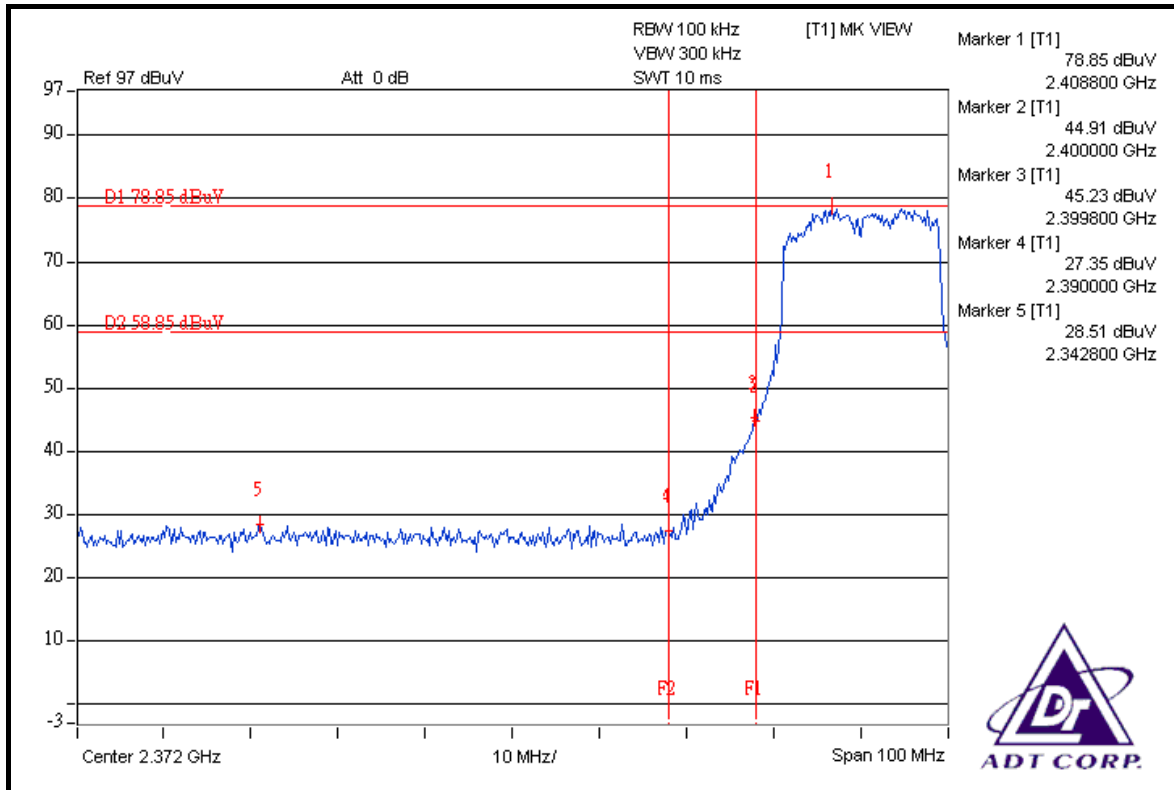

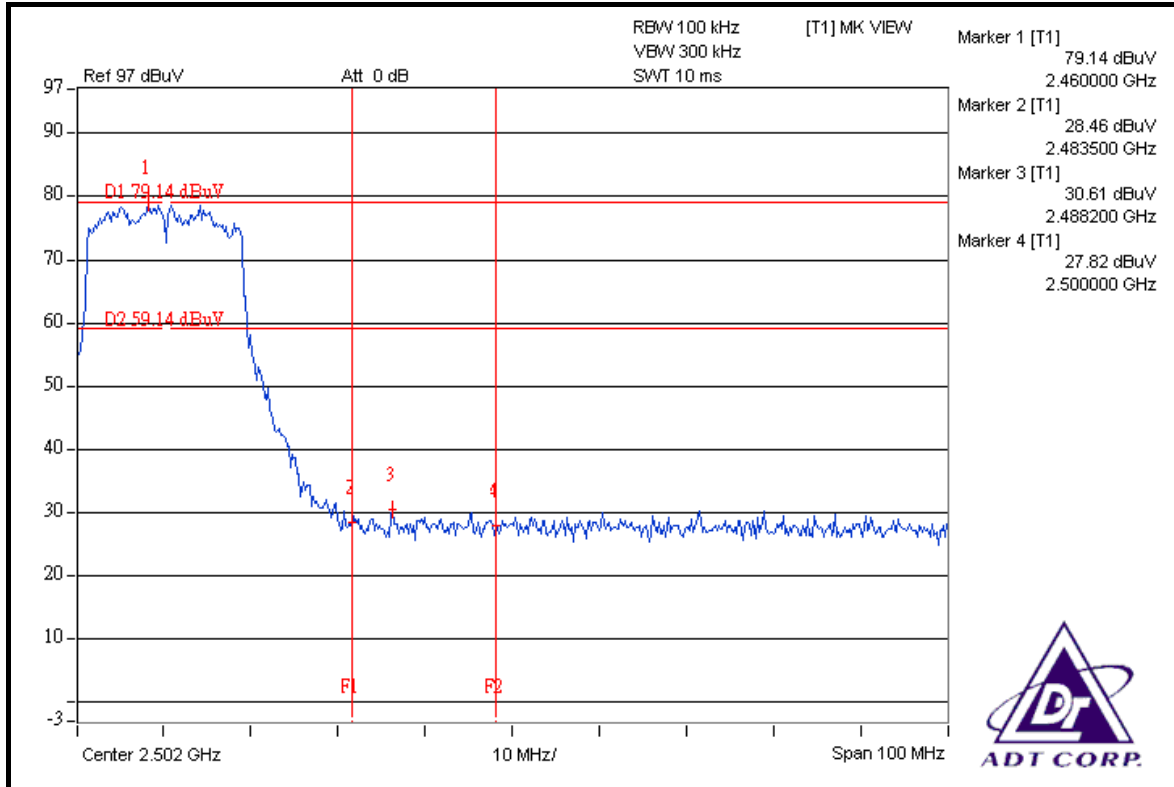
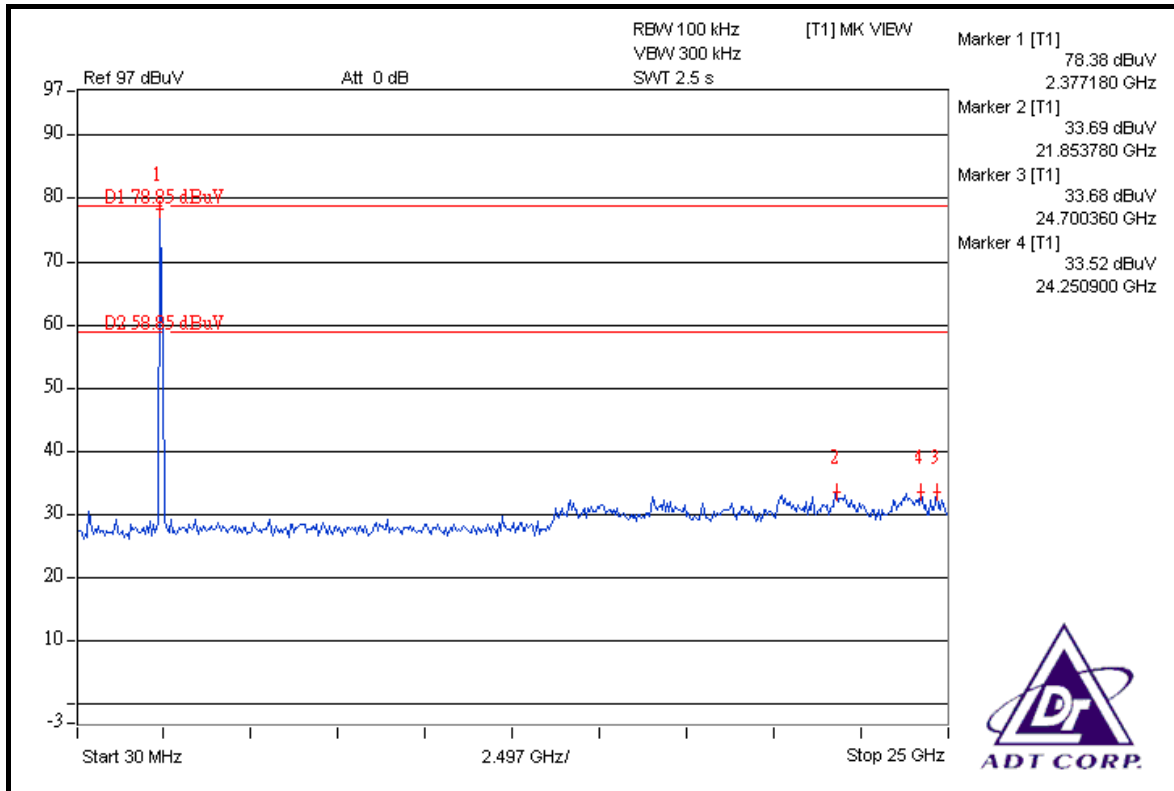

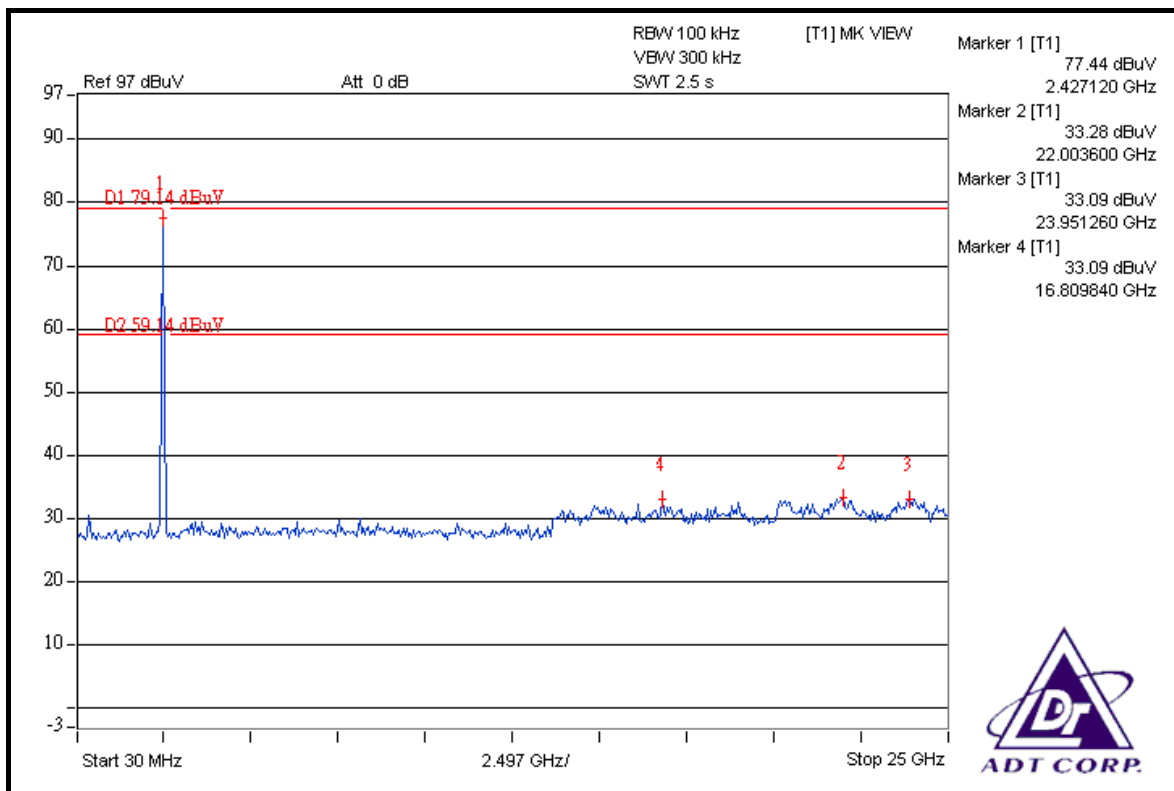
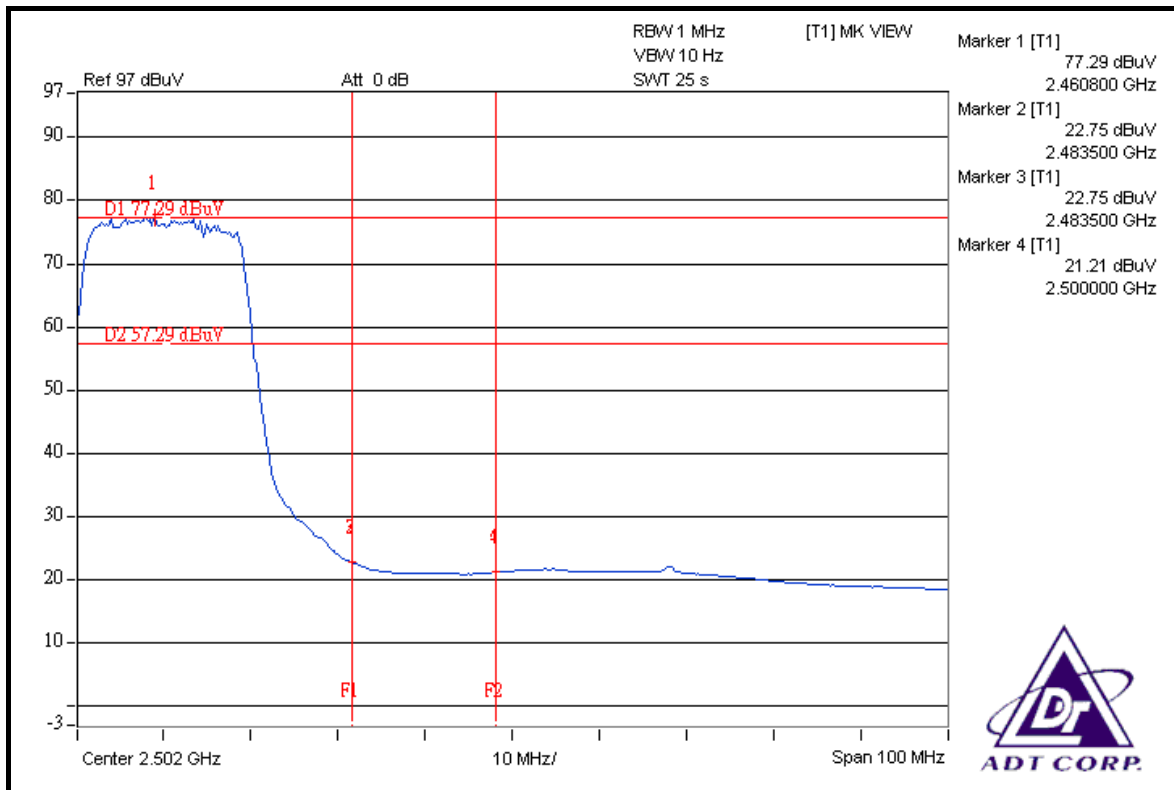

## DRAFT 802.11n (40MHz) OFDM MODULATION

**NOTE 1:** The band edge emission plot on the next page shows 43.50dBc between carrier maximum power and local maximum emission in restrict band (2.3844GHz). The emission of carrier strength list in the test result of channel 1 at the item 4.2.7 is 111.28dBuV/m (Peak), so the maximum field strength in restrict band is  $111.28 - 43.50 = 67.78$ dBuV/m which is under 74dBuV/m limit.

The band edge emission plot of on the next page shows 45.05dBc between carrier maximum power and local maximum emission in restrict band (2.3900GHz). The emission of carrier strength list in the test result of channel 1 at the item 4.2.7 is 96.68dBuV/m (Average), so the maximum field strength in restrict band is  $96.68 - 45.05 = 51.63$ dBuV/m which is under 54dBuV/m limit.

**NOTE 2:** The band edge emission plot on the next second page shows 46.81dBc between carrier maximum power and local maximum emission in restrict band (2.4844GHz). The emission of carrier strength list in the test result of channel 7 at the item 4.2.7 is 111.05dBuV/m (Peak), so the maximum field strength in restrict band is  $111.05 - 46.81 = 64.24$ dBuV/m which is under 74dBuV/m limit.

The band edge emission plot on the next third page shows 47.88dBc between carrier maximum power and local maximum emission in restrict band (2.4835GHz). The emission of carrier strength list in the test result of channel 7 at the item 4.2.7 is 96.89dBuV/m (Average), so the maximum field strength in restrict band is  $96.89 - 47.88 = 49.01$ dBuV/m which is under 54dBuV/m limit.

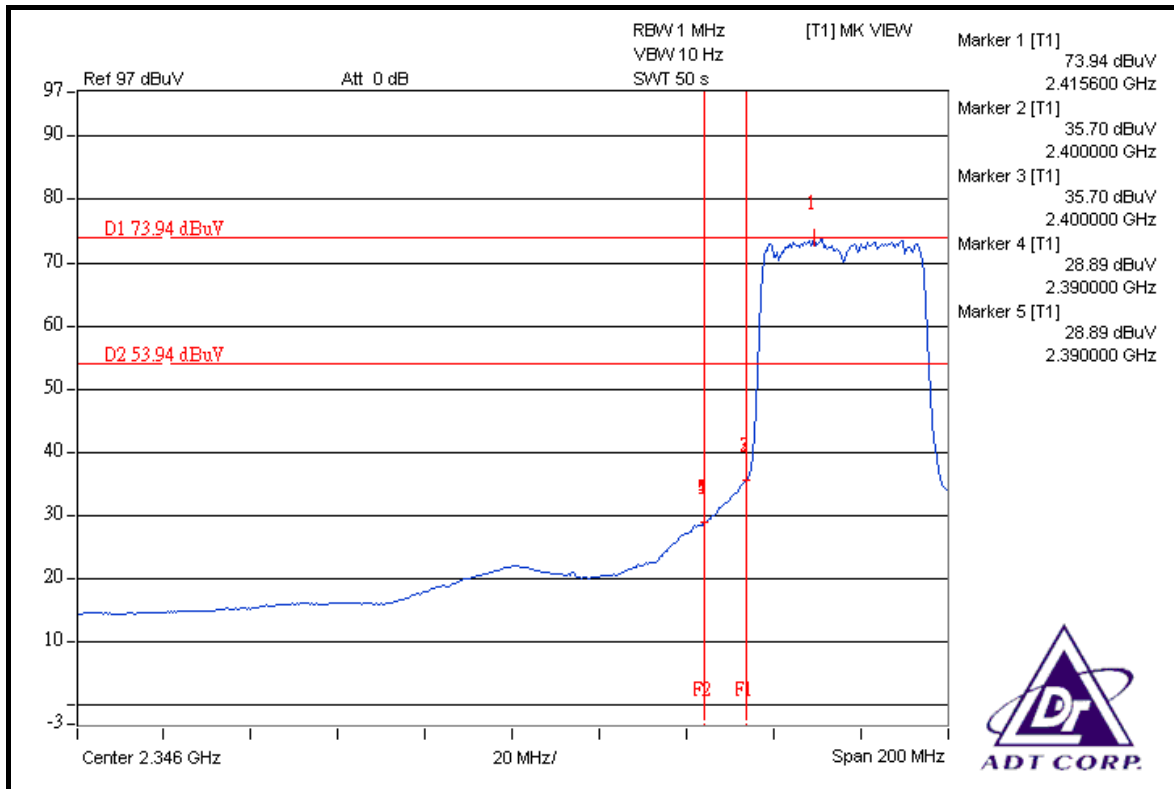
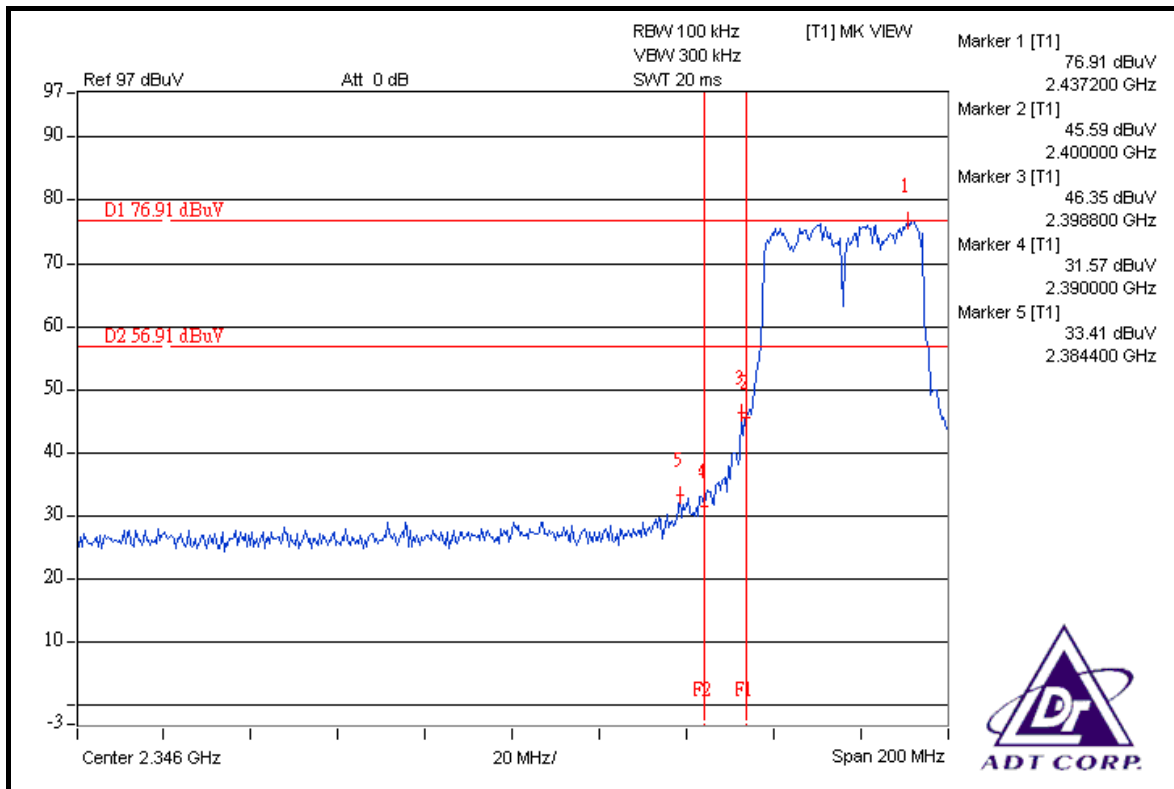



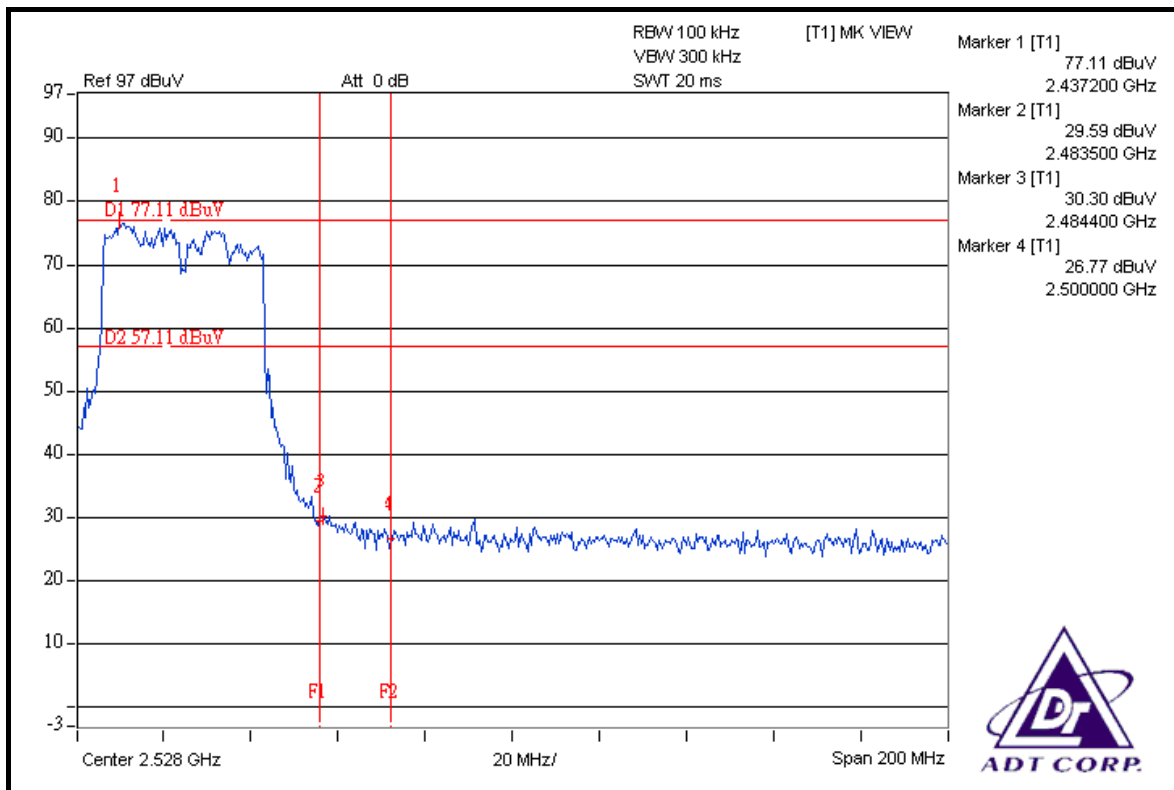
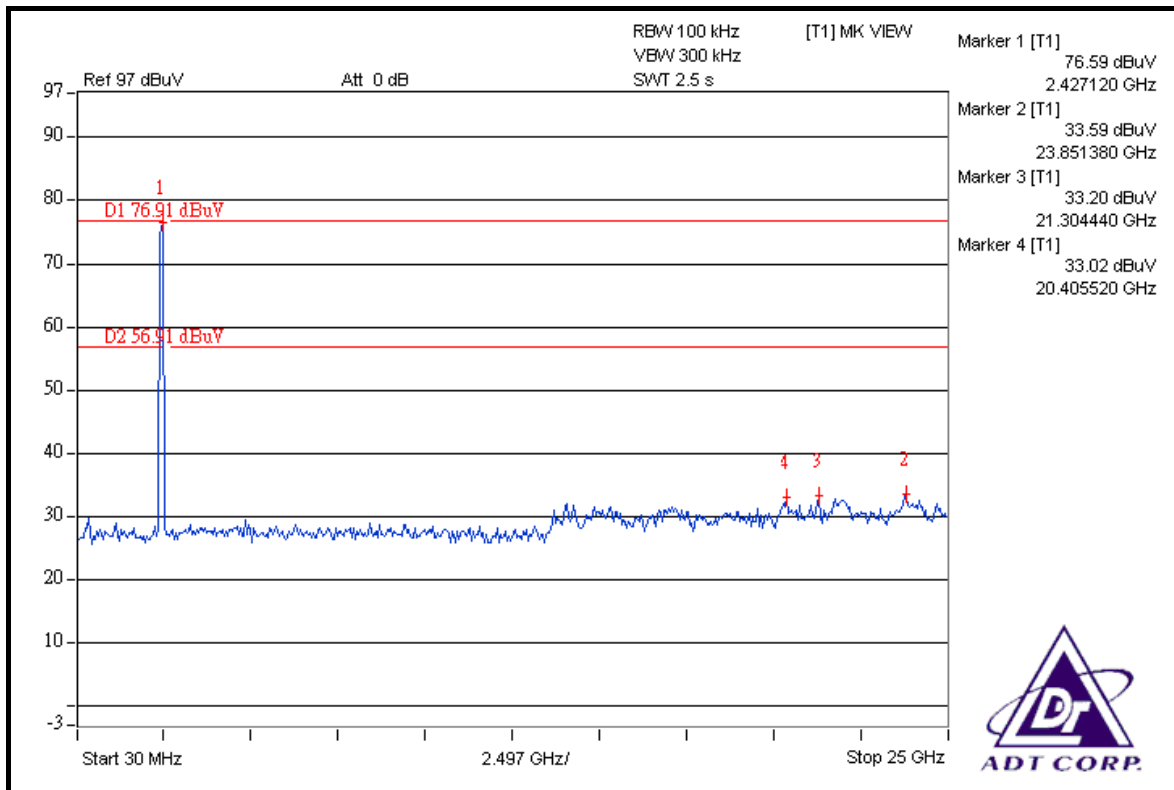

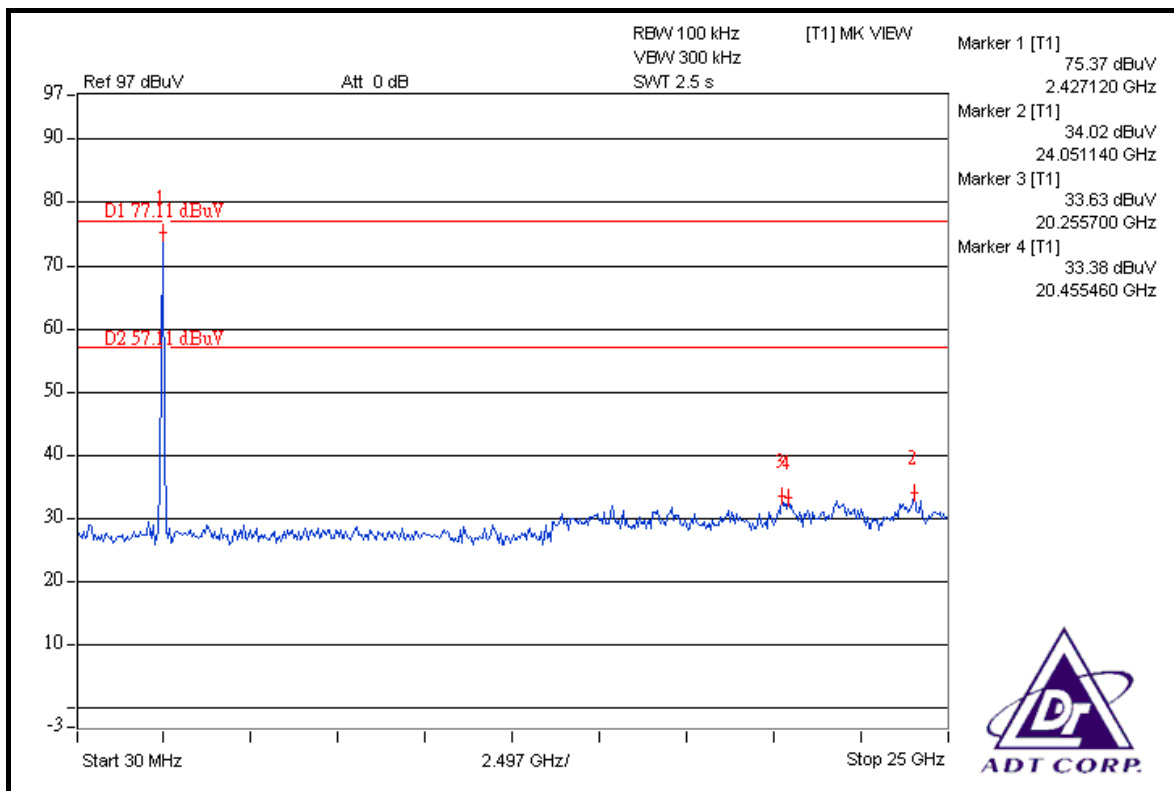
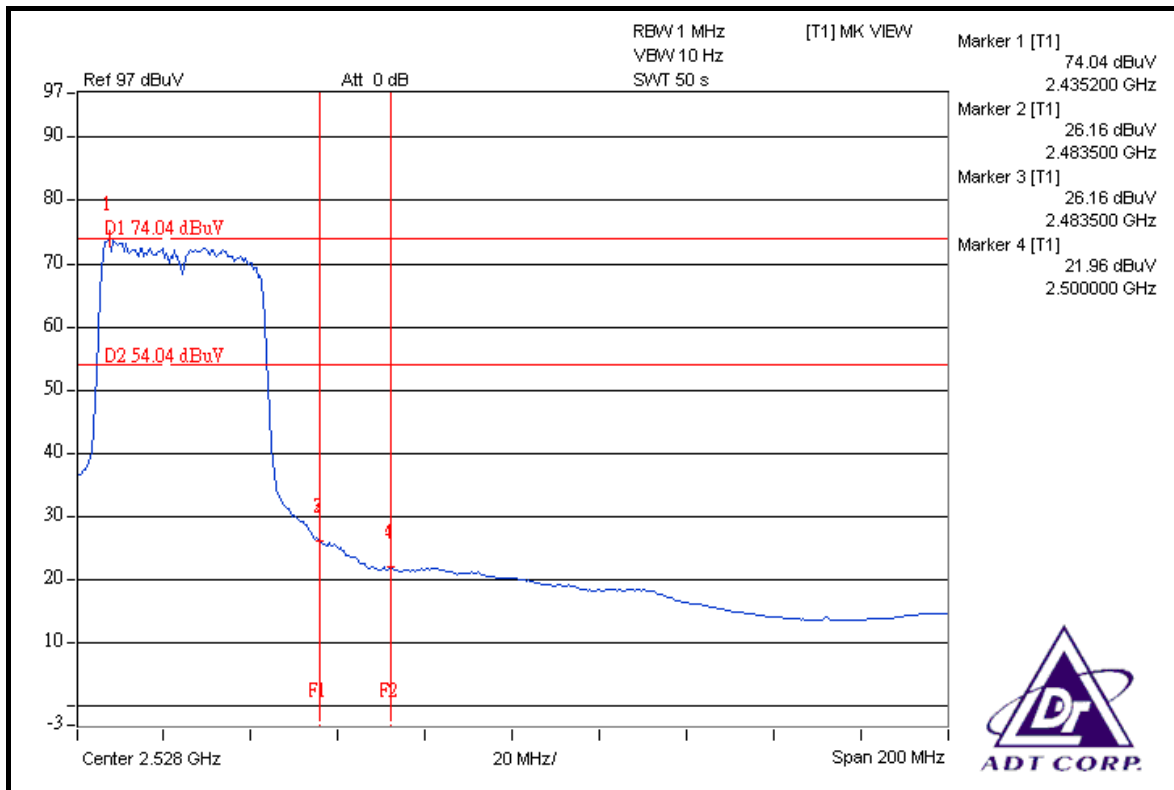



## **4.7 ANTENNA REQUIREMENT**

### **4.7.1 STANDARD APPLICABLE**

For intentional device, according to FCC 47 CFR Section 15.203, an intentional radiator shall be designed to ensure that no antenna other than that furnished by the responsible party shall be used with the device.

And according to FCC 47 CFR Section 15.247 (b), if transmitting antennas of directional gain greater than 6dBi are used, the power shall be reduced by the amount in dB that the directional gain of the antenna exceeds 6dBi.

### **4.7.2 ANTENNA CONNECTED CONSTRUCTION**

The antenna used in this product is Dipole antenna with UFL connector. The maximum Gain of the antenna is 3dBi.

## 5. TEST TYPES AND RESULTS (FOR 5.0GHz BAND)

### 5.1 RADIATED EMISSION MEASUREMENT

#### 5.1.1 LIMITS OF RADIATED EMISSION MEASUREMENT

Emissions radiated outside of the specified bands, shall be according to the general radiated limits in 15.209 as following:

FREQUENCIES (MHz)	FIELD STRENGTH (microvolts/meter)	MEASUREMENT DISTANCE (meters)
0.009 ~ 0.490	2400/F(kHz)	300
0.490 ~ 1.705	24000/F(kHz)	30
1.705 ~ 30.0	30	30
30 ~ 88	100	3
88 ~ 216	150	3
216 ~ 960	200	3
Above 960	500	3

**NOTE:**

1. The lower limit shall apply at the transition frequencies.
2. Emission level (dBuV/m) = 20 log Emission level (uV/m).
3. As shown in 15.35(b), for frequencies above 1000MHz, the field strength limits are based on average detector, however, the peak field strength of any emission shall not exceed the maximum permitted average limits, specified above by more than 20dB under any condition of modulation.



### 5.1.2 TEST INSTRUMENTS

DESCRIPTION & MANUFACTURER	MODEL NO.	SERIAL NO.	DATE OF CALIBRATION	DUE DATE OF CALIBRATION
Test Receiver ROHDE & SCHWARZ	ESI7	100033	Jun. 30, 2008	Jun. 29, 2009
Spectrum Analyzer Agilent	FSP	100041	Apr. 22, 2008	Apr. 21, 2009
BILOG Antenna SCHWARZBECK	VULB9168	9168-160	May, 02, 2008	May, 01, 2009
HORN Antenna SCHWARZBECK	9120D	9120D-209	Jun. 24, 2008	Jun. 23, 2009
HORN Antenna SCHWARZBECK	BBHA 9170	BBHA9170243	Dec. 25, 2007	Dec. 24, 2008
Preamplifier Agilent	8447D	2944A10633	Oct. 29, 2007	Oct. 28, 2008
Preamplifier Agilent	8449B	3008A01964	Oct. 24, 2007	Oct. 23, 2008
RF signal cable HUBER+SUHNNER	SUCOFLEX 104	283402/4	Dec. 07, 2007	Dec. 06, 2008
RF signal cable HUBER+SUHNNER	SUCOFLEX 104	251644/4	Dec. 07, 2007	Dec. 06, 2008
Software ADT.	ADT_Radiated_V7.6	NA	NA	NA
Antenna Tower inn-co GmbH	MA 4000	013303	NA	NA
Antenna Tower Controller inn-co GmbH	CO2000	017303	NA	NA
Turn Table ADT.	TT100.	TT93021703	NA	NA
Turn Table Controller ADT.	SC100.	SC93021703	NA	NA

- NOTE:**
1. The calibration interval of the above test instruments is 12 months and the calibrations are traceable to NML/ROC and NIST/USA.
  2. The test was performed in HwaYa Chamber 3.
  3. The horn antenna and HP preamplifier (model: 8449B) are used only for the measurement of emission frequency above 1GHz if tested.
  4. The FCC Site Registration No. is 988962.
  5. The IC Site Registration No. is IC3789B-3.

### 5.1.3 TEST PROCEDURES

- a. The EUT was placed on the top of a rotating table 0.8 meters above the ground at a 3 meters semi-anechoic chamber. The table was rotated 360 degrees to determine the position of the highest radiation.
- b. The EUT was set 3 meters away from the interference-receiving antenna, which was mounted on the top of a variable-height antenna tower.
- c. The antenna is a broadband antenna, and its height is varied from one meter to four meters above the ground to determine the maximum value of the field strength. Both horizontal and vertical polarizations of the antenna are set to make the measurement.
- d. For each suspected emission, the EUT was arranged to its worst case and then the antenna was tuned to heights from 1 meter to 4 meters and the rotatable table was turned from 0 degrees to 360 degrees to find the maximum reading.
- e. The test-receiver system was set to Peak Detect Function and Specified Bandwidth with Maximum Hold Mode.
- f. If the emission level of the EUT in peak mode was lower than the limit specified, then testing could be stopped and the peak values of the EUT would be reported. Otherwise the emissions would be re-tested one by one using peak, quasi-peak or average method as specified and then reported in a data sheet.

**NOTE:**

1. The resolution bandwidth and video bandwidth of test receiver/spectrum analyzer is 120kHz for Quasi-peak detection at frequency below 1GHz.
2. The resolution bandwidth of test receiver/spectrum analyzer is 100kHz and video bandwidth is 300kHz for Peak detection at frequency above 1GHz.
3. The resolution bandwidth of test receiver/spectrum analyzer is 1MHz and the video bandwidth is 10Hz for Average detection (AV) at frequency above 1GHz.
4. All modes of operation were investigated and the worst-case emissions are reported.

### 5.1.4 DEVIATION FROM TEST STANDARD

No deviation

### 5.1.5 TEST SETUP

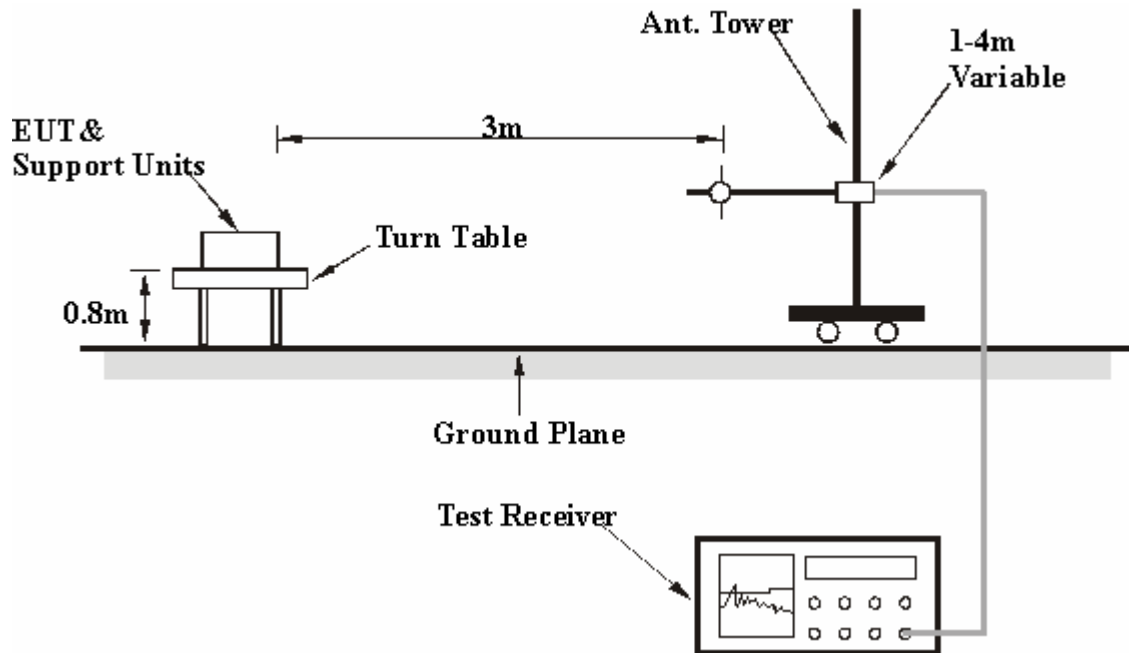

For the actual test configuration, please refer to the attached file (Test Setup Photo).

### 5.1.6 EUT OPERATING CONDITIONS

Same as 4.1.6

## 5.1.7 TEST RESULTS

### 802.11a OFDM MODULATION

EUT TEST CONDITION		MEASUREMENT DETAIL	
CHANNEL	Channel 149	FREQUENCY RANGE	1 ~ 40GHz
INPUT POWER (SYSTEM)	120Vac, 60 Hz	DETECTOR FUNCTION	Peak (PK) Average (AV)
ENVIRONMENTAL CONDITIONS	24deg. C, 64%RH 999hPa	TESTED BY	Kevin Liang

ANTENNA POLARITY & TEST DISTANCE: HORIZONTAL AT 3 M								
NO.	FREQ. (MHz)	EMISSION LEVEL (dBuV/m)	LIMIT (dBuV/m)	MARGIN (dB)	ANTENNA HEIGHT (m)	TABLE ANGLE (Degree)	RAW VALUE (dBuV)	CORRECTION FACTOR (dB/m)
1	#5725.00	50.58 PK	77.59	-27.01	1.40 H	319	10.74	39.84
2	#5725.00	33.38 AV	65.41	-32.03	1.40 H	319	-6.46	39.84
3	*5745.00	97.59 PK			1.40 H	319	57.72	39.87
4	*5745.00	85.41 AV			1.40 H	319	45.54	39.87
5	11490.00	59.85 PK	74.00	-14.15	1.07 H	186	9.85	50.00
6	11490.00	46.72 AV	54.00	-7.28	1.07 H	186	-3.28	50.00
ANTENNA POLARITY & TEST DISTANCE: VERTICAL AT 3 M								
NO.	FREQ. (MHz)	EMISSION LEVEL (dBuV/m)	LIMIT (dBuV/m)	MARGIN (dB)	ANTENNA HEIGHT (m)	TABLE ANGLE (Degree)	RAW VALUE (dBuV)	CORRECTION FACTOR (dB/m)
1	#5725.00	66.09 PK	89.28	-23.19	1.00 V	345	26.25	39.84
2	#5725.00	44.38 AV	77.44	-33.06	1.00 V	345	4.54	39.84
3	*5745.00	109.28 PK			1.00 V	345	69.41	39.87
4	*5745.00	97.44 AV			1.00 V	345	57.57	39.87
5	11490.00	62.34 PK	74.00	-11.66	1.28 V	175	12.34	50.00
6	11490.00	47.66 AV	54.00	-6.34	1.28 V	175	-2.34	50.00

- REMARKS:**
1. Emission level (dBuV/m) = Raw Value (dBuV) + Correction Factor (dB/m).
  2. Correction Factor (dB/m) = Antenna Factor (dB/m) + Cable Factor (dB).
  3. The other emission levels were very low against the limit.
  4. Margin value = Emission level – Limit value.
  5. “ \* “: Fundamental frequency.
  6. The limit value is defined as per 15.247.
  7. "#":The radiated frequency is out the restricted band.



EUT TEST CONDITION		MEASUREMENT DETAIL	
CHANNEL	Channel 157	FREQUENCY RANGE	1 ~ 40GHz
INPUT POWER (SYSTEM)	120Vac, 60 Hz	DETECTOR FUNCTION	Peak (PK) Average (AV)
ENVIRONMENTAL CONDITIONS	24deg. C, 64%RH 999hPa	TESTED BY	Kevin Liang

ANTENNA POLARITY & TEST DISTANCE: HORIZONTAL AT 3 M								
NO.	FREQ. (MHz)	EMISSION LEVEL (dBuV/m)	LIMIT (dBuV/m)	MARGIN (dB)	ANTENNA HEIGHT (m)	TABLE ANGLE (Degree)	RAW VALUE (dBuV)	CORRECTION FACTOR (dB/m)
1	*5785.00	96.34 PK			1.75 H	356	56.41	39.93
2	*5785.00	84.90 AV			1.75 H	356	44.97	39.93
3	11570.00	59.93 PK	74.00	-14.07	1.08 H	182	10.04	49.89
4	11570.00	46.76 AV	54.00	-7.24	1.08 H	182	-3.13	49.89
ANTENNA POLARITY & TEST DISTANCE: VERTICAL AT 3 M								
NO.	FREQ. (MHz)	EMISSION LEVEL (dBuV/m)	LIMIT (dBuV/m)	MARGIN (dB)	ANTENNA HEIGHT (m)	TABLE ANGLE (Degree)	RAW VALUE (dBuV)	CORRECTION FACTOR (dB/m)
1	*5785.00	109.50 PK			1.00 V	312	69.57	39.93
2	*5785.00	98.22 AV			1.00 V	312	58.29	39.93
3	11570.00	62.45 PK	74.00	-11.55	1.26 V	188	12.56	49.89
4	11570.00	47.82 AV	54.00	-6.18	1.26 V	188	-2.07	49.89

- REMARKS:**
1. Emission level (dBuV/m) = Raw Value (dBuV) + Correction Factor (dB/m).
  2. Correction Factor (dB/m) = Antenna Factor (dB/m) + Cable Factor (dB).
  3. The other emission levels were very low against the limit.
  4. Margin value = Emission level – Limit value.
  5. “ \* “: Fundamental frequency.
  6. The limit value is defined as per 15.247.

EUT TEST CONDITION		MEASUREMENT DETAIL	
CHANNEL	Channel 165	FREQUENCY RANGE	1 ~ 40GHz
INPUT POWER (SYSTEM)	120Vac, 60 Hz	DETECTOR FUNCTION	Peak (PK) Average (AV)
ENVIRONMENTAL CONDITIONS	24deg. C, 64%RH 999hPa	TESTED BY	Kevin Liang

ANTENNA POLARITY & TEST DISTANCE: HORIZONTAL AT 3 M								
NO.	FREQ. (MHz)	EMISSION LEVEL (dBuV/m)	LIMIT (dBuV/m)	MARGIN (dB)	ANTENNA HEIGHT (m)	TABLE ANGLE (Degree)	RAW VALUE (dBuV)	CORRECTION FACTOR (dB/m)
1	*5825.00	98.25 PK			1.65 H	321	58.22	40.03
2	*5825.00	86.59 AV			1.65 H	321	46.56	40.03
3	#5850.00	51.20 PK	78.25	-27.05	1.65 H	321	11.10	40.10
4	#5850.00	36.62 AV	66.59	-29.97	1.65 H	321	-3.48	40.10
5	11650.00	59.83 PK	74.00	-14.17	1.25 H	195	9.99	49.84
6	11650.00	46.57 AV	54.00	-7.43	1.25 H	195	-3.27	49.84
ANTENNA POLARITY & TEST DISTANCE: VERTICAL AT 3 M								
NO.	FREQ. (MHz)	EMISSION LEVEL (dBuV/m)	LIMIT (dBuV/m)	MARGIN (dB)	ANTENNA HEIGHT (m)	TABLE ANGLE (Degree)	RAW VALUE (dBuV)	CORRECTION FACTOR (dB/m)
1	*5825.00	109.33 PK			1.01 V	321	69.30	40.03
2	*5825.00	97.48 AV			1.01 V	321	57.45	40.03
3	#5850.00	56.30 PK	89.33	-33.03	1.01 V	321	16.20	40.10
4	#5850.00	40.95 AV	77.48	-36.53	1.01 V	321	0.85	40.10
5	11650.00	62.83 PK	74.00	-11.17	1.11 V	189	12.99	49.84
6	11650.00	48.34 AV	54.00	-5.66	1.11 V	189	-1.50	49.84

- REMARKS:**
1. Emission level (dBuV/m) = Raw Value (dBuV) + Correction Factor (dB/m).
  2. Correction Factor (dB/m) = Antenna Factor (dB/m) + Cable Factor (dB).
  3. The other emission levels were very low against the limit.
  4. Margin value = Emission level – Limit value.
  5. “ \* “: Fundamental frequency.
  6. The limit value is defined as per 15.247.
  7. “#“: The radiated frequency is out the restricted band.

### DRAFT 802.11n (20MHz) OFDM MODULATION

EUT TEST CONDITION		MEASUREMENT DETAIL	
CHANNEL	Channel 149	FREQUENCY RANGE	1 ~ 40GHz
INPUT POWER (SYSTEM)	120Vac, 60 Hz	DETECTOR FUNCTION	Peak (PK) Average (AV)
ENVIRONMENTAL CONDITIONS	26deg. C, 60%RH 999hPa	TESTED BY	Kevin Liang

ANTENNA POLARITY & TEST DISTANCE: HORIZONTAL AT 3 M								
NO.	FREQ. (MHz)	EMISSION LEVEL (dBuV/m)	LIMIT (dBuV/m)	MARGIN (dB)	ANTENNA HEIGHT (m)	TABLE ANGLE (Degree)	RAW VALUE (dBuV)	CORRECTION FACTOR (dB/m)
1	#5725.00	57.51 PK	77.79	-20.28	1.70 H	297	17.99	39.52
2	#5725.00	37.42 AV	64.14	-26.72	1.70 H	297	-2.10	39.52
3	*5745.00	97.79 PK			1.70 H	297	58.22	39.57
4	*5745.00	84.14 AV			1.70 H	297	44.57	39.57
5	11490.00	59.26 PK	74.00	-14.74	1.00 H	53	8.51	50.75
6	11490.00	46.38 AV	54.00	-7.62	1.00 H	53	-4.37	50.75
ANTENNA POLARITY & TEST DISTANCE: VERTICAL AT 3 M								
NO.	FREQ. (MHz)	EMISSION LEVEL (dBuV/m)	LIMIT (dBuV/m)	MARGIN (dB)	ANTENNA HEIGHT (m)	TABLE ANGLE (Degree)	RAW VALUE (dBuV)	CORRECTION FACTOR (dB/m)
1	#5725.00	65.29 PK	89.50	-24.21	1.42 V	156	25.77	39.52
2	#5725.00	45.47 AV	76.06	-30.59	1.42 V	156	5.95	39.52
3	*5745.00	109.50 PK			1.42 V	156	69.93	39.57
4	*5745.00	96.06 AV			1.42 V	156	56.49	39.57
5	11490.00	60.42 PK	74.00	-13.58	1.13 V	239	9.67	50.75
6	11490.00	46.61 AV	54.00	-7.39	1.13 V	239	-4.14	50.75

- REMARKS:**
1. Emission level (dBuV/m) = Raw Value (dBuV) + Correction Factor (dB/m).
  2. Correction Factor (dB/m) = Antenna Factor (dB/m) + Cable Factor (dB).
  3. The other emission levels were very low against the limit.
  4. Margin value = Emission level – Limit value.
  5. “ \* “: Fundamental frequency.
  6. The limit value is defined as per 15.247.
  7. “#”:The radiated frequency is out the restricted band.



EUT TEST CONDITION		MEASUREMENT DETAIL	
CHANNEL	Channel 157	FREQUENCY RANGE	1 ~ 40GHz
INPUT POWER (SYSTEM)	120Vac, 60 Hz	DETECTOR FUNCTION	Peak (PK) Average (AV)
ENVIRONMENTAL CONDITIONS	26deg. C, 60%RH 999hPa	TESTED BY	Kevin Liang

ANTENNA POLARITY & TEST DISTANCE: HORIZONTAL AT 3 M								
NO.	FREQ. (MHz)	EMISSION LEVEL (dBuV/m)	LIMIT (dBuV/m)	MARGIN (dB)	ANTENNA HEIGHT (m)	TABLE ANGLE (Degree)	RAW VALUE (dBuV)	CORRECTION FACTOR (dB/m)
1	*5785.00	96.11 PK			1.67 H	297	56.44	39.67
2	*5785.00	82.77 AV			1.67 H	297	43.10	39.67
3	11570.00	59.14 PK	74.00	-14.86	1.01 H	58	8.52	50.62
4	11570.00	46.27 AV	54.00	-7.73	1.01 H	58	-4.35	50.62
ANTENNA POLARITY & TEST DISTANCE: VERTICAL AT 3 M								
NO.	FREQ. (MHz)	EMISSION LEVEL (dBuV/m)	LIMIT (dBuV/m)	MARGIN (dB)	ANTENNA HEIGHT (m)	TABLE ANGLE (Degree)	RAW VALUE (dBuV)	CORRECTION FACTOR (dB/m)
1	*5785.00	109.23 PK			1.42 V	50	69.56	39.67
2	*5785.00	95.16 AV			1.42 V	50	55.49	39.67
3	11570.00	60.18 PK	74.00	-13.82	1.17 V	245	9.56	50.62
4	11570.00	46.52 AV	54.00	-7.48	1.17 V	245	-4.10	50.62

- REMARKS:**
1. Emission level (dBuV/m) = Raw Value (dBuV) + Correction Factor (dB/m).
  2. Correction Factor (dB/m) = Antenna Factor (dB/m) + Cable Factor (dB).
  3. The other emission levels were very low against the limit.
  4. Margin value = Emission level – Limit value.
  5. “ \* “: Fundamental frequency.
  6. The limit value is defined as per 15.247.

EUT TEST CONDITION		MEASUREMENT DETAIL	
CHANNEL	Channel 165	FREQUENCY RANGE	1 ~ 40GHz
INPUT POWER (SYSTEM)	120Vac, 60 Hz	DETECTOR FUNCTION	Peak (PK) Average (AV)
ENVIRONMENTAL CONDITIONS	26deg. C, 60%RH 999hPa	TESTED BY	Kevin Liang

ANTENNA POLARITY & TEST DISTANCE: HORIZONTAL AT 3 M								
NO.	FREQ. (MHz)	EMISSION LEVEL (dBuV/m)	LIMIT (dBuV/m)	MARGIN (dB)	ANTENNA HEIGHT (m)	TABLE ANGLE (Degree)	RAW VALUE (dBuV)	CORRECTION FACTOR (dB/m)
1	*5825.00	97.32 PK			1.66 H	294	57.54	39.78
2	*5825.00	83.79 AV			1.66 H	294	44.02	39.78
3	#5850.00	53.34 PK	77.32	-23.98	1.66 H	294	13.50	39.84
4	#5850.00	37.18 AV	63.79	-26.61	1.66 H	294	-2.66	39.84
5	11650.00	59.17 PK	74.00	-14.83	1.01 H	49	8.71	50.46
6	11650.00	46.30 AV	54.00	-7.70	1.01 H	49	-4.16	50.46
ANTENNA POLARITY & TEST DISTANCE: VERTICAL AT 3 M								
NO.	FREQ. (MHz)	EMISSION LEVEL (dBuV/m)	LIMIT (dBuV/m)	MARGIN (dB)	ANTENNA HEIGHT (m)	TABLE ANGLE (Degree)	RAW VALUE (dBuV)	CORRECTION FACTOR (dB/m)
1	*5825.00	109.02 PK			1.48 V	52	69.24	39.78
2	*5825.00	95.62 AV			1.48 V	52	55.85	39.78
3	#5850.00	53.87 PK	89.02	-35.15	1.48 V	52	14.03	39.84
4	#5850.00	39.06 AV	75.62	-36.56	1.48 V	52	-0.78	39.84
5	11650.00	60.21 PK	74.00	-13.79	1.13 V	247	9.75	50.46
6	11650.00	46.37 AV	54.00	-7.63	1.13 V	247	-4.09	50.46

- REMARKS:**
1. Emission level (dBuV/m) = Raw Value (dBuV) + Correction Factor (dB/m).
  2. Correction Factor (dB/m) = Antenna Factor (dB/m) + Cable Factor (dB).
  3. The other emission levels were very low against the limit.
  4. Margin value = Emission level – Limit value.
  5. “ \* “: Fundamental frequency.
  6. The limit value is defined as per 15.247.
  7. “#“: The radiated frequency is out the restricted band.

### DRAFT 802.11n (40MHz) OFDM MODULATION

EUT TEST CONDITION		MEASUREMENT DETAIL	
CHANNEL	Channel 151	FREQUENCY RANGE	1 ~ 40GHz
INPUT POWER (SYSTEM)	120Vac, 60 Hz	DETECTOR FUNCTION	Peak (PK) Average (AV)
ENVIRONMENTAL CONDITIONS	26deg. C, 60%RH 999hPa	TESTED BY	Kevin Liang

ANTENNA POLARITY & TEST DISTANCE: HORIZONTAL AT 3 M								
NO.	FREQ. (MHz)	EMISSION LEVEL (dBuV/m)	LIMIT (dBuV/m)	MARGIN (dB)	ANTENNA HEIGHT (m)	TABLE ANGLE (Degree)	RAW VALUE (dBuV)	CORRECTION FACTOR (dB/m)
1	#5725.00	67.52 PK	77.51	-9.99	1.81 H	300	28.00	39.52
2	#5725.00	40.10 AV	63.57	-23.47	1.81 H	300	0.58	39.52
3	*5755.00	97.51 PK			1.82 H	300	57.91	39.60
4	*5755.00	83.57 AV			1.82 H	300	43.97	39.60
5	11510.00	58.96 PK	74.00	-15.04	1.05 H	78	8.23	50.73
6	11510.00	46.24 AV	54.00	-7.76	1.05 H	78	-4.49	50.73
ANTENNA POLARITY & TEST DISTANCE: VERTICAL AT 3 M								
NO.	FREQ. (MHz)	EMISSION LEVEL (dBuV/m)	LIMIT (dBuV/m)	MARGIN (dB)	ANTENNA HEIGHT (m)	TABLE ANGLE (Degree)	RAW VALUE (dBuV)	CORRECTION FACTOR (dB/m)
1	#5725.00	72.56 PK	86.61	-14.05	1.40 V	323	33.04	39.52
2	#5725.00	48.38 AV	72.21	-23.83	1.40 V	323	8.86	39.52
3	*5755.00	106.61 PK			1.40 V	323	67.01	39.60
4	*5755.00	92.21 AV			1.40 V	323	52.61	39.60
5	11510.00	60.34 PK	74.00	-13.66	1.18 V	243	9.61	50.73
6	11510.00	46.58 AV	54.00	-7.42	1.18 V	243	-4.15	50.73

- REMARKS:**
1. Emission level (dBuV/m) = Raw Value (dBuV) + Correction Factor (dB/m).
  2. Correction Factor (dB/m) = Antenna Factor (dB/m) + Cable Factor (dB).
  3. The other emission levels were very low against the limit.
  4. Margin value = Emission level – Limit value.
  5. “ \* “: Fundamental frequency.
  6. The limit value is defined as per 15.247.
  7. "#":The radiated frequency is out the restricted band.

EUT TEST CONDITION		MEASUREMENT DETAIL	
CHANNEL	Channel 159	FREQUENCY RANGE	1 ~ 40GHz
INPUT POWER (SYSTEM)	120Vac, 60 Hz	DETECTOR FUNCTION	Peak (PK) Average (AV)
ENVIRONMENTAL CONDITIONS	26deg. C, 60%RH 999hPa	TESTED BY	Kevin Liang

ANTENNA POLARITY & TEST DISTANCE: HORIZONTAL AT 3 M								
NO.	FREQ. (MHz)	EMISSION LEVEL (dBuV/m)	LIMIT (dBuV/m)	MARGIN (dB)	ANTENNA HEIGHT (m)	TABLE ANGLE (Degree)	RAW VALUE (dBuV)	CORRECTION FACTOR (dB/m)
1	*5795.00	96.61 PK			1.83 H	298	56.91	39.70
2	*5795.00	82.40 AV			1.83 H	298	42.70	39.70
3	#5850.00	47.61 PK	76.61	-29.00	1.83 H	298	7.77	39.84
4	#5850.00	34.98 AV	62.40	-27.42	1.83 H	298	-4.86	39.84
5	11590.00	59.05 PK	74.00	-14.95	1.02 H	71	8.47	50.58
6	11590.00	46.28 AV	54.00	-7.72	1.02 H	71	-4.30	50.58
ANTENNA POLARITY & TEST DISTANCE: VERTICAL AT 3 M								
NO.	FREQ. (MHz)	EMISSION LEVEL (dBuV/m)	LIMIT (dBuV/m)	MARGIN (dB)	ANTENNA HEIGHT (m)	TABLE ANGLE (Degree)	RAW VALUE (dBuV)	CORRECTION FACTOR (dB/m)
1	*5795.00	105.42 PK			1.40 V	321	65.72	39.70
2	*5795.00	91.37 AV			1.40 V	321	51.67	39.70
3	#5850.00	55.90 PK	85.42	-29.52	1.40 V	321	16.06	39.84
4	#5850.00	38.68 AV	71.37	-32.69	1.40 V	321	-1.16	39.84
5	11590.00	60.27 PK	74.00	-13.73	1.17 V	248	9.69	50.58
6	11590.00	46.48 AV	54.00	-7.52	1.17 V	248	-4.10	50.58

- REMARKS:**
1. Emission level (dBuV/m) = Raw Value (dBuV) + Correction Factor (dB/m).
  2. Correction Factor (dB/m) = Antenna Factor (dB/m) + Cable Factor (dB).
  3. The other emission levels were very low against the limit.
  4. Margin value = Emission level – Limit value.
  5. “ \* “: Fundamental frequency.
  6. The limit value is defined as per 15.247.
  7. “#“: The radiated frequency is out the restricted band.

**BELOW 1GHz WORST-CASE DATA : DRAFT 802.11n (20MHz) OFDM MODULATION**

EUT TEST CONDITION		MEASUREMENT DETAIL	
CHANNEL	Channel 165	FREQUENCY RANGE	Below 1000MHz
INPUT POWER (SYSTEM)	120Vac, 60 Hz	DETECTOR FUNCTION	Quasi-Peak
ENVIRONMENTAL CONDITIONS	24deg. C, 64%RH 999hPa	TESTED BY	Match Tsui

ANTENNA POLARITY & TEST DISTANCE: HORIZONTAL AT 3 M								
NO.	FREQ. (MHz)	EMISSION LEVEL (dBuV/m)	LIMIT (dBuV/m)	MARGIN (dB)	ANTENNA HEIGHT (m)	TABLE ANGLE (Degree)	RAW VALUE (dBuV)	CORRECTION FACTOR (dB/m)
1	92.12	34.81 QP	43.50	-8.69	2.00 H	169	25.75	9.06
2	99.89	42.45 QP	43.50	-1.05	2.00 H	163	30.51	11.94
3	132.95	42.48 QP	43.50	-1.02	2.00 H	151	29.64	12.84
4	175.72	42.37 QP	43.50	-1.13	1.50 H	10	28.70	13.67
5	197.11	42.33 QP	43.50	-1.17	1.50 H	13	31.14	11.19
6	232.11	38.01 QP	46.00	-7.99	1.50 H	163	24.80	13.21
7	265.16	42.96 QP	46.00	-3.04	1.25 H	151	28.54	14.42
8	333.21	37.84 QP	46.00	-8.16	1.25 H	10	21.89	15.94
9	387.65	35.32 QP	46.00	-10.68	1.00 H	109	16.92	18.39
10	465.42	35.23 QP	46.00	-10.77	2.00 H	340	14.69	20.55
11	601.52	38.80 QP	46.00	-7.20	1.25 H	91	15.10	23.70
12	914.55	41.67 QP	46.00	-4.33	1.25 H	250	11.61	30.06

ANTENNA POLARITY & TEST DISTANCE: VERTICAL AT 3 M								
NO.	FREQ. (MHz)	EMISSION LEVEL (dBuV/m)	LIMIT (dBuV/m)	MARGIN (dB)	ANTENNA HEIGHT (m)	TABLE ANGLE (Degree)	RAW VALUE (dBuV)	CORRECTION FACTOR (dB/m)
1	59.06	36.79 QP	40.00	-3.21	1.00 V	100	23.55	13.24
2	64.90	38.37 QP	40.00	-1.63	1.00 V	103	24.95	13.42
3	99.89	39.28 QP	43.50	-4.22	2.00 V	121	27.34	11.94
4	148.50	37.75 QP	43.50	-5.75	1.00 V	313	23.38	14.36
5	191.28	35.79 QP	43.50	-7.71	1.25 V	286	24.29	11.51
6	199.05	34.37 QP	43.50	-9.13	1.50 V	280	23.29	11.08
7	267.10	37.51 QP	46.00	-8.49	2.00 V	304	23.08	14.42
8	827.06	37.81 QP	46.00	-8.19	1.00 V	310	9.62	28.19

- REMARKS:**
1. Emission level (dBuV/m) = Raw Value (dBuV) + Correction Factor (dB/m).
  2. Correction Factor (dB/m) = Antenna Factor (dB/m) + Cable Factor (dB).
  3. The other emission levels were very low against the limit.
  4. Margin value = Emission level – Limit value.



## 5.2 CONDUCTED EMISSION MEASUREMENT

### 5.2.1 LIMITS OF CONDUCTED EMISSION MEASUREMENT

FREQUENCY OF EMISSION (MHz)	CONDUCTED LIMIT (dB $\mu$ V)	
	Quasi-peak	Average
0.15 ~ 0.5	66 to 56	56 to 46
0.5 ~ 5	56	46
5 ~ 30	60	50

- NOTE:**
1. The lower limit shall apply at the transition frequencies.
  2. The limit decreases in line with the logarithm of the frequency in the range of 0.15 to 0.50MHz.
  3. All emanations from a class A/B digital device or system, including any network of conductors and apparatus connected thereto, shall not exceed the level of field strengths specified above.

### 5.2.2 TEST INSTRUMENTS

DESCRIPTION & MANUFACTURER	MODEL NO.	SERIAL NO.	DATE OF CALIBRATION	DUE DATE OF CALIBRATION
Test Receiver ROHDE & SCHWARZ	ESCS30	100291	Nov. 22, 2007	Nov. 21, 2008
RF signal cable Woken	5D-FB	Cable-HYC01-01	Jan. 04, 2008	Jan. 03, 2009
LISN ROHDE & SCHWARZ	ESH3-Z5	100312	Jun. 13, 2008	Jun. 12, 2009
LISN ROHDE & SCHWARZ	ESH2-Z5	100104	Sep. 12, 2007	Sep. 11, 2008
Software ADT	ADT_Cond_V3	NA	NA	NA

- NOTE:**
1. The calibration interval of the above test instruments is 12 months and the calibrations are traceable to NML/ROC and NIST/USA.
  2. The test was performed in HwaYa Shielded Room 1.
  3. The VCCI Site Registration No. is C-2040.

### 5.2.3 TEST PROCEDURES

- a. The EUT was placed 0.4 meters from the conducting wall of the shielded room with EUT being connected to the power mains through a line impedance stabilization network (LISN). Other support units were connected to the power mains through another LISN. The two LISNs provide 50 ohm/ 50uH of coupling impedance for the measuring instrument.
- b. Both lines of the power mains connected to the EUT were checked for maximum conducted interference.
- c. The frequency range from 150kHz to 30MHz was searched. Emission levels under (Limit - 20dB) was not recorded.

### 5.2.4 DEVIATION FROM TEST STANDARD

No deviation

## 5.2.5 TEST SETUP

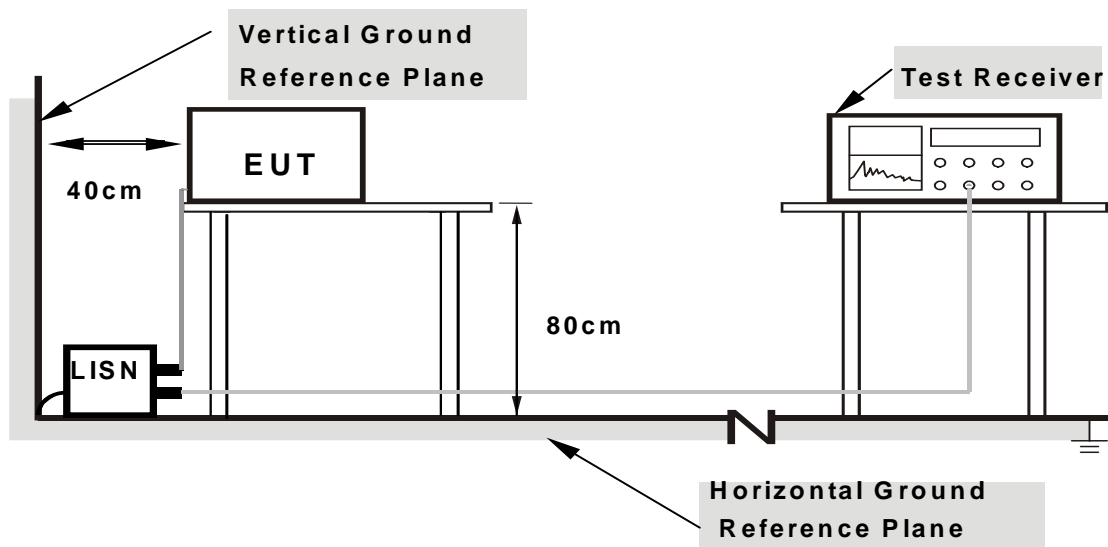

**Note: 1. Support units were connected to second LISN.**

**2. Both of LISNs (AMN) are 80 cm from EUT and at least 80 from other units and other metal planes**

For the actual test configuration, please refer to the attached file (Test Setup Photo).

## 5.2.6 EUT OPERATING CONDITIONS

Same as 4.1.6

## 5.2.7 TEST RESULTS

### CONDUCTED WORST-CASE DATA : DRAFT 802.11n (20MHz) OFDM MODULATION

EUT TEST CONDITION		MEASUREMENT DETAIL	
CHANNEL	Channel 165	PHASE	Line 1
MODULATION TYPE	BPSK	INPUT POWER (SYSTEM)	120Vac, 60Hz
TRANSFER RATE	7.2Mbps	6dB BANDWIDTH	9kHz
ENVIRONMENTAL CONDITIONS	25deg. C, 63%RH, 988hPa	TESTED BY	Kevin Liang

No	Freq. [MHz]	Corr. Factor (dB)	Reading Value [dB (uV)]		Emission Level [dB (uV)]		Limit [dB (uV)]		Margin (dB)	
			Q.P.	AV.	Q.P.	AV.	Q.P.	AV.	Q.P.	AV.
1	0.172	0.20	49.26	-	49.46	-	64.85	54.85	-15.39	-
2	0.232	0.20	43.13	-	43.33	-	62.38	52.38	-19.05	-
3	0.404	0.20	30.62	-	30.82	-	57.77	47.77	-26.95	-
4	1.905	0.20	35.81	-	36.01	-	56.00	46.00	-19.99	-
5	3.984	0.40	33.02	-	33.42	-	56.00	46.00	-22.58	-
6	9.871	0.53	30.44	-	30.97	-	60.00	50.00	-29.03	-

- REMARKS:**
1. Q.P. and AV. are abbreviations of quasi-peak and average individually.
  2. "-": The Quasi-peak reading value also meets average limit and measurement with the average detector is unnecessary.
  3. The emission levels of other frequencies were very low against the limit.
  4. Margin value = Emission level - Limit value
  5. Correction factor = Insertion loss + Cable loss
  6. Emission Level = Correction Factor + Reading Value.

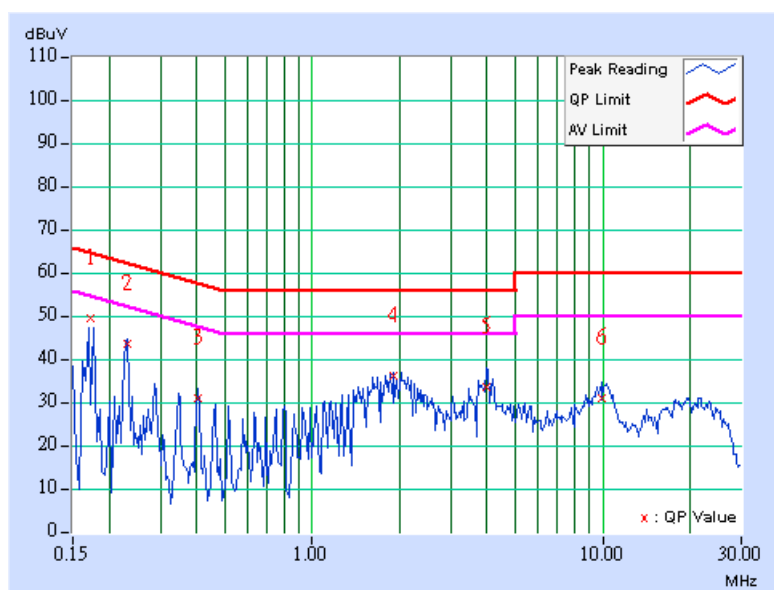

EUT TEST CONDITION		MEASUREMENT DETAIL	
CHANNEL	Channel 165	PHASE	Line 2
MODULATION TYPE	BPSK	INPUT POWER (SYSTEM)	120Vac, 60Hz
TRANSFER RATE	7.2Mbps	6dB BANDWIDTH	9kHz
ENVIRONMENTAL CONDITIONS	25deg. C, 63%RH, 988hPa	TESTED BY	Kevin Liang

No	Freq. [MHz]	Corr. Factor (dB)	Reading Value [dB (uV)]		Emission Level [dB (uV)]		Limit [dB (uV)]		Margin (dB)	
			Q.P.	AV.	Q.P.	AV.	Q.P.	AV.	Q.P.	AV.
1	0.172	0.20	49.26	-	49.46	-	64.86	54.86	-15.40	-
2	0.228	0.20	40.70	-	40.90	-	62.52	52.52	-21.62	-
3	0.344	0.20	35.21	-	35.41	-	59.11	49.11	-23.70	-
4	1.844	0.20	34.15	-	34.35	-	56.00	46.00	-21.65	-
5	3.805	0.38	30.43	-	30.81	-	56.00	46.00	-25.19	-
6	19.797	0.51	25.44	-	25.95	-	60.00	50.00	-34.05	-

- REMARKS:**
1. Q.P. and AV. are abbreviations of quasi-peak and average individually.
  2. "-": The Quasi-peak reading value also meets average limit and measurement with the average detector is unnecessary.
  3. The emission levels of other frequencies were very low against the limit.
  4. Margin value = Emission level - Limit value
  5. Correction factor = Insertion loss + Cable loss
  6. Emission Level = Correction Factor + Reading Value.

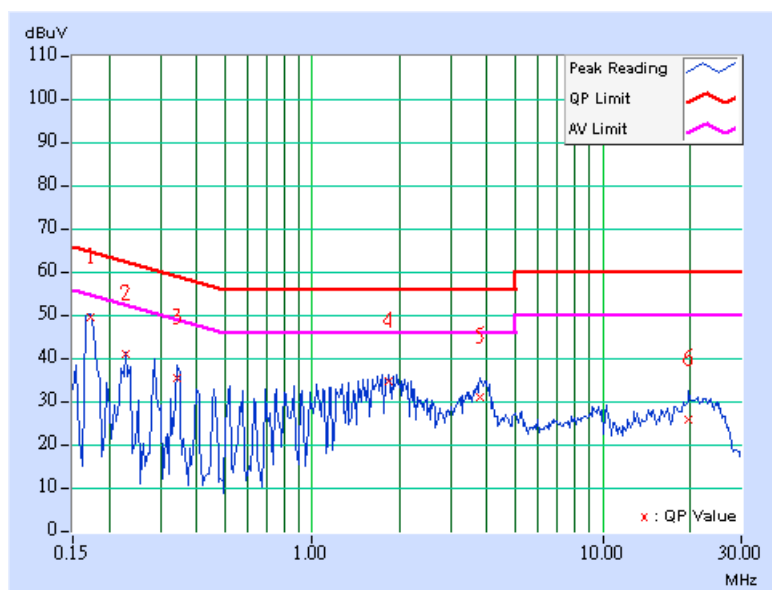



### 5.3 6dB BANDWIDTH MEASUREMENT

#### 5.3.1 LIMITS OF 6dB BANDWIDTH MEASUREMENT

The minimum of 6dB Bandwidth Measurement is 0.5MHz.

#### 5.3.2 TEST INSTRUMENTS

DESCRIPTION & MANUFACTURER	MODEL NO.	SERIAL NO.	DATE OF CALIBRATION	CALIBRATED UNTIL
R&S SPECTRUM ANALYZER	FSP40	100041	Apr. 22, 2008	Apr. 21, 2009

**NOTE:** The calibration interval of the above test instruments is 12 months and the calibrations are traceable to NML/ROC and NIST/USA.

#### 5.3.3 TEST PROCEDURE

The transmitter output was connected to the spectrum analyzer through an attenuator. The bandwidth of the fundamental frequency was measured by spectrum analyzer with 100kHz RBW and 300kHz VBW. The 6dB bandwidth is defined as the total spectrum the power of which is higher than peak power minus 6dB.

#### 5.3.4 DEVIATION FROM TEST STANDARD

No deviation

#### 5.3.5 TEST SETUP

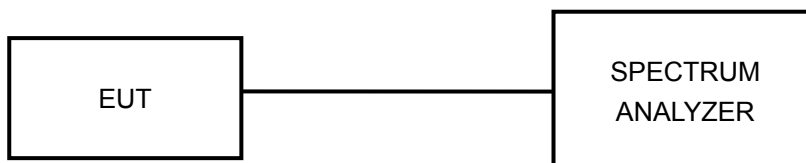

#### 5.3.6 EUT OPERATING CONDITIONS

The software provided by client to enable the EUT under transmission condition continuously at lowest, middle and highest channel frequencies individually.

### 5.3.7 TEST RESULTS

#### 802.11a OFDM MODULATION

<b>MODULATION TYPE</b>	BPSK	<b>TRANSFER RATE</b>	6.0Mbps
<b>INPUT POWER (SYSTEM)</b>	120Vac, 60Hz	<b>ENVIRONMENTAL CONDITIONS</b>	25 deg.C, 63%RH, 991hPa
<b>TESTED BY</b>	Dean Wang		

CHANNEL	CHANNEL FREQUENCY (MHz)	6dB BANDWIDTH (MHz)	MINIMUM LIMIT (MHz)	PASS / FAIL
149	5745	16.41	0.5	PASS
157	5785	16.42	0.5	PASS
165	5825	16.42	0.5	PASS

#### CH 149

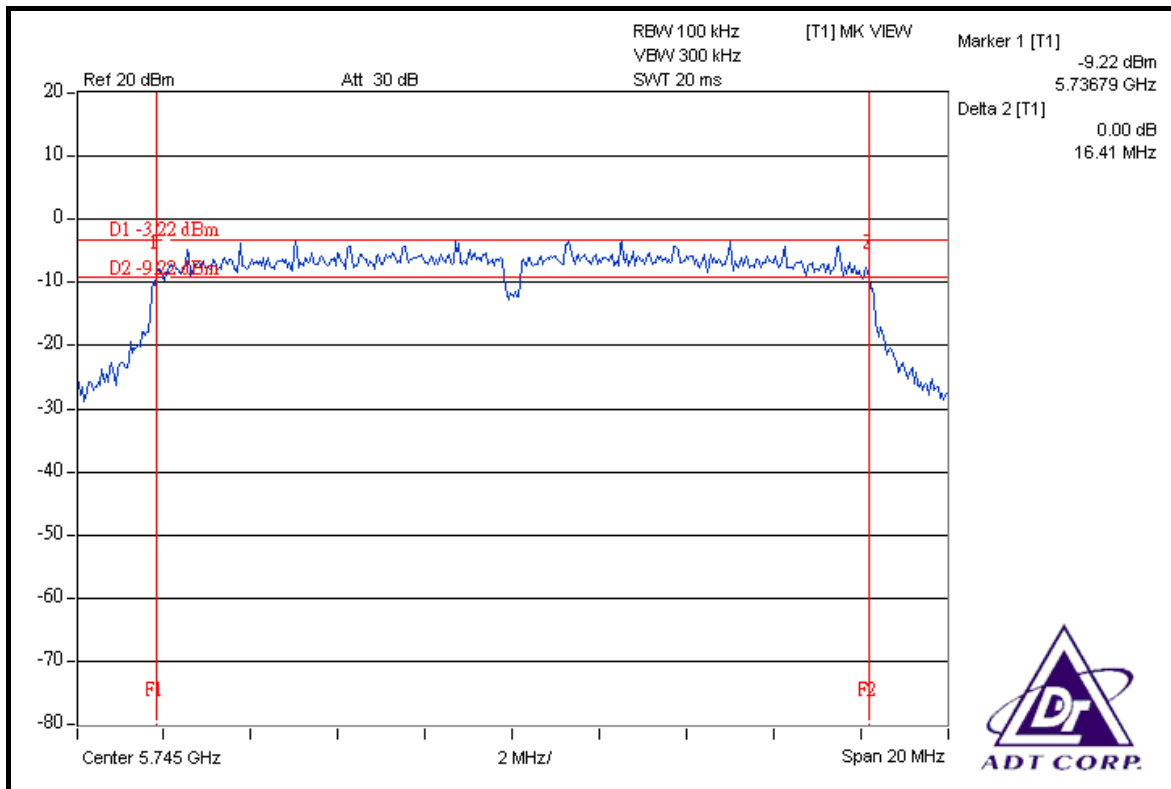



### CH 157

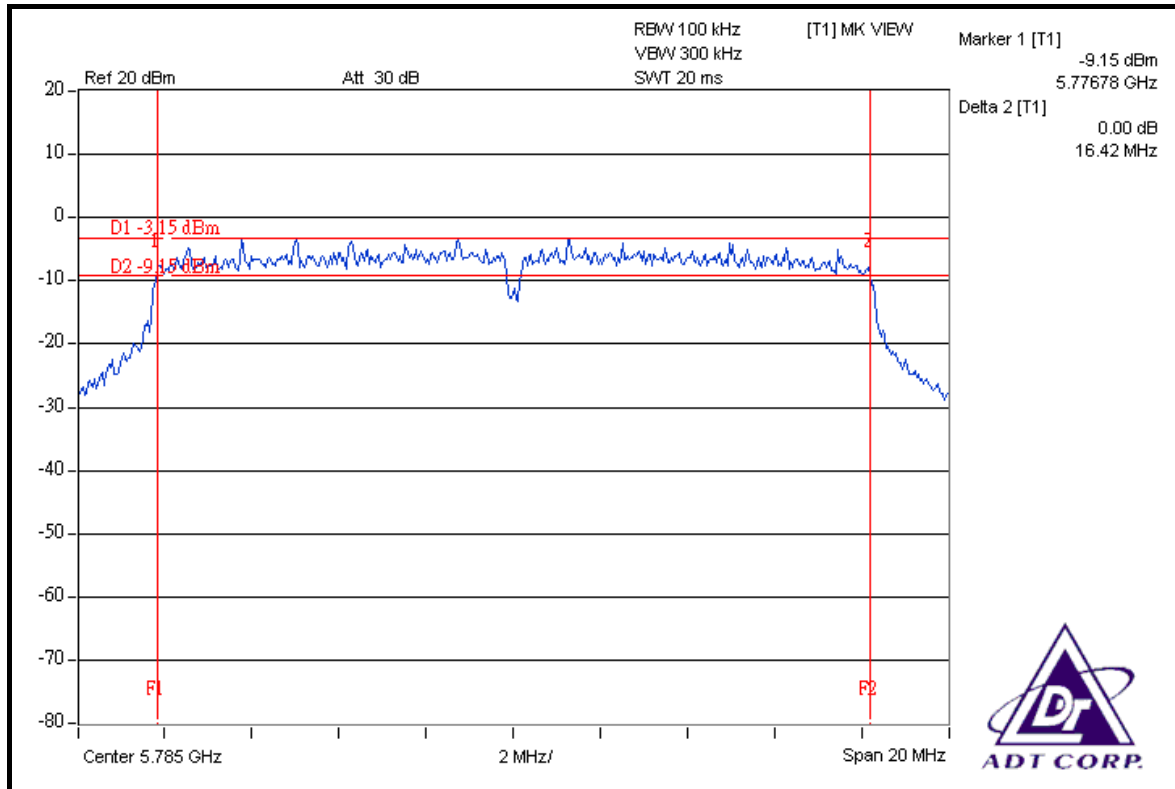

### CH 165

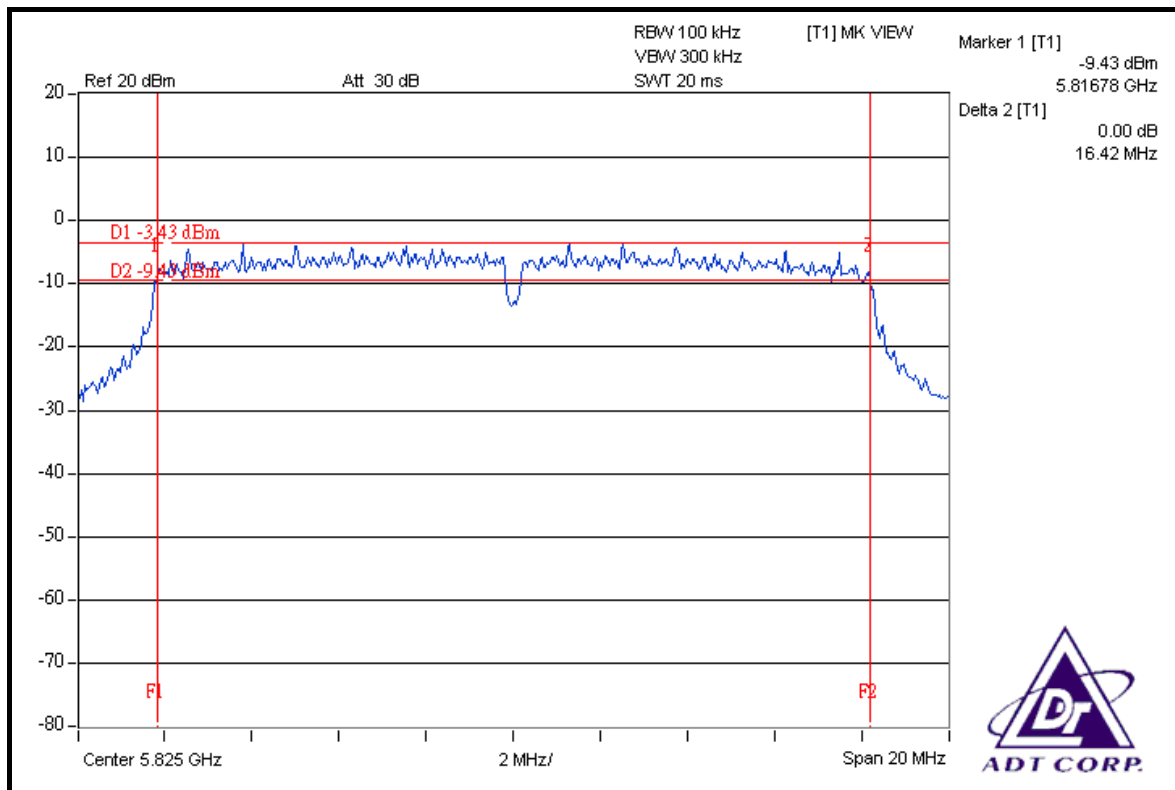



**DRAFT 802.11n (20MHz) OFDM MODULATION**

<b>MODULATION TYPE</b>	BPSK	<b>TRANSFER RATE</b>	7.2Mbps
<b>INPUT POWER (SYSTEM)</b>	120Vac, 60Hz	<b>ENVIRONMENTAL CONDITIONS</b>	25deg.C, 63%RH, 991hPa
<b>TESTED BY</b>	Dean Wang		

CHANNEL	CHANNEL FREQUENCY (MHz)	6dB BANDWIDTH (MHz)			MINIMUM LIMIT (MHz)	PASS / FAIL
		CHAIN 0	CHAIN 1	CHAIN 2		
149	5745	17.58	17.55	17.62	0.5	PASS
157	5785	17.19	17.31	17.60	0.5	PASS
165	5825	17.37	17.11	17.58	0.5	PASS

**FOR CHAIN 0: CH 149**

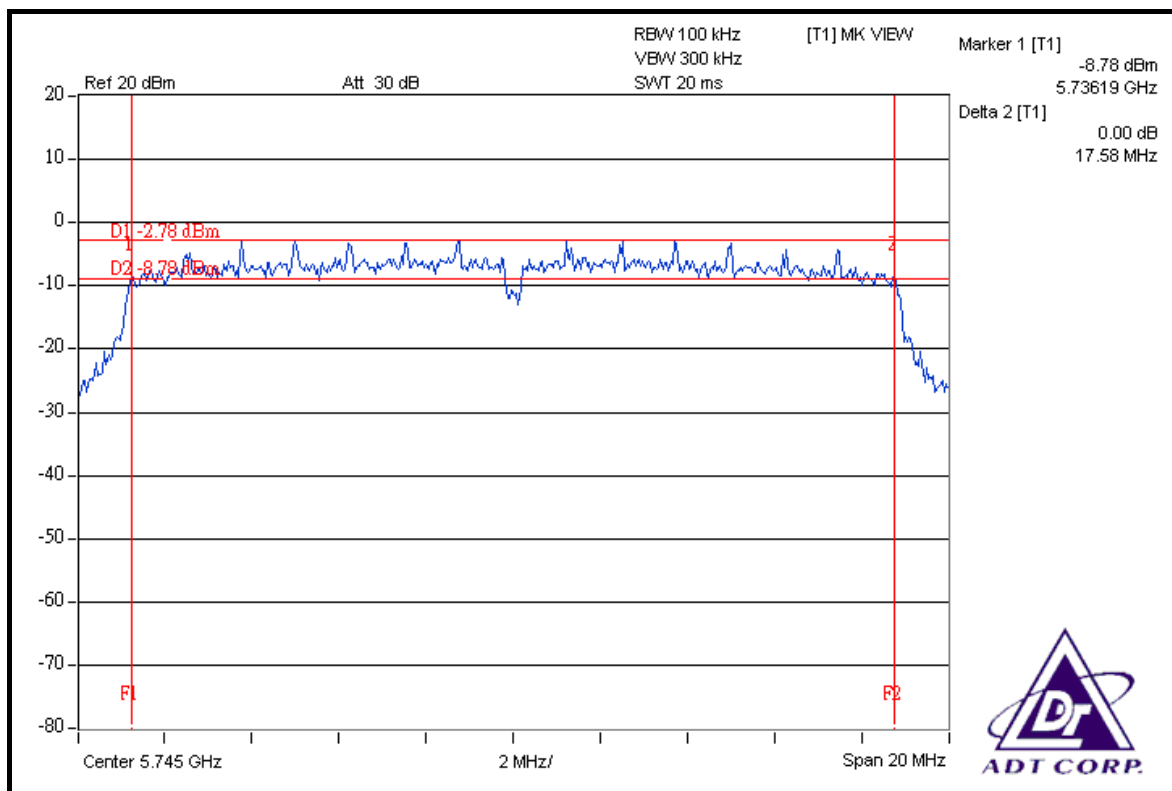

### CH 157

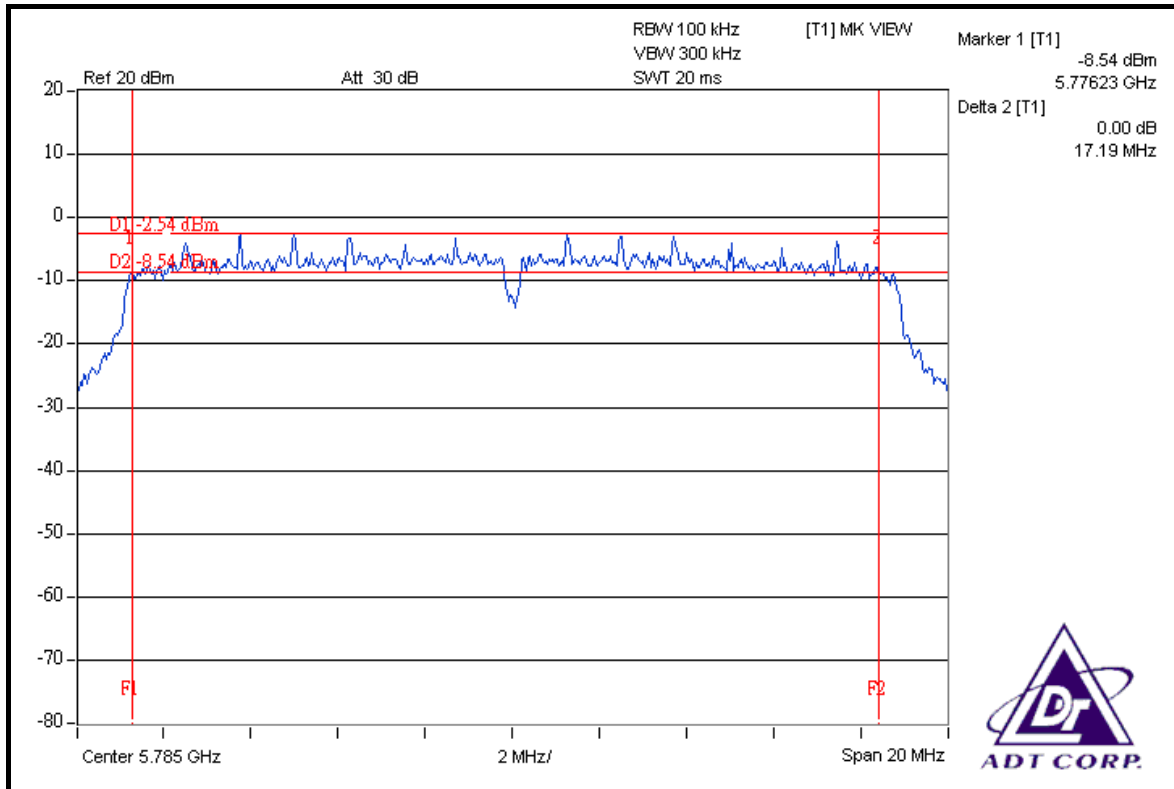

### CH 165

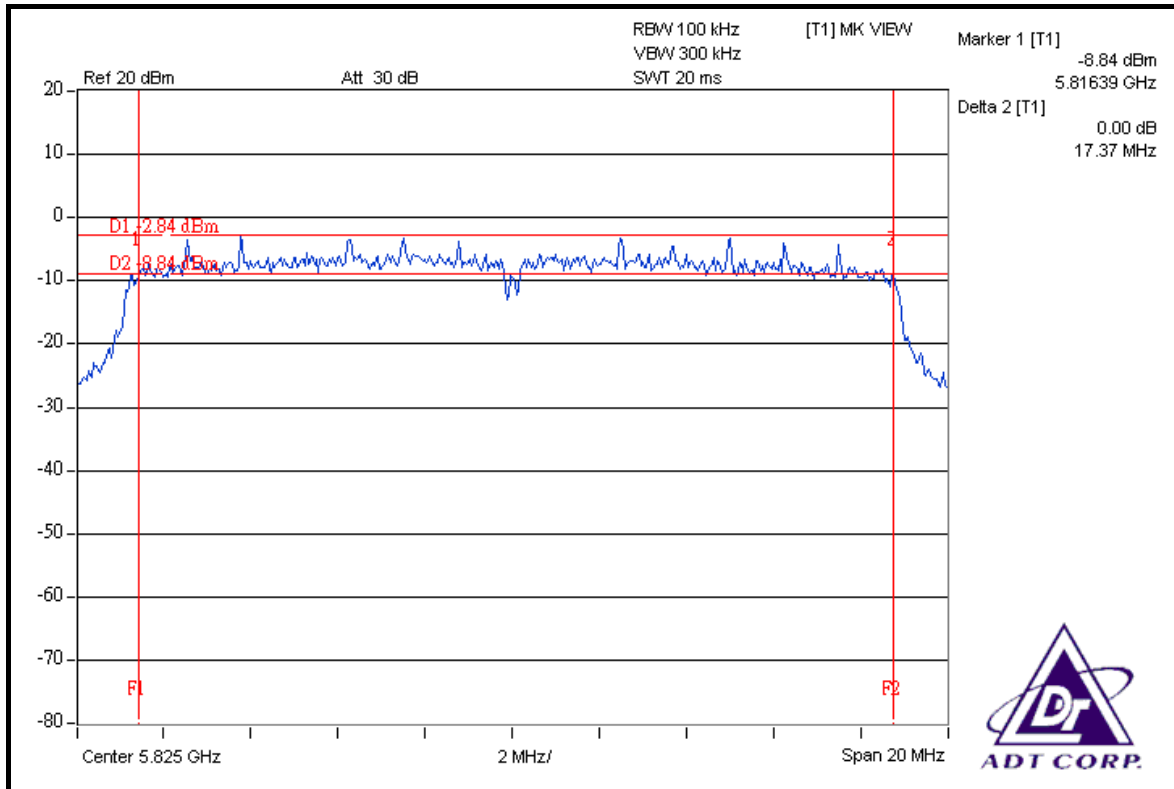



### FOR CHAIN 1: CH 149

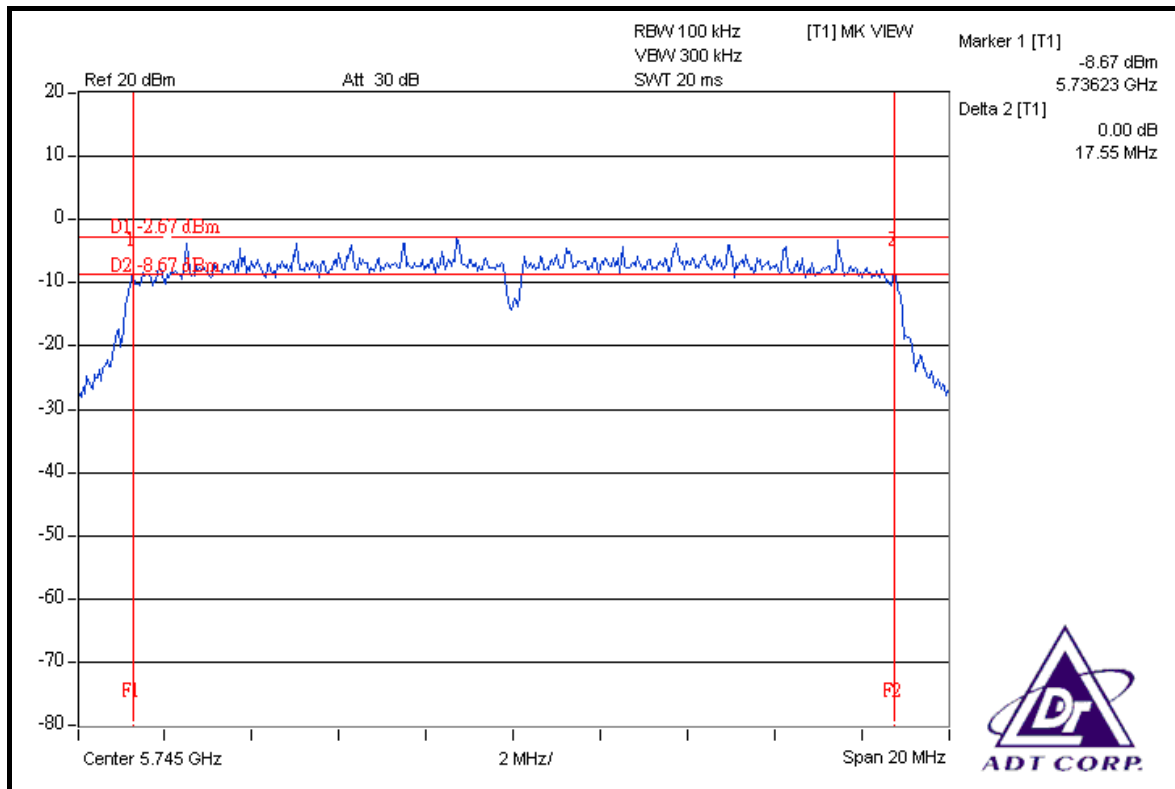

### CH 157

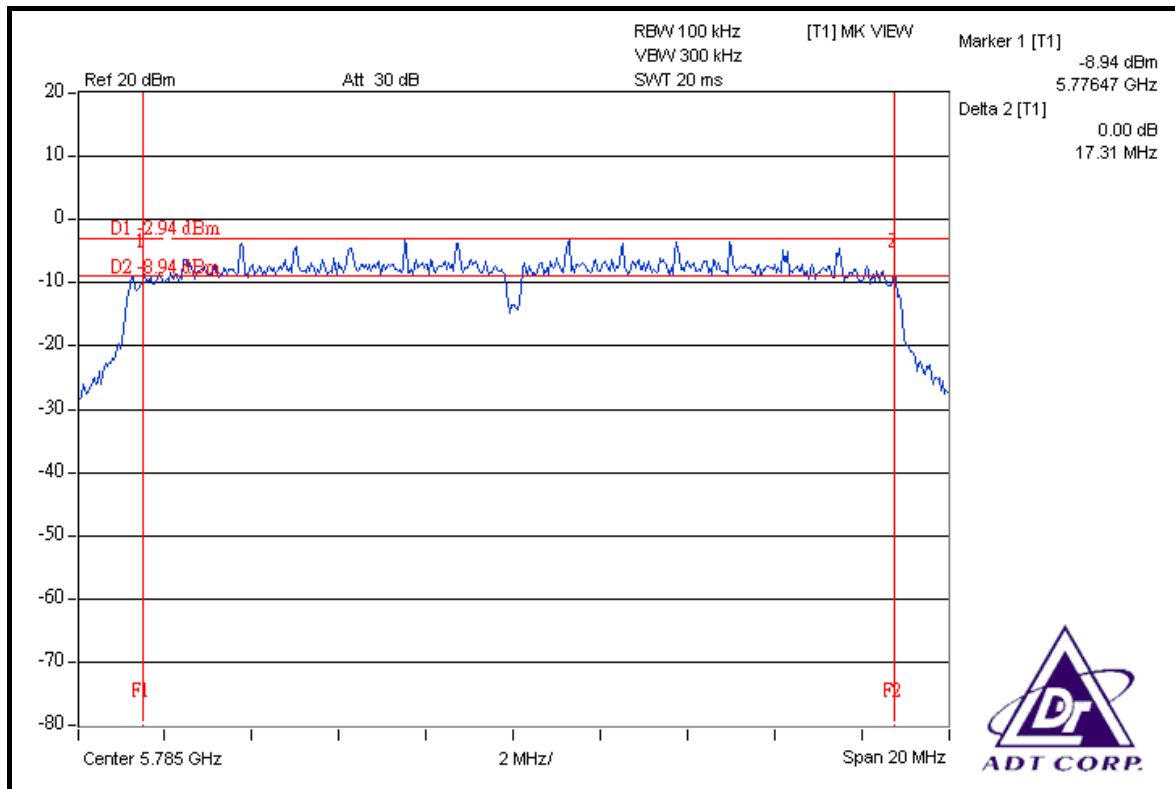



### CH 165

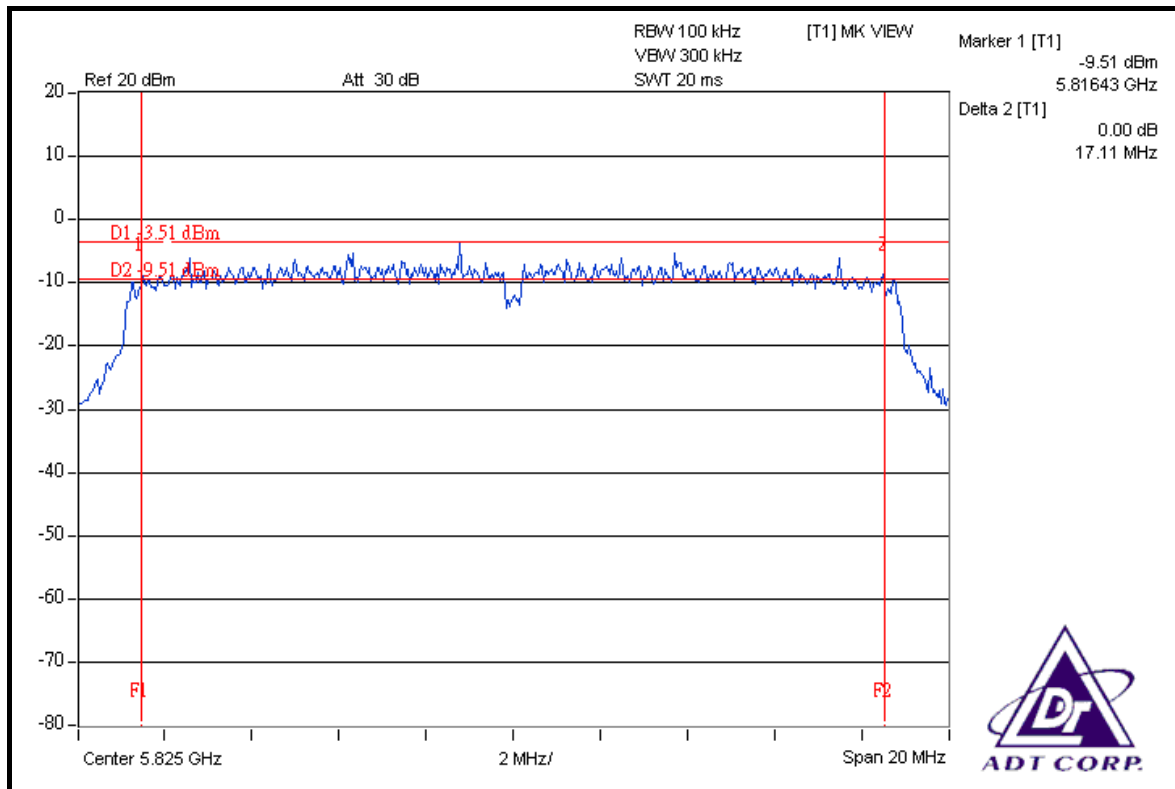

### FOR CHAIN 2: CH 149

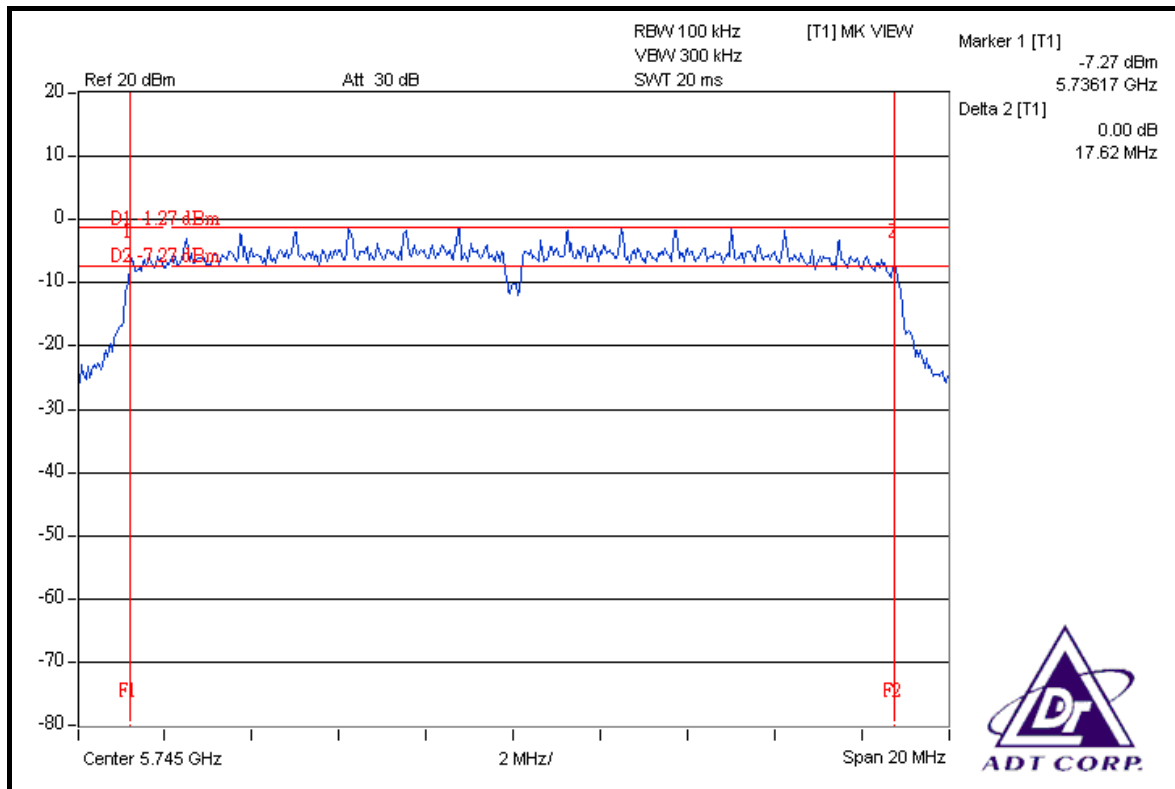

### CH 157

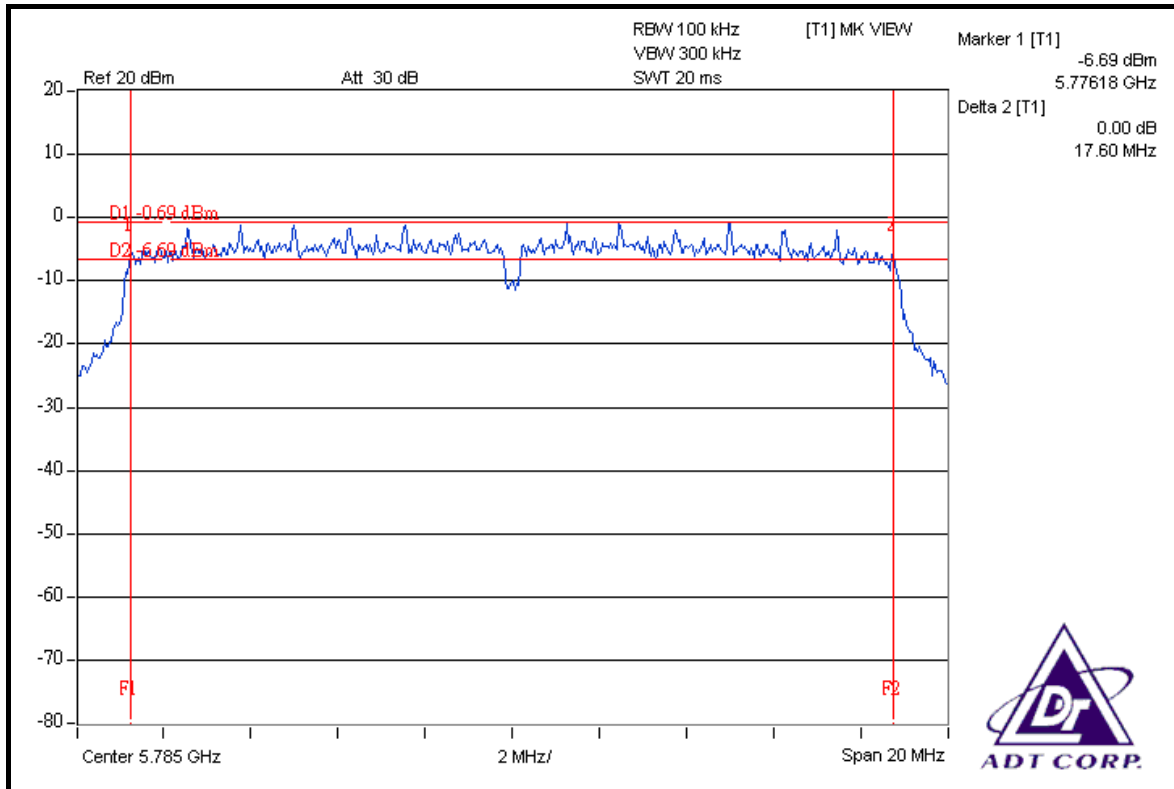

### CH 165

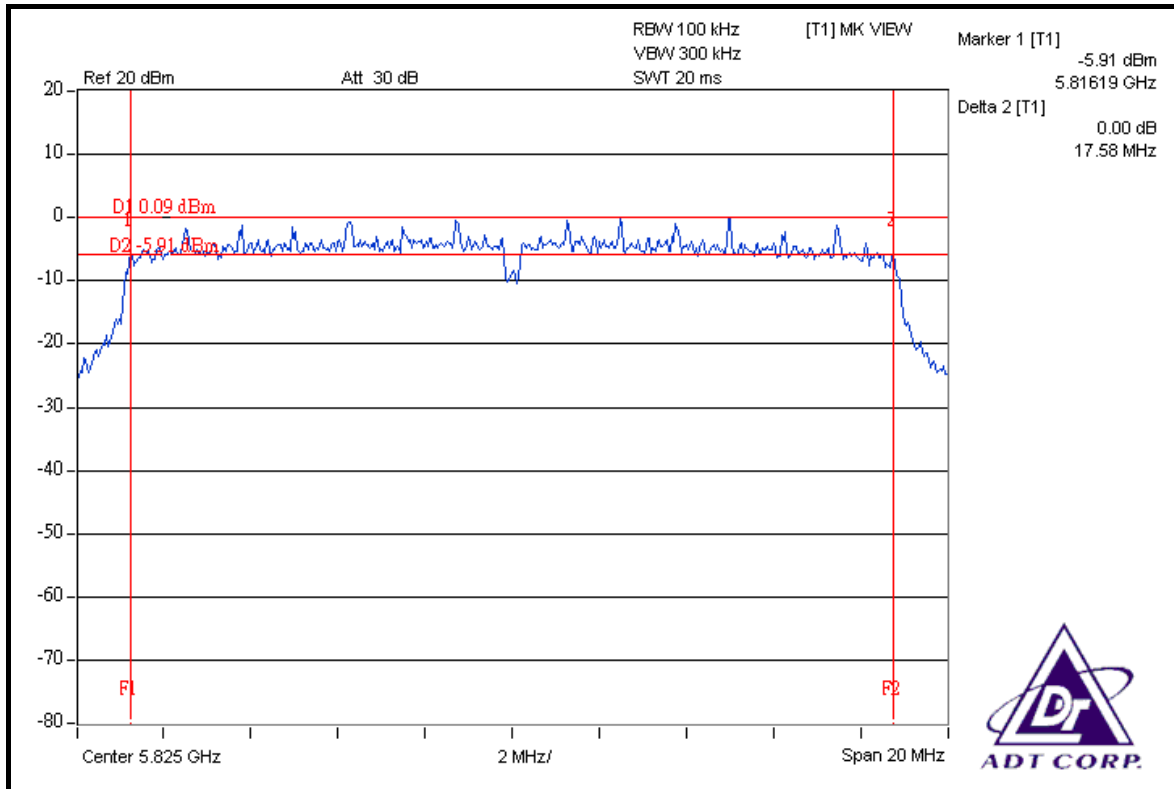



**DRAFT 802.11n (40MHz) OFDM MODULATION**

<b>MODULATION TYPE</b>	BPSK	<b>TRANSFER RATE</b>	15Mbps
<b>INPUT POWER (SYSTEM)</b>	120Vac, 60Hz	<b>ENVIRONMENTAL CONDITIONS</b>	25deg.C, 63%RH, 991hPa
<b>TESTED BY</b>	Dean Wang		

CHANNEL	CHANNEL FREQUENCY (MHz)	6dB BANDWIDTH (MHz)			MINIMUM LIMIT (MHz)	PASS / FAIL
		CHAIN 0	CHAIN 1	CHAIN 2		
151	5755	36.36	36.45	36.39	0.5	PASS
159	5795	36.06	36.37	36.37	0.5	PASS



### FOR CHAIN 0: CH 151

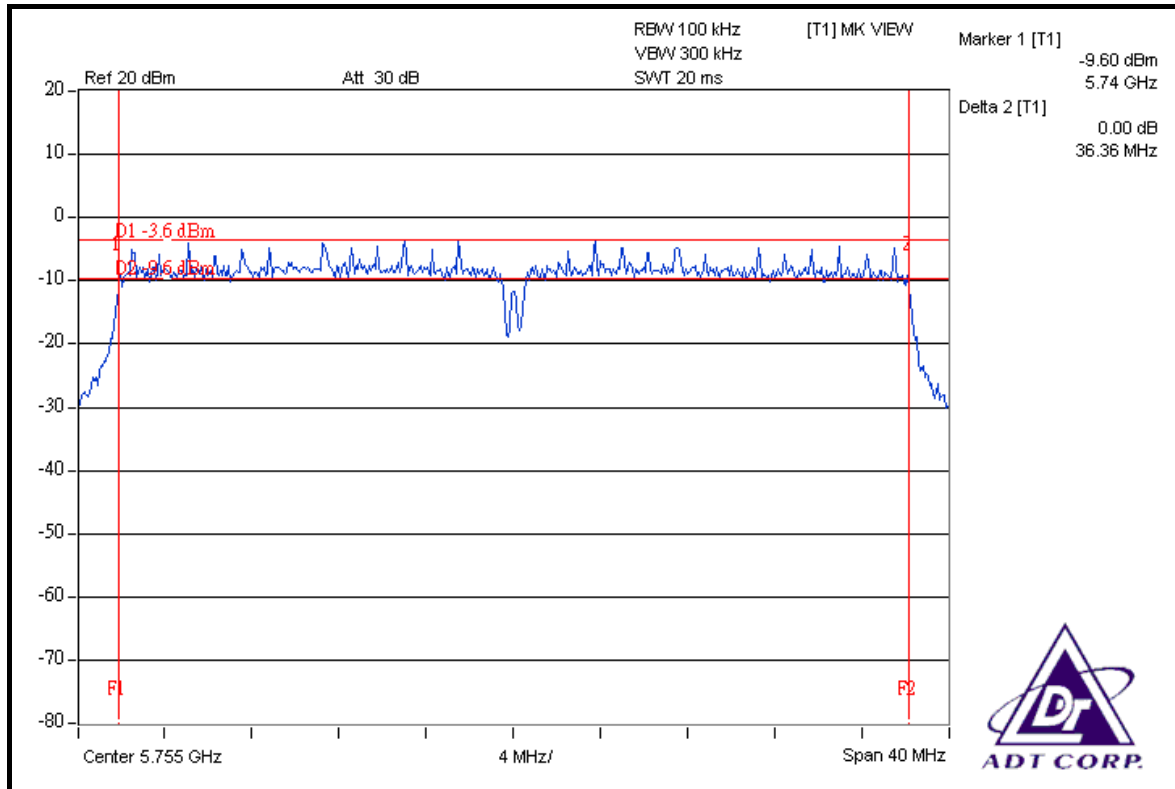

### CH 159

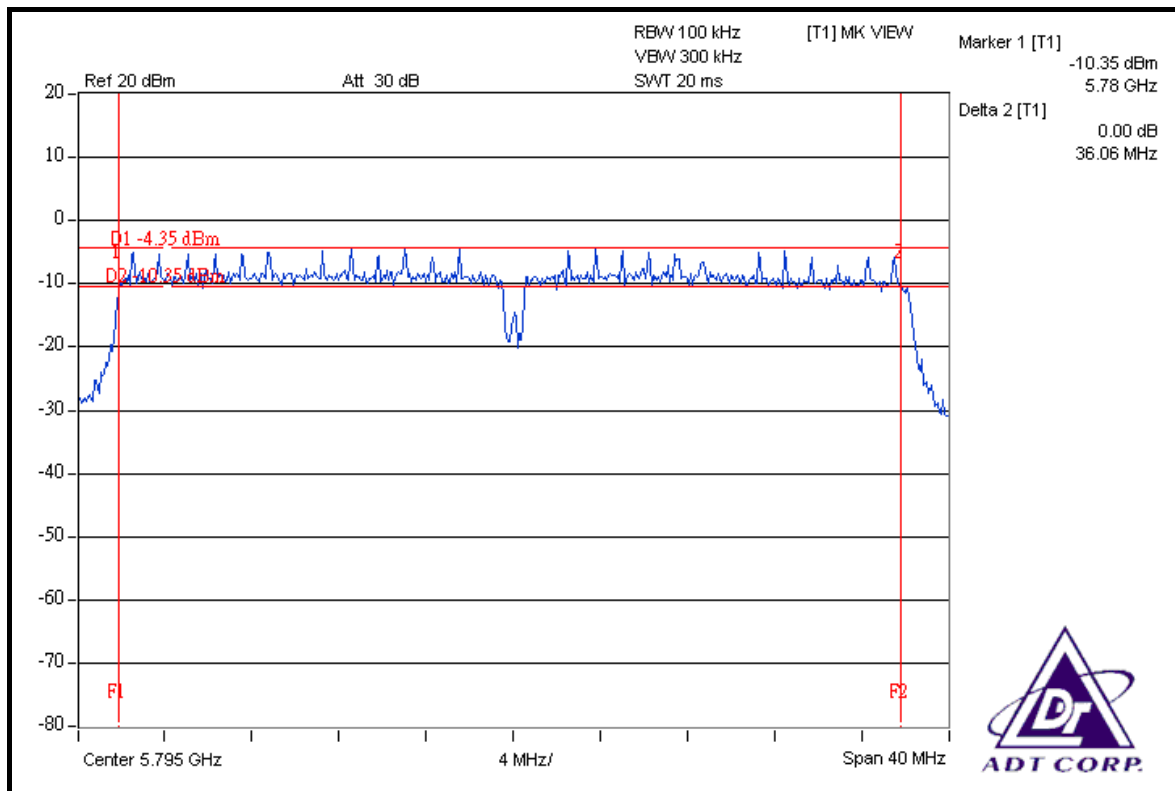





### FOR CHAIN 1: CH 151

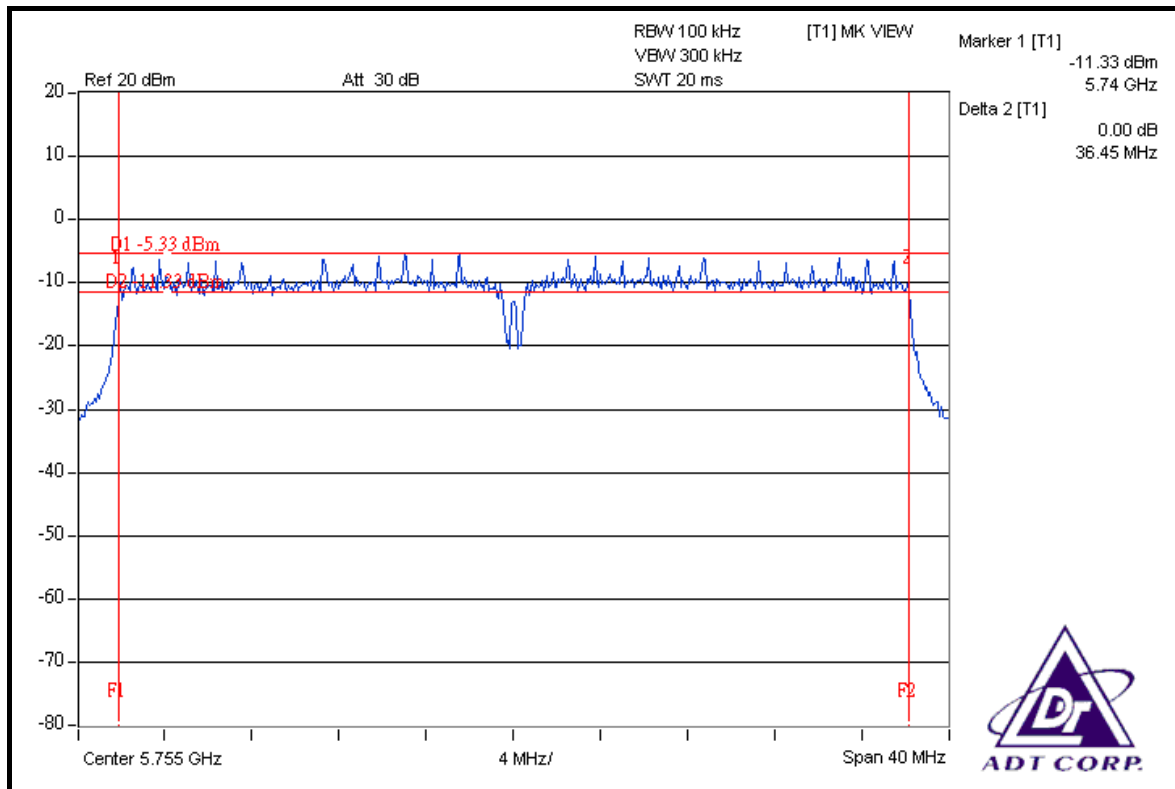

### CH 159

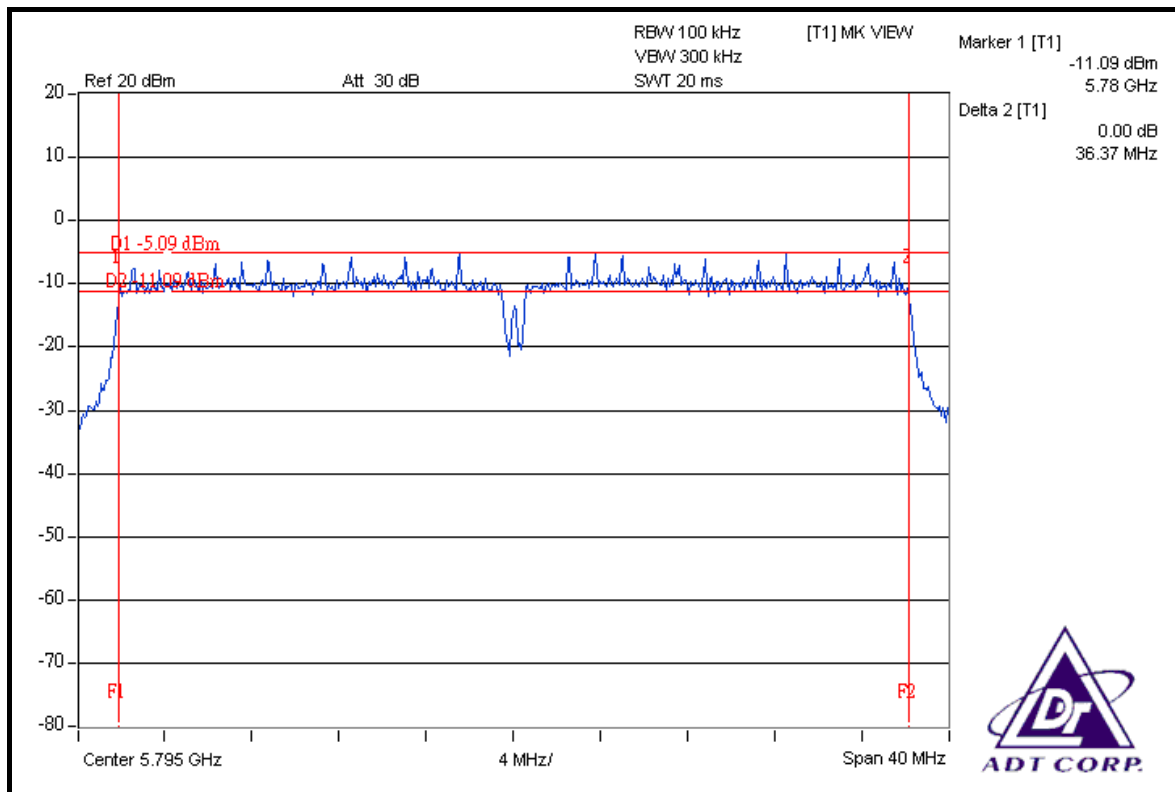



### FOR CHAIN 2: CH 151

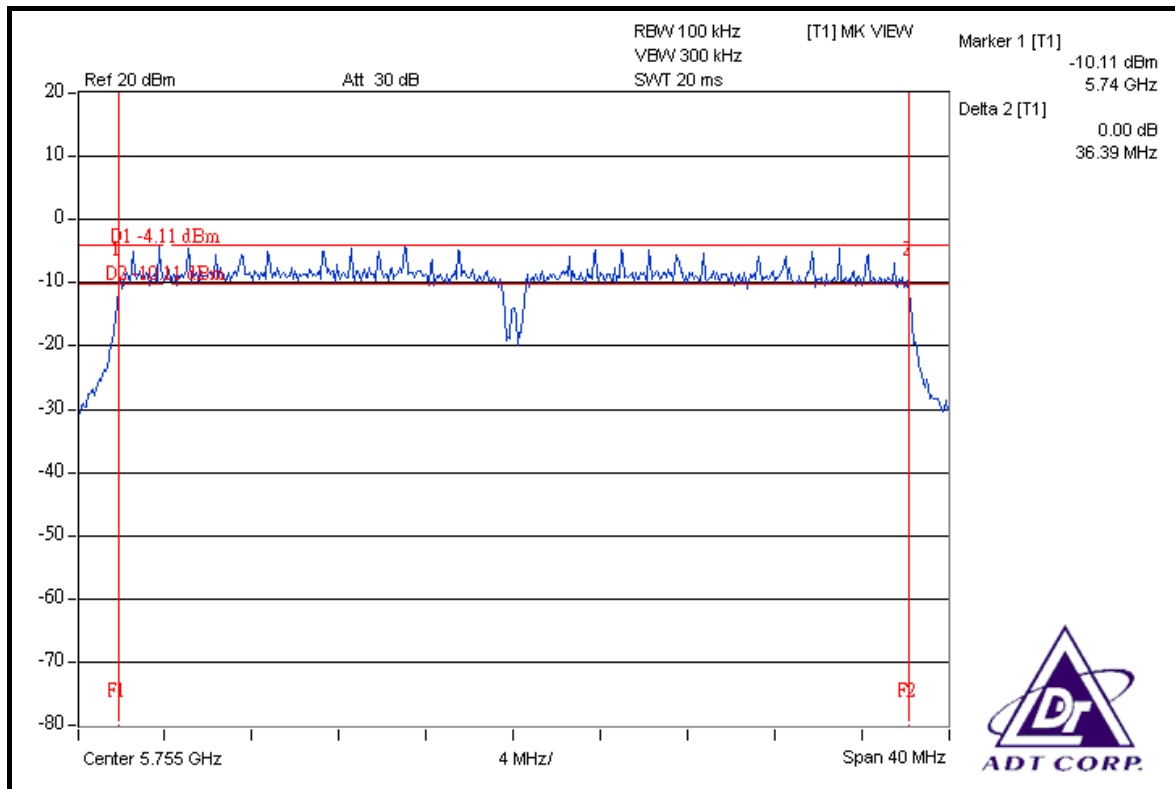

### CH 159

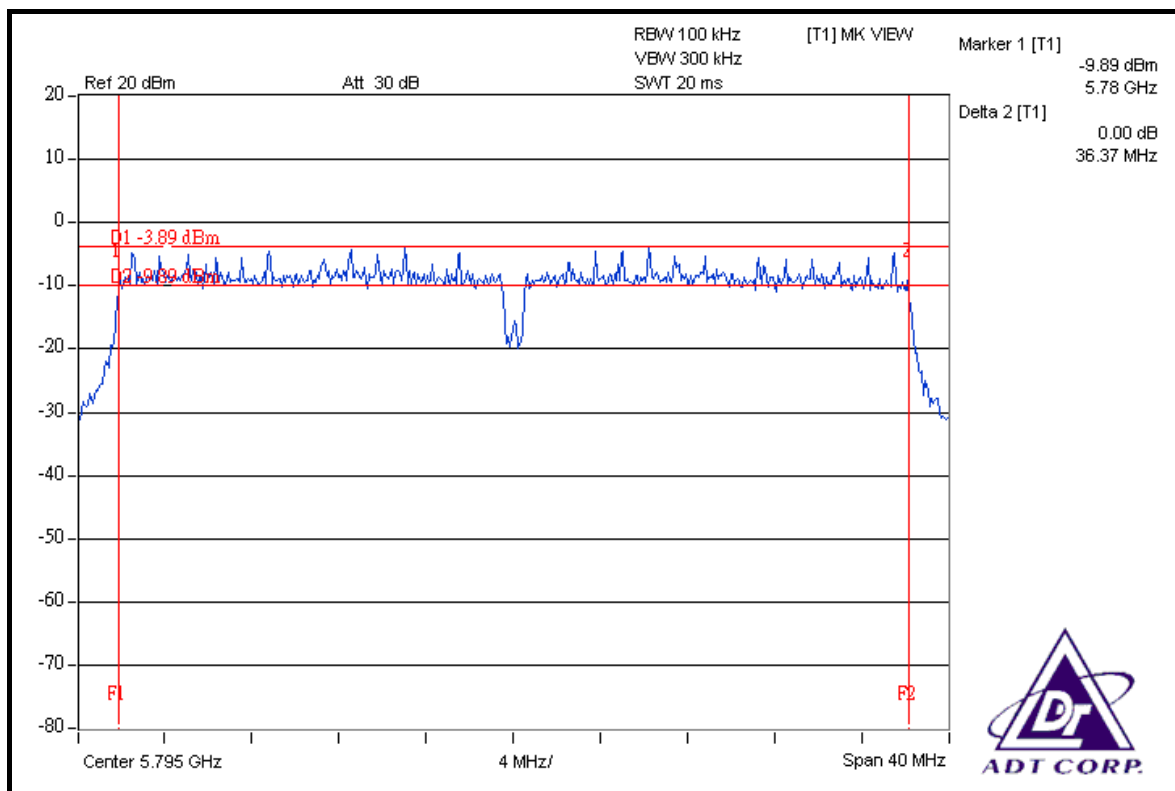



## 5.4 MAXIMUM PEAK OUTPUT POWER

### 5.4.1 LIMITS OF MAXIMUM PEAK OUTPUT POWER MEASUREMENT

The Maximum Peak Output Power Measurement is 30dBm.

### 5.4.2 INSTRUMENTS

DESCRIPTION & MANUFACTURER	MODEL NO.	SERIAL NO.	DATE OF CALIBRATION	CALIBRATED UNTIL
High Speed Peak Power Meter	ML2495A	0824012	Aug. 04, 2008	Aug. 03, 2009
Power Sensor	MA2444B	0738138	Aug. 04, 2008	Aug. 03, 2009

**Note:**

1. The calibration interval of the above test instruments is 12 months and the calibrations are traceable to NML/ROC and NIST/USA.
2. Measurement Bandwidth of ML2495A is 65MHz greater than 6dB bandwidth of emission.

### 5.4.3 TEST PROCEDURES

A power sensor was used on the output port of the EUT. A power meter was used to read the response of the power sensor. Record the power level.

#### 5.4.4 DEVIATION FROM TEST STANDARD

No deviation

#### 5.4.5 TEST SETUP

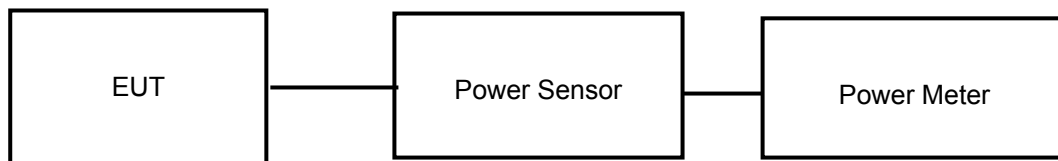

#### 5.4.6 EUT OPERATING CONDITIONS

Same as Item 5.3.6



## 5.4.7 TEST RESULTS

### 802.11a OFDM MODULATION

<b>MODULATION TYPE</b>	BPSK	<b>TRANSFER RATE</b>	6.0Mbps
<b>INPUT POWER (SYSTEM)</b>	120Vac, 60Hz	<b>ENVIRONMENTAL CONDITIONS</b>	25 deg.C, 63%RH, 991hPa
<b>TESTED BY</b>	Dean Wang		

CHANNEL	CHANNEL FREQUENCY (MHz)	PEAK POWER OUTPUT (mW)	PEAK POWER OUTPUT (dBm)	PEAK POWER LIMIT (dBm)	PASS / FAIL
149	5745	81.283	19.10	30	PASS
157	5785	81.096	19.09	30	PASS
165	5825	80.724	19.07	30	PASS

### DRAFT 802.11n (20MHz) OFDM MODULATION

<b>MODULATION TYPE</b>	BPSK	<b>TRANSFER RATE</b>	7.2Mbps
<b>INPUT POWER (SYSTEM)</b>	120Vac, 60Hz	<b>ENVIRONMENTAL CONDITIONS</b>	25 deg.C, 63%RH, 991hPa
<b>TESTED BY</b>	Dean Wang		

CHAN.	CHAN. FREQ. (MHz)	PEAK POWER OUTPUT (dBm)			TOTAL PEAK POWER (mW)	TOTAL PEAK POWER (dBm)	PEAK POWER LIMIT (dBm)	PASS / FAIL
		CHAIN 0	CHAIN 1	CHAIN 2				
149	5745	19.07	18.55	19.60	243.539	23.87	30	PASS
157	5785	19.04	18.04	20.06	245.238	23.90	30	PASS
165	5825	19.07	17.61	21.10	267.225	24.27	30	PASS



**DRAFT 802.11n (40MHz) OFDM MODULATION**

<b>MODULATION TYPE</b>	BPSK	<b>TRANSFER RATE</b>	15Mbps
<b>INPUT POWER (SYSTEM)</b>	120Vac, 60Hz	<b>ENVIRONMENTAL CONDITIONS</b>	25 deg.C, 63%RH, 991hPa
<b>TESTED BY</b>	Dean Wang		

CHAN.	CHAN. FREQ. (MHz)	PEAK POWER OUTPUT (dBm)			TOTAL PEAK POWER (mW)	TOTAL PEAK POWER (dBm)	PEAK POWER LIMIT (dBm)	PASS / FAIL
		CHAIN 0	CHAIN 1	CHAIN 2				
151	5755	19.05	18.09	19.60	235.971	23.73	30	PASS
159	5795	18.57	18.10	19.61	227.922	23.58	30	PASS



## 5.5 POWER SPECTRAL DENSITY MEASUREMENT

### 5.5.1 LIMITS OF POWER SPECTRAL DENSITY MEASUREMENT

The Maximum of Power Spectral Density Measurement is 8dBm.

### 5.5.2 TEST INSTRUMENTS

DESCRIPTION & MANUFACTURER	MODEL NO.	SERIAL NO.	DATE OF CALIBRATION	CALIBRATED UNTIL
R&S SPECTRUM ANALYZER	FSP40	100041	Apr. 22, 2008	Apr. 21, 2009

**NOTE:** The calibration interval of the above test instruments is 12 months and the calibrations are traceable to NML/ROC and NIST/USA.

### 5.5.3 TEST PROCEDURE

The transmitter output was connected to the spectrum analyzer through an attenuator, the bandwidth of the fundamental frequency was measured with the spectrum analyzer using 3kHz RBW and 30kHz VBW, set sweep time = span/3kHz. The power spectral density was measured and recorded.

The sweep time is allowed to be longer than span/3kHz for a full response of the mixer in the spectrum analyzer.

#### 5.5.4 DEVIATION FROM TEST STANDARD

No deviation

#### 5.5.5 TEST SETUP

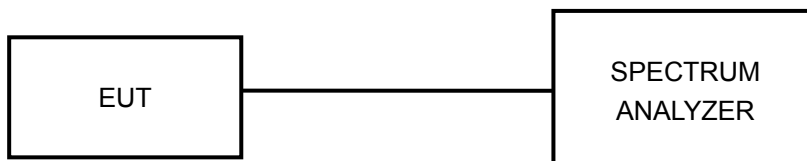

#### 5.5.6 EUT OPERATING CONDITION

Same as Item 5.3.6



## 5.5.7 TEST RESULTS

### 802.11a OFDM MODULATION

<b>MODULATION TYPE</b>	BPSK	<b>TRANSFER RATE</b>	6.0Mbps
<b>INPUT POWER (SYSTEM)</b>	120Vac, 60Hz	<b>ENVIRONMENTAL CONDITIONS</b>	25deg.C, 63%RH, 991hPa
<b>TESTED BY</b>	Dean Wang		

CHANNEL	CHANNEL FREQUENCY (MHz)	RF POWER LEVEL IN 3kHz BW (dBm)	MAXIMUM LIMIT (dBm)	PASS / FAIL
149	5745	-15.62	8	PASS
157	5785	-15.60	8	PASS
165	5825	-15.84	8	PASS

### CH 149

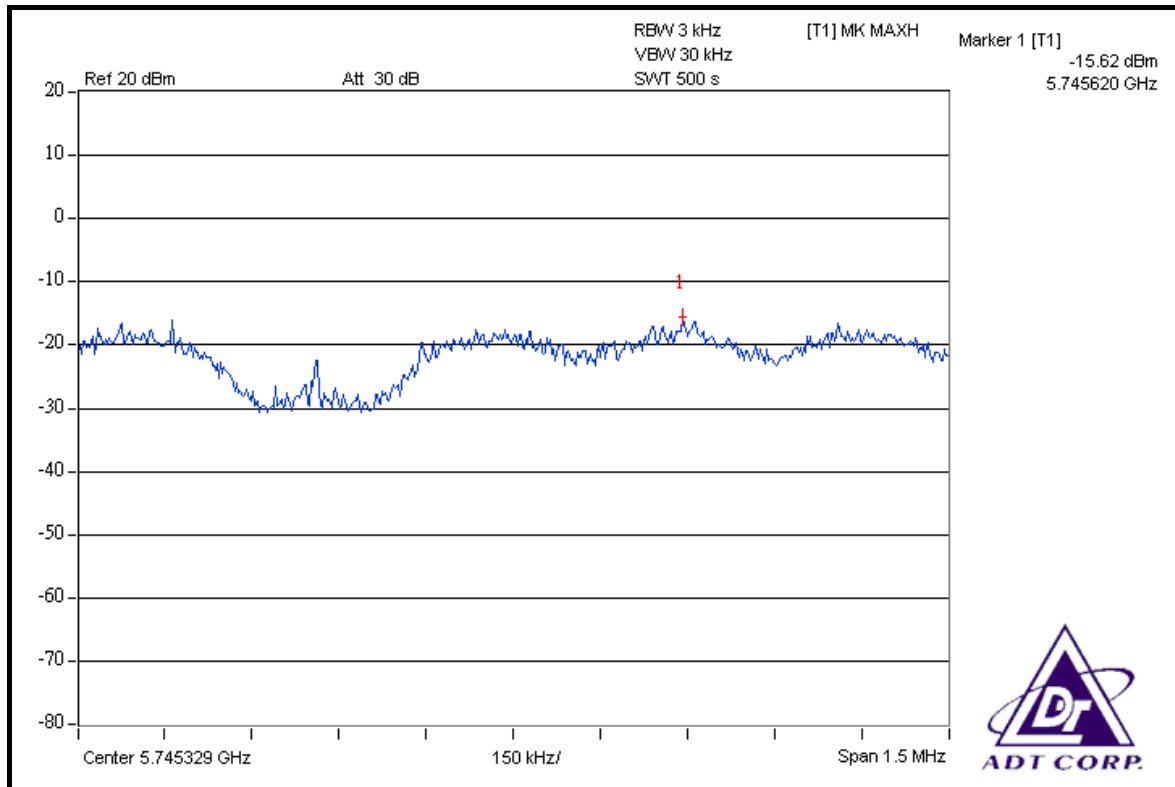



CH 157

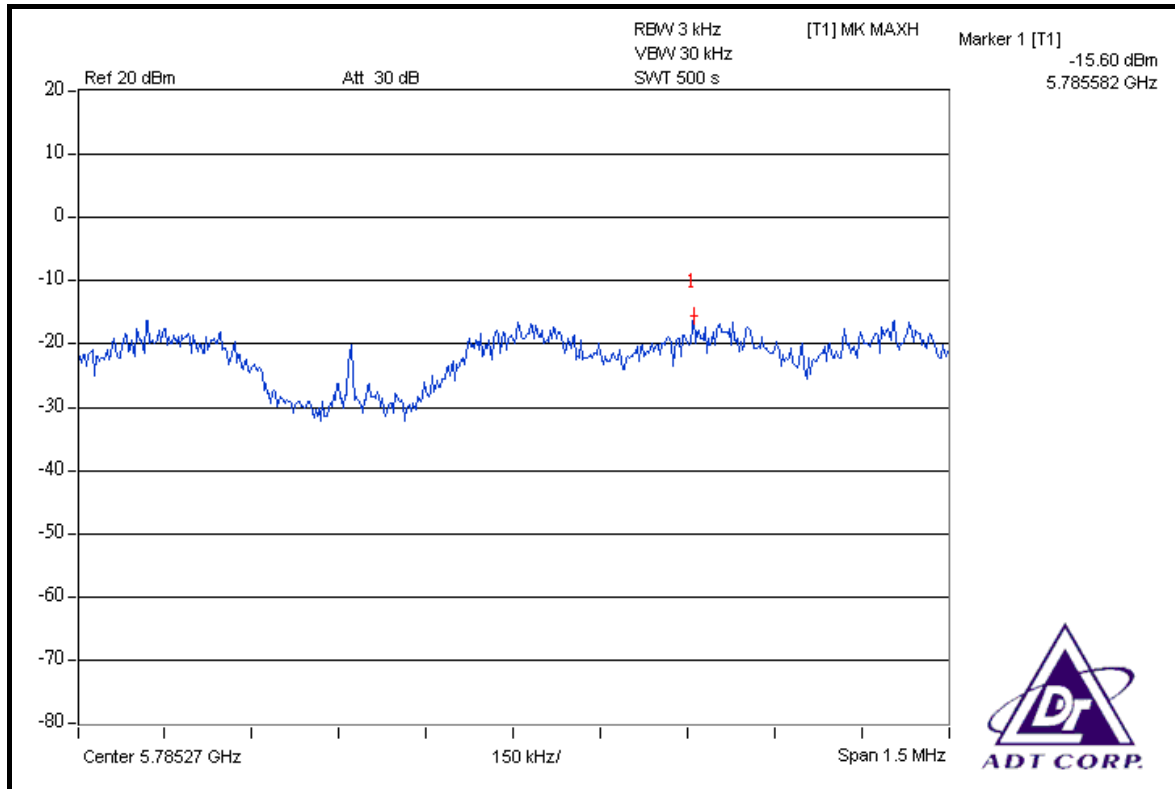

CH 165

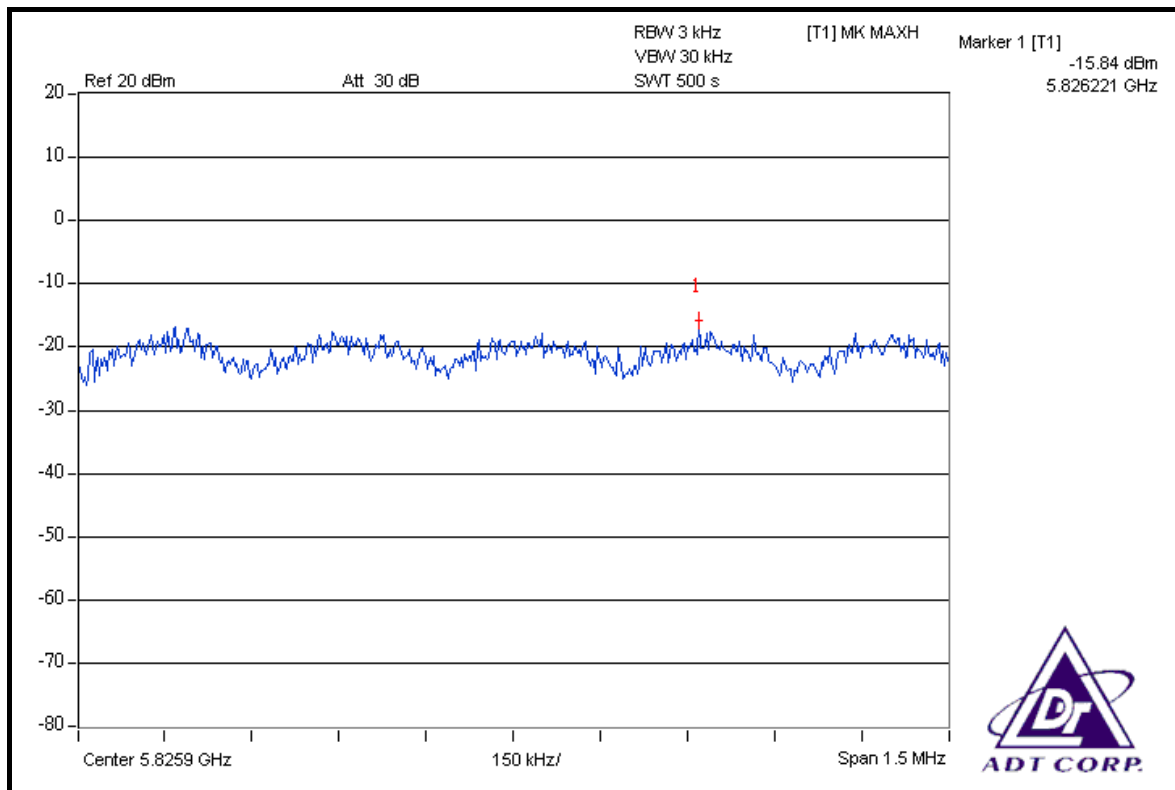



**DRAFT 802.11n (20MHz) OFDM MODULATION**

<b>MODULATION TYPE</b>	BPSK	<b>TRANSFER RATE</b>	7.2Mbps
<b>INPUT POWER (SYSTEM)</b>	120Vac, 60Hz	<b>ENVIRONMENTAL CONDITIONS</b>	25 deg.C, 63%RH, 991hPa
<b>TESTED BY</b>	Dean Wang		

CHAN.	CHAN. FREQ. (MHz)	RF POWER LEVEL IN 3kHz BW (dBm)			TOTAL POWER DENSITY (mW)	TOTAL POWER DENSITY (dBm)	MAX. LIMIT (dBm)	PASS / FAIL
		CHAIN 0	CHAIN 1	CHAIN 2				
149	5745	-16.08	-17.59	-14.21	0.080	-10.97	8	PASS
157	5785	-15.93	-17.89	-13.58	0.086	-10.67	8	PASS
165	5825	-15.89	-18.42	-12.56	0.096	-10.19	8	PASS

**FOR CHAIN 0: CH 149**

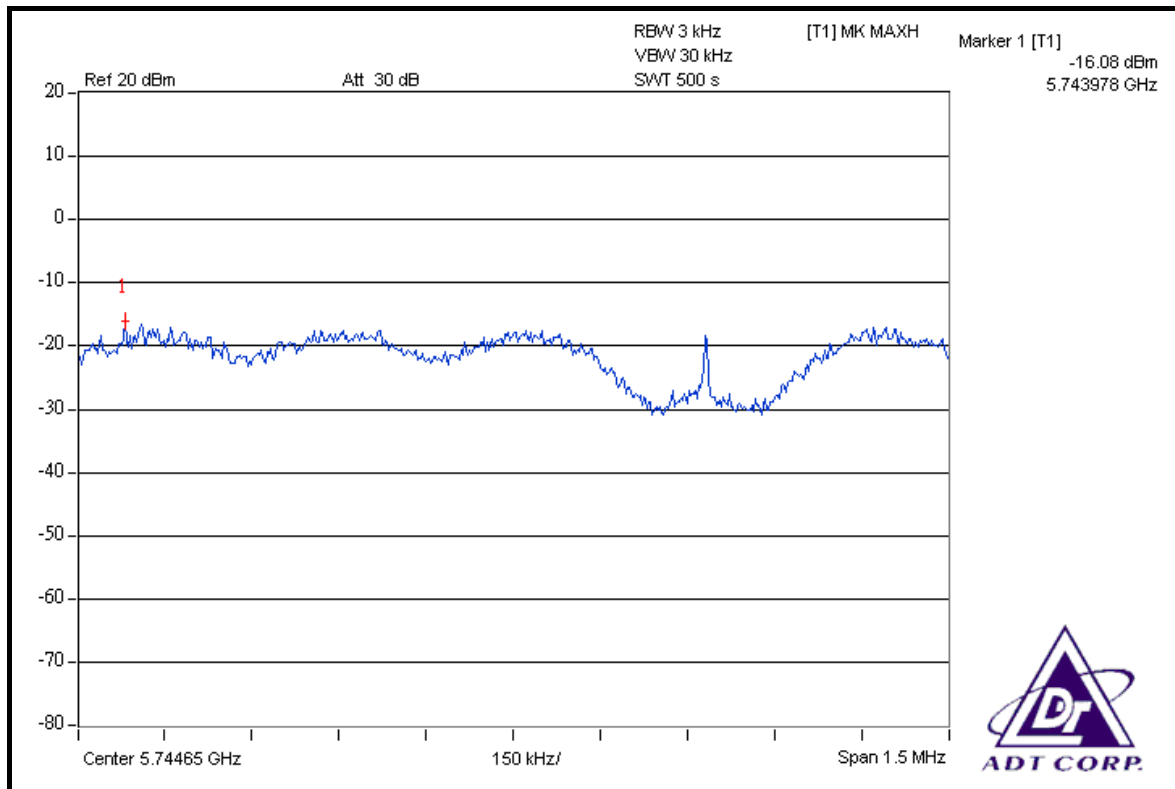

### CH 157

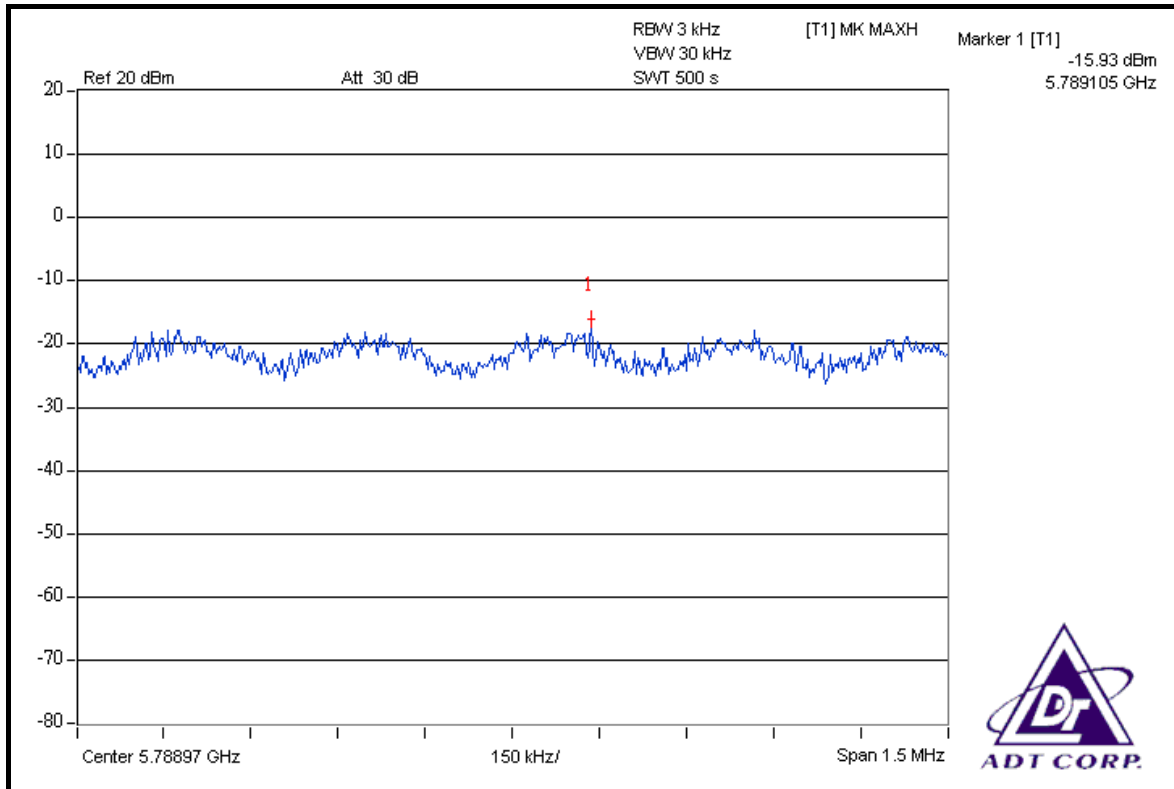

### CH 165

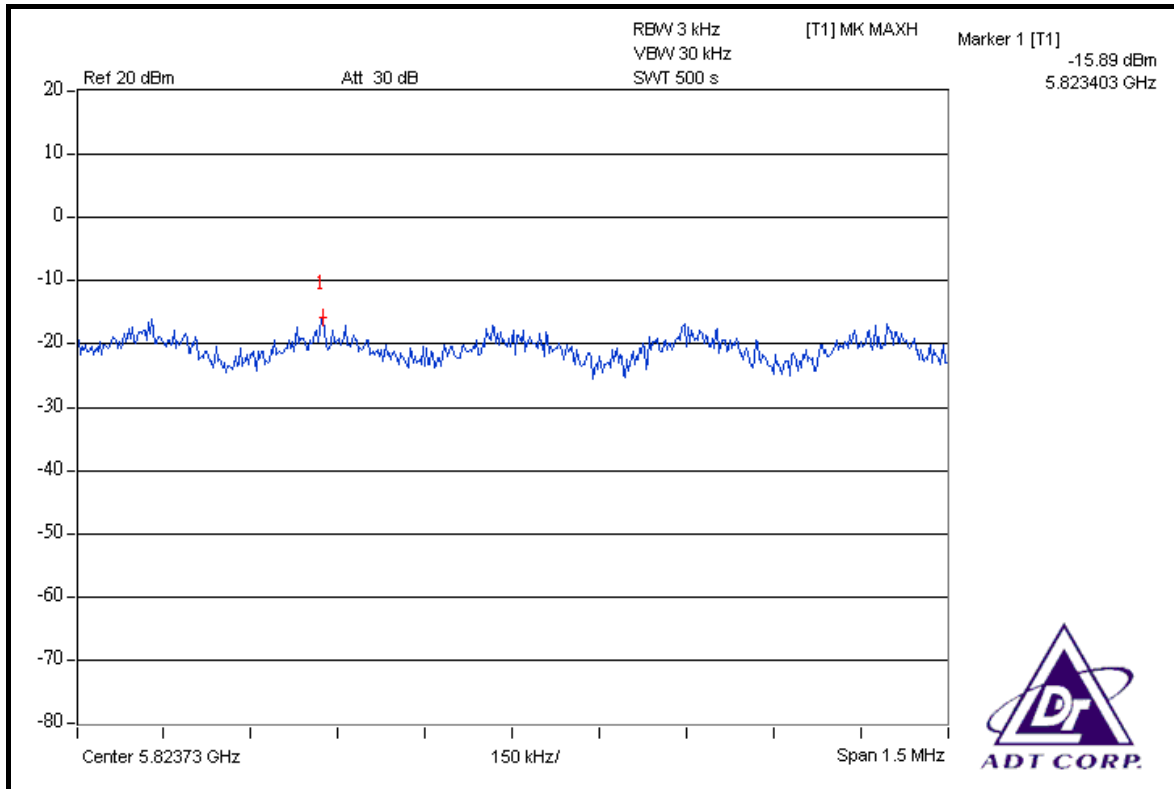



FOR CHAIN 1: CH 149

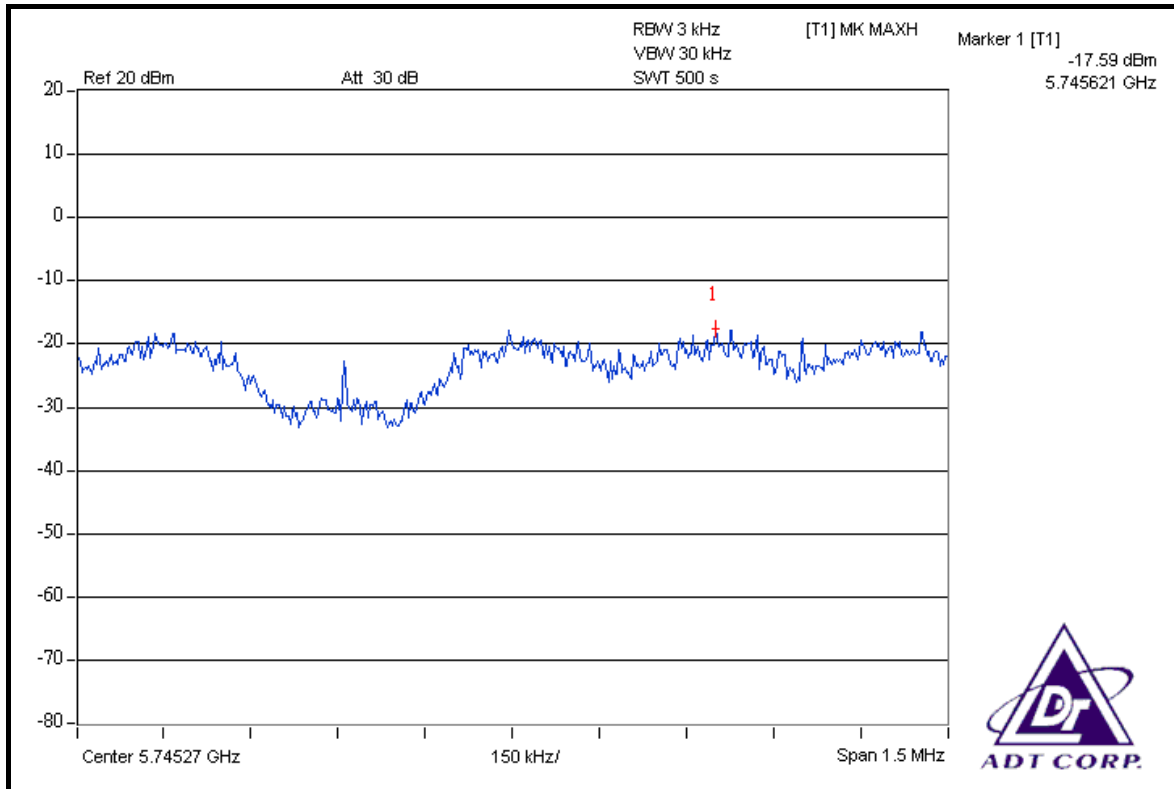

CH 157

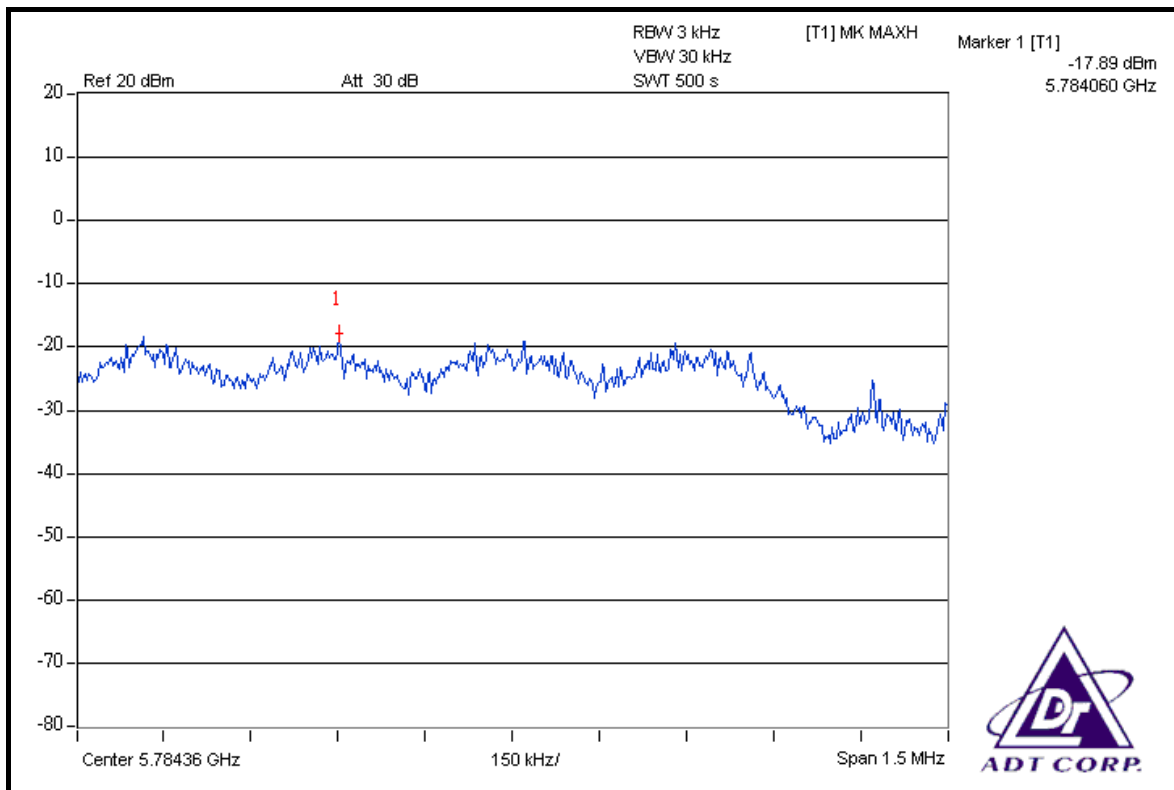



### CH 165

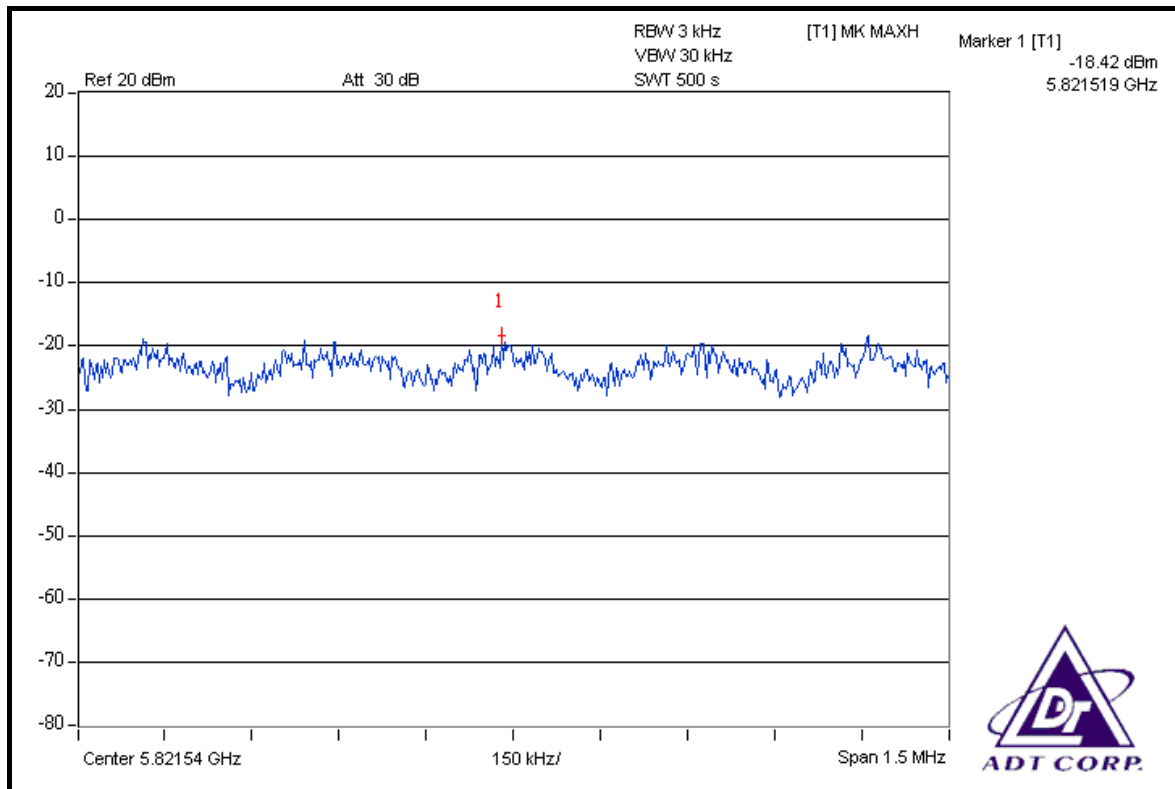

### FOR CHAIN 2: CH 149

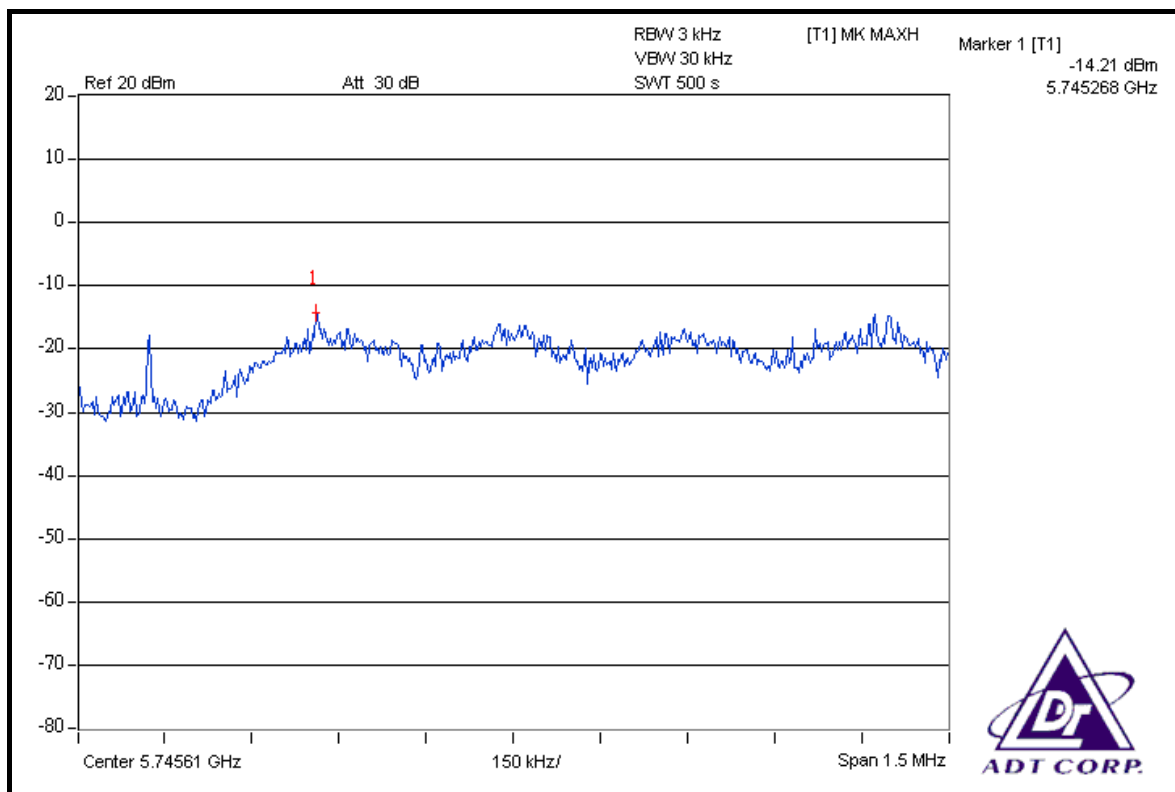



### CH 157

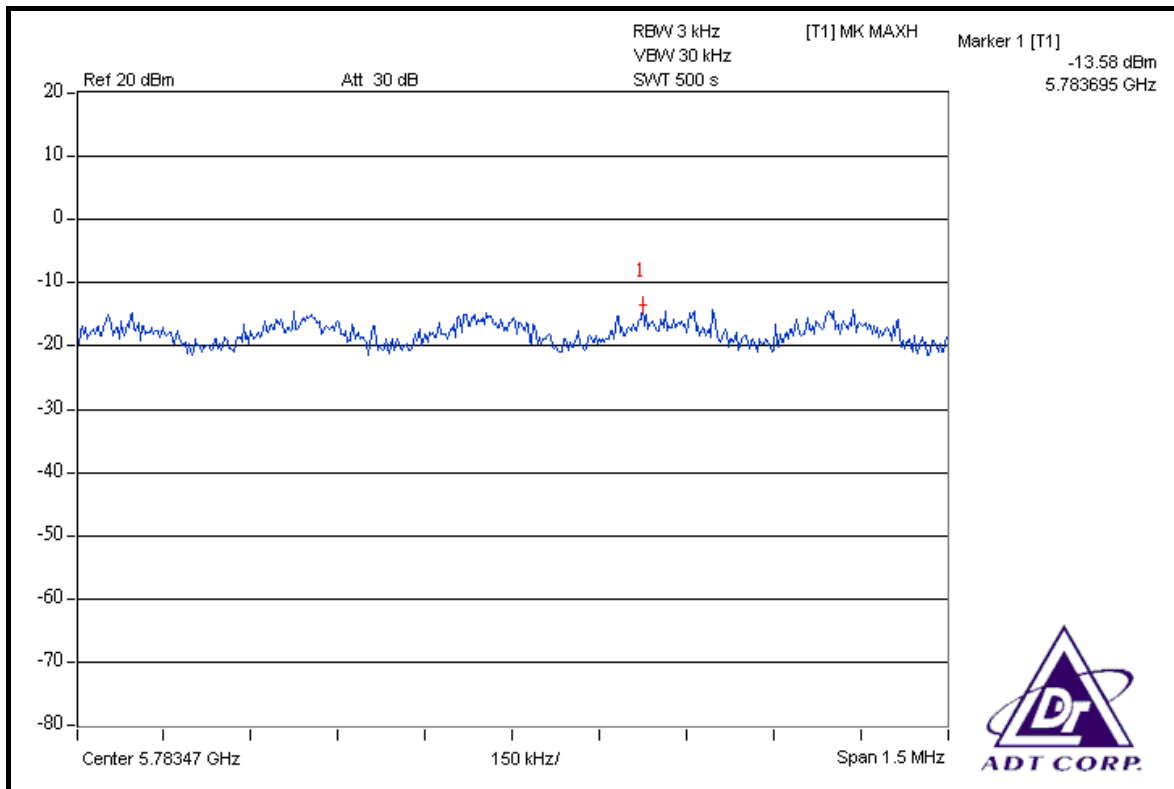

### CH 165

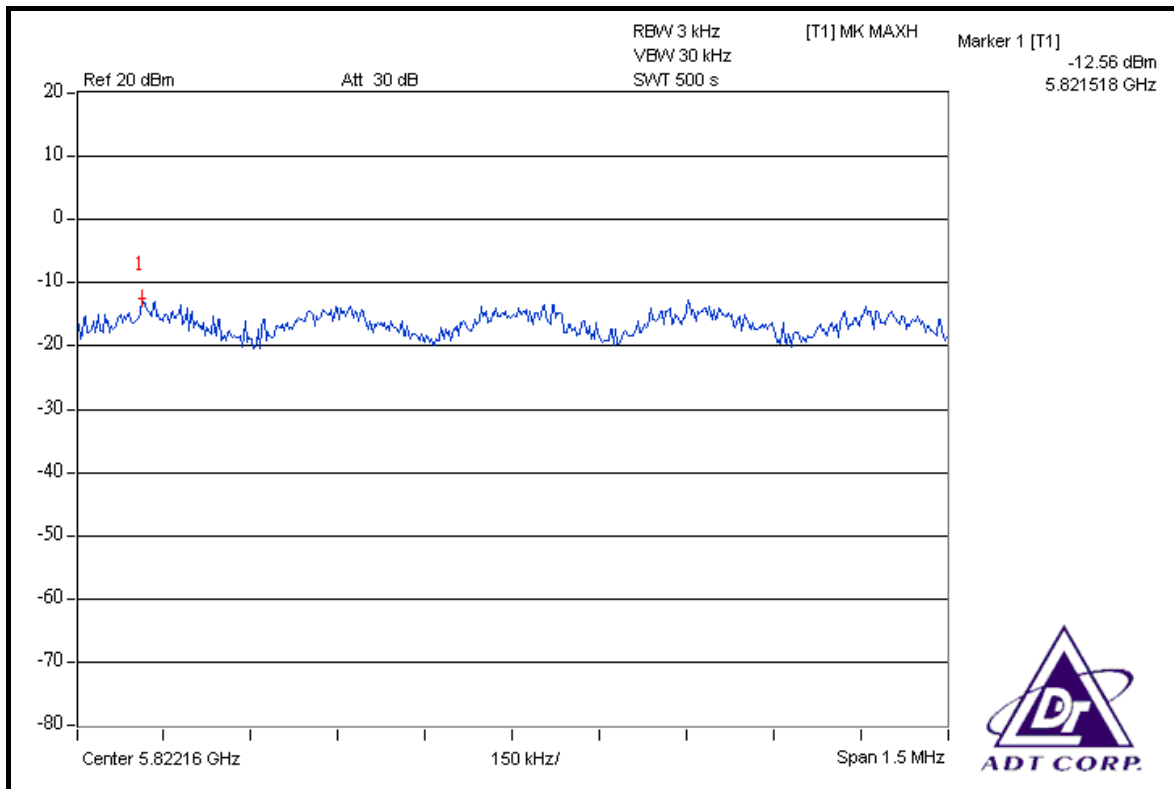



**DRAFT 802.11n (40MHz) OFDM MODULATION**

<b>MODULATION TYPE</b>	BPSK	<b>TRANSFER RATE</b>	15Mbps
<b>INPUT POWER (SYSTEM)</b>	120Vac, 60Hz	<b>ENVIRONMENTAL CONDITIONS</b>	25 deg.C, 63%RH, 991hPa
<b>TESTED BY</b>	Dean Wang		

CHAN.	CHAN. FREQ. (MHz)	RF POWER LEVEL IN 3kHz BW (dBm)			TOTAL POWER DENSITY (mW)	TOTAL POWER DENSITY (dBm)	MAX. LIMIT (dBm)	PASS / FAIL
		CHAIN 0	CHAIN 1	CHAIN 2				
151	5755	-15.74	-16.69	-16.88	0.069	-11.64	8	PASS
159	5795	-16.06	-16.57	-16.65	0.068	-11.65	8	PASS





### FOR CHAIN 0: CH 151

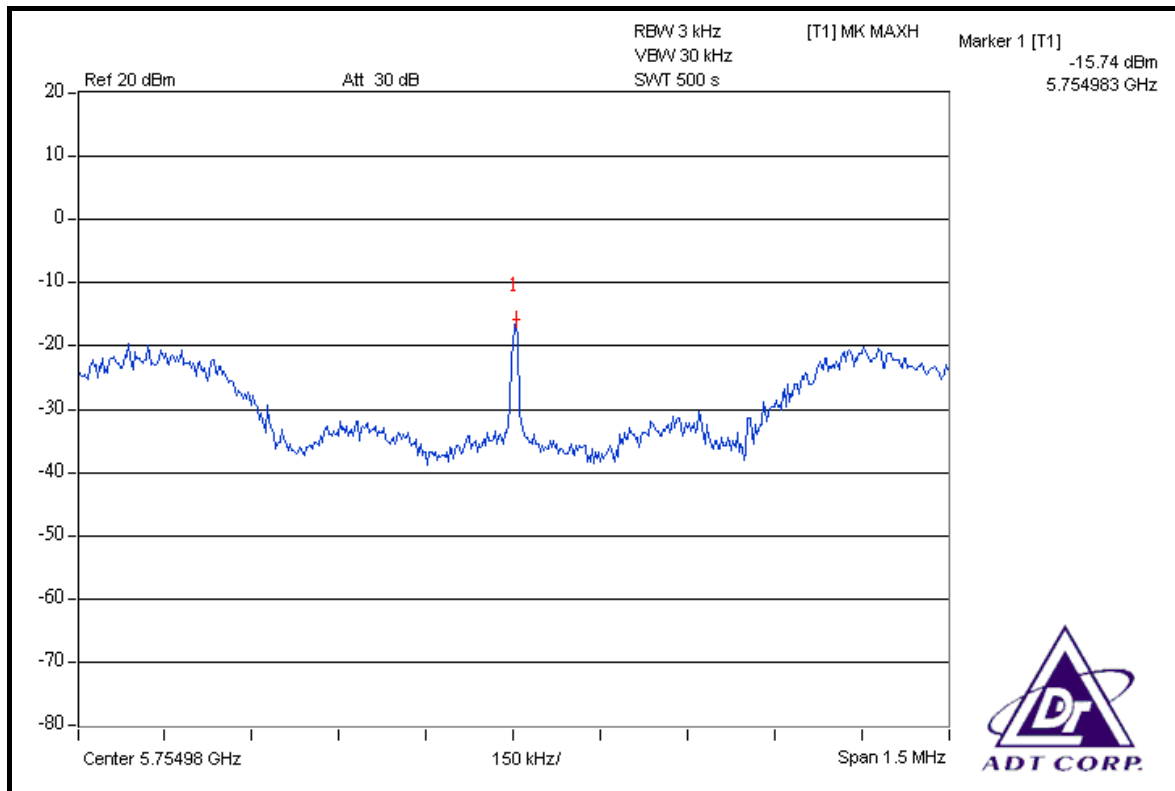

### CH 159

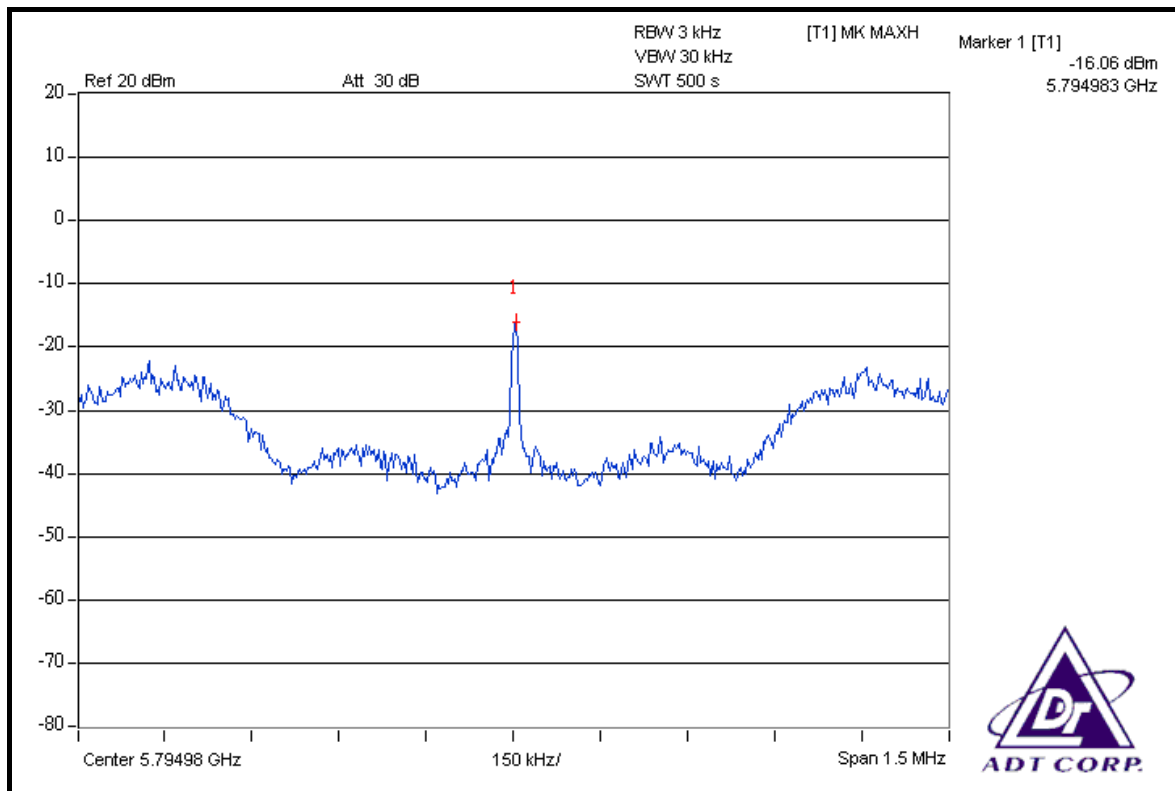



### FOR CHAIN 1: CH 151

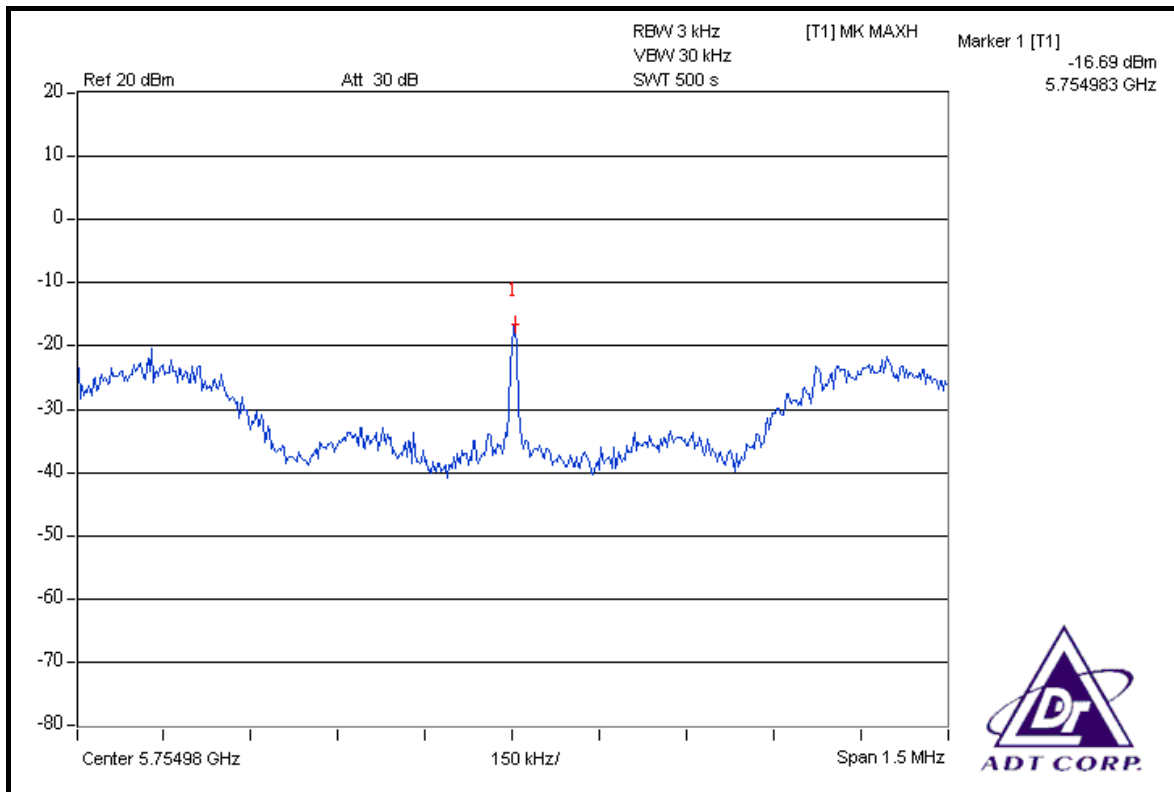

### CH 159

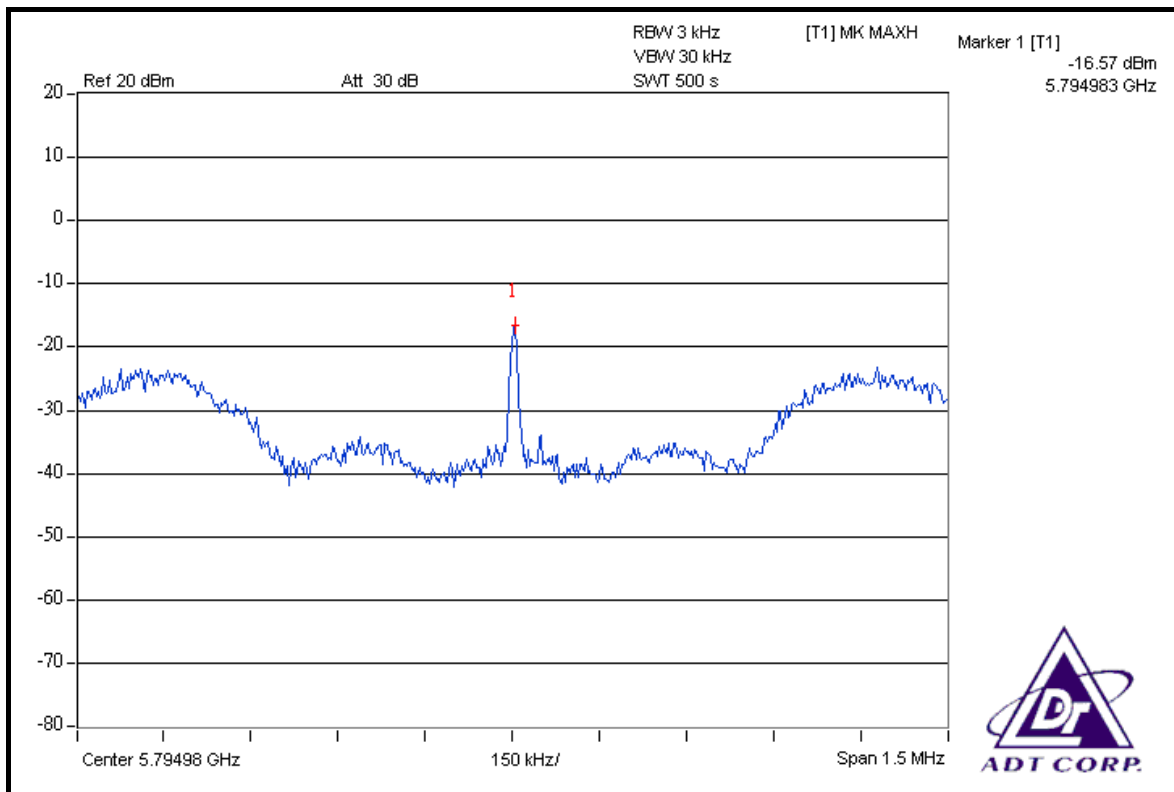



### FOR CHAIN 2: CH 151

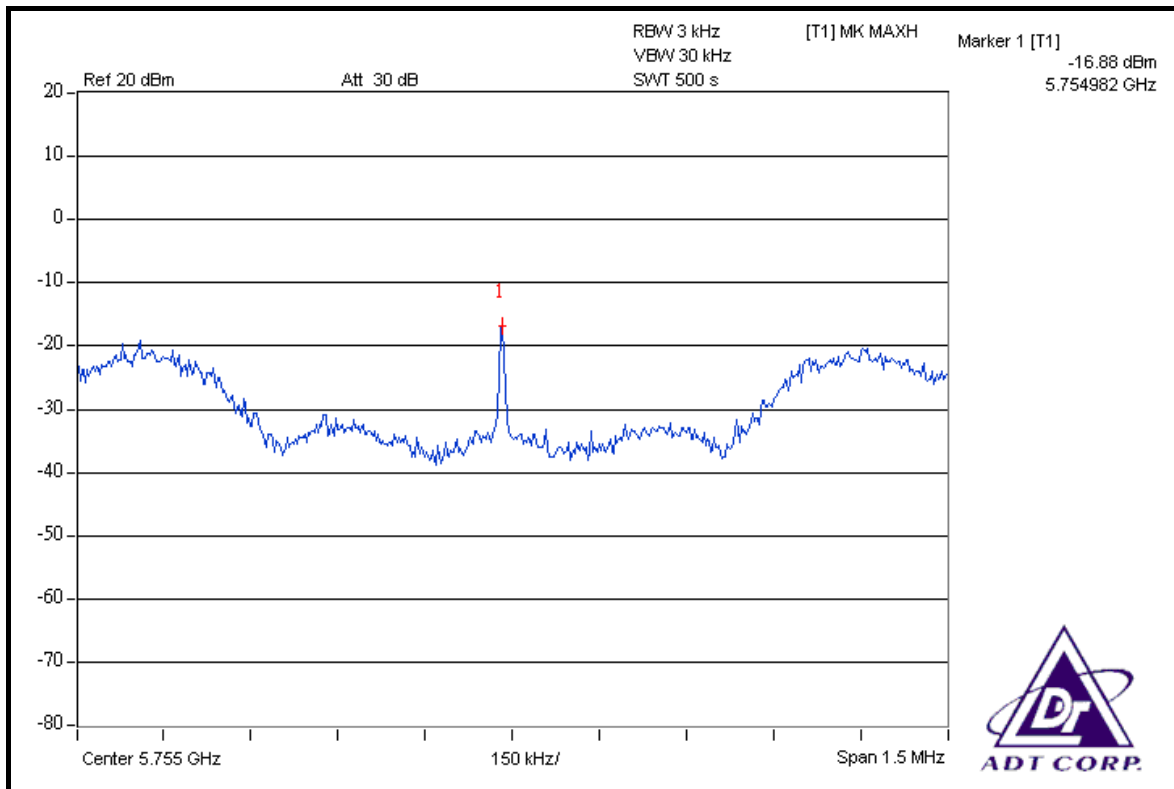

### CH 159

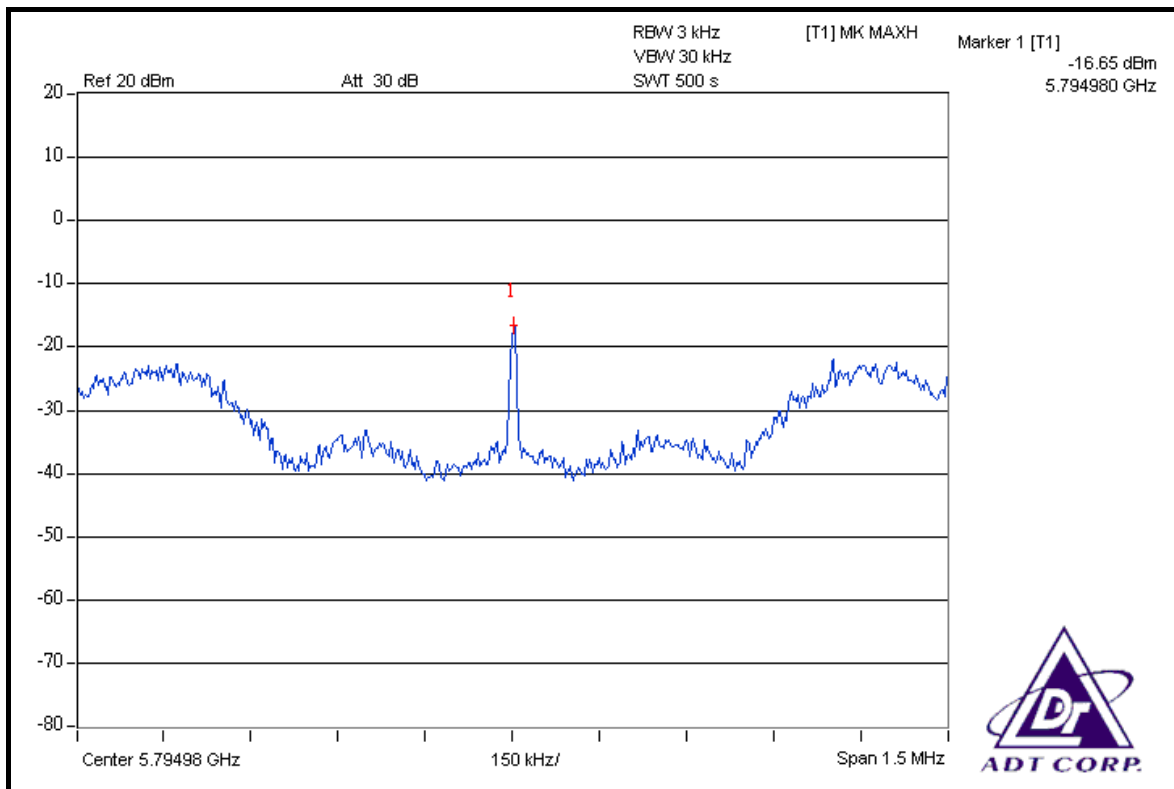



## 5.6 BAND EDGES MEASUREMENT

### 5.6.1 LIMITS OF BAND EDGES MEASUREMENT

Below -20dB of the highest emission level of operating band (in 100kHz Resolution Bandwidth).

### 5.6.2 TEST INSTRUMENTS

DESCRIPTION & MANUFACTURER	MODEL NO.	SERIAL NO.	DATE OF CALIBRATION	CALIBRATED UNTIL
<b>FOR CONDUCTED MEASUREMENT:</b>				
R&S SPECTRUM ANALYZER	FSP40	100041	Apr. 22, 2008	Apr. 21, 2009
<b>FOR RADIATED MEASUREMENT:</b>				
Test Receiver ROHDE & SCHWARZ	ESI7	100033	Jun. 30, 2008	Jun. 29, 2009
Spectrum Analyzer Agilent	FSP	100041	Apr. 22, 2008	Apr. 21, 2009
BILOG Antenna SCHWARZBECK	VULB9168	9168-160	May, 02, 2008	May, 01, 2009
HORN Antenna SCHWARZBECK	9120D	9120D-209	Jun. 24, 2008	Jun. 23, 2009
HORN Antenna SCHWARZBECK	BBHA 9170	BBHA9170243	Dec. 25, 2007	Dec. 24, 2008
Preamplifier Agilent	8447D	2944A10633	Oct. 29, 2007	Oct. 28, 2008
Preamplifier Agilent	8449B	3008A01964	Oct. 24, 2007	Oct. 23, 2008
RF signal cable HUBER+SUHNNER	SUCOFLEX 104	283402/4	Dec. 07, 2007	Dec. 06, 2008
RF signal cable HUBER+SUHNNER	SUCOFLEX 104	251644/4	Dec. 07, 2007	Dec. 06, 2008
Software ADT.	ADT_Radiated_V7.6	NA	NA	NA
Antenna Tower inn-co GmbH	MA 4000	013303	NA	NA
Antenna Tower Controller inn-co GmbH	CO2000	017303	NA	NA
Turn Table ADT.	TT100.	TT93021703	NA	NA
Turn Table Controller ADT.	SC100.	SC93021703	NA	NA

**NOTE:** The calibration interval of the above test instruments is 12 months and the calibrations are traceable to NML/ROC and NIST/USA.

### 5.6.3 TEST PROCEDURE

#### FOR CONDUCTED MEASUREMENT:

The transmitter output was connected to the spectrum analyzer via a low loss cable. Set both RBW and VBW of spectrum analyzer to 100kHz and 300kHz with suitable frequency span including 100MHz bandwidth from band edge. The band edges was measured and recorded.

#### FOR RADIATED MEASUREMENT:

- a. The EUT was placed on the top of a rotating table 0.8 meters above the ground at a 3 meter semi-anechoic chamber. The table was rotated 360 degrees to determine the position of the highest radiation.
- b. The EUT was set 3 meters away from the interference-receiving antenna, which was mounted on the top of a variable-height antenna tower.
- c. The antenna is a broadband antenna, and its height is varied from one meter to four meters above the ground to determine the maximum value of the field strength. Both horizontal and vertical polarizations of the antenna are set to make the measurement.
- d. For each suspected emission, the EUT was arranged to its worst case and then the antenna was tuned to heights from 1 meter to 4 meters and the rotatable table was turned from 0 degrees to 360 degrees to find the maximum reading.
- e. Set both RBW and VBW of spectrum analyzer to 100kHz and 300kHz with suitable frequency span including 100MHz bandwidth from band edge. The band edges was measured and recorded.

**NOTE:** The resolution bandwidth of test receiver/spectrum analyzer is 1MHz and the video bandwidth is 10Hz for Average detection (AV) at frequency above 1GHz.

#### 5.6.4 DEVIATION FROM TEST STANDARD

No deviation

#### 5.6.5 EUT OPERATING CONDITION

Same as Item 5.3.6

#### 5.6.6 TEST RESULTS

The spectrum plots are attached on the following pages. D1 line indicates the highest level, D2 line indicates the 20dB offset below D1. It shows compliance with the requirement in part 15.247(d).

### 802.11a OFDM MODULATION

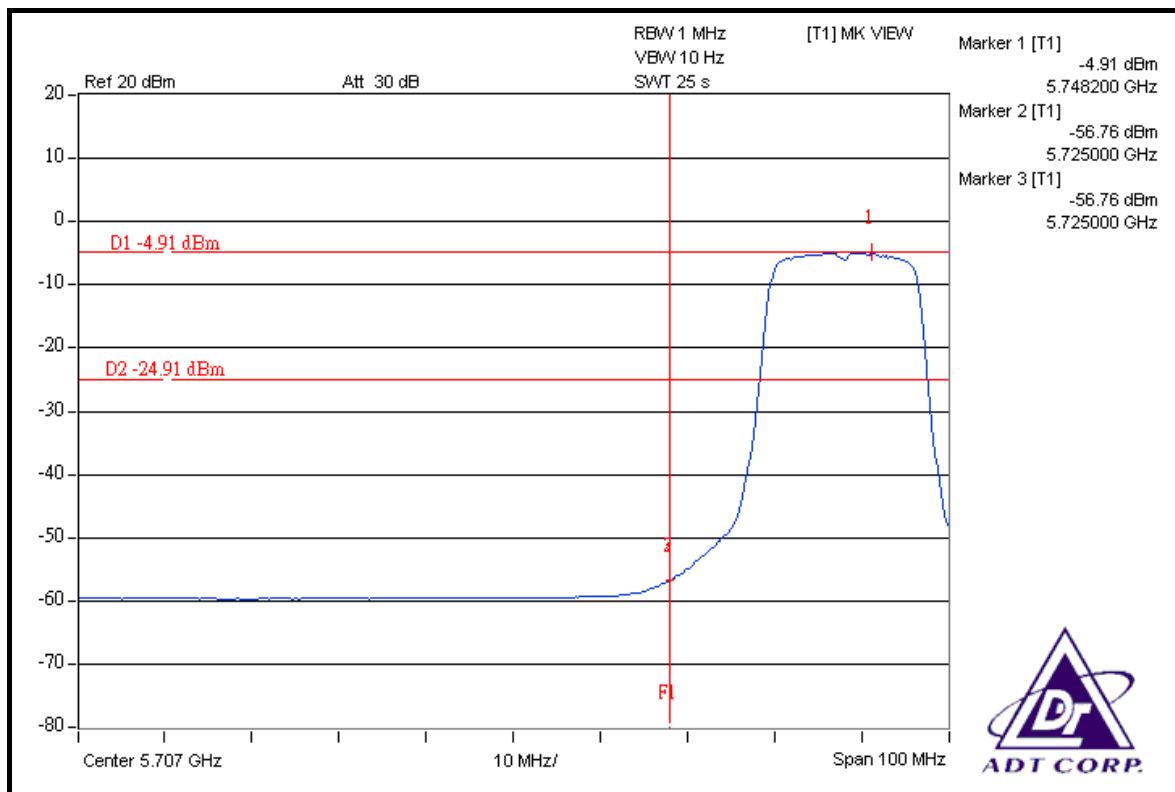
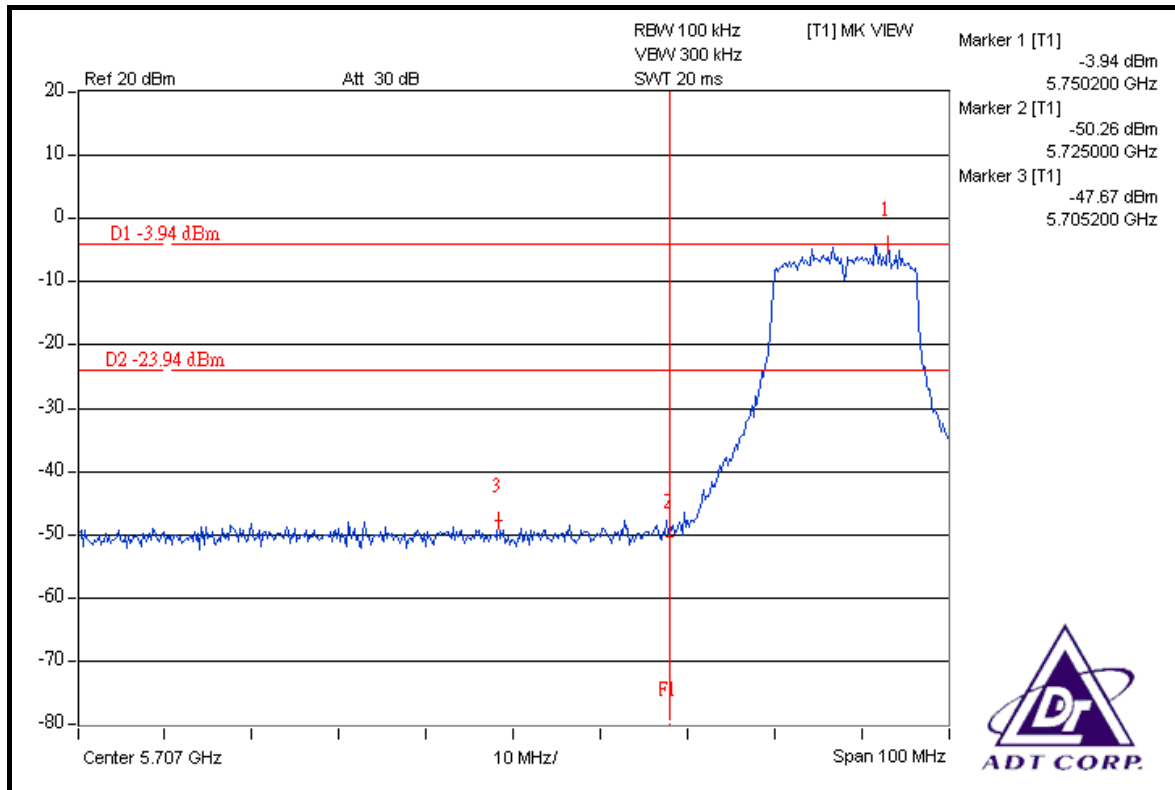

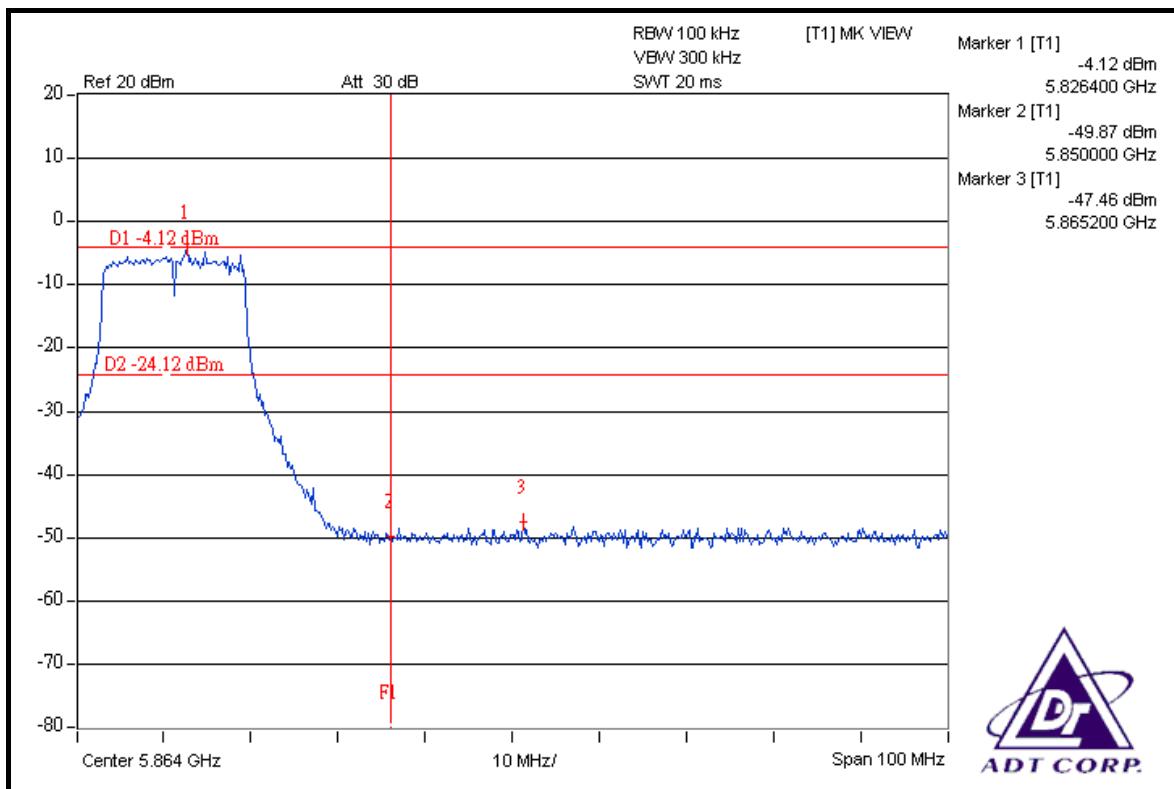
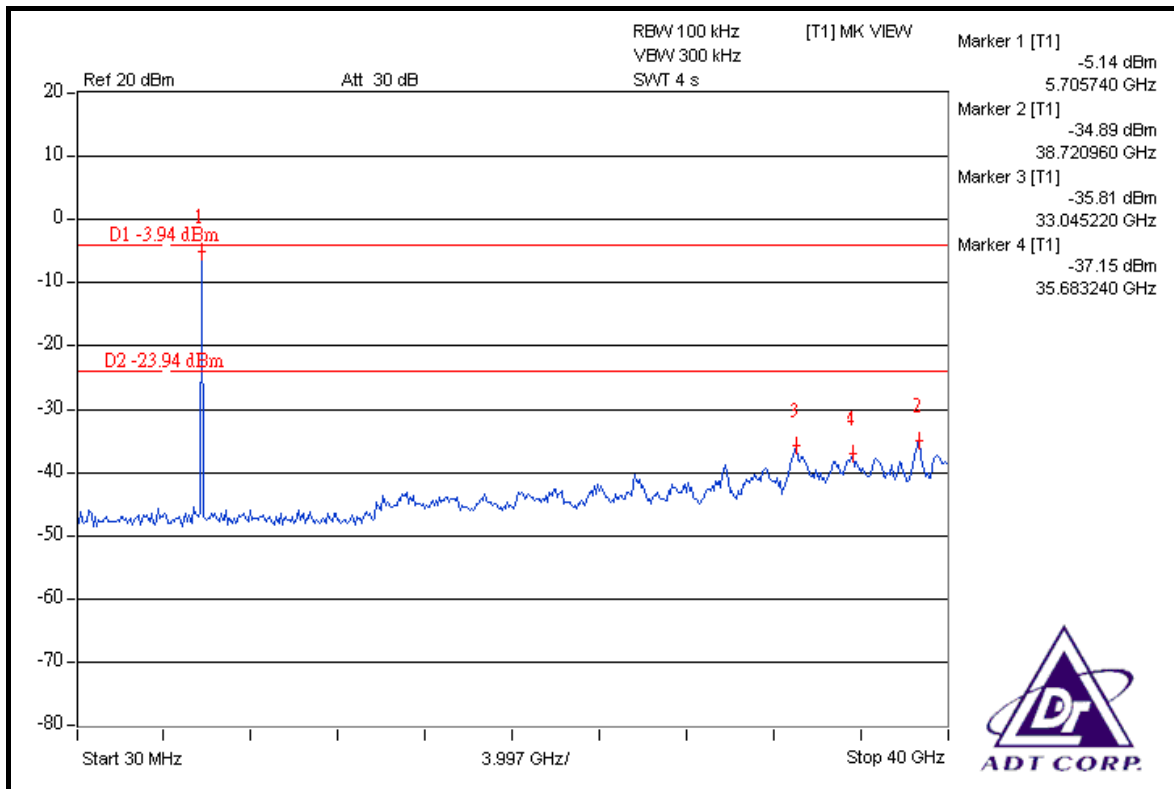



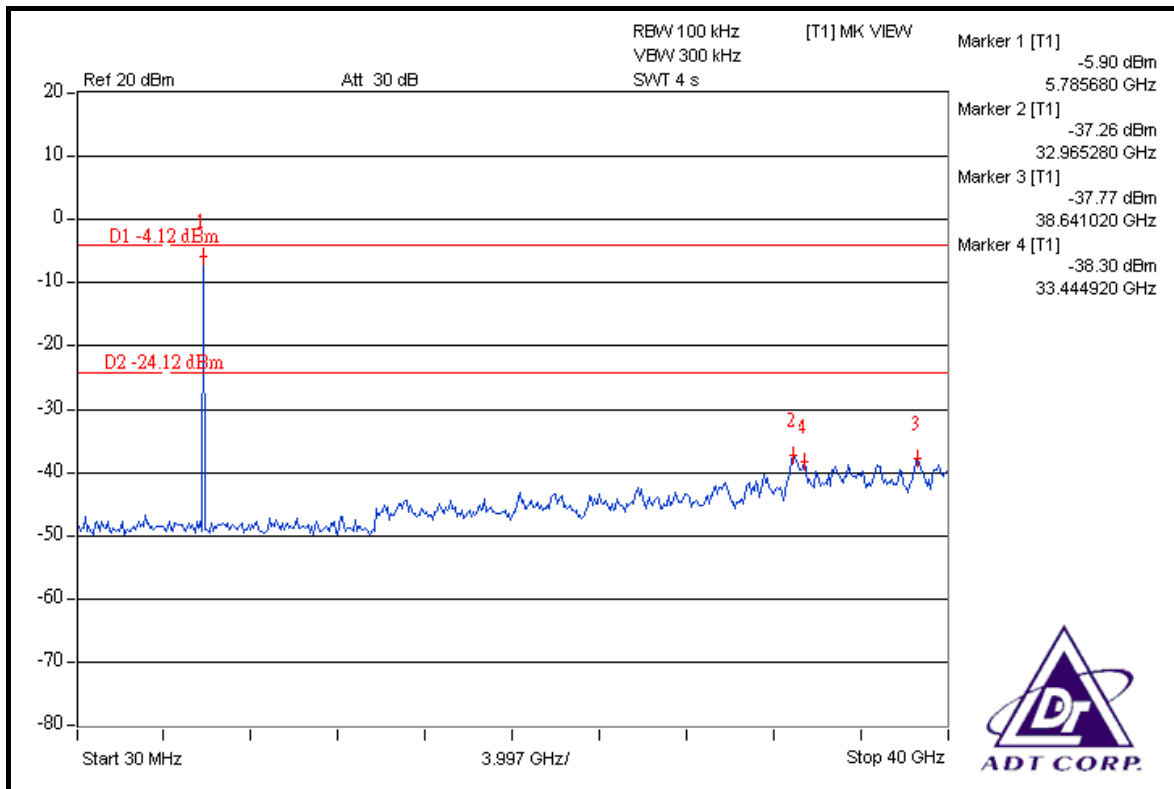
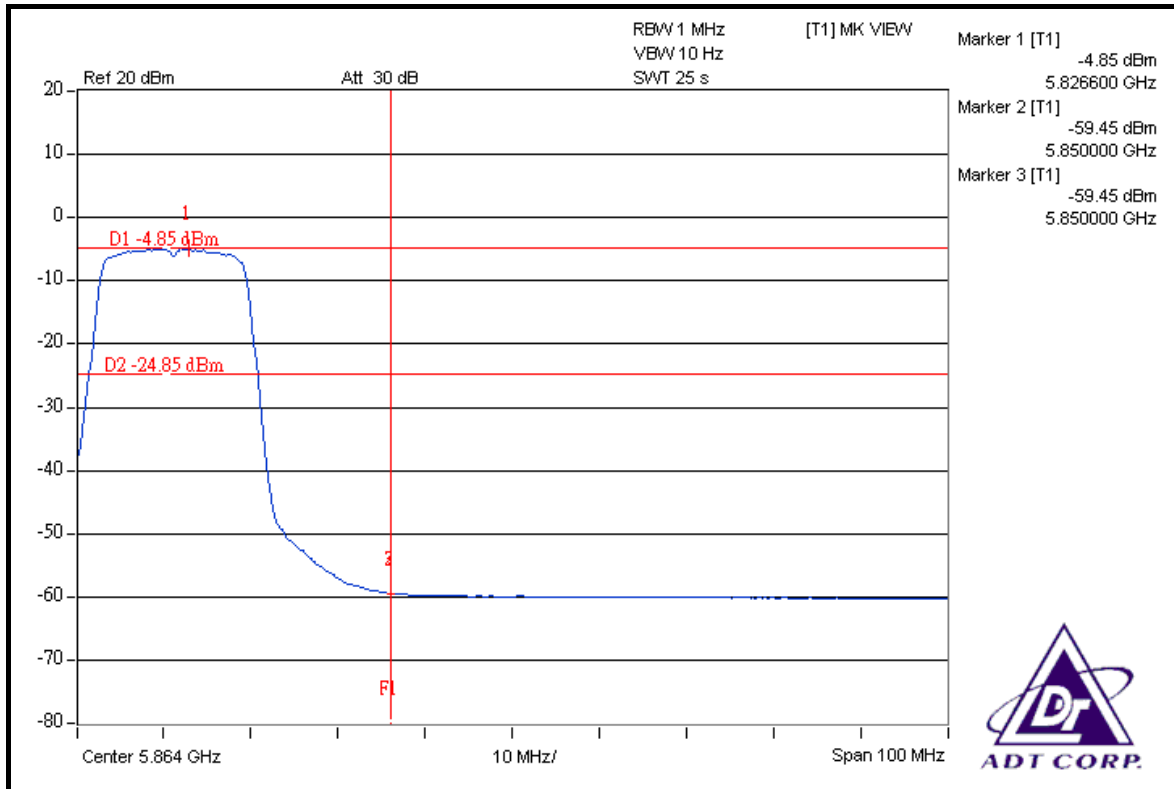

### DRAFT 802.11n (20MHz) OFDM MODULATION

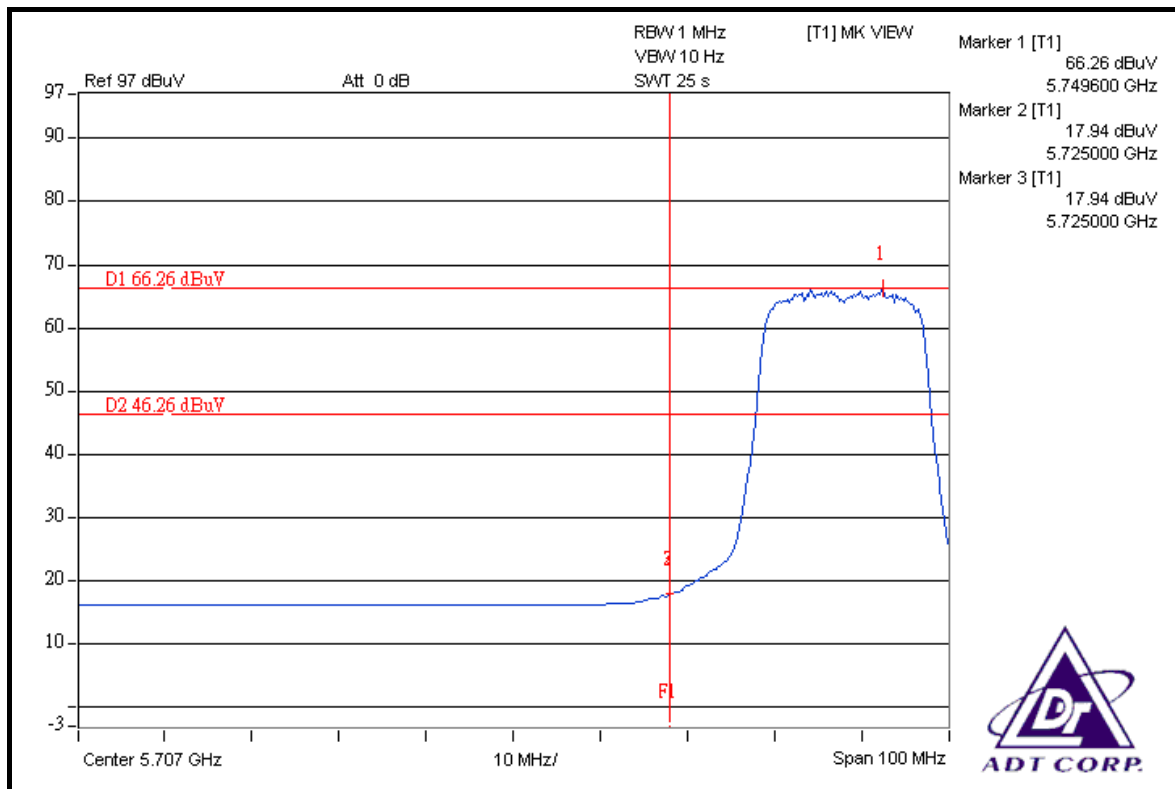
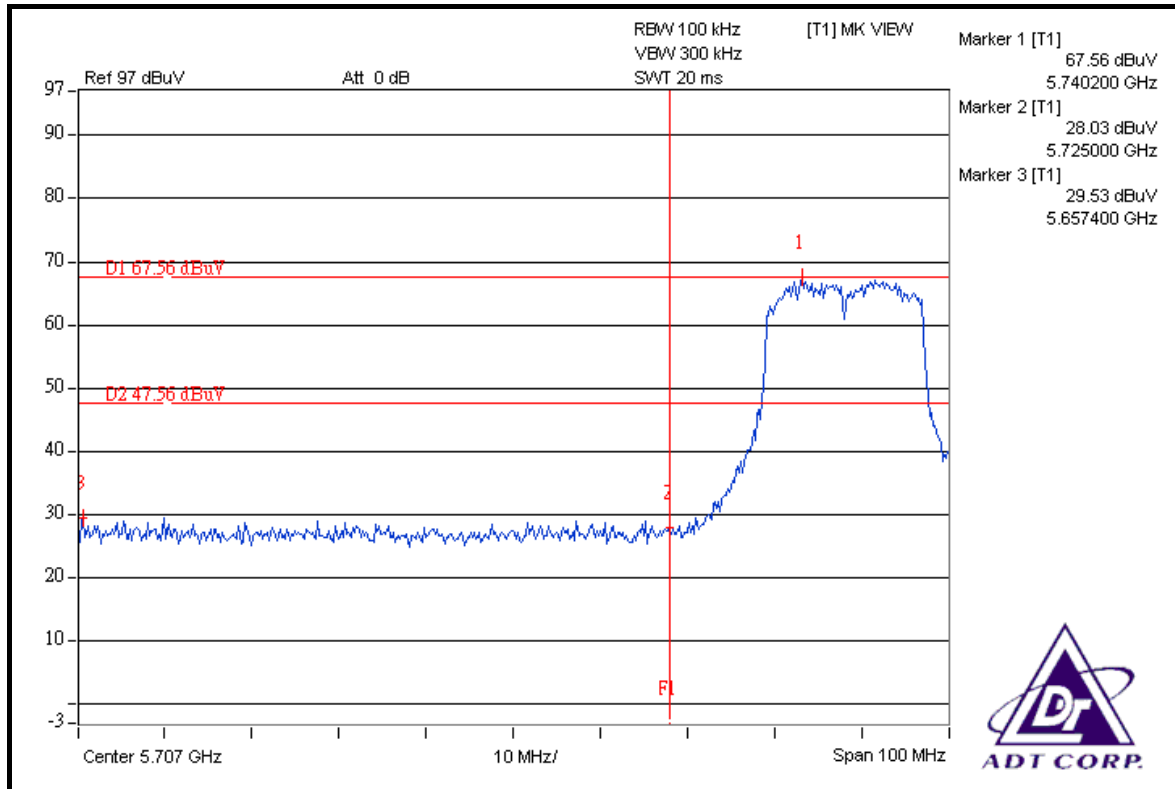

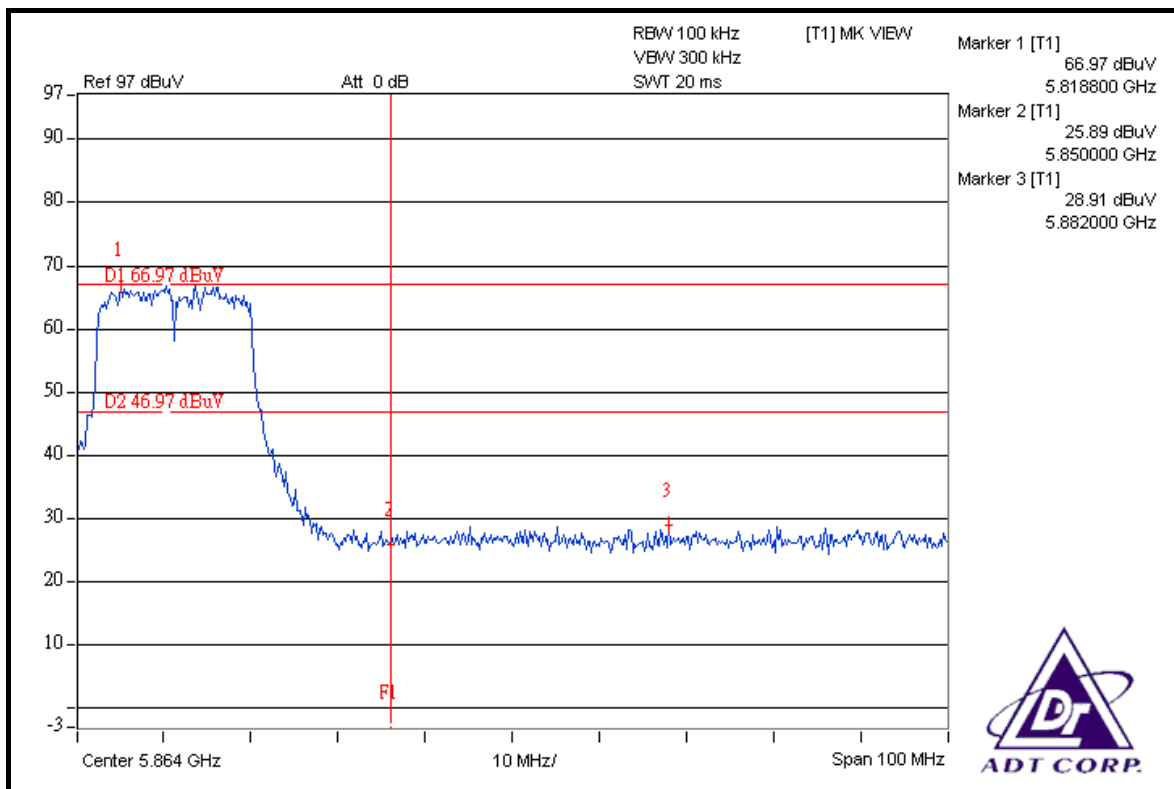
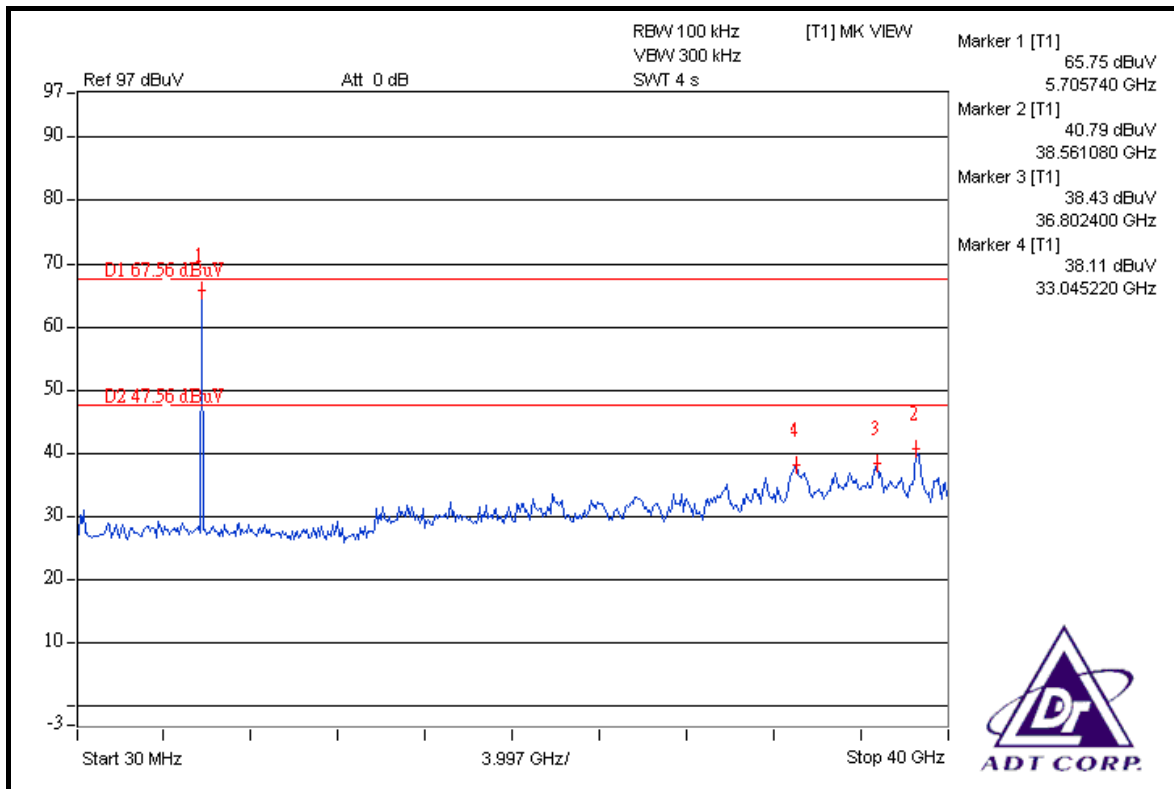

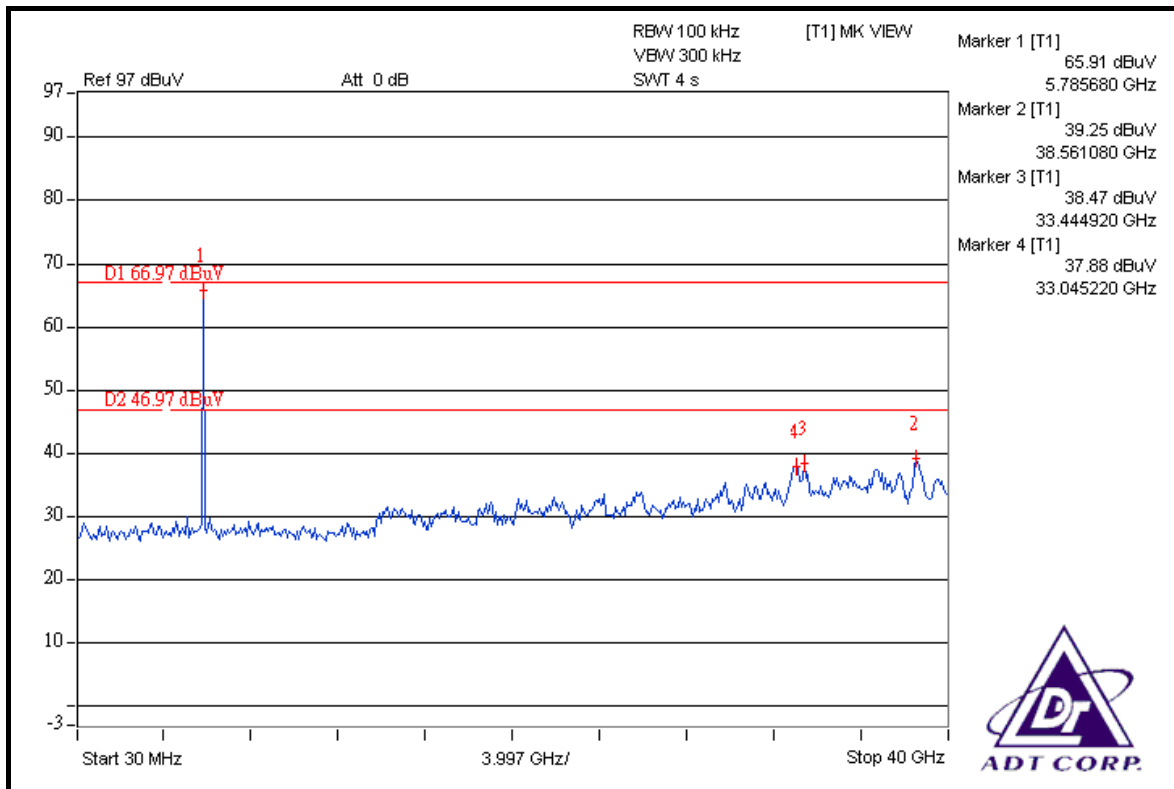
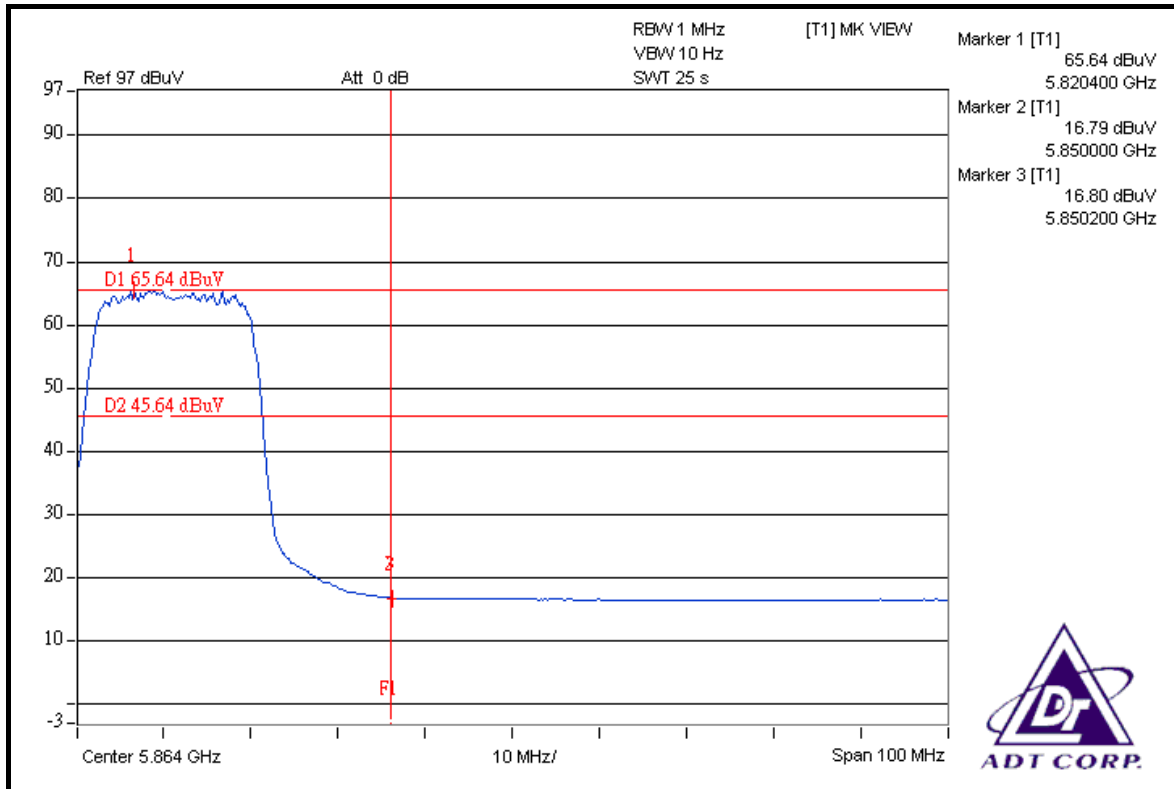



### DRAFT 802.11n (40MHz) OFDM MODULATION

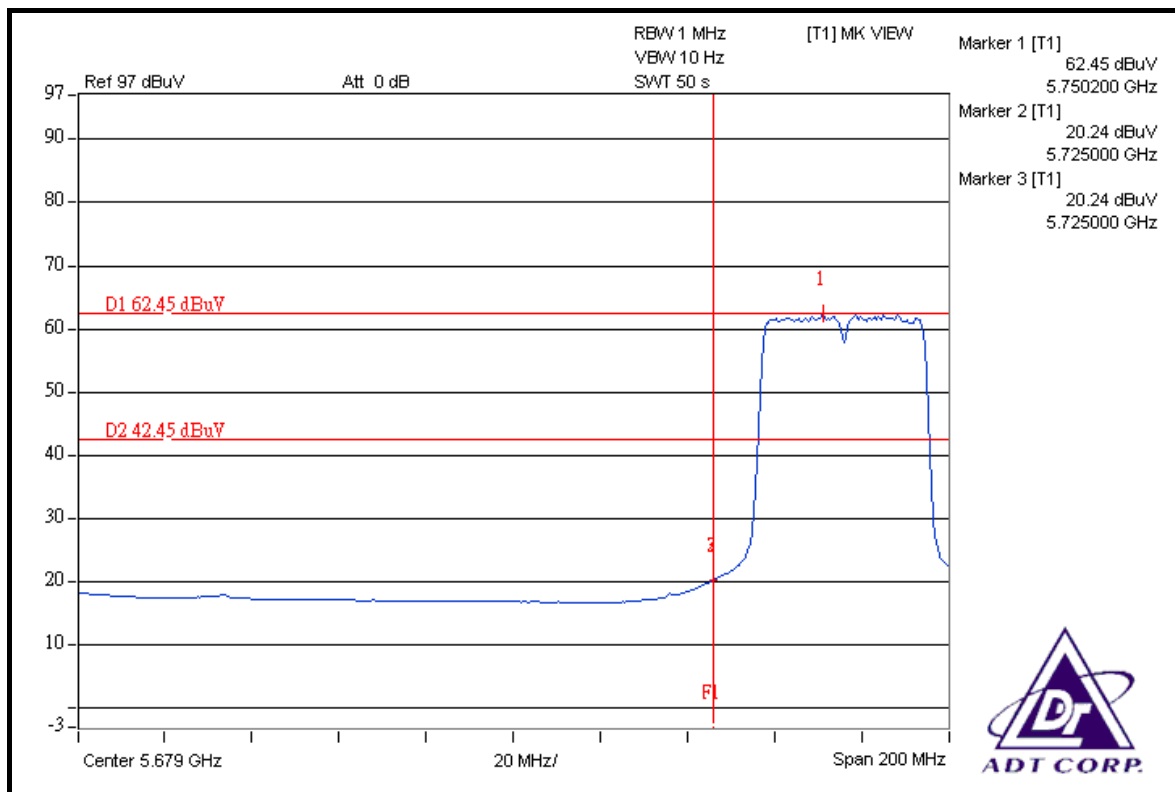
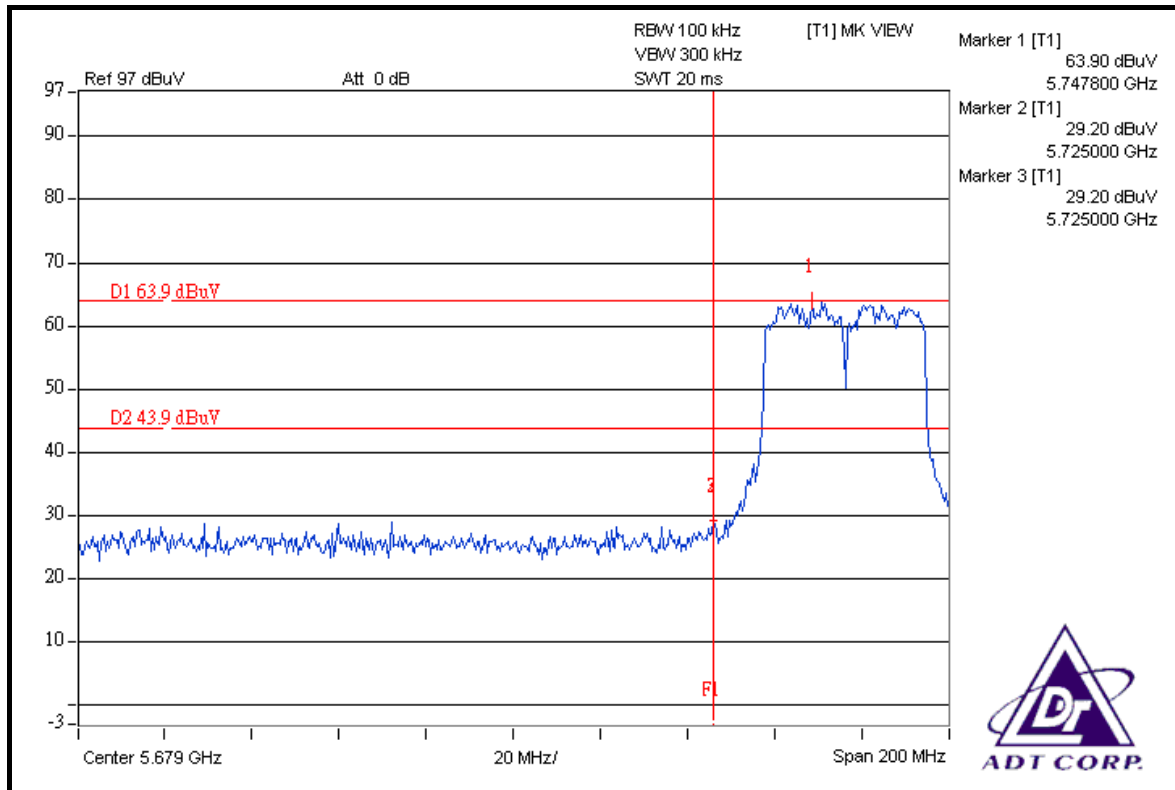

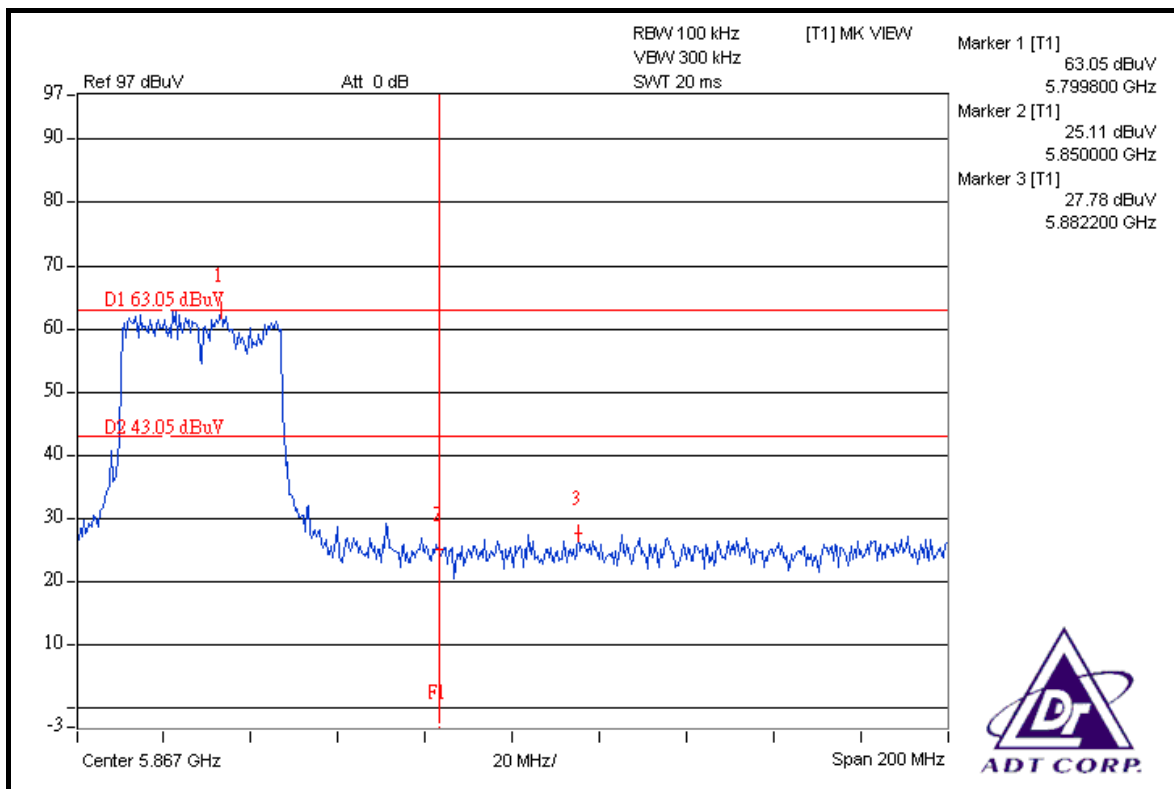
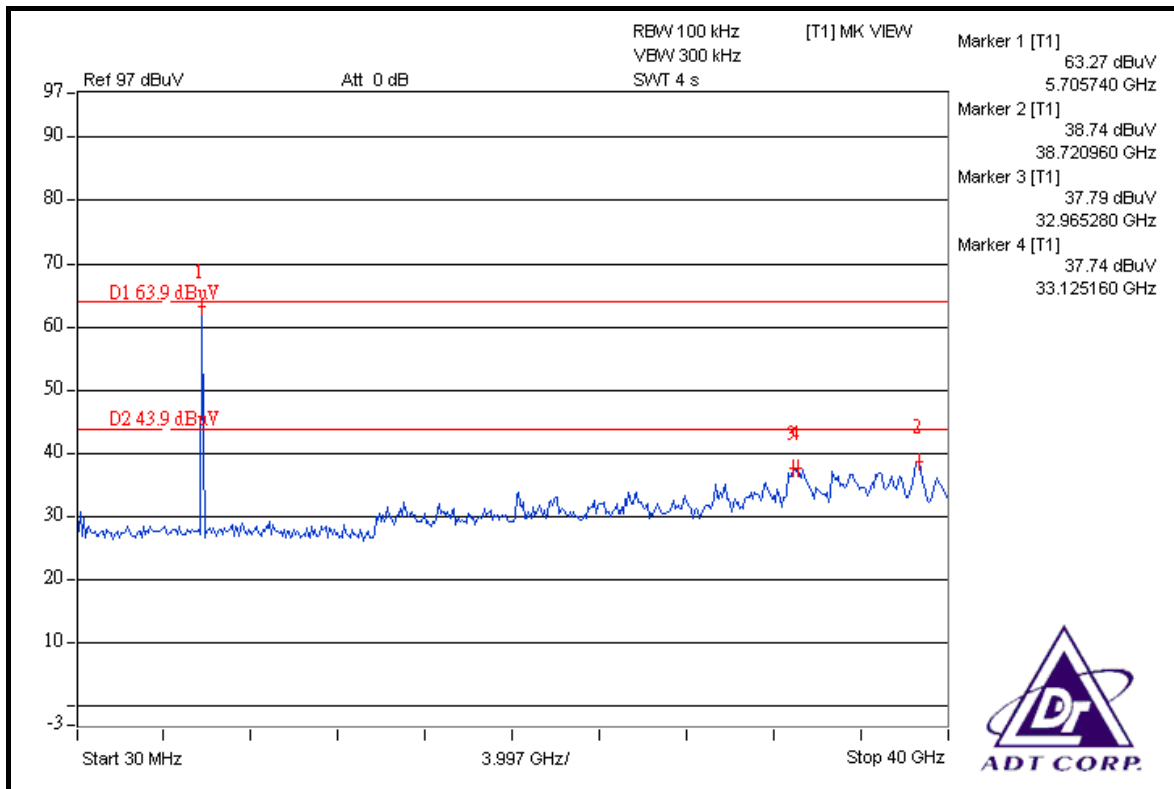

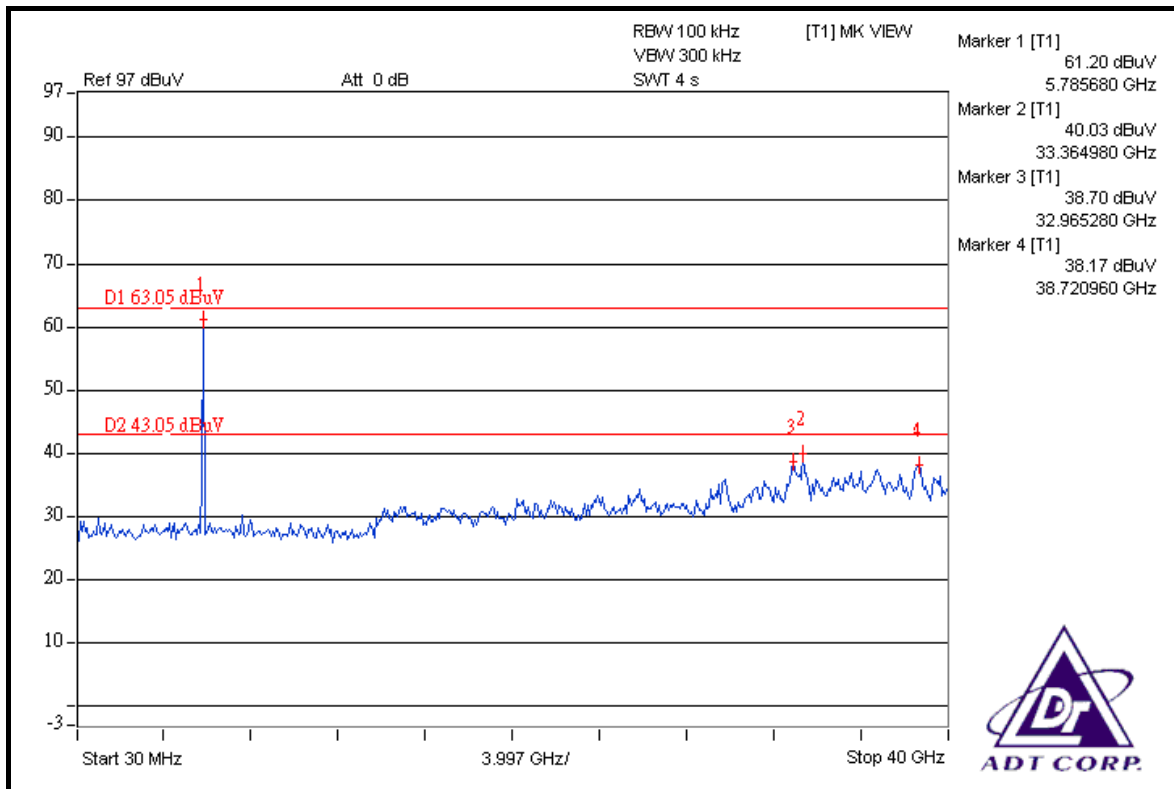
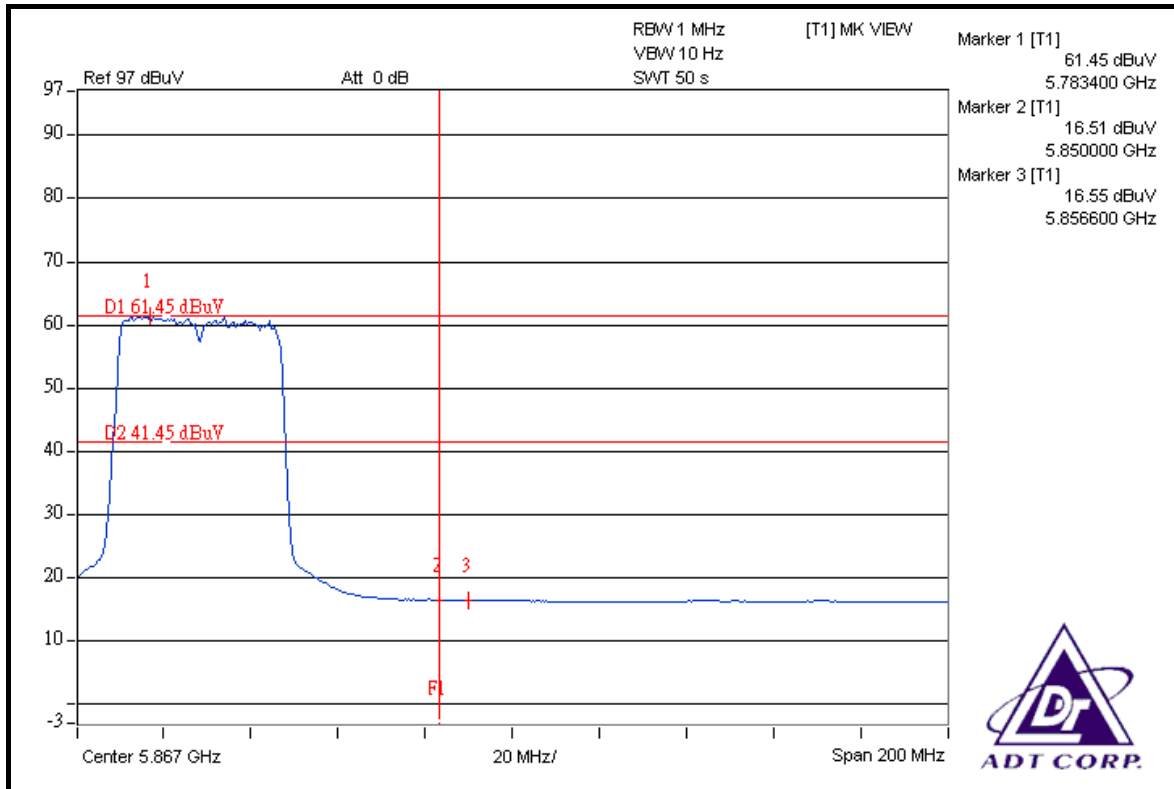



## **5.7 ANTENNA REQUIREMENT**

### **5.7.1 STANDARD APPLICABLE**

For intentional device, according to FCC 47 CFR Section 15.203, an intentional radiator shall be designed to ensure that no antenna other than that furnished by the responsible party shall be used with the device.

And according to FCC 47 CFR Section 15.247(a), if transmitting antennas of directional gain greater than 6dBi are used, the power shall be reduced by the amount in dB that the directional gain of the antenna exceeds 6dBi.

### **5.7.2 ANTENNA CONNECTED CONSTRUCTION**

The antenna used in this product is Dipole antenna with UFL connector. The maximum Gain of the antenna is 4dBi.





## 6. PHOTOGRAPHS OF THE TEST CONFIGURATION

Please refer to the attached file (Test Setup Photo).



## 7. INFORMATION ON THE TESTING LABORATORIES

We, ADT Corp., were founded in 1988 to provide our best service in EMC, Radio, Telecom and Safety consultation. Our laboratories are accredited and approved by the following approval agencies according to ISO/IEC 17025.

<b>USA</b>	FCC, UL
<b>Germany</b>	TUV Rheinland
<b>Japan</b>	VCCI
<b>Norway</b>	NEMKO
<b>Canada</b>	INDUSTRY CANADA , CSA
<b>R.O.C.</b>	TAF, BSMI, NCC
<b>Netherlands</b>	Telefication
<b>Singapore</b>	GOST-ASIA(MOU)
<b>Russia</b>	CERTIS(MOU)

Copies of accreditation certificates of our laboratories obtained from approval agencies can be downloaded from our web site:

[www.adt.com.tw/index.5/phtml](http://www.adt.com.tw/index.5/phtml). If you have any comments, please feel free to contact us at the following:

**Linko EMC/RF Lab:**

Tel: 886-2-26052180

Fax: 886-2-26051924

**Hsin Chu EMC/RF Lab:**

Tel: 886-3-5935343

Fax: 886-3-5935342

**Hwa Ya EMC/RF/Safety Telecom Lab:**

Tel: 886-3-3183232

Fax: 886-3-3185050

**Web Site:** [www.adt.com.tw](http://www.adt.com.tw)

The address and road map of all our labs can be found in our web site also.

## **8. APPENDIX A - MODIFICATIONS RECORDERS FOR ENGINEERING CHANGES TO THE EUT BY THE LAB**

No any modifications are made to the EUT by the lab during the test.

---END---