

User Manual (*English*)

FreeStyl 2 Digital Long Range Cordless Phone



Table of Contents

| | |
|--|----|
| Safety Instructions | 4 |
| General Safety Instructions..... | 4 |
| Product Safety Instructions..... | 4 |
| Battery Safety Instructions | 6 |
| Regulatory Information..... | 7 |
| Equipment Checklist | 10 |
| Handset Illustration..... | 11 |
| Handset Features | 13 |
| Basic Handset Features | 13 |
| Additional Handset Features | 15 |
| Base Illustration | 21 |
| Base Features | 21 |
| Base Features | 22 |
| Basic Base Station Features | 22 |
| Charger Illustration | 23 |
| Charger Features..... | 24 |
| Getting Started..... | 25 |
| Base Station Installation | 25 |
| Handset and Charger Installation | 26 |
| Basic Operations | 27 |
| Operation Modes | 27 |
| A. Base Operation Modes | 27 |
| B. Handset Operation Modes | 27 |
| Making a Telephone Call..... | 29 |
| Making an 2-Way/ Intercom Call | 29 |
| Making a Broadcast..... | 30 |
| A. Handset to Handset Calls..... | 30 |
| Redial..... | 31 |
| Receiving a Telephone Call | 31 |
| Receiving an Intercom Call..... | 32 |
| Ending a Call..... | 33 |
| Adjusting Handset Receiver (Earpiece) Voice Volume | 33 |

| | |
|---|----|
| Adjusting Handset Speakerphone Voice Volume | 33 |
| Placing a Call On Hold | 33 |
| Mute..... | 34 |
| Do Not Disturb (Silent Ring)..... | 34 |
| Key Guard..... | 34 |
| Battery Recharge and Replacement | 35 |
| Advanced Operations..... | 36 |
| Handset Registration | 36 |
| Handset Group Subscription..... | 37 |
| Call Transfer | 38 |
| Phonebook Operations | 39 |
| Call Barring..... | 43 |
| Programmable Feature Call | 45 |
| Caller ID..... | 47 |
| Visual Message Waiting Indicator (VMWI) | 48 |
| Adjust Handset Microphone Gain (sensitivity)..... | 49 |
| Adjust Headset Ring..... | 49 |
| Baby Monitor | 49 |
| Index..... | 57 |
| Technical Specifications | 61 |
| FCC Part 68 Statement..... | 62 |
| IC CS-03 Statement | 63 |

Safety Instructions

Caution: *Your wireless telephone gives you freedom and flexibility to stay in touch while you move around. However, when using your phone equipment, safety instructions should be followed to avoid the risks of fire, electric shock, injury to person, and damage to property.*

General Safety Instructions

1. When using your wireless phone, ensure your safety and the safety of others:
 - a. Always watch where you are walking and standing.
 - b. Don't let a phone call distract you from working safely.
 - c. If power goes out, it won't work, so back-up power is recommended.
2. In an emergency:
 - a. If an emergency occurs, dial the emergency phone number. Remember: if you are in an area where your phone does not have a clear signal from the base, it is highly probable that the call may not go through. Locate the nearest landline telephone or other communications device to call for help.
 - b. Emergency calls may not automatically provide emergency personnel with your name, phone number or location.
3. Notice to Hearing Aid Users: This phone system is compatible with inductively coupled hearing aids.
4. Notice to Cardiac Pacemaker Users: Preliminary studies done by the US FDA and others have shown that, although interference to the implanted cardiac pacemaker may occur when operating very closely, wireless telephones "do not seem to pose a significant problem for pacemaker wearers." However, until more is known, FDA suggests that people with pacemakers may want to take precautions when using or carrying a wireless telephone to ensure that there is ample distance between the telephone and the pacemaker. Do not carry the handset in a breast pocket. If you have any reason to suspect that interference is taking place, turn off your handset immediately.

Product Safety Instructions

1. Read and understand all instructions.
2. Follow all warnings and instructions including those marked on the product.

3. Changes or modifications to this product not expressly approved by the manufacturer will void the warranty and the FCC authorization to operate the equipment. Use only manufacturer provided accessories.
4. Do not use the telephone near water. Never spill liquid of any kind on this product.
5. Unplug the product from the wall telephone jack and power outlet before cleaning. Do not use liquid or aerosol cleaners. Use damp cloth for cleaning.
6. Do not place this product on an unstable cart, stand, or table. The product may fall and cause personal injury or damage to the product or other property.
7. Power Outage: In the event of a power outage, your handset charger will not recharge the handset battery, and the base station will not allow you to make an outgoing call or take an incoming call. Both the charger and the base station require electricity for operation. You should have a telephone that does not require electricity available for use during power outage, or have a temporary backup power supply.
8. Slots or openings in the product's housing are provided for ventilation. These openings must not be blocked or covered. Placing the product on a bed, carpeting, or other similar surface may block these openings and should be avoided. This product should never be placed near or over a radiator or heat register, or in a built-in installation unless proper ventilation is provided.
9. Never push objects of any kind into this product through housing slots/openings as they may damage the product, touch dangerous voltage points or short out parts that could result in fire, electric shock, or injury.
10. This product should be operated only from the type of power source indicated on the marking label. If you are not sure of the type of power supply to your home, consult your dealer or local power company.
11. Do not overload wall power outlets and extension cords as this may result in fire or electric shock.
12. To avoid electric shock or burn, do not disassemble this product. Send this product to an authorized service center when service or repair work is required. Opening or removing covers may expose you to dangerous voltages, electrical currents or other risks. Incorrect reassembling of the product may cause electric shock when the product is subsequently used.
13. Avoid using the product during a storm. There may be a risk of electric shock from lightning.
14. Do not place the product where persons can step, trip, or fall on it.
15. Do not place conductive objects over or near the antenna.
16. Do not use the product to report a gas leak while in the vicinity of the leak.

17. Do not install the base station or the handset charger near microwave ovens, radios, TV sets, speakers, or other electrical equipment. These appliances may cause interference to the product or experience interference from the product.
18. Unplug the base station or the charger adaptor from the power outlet and refer to an authorized service center under the following conditions:
 - a. If liquid has been spilled into the product.
 - b. When the power supply cord or plug is damaged or frayed.
 - c. If the product has been exposed to rain or water.
 - d. If the product does not operate normally by following the operating instructions.
 - e. If the product has been dropped or housing has been damaged.
 - f. If the product shows a distinct change in performance.

Battery Safety Instructions

1. Use only manufacturer approved Li-ion rechargeable batteries and charger. Do not use other types of rechargeable batteries or non-rechargeable batteries. The batteries could short-circuit, and the battery enclosure may be damaged causing a hazardous condition.
2. Follow the charging instruction in this manual and instruction labels and markings in the handset and charger compartments.
3. The battery should not be charged in the place where the temperature is less than 0°C or greater than 40°C
4. Battery must be recycled or disposed of properly. Do not dispose the battery in a fire. The cells may explode.
5. Do not dispose of the battery in municipal waste. Check with local codes for disposal instructions.
6. Exercise care in handling the batteries in order not to short-circuit the battery with conductive materials such as rings, bracelets, keys, pocketknife, and coins. The battery or conductive material may overheat and cause burn or fire.
7. Do not expose batteries to rain or water.
8. Do not open or mutilate the battery. Released electrolyte is corrosive and may cause injury to eyes or skin. The electrolyte may be toxic if swallowed.
9. During charging, the battery heats up. This is normal and is not dangerous.

Regulatory Information

FreeStyl 2

FCC ID : U2M-FS2

IC : 3616C-FS2

This device complies with Part 15 of the FCC Rules. Operation is subject to the following two conditions:

- 1) this device may not cause harmful interference, and
- 2) this device must accept any interference received, including interference that may cause undesired operation.

Base Station

Federal Communication Commission Interference Statement

This equipment has been tested and found to comply with the limits for a Class B digital device, pursuant to Part 15 of the FCC Rules. These limits are designed to provide reasonable protection against harmful interference in a residential installation. This equipment generates radio frequency energy and, if not installed and used in accordance with the instructions, may cause harmful interference to radio communications. However, there is no guarantee that interference will not occur in a particular installation. If this equipment does cause harmful interference to radio or television reception, which can be determined by turning the equipment off and on, the user is encouraged to try to correct the interference by one of the following measures:

- Reorient or relocate the receiving antenna.
- Increase the separation between the equipment and receiver.
- Connect the equipment into an outlet on a circuit different from that to which the receiver is connected.
- Consult the dealer or an experienced radio/TV technician for help.

FCC Caution: Any changes or modifications not expressly approved by the party responsible for compliance could void the user's authority to operate this equipment.

This device complies with Part 15 of the FCC Rules. Operation is subject to the following two conditions: (1) This device may not cause harmful interference, and (2) this device must accept any interference received, including interference that may cause undesired operation.

IMPORTANT NOTE:

FCC Radiation Exposure Statement:

This equipment complies with FCC radiation exposure limits set forth for an uncontrolled environment. This equipment should be installed and operated with minimum distance 20cm between the radiator & your body.

This transmitter must not be co-located or operating in conjunction with any other antenna or transmitter.

Industry Canada statement:

This device complies with RSS-210 of the Industry Canada Rules. Operation is subject to the following two conditions:

(1) This device may not cause harmful interference, and (2) this device must accept any interference received, including interference that may cause undesired operation.

IMPORTANT NOTE:

Radiation Exposure Statement:

This equipment complies with IC radiation exposure limits set forth for an uncontrolled environment. This equipment should be installed and operated with minimum distance 20cm between the radiator & your body.

This device has been designed to operate with an antenna having a maximum gain of 1.5 dBi. Antenna having a higher gain is strictly prohibited per regulations of Industry Canada. The required antenna impedance is 50 ohms.

Portable Handset

Federal Communication Commission Interference Statement

This equipment has been tested and found to comply with the limits for a Class B digital device, pursuant to Part 15 of the FCC Rules. These limits are designed to provide reasonable protection against harmful interference in a residential installation. This equipment generates, uses, and can radiate radio frequency energy and, if not installed and used in accordance with the instructions, may cause harmful interference to radio communications. However, there is no guarantee that interference will not occur in a particular installation. If this equipment does cause harmful interference to radio or television reception, which can be determined by turning the equipment off and on, the user is encouraged to try to correct the interference by one of the following measures:

- Reorient or relocate the receiving antenna.
- Increase the separation between the equipment and receiver.

- Connect the equipment into an outlet on a circuit different from that to which the receiver is connected.
- Consult the dealer or an experienced radio/TV technician for help.

FCC Caution: Any changes or modifications not expressly approved by the party responsible for compliance could void the user's authority to operate this equipment.

This device complies with Part 15 of the FCC Rules. Operation is subject to the following two conditions: (1) This device may not cause harmful interference, and (2) this device must accept any interference received, including interference that may cause undesired operation.

IMPORTANT NOTE:

Radiation Exposure Statement:

This equipment complies with FCC radiation exposure limits set forth for an uncontrolled environment. End users must follow the specific operating instructions for satisfying RF exposure compliance. To maintain compliance with FCC RF exposure compliance requirements, please follow operation instruction as documented in this manual.

This transmitter must not be co-located or operating in conjunction with any other antenna or transmitter.

Industry Canada statement:

This device complies with RSS-210 of the Industry Canada Rules. Operation is subject to the following two conditions: (1) This device may not cause harmful interference, and (2) this device must accept any interference received, including interference that may cause undesired operation.

IMPORTANT NOTE:

Radiation Exposure Statement:

This equipment complies with IC radiation exposure limits set forth for an uncontrolled environment. End users must follow the specific operating instructions for satisfying RF exposure compliance. To maintain compliance with IC RF exposure compliance requirements, please follow operation instruction as documented in this manual.

This device has been designed to operate with an antenna having a maximum gain of 1.5 dBi. Antenna having a higher gain is strictly prohibited per regulations of Industry Canada. The required antenna impedance is 50 ohms.

Equipment Checklist

1. In a Base + Handset package, please find the following components:
 - a. Base Station x 1 (antenna installed)
 - b. Base AC/DC Adaptor x 1
 - c. Handset x 1 (antenna installed)
 - d. Desktop Charger x 1
 - e. Charger AC/DC Adaptor x 1
 - f. 1100mA Li-ion Battery Pack x 1
 - g. Telephone Cord x 1
 - h. CD (User's Manual), Quick Guide
 - i. Belt clip x 1

2. In a Handset package, please find the following components:
 - a. Handset x 1 (antenna installed)
 - b. 1100mA Li-ion Battery Pack x 1
 - c. Desktop Charger x 1
 - d. Charger AC/DC Adaptor x 1
 - e. Quick Guide
 - f. Belt clip x 1





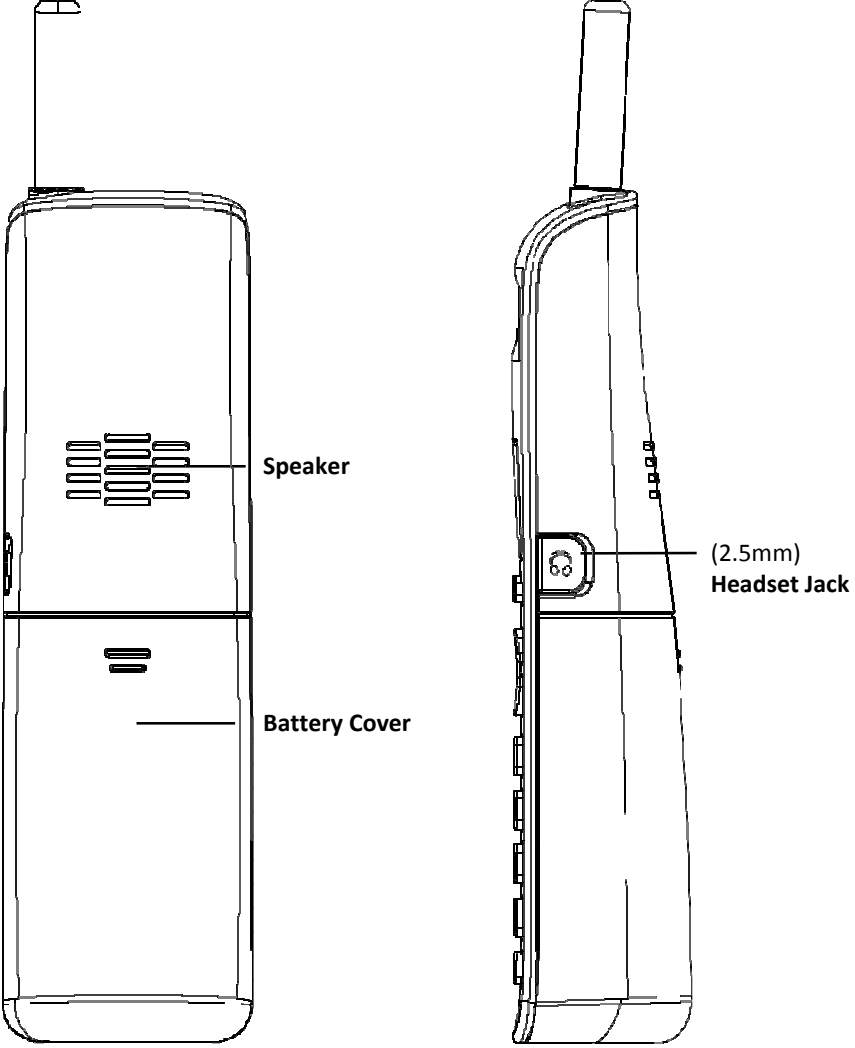
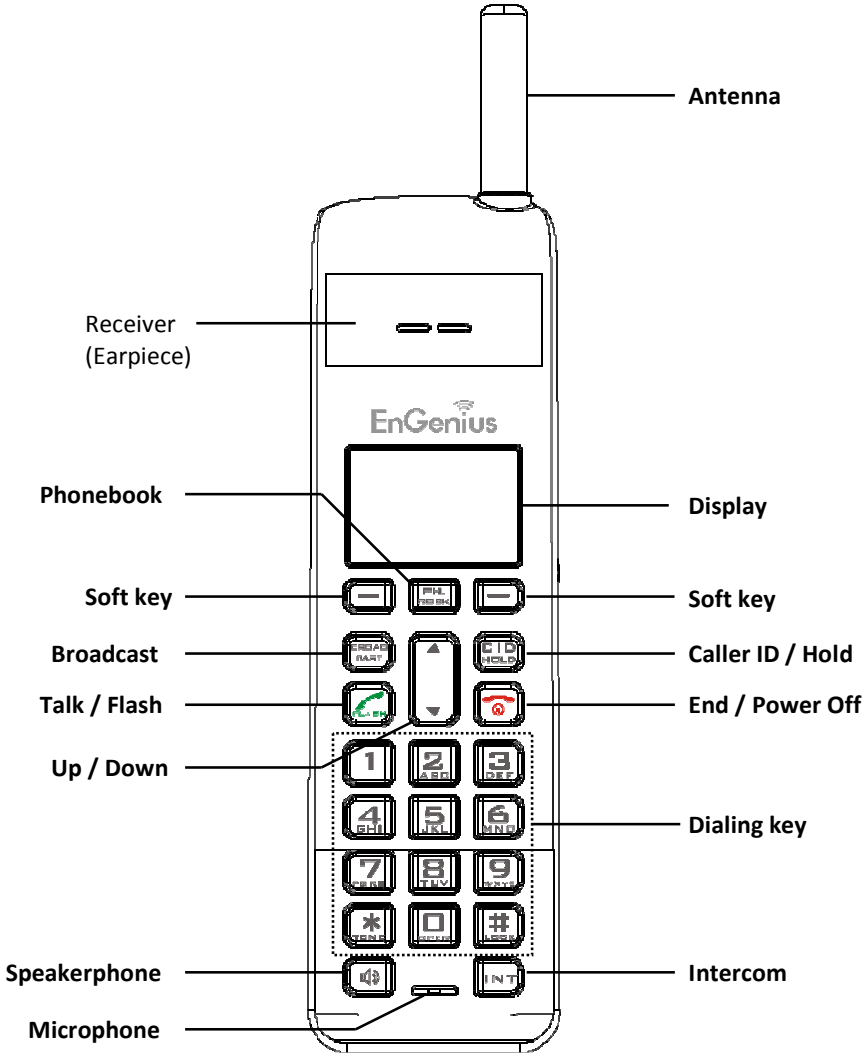







3. Optional Accessories
 - a. Outdoor External Antenna Kit for Base Station (including antenna and cable)
 - b. Indoor External Antenna Kit for Base Station (including antenna and cable)
 - c. Lightning Protection Kit
 - d. High-gain handset antenna (Long antenna)
 - e. Headset
 - f. Antenna Splitter

Handset Illustration











Handset Features





Basic Handset Features

1. 4-line LCD (Liquid Crystal Display)
 - a. The LCD display has LED (Light Emitting Diode) for backlighting.
 - b. The 1st line of LCD consists of icons.
 - c. Icons explanation from left to right
 - (1) **RSSI level** (Receive Signal Strength Indicator)
 During a call, the number of bars is proportional to the radio signal strength received.
 - (2) **Link mode**
 **(2.1) Call in-progress** (ON/OFF-Hook)
 The phone symbol indicates the phone line is active when making incoming or outgoing call.
 **(2.2) Intercom in-progress**
 Indicates if Intercom mode is active
 Indicate the Handset ID which is making intercom with.
 - (3) **Speech mode**
 **(3.1) Speaker Indicator**
 Indicate if the speaker is active
 **(3.2) Headset mode**
 - (4) **Sound and Indication**
 **(4.1) Enable ringer**
 **(4.2) Disable ringer**
 **(4.3) Ringer and vibrate mode**
 **(4.4) Vibrate mode**
 **(4.5) Message waiting indicator**
 - (5) **Disable PA**
 Indicate if the incoming broadcast is disabled.
 - (6) **Two-Digit Handset ID**
11 Displays the 2-digit Handset ID of own.
 - (7) **Battery Strength**
 Number of bars is proportional to the amount of battery time remaining.
 - d. The 2nd and 3rd lines of the LCD, maximum 16 characters each, display status, message, menu selections, or user-editable alphanumerical characters.
 - e. The last line displays the left and right soft keys.



2. Ringer
 - a. Rings to an incoming call and intercom call.
 - b. Distinctive alert sounds indicating various events:
 - (1) Single beep: successful key entry.
 - (2) Double beep: indicates power on/off.
 - (3) Triple beep: failed operation.
 - (4) Periodic 1-Long-2-Short beep (every 1 minute): low battery warning \ out of range or call on hold
 Re: No any beep for invalid key entry.
3. TALK/FLASH 
 - a. Places or answers a telephone or intercom call
 - b. Sends a Flash signal to phone line to retrieve a dial tone after the call ends, or to perform the call waiting feature provided by local phone companies during a call. See page 18 for more information.
 Re: Default flash time is 600ms.
4. SPEAKERPHONE 

Press the key to enable/disable the speakerphone during incoming, outgoing or intercom call.
5. 2-WAY INTERCOM 
 - a. Places an intercom call to another handset, a group handset (group paging) or all registered handsets.
 - b. Intercom calls are digital, full duplex, and are conducted without the assistance from the base station.
6. BROADCAST 
 - a. Half duplex broadcasting to handsets for immediate announcement
 - b. Half duplex broadcasting to base stations
 Re : Press the  key on the left top corner of handset to activate the broadcast function.
7. Left/Right Soft Keys  
 - a. Make menu selection.
8. Up  /Down  Scrolling Keys
 - a. Scroll through records and menu selections.

- b. Adjust receiver voice volume when in the Talk mode.
 - c. Press  to adjust ringer volume when in the Standby mode.
 - d. Press  to enter phonebook when in the Standby mode.
9. END; On/Off Key ()
- a. Ends a call.
 - b. Leaves current menu operation, up one level.
 - c. Press for 3 seconds to turn off the handset.
10. CALLER ID Key ()
- a. Review caller ID list.
 - b. Including received and missed caller ID.

Additional Handset Features

1. Multiple handsets registration
 - a. Up to 9 handsets can be registered to a base station
 - b. ID 11-19: individual Handset IDs.
 - c. ID 91-99: Group IDs. Handsets can “subscribe” from the handset menu to group(s) and be paged when an intercom caller enters a Group ID.
2. Ringer Vibrator
 - a. Two options for Line (incoming call) ringing & Intercom ringing.
 - b. Six-level ringer volume selections (Off/Low/Medium/High/Vibrate/ Vibrate & High) for each option.
 - c. Eight ringer type selections for each option.
3. Caller ID

Displays incoming call phone number and name on the LCD (needs Caller ID service from local telephone company or PBX/Key phone system analog port).
4. Call waiting with caller ID

Displays 2nd incoming call information on the same phone line when 1st call is in progress (needs Call Waiting with Caller ID service from local telephone company or PBX/Key phone system analog port).
5. Name tagging with caller ID

Match the caller ID with the phone book entries; once matched, the LCD screen will display the name or nickname instead of pure caller ID info (needs Call Waiting with Caller ID service from local telephone company or PBX/Key phone system analog port).

6. DND (Do Not Disturb, i.e., Silent Ring)
7. Call Logs
 - a. Redial: Stores 10 phone numbers (up to 26 digits each) dialed most recently. Can perform last-number redial on all 10 numbers.
 - b. Received & New Call Log: Total 50 entries (16-digit phone number, 16-character names, and Date/Time stamp), needs Caller ID service from local telephone company.
 - c. Phone numbers and names can be saved into phonebook while in display.
8. Call Barring: Block outgoing calls and incoming calls.
 - a. Outgoing call:
 - a-1. Block the users from dialing long distance calls or international calls
 - a-2. Up to 5 digits of each call barring setting; up to 5 entries allowed.
 - b. Incoming call:
 - b-1. PA On/Off: Enable or disable the broadcast from other handsets or base station. When PA is Off, the handset can't receive broadcast from base station or other registered handsets, but it can broadcast to base station or other registered handsets.
 - b-2. Line On/Off: Enable or disable the capability to receive incoming call from telephone line. When Line is Off, the handset can't receive incoming call from telephone line, but it can still make outgoing call.
 - b-3. Int. On/Off: Enable or disable the intercom from other handsets or base station. When Int. is Off, the handset can't receive intercom from base station or other registered handsets, but it can intercom to base station or other registered handsets.
 - c. This changing requires to entering the “Call Settings” (**MENU**-4-3).
[Note] You need to key in the accurate user ID and password to perform this feature. The default password is 0000.
9. Any Key Answer (except  and **SILENT** Soft Key)
10. Key-guard
 - a. When the keyguard is selected, all keys will be locked. Press **UNLOCK** (Left) soft key followed by * to release it.
 - b. The keyguard will be automatically enabled once returning back to idle mode for 15 seconds.

11. Dialing Prefix
 - a. Up to 14 digits, including pause(s), one access code can be pre-programmed to be added automatically in front of the dialed number when dialing from call logs, phonebook, and dial-and-send dialing. See page 51 for more details.
12. Call Hold
 - a. Places call on hold.
13. Mute
 - a. Press **MUTE** (Left) soft key during talk, the handset microphone will be muted.
Press **UNMUTE** (Left) soft key to release it.
14. Phonebook
 - a. 50 entries, each stores a phone number or handset ID (up to 26 digits) and name (up to 16 characters)
 - b. Alphabetically sorted display and search by letter.
 - c. Dial from display.
 - d. During the stand-by mode, you can enter the phone book by pressing  scrolling key.
 - e. Phone book transfer via air
 - i. Transfer specific phonebook to one handset or all registered handsets.
 - ii. Transfer all phonebooks to one handset or all registered handsets.
15. Key tone
 - a. Four-level key tone volume selections (Off/Low/Medium/High).
 - b. Four key tone type selections.
16. Call Timers
 - a. Display call time duration for current call during and immediately after the call.
17. Programmable Feature Call
 - a. Allows user to pre-program the most frequently used Feature code into FREESTYL 2.
 - b. Up to 10 entries can be saved.
 - c. Once the feature code is programmed, you can quickly perform those functions during the active call by pressing **OPTION** soft key.
18. Menu Display
 - a. To avoid making errors, in the "Call Settings" (**MENU-4**), "Phone Settings" (**MENU-5**) and "Base Settings" (**MENU-6**), these settings can be hidden.
 - b. Handset password is required before enter Menu Display (**MENU-8**), the default handset password is 0000.
 - c. When disabling the settings, these setting will no longer be displayed, unless enabled by entering the Menu Display again.
19. PA On/Off
 - a. Enable or disable the broadcast function.
 - b. When PA is Off, the handset can't receive broadcast from base station or other registered handsets; But it can broadcast to base station or other registered handsets.
20. Group Setting
 - a. Allow handset to subscribe to one or several groups.
Re: Up to 9 groups (91~99) can be subscribed.
21. Custom Name
 - a. Allow changing the "FREESTYL 2" screen to the desired wording or info, such as the user's name.
Re: Up to 32 characters can be entered.
22. Change Pwd
 - a. Allow changing the handset password which requires entering in Call Barring (**MENU-4-3**) and Menu Display (**MENU-8**).
Re: Default is 0000.
23. Adjusting DTMF Duration
 - a. From **MENU-6-1** to select variable duration of DTMF tone.
 - b. Default is 100ms.
 - c. When entering the Base Settings, PIN is required. Default is 0000.

Re: First verify the line or PBX port is not the issue by testing with another known good analog telephone. Change this setting only when you have verified that indeed DTMF digits are not being recognized by the PBX/Key system. Also, check into adjusting parameters in the PBX as this may prove more successful in getting DTMF digits to be recognized.
24. Changing the flash time
 - a. From **MENU-6-2** to select flash key timing
 - b. 9-level (100 ms - 900 ms) timing selections, default= 600 ms.
 - c. The default value (600 ms) works in most areas. Change only when you are certain of the new value would work.

- d. When entering the Base Settings, PIN is required. Default is 0000.
Re: Do not change this setting unless you have issues with either answering inbound calls, or transferring calls. Many newer IP-PBX's/VOIP Server type phone systems want a shorter flash time of 200ms or 300ms.
25. Assign next handset ID for new handset
- Using registered handset from **MENU-6** -<enter the password> -3, to assign a next handset ID to a new handset.
 - If do not assign the next handset ID, the system will automatically assign a handset ID to a new handset.
 - When entering the Base Settings, PIN is required. Default is 0000.
Re: Handset ID range is 11-19, if all ID's are taken you will need to reset the base to start the ID numbering over again. See page 22 for resetting the base.
26. Clear Handset
- Using a registered handset, press **MENU-6**-<then enter the password> -4 to remove the other registered handset. (Use this if you are unable to deregister a handset from the system (a damaged handset for example)
 - Once removing the other registered handset, you will be able to register a new handset with that ID.
 - When entering the Base Settings, PIN is required. Default is 0000.
27. Change the PIN
- To change the base PIN, you will need to go to "Base Settings" (**MENU-6-5**).
- Use a registered handset to change PIN from **MENU-6-5**.
 - When entering the Base Settings, PIN is required. Default is 0000.
28. Auto Hang Up feature
- Use a registered handset, press **MENU-6**-<then enter the password> -6 to turn on/off the auto hang up feature. Default password is 0000.
The default of auto hang up is OFF.
 - When enabling the auto-hang up feature, the handset will automatically hang up the call when the far-end hangs up the call.
Note: Use this feature with caution. The phone will end the call if a line-reversal signal (momentary open signal) is detected. Sometimes this signal is detected erroneously. If this happens often, you may need to keep this feature turned off.
29. Set Time
- The set time function allows user to set date/time to support the DTMF caller ID (DTMF caller ID doesn't attach date/time when receiving from PSTN, using this setting, user is able to review the date/time when the caller ID received).
- Enter **MENU-6** to set Base Settings.
 - Enter "7" to enter Set Time.
 - Enter 4 digits for MM/DD(Month/Day), then enter 4 digits for hr:mm (Hour : Minute)
 - Press **SAVE** (left soft key) to finish the setting.
30. Mic Gain
- Allow(s) changing the handset microphone gain based on the handset in different environment(s) - Quiet, Normal and Noisy environment.
This requires entering the "Phone Settings" (**MENU-5-1**).
31. Headset Ring
- Allow changing the ringer emitted either from handset speaker or receiver of headset.
This requires entering the "Phone Settings" (**MENU-5-9**).
32. Baby Monitor
- This setting will change the handset to act as a baby monitor via an intercom call.
When setting Baby Monitor ON, this dedicated handset will not answer any incoming calls except the 2-way intercom.
This requires entering the "Call Settings" (**MENU-4-5**).

Base Illustration

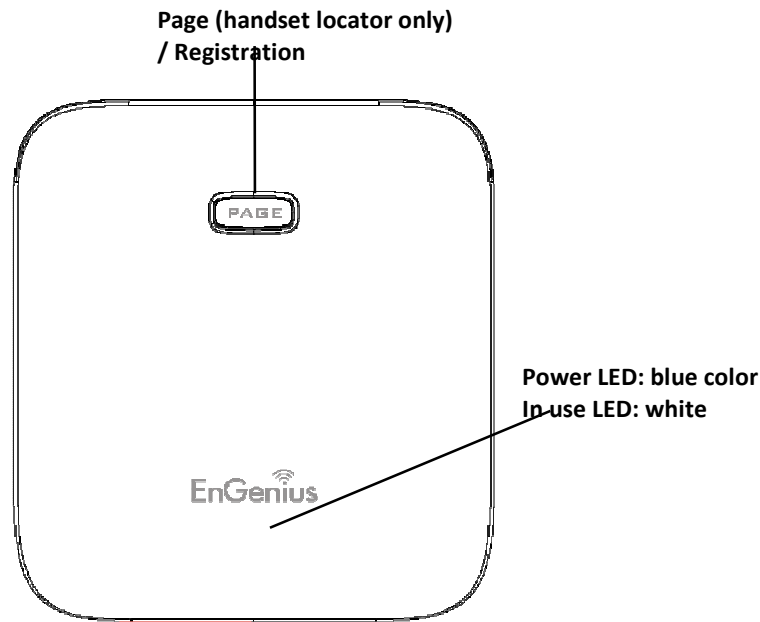

Base unit Diagram

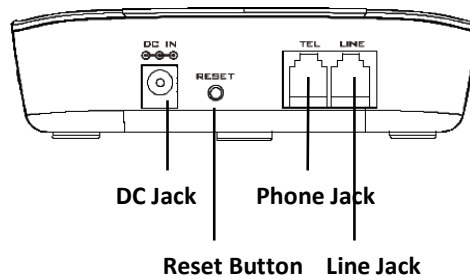

Base Features

Basic Base Station Features

1. Antenna
 - a. The antenna port has a **reversed thread connector**; to remove antenna or cable, turn counterclockwise; to install, turn clockwise. Improper installation may damage the connector.
 - b. When using an outdoor antenna, locate the antenna (not the base station itself) as high as possible for a clear transmission path.
2. LED
 - a. Power (blue color): indicates base station has power.
 - b. In-Use (white color): indicates an active telephone line.
3. RESET Button
 - a. Restores base station to factory settings
 - b. Reset button is intended to prevent accidental system reset.
 - c. All handsets (including administrator) need to be re-registered after a base station reset.
4. Page Button (Locate handset)

To find a misplaced handset; press "PAGE" and all registered handsets will beep for 30 seconds.

Press "PAGE" again or any key on handset to stop.

Re: "PAGE" is for locating handset only, not able to make intercom with handset.
5. Registration Button (PAGE)

Enters registration mode along with handset, assigns handset ID (11-19).
6. Line Jack
Standard RJ-11C/CA-11A connector to plug in the telephone line
7. Telephone Jack
Another RJ-11C to plug in the optional answering machine
8. DC In: to plug in the power adaptor

Charger Illustration

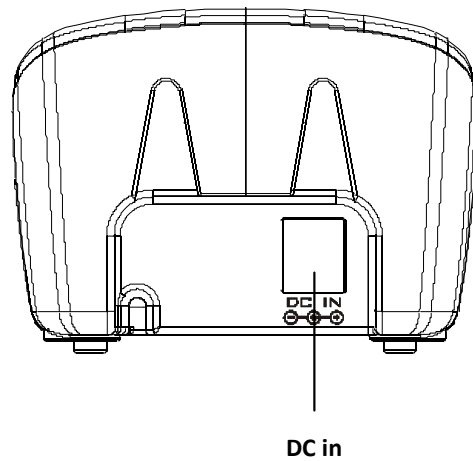
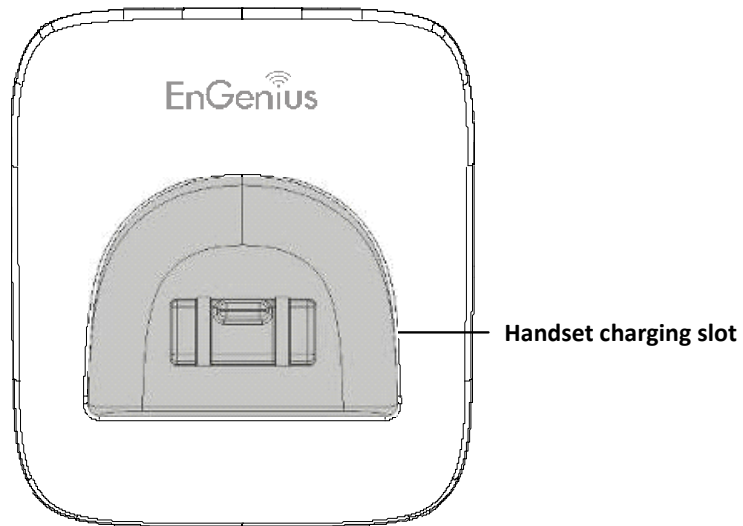

Charger Features

1. DC In
Connects to Charger AC Adaptor.
2. Handset Charging Slot
 - a. Charge handset battery when handset is placed in cradle.
 - b. Refer to the handset LCD for charging status
 - (1) Charging: battery status bar is running and the LCD screen will show : "Charging".
 - (2) Fully Charged: battery status bar stands still and the LCD screen will display "Charge Complete"
 - (3) Charge Fail: If there are any errors during charging mode, the LCD screen will display "Charge Fail"
3. It is impossible to overcharge the battery using this charger.
4. The adaptor for the charging station can be used as travel charger as well. However, you can't turn off the power while you charge the handset via travel charger. A warning message "Unplug Travel Charger then OFF" will be shown on the LCD.

Notes:

1. Fully charge battery packs before first use.
2. Handset will "power on" automatically when placed in the charging slot.
3. However if you fully drain the battery, it will take around one minute for the handset to auto power on.

Getting Started

Base Station Installation

There are three possible base station setups:

- Base station alone
- Base station plus telephone answering device
- Base station plus standard telephone

For best performance, maintain at least a distance of 1 meter (about 3 feet) between the base station and other electronic devices (e.g., TV, computer, stereo, fax machine, answer machine, cordless phone, etc.)

1. Install base station antenna.

The base station's antenna port has a **Reversed-thread connector**; to install antenna or cable, turn clockwise; to remove, turn counter-clockwise. Improper installation may damage the connector.

2. Plug the transformer end of the base station AC/DC adaptor into a standard AC electrical power outlet, plug the other end into the "DC In" jack on the back of the base station.

- a. The base adaptor's DC plug is same dimension as the charger's DC plug. The charger adaptor's DC plug can fit into the base's DC In jack.

3. Plug phone cord into the "LINE" Jack

4. A standard telephone or answering machine can be plugged into the adjacent jack on the back of the base station marked TEL

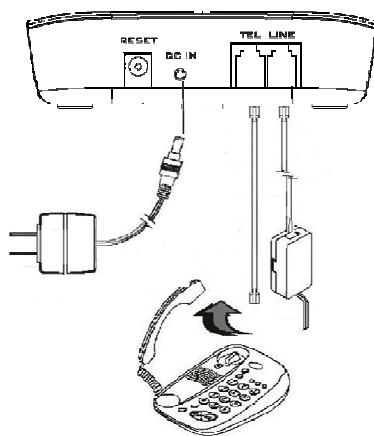

Handset and Charger Installation

1. Plug the transformer end of the Charger AC/DC adaptor into a standard AC electric power outlet, plug the other end into the "DC In" jack on the back of the Charger.
2. Install battery pack onto the handset.
3. Install handset antenna.
4. Place handset onto the charger slot.
5. Fully charge the battery for three hours before use.
6. The phone system is now ready to perform basic functions such as making and receiving phone calls and intercom calls. No base station or handset programming is needed for basic operations.

Note:

1. Handset(s) packaged along with a Base Station are pre-registered at the factory. If you have a new handset, you will need to register the handset with the base station in order to be recognized as a member handset by the base(s) and by other handsets. See Handset Registration.
2. Fully charge battery packs before the first usage.

Basic Operations

Operation Modes

Both the base station and handset have levels of operation at which time only certain procedures of functions can be performed.

A. Base Operation Modes

1. **STANDBY mode**- this is the default mode. The page key is active in standby mode only. The base “Power” (blue color) LED will light up during this mode.
2. **TALK mode**- the base station operates in this mode during phone call. The “In Use” (white color) LED will light up during this mode.
3. **REGISTRATION mode**- the base station enters this mode by pressing the PAGE button for three seconds. The “Power” (blue color) LED will be blinking in “Registration” mode, also a prompt sound will be emitted.

B. Handset Operation Modes

1. **STANDBY mode**- this is the default mode.
 - a. If there is no on-going activity, the handset automatically goes into SLEEP/STANDBY mode to save battery power.
 - b. The handset can be turned off completely by holding Down the  key for 3 seconds.
 - c. The standby screen display (custom name) can be edited.
 - d. The 2-dight number represents the handset ID
2. **MENU mode**
 - a. Press the Right soft function key to activate Menu mode.
 - b. In Menu mode, the handset settings and information contained in memory can be changed.
 - c. The functions available through the Menu selection are covered in greater detail from page 53.
 - d. The Menu structure display as below:

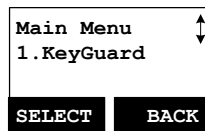

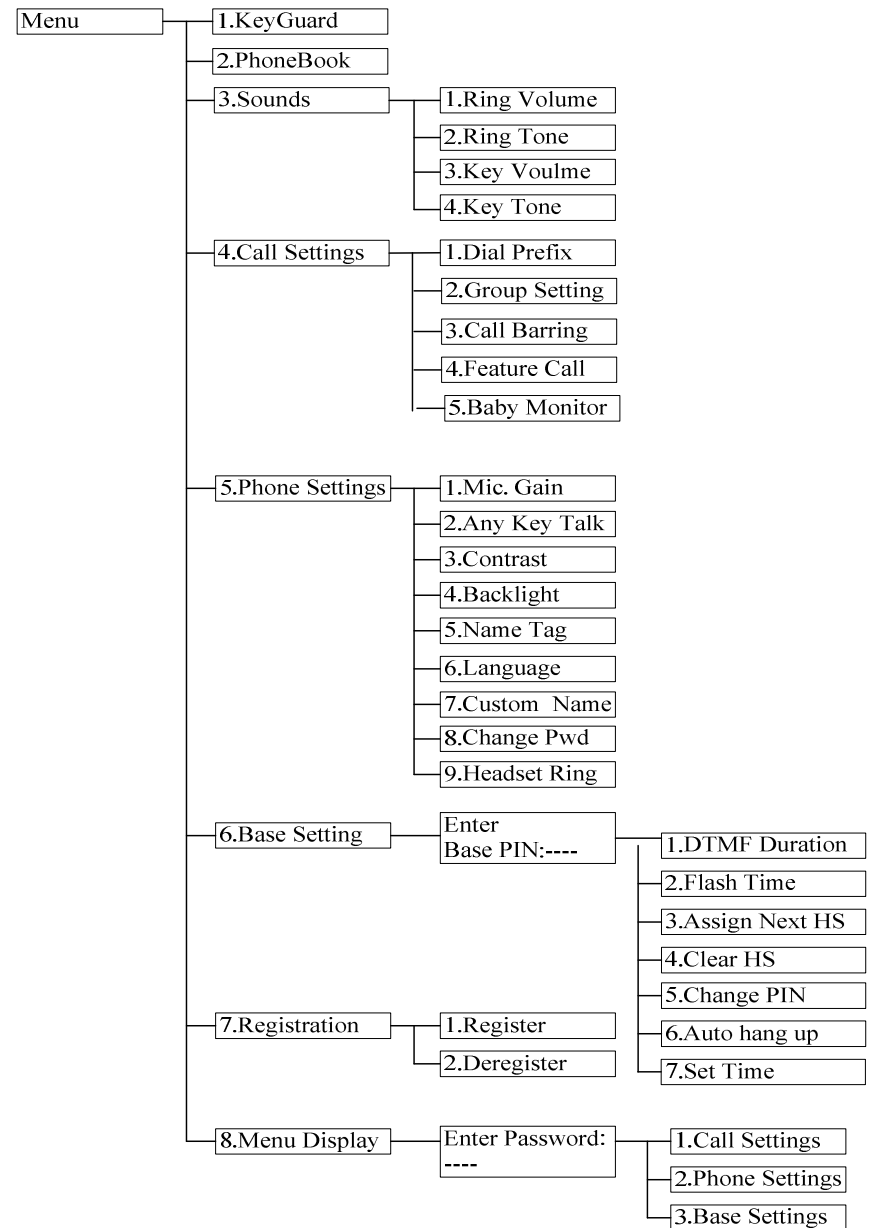

3. Menu Tree

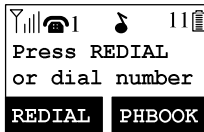

Making a Telephone Call

1. Press , wait for dial tone, and then enter phone number.



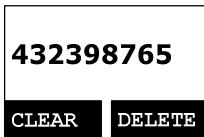

2. Alternatively, you can enter phone number first then press  key.

When using this method, you can use the **CLEAR** (Left) and **DELETE** (Right) soft keys to edit the number entered. "Delete" erases the last digit entered. "Clear" erases the entire line but remains in the dial-and send dialing.



3. **Speed dial** by accessing the entries in the phone book (Menu→2)

- Press  or  scrolling key to enter the phone book
- Press  to dial out the number

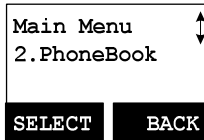

4. To abort dialing, press  key.

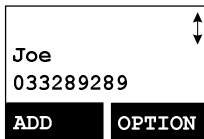

Notes:

- If a link cannot be established, the LCD will show "Base not found" after a 6-second time out.
- A call duration timer will start displaying the length of the call after link is established.

Making an 2-Way/ Intercom Call

The FREESTYL 2 Cordless Phone System offers private, Intercom/ 2-way radio calls independent of base station. Intercom/ 2-way communication can be placed between handsets.

1. Press  key followed by a two-digit handset ID or Group ID.

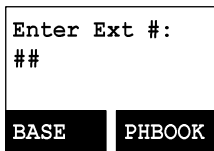

2. Press  key to end the call.



Notes:

- Intercom calls can be made regardless if the Base Station is present.
- If a Group ID is entered, the first handset (belonging to that group) that answers will establish a link with the caller. See Handset Group Subscription.
- If a link cannot be established, the LCD shows "Paging timeout" after a 35-second time out.

Making a Broadcast



A. Handset to Handset Calls

1. Broadcasting all handsets

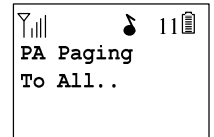
- Press and hold  key (left top corner of keys) from one handset.
- Hear a long "Du..." sound while the initiating handset broadcasts to all handsets within communication coverage.
- Speak the message to be broadcasted once you hear the "Du Du" sound; the speakerphone of destination handsets will open if it receives a voice.
Re: Pressing and holding the  key is needed during the speaking of the broadcast.
- Release  key to end the broadcasting.



2. Broadcasting to only a group of handsets

- Enter the Group ID and then press and hold  key (left top corner of keys). See page 37 for instructions on creating groups
- Hear a long "Du..." sound while the initiating handset broadcasting to all handsets.
- Start to speak the message to be broadcasted once you hear the "Du Du" sound; the speakerphone of destination handsets will open if it receives a voice.
Re: the initiating handset press and hold the  key is needed during the

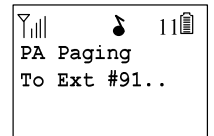

speaking of the broadcast.

d. Release  key to end the broadcasting.

3. Broadcasting to an individual handset

a. Enter the Handset ID and then press and hold  key (left top corner of keys).

b. Hear a long “Du...” sound while the initiating handset broadcast all handsets within communication coverage.

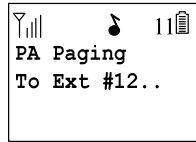

c. Start to speak the message to be broadcasted once you hear the “Du Du” sound; the speakerphone of destination handsets will be opened if it received a voice.

Re: the initiating handset press and hold the  key is needed during the speaking of the broadcast.



d. Release  key to end the broadcasting.

Redial

1. Press **REDIAL** (Left) soft key.

2. The LCD shows the last phone number dialed. To dial this number, press  key.



3. Use  or  key to scroll through the last 10 phone numbers dialed. Select and press  key to dial the selected number.
[Note] Intercom numbers (Handset ID) are not stored in the last 10 numbers dialed log.



Receiving a Telephone Call

When an incoming call arrives, the LCD will show the caller ID message, and the ringer will ring or vibrate unless the ringer has been turned off.

If the handset is on the charger cradle (ringer will be temporarily switched to “Ring” if it has been set to “Vibrate”), lift the handset and press  key to start conversation.



Re: You can turn on the “Any Key Talk” from **MENU-5-2** which will allow you to press any key instead of just the talk key, to answer an incoming call.

Notes:

1. You can press **SILENT** (Left) soft key if you choose to ignore the call. Unlike turning off the ringer (from the handset menu), the **SILENT** key operation is valid only when the phone is actually ringing.
2. If Caller ID service is available, the LCD will display the incoming call information. If the LCD shows “Private” or “Unknown”, the caller’s information may have been blocked by the caller or the originating phone company.

Receiving an Intercom Call

1. When an intercom call arrives (called from other handsets, ex. Handset 12), the ringer will ring or vibrate unless the ringer has been turned off. Press  to answer the intercom call.

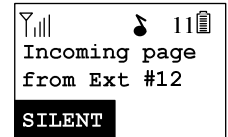

2. If the handset is on the charger cradle (ringer will be temporarily switched to “Ring” if it has been set to “Vibrate”), lift the handset and press  key to start conversation.

3. If the handset is not on the cradle and **MENU-6-2** “Any Key Talk” setting is “On”, press any key (except  and the **SILENT** soft key) to answer.



Notes:

1. The LCD displays the caller’s Handset ID.
2. You can press the **SILENT** (Left) soft key if you choose to ignore the call. Unlike turning off the ringer the **SILENT** key operation is valid only for the current incoming call.

Ending a Call



To end a telephone or intercom call, press  key, or place handset into charger cradle.

Adjusting Handset Receiver (Earpiece) Voice Volume

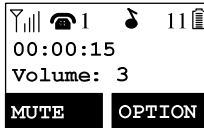
- Voice volume can only be adjusted during a call.
- There are 6 levels of volume selections. Use  or  key to adjust
- The new setting remains effective for all future calls until changed.



Adjusting Handset Speakerphone Voice Volume

- Voice volume can only be adjusted during a call (in speakerphone mode).
- There are 6 levels of volume selections. Use  or  key to adjust
- The new setting remains effective for all future calls until changed.

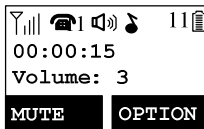

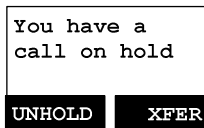

Placing a Call On Hold

- When a call is in progress, it can be put on hold by pressing the  key.
- To return to the conversation, press **UNHOLD** (Left) soft key



Notes:

- The call being placed on hold can be "un-hold" by the handset that puts it on hold. But if after you press the  key to go

back to standby, then other handsets can press  or  to pick this held call.

- Handset LCD displays a call is on hold. An alert tone (double beep) will occur every 30 seconds to remind the handset user that a call is still on hold.
- If the operation (e.g., call transfer) after putting a call on-hold fails, the held call may be dropped.

Mute

- After a link is established, you can press **MUTE** (Left) soft key to mute the handset microphone.
- When mute is active, the other end will not hear your voice, but still can speak to you.
- To leave the mute state, press **UNMUTE** (Left) soft key. Mute is effective only for the current call.

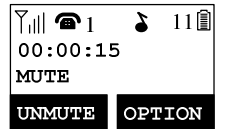

Do Not Disturb (Silent Ring)

- Enter the key sequence **MENU-3-1**, then select "Off". Press **SELECT** (Left) soft key to confirm your choice. This will turn off the ringer until it is turn on again from the menu.
Re: When setting the ringer "Off", the standby screen will show "Ringer off".
- For temporary silencing the ringer when an incoming call arrives, press **SILENT** (Left) soft key.



Key Guard

- To prevent accidental dialing, you can press **MENU** (Right) soft key, then press "1" to select the KeyGuard option. The handset keypad is locked. No key entry will be accepted.

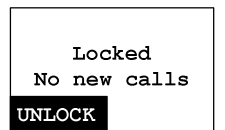



- To unlock the keypad, press the **UNLOCK** (Left) soft key, then, within 2 seconds, press the digit “*” to unlock.

Press * to
confirm unlock

- Once returning back to standby mode for 15 seconds, the Keyguard will automatically re-enable.
- Key Guard is in effect until unlocked.

Battery Recharge and Replacement

- Charge the battery when one or several of the following things happen:
 - Phone beeps twice (every 60 seconds in talk mode, every 10 minutes in standby mode).
 - Battery icon is empty.
 - Phone does not respond when a power on/off key  is pressed.
 - LCD and backlighting become dim.
 - Talk range shortfall is experienced.
- You can replace the handset battery even while on an active phone call by putting the call on-hold first and then by pressing the  key. To retrieve the call on hold, press the talk key again after replacing the battery and powering the handset on.
- Battery talk time and standby time vary depending on the talk/standby pattern and the operating distance. Putting the handset back in the charger cradle as often as possible is recommended for best performance. **Use only manufacturer provided battery and charger!**

Advanced Operations

Handset Registration

- If your handset(s) is purchased as part of a system, it has been pre-registered with the base station at the factory.
- If Handset ID shows “00,” that means it is a new handset or the ID has been erased. You need to register the handset with the base station.

3. Registering Handsets:

- Press **MENU-7** to enter the registration section.
- Press and hold the base’s PAGE button for 3 seconds until the In Use LED (white color) lights up and flashes; The base station will produce a sound to remind you the base station is in the registration mode.
- Press handset key “1”. This completes the registration process. The base station will assign a handset ID between 11 and 19 automatically. The assigned ID will be displayed on the handset LCD, indicating successful registration. If you get a “base has no available ID” prompt, you will need to reset the base (see page 22).
- Repeat above steps for all additional handsets.

Main Menu
7.Registration
SELECT BACK

Registration
1.Register
SELECT BACK

4. De-registration:

- You can de-register the handset you’re using from the base station. De-registration will reset the Handset ID to 00, erase the system security code, and free up the handset ID for future registration.(registrations of other handsets)
- After deregistration, the handset will not be able to use the base station to make or receive phone calls, nor can it intercom other handsets.
- Press **MENU-7** to enter the registration section.
- Press and hold the base’s PAGE button for 3 seconds until the In Use LED (white color) lights up and flashes; The base station will produce a sound to remind you the base station is in the registration mode.
- Press the handset number key “2”. This completes the de-registration process. Upon successful de-

Main Menu
7.Registration
SELECT BACK

Registration
2.Deregister
SELECT BACK

registration, the handset display will show “Please register”.

Notes:

1. The base station has a 30 second registration timeout starting from pressing the PAGE button. The handset has a 6 second registration timeout starting from the registration or de-registration option has been selected. The base station and handset will automatically exit registration mode after timeout.
2. Repeat registration or de-registration process if unsuccessful.

Notes:

1. The handset can change group affiliations at any time.
2. The base station is not responsible for group assignments. Consequently, it cannot de-subscribe a handset from a group.
3. When an intercom caller enters a group ID, all handsets subscribed to this group will ring. The first handset to answer will establish a link with the caller. Afterward, it is a one-to-one call, not a one-to-many call.

Handset Group Subscription

1. Up to nine handset groups (91-99) can be defined and handsets can decide which group(s) they want to be in.
2. For example, Group 1 represents the Customer Service Group, Group 2 represents the Sales Group, and Group 3 is the Marketing Group. Suppose that Handset 11 wants to receive incoming rings for all Sales and Marketing related calls. Then handset 11 will need to “subscribe” to Group 2 and Group 3.

Re: the above wording is in regards to intercom <or broadcast>, not incoming calls.

3. Group Selections:
 - a. Press handset **MENU**-4 to enter the Call Settings menu
Press number “2”, handset enters group setting menu.
 - b.
 - c. Press **OPTION** soft key and followed by “1” key to subscribe the group (“9 #”, #:1~9). Enter 1~9.
 - d. Repeat for all desired groups.
 - e. Delete group selections by pressing **OPTION** soft key and followed by “2” to Unsubscribe the group.

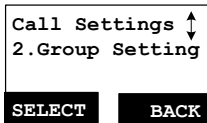
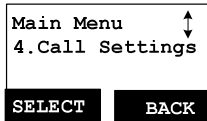

Call Transfer

While a telephone call is in progress, you can transfer it between different handsets.

Direct transfer (Unannounced Transfer)

1. Press **CHD HOLD** key to put the call on hold.
2. Press **XFER** (Right) soft key, followed by the destination handset ID, then the held call will be transferred directly.

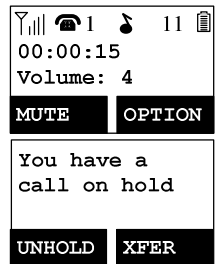

After the call transferred to the destination handset, the original handset will go back to standby mode automatically.

Indirect transfer (Announced Transfer)

If you want to talk to the destination handset before the call is transferred, you can follow the method below:

1. During the call, press **INT** key, followed by entering the destination handset ID.
2. At the destination handset, press the **CLAMP** or **INT** to answer the intercom call. After talking, press **END** to end the intercom call. After an intercom call is ended, the phone on the other end will also go back to standby mode

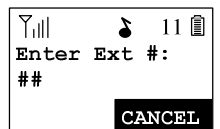
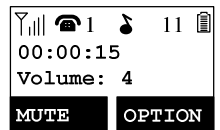
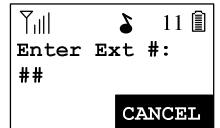

automatically.

Notes: If the destination handset does not answer after handset paging or transferring **times out**, the call is routed back to the originating handset.

Phonebook Operations

1. You can store up to 50 entries in the phonebook. Each entry can contain a phone number or handset ID (up to 26 digits) and a name (up to 16 characters).
2. To access the phonebook, press **MENU** (Right) soft key, followed by **2**; or press  scrolling key while the handset is in standby mode.

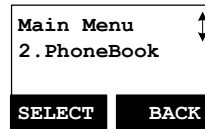



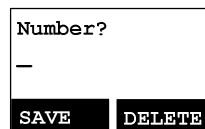
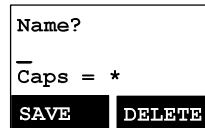
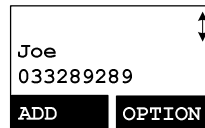



3. To add a new entry:
 - a. Press **ADD** (Left) soft key.
 - b. Enter the name when LCD prompts "Name?" Use **DELETE** (Right) soft key to delete the last digit entered. When completed, press **SAVE** (Left) soft key to save. Re: Up to 16 characters can be entered as the name.
 - c. You will then be prompted to enter a number for the name just entered. Re: Up to 26 digits can be entered as the number.
 - d. After entering the number, press the **SAVE** (Left) soft key to save this entry into phonebook.
 - e. If you enter a phonebook entry without a name, all records without a name will be placed on the top of the phonebook list.
 - f. To enter the name, press the corresponding keypad number one or more times according to the order of the character on the key.



See table below for a list of available characters and their orders. For example, press **2** once for the character "A", twice for "B", etc.

Notes:

1. When entering a phone number, the cursor automatically advances to the next digit field. Use  or  scrolling key to move the cursor backward or forward to insert or delete (the digit above the cursor, or left of the cursor if cursor is on the right of the last digit).
2. When entering a name, the cursor automatically advances to the next character field if you press a different key for the next character. If you need to enter consecutive characters from the same key, you can wait for the cursor to advance or use  or  scrolling key to move the cursor backward or forward manually. Also use  or  to move the cursor to insert (to the left of the cursor) or delete (the character above the cursor, or left of the cursor if cursor is on the right of the last character).
3. By default, all letters are entered in upper case. Use the * key to toggle between upper and lower cases.
4. A "Pause" entry represents a 1 second delay in dialing the following digits, which is useful when calling a sequence of segmented numbers (e.g., access code, credit card number, auto-attendant entries, etc.) Pause is entered by pressing the # key twice (LCD displays P). Entering pause twice (PP) will result in 2 seconds pause in the dialing.



5. Character Table:

| Key | Characters and Orders |
|-----|---|
| 1 | ' + , . * () & 1 |
| 2 | A B C 2 |
| 3 | D E F 3 |
| 4 | G H I 4 |
| 5 | J K L 5 |
| 6 | M N O 6 |
| 7 | P Q R S 7 |
| 8 | T U V 8 |
| 9 | W X Y Z 9 |
| 0 | 0 |
| * | Caps – when in character editing. * – when in number editing. |
| # | Space & # – when in character editing # & P (Pause) – when in number editing |



4. The entries are alphabetically sorted and stored as a list in an ascending order (A to Z) from the top of the list.

5. The first line of LCD display shows name and the 2nd line shows the phone number. If the phone number is longer than 16 digits, press **OPTION** (Right) soft key and select Option 3 “View Number” to view the complete number.

6. To search for a record:

- Use  scrolling key to enter Phone Book mode.
- Press a key that corresponds to the first character of the name you are looking for.
- For example, if you are looking for “EnGenius”, press the number **3** key once.
- Use  or  scrolling key to locate the exact record you are looking for.

7. To erase a phonebook entry:

- Use  or  scrolling key or the alphabetical search method to locate the record to be erased or edited.

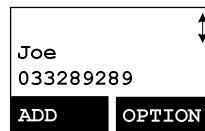

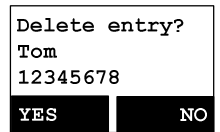

b. Press **OPTION** (Right) soft key to enter the option menu.

- Press **1** to erase the intended phone entry.
- LCD will show “Delete entry?” Press **YES** (Left) soft key to confirm your change.



8. To edit a phonebook entry:



- Use  or  scrolling key or the alphabetical search method to locate the record to be erased or edited.



- Press **OPTION** (Right) soft key to enter option menu.
- Press **2** to edit the intended phone entry.





9. Dial from display:

- Press  or  to dial the phone number or Handset ID displayed.

10. To transfer the phonebook to another handset:

To transfer phonebook, both parties have to enter the phonebook transfer mode first by following below:

- Press **OPTION** right soft key followed by **5** or  or  scrolling key to transfer while handset is in phonebook mode.
- For the phone doing the sending, press **1** to enter sending mode.

- Either press **TX ALL** (left softkey) to transfer all phonebook entries to another handset(s)

Note: if you want to transfer all entries from an handset but the entry is not from beginning (entry #1), it will only transfer the remaining entries. For example, if you have 10 entries, and you start at entry #5, then it only transfers #5 through #10.

- Or press **TX ONE** (right softkey) to transfer just one entry to another handset(s).

Note: you will need to at the desired entry before going to the TX ONE option for that particular entry to be transferred.

- Press the 2-digit handset ID or group ID, then select all phonebook entries or one entry to be transferred.

Re : "00" means all handsets

- iv. During phonebook transferring, LCD shows "Sending" and 2-digit countdown on the LCD will indicate the remaining phonebook numbers which are still pending to be sent.
- c. For the phone that is to receive the phonebook, press **2** to enter receiving mode.
 - i. When entering the receiving mode, the LCD will show "Ready".
 - ii. To start to receiving the phonebook, the LCD will show "Get phonebook from Ext. # : xx" (the handset ID that will be doing the sending).
 - iii. A beep will be emitted when receiving each phonebook entry.
 - iv. While receiving phone book entries, a 2-digit countdown on the LCD will indicate the number of phonebook numbers remaining.

Re: Note: The phonebook transfer is via a wireless interface so there can be times where some entries are not transferred due to interference. It is recommended to have handsets in very close range during transfers.

Call Barring

- 1. Block the users from dialing long distance or international calls. Call barring can also be used to block incoming calls from an outside line or other registered handset.

Note: Entering a password is required (default password is 0000).

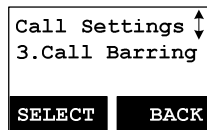

- 2. Press **MENU**-4-3 to enter Call Barring. Enter the password of the handset, followed by **OK** (Left) soft key

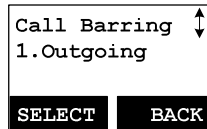

Block Outgoing Call

- 1. Press **SELECT** left soft key to select "Outgoing" and confirm your selection.



- 2. Use  or  scrolling key to switch between On and Off of this setting. Press **SELECT** left soft key to confirm your selection.

Re : The default setting of Call Barring is "Off".

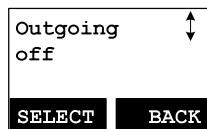

- 3. To enter a Call Barring code

- a. Once the Call Barring feature is turned on, you can key in the "Call Barring" code.

Press **ADD** (Left) soft key then start entering the Call Barring code after the number is entered, then press the **SAVE** (Left) soft key to save.

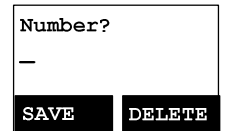

- (1) Up to 5 digits can be entered in as a Barring code. For example, if you want to block all call dialing to Manhatttan, NY area, you can enter 1212 as the Call Barring code.
- (2) If the base station is connected behind a PBX system, be sure to include the outside dial tone digit as well (example, 9 to dial out).

- b. Press **OPTION** right soft key to delete or edit Call Barring codes.





- c. Up to 5 sets of Call Barring codes can be programmed.

- d. If you want to block all outgoing calls, enter * * * * * keys followed by, press **SAVE** (Left) soft key to save. Doing so will cause all outgoing calls to be restricted.

Block Incoming Calls and blocking intercom or broadcasts from handsets.

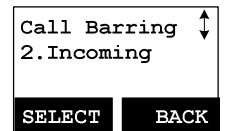
- 1. Press **SELECT** left soft key to confirm your selection for "Incoming".



Use  or  scrolling key to select blocking item.

- a. Press **SELECT** left soft key to confirm your selection to block broadcasts.

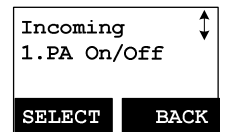

Press **CHANGE** left soft key to switch between On and Off of this setting.

Re: "On" means to be able to receive broadcast from other handsets or base station. "Off" means to restrict the broadcast from other handsets or base station. The default setting is "On".

- b. Press **SELECT** left soft key to confirm your selection for receiving or blocking line calls.

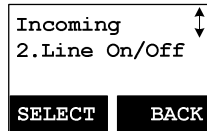

Press **CHANGE** left soft key to switch between On and Off of this setting.

Re: "On" means to be able to receive calls from outside line; "Off" means to restrict calls from outside line. The default setting is "On".

- c. Press **SELECT** left soft key to confirm your selection for receiving or blocking intercom calls.

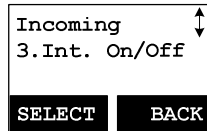

Press **CHANGE** left soft key to switch between On and Off of this setting.

Re: "On" means to be able to receive intercom calls from other handsets or base station; "Off" means to restrict intercom calls from other handset or base station. Default setting is "On".

Programmable Feature Call

- If the FREESTYL 2 base station is installed behind a PBX system, you may want to pre-program some feature calls along with the PBX's feature codes into the handset(s).
- Up to 10 most frequently used feature call codes can be pre-programmed.
- Naming and entering feature call codes:

- Press **MENU** (Right) soft key while the handset is in standby mode.
- Press "4", followed by "4" to enter the "Feature Call" menu.
- Press **ADD** (Left) soft key to add a new entry.
- Key in the name for the feature call, press **SAVE** (Left) soft key to confirm.

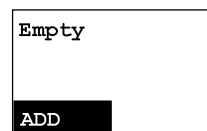
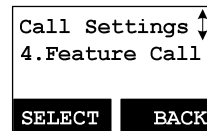

- e. Key in the feature call code of the correspondence PBX feature i.e. F*70 (Nortel transfer code).

Press **SAVE** (Left) soft key to confirm.

Re: "F" represent the Flash signal.

Note: To enter "F" press the talk key.



- f. The 1st feature call and correspondence feature call code you entered will appear on the LCD screen.



- g. Press **OPTION** (Right) soft key to delete or edit the feature call you programmed into the handset.

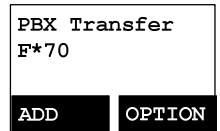

- h. Repeat the same operation to enter additional (up to ten) feature call entries.

4. How to use a pre-programmed feature call during an active phone call.

- a. Press **OPTION** (Right) soft key while the handset is in talk mode.

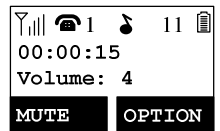

- b. Press the corresponding number of the feature call of which you want to use, i.e. press "0" to perform the "PBX Transfer" in the example.

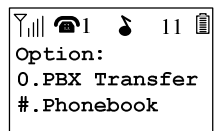



Notes:

- This feature call would be useful if the FREESTYL 2 base station is connected behind a PBX system.
- If you have not pre-programmed any feature calls into the system, only the "#.Phonebook" will show in the **OPTION** menu.
- The FREESTYL 2's programmable feature call may not function with all PBX or Key phone systems due to the diversity of various proprietary systems.



Caller ID

- Contact with your local phone company to subscribe to this feature. The phone system receives and displays Caller ID information transmitted by your local phone company. This information may include the calling phone number, name, date, and time. This unit can store up to 50 calls of caller ID information.
- The display will show the date and time of call on the first line, followed by the name on the second line, and the phone number on the third line. An unread record will display "NEW" at the end of the first line of display.
- When viewing a call record, the number can be dialed, stored to the phonebook, or deleted.

View Call Log



- To view the call log, press  to enter the Call Log.
Press  or  key to scroll through the numbers and names when available.

| |
|-----------------------------|
| 01/04 08:20P NEW |
| Johnson |
| 423-1234 |
| FORMAT OPTION |

- Press **OPTION** right soft key, you can  or  key to choose save, delete, or clear all.



| |
|---------------------------|
| Option: |
| Save |
| SELECT BACK |

- Save call log:

- Press **SELECT** right soft key, you can use  or  key to scroll the name, and press **DELETE** to edit the name.

Then press **SAVE** left soft key to save the name.

| |
|---------------------------|
| Name? |
| Johnson_ |
| Cap = * |
| SAVE DELETE |

- Use  or  key to scroll through the numbers, and press **DELETE** to edit the number.
Then press **SAVE** left soft key to save the number.

| |
|---------------------------|
| Number? |
| 4231234_ |
| SAVE DELETE |

- After the above process, the call log number will be saved into the phonebook.

- Delete call log:

- Press **SELECT** right soft key followed by **YES** left soft key to confirm deleting.







| |
|---------------------------|
| Option: |
| Delete |
| SELECT BACK |

- Clear All:

- Press **SELECT** right soft key followed by **YES** left soft key to confirm clearing all caller ID records.

| |
|---------------------------|
| Option: |
| Clear all |
| SELECT BACK |

Call a Caller ID

- Press  key, use  or  key to scroll through the call log.
- When at the display of a caller ID entry, Press  or  to dial this number.
- The displayed CID number in most cases will be a 10-digit number with the 3-digit area code followed by the 7-digit telephone number. If the area code is unnecessary for calling back, you can follow below rule to adjust the calling back number:
 - Press **FORMAT** key once, the 3-digit area code will be removed.
 - Press **FORMAT** key twice, "1" will be added in front of the displayed number
 - Press **FORMAT** key three times, it will loop back original displayed number.
 Re. The CID default is 10 digits, when press **FORMAT** key, it will be 7-digit → 11-digit → 10-digit in circle.
- After the displayed number chosen, press  or  key to call back.

Visual Message Waiting Indicator (VMWI)

VMWI feature is supported via FSK message signaling when received from the phone company telephone line or PBX system; It will activate a message icon on the handset display and flash the VOICE MESSAGE LED on the base.



Notes:

- A subscription to the telephone company voice mail service is required.

2. If the handset still indicates the icon even after you have listened to all messages, turn it off by pressing and holding the “Caller ID” key on the handset.

Adjust Handset Microphone Gain (sensitivity)

The microphone gain setting option is provided so you can adjust microphone sensitivity custom to your workplace environment (such as a loud, noisy environment etc.). Note: You may also want to adjust earpiece settings as well if the workplace environment is extremely loud.

- a. Press **MENU** right soft key while the handset is in standby mode.
- b. Press “5” (Phone Settings), followed by “1” to enter the “Mic. Gain” menu.
- c. Use  or  key to scroll the “Standard”, “Medium” and “Low” options.
- d. If you are using the handset in a quiet environment, like office or meeting room, the level of “Standard” is recommended.

If you are using the handset in a noisy environment, like a factory or outdoor place, the level of “Medium” or “Low” is recommended.

Adjust Headset Ring

When using a headset, you can avoid missing a call due to the ringer ringing inside the headset rather than outside the phone, by changing the ringer to the outside speaker.

- a. Press **MENU** right soft key while the handset is in standby mode.
- b. Press “5” (Phone Settings), followed by “9” to enter the “Headset Ring” menu.
- c. Select “On”, the ringer will be heard in the headset.
Select “Off”, the ringer will be heard from the outside speaker.
Note: Default setting is “On”.

Baby Monitor

You can set any one handset as a “baby unit” to monitor a baby or older person.

When enabling baby monitor mode, the “baby unit” will automatically enter the monitoring mode via 2-way intercom.

For example, if you set handset A as a “baby unit”, when making an intercom call from handset B, handset A will automatically enter monitoring mode without ringing. You will be able to hear all movements around handset A via handset B.

- a. Press **MENU** right soft key while the handset is in standby mode.
- b. Press “4” (Call Settings), followed by “5” to enter the “Baby Monitor” menu.
- c. Press “CHANGE” to switch ON or OFF (default is OFF).

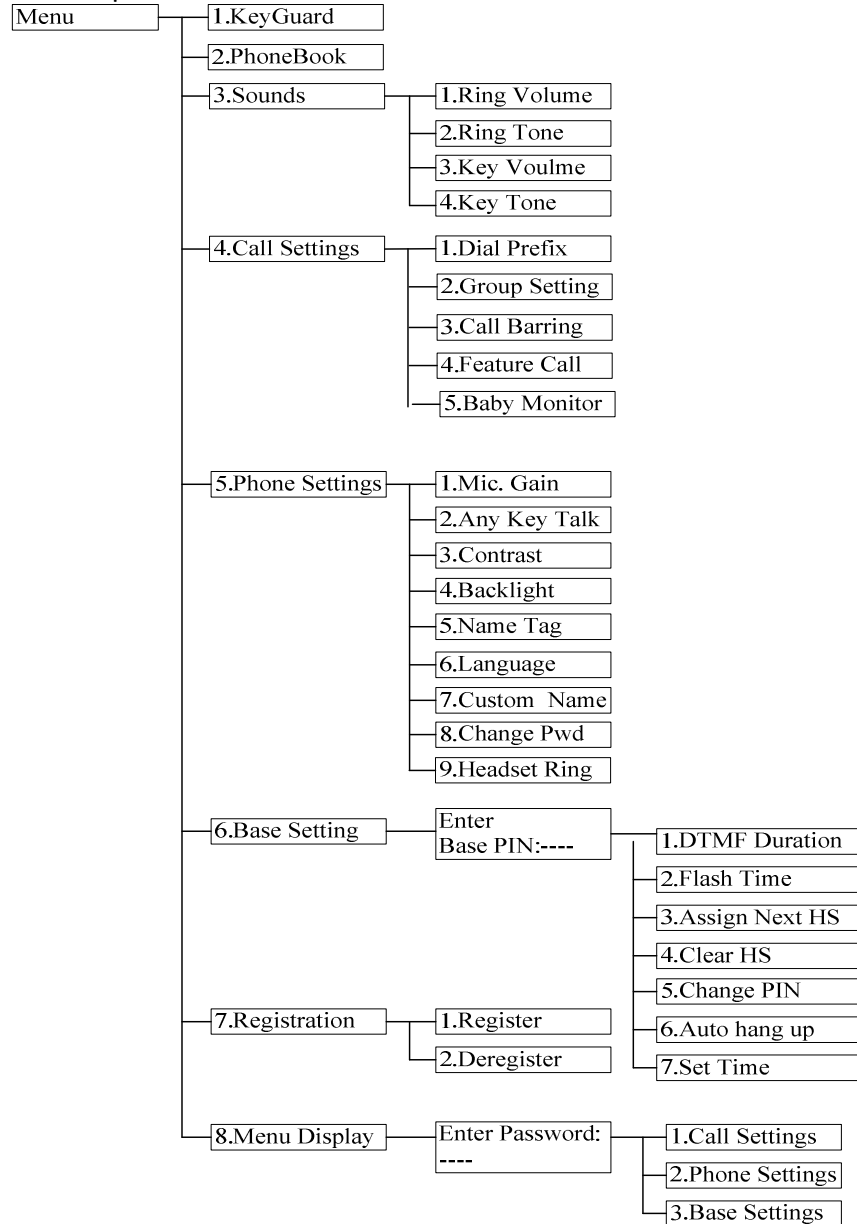

Re: To avoid any interruptions while monitoring is active, the handset in baby monitor mode will not ring from incoming calls, except intercom.

Menu Operations













Note: Default base pin or password is 0000.

1. Press **MENU** right soft key to enter menu mode while the phone is in standby mode.

Re: You can either press  or , followed by **SELECT** left soft key to confirm the selected menu. Or Press the digit directly to confirm the selected menu. For example, press **MENU** right soft key followed by **4** and **1** to select Ring Volume.

2. Press **1** to select KeyGuard (see Key Guard operation on page [34](#)).
3. Press **2** to add, delete, edit, view and edit the phonebook (see Phonebook instructions on page [39](#)).
4. Press **3** to set Sound settings:
 - a. Press **1** to select Ring Volume:
There are two options for ring volume: Line (for incoming call) and Intercom (for intercom calls). Set each option respectively.

When setting each option, use  or  to scroll through 6 options: "Off", "Low", "Medium", "High", "Vibrate" and "Vibrate & High". Press **SELECT** left soft key to save selection. Default = Medium.
 - b. Press **2** to select Ring Tone:
There are two options for ring tone: Line (ring tone for incoming call) and Intercom (ringer for intercom call). Set each option respectively.





Use the  or  to scroll through 8 ringer types, press **SELECT** left soft key to save the selection. Default = 1.
 - c. Press **3** to select Key Volume for when a key is pressed:
Use  or  to scroll through 4 options: Off, Low, Medium, and High. Press **SELECT** left soft key to save selection. Default = Medium.
 - d. Press **4** to select Key Tone for when a key is pressed:
Use the  or  to scroll through 4 options: 1, 2, 3 and 4. Press **SELECT** left soft key to save selection. Default = 1.
5. Press **4** to set Call Settings:
 - a. Press **1** to set Dial Prefix:
(1) Press  or  to turn on or off the dial prefix feature. Default =

Off.

- (2) If "On" is selected, the handset is prompted to enter the prefix number (up to 14 digits can be entered).
- (3) Use **Delete** right soft key to delete the prefix number.
- (4) Press **SAVE** left soft key to confirm the selection.
- (5) When this feature is turned on, the LCD will prompt the user "Dial Prefix? Yes or No". On each outgoing phone call from call logs, phonebook, and dial-and-send dialing, the current prefix is also displayed.

Re: the prefix number will be added automatically in front of the dialed number if the **YES** left soft key is pressed.

- (6) This feature is useful for access code (PBX code for outside dial tone), a calling card, or credit card calls, etc.



- b. Press **2** to set Group Select: see Handset Group Subscription on page [37](#).
 - c. Press **3** to set Call Barring: see Call Barring operation on Page [43](#).
 - d. Press **4** to set Feature Call: see Feature Call operation on Page [45](#).
 - e. Press **5** to set Baby Monitor: see Baby Monitor operation on Page [49](#).
6. Press **5** to set Phone Settings:
- a. Press **1** to set Mic Gain: See Mic Gain operation on Page [49](#).
 - b. Press **2** to set Any Key TALK (answering a call by pressing any key versus only the talk key):
Use **CHANGE** left soft key to select and confirm "On" or "Off".
Default is "Off".
Re: When set to "on", press any key (except  and **SILENT** key) to answer the incoming call.
 - c. Press **3** to set LCD Contrast:
 - (1) Use  or  to scroll through option 1~8. Default is 6.
 - (2) Press **SAVE** left soft key to confirm selection.
 - d. Press **4** to set LCD Backlight:
 - (1) Use  or  to scroll through option 1~3 (1.8 seconds 2.On 3.Off). Default is 8 seconds.
 - (2) Press **SAVE** left soft key to confirm selection.
 - e. Press **5** to set Name Tag:

- (1) Use **CHANGE** left soft key to select and confirm "On" or "Off". Default is "Off".

- (2) Press **SAVE** left soft key to confirm selection.

Re: When Set to "On", the handset will match the caller ID with the phone book entries. Once matched, the LCD screen will display the name or nickname instead of pure caller ID info (needs Call Waiting with Caller ID service from local telephone company along with PBX system if a PBX system is used).

- f. Press **6** to set Language:



- (1) Use  or  to scroll through option 1~3 (1.English 2.Spanish 3.French).

Default is "English".

- (2) Press **SAVE** (Left) soft key to confirm selection.

- g. Press **7** to set Custom Name:

- (1) Enter characters using the Character Table and method discussed in the Phonebook section (On page 41).

- (2) Use  or  to move the cursor backward or forward to insert (to the left of the cursor) or delete (the character above the cursor, or left of the cursor if cursor is on the right of the last character).

- (3) Press **SAVE** (Left) soft key to confirm setting.

Re: Once entering the custom name, the greeting of LCD in standby mode will be changed to what you have entered.

Default greeting is "FREESTYL 2".

- h. Press **8** to Change Password:

- (1) Enter original password (4 digits) of handset then press **OK** left soft key when enter this menu (**default password is 0000**).

- (2) Enter new password (4 digits) then press **SAVE** left soft key to confirm new password.

- i. Press **9** to set Headset Ring: See Headset Ring operation on Page [49](#).

7. Press **6** to set Base Settings:

When entering this menu, you must enter the Base PIN code first (4 digits).



Re: The PIN code is for Base Settings. Default is 0000.

- a. Press **1** to set DTMF Duration.

(1) Enter the DTMF duration (90~200ms), press **OK** left soft key to confirm the setting. Default is 100ms.

Re: Please check with your dealer before changing. If the duration does not match with the PSTN or PBX setting, some or all of the DTMF digits you press may not be recognized.

b. Press **2** select flash key timing. Default is 600ms.

(1) Use  or  to scroll through option 1~9 (100~900ms). Or press digit key (1~9) directly.

(2) Press **SELECT** left soft key to confirm selection.

Re: The default value (600 ms) works in most areas. Changing this setting may cause the flash-hook signal to not be recognized properly by the PSTN line or PBX system. You may need to change this setting if you find you are unable to properly answer incoming calls, or are unable to transfer calls. Many of the newer IP-PBX (VOIP server type) systems do require a flash time of 200ms or 300ms.

c. Press **3** to set Assign Next HS

(1) Enter the 2-digit handset ID followed by pressing **OK** left soft key.

(2) Normally when registering a handset, the base will give a handset the next available registration ID. Assign next will allow you to customize the next registration ID (as long as it is available and between 11 and 19).

d. Press **4** to set Clear HS

(1) Enter the 2-digit handset ID followed by pressing **OK** left soft key.

(2) The base will erase the handset ID from the system.

e. Press **5** to Change PIN:

(1) Enter the new Base PIN followed by **OK** left soft key.

Re: Default Base PIN is 0000.

f. Press **6** to set Auto Hang Up:

(1) Use **CHANGE** left soft key to select and confirm on or off. The

Re: When setting "on", the FREESTYL 2 will automatically hang up if the far end caller has hung up. However, this function depends on if there is a "dial tone or busy tone" signal sent out by PBX or PSTN, after the call is hung up. Default = OFF

g. Press **7** to Set Time to support DTMF Caller ID:

(1) Use **SAVE** left soft key to select and confirm the Date and Time you have set (see Set Time operation on page 20).

8. Press **7** to register and de-register handsets: see Handset Registration operation on Page 36.

9. Press **8** to set Menu Display:

To avoid users changing phone settings such as Call Settings (MENU-4), Phone Settings (MENU-5) and Base Settings (MENU-6), you can hide these menus.

Re: When entering the Menu Display, you have to enter a password first.

a. Press **1** to set hiding/un-hiding of the Call Settings menu.

(1) Use **CHANGE** left soft key to select and confirm on or off.

b. Press **2** to set hiding/un-hiding of the Phone Settings menu.

(1) Use **CHANGE** left soft key to select and confirm on or off.

c. Press **3** to set hiding/un-hiding of the Base Settings menu.

(1) Use **CHANGE** left soft key to select and confirm on or off.

Re: Select "On" means the menu will be displayed on screen. Select "Off" means the menu will be hidden.

Index

- 2
- 2-Way Intercom, 14, 29

- A
- Adjusting Receiver (Earpiece) Voice Volume, 33
- Adjusting Handset Speakerphone Voice Volume, 33
- Adjust Handset Microphone Gain, 50
- Adjust Headset Ring, 51

- B
- Base ID, 48
- Base Illustration, 21
- Base Operation, 27
- Base PIN, 18, 19, 20
- Base Station, 5, 6, 9, 10, 14, 15, 20, 22, 25, 26, 27, 28, 30, 36, 43
- Base Station Features, 22
- Base Station Installation, 25
- Battery, 5, 7, 10, 24, 26, 27, 35
- Battery Recharge and Replacement, 35
- Battery Safety Instructions, 7
- Battery Strength, 13
- Block Incoming Call, 43
- Block Outgoing Call, 43
- Broadcast, 14, 16, 18, 31, 44, 49
- Broadcasting a Group of Handsets, 30
- Broadcasting all Handsets, 30
- Broadcasting an Individual Handset, 31
- BS Selection, 49

- C
- Call Barring, 16, 18, 42, 43, 54
- Call Log, 16, 17, 46, 47
- Call Timer, 17
- Call Transfer, 33, 37
- Call Hold, 17
- Caller ID, 15, 20, 31, 32, 46, 47, 50, 55, 56
- Call in-progress, 13
- Call Manager, 49, 50, 54
- Call Settings, 16, 18, 20, 37, 49, 50, 51, 54, 57
- Call Waiting, 14, 15

- Call Waiting with Caller ID, 15, 55
- Cardiac Pacemaker, 4
- Change PIN, 18, 19, 56
- Charger Features, 24
- Charger Illustration, 23

- D
- De-registration, 36
- DND, 15
- Do Not Disturb (Silent Ring), 15, 34
- DTMF Tone, 18
- DTMF Duration, 18, 56

- E
- Electric Shock, 4, 5, 6
- Emergency, 4
- Equipment Checklist, 10

- F
- Flash, 14, 19, 36, 45, 48, 50, 56
- Feature Call, 17, 45, 54

- G
- General Safety Instructions, 4
- Group ID, 15, 30, 38, 42
- Group Setting, 18, 37
- Group Selections, 37, 54

- H
- Handset and Charger Installation, 26
- Handset Charging Slot, 24
- Handset Features, 13, 15
- Handset Group Subscription, 37, 54
- Handset ID, 13, 15, 17, 19, 22, 27, 30, 31, 32, 36, 38, 39, 42, 48, 56
- Handset Registration, 36, 57
- Handset to Handset Call, 30
- Hearing Aid, 4

- I
- IDLE Mode, 17, 27, 35

- K

Key Guard, 34, 53
Key Tone, 17, 53
Key Volume, 53

- L

Line Jack, 22
Lithium-Ion (Li-Ion), 7, 10
Line Reversal, 56

- M

Making a Broadcast, 30
Making a Telephone Call, 29
Making an 2-Way/ Intercom Call, 29
Memory, 27
Menu Display, 18, 57
Menu Mode, 27, 53
Multiple Handsets Registration, 15
Mute, 17, 33

- N

Name Tagging, 15, 55

- O

Outdoor Antenna, 10, 22

- P

Phonebook, 14, 16, 17, 39, 45, 46, 47, 53, 55
Phone Settings, 18, 20, 50, 51, 54, 57
Placing a Call On Hold, 33
Power Outage, 5, 9, 25, 26
Product Safety Instructions, 5
Programmable Flash, 19
Programmable feature call, 17, 45, 46

- R

Receiving a Telephone Call, 31
Receiving an Intercom Call, 32
Redial, 16, 31
REG, 22, 37, 48
Registration Key, 22
Registration Mode, 22, 27, 36, 48

Regulatory Information, 8

REN, 8

Reset Button, 22

Ringer, 14, 15, 20, 31, 32, 34, 51, 53

Ringer Volume, 14, 15

RSSI, 13

- S

Safety Instructions, 4

Set Time, 20

SILENT, 15, 32, 34

Spare Battery, 10

Speed Dial, 29

Speakerphone, 14, 30, 31, 33, 48

Subscribe BS, 49

- T

Talk Mode, 14, 27, 46

Talk/Flash, 14

Technical Specifications, 62

Transformer, 25, 26

Two-Digit Address Index, 13

- V

Vibrator, 15

View Call log, 46

Visual Message Waiting Indicator, 50

- W

Warning Message, 24

Technical Specifications

| Electrical Specifications | Base Station | Portable Handset |
|---------------------------|--|--|
| Frequency | 902-928 MHz | 902-928 MHz |
| RF Output Power | Peak: 27 dBm Average: 21 dBm | Peak: 26 dBm Average: 20 dBm |
| Channel Spacing | 101 kHz | 101 kHz |
| Number of Channels | 252 | 252 |
| Modulation | Differentially Encoded MSK | Differentially Encoded MSK |
| Multiple Access | Frequency Hopping TDD | Frequency Hopping TDD |
| Frequency Hopping Rate | 100 per second | 100 per second |
| TDD Frame Length | 10 ms | 10 ms |
| Number of Slots/Frame | 4 | 4 |
| Receiver Sensitivity | <-111dBm (@ BER 10 ⁻²) | <-111dBm (@ BER 10 ⁻²) |
| Antenna Gain | 2 dBi | Long: 2.5 dBi; Short: 1.5 dBi |
| Antenna Connector | Reversed TNC | Proprietary |
| Telephone Interface | RJ11 x 2 | NA |
| Channel Coding | 8 kbps Convolutional + CRC | 8 kbps Convolutional + CRC |
| Transmission Data Rate | 85.333 kbps | 85.333 kbps |
| Speech Coding | 8 kbps G.729AB | 8 kbps G.729AB |
| User Data Rate | 64kbps duplex | 64kbps duplex |
| Duplex | Time Division Duplex (TDD) | Time Division Duplex (TDD) |
| Number of System ID | 65,536 | 65,536 |
| Ring Signal | 20-50 Hz, 30-90 Vrms | NA |
| Flash Time | 100-900 ms programmable | NA |
| Power Source | AC/DC 5V/1A Adapter | 3.7V/1100mAh Li-Ion Battery |
| Charger Current | NA | 550mA (550/850mA for desktop charger) |
| Charge Time | NA | 3hours |
| Regulation Compliance | FCC Part 15, Part 68 Canada RSS-210, CS03 | FCC Part 15, Part 68 Hearing Aid Compatible Canada RSS-210, CS03 |
| Operating Temperature | 0 – 50 °C | -10 – 60 °C |
| Storage Temperature | -40 – 70 °C | -40 – 70 °C |
| Humidity | 20 – 75 % | 20 – 75 % |

Notes:

1. NA = Not Applicable.
2. The manufacturer reserves the right to change designs and specifications without notice.

FCC Part 68 Statement

This equipment complies with Part 68 of the FCC rules and the requirements adopted by the ACTA. On the bottom of FreeStyl 2 base station is a label that contains, among other information, a product identifier in the format US: SNIW403BFS2. If requested, this number must be provided to the telephone company.

Applicable connector jack Universal Service Order Codes (“USOC”) for the Equipment is RJ11C.

A plug and jack used to connect this equipment to the premises wiring and telephone network must comply with the applicable FCC Part 68 rules and requirements adopted by the ACTA. A compliant telephone cord and modular plug is provided with this product. It is designed to be connected to a compatible modular jack that is also compliant. See installation instructions for details.

The REN is used to determine the number of devices that may be connected to a telephone line. Excessive RENs on a telephone line may result in the devices not ringing in response to an incoming call. In most but not all areas, the sum of RENs should not exceed five (5.0). To be certain of the number of devices that may be connected to a line, as determined by the total RENs, contact the local telephone company. For products approved after July 23, 2001, the REN for this product is part of the product identifier that has the format US: SNIW403BFS2. The digits represented by 0.3 are the REN without a decimal point (*e.g.*, 03 is a REN of 0.3).

If this FreeStyl 2 causes harm to the telephone network, the telephone company will notify you in advance that temporary discontinuance of service may be required. But if advance notice isn't practical, the telephone company will notify the customer as soon as possible. Also, you will be advised of your right to file a complaint with the FCC if you believe it is necessary.

The telephone company may make changes in its facilities, equipment, operations or procedures that could affect the operation of the equipment. If this happens the telephone company will provide advance notice in order for you to make necessary modifications to maintain uninterrupted service.

If trouble is experienced with this FreeStyl 2, for repair or warranty information, please contact:

Company: Senao Networks, Inc.

Address: 3F, No. 529, Chung Cheng Rd., Hsintien, Taipei, Taiwan, R.O.C.
Tel no.: 886-3-328-9289

If the equipment is causing harm to the telephone network, the telephone company may request that you disconnect the equipment until the problem is resolved.

Connection to party line service is subject to state tariffs. Contact the state public utility commission, public service commission or corporation commission for information.

If your home has specially wired alarm equipment connected to the telephone line, ensure the installation of this equipment does not disable your alarm equipment. If you have questions about what will disable alarm equipment, consult your telephone company or a qualified installer.

WHEN PROGRAMMING EMERGENCY NUMBERS AND(OR) MAKING TEST CALLS TO EMERGENCY NUMBERS:

- 1) Remain on the line and briefly explain to the dispatcher the reason for the call.
- 2) Perform such activities in the off-peak hours, such as early morning or late evenings.

IC CS-03 Statement

"NOTICE: This equipment meets the applicable Industry Canada Terminal Equipment Technical Specifications. This is confirmed by the registration number. The abbreviation, IC, before the registration number signifies that registration was performed based on a Declaration of Conformity indicating that Industry Canada technical specifications were met. It does not imply that Industry Canada approved the equipment."

"NOTICE: The Ringer Equivalence Number (REN) for this terminal equipment is 0.3. The REN assigned to each terminal equipment provides an indication of the maximum number of terminals allowed to be connected to a telephone interface. The termination on an interface may consist of any combination of devices subject only to the requirement that the sum of the Ringer Equivalence Numbers of all the devices does not exceed five."