



A D T

FCC TEST REPORT

REPORT NO.: RF120622C18
MODEL NO.: FreeStyl 2
FCC ID: U2M-FS2
RECEIVED: Jun. 22, 2012
TESTED: Jun. 28 ~ Jul. 05, 2012
ISSUED: Jul. 16, 2012

APPLICANT: Senao Networks, Inc.

ADDRESS: 3F, No. 529, Chung Cheng Rd., Hsintien, Taipei,
Taiwan, R.O.C.

ISSUED BY: Bureau Veritas Consumer Products Services
(H.K.) Ltd., Taoyuan Branch

LAB ADDRESS: No. 47, 14th Ling, Chia Pau Vil., Lin Kou Dist.,
New Taipei City, Taiwan, R.O.C.

TEST LOCATION: No. 19, Hwa Ya 2nd Rd, Wen Hwa Tsuen, Kwei
Shan Hsiang, Taoyuan Hsien 333, Taiwan, R.O.C.

This report should not be used by the client to claim product certification, approval, or endorsement by TAF or any government agencies.



This report is for your exclusive use. Any copying or replication of this report to or for any other person or entity, or use of our name or trademark, is permitted only with our prior written permission. This report sets forth our findings solely with respect to the test samples identified herein. The results set forth in this report are not indicative or representative of the quality or characteristics of the lot from which a test sample was taken or any similar or identical product unless specifically and expressly noted. Our report includes all of the tests requested by you and the results thereof based upon the information that you provided to us. You have 60 days from date of issuance of this report to notify us of any material error or omission caused by our negligence, provided, however, that such notice shall be in writing and shall specifically address the issue you wish to raise. A failure to raise such issue within the prescribed time shall constitute your unqualified acceptance of the completeness of this report, the tests conducted and the correctness of the report contents. Unless specific mention, the uncertainty of measurement has been explicitly taken into account to declare the compliance or non-compliance to the specification.



TABLE OF CONTENTS

RELEASE CONTROL RECORD.....	4
1. CERTIFICATION	5
2. SUMMARY OF TEST RESULTS	6
2.1 MEASUREMENT UNCERTAINTY.....	6
3. GENERAL INFORMATION.....	7
3.1 GENERAL DESCRIPTION OF EUT	7
3.2 DESCRIPTION OF TEST MODES.....	9
3.2.1 TEST MODE APPLICABILITY AND TESTED CHANNEL DETAIL	11
3.3 DESCRIPTION OF SUPPORT UNITS	13
3.3.1 CONFIGURATION OF SYSTEM UNDER TEST	13
3.4 GENERAL DESCRIPTION OF APPLIED STANDARDS	15
4. TEST TYPES AND RESULTS	16
4.1 RADIATED EMISSION AND BANDEDGE MEASUREMENT.....	16
4.1.1 LIMITS OF RADIATED EMISSION AND BANDEDGE MEASUREMENT	16
4.1.2 TEST INSTRUMENTS.....	17
4.1.3 TEST PROCEDURES	18
4.1.4 DEVIATION FROM TEST STANDARD	18
4.1.5 TEST SETUP.....	19
4.1.6 EUT OPERATING CONDITIONS	19
4.1.7 TEST RESULTS	20
4.2 CONDUCTED EMISSION MEASUREMENT	41
4.2.1 LIMITS OF CONDUCTED EMISSION MEASUREMENT.....	41
4.2.2 TEST INSTRUMENTS.....	41
4.2.3 TEST PROCEDURES	42
4.2.4 DEVIATION FROM TEST STANDARD	42
4.2.5 TEST SETUP.....	42
4.2.6 EUT OPERATING CONDITIONS	42
4.2.7 TEST RESULTS	43
4.3 NUMBER OF HOPPING FREQUENCY USED	47
4.3.1 LIMIT OF HOPPING FREQUENCY USED.....	47
4.3.2 TEST SETUP.....	47
4.3.3 TEST INSTRUMENTS.....	47
4.3.4 TEST PROCEDURES	47
4.3.5 DEVIATION FROM TEST STANDARD	47
4.3.6 TEST RESULTS	47
4.4 DWELL TIME ON EACH CHANNEL	54
4.4.1 LIMIT OF DWELL TIME USED.....	54
4.4.2 TEST SETUP.....	54
4.4.3 TEST INSTRUMENTS.....	54
4.4.4 TEST PROCEDURES	54
4.4.5 DEVIATION FROM TEST STANDARD	54
4.4.6 TEST RESULTS	55



4.5	CHANNEL BANDWIDTH.....	56
4.5.1	LIMITS OF CHANNEL BANDWIDTH	56
4.5.2	TEST SETUP.....	56
4.5.3	TEST INSTRUMENTS.....	56
4.5.4	TEST PROCEDURE.....	56
4.5.5	DEVIATION FROM TEST STANDARD	56
4.5.6	EUT OPERATING CONDITION	56
4.5.7	TEST RESULTS	57
4.6	HOPPING CHANNEL SEPARATION	59
4.6.1	LIMIT OF HOPPING CHANNEL SEPARATION	59
4.6.2	TEST SETUP.....	59
4.6.3	TEST INSTRUMENTS.....	59
4.6.4	TEST PROCEDURES	59
4.6.5	DEVIATION FROM TEST STANDARD	59
4.6.6	TEST RESULTS	60
4.7	MAXIMUM OUTPUT POWER.....	62
4.7.1	LIMITS OF MAXIMUM OUTPUT POWER MEASUREMENT	62
4.7.2	TEST SETUP.....	62
4.7.3	TEST INSTRUMENTS.....	62
4.7.4	TEST PROCEDURES	62
4.7.5	DEVIATION FROM TEST STANDARD	62
4.7.6	EUT OPERATING CONDITION	62
4.7.7	TEST RESULTS	63
4.8	CONDUCTED OUT OF BAND EMISSION MEASUREMENT	65
4.8.1	LIMITS OF CONDUCTED OUT OF BAND EMISSION MEASUREMENT	65
4.8.2	TEST INSTRUMENTS.....	65
4.8.3	TEST PROCEDURE.....	65
4.8.4	DEVIATION FROM TEST STANDARD	65
4.8.5	EUT OPERATING CONDITION	65
4.8.6	TEST RESULTS	65
5.	PHOTOGRAPHS OF THE TEST CONFIGURATION.....	68
6.	INFORMATION ON THE TESTING LABORATORIES	69
7.	APPENDIX A - MODIFICATIONS RECORDERS FOR ENGINEERING CHANGES TO THE EUT BY THE LAB	70



A D T

RELEASE CONTROL RECORD

ISSUE NO.	REASON FOR CHANGE	DATE ISSUED
RF120622C18	Original release	Jul. 16, 2012

1. CERTIFICATION

PRODUCT: Single Line Long Range Cordless Telephone
MODEL NO.: FreeStyl 2
BRAND: EnGenius
APPLICANT: Senao Networks, Inc.
TESTED: Jun. 28 ~ Jul. 05, 2012
TEST SAMPLE: ENGINEERING SAMPLE
STANDARDS: **FCC Part 15, Subpart C (Section 15.247)**
ANSI C63.10-2009

The above equipment (model: FreeStyl 2) has been tested by **Bureau Veritas Consumer Products Services (H.K.) Ltd., Taoyuan Branch**, and found compliance with the requirement of the above standards. The test record, data evaluation & Equipment Under Test (EUT) configurations represented herein are true and accurate accounts of the measurements of the sample's EMC characteristics under the conditions specified in this report.

PREPARED BY : Ivy Lin, **DATE :** Jul. 16, 2012
Ivy Lin / Specialist

APPROVED BY : Ken Liu, **DATE :** Jul. 16, 2012
Ken Liu / Manager

2. SUMMARY OF TEST RESULTS

The EUT has been tested according to the following specifications:

APPLIED STANDARD: FCC PART 15, SUBPART C (SECTION 15.247)			
STANDARD SECTION	TEST TYPE AND LIMIT	RESULT	REMARK
15.207	AC Power Conducted Emission	PASS	Meet the requirement of limit. Minimum passing margin is -15.78dB at 0.16172MHz.
15.247(a)(1)(i)	Number of Hopping Frequency Used Spec.: At least 50 channels	PASS	Meet the requirement of limit.
15.247(a)(1)(i)	Dwell Time on Each Channel Spec.: Max. 0.4 second within 20 second	PASS	Meet the requirement of limit.
15.247(a)(1)(i)	1. Hopping Channel Separation Spec.: Min. 25 kHz or 20 dB bandwidth, whichever is greater 2. Spectrum Bandwidth of a Frequency Hopping Sequence Spread Spectrum System	PASS	Meet the requirement of limit.
15.247(b)(2)	Maximum Peak Output Power Spec.: max. 30dBm	PASS	Meet the requirement of limit.
15.247(d)	Transmitter Radiated Emissions Spec.: Table 15.209	PASS	Meet the requirement of limit. Minimum passing margin is -1.0dB at 899.20MHz & 936.07MHz.
15.247(d)	Band Edge Measurement	PASS	Meet the requirement of limit.
15.203	Antenna Requirement	PASS	Base station: Antenna connector is Reverse TNC not a standard connector. Portable handset: No antenna connector is used.

2.1 MEASUREMENT UNCERTAINTY

Where relevant, the following measurement uncertainty levels have been estimated for tests performed on the EUT as specified in CISPR 16-4-2:

MEASUREMENT	FREQUENCY	UNCERTAINTY
Conducted emissions	150kHz~30MHz	2.44dB
Radiated emissions	30MHz ~ 200MHz	3.19dB
	200MHz ~1000MHz	3.21dB
	1GHz ~ 18GHz	2.26dB
	18GHz ~ 40GHz	1.94dB

This uncertainty represents an expanded uncertainty expressed at approximately the 95% confidence level using a coverage factor of $k = 2$.



3. GENERAL INFORMATION

3.1 GENERAL DESCRIPTION OF EUT

EUT	Single Line Long Range Cordless Telephone
MODEL NO.	FreeStyl 2
POWER SUPPLY	Base Station: 5Vdc (AC Adapter) Portable Handset: 3.7Vdc (Battery) 5Vdc (Charger)
MODULATION TYPE	Differentially Encoded MSK
TRANSFER RATE	42.667 kbps
OPERATING FREQUENCY	902.269668 ~ 927.654755MHz
CHANNEL SPACING	101.136KHz
NUMBER OF CHANNEL	252
OUTPUT POWER	924.698mW
ANTENNA TYPE	Refer to Note as below
ANTENNA CONNECTOR	Refer to Note as below
DATA CABLE	NA
I/O PORTS	Refer to user's manual
ACCESSORY DEVICES	Adapter, Charger, Battery

NOTE:

1. The EUT is including Base station and Portable handset. The following antennas are provided to EUT.

	Antenna Type	Antenna Connector	Antenna Gain (dBi)
Base station	Dipole antenna	Reverse TNC	2
Portable handset	Dipole antenna	NA	1.5

2. The portable handset is on standby mode when charging.
3. The EUT consumes power from the following adapter, battery and charger.

ADAPTER (for Base Station and Portable Handset Charger used)	
BRAND	DVE
MODEL	DSA-6E-05 US 050100
INPUT POWER	100-240Vac, 50/60Hz, 0.3A
OUTPUT POWER	+5Vdc, 1A
POEWR LINE	1.5m non-shielded cable without core



A D T

BATTERY (for Portable Handset used)	
BRAND	EnGenius
POWER RATING	3.7Vdc, 1100mAh

CHARGER (for Portable Handset used)	
BRAND	EnGenius

4. The above EUT information was declared by the manufacturer and for more detailed features description, please refer to the manufacturer's specifications or User's Manual.

3.2 DESCRIPTION OF TEST MODES

252 channels are provided to this EUT:

CH.	FREQ. (MHz)	CH.	FREQ. (MHz)	CH.	FREQ. (MHz)	CH	FREQ. (MHz)	CH	FREQ. (MHz)
2	902.269668	32	905.303742	62	908.337817	92	911.371891	122	914.405965
3	902.370804	33	905.404878	63	908.438952	93	911.473026	123	914.507100
4	902.471940	34	905.506014	64	908.540088	94	911.574162	124	914.608236
5	902.573076	35	905.607150	65	908.540088	95	911.675298	125	914.709372
6	902.674212	36	905.708286	66	908.742360	96	911.776434	126	914.810508
7	902.775347	37	905.809421	67	908.843496	97	911.877570	127	914.911644
8	902.876483	38	905.910557	68	908.944631	98	911.978705	128	915.012779
9	902.977619	39	906.011693	69	909.045767	99	912.079841	129	915.113915
10	903.078755	40	906.112829	70	909.146903	100	912.180977	130	915.113915
11	903.179891	41	906.213965	71	909.248039	101	912.282113	131	915.316187
12	903.281026	42	906.315100	72	909.349175	102	912.383249	132	915.417323
13	903.382162	43	906.416236	73	909.450310	103	912.484384	133	915.518458
14	903.483298	44	906.517372	74	909.551446	104	912.585520	134	915.619594
15	903.584434	45	906.618508	75	909.652582	105	912.686656	135	915.720730
16	903.685570	46	906.719644	76	909.753718	106	912.787792	136	915.821866
17	903.786705	47	906.820779	77	909.854854	107	912.888928	137	915.923002
18	903.887841	48	906.921915	78	909.955989	108	912.990063	138	916.024138
19	903.988977	49	907.023051	79	910.057125	109	913.091199	139	916.125273
20	904.090113	50	907.124187	80	910.158261	110	913.192335	140	916.226409
21	904.191249	51	907.225323	81	910.259397	111	913.293471	141	916.327545
22	904.292384	52	907.326458	82	910.360533	112	913.394607	142	916.428681
23	904.393520	53	907.427594	83	910.461668	113	913.495742	143	916.529817
24	904.494656	54	907.528730	84	910.562804	114	913.596878	144	916.630952
25	904.595792	55	907.629866	85	910.663940	115	913.698014	145	916.732088
26	904.696928	56	907.731002	86	910.765076	116	913.799150	146	916.833224
27	904.798063	57	907.832138	87	910.866212	117	913.900286	147	916.934360
28	904.899199	58	907.933273	88	910.967347	118	914.001421	148	917.035496
29	905.000335	59	908.034409	89	911.068483	119	914.102557	149	917.136631
30	905.101471	60	908.135545	90	911.169619	120	914.203693	150	917.237767
31	905.202607	61	908.236681	91	911.270755	121	914.304829	151	917.338903



A D T

Ch.	Freq. (MHz)	Ch.	Freq. (MHz)	Ch.	Freq. (MHz)	Ch	Freq. (MHz)	Ch	Freq. (MHz)
152	917.440039	173	919.563891	194	921.687742	215	923.811594	236	925.935446
153	917.541175	174	919.665026	195	921.687742	216	923.912730	237	926.036582
154	917.642310	175	919.766162	196	921.890014	217	924.013866	238	926.137718
155	917.743446	176	919.867298	197	921.991150	218	924.115002	239	926.238854
156	917.844582	177	919.968434	198	922.092286	219	924.216138	240	926.339989
157	917.945718	178	920.069570	199	922.193421	220	924.317273	241	926.441125
158	918.046854	179	920.170705	200	922.294557	221	924.418409	242	926.542261
159	918.147989	180	920.271841	201	922.395693	222	924.519545	243	926.643397
160	918.249125	181	920.372977	202	922.496829	223	924.620681	244	926.744533
161	918.350261	182	920.474113	203	922.597965	224	924.721817	245	926.845668
162	918.451397	183	920.575249	204	922.699100	225	924.822952	246	926.946804
163	918.552533	184	920.676384	205	922.800236	226	924.924088	247	927.047940
164	918.653668	185	920.777520	206	922.901372	227	925.025224	248	927.149076
165	918.754804	186	920.878656	207	923.002508	228	925.126360	249	927.250212
166	918.855940	187	920.979792	208	923.103644	229	925.227496	250	927.351347
167	918.957076	188	921.080928	209	923.204779	230	925.328631	251	927.452483
168	919.058212	189	921.182063	210	923.305915	231	925.429767	252	927.553619
169	919.159347	190	921.283199	211	923.407051	232	925.530903	253	927.654755
170	919.260483	191	921.384335	212	923.508187	233	925.632039		
171	919.361619	192	921.485471	213	923.609323	234	925.733175		
172	919.462755	193	921.586607	214	923.710458	235	925.834310		

3.2.1 TEST MODE APPLICABILITY AND TESTED CHANNEL DETAIL

EUT CONFIGURE MODE	APPLICABLE TO				DESCRIPTION
	RE \geq 1G	RE<1G	PLC	APCM	
A	√	√	√	√	Base station
B	√	√	NOTE 3	√	Portable handset: Battery mode
C	NOTE 4	√	√	NOTE 4	Portable handset: Charge mode

Where **RE \geq 1G**: Radiated Emission above 1GHz **RE<1G**: Radiated Emission below 1GHz
PLC: Power Line Conducted Emission **APCM**: Antenna Port Conducted Measurement

NOTE:

- Base station:** The EUT had been pre-tested on the positioned of each 3 axis. The worst case was found when positioned on **Z-plane**.
- Portable handset:** The EUT had been pre-tested on the positioned of each 3 axis. The worst case was found when positioned on **X-plane**.
- No need to concern of Conducted Emission due to the EUT is powered by battery.
- The portable handset is on standby mode when charging.

RADIATED EMISSION TEST (ABOVE 1GHz):

- Pre-Scan has been conducted to determine the worst-case mode from all possible combinations between available modulations, data rates and antenna ports (if EUT with antenna diversity architecture).
- Following channel(s) was (were) selected for the final test as listed below.

EUT CONFIGURE MODE	AVAILABLE CHANNEL	TESTED CHANNEL	MODULATION TYPE
A, B	2 to 253	2, 127, 253	Differentially Encoded MSK

RADIATED EMISSION TEST (BELOW 1GHz):

- Pre-Scan has been conducted to determine the worst-case mode from all possible combinations between available modulations, data rates and antenna ports (if EUT with antenna diversity architecture).
- Following channel(s) was (were) selected for the final test as listed below.

EUT CONFIGURE MODE	AVAILABLE CHANNEL	TESTED CHANNEL	MODULATION TYPE
A, B, C	2 to 253	2, 127, 253	Differentially Encoded MSK

POWER LINE CONDUCTED EMISSION TEST:

- Pre-Scan has been conducted to determine the worst-case mode from all possible combinations between available modulations, data rates and antenna ports (if EUT with antenna diversity architecture).
- Following channel(s) was (were) selected for the final test as listed below.

EUT CONFIGURE MODE	AVAILABLE CHANNEL	TESTED CHANNEL	MODULATION TYPE
A, C	2 to 253	2	Differentially Encoded MSK

BANDEDGE MEASUREMENT:

- Pre-Scan has been conducted to determine the worst-case mode from all possible combinations between available modulations, data rates and antenna ports (if EUT with antenna diversity architecture).
- Following channel(s) was (were) selected for the final test as listed below.

EUT CONFIGURE MODE	AVAILABLE CHANNEL	TESTED CHANNEL	MODULATION TYPE
A, B	2 to 253	2, 253	Differentially Encoded MSK

ANTENNA PORT CONDUCTED MEASUREMENT:

- This item includes all test value of each mode, but only includes spectrum plot of worst value of each mode.
- Pre-Scan has been conducted to determine the worst-case mode from all possible combinations between available modulations, data rates and antenna ports (if EUT with antenna diversity architecture).
- Following channel(s) was (were) selected for the final test as listed below.

EUT CONFIGURE MODE	AVAILABLE CHANNEL	TESTED CHANNEL	MODULATION TYPE
A, B	2 to 253	2, 127, 253	Differentially Encoded MSK

TEST CONDITION:

APPLICABLE TO	TEST MODE	ENVIRONMENTAL CONDITIONS	INPUT POWER	TESTED BY
RE \geq 1G	A	22deg. C, 70%RH	120Vac, 60Hz	Anderson Hong
	B	22deg. C, 70%RH	3.7Vdc	Anderson Hong
RE $<$ 1G	A, C	22deg. C, 70%RH	120Vac, 60Hz	Anderson Hong
	B	22deg. C, 70%RH	3.7Vdc	Anderson Hong
PLC	A, C	25deg. C, 60%RH	120Vac, 60Hz	Hero Yang
APCM	A	22deg. C, 70%RH	120Vac, 60Hz	Anderson Hong
	B	22deg. C, 70%RH	3.7Vdc	Anderson Hong

3.3 DESCRIPTION OF SUPPORT UNITS

The EUT has been tested as an independent unit together with other necessary accessories or support units. The following support units or accessories were used to form a representative test configuration during the tests.

NO.	PRODUCT	BRAND	MODEL NO.	SERIAL NO.	FCC ID
1	TELEPHONE	WONDER	WD-303	5C17DA03132	NA
2	EARPHONE	Panasonic	KX-TCA400	NA	NA

NO.	SIGNAL CABLE DESCRIPTION OF THE ABOVE SUPPORT UNITS
1	1.8 m non-shielded cable, RJ11 connector, w/o core.
2	1.2m audio cable.

NOTE: All power cords of the above support units are non shielded (1.8m).

3.3.1 CONFIGURATION OF SYSTEM UNDER TEST

TEST MODE A (Base station)

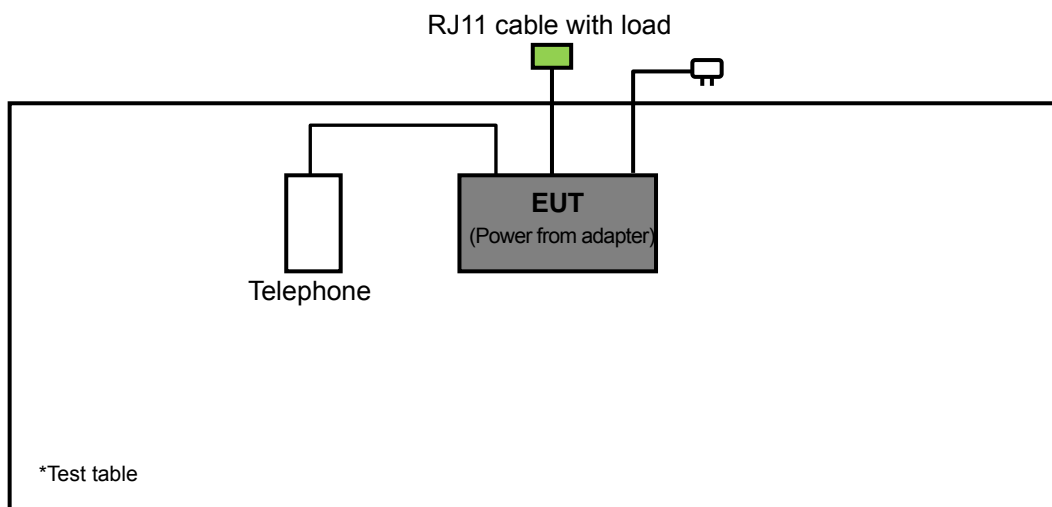

TEST MODE B (Portable handset: Battery mode)

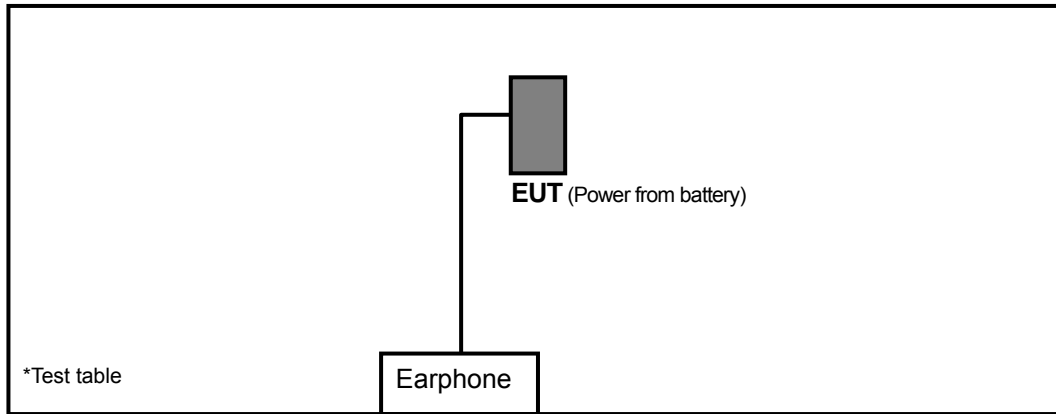

TEST MODE C (Portable handset: Charge mode)

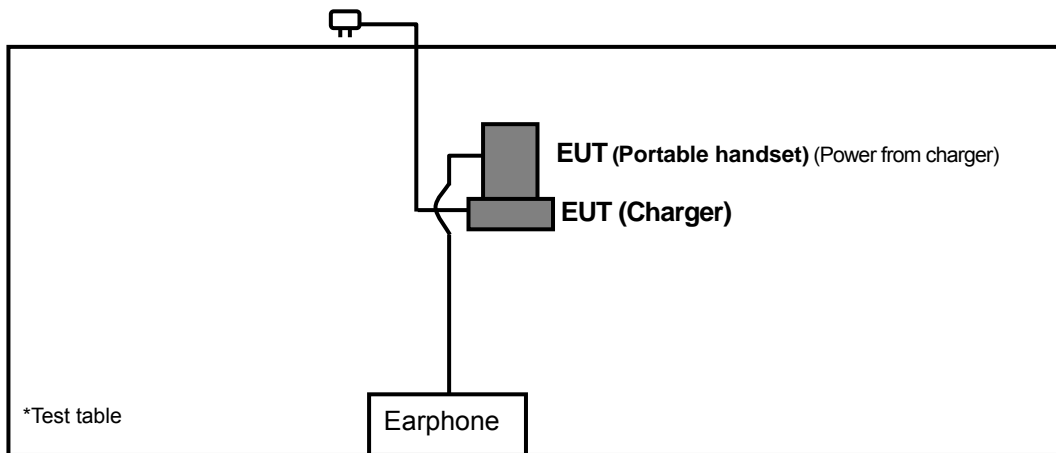



3.4 GENERAL DESCRIPTION OF APPLIED STANDARDS

The EUT is a RF Product. According to the specifications of the manufacturer, it must comply with the requirements of the following standards:

FCC Part 15, Subpart C (15.247)

ANSI C63.10-2009

All test items have been performed and recorded as per the above standards.

4. TEST TYPES AND RESULTS

4.1 RADIATED EMISSION AND BANDEDGE MEASUREMENT

4.1.1 LIMITS OF RADIATED EMISSION AND BANDEDGE MEASUREMENT

Emissions radiated outside of the specified bands, shall be according to the general radiated limits in 15.209 as following:

FREQUENCIES (MHz)	FIELD STRENGTH (microvolts/meter)	MEASUREMENT DISTANCE (meters)
0.009 ~ 0.490	2400/F(kHz)	300
0.490 ~ 1.705	24000/F(kHz)	30
1.705 ~ 30.0	30	30
30 ~ 88	100	3
88 ~ 216	150	3
216 ~ 960	200	3
Above 960	500	3

NOTE:

1. The lower limit shall apply at the transition frequencies.
2. Emission level (dBuV/m) = 20 log Emission level (uV/m).
3. As shown in 15.35(b), for frequencies above 1000MHz, the field strength limits are based on average detector, however, the peak field strength of any emission shall not exceed the maximum permitted average limits, specified above by more than 20dB under any condition of modulation.



4.1.2 TEST INSTRUMENTS

DESCRIPTION & MANUFACTURER	MODEL NO.	SERIAL NO.	DATE OF CALIBRATION	DUE DATE OF CALIBRATION
Test Receiver ROHDE & SCHWARZ	ESCI	100744	Apr. 19, 2012	Apr. 18, 2013
Spectrum Analyzer ROHDE & SCHWARZ	FSP40	100040	Aug. 04, 2011	Aug. 03, 2012
BILOG Antenna SCHWARZBECK	VULB9168	9168-156	Apr. 03, 2012	Apr. 02, 2013
HORN Antenna SCHWARZBECK	BBHA 9120 D	9120D-563	Sep. 06, 2011	Sep. 05, 2012
HORN Antenna SCHWARZBECK	BBHA 9170	148	Jul. 20, 2011	Jul. 19, 2012
Preamplifier Agilent	8449B	3008A01911	Oct. 29, 2011	Oct. 28, 2012
Preamplifier Agilent	8447D	2944A10638	Oct. 29, 2011	Oct. 28, 2012
RF signal cable HUBER+SUHNNER	SUCOFLEX 104	295013/4 283403/4	Aug. 19, 2011	Aug. 18, 2012
RF signal cable Worken	8D-FB	Cable-HYCH9-0 1	Aug. 13, 2011	Aug. 12, 2012
Software	ADT_Radiated_ V7.6.15.9.2	NA	NA	NA
Antenna Tower EMCO	2070/2080	512.835.4684	NA	NA
Turn Table EMCO	2087-2.03	NA	NA	NA
Antenna Tower & Turn Table Controller EMCO	2090	NA	NA	NA

- NOTE:**
1. The calibration interval of the above test instruments is 12 months and the calibrations are traceable to NML/ROC and NIST/USA.
 2. The test was performed in HwaYa Chamber 9.
 3. The horn antenna and HP preamplifier (model: 8449B) are used only for the measurement of emission frequency above 1GHz if tested.
 4. The FCC Site Registration No. is 460141.
 5. The IC Site Registration No. is IC 7450F-4.

4.1.3 TEST PROCEDURES

- a. The EUT was placed on the top of a rotating table 0.8 meters above the ground at a 3 meters semi-anechoic chamber. The table was rotated 360 degrees to determine the position of the highest radiation.
- b. The EUT was set 3 meters away from the interference-receiving antenna, which was mounted on the top of a variable-height antenna tower.
- c. Height of receiving antenna is varied from one meter to four meters above the ground to determine the maximum value of the field strength. Both horizontal and vertical polarizations of the antenna are set to make the measurement.
- d. For each suspected emission, the EUT was arranged to its worst case and then the antenna was tuned to heights from 1 meter to 4 meters and the rotatable table was turned from 0 degrees to 360 degrees to find the maximum reading.
- e. The test-receiver system was set to Peak Detect Function and Specified Bandwidth with Maximum Hold Mode.
- f. If the emission level of the EUT in peak mode was lower than the limit specified, then testing could be stopped and the peak values of the EUT would be reported. Otherwise the emissions would be re-tested one by one using peak, quasi-peak or average method as specified and then reported in a data sheet.

NOTE:

1. The resolution bandwidth and video bandwidth of test receiver/spectrum analyzer is 120kHz for Quasi-peak detection at frequency below 1GHz.
2. The resolution bandwidth of test receiver/spectrum analyzer is 1MHz and video bandwidth is 3MHz for Peak detection at frequency above 1GHz.
3. The resolution bandwidth of test receiver/spectrum analyzer is 1MHz and the video bandwidth is 10Hz for Average detection (AV) at frequency above 1GHz.
4. All modes of operation were investigated and the worst-case emissions are reported.

4.1.4 DEVIATION FROM TEST STANDARD

No deviation.

4.1.5 TEST SETUP

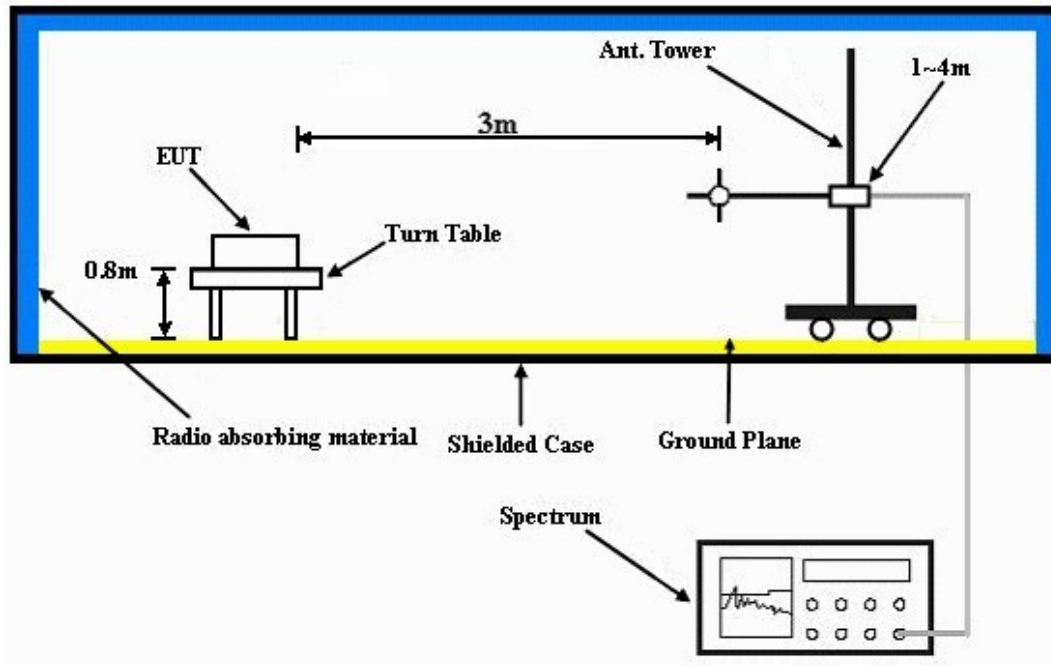

For the actual test configuration, please refer to the attached file (Test Setup Photo).

4.1.6 EUT OPERATING CONDITIONS

- a. Placed the EUT on a testing table.
- b. Set the EUT under transmission condition continuously at specific channel frequency.
- c. The necessary accessories enable the system in full functions.



A D T

4.1.7 TEST RESULTS

EUT TEST CONDITION		MEASUREMENT DETAIL	
CHANNEL	Channel 2	FREQUENCY RANGE	Below 1000MHz
INPUT POWER (SYSTEM)	120Vac, 60Hz	DETECTOR FUNCTION	Peak (PK) Average (AV)
ENVIRONMENTAL CONDITIONS	22deg. C, 70%RH	TESTED BY	Anderson Hong
TEST MODE	A		

ANTENNA POLARITY & TEST DISTANCE: HORIZONTAL AT 3 M								
NO.	FREQ. (MHz)	EMISSION LEVEL (dBuV/m)	LIMIT (dBuV/m)	MARGIN (dB)	ANTENNA HEIGHT (m)	TABLE ANGLE (Degree)	RAW VALUE (dBuV)	CORRECTION FACTOR (dB/m)
1	#902.00	59.9 PK	108.5	-48.6	2.02 H	207	33.60	26.30
2	#902.00	16.8 AV	77.9	-61.1	2.02 H	207	-9.50	26.30
3	*902.27	128.5 PK			1.36 H	53	102.20	26.30
4	*902.27	97.9 AV			1.36 H	53	71.60	26.30

ANTENNA POLARITY & TEST DISTANCE: VERTICAL AT 3 M								
NO.	FREQ. (MHz)	EMISSION LEVEL (dBuV/m)	LIMIT (dBuV/m)	MARGIN (dB)	ANTENNA HEIGHT (m)	TABLE ANGLE (Degree)	RAW VALUE (dBuV)	CORRECTION FACTOR (dB/m)
1	#902.00	59.5 PK	107.9	-48.4	1.00 V	341	33.20	26.30
2	#902.00	15.8 AV	77.3	-61.5	1.00 V	341	-10.50	26.30
3	*902.27	127.9 PK			1.00 V	264	101.60	26.30
4	*902.27	97.3 AV			1.00 V	264	-71.00	26.30

REMARKS:

1. Emission level (dBuV/m) = Raw Value (dBuV) + Correction Factor (dB/m).
2. Correction Factor (dB/m) = Antenna Factor (dB/m) + Cable Factor (dB).
3. The other emission levels were very low against the limit.
4. Margin value = Emission level – Limit value.
5. “ * “: Fundamental frequency.
6. "#":The radiated frequency is out the restricted band.
7. The average value of fundamental frequency is: Average = Peak value + 20log(Duty cycle) Where the duty factor is calculated from following formula:
 $20 \log (\text{Duty cycle}) = 20 \log (2.96 \text{ ms} / 100 \text{ ms}) = -30.6 \text{ dB}$
 Please see page 23 for plotted duty.



EUT TEST CONDITION		MEASUREMENT DETAIL	
CHANNEL	Channel 127	FREQUENCY RANGE	Below 1000MHz
INPUT POWER (SYSTEM)	120Vac, 60Hz	DETECTOR FUNCTION	Peak (PK) Average (AV)
ENVIRONMENTAL CONDITIONS	22deg. C, 70%RH	TESTED BY	Anderson Hong
TEST MODE	A		

ANTENNA POLARITY & TEST DISTANCE: HORIZONTAL AT 3 M

NO.	FREQ. (MHz)	EMISSION LEVEL (dBuV/m)	LIMIT (dBuV/m)	MARGIN (dB)	ANTENNA HEIGHT (m)	TABLE ANGLE (Degree)	RAW VALUE (dBuV)	CORRECTION FACTOR (dB/m)
1	#668.91	56.4 PK	106.5	-50.1	1.26 H	18	33.70	22.70
2	#668.91	27.0 AV	75.9	-48.9	1.26 H	18	4.30	22.70
3	#893.51	58.9 PK	106.5	-47.6	1.53 H	228	32.70	26.20
4	#893.51	39.1 AV	75.9	-36.8	1.53 H	228	12.90	26.20
5	#936.38	52.1 PK	106.5	-54.4	1.51 H	282	25.60	26.50
6	#936.38	32.4 AV	75.9	-43.5	1.51 H	282	25.60	26.50
7	*914.91	126.5 PK			1.34 H	56	100.10	26.40
8	*914.91	95.9 AV			1.34 H	56	69.50	26.40

ANTENNA POLARITY & TEST DISTANCE: VERTICAL AT 3 M

NO.	FREQ. (MHz)	EMISSION LEVEL (dBuV/m)	LIMIT (dBuV/m)	MARGIN (dB)	ANTENNA HEIGHT (m)	TABLE ANGLE (Degree)	RAW VALUE (dBuV)	CORRECTION FACTOR (dB/m)
1	#668.91	57.5 PK	105.7	-48.2	1.51 V	182	34.80	22.70
2	#668.91	25.8 AV	75.1	-49.3	1.51 V	182	3.10	22.70
3	#893.51	53.5 PK	105.7	-52.2	3.00 V	20	27.30	26.20
4	#893.51	32.8 AV	75.1	-42.3	3.00 V	20	6.6	26.20
5	#936.38	52.9 PK	105.7	-52.8	2.03 V	206	26.40	26.50
6	#936.38	32.9 AV	75.1	-42.2	2.03 V	206	6.40	26.50
7	*914.91	125.7 PK			1.00 V	305	99.30	26.40
8	*914.91	95.1 AV			1.00 V	305	68.70	26.40

REMARKS:

- Emission level (dBuV/m) = Raw Value (dBuV) + Correction Factor (dB/m).
- Correction Factor (dB/m) = Antenna Factor (dB/m) + Cable Factor (dB).
- The other emission levels were very low against the limit.
- Margin value = Emission level – Limit value.
- " * ": Fundamental frequency.
- "#":The radiated frequency is out the restricted band.
- The average value of fundamental frequency is: Average = Peak value + 20log(Duty cycle) Where the duty factor is calculated from following formula:

$$20 \log (\text{Duty cycle}) = 20 \log (2.96 \text{ ms} / 100 \text{ ms}) = -30.6 \text{ dB}$$
 Please see page 23 for plotted duty.



A D T

EUT TEST CONDITION		MEASUREMENT DETAIL	
CHANNEL	Channel 253	FREQUENCY RANGE	Below 1000MHz
INPUT POWER (SYSTEM)	120Vac, 60Hz	DETECTOR FUNCTION	Peak (PK) Average (AV)
ENVIRONMENTAL CONDITIONS	22deg. C, 70%RH	TESTED BY	Anderson Hong
TEST MODE	A		

ANTENNA POLARITY & TEST DISTANCE: HORIZONTAL AT 3 M								
NO.	FREQ. (MHz)	EMISSION LEVEL (dBuV/m)	LIMIT (dBuV/m)	MARGIN (dB)	ANTENNA HEIGHT (m)	TABLE ANGLE (Degree)	RAW VALUE (dBuV)	CORRECTION FACTOR (dB/m)
1	#681.65	58.8 PK	108.2	-49.4	2.18 H	22	36.10	22.70
2	#681.65	26.0 AV	77.6	-51.6	2.18 H	22	39.20	22.70
3	#928.00	65.7 PK	108.2	-42.5	1.25 H	273	39.20	26.50
4	#928.00	16.5 AV	77.6	-61.1	1.25 H	273	-10.00	26.50
5	#949.12	52.9 PK	108.2	-55.3	1.98 H	214	26.30	26.60
6	#949.12	34.8 AV	77.6	-42.8	1.98 H	214	8.20	26.60
7	*927.65	128.2 PK			1.28 H	54	101.70	26.50
8	*927.65	97.6 AV			1.28 H	54	71.10	26.50
ANTENNA POLARITY & TEST DISTANCE: VERTICAL AT 3 M								
NO.	FREQ. (MHz)	EMISSION LEVEL (dBuV/m)	LIMIT (dBuV/m)	MARGIN (dB)	ANTENNA HEIGHT (m)	TABLE ANGLE (Degree)	RAW VALUE (dBuV)	CORRECTION FACTOR (dB/m)
1	#681.65	53.8 PK	106.5	-52.7	1.55 V	229	31.10	22.70
2	#681.65	22.9 AV	75.9	-53.0	1.55 V	229	-0.2	22.70
3	#928.00	67.9 PK	106.5	-38.6	2.00 V	211	41.40	26.50
4	#928.00	18.5 AV	75.9	-57.4	2.00 V	211	-8.0	26.50
5	#949.12	57.0 PK	106.5	-49.5	2.02 V	197	30.40	26.60
6	#949.12	39.0 AV	75.9	-36.9	2.02 V	197	12.4	26.60
7	*927.65	126.5 PK			1.33 V	317	100.00	26.50
8	*927.65	95.9 AV			1.33 V	317	69.4	26.50

REMARKS:

1. Emission level (dBuV/m) = Raw Value (dBuV) + Correction Factor (dB/m).
2. Correction Factor (dB/m) = Antenna Factor (dB/m) + Cable Factor (dB).
3. The other emission levels were very low against the limit.
4. Margin value = Emission level – Limit value.
5. “ * “: Fundamental frequency.
6. "#":The radiated frequency is out the restricted band.
7. The average value of fundamental frequency is: Average = Peak value + 20log(Duty cycle) Where the duty factor is calculated from following formula:

$$20 \log (\text{Duty cycle}) = 20 \log (2.96 \text{ ms} / 100 \text{ ms}) = -30.6 \text{ dB}$$
 Please see page 23 for plotted duty.



A D T

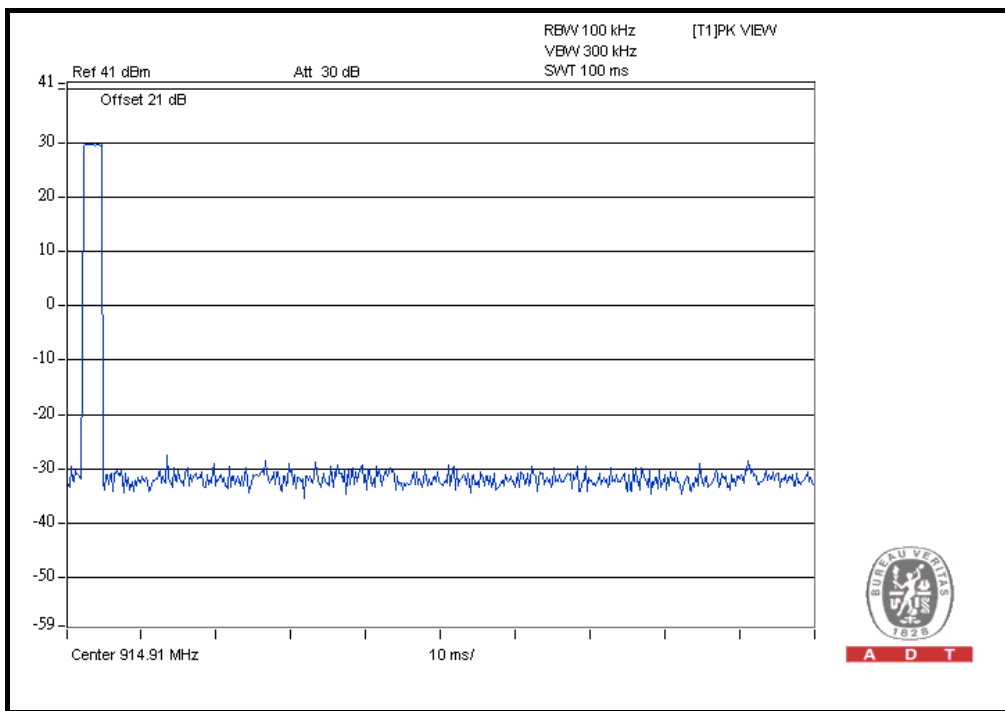
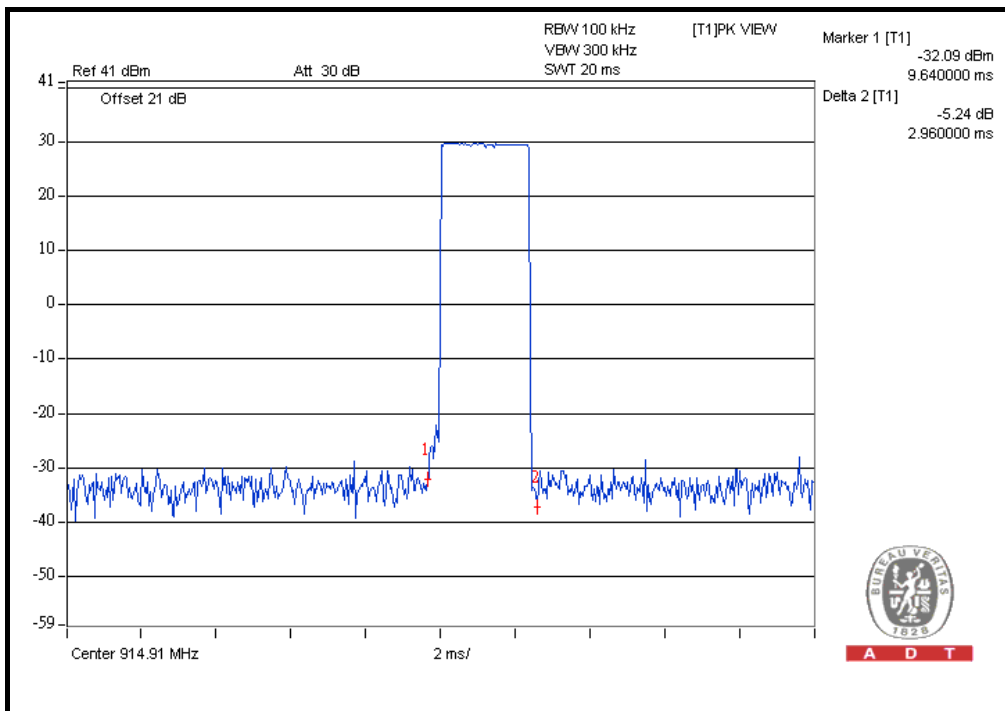

$$20 \log (\text{Duty cycle}) = 20 \log (2.96 \text{ ms} / 100 \text{ ms}) = -30.6 \text{ dB}$$



A D T

ABOVE 1GHz DATA

EUT TEST CONDITION		MEASUREMENT DETAIL	
CHANNEL	Channel 2	FREQUENCY RANGE	1 ~ 10GHz
INPUT POWER (SYSTEM)	120Vac, 60Hz	DETECTOR FUNCTION	Peak (PK) Average (AV)
ENVIRONMENTAL CONDITIONS	22deg. C, 70%RH	TESTED BY	Anderson Hong
TEST MODE	A		

ANTENNA POLARITY & TEST DISTANCE: HORIZONTAL AT 3 M

NO.	FREQ. (MHz)	EMISSION LEVEL (dBuV/m)	LIMIT (dBuV/m)	MARGIN (dB)	ANTENNA HEIGHT (m)	TABLE ANGLE (Degree)	RAW VALUE (dBuV)	CORRECTION FACTOR (dB/m)
1	#1804.54	43.8 PK	74.0	-30.2	1.08 H	225	14.50	29.30
2	#1804.54	13.2 AV	54.0	-40.8	1.08 H	225	-16.10	29.30
3	2706.81	44.5 PK	74.0	-29.5	1.64 H	42	12.10	32.40
4	2706.81	13.9 AV	54.0	-40.1	1.64 H	42	-18.50	32.40
5	4511.35	49.3 PK	74.0	-24.7	1.21 H	27	12.70	36.60
6	4511.35	18.7 AV	54.0	-35.3	1.21 H	27	-17.90	36.60

ANTENNA POLARITY & TEST DISTANCE: VERTICAL AT 3 M

NO.	FREQ. (MHz)	EMISSION LEVEL (dBuV/m)	LIMIT (dBuV/m)	MARGIN (dB)	ANTENNA HEIGHT (m)	TABLE ANGLE (Degree)	RAW VALUE (dBuV)	CORRECTION FACTOR (dB/m)
1	#1804.54	46.1 PK	74.0	-27.9	1.00 V	180	16.80	29.30
2	#1804.54	15.5 AV	54.0	-38.5	1.00 V	180	-13.80	29.30
3	2706.81	42.6 PK	74.0	-31.4	1.00 V	339	10.20	32.40
4	2706.81	12.0 AV	54.0	-42.0	1.00 V	339	-20.40	32.40
5	4511.35	48.1 PK	74.0	-25.9	1.41 V	13	11.50	36.60
6	4511.35	17.5 AV	54.0	-36.5	1.41 V	13	-19.10	36.60

REMARKS:

1. Emission level (dBuV/m) = Raw Value (dBuV) + Correction Factor (dB/m).
2. Correction Factor (dB/m) = Antenna Factor (dB/m) + Cable Factor (dB).
3. The other emission levels were very low against the limit.
4. Margin value = Emission level – Limit value.
5. "#":The radiated frequency is out the restricted band.



A D T

EUT TEST CONDITION		MEASUREMENT DETAIL	
CHANNEL	Channel 127	FREQUENCY RANGE	1 ~ 10GHz
INPUT POWER (SYSTEM)	120Vac, 60Hz	DETECTOR FUNCTION	Peak (PK) Average (AV)
ENVIRONMENTAL CONDITIONS	22deg. C, 70%RH	TESTED BY	Anderson Hong
TEST MODE	A		

ANTENNA POLARITY & TEST DISTANCE: HORIZONTAL AT 3 M								
NO.	FREQ. (MHz)	EMISSION LEVEL (dBuV/m)	LIMIT (dBuV/m)	MARGIN (dB)	ANTENNA HEIGHT (m)	TABLE ANGLE (Degree)	RAW VALUE (dBuV)	CORRECTION FACTOR (dB/m)
1	#1829.82	44.9 PK	74.0	-29.1	1.05 H	221	15.50	29.40
2	#1829.82	14.3 AV	54.0	-39.7	1.05 H	221	-15.10	29.40
3	2744.73	45.7 PK	74.0	-28.3	1.60 H	39	13.20	32.50
4	2744.73	15.1 AV	54.0	-38.9	1.60 H	39	-17.40	32.50
5	7319.28	60.7 PK	74.0	-13.3	1.00 H	19	16.90	43.80
6	7319.28	30.1 AV	54.0	-23.9	1.00 H	19	-13.70	43.80
ANTENNA POLARITY & TEST DISTANCE: VERTICAL AT 3 M								
NO.	FREQ. (MHz)	EMISSION LEVEL (dBuV/m)	LIMIT (dBuV/m)	MARGIN (dB)	ANTENNA HEIGHT (m)	TABLE ANGLE (Degree)	RAW VALUE (dBuV)	CORRECTION FACTOR (dB/m)
1	#1829.82	47.3 PK	74.0	-26.7	1.00 V	183	17.90	29.40
2	#1829.82	16.7 AV	54.0	-37.3	1.00 V	183	-12.70	29.40
3	2744.73	43.7 PK	74.0	-30.3	1.00 V	341	11.20	32.50
4	2744.73	13.1 AV	54.0	-40.9	1.00 V	341	-19.40	32.50
5	7319.28	59.6 PK	74.0	-14.4	1.00 V	23	15.80	43.80
6	7319.28	29.0 AV	54.0	-25.0	1.00 V	23	-14.80	43.80

REMARKS:

1. Emission level (dBuV/m) = Raw Value (dBuV) + Correction Factor (dB/m).
2. Correction Factor (dB/m) = Antenna Factor (dB/m) + Cable Factor (dB).
3. The other emission levels were very low against the limit.
4. Margin value = Emission level – Limit value.
5. "#":The radiated frequency is out the restricted band.



A D T

EUT TEST CONDITION		MEASUREMENT DETAIL	
CHANNEL	Channel 253	FREQUENCY RANGE	1 ~ 10GHz
INPUT POWER (SYSTEM)	120Vac, 60Hz	DETECTOR FUNCTION	Peak (PK) Average (AV)
ENVIRONMENTAL CONDITIONS	22deg. C, 70%RH	TESTED BY	Anderson Hong
TEST MODE	A		

ANTENNA POLARITY & TEST DISTANCE: HORIZONTAL AT 3 M								
NO.	FREQ. (MHz)	EMISSION LEVEL (dBuV/m)	LIMIT (dBuV/m)	MARGIN (dB)	ANTENNA HEIGHT (m)	TABLE ANGLE (Degree)	RAW VALUE (dBuV)	CORRECTION FACTOR (dB/m)
1	#1855.30	44.2 PK	74.0	-29.8	1.04 H	221	14.70	29.50
2	#1855.30	13.6 AV	54.0	-40.4	1.04 H	221	-15.90	29.50
3	2782.95	44.9 PK	74.0	-29.1	1.61 H	39	12.30	32.60
4	2782.95	14.3 AV	54.0	-39.7	1.61 H	39	-18.30	32.60
5	7421.20	59.7 PK	74.0	-14.3	1.00 H	25	15.70	44.00
6	7421.20	29.1 AV	54.0	-24.9	1.00 H	25	-14.90	44.00
ANTENNA POLARITY & TEST DISTANCE: VERTICAL AT 3 M								
NO.	FREQ. (MHz)	EMISSION LEVEL (dBuV/m)	LIMIT (dBuV/m)	MARGIN (dB)	ANTENNA HEIGHT (m)	TABLE ANGLE (Degree)	RAW VALUE (dBuV)	CORRECTION FACTOR (dB/m)
1	#1855.30	46.5 PK	74.0	-27.5	1.02 V	176	17.00	29.50
2	#1855.30	15.9 AV	54.0	-38.1	1.02 V	176	-13.60	29.50
3	2782.95	43.0 PK	74.0	-31.0	1.01 V	335	10.40	32.60
4	2782.95	12.4 AV	54.0	-41.6	1.01 V	335	-20.20	32.60
5	7421.20	58.6 PK	74.0	-15.4	1.00 V	19	14.60	44.00
6	7421.20	28.0 AV	54.0	-26.0	1.00 V	19	-16.00	44.00

REMARKS:

1. Emission level (dBuV/m) = Raw Value (dBuV) + Correction Factor (dB/m).
2. Correction Factor (dB/m) = Antenna Factor (dB/m) + Cable Factor (dB).
3. The other emission levels were very low against the limit.
4. Margin value = Emission level – Limit value.
5. "#":The radiated frequency is out the restricted band.



A D T

BELOW 1GHz WORST-CASE DATA

EUT TEST CONDITION		MEASUREMENT DETAIL	
CHANNEL	Channel 2	FREQUENCY RANGE	Below 1000MHz
INPUT POWER (SYSTEM)	120Vac, 60Hz	DETECTOR FUNCTION	Quasi-Peak
ENVIRONMENTAL CONDITIONS	22deg. C, 70%RH	TESTED BY	Anderson Hong
TEST MODE	A		

ANTENNA POLARITY & TEST DISTANCE: HORIZONTAL AT 3 M								
NO.	FREQ. (MHz)	EMISSION LEVEL (dBuV/m)	LIMIT (dBuV/m)	MARGIN (dB)	ANTENNA HEIGHT (m)	TABLE ANGLE (Degree)	RAW VALUE (dBuV)	CORRECTION FACTOR (dB/m)
1	187.07	32.8 QP	43.5	-10.7	2.00 H	17	20.60	12.20
2	317.08	36.8 QP	46.0	-9.2	1.00 H	288	21.50	15.30
3	656.65	44.7 QP	46.0	-1.3	2.00 H	349	22.10	22.60
4	823.52	36.8 QP	46.0	-9.2	1.50 H	188	11.30	25.50
5	891.44	44.8 QP	46.0	-1.2	1.25 H	17	18.60	26.20
6	934.13	39.8 QP	46.0	-6.2	1.25 H	280	13.30	26.50
ANTENNA POLARITY & TEST DISTANCE: VERTICAL AT 3 M								
NO.	FREQ. (MHz)	EMISSION LEVEL (dBuV/m)	LIMIT (dBuV/m)	MARGIN (dB)	ANTENNA HEIGHT (m)	TABLE ANGLE (Degree)	RAW VALUE (dBuV)	CORRECTION FACTOR (dB/m)
1	189.01	27.8 QP	43.5	-15.7	1.00 V	3	15.80	12.00
2	350.07	30.6 QP	46.0	-15.4	1.25 V	262	14.40	16.20
3	656.65	39.3 QP	46.0	-6.7	3.00 V	192	16.70	22.60
4	823.52	40.6 QP	46.0	-5.4	1.00 V	23	15.10	25.50
5	837.11	39.7 QP	46.0	-6.3	1.00 V	267	14.10	25.60
6	936.07	45.0 QP	46.0	-1.0	2.00 V	17	18.50	26.50

REMARKS:

1. Emission level (dBuV/m) = Raw Value (dBuV) + Correction Factor (dB/m).
2. Correction Factor (dB/m) = Antenna Factor (dB/m) + Cable Factor (dB).
3. The other emission levels were very low against the limit.
4. Margin value = Emission level – Limit value.



A D T

EUT TEST CONDITION		MEASUREMENT DETAIL	
CHANNEL	Channel 127	FREQUENCY RANGE	Below 1000MHz
INPUT POWER (SYSTEM)	120Vac, 60Hz	DETECTOR FUNCTION	Quasi-Peak
ENVIRONMENTAL CONDITIONS	22deg. C, 70%RH	TESTED BY	Anderson Hong
TEST MODE	A		

ANTENNA POLARITY & TEST DISTANCE: HORIZONTAL AT 3 M								
NO.	FREQ. (MHz)	EMISSION LEVEL (dBuV/m)	LIMIT (dBuV/m)	MARGIN (dB)	ANTENNA HEIGHT (m)	TABLE ANGLE (Degree)	RAW VALUE (dBuV)	CORRECTION FACTOR (dB/m)
1	187.07	33.2 QP	43.5	-10.3	1.25 H	17	21.00	12.20
2	237.52	34.4 QP	46.0	-11.6	1.00 H	251	21.80	12.60
3	286.03	33.0 QP	46.0	-13.0	1.00 H	269	18.60	14.40
4	324.84	34.5 QP	46.0	-11.5	1.00 H	276	19.00	15.50
5	825.46	43.6 QP	46.0	-2.4	2.00 H	17	18.10	25.50
6	858.45	38.9 QP	46.0	-7.1	1.50 H	231	13.10	25.80

ANTENNA POLARITY & TEST DISTANCE: VERTICAL AT 3 M								
NO.	FREQ. (MHz)	EMISSION LEVEL (dBuV/m)	LIMIT (dBuV/m)	MARGIN (dB)	ANTENNA HEIGHT (m)	TABLE ANGLE (Degree)	RAW VALUE (dBuV)	CORRECTION FACTOR (dB/m)
1	68.71	22.8 QP	40.0	-17.2	1.00 V	191	10.20	12.60
2	189.01	26.1 QP	43.5	-17.4	1.00 V	9	14.10	12.00
3	338.42	30.5 QP	46.0	-15.5	1.25 V	225	14.60	15.90
4	357.83	29.7 QP	46.0	-16.3	1.25 V	242	13.30	16.40
5	825.46	44.1 QP	46.0	-1.9	1.25 V	17	18.60	25.50
6	967.11	38.1 QP	54.0	-15.9	1.25 V	349	11.30	26.80

REMARKS:

1. Emission level (dBuV/m) = Raw Value (dBuV) + Correction Factor (dB/m).
2. Correction Factor (dB/m) = Antenna Factor (dB/m) + Cable Factor (dB).
3. The other emission levels were very low against the limit.
4. Margin value = Emission level – Limit value.



A D T

EUT TEST CONDITION		MEASUREMENT DETAIL	
CHANNEL	Channel 253	FREQUENCY RANGE	Below 1000MHz
INPUT POWER (SYSTEM)	120Vac, 60Hz	DETECTOR FUNCTION	Quasi-Peak
ENVIRONMENTAL CONDITIONS	22deg. C, 70%RH	TESTED BY	Anderson Hong
TEST MODE	A		

ANTENNA POLARITY & TEST DISTANCE: HORIZONTAL AT 3 M								
NO.	FREQ. (MHz)	EMISSION LEVEL (dBuV/m)	LIMIT (dBuV/m)	MARGIN (dB)	ANTENNA HEIGHT (m)	TABLE ANGLE (Degree)	RAW VALUE (dBuV)	CORRECTION FACTOR (dB/m)
1	187.07	32.9 QP	43.5	-10.6	1.25 H	8	20.70	12.20
2	317.08	35.5 QP	46.0	-10.5	1.00 H	297	20.20	15.30
3	740.09	32.7 QP	46.0	-13.3	1.50 H	8	8.90	23.80
4	828.91	36.9 QP	46.0	-9.1	1.00 H	200	11.40	25.50
5	875.91	40.7 QP	46.0	-5.3	1.00 H	197	14.70	26.00
6	949.55	43.5 QP	46.0	-2.5	1.97 H	207	16.80	26.70
ANTENNA POLARITY & TEST DISTANCE: VERTICAL AT 3 M								
NO.	FREQ. (MHz)	EMISSION LEVEL (dBuV/m)	LIMIT (dBuV/m)	MARGIN (dB)	ANTENNA HEIGHT (m)	TABLE ANGLE (Degree)	RAW VALUE (dBuV)	CORRECTION FACTOR (dB/m)
1	189.01	26.5 QP	43.5	-17.0	1.25 V	30	14.50	12.00
2	295.73	31.1 QP	46.0	-14.9	1.25 V	325	16.40	14.70
3	598.44	28.9 QP	46.0	-17.1	1.25 V	243	6.60	22.30
4	681.87	42.0 QP	46.0	-4.0	1.25 V	257	19.30	22.70
5	827.40	44.8 QP	46.0	-1.2	1.00 V	165	19.30	25.50
6	873.97	41.0 QP	46.0	-5.0	1.00 V	319	15.00	26.00

REMARKS:

1. Emission level (dBuV/m) = Raw Value (dBuV) + Correction Factor (dB/m).
2. Correction Factor (dB/m) = Antenna Factor (dB/m) + Cable Factor (dB).
3. The other emission levels were very low against the limit.
4. Margin value = Emission level – Limit value.



A D T

EUT TEST CONDITION		MEASUREMENT DETAIL	
CHANNEL	Channel 2	FREQUENCY RANGE	Below 1000MHz
INPUT POWER (SYSTEM)	120Vac, 60Hz	DETECTOR FUNCTION	Peak (PK) Average (AV)
ENVIRONMENTAL CONDITIONS	22deg. C, 70%RH	TESTED BY	Anderson Hong
TEST MODE	B		

ANTENNA POLARITY & TEST DISTANCE: HORIZONTAL AT 3 M								
NO.	FREQ. (MHz)	EMISSION LEVEL (dBuV/m)	LIMIT (dBuV/m)	MARGIN (dB)	ANTENNA HEIGHT (m)	TABLE ANGLE (Degree)	RAW VALUE (dBuV)	CORRECTION FACTOR (dB/m)
1	#902.00	51.5 PK	110.2	-58.7	1.27 H	54	25.20	26.30
2	#902.00	13.0 AV	79.6	-66.6	1.27 H	54	-13.30	26.30
3	*902.27	130.2 PK			1.39 H	302	103.90	26.30
4	*902.27	99.6 AV			1.39 H	302	73.30	26.30
ANTENNA POLARITY & TEST DISTANCE: VERTICAL AT 3 M								
NO.	FREQ. (MHz)	EMISSION LEVEL (dBuV/m)	LIMIT (dBuV/m)	MARGIN (dB)	ANTENNA HEIGHT (m)	TABLE ANGLE (Degree)	RAW VALUE (dBuV)	CORRECTION FACTOR (dB/m)
1	#902.00	51.2 PK	101.4	-50.2	1.47 V	12	24.90	26.30
2	#902.00	12.5 AV	70.8	-58.3	1.47 V	12	-13.80	26.30
3	*902.27	121.4 PK			1.48 V	6	95.10	26.30
4	*902.27	90.8 AV			1.48 V	6	64.50	26.30

REMARKS:

- Emission level (dBuV/m) = Raw Value (dBuV) + Correction Factor (dB/m).
- Correction Factor (dB/m) = Antenna Factor (dB/m) + Cable Factor (dB).
- The other emission levels were very low against the limit.
- Margin value = Emission level – Limit value.
- " * ": Fundamental frequency.
- "#":The radiated frequency is out the restricted band.
- The average value of fundamental frequency is: Average = Peak value + 20log(Duty cycle) Where the duty factor is calculated from following formula:

$$20 \log (\text{Duty cycle}) = 20 \log (2.96 \text{ ms} / 100 \text{ ms}) = -30.6 \text{ dB}$$
 Please see page 33 for plotted duty.



EUT TEST CONDITION		MEASUREMENT DETAIL	
CHANNEL	Channel 127	FREQUENCY RANGE	Below 1000MHz
INPUT POWER (SYSTEM)	120Vac, 60Hz	DETECTOR FUNCTION	Peak (PK) Average (AV)
ENVIRONMENTAL CONDITIONS	22deg. C, 70%RH	TESTED BY	Anderson Hong
TEST MODE	B		

ANTENNA POLARITY & TEST DISTANCE: HORIZONTAL AT 3 M

NO.	FREQ. (MHz)	EMISSION LEVEL (dBuV/m)	LIMIT (dBuV/m)	MARGIN (dB)	ANTENNA HEIGHT (m)	TABLE ANGLE (Degree)	RAW VALUE (dBuV)	CORRECTION FACTOR (dB/m)
1	#930.46	54.9 PK	111.3	-56.4	1.24 H	306	28.40	26.50
2	#930.46	35.6 AV	80.7	-45.1	1.24 H	306	9.10	26.50
3	*914.91	131.3 PK			1.34 H	302	104.90	26.40
4	*914.91	100.7 AV			1.34 H	302	74.3	26.40

ANTENNA POLARITY & TEST DISTANCE: VERTICAL AT 3 M

NO.	FREQ. (MHz)	EMISSION LEVEL (dBuV/m)	LIMIT (dBuV/m)	MARGIN (dB)	ANTENNA HEIGHT (m)	TABLE ANGLE (Degree)	RAW VALUE (dBuV)	CORRECTION FACTOR (dB/m)
1	#930.46	52.8 PK	103.4	-50.6	1.50 V	6	26.30	26.50
2	#930.46	35.1 AV	72.8	-37.7	1.50 V	6	8.6	26.50
3	*914.91	123.4 PK			1.47 V	5	97.00	26.40
4	*914.91	92.8 AV			1.47 V	5	66.4	26.40

REMARKS:

- Emission level (dBuV/m) = Raw Value (dBuV) + Correction Factor (dB/m).
- Correction Factor (dB/m) = Antenna Factor (dB/m) + Cable Factor (dB).
- The other emission levels were very low against the limit.
- Margin value = Emission level – Limit value.
- “ * “: Fundamental frequency.
- “ # “: The radiated frequency is out the restricted band.
- The average value of fundamental frequency is: Average = Peak value + 20log(Duty cycle) Where the duty factor is calculated from following formula:
 $20 \log (\text{Duty cycle}) = 20 \log (2.96 \text{ ms} / 100 \text{ ms}) = -30.6 \text{ dB}$
 Please see page 33 for plotted duty.



A D T

EUT TEST CONDITION		MEASUREMENT DETAIL	
CHANNEL	Channel 253	FREQUENCY RANGE	Below 1000MHz
INPUT POWER (SYSTEM)	120Vac, 60Hz	DETECTOR FUNCTION	Peak (PK) Average (AV)
ENVIRONMENTAL CONDITIONS	22deg. C, 70%RH	TESTED BY	Anderson Hong
TEST MODE	B		

ANTENNA POLARITY & TEST DISTANCE: HORIZONTAL AT 3 M

NO.	FREQ. (MHz)	EMISSION LEVEL (dBuV/m)	LIMIT (dBuV/m)	MARGIN (dB)	ANTENNA HEIGHT (m)	TABLE ANGLE (Degree)	RAW VALUE (dBuV)	CORRECTION FACTOR (dB/m)
1	#928.00	71.3 PK	110.3	-39.0	1.41 H	63	44.80	26.50
2	#928.00	18.2 AV	79.7	-61.5	1.41 H	63	-8.30	26.50
3	*927.65	130.3 PK			1.33 H	303	103.80	26.50
4	*927.65	99.7 AV			1.33 H	303	73.20	26.50

ANTENNA POLARITY & TEST DISTANCE: VERTICAL AT 3 M

NO.	FREQ. (MHz)	EMISSION LEVEL (dBuV/m)	LIMIT (dBuV/m)	MARGIN (dB)	ANTENNA HEIGHT (m)	TABLE ANGLE (Degree)	RAW VALUE (dBuV)	CORRECTION FACTOR (dB/m)
1	#928.00	66.9 PK	102.6	-35.7	1.47 V	5	40.40	26.50
2	#928.00	15.3 AV	72.0	-56.7	1.47 V	5	-11.2	26.50
3	*927.65	122.6 PK			1.44 V	4	96.10	26.50
4	*927.65	92.0 AV			1.44 V	4	65.50	26.50

REMARKS:

- Emission level (dBuV/m) = Raw Value (dBuV) + Correction Factor (dB/m).
- Correction Factor (dB/m) = Antenna Factor (dB/m) + Cable Factor (dB).
- The other emission levels were very low against the limit.
- Margin value = Emission level – Limit value.
- " * ": Fundamental frequency.
- "#": The radiated frequency is out the restricted band.
- The average value of fundamental frequency is: Average = Peak value + 20log(Duty cycle) Where the duty factor is calculated from following formula:

$$20 \log (\text{Duty cycle}) = 20 \log (2.96 \text{ ms} / 100 \text{ ms}) = -30.6 \text{ dB}$$
 Please see page 33 for plotted duty.



A D T

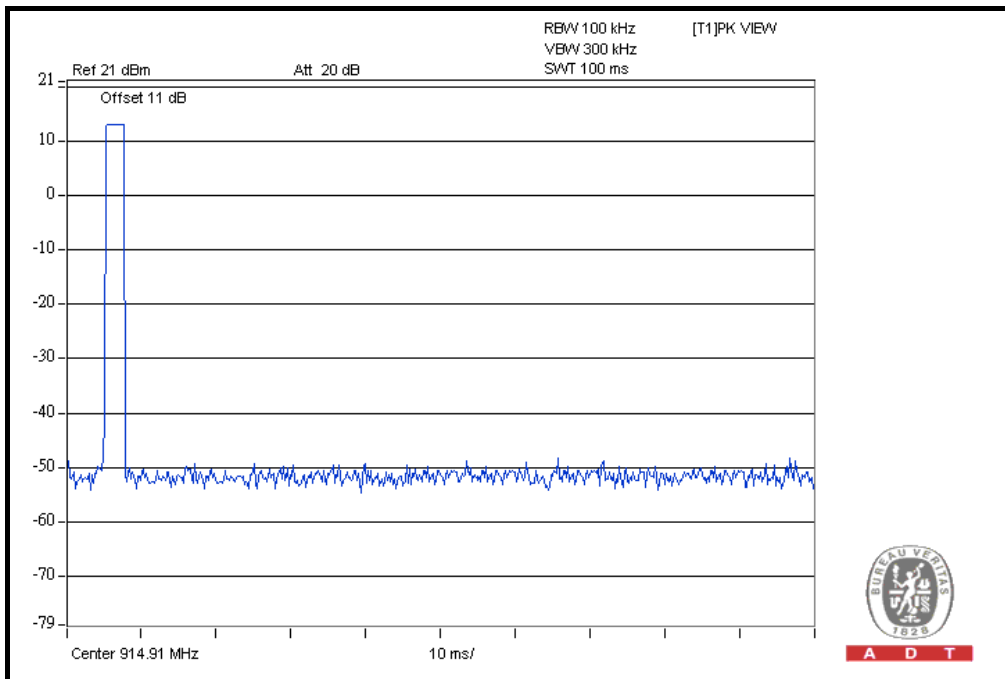
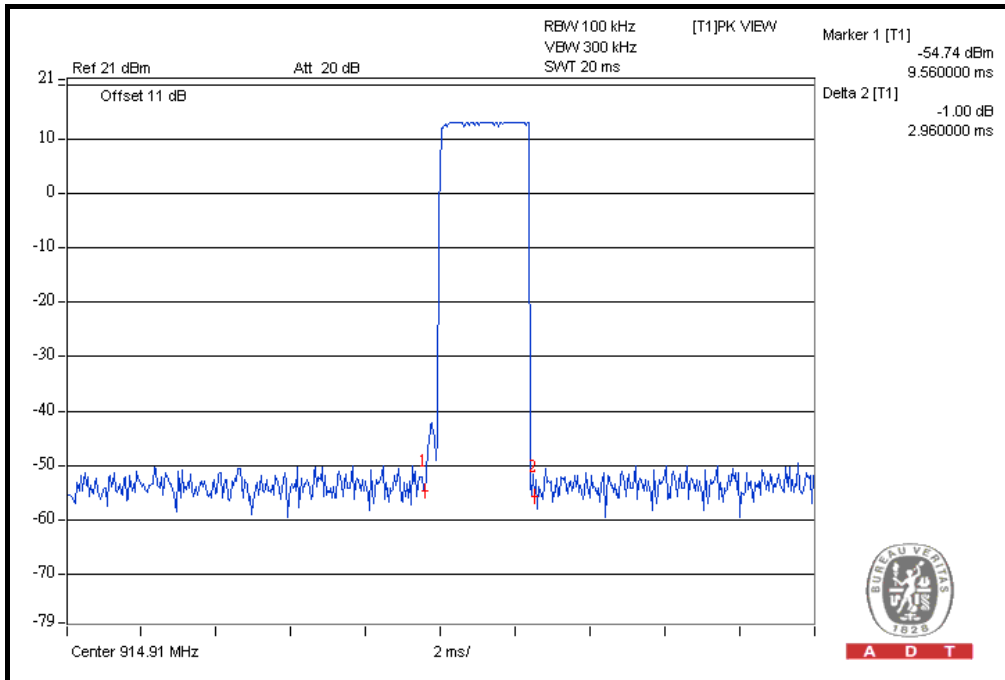

$$20 \log (\text{Duty cycle}) = 20 \log (2.96 \text{ ms} / 100 \text{ ms}) = -30.6 \text{ dB}$$



A D T

ABOVE 1GHz DATA

EUT TEST CONDITION		MEASUREMENT DETAIL	
CHANNEL	Channel 2	FREQUENCY RANGE	1 ~ 10GHz
INPUT POWER (SYSTEM)	120Vac, 60Hz	DETECTOR FUNCTION	Peak (PK) Average (AV)
ENVIRONMENTAL CONDITIONS	22deg. C, 70%RH	TESTED BY	Anderson Hong
TEST MODE	B		

ANTENNA POLARITY & TEST DISTANCE: HORIZONTAL AT 3 M

NO.	FREQ. (MHz)	EMISSION LEVEL (dBuV/m)	LIMIT (dBuV/m)	MARGIN (dB)	ANTENNA HEIGHT (m)	TABLE ANGLE (Degree)	RAW VALUE (dBuV)	CORRECTION FACTOR (dB/m)
1	#1804.54	41.3 PK	74.0	-32.7	1.00 H	80	12.00	29.30
2	#1804.54	10.7 AV	54.0	-43.3	1.00 H	80	-18.60	29.30
3	2706.81	44.4 PK	74.0	-29.6	1.35 H	28	12.00	32.40
4	2706.81	13.8 AV	54.0	-40.2	1.35 H	28	-18.60	32.40
5	3609.08	46.4 PK	74.0	-27.6	1.05 H	264	12.00	34.40
6	3609.08	15.8 AV	54.0	-38.2	1.05 H	264	-18.60	34.40

ANTENNA POLARITY & TEST DISTANCE: VERTICAL AT 3 M

NO.	FREQ. (MHz)	EMISSION LEVEL (dBuV/m)	LIMIT (dBuV/m)	MARGIN (dB)	ANTENNA HEIGHT (m)	TABLE ANGLE (Degree)	RAW VALUE (dBuV)	CORRECTION FACTOR (dB/m)
1	#1804.54	41.4 PK	74.0	-32.6	1.00 V	346	12.10	29.30
2	#1804.54	10.8 AV	54.0	-43.2	1.00 V	346	-18.50	29.30
3	2706.81	45.9 PK	74.0	-28.1	1.08 V	283	13.50	32.40
4	2706.81	15.3 AV	54.0	-38.7	1.08 V	283	-17.10	32.40
5	3609.08	45.1 PK	74.0	-28.9	1.00 V	335	10.70	34.40
6	3609.08	14.5 AV	54.0	-39.5	1.00 V	335	-19.90	34.40

REMARKS:

1. Emission level (dBuV/m) = Raw Value (dBuV) + Correction Factor (dB/m).
2. Correction Factor (dB/m) = Antenna Factor (dB/m) + Cable Factor (dB).
3. The other emission levels were very low against the limit.
4. Margin value = Emission level – Limit value.
5. "#":The radiated frequency is out the restricted band.



A D T

EUT TEST CONDITION		MEASUREMENT DETAIL	
CHANNEL	Channel 127	FREQUENCY RANGE	1 ~ 10GHz
INPUT POWER (SYSTEM)	120Vac, 60Hz	DETECTOR FUNCTION	Peak (PK) Average (AV)
ENVIRONMENTAL CONDITIONS	22deg. C, 70%RH	TESTED BY	Anderson Hong
TEST MODE	B		

ANTENNA POLARITY & TEST DISTANCE: HORIZONTAL AT 3 M								
NO.	FREQ. (MHz)	EMISSION LEVEL (dBuV/m)	LIMIT (dBuV/m)	MARGIN (dB)	ANTENNA HEIGHT (m)	TABLE ANGLE (Degree)	RAW VALUE (dBuV)	CORRECTION FACTOR (dB/m)
1	#1829.82	41.7 PK	74.0	-32.3	1.02 H	83	12.30	29.40
2	#1829.82	11.1 AV	54.0	-42.9	1.02 H	83	-18.30	29.40
3	2744.73	44.7 PK	74.0	-29.3	1.31 H	24	12.20	32.50
4	2744.73	14.1 AV	54.0	-39.9	1.31 H	24	-18.40	32.50
5	3659.64	47.5 PK	74.0	-26.5	1.09 H	268	13.00	34.50
6	3659.64	16.9 AV	54.0	-37.1	1.09 H	268	-17.60	34.50
ANTENNA POLARITY & TEST DISTANCE: VERTICAL AT 3 M								
NO.	FREQ. (MHz)	EMISSION LEVEL (dBuV/m)	LIMIT (dBuV/m)	MARGIN (dB)	ANTENNA HEIGHT (m)	TABLE ANGLE (Degree)	RAW VALUE (dBuV)	CORRECTION FACTOR (dB/m)
1	#1829.82	42.2 PK	74.0	-31.8	1.31 V	85	12.80	29.40
2	#1829.82	11.6 AV	54.0	-42.4	1.31 V	85	-17.80	29.40
3	2744.73	44.7 PK	74.0	-29.3	1.15 V	280	12.20	32.50
4	2744.73	14.1 AV	54.0	-39.9	1.15 V	280	-18.40	32.50
5	3659.64	46.3 PK	74.0	-27.7	1.00 V	332	11.80	34.50
6	3659.64	15.7 AV	54.0	-38.3	1.00 V	332	-18.80	34.50

REMARKS:

1. Emission level (dBuV/m) = Raw Value (dBuV) + Correction Factor (dB/m).
2. Correction Factor (dB/m) = Antenna Factor (dB/m) + Cable Factor (dB).
3. The other emission levels were very low against the limit.
4. Margin value = Emission level – Limit value.
5. "#":The radiated frequency is out the restricted band.



A D T

EUT TEST CONDITION		MEASUREMENT DETAIL	
CHANNEL	Channel 253	FREQUENCY RANGE	1 ~ 10GHz
INPUT POWER (SYSTEM)	120Vac, 60Hz	DETECTOR FUNCTION	Peak (PK) Average (AV)
ENVIRONMENTAL CONDITIONS	22deg. C, 70%RH	TESTED BY	Anderson Hong
TEST MODE	B		

ANTENNA POLARITY & TEST DISTANCE: HORIZONTAL AT 3 M

NO.	FREQ. (MHz)	EMISSION LEVEL (dBuV/m)	LIMIT (dBuV/m)	MARGIN (dB)	ANTENNA HEIGHT (m)	TABLE ANGLE (Degree)	RAW VALUE (dBuV)	CORRECTION FACTOR (dB/m)
1	#1855.30	42.3 PK	74.0	-31.7	1.00 H	79	12.80	29.50
2	#1855.30	11.7 AV	54.0	-42.3	1.00 H	79	-17.80	29.50
3	2782.95	45.4 PK	74.0	-28.6	1.29 H	27	12.80	32.60
4	2782.95	14.8 AV	54.0	-39.2	1.29 H	27	-17.80	32.60
5	3710.60	46.7 PK	74.0	-27.3	1.08 H	261	12.00	34.70
6	3710.60	16.1 AV	54.0	-37.9	1.08 H	261	-18.60	34.70

ANTENNA POLARITY & TEST DISTANCE: VERTICAL AT 3 M

NO.	FREQ. (MHz)	EMISSION LEVEL (dBuV/m)	LIMIT (dBuV/m)	MARGIN (dB)	ANTENNA HEIGHT (m)	TABLE ANGLE (Degree)	RAW VALUE (dBuV)	CORRECTION FACTOR (dB/m)
1	#1855.30	42.6 PK	74.0	-31.4	1.32 V	90	13.10	29.50
2	#1855.30	12.0 AV	54.0	-42.0	1.32 V	90	-17.50	29.50
3	2782.95	44.4 PK	74.0	-29.6	1.11 V	278	11.80	32.60
4	2782.95	13.8 AV	54.0	-40.2	1.11 V	278	-18.80	32.60
5	3710.60	45.5 PK	74.0	-28.5	1.00 V	330	10.80	34.70
6	3710.60	14.9 AV	54.0	-39.1	1.00 V	330	-19.80	34.70

REMARKS:

1. Emission level (dBuV/m) = Raw Value (dBuV) + Correction Factor (dB/m).
2. Correction Factor (dB/m) = Antenna Factor (dB/m) + Cable Factor (dB).
3. The other emission levels were very low against the limit.
4. Margin value = Emission level – Limit value.
5. "#": The radiated frequency is out the restricted band.



A D T

BELOW 1GHz WORST-CASE DATA

EUT TEST CONDITION		MEASUREMENT DETAIL	
CHANNEL	Channel 2	FREQUENCY RANGE	Below 1000MHz
INPUT POWER (SYSTEM)	120Vac, 60Hz	DETECTOR FUNCTION	Quasi-Peak
ENVIRONMENTAL CONDITIONS	22deg. C, 70%RH	TESTED BY	Anderson Hong
TEST MODE	B		

ANTENNA POLARITY & TEST DISTANCE: HORIZONTAL AT 3 M								
NO.	FREQ. (MHz)	EMISSION LEVEL (dBuV/m)	LIMIT (dBuV/m)	MARGIN (dB)	ANTENNA HEIGHT (m)	TABLE ANGLE (Degree)	RAW VALUE (dBuV)	CORRECTION FACTOR (dB/m)
1	245.28	24.2 QP	46.0	-21.8	1.25 H	96	11.30	12.90
2	656.65	44.3 QP	46.0	-1.7	1.25 H	84	21.70	22.60
3	809.94	38.5 QP	46.0	-7.5	1.50 H	309	13.20	25.30
4	829.34	40.2 QP	46.0	-5.8	1.50 H	81	14.70	25.50
5	874.01	44.8 QP	46.0	-1.2	1.25 H	71	18.80	26.00
6	939.95	40.6 QP	46.0	-5.4	1.25 H	314	14.00	26.60
ANTENNA POLARITY & TEST DISTANCE: VERTICAL AT 3 M								
NO.	FREQ. (MHz)	EMISSION LEVEL (dBuV/m)	LIMIT (dBuV/m)	MARGIN (dB)	ANTENNA HEIGHT (m)	TABLE ANGLE (Degree)	RAW VALUE (dBuV)	CORRECTION FACTOR (dB/m)
1	189.01	26.1 QP	43.5	-17.4	1.50 V	3	14.10	12.00
2	295.73	22.8 QP	46.0	-23.2	1.00 V	103	8.10	14.70
3	656.65	35.8 QP	46.0	-10.2	1.50 V	3	13.20	22.60
4	821.58	35.0 QP	46.0	-11.0	2.00 V	17	9.50	25.50
5	873.97	40.5 QP	46.0	-5.5	1.50 V	11	14.50	26.00
6	930.54	44.9 QP	46.0	-1.1	2.46 V	8	18.40	26.50

REMARKS:

1. Emission level (dBuV/m) = Raw Value (dBuV) + Correction Factor (dB/m).
2. Correction Factor (dB/m) = Antenna Factor (dB/m) + Cable Factor (dB).
3. The other emission levels were very low against the limit.
4. Margin value = Emission level – Limit value.



A D T

EUT TEST CONDITION		MEASUREMENT DETAIL	
CHANNEL	Channel 127	FREQUENCY RANGE	Below 1000MHz
INPUT POWER (SYSTEM)	120Vac, 60Hz	DETECTOR FUNCTION	Quasi-Peak
ENVIRONMENTAL CONDITIONS	22deg. C, 70%RH	TESTED BY	Anderson Hong
TEST MODE	B		

ANTENNA POLARITY & TEST DISTANCE: HORIZONTAL AT 3 M								
NO.	FREQ. (MHz)	EMISSION LEVEL (dBuV/m)	LIMIT (dBuV/m)	MARGIN (dB)	ANTENNA HEIGHT (m)	TABLE ANGLE (Degree)	RAW VALUE (dBuV)	CORRECTION FACTOR (dB/m)
1	189.01	19.1 QP	43.5	-24.4	1.25 H	17	7.10	12.00
2	245.28	24.6 QP	46.0	-21.4	1.25 H	258	11.70	12.90
3	295.73	20.4 QP	46.0	-25.6	2.00 H	13	5.70	14.70
4	670.23	44.8 QP	46.0	-1.2	1.00 H	92	22.10	22.70
5	902.00	44.9 QP	46.0	-1.1	1.51 H	52	18.60	26.30
6	935.50	44.8 QP	46.0	-1.2	1.24 H	307	18.30	26.50

ANTENNA POLARITY & TEST DISTANCE: VERTICAL AT 3 M								
NO.	FREQ. (MHz)	EMISSION LEVEL (dBuV/m)	LIMIT (dBuV/m)	MARGIN (dB)	ANTENNA HEIGHT (m)	TABLE ANGLE (Degree)	RAW VALUE (dBuV)	CORRECTION FACTOR (dB/m)
1	189.01	25.6 QP	43.5	-17.9	1.25 V	16	13.60	12.00
2	243.34	21.2 QP	46.0	-24.8	1.00 V	123	8.40	12.80
3	295.73	22.7 QP	46.0	-23.3	1.00 V	105	8.00	14.70
4	670.23	36.6 QP	46.0	-9.4	1.25 V	6	13.90	22.70
5	809.94	32.1 QP	46.0	-13.9	2.00 V	17	6.80	25.30
6	846.81	33.8 QP	46.0	-12.2	2.00 V	10	8.10	25.70

REMARKS:

1. Emission level (dBuV/m) = Raw Value (dBuV) + Correction Factor (dB/m).
2. Correction Factor (dB/m) = Antenna Factor (dB/m) + Cable Factor (dB).
3. The other emission levels were very low against the limit.
4. Margin value = Emission level – Limit value.



A D T

EUT TEST CONDITION		MEASUREMENT DETAIL	
CHANNEL	Channel 253	FREQUENCY RANGE	Below 1000MHz
INPUT POWER (SYSTEM)	120Vac, 60Hz	DETECTOR FUNCTION	Quasi-Peak
ENVIRONMENTAL CONDITIONS	22deg. C, 70%RH	TESTED BY	Anderson Hong
TEST MODE	B		

ANTENNA POLARITY & TEST DISTANCE: HORIZONTAL AT 3 M								
NO.	FREQ. (MHz)	EMISSION LEVEL (dBuV/m)	LIMIT (dBuV/m)	MARGIN (dB)	ANTENNA HEIGHT (m)	TABLE ANGLE (Degree)	RAW VALUE (dBuV)	CORRECTION FACTOR (dB/m)
1	431.56	28.3 QP	46.0	-17.7	2.50 H	17	10.00	18.30
2	681.87	44.7 QP	46.0	-1.3	2.00 H	270	22.00	22.70
3	813.82	38.5 QP	46.0	-7.5	1.50 H	282	13.10	25.40
4	872.03	41.2 QP	46.0	-4.8	1.50 H	292	15.20	26.00
5	899.20	45.0 QP	46.0	-1.0	1.50 H	316	18.70	26.30
6	953.53	44.7 QP	46.0	-1.3	1.50 H	307	18.00	26.70
ANTENNA POLARITY & TEST DISTANCE: VERTICAL AT 3 M								
NO.	FREQ. (MHz)	EMISSION LEVEL (dBuV/m)	LIMIT (dBuV/m)	MARGIN (dB)	ANTENNA HEIGHT (m)	TABLE ANGLE (Degree)	RAW VALUE (dBuV)	CORRECTION FACTOR (dB/m)
1	189.01	25.1 QP	43.5	-18.4	1.50 V	213	13.10	12.00
2	295.73	22.8 QP	46.0	-23.2	1.25 V	119	8.10	14.70
3	681.87	36.6 QP	46.0	-9.4	1.00 V	325	13.90	22.70
4	827.40	33.8 QP	46.0	-12.2	2.00 V	6	8.30	25.50
5	872.03	36.5 QP	46.0	-9.5	2.00 V	6	10.50	26.00
6	899.20	44.1 QP	46.0	-1.9	1.50 V	11	17.80	26.30

REMARKS:

1. Emission level (dBuV/m) = Raw Value (dBuV) + Correction Factor (dB/m).
2. Correction Factor (dB/m) = Antenna Factor (dB/m) + Cable Factor (dB).
3. The other emission levels were very low against the limit.
4. Margin value = Emission level – Limit value.



A D T

BELOW 1GHz WORST-CASE DATA

EUT TEST CONDITION		MEASUREMENT DETAIL	
INPUT POWER (SYSTEM)	120Vac, 60Hz	FREQUENCY RANGE	Below 1000MHz
ENVIRONMENTAL CONDITIONS	22deg. C, 70%RH	DETECTOR FUNCTION	Quasi-Peak
TESTED BY	Anderson Hong	TEST MODE	C

ANTENNA POLARITY & TEST DISTANCE: HORIZONTAL AT 3 M								
NO.	FREQ. (MHz)	EMISSION LEVEL (dBuV/m)	LIMIT (dBuV/m)	MARGIN (dB)	ANTENNA HEIGHT (m)	TABLE ANGLE (Degree)	RAW VALUE (dBuV)	CORRECTION FACTOR (dB/m)
1	66.77	25.2 QP	40.0	-14.8	1.00 H	83	12.40	12.80
2	173.49	25.5 QP	43.5	-18.0	1.50 H	285	12.20	13.30
3	425.74	24.9 QP	46.0	-21.1	2.00 H	247	6.80	18.10
4	443.21	25.8 QP	46.0	-20.2	1.50 H	252	7.20	18.60
5	491.72	28.1 QP	46.0	-17.9	1.50 H	222	8.20	19.90
6	544.11	27.6 QP	46.0	-18.4	1.00 H	7	6.50	21.10

ANTENNA POLARITY & TEST DISTANCE: VERTICAL AT 3 M								
NO.	FREQ. (MHz)	EMISSION LEVEL (dBuV/m)	LIMIT (dBuV/m)	MARGIN (dB)	ANTENNA HEIGHT (m)	TABLE ANGLE (Degree)	RAW VALUE (dBuV)	CORRECTION FACTOR (dB/m)
1	66.86	30.5 QP	40.0	-9.5	1.00 V	196	17.80	12.70
2	189.08	27.7 QP	43.5	-15.8	1.25 V	228	15.70	12.00
3	243.40	23.2 QP	46.0	-22.8	1.00 V	16	10.40	12.80
4	295.78	23.7 QP	46.0	-22.3	1.25 V	312	9.00	14.70
5	392.78	24.6 QP	46.0	-21.4	1.50 V	289	7.30	17.30
6	491.72	25.1 QP	46.0	-20.9	1.00 V	184	5.20	19.90

REMARKS:

1. Emission level (dBuV/m) = Raw Value (dBuV) + Correction Factor (dB/m).
2. Correction Factor (dB/m) = Antenna Factor (dB/m) + Cable Factor (dB).
3. The other emission levels were very low against the limit.
4. Margin value = Emission level – Limit value.

4.2 CONDUCTED EMISSION MEASUREMENT

4.2.1 LIMITS OF CONDUCTED EMISSION MEASUREMENT

FREQUENCY OF EMISSION (MHz)	CONDUCTED LIMIT (dB μ V)	
	Quasi-peak	Average
0.15 ~ 0.5	66 to 56	56 to 46
0.5 ~ 5	56	46
5 ~ 30	60	50

- NOTE:** 1. The lower limit shall apply at the transition frequencies.
2. The limit decreases in line with the logarithm of the frequency in the range of 0.15 to 0.50MHz.
3. All emanations from a class A/B digital device or system, including any network of conductors and apparatus connected thereto, shall not exceed the level of field strengths specified above.

4.2.2 TEST INSTRUMENTS

DESCRIPTION & MANUFACTURER	MODEL NO.	SERIAL NO.	DATE OF CALIBRATION	DUE DATE OF CALIBRATION
Test Receiver ROHDE & SCHWARZ	ESCS30	100291	Nov. 23, 2011	Nov. 22, 2012
RF signal cable Woken	5D-FB	Cable-HYC01-01	Dec. 29, 2011	Dec. 28, 2012
LISN ROHDE & SCHWARZ (Peripheral)	ESH3-Z5	100312	Jul. 02, 2012	Jul. 01, 2013
LISN ROHDE & SCHWARZ (EUT)	ESH3-Z5	835239/001	Feb. 07, 2012	Feb. 06, 2013
Software ADT	BV ADT_Cond_ V7.3.7.3	NA	NA	NA

- NOTE:** 1. The calibration interval of the above test instruments is 12 months and the calibrations are traceable to NML/ROC and NIST/USA.
2. The test was performed in HwaYa Shielded Room 1.
3. The VCCI Site Registration No. is C-2040.

4.2.3 TEST PROCEDURES

- a. The EUT was placed 0.4 meters from the conducting wall of the shielded room with EUT being connected to the power mains through a line impedance stabilization network (LISN). Other support units were connected to the power mains through another LISN. The two LISNs provide 50 ohm/ 50uH of coupling impedance for the measuring instrument.
- b. Both lines of the power mains connected to the EUT were checked for maximum conducted interference.
- c. The frequency range from 150kHz to 30MHz was searched. Emission levels under (Limit - 20dB) was not recorded.

NOTE: All modes of operation were investigated and the worst-case emissions are reported.

4.2.4 DEVIATION FROM TEST STANDARD

No deviation.

4.2.5 TEST SETUP

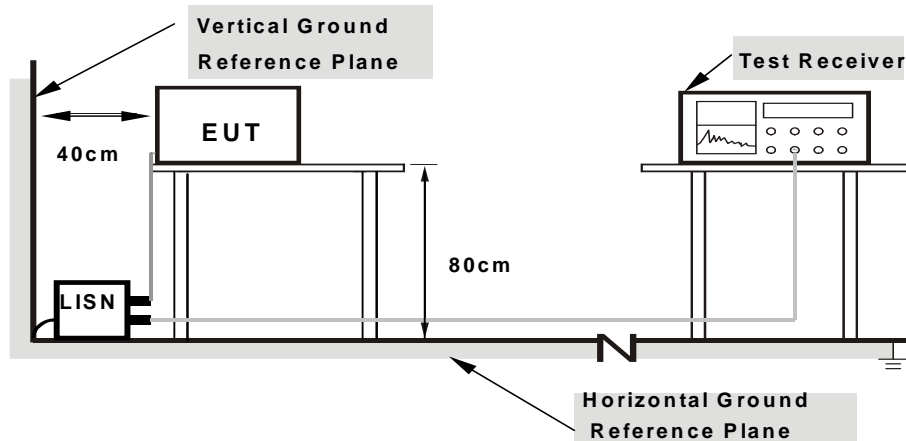

- Note:**
1. Support units were connected to second LISN.
 2. Both of LISNs (AMN) are 80 cm from EUT and at least 80 from other units and other metal planes

For the actual test configuration, please refer to the attached file (Test Setup Photo).

4.2.6 EUT OPERATING CONDITIONS

Same as 4.1.6.

4.2.7 TEST RESULTS

CONDUCTED WORST-CASE DATA :

PHASE	Line 1	6dB BANDWIDTH	9kHz
TEST MODE	A		

No	Freq. [MHz]	Corr. Factor (dB)	Reading Value		Emission Level		Limit		Margin	
			[dB (uV)]		[dB (uV)]		[dB (uV)]		(dB)	
			Q.P.	AV.	Q.P.	AV.	Q.P.	AV.	Q.P.	AV.
1	0.16172	0.16	48.04	30.09	48.20	30.25	65.38	55.38	-17.18	-25.13
2	0.18906	0.21	45.23	28.28	45.44	28.49	64.08	54.08	-18.64	-25.59
3	0.20859	0.23	42.23	22.93	42.46	23.16	63.26	53.26	-20.80	-30.10
4	0.31016	0.19	35.75	18.38	35.94	18.57	59.97	49.97	-24.02	-31.39
5	0.77109	0.19	20.05	7.50	20.24	7.69	56.00	46.00	-35.76	-38.31
6	12.16016	0.64	12.72	-0.87	13.36	-0.23	60.00	50.00	-46.64	-50.23

REMARKS:

1. Q.P. and AV. are abbreviations of quasi-peak and average individually.
2. The emission levels of other frequencies were very low against the limit.
3. Margin value = Emission level - Limit value
4. Correction factor = Insertion loss + Cable loss
5. Emission Level = Correction Factor + Reading Value.

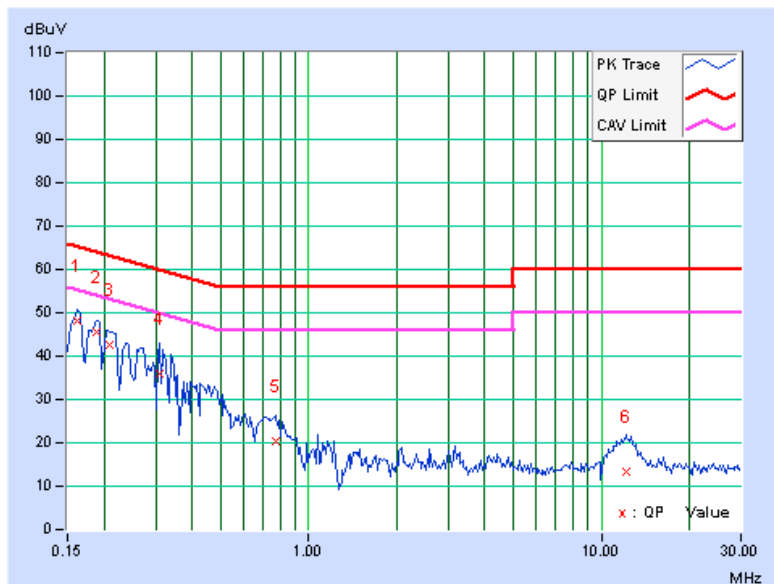

PHASE	Line 2	6dB BANDWIDTH	9kHz
TEST MODE	A		

No	Freq. [MHz]	Corr. Factor (dB)	Reading Value		Emission Level		Limit		Margin	
			[dB (uV)]		[dB (uV)]		[dB (uV)]		(dB)	
			Q.P.	AV.	Q.P.	AV.	Q.P.	AV.	Q.P.	AV.
1	0.16172	0.25	49.34	31.67	49.59	31.92	65.38	55.38	-15.78	-23.45
2	0.18906	0.29	46.50	29.05	46.79	29.34	64.08	54.08	-17.28	-24.73
3	0.21250	0.31	43.94	26.12	44.25	26.43	63.11	53.11	-18.86	-26.68
4	0.23792	0.30	40.46	21.99	40.76	22.29	62.17	52.17	-21.41	-29.88
5	0.32578	0.27	37.11	22.62	37.38	22.89	59.56	49.56	-22.18	-26.67
6	11.33594	0.70	16.04	2.41	16.74	3.11	60.00	50.00	-43.26	-46.89

REMARKS:

1. Q.P. and AV. are abbreviations of quasi-peak and average individually.
2. The emission levels of other frequencies were very low against the limit.
3. Margin value = Emission level - Limit value
4. Correction factor = Insertion loss + Cable loss
5. Emission Level = Correction Factor + Reading Value.

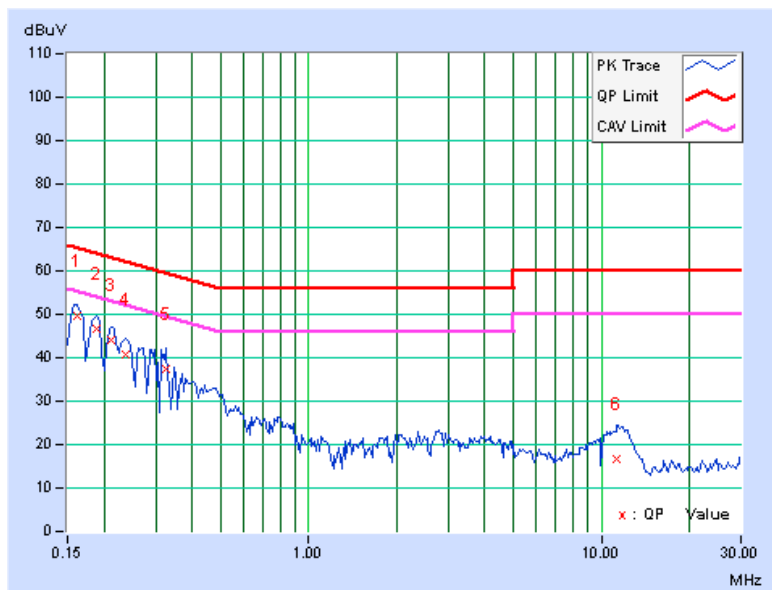

PHASE	Line 1	6dB BANDWIDTH	9kHz
TEST MODE	C		

No	Freq. [MHz]	Corr. Factor (dB)	Reading Value		Emission Level		Limit		Margin	
			[dB (uV)]		[dB (uV)]		[dB (uV)]		(dB)	
			Q.P.	AV.	Q.P.	AV.	Q.P.	AV.	Q.P.	AV.
1	0.15253	0.14	40.19	25.38	40.33	25.52	65.86	55.86	-25.53	-30.34
2	0.18528	0.20	45.77	25.16	45.97	25.36	64.25	54.25	-18.27	-28.88
3	0.19297	0.22	46.91	28.29	47.13	28.51	63.91	53.91	-16.78	-25.40
4	0.23203	0.22	41.82	22.87	42.04	23.09	62.38	52.38	-20.34	-29.29
5	0.33718	0.18	38.42	29.41	38.60	29.59	59.27	49.27	-20.67	-19.68
6	3.82422	0.33	23.93	6.19	24.26	6.52	56.00	46.00	-31.74	-39.48

REMARKS:

1. Q.P. and AV. are abbreviations of quasi-peak and average individually.
2. The emission levels of other frequencies were very low against the limit.
3. Margin value = Emission level - Limit value
4. Correction factor = Insertion loss + Cable loss
5. Emission Level = Correction Factor + Reading Value.

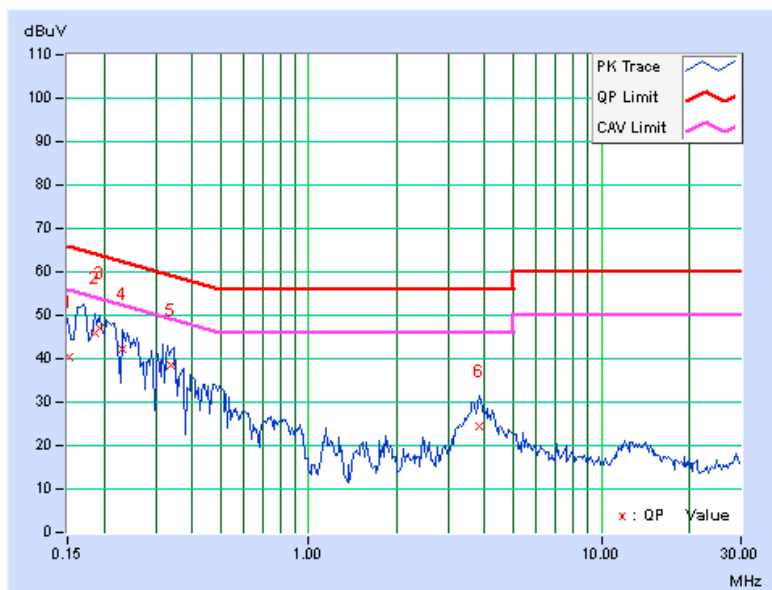

PHASE	Line 2	6dB BANDWIDTH	9kHz
TEST MODE	C		

No	Freq. [MHz]	Corr. Factor (dB)	Reading Value		Emission Level		Limit		Margin	
			[dB (uV)]		[dB (uV)]		[dB (uV)]		(dB)	
			Q.P.	AV.	Q.P.	AV.	Q.P.	AV.	Q.P.	AV.
1	0.15440	0.24	36.58	20.98	36.82	21.22	65.76	55.76	-28.94	-34.54
2	0.19687	0.31	43.89	20.95	44.20	21.26	63.74	53.74	-19.55	-32.49
3	0.21641	0.31	43.88	24.18	44.19	24.49	62.96	52.96	-18.77	-28.47
4	0.32568	0.27	37.67	18.59	37.94	18.86	59.56	49.56	-21.62	-30.70
5	3.71094	0.43	24.91	11.90	25.34	12.33	56.00	46.00	-30.66	-33.67
6	12.16406	0.72	17.32	5.42	18.04	6.14	60.00	50.00	-41.96	-43.86

REMARKS:

1. Q.P. and AV. are abbreviations of quasi-peak and average individually.
2. The emission levels of other frequencies were very low against the limit.
3. Margin value = Emission level - Limit value
4. Correction factor = Insertion loss + Cable loss
5. Emission Level = Correction Factor + Reading Value.

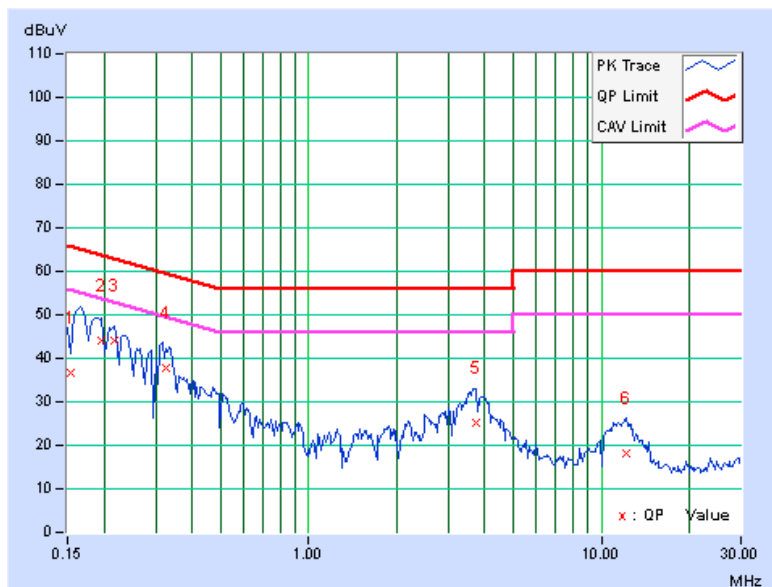

4.3 NUMBER OF HOPPING FREQUENCY USED

4.3.1 LIMIT OF HOPPING FREQUENCY USED

At least 50 channels frequencies, and should be equally spaced.

4.3.2 TEST SETUP

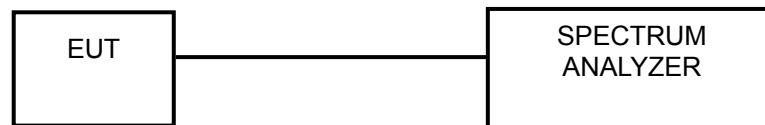

4.3.3 TEST INSTRUMENTS

Refer to section 4.1.2 to get information of above instrument.

4.3.4 TEST PROCEDURES

- a. Check the calibration of the measuring instrument (SA) using either an internal calibrator or a known signal from an external generator.
- b. Turn on the EUT and connect its antenna terminal to measurement via a low loss cable. Then set it to any one measured frequency within its operating range and make sure the instrument is operated in its linear range.
- c. Set the SA on MaxHold Mode, and then keep the EUT in hopping mode. Record all the signals from each channel until each one has been recorded.
- d. Set the SA on View mode and then plot the result on SA screen.
- e. Repeat above procedures until all frequencies measured were complete.

4.3.5 DEVIATION FROM TEST STANDARD

No deviation.

4.3.6 TEST RESULTS

There are 252 hopping frequencies in the hopping mode. Please refer to next page for the test result. On the plots, it shows that the hopping frequencies are equally spaced.



A D T

TEST MODE A

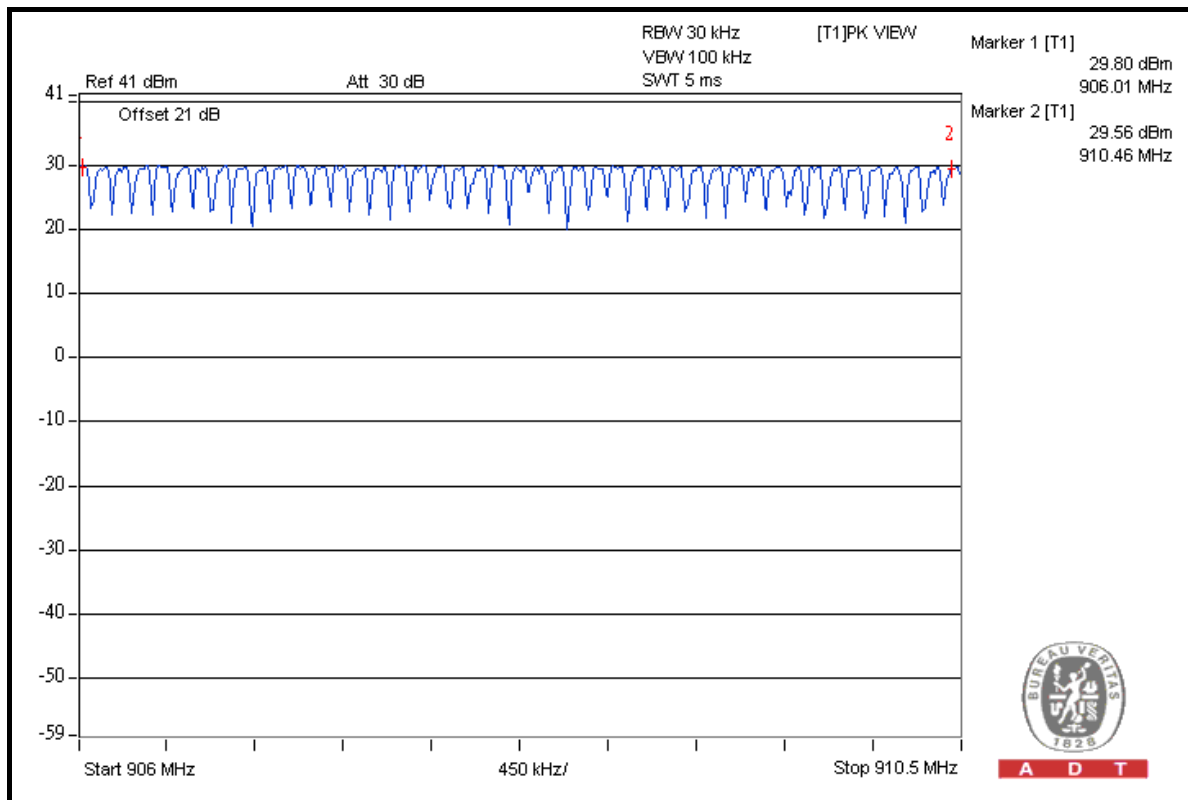
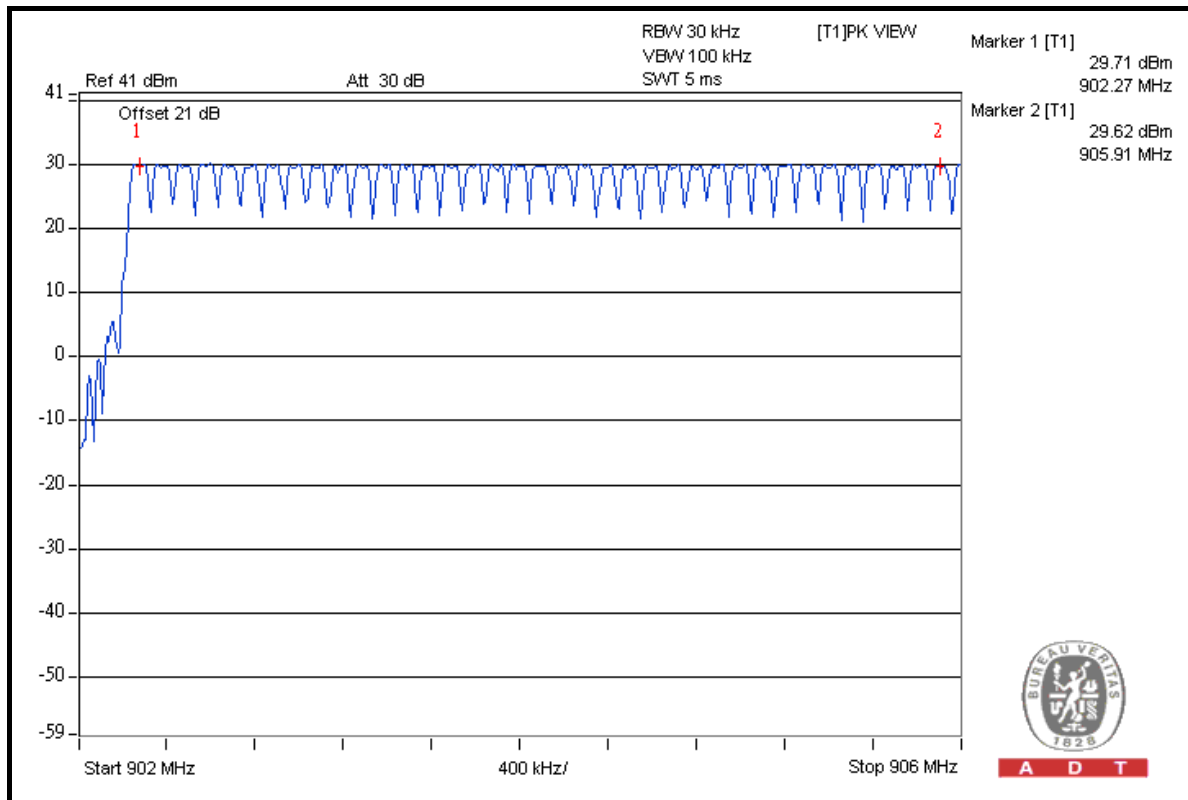



A D T

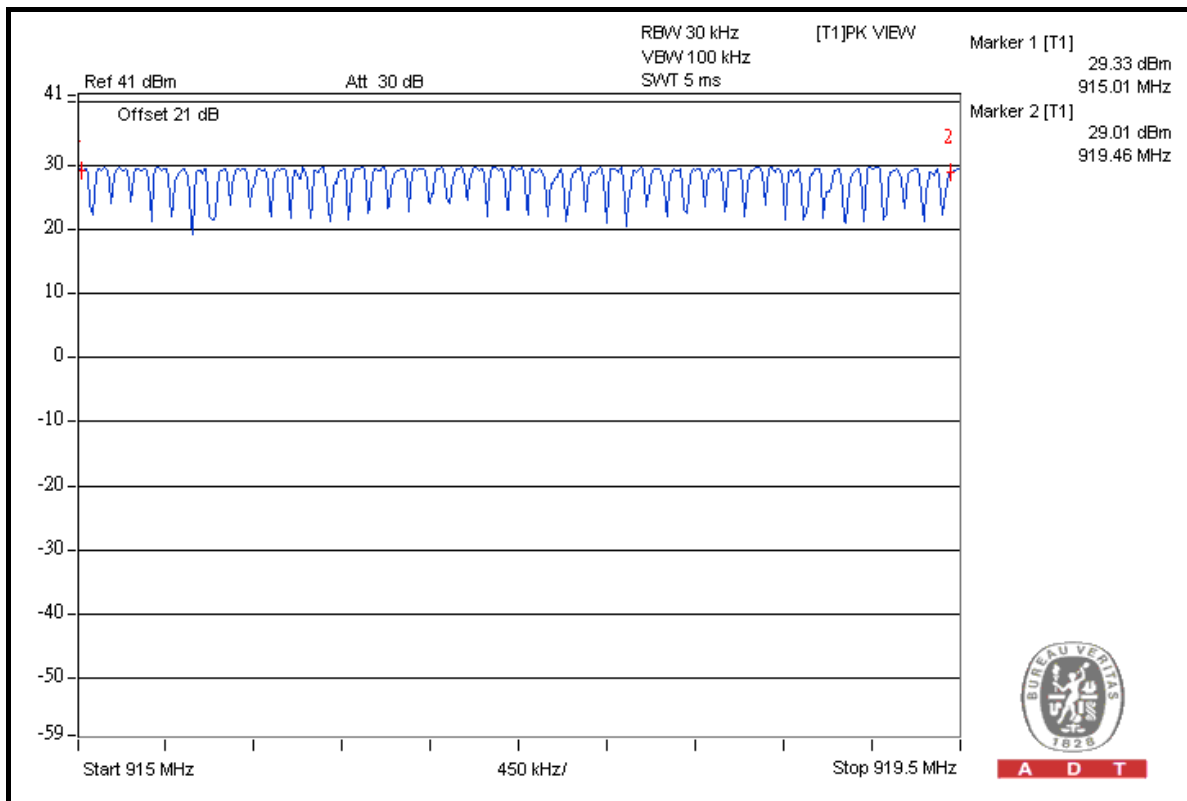
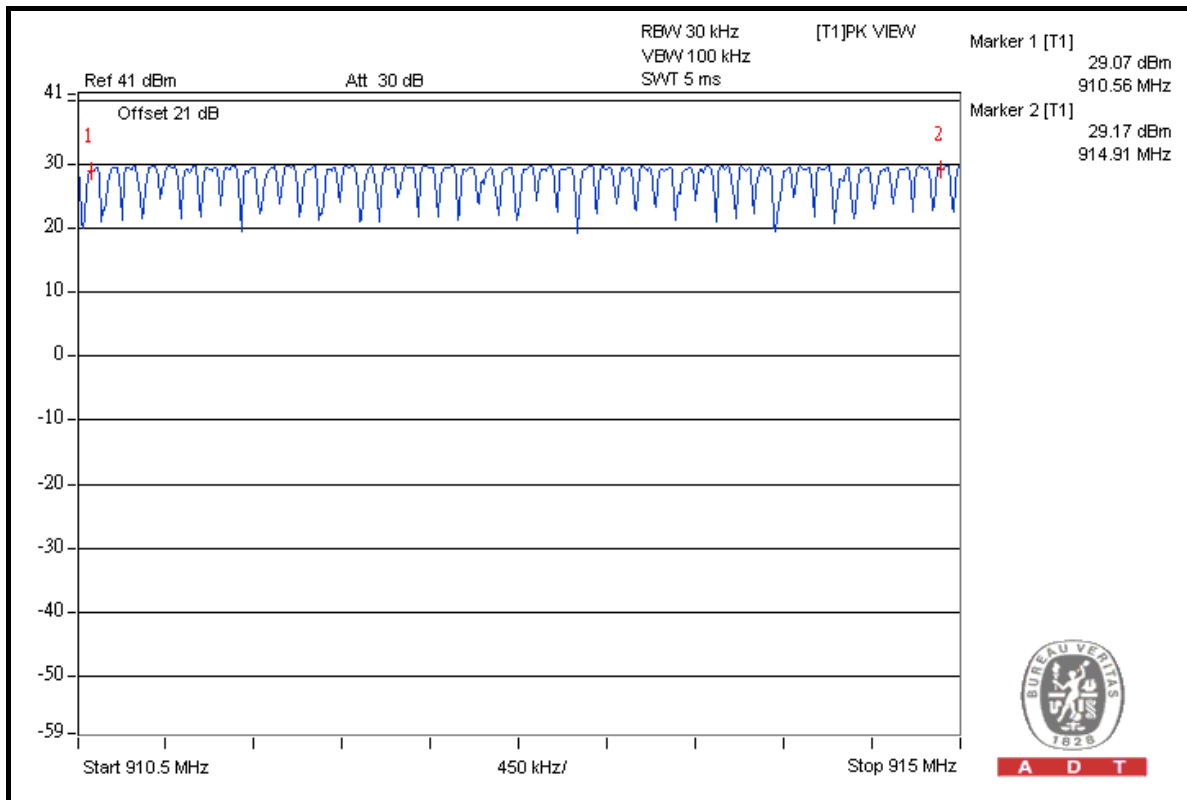



A D T

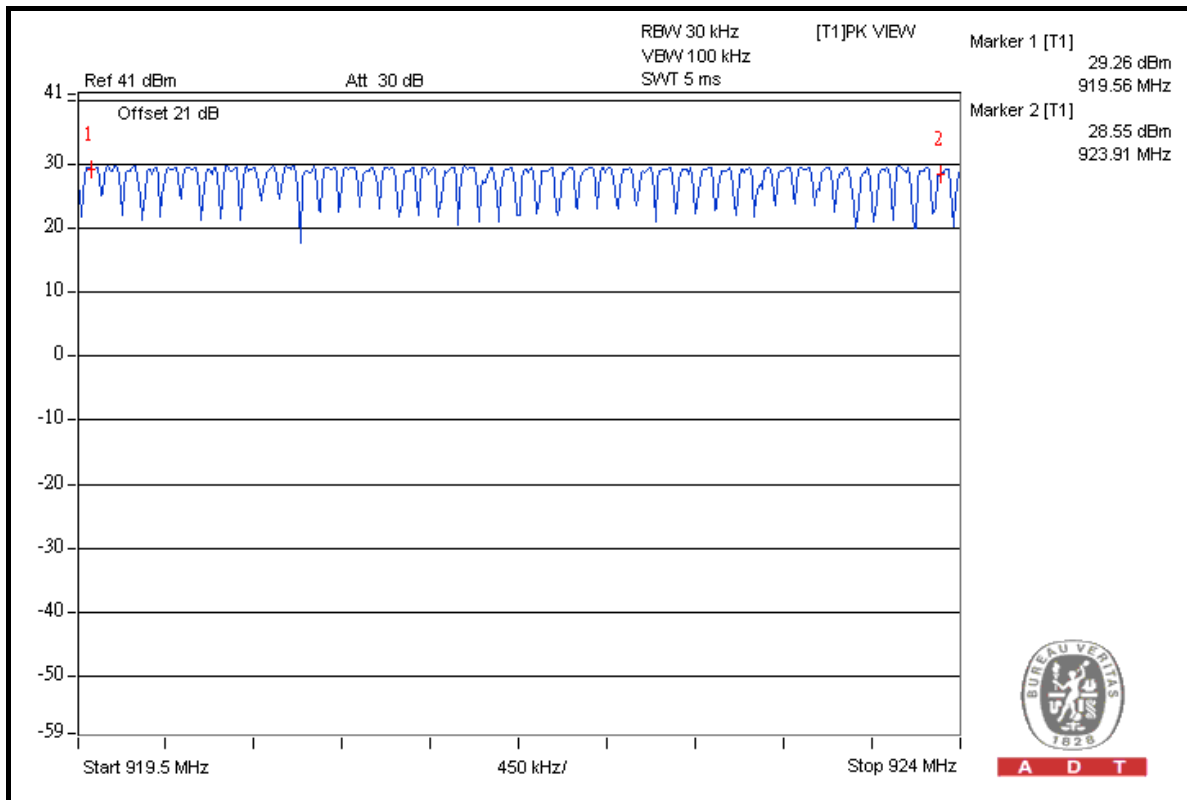

A D T

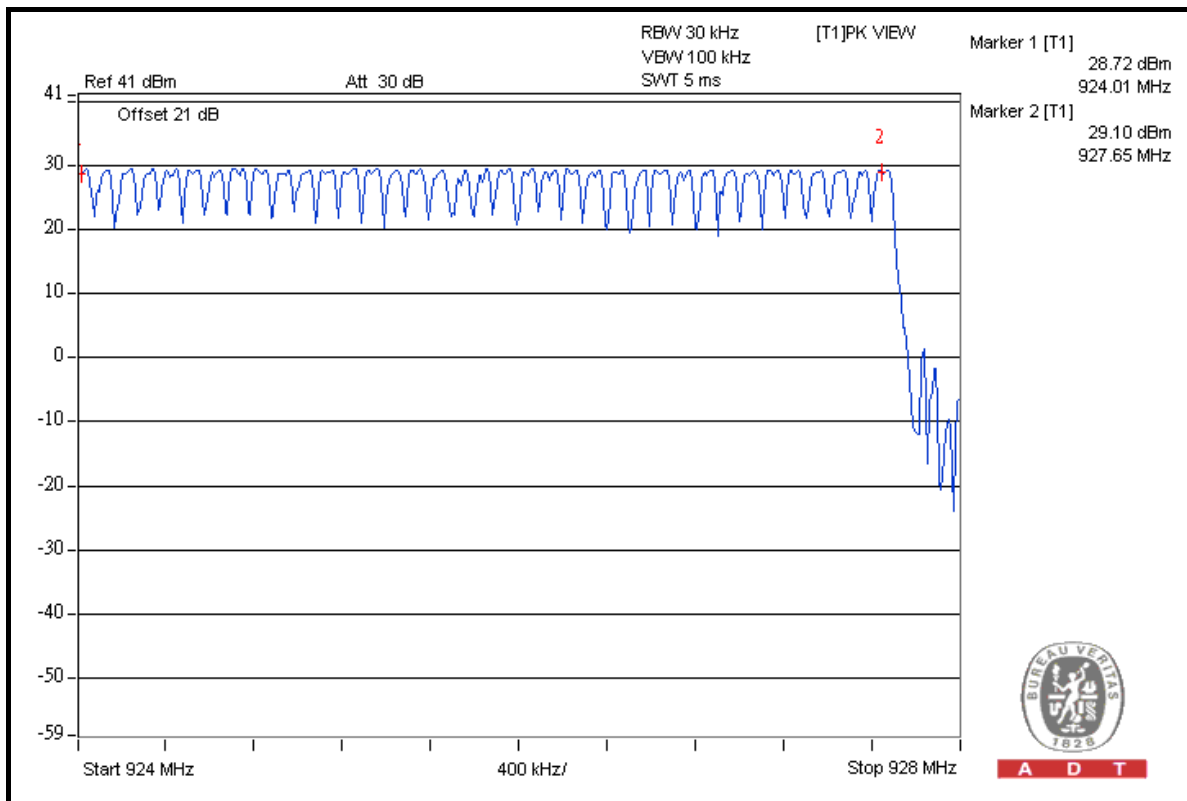

A D T



A D T

TEST MODE B

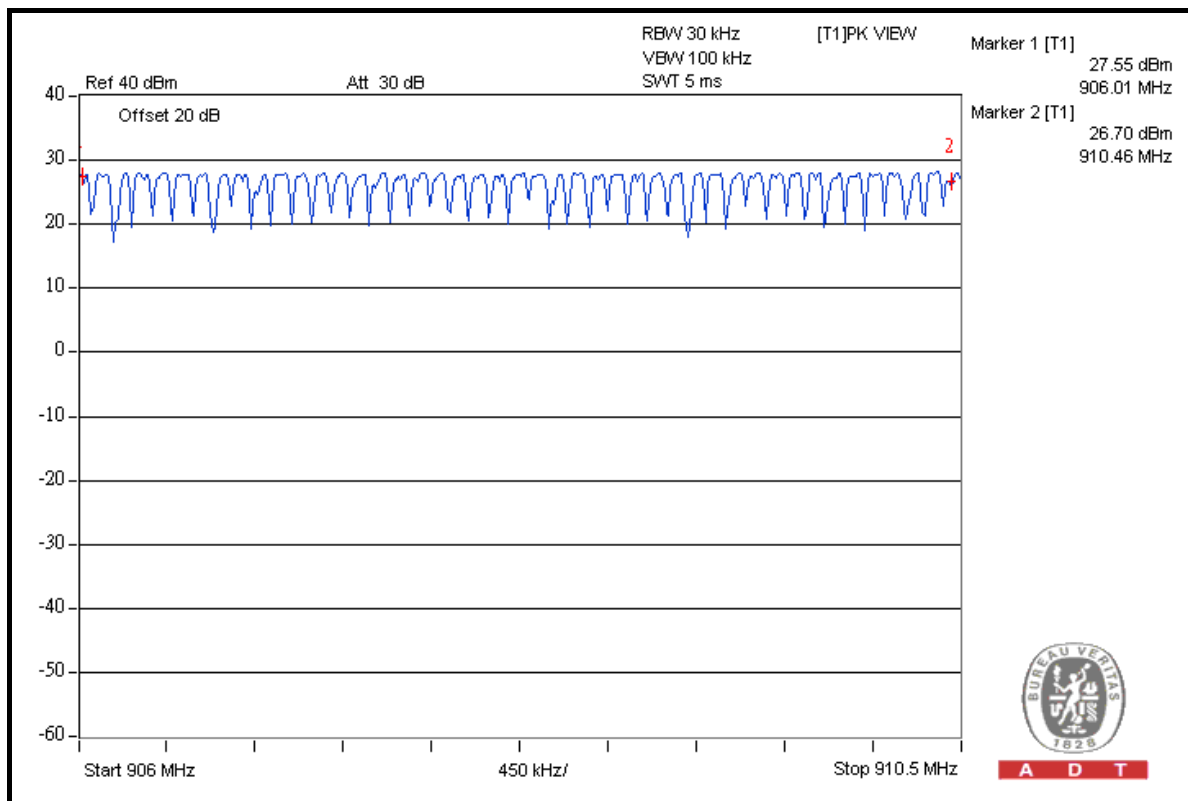
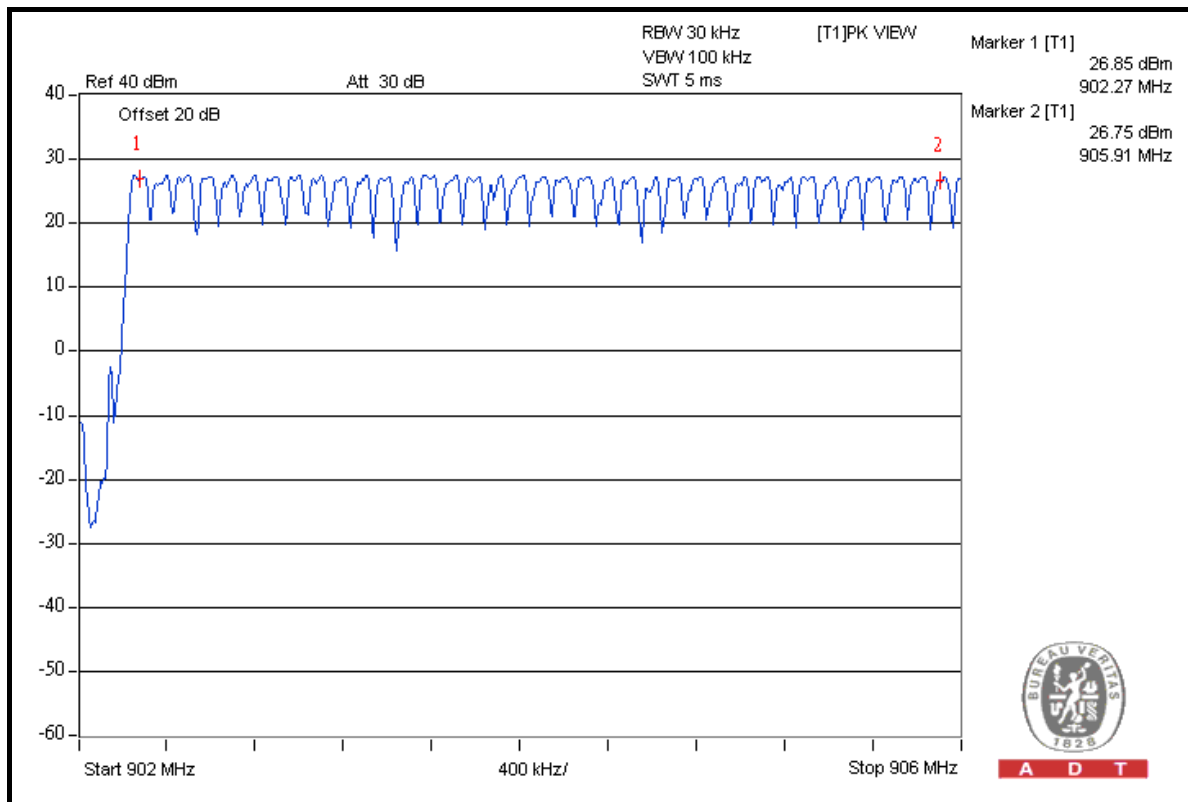



A D T

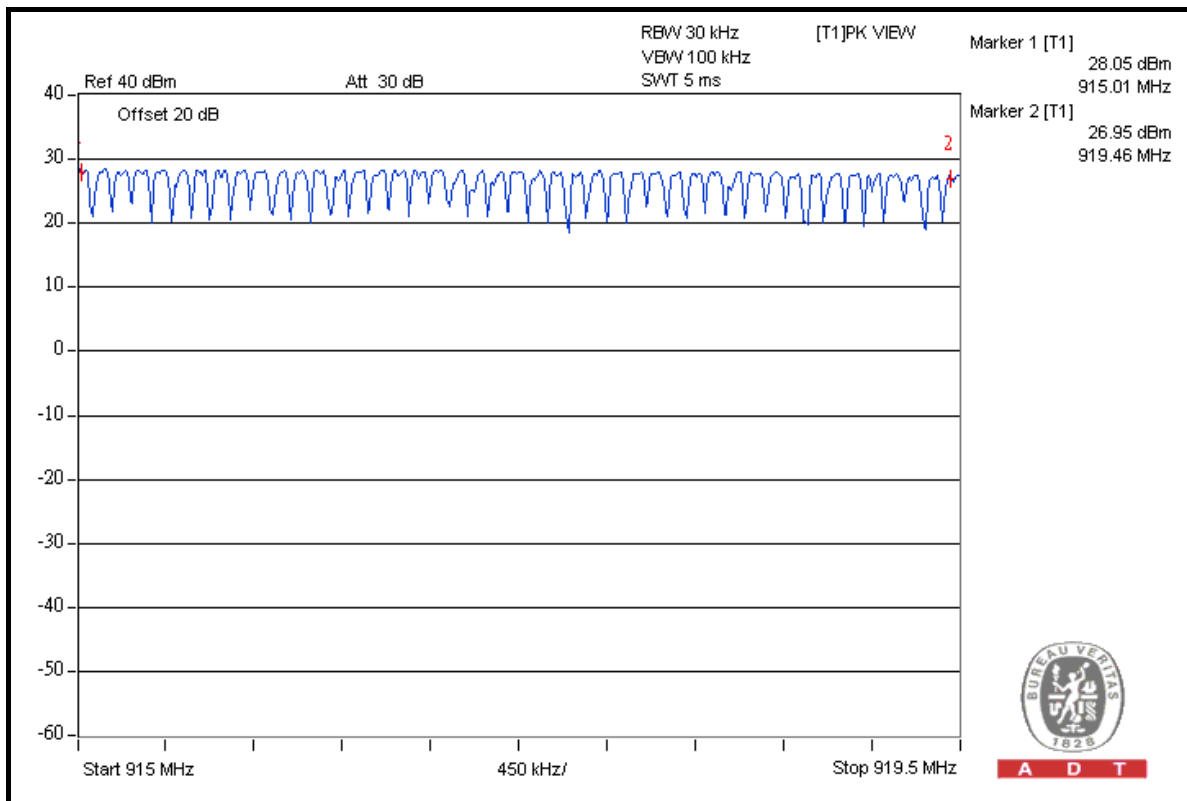
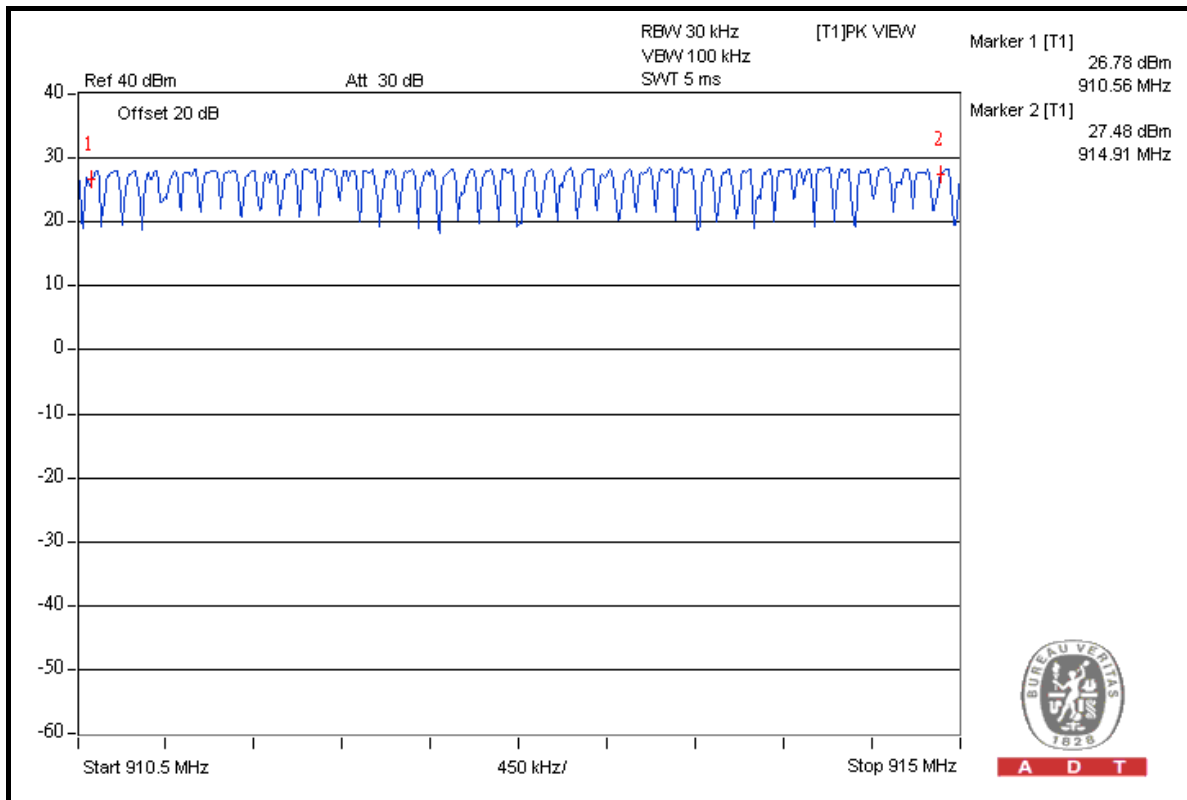



A D T

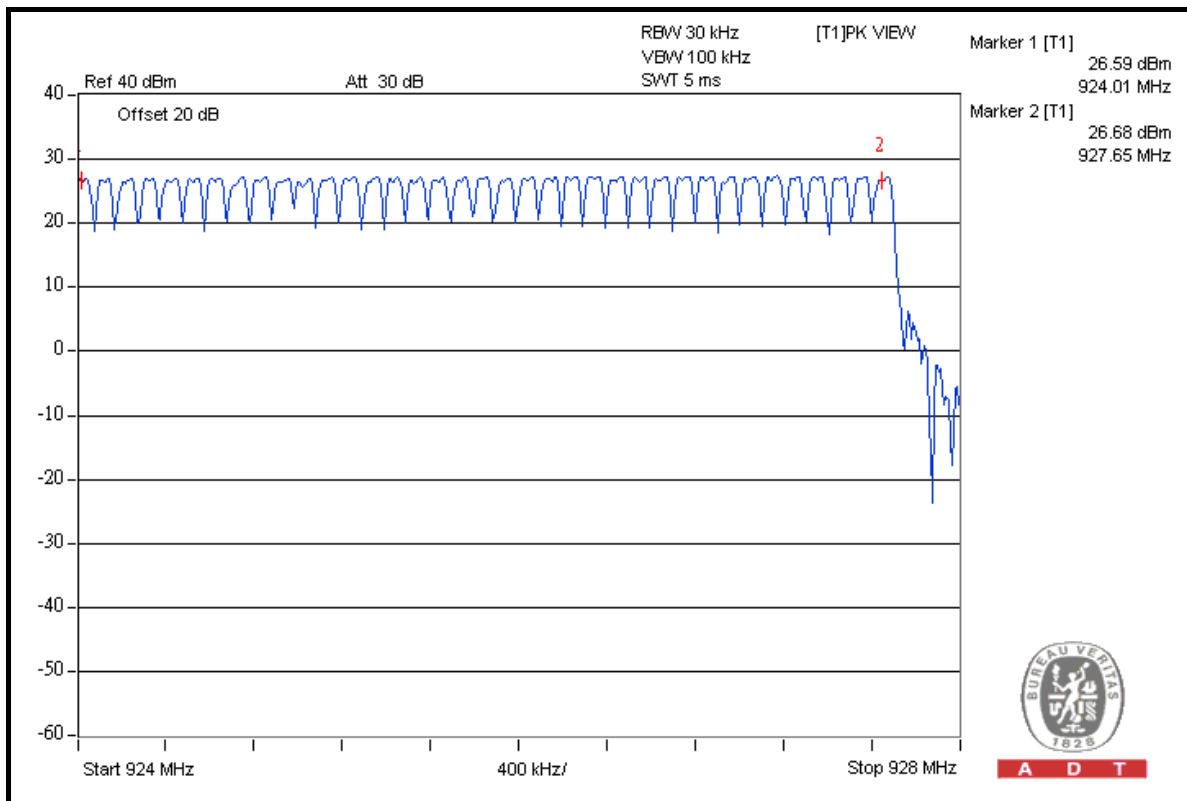
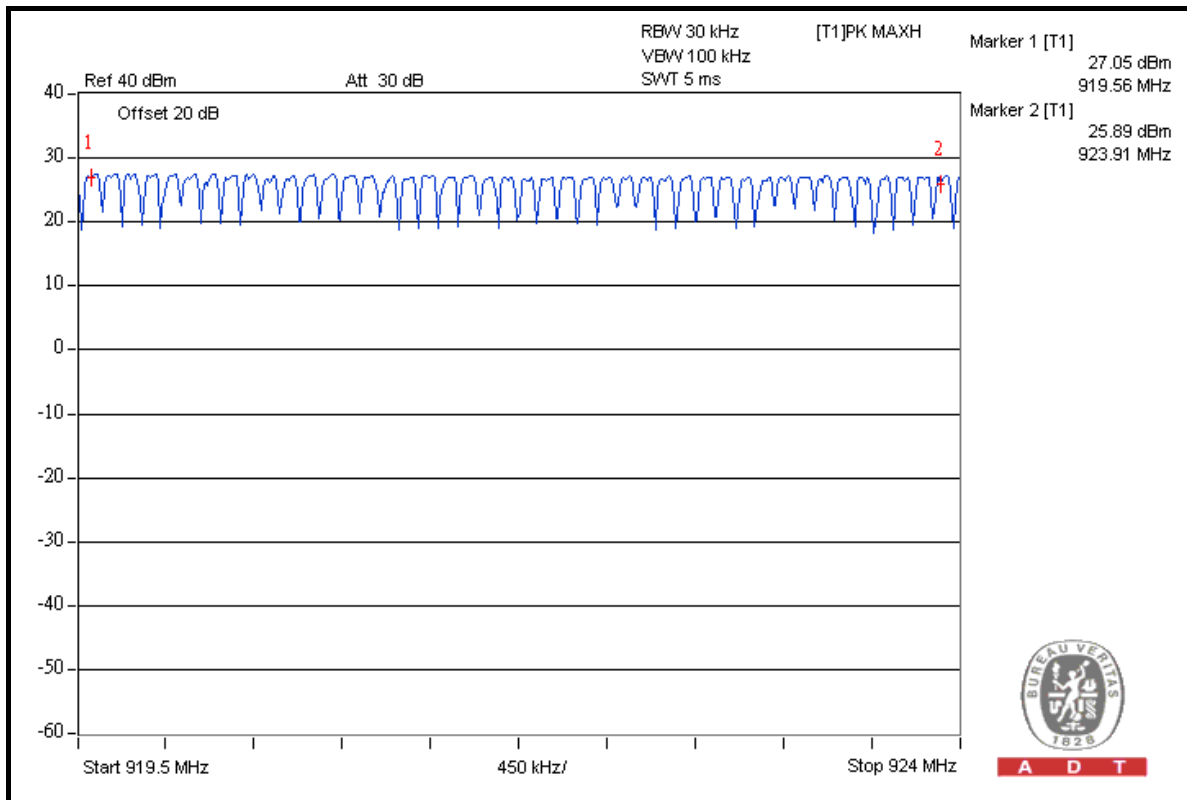

4.4 DWELL TIME ON EACH CHANNEL

4.4.1 LIMIT OF DWELL TIME USED

The average time of occupancy on any frequency shall not be greater than 0.4 seconds within a 20 second period.

4.4.2 TEST SETUP

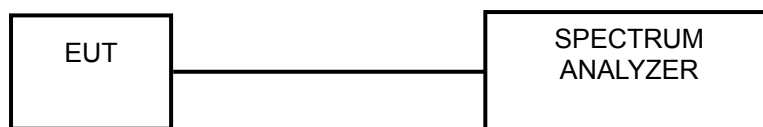

4.4.3 TEST INSTRUMENTS

Refer to section 4.1.2 to get information of above instrument.

4.4.4 TEST PROCEDURES

- Check the calibration of the measuring instrument (SA) using either an internal calibrator or a known signal from an external generator.
- Turn on the EUT and connect its antenna terminal to measurement via a low loss cable. Then set it to any one measured frequency within its operating range and make sure the instrument is operated in its linear range.
- Adjust the center frequency of SA on any frequency be measured and set SA to zero span mode. And then, set RBW and VBW of spectrum analyzer to proper value.
- Measure the time duration of one transmission on the measured frequency. And then plot the result with time difference of this time duration.
- Repeat above procedures until all different time-slot modes have been completed.

4.4.5 DEVIATION FROM TEST STANDARD

No deviation.

4.4.6 TEST RESULTS

TEST MODE A

Length of transmission time (ms)	TX Burst of 20s period	Result	Limit
2.96	8	23.68ms / 20s	400ms / 20s

NOTE: Test plots of the transmitting time slot are shown on following.

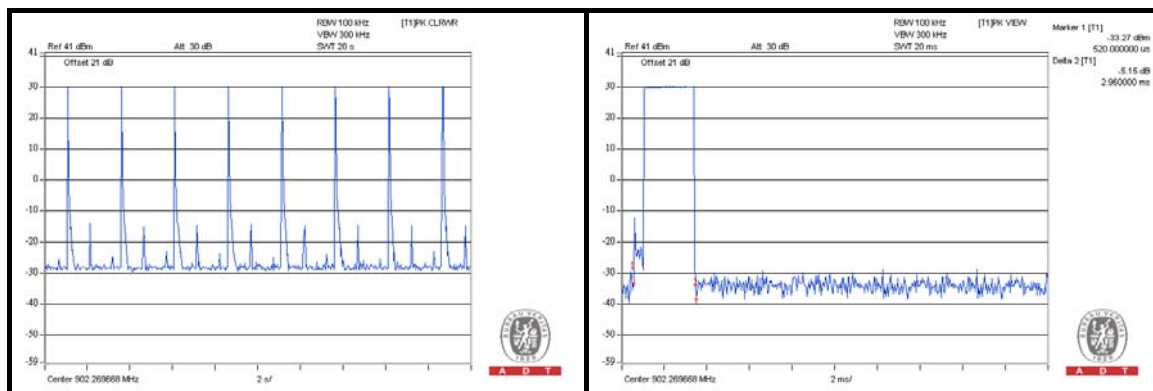

TEST MODE B

Length of transmission time (ms)	TX Burst of 20s period	Result	Limit
2.96	8	23.68ms / 20s	400ms / 20s

NOTE: Test plots of the transmitting time slot are shown on following.

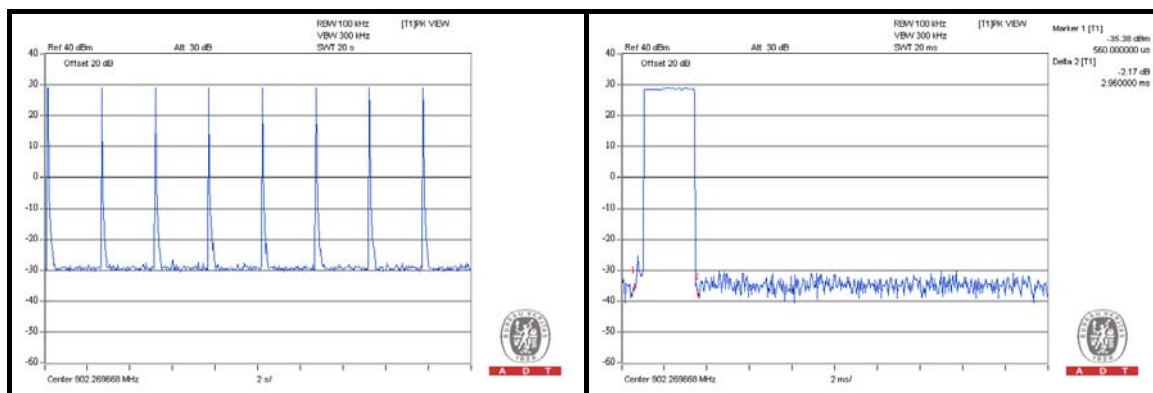

4.5 CHANNEL BANDWIDTH

4.5.1 LIMITS OF CHANNEL BANDWIDTH

The 20 dB bandwidth of the hopping channel shall be less than 250 kHz.

4.5.2 TEST SETUP

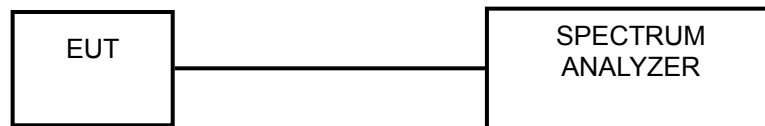

4.5.3 TEST INSTRUMENTS

Refer to section 4.1.2 to get information of above instrument.

4.5.4 TEST PROCEDURE

- a. Check the calibration of the measuring instrument using either an internal calibrator or a known signal from an external generator.
- b. Turn on the EUT and connect it to measurement instrument. Then set it to any one convenient frequency within its operating range. Set a reference level on the measuring instrument equal to the highest peak value.
- c. Measure the frequency difference of two frequencies that were attenuated 20dB from the reference level. Record the frequency difference as the emission bandwidth.
- d. Repeat above procedures until all frequencies measured were complete.

4.5.5 DEVIATION FROM TEST STANDARD

No deviation.

4.5.6 EUT OPERATING CONDITION

The software provided by client enabled the EUT to transmit and receive data at lowest, middle and highest channel frequencies individually.



A D T

4.5.7 TEST RESULTS

TEST MODE A

CHANNEL	CHANNEL FREQUENCY (MHz)	20dB BANDWIDTH (kHz)	LIMIT (kHz)
2	902.269668	100.00	250
127	914.911644	100.00	250
253	927.654755	100.00	250

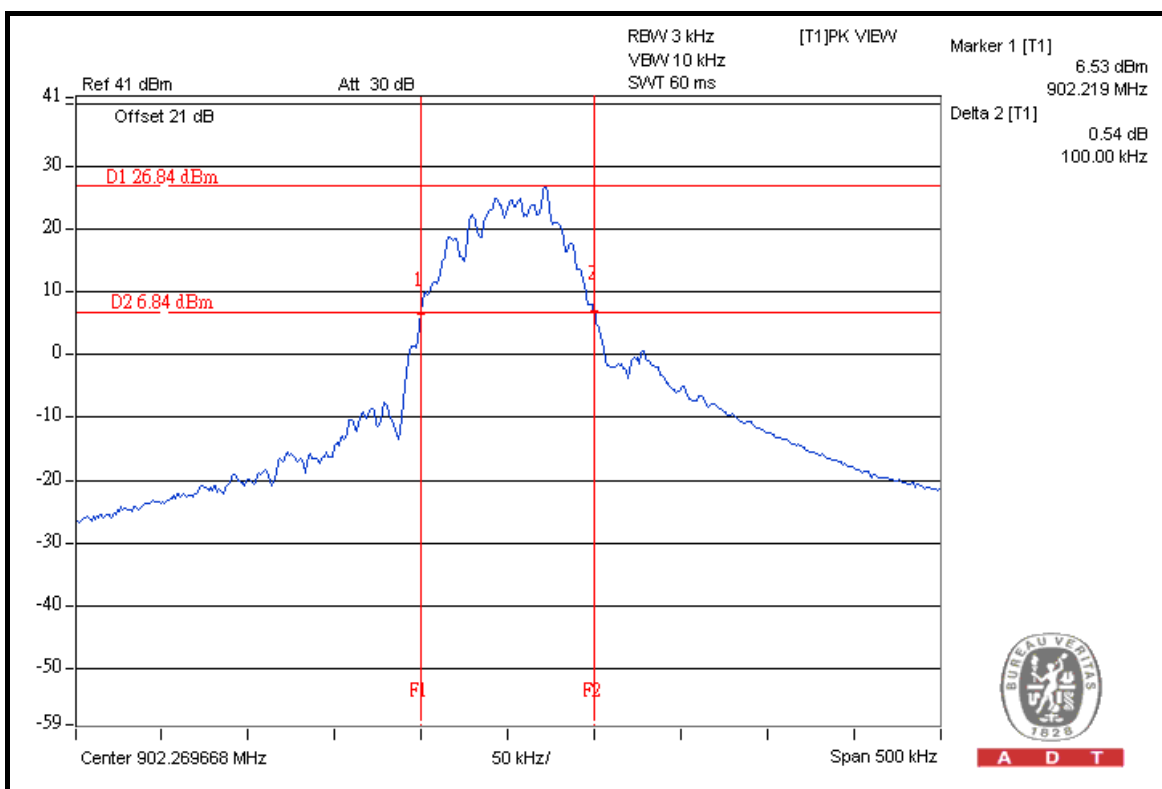



A D T

TEST MODE B

CHANNEL	CHANNEL FREQUENCY (MHz)	20dB BANDWIDTH (kHz)	LIMIT (kHz)
2	902.269668	100.00	250
127	914.911644	100.00	250
253	927.654755	100.00	250

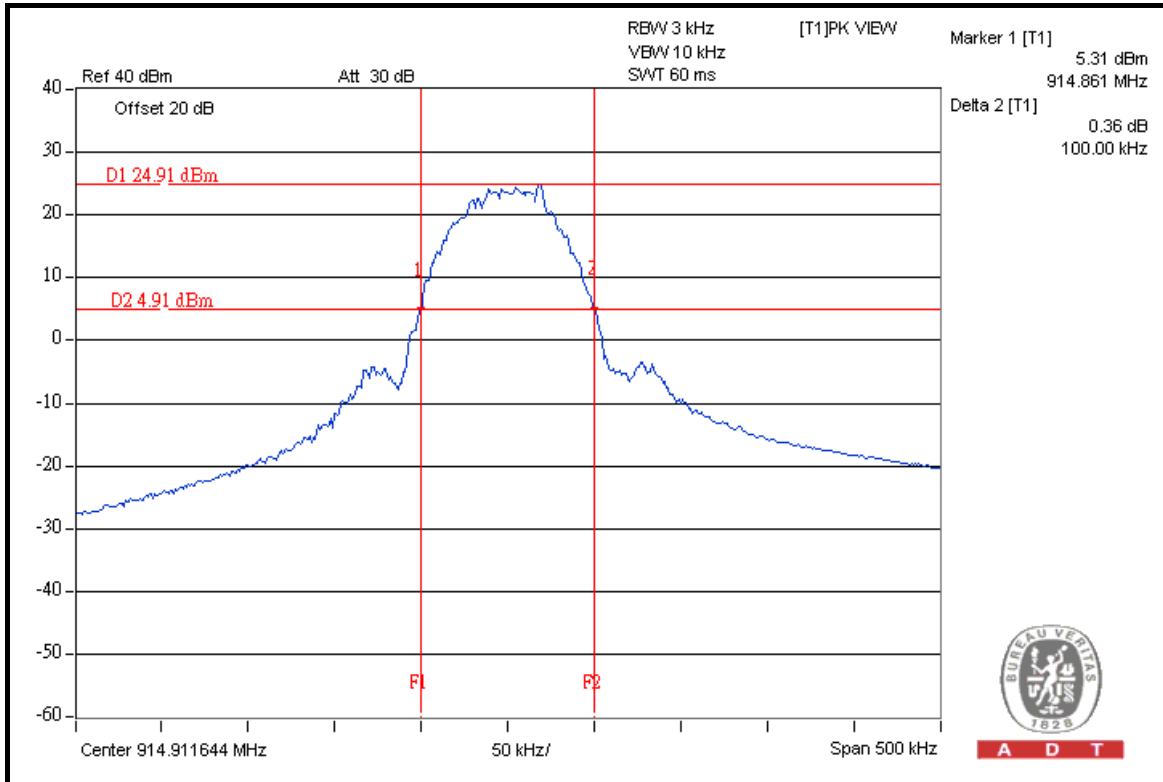

4.6 HOPPING CHANNEL SEPARATION

4.6.1 LIMIT OF HOPPING CHANNEL SEPARATION

At least 25kHz or 20dB hopping channel bandwidth (whichever is greater).

4.6.2 TEST SETUP

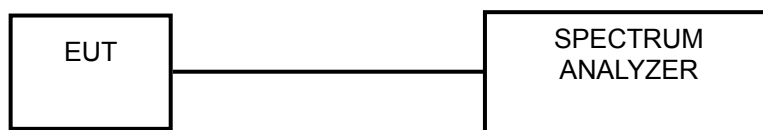

4.6.3 TEST INSTRUMENTS

Refer to section 4.1.2 to get information of above instrument.

4.6.4 TEST PROCEDURES

1. Check the calibration of the measuring instrument using either an internal calibrator or a known signal from an external generator.
2. Turn on the EUT and connect it to measurement instrument. Then set it to any one convenient frequency within its operating range.
3. By using the MaxHold function record the separation of two adjacent channels.
4. Measure the frequency difference of these two adjacent channels by SA MARK function. And then plot the result on SA screen.
5. Repeat above procedures until all frequencies measured were complete.

4.6.5 DEVIATION FROM TEST STANDARD

No deviation.



A D T

4.6.6 TEST RESULTS

TEST MODE A

CHANNEL	FREQUENCY (MHz)	ADJACENT CHANNEL SEPARATION (kHz)	MINIMUM LIMIT (kHz)	PASS / FAIL
2	902.269668	101.00	100.00	PASS
127	914.911644	101.00	100.00	PASS
253	927.654755	101.00	100.00	PASS

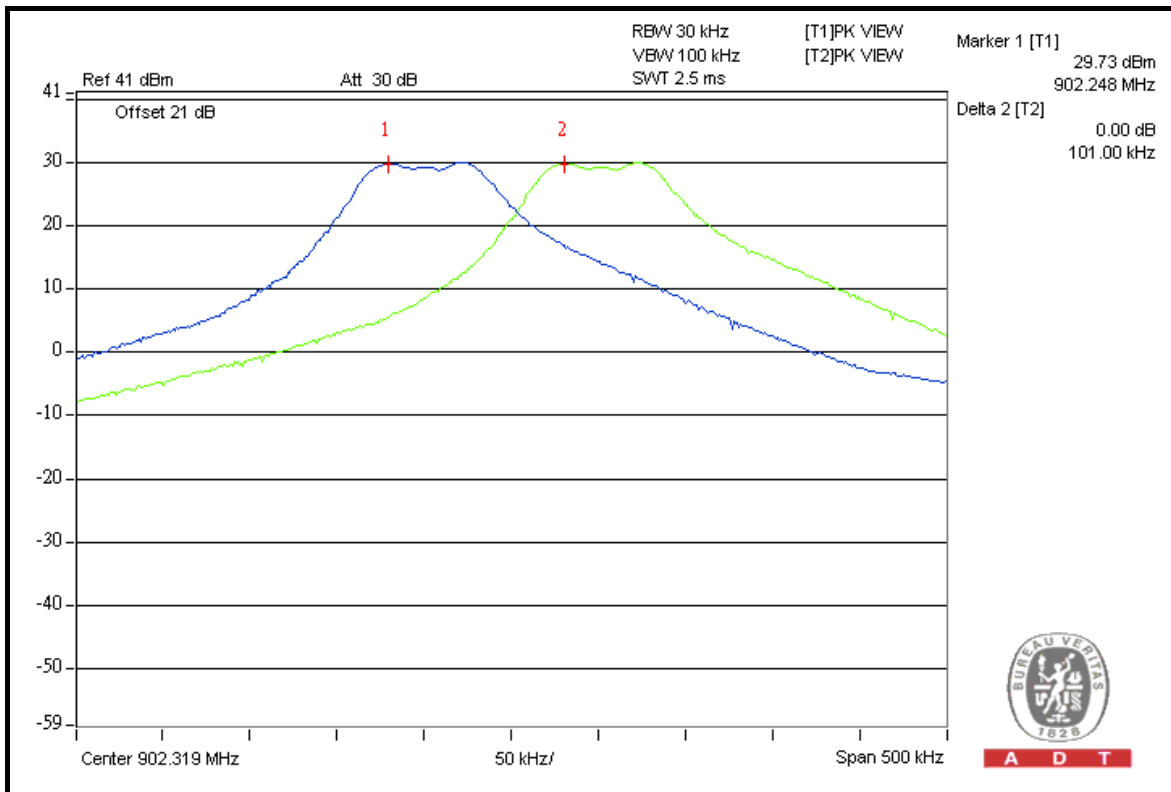

A D T



A D T

TEST MODE B

CHANNEL	FREQUENCY (MHz)	ADJACENT CHANNEL SEPARATION (kHz)	MINIMUM LIMIT (kHz)	PASS / FAIL
2	902.269668	102.00	100.00	PASS
127	914.911644	101.00	100.00	PASS
253	927.654755	101.00	100.00	PASS

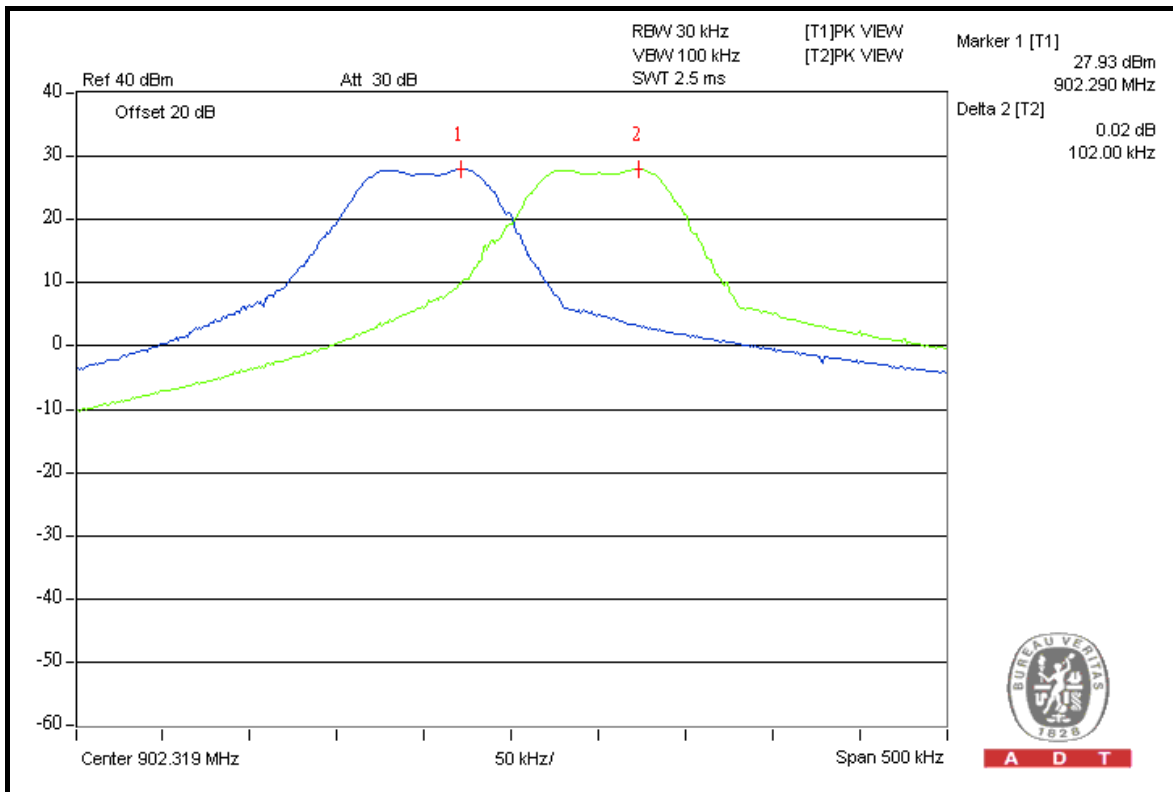

4.7 MAXIMUM OUTPUT POWER

4.7.1 LIMITS OF MAXIMUM OUTPUT POWER MEASUREMENT

The Maximum Output Power Measurement is 30dBm.

4.7.2 TEST SETUP

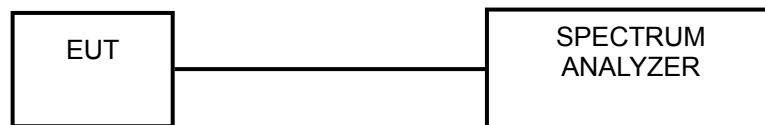

4.7.3 TEST INSTRUMENTS

Refer to section 4.1.2 to get information of above instrument.

4.7.4 TEST PROCEDURES

- a. Check the calibration of the measuring instrument using either an internal calibrator or a known signal from an external generator.
- b. Turn on the EUT and connect it to measurement instrument. Then set it to any one convenient frequency within its operating range. Set a reference level on the measuring instrument equal to the highest peak value.
- c. The center frequency of the spectrum analyzer is set to the fundamental frequency and using 1MHz RBW and 3 MHz VBW.
- d. Measure the captured power within the band and recording the plot.
- e. Repeat above procedures until all frequencies required were complete.

4.7.5 DEVIATION FROM TEST STANDARD

No deviation

4.7.6 EUT OPERATING CONDITION

The software provided by client enabled the EUT to transmit and receive data at lowest, middle and highest channel frequencies individually.



A D T

4.7.7 TEST RESULTS

TEST MODE A

CHANNEL	CHANNEL FREQUENCY (MHz)	POWER OUTPUT (mW)	POWER OUTPUT (dBm)	POWER LIMIT (dBm)	PASS/FAIL
2	902.269668	924.698	29.66	30	PASS
127	914.911644	899.498	29.54	30	PASS
253	927.654755	847.227	29.28	30	PASS

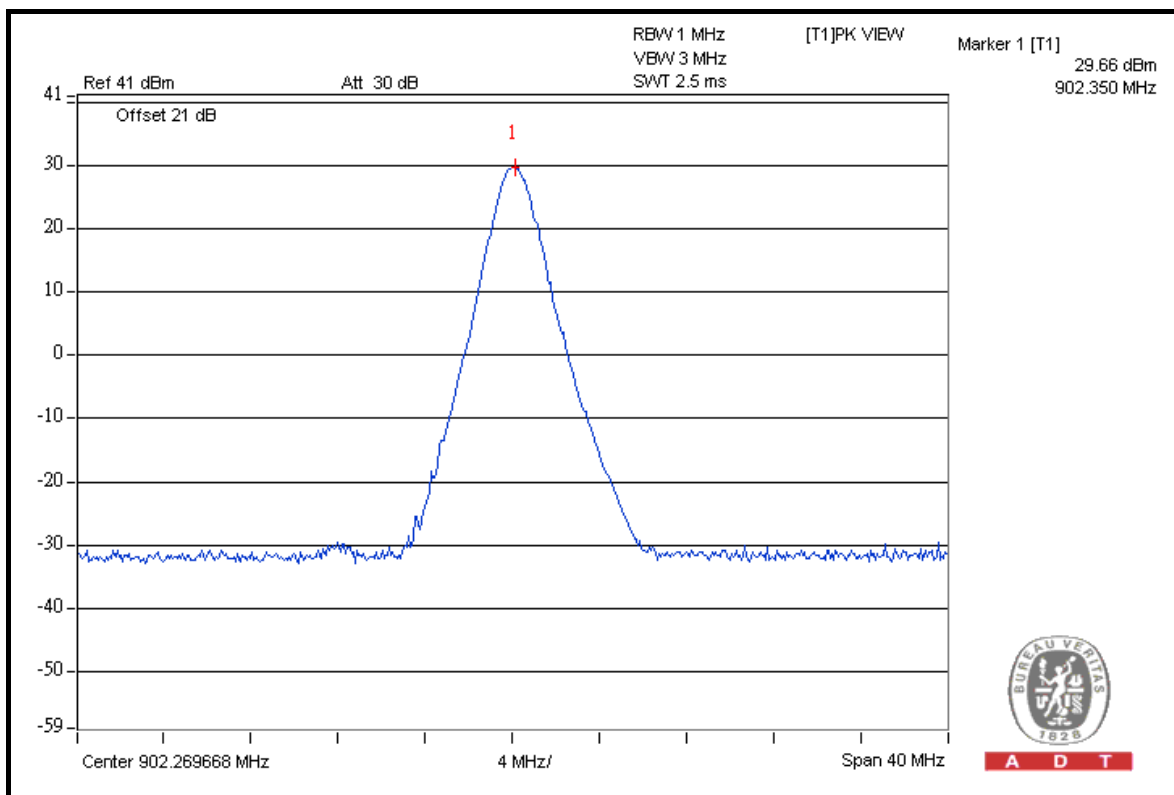

A D T



A D T

TEST MODE B

CHANNEL	CHANNEL FREQUENCY (MHz)	POWER OUTPUT (mW)	POWER OUTPUT (dBm)	POWER LIMIT (dBm)	PASS/FAIL
2	902.269668	601.174	27.79	30	PASS
127	914.911644	612.350	27.87	30	PASS
253	927.654755	533.335	27.27	30	PASS

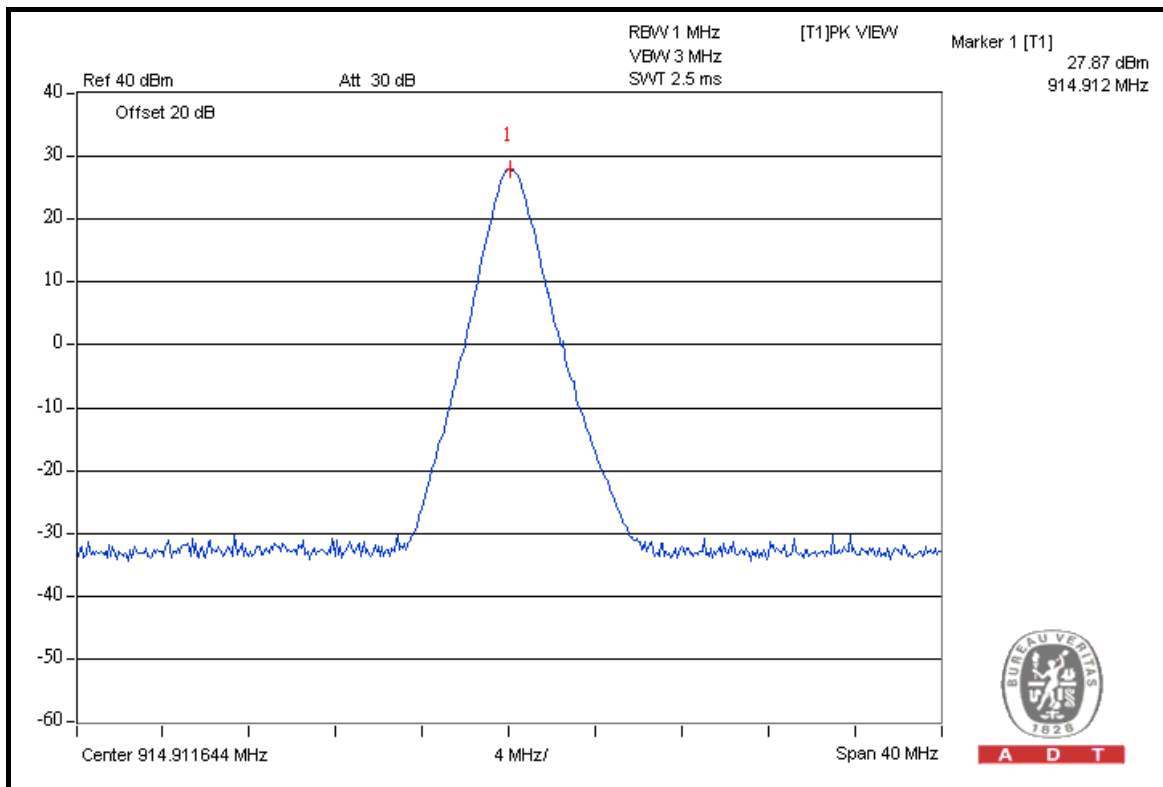

4.8 CONDUCTED OUT OF BAND EMISSION MEASUREMENT

4.8.1 LIMITS OF CONDUCTED OUT OF BAND EMISSION MEASUREMENT

Below -20dB of the highest emission level of operating band (in 100KHz RBW).

4.8.2 TEST INSTRUMENTS

Refer to section 4.1.2 to get information of above instrument.

4.8.3 TEST PROCEDURE

The transmitter output was connected to the spectrum analyzer via a low lose cable. Set both RBW and VBW of spectrum analyzer to 100 / 300 kHz with suitable frequency span including 100 MHz bandwidth from band edge. The band edges was measured and recorded.

4.8.4 DEVIATION FROM TEST STANDARD

No deviation.

4.8.5 EUT OPERATING CONDITION

The software provided by client enabled the EUT to transmit and receive data at lowest and highest channel frequencies individually.

4.8.6 TEST RESULTS

The spectrum plots are attached on the following images. D1 line indicates the highest level, D2 line indicates the 20dB offset below D1. It shows compliance with the requirement.



A D T

TEST MODE A

Low Channel

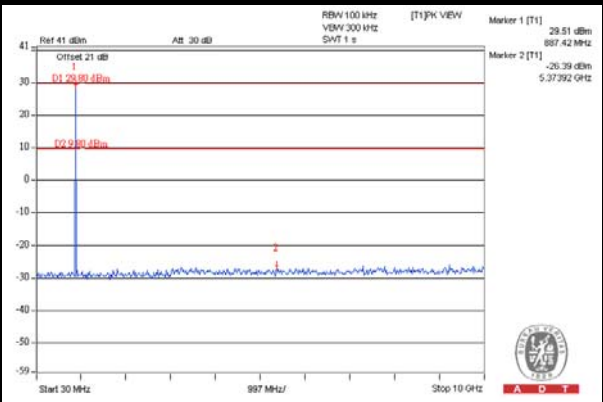
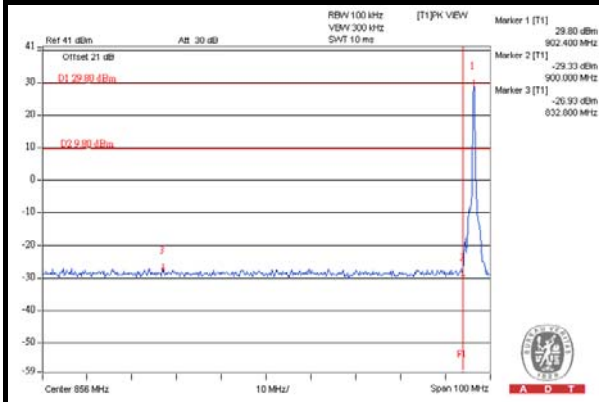

High Channel

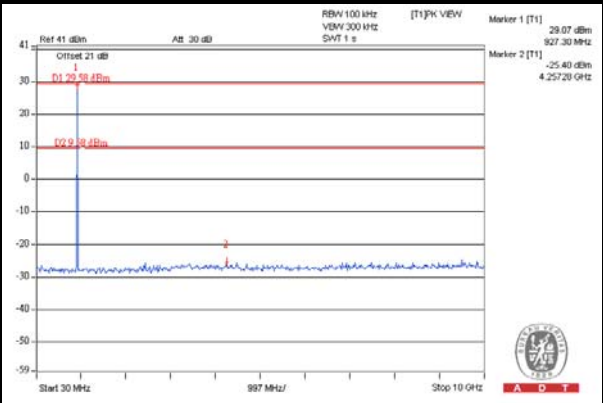
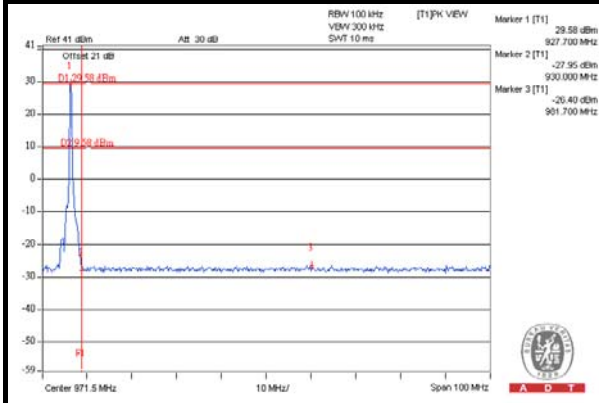



A D T

TEST MODE B

Low Channel

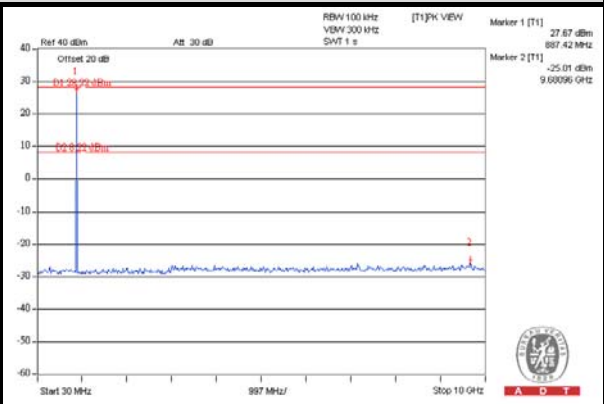
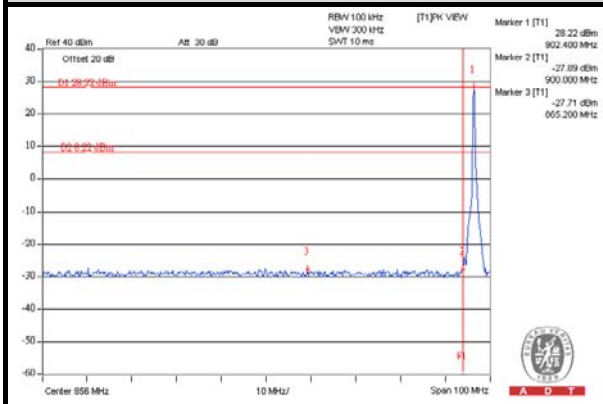

High Channel

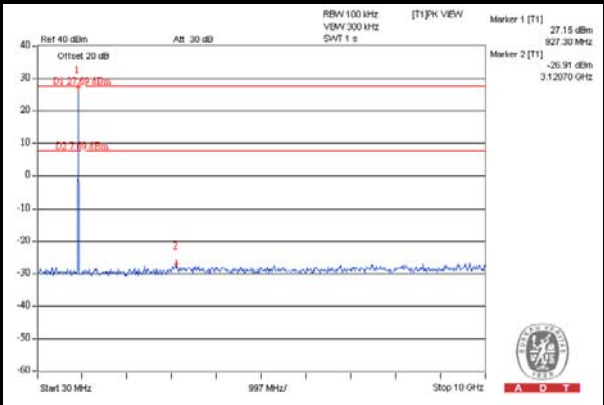
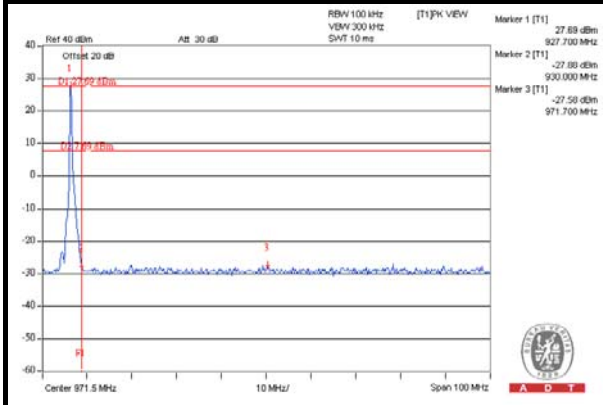



A D T

5. PHOTOGRAPHS OF THE TEST CONFIGURATION

Please refer to the attached file (Test Setup Photo).



6. INFORMATION ON THE TESTING LABORATORIES

We, Bureau Veritas Consumer Products Services (H.K.) Ltd., Taoyuan Branch, were founded in 1988 to provide our best service in EMC, Radio, Telecom and Safety consultation. Our laboratories are accredited and approved according to ISO/IEC 17025.

If you have any comments, please feel free to contact us at the following:

Linko EMC/RF Lab:

Tel: 886-2-26052180

Fax: 886-2-26051924

Hsin Chu EMC/RF Lab:

Tel: 886-3-5935343

Fax: 886-3-5935342

Hwa Ya EMC/RF/Safety Telecom Lab:

Tel: 886-3-3183232

Fax: 886-3-3270892

Email: service.adt@tw.bureauveritas.com

Web Site: www.adt.com.tw

The address and road map of all our labs can be found in our web site also.



A D T

7. APPENDIX A - MODIFICATIONS RECORDERS FOR ENGINEERING CHANGES TO THE EUT BY THE LAB

No any modifications are made to the EUT by the lab during the test.

---END---