

FCC Test Report

Report No.: RF990121L17C

FCC ID: U2M-FS1

Test Model: FreeStyl 1

Received Date: Oct. 16, 2015

Test Date: Oct. 21 ~ Dec. 07, 2015

Issued Date: Dec. 14, 2015

Applicant: Senao Networks, Inc.

Address: 3F, No. 529, Chung Cheng Rd., Hsintien, Taipei, Taiwan, R.O.C.

Issued By: Bureau Veritas Consumer Products Services (H.K.) Ltd., Taoyuan Branch

Lab Address: No. 47-2, 14th Ling, Chia Pau Vil., Lin Kou Dist., New Taipei City, Taiwan

Test Location: No. 19, Hwa Ya 2nd Rd., Wen Hwa Vil., Kwei Shan Dist., Taoyuan City
33383, TAIWAN (R.O.C.)



This report is for your exclusive use. Any copying or replication of this report to or for any other person or entity, or use of our name or trademark, is permitted only with our prior written permission. This report sets forth our findings solely with respect to the test samples identified herein. The results set forth in this report are not indicative or representative of the quality or characteristics of the lot from which a test sample was taken or any similar or identical product unless specifically and expressly noted. Our report includes all of the tests requested by you and the results thereof based upon the information that you provided to us. You have 60 days from date of issuance of this report to notify us of any material error or omission caused by our negligence, provided, however, that such notice shall be in writing and shall specifically address the issue you wish to raise. A failure to raise such issue within the prescribed time shall constitute your unqualified acceptance of the completeness of this report, the tests conducted and the correctness of the report contents. Unless specific mention, the uncertainty of measurement has been explicitly taken into account to declare the compliance or non-compliance to the specification. The report must not be used by the client to claim product certification, approval, or endorsement by TAF or any government agencies.

Table of Contents

Release Control Record	3
1 Certificate of Conformity	4
2 Summary of Test Results	5
2.1 Measurement Uncertainty.....	5
2.2 Modification Record.....	5
3 General Information	6
3.1 General Description of EUT.....	6
3.2 Description of Test Modes.....	8
3.2.1 Test Mode Applicability and Tested Channel Detail.....	10
3.3 Description of Support Units.....	11
3.3.1 Configuration of System under Test.....	11
3.4 General Description of Applied Standards.....	12
4 Test Types and Results	13
4.1 Radiated Emission and Bandedge Measurement.....	13
4.1.1 Limits of Radiated Emission and Bandedge Measurement.....	13
4.1.2 Test Instruments.....	14
4.1.3 Test Procedures.....	15
4.1.4 Deviation from Test Standard.....	15
4.1.5 Test Set Up.....	16
4.1.6 EUT Operating Conditions.....	16
4.1.7 Test Results.....	17
4.2 Conducted Emission Measurement.....	29
4.2.1 Limits of Conducted Emission Measurement.....	29
4.2.2 Test Instruments.....	29
4.2.3 Test Procedures.....	30
4.2.4 Deviation from Test Standard.....	30
4.2.5 Test Setup.....	30
4.2.6 EUT Operating Conditions.....	30
4.2.7 Test Results.....	31
5 Pictures of Test Arrangements	55
Appendix – Information on the Testing Laboratories	56



A D T

Release Control Record

Issue No.	Description	Date Issued
RF990121L17C	Original release.	Dec. 14, 2015

1 Certificate of Conformity

Product: Single Line Long Range Cordless Telephone

Brand: EnGenius

Test Model: FreeStyl 1

Sample Status: Engineering sample

Applicant: Senao Networks, Inc.

Test Date: Oct. 21 ~ Dec. 07, 2015

Standards: 47 CFR FCC Part 15, Subpart C (Section 15.247)
ANSI C63.10:2013

This report is issued as a supplementary report of RF990121L17B. This report shall be used combined together with its original report.

Prepared by :



Pettie Chen / Senior Specialist

Date:

Dec. 14, 2015

Approved by :



Ken Liu / Senior Manager

Date:

Dec. 14, 2015

Note: Radiated emission below 1GHz and conducted emission items are performed for the addendum. Refer to original report for the other test data.

2 Summary of Test Results

47 CFR FCC Part 15, Subpart C (SECTION 15.247)			
FCC Clause	Test Item	Result	Remarks
15.207	AC Power Conducted Emission	PASS	Meet the requirement of limit. Minimum passing margin is -1.90dB at 0.16825MHz.
15.205 / 15.209 / 15.247(d)	Radiated Emissions and Band Edge Measurement	PASS	Meet the requirement of limit. Minimum passing margin is -2.1dB at 846.50MHz.
15.247(d)	Antenna Port Emission	N/A	Refer to Note
15.247(a)(2)	6dB bandwidth	N/A	Refer to Note
15.247(b)	Conducted power	N/A	Refer to Note
15.247(e)	Power Spectral Density	N/A	Refer to Note
15.203	Antenna Requirement	N/A	Refer to Note

Note: Radiated emission below 1GHz and conducted emission items are performed for the addendum. Refer to original report for the other test data.

2.1 Measurement Uncertainty

Where relevant, the following measurement uncertainty levels have been estimated for tests performed on the EUT as specified in CISPR 16-4-2:

Measurement	Frequency	Expanded Uncertainty (k=2) (\pm)
Conducted Emissions at mains ports	150kHz ~ 30MHz	2.44 dB
Radiated Emissions up to 1 GHz	30MHz ~ 200MHz	3.86 dB
	200MHz ~ 1000MHz	3.87 dB

2.2 Modification Record

There were no modifications required for compliance.

3 General Information

3.1 General Description of EUT

Product	Single Line Long Range Cordless Telephone
Brand	EnGenius
Test Model	FreeStyl 1
Status of EUT	Engineering sample
Power Supply Rating	12Vdc (from AC Adapter) 3.7Vdc (from battery) 5.5Vdc (from charger)
Modulation Type	MSK / TDD (Frequency hopping)
Operating Frequency	902.269668 ~ 927.654755MHz
Number of Channel	252
Channel Spacing	101.136kHz
Output Power	831.8mW
Antenna Type	Dipole antenna with 2dBi gain (Base Station) Dipole antenna with 2.5dBi gain (long Ant. Portable Handset) Dipole antenna with 1.5dBi gain (short Ant. Portable Handset)
Antenna Connector	Reversed-thread TNC (Base Station) Sheet metal (Portable Handset)
Data Cable	NA
I/O Ports	Refer to user's manual
Accessory Device	Adapter, Charger, Battery

NOTE:

1. This report is prepared for FCC class II permissive change. This report is issued as a supplementary report of BVADT report no.: RF990121L17B. Differences compared with the original report are adding 4 adapters. The test result was worse than original results. Therefore, only the test item of radiated emission below 1GHz and conducted emission tests had been an addendum test to this report. Refer to original report for the other test data.

3. The EUT uses following adapters, battery & Charger. (The new adapters as below, original adapters please refer to original report).

Adapter 1 (for Base Station used)	
Brand	DVE
Model	DSA-12PFT-12 FUS 120100
Input Power	100-240Vac~50/60Hz 0.5A
Output Power	+12Vdc / 1A
Poewr Line	1.45m non-shielded cable without core

Adapter 2 (for Base Station used)	
Brand	Atech OEM
Model	A0126PU-120010
Input Power	100-240Vac~50-60Hz 0.5A
Output Power	12Vdc / 1.0A
Poewr Line	1.5m non-shielded cable without core

Battery (for Portable Handset used)	
Brand	EnGenius
Rating	3.7Vdc, 1100mAh

Adapter 3 (for Portable Handset Charger used)	
Brand	Powertron Electronics Corp.
Model	PS1012-055HUB150
Input Power	100-240Vac~50/60Hz 0.4A
Output Power	5.5Vdc / 1.5A 8.25W Max
Poewr Line	1.5m non-shielded cable without core

Adapter 4 (for Portable Handset Charger used)	
Brand	Atech OEM
Model	ADS012T-W055150
Input Power	100-240Vac~50-60Hz 0.5A
Output Power	5.5Vdc / 1.5A
Poewr Line	1.5m non-shielded cable without core

4. A set of the EUT include Base station & Portable handset

5. The above EUT information was declared by the manufacturer and for more detailed features description, please refer to the manufacturer's specifications or User's Manual.

3.2 Description of Test Modes

252 channels are provided to this EUT:

Ch.	Freq. (MHz)	Ch.	Freq. (MHz)	Ch.	Freq. (MHz)	Ch.	Freq. (MHz)	Ch.	Freq. (MHz)
1	902.269668	31	905.303742	61	908.337817	91	911.371891	121	914.405965
2	902.370804	32	905.404878	62	908.438952	92	911.473026	122	914.507100
3	902.471940	33	905.506014	63	908.540088	93	911.574162	123	914.608236
4	902.573076	34	905.607150	64	908.540088	94	911.675298	124	914.709372
5	902.674212	35	905.708286	65	908.742360	95	911.776434	125	914.810508
6	902.775347	36	905.809421	66	908.843496	96	911.877570	126	914.911644
7	902.876483	37	905.910557	67	908.944631	97	911.978705	127	915.012779
8	902.977619	38	906.011693	68	909.045767	98	912.079841	128	915.113915
9	903.078755	39	906.112829	69	909.146903	99	912.180977	129	915.113915
10	903.179891	40	906.213965	70	909.248039	100	912.282113	130	915.316187
11	903.281026	41	906.315100	71	909.349175	101	912.383249	131	915.417323
12	903.382162	42	906.416236	72	909.450310	102	912.484384	132	915.518458
13	903.483298	43	906.517372	73	909.551446	103	912.585520	133	915.619594
14	903.584434	44	906.618508	74	909.652582	104	912.686656	134	915.720730
15	903.685570	45	906.719644	75	909.753718	105	912.787792	135	915.821866
16	903.786705	46	906.820779	76	909.854854	106	912.888928	136	915.923002
17	903.887841	47	906.921915	77	909.955989	107	912.990063	137	916.024138
18	903.988977	48	907.023051	78	910.057125	108	913.091199	138	916.125273
19	904.090113	49	907.124187	79	910.158261	109	913.192335	139	916.226409
20	904.191249	50	907.225323	80	910.259397	110	913.293471	140	916.327545
21	904.292384	51	907.326458	81	910.360533	111	913.394607	141	916.428681
22	904.393520	52	907.427594	82	910.461668	112	913.495742	142	916.529817
23	904.494656	53	907.528730	83	910.562804	113	913.596878	143	916.630952
24	904.595792	54	907.629866	84	910.663940	114	913.698014	144	916.732088
25	904.696928	55	907.731002	85	910.765076	115	913.799150	145	916.833224
26	904.798063	56	907.832138	86	910.866212	116	913.900286	146	916.934360
27	904.899199	57	907.933273	87	910.967347	117	914.001421	147	917.035496
28	905.000335	58	908.034409	88	911.068483	118	914.102557	148	917.136631
29	905.101471	59	908.135545	89	911.169619	119	914.203693	149	917.237767
30	905.202607	60	908.236681	90	911.270755	120	914.304829	150	917.338903

Ch.	Freq. (MHz)	Ch.	Freq. (MHz)	Ch.	Freq. (MHz)	Ch.	Freq. (MHz)	Ch.	Freq. (MHz)
151	917.440039	172	919.563891	193	921.687742	214	923.811594	235	925.935446
152	917.541175	173	919.665026	194	921.687742	215	923.912730	236	926.036582
153	917.642310	174	919.766162	195	921.890014	216	924.013866	237	926.137718
154	917.743446	175	919.867298	196	921.991150	217	924.115002	238	926.238854
155	917.844582	176	919.968434	197	922.092286	218	924.216138	239	926.339989
156	917.945718	177	920.069570	198	922.193421	219	924.317273	240	926.441125
157	918.046854	178	920.170705	199	922.294557	220	924.418409	241	926.542261
158	918.147989	179	920.271841	200	922.395693	221	924.519545	242	926.643397
159	918.249125	180	920.372977	201	922.496829	222	924.620681	243	926.744533
160	918.350261	181	920.474113	202	922.597965	223	924.721817	244	926.845668
161	918.451397	182	920.575249	203	922.699100	224	924.822952	245	926.946804
162	918.552533	183	920.676384	204	922.800236	225	924.924088	246	927.047940
163	918.653668	184	920.777520	205	922.901372	226	925.025224	247	927.149076
164	918.754804	185	920.878656	206	923.002508	227	925.126360	248	927.250212
165	918.855940	186	920.979792	207	923.103644	228	925.227496	249	927.351347
166	918.957076	187	921.080928	208	923.204779	229	925.328631	250	927.452483
167	919.058212	188	921.182063	209	923.305915	230	925.429767	251	927.553619
168	919.159347	189	921.283199	210	923.407051	231	925.530903	252	927.654755
169	919.260483	190	921.384335	211	923.508187	232	925.632039		
170	919.361619	191	921.485471	212	923.609323	233	925.733175		
171	919.462755	192	921.586607	213	923.710458	234	925.834310		

3.2.1 Test Mode Applicability and Tested Channel Detail

EUT CONFIGURE MODE	APPLICABLE TO		DESCRIPTION
	RE<1G	PLC	
A	√	√	Base Station mode with adapter 1
B	√	√	Base Station mode with adapter 2
C	√	√	Handset mode with adapter 3
D	√	√	Handset mode with adapter 4

Where **RE<1G**: Radiated Emission below 1GHz **PLC**: Power Line Conducted Emission

Radiated Emission Test (Below 1GHz):

- Pre-Scan has been conducted to determine the worst-case mode from all possible combinations between available modulations, data rates and antenna ports (if EUT with antenna diversity architecture).
- Following channel(s) was (were) selected for the final test as listed below.

EUT CONFIGURE MODE	AVAILABLE CHANNEL	TESTED CHANNEL	MODULATION TYPE	AXIS
A, B	1 to 252	1, 126, 252	MSK	X
C, D	1 to 252	1, 126, 252	MSK	Y

Power Line Conducted Emission Test:

- Pre-Scan has been conducted to determine the worst-case mode from all possible combinations between available modulations, data rates and antenna ports (if EUT with antenna diversity architecture).
- Following channel(s) was (were) selected for the final test as listed below.

EUT CONFIGURE MODE	AVAILABLE CHANNEL	TESTED CHANNEL	MODULATION TYPE
A, B	1 to 252	1, 126, 252	MSK
C, D	1 to 252	1, 126, 252	MSK

Test Condition:

APPLICABLE TO	ENVIRONMENTAL CONDITIONS	INPUT POWER	TESTED BY
RE<1G	18deg. C, 70%RH 21deg. C, 70%RH 23deg. C, 66%RH	120Vac, 60Hz	Nick Hsu Jones Chang
PLC	18deg. C, 70%RH 20deg. C, 70%RH	120Vac, 60Hz	Nick Hsu Jones Chang

3.3 Description of Support Units

The EUT has been tested as an independent unit together with other necessary accessories or support units. The following support units or accessories were used to form a representative test configuration during the tests.

ID	Product	Brand	Model No.	Serial No.	FCC ID	Remarks
A.	Load	NA	NA	NA	NA	-
B.	Earphone	PHILIPS	SBC HL150	NA	NA	For test mode C
C.	Earphone	HTC	NA	NA	NA	For test mode D

Note:

1. All power cords of the above support units are non-shielded (1.8m).

ID	Descriptions	Qty.	Length (m)	Shielding (Yes/No)	Cores (Qty.)	Remarks
1.	RJ11 cable	2	1.8	N	0	-
2.	Audio cable	1	1.2	N	0	-

3.3.1 Configuration of System under Test

TEST MODE A, B

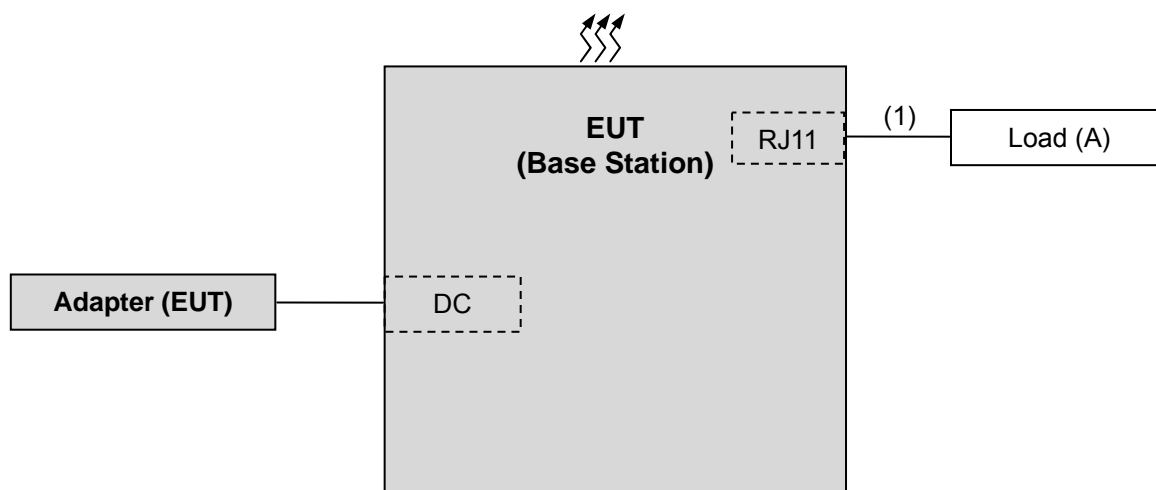

TEST MODE C, D

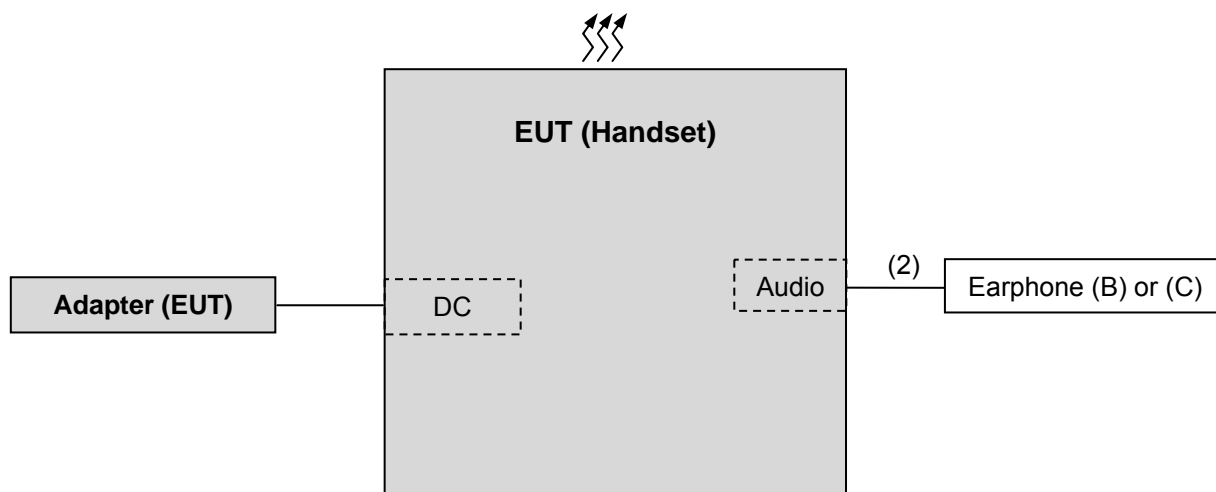

3.4 General Description of Applied Standards

The EUT is a RF Product. According to the specifications of the manufacturer, it must comply with the requirements of the following standards:

FCC Part 15, Subpart C (15.247)
558074 D01 DTS Meas Guidance v03r03
662911 D01 Multiple Transmitter Output v02r01
ANSI C63.10-2013

All test items have been performed and recorded as per the above standards.

NOTE: The EUT has been verified to comply with the requirements of FCC Part 15, Subpart B, Class B (DoC). The test report has been issued separately.

4 Test Types and Results

4.1 Radiated Emission and Bandedge Measurement

4.1.1 Limits of Radiated Emission and Bandedge Measurement

Radiated emissions which fall in the restricted bands must comply with the radiated emission limits specified as below table. Other emissions shall be at least 20dB below the highest level of the desired power:

Frequencies (MHz)	Field Strength (microvolts/meter)	Measurement Distance (meters)
0.009 ~ 0.490	2400/F(kHz)	300
0.490 ~ 1.705	24000/F(kHz)	30
1.705 ~ 30.0	30	30
30 ~ 88	100	3
88 ~ 216	150	3
216 ~ 960	200	3
Above 960	500	3

NOTE:

1. The lower limit shall apply at the transition frequencies.
2. Emission level (dBuV/m) = 20 log Emission level (uV/m).
3. For frequencies above 1000MHz, the field strength limits are based on average detector, however, the peak field strength of any emission shall not exceed the maximum permitted average limits, specified above by more than 20dB under any condition of modulation.



A D T

4.1.2 Test Instruments

Description & Manufacturer	Model No.	Serial No.	Cal. Date	Cal. Due
Test Receiver ROHDE & SCHWARZ	ESIB7	100187	Apr. 10, 2015	Apr. 09, 2016
Spectrum Analyzer ROHDE & SCHWARZ	FSP40	100041	Sep. 02, 2015	Sep. 01, 2016
BILOG Antenna SCHWARZBECK	VULB9168	9168-160	Feb. 05, 2015	Feb. 04, 2016
HORN Antenna SCHWARZBECK	9120D	209	Feb. 09, 2015	Feb. 08, 2016
HORN Antenna SCHWARZBECK	BBHA 9170	BBHA9170241	Feb. 09, 2015	Feb. 08, 2016
Preamplifier Agilent	8447D	2944A10738	Oct.18, 2015	Oct. 17, 2016
Preamplifier Agilent	8449B	3008A01964	Aug. 22, 2015	Aug. 21, 2016
RF signal cable HUBER+SUHNER	SUCOFLEX 104	Cable-CH3-03(214 378)	Aug. 22, 2015	Aug. 21, 2016
RF signal cable HUBER+SUHNER	SUCOFLEX 106	Cable-CH3-03(309 224+12738)	Aug. 22, 2015	Aug. 21, 2016
Software BV ADT	ADT_Radiated_ V7.6.15.9.4	NA	NA	NA
Antenna Tower inn-co GmbH	MA 4000	013303	NA	NA
Antenna Tower Controller BV ADT	AT100	AT93021702	NA	NA
Turn Table BV ADT	TT100	TT93021702	NA	NA
Turn Table Controller BV ADT	SC100	SC93021702	NA	NA
Turn Table Controller BV ADT	SC100	SC93021705	NA	NA

Note: 1. The calibration interval of the above test instruments is 12 months and the calibrations are traceable to NML/ROC and NIST/USA.

2. The test was performed in HwaYa Chamber 3.

3. The horn antenna and preamplifier (model: 8449B) are used only for the measurement of emission frequency above 1GHz if tested.

4. The FCC Site Registration No. is 988962.

5. The IC Site Registration No. is IC 7450F-3.

4.1.3 Test Procedures

- a. The EUT was placed on the top of a rotating table 0.8 meters above the ground at 3 meter chamber room for test. The table was rotated 360 degrees to determine the position of the highest radiation.
- b. The EUT was set 3 meters away from the interference-receiving antenna, which was mounted on the top of a variable-height antenna tower.
- c. The height of antenna is varied from one meter to four meters above the ground to determine the maximum value of the field strength. Both horizontal and vertical polarizations of the antenna are set to make the measurement.
- d. For each suspected emission, the EUT was arranged to its worst case and then the antenna was tuned to heights from 1 meter to 4 meters and the rotatable table was turned from 0 degrees to 360 degrees to find the maximum reading.
- e. The test-receiver system was set to quasi-peak detect function and specified bandwidth with maximum hold mode when the test frequency is below 1 GHz.
- f. The test-receiver system was set to peak and average detect function and specified bandwidth with maximum hold mode when the test frequency is above 1 GHz. If the peak reading value also meets average limit, measurement with the average detector is unnecessary.

Note:

1. The resolution bandwidth and video bandwidth of test receiver/spectrum analyzer is 120kHz for Quasi-peak detection (QP) at frequency below 1GHz.
2. The resolution bandwidth of test receiver/spectrum analyzer is 1 MHz and the video bandwidth is 3 MHz for Peak detection (PK) at frequency above 1GHz.
3. All modes of operation were investigated and the worst-case emissions are reported.

4.1.4 Deviation from Test Standard

No deviation.

4.1.5 Test Set Up

<Frequency Range below 1GHz>

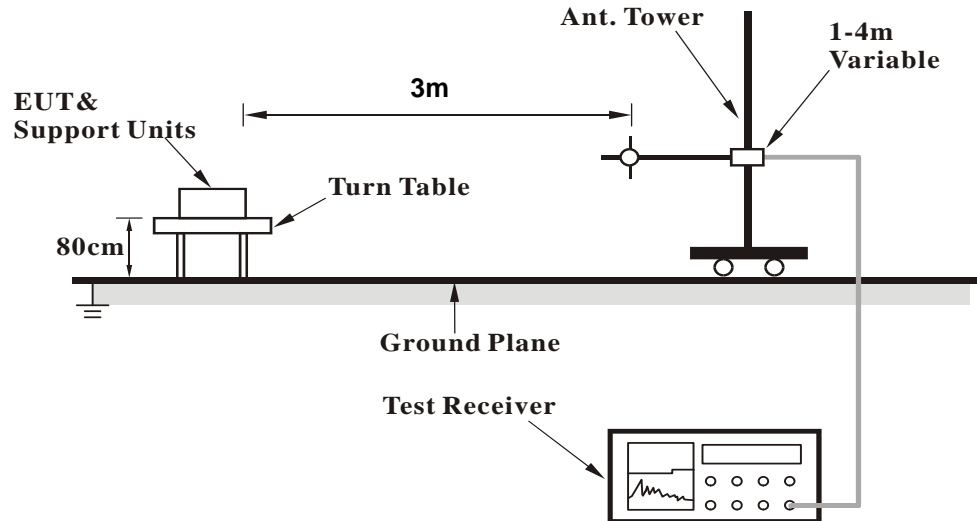

For the actual test configuration, please refer to the attached file (Test Setup Photo).

4.1.6 EUT Operating Conditions

- a. Placed the EUT on a testing table.
- b. Set the EUT under transmission condition continuously at specific channel frequency.
- c. The necessary accessories enable the system in full functions.

4.1.7 Test Results

Below 1GHz Worst-Case Data

Channel	Channel 1	Detector Function	Quasi-Peak (QP)
Frequency Range	30MHz ~ 1GHz	Test Mode	A

ANTENNA POLARITY & TEST DISTANCE: HORIZONTAL AT 3 M

NO.	FREQ. (MHz)	EMISSION LEVEL (dBuV/m)	LIMIT (dBuV/m)	MARGIN (dB)	ANTENNA HEIGHT (m)	TABLE ANGLE (Degree)	RAW VALUE (dBuV)	CORRECTION FACTOR (dB/m)
1	138.78	19.6 QP	43.5	-23.9	1.99 H	56	34.30	-14.70
2	335.15	29.6 QP	46.0	-16.4	1.03 H	54	41.40	-11.80
3	385.70	34.3 QP	46.0	-11.7	1.03 H	85	45.10	-10.80
4	416.81	30.5 QP	46.0	-15.5	1.03 H	149	40.70	-10.20
5	803.73	29.9 QP	46.0	-16.1	1.03 H	6	32.00	-2.10
6	875.67	33.0 QP	46.0	-13.0	1.03 H	29	33.90	-0.90

ANTENNA POLARITY & TEST DISTANCE: VERTICAL AT 3 M

NO.	FREQ. (MHz)	EMISSION LEVEL (dBuV/m)	LIMIT (dBuV/m)	MARGIN (dB)	ANTENNA HEIGHT (m)	TABLE ANGLE (Degree)	RAW VALUE (dBuV)	CORRECTION FACTOR (dB/m)
1	47.40	25.5 QP	40.0	-14.5	1.50 V	226	40.10	-14.60
2	385.70	29.1 QP	46.0	-16.9	1.50 V	289	39.90	-10.80
3	442.09	30.5 QP	46.0	-15.5	1.50 V	78	40.00	-9.50
4	467.36	29.0 QP	46.0	-17.0	1.50 V	61	38.10	-9.10
5	655.96	28.8 QP	46.0	-17.2	1.00 V	321	34.00	-5.20
6	875.67	36.2 QP	46.0	-9.8	1.50 V	14	37.10	-0.90

REMARKS:

1. Emission Level(dBuV/m) = Raw Value(dBuV) + Correction Factor(dB/m)
2. Correction Factor(dB/m) = Antenna Factor(dB/m) + Cable Factor(dB)
3. The other emission levels were very low against the limit.
4. Margin value = Emission Level – Limit value

Channel	Channel 126	Detector Function	Quasi-Peak (QP)
Frequency Range	30MHz ~ 1GHz	Test Mode	A

ANTENNA POLARITY & TEST DISTANCE: HORIZONTAL AT 3 M

NO.	FREQ. (MHz)	EMISSION LEVEL (dBuV/m)	LIMIT (dBuV/m)	MARGIN (dB)	ANTENNA HEIGHT (m)	TABLE ANGLE (Degree)	RAW VALUE (dBuV)	CORRECTION FACTOR (dB/m)
1	335.15	30.0 QP	46.0	-16.0	1.00 H	53	41.80	-11.80
2	385.70	33.5 QP	46.0	-12.5	1.00 H	104	44.30	-10.80
3	416.81	32.7 QP	46.0	-13.3	1.00 H	150	42.90	-10.20
4	467.36	29.6 QP	46.0	-16.4	1.99 H	333	38.70	-9.10
5	669.57	28.5 QP	46.0	-17.5	1.50 H	223	33.40	-4.90
6	809.56	30.7 QP	46.0	-15.3	1.00 H	5	32.70	-2.00

ANTENNA POLARITY & TEST DISTANCE: VERTICAL AT 3 M

NO.	FREQ. (MHz)	EMISSION LEVEL (dBuV/m)	LIMIT (dBuV/m)	MARGIN (dB)	ANTENNA HEIGHT (m)	TABLE ANGLE (Degree)	RAW VALUE (dBuV)	CORRECTION FACTOR (dB/m)
1	45.45	28.3 QP	40.0	-11.7	2.00 V	250	43.10	-14.80
2	385.70	32.6 QP	46.0	-13.4	1.50 V	289	43.40	-10.80
3	434.31	33.1 QP	46.0	-12.9	1.01 V	104	42.60	-9.50
4	467.36	31.3 QP	46.0	-14.7	1.01 V	179	40.40	-9.10
5	669.57	29.0 QP	46.0	-17.0	1.50 V	348	33.90	-4.90
6	811.50	29.9 QP	46.0	-16.1	1.01 V	63	31.90	-2.00

REMARKS:

1. Emission Level(dBuV/m) = Raw Value(dBuV) + Correction Factor(dB/m)
2. Correction Factor(dB/m) = Antenna Factor(dB/m) + Cable Factor(dB)
3. The other emission levels were very low against the limit.
4. Margin value = Emission Level – Limit value

Channel	Channel 252	Detector Function	Quasi-Peak (QP)
Frequency Range	30MHz ~ 1GHz	Test Mode	A

ANTENNA POLARITY & TEST DISTANCE: HORIZONTAL AT 3 M

NO.	FREQ. (MHz)	EMISSION LEVEL (dBuV/m)	LIMIT (dBuV/m)	MARGIN (dB)	ANTENNA HEIGHT (m)	TABLE ANGLE (Degree)	RAW VALUE (dBuV)	CORRECTION FACTOR (dB/m)
1	335.15	30.4 QP	46.0	-15.6	1.00 H	47	42.20	-11.80
2	385.70	34.4 QP	46.0	-11.6	1.00 H	83	45.20	-10.80
3	416.81	32.8 QP	46.0	-13.2	1.00 H	155	43.00	-10.20
4	434.31	29.9 QP	46.0	-16.1	2.00 H	208	39.40	-9.50
5	825.11	30.8 QP	46.0	-15.2	1.50 H	6	32.60	-1.80
6	949.55	36.6 QP	46.0	-9.4	1.50 H	331	36.20	0.40

ANTENNA POLARITY & TEST DISTANCE: VERTICAL AT 3 M

NO.	FREQ. (MHz)	EMISSION LEVEL (dBuV/m)	LIMIT (dBuV/m)	MARGIN (dB)	ANTENNA HEIGHT (m)	TABLE ANGLE (Degree)	RAW VALUE (dBuV)	CORRECTION FACTOR (dB/m)
1	385.70	32.5 QP	46.0	-13.5	1.50 V	315	43.30	-10.80
2	416.81	32.9 QP	46.0	-13.1	1.50 V	145	43.10	-10.20
3	467.36	32.8 QP	46.0	-13.2	1.50 V	80	41.90	-9.10
4	515.97	29.6 QP	46.0	-16.4	1.00 V	166	37.70	-8.10
5	681.24	29.8 QP	46.0	-16.2	1.99 V	3	34.40	-4.60
6	821.23	31.6 QP	46.0	-14.4	1.50 V	7	33.40	-1.80

REMARKS:

1. Emission Level(dBuV/m) = Raw Value(dBuV) + Correction Factor(dB/m)
2. Correction Factor(dB/m) = Antenna Factor(dB/m) + Cable Factor(dB)
3. The other emission levels were very low against the limit.
4. Margin value = Emission Level – Limit value

Channel	Channel 1	Detector Function	Quasi-Peak (QP)
Frequency Range	30MHz ~ 1GHz	Test Mode	B

ANTENNA POLARITY & TEST DISTANCE: HORIZONTAL AT 3 M

NO.	FREQ. (MHz)	EMISSION LEVEL (dBuV/m)	LIMIT (dBuV/m)	MARGIN (dB)	ANTENNA HEIGHT (m)	TABLE ANGLE (Degree)	RAW VALUE (dBuV)	CORRECTION FACTOR (dB/m)
1	164.06	23.3 QP	43.5	-20.2	1.50 H	263	37.30	-14.00
2	220.44	25.9 QP	46.0	-20.1	1.50 H	283	42.40	-16.50
3	368.21	35.0 QP	46.0	-11.0	1.00 H	153	46.20	-11.20
4	385.70	33.6 QP	46.0	-12.4	1.00 H	161	44.40	-10.80
5	434.31	32.1 QP	46.0	-13.9	1.99 H	154	41.60	-9.50
6	811.50	30.4 QP	46.0	-15.6	1.00 H	9	32.40	-2.00

ANTENNA POLARITY & TEST DISTANCE: VERTICAL AT 3 M

NO.	FREQ. (MHz)	EMISSION LEVEL (dBuV/m)	LIMIT (dBuV/m)	MARGIN (dB)	ANTENNA HEIGHT (m)	TABLE ANGLE (Degree)	RAW VALUE (dBuV)	CORRECTION FACTOR (dB/m)
1	53.23	21.5 QP	40.0	-18.5	1.50 V	333	36.00	-14.50
2	335.15	31.0 QP	46.0	-15.0	1.50 V	236	42.80	-11.80
3	385.70	34.5 QP	46.0	-11.5	1.50 V	345	45.30	-10.80
4	467.36	33.7 QP	46.0	-12.3	1.50 V	310	42.80	-9.10
5	515.97	30.7 QP	46.0	-15.3	1.00 V	229	38.80	-8.10
6	655.96	28.6 QP	46.0	-17.4	1.00 V	319	33.80	-5.20

REMARKS:

1. Emission Level(dBuV/m) = Raw Value(dBuV) + Correction Factor(dB/m)
2. Correction Factor(dB/m) = Antenna Factor(dB/m) + Cable Factor(dB)
3. The other emission levels were very low against the limit.
4. Margin value = Emission Level – Limit value

Channel	Channel 126	Detector Function	Quasi-Peak (QP)
Frequency Range	30MHz ~ 1GHz	Test Mode	B

ANTENNA POLARITY & TEST DISTANCE: HORIZONTAL AT 3 M

NO.	FREQ. (MHz)	EMISSION LEVEL (dBuV/m)	LIMIT (dBuV/m)	MARGIN (dB)	ANTENNA HEIGHT (m)	TABLE ANGLE (Degree)	RAW VALUE (dBuV)	CORRECTION FACTOR (dB/m)
1	121.28	25.7 QP	43.5	-17.8	1.51 H	54	41.90	-16.20
2	183.50	35.9 QP	43.5	-7.6	1.51 H	65	51.40	-15.50
3	368.21	34.1 QP	46.0	-11.9	1.01 H	79	45.30	-11.20
4	385.70	33.3 QP	46.0	-12.7	1.01 H	76	44.10	-10.80
5	669.57	28.8 QP	46.0	-17.2	1.51 H	337	33.70	-4.90
6	815.39	31.1 QP	46.0	-14.9	1.01 H	10	33.00	-1.90

ANTENNA POLARITY & TEST DISTANCE: VERTICAL AT 3 M

NO.	FREQ. (MHz)	EMISSION LEVEL (dBuV/m)	LIMIT (dBuV/m)	MARGIN (dB)	ANTENNA HEIGHT (m)	TABLE ANGLE (Degree)	RAW VALUE (dBuV)	CORRECTION FACTOR (dB/m)
1	53.23	22.8 QP	40.0	-17.2	1.99 V	201	37.30	-14.50
2	383.76	31.4 QP	46.0	-14.6	1.49 V	314	42.30	-10.90
3	416.81	32.8 QP	46.0	-13.2	1.00 V	203	43.00	-10.20
4	467.36	30.8 QP	46.0	-15.2	1.00 V	178	39.90	-9.10
5	669.57	28.3 QP	46.0	-17.7	1.49 V	45	33.20	-4.90
6	819.28	31.9 QP	46.0	-14.1	1.00 V	100	33.80	-1.90

REMARKS:

1. Emission Level(dBuV/m) = Raw Value(dBuV) + Correction Factor(dB/m)
2. Correction Factor(dB/m) = Antenna Factor(dB/m) + Cable Factor(dB)
3. The other emission levels were very low against the limit.
4. Margin value = Emission Level – Limit value

Channel	Channel 252	Detector Function	Quasi-Peak (QP)
Frequency Range	30MHz ~ 1GHz	Test Mode	B

ANTENNA POLARITY & TEST DISTANCE: HORIZONTAL AT 3 M

NO.	FREQ. (MHz)	EMISSION LEVEL (dBuV/m)	LIMIT (dBuV/m)	MARGIN (dB)	ANTENNA HEIGHT (m)	TABLE ANGLE (Degree)	RAW VALUE (dBuV)	CORRECTION FACTOR (dB/m)
1	57.12	19.8 QP	40.0	-20.2	1.99 H	12	34.60	-14.80
2	220.44	28.8 QP	46.0	-17.2	1.49 H	310	45.30	-16.50
3	385.70	34.6 QP	46.0	-11.4	1.00 H	230	45.40	-10.80
4	434.31	32.9 QP	46.0	-13.1	1.99 H	252	42.40	-9.50
5	681.24	29.3 QP	46.0	-16.7	1.99 H	12	33.90	-4.60
6	825.11	31.2 QP	46.0	-14.8	1.99 H	12	33.00	-1.80

ANTENNA POLARITY & TEST DISTANCE: VERTICAL AT 3 M

NO.	FREQ. (MHz)	EMISSION LEVEL (dBuV/m)	LIMIT (dBuV/m)	MARGIN (dB)	ANTENNA HEIGHT (m)	TABLE ANGLE (Degree)	RAW VALUE (dBuV)	CORRECTION FACTOR (dB/m)
1	59.06	22.0 QP	40.0	-18.0	1.50 V	293	36.80	-14.80
2	385.70	34.7 QP	46.0	-11.3	1.50 V	5	45.50	-10.80
3	467.36	34.9 QP	46.0	-11.1	1.50 V	330	44.00	-9.10
4	515.97	30.5 QP	46.0	-15.5	1.00 V	228	38.60	-8.10
5	681.24	29.4 QP	46.0	-16.6	1.00 V	350	34.00	-4.60
6	825.11	30.1 QP	46.0	-15.9	1.00 V	85	31.90	-1.80

REMARKS:

1. Emission Level(dBuV/m) = Raw Value(dBuV) + Correction Factor(dB/m)
2. Correction Factor(dB/m) = Antenna Factor(dB/m) + Cable Factor(dB)
3. The other emission levels were very low against the limit.
4. Margin value = Emission Level – Limit value

Channel	Channel 1	Detector Function	Quasi-Peak (QP)
Frequency Range	30MHz ~ 1GHz	Test Mode	C

ANTENNA POLARITY & TEST DISTANCE: HORIZONTAL AT 3 M

NO.	FREQ. (MHz)	EMISSION LEVEL (dBuV/m)	LIMIT (dBuV/m)	MARGIN (dB)	ANTENNA HEIGHT (m)	TABLE ANGLE (Degree)	RAW VALUE (dBuV)	CORRECTION FACTOR (dB/m)
1	129.06	25.4 QP	43.5	-18.1	1.50 H	85	41.00	-15.60
2	210.72	28.6 QP	43.5	-14.9	1.50 H	238	45.30	-16.70
3	340.99	28.8 QP	46.0	-17.2	1.00 H	285	40.60	-11.80
4	471.25	28.7 QP	46.0	-17.3	1.00 H	144	37.70	-9.00
5	669.57	39.6 QP	46.0	-6.4	1.50 H	211	44.50	-4.90
6	846.50	38.9 QP	46.0	-7.1	1.00 H	55	40.50	-1.60

ANTENNA POLARITY & TEST DISTANCE: VERTICAL AT 3 M

NO.	FREQ. (MHz)	EMISSION LEVEL (dBuV/m)	LIMIT (dBuV/m)	MARGIN (dB)	ANTENNA HEIGHT (m)	TABLE ANGLE (Degree)	RAW VALUE (dBuV)	CORRECTION FACTOR (dB/m)
1	61.01	31.4 QP	40.0	-8.6	1.50 V	338	46.60	-15.20
2	109.62	30.0 QP	43.5	-13.5	1.00 V	40	47.40	-17.40
3	272.94	25.5 QP	46.0	-20.5	1.00 V	59	38.70	-13.20
4	471.25	27.6 QP	46.0	-18.4	1.00 V	142	36.60	-9.00
5	669.57	35.6 QP	46.0	-10.4	1.50 V	88	40.50	-4.90
6	846.50	34.7 QP	46.0	-11.3	1.00 V	185	36.30	-1.60

REMARKS:

1. Emission Level(dBuV/m) = Raw Value(dBuV) + Correction Factor(dB/m)
2. Correction Factor(dB/m) = Antenna Factor(dB/m) + Cable Factor(dB)
3. The other emission levels were very low against the limit.
4. Margin value = Emission Level – Limit value

Channel	Channel 126	Detector Function	Quasi-Peak (QP)
Frequency Range	30MHz ~ 1GHz	Test Mode	C

ANTENNA POLARITY & TEST DISTANCE: HORIZONTAL AT 3 M

NO.	FREQ. (MHz)	EMISSION LEVEL (dBuV/m)	LIMIT (dBuV/m)	MARGIN (dB)	ANTENNA HEIGHT (m)	TABLE ANGLE (Degree)	RAW VALUE (dBuV)	CORRECTION FACTOR (dB/m)
1	129.06	24.9 QP	43.5	-18.6	1.50 H	54	40.50	-15.60
2	208.77	28.9 QP	43.5	-14.6	1.00 H	253	45.70	-16.80
3	344.87	27.8 QP	46.0	-18.2	1.00 H	220	39.60	-11.80
4	471.25	28.5 QP	46.0	-17.5	1.00 H	141	37.50	-9.00
5	669.57	43.7 QP	46.0	-2.3	1.00 H	128	48.60	-4.90
6	846.50	39.1 QP	46.0	-6.9	1.00 H	57	40.70	-1.60

ANTENNA POLARITY & TEST DISTANCE: VERTICAL AT 3 M

NO.	FREQ. (MHz)	EMISSION LEVEL (dBuV/m)	LIMIT (dBuV/m)	MARGIN (dB)	ANTENNA HEIGHT (m)	TABLE ANGLE (Degree)	RAW VALUE (dBuV)	CORRECTION FACTOR (dB/m)
1	61.01	31.5 QP	40.0	-8.5	1.50 V	337	46.70	-15.20
2	109.62	30.3 QP	43.5	-13.2	1.00 V	77	47.70	-17.40
3	270.99	25.3 QP	46.0	-20.7	1.00 V	40	38.60	-13.30
4	471.25	27.5 QP	46.0	-18.5	1.00 V	9	36.50	-9.00
5	669.57	33.4 QP	46.0	-12.6	1.50 V	154	38.30	-4.90
6	846.50	30.6 QP	46.0	-15.4	1.00 V	53	32.20	-1.60

REMARKS:

1. Emission Level(dBuV/m) = Raw Value(dBuV) + Correction Factor(dB/m)
2. Correction Factor(dB/m) = Antenna Factor(dB/m) + Cable Factor(dB)
3. The other emission levels were very low against the limit.
4. Margin value = Emission Level – Limit value

Channel	Channel 252	Detector Function	Quasi-Peak (QP)
Frequency Range	30MHz ~ 1GHz	Test Mode	C

ANTENNA POLARITY & TEST DISTANCE: HORIZONTAL AT 3 M

NO.	FREQ. (MHz)	EMISSION LEVEL (dBuV/m)	LIMIT (dBuV/m)	MARGIN (dB)	ANTENNA HEIGHT (m)	TABLE ANGLE (Degree)	RAW VALUE (dBuV)	CORRECTION FACTOR (dB/m)
1	109.62	25.3 QP	43.5	-18.2	1.50 H	73	42.70	-17.40
2	197.11	29.0 QP	43.5	-14.5	1.00 H	235	45.50	-16.50
3	342.93	29.3 QP	46.0	-16.7	1.00 H	213	41.00	-11.70
4	669.57	43.7 QP	46.0	-2.3	1.00 H	284	48.60	-4.90
5	846.50	36.8 QP	46.0	-9.2	1.50 H	53	38.40	-1.60
6	941.77	36.9 QP	46.0	-9.1	1.50 H	187	36.70	0.20

ANTENNA POLARITY & TEST DISTANCE: VERTICAL AT 3 M

NO.	FREQ. (MHz)	EMISSION LEVEL (dBuV/m)	LIMIT (dBuV/m)	MARGIN (dB)	ANTENNA HEIGHT (m)	TABLE ANGLE (Degree)	RAW VALUE (dBuV)	CORRECTION FACTOR (dB/m)
1	61.01	31.4 QP	40.0	-8.6	1.50 V	325	46.60	-15.20
2	129.06	29.8 QP	43.5	-13.7	1.00 V	11	45.40	-15.60
3	304.04	26.6 QP	46.0	-19.4	1.00 V	11	39.00	-12.40
4	471.25	27.0 QP	46.0	-19.0	1.50 V	352	36.00	-9.00
5	669.57	34.6 QP	46.0	-11.4	1.50 V	185	39.50	-4.90
6	846.50	33.5 QP	46.0	-12.5	1.00 V	170	35.10	-1.60

REMARKS:

1. Emission Level(dBuV/m) = Raw Value(dBuV) + Correction Factor(dB/m)
2. Correction Factor(dB/m) = Antenna Factor(dB/m) + Cable Factor(dB)
3. The other emission levels were very low against the limit.
4. Margin value = Emission Level – Limit value

Channel	Channel 1	Detector Function	Quasi-Peak (QP)
Frequency Range	30MHz ~ 1GHz	Test Mode	D

ANTENNA POLARITY & TEST DISTANCE: HORIZONTAL AT 3 M

NO.	FREQ. (MHz)	EMISSION LEVEL (dBuV/m)	LIMIT (dBuV/m)	MARGIN (dB)	ANTENNA HEIGHT (m)	TABLE ANGLE (Degree)	RAW VALUE (dBuV)	CORRECTION FACTOR (dB/m)
1	134.89	33.0 QP	43.5	-10.5	2.00 H	60	47.90	-14.90
2	302.10	29.5 QP	46.0	-16.5	1.00 H	242	41.70	-12.20
3	492.64	33.7 QP	46.0	-12.3	1.00 H	304	41.90	-8.20
4	706.51	37.6 QP	46.0	-8.4	1.00 H	98	41.50	-3.90
5	737.62	43.8 QP	46.0	-2.2	2.00 H	103	46.90	-3.10
6	984.55	45.2 QP	54.0	-8.8	1.49 H	114	44.30	0.90

ANTENNA POLARITY & TEST DISTANCE: VERTICAL AT 3 M

NO.	FREQ. (MHz)	EMISSION LEVEL (dBuV/m)	LIMIT (dBuV/m)	MARGIN (dB)	ANTENNA HEIGHT (m)	TABLE ANGLE (Degree)	RAW VALUE (dBuV)	CORRECTION FACTOR (dB/m)
1	66.84	25.6 QP	40.0	-14.4	1.50 V	16	41.20	-15.60
2	134.89	34.5 QP	43.5	-9.0	1.00 V	154	49.40	-14.90
3	706.51	32.3 QP	46.0	-13.7	1.00 V	4	36.20	-3.90
4	737.62	41.5 QP	46.0	-4.5	2.00 V	169	44.60	-3.10
5	821.23	40.0 QP	46.0	-6.0	2.00 V	9	41.60	-1.60
6	984.55	40.7 QP	54.0	-13.3	1.50 V	162	39.80	0.90

REMARKS:

1. Emission Level(dBuV/m) = Raw Value(dBuV) + Correction Factor(dB/m)
2. Correction Factor(dB/m) = Antenna Factor(dB/m) + Cable Factor(dB)
3. The other emission levels were very low against the limit.
4. Margin value = Emission Level – Limit value

Channel	Channel 126	Detector Function	Quasi-Peak (QP)
Frequency Range	30MHz ~ 1GHz	Test Mode	D

ANTENNA POLARITY & TEST DISTANCE: HORIZONTAL AT 3 M

NO.	FREQ. (MHz)	EMISSION LEVEL (dBuV/m)	LIMIT (dBuV/m)	MARGIN (dB)	ANTENNA HEIGHT (m)	TABLE ANGLE (Degree)	RAW VALUE (dBuV)	CORRECTION FACTOR (dB/m)
1	129.06	32.5 QP	43.5	-11.0	2.00 H	86	48.00	-15.50
2	302.10	30.0 QP	46.0	-16.0	1.00 H	254	42.20	-12.20
3	492.64	33.9 QP	46.0	-12.1	1.00 H	329	42.10	-8.20
4	706.51	35.5 QP	46.0	-10.5	1.00 H	84	39.40	-3.90
5	846.50	43.9 QP	46.0	-2.1	1.00 H	62	45.20	-1.30
6	984.55	46.9 QP	54.0	-7.1	1.51 H	240	46.00	0.90

ANTENNA POLARITY & TEST DISTANCE: VERTICAL AT 3 M

NO.	FREQ. (MHz)	EMISSION LEVEL (dBuV/m)	LIMIT (dBuV/m)	MARGIN (dB)	ANTENNA HEIGHT (m)	TABLE ANGLE (Degree)	RAW VALUE (dBuV)	CORRECTION FACTOR (dB/m)
1	45.45	25.4 QP	40.0	-14.6	1.50 V	304	40.10	-14.70
2	134.89	34.0 QP	43.5	-9.5	1.00 V	156	48.90	-14.90
3	492.64	30.1 QP	46.0	-15.9	1.00 V	144	38.30	-8.20
4	737.62	32.1 QP	46.0	-13.9	2.00 V	168	35.20	-3.10
5	846.50	38.6 QP	46.0	-7.4	2.00 V	355	39.90	-1.30
6	984.55	42.3 QP	54.0	-11.7	1.50 V	166	41.40	0.90

REMARKS:

1. Emission Level(dBuV/m) = Raw Value(dBuV) + Correction Factor(dB/m)
2. Correction Factor(dB/m) = Antenna Factor(dB/m) + Cable Factor(dB)
3. The other emission levels were very low against the limit.
4. Margin value = Emission Level – Limit value

Channel	Channel 252	Detector Function	Quasi-Peak (QP)
Frequency Range	30MHz ~ 1GHz	Test Mode	D

ANTENNA POLARITY & TEST DISTANCE: HORIZONTAL AT 3 M

NO.	FREQ. (MHz)	EMISSION LEVEL (dBuV/m)	LIMIT (dBuV/m)	MARGIN (dB)	ANTENNA HEIGHT (m)	TABLE ANGLE (Degree)	RAW VALUE (dBuV)	CORRECTION FACTOR (dB/m)
1	129.06	32.9 QP	43.5	-10.6	1.50 H	62	48.40	-15.50
2	471.25	30.5 QP	46.0	-15.5	1.00 H	331	39.10	-8.60
3	706.51	35.2 QP	46.0	-10.8	2.00 H	37	39.10	-3.90
4	871.78	42.1 QP	46.0	-3.9	1.50 H	62	42.80	-0.70
5	963.16	41.8 QP	54.0	-12.2	1.50 H	243	41.00	0.80
6	984.55	46.1 QP	54.0	-7.9	1.50 H	244	45.20	0.90

ANTENNA POLARITY & TEST DISTANCE: VERTICAL AT 3 M

NO.	FREQ. (MHz)	EMISSION LEVEL (dBuV/m)	LIMIT (dBuV/m)	MARGIN (dB)	ANTENNA HEIGHT (m)	TABLE ANGLE (Degree)	RAW VALUE (dBuV)	CORRECTION FACTOR (dB/m)
1	70.73	32.9 QP	40.0	-7.1	1.01 V	247	49.00	-16.10
2	134.89	33.7 QP	43.5	-9.8	1.01 V	134	48.60	-14.90
3	737.62	33.1 QP	46.0	-12.9	2.00 V	162	36.20	-3.10
4	871.78	40.6 QP	46.0	-5.4	1.50 V	16	41.30	-0.70
5	953.44	41.6 QP	46.0	-4.4	1.50 V	163	41.10	0.50
6	984.55	43.0 QP	54.0	-11.0	1.50 V	157	42.10	0.90

REMARKS:

1. Emission Level(dBuV/m) = Raw Value(dBuV) + Correction Factor(dB/m)
2. Correction Factor(dB/m) = Antenna Factor(dB/m) + Cable Factor(dB)
3. The other emission levels were very low against the limit.
4. Margin value = Emission Level – Limit value

4.2 Conducted Emission Measurement

4.2.1 Limits of Conducted Emission Measurement

Frequency (MHz)	Conducted Limit (dBuV)	
	Quasi-peak	Average
0.15 - 0.5	66 - 56	56 - 46
0.50 - 5.0	56	46
5.0 - 30.0	60	50

Note: 1. The lower limit shall apply at the transition frequencies.

2. The limit decreases in line with the logarithm of the frequency in the range of 0.15 to 0.50MHz.

4.2.2 Test Instruments

Description & Manufacturer	Model No.	Serial No.	Date Of Calibration	Due Date Of Calibration
Test Receiver ROHDE & SCHWARZ	ESCS 30	100288	Apr. 27, 2015	Apr. 26, 2016
RF signal cable (with 10dB PAD) Woken	5D-FB	Cable-cond2-01	Dec. 26, 2014	Dec. 25, 2015
LISN ROHDE & SCHWARZ (EUT)	ESH2-Z5	100100	Dec. 30, 2014	Dec. 29, 2015
LISN ROHDE & SCHWARZ (Peripheral)	ESH3-Z5	100312	Jul. 21, 2015	Jul. 20, 2016
Software ADT	BV ADT_Cond_ V7.3.7.3	NA	NA	NA

Note: 1. The calibration interval of the above test instruments is 12 months and the calibrations are traceable to NML/ROC and NIST/USA.

2. The test was performed in HwaYa Shielded Room 2.

3. The VCCI Site Registration No. is C-2047.

4.2.3 Test Procedures

- a. The EUT was placed 0.4 meters from the conducting wall of the shielded room with EUT being connected to the power mains through a line impedance stabilization network (LISN). Other support units were connected to the power mains through another LISN. The two LISNs provide 50 ohm/ 50uH of coupling impedance for the measuring instrument.
- b. Both lines of the power mains connected to the EUT were checked for maximum conducted interference.
- c. The frequency range from 150kHz to 30MHz was searched. Emission levels under (Limit - 20dB) was not recorded.

NOTE: The resolution bandwidth and video bandwidth of test receiver is 9kHz for quasi-peak detection (QP) and average detection (AV) at frequency 0.15MHz-30MHz.

4.2.4 Deviation from Test Standard

No deviation.

4.2.5 Test Setup

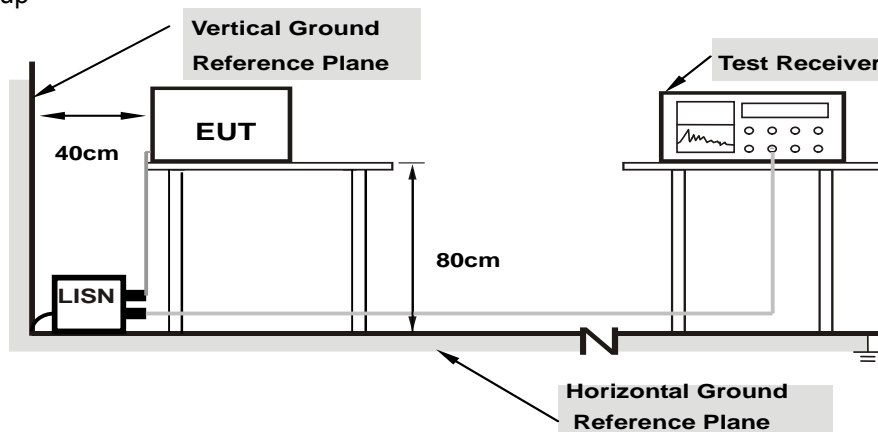

Note: 1.Support units were connected to second LISN.

For the actual test configuration, please refer to the attached file (Test Setup Photo).

4.2.6 EUT Operating Conditions

Same as 4.1.6.

4.2.7 Test Results

Phase	Line (L)	Detector Function	Quasi-Peak (QP) / Average (AV)
Channel	Channel 1	Test Mode	A

No	Freq. [MHz]	Corr. Factor (dB)	Reading Value [dB (uV)]		Emission Level [dB (uV)]		Limit [dB (uV)]		Margin (dB)	
			Q.P.	AV.	Q.P.	AV.	Q.P.	AV.	Q.P.	AV.
			1	0.15000	9.94	36.46	23.92	46.40	33.86	66.00
2	0.18125	9.94	32.56	18.04	42.50	27.98	64.43	54.43	-21.92	-26.44
3	0.21641	9.95	27.41	9.90	37.36	19.85	62.96	52.96	-25.60	-33.11
4	0.40781	9.95	27.75	19.49	37.70	29.44	57.69	47.69	-19.99	-18.25
5	0.91172	10.05	17.51	8.94	27.56	18.99	56.00	46.00	-28.44	-27.01
6	8.87891	10.40	22.45	17.29	32.85	27.69	60.00	50.00	-27.15	-22.31

REMARKS:

1. Q.P. and AV. are abbreviations of quasi-peak and average individually.
2. The emission levels of other frequencies were very low against the limit.
3. Margin value = Emission level - Limit value
4. Correction factor = Insertion loss + Cable loss
5. Emission Level = Correction Factor + Reading Value.

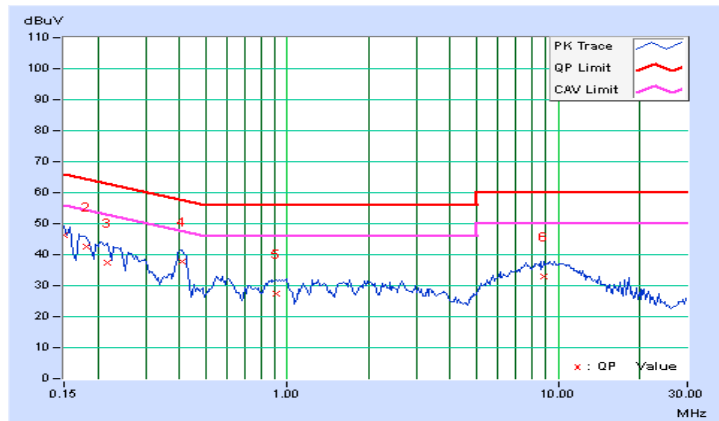

Phase	Neutral (N)	Detector Function	Quasi-Peak (QP) / Average (AV)
Channel	Channel 1	Test Mode	A

No	Freq. [MHz]	Corr. Factor (dB)	Reading Value [dB (uV)]		Emission Level [dB (uV)]		Limit [dB (uV)]		Margin (dB)	
			Q.P.	AV.	Q.P.	AV.	Q.P.	AV.	Q.P.	AV.
			1	0.15000	9.95	34.47	21.10	44.42	31.05	66.00
2	0.17734	9.96	32.28	18.60	42.24	28.56	64.61	54.61	-22.37	-26.05
3	0.23203	9.97	27.71	11.87	37.68	21.84	62.38	52.38	-24.70	-30.54
4	0.39609	10.00	25.24	11.58	35.24	21.58	57.93	47.93	-22.69	-26.35
5	0.59531	10.03	13.09	3.48	23.12	13.51	56.00	46.00	-32.88	-32.49
6	8.88672	10.46	20.06	15.31	30.52	25.77	60.00	50.00	-29.48	-24.23

REMARKS:

1. Q.P. and AV. are abbreviations of quasi-peak and average individually.
2. The emission levels of other frequencies were very low against the limit.
3. Margin value = Emission level - Limit value
4. Correction factor = Insertion loss + Cable loss
5. Emission Level = Correction Factor + Reading Value.

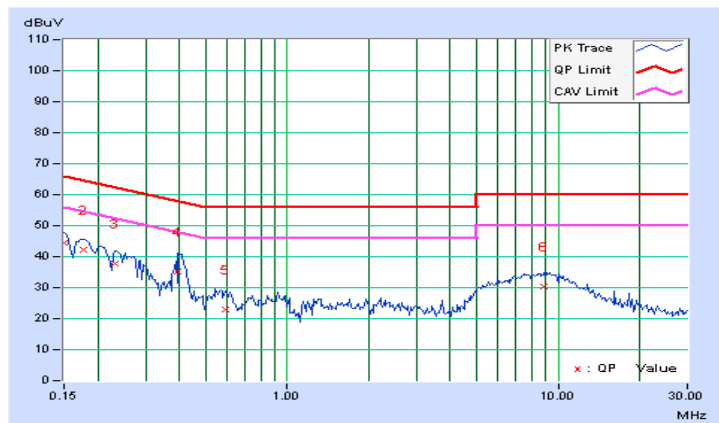

Phase	Line (L)	Detector Function	Quasi-Peak (QP) / Average (AV)
Channel	Channel 126	Test Mode	A

No	Freq. [MHz]	Corr. Factor (dB)	Reading Value [dB (uV)]		Emission Level [dB (uV)]		Limit [dB (uV)]		Margin (dB)	
			Q.P.	AV.	Q.P.	AV.	Q.P.	AV.	Q.P.	AV.
			1	0.15000	9.94	36.32	24.04	46.26	33.98	66.00
2	0.17344	9.94	33.14	18.16	43.08	28.10	64.79	54.79	-21.71	-26.69
3	0.21250	9.95	29.47	14.34	39.42	24.29	63.11	53.11	-23.69	-28.82
4	0.40391	9.95	27.50	18.94	37.45	28.89	57.77	47.77	-20.32	-18.88
5	0.90000	10.05	17.35	8.68	27.40	18.73	56.00	46.00	-28.60	-27.27
6	9.43359	10.41	22.07	16.34	32.48	26.75	60.00	50.00	-27.52	-23.25

REMARKS:

1. Q.P. and AV. are abbreviations of quasi-peak and average individually.
2. The emission levels of other frequencies were very low against the limit.
3. Margin value = Emission level - Limit value
4. Correction factor = Insertion loss + Cable loss
5. Emission Level = Correction Factor + Reading Value.

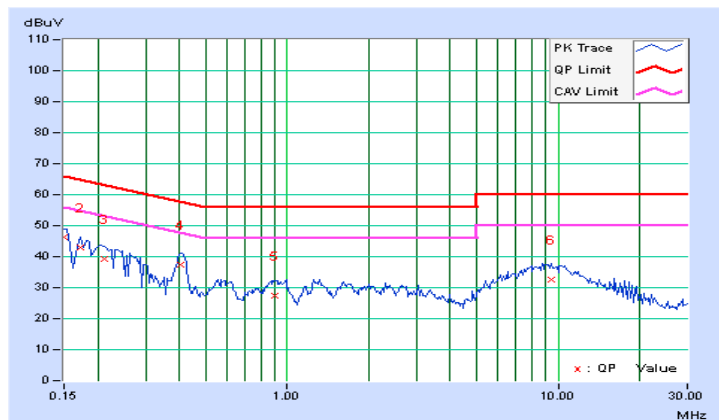

Phase	Neutral (N)	Detector Function	Quasi-Peak (QP) / Average (AV)
Channel	Channel 126	Test Mode	A

No	Freq. [MHz]	Corr. Factor (dB)	Reading Value [dB (uV)]		Emission Level [dB (uV)]		Limit [dB (uV)]		Margin (dB)	
			Q.P.	AV.	Q.P.	AV.	Q.P.	AV.	Q.P.	AV.
			1	0.15000	9.95	34.57	21.18	44.52	31.13	66.00
2	0.17344	9.96	31.80	16.55	41.76	26.51	64.79	54.79	-23.04	-28.29
3	0.22031	9.97	24.50	5.97	34.47	15.94	62.81	52.81	-28.34	-36.87
4	0.40781	10.00	25.58	13.97	35.58	23.97	57.69	47.69	-22.11	-23.72
5	5.68750	10.36	17.23	12.09	27.59	22.45	60.00	50.00	-32.41	-27.55
6	8.90234	10.46	20.21	15.01	30.67	25.47	60.00	50.00	-29.33	-24.53

REMARKS:

1. Q.P. and AV. are abbreviations of quasi-peak and average individually.
2. The emission levels of other frequencies were very low against the limit.
3. Margin value = Emission level - Limit value
4. Correction factor = Insertion loss + Cable loss
5. Emission Level = Correction Factor + Reading Value.

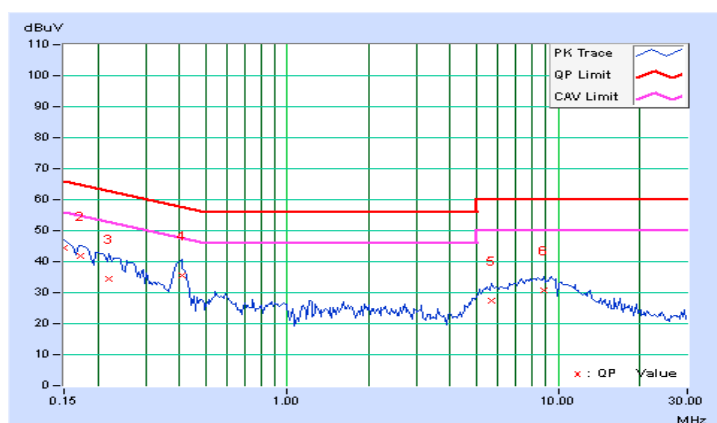

Phase	Line (L)	Detector Function	Quasi-Peak (QP) / Average (AV)
Channel	Channel 252	Test Mode	A

No	Freq. [MHz]	Corr. Factor (dB)	Reading Value [dB (uV)]		Emission Level [dB (uV)]		Limit [dB (uV)]		Margin (dB)	
			Q.P.	AV.	Q.P.	AV.	Q.P.	AV.	Q.P.	AV.
			1	0.15000	9.94	36.15	24.24	46.09	34.18	66.00
2	0.17734	9.94	32.92	19.19	42.86	29.13	64.61	54.61	-21.75	-25.48
3	0.20859	9.95	30.00	15.83	39.95	25.78	63.26	53.26	-23.32	-27.49
4	0.41172	9.95	27.57	19.43	37.52	29.38	57.61	47.61	-20.09	-18.23
5	0.89609	10.05	17.59	8.88	27.64	18.93	56.00	46.00	-28.36	-27.07
6	8.72656	10.39	22.20	17.03	32.59	27.42	60.00	50.00	-27.41	-22.58

REMARKS:

1. Q.P. and AV. are abbreviations of quasi-peak and average individually.
2. The emission levels of other frequencies were very low against the limit.
3. Margin value = Emission level - Limit value
4. Correction factor = Insertion loss + Cable loss
5. Emission Level = Correction Factor + Reading Value.

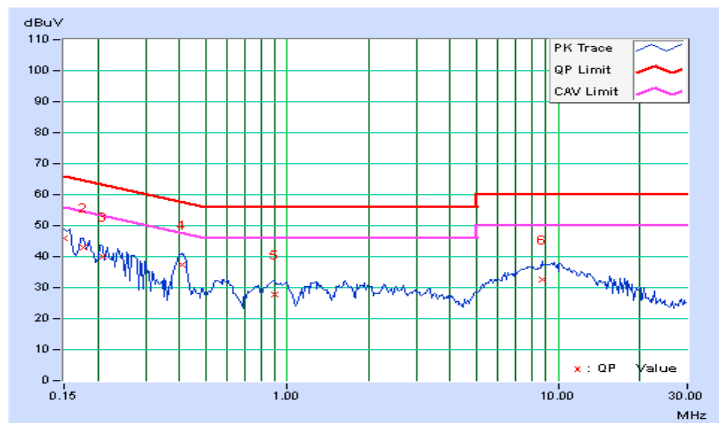

Phase	Neutral (N)	Detector Function	Quasi-Peak (QP) / Average (AV)
Channel	Channel 252	Test Mode	A

No	Freq. [MHz]	Corr. Factor (dB)	Reading Value [dB (uV)]		Emission Level [dB (uV)]		Limit [dB (uV)]		Margin (dB)	
			Q.P.	AV.	Q.P.	AV.	Q.P.	AV.	Q.P.	AV.
			1	0.15000	9.95	34.69	21.48	44.64	31.43	66.00
2	0.17734	9.96	32.31	18.11	42.27	28.07	64.61	54.61	-22.34	-26.54
3	0.22031	9.97	26.07	7.14	36.04	17.11	62.81	52.81	-26.77	-35.70
4	0.40781	10.00	25.39	13.87	35.39	23.87	57.69	47.69	-22.30	-23.82
5	0.60703	10.03	13.33	3.37	23.36	13.40	56.00	46.00	-32.64	-32.60
6	8.78125	10.46	20.24	15.44	30.70	25.90	60.00	50.00	-29.30	-24.10

REMARKS:

1. Q.P. and AV. are abbreviations of quasi-peak and average individually.
2. The emission levels of other frequencies were very low against the limit.
3. Margin value = Emission level - Limit value
4. Correction factor = Insertion loss + Cable loss
5. Emission Level = Correction Factor + Reading Value.

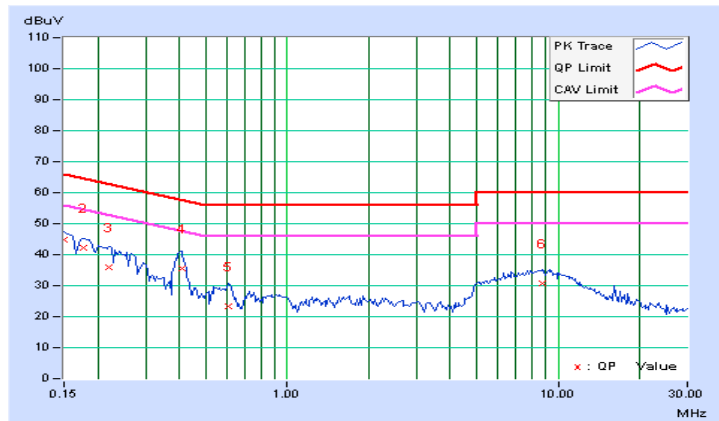

Phase	Line (L)	Detector Function	Quasi-Peak (QP) / Average (AV)
Channel	Channel 1	Test Mode	B

No	Freq. [MHz]	Corr. Factor (dB)	Reading Value [dB (uV)]		Emission Level [dB (uV)]		Limit [dB (uV)]		Margin (dB)	
			Q.P.	AV.	Q.P.	AV.	Q.P.	AV.	Q.P.	AV.
			1	0.15000	9.94	28.38	19.77	38.32	29.71	66.00
2	0.17734	9.94	23.52	13.63	33.46	23.57	64.61	54.61	-31.15	-31.04
3	0.50519	9.97	28.04	22.49	38.01	32.46	56.00	46.00	-17.99	-13.54
4	0.91172	10.05	19.00	12.48	29.05	22.53	56.00	46.00	-26.95	-23.47
5	1.18359	10.08	16.10	10.37	26.18	20.45	56.00	46.00	-29.82	-25.55
6	1.48438	10.11	13.84	6.39	23.95	16.50	56.00	46.00	-32.05	-29.50

REMARKS:

1. Q.P. and AV. are abbreviations of quasi-peak and average individually.
2. The emission levels of other frequencies were very low against the limit.
3. Margin value = Emission level - Limit value
4. Correction factor = Insertion loss + Cable loss
5. Emission Level = Correction Factor + Reading Value.

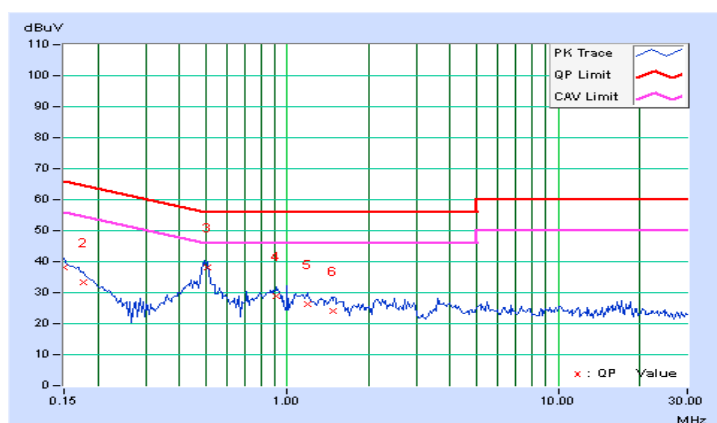

Phase	Neutral (N)	Detector Function	Quasi-Peak (QP) / Average (AV)
Channel	Channel 1	Test Mode	B

No	Freq. [MHz]	Corr. Factor (dB)	Reading Value [dB (uV)]		Emission Level [dB (uV)]		Limit [dB (uV)]		Margin (dB)	
			Q.P.	AV.	Q.P.	AV.	Q.P.	AV.	Q.P.	AV.
			1	0.15000	9.95	28.42	19.79	38.37	29.74	66.00
2	0.18125	9.96	23.92	11.63	33.88	21.59	64.43	54.43	-30.55	-32.84
3	0.50315	10.01	26.49	20.80	36.50	30.81	56.00	46.00	-19.50	-15.19
4	0.91163	10.07	17.42	10.77	27.49	20.84	56.00	46.00	-28.51	-25.16
5	1.45313	10.13	15.72	10.32	25.85	20.45	56.00	46.00	-30.15	-25.55
6	1.89453	10.18	12.08	5.25	22.26	15.43	56.00	46.00	-33.74	-30.57

REMARKS:

1. Q.P. and AV. are abbreviations of quasi-peak and average individually.
2. The emission levels of other frequencies were very low against the limit.
3. Margin value = Emission level - Limit value
4. Correction factor = Insertion loss + Cable loss
5. Emission Level = Correction Factor + Reading Value.

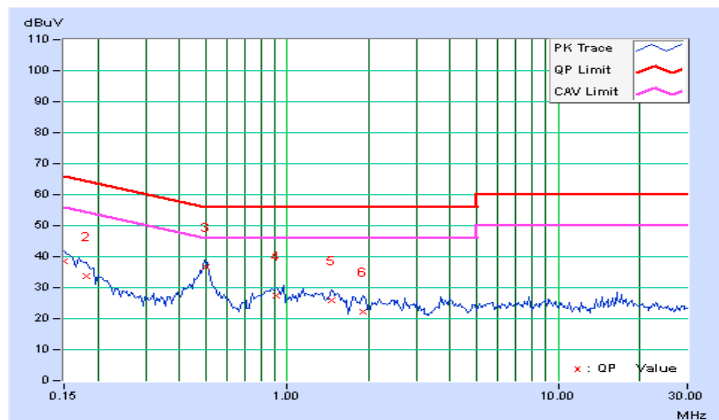

Phase	Line (L)	Detector Function	Quasi-Peak (QP) / Average (AV)
Channel	Channel 126	Test Mode	B

No	Freq. [MHz]	Corr. Factor (dB)	Reading Value [dB (uV)]		Emission Level [dB (uV)]		Limit [dB (uV)]		Margin (dB)	
			Q.P.	AV.	Q.P.	AV.	Q.P.	AV.	Q.P.	AV.
			1	0.15000	9.94	27.94	19.30	37.88	29.24	66.00
2	0.18516	9.94	22.20	11.05	32.14	20.99	64.25	54.25	-32.11	-33.26
3	0.50608	9.97	26.85	21.36	36.82	31.33	56.00	46.00	-19.18	-14.67
4	0.91290	10.05	17.82	11.54	27.87	21.59	56.00	46.00	-28.13	-24.41
5	1.10938	10.08	15.27	8.37	25.35	18.45	56.00	46.00	-30.65	-27.55
6	1.50000	10.11	14.46	9.47	24.57	19.58	56.00	46.00	-31.43	-26.42

REMARKS:

1. Q.P. and AV. are abbreviations of quasi-peak and average individually.
2. The emission levels of other frequencies were very low against the limit.
3. Margin value = Emission level - Limit value
4. Correction factor = Insertion loss + Cable loss
5. Emission Level = Correction Factor + Reading Value.

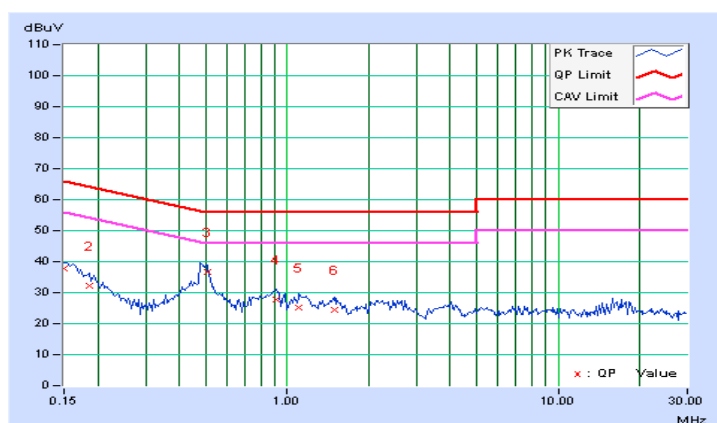

Phase	Neutral (N)	Detector Function	Quasi-Peak (QP) / Average (AV)
Channel	Channel 126	Test Mode	B

No	Freq. [MHz]	Corr. Factor (dB)	Reading Value [dB (uV)]		Emission Level [dB (uV)]		Limit [dB (uV)]		Margin (dB)	
			Q.P.	AV.	Q.P.	AV.	Q.P.	AV.	Q.P.	AV.
			1	0.15000	9.95	28.24	19.75	38.19	29.70	66.00
2	0.18125	9.96	23.84	11.63	33.80	21.59	64.43	54.43	-30.63	-32.84
3	0.49766	10.01	25.51	18.66	35.52	28.67	56.04	46.04	-20.52	-17.37
4	0.88946	10.06	17.27	11.13	27.33	21.19	56.00	46.00	-28.67	-24.81
5	1.17969	10.10	16.26	10.98	26.36	21.08	56.00	46.00	-29.64	-24.92
6	1.47656	10.13	15.72	11.01	25.85	21.14	56.00	46.00	-30.15	-24.86

REMARKS:

1. Q.P. and AV. are abbreviations of quasi-peak and average individually.
2. The emission levels of other frequencies were very low against the limit.
3. Margin value = Emission level - Limit value
4. Correction factor = Insertion loss + Cable loss
5. Emission Level = Correction Factor + Reading Value.

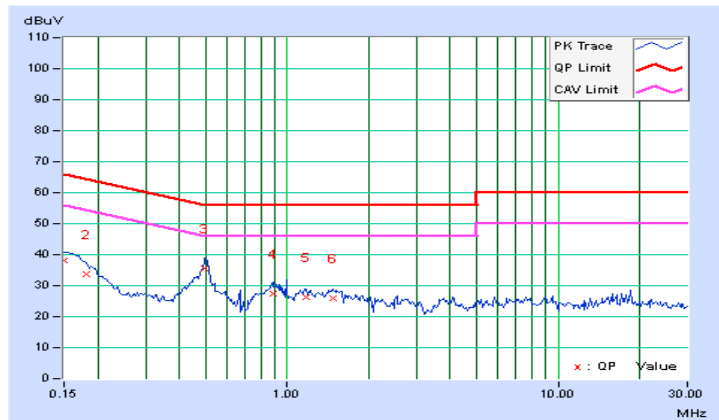

Phase	Line (L)	Detector Function	Quasi-Peak (QP) / Average (AV)
Channel	Channel 252	Test Mode	B

No	Freq. [MHz]	Corr. Factor (dB)	Reading Value [dB (uV)]		Emission Level [dB (uV)]		Limit [dB (uV)]		Margin (dB)	
			Q.P.	AV.	Q.P.	AV.	Q.P.	AV.	Q.P.	AV.
			1	0.15000	9.94	27.88	19.28	37.82	29.22	66.00
2	0.18125	9.94	22.45	11.20	32.39	21.14	64.43	54.43	-32.03	-33.28
3	0.50156	9.97	25.72	19.85	35.69	29.82	56.00	46.00	-20.31	-16.18
4	0.95859	10.06	15.23	6.82	25.29	16.88	56.00	46.00	-30.71	-29.12
5	1.17578	10.08	15.81	10.33	25.89	20.41	56.00	46.00	-30.11	-25.59
6	2.23438	10.17	12.80	6.91	22.97	17.08	56.00	46.00	-33.03	-28.92

REMARKS:

1. Q.P. and AV. are abbreviations of quasi-peak and average individually.
2. The emission levels of other frequencies were very low against the limit.
3. Margin value = Emission level - Limit value
4. Correction factor = Insertion loss + Cable loss
5. Emission Level = Correction Factor + Reading Value.

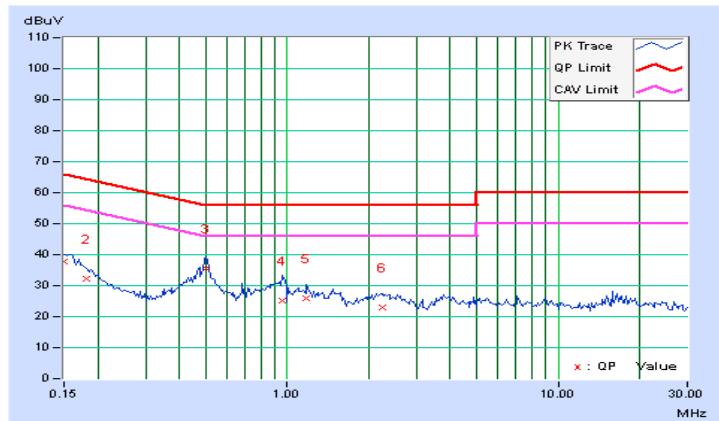

Phase	Neutral (N)	Detector Function	Quasi-Peak (QP) / Average (AV)
Channel	Channel 252	Test Mode	B

No	Freq. [MHz]	Corr. Factor (dB)	Reading Value [dB (uV)]		Emission Level [dB (uV)]		Limit [dB (uV)]		Margin (dB)	
			Q.P.	AV.	Q.P.	AV.	Q.P.	AV.	Q.P.	AV.
	1	0.15000	9.95	28.20	19.69	38.15	29.64	66.00	56.00	-27.85
2	0.18516	9.96	23.37	11.34	33.33	21.30	64.25	54.25	-30.92	-32.95
3	0.50509	10.01	26.71	21.10	36.72	31.11	56.00	46.00	-19.28	-14.89
4	0.88828	10.06	17.31	11.27	27.37	21.33	56.00	46.00	-28.63	-24.67
5	1.16016	10.10	15.17	9.23	25.27	19.33	56.00	46.00	-30.73	-26.67
6	1.43359	10.13	14.93	7.74	25.06	17.87	56.00	46.00	-30.94	-28.13

REMARKS:

1. Q.P. and AV. are abbreviations of quasi-peak and average individually.
2. The emission levels of other frequencies were very low against the limit.
3. Margin value = Emission level - Limit value
4. Correction factor = Insertion loss + Cable loss
5. Emission Level = Correction Factor + Reading Value.

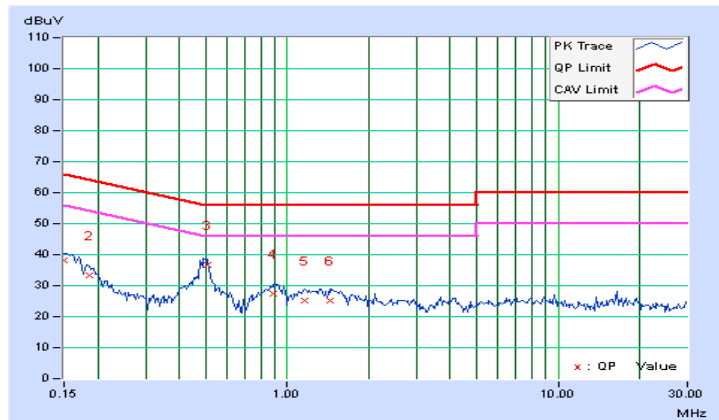

Phase	Line (L)	Detector Function	Quasi-Peak (QP) / Average (AV)
Channel	Channel 1	Test Mode	C

No	Freq. [MHz]	Corr. Factor (dB)	Reading Value [dB (uV)]		Emission Level [dB (uV)]		Limit [dB (uV)]		Margin (dB)	
			Q.P.	AV.	Q.P.	AV.	Q.P.	AV.	Q.P.	AV.
			1	0.18906	9.94	31.85	18.78	41.79	28.72	64.08
2	0.23594	9.95	29.49	19.18	39.44	29.13	62.24	52.24	-22.80	-23.11
3	0.52109	9.97	33.95	24.85	43.92	34.82	56.00	46.00	-12.08	-11.18
4	0.99766	10.07	26.37	13.50	36.44	23.57	56.00	46.00	-19.56	-22.43
5	1.53906	10.11	26.24	15.85	36.35	25.96	56.00	46.00	-19.65	-20.04
6	2.08203	10.16	25.38	15.19	35.54	25.35	56.00	46.00	-20.46	-20.65

REMARKS:

1. Q.P. and AV. are abbreviations of quasi-peak and average individually.
2. The emission levels of other frequencies were very low against the limit.
3. Margin value = Emission level - Limit value
4. Correction factor = Insertion loss + Cable loss
5. Emission Level = Correction Factor + Reading Value.

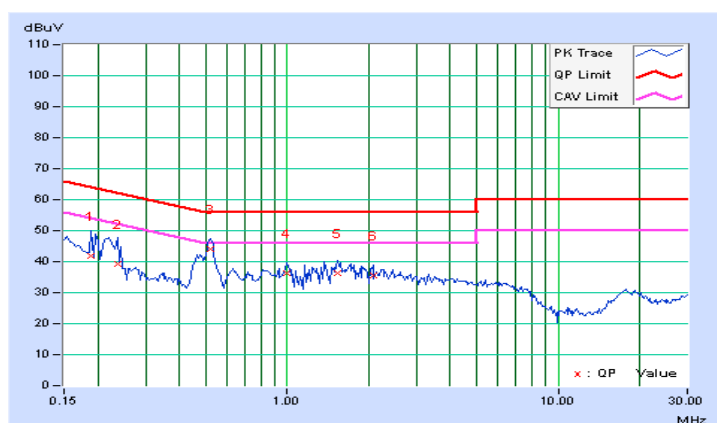

Phase	Neutral (N)	Detector Function	Quasi-Peak (QP) / Average (AV)
Channel	Channel 1	Test Mode	C

No	Freq. [MHz]	Corr. Factor (dB)	Reading Value [dB (uV)]		Emission Level [dB (uV)]		Limit [dB (uV)]		Margin (dB)	
			Q.P.	AV.	Q.P.	AV.	Q.P.	AV.	Q.P.	AV.
			1	0.17734	9.96	32.58	18.01	42.54	27.97	64.61
2	0.19687	9.96	30.41	15.35	40.37	25.31	63.74	53.74	-23.37	-28.43
3	0.53281	10.02	30.45	21.06	40.47	31.08	56.00	46.00	-15.53	-14.92
4	1.26953	10.11	23.57	13.88	33.68	23.99	56.00	46.00	-22.32	-22.01
5	1.63672	10.15	23.85	14.13	34.00	24.28	56.00	46.00	-22.00	-21.72
6	3.37891	10.27	19.50	10.04	29.77	20.31	56.00	46.00	-26.23	-25.69

REMARKS:

1. Q.P. and AV. are abbreviations of quasi-peak and average individually.
2. The emission levels of other frequencies were very low against the limit.
3. Margin value = Emission level - Limit value
4. Correction factor = Insertion loss + Cable loss
5. Emission Level = Correction Factor + Reading Value.

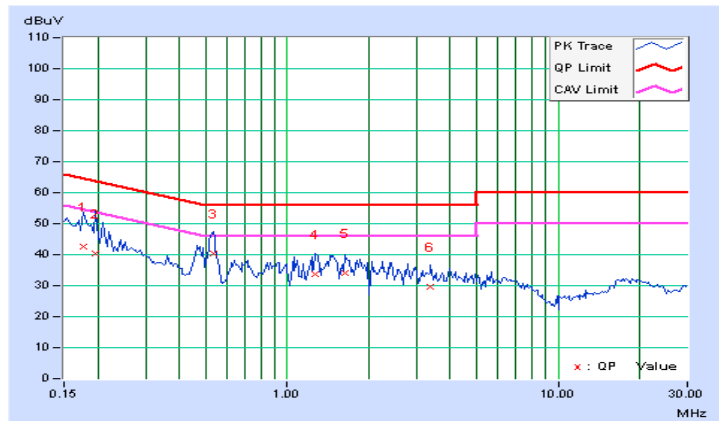

Phase	Line (L)	Detector Function	Quasi-Peak (QP) / Average (AV)
Channel	Channel 126	Test Mode	C

No	Freq. [MHz]	Corr. Factor (dB)	Reading Value [dB (uV)]		Emission Level [dB (uV)]		Limit [dB (uV)]		Margin (dB)	
			Q.P.	AV.	Q.P.	AV.	Q.P.	AV.	Q.P.	AV.
			1	0.16562	9.94	31.02	17.46	40.96	27.40	65.18
2	0.27500	9.95	23.08	13.91	33.03	23.86	60.97	50.97	-27.94	-27.11
3	0.51800	9.97	33.93	24.60	43.90	34.57	56.00	46.00	-12.10	-11.43
4	0.99766	10.07	26.47	13.84	36.54	23.91	56.00	46.00	-19.46	-22.09
5	1.55078	10.12	26.36	15.93	36.48	26.05	56.00	46.00	-19.52	-19.95
6	2.07031	10.16	25.42	15.48	35.58	25.64	56.00	46.00	-20.42	-20.36

REMARKS:

1. Q.P. and AV. are abbreviations of quasi-peak and average individually.
2. The emission levels of other frequencies were very low against the limit.
3. Margin value = Emission level - Limit value
4. Correction factor = Insertion loss + Cable loss
5. Emission Level = Correction Factor + Reading Value.

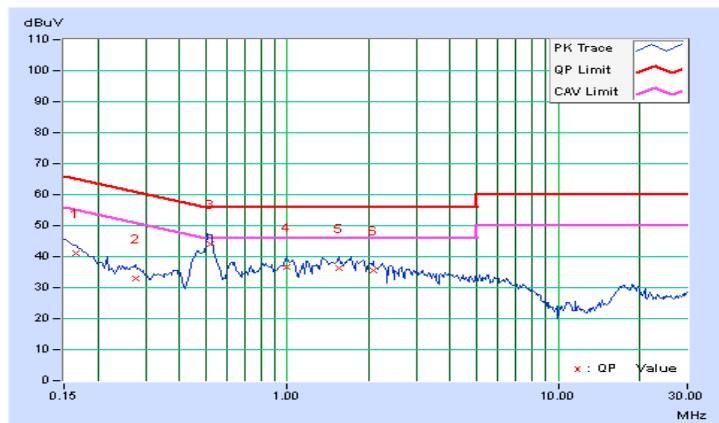

Phase	Neutral (N)	Detector Function	Quasi-Peak (QP) / Average (AV)
Channel	Channel 126	Test Mode	C

No	Freq. [MHz]	Corr. Factor (dB)	Reading Value [dB (uV)]		Emission Level [dB (uV)]		Limit [dB (uV)]		Margin (dB)	
			Q.P.	AV.	Q.P.	AV.	Q.P.	AV.	Q.P.	AV.
			1	0.15781	9.95	31.78	17.45	41.73	27.40	65.58
2	0.52500	10.02	31.65	22.63	41.67	32.65	56.00	46.00	-14.33	-13.35
3	0.90781	10.07	21.80	11.92	31.87	21.99	56.00	46.00	-24.13	-24.01
4	1.60156	10.15	23.33	13.98	33.48	24.13	56.00	46.00	-22.52	-21.87
5	2.41406	10.22	22.07	12.47	32.29	22.69	56.00	46.00	-23.71	-23.31
6	3.71484	10.29	18.26	9.62	28.55	19.91	56.00	46.00	-27.45	-26.09

REMARKS:

1. Q.P. and AV. are abbreviations of quasi-peak and average individually.
2. The emission levels of other frequencies were very low against the limit.
3. Margin value = Emission level - Limit value
4. Correction factor = Insertion loss + Cable loss
5. Emission Level = Correction Factor + Reading Value.

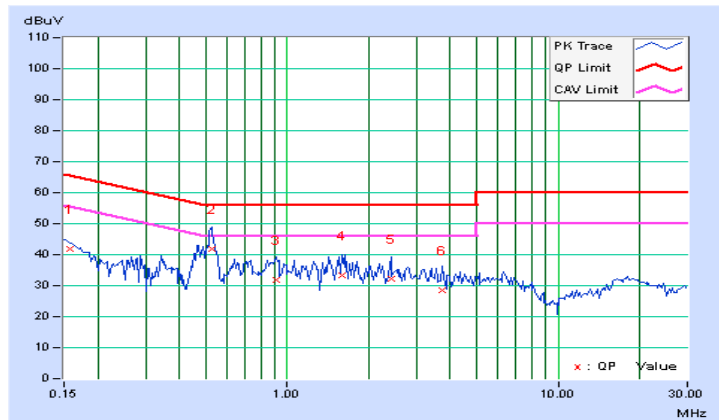

Phase	Line (L)	Detector Function	Quasi-Peak (QP) / Average (AV)
Channel	Channel 252	Test Mode	C

No	Freq. [MHz]	Corr. Factor (dB)	Reading Value [dB (uV)]		Emission Level [dB (uV)]		Limit [dB (uV)]		Margin (dB)	
			Q.P.	AV.	Q.P.	AV.	Q.P.	AV.	Q.P.	AV.
			1	0.15781	9.94	29.38	17.13	39.32	27.07	65.58
2	0.46641	9.96	29.68	20.66	39.64	30.62	56.58	46.58	-16.93	-15.95
3	0.52109	9.97	34.23	25.09	44.20	35.06	56.00	46.00	-11.80	-10.94
4	0.98984	10.07	26.91	13.64	36.98	23.71	56.00	46.00	-19.02	-22.29
5	1.53906	10.11	26.84	16.56	36.95	26.67	56.00	46.00	-19.05	-19.33
6	2.08203	10.16	25.80	15.92	35.96	26.08	56.00	46.00	-20.04	-19.92

REMARKS:

1. Q.P. and AV. are abbreviations of quasi-peak and average individually.
2. The emission levels of other frequencies were very low against the limit.
3. Margin value = Emission level - Limit value
4. Correction factor = Insertion loss + Cable loss
5. Emission Level = Correction Factor + Reading Value.

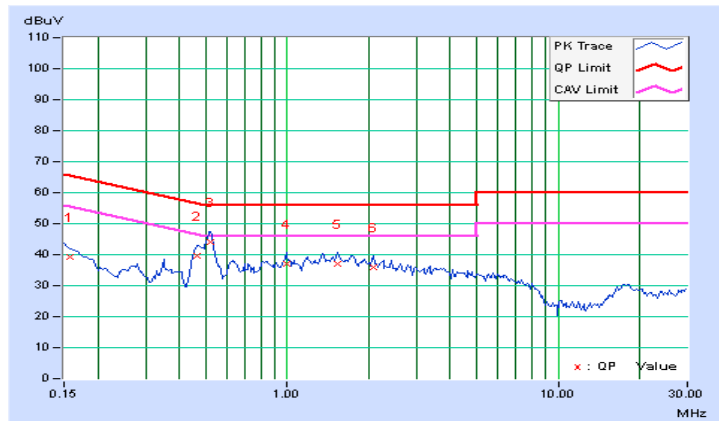

Phase	Neutral (N)	Detector Function	Quasi-Peak (QP) / Average (AV)
Channel	Channel 252	Test Mode	C

No	Freq. [MHz]	Corr. Factor (dB)	Reading Value [dB (uV)]		Emission Level [dB (uV)]		Limit [dB (uV)]		Margin (dB)	
			Q.P.	AV.	Q.P.	AV.	Q.P.	AV.	Q.P.	AV.
			1	0.15391	9.95	31.56	17.63	41.51	27.58	65.79
2	0.47031	10.01	28.09	18.68	38.10	28.69	56.51	46.51	-18.41	-17.82
3	0.52500	10.02	31.69	22.73	41.71	32.75	56.00	46.00	-14.29	-13.25
4	0.84531	10.06	22.36	13.46	32.42	23.52	56.00	46.00	-23.58	-22.48
5	1.47266	10.13	24.88	14.93	35.01	25.06	56.00	46.00	-20.99	-20.94
6	2.59375	10.23	21.52	12.10	31.75	22.33	56.00	46.00	-24.25	-23.67

REMARKS:

1. Q.P. and AV. are abbreviations of quasi-peak and average individually.
2. The emission levels of other frequencies were very low against the limit.
3. Margin value = Emission level - Limit value
4. Correction factor = Insertion loss + Cable loss
5. Emission Level = Correction Factor + Reading Value.

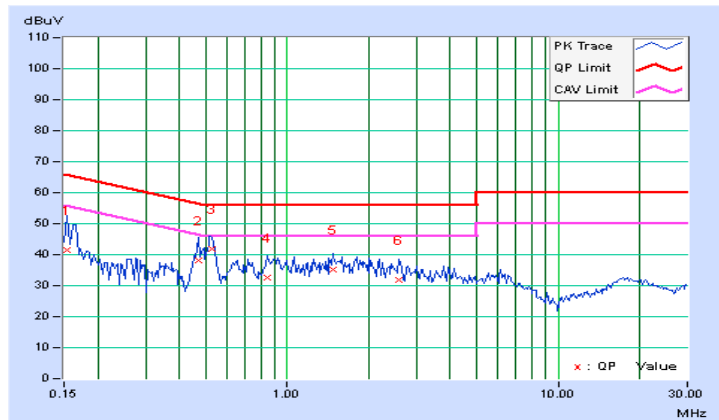

Phase	Line (L)	Detector Function	Quasi-Peak (QP) / Average (AV)
Channel	Channel 1	Test Mode	D

No	Freq. [MHz]	Corr. Factor (dB)	Reading Value [dB (uV)]		Emission Level [dB (uV)]		Limit [dB (uV)]		Margin (dB)	
			Q.P.	AV.	Q.P.	AV.	Q.P.	AV.	Q.P.	AV.
			1	0.17344	9.94	48.90	34.08	58.84	44.02	64.79
2	0.43906	9.96	37.28	27.47	47.24	37.43	57.08	47.08	-9.84	-9.65
3	0.82969	10.03	31.52	22.47	41.55	32.50	56.00	46.00	-14.45	-13.50
4	1.67578	10.13	31.45	24.01	41.58	34.14	56.00	46.00	-14.42	-11.86
5	3.01563	10.21	30.94	24.49	41.15	34.70	56.00	46.00	-14.85	-11.30
6	6.46094	10.34	30.88	24.11	41.22	34.45	60.00	50.00	-18.78	-15.55

REMARKS:

1. Q.P. and AV. are abbreviations of quasi-peak and average individually.
2. The emission levels of other frequencies were very low against the limit.
3. Margin value = Emission level - Limit value
4. Correction factor = Insertion loss + Cable loss
5. Emission Level = Correction Factor + Reading Value.

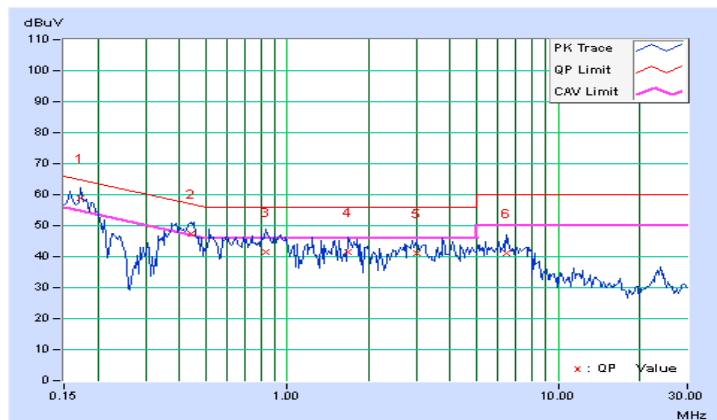

Phase	Neutral (N)	Detector Function	Quasi-Peak (QP) / Average (AV)
Channel	Channel 1	Test Mode	D

No	Freq. [MHz]	Corr. Factor (dB)	Reading Value [dB (uV)]		Emission Level [dB (uV)]		Limit [dB (uV)]		Margin (dB)	
			Q.P.	AV.	Q.P.	AV.	Q.P.	AV.	Q.P.	AV.
			1	0.16562	9.95	47.10	31.07	57.05	41.02	65.18
2	0.44688	10.01	39.71	32.30	49.72	42.31	56.93	46.93	-7.22	-4.63
3	0.60703	10.03	33.60	24.94	43.63	34.97	56.00	46.00	-12.37	-11.03
4	1.21484	10.10	32.97	27.71	43.07	37.81	56.00	46.00	-12.93	-8.19
5	1.69531	10.16	32.44	26.73	42.60	36.89	56.00	46.00	-13.40	-9.11
6	6.53125	10.38	31.94	25.40	42.32	35.78	60.00	50.00	-17.68	-14.22

REMARKS:

1. Q.P. and AV. are abbreviations of quasi-peak and average individually.
2. The emission levels of other frequencies were very low against the limit.
3. Margin value = Emission level - Limit value
4. Correction factor = Insertion loss + Cable loss
5. Emission Level = Correction Factor + Reading Value.

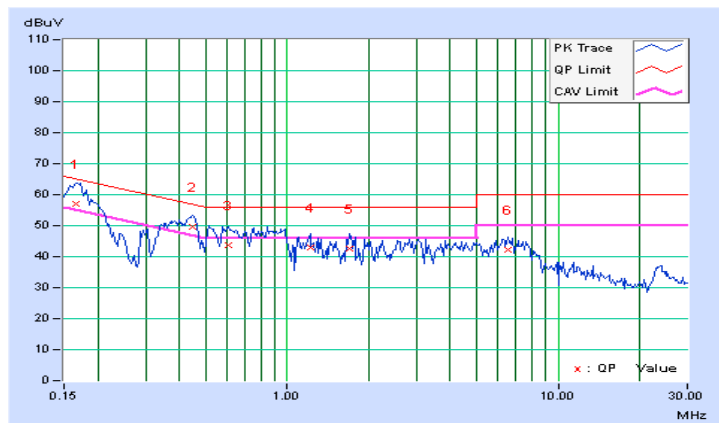

Phase	Line (L)	Detector Function	Quasi-Peak (QP) / Average (AV)
Channel	Channel 126	Test Mode	D

No	Freq. [MHz]	Corr. Factor (dB)	Reading Value [dB (uV)]		Emission Level [dB (uV)]		Limit [dB (uV)]		Margin (dB)	
			Q.P.	AV.	Q.P.	AV.	Q.P.	AV.	Q.P.	AV.
			1	0.15391	9.94	48.62	41.35	58.56	51.29	65.79
2	0.43516	9.96	36.71	25.18	46.67	35.14	57.15	47.15	-10.49	-12.02
3	0.58750	9.99	32.99	24.61	42.98	34.60	56.00	46.00	-13.02	-11.40
4	0.88047	10.04	30.84	25.00	40.88	35.04	56.00	46.00	-15.12	-10.96
5	1.61328	10.12	31.66	24.14	41.78	34.26	56.00	46.00	-14.22	-11.74
6	6.59766	10.34	30.68	24.31	41.02	34.65	60.00	50.00	-18.98	-15.35

REMARKS:

1. Q.P. and AV. are abbreviations of quasi-peak and average individually.
2. The emission levels of other frequencies were very low against the limit.
3. Margin value = Emission level - Limit value
4. Correction factor = Insertion loss + Cable loss
5. Emission Level = Correction Factor + Reading Value.

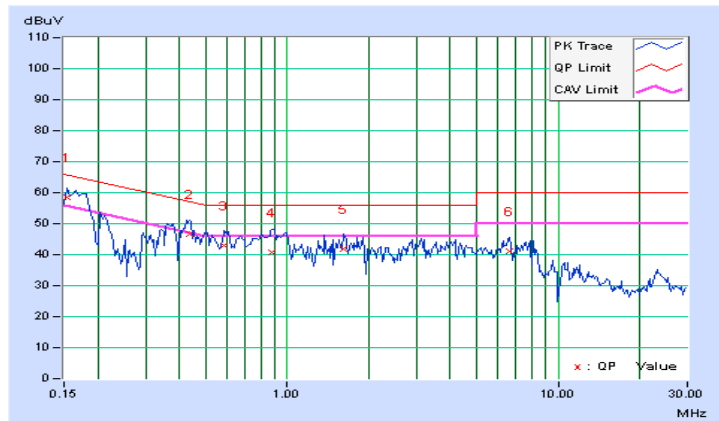

Phase	Neutral (N)	Detector Function	Quasi-Peak (QP) / Average (AV)
Channel	Channel 126	Test Mode	D

No	Freq. [MHz]	Corr. Factor (dB)	Reading Value [dB (uV)]		Emission Level [dB (uV)]		Limit [dB (uV)]		Margin (dB)	
			Q.P.	AV.	Q.P.	AV.	Q.P.	AV.	Q.P.	AV.
			1	0.15362	9.95	49.38	41.86	59.33	51.81	65.80
2	0.37266	10.00	36.34	23.78	46.34	33.78	58.44	48.44	-12.11	-14.67
3	0.43906	10.01	39.92	32.29	49.93	42.30	57.08	47.08	-7.15	-4.78
4	0.99375	10.08	32.93	27.31	43.01	37.39	56.00	46.00	-12.99	-8.61
5	1.87500	10.18	30.15	22.50	40.33	32.68	56.00	46.00	-15.67	-13.32
6	2.97656	10.25	32.18	26.18	42.43	36.43	56.00	46.00	-13.57	-9.57
7	7.72266	10.42	31.65	25.06	42.07	35.48	60.00	50.00	-17.93	-14.52

REMARKS:

1. Q.P. and AV. are abbreviations of quasi-peak and average individually.
2. The emission levels of other frequencies were very low against the limit.
3. Margin value = Emission level - Limit value
4. Correction factor = Insertion loss + Cable loss
5. Emission Level = Correction Factor + Reading Value.

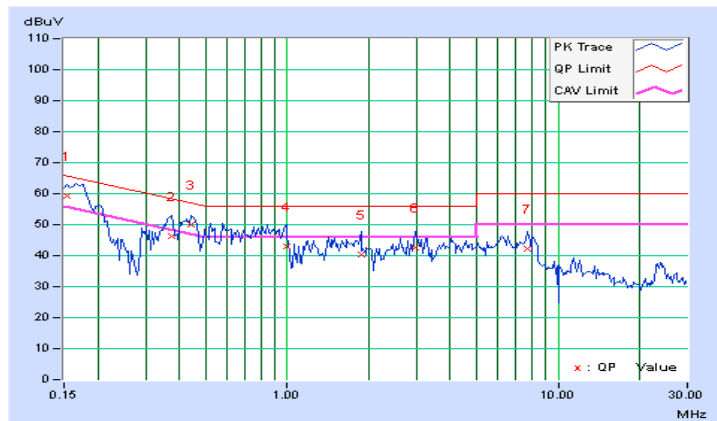

Phase	Line (L)	Detector Function	Quasi-Peak (QP) / Average (AV)
Channel	Channel 252	Test Mode	D

No	Freq. [MHz]	Corr. Factor (dB)	Reading Value [dB (uV)]		Emission Level [dB (uV)]		Limit [dB (uV)]		Margin (dB)	
			Q.P.	AV.	Q.P.	AV.	Q.P.	AV.	Q.P.	AV.
	1	0.16825	9.94	50.89	43.20	60.83	53.14	65.05	55.05	-4.21
2	0.43012	9.96	39.61	33.07	49.57	43.03	57.25	47.25	-7.68	-4.22
3	0.51328	9.97	34.47	21.04	44.44	31.01	56.00	46.00	-11.56	-14.99
4	0.95859	10.06	33.50	25.72	43.56	35.78	56.00	46.00	-12.44	-10.22
5	1.44141	10.11	32.42	26.10	42.53	36.21	56.00	46.00	-13.47	-9.79
6	3.16797	10.22	33.30	27.27	43.52	37.49	56.00	46.00	-12.48	-8.51
7	6.69922	10.34	31.95	26.17	42.29	36.51	60.00	50.00	-17.71	-13.49

REMARKS:

1. Q.P. and AV. are abbreviations of quasi-peak and average individually.
2. The emission levels of other frequencies were very low against the limit.
3. Margin value = Emission level - Limit value
4. Correction factor = Insertion loss + Cable loss
5. Emission Level = Correction Factor + Reading Value.

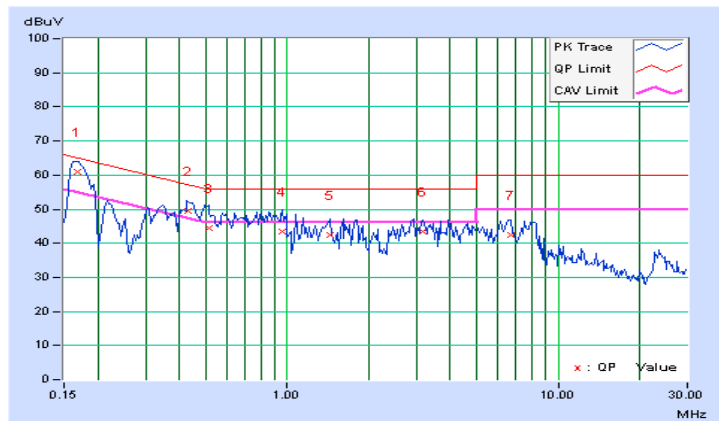

Phase	Neutral (N)	Detector Function	Quasi-Peak (QP) / Average (AV)
Channel	Channel 252	Test Mode	D

No	Freq. [MHz]	Corr. Factor (dB)	Reading Value [dB (uV)]		Emission Level [dB (uV)]		Limit [dB (uV)]		Margin (dB)	
			Q.P.	AV.	Q.P.	AV.	Q.P.	AV.	Q.P.	AV.
			1	0.16562	9.95	48.33	39.99	58.28	49.94	65.18
2	0.43906	10.01	37.46	28.44	47.47	38.45	57.08	47.08	-9.61	-8.63
3	0.60313	10.03	32.83	24.86	42.86	34.89	56.00	46.00	-13.14	-11.11
4	0.84922	10.06	31.54	26.09	41.60	36.15	56.00	46.00	-14.40	-9.85
5	1.58203	10.15	32.45	26.13	42.60	36.28	56.00	46.00	-13.40	-9.72
6	6.33984	10.38	31.49	25.24	41.87	35.62	60.00	50.00	-18.13	-14.38

REMARKS:

1. Q.P. and AV. are abbreviations of quasi-peak and average individually.
2. The emission levels of other frequencies were very low against the limit.
3. Margin value = Emission level - Limit value
4. Correction factor = Insertion loss + Cable loss
5. Emission Level = Correction Factor + Reading Value.

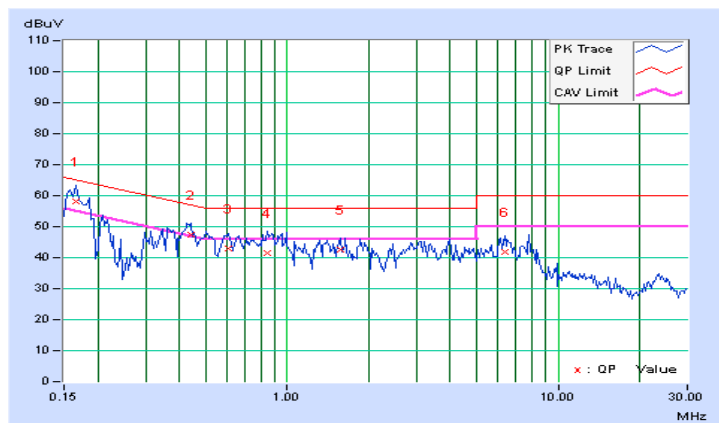

5 Pictures of Test Arrangements

Please refer to the attached file (Test Setup Photo).

Appendix – Information on the Testing Laboratories

We, Bureau Veritas Consumer Products Services (H.K.) Ltd., Taoyuan Branch, were founded in 1988 to provide our best service in EMC, Radio, Telecom and Safety consultation. Our laboratories are accredited and approved according to ISO/IEC 17025.

If you have any comments, please feel free to contact us at the following:

Linko EMC/RF Lab

Tel: 886-2-26052180

Fax: 886-2-26051924

Hsin Chu EMC/RF/Telecom Lab

Tel: 886-3-5935343

Fax: 886-3-5935342

Hwa Ya EMC/RF/Safety Lab

Tel: 886-3-3183232

Fax: 886-3-3270892

Email: service.adt@tw.bureauveritas.com

Web Site: www.bureauveritas-adt.com

The address and road map of all our labs can be found in our web site also.

--- END ---