



# FCC TEST REPORT (15.407)

**REPORT NO.:** RF111005C10

**MODEL NO.:** ENH500, ENH500EXT

**FCC ID:** U2M-ENH500

**RECEIVED:** Oct. 5, 2011

**TESTED:** Oct. 14 ~ 18, 2011

**ISSUED:** Oct. 26, 2011

**APPLICANT:** Senao Networks, Inc.

**ADDRESS:** 3F, No. 529, Chung Cheng Rd., Hsintien, Taipei,  
Taiwan, R.O.C.

**ISSUED BY:** Bureau Veritas Consumer Products Services  
(H.K.) Ltd., Taoyuan Branch

**LAB LOCATION:** No. 47, 14th Ling, Chia Pau Vil., Lin Kou  
Dist., New Taipei City, Taiwan ( R.O.C. )

This test report consists of 83 pages in total. It may be duplicated completely for legal use with the approval of the applicant. It should not be reproduced except in full, without the written approval of our laboratory. The client should not use it to claim product endorsement by TAF or any government agencies. The test results in the report only apply to the tested sample.



## TABLE OF CONTENTS

RELEASE CONTROL RECORD.....	4
1. CERTIFICATION .....	5
2. SUMMARY OF TEST RESULTS.....	6
2.1 MEASUREMENT UNCERTAINTY.....	6
3. GENERAL INFORMATION.....	7
3.1 GENERAL DESCRIPTION OF EUT.....	7
3.2 DESCRIPTION OF TEST MODES.....	9
3.2.1 CONFIGURATION OF SYSTEM UNDER TEST .....	9
3.2.2 TEST MODE APPLICABILITY AND TESTED CHANNEL DETAIL .....	10
3.3 GENERAL DESCRIPTION OF APPLIED STANDARDS .....	12
3.4 DESCRIPTION OF SUPPORT UNITS .....	12
4. TEST TYPES AND RESULTS .....	13
4.1 CONDUCTED EMISSION MEASUREMENT .....	13
4.1.1 LIMITS OF CONDUCTED EMISSION MEASUREMENT .....	13
4.1.2 TEST INSTRUMENTS .....	13
4.1.3 TEST PROCEDURES .....	14
4.1.4 DEVIATION FROM TEST STANDARD .....	14
4.1.5 TEST SETUP .....	15
4.1.6 EUT OPERATING CONDITIONS .....	15
4.1.7 TEST RESULTS.....	16
4.2 RADIATED EMISSION MEASUREMENT .....	18
4.2.1 LIMITS OF RADIATED EMISSION MEASUREMENT .....	18
4.2.2 LIMITS OF UNWANTED EMISSION OUT OF THE RESTRICTED BANDS .....	18
4.2.3 TEST INSTRUMENTS .....	19
4.2.4 TEST PROCEDURES.....	20
4.2.5 DEVIATION FROM TEST STANDARD .....	20
4.2.6 TEST SETUP .....	21
4.2.7 EUT OPERATING CONDITION .....	21
4.2.8 TEST RESULTS.....	22
4.3 PEAK TRANSMIT POWER MEASUREMENT .....	31
4.3.1 LIMITS OF PEAK TRANSMIT POWER MEASUREMENT .....	31
4.3.2 TEST INSTRUMENTS .....	31
4.3.3 TEST PROCEDURE .....	32
4.3.4 DEVIATION FROM TEST STANDARD .....	32
4.3.5 TEST SETUP .....	32
4.3.6 EUT OPERATING CONDITIONS .....	32
4.3.7 TEST RESULTS.....	33
4.4 PEAK POWER EXCURSION MEASUREMENT .....	36
4.4.1 LIMITS OF PEAK POWER EXCURSION MEASUREMENT .....	36
4.4.2 TEST INSTRUMENTS .....	36
4.4.3 TEST PROCEDURE .....	36
4.4.4 DEVIATION FROM TEST STANDARD .....	37



4.4.5	TEST SETUP .....	37
4.4.6	EUT OPERATING CONDITIONS .....	37
4.4.7	TEST RESULTS .....	38
4.5	PEAK POWER SPECTRAL DENSITY MEASUREMENT .....	44
4.5.1	LIMITS OF PEAK POWER SPECTRAL DENSITY MEASUREMENT .....	44
4.5.2	TEST INSTRUMENTS .....	44
4.5.3	TEST PROCEDURES .....	44
4.5.4	DEVIATION FROM TEST STANDARD .....	45
4.5.5	TEST SETUP .....	45
4.5.6	EUT OPERATING CONDITIONS .....	45
4.5.7	TEST RESULTS .....	46
4.6	FREQUENCY STABILITY .....	49
4.6.1	LIMITS OF FREQUENCY STABILITY MEASUREMENT .....	49
4.6.2	TEST INSTRUMENTS .....	49
4.6.3	TEST PROCEDURE .....	49
4.6.4	DEVIATION FROM TEST STANDARD .....	50
4.6.5	TEST SETUP .....	50
4.6.6	EUT OPERATING CONDITION .....	50
4.6.7	TEST RESULTS .....	51
4.7	BAND EDGES MEASUREMENT .....	52
4.7.1	TEST INSTRUMENTS .....	52
4.7.2	TEST PROCEDURE .....	53
4.7.3	EUT OPERATING CONDITION .....	53
4.7.4	TEST RESULTS .....	54
5.	PHOTOGRAPHS OF THE TEST CONFIGURATION .....	81
6.	INFORMATION ON THE TESTING LABORATORIES .....	82
7.	APPENDIX A - MODIFICATIONS RECORDERS FOR ENGINEERING CHANGES TO THE EUT BY THE LAB .....	83



A D T

## RELEASE CONTROL RECORD

ISSUE NO.	REASON FOR CHANGE	DATE ISSUED
RF111005C10	Original release	Oct. 26, 2011



## 1. CERTIFICATION

**PRODUCT:** Wireless 802.11an Access Point  
**BRAND NAME:** EnGenius  
**MODEL NO.:** ENH500, ENH500EXT  
**APPLICANT:** Senao Networks, Inc.  
**TEST SAMPLE:** ENGINEERING SAMPLE  
**TESTED:** Oct. 14 ~ 18, 2011  
**STANDARDS:** FCC Part 15, Subpart E (Section 15.407)  
ANSI C63.4-2003  
ANSI C63.10-2009

The above equipment (model no.: ENH500) has been tested by **Bureau Veritas Consumer Products Services (H.K.) Ltd., Taoyuan Branch**, and found compliance with the requirement of the above standards. The test record, data evaluation & Equipment Under Test (EUT) configurations represented herein are true and accurate accounts of the measurements of the sample's EMC characteristics under the conditions specified in this report.

PREPARED BY : Celia Chen , DATE: Oct. 26, 2011  
( Celia Chen / Senior Specialist )

APPROVED BY : Ken Liu , DATE: Oct. 26, 2011  
( Ken Liu / Manager )

## 2. SUMMARY OF TEST RESULTS

The EUT has been tested according to the following specifications:

APPLIED STANDARD: FCC PART 15, SUBPART E (SECTION 15.407)			
STANDARD SECTION	TEST TYPE AND LIMIT	RESULT	REMARK
15.407(b)(5)	AC Power Conducted Emission	PASS	Meet the requirement of limit. Minimum passing margin is -13.36dB at 12.180MHz
15.407(b/1/2/3)(b)(5)	Electric Field Strength Spurious Emissions, 30MHz ~ 40000MHz	PASS	Meet the requirement of limit. Minimum passing margin is -0.5dB at 798.25MHz.
15.407(a/1/2/3)	Peak Transmit Power	PASS	Meet the requirement of limit.
15.407(a)(6)	Peak Power Excursion	PASS	Meet the requirement of limit.
15.407(a/1/2/3)	Peak Power Spectral Density	PASS	Meet the requirement of limit.
15.407(g)	Frequency Stability	PASS	Meet the requirement of limit.
15.203	Antenna Requirement	PASS	Antenna connector is I-PEX not a standard connector.

### 2.1 MEASUREMENT UNCERTAINTY

Where relevant, the following measurement uncertainty levels have been estimated for tests performed on the EUT as specified in CISPR 16-4-2:

This uncertainty represents an expanded uncertainty expressed at approximately the 95% confidence level using a coverage factor of  $k = 2$ .

MEASUREMENT	FREQUENCY	UNCERTAINTY
Conducted emissions	150kHz~30MHz	2.41 dB
Radiated emissions	30MHz ~ 1GHz	3.87 dB
	Above 1GHz	3.36 dB

### 3. GENERAL INFORMATION

#### 3.1 GENERAL DESCRIPTION OF EUT

<b>EUT</b>	Wireless 802.11an Access Point
<b>MODEL NO.</b>	ENH500, ENH500EXT
<b>FCC ID</b>	U2M-ENH500
<b>NOMINAL VOLTAGE</b>	24Vdc
<b>MODULATION TYPE</b>	64QAM, 16QAM, QPSK, BPSK for OFDM
<b>MODULATION TECHNOLOGY</b>	OFDM
<b>TRANSFER RATE</b>	802.11a: 54.0/48.0/36.0/24.0/18.0/12.0/9.0/6.0Mbps 802.11n: up to 300.0Mbps
<b>OPERATING FREQUENCY</b>	5180 ~ 5240MHz
<b>NUMBER OF CHANNEL</b>	4 for 802.11a, 802.11n (20MHz) 2 for 802.11n (40MHz)
<b>OUTPUT POWER</b>	9.96 mW
<b>ANTENNA TYPE</b>	Patch antenna with 13dBi gain
<b>ANTENNA CONNECTOR</b>	I-PEX connector
<b>I/O PORTS</b>	Refer to User's manual
<b>DATA CABLE</b>	Refer to User's manual
<b>ACCESSORY DEVICES</b>	Refer to note as below

#### NOTE:

- The EUT is a Wireless 802.11an Access Point. The functions of EUT listed as below:

FUNCTION	TEST STANDARD	REFERENCE REPORT
WLAN 802.11a/n (5745~5825 MHz)	FCC Part 15, Subpart C (Section 15.247)	RF111005C10-1
WLAN 802.11a/n (5180~ 5240MHz)	FCC Part 15, Subpart E (Section 15.407)	RF11005C10

- The EUT has several models, which are identical to each other except for marketing differences only, as the following:

Brand	Model No.	Differentiation
EnGenius	ENH500	marketing differentiation
	ENH500EXT	

During the test, **model no.: ENH500** was selected as the representative one for the test and only its test data was recorded in this report.

3. The frequency bands used in this EUT are listed as follows:

Frequency Band (MHz)	5180~5240	5745~5825
802.11a	√	√
802.11n (20MHz)	√	√
802.11n (40MHz)	√	√

4. The EUT incorporates a MIMO function. Physically, the EUT provides two completed transmitters and two receivers.

MODULATION MODE	TX FUNCTION
802.11a	2TX
802.11n (20MHz)	2TX
802.11n (40MHz)	2TX

5. The EUT consumes power from POE, as follows:

<b>POE</b>	
<b>BRAND</b>	EnGenius
<b>MODEL</b>	EPE-24R
<b>POE's Adapter</b>	
<b>BRAND</b>	powertron
<b>MODEL</b>	PA1024-3HU
<b>SPEC.</b>	AC I/P: 100-240V~ 50-60Hz, 0.6A DC O/P: 24V/1A AC 2-pin Non-shielded DC cable (1.5m)

6. The above EUT information was declared by manufacturer and for more detailed features description, please refer to the manufacturer's specifications or user's manual.



### 3.2 DESCRIPTION OF TEST MODES

4 channels are provided for 802.11a, draft 802.11n (20MHz):

CHANNEL	FREQUENCY	CHANNEL	FREQUENCY
36	5180 MHz	44	5220 MHz
40	5200 MHz	48	5240 MHz

2 channels are provided for draft 802.11n (40MHz):

CHANNEL	FREQUENCY	CHANNEL	FREQUENCY
38	5190MHz	46	5230MHz

#### 3.2.1 CONFIGURATION OF SYSTEM UNDER TEST

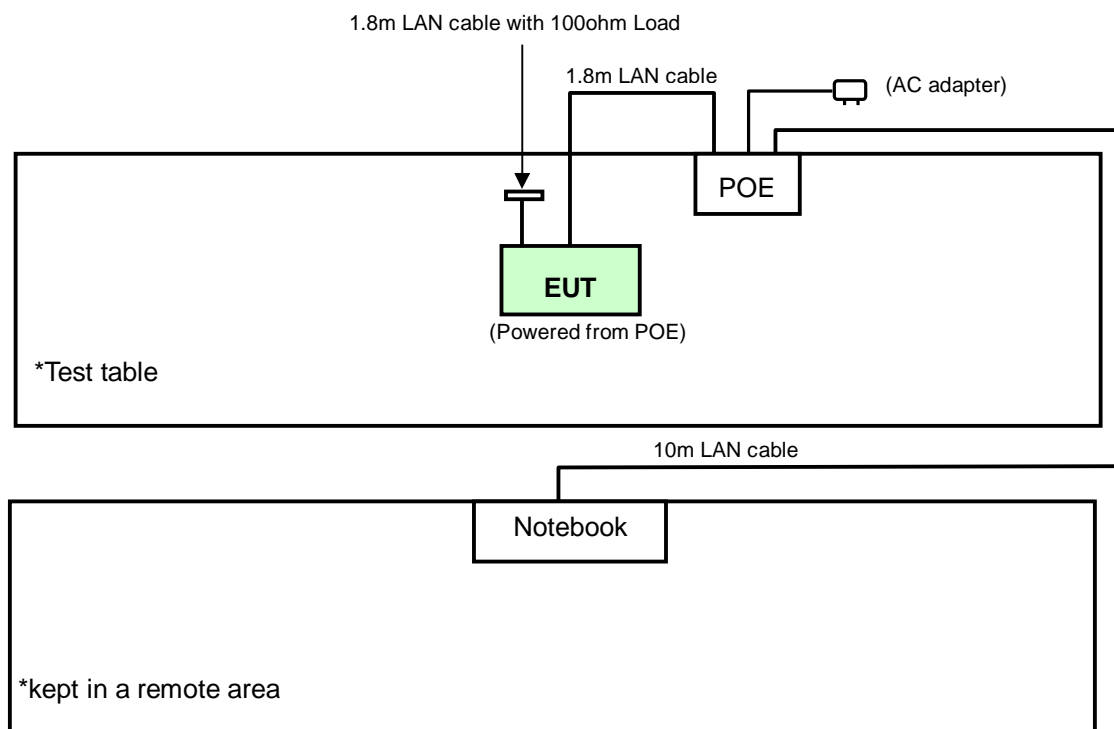



### 3.2.2 TEST MODE APPLICABILITY AND TESTED CHANNEL DETAIL

EUT CONFIGURE MODE	APPLICABLE TO				DESCRIPTION
	RE <sup>3</sup> 1G	RE<1G	PLC	APCM	
-	√	√	√	√	-

Where **RE<sup>3</sup>1G**: Radiated Emission above 1GHz      **RE<1G**: Radiated Emission below 1GHz  
**PLC**: Power Line Conducted Emission      **APCM**: Antenna Port Conducted Measurement

#### **RADIATED EMISSION TEST (ABOVE 1GHz):**

- Pre-Scan has been conducted to determine the worst-case mode from all possible combinations between available modulations, XYZ Axis and antenna ports (if EUT with antenna diversity architecture).
- Following channel(s) was (were) selected for the final test as listed below.

MODE	FREQ. BAND (MHz)	AVAILABLE CHANNEL	TESTED CHANNEL	MODULATION TECHNOLOGY	MODULATION TYPE	DATA RATE (Mbps)	AXIS
802.11a	5180-5240	36 to 48	36, 40, 48	OFDM	BPSK	6.0	Z
802.11n (20MHz)		36 to 48	36, 40, 48	OFDM	BPSK	13.0	Z
802.11n (40MHz)		38 to 46	38, 46	OFDM	BPSK	27.0	Z

#### **RADIATED EMISSION TEST (BELOW 1GHz):**

- Pre-Scan has been conducted to determine the worst-case mode from all possible combinations between available modulations, data rates, XYZ Axis and antenna ports (if EUT with antenna diversity architecture).
- Following channel(s) was (were) selected for the final test as listed below.

MODE	FREQ. BAND (MHz)	AVAILABLE CHANNEL	TESTED CHANNEL	MODULATION TECHNOLOGY	MODULATION TYPE	DATA RATE (Mbps)	AXIS
802.11a	5180-5240	36 to 48	48	OFDM	BPSK	6.0	Z

#### **POWER LINE CONDUCTED EMISSION TEST:**

- Pre-Scan has been conducted to determine the worst-case mode from all possible combinations between available modulations, data rates and antenna ports (if EUT with antenna diversity architecture).
- Following channel(s) was (were) selected for the final test as listed below.

MODE	FREQ. BAND (MHz)	AVAILABLE CHANNEL	TESTED CHANNEL	MODULATION TECHNOLOGY	MODULATION TYPE	DATA RATE (Mbps)
802.11a	5180-5240	36 to 48	48	OFDM	BPSK	6.0



**BANDEDGE MEASUREMENT:**

- Pre-Scan has been conducted to determine the worst-case mode from all possible combinations between available modulations, data rates, XYZ Axis and antenna ports (if EUT with antenna diversity architecture).
- Following channel(s) was (were) selected for the final test as listed below.

MODE	FREQ. BAND (MHz)	AVAILABLE CHANNEL	TESTED CHANNEL	MODULATION TECHNOLOGY	MODULATION TYPE	DATA RATE (Mbps)	AXIS
802.11a	5180-5240	36 to 48	36, 48	OFDM	BPSK	6.0	Z
802.11n (20MHz)		36 to 48	36, 48	OFDM	BPSK	13.0	Z
802.11n (40MHz)		38 to 46	38, 46	OFDM	BPSK	27.0	Z

**ANTENNA PORT CONDUCTED MEASUREMENT:**

- This item includes all test value of each mode, but only includes spectrum plot of worst value of each mode.
- Pre-Scan has been conducted to determine the worst-case mode from all possible combinations between available modulations, data rates and antenna ports (if EUT with antenna diversity architecture).
- Following channel(s) was (were) selected for the final test as listed below.

MODE	FREQ. BAND (MHz)	AVAILABLE CHANNEL	TESTED CHANNEL	MODULATION TECHNOLOGY	MODULATION TYPE	DATA RATE (Mbps)
802.11a	5180-5240	36 to 48	36, 40, 48	OFDM	BPSK	6.0
802.11n (20MHz)		36 to 48	36, 40, 48	OFDM	BPSK	13.0
802.11n (40MHz)		38 to 46	38, 46	OFDM	BPSK	27.0

**TEST CONDITION:**

APPLICABLE TO	ENVIRONMENTAL CONDITIONS	INPUT POWER	TESTED BY
PLC	25deg. C, 73% RH	120Vac, 60Hz	Nick Chen
RE <sup>3</sup> 1G	24deg. C, 72% RH	120Vac, 60Hz	Nick Chen
RE <1G	24deg. C, 72% RH	120Vac, 60Hz	Nick Chen
APCM	25deg. C, 78% RH	120Vac, 60Hz	Chad Lee

### 3.3 GENERAL DESCRIPTION OF APPLIED STANDARDS

The EUT is a RF Product. According to the specifications of the manufacturer, it must comply with the requirements of the following standards:

**FCC Part 15, Subpart E (15.407)**

**ANSI C63.4-2003**

**ANSI C63.10-2009**

All test items have been performed and recorded as per the above standards.

**NOTE:** The EUT is also considered as a kind of computer peripheral, because the connection to computer is necessary for typical use. It has been verified to comply with the requirements of FCC Part 15, Subpart B, Class B (DoC). The test report has been issued separately.

### 3.4 DESCRIPTION OF SUPPORT UNITS

The EUT has been tested as an independent unit together with other necessary accessories or support units. The following support units or accessories were used to form a representative test configuration during the tests.

NO.	PRODUCT	BRAND	MODEL NO.	SERIAL NO.	FCC ID
1	NOTEBOOK COMPUTER	DELL	PP05L	19227741184	FCC DoC Approved

NO.	SIGNAL CABLE DESCRIPTION OF THE ABOVE SUPPORT UNITS
1	10m UTP LAN cable

- NOTE:** (1) All power cords of the above support units are non-shielded (1.8m).  
 (2) One LAN cable (1.8m) was connected to EUT to form an open loop cable, which was terminated with a 100ohm resistor load.  
 (3) One LAN cable (1.8m) was connected from EUT to POE.

## 4. TEST TYPES AND RESULTS

### 4.1 CONDUCTED EMISSION MEASUREMENT

#### 4.1.1 LIMITS OF CONDUCTED EMISSION MEASUREMENT

FREQUENCY OF EMISSION (MHz)	CONDUCTED LIMIT (dB $\mu$ V)	
	Quasi-peak	Average
0.15 ~ 0.5	66 to 56	56 to 46
0.5 ~ 5	56	46
5 ~ 30	60	50

- NOTE:** 1. The lower limit shall apply at the transition frequencies.
2. The limit decreases in line with the logarithm of the frequency in the range of 0.15 to 0.50MHz.
3. All emanations from a class A/B digital device or system, including any network of conductors and apparatus connected thereto, shall not exceed the level of field strengths specified above.

#### 4.1.2 TEST INSTRUMENTS

DESCRIPTION & MANUFACTURER	MODEL NO.	SERIAL NO.	CALIBRATED DATE	CALIBRATED UNTIL
ROHDE & SCHWARZ Test Receiver	ESCS 30	100276	Dec. 31, 2010	Dec. 30, 2011
ROHDE & SCHWARZ Artificial Mains Network (for EUT)	ESH3-Z5	100219	Nov. 24, 2010	Nov. 23, 2011
LISN With Adapter (for EUT)	AD10	C10Ada-001	Nov. 24, 2010	Nov. 23, 2011
ROHDE & SCHWARZ Artificial Mains Network (for peripherals)	ESH3-Z5	100218	Nov. 24, 2010	Nov. 23, 2011
Software	ADT_Cond_V7.3.7	NA	NA	NA
Software	ADT_ISN_V7.3.7	NA	NA	NA
RF cable (JYBAO)	5D-FB	Cable-C10.01	Feb. 22, 2011	Feb. 21, 2012
SUHNER Terminator (For ROHDE & SCHWARZ LISN)	65BNC-5001	E1-010773	Feb. 26, 2011	Feb. 25, 2012

- NOTE:** 1. The calibration interval of the above test instruments is 12 months and the calibrations are traceable to NML/ROC and NIST/USA.
2. The test was performed in Shielded Room No. 10.
3. The VCCI Site Registration No. C-1852.

### 4.1.3 TEST PROCEDURES

- a. The EUT was placed 0.4 meters from the conducting wall of the shielded room with EUT being connected to the power mains through a line impedance stabilization network (LISN). Other support units were connected to the power mains through another LISN. The two LISNs provide 50 ohm/ 50uH of coupling impedance for the measuring instrument.
- b. Both lines of the power mains connected to the EUT were checked for maximum conducted interference.
- c. The frequency range from 150kHz to 30MHz was searched. Emission levels under (Limit - 20dB) was not recorded.

**NOTE:** All modes of operation were investigated and the worst-case emissions are reported.

### 4.1.4 DEVIATION FROM TEST STANDARD

No deviation

## 4.1.5 TEST SETUP

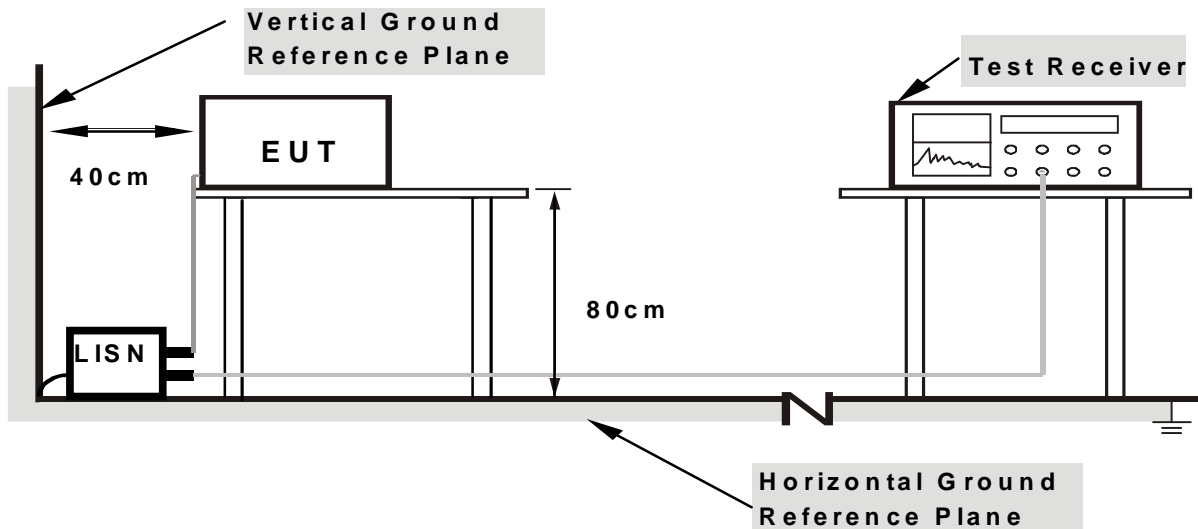

- Note:**
1. Support units were connected to second LISN.
  2. Both of LISNs (AMN) are 80 cm from EUT and at least 80 cm from other units and other metal planes support units.

For the actual test configuration, please refer to the attached file (Test Setup Photo).

## 4.1.6 EUT OPERATING CONDITIONS

- a. Turn on the power of all equipment.
- b. Notebook PC ran a test program (provided by manufacture) to enable EUT under transmitting condition at specific channel continuously.

### 4.1.7 TEST RESULTS

#### CONDUCTED WORST-CASE DATA : 802.11a

<b>6dB BANDWIDTH</b>	9kHz	<b>PHASE</b>	Line 1
<b>CHANNEL</b>	Channel 48		

No	Freq. [MHz]	Corr. Factor (dB)	Reading Value		Emission Level		Limit		Margin	
			[dB (uV)]		[dB (uV)]		[dB (uV)]		(dB)	
			Q.P.	AV.	Q.P.	AV.	Q.P.	AV.	Q.P.	AV.
1	0.173	0.17	49.10	-	49.27	-	64.79	54.79	-15.53	-
2	0.205	0.17	44.47	-	44.64	-	63.42	53.42	-18.78	-
3	0.384	0.23	41.08	-	41.31	-	58.18	48.18	-16.87	-
4	3.163	0.42	36.51	-	36.93	-	56.00	46.00	-19.07	-
5	12.219	0.91	41.71	-	42.62	-	60.00	50.00	-17.38	-
6	21.226	1.38	33.69	-	35.07	-	60.00	50.00	-24.93	-

- REMARKS:**
1. Q.P. and AV. are abbreviations of quasi-peak and average individually.
  2. "-": The Quasi-peak reading value also meets average limit and measurement with the average detector is unnecessary.
  3. The emission levels of other frequencies were very low against the limit.
  4. Margin value = Emission level - Limit value
  5. Correction factor = Insertion loss + Cable loss
  6. Emission Level = Correction Factor + Reading Value.

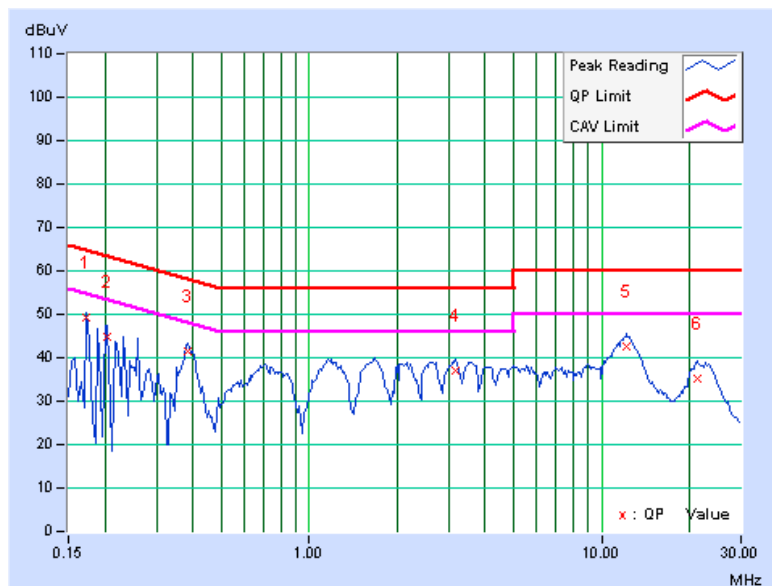





A D T

<b>6dB BANDWIDTH</b>	9kHz	<b>PHASE</b>	Line 2
<b>CHANNEL</b>	Channel 48		

No	Freq. [MHz]	Corr. Factor (dB)	Reading Value		Emission Level		Limit		Margin	
			[dB (uV)]		[dB (uV)]		[dB (uV)]		(dB)	
			Q.P.	AV.	Q.P.	AV.	Q.P.	AV.	Q.P.	AV.
1	0.162	0.18	49.23	-	49.41	-	65.38	55.38	-15.97	-
2	0.193	0.18	46.64	-	46.82	-	63.91	53.91	-17.09	-
3	0.392	0.25	38.68	-	38.93	-	58.02	48.02	-19.09	-
4	1.680	0.31	38.10	-	38.41	-	56.00	46.00	-17.59	-
5	3.637	0.44	39.36	-	39.80	-	56.00	46.00	-16.20	-
<b>6</b>	<b>12.180</b>	<b>0.75</b>	<b>45.89</b>	-	<b>46.64</b>	-	<b>60.00</b>	<b>50.00</b>	<b>-13.36</b>	-

- REMARKS:**
1. Q.P. and AV. are abbreviations of quasi-peak and average individually.
  2. "-": The Quasi-peak reading value also meets average limit and measurement with the average detector is unnecessary.
  3. The emission levels of other frequencies were very low against the limit.
  4. Margin value = Emission level - Limit value
  5. Correction factor = Insertion loss + Cable loss
  6. Emission Level = Correction Factor + Reading Value.

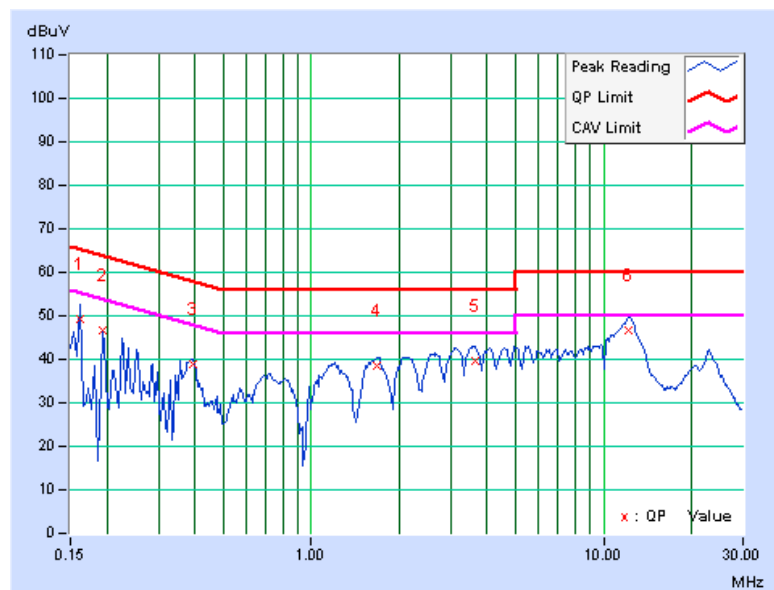

## 4.2 RADIATED EMISSION MEASUREMENT

### 4.2.1 LIMITS OF RADIATED EMISSION MEASUREMENT

Emissions radiated outside of the specified bands, shall be according to the general radiated limits in 15.209 as following:

FREQUENCIES (MHz)	FIELD STRENGTH (microvolts/meter)	MEASUREMENT DISTANCE (meters)
0.009 ~ 0.490	2400/F(kHz)	300
0.490 ~ 1.705	24000/F(kHz)	30
1.705 ~ 30.0	30	30
30 ~ 88	100	3
88 ~ 216	150	3
216 ~ 960	200	3
Above 960	500	3

**NOTE:**

1. The lower limit shall apply at the transition frequencies.
2. Emission level (dBuV/m) = 20 log Emission level (uV/m).
3. As shown in 15.35(b), for frequencies above 1000MHz, the field strength limits are based on average detector, however, the peak field strength of any emission shall not exceed the maximum permitted average limits, specified above by more than 20dB under any condition of modulation.

### 4.2.2 LIMITS OF UNWANTED EMISSION OUT OF THE RESTRICTED BANDS

FREQUENCIES (MHz)	EIRP LIMIT (dBm)	EQUIVALENT FIELD STRENGTH AT 3m (dBµV/m) *NOTE
	PK	PK
5150 ~ 5350	-27	68.3
5470 ~ 5725	-27	68.3

**NOTE:** The following formula is used to convert the equipment isotropic radiated power (eirp) to field strength:

$$E = \frac{1000000\sqrt{30P}}{3} \mu\text{V/m, where P is the eirp (Watts).}$$

## 4.2.3 TEST INSTRUMENTS

DESCRIPTION & MANUFACTURER	MODEL NO.	SERIAL NO.	CALIBRATED DATE	CALIBRATED UNTIL
HP Preamplifier	8447D	2432A03504	Mar. 04, 2011	Mar. 03, 2012
HP Preamplifier	8449B	3008A01924	Mar. 04, 2011	Mar. 03, 2012
HP Preamplifier	8449B	3008A01292	Mar. 04, 2011	Mar. 03, 2012
Agilent Spectrum Analyzer	E4446A	MY46180403	Jun. 22, 2011	Jun. 21, 2012
Schwarzbeck Antenna	VULB 9168	137	Apr. 12, 2011	Apr. 11, 2012
Schwarzbeck Antenna	VHBA 9123	480	May 06, 2011	May 05, 2012
ADT. Turn Table	TT100	0306	NA	NA
ADT. Tower	AT100	0306	NA	NA
Software	ADT_Radiated_V 7.6.15.9.2	NA	NA	NA
SUHNER RF cable	SF102	CABLE-CH6	Aug. 19, 2011	Aug. 18, 2012
EMCO Horn Antenna	3115	6714	Oct. 29, 2010	Oct. 28, 2011
EMCO Horn Antenna	3115	9312-4192	Apr. 22, 2011	Apr. 21, 2012
Highpass filter Wainwright Instruments	WHK 3.1/18G-10SS	SN 8	NA	NA

- NOTE:**
1. The calibration interval of the above test instruments is 12 months. And the calibrations are traceable to NML/ROC and NIST/USA.
  2. The horn antenna and HP preamplifier (model: 8449B) are used only for the measurement of emission frequency above 1GHz if tested.
  3. The test was performed in Chamber No. 6.
  4. The Industry Canada Reference No. IC 7450E-6.
  5. The FCC Site Registration No. is 447212.

#### 4.2.4 TEST PROCEDURES

- a. The EUT was placed on the top of a rotating table 0.8 meters above the ground at a 3 meter semi-anechoic chamber. The table was rotated 360 degrees to determine the position of the highest radiation.
- b. The EUT was set 3 meters away from the interference-receiving antenna, which was mounted on the top of a variable-height antenna tower.
- c. The antenna is a broadband antenna, and its height is varied from one meter to four meters above the ground to determine the maximum value of the field strength. Both horizontal and vertical polarizations of the antenna are set to make the measurement.
- d. For each suspected emission, the EUT was arranged to its worst case and then the antenna was tuned to heights from 1 meter to 4 meters and the rotatable table was turned from 0 degrees to 360 degrees to find the maximum reading.
- e. The test-receiver system was set to Peak Detect Function and Specified Bandwidth with Maximum Hold Mode.
- f. If the emission level of the EUT in peak mode was 10dB lower than the limit specified, then testing could be stopped and the peak values of the EUT would be reported. Otherwise the emissions that did not have 10dB margin would be re-tested one by one using peak, quasi-peak or average method as specified and then reported in a data sheet.

**NOTE:**

1. The resolution bandwidth and video bandwidth of test receiver/spectrum analyzer is 120kHz for Peak detection (PK) and Quasi-peak detection (QP) at frequency below 1GHz.
2. The resolution bandwidth of test receiver/spectrum analyzer is 1MHz and video bandwidth is 3MHz for Peak detection at frequency above 1GHz.
3. The resolution bandwidth of test receiver/spectrum analyzer is 1MHz and the video bandwidth is 10Hz for Average detection (AV) at frequency above 1GHz.
4. All modes of operation were investigated and the worst-case emissions are reported.

#### 4.2.5 DEVIATION FROM TEST STANDARD

No deviation.

## 4.2.6 TEST SETUP

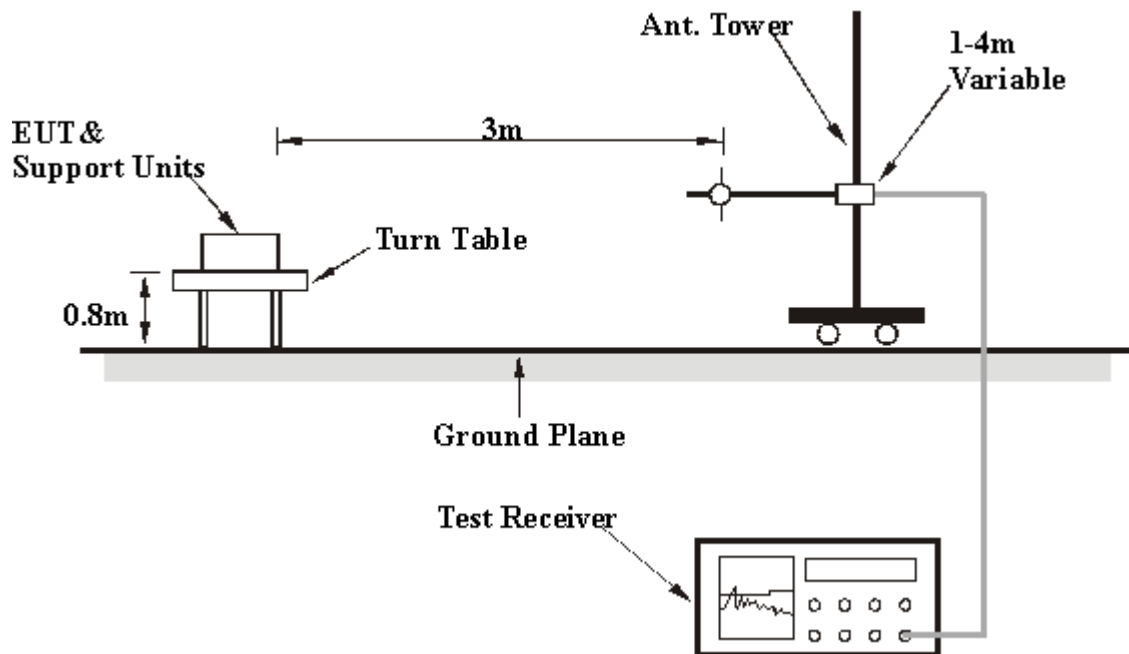

For the actual test configuration, please refer to the attached file (Test Setup Photo).

## 4.2.7 EUT OPERATING CONDITION

Set the EUT under transmission condition continuously at specific channel frequency.

## 4.2.8 TEST RESULTS

802.11a

EUT TEST CONDITION		MEASUREMENT DETAIL	
CHANNEL	Channel 36	FREQUENCY RANGE	1 ~ 40GHz
INPUT POWER	120Vac, 60Hz	DETECTOR FUNCTION	Peak (PK) Average (AV)
ENVIRONMENTAL CONDITIONS	24deg. C, 72%RH	TESTED BY	Nick Chen

ANTENNA POLARITY & TEST DISTANCE: HORIZONTAL AT 3 M								
NO.	FREQ. (MHz)	EMISSION LEVEL (dBuV/m)	LIMIT (dBuV/m)	MARGIN (dB)	ANTENNA HEIGHT (m)	TABLE ANGLE (Degree)	RAW VALUE (dBuV)	CORRECTION FACTOR (dB/m)
1	5150.00	54.9 PK	74.0	-19.1	1.58 H	91	15.59	39.27
2	5150.00	45.2 AV	54.0	-8.8	1.58 H	91	5.97	39.27
3	*5180.00	105.7 PK			1.58 H	91	66.42	39.31
4	*5180.00	94.9 AV			1.58 H	91	55.55	39.31
5	#10360.00	58.7 PK	68.3	-9.6	1.05 H	173	9.34	49.36
ANTENNA POLARITY & TEST DISTANCE: VERTICAL AT 3 M								
NO.	FREQ. (MHz)	EMISSION LEVEL (dBuV/m)	LIMIT (dBuV/m)	MARGIN (dB)	ANTENNA HEIGHT (m)	TABLE ANGLE (Degree)	RAW VALUE (dBuV)	CORRECTION FACTOR (dB/m)
1	5150.00	53.7 PK	74.0	-20.3	1.41 V	90	14.46	39.27
2	5150.00	40.1 AV	54.0	-13.9	1.41 V	90	0.79	39.27
3	*5180.00	98.8 PK			1.41 V	90	59.50	39.31
4	*5180.00	87.3 AV			1.41 V	90	48.00	39.31
5	#10360.00	58.5 PK	68.3	-9.8	1.22 V	126	9.12	49.36

- REMARKS:**
1. Emission level (dBuV/m) = Raw Value (dBuV) + Correction Factor (dB/m).
  2. Correction Factor (dB/m) = Antenna Factor (dB/m) + Cable Factor (dB).
  3. The other emission levels were very low against the limit.
  4. Margin value = Emission level – Limit value.
  5. “ \* “: Fundamental frequency.
  6. "#":The radiated frequency is out the restricted band.



A D T

EUT TEST CONDITION		MEASUREMENT DETAIL	
CHANNEL	Channel 40	FREQUENCY RANGE	1 ~ 40GHz
INPUT POWER	120Vac, 60Hz	DETECTOR FUNCTION	Peak (PK) Average (AV)
ENVIRONMENTAL CONDITIONS	24deg. C, 72%RH	TESTED BY	Nick Chen

ANTENNA POLARITY & TEST DISTANCE: HORIZONTAL AT 3 M								
NO.	FREQ. (MHz)	EMISSION LEVEL (dBuV/m)	LIMIT (dBuV/m)	MARGIN (dB)	ANTENNA HEIGHT (m)	TABLE ANGLE (Degree)	RAW VALUE (dBuV)	CORRECTION FACTOR (dB/m)
1	*5200.00	106.0 PK			1.50 H	90	66.65	39.33
2	*5200.00	93.9 AV			1.50 H	90	54.53	39.33
3	#10400.00	59.8 PK	68.3	-8.5	1.44 H	100	10.45	49.38
ANTENNA POLARITY & TEST DISTANCE: VERTICAL AT 3 M								
NO.	FREQ. (MHz)	EMISSION LEVEL (dBuV/m)	LIMIT (dBuV/m)	MARGIN (dB)	ANTENNA HEIGHT (m)	TABLE ANGLE (Degree)	RAW VALUE (dBuV)	CORRECTION FACTOR (dB/m)
1	*5200.00	98.6 PK			1.35 V	91	59.23	39.33
2	*5200.00	88.4 AV			1.35 V	91	49.07	39.33
3	#10400.00	58.5 PK	68.3	-9.8	1.31 V	119	9.15	49.38

- REMARKS:**
1. Emission level (dBuV/m) = Raw Value (dBuV) + Correction Factor (dB/m).
  2. Correction Factor (dB/m) = Antenna Factor (dB/m) + Cable Factor (dB).
  3. The other emission levels were very low against the limit.
  4. Margin value = Emission level – Limit value.
  5. “ \* “: Fundamental frequency.
  6. “ # “: The radiated frequency is out the restricted band.



A D T

EUT TEST CONDITION		MEASUREMENT DETAIL	
CHANNEL	Channel 48	FREQUENCY RANGE	1 ~ 40GHz
INPUT POWER	120Vac, 60Hz	DETECTOR FUNCTION	Peak (PK) Average (AV)
ENVIRONMENTAL CONDITIONS	24deg. C, 72%RH	TESTED BY	Nick Chen

ANTENNA POLARITY & TEST DISTANCE: HORIZONTAL AT 3 M								
NO.	FREQ. (MHz)	EMISSION LEVEL (dBuV/m)	LIMIT (dBuV/m)	MARGIN (dB)	ANTENNA HEIGHT (m)	TABLE ANGLE (Degree)	RAW VALUE (dBuV)	CORRECTION FACTOR (dB/m)
1	*5240.00	107.0 PK			1.52 H	93	67.57	39.38
2	*5240.00	95.4 AV			1.52 H	93	56.03	39.38
3	5350.00	53.0 PK	74.0	-21.1	1.52 H	93	13.43	39.52
4	5350.00	40.2 AV	54.0	-13.8	1.52 H	93	0.68	39.52
5	#10480.00	59.3 PK	68.3	-9.0	1.47 H	83	9.86	49.48
ANTENNA POLARITY & TEST DISTANCE: VERTICAL AT 3 M								
NO.	FREQ. (MHz)	EMISSION LEVEL (dBuV/m)	LIMIT (dBuV/m)	MARGIN (dB)	ANTENNA HEIGHT (m)	TABLE ANGLE (Degree)	RAW VALUE (dBuV)	CORRECTION FACTOR (dB/m)
1	*5240.00	85.1 PK			1.36 V	94	45.72	39.38
2	*5240.00	74.9 AV			1.36 V	94	35.56	39.38
3	5350.00	52.2 PK	74.0	-21.8	1.36 V	94	12.64	39.52
4	5350.00	39.7 AV	54.0	-14.3	1.36 V	94	0.14	39.52
5	#10480.00	58.7 PK	68.3	-9.6	1.34 V	117	9.25	49.48

- REMARKS:**
1. Emission level (dBuV/m) = Raw Value (dBuV) + Correction Factor (dB/m).
  2. Correction Factor (dB/m) = Antenna Factor (dB/m) + Cable Factor (dB).
  3. The other emission levels were very low against the limit.
  4. Margin value = Emission level – Limit value.
  5. “ \* “: Fundamental frequency.
  6. “ # “: The radiated frequency is out the restricted band.





A D T

802.11n (20MHz)

EUT TEST CONDITION		MEASUREMENT DETAIL	
CHANNEL	Channel 36	FREQUENCY RANGE	1 ~ 40GHz
INPUT POWER	120Vac, 60Hz	DETECTOR FUNCTION	Peak (PK) Average (AV)
ENVIRONMENTAL CONDITIONS	24deg. C, 72%RH	TESTED BY	Nick Chen

ANTENNA POLARITY & TEST DISTANCE: HORIZONTAL AT 3 M								
NO.	FREQ. (MHz)	EMISSION LEVEL (dBuV/m)	LIMIT (dBuV/m)	MARGIN (dB)	ANTENNA HEIGHT (m)	TABLE ANGLE (Degree)	RAW VALUE (dBuV)	CORRECTION FACTOR (dB/m)
1	5150.00	56.5 PK	74.0	-17.5	1.48 H	95	17.22	39.27
2	5150.00	43.9 AV	54.0	-10.1	1.48 H	95	4.61	39.27
3	*5180.00	110.2 PK			1.48 H	95	70.86	39.31
4	*5180.00	100.2 AV			1.48 H	95	60.88	39.31
5	#10360.00	58.6 PK	68.3	-9.8	1.07 H	164	9.19	49.36

ANTENNA POLARITY & TEST DISTANCE: VERTICAL AT 3 M								
NO.	FREQ. (MHz)	EMISSION LEVEL (dBuV/m)	LIMIT (dBuV/m)	MARGIN (dB)	ANTENNA HEIGHT (m)	TABLE ANGLE (Degree)	RAW VALUE (dBuV)	CORRECTION FACTOR (dB/m)
1	5150.00	55.1 PK	74.0	-18.9	1.36 V	91	15.84	39.27
2	5150.00	40.8 AV	54.0	-13.3	1.36 V	91	1.48	39.27
3	*5180.00	109.2 PK			1.36 V	91	69.90	39.31
4	*5180.00	98.7 AV			1.36 V	91	59.40	39.31
5	#10360.00	58.0 PK	68.3	-10.3	1.36 V	91	8.63	49.36

- REMARKS:**
1. Emission level (dBuV/m) = Raw Value (dBuV) + Correction Factor (dB/m).
  2. Correction Factor (dB/m) = Antenna Factor (dB/m) + Cable Factor (dB).
  3. The other emission levels were very low against the limit.
  4. Margin value = Emission level – Limit value.
  5. “ \* “: Fundamental frequency.
  6. “#”:The radiated frequency is out the restricted band.



A D T

EUT TEST CONDITION		MEASUREMENT DETAIL	
CHANNEL	Channel 40	FREQUENCY RANGE	1 ~ 40GHz
INPUT POWER	120Vac, 60Hz	DETECTOR FUNCTION	Peak (PK) Average (AV)
ENVIRONMENTAL CONDITIONS	24deg. C, 72%RH	TESTED BY	Nick Chen

ANTENNA POLARITY & TEST DISTANCE: HORIZONTAL AT 3 M								
NO.	FREQ. (MHz)	EMISSION LEVEL (dBuV/m)	LIMIT (dBuV/m)	MARGIN (dB)	ANTENNA HEIGHT (m)	TABLE ANGLE (Degree)	RAW VALUE (dBuV)	CORRECTION FACTOR (dB/m)
1	*5200.00	111.4 PK			1.50 H	91	72.03	39.33
2	*5200.00	100.4 AV			1.50 H	91	61.07	39.33
3	#10400.00	58.3 PK	68.3	-10.0	1.08 H	194	8.96	49.38
ANTENNA POLARITY & TEST DISTANCE: VERTICAL AT 3 M								
NO.	FREQ. (MHz)	EMISSION LEVEL (dBuV/m)	LIMIT (dBuV/m)	MARGIN (dB)	ANTENNA HEIGHT (m)	TABLE ANGLE (Degree)	RAW VALUE (dBuV)	CORRECTION FACTOR (dB/m)
1	*5200.00	109.7 PK			1.35 V	90	70.33	39.33
2	*5200.00	99.5 AV			1.35 V	90	60.21	39.33
3	#10400.00	57.8 PK	68.3	-10.5	1.20 V	130	8.44	49.38

- REMARKS:**
1. Emission level (dBuV/m) = Raw Value (dBuV) + Correction Factor (dB/m).
  2. Correction Factor (dB/m) = Antenna Factor (dB/m) + Cable Factor (dB).
  3. The other emission levels were very low against the limit.
  4. Margin value = Emission level – Limit value.
  5. “ \* “: Fundamental frequency.
  6. “#”:The radiated frequency is out the restricted band.



A D T

EUT TEST CONDITION		MEASUREMENT DETAIL	
CHANNEL	Channel 48	FREQUENCY RANGE	1 ~ 40GHz
INPUT POWER	120Vac, 60Hz	DETECTOR FUNCTION	Peak (PK) Average (AV)
ENVIRONMENTAL CONDITIONS	24deg. C, 72%RH	TESTED BY	Nick Chen

ANTENNA POLARITY & TEST DISTANCE: HORIZONTAL AT 3 M								
NO.	FREQ. (MHz)	EMISSION LEVEL (dBuV/m)	LIMIT (dBuV/m)	MARGIN (dB)	ANTENNA HEIGHT (m)	TABLE ANGLE (Degree)	RAW VALUE (dBuV)	CORRECTION FACTOR (dB/m)
1	*5240.00	111.5 PK			1.36 H	90	72.14	39.38
2	*5240.00	100.2 AV			1.36 H	90	60.83	39.38
3	5350.00	51.3 PK	74.0	-22.7	1.36 H	90	11.81	39.52
4	5350.00	39.8 AV	54.0	-14.2	1.36 H	90	0.30	39.52
5	#10480.00	58.6 PK	68.3	-9.7	1.04 H	187	9.14	49.48
ANTENNA POLARITY & TEST DISTANCE: VERTICAL AT 3 M								
NO.	FREQ. (MHz)	EMISSION LEVEL (dBuV/m)	LIMIT (dBuV/m)	MARGIN (dB)	ANTENNA HEIGHT (m)	TABLE ANGLE (Degree)	RAW VALUE (dBuV)	CORRECTION FACTOR (dB/m)
1	*5240.00	110.2 PK			1.35 V	91	70.83	39.38
2	*5240.00	98.3 AV			1.35 V	91	58.93	39.38
3	5350.00	50.8 PK	74.0	-23.2	1.35 V	91	11.30	39.52
4	5350.00	39.5 AV	54.0	-14.5	1.35 V	91	0.02	39.52
5	#10480.00	58.0 PK	68.3	-10.3	1.23 V	137	8.53	49.48

- REMARKS:**
1. Emission level (dBuV/m) = Raw Value (dBuV) + Correction Factor (dB/m).
  2. Correction Factor (dB/m) = Antenna Factor (dB/m) + Cable Factor (dB).
  3. The other emission levels were very low against the limit.
  4. Margin value = Emission level – Limit value.
  5. " \* ": Fundamental frequency.
  6. "#": The radiated frequency is out the restricted band.

802.11n (40MHz)

EUT TEST CONDITION		MEASUREMENT DETAIL	
CHANNEL	Channel 38	FREQUENCY RANGE	1 ~ 40GHz
INPUT POWER	120Vac, 60Hz	DETECTOR FUNCTION	Peak (PK) Average (AV)
ENVIRONMENTAL CONDITIONS	24deg. C, 72%RH	TESTED BY	Nick Chen

ANTENNA POLARITY & TEST DISTANCE: HORIZONTAL AT 3 M								
NO.	FREQ. (MHz)	EMISSION LEVEL (dBuV/m)	LIMIT (dBuV/m)	MARGIN (dB)	ANTENNA HEIGHT (m)	TABLE ANGLE (Degree)	RAW VALUE (dBuV)	CORRECTION FACTOR (dB/m)
1	5150.00	64.4 PK	74.0	-9.7	1.48 H	91	25.08	39.27
2	5150.00	48.3 AV	54.0	-5.7	1.48 H	91	9.01	39.27
3	*5190.00	109.0 PK			1.48 H	91	69.63	39.32
4	*5190.00	97.8 AV			1.48 H	91	58.45	39.32
5	#10380.00	58.6 PK	68.3	-9.7	1.09 H	197	9.26	49.37

ANTENNA POLARITY & TEST DISTANCE: VERTICAL AT 3 M								
NO.	FREQ. (MHz)	EMISSION LEVEL (dBuV/m)	LIMIT (dBuV/m)	MARGIN (dB)	ANTENNA HEIGHT (m)	TABLE ANGLE (Degree)	RAW VALUE (dBuV)	CORRECTION FACTOR (dB/m)
1	5150.00	60.1 PK	74.0	-13.9	1.36 V	92	20.82	39.27
2	5150.00	46.5 AV	54.0	-7.5	1.36 V	92	7.25	39.27
3	*5190.00	107.6 PK			1.36 V	92	68.24	39.32
4	*5190.00	97.2 AV			1.36 V	92	57.86	39.32
5	#10380.00	57.5 PK	68.3	-10.8	1.33 V	145	8.15	49.37

- REMARKS:**
1. Emission level (dBuV/m) = Raw Value (dBuV) + Correction Factor (dB/m).
  2. Correction Factor (dB/m) = Antenna Factor (dB/m) + Cable Factor (dB).
  3. The other emission levels were very low against the limit.
  4. Margin value = Emission level – Limit value.
  5. “ \* “: Fundamental frequency.
  6. “#”:The radiated frequency is out the restricted band.



A D T

EUT TEST CONDITION		MEASUREMENT DETAIL	
CHANNEL	Channel 46	FREQUENCY RANGE	1 ~ 40GHz
INPUT POWER	120Vac, 60Hz	DETECTOR FUNCTION	Peak (PK) Average (AV)
ENVIRONMENTAL CONDITIONS	24deg. C, 72%RH	TESTED BY	Nick Chen

ANTENNA POLARITY & TEST DISTANCE: HORIZONTAL AT 3 M								
NO.	FREQ. (MHz)	EMISSION LEVEL (dBuV/m)	LIMIT (dBuV/m)	MARGIN (dB)	ANTENNA HEIGHT (m)	TABLE ANGLE (Degree)	RAW VALUE (dBuV)	CORRECTION FACTOR (dB/m)
1	*5230.00	108.5 PK			1.35 H	90	69.16	39.37
2	*5230.00	97.9 AV			1.35 H	90	58.55	39.37
3	5350.00	54.7 PK	74.0	-19.3	1.35 H	90	15.17	39.52
4	5350.00	42.9 AV	54.0	-11.1	1.35 H	90	3.36	39.52
5	#10460.00	58.6 PK	68.3	-9.8	1.05 H	169	9.09	49.46
ANTENNA POLARITY & TEST DISTANCE: VERTICAL AT 3 M								
NO.	FREQ. (MHz)	EMISSION LEVEL (dBuV/m)	LIMIT (dBuV/m)	MARGIN (dB)	ANTENNA HEIGHT (m)	TABLE ANGLE (Degree)	RAW VALUE (dBuV)	CORRECTION FACTOR (dB/m)
1	*5230.00	107.9 PK			1.34 V	90	68.55	39.37
2	*5230.00	97.7 AV			1.34 V	90	58.33	39.37
3	5350.00	53.6 PK	74.0	-20.4	1.34 V	90	14.12	39.52
4	5350.00	42.6 AV	54.0	-11.4	1.34 V	90	3.04	39.52
5	#10460.00	57.6 PK	68.3	-10.7	1.29 V	155	8.17	49.46

- REMARKS:**
1. Emission level (dBuV/m) = Raw Value (dBuV) + Correction Factor (dB/m).
  2. Correction Factor (dB/m) = Antenna Factor (dB/m) + Cable Factor (dB).
  3. The other emission levels were very low against the limit.
  4. Margin value = Emission level – Limit value.
  5. " \* ": Fundamental frequency.
  6. "#": The radiated frequency is out the restricted band.

**BELOW 1GHz WORST-CASE DATA : 802.11a**

EUT TEST CONDITION		MEASUREMENT DETAIL	
CHANNEL	Channel 48	FREQUENCY RANGE	Below 1000MHz
INPUT POWER	120Vac, 60Hz	DETECTOR FUNCTION	Quasi-Peak
ENVIRONMENTAL CONDITIONS	24deg. C, 72%RH	TESTED BY	Nick Chen

ANTENNA POLARITY & TEST DISTANCE: HORIZONTAL AT 3 M								
NO.	FREQ. (MHz)	EMISSION LEVEL (dBuV/m)	LIMIT (dBuV/m)	MARGIN (dB)	ANTENNA HEIGHT (m)	TABLE ANGLE (Degree)	RAW VALUE (dBuV)	CORRECTION FACTOR (dB/m)
1	50.98	37.5 QP	40.0	-2.5	1.07 H	112	23.66	13.82
2	94.56	41.1 QP	43.5	-2.4	1.22 H	139	32.12	8.97
3	142.98	31.1 QP	43.5	-12.4	1.32 H	271	17.17	13.90
4	249.50	34.8 QP	46.0	-11.2	1.07 H	154	21.29	13.53
5	522.26	33.4 QP	46.0	-12.6	1.08 H	238	11.73	21.71
6	599.73	35.5 QP	46.0	-10.5	1.22 H	280	12.08	23.42
7	<b>798.25</b>	<b>45.5 QP</b>	<b>46.0</b>	<b>-0.5</b>	<b>1.00 H</b>	<b>265</b>	<b>18.94</b>	<b>26.57</b>
8	893.48	36.6 QP	46.0	-9.4	1.05 H	331	8.88	27.71
ANTENNA POLARITY & TEST DISTANCE: VERTICAL AT 3 M								
NO.	FREQ. (MHz)	EMISSION LEVEL (dBuV/m)	LIMIT (dBuV/m)	MARGIN (dB)	ANTENNA HEIGHT (m)	TABLE ANGLE (Degree)	RAW VALUE (dBuV)	CORRECTION FACTOR (dB/m)
1	50.98	39.2 QP	40.0	-0.8	1.11 V	73	25.34	13.82
2	94.56	42.8 QP	43.5	-0.7	1.08 V	124	33.81	8.97
3	142.98	39.1 QP	43.5	-4.4	1.22 V	190	25.16	13.90
4	199.47	38.5 QP	43.5	-5.0	1.28 V	67	27.12	11.39
5	280.17	31.8 QP	46.0	-14.2	1.20 V	226	17.00	14.80
6	599.73	32.1 QP	46.0	-13.9	1.13 V	172	8.72	23.42
7	798.25	37.5 QP	46.0	-8.5	1.00 V	187	10.91	26.57

- REMARKS:**
1. Emission level (dBuV/m) = Raw Value (dBuV) + Correction Factor (dB/m).
  2. Correction Factor (dB/m) = Antenna Factor (dB/m) + Cable Factor (dB).
  3. The other emission levels were very low against the limit.
  4. Margin value = Emission level – Limit value.

## 4.3 PEAK TRANSMIT POWER MEASUREMENT

### 4.3.1 LIMITS OF PEAK TRANSMIT POWER MEASUREMENT

FREQUENCY BAND	LIMIT
5.150 ~ 5.250GHz	The lesser of 50mW (17dBm) or 4dBm + 10logB
5.250 ~ 5.350GHz	The lesser of 250mW (24dBm) or 11dBm + 10logB
5.470 ~ 5.725GHz	The lesser of 250mW (24dBm) or 11dBm + 10logB

**NOTE:** Where B is the 26dB emission bandwidth in MHz.

### 4.3.2 TEST INSTRUMENTS

#### FOR POWER OUTPUT MEASUREMENT

DESCRIPTION & MANUFACTURER	MODEL NO.	SERIAL NO.	DATE OF CALIBRATION	CALIBRATED UNTIL
Anritsu Power Sensor	MA2411B	0738404	Apr. 26, 2011	Apr. 25, 2012
Anritsu Power Meter	ML2495A	0842014	Apr. 26, 2011	Apr. 25, 2012

**Note:**

1. The calibration interval of the above test instruments is 12 months and the calibrations are traceable to NML/ROC and NIST/USA.
2. Measurement Bandwidth of ML2495A is 65MHz greater than 26dB bandwidth of emission.

#### FOR 26dB OCCUPIED BANDWIDTH

DESCRIPTION & MANUFACTURER	MODEL NO.	SERIAL NO.	DATE OF CALIBRATION	DUE DATE OF CALIBRATION
SPECTRUM ANALYZER	FSP 40	100036	Apr. 29, 2011	Apr. 28, 2012

**NOTE:** The calibration interval of the above test instruments is 12 months and the calibrations are traceable to NML/ROC and NIST/USA.

### 4.3.3 TEST PROCEDURE

#### FOR POWER OUTPUT MEASUREMENT

A power sensor was used on the output port of the EUT. A power meter was used to read the response of the power sensor. Record the power level.

#### FOR 26dB OCCUPIED BANDWIDTH

The transmitter output was connected to the spectrum analyzer through an attenuator. The bandwidth of the fundamental frequency was measured by spectrum analyzer with 300kHz RBW and 1MHz VBW. The 26dB bandwidth is defined as the total spectrum the power of which is higher than peak power minus 26dB.

### 4.3.4 DEVIATION FROM TEST STANDARD

No deviation.

### 4.3.5 TEST SETUP

#### FOR POWER OUTPUT MEASUREMENT

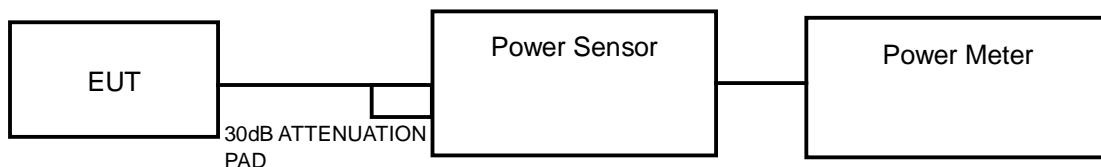

#### FOR 26dB OCCUPIED BANDWIDTH

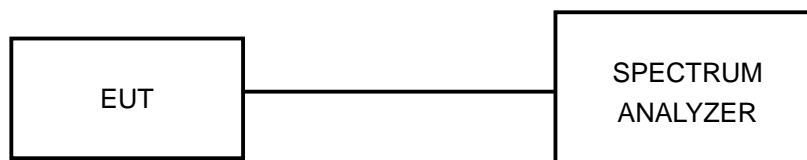

### 4.3.6 EUT OPERATING CONDITIONS

The software provided by client to enable the EUT under transmission condition continuously at specific channel frequencies individually.





A D T

### 4.3.7 TEST RESULTS

#### POWER OUTPUT: 802.11a

CHAN.	CHAN. FREQ. (MHz)	POWER OUTPUT (dBm)		TOTAL POWER (mW)	TOTAL POWER (dBm)	POWER LIMIT (dBm)	PASS / FAIL
		CHAIN 0	CHAIN 1				
36	5180	2.3	4.0	4.2	6.2	7	PASS
40	5200	2.9	4.0	4.5	6.5	7	PASS
48	5240	2.9	4.4	4.7	6.7	7	PASS

**NOTE:** Directional gain = 13dBi + 10log(2)=16dBi > 6dBi , so the conducted power limit shall be reduced to 17-(16-6)=7dBm.

#### 26dB OCCUPIED BANDWIDTH: 802.11a

CHANNEL	CHANNEL FREQUENCY (MHz)	26dBc OCCUPIED BANDWIDTH (MHz)		PASS / FAIL
		CHAIN 0	CHAIN 1	
36	5180	25.15	26.06	PASS
40	5200	25.99	25.89	PASS
48	5240	25.19	25.81	PASS

#### CHAIN 1: CH 36

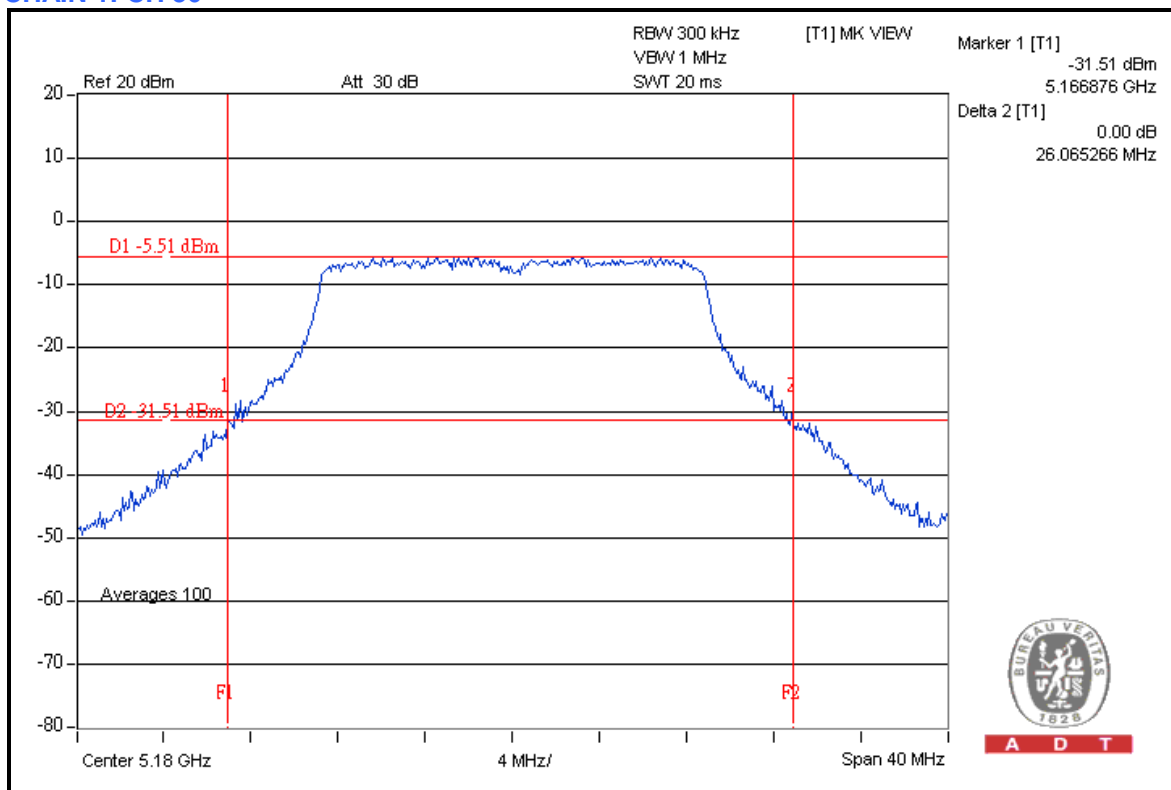



A D T

**POWER OUTPUT: 802.11n (20MHz)**

CHAN.	CHAN. FREQ. (MHz)	POWER OUTPUT (dBm)		TOTAL POWER (mW)	TOTAL POWER (dBm)	POWER LIMIT (dBm)	PASS / FAIL
		CHAIN 0	CHAIN 1				
36	5180	5.8	7.5	9.4	9.7	10	PASS
40	5200	6.0	7.4	9.5	9.8	10	PASS
48	5240	6.1	7.7	<b>9.96</b>	9.98	10	PASS

**NOTE:** Directional gain =13dBi > 6dBi, so the conducted power limit shall be reduced to 17-(13-6)=10dBm.

**26dB OCCUPIED BANDWIDTH: 802.11n (20MHz)**

CHANNEL	CHANNEL FREQUENCY (MHz)	26dBc OCCUPIED BANDWIDTH (MHz)		PASS / FAIL
		CHAIN 0	CHAIN 1	
36	5180	26.52	25.41	PASS
40	5200	26.69	25.53	PASS
48	5240	26.26	25.79	PASS

**CHAIN 0: CH 40**

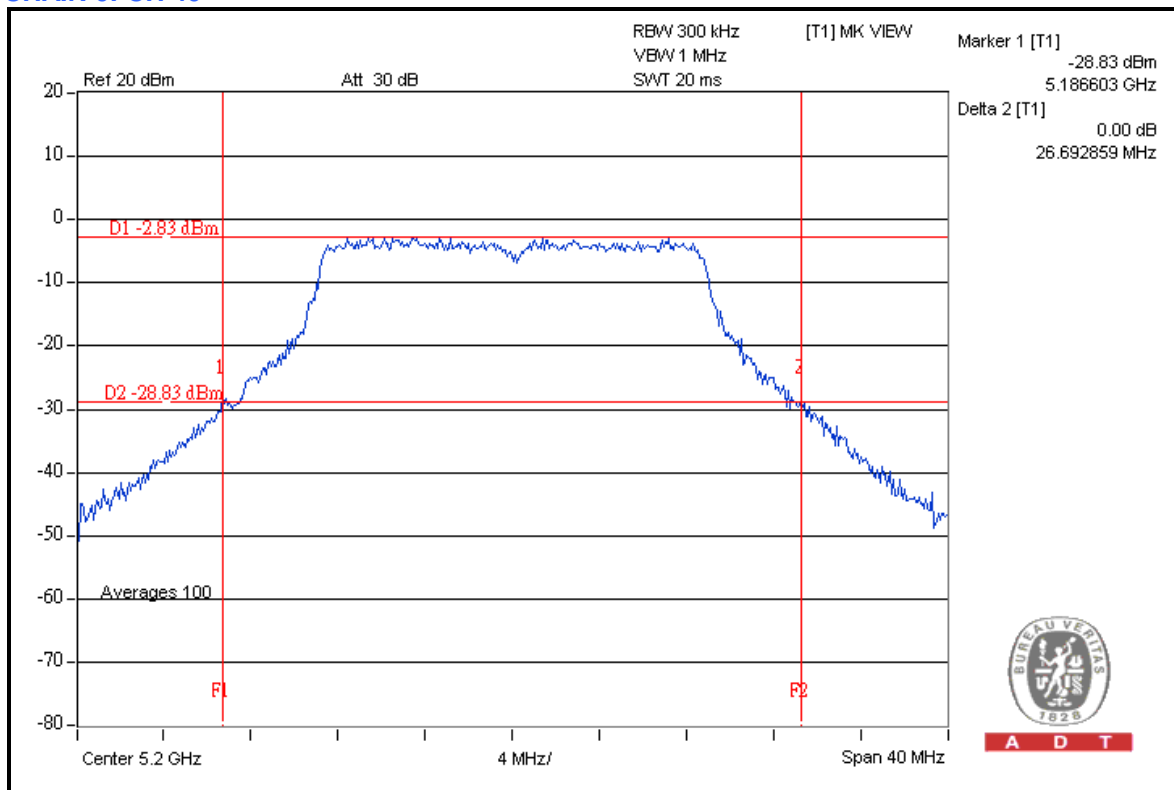



A D T

**POWER OUTPUT: 802.11n (40MHz)**

CHAN.	CHAN. FREQ. (MHz)	POWER OUTPUT (dBm)		TOTAL POWER (mW)	TOTAL POWER (dBm)	POWER LIMIT (dBm)	PASS / FAIL
		CHAIN 0	CHAIN 1				
38	5190	6.2	7.5	9.8	9.9	10	PASS
46	5230	6.1	7.5	9.7	9.9	10	PASS

**NOTE:** Directional gain =13dBi > 6dBi, so the conducted power limit shall be reduced to 17-(13-6)=10dBm.

**26dB OCCUPIED BANDWIDTH: 802.11n (40MHz)**

CHANNEL	CHANNEL FREQUENCY (MHz)	26dBc OCCUPIED BANDWIDTH (MHz)		PASS / FAIL
		CHAIN 0	CHAIN 1	
38	5190	49.41	47.62	PASS
46	5230	51.53	48.17	PASS

**CHAIN 0: CH 46**

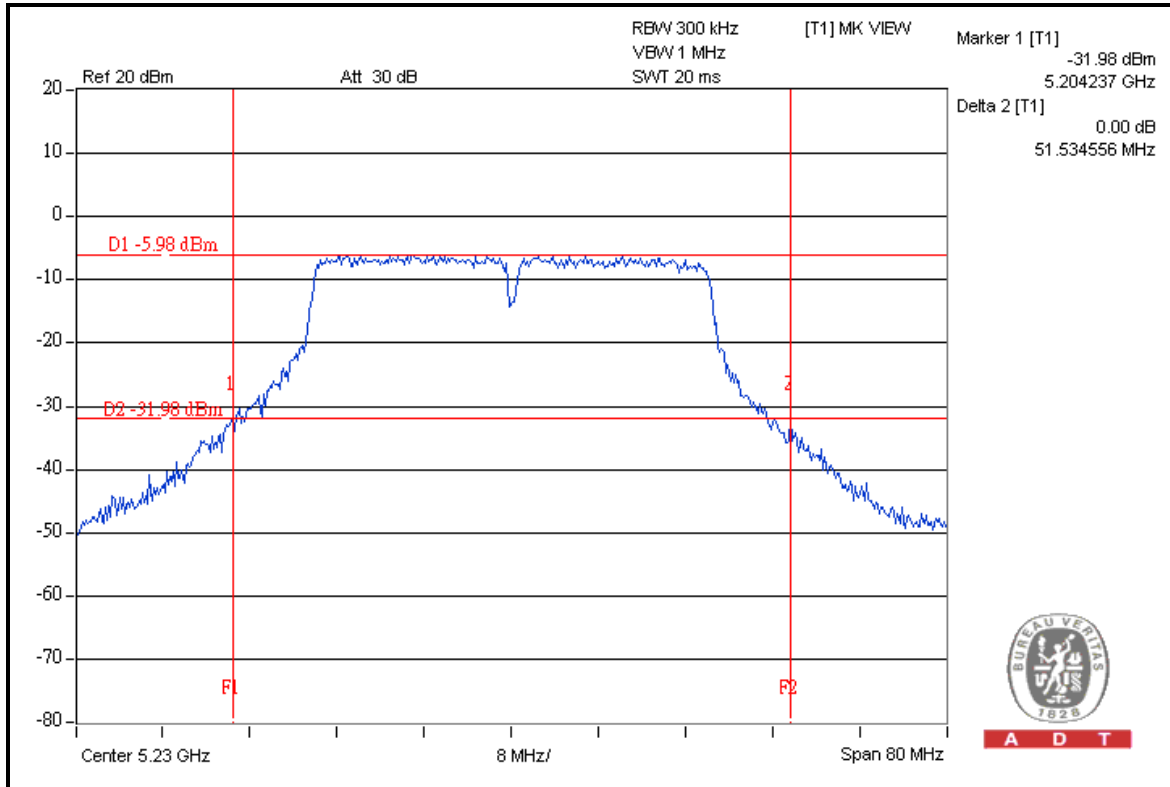

## 4.4 PEAK POWER EXCURSION MEASUREMENT

### 4.4.1 LIMITS OF PEAK POWER EXCURSION MEASUREMENT

FREQUENCY BAND	LIMIT
5.150 ~ 5.250GHz	13dB
5.250 ~ 5.350GHz	13dB
5.470 ~ 5.725GHz	13dB

### 4.4.2 TEST INSTRUMENTS

DESCRIPTION & MANUFACTURER	MODEL NO.	SERIAL NO.	DATE OF CALIBRATION	CALIBRATED UNTIL
SPECTRUM ANALYZER	FSP 40	100036	Apr. 29, 2011	Apr. 28, 2012

**NOTE:** The calibration interval of the above test instruments is 12 months and the calibrations are traceable to NML/ROC and NIST/USA.

### 4.4.3 TEST PROCEDURE

- a. The transmitter output was connected to the spectrum analyzer.
- b. Set the spectrum bandwidth span to view the entire spectrum.
- c. Using peak detector and Max-hold function for Trace 1 (RB = 1MHz, VB = 3MHz) and 2 (RB = 1MHz, VB = 300kHz).
- d. The differences between Trace1 and Trace 2 in any 1MHz band at f1 to f2 range were recorded and showed to another trace.

#### 4.4.4 DEVIATION FROM TEST STANDARD

No deviation.

#### 4.4.5 TEST SETUP

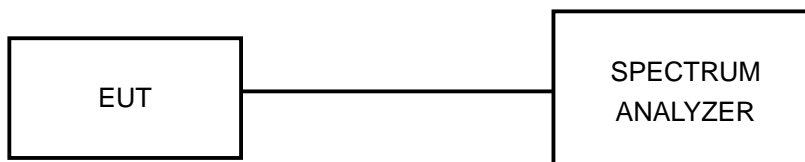

#### 4.4.6 EUT OPERATING CONDITIONS

The software provided by client to enable the EUT under transmission condition continuously at specific channel frequencies individually.

## 4.4.7 TEST RESULTS

### 802.11a

CHANNEL	CHANNEL FREQUENCY (MHz)	PEAK POWER EXCURSION (dB)		PEAK to AVERAGE EXCURSION LIMIT (dB)	PASS/FAIL
		CHAIN 0	CHAIN 1		
36	5180	8.34	7.72	13	PASS
40	5200	9.45	8.86	13	PASS
48	5240	8.88	7.99	13	PASS



A D T

### CHAIN 0: CH 40

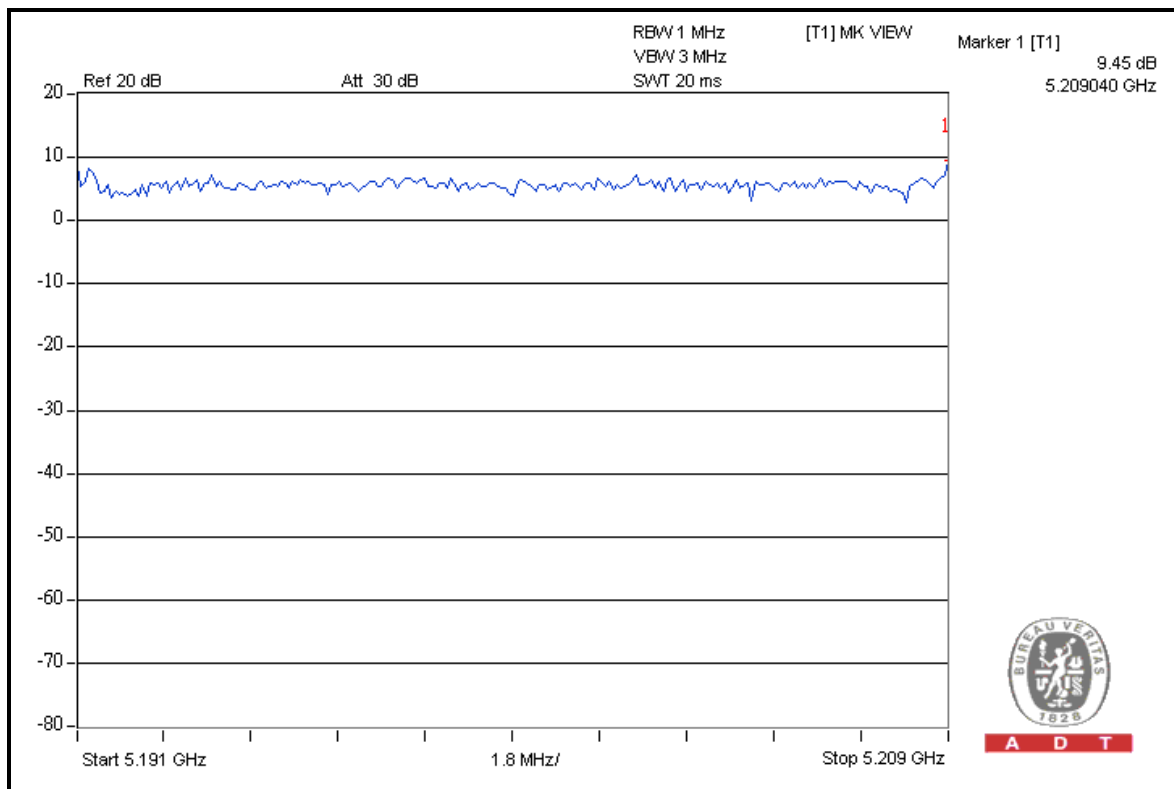
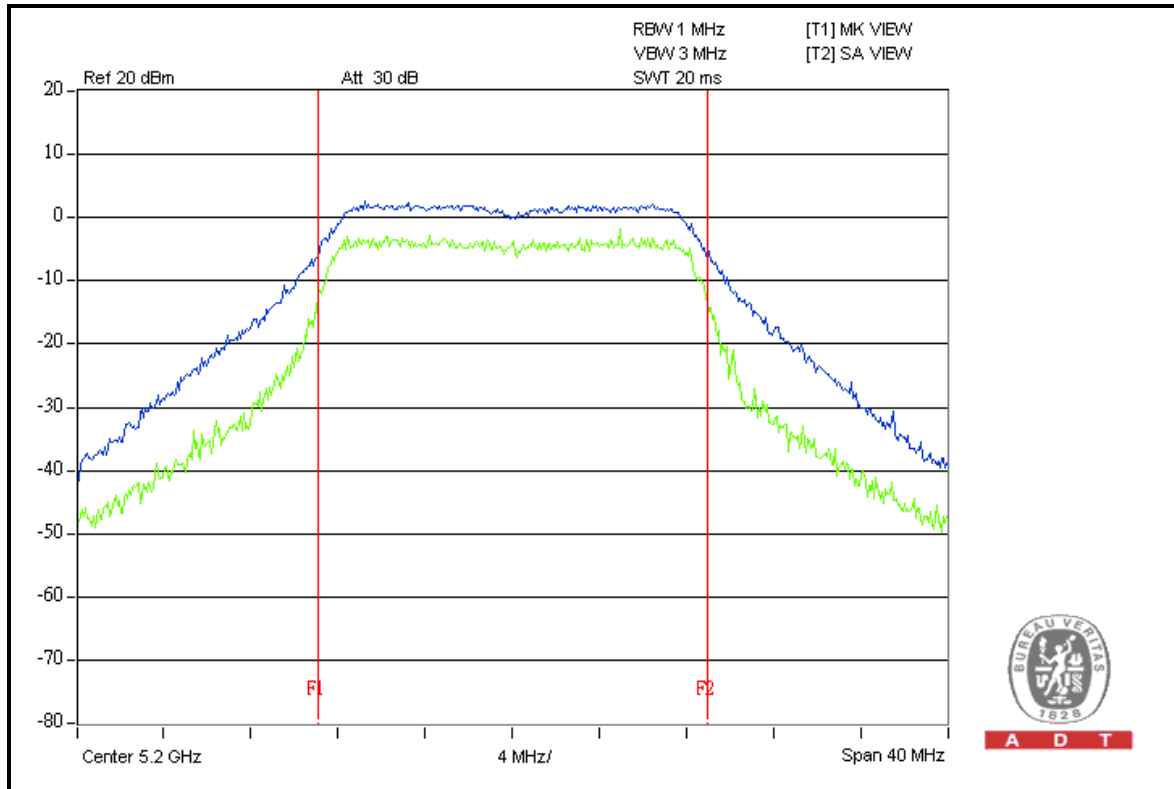



A D T

802.11n (20MHz)

CHANNEL	CHANNEL FREQUENCY (MHz)	PEAK POWER EXCURSION (dB)		PEAK to AVERAGE EXCURSION LIMIT (dB)	PASS/FAIL
		CHAIN 0	CHAIN 1		
36	5180	9.01	7.48	13	PASS
40	5200	7.31	7.05	13	PASS
48	5240	7.48	7.18	13	PASS





A D T

### CHAIN 0: CH 36

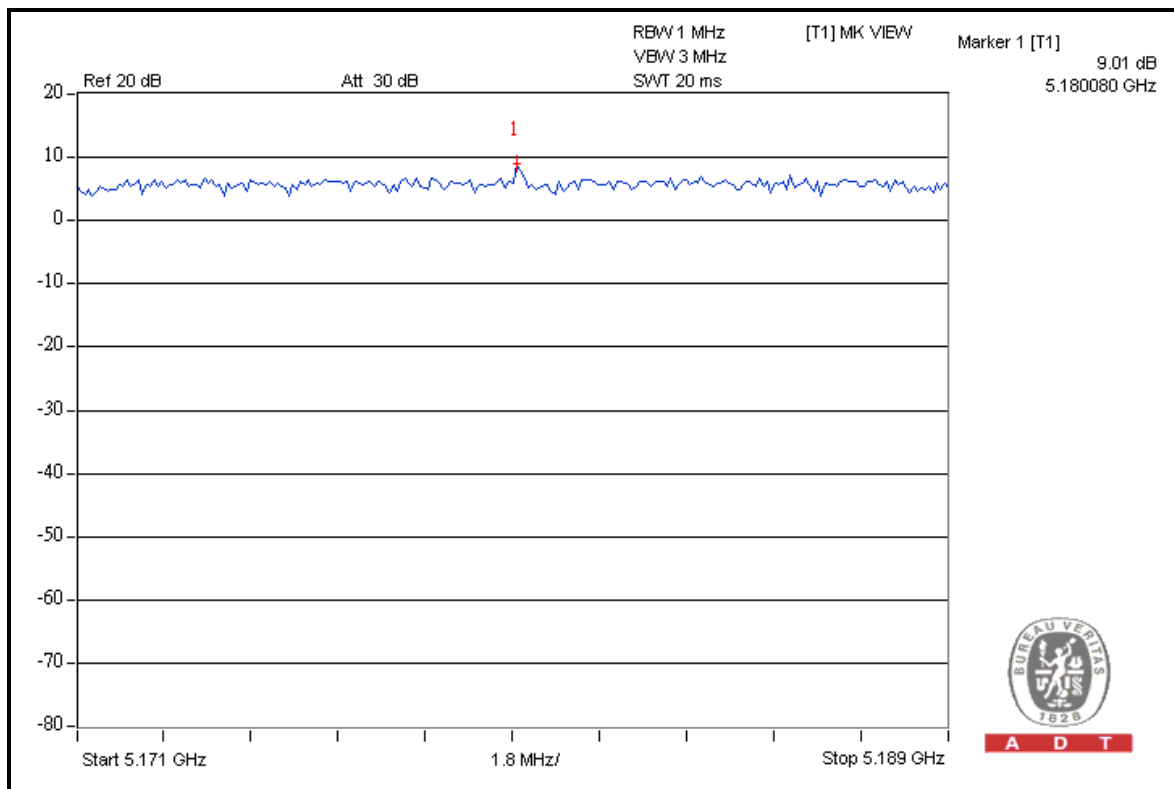
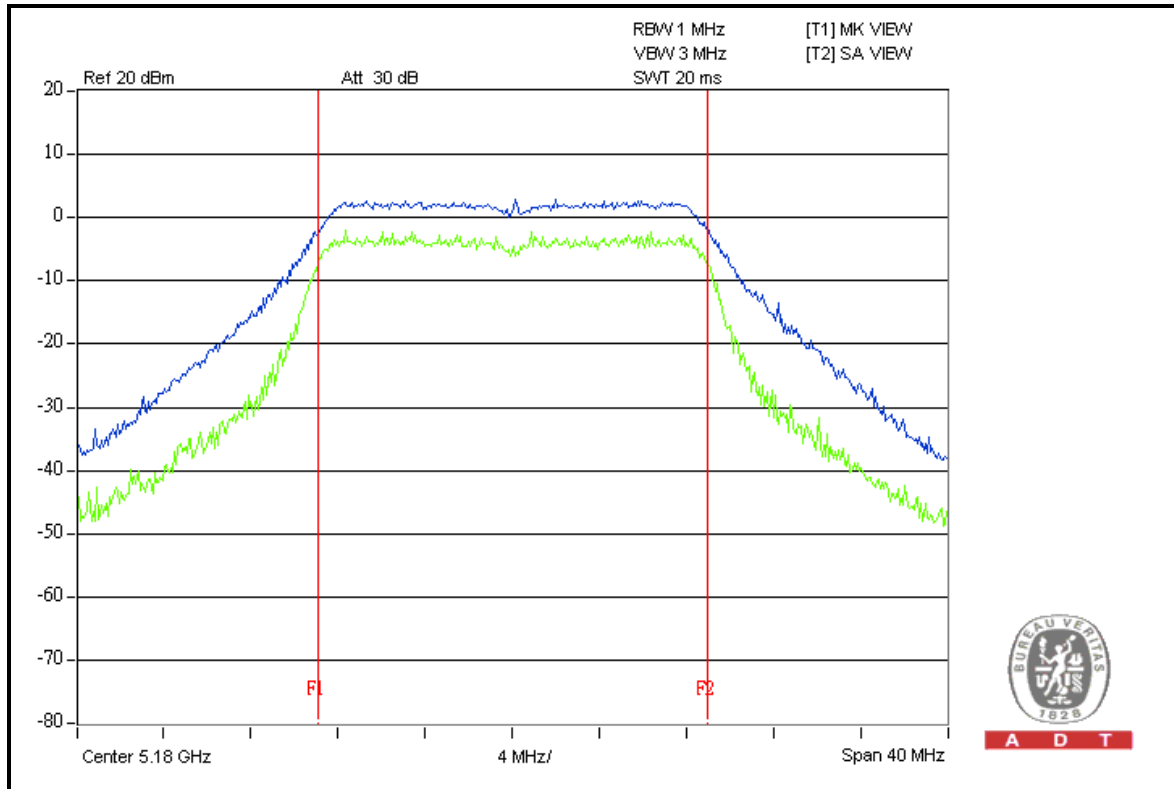



A D T

802.11n (40MHz)

CHANNEL	CHANNEL FREQUENCY (MHz)	PEAK POWER EXCURSION (dB)		PEAK to AVERAGE EXCURSION LIMIT (dB)	PASS/FAIL
		CHAIN 0	CHAIN 1		
38	5190	8.69	8.42	13	PASS
46	5230	9.81	10.55	13	PASS



A D T

### CHAIN 1: CH 46

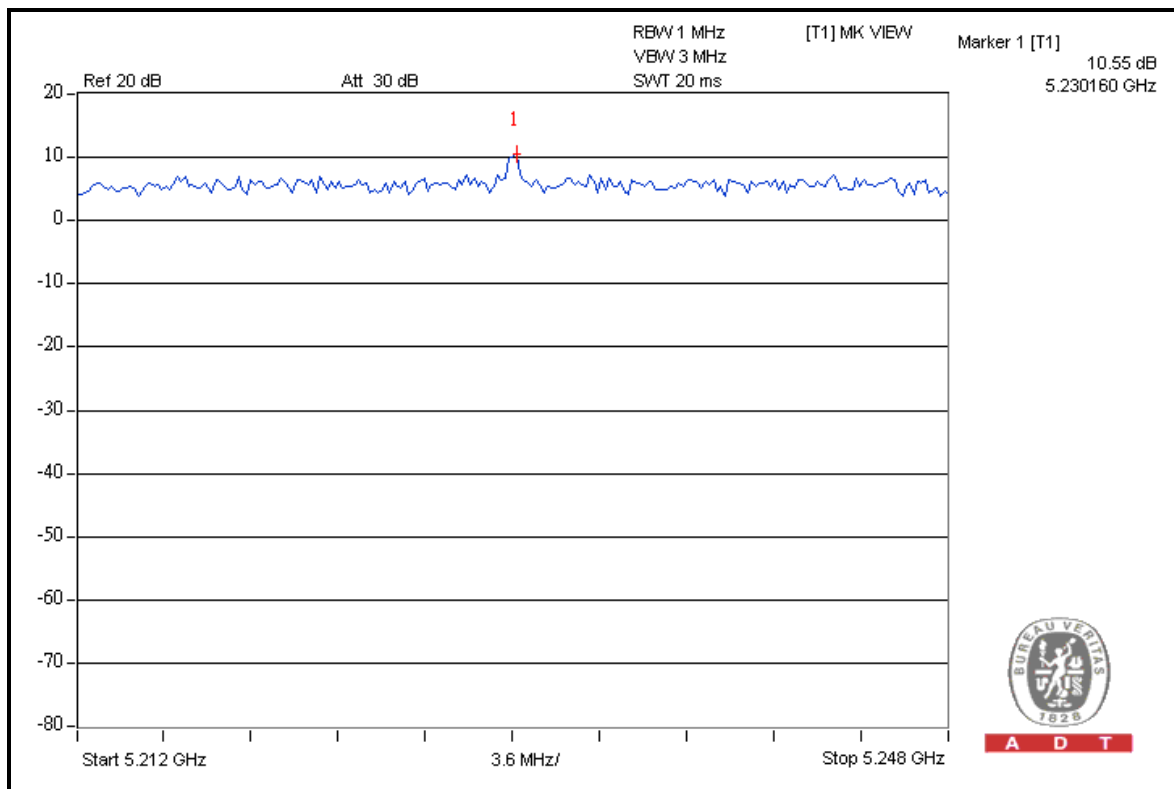
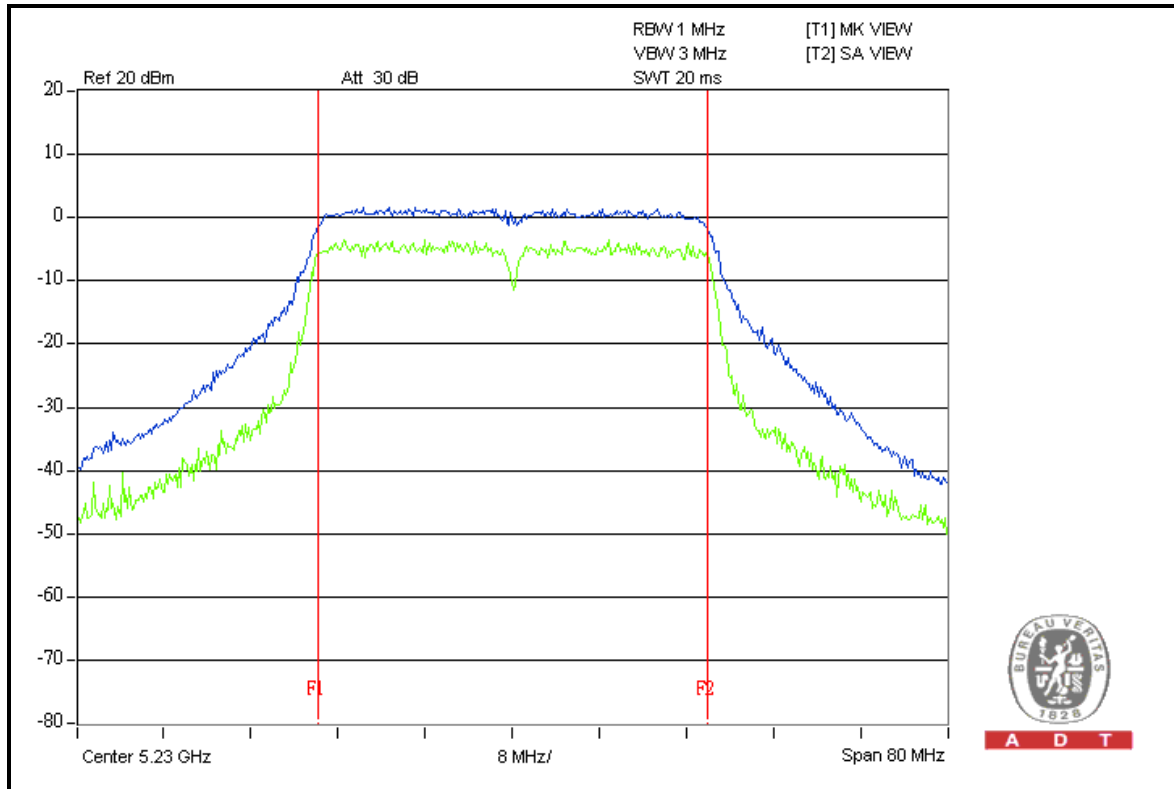

## 4.5 PEAK POWER SPECTRAL DENSITY MEASUREMENT

### 4.5.1 LIMITS OF PEAK POWER SPECTRAL DENSITY MEASUREMENT

FREQUENCY BAND	LIMIT
5.150 ~ 5.250GHz	4dBm
5.250 ~ 5.350GHz	11dBm
5.470 ~ 5.725GHz	11dBm

### 4.5.2 TEST INSTRUMENTS

DESCRIPTION & MANUFACTURER	MODEL NO.	SERIAL NO.	DATE OF CALIBRATION	CALIBRATED UNTIL
SPECTRUM ANALYZER	FSP 40	100036	Apr. 29, 2011	Apr. 28, 2012

**NOTE:** The calibration interval of the above test instruments is 12 months and the calibrations are traceable to NML/ROC and NIST/USA.

### 4.5.3 TEST PROCEDURES

- a. The transmitter output was connected to the spectrum analyzer.
- b. Set RBW = 1MHz, VBW = 3MHz. The PPSD is the highest level found across the emission in any 1MHz band.

Follow method 2 of KDB 662911 D01 Multiple Transmitter Output v01 to calculate total power density of 2 TX port.

#### 4.5.4 DEVIATION FROM TEST STANDARD

No deviation.

#### 4.5.5 TEST SETUP

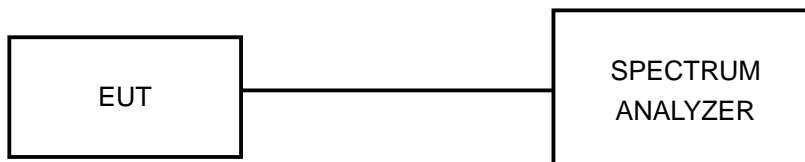

#### 4.5.6 EUT OPERATING CONDITIONS

Same as 4.4.6.



A D T

### 4.5.7 TEST RESULTS

#### 802.11a

CHAIN	CHAN.	CHAN. FREQ. (MHz)	RF POWER LEVEL IN 3kHz BW (dBm)		TOTAL POWER DENSITY (dBm)	MAX. LIMIT (dBm)	PASS / FAIL
			MEASURED	10 log (N=2) dB			
0	36	5180	-10.0	3.01	-7.0	-6	PASS
	40	5200	-9.1	3.01	-6.1	-6	PASS
	48	5240	-10.2	3.01	-7.2	-6	PASS
1	36	5180	-9.8	3.01	-6.8	-6	PASS
	40	5200	-9.4	3.01	-6.4	-6	PASS
	48	5240	-9.5	3.01	-6.5	-6	PASS

**NOTE:** Directional gain = 13dBi + 10log(2)=16dBi > 6dBi , so the power density limit shall be reduced to 4-(16-6)=-6dBm.

#### CHAIN 0: CH 40

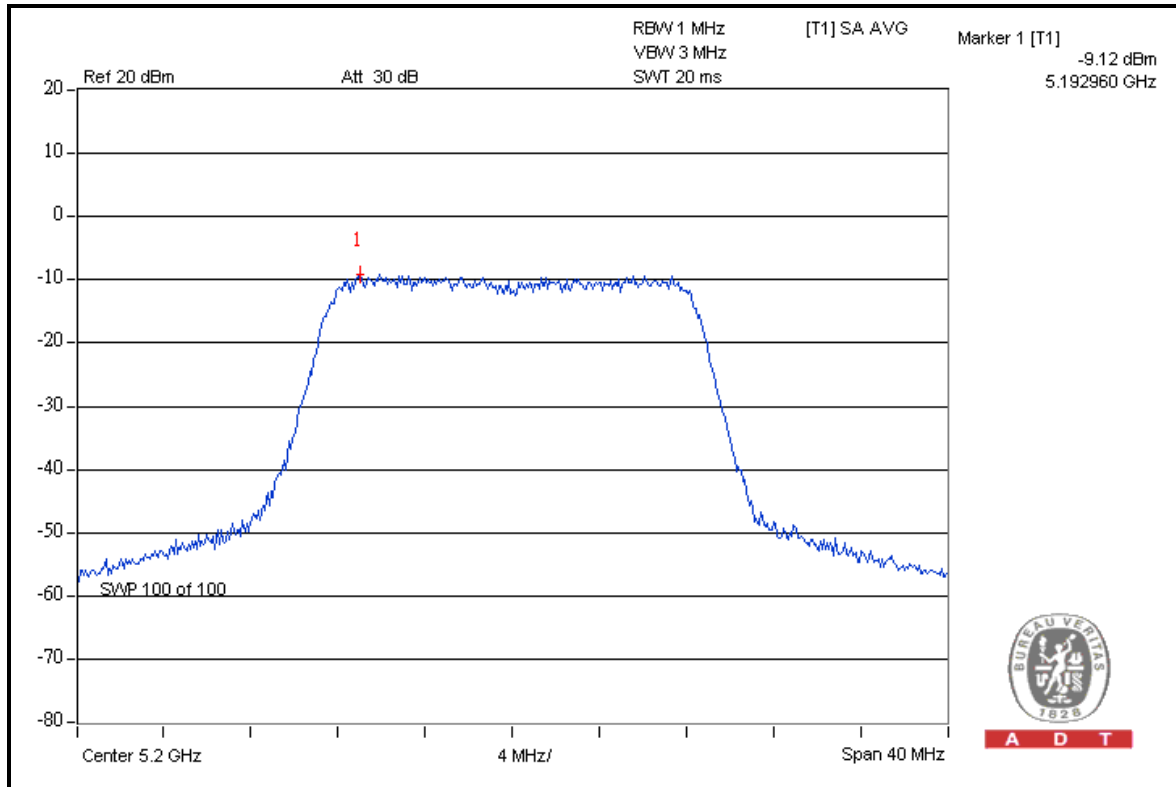

A D T



A D T

### 802.11n (20MHz)

CHAIN	CHAN.	CHAN. FREQ. (MHz)	RF POWER LEVEL IN 3kHz BW (dBm)		TOTAL POWER DENSITY (dBm)	MAX. LIMIT (dBm)	PASS / FAIL
			MEASURED	10 log (N=2) dB			
0	36	5180	-8.8	3.01	-5.8	-3	PASS
	40	5200	-8.2	3.01	-5.2	-3	PASS
	48	5240	-8.5	3.01	-5.5	-3	PASS
1	36	5180	-7.4	3.01	-4.4	-3	PASS
	40	5200	-6.6	3.01	-3.6	-3	PASS
	48	5240	-6.5	3.01	-3.5	-3	PASS

**NOTE:** Directional gain = 13dBi > 6dBi, so the power density limit shall be reduced to 4-(13-6)=-3dBm.

### CHAIN 1: CH 48

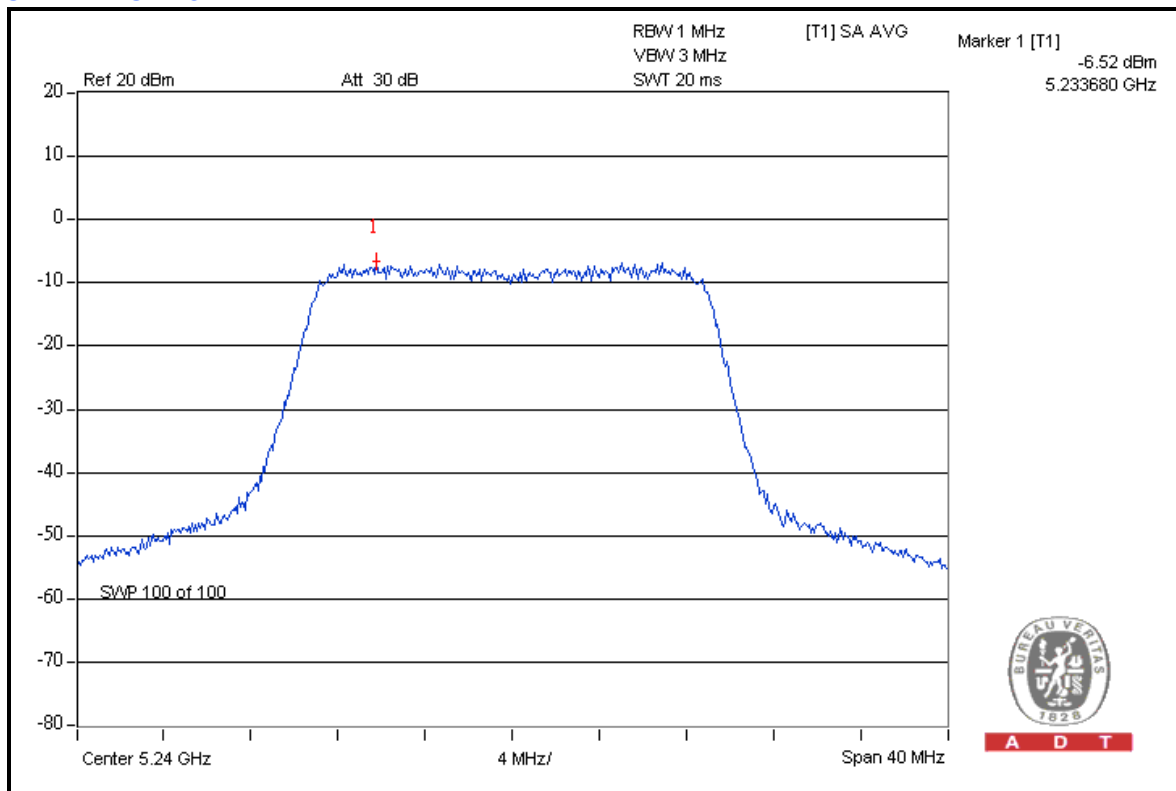

A D T



A D T

### 802.11n (40MHz)

CHAIN	CHAN.	CHAN. FREQ. (MHz)	RF POWER LEVEL IN 3kHz BW (dBm)		TOTAL POWER DENSITY (dBm)	MAX. LIMIT (dBm)	PASS / FAIL
			MEASURED	10 log (N=2) dB			
0	38	5190	-11.7	3.01	-8.7	-3	PASS
	46	5230	-10.9	3.01	-7.9	-3	PASS
1	38	5190	-9.8	3.01	-6.8	-3	PASS
	46	5230	-10.0	3.01	-7.0	-3	PASS

**NOTE:** Directional gain = 13dBi > 6dBi, so the power density limit shall be reduced to 4-(13-6)=-3dBm.

### CHAIN 1: CH 38

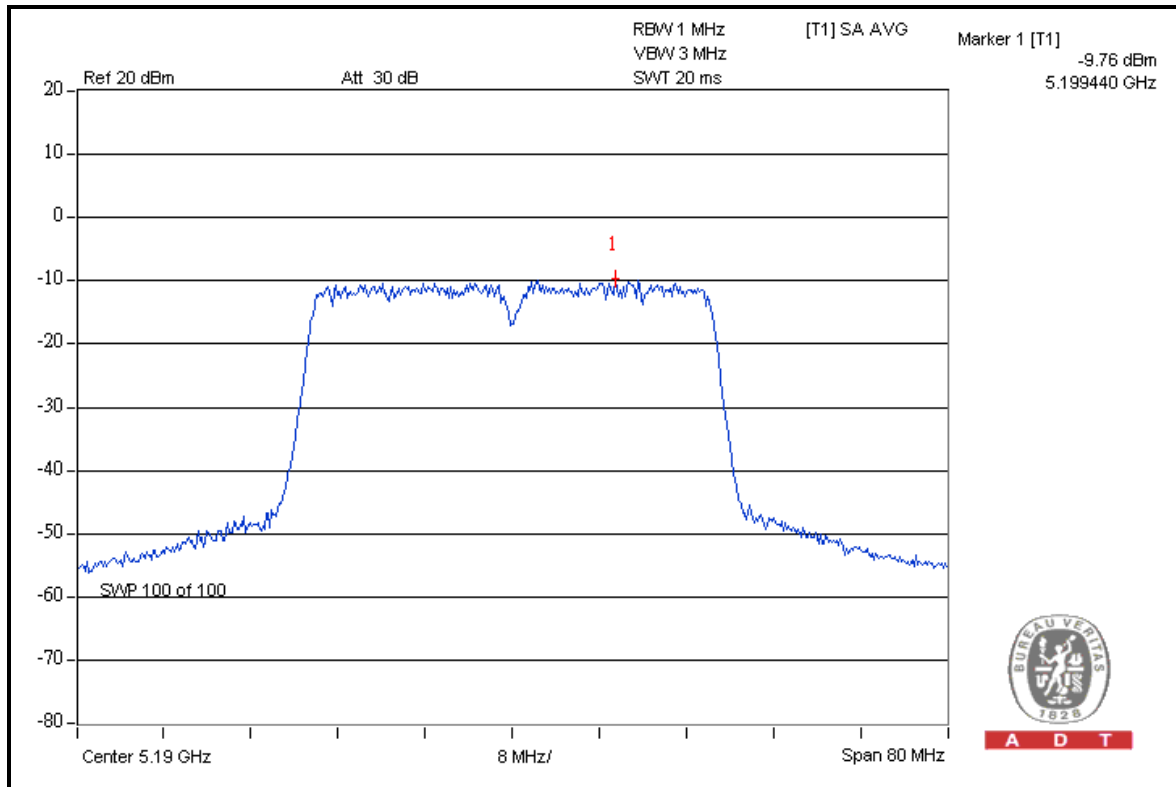



## 4.6 FREQUENCY STABILITY

### 4.6.1 LIMITS OF FREQUENCY STABILITY MEASUREMENT

The frequency tolerance of the carrier signal shall be maintained within the band of operation frequency over a temperature variation of –20 degrees to 50 degrees C at normal supply voltage, and for a variation in the primary supply voltage from 85% to 115% of the rated supply voltage at a temperature of 20 degrees C.

### 4.6.2 TEST INSTRUMENTS

DESCRIPTION & MANUFACTURER	MODEL NO.	SERIAL NO.	DATE OF CALIBRATION	CALIBRATED UNTIL
SPECTRUM ANALYZER	FSP 40	100036	Apr. 29, 2011	Apr. 28, 2012
WIT STANDARD TEMPERATURE AND HUMIDITY CHAMBER	TH-4S-C	W981030	Jun. 15, 2011	Jun. 14, 2012

**NOTE:** The calibration interval of the above test instruments is 12 months and the calibrations are traceable to NML/ROC and NIST/USA.

### 4.6.3 TEST PROCEDURE

- a. The EUT was placed inside the environmental test chamber and powered by nominal DC voltage.
- b. Turn the EUT on and couple its output to a spectrum analyzer.
- c. Turn the EUT off and set the chamber to the highest temperature specified.
- d. Allow sufficient time (approximately 30 min) for the temperature of the chamber to stabilize, turn the EUT on and measure the operating frequency after 2, 5, and 10 minutes.
- e. Repeat step 2 and 3 with the temperature chamber set to the lowest temperature.
- f. The test chamber was allowed to stabilize at +20 degree C for a minimum of 30 minutes. The supply voltage was then adjusted on the EUT from 85% to 115% and the frequency record.

#### 4.6.4 DEVIATION FROM TEST STANDARD

No deviation.

#### 4.6.5 TEST SETUP

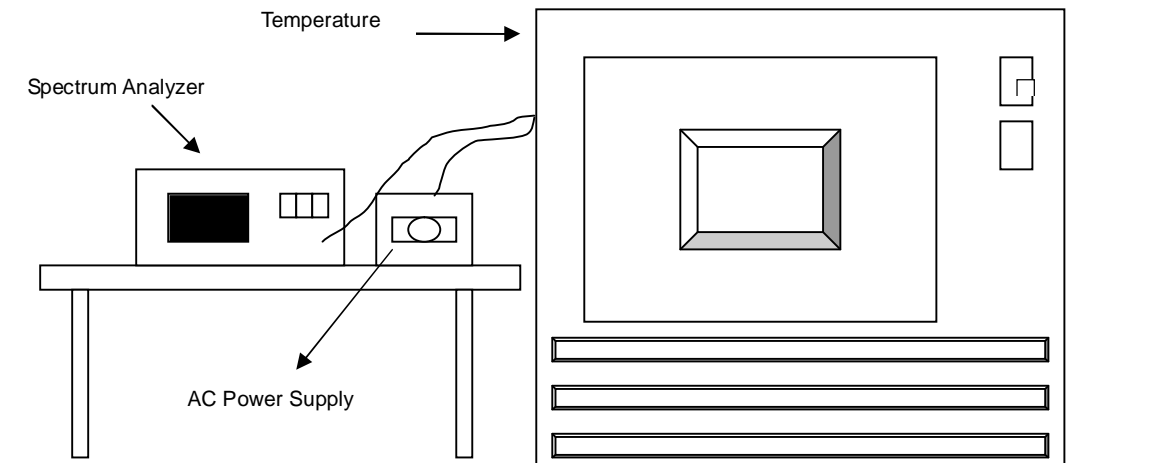

#### 4.6.6 EUT OPERATING CONDITION

Same as Item 4.4.6.

### 4.6.7 TEST RESULTS

FREQUENCY STABILITY VERSUS TEMP.									
OPERATING FREQUENCY: 5180MHz									
TEMP. (°C)	POWER SUPPLY (Vac)	0 MINUTE		2 MINUTE		5 MINUTE		10 MINUTE	
		Measured Frequency (MHz)	Frequency Drift (%)	Measured Frequency (MHz)	Frequency Drift (%)	Measured Frequency (MHz)	Frequency Drift (%)	Measured Frequency (MHz)	Frequency Drift (%)
50	120.0	5199.988024	-0.0002303	5199.987855	-0.0002336	5199.987973	-0.0002313	5199.987992	-0.0002309
40	120.0	5199.98812	-0.0002285	5199.988285	-0.0002253	5199.987656	-0.0002374	5199.988108	-0.0002287
30	120.0	5199.987751	-0.0002356	5199.988208	-0.0002268	5199.987059	-0.0002489	5199.988035	-0.0002301
20	120.0	5199.987502	-0.0002403	5199.988132	-0.0002282	5199.986462	-0.0002603	5199.987961	-0.0002315
10	120.0	5199.987253	-0.0002451	5199.988055	-0.0002297	5199.985865	-0.0002718	5199.987888	-0.0002329
0	120.0	5199.987004	-0.0002499	5199.987979	-0.0002312	5199.985268	-0.0002833	5199.987814	-0.0002343
-10	120.0	5199.986755	-0.0002547	5199.987902	-0.0002326	5199.984671	-0.0002948	5199.987741	-0.0002358
-20	120.0	5199.986506	-0.0002595	5199.987826	-0.0002341	5199.984074	-0.0003063	5199.987667	-0.0002372

FREQUENCY STABILITY VERSUS VOLTAGE									
OPERATING FREQUENCY: 5180MHz									
TEMP. (°C)	POWER SUPPLY (Vac)	0 MINUTE		2 MINUTE		5 MINUTE		10 MINUTE	
		Measured Frequency (MHz)	Frequency Drift (%)	Measured Frequency (MHz)	Frequency Drift (%)	Measured Frequency (MHz)	Frequency Drift (%)	Measured Frequency (MHz)	Frequency Drift (%)
20	138.0	5199.987585	-0.0002387	5199.988157	-0.0002277	5199.986661	-0.0002565	5199.987986	-0.0002310
	120.0	5199.987502	-0.0002403	5199.988132	-0.0002282	5199.986462	-0.0002603	5199.987961	-0.0002315
	102.0	5199.987419	-0.0002419	5199.988106	-0.0002287	5199.986263	-0.0002642	5199.987937	-0.0002320



## 4.7 BAND EDGES MEASUREMENT

### 4.7.1 TEST INSTRUMENTS

DESCRIPTION & MANUFACTURER	MODEL NO.	SERIAL NO.	DATE OF CALIBRATION	CALIBRATED UNTIL
HP Preamplifier	8447D	2432A03504	Mar. 04, 2011	Mar. 03, 2012
HP Preamplifier	8449B	3008A01924	Mar. 04, 2011	Mar. 03, 2012
HP Preamplifier	8449B	3008A01292	Mar. 04, 2011	Mar. 03, 2012
Agilent Spectrum Analyzer	E4446A	MY46180403	Jun. 22, 2011	Jun. 21, 2012
Schwarzbeck Antenna	VULB 9168	137	Apr. 12, 2011	Apr. 11, 2012
Schwarzbeck Antenna	VHBA 9123	480	May 06, 2011	May 05, 2012
ADT. Turn Table	TT100	0306	NA	NA
ADT. Tower	AT100	0306	NA	NA
Software	ADT_Radiated_V7.6.15.9.2	NA	NA	NA
SUHNER RF cable	SF102	CABLE-CH6	Aug. 19, 2011	Aug. 18, 2012
EMCO Horn Antenna	3115	6714	Oct. 29, 2010	Oct. 28, 2011
EMCO Horn Antenna	3115	9312-4192	Apr. 22, 2011	Apr. 21, 2012
Highpass filter Wainwright Instruments	WHK 3.1/18G-10SS	SN 8	NA	NA

**NOTE:** The calibration interval of the above test instruments is 12 months. And the calibrations are traceable to NML/ROC and NIST/USA.

## 4.7.2 TEST PROCEDURE

- a. The EUT was placed on the top of a rotating table 0.8 meters above the ground at a 3 meter semi-anechoic chamber. The table was rotated 360 degrees to determine the position of the highest radiation.
- b. The EUT was set 3 meters away from the interference-receiving antenna, which was mounted on the top of a variable-height antenna tower.
- c. The height of antenna is varied from one meter to four meters above the ground to determine the maximum value of the field strength. Both horizontal and vertical polarizations of the antenna are set to make the measurement.
- d. For each suspected emission, the EUT was arranged to its worst case and then the antenna was tuned to heights from 1 meter to 4 meters and the rotatable table was turned from 0 degrees to 360 degrees to find the maximum reading.
- e. Set both RBW and VBW of spectrum analyzer to 1MHz and 3MHz with suitable frequency span including 100MHz bandwidth from band edge. The band edges was measured and recorded.

**NOTE:** The resolution bandwidth of test receiver/spectrum analyzer is 1MHz and the video bandwidth is 10Hz for Average detection (AV) at frequency above 1GHz.

## 4.7.3 EUT OPERATING CONDITION

The software provided by client to enable the EUT under transmission condition continuously at specific channel frequencies individually.

#### 4.7.4 TEST RESULTS

For signals in the restricted bands above and below the 5.15 to 5.25GHz allocated band a measurement was made of the amplitude of the spurious emissions with respect to the intentional signals. The relative amplitude, in dBc, was applied to the average and peak field strength of the intentional signal made on the OATS to calculate the field strength of the unintentional signals.

The spectrum plots (Peak RBW = 1MHz, VBW = 3MHz; Average RBW = 1MHz, VBW = 10Hz) are attached on the following pages.

##### 802.11a

##### RESTRICT BAND (4500 ~ 5150 MHz)

FREQUENCY (MHz)	FUNDAMENTAL EMISSION (dBuV/m)	DELTA (dB)	MAXIMUM FIELD STRENGTH IN RESTRICT BAND (dBuV/m)	LIMIT (dBuV/m)
5180.00 (PK)	105.7	54.2	51.5	74.0
5180.00 (AV)	94.9	53.3	41.6	54.0

##### RESTRICT BAND (5350 ~ 5460 MHz)

FREQUENCY (MHz)	FUNDAMENTAL EMISSION (dBuV/m)	DELTA (dB)	MAXIMUM FIELD STRENGTH IN RESTRICT BAND (dBuV/m)	LIMIT (dBuV/m)
5240.00 (PK)	107.0	52.2	54.8	74.0
5240.00 (AV)	95.4	55.6	39.8	54.0

##### NOTE:

- Delta = Amplitude between the peak of the fundamental and the peak of the band edge emission. Please check following 2 pages.
- Maximum field strength in restrict band = Fundamental emission – Delta.



A D T

### FOR RADIATED MEASURED (TWO CHAINS ON)

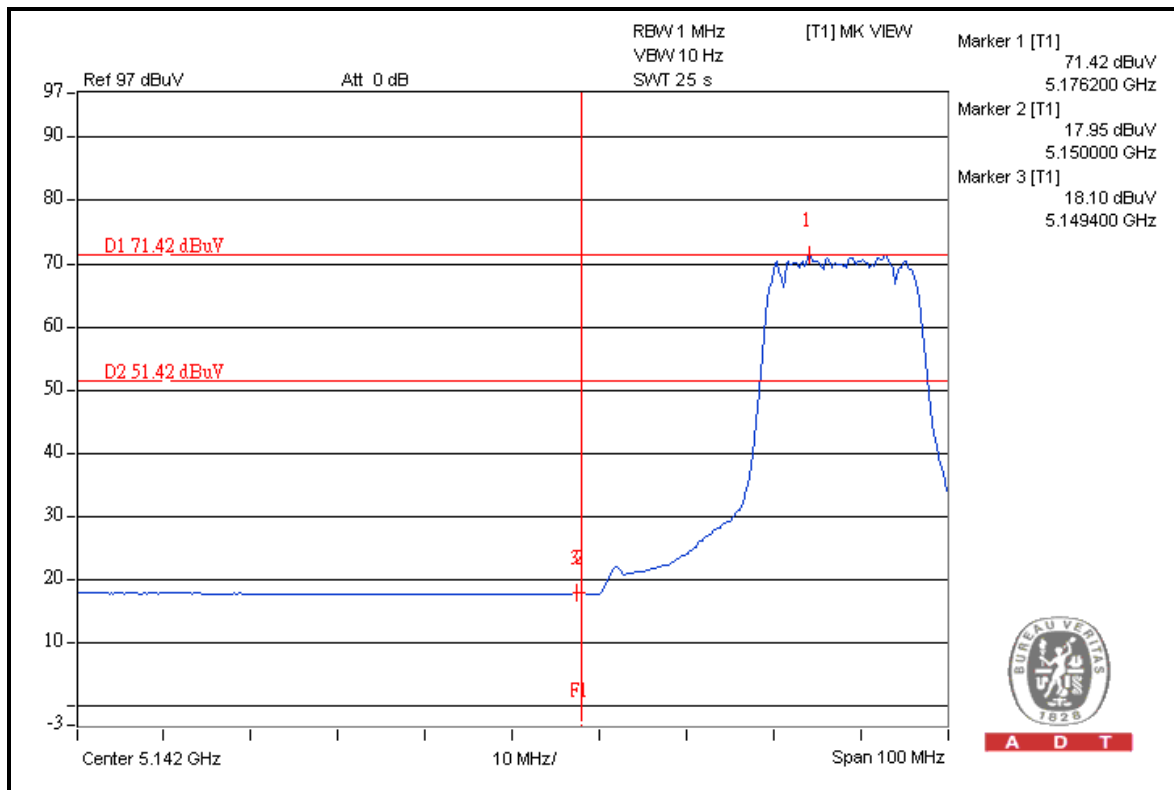
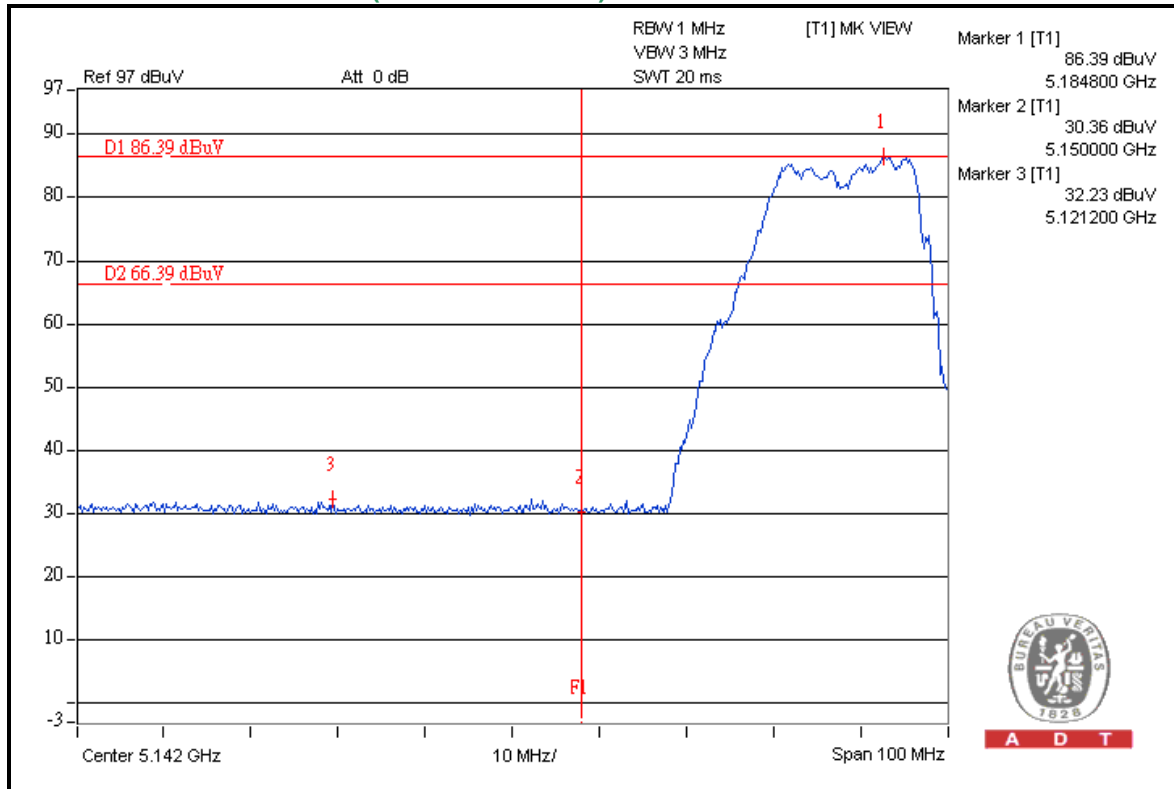



A D T

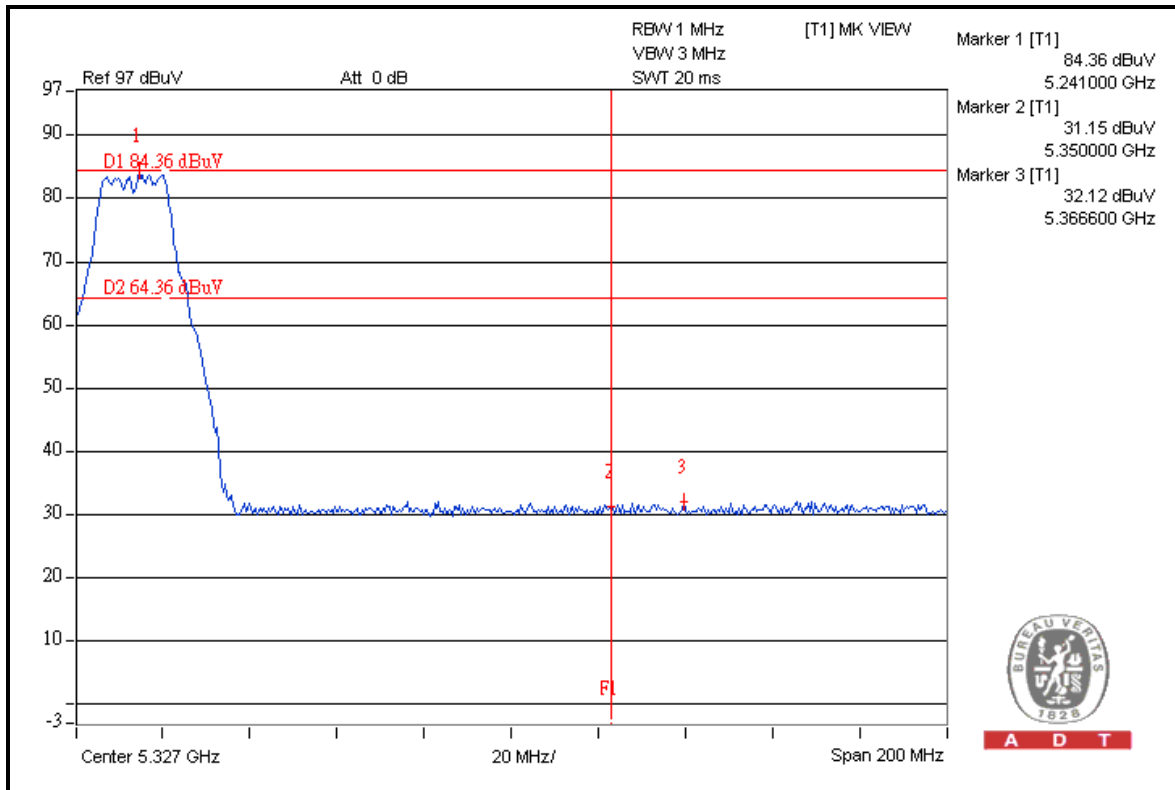

A D T

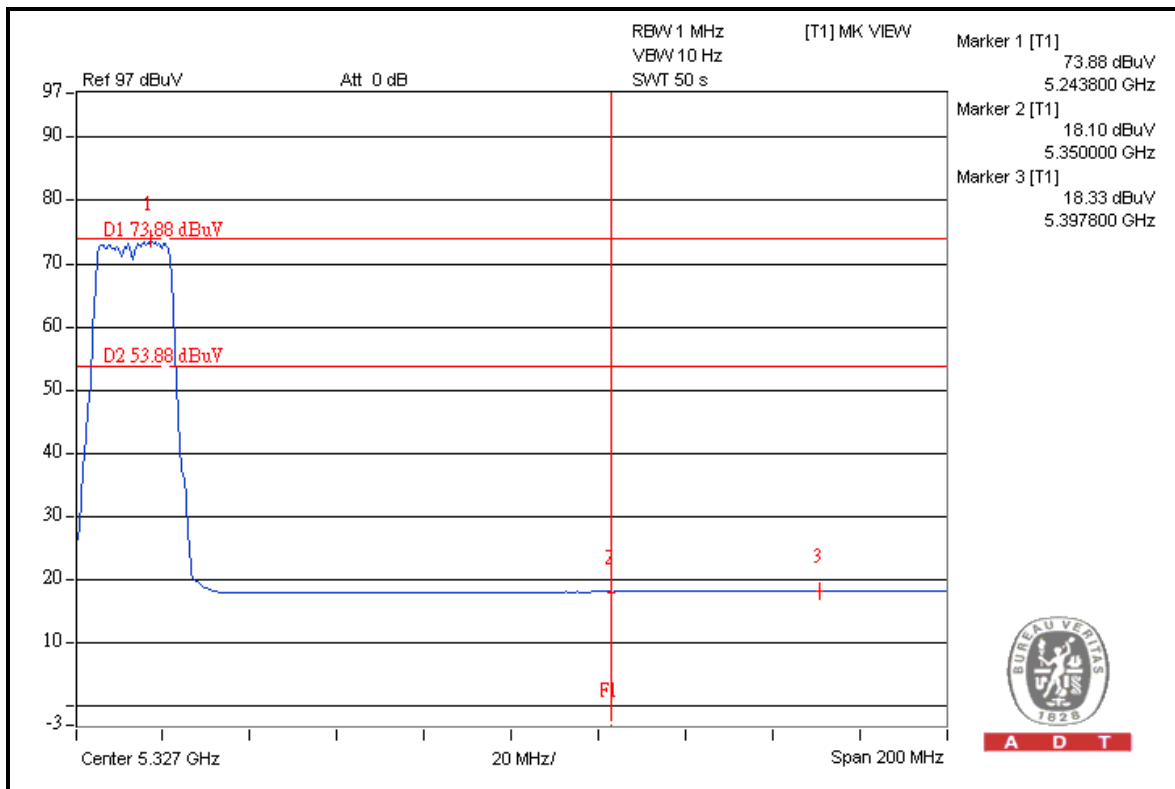

A D T





A D T

### FOR CONDUCTED MEASURED CHAIN 0

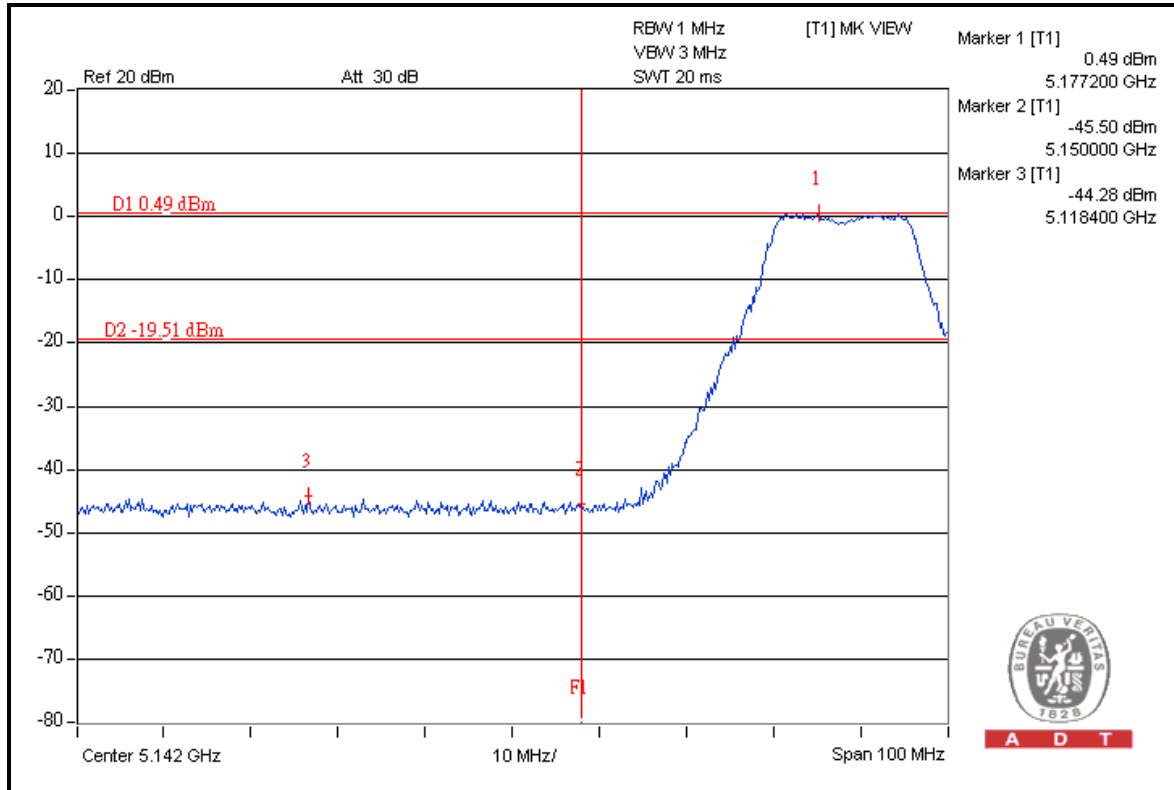

A D T

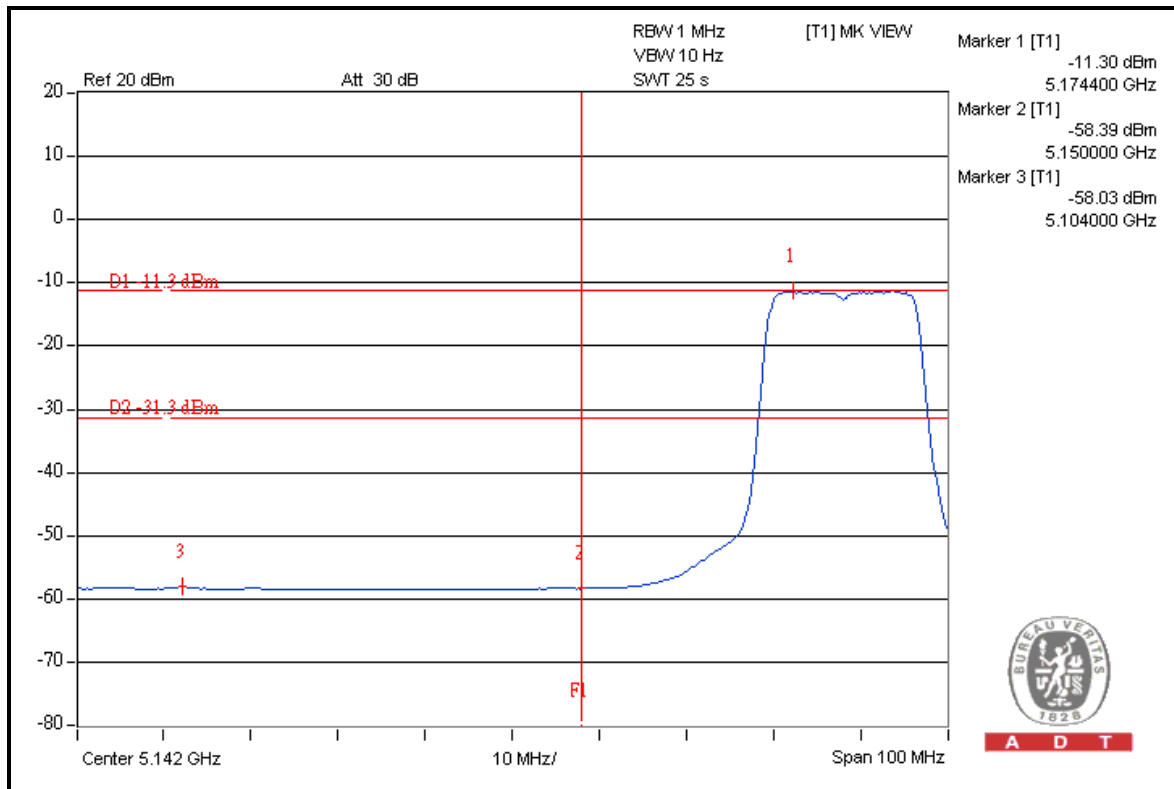

A D T



A D T

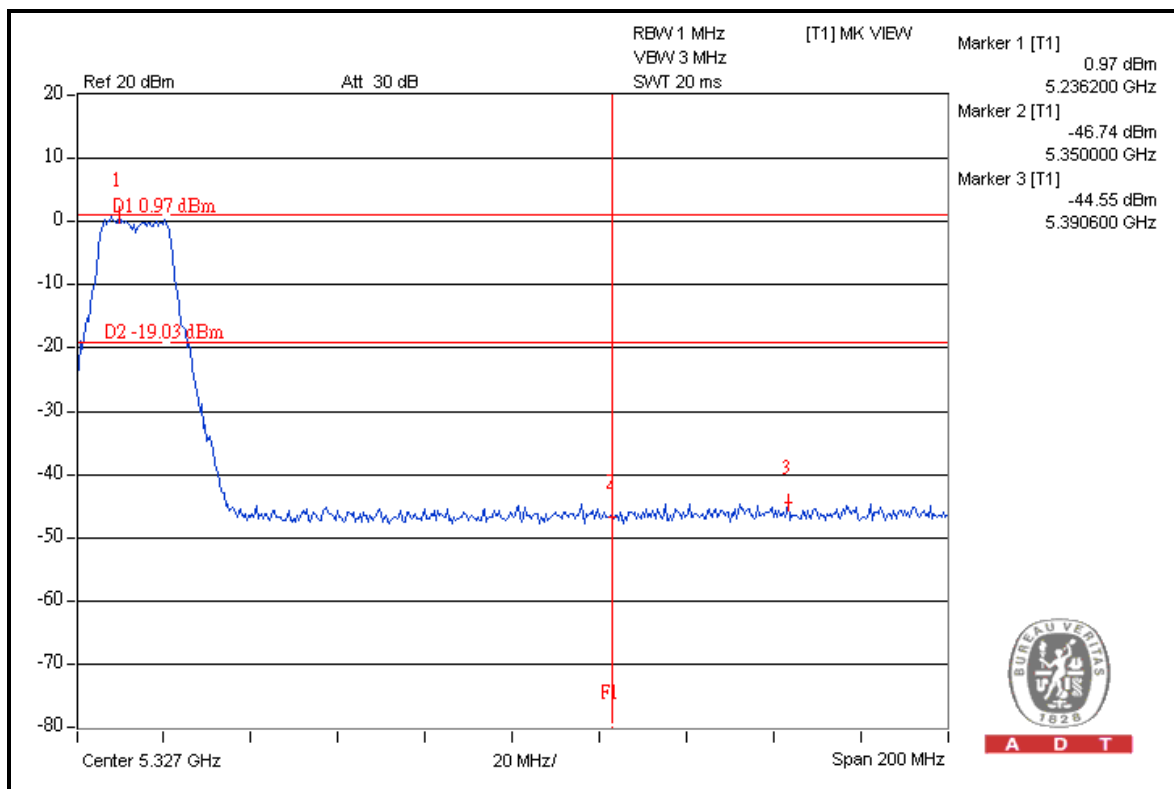
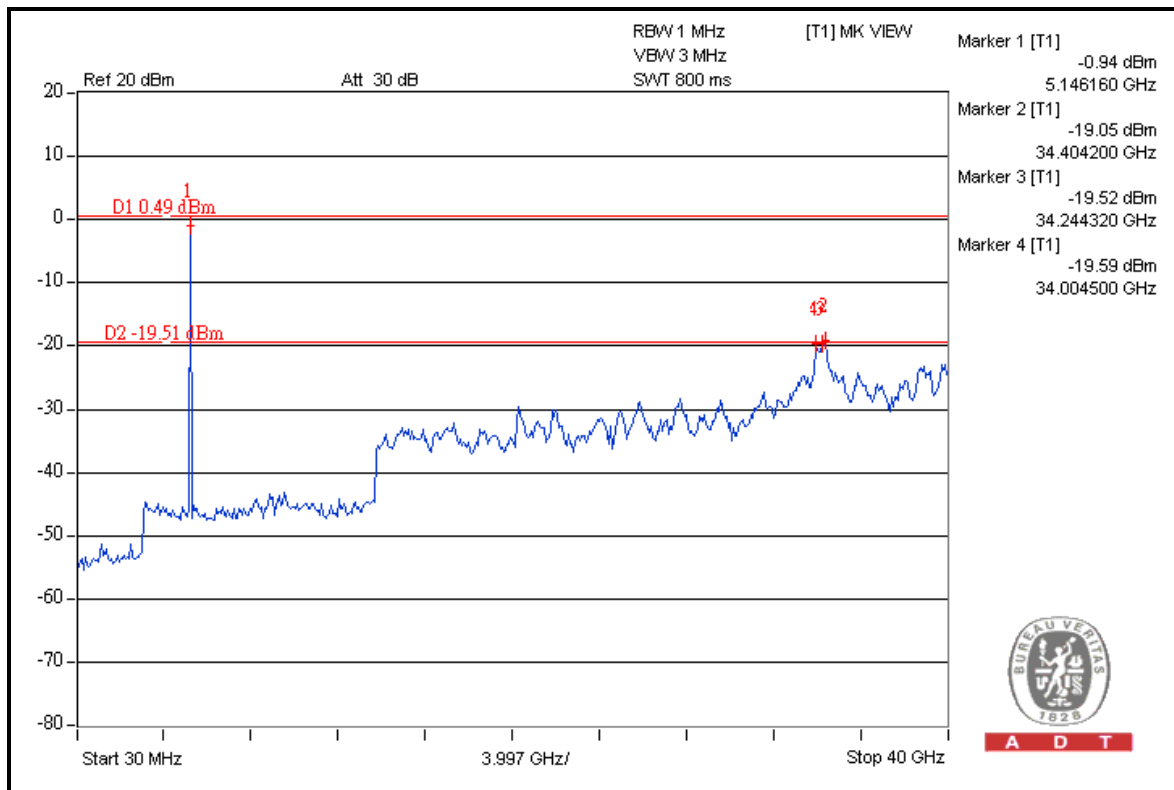



A D T

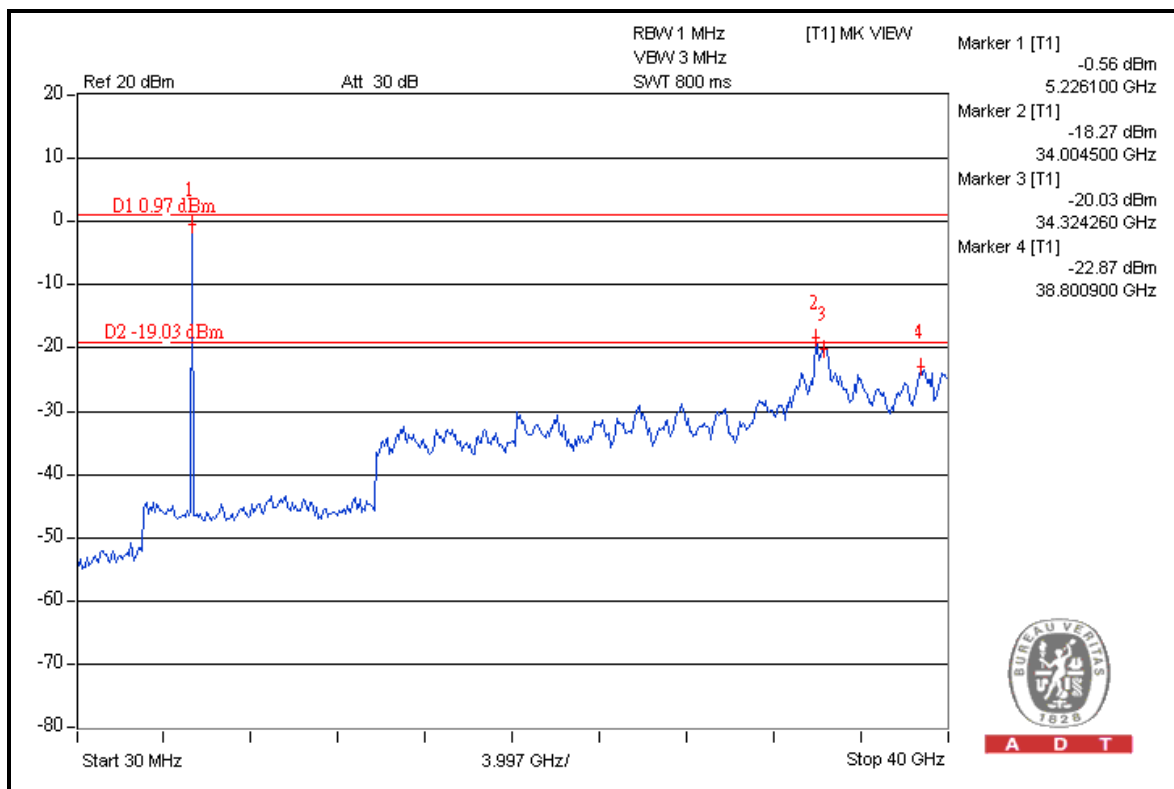
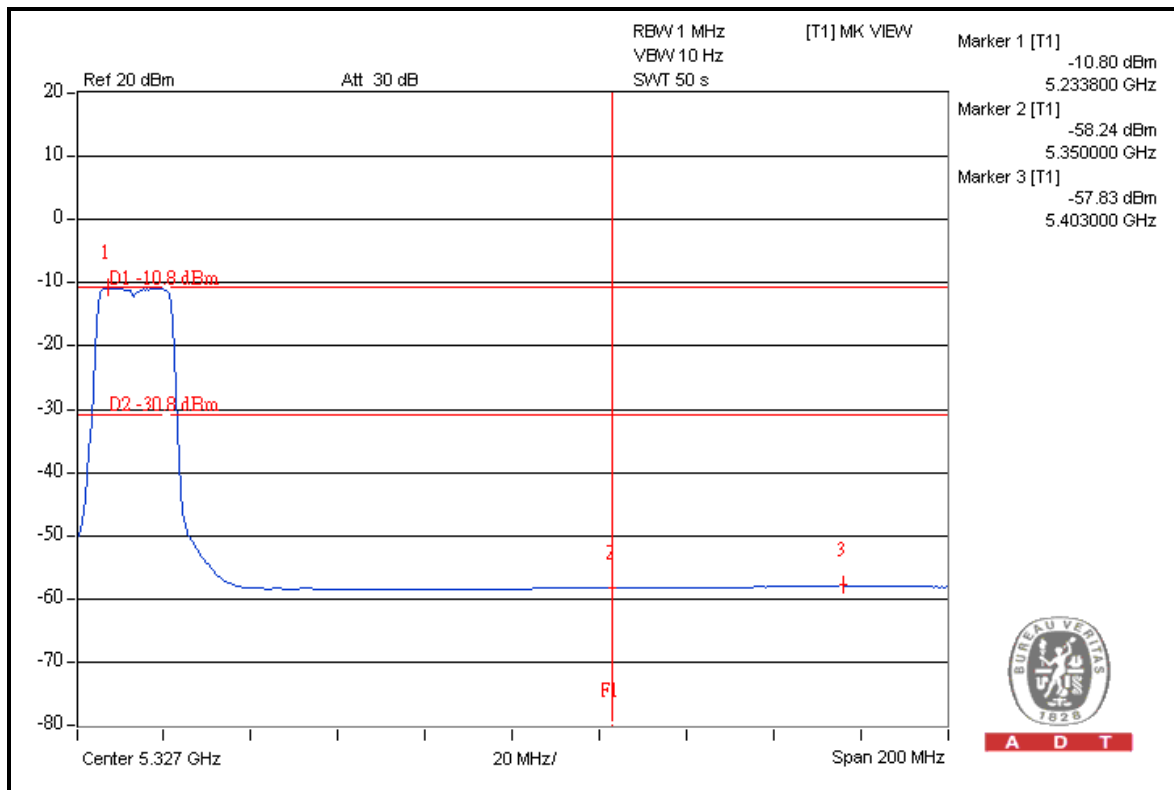



A D T

### CHAIN 1

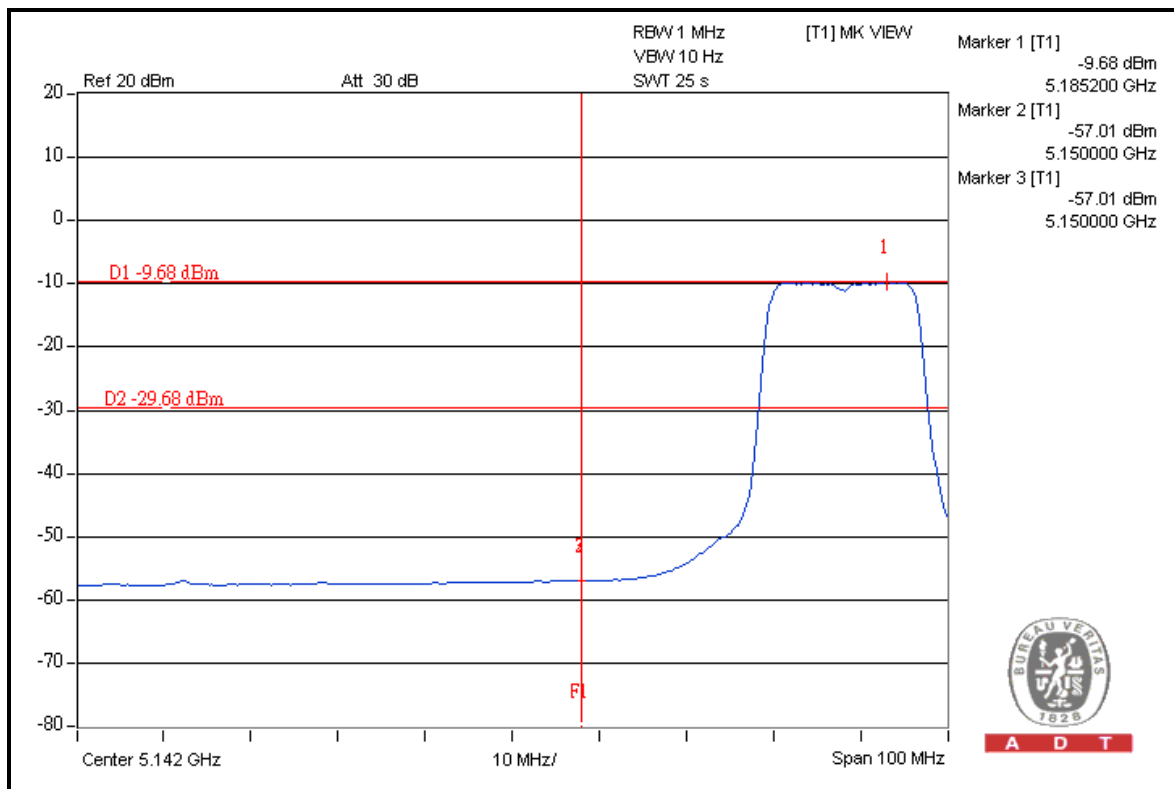
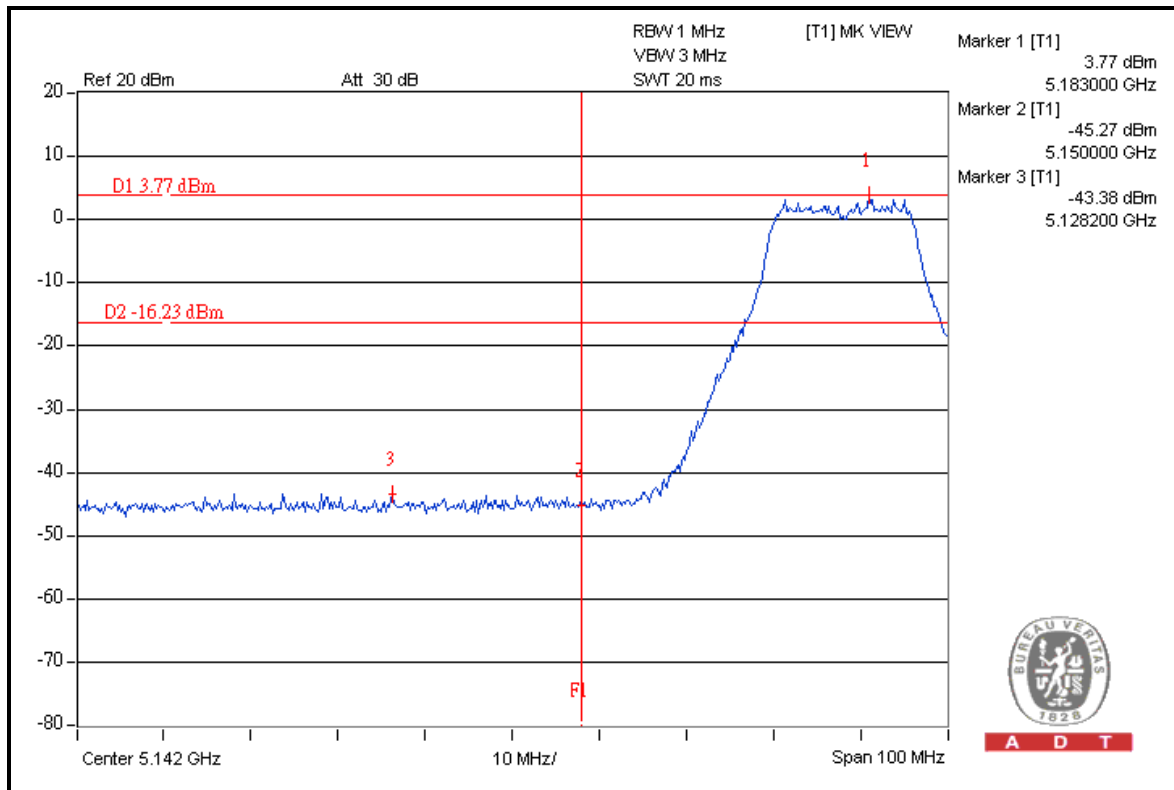



A D T

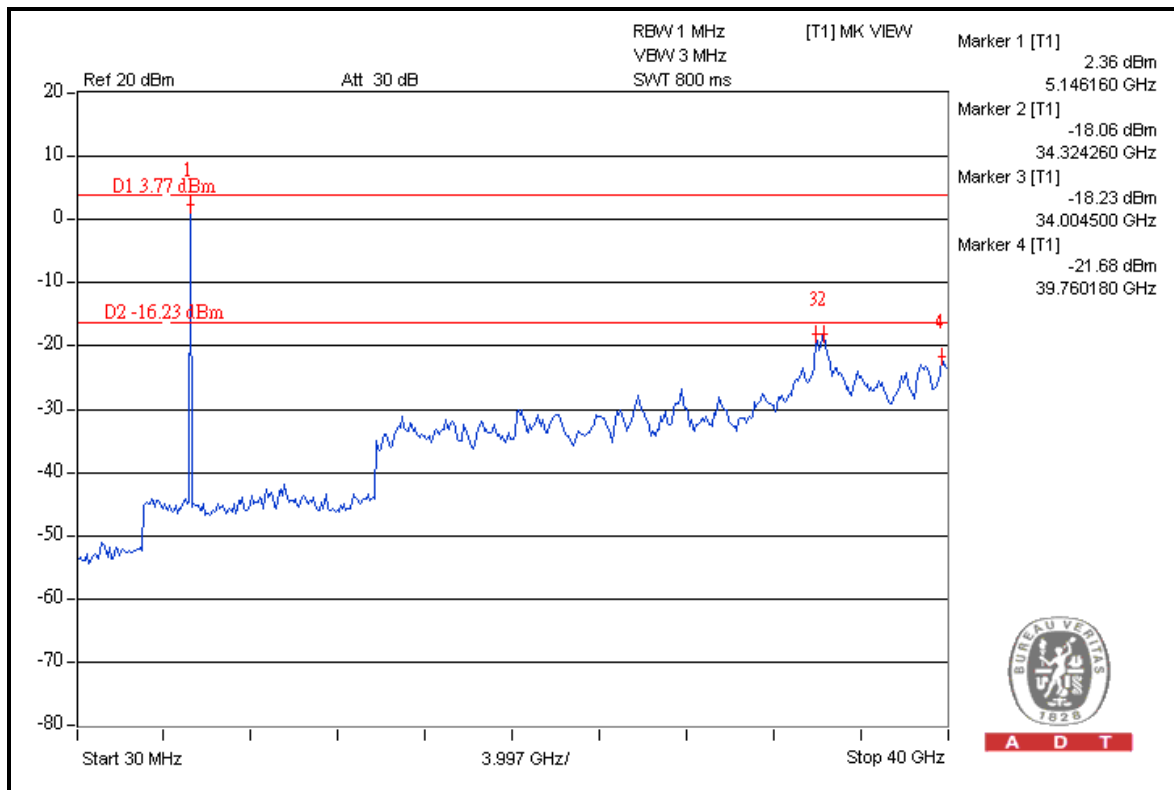

A D T

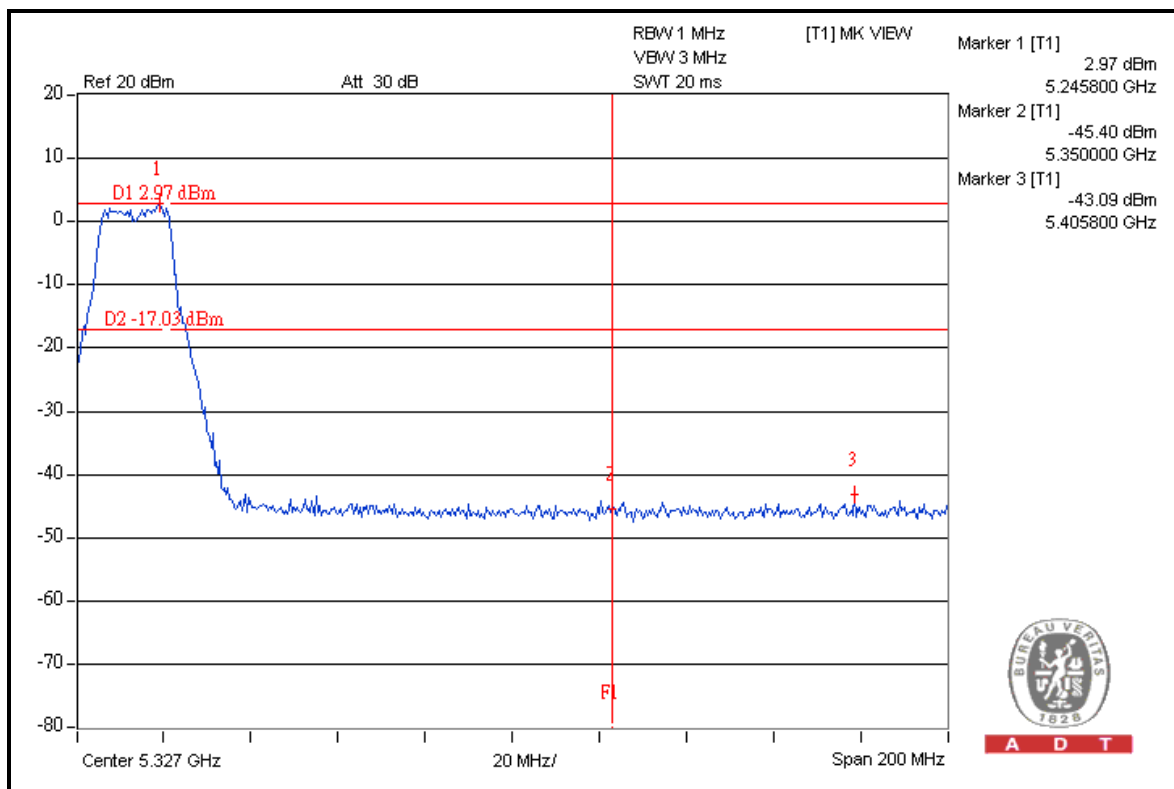

A D T



A D T

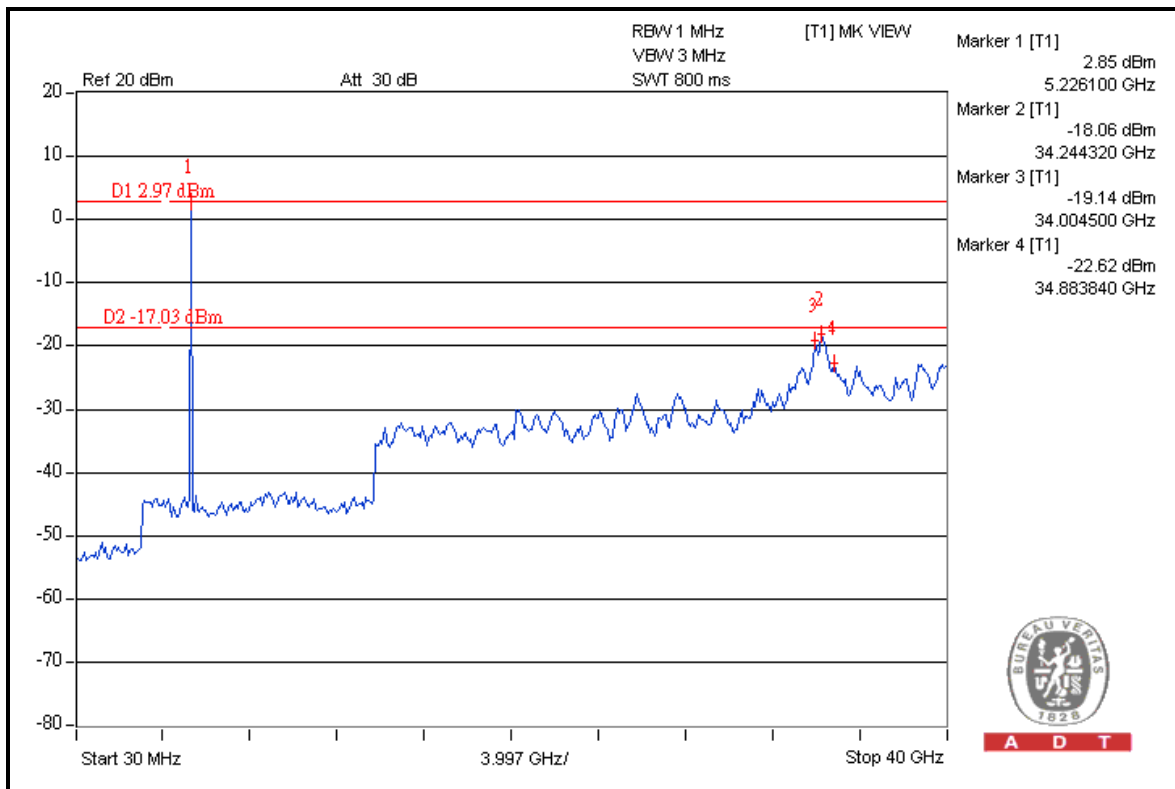
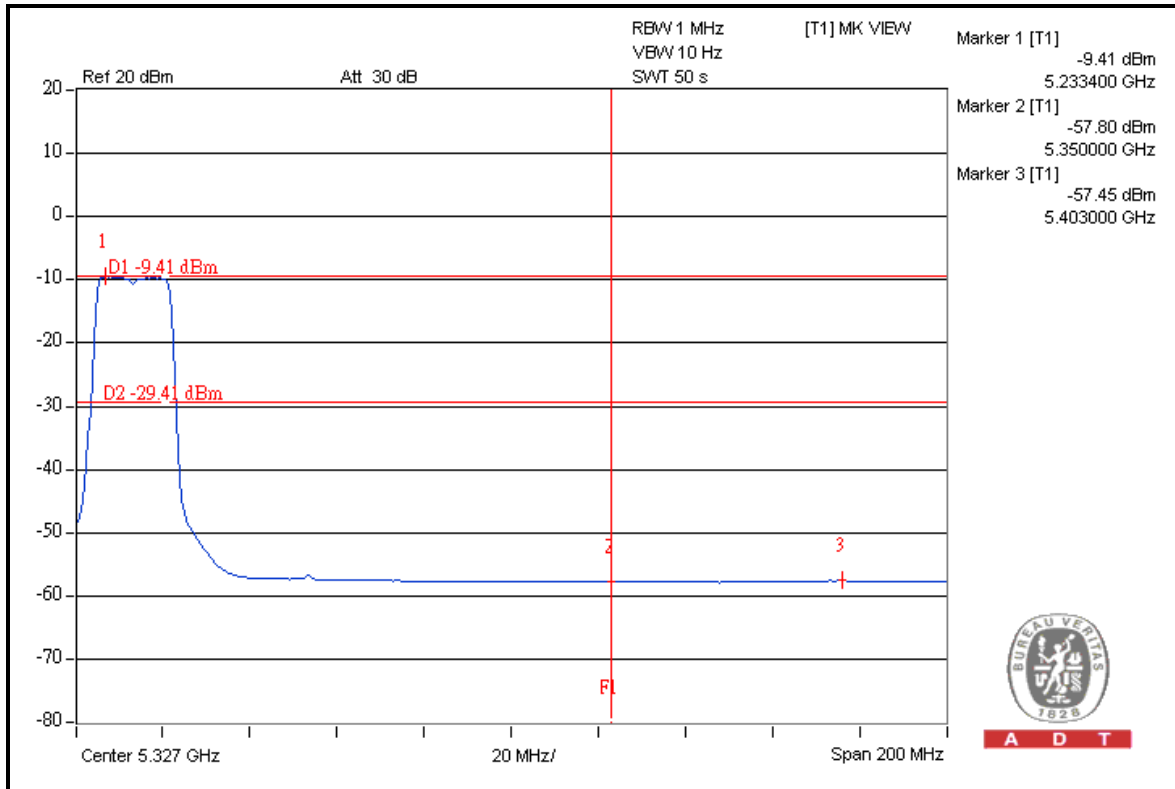

**802.11n (20MHz)**

**RESTRICT BAND (4500 ~ 5150 MHz)**

FREQUENCY (MHz)	FUNDAMENTAL EMISSION (dBuV/m)	DELTA (dB)	MAXIMUM FIELD STRENGTH IN RESTRICT BAND (dBuV/m)	LIMIT (dBuV/m)
5180.00 (PK)	110.2	52.8	57.4	74.0
5180.00 (AV)	100.2	54.0	46.2	54.0

**RESTRICT BAND (5350 ~ 5460 MHz)**

FREQUENCY (MHz)	FUNDAMENTAL EMISSION (dBuV/m)	DELTA (dB)	MAXIMUM FIELD STRENGTH IN RESTRICT BAND (dBuV/m)	LIMIT (dBuV/m)
5240.00 (PK)	111.5	54.2	57.3	74.0
5240.00 (AV)	100.2	56.2	44.0	54.0

**NOTE:**

- Delta = Amplitude between the peak of the fundamental and the peak of the band edge emission. Please check following 2 pages.
- Maximum field strength in restrict band = Fundamental emission – Delta.



A D T

### FOR RADIATED MEASURED (TWO CHAINS ON)

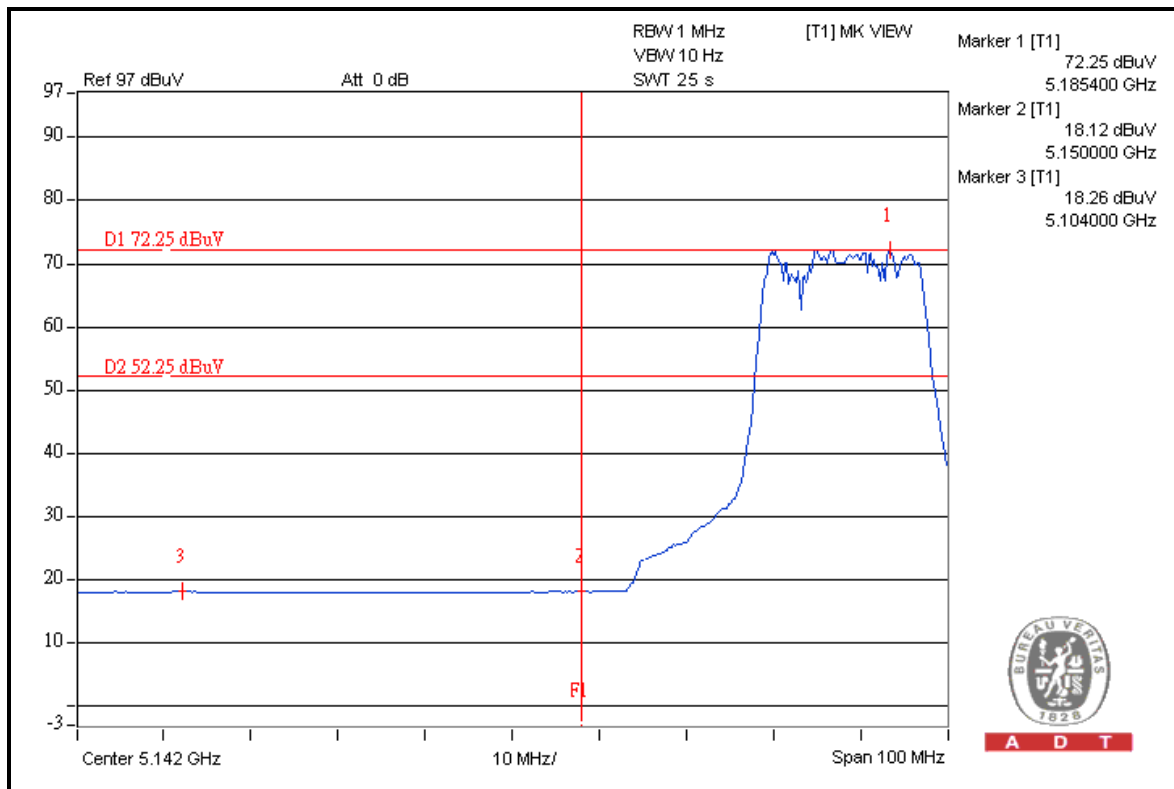
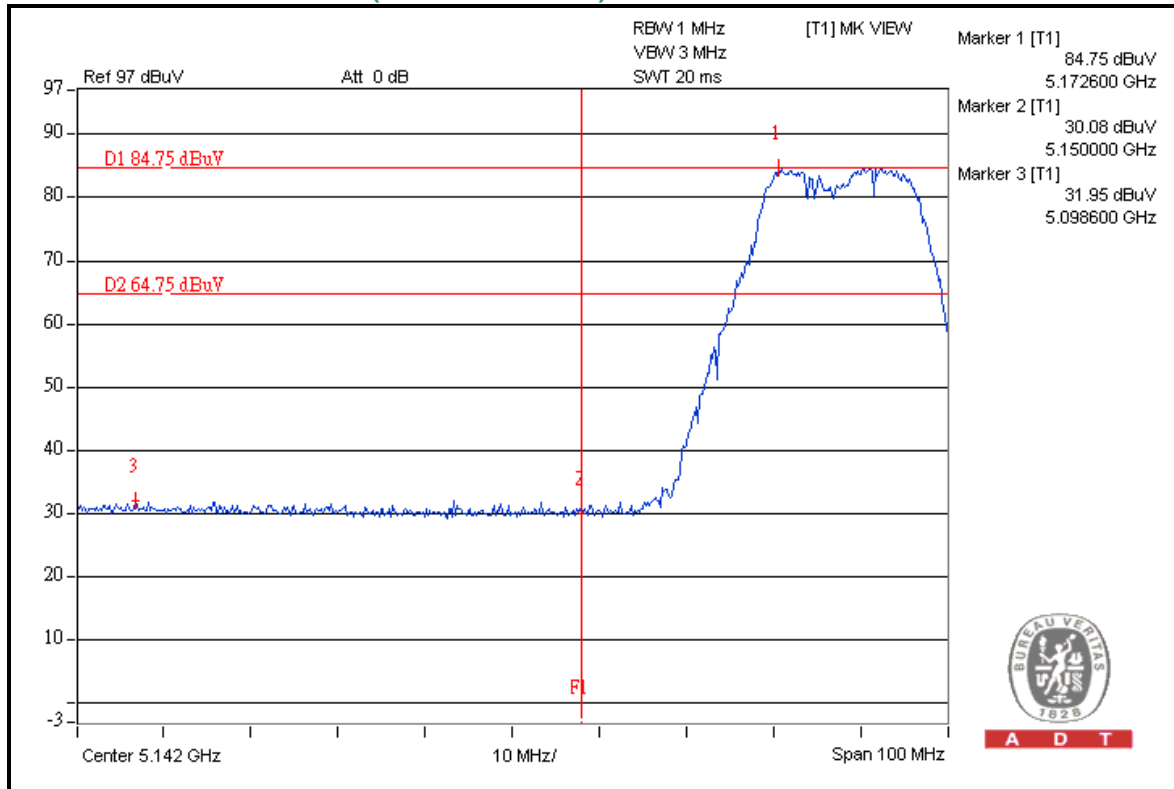





A D T

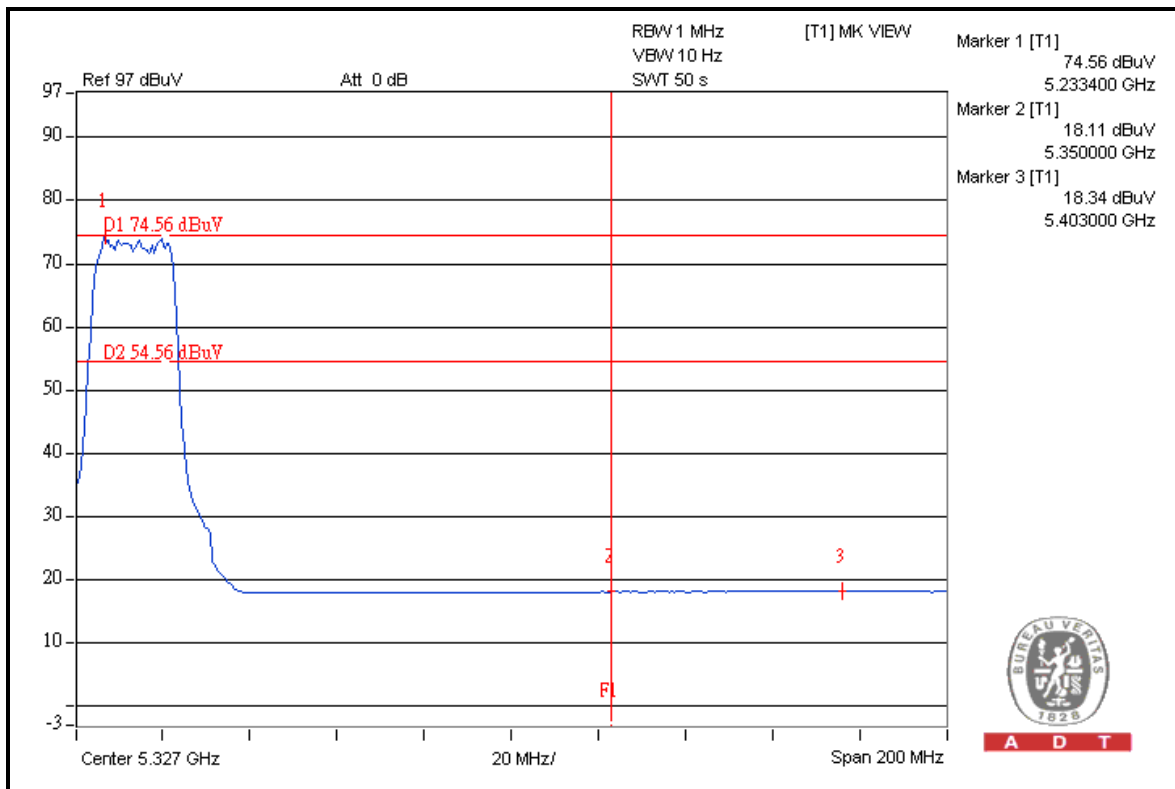
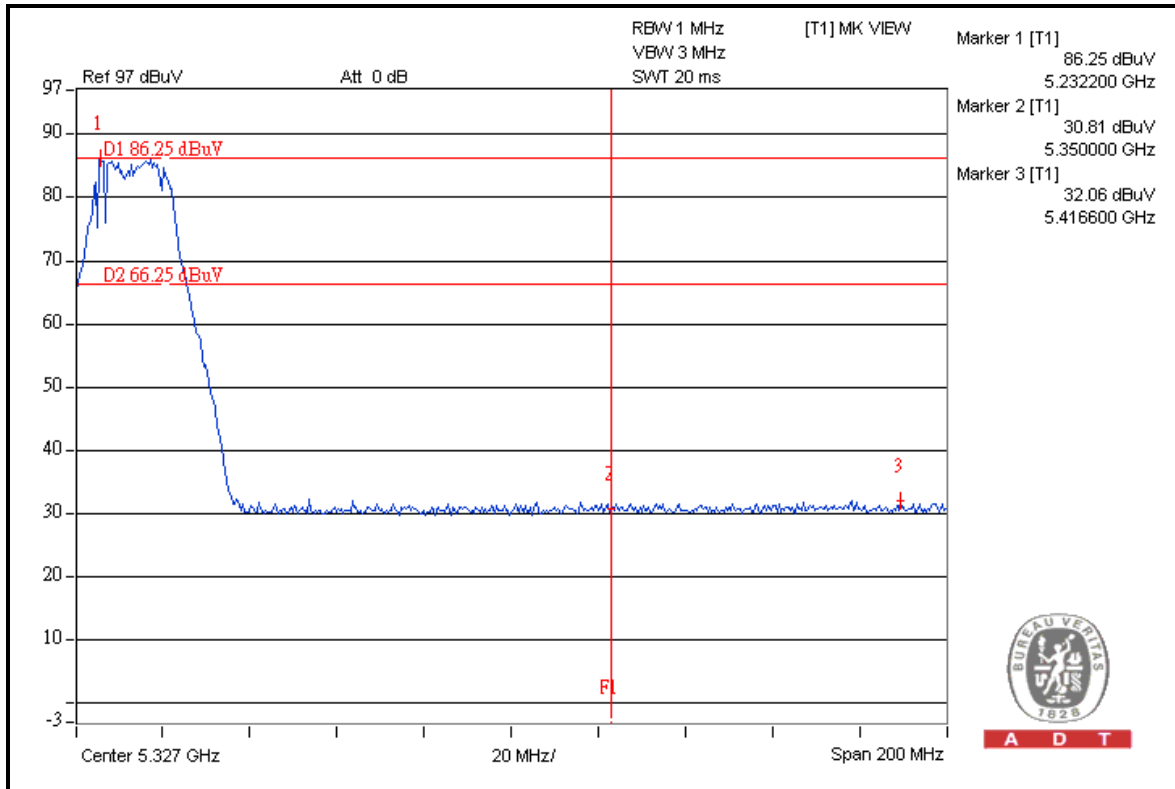



A D T

### FOR CONDUCTED MEASURED

### CHAIN 0

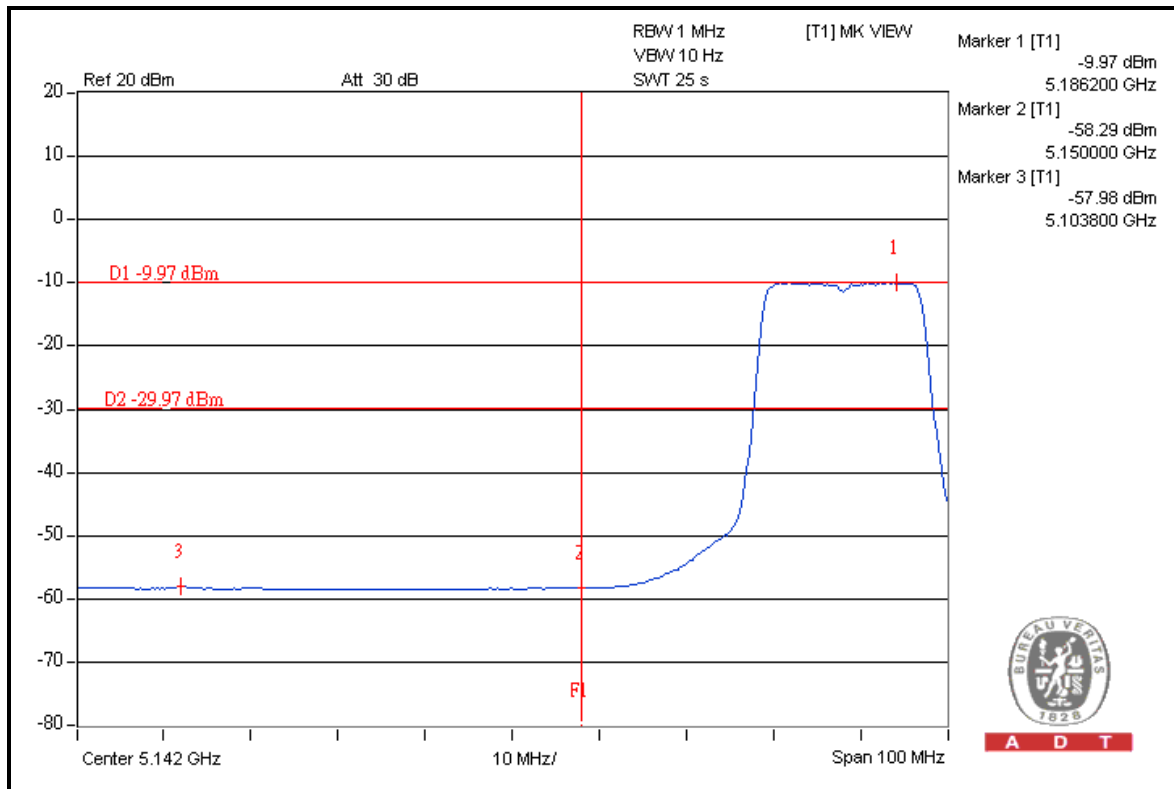
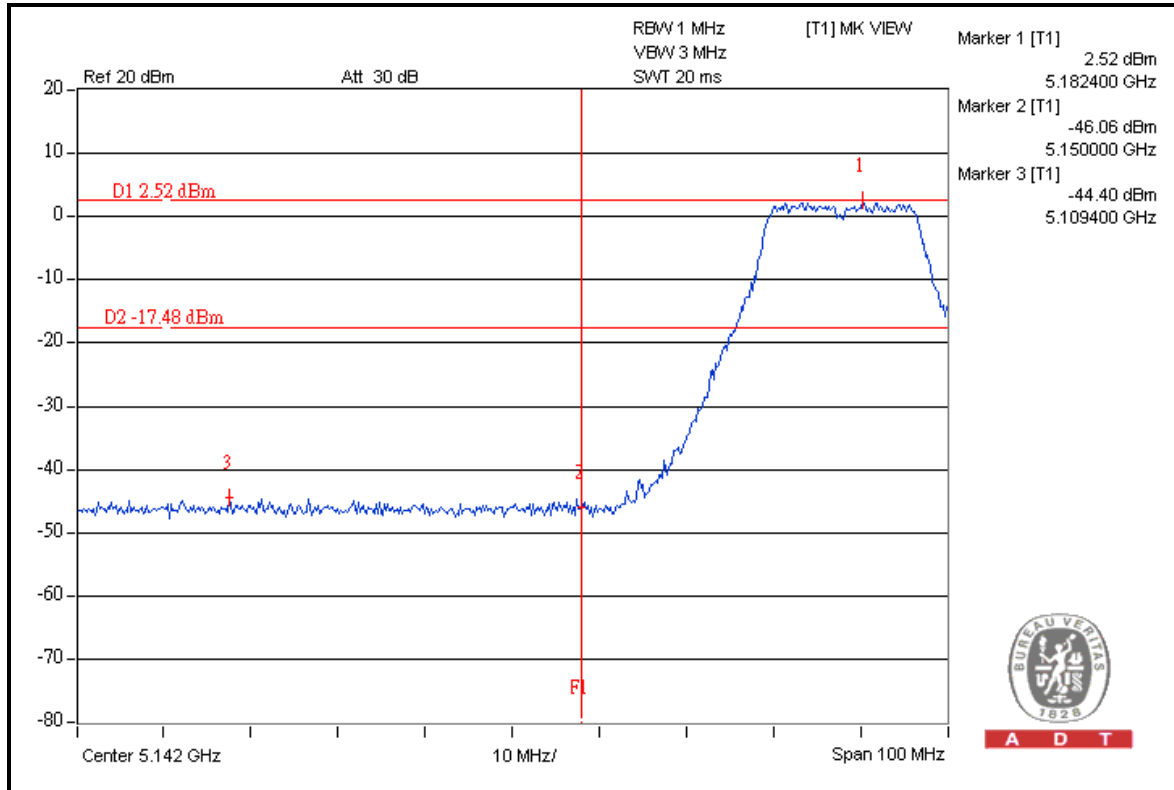



A D T

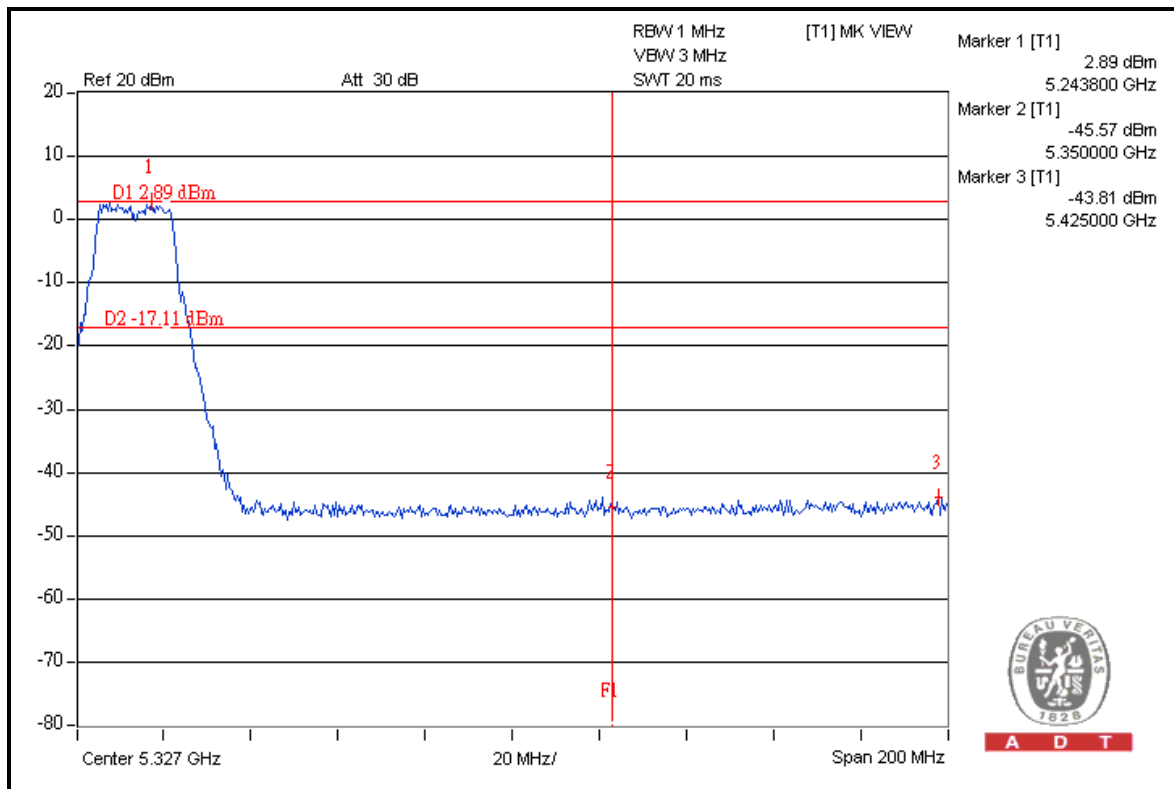
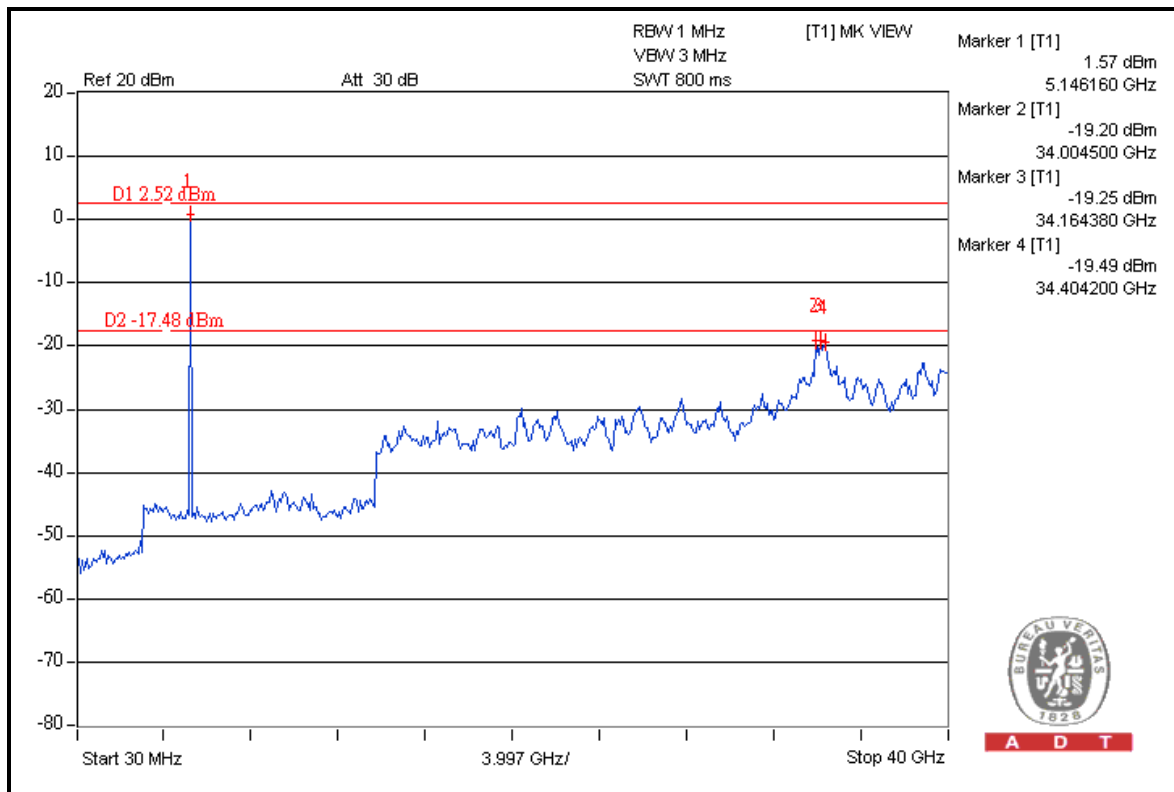



A D T

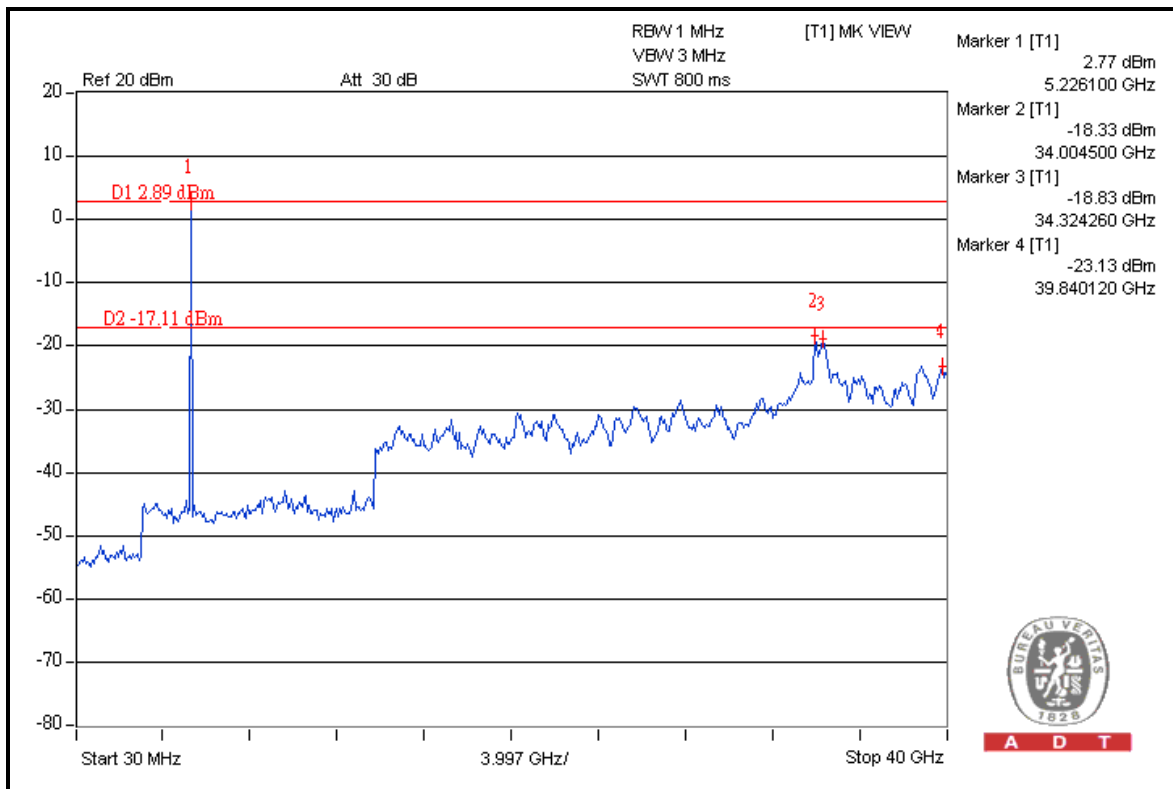
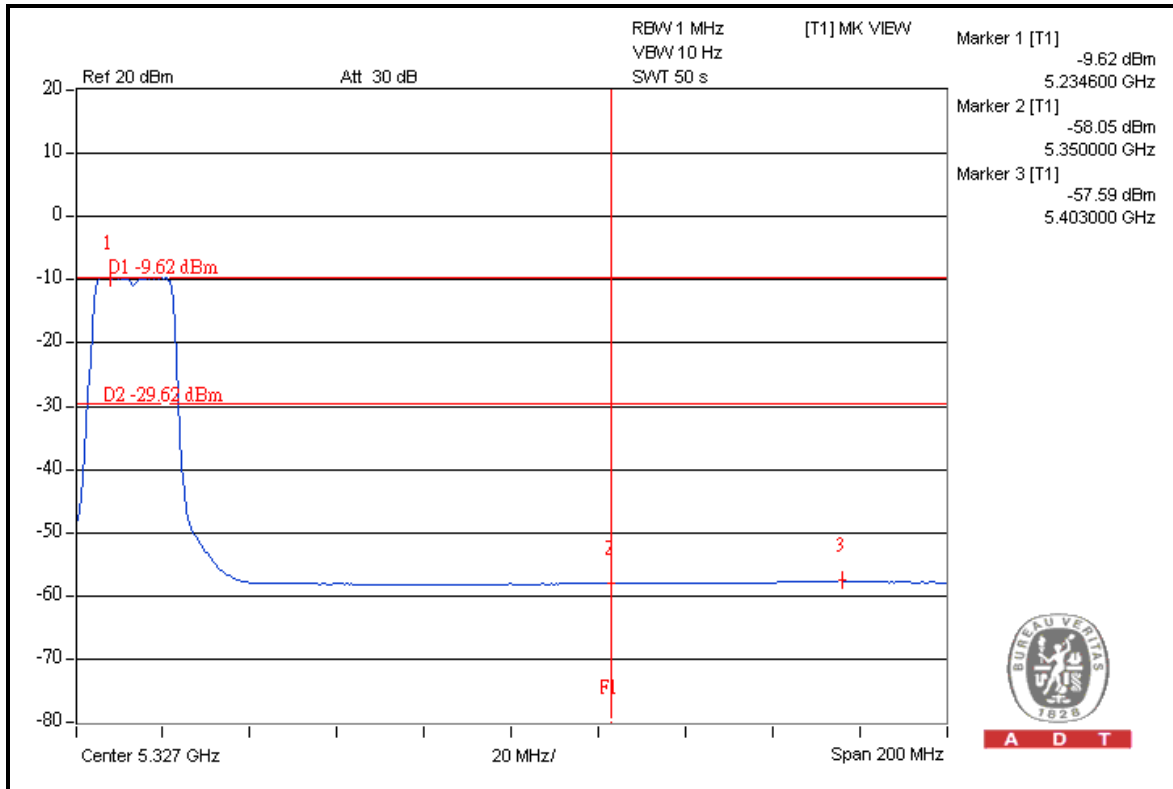



A D T

### CHAIN 1

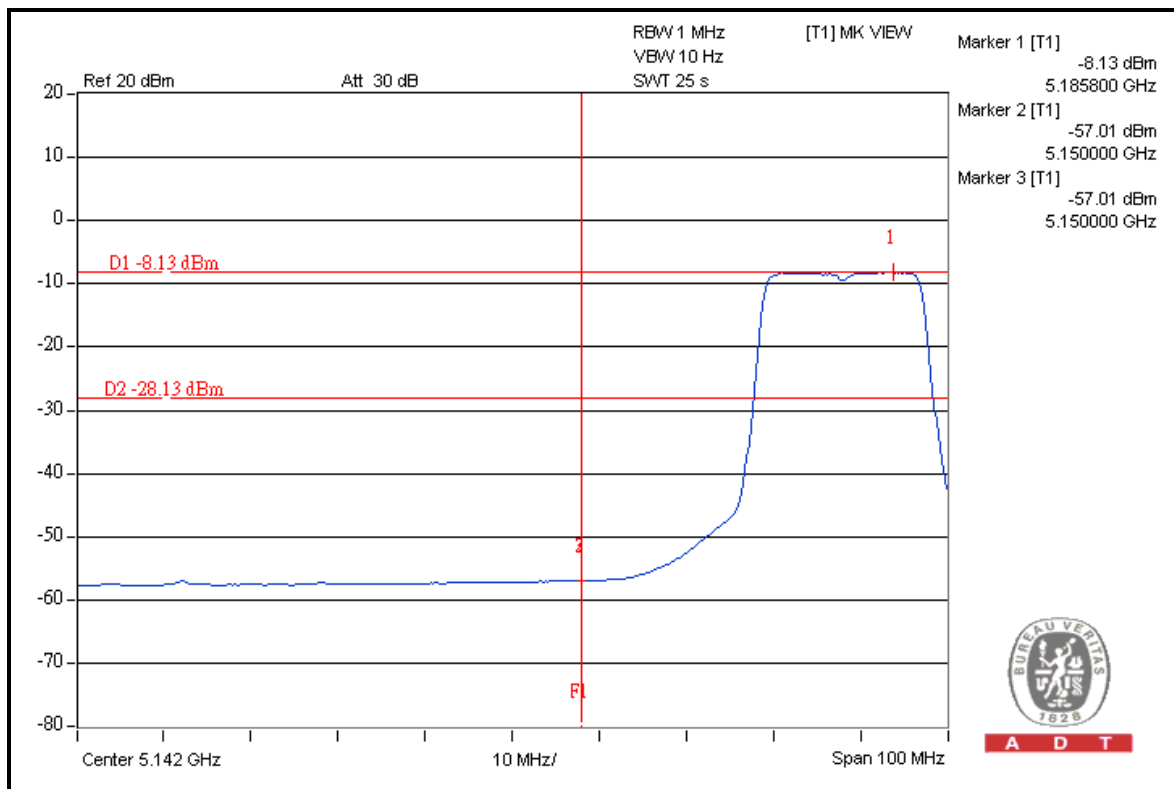
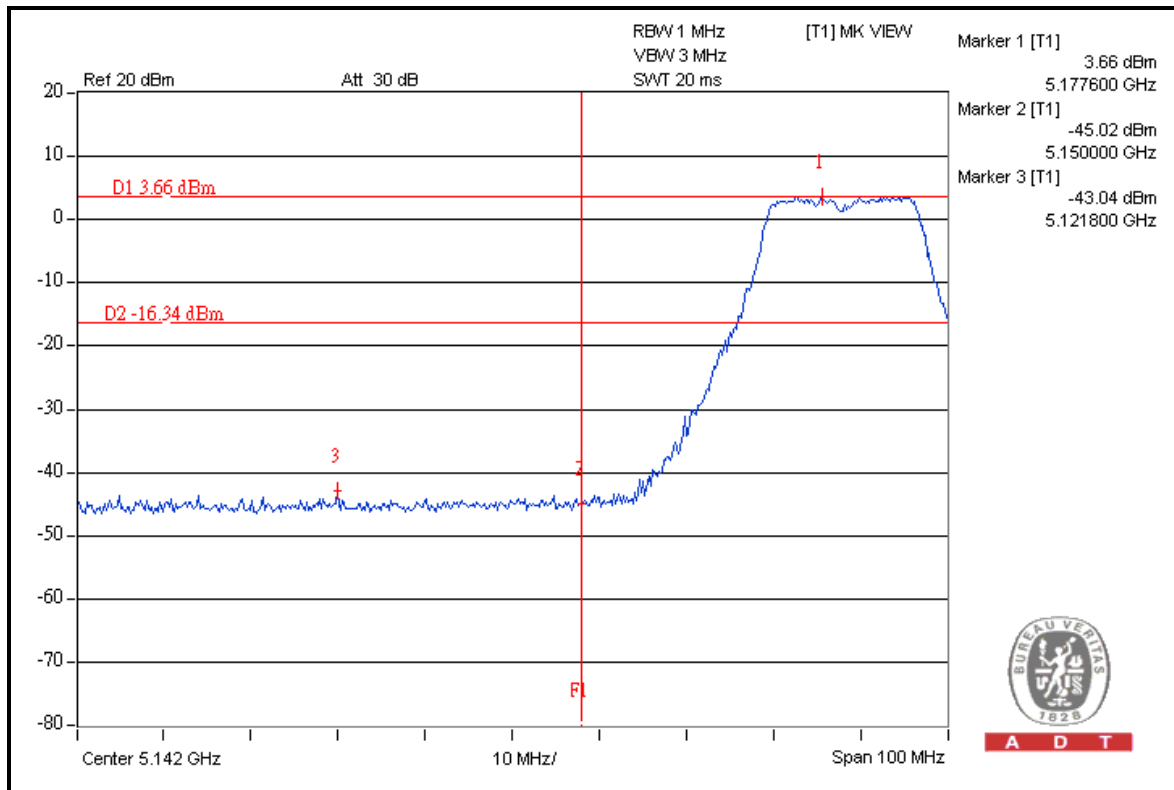



A D T

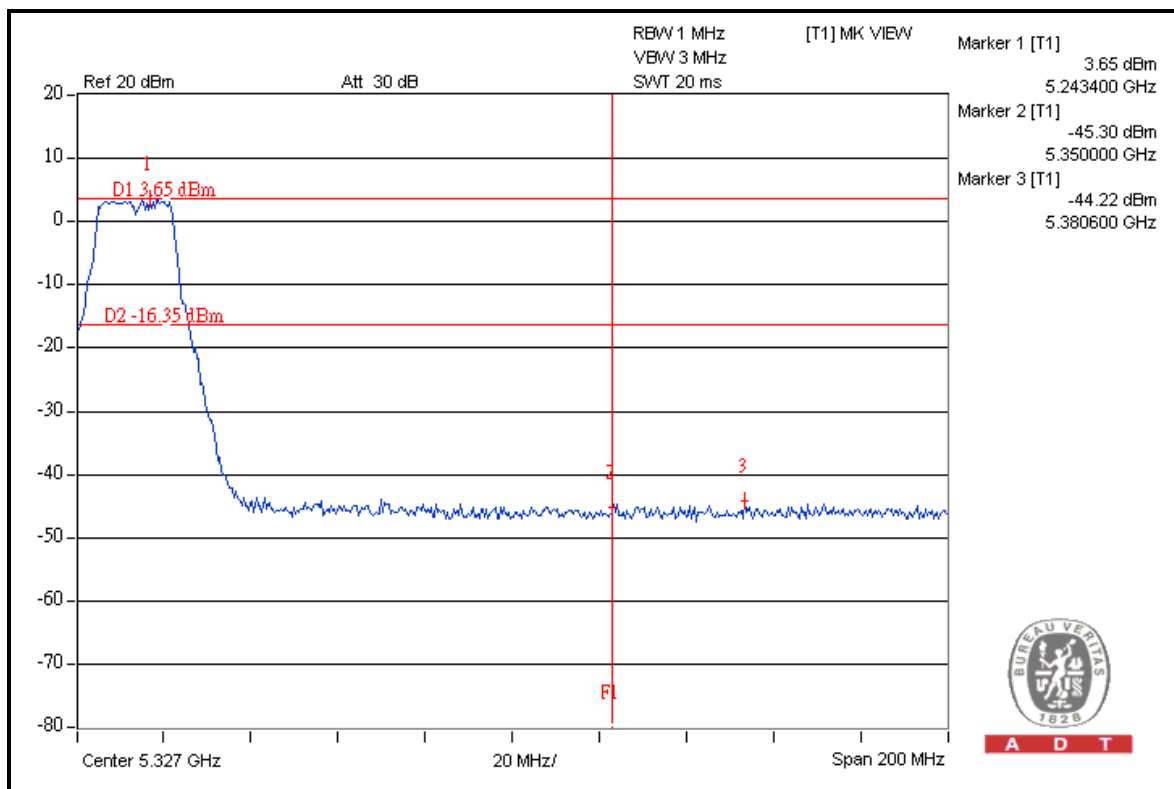
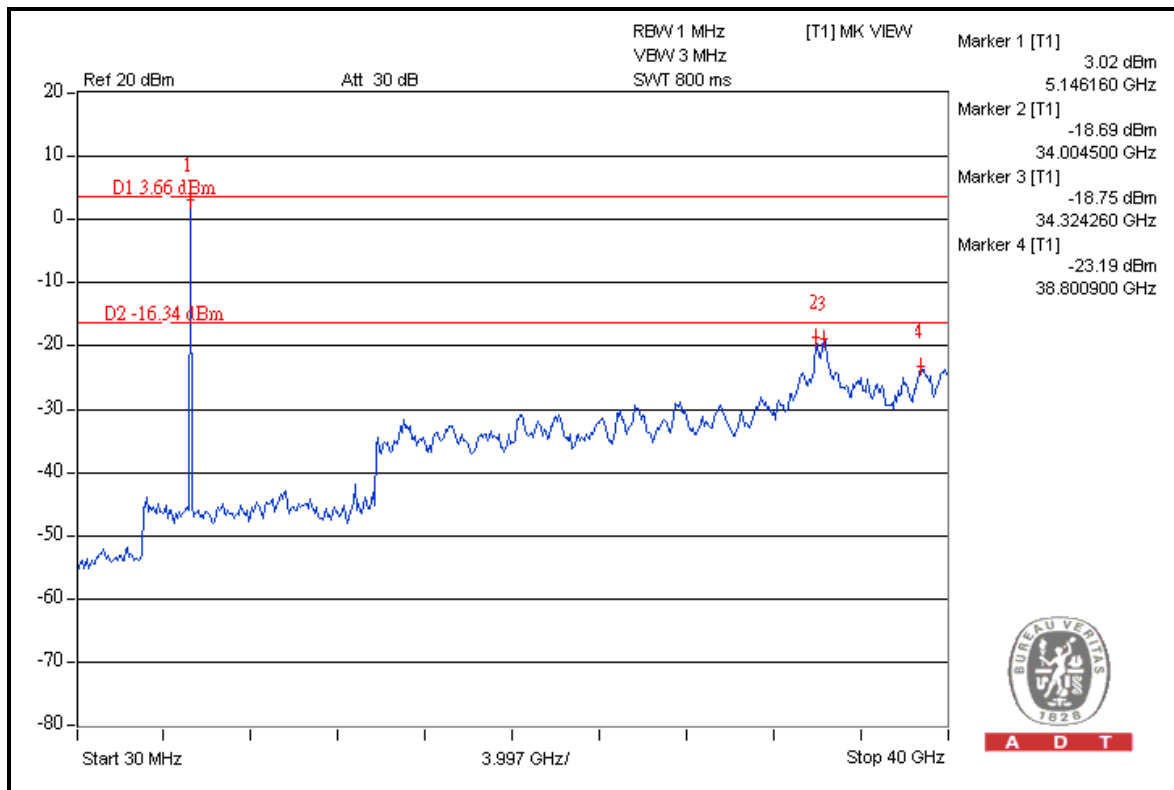



A D T

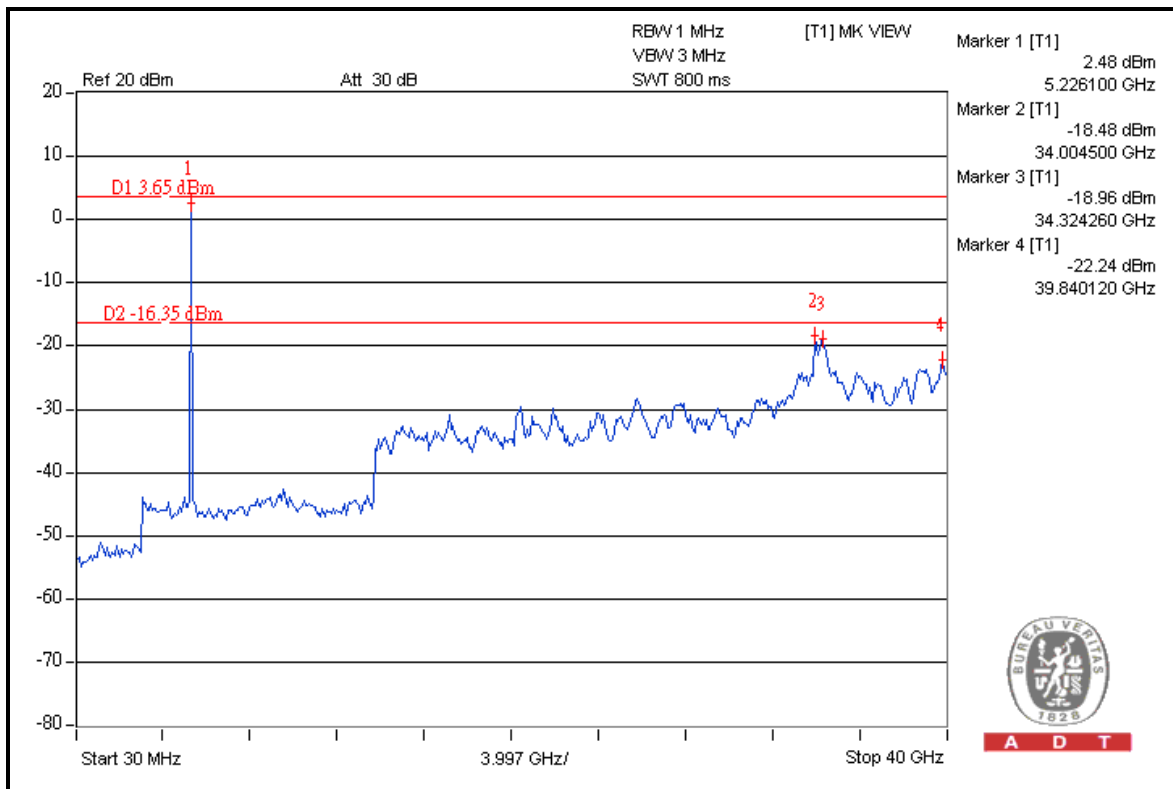
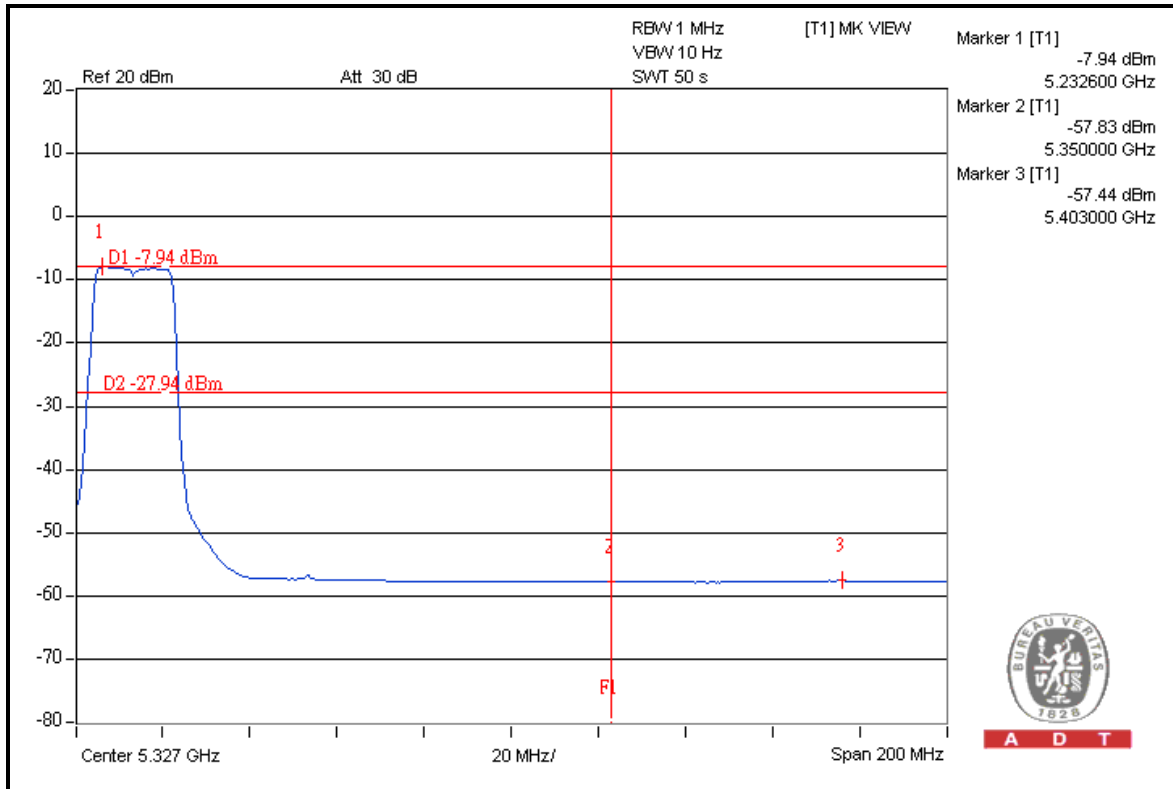

**802.11n (40MHz)**

**RESTRICT BAND (4500 ~ 5150 MHz)**

FREQUENCY (MHz)	FUNDAMENTAL EMISSION (dBuV/m)	DELTA (dB)	MAXIMUM FIELD STRENGTH IN RESTRICT BAND (dBuV/m)	LIMIT (dBuV/m)
5190.00 (PK)	109.0	52.7	56.3	74.0
5190.00 (AV)	97.8	51.9	45.9	54.0

**RESTRICT BAND (5350 ~ 5460 MHz)**

FREQUENCY (MHz)	FUNDAMENTAL EMISSION (dBuV/m)	DELTA (dB)	MAXIMUM FIELD STRENGTH IN RESTRICT BAND (dBuV/m)	LIMIT (dBuV/m)
5230.00 (PK)	108.5	51.0	57.5	74.0
5230.00 (AV)	97.9	53.6	44.3	54.0

**NOTE:**

1. Delta = Amplitude between the peak of the fundamental and the peak of the band edge emission. Please check following 2 pages.
2. Maximum field strength in restrict band = Fundamental emission – Delta.





A D T

### FOR RADIATED MEASURED (TWO CHAINS ON)

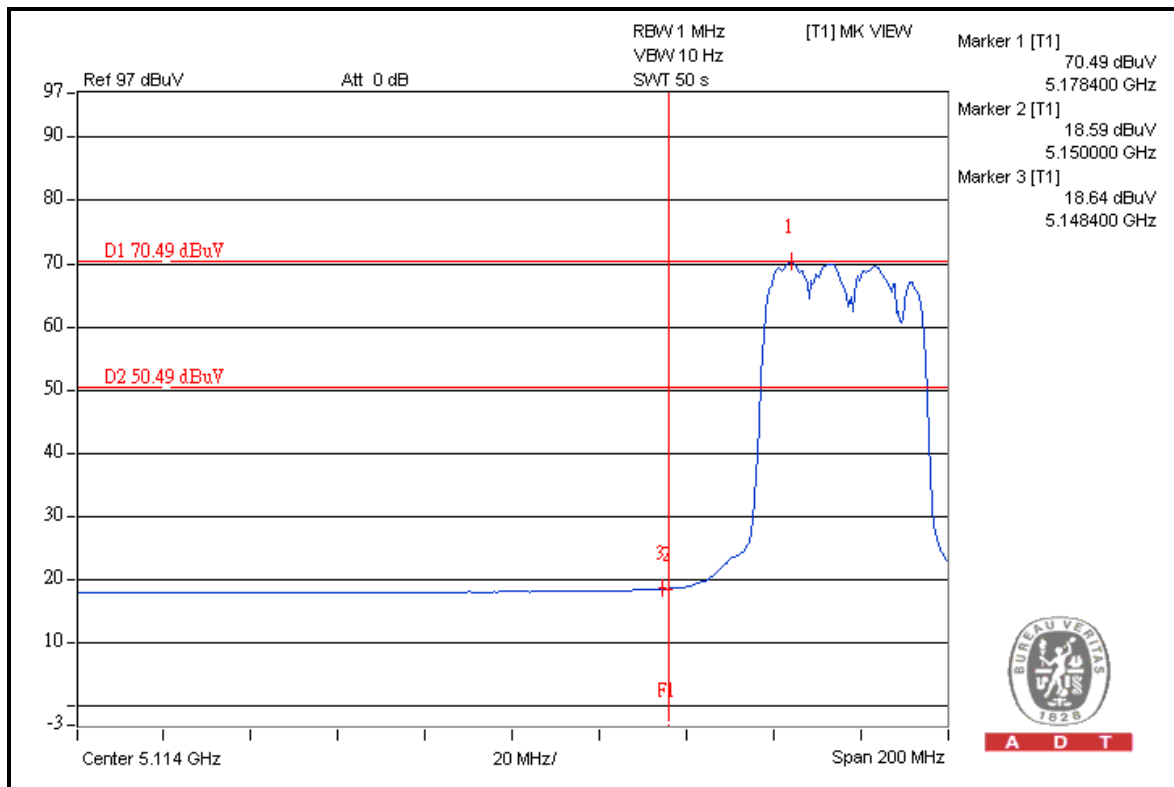
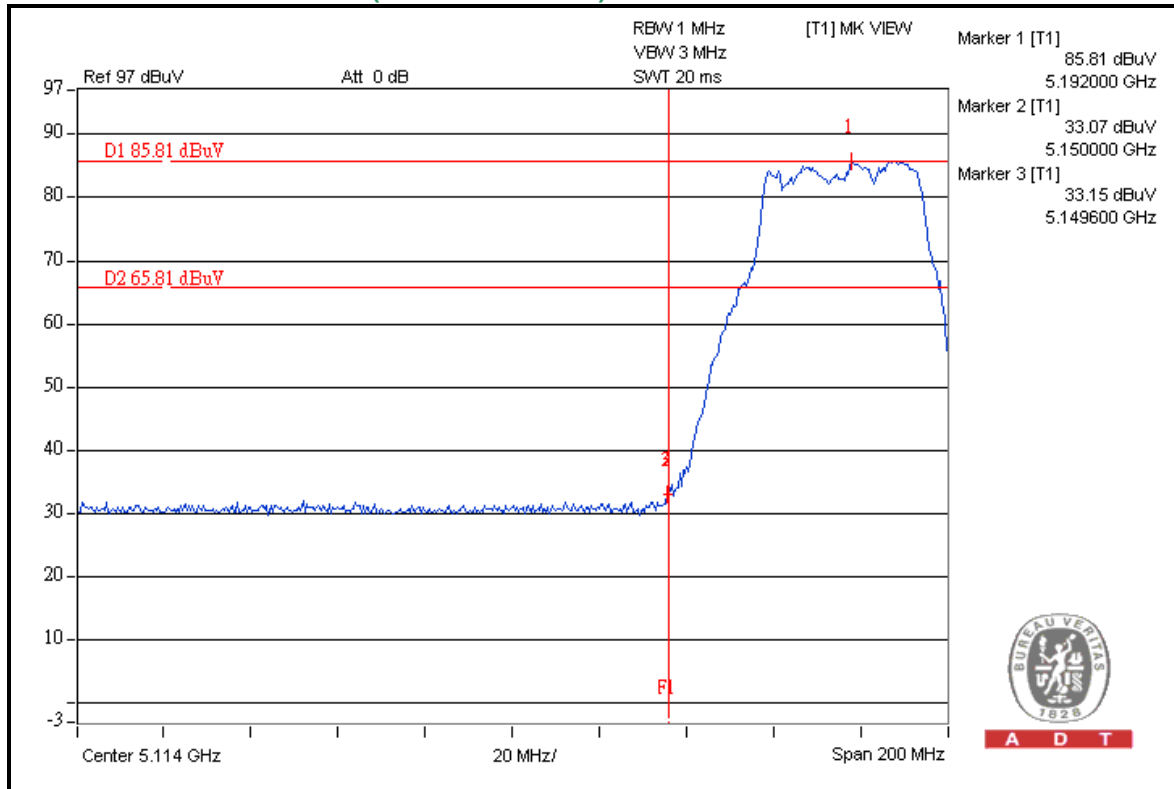



A D T

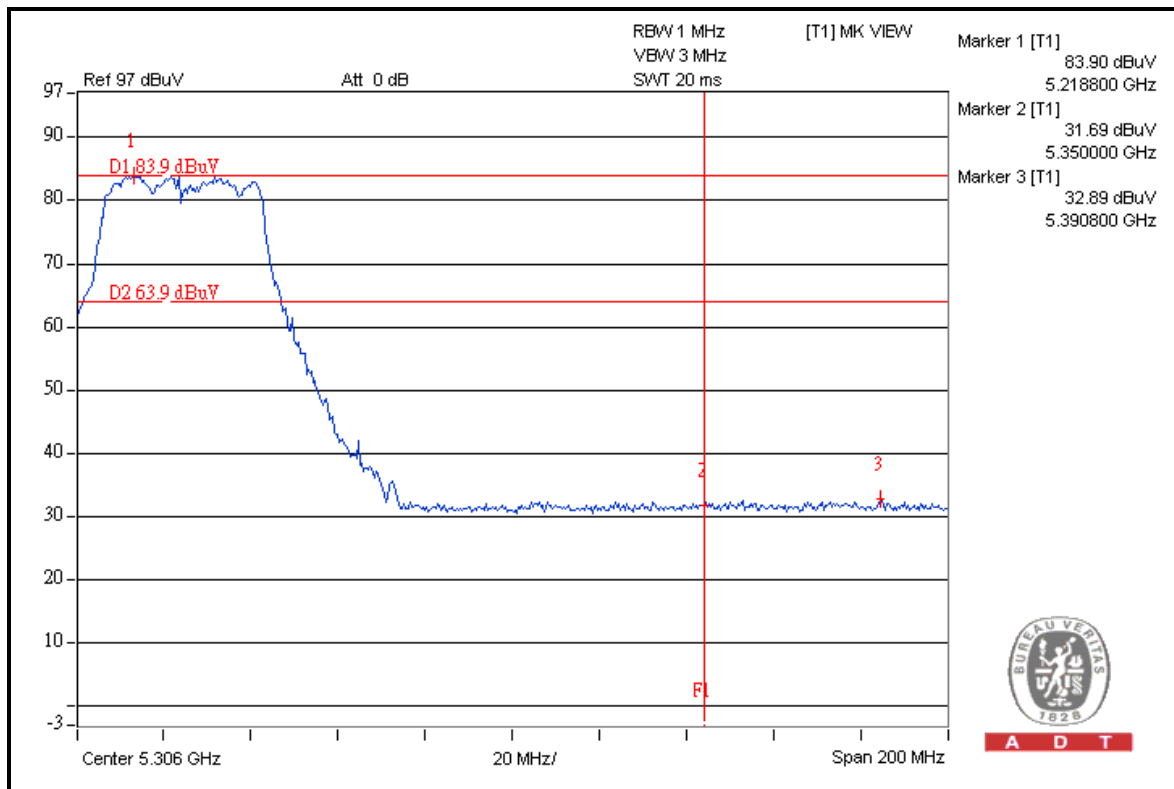

A D T

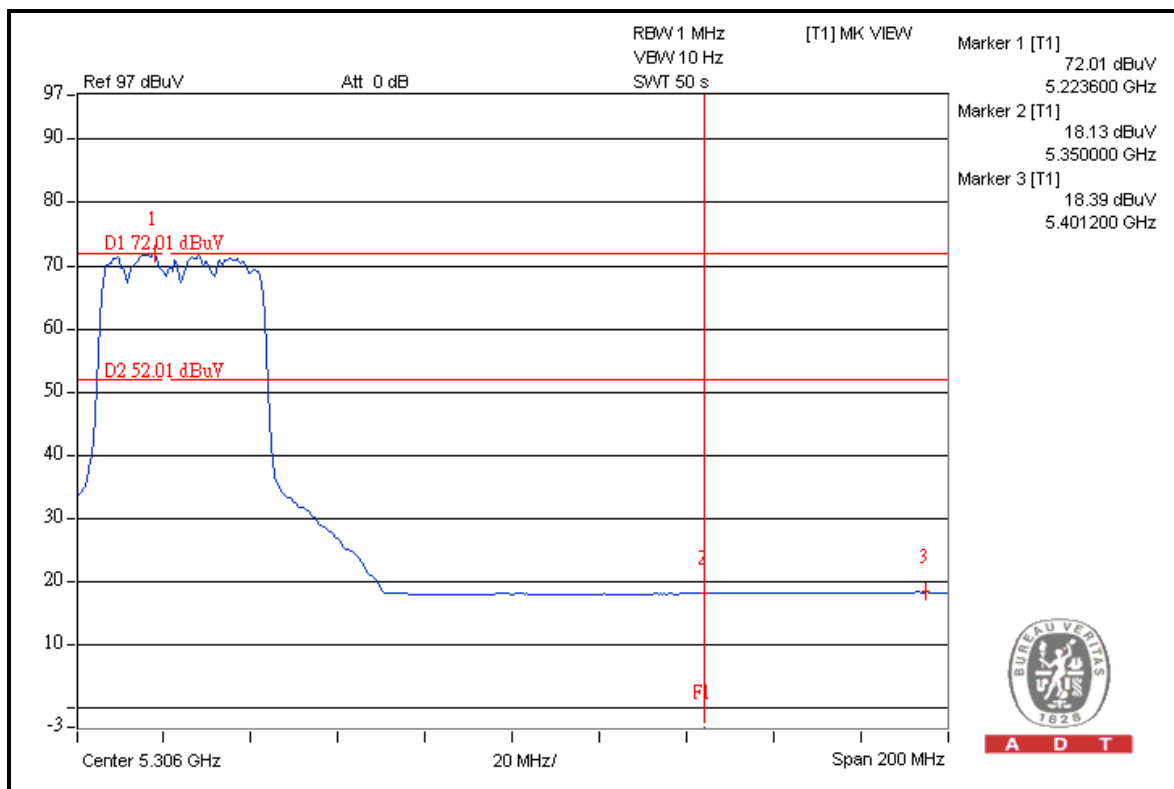

A D T



A D T

### FOR CONDUCTED MEASURED

### CHAIN 0

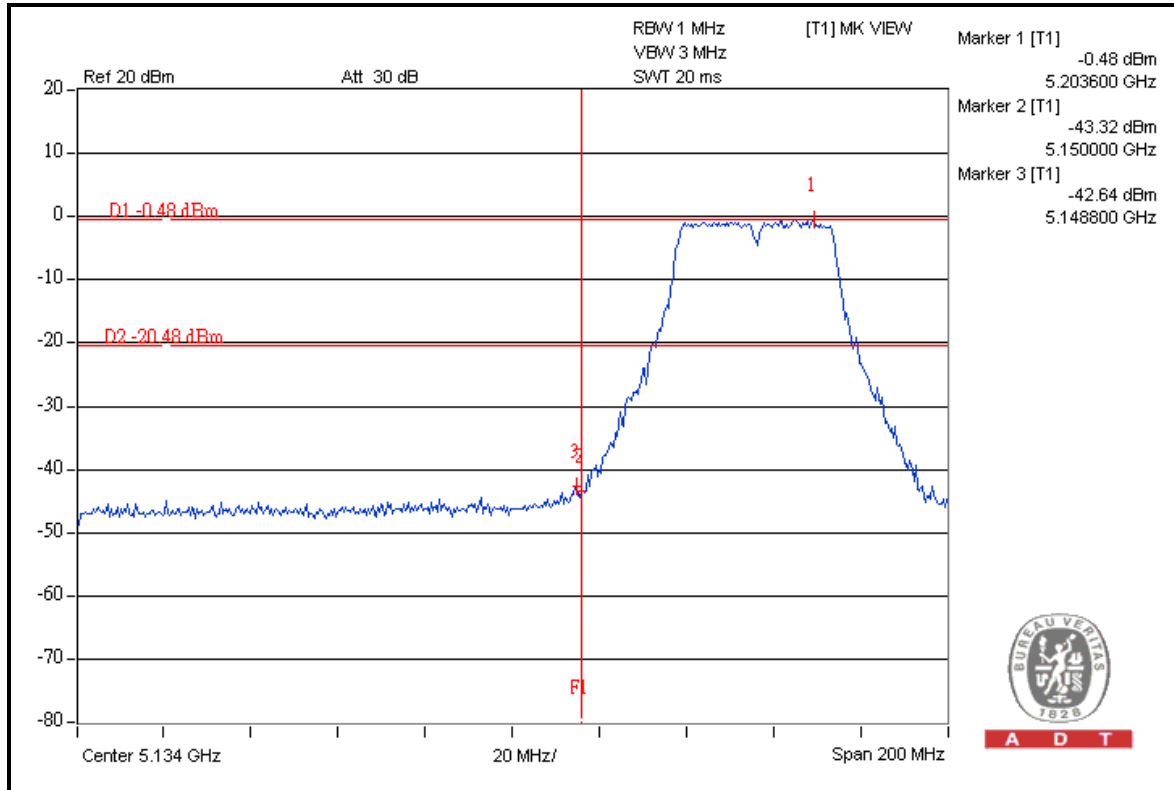

A D T

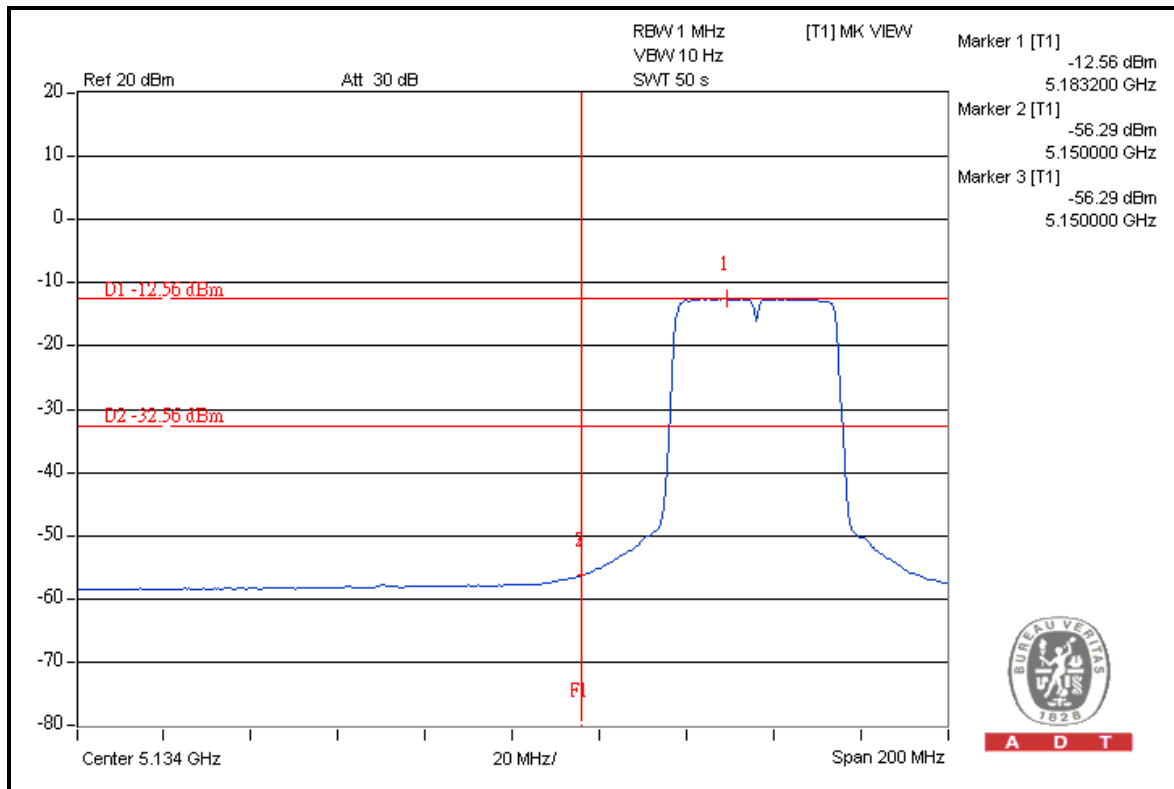

A D T



A D T

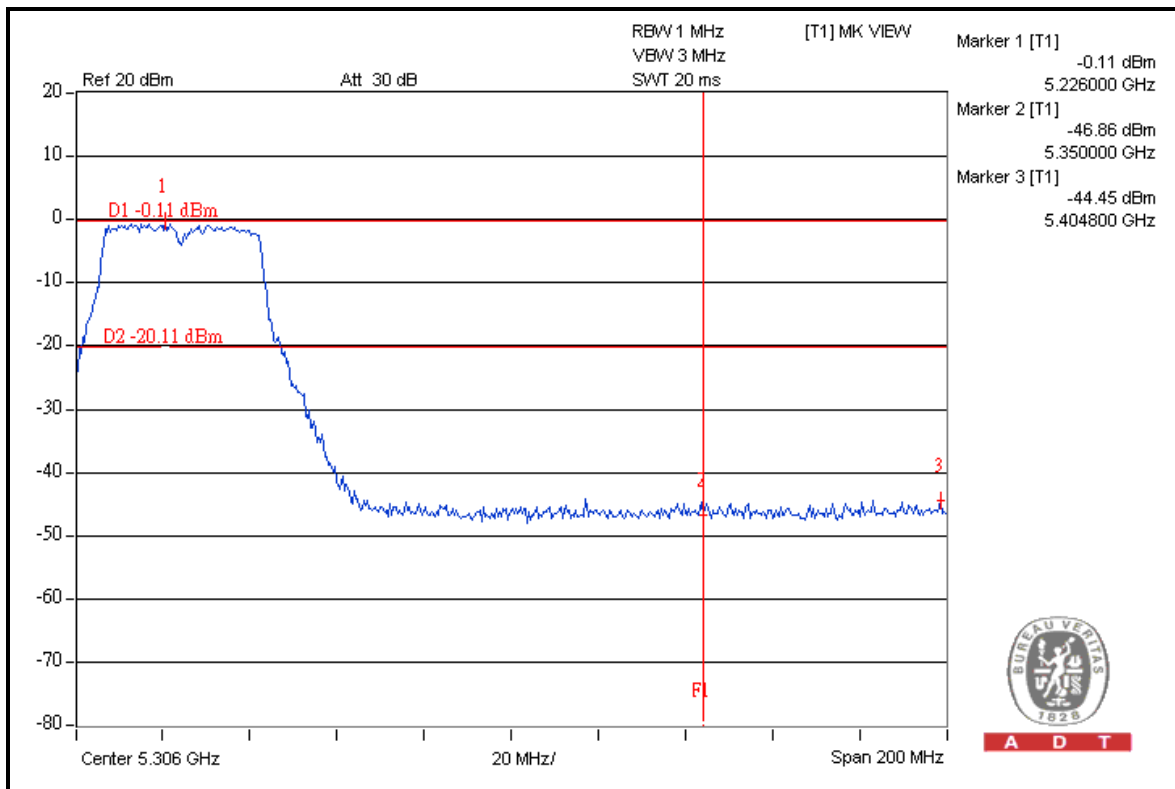
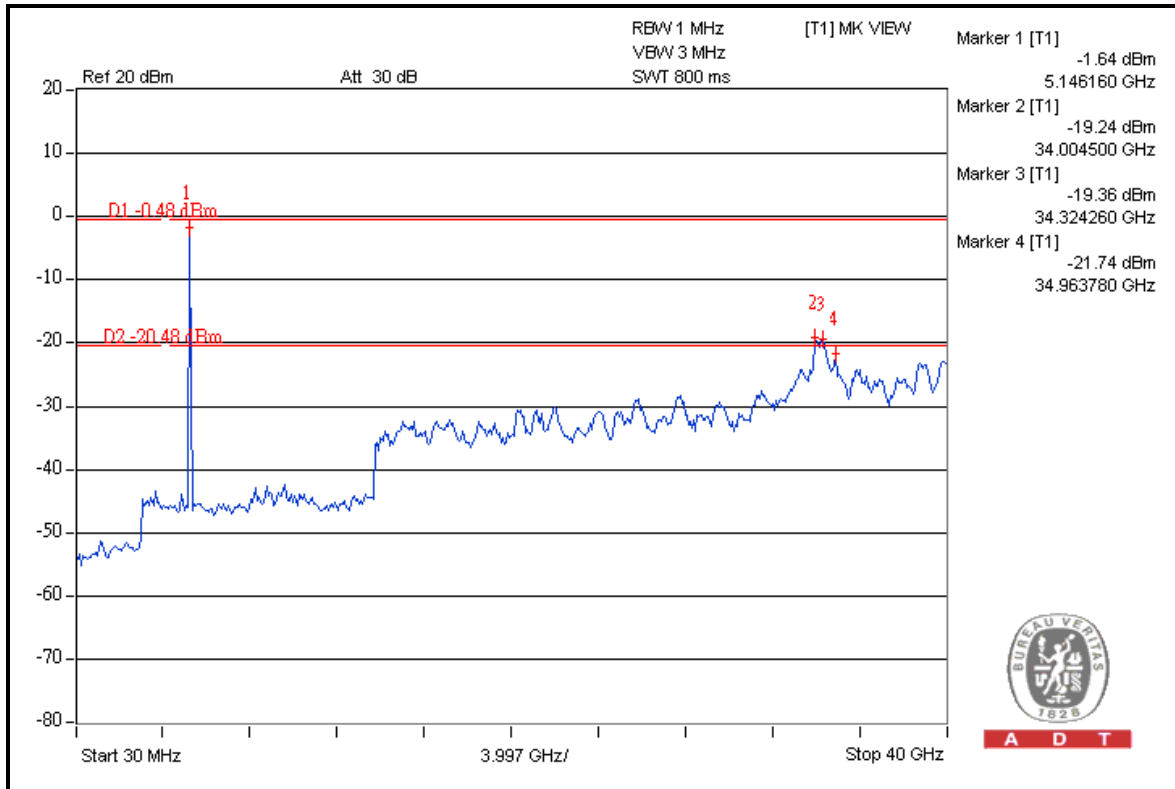



A D T

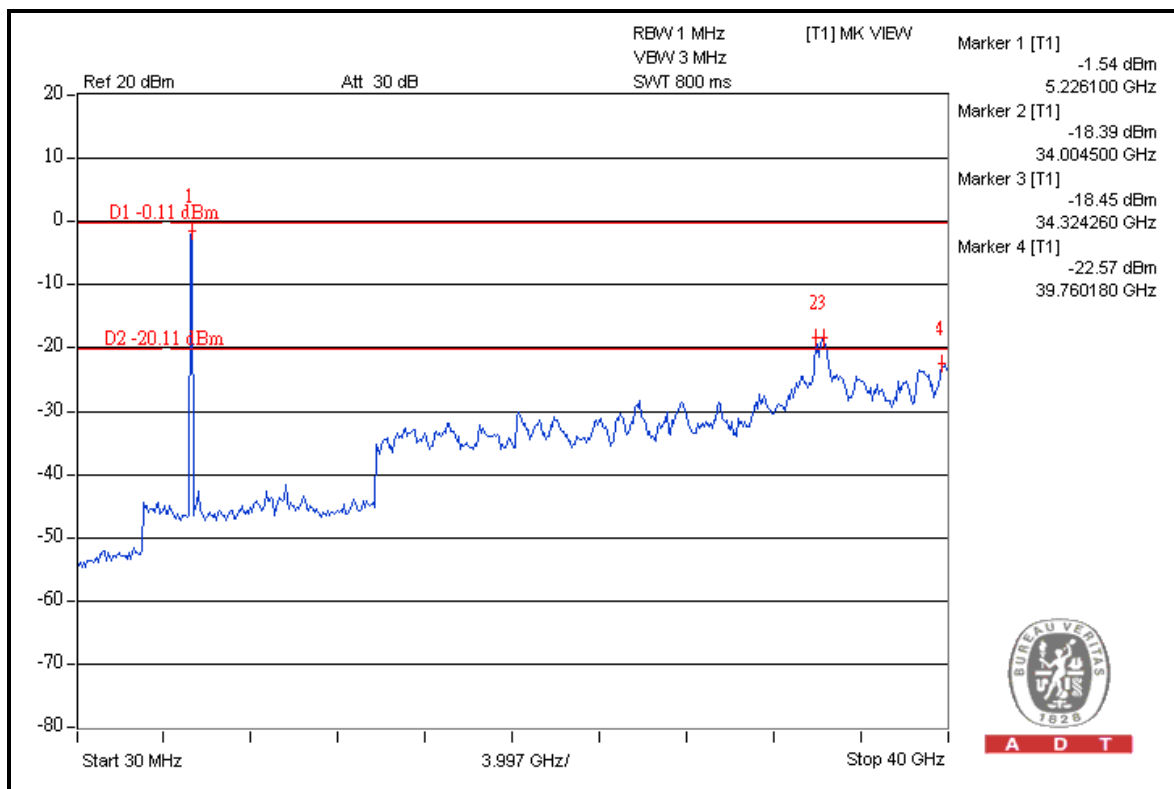
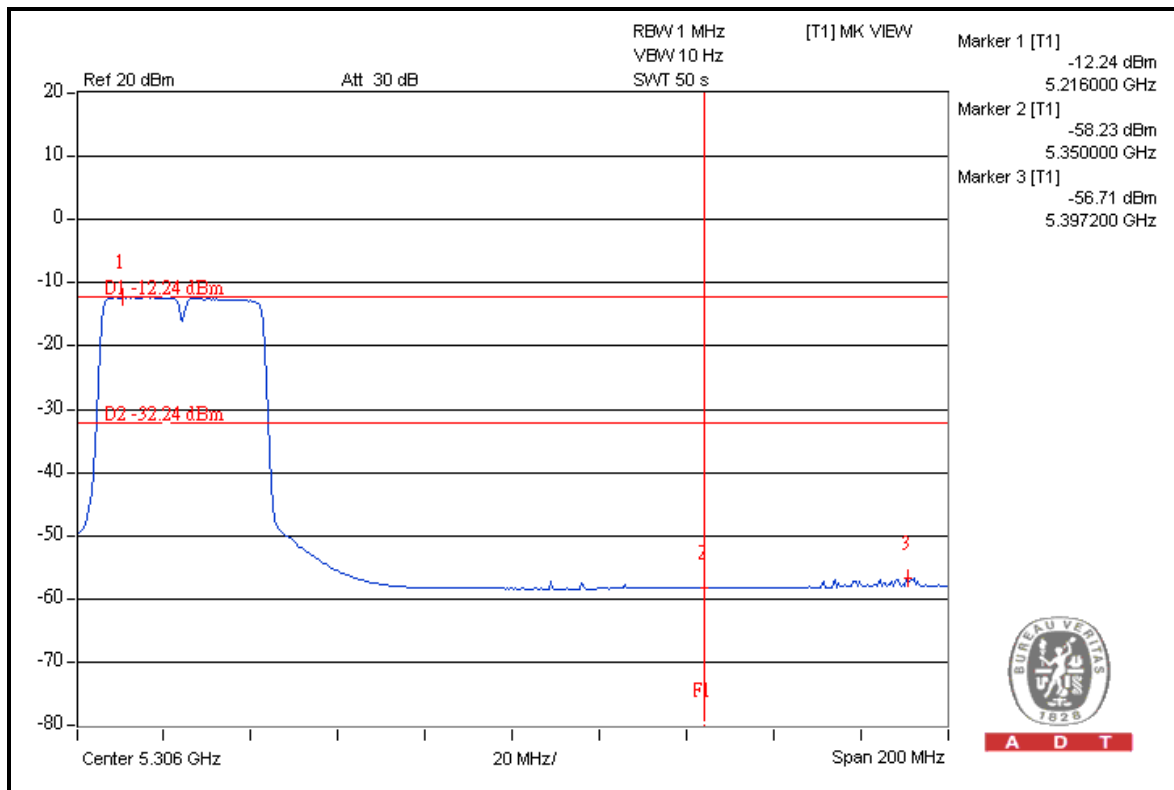



A D T

### CHAIN 1

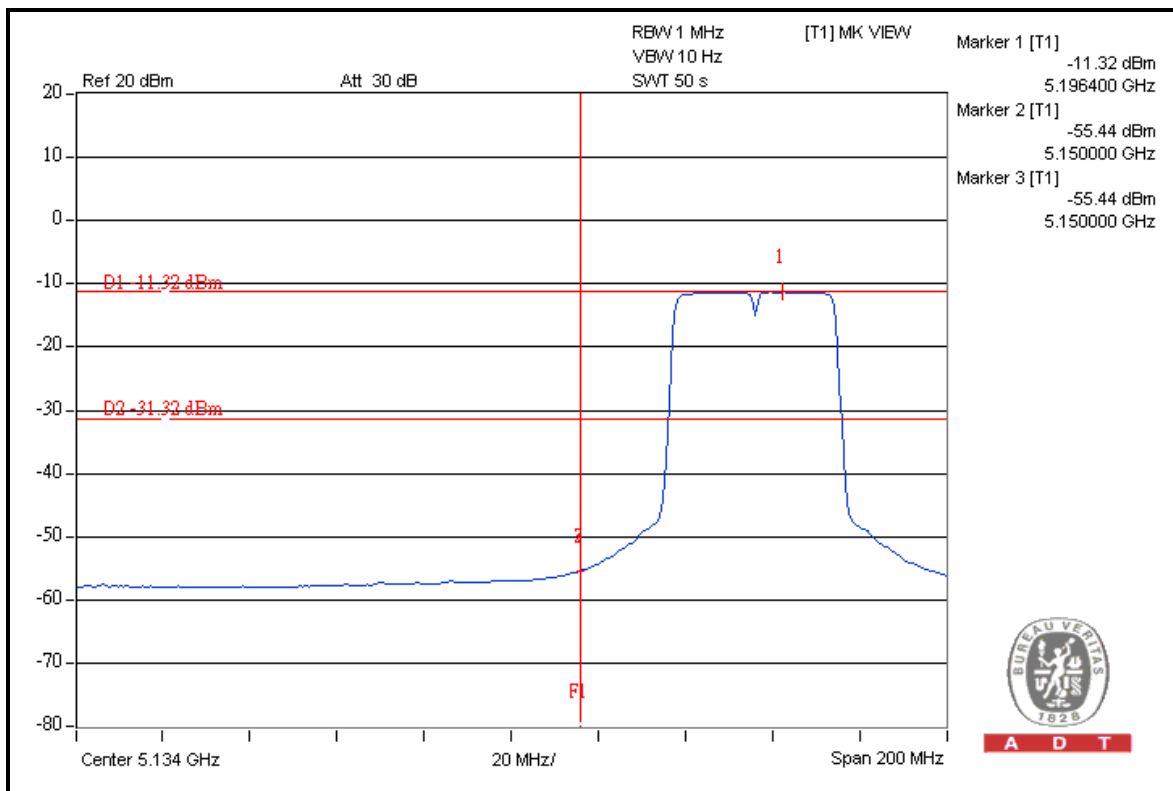
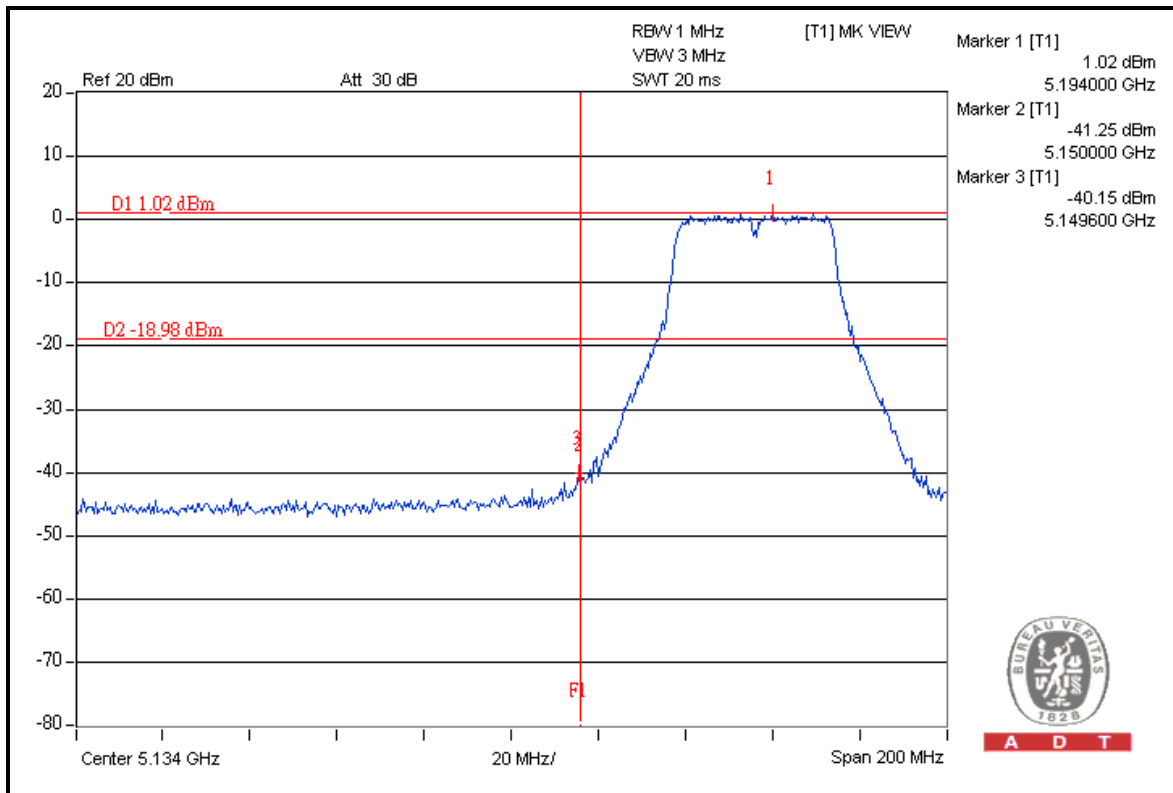



A D T

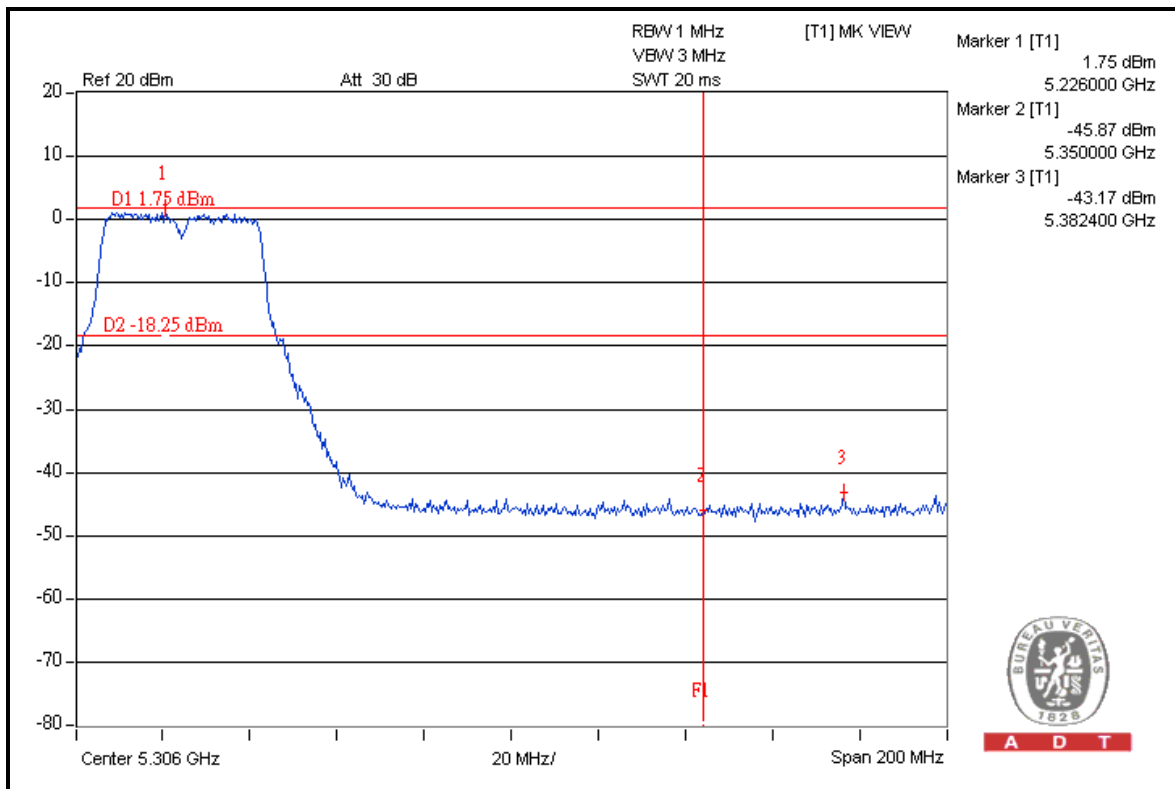
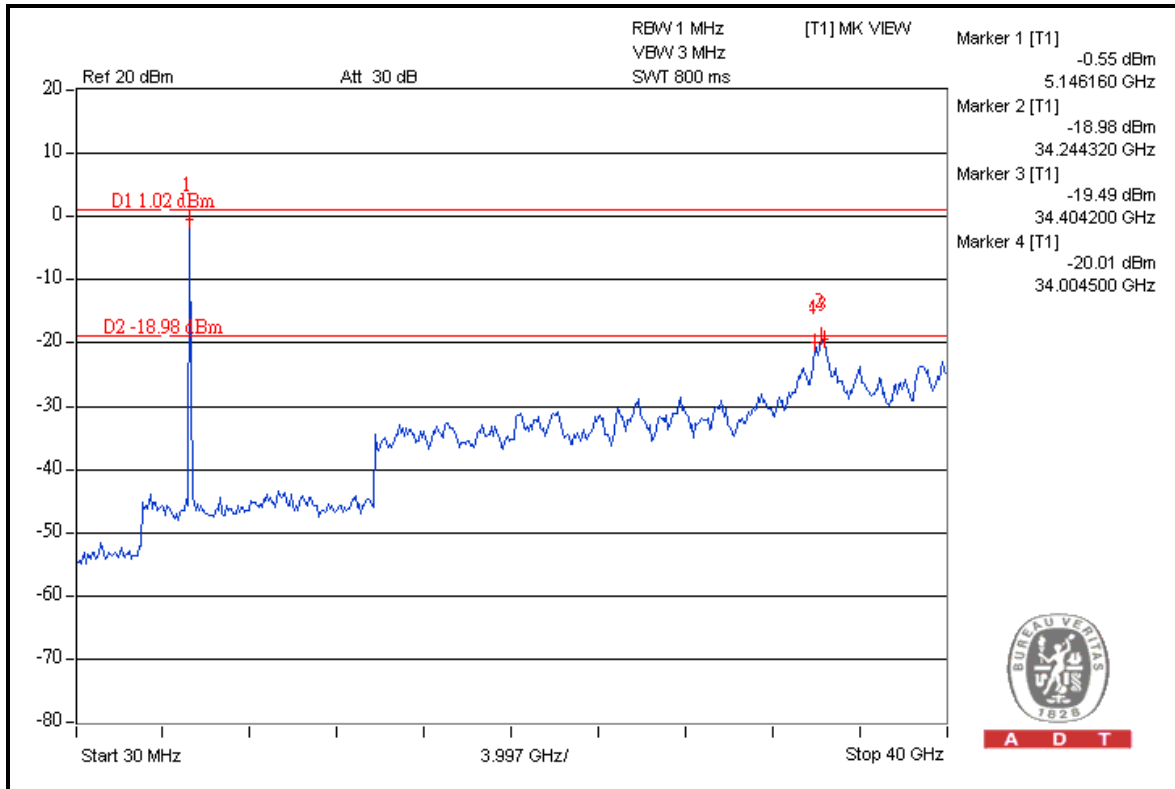



A D T

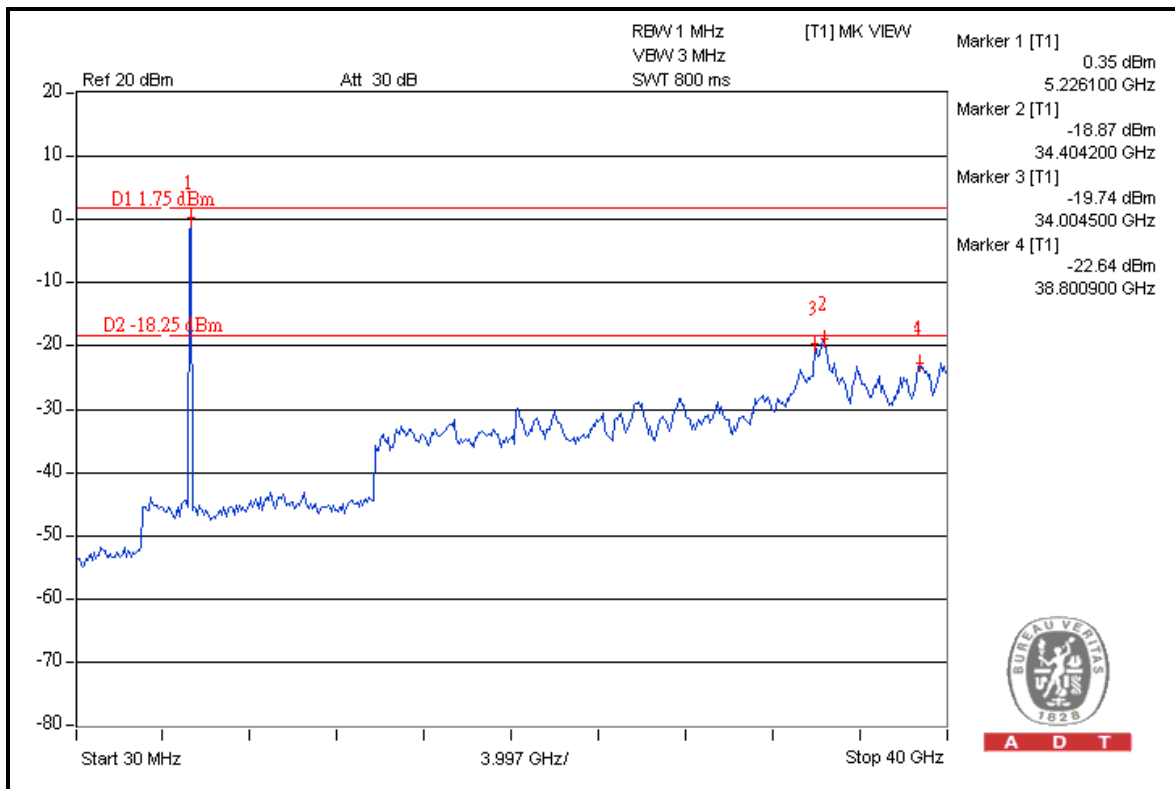
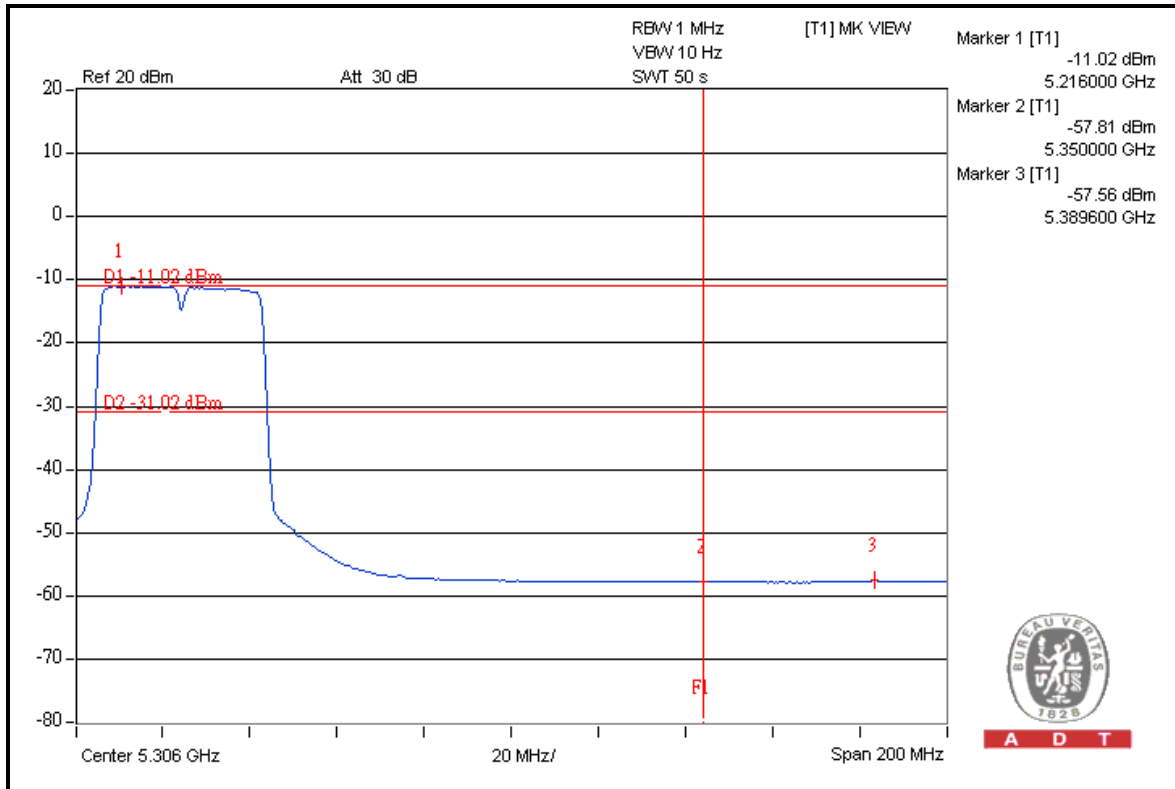



## 5. PHOTOGRAPHS OF THE TEST CONFIGURATION

Please refer to the attached file (Test Setup Photo).



## 6. INFORMATION ON THE TESTING LABORATORIES

We, Bureau Veritas Consumer Products Services (H.K.) Ltd., Taoyuan Branch, were founded in 1988 to provide our best service in EMC, Radio, Telecom and Safety consultation. Our laboratories are accredited and approved according to ISO/IEC 17025.

Copies of accreditation and authorization certificates of our laboratories obtained from approval agencies can be downloaded from our web site: [www.adt.com.tw/index.5.phtml](http://www.adt.com.tw/index.5.phtml). If you have any comments, please feel free to contact us at the following:

**Linko EMC/RF Lab:**

Tel: 886-2-26052180

Fax: 886-2-26051924

**Hsin Chu EMC/RF Lab:**

Tel: 886-3-5935343

Fax: 886-3-5935342

**Hwa Ya EMC/RF/Safety Telecom Lab:**

Tel: 886-3-3183232

Fax: 886-3-3185050

**Email:** [service.adt@tw.bureauveritas.com](mailto:service.adt@tw.bureauveritas.com)

**Web Site:** [www.adt.com.tw](http://www.adt.com.tw)

The address and road map of all our labs can be found in our web site also.

## **7. APPENDIX A - MODIFICATIONS RECORDERS FOR ENGINEERING CHANGES TO THE EUT BY THE LAB**

No any modifications are made to the EUT by the lab during the test.

**---END---**