



# FCC RF Test Report

**APPLICANT** : Senao Networks, Inc.  
**EQUIPMENT** : Wireless 802.11 ac/a/b/g/n Access Point  
**BRAND NAME** : Senao Networks  
**MODEL NAME** : CAP7252AG  
**FCC ID** : U2M-CAP7252AG  
**STANDARD** : FCC Part 15 Subpart E §15.407  
**CLASSIFICATION** : (NII) Unlicensed National Information Infrastructure

The product was received on Jan. 28, 2016 and testing was completed on Feb. 03, 2016. We, SPORTON INTERNATIONAL INC., would like to declare that the tested sample has been evaluated in accordance with the test procedures and has been in compliance with the applicable technical standards.

The test results in this report apply exclusively to the tested model / sample. Without written approval of SPORTON INTERNATIONAL INC., the test report shall not be reproduced except in full.

Reviewed by: Joseph Lin / Supervisor

Approved by: Jones Tsai / Manager



## **SPORTON INTERNATIONAL INC.**

**No. 52, Hwa Ya 1<sup>st</sup> Rd., Hwa Ya Technology Park, Kwei-Shan District, Tao Yuan City, Taiwan, R.O.C.**

SPORTON INTERNATIONAL INC.

TEL : 886-3-327-3456

FAX : 886-3-328-4978

FCC ID : U2M-CAP7252AG

Page Number : 1 of 39

Report Issued Date : Sep. 30, 2016

Report Version : Rev. 02

Report Template No.: BU5-FR15EWLB4 AC MA Version 1.2



# TABLE OF CONTENTS

**REVISION HISTORY ..... 3**

**SUMMARY OF TEST RESULT ..... 4**

**1 GENERAL DESCRIPTION ..... 5**

1.1 Applicant ..... 5

1.2 Manufacturer ..... 5

1.3 Product Feature of Equipment Under Test ..... 5

1.4 Product Specification of Equipment Under Test ..... 6

1.5 Modification of EUT ..... 6

1.6 Testing Location ..... 7

1.7 Applicable Standards ..... 7

**2 TEST CONFIGURATION OF EQUIPMENT UNDER TEST ..... 8**

2.1 Carrier Frequency and Channel ..... 8

2.2 Pre-Scanned RF Power ..... 9

2.3 Test Mode ..... 10

2.4 Connection Diagram of Test System ..... 11

2.5 Support Unit used in test configuration and system ..... 12

2.6 EUT Operation Test Setup ..... 12

2.7 Measurement Results Explanation Example ..... 12

**3 TEST RESULT ..... 13**

3.1 6dB and 26dB and 99% Occupied Bandwidth Measurement ..... 13

3.2 Maximum Conducted Output Power Measurement ..... 16

3.3 Power Spectral Density Measurement ..... 17

3.4 Unwanted Emissions Measurement ..... 20

3.5 AC Conducted Emission Measurement ..... 25

3.6 Frequency Stability Measurement ..... 35

3.7 Automatically Discontinue Transmission ..... 36

3.8 Antenna Requirements ..... 37

**4 LIST OF MEASURING EQUIPMENT ..... 38**

**5 UNCERTAINTY OF EVALUATION ..... 39**

**APPENDIX A. CONDUCTED TEST RESULTS**

**APPENDIX B. RADIATED TEST RESULTS**

**APPENDIX C. RADIATED SPURIOUS EMISSION PLOTS**

**APPENDIX D. SETUP PHOTOGRAPHS**





### SUMMARY OF TEST RESULT

Report Section	FCC Rule	Description	Limit	Result	Remark
3.1	15.403(i)	6dB, 26dB and 99% Occupied Bandwidth	> 500kHz	Pass	-
3.2	15.407(a)	Maximum Conducted Output Power	≤ 30 dBm	Pass	-
3.3	15.407(a)	Power Spectral Density	≤ 30 dBm/500kHz	Pass	-
3.4	15.407(b)	Unwanted Emissions	≤ -17, -27 dBm/MHz & 15.209(a)	Pass	Under limit 0.45 dB at 11650.000 MHz
3.5	15.207	AC Conducted Emission	15.207(a)	Pass	Under limit 4.80 dB at 0.366 MHz
3.6	15.407(g)	Frequency Stability	Within Operation Band	Pass	-
3.7	15.407(c)	Automatically Discontinue Transmission	Discontinue Transmission	Pass	-
3.8	15.203 & 15.407(a)	Antenna Requirement	N/A	Pass	-



# 1 General Description

## 1.1 Applicant

**Senao Networks, Inc.**

3F, No. 529, Chung Cheng Rd., Hsintien, Taipei, Taiwan, R.O.C

## 1.2 Manufacturer

**Senao Networks, Inc.**

3F, No. 529, Chung Cheng Rd., Hsintien, Taipei, Taiwan, R.O.C

## 1.3 Product Feature of Equipment Under Test

Product Feature	
Equipment	Wireless 802.11 ac/a/b/g/n Access Point
Brand Name	Senao Networks
Model Name	CAP7252AG
FCC ID	U2M-CAP7252AG
EUT supports Radios application	WLAN 11a/b/g/n HT20/HT40 WLAN 11ac VHT20/VHT40/VHT80
EUT Stage	Production Unit

**Remark:** The above EUT's information was declared by manufacturer. Please refer to the specifications or user's manual for more detailed description.



### 1.4 Product Specification of Equipment Under Test

Standards-related Product Specification							
<b>Tx/Rx Channel Frequency Range</b>	5745 MHz ~ 5825 MHz						
<b>Maximum Output Power</b>	<b>MIMO &lt;Ant. 1 + 2&gt;</b> 802.11a : 22.19 dBm / 0.1656 W 802.11n HT20 : 23.25 dBm / 0.2113 W 802.11n HT40 : 23.45 dBm / 0.2213 W 802.11ac VHT20: 23.30 dBm / 0.2138 W 802.11ac VHT40: 23.58 dBm / 0.2280 W 802.11ac VHT80: 14.05 dBm / 0.0254 W						
<b>99% Occupied Bandwidth</b>	802.11a : 17.55 MHz 802.11n HT20 : 18.80 MHz 802.11n HT40 : 36.90 MHz 802.11ac VHT20 : 18.95 MHz 802.11ac VHT40 : 36.80 MHz 802.11ac VHT80 : 75.96 MHz						
<b>Type of Modulation</b>	802.11a/n : OFDM (BPSK / QPSK / 16QAM / 64QAM) 802.11ac : OFDM (BPSK / QPSK / 16QAM / 64QAM / 256QAM)						
<b>Antenna Type</b>	Ant. 1 : PIFA Antenna Ant. 2 : PIFA Antenna						
<b>Antenna Gain</b>	Ant. 1 : 5.23 dBi Ant. 2 : 5.68 dBi						
<b>Antenna Function Description</b>	<table border="1"> <thead> <tr> <th></th> <th>Ant. 1</th> <th>Ant. 2</th> </tr> </thead> <tbody> <tr> <td>802.11 a/n/ac MIMO</td> <td>V</td> <td>V</td> </tr> </tbody> </table>		Ant. 1	Ant. 2	802.11 a/n/ac MIMO	V	V
	Ant. 1	Ant. 2					
802.11 a/n/ac MIMO	V	V					

### 1.5 Modification of EUT

No modifications are made to the EUT during all test items.



### 1.6 Testing Location

Sporton Lab is accredited to ISO 17025 by Taiwan Accreditation Foundation (TAF code : 1190) and the FCC designation No. TW1022 under the FCC 2.948(e) by Mutual Recognition Agreement (MRA) in FCC Test.

<b>Test Site</b>	SPORTON INTERNATIONAL INC.	
<b>Test Site Location</b>	No. 52, Hwa Ya 1 <sup>st</sup> Rd., Hwa Ya Technology Park, Kwei-Shan District, Tao Yuan City, Taiwan, R.O.C. TEL: +886-3-327-3456 FAX: +886-3-328-4978	
<b>Test Site No.</b>	<b>Sporton Site No.</b>	
	TH02-HY	CO05-HY

**Note:** The test site complies with ANSI C63.4 2014 requirement.

<b>Test Site</b>	SPORTON INTERNATIONAL INC.	
<b>Test Site Location</b>	No.58, Aly. 75, Ln. 564, Wenhua 3rd Rd. Guishan Dist, Taoyuan City, Taiwan (R.O.C.) TEL: +886-3-327-0868 FAX: +886-3-327-0855	
<b>Test Site No.</b>	<b>Sporton Site No.</b>	
	03CH12-HY	

**Note:** The test site complies with ANSI C63.4 2014 requirement.

### 1.7 Applicable Standards

According to the specifications of the manufacturer, the EUT must comply with the requirements of the following standards:

- ♦ FCC Part 15 Subpart E
- ♦ FCC KDB 789033 D02 General UNII Test Procedures New Rules v01r03
- ♦ FCC KDB 662911 D01 Multiple Transmitter Output v02r01.
- ♦ ANSI C63.10-2013

**Remark:** All test items were verified and recorded according to the standards and without any deviation during the test.



## 2 Test Configuration of Equipment Under Test

The EUT has been associated with peripherals and configuration operated in a manner tended to maximize its emission characteristics in a typical application. Frequency range investigated: conducted emission (150 kHz to 30 MHz) and radiated emission (9 kHz to the 10th harmonic of the highest fundamental frequency or to 40 GHz, whichever is lower). For radiated measurement, pre-scanned in three orthogonal panels, X, Y, Z. The worst cases (Y plane) were recorded in this report.

The final configuration from all the combinations and the worst-case data rates were investigated by measuring the maximum power across all the data rates and modulation modes under section 2.2.

Based on the worst configuration found above, the RF power setting is set individually to meet FCC compliance limit for the final conducted and radiated tests shown in section 2.3.

### 2.1 Carrier Frequency and Channel

Frequency Band	Channel	Freq. (MHz)	Channel	Freq. (MHz)
5725-5850 MHz Band 4 (U-NII-3)	149	5745	157	5785
	<b>151</b>	<b>5755</b>	<b>159</b>	<b>5795</b>
	153	5765	161	5805
	155	5775	165	5825

**Note:** The above Frequency and Channel in boldface were 802.11n HT40.





## 2.2 Pre-Scanned RF Power

Preliminary tests were performed in different data rate and data rate associated with the highest power were chosen for full test in the following tables.

### MIMO <Ant. 1+2>

5GHz 802.11a mode								
Data Rate (MHz)	6M bps	9M bps	12M bps	18M bps	24M bps	36M bps	48M bps	54M bps
Average Power (dBm)	22.19	21.83	22.00	22.03	22.18	21.57	21.83	21.73

5GHz 802.11n HT20 mode								
Data Rate (MHz)	MCS0	MCS1	MCS2	MCS3	MCS4	MCS5	MCS6	MCS7
Average Power (dBm)	23.25	22.86	23.00	23.04	22.96	22.62	22.77	22.71

5GHz 802.11n HT40 mode								
Data Rate (MHz)	MCS0	MCS1	MCS2	MCS3	MCS4	MCS5	MCS6	MCS7
Average Power (dBm)	23.45	23.27	23.23	23.28	23.09	22.88	22.84	22.87

5GHz 802.11ac VHT20 mode									
Data Rate (MHz)	MCS 0	MCS 1	MCS 2	MCS 3	MCS 4	MCS 5	MCS 6	MCS 7	MCS 8
Average Power (dBm)	23.30	22.92	22.77	22.98	22.86	22.84	22.80	22.88	22.80

5GHz 802.11ac VHT40 mode										
Data Rate (MHz)	MCS 0	MCS 1	MCS 2	MCS 3	MCS 4	MCS 5	MCS 6	MCS 7	MCS 8	MCS 9
Average Power (dBm)	23.58	23.40	23.56	23.52	23.57	23.54	23.01	23.22	23.13	23.11

5GHz 802.11ac VHT80 mode										
Data Rate (MHz)	MCS 0	MCS 1	MCS 2	MCS 3	MCS 4	MCS 5	MCS 6	MCS 7	MCS 8	MCS 9
Average Power (dBm)	14.05	13.98	13.93	13.83	13.92	13.93	13.86	13.96	13.91	13.92

Note: MIMO Ant. 1+2 is a calculated result from sum of the power MIMO Ant. 1 and MIMO Ant. 2.



### 2.3 Test Mode

Final test mode of conducted test items and radiated spurious emissions are considering the modulation and worse data rates from the power table described in section 2.2.

#### MIMO Antenna

Modulation	Data Rate
802.11a	6 Mbps
802.11n HT20	MCS0
802.11n HT40	MCS0
802.11ac VHT20	MCS0
802.11ac VHT40	MCS0
802.11ac VHT80	MCS0

<b>AC Conducted Emission</b>	Mode 1 : 5G Tx + RJ-45 Link + Adapter Mode 2 : 5G Tx + RJ-45 Link + PoE
<b>Remark:</b> The worst case of conducted emission is mode1; only the test data of it was reported.	

Ch. #		Band IV : 5725-5850 MHz		
		802.11a	802.11n HT20	802.11n HT40
L	Low	149	149	151
M	Middle	157	157	-
H	High	165	165	159

Ch. #		Band IV : 5725-5850 MHz		
		802.11ac VHT20	802.11ac VHT40	802.11ac VHT80
L	Low	149	151	-
M	Middle	157	-	155
H	High	165	159	-

## 2.4 Connection Diagram of Test System

<EUT with Adapter Mode>

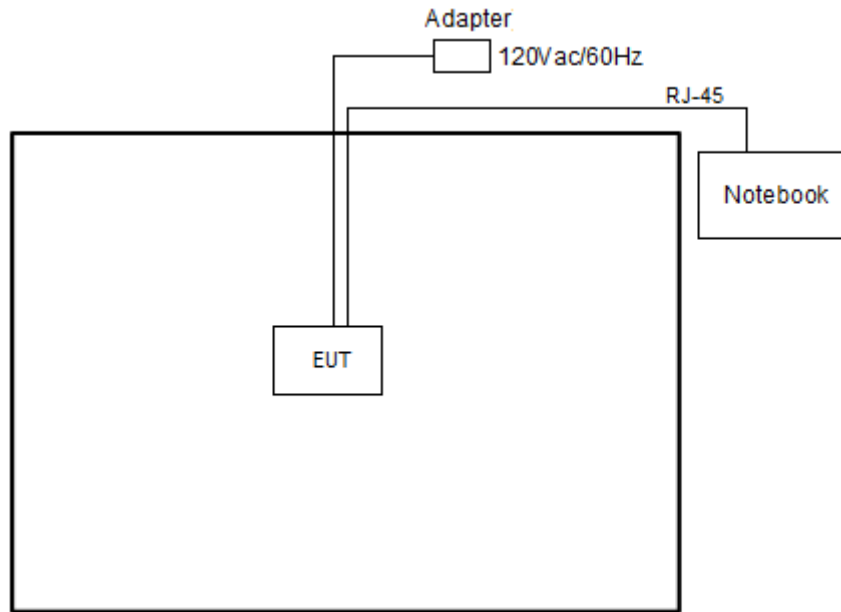

<EUT with POE Mode>

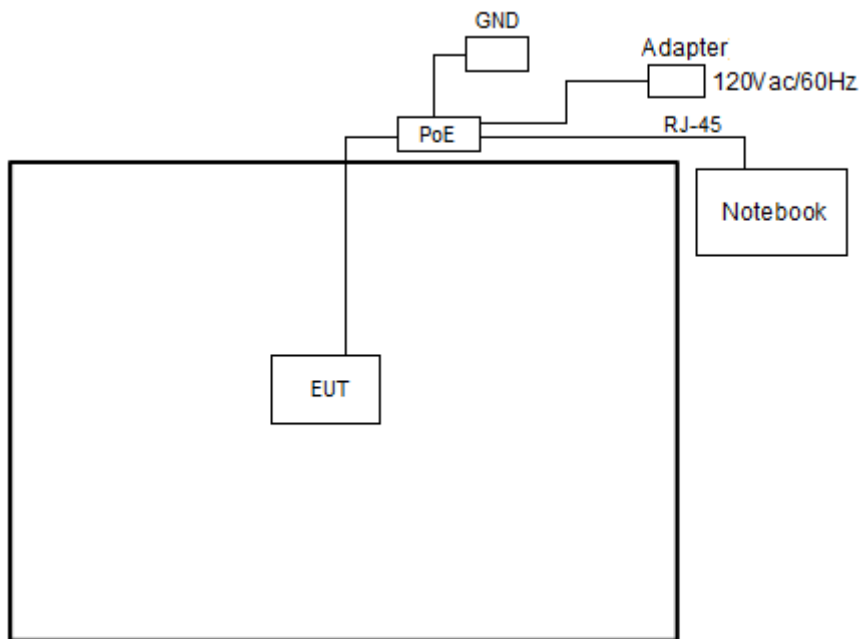



### 2.5 Support Unit used in test configuration and system

Item	Equipment	Trade Name	Model Name	FCC ID	Data Cable	Power Cord
1.	Notebook	DELL	Latitude E6320	FCC DoC/ Contains FCC ID: QDS-BRCM1054	N/A	AC I/P: Unshielded, 1.2 m DC O/P: Shielded, 1.8 m
2.	Notebook	Lenovo	M490S	FCC DoC	N/A	AC I/P: Unshielded, 1.2 m DC O/P: Shielded, 1.8 m
3.	POE Adapter	Powertron Electronics Corp	PA1040-480IB080	N/A	N/A	1.5m
4.	POE	N/A	NPE-5818	N/A	N/A	N/A
5.	Adapter	Powertron Electronics Corp.	PA1015-2I/PA1015-2I PA1015-2I120125	N/A	N/A	1.2m

### 2.6 EUT Operation Test Setup

For WLAN function, programmed RF utility, “Art2-gui Tool” installed in the notebook make the EUT provide functions like channel selection and power level for continuous transmitting and receiving signals.

N AP under large package sizes transmission.

### 2.7 Measurement Results Explanation Example

For all conducted test items:

The offset level is set in the spectrum analyzer to compensate the RF cable loss and attenuator factor between EUT conducted output port and spectrum analyzer. With the offset compensation, the spectrum analyzer reading level is exactly the EUT RF output level.

Example :

The spectrum analyzer offset is derived from RF cable loss and attenuator factor.

*Offset = RF cable loss + attenuator factor.*

Following shows an offset computation example with cable loss 4.2 dB and 10dB attenuator.

$$\begin{aligned}
\text{Offset(dB)} &= \text{RF cable loss(dB)} + \text{attenuator factor(dB)}. \\
&= 4.2 + 10 = 14.2 \text{ (dB)}
\end{aligned}$$

### 3 Test Result

#### 3.1 6dB and 26dB and 99% Occupied Bandwidth Measurement

##### 3.1.1 Description of 6dB and 26dB and 99% Occupied Bandwidth

The minimum 6 dB bandwidth shall be at least 500 kHz.

26dB and 99% Occupied bandwidth are reporting only.

##### 3.1.2 Measuring Instruments

The measuring equipment is listed in the section 4 of this test report.

##### 3.1.3 Test Procedures

1. The testing follows FCC KDB 789033 D02 General UNII Test Procedures New Rules v01r03.  
Section C) Emission bandwidth for the band 5.725-5.85GHz
2. Set RBW = 100kHz.
3. Set the VBW  $\geq 3 \times$  RBW.
4. Detector = Peak.
5. Trace mode = max hold
6. Measure the maximum width of the emission that is 6 dB down from the peak of the emission.
7. Measure and record the results in the test report.

##### 3.1.4 Test Setup

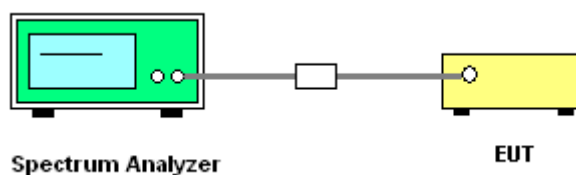



### 3.1.5 Test Result of 6dB Bandwidth

Please refer to Appendix A.

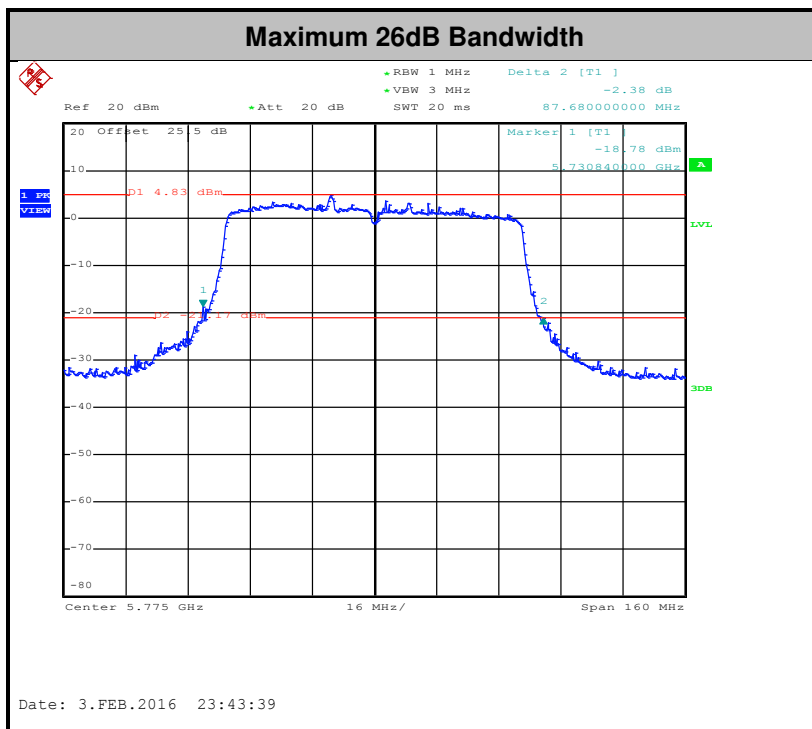
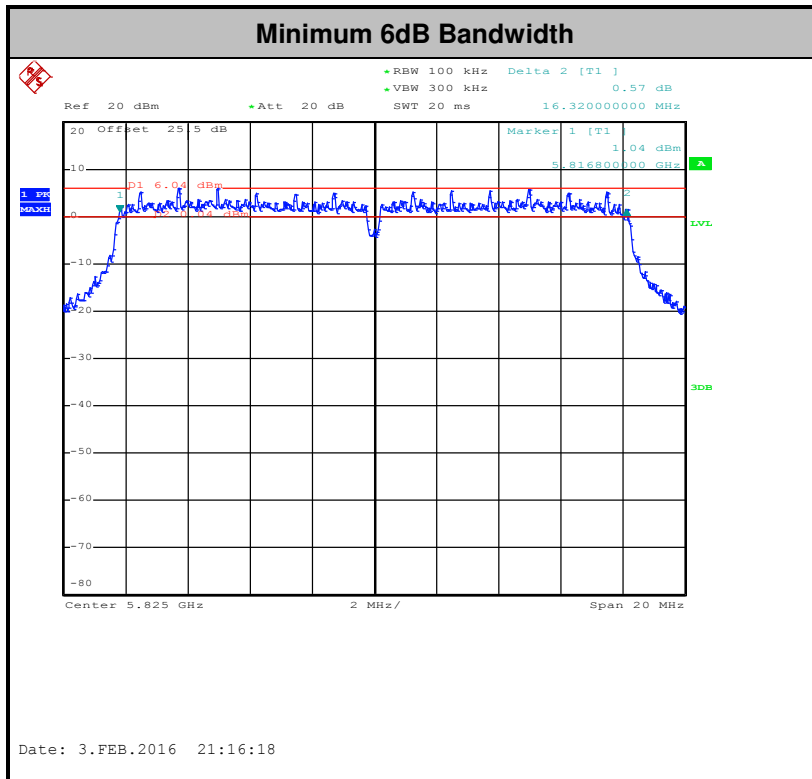

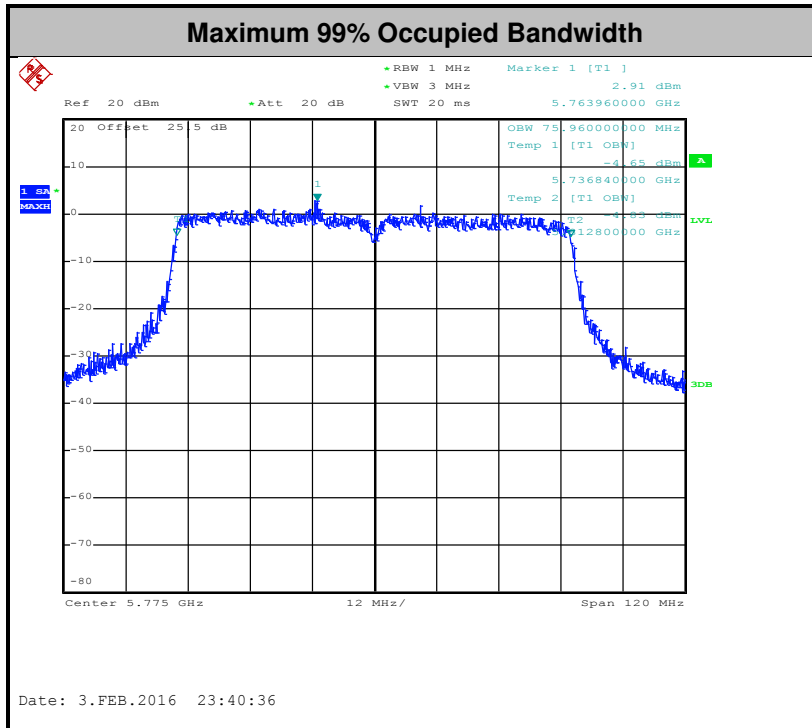

**Note:** The occupied channel bandwidth is maintained within the band of operation for all of the modulations.

## 3.2 Maximum Conducted Output Power Measurement

### 3.2.1 Limit of Maximum Conducted Output Power

For the band 5.725–5.85 GHz, the maximum conducted output power over the frequency band of operation shall not exceed 1 W.

If transmitting antennas of directional gain greater than 6 dBi are used, the peak output power shall be reduced by the amount in dB that the directional gain of the antenna exceeds 6 dBi.

### 3.2.2 Measuring Instruments

The measuring equipment is listed in the section 4 of this test report.

### 3.2.3 Test Procedures

The testing follows Method PM of FCC KDB 789033 D02 General UNII Test Procedures New Rules v01r03.

Method PM (Measurement using an RF average power meter):

1. Measurement is performed using a wideband RF power meter.
2. The EUT is configured to transmit continuously with a consistent duty cycle at its maximum power control level.
3. Measure the average power of the transmitter, and the average power is corrected with duty factor,  $10 \log(1/x)$ , where  $x$  is the duty cycle.

### 3.2.4 Test Setup

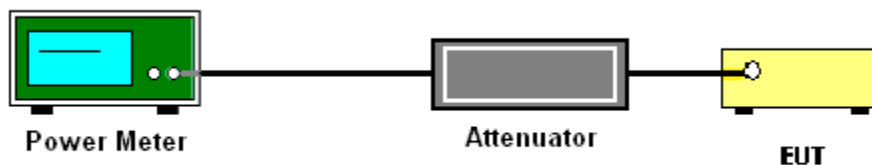

### 3.2.5 Test Result of Maximum Conducted Output Power

Please refer to Appendix A.





### 3.3 Power Spectral Density Measurement

#### 3.3.1 Limit of Power Spectral Density

For the band 5.725–5.85 GHz, the maximum power spectral density shall not exceed 30 dBm in any 500-kHz band.

If transmitting antennas of directional gain greater than 6 dBi are used, the peak output power shall be reduced by the amount in dB that the directional gain of the antenna exceeds 6 dBi.

#### 3.3.2 Measuring Instruments

The measuring equipment is listed in the section 4 of this test report.

#### 3.3.3 Test Procedures

The testing follows FCC KDB 789033 D02 General UNII Test Procedures New Rules v01r03. Section F) Maximum power spectral density.

##### # Method SA-2 #

(trace averaging across on and off times of the EUT transmissions, followed by duty cycle correction).

- Measure the duty cycle.
- Set span to encompass the entire emission bandwidth (EBW) of the signal.
- Set RBW = 300 kHz.
- Set VBW  $\geq$  1 MHz.
- Number of points in sweep  $\geq$  2 Span / RBW.
- Sweep time = auto.
- Detector = RMS
- Trace average at least 100 traces in power averaging mode.
- Add  $10 \log(500\text{kHz}/\text{RBW})$  to the test result.
- Add  $10 \log(1/x)$ , where  $x$  is the duty cycle, to the measured power in order to compute the average power during the actual transmission times. For example, add  $10 \log(1/0.25) = 6$  dB if the duty cycle is 25 percent.

1. The RF output of EUT was connected to the spectrum analyzer by a low loss cable.
2. Each plot has already offset with cable loss, and attenuator loss. Measure the PPSD and record it.
3. For MIMO mode, calculation method follows FCC KDB 662911 D01 Multiple Transmitter Output v02r01.

Method (a): Measure and sum the spectra across the outputs.

The total final Power Spectral Density is from a device with 2 transmitter outputs. The spectrum measurements of the individual outputs are all performed with the same span and number of points, the spectrum value in the first spectral bin of output 1 is summed with that in the first spectral bin of output 2 to obtain the value for the first frequency bin of the summed spectrum.

### 3.3.4 Test Setup

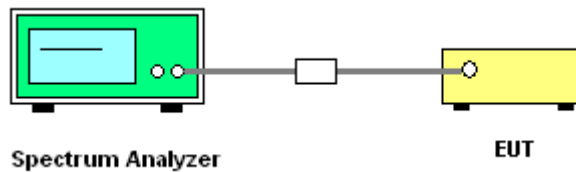



### 3.3.5 Test Result of Power Spectral Density

Please refer to Appendix A.

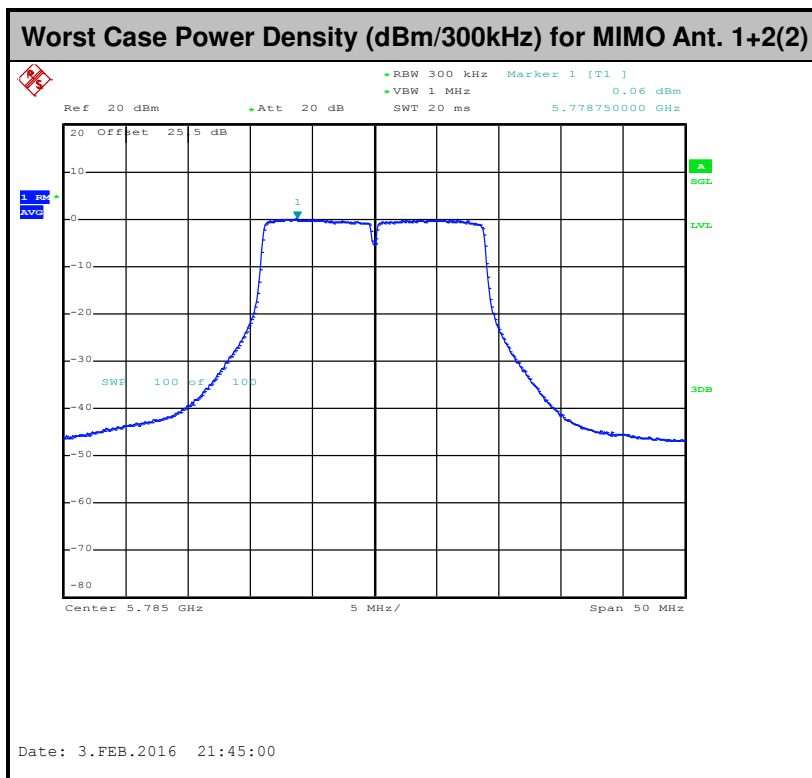
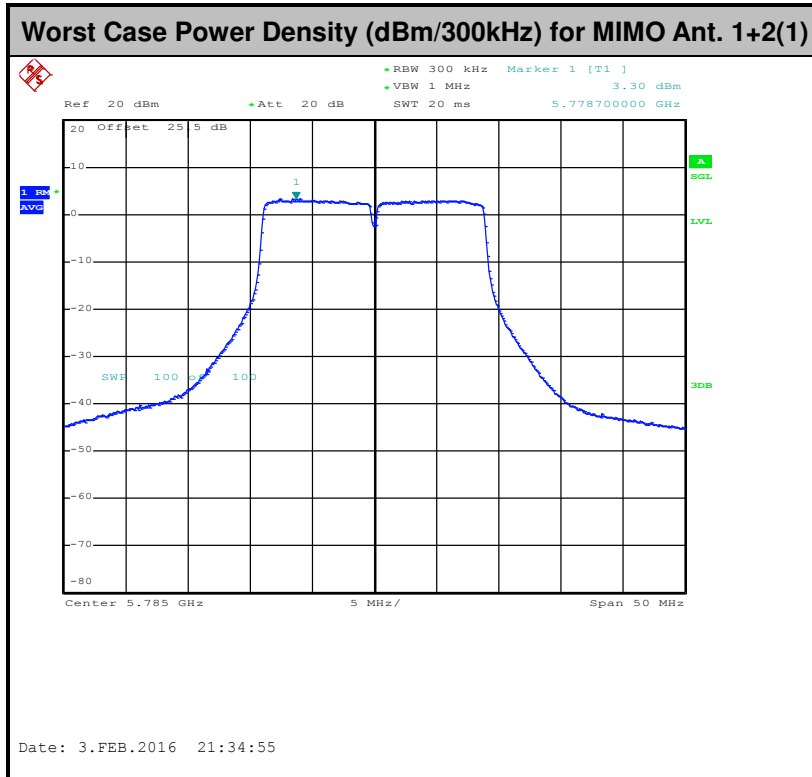



### 3.4 Unwanted Emissions Measurement

This section as specified in FCC Part 15.407(b) is to measure unwanted emissions through radiated measurement for band edge spurious emissions and out of band emissions measurement. The unwanted emissions shall comply with 15.407(b)(1) to (6), and restricted bands per FCC Part15.205.

#### 3.4.1 Limit of Unwanted Emissions

- (1) For transmitters operating in the 5725-5850 MHz band: all emissions within the frequency range from the band edge to 10 MHz above or below the band edge shall not exceed an EIRP of -17 dBm/MHz (78.3dBµV/m); for frequencies 10 MHz or greater above or below the band edge, emissions shall not exceed an EIRP of -27 dBm/MHz (68.3dBµV/m).
- (2) Unwanted spurious emissions fallen in restricted bands per FCC Part15.205 shall comply with the general field strength limits set forth in § 15.209 as below table,

Frequency (MHz)	Field Strength (microvolts/meter)	Measurement Distance (meters)
0.009 – 0.490	2400/F(kHz)	300
0.490 – 1.705	24000/F(kHz)	30
1.705 – 30.0	30	30
30 – 88	100	3
88 – 216	150	3
216 - 960	200	3
Above 960	500	3

**Note:** The following formula is used to convert the EIRP to field strength.

$$E = \frac{1000000\sqrt{30P}}{3} \mu\text{V/m, where P is the eirp (Watts)}$$

EIRP (dBm)	Field Strength at 3m (dBµV/m)
-17	78.3
- 27	68.3

- (1) KDB 789033 D02 General UNII Test Procedures New Rules v01r03 G)2)c) As specified in 15.407(b), emissions above 1000 MHz that are outside of the restricted bands are subject to a peak emission limit of -27 dBm/MHz (or -17 dBm/MHz as specified in 15.407(b)(4)). However, an out-of-band emission that complies with both the average and peak limits of 15.209 is not required to satisfy the -27 dBm/MHz or -17 dBm/MHz peak emission limit.



### **3.4.2 Measuring Instruments**

The measuring equipment is listed in the section 4 of this test report.

### **3.4.3 Test Procedures**

1. The testing follows FCC KDB 789033 D02 General UNII Test Procedures New Rules v01r03. Section G) Unwanted emissions measurement.

(1) Procedure for Unwanted Emissions Measurements Below 1000MHz

- RBW = 120 kHz
- VBW = 300 kHz
- Detector = Peak
- Trace mode = max hold

(2) Procedure for Peak Unwanted Emissions Measurements Above 1000 MHz

- RBW = 1 MHz
- VBW  $\geq$  3 MHz
- Detector = Peak
- Sweep time = auto
- Trace mode = max hold

(3) Procedures for Average Unwanted Emissions Measurements Above 1000MHz

- RBW = 1 MHz
- VBW = 10 Hz, when duty cycle is no less than 98 percent.
- VBW  $\geq$  1/T, when duty cycle is less than 98 percent where T is the minimum transmission duration over which the transmitter is on and is transmitting at its maximum power control level for the tested mode of operation.



Antenna	Band	Duty Cycle(%)	T(us)	1/T(kHz)	VBW Setting
1+2	5GHz 802.11a for Ant 1	96.18	2016	0.496031746	1kHz
1+2	5GHz 802.11a for Ant 2	96.18	2016	0.496031746	1kHz
1+2	5GHz 802.11n HT20 for Ant 1	96.72	1888	0.529661017	1kHz
1+2	5GHz 802.11n HT20 for Ant 2	95.9	1872	0.534188034	1kHz
1+2	5GHz 802.11n HT40 for Ant 1	93	930	1.075268817	3kHz
1+2	5GHz 802.11n HT40 for Ant 2	93.94	930	1.075268817	3kHz
1+2	5GHz 802.11ac VHT20 for Ant 1	95.94	1888	0.529661017	1kHz
1+2	5GHz 802.11ac VHT20 for Ant 2	95.97	1904	0.525210084	1kHz
1+2	5GHz 802.11ac VHT40 for Ant 1	93.07	940	1.063829787	3kHz
1+2	5GHz 802.11ac VHT40 for Ant 2	93.07	940	1.063829787	3kHz
1+2	5GHz 802.11ac VHT80 for Ant 1	87.36	456	2.192982456	3kHz
1+2	5GHz 802.11ac VHT80 for Ant 2	87.21	450	2.222222222	3kHz

- The EUT was placed on a turntable with 0.8 meter for frequency below 1GHz and 1.5 meter for frequency above 1GHz respectively above ground.
- The EUT was set 3 meters from the interference receiving antenna which was mounted on the top of a variable height antenna tower.
- The antenna is a broadband antenna and its height is adjusted between one meter and four meters above ground to find the maximum value of the field strength for both horizontal polarization and vertical polarization of the antenna.
- For each suspected emission, the EUT was arranged to its worst case and then adjust the antenna tower (from 1 m to 4 m) and turntable (from 0 degree to 360 degrees) to find the maximum reading.
- For testing below 1GHz, if the emission level of the EUT in peak mode was 3 dB lower than the limit specified, then peak values of EUT will be reported, otherwise, the emissions will be repeated one by one using the CISPR quasi-peak method and reported.
- For testing above 1GHz, the emission level of the EUT in peak mode was 20dB lower than average limit (that means the emission level in average mode also complies with the limit in average mode), then peak values of EUT will be reported, otherwise, the emissions will be measured in average mode again and reported.

### 3.4.4 Test Setup

For radiated emissions below 30MHz

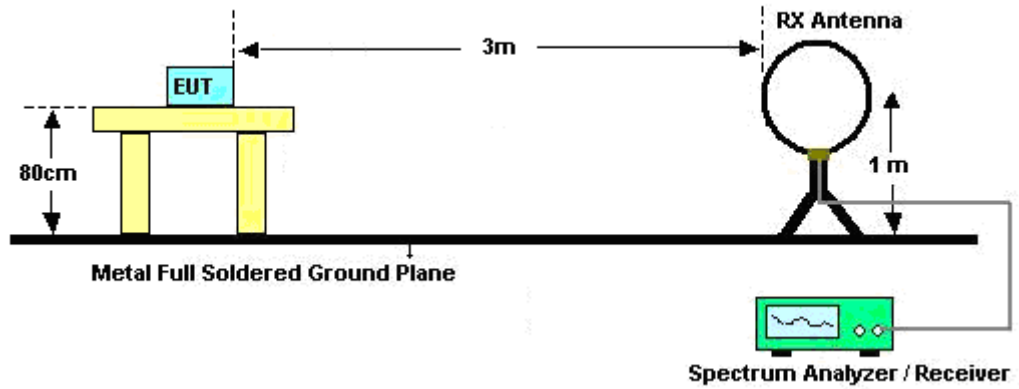

For radiated emissions from 30MHz to 1GHz

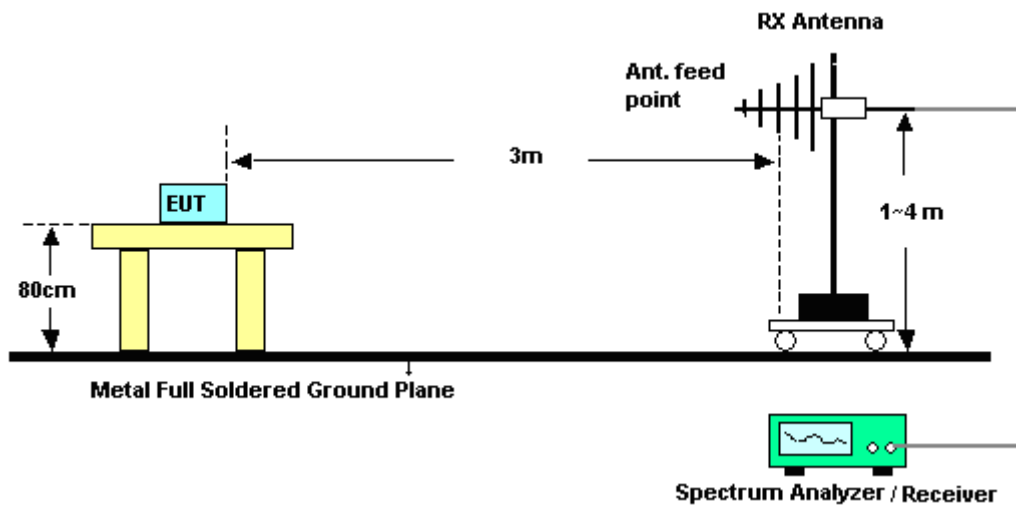

For radiated emissions above 1GHz

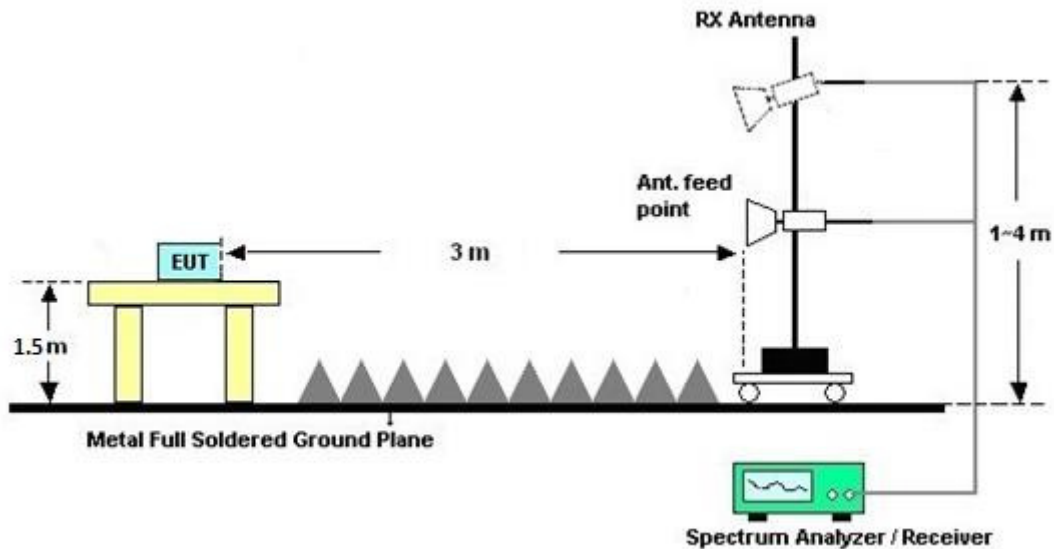

### 3.4.5 Test Results of Radiated Emissions (9 kHz ~ 30 MHz)

The low frequency, which started from 9 kHz to 30MHz, was pre-scanned and the result which was 20dB lower than the limit line per 15.31(o) was not reported.

### 3.4.6 Test Result of Radiated Band Edges

Please refer to Appendix B and Appendix C.

### 3.4.7 Test Result of Unwanted Radiated Emission (30MHz ~ 10th Harmonic)

Please refer to Appendix B and Appendix C.





### 3.5 AC Conducted Emission Measurement

#### 3.5.1 Limit of AC Conducted Emission

For equipment that is designed to be connected to the public utility (AC) power line, the radio frequency voltage that is conducted back onto the AC power line on any frequency or frequencies within the band 150 kHz to 30 MHz shall not exceed the limits in the following table.

Frequency of emission (MHz)	Conducted limit (dB $\mu$ V)	
	Quasi-peak	Average
0.15-0.5	66 to 56*	56 to 46*
0.5-5	56	46
5-30	60	50

\*Decreases with the logarithm of the frequency.

#### 3.5.2 Measuring Instruments

The measuring equipment is listed in the section 4 of this test report.

#### 3.5.3 Test Procedures

1. The EUT was placed 0.4 meter from the conducting wall of the shielding room was kept at least 80 centimeters from any other grounded conducting surface.
2. Connect EUT to the power mains through a line impedance stabilization network (LISN).
3. All the support units are connecting to the other LISN.
4. The LISN provides 50 ohm coupling impedance for the measuring instrument.
5. The FCC states that a 50 ohm, 50 microhenry LISN should be used.
6. Both sides of AC line were checked for maximum conducted interference.
7. The frequency range from 150 kHz to 30 MHz was searched.
8. Set the test-receiver system to Peak Detect Function and specified bandwidth with Maximum Hold Mode.

### 3.5.4 Test Setup

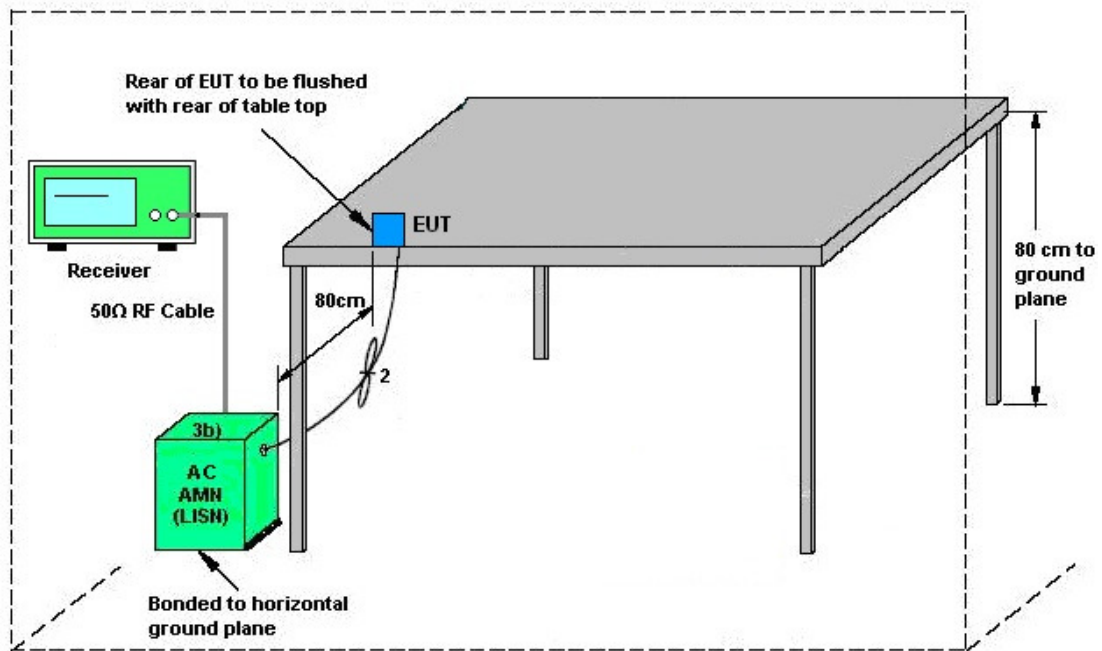

AMN = Artificial mains network (LISN)  
AE = Associated equipment  
EUT = Equipment under test  
ISN = Impedance stabilization network



### 3.5.5 Test Result of AC Conducted Emission

Test Mode :	Mode 1	Temperature :	24~25°C
Test Engineer :	Kai-Chun Chu	Relative Humidity :	53~25%
Test Voltage :	120Vac / 60Hz	Phase :	Line
Function Type :	5G Tx + RJ-45 Link + Adapter		

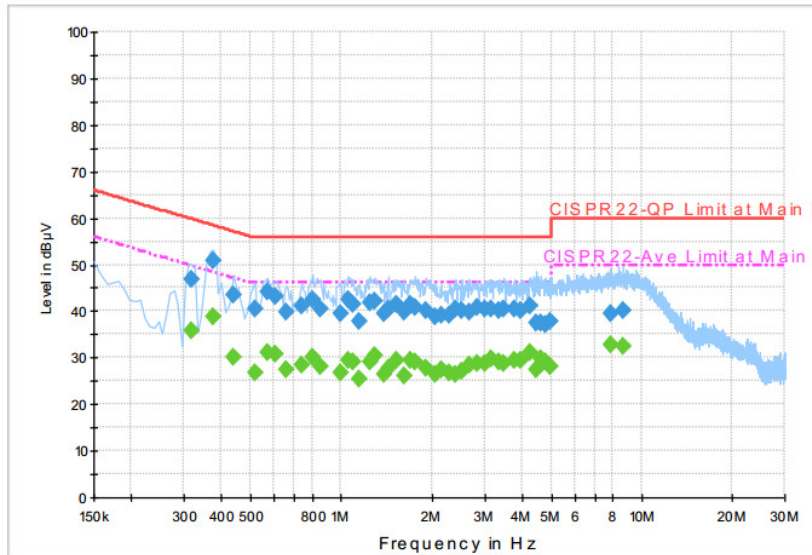

**Final Result : QuasiPeak**

Frequency (MHz)	QuasiPeak (dBµV)	Filter	Line	Corr. (dB)	Margin (dB)	Limit (dBµV)
0.318000	46.9	Off	L1	19.6	12.9	59.8
0.374000	50.7	Off	L1	19.6	7.7	58.4
0.438000	43.4	Off	L1	19.6	13.7	57.1
0.518000	40.6	Off	L1	19.6	15.4	56.0
0.566000	44.1	Off	L1	19.6	11.9	56.0
0.606000	43.2	Off	L1	19.6	12.8	56.0
0.654000	39.8	Off	L1	19.6	16.2	56.0
0.742000	41.2	Off	L1	19.6	14.8	56.0
0.806000	42.6	Off	L1	19.6	13.4	56.0
0.854000	40.5	Off	L1	19.6	15.5	56.0
0.998000	39.6	Off	L1	19.6	16.4	56.0
1.054000	42.3	Off	L1	19.6	13.7	56.0
1.094000	41.3	Off	L1	19.6	14.7	56.0
1.150000	37.9	Off	L1	19.6	18.1	56.0
1.246000	41.7	Off	L1	19.6	14.3	56.0
1.294000	42.1	Off	L1	19.6	13.9	56.0
1.382000	39.6	Off	L1	19.6	16.4	56.0
1.438000	40.6	Off	L1	19.6	15.4	56.0
1.526000	41.4	Off	L1	19.6	14.6	56.0
1.614000	39.8	Off	L1	19.6	16.2	56.0
1.702000	41.4	Off	L1	19.6	14.6	56.0



Test Mode :	Mode 1	Temperature :	24~25°C
Test Engineer :	Kai-Chun Chu	Relative Humidity :	53~25%
Test Voltage :	120Vac / 60Hz	Phase :	Line
Function Type :	5G Tx + RJ-45 Link + Adapter		

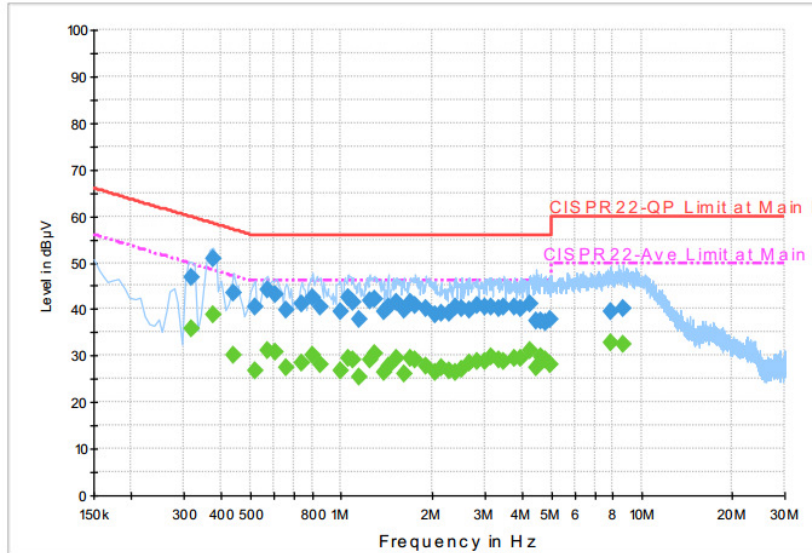

Final Result : QuasiPeak

Frequency (MHz)	QuasiPeak (dBµV)	Filter	Line	Corr. (dB)	Margin (dB)	Limit (dBµV)
1.774000	40.9	Off	L1	19.6	15.1	56.0
1.918000	40.2	Off	L1	19.6	15.8	56.0
2.054000	38.9	Off	L1	18.6	17.1	56.0
2.150000	39.1	Off	L1	18.4	16.9	56.0
2.294000	39.1	Off	L1	18.9	16.9	56.0
2.414000	40.5	Off	L1	19.1	15.5	56.0
2.534000	40.0	Off	L1	19.3	16.0	56.0
2.670000	39.8	Off	L1	19.4	16.2	56.0
2.846000	40.8	Off	L1	19.5	15.2	56.0
3.022000	40.5	Off	L1	19.6	15.5	56.0
3.150000	40.5	Off	L1	19.6	15.5	56.0
3.358000	40.1	Off	L1	19.6	15.9	56.0
3.494000	40.4	Off	L1	19.6	15.6	56.0
3.782000	40.5	Off	L1	19.7	15.5	56.0
3.966000	40.3	Off	L1	19.7	15.7	56.0
4.246000	41.0	Off	L1	19.7	15.0	56.0
4.478000	37.6	Off	L1	19.7	18.4	56.0
4.630000	37.5	Off	L1	19.7	18.5	56.0
4.806000	37.1	Off	L1	19.7	18.9	56.0
4.950000	37.6	Off	L1	19.7	18.4	56.0
7.926000	39.6	Off	L1	19.7	20.4	60.0
8.686000	40.0	Off	L1	19.7	20.0	60.0



Test Mode :	Mode 1	Temperature :	24~25°C
Test Engineer :	Kai-Chun Chu	Relative Humidity :	53~25%
Test Voltage :	120Vac / 60Hz	Phase :	Line
Function Type :	5G Tx + RJ-45 Link + Adapter		

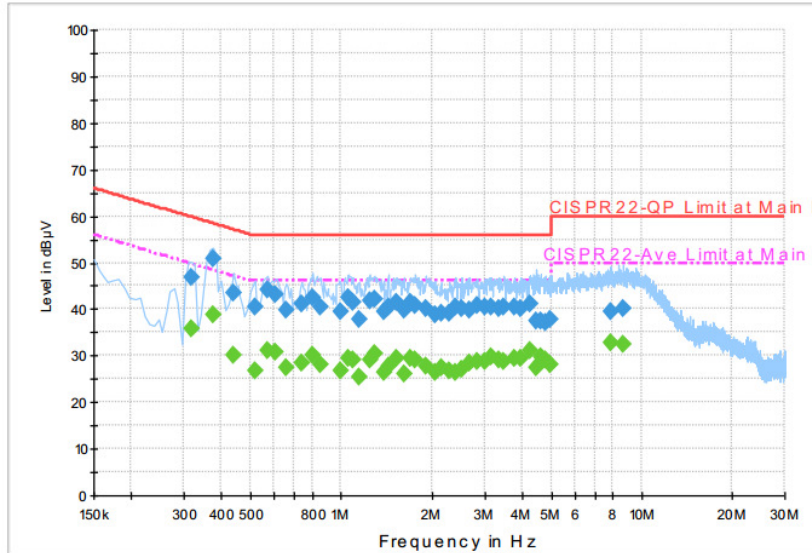

**Final Result : Average**

Frequency (MHz)	Average (dBµV)	Filter	Line	Corr. (dB)	Margin (dB)	Limit (dBµV)
0.318000	35.8	Off	L1	19.6	14.0	49.8
0.374000	38.8	Off	L1	19.6	9.6	48.4
0.438000	30.0	Off	L1	19.6	17.1	47.1
0.518000	26.8	Off	L1	19.6	19.2	46.0
0.566000	31.2	Off	L1	19.6	14.8	46.0
0.606000	30.6	Off	L1	19.6	15.4	46.0
0.654000	27.5	Off	L1	19.6	18.5	46.0
0.742000	28.5	Off	L1	19.6	17.5	46.0
0.806000	30.1	Off	L1	19.6	15.9	46.0
0.854000	28.2	Off	L1	19.6	17.8	46.0
0.998000	26.8	Off	L1	19.6	19.2	46.0
1.054000	29.5	Off	L1	19.6	16.5	46.0
1.094000	29.0	Off	L1	19.6	17.0	46.0
1.150000	25.6	Off	L1	19.6	20.4	46.0
1.246000	29.0	Off	L1	19.6	17.0	46.0
1.294000	30.3	Off	L1	19.6	15.7	46.0
1.382000	26.5	Off	L1	19.6	19.5	46.0
1.438000	27.6	Off	L1	19.6	18.4	46.0
1.526000	29.4	Off	L1	19.6	16.6	46.0
1.614000	26.0	Off	L1	19.6	20.0	46.0
1.702000	29.4	Off	L1	19.6	16.6	46.0



Test Mode :	Mode 1	Temperature :	24~25°C
Test Engineer :	Kai-Chun Chu	Relative Humidity :	53~25%
Test Voltage :	120Vac / 60Hz	Phase :	Line
Function Type :	5G Tx + RJ-45 Link + Adapter		

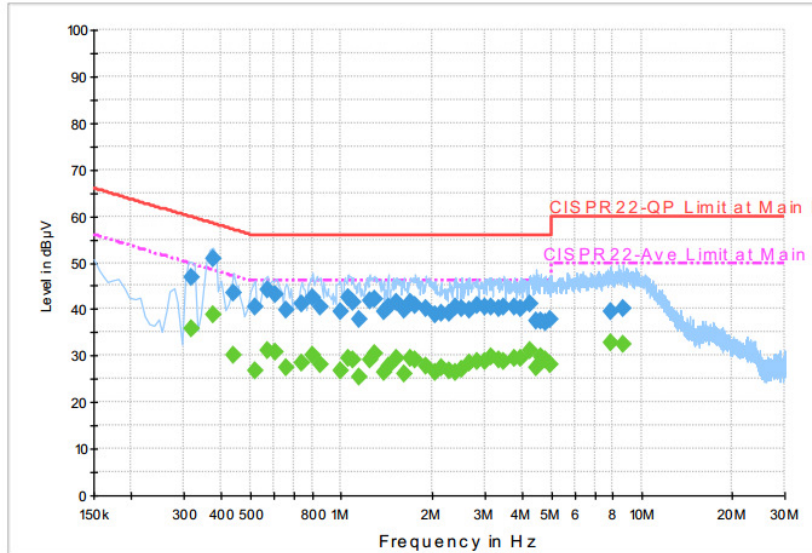

Final Result : Average

Frequency (MHz)	Average (dBµV)	Filter	Line	Corr. (dB)	Margin (dB)	Limit (dBµV)
1.774000	29.2	Off	L1	19.6	16.8	46.0
1.918000	27.9	Off	L1	19.6	18.1	46.0
2.054000	26.3	Off	L1	18.6	19.7	46.0
2.150000	27.6	Off	L1	18.4	18.4	46.0
2.294000	26.6	Off	L1	18.9	19.4	46.0
2.414000	26.3	Off	L1	19.1	19.7	46.0
2.534000	27.3	Off	L1	19.3	18.7	46.0
2.670000	28.5	Off	L1	19.4	17.5	46.0
2.846000	28.7	Off	L1	19.5	17.3	46.0
3.022000	28.9	Off	L1	19.6	17.1	46.0
3.150000	29.9	Off	L1	19.6	16.1	46.0
3.358000	29.1	Off	L1	19.6	16.9	46.0
3.494000	28.7	Off	L1	19.6	17.3	46.0
3.782000	29.6	Off	L1	19.7	16.4	46.0
3.966000	29.4	Off	L1	19.7	16.6	46.0
4.246000	31.1	Off	L1	19.7	14.9	46.0
4.478000	27.6	Off	L1	19.7	18.4	46.0
4.630000	29.6	Off	L1	19.7	16.4	46.0
4.806000	29.0	Off	L1	19.7	17.0	46.0
4.950000	28.0	Off	L1	19.7	18.0	46.0
7.926000	32.6	Off	L1	19.7	17.4	50.0
8.686000	32.3	Off	L1	19.7	17.7	50.0



Test Mode :	Mode 1	Temperature :	24~25°C
Test Engineer :	Kai-Chun Chu	Relative Humidity :	53~25%
Test Voltage :	120Vac / 60Hz	Phase :	Neutral
Function Type :	5G Tx + RJ-45 Link + Adapter		

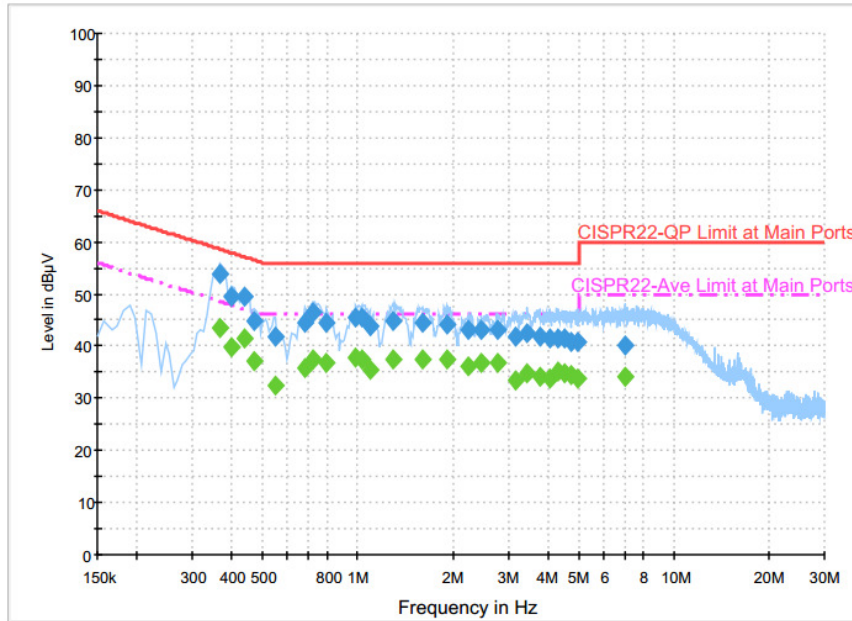

Final Result : QuasiPeak

Frequency (MHz)	QuasiPeak (dBµV)	Filter	Line	Corr. (dB)	Margin (dB)	Limit (dBµV)
0.366000	53.8	Off	N	19.6	4.8	58.6
0.398000	49.5	Off	N	19.6	8.4	57.9
0.438000	49.5	Off	N	19.6	7.6	57.1
0.470000	44.9	Off	N	19.6	11.6	56.5
0.550000	41.6	Off	N	19.6	14.4	56.0
0.678000	44.3	Off	N	19.6	11.7	56.0
0.726000	46.4	Off	N	19.6	9.6	56.0
0.798000	44.5	Off	N	19.6	11.5	56.0
0.990000	45.3	Off	N	19.6	10.7	56.0
1.030000	45.3	Off	N	19.6	10.7	56.0
1.094000	43.7	Off	N	19.6	12.3	56.0
1.294000	44.8	Off	N	19.6	11.2	56.0



Test Mode :	Mode 1	Temperature :	24~25°C
Test Engineer :	Kai-Chun Chu	Relative Humidity :	53~25%
Test Voltage :	120Vac / 60Hz	Phase :	Neutral
Function Type :	5G Tx + RJ-45 Link + Adapter		

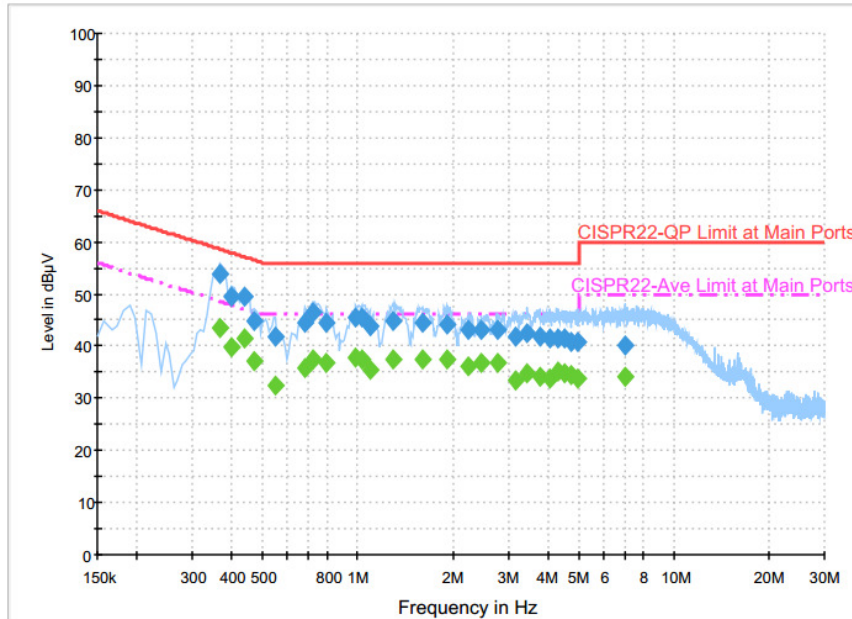

**Final Result : QuasiPeak**

Frequency (MHz)	QuasiPeak (dBµV)	Filter	Line	Corr. (dB)	Margin (dB)	Limit (dBµV)
1.598000	44.6	Off	N	19.6	11.4	56.0
1.926000	44.1	Off	N	19.6	11.9	56.0
2.230000	43.1	Off	N	18.7	12.9	56.0
2.462000	43.2	Off	N	19.2	12.8	56.0
2.782000	43.0	Off	N	19.5	13.0	56.0
3.174000	41.8	Off	N	19.6	14.2	56.0
3.446000	42.4	Off	N	19.6	13.6	56.0
3.766000	41.7	Off	N	19.6	14.3	56.0
4.070000	41.6	Off	N	19.6	14.4	56.0
4.294000	41.6	Off	N	19.6	14.4	56.0
4.510000	41.5	Off	N	19.7	14.5	56.0
4.766000	40.9	Off	N	19.7	15.1	56.0
4.950000	40.7	Off	N	19.7	15.3	56.0
7.014000	40.3	Off	N	19.7	19.7	60.0





Test Mode :	Mode 1	Temperature :	24~25°C
Test Engineer :	Kai-Chun Chu	Relative Humidity :	53~25%
Test Voltage :	120Vac / 60Hz	Phase :	Neutral
Function Type :	5G Tx + RJ-45 Link + Adapter		

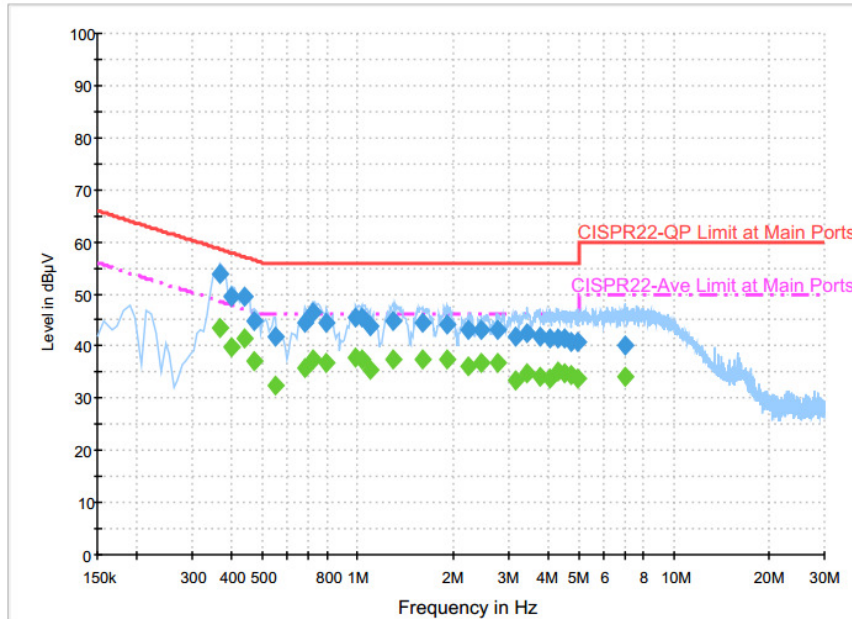

**Final Result : Average**

Frequency (MHz)	Average (dBµV)	Filter	Line	Corr. (dB)	Margin (dB)	Limit (dBµV)
0.366000	43.3	Off	N	19.6	5.3	48.6
0.398000	39.9	Off	N	19.6	8.0	47.9
0.438000	41.6	Off	N	19.6	5.5	47.1
0.470000	37.0	Off	N	19.6	9.5	46.5
0.550000	32.5	Off	N	19.6	13.5	46.0
0.678000	35.9	Off	N	19.6	10.1	46.0
0.726000	37.5	Off	N	19.6	8.5	46.0
0.798000	36.7	Off	N	19.6	9.3	46.0
0.990000	37.6	Off	N	19.6	8.4	46.0
1.030000	37.4	Off	N	19.6	8.6	46.0
1.094000	35.5	Off	N	19.6	10.5	46.0
1.294000	37.3	Off	N	19.6	8.7	46.0



Test Mode :	Mode 1	Temperature :	24~25°C
Test Engineer :	Kai-Chun Chu	Relative Humidity :	53~25%
Test Voltage :	120Vac / 60Hz	Phase :	Neutral
Function Type :	5G Tx + RJ-45 Link + Adapter		

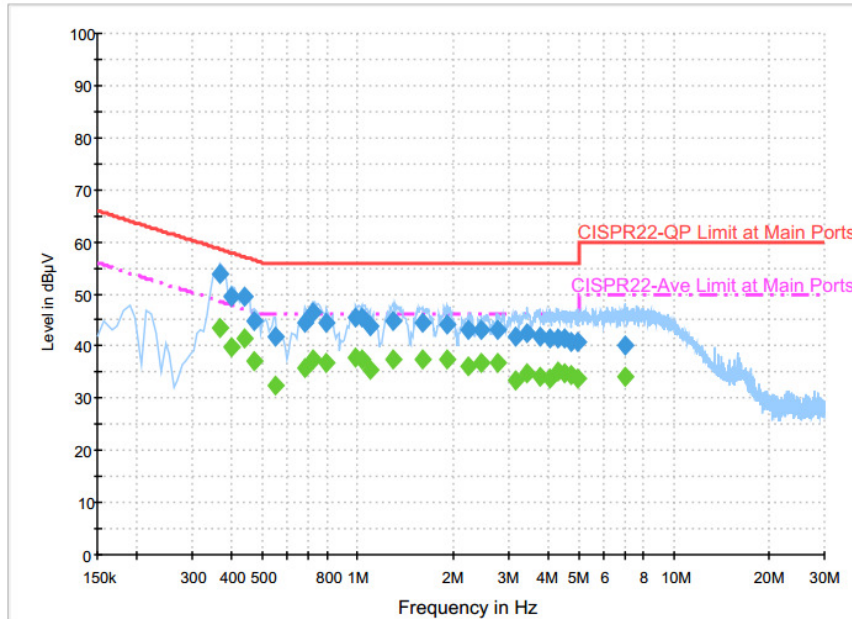

**Final Result : Average**

Frequency (MHz)	Average (dBµV)	Filter	Line	Corr. (dB)	Margin (dB)	Limit (dBµV)
1.598000	37.6	Off	N	19.6	8.4	46.0
1.926000	37.4	Off	N	19.6	8.6	46.0
2.230000	36.2	Off	N	18.7	9.8	46.0
2.462000	36.8	Off	N	19.2	9.2	46.0
2.782000	36.8	Off	N	19.5	9.2	46.0
3.174000	33.5	Off	N	19.6	12.5	46.0
3.446000	34.8	Off	N	19.6	11.2	46.0
3.766000	34.1	Off	N	19.6	11.9	46.0
4.070000	33.9	Off	N	19.6	12.1	46.0
4.294000	35.1	Off	N	19.6	10.9	46.0
4.510000	34.8	Off	N	19.7	11.2	46.0
4.766000	34.6	Off	N	19.7	11.4	46.0
4.950000	33.8	Off	N	19.7	12.2	46.0
7.014000	34.1	Off	N	19.7	15.9	50.0

## 3.6 Frequency Stability Measurement

### 3.6.1 Limit of Frequency Stability

Manufacturers of U-NII devices are responsible for ensuring frequency stability such that an emission is maintained within the band of operation under all conditions of normal operation as specified in the user's manual.

### 3.6.2 Measuring Instruments

The measuring equipment is listed in the section 4 of this test report.

### 3.6.3 Test Procedures

1. To ensure emission at the band edge is maintained within the authorized band, those values shall be measured by radiation emissions at upper and lower frequency points, and finally compensated by frequency deviation as procedures below.
2. The EUT was operated at the maximum output power, and connected to the spectrum analyzer, which is set to maximum hold function and peak detector. The peak value of the power envelope was measured and noted. The upper and lower frequency points were respectively measured relatively 10dB lower than the measured peak value.
3. The frequency deviation was calculated by adding the upper frequency point and the lower frequency point divided by two. Those detailed values of frequency deviation are provided in table below.

### 3.6.4 Test Setup

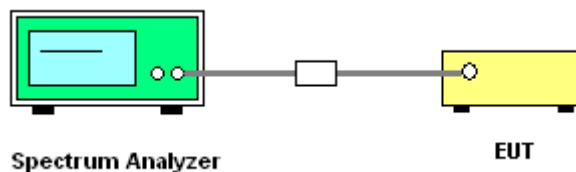

### 3.6.5 Test Result of Frequency Stability

Please refer to Appendix A.



## **3.7 Automatically Discontinue Transmission**

### **3.7.1 Limit of Automatically Discontinue Transmission**

The device shall automatically discontinue transmission in case of either absence of information to transmit or operational failure. These provisions are not intended to preclude the transmission of control or signaling information or the use of repetitive codes used by certain digital technologies to complete frame or burst intervals. Applicants shall include in their application for equipment authorization to describe how this requirement is met.

### **3.7.2 Measuring Instruments**

The measuring equipment is listed in the section 4 of this test report.

### **3.7.3 Test Result of Automatically Discontinue Transmission**

While the EUT is not transmitting any information, the EUT can automatically discontinue transmission and become standby mode for power saving. The EUT can detect the controlling signal of ACK message transmitting from remote device and verify whether it shall resend or discontinue transmission.



### 3.8 Antenna Requirements

#### 3.8.1 Standard Applicable

According to FCC 47 CFR Section 15.407(a)(1)(2) ,if transmitting antenna directional gain is greater than 6 dBi, both the peak transmit power and the peak power spectral density shall be reduced by the amount in dB that the directional gain of the antenna exceeds 6 dBi.

#### 3.8.2 Antenna Anti-Replacement Construction

An embedded-in antenna design is used.

#### 3.8.3 Antenna Gain

FCC KDB 662911 D01 Multiple Transmitter Output v02r01

For CDD transmissions, directional gain is calculated as

Directional gain =  $G_{ANT} + \text{Array Gain}$ , where Array Gain is as follows.

For power spectral density (PSD) measurements on all devices,

Array Gain =  $10 \log(N_{ANT}/N_{SS}=1)$  dB.

For power measurements on IEEE 802.11 devices,

Array Gain = 0 dB (i.e., no array gain) for  $N_{ANT} \leq 4$ .

The EUT supports CDD mode.

The power and PSD limit should be modified if the directional gain of EUT is over 6 dBi,

The directional gain “DG” is calculated as following table.

			DG	DG	Power	PSD
			for	for	Limit	Limit
	Ant 1	Ant 2	Power	PSD	Reduction	Reduction
	(dBi)	(dBi)	(dBi)	(dBi)	(dB)	(dB)
Band IV	5.23	5.68	5.68	8.47	0.00	2.47

*Power limit reduction = Composite gain – 6dBi, ( min = 0 )*

*PSD limit reduction = Composite gain + PSD Array gain – 6dBi, ( min = 0 )*



## 4 List of Measuring Equipment

Instrument	Manufacturer	Model No.	Serial No.	Characteristics	Calibration Date	Test Date	Due Date	Remark
DC Power Supply	TOPWARD	3303D	740889	N/A	May 27, 2015	Feb. 03, 2016	May 26, 2016	Conducted (TH02-HY)
Power Meter	Anritsu	ML2495A	1036004	300MHz~40GHz	Jul. 29, 2015	Feb. 03, 2016	Jul. 28, 2016	Conducted (TH02-HY)
Power Sensor	Anritsu	MA2411B	1027253	300MHz~40GHz	Jul. 29, 2015	Feb. 03, 2016	Jul. 28, 2016	Conducted (TH02-HY)
Spectrum Analyzer	Rohde & Schwarz	FSP40	100055	9kHz~40GHz	Jun. 18, 2015	Feb. 03, 2016	Jun. 17, 2016	Conducted (TH02-HY)
Loop Antenna	Rohde & Schwarz	HFH2-Z2	100315	9 kHz~30 MHz	Sep. 02, 2015	Jan. 31, 2016 ~ Feb. 03, 2016	Sep. 01, 2016	Radiation (03CH12-HY)
Bilog Antenna	TESEQ	CBL 6111D	37059	30MHz~1GHz	Dec. 29, 2015	Jan. 31, 2016 ~ Feb. 03, 2016	Dec. 28, 2016	Radiation (03CH12-HY)
EMI Test Receiver	Rohde & Schwarz	ESU26	100390	20Hz~26.5GHz	Dec. 21, 2015	Jan. 31, 2016 ~ Feb. 03, 2016	Dec. 20, 2016	Radiation (03CH12-HY)
Horn Antenna	SCHWARZBECK	BBHA 9120D	9120D-1328	1GHz ~ 18GHz	Nov. 02, 2015	Jan. 31, 2016 ~ Feb. 03, 2016	Nov. 01, 2016	Radiation (03CH12-HY)
Horn Antenna	SCHWARZBECK	BBHA 9170	BBHA9170584	18GHz- 40GHz	Nov. 02, 2015	Jan. 31, 2016 ~ Feb. 03, 2016	Nov. 01, 2016	Radiation (03CH12-HY)
Preamplifier	COM-POWER	PA-103A	161075	10MHz~1GHz	Apr. 09, 2015	Jan. 31, 2016 ~ Feb. 03, 2016	Apr. 08, 2016	Radiation (03CH12-HY)
Preamplifier	MITEQ	AMF-7D-0010 1800-30-10P	1815698	1GHz~18GHz	Dec. 14, 2015	Jan. 31, 2016 ~ Feb. 03, 2016	Dec. 13, 2016	Radiation (03CH12-HY)
Preamplifier	Agilent	8449B	3008A02375	1GHz~26.5GHz	Jan. 05, 2016	Jan. 31, 2016 ~ Feb. 03, 2016	Jan. 04, 2017	Radiation (03CH12-HY)
Controller	EMEC	EM1000	N/A	Control Turn table & Ant Mast	N/A	Jan. 31, 2016 ~ Feb. 03, 2016	N/A	Radiation (03CH12-HY)
Antenna Mast	EMEC	AM-BS-4500-B	N/A	1m~4m	N/A	Jan. 31, 2016 ~ Feb. 03, 2016	N/A	Radiation (03CH12-HY)
Turn Table	EMEC	TT2000	N/A	0-360 degree	N/A	Jan. 31, 2016 ~ Feb. 03, 2016	N/A	Radiation (03CH12-HY)
Preamplifier	MITEQ	JS44-1800400 0-33-8P	1840917	18GHz ~ 40GHz	Jun. 02, 2015	Jan. 31, 2016 ~ Feb. 03, 2016	Jun. 01, 2016	Radiation (03CH12-HY)
AC Power Source	ChainTek	APC-1000W	N/A	N/A	N/A	Feb. 03, 2016	N/A	Conduction (CO05-HY)
EMI Test Receiver	Rohde & Schwarz	ESCI 7	100724	9kHz~7GHz	Aug. 26, 2015	Feb. 03, 2016	Aug. 25, 2016	Conduction (CO05-HY)
LISN	Rohde & Schwarz	ENV216	100080	9kHz~30MHz	Dec. 02, 2015	Feb. 03, 2016	Dec. 01, 2016	Conduction (CO05-HY)
Pulse Limiter	Rohde & Schwarz	ESH3-Z2	100851	N/A	Jan. 08, 2016	Feb. 03, 2016	Jan. 07, 2017	Conduction (CO05-HY)



## 5 Uncertainty of Evaluation

### Uncertainty of Conducted Emission Measurement (150kHz ~ 30MHz)

Measuring Uncertainty for a Level of Confidence of 95% ( $U = 2Uc(y)$ )	2.26
---	------

### Uncertainty of Radiated Emission Measurement (30 MHz ~ 1000 MHz)

Measuring Uncertainty for a Level of Confidence of 95% ( $U = 2Uc(y)$ )	4.9
---	-----



## **Appendix A. Conducted Test Results**



Test Engineer:	AC Chang	Temperature:	21~25	°C
Test Date:	2016/2/3	Relative Humidity:	51~54	%

**TEST RESULTS DATA**  
**6dB and 26dB EBW and 99% OBW**

Band IV													
Mod.	Data Rate	NTX	CH.	Freq. (MHz)	99% Bandwidth (MHz)		26dB Bandwidth (MHz)		6 dB Bandwidth (MHz)		6 dB Bandwidth Min. Limit (MHz)		Pass/Fail
					Ant 1	Ant 2	Ant 1	Ant 2	Ant 1	Ant 2	Ant 1	Ant 2	
11a	6Mbps	2	149	5745	17.50	17.35	24.30	23.90	16.36	16.32	0.5	0.5	Pass
11a	6Mbps	2	157	5785	17.55	17.50	23.70	23.50	16.38	16.36	0.5	0.5	Pass
11a	6Mbps	2	165	5825	17.50	17.55	24.20	23.50	16.32	16.36	0.5	0.5	Pass
HT20	MCS0	2	149	5745	18.80	18.75	25.40	25.20	17.56	17.60	0.5	0.5	Pass
HT20	MCS0	2	157	5785	18.70	18.60	25.20	24.90	17.56	17.58	0.5	0.5	Pass
HT20	MCS0	2	165	5825	18.50	18.65	24.90	24.60	17.56	17.60	0.5	0.5	Pass
HT40	MCS0	2	151	5755	36.80	36.90	47.34	45.36	36.28	36.00	0.5	0.5	Pass
HT40	MCS0	2	159	5795	36.80	36.80	46.26	46.44	36.08	36.04	0.5	0.5	Pass
VHT20	MCS0	2	149	5745	18.65	18.65	24.80	25.50	17.56	17.60	0.5	0.5	Pass
VHT20	MCS0	2	157	5785	18.55	18.70	24.40	25.10	17.56	17.60	0.5	0.5	Pass
VHT20	MCS0	2	165	5825	18.95	18.55	25.00	24.40	17.56	17.54	0.5	0.5	Pass
VHT40	MCS0	2	151	5755	36.70	36.60	44.82	43.74	36.40	36.40	0.5	0.5	Pass
VHT40	MCS0	2	159	5795	36.80	36.80	46.62	46.80	36.32	36.40	0.5	0.5	Pass
VHT80	MCS0	2	155	5775	75.96	75.84	86.08	87.68	75.84	75.84	0.5	0.5	Pass

**TEST RESULTS DATA**  
**Average Power Table**

Band IV														
Mod.	Data Rate	NTX	CH.	Freq. (MHz)	Duty Factor (dB)		Average Conducted Power (dBm)			FCC Conducted Power Limit (dBm)		DG (dBi)		Pass/Fail
					Ant 1	Ant 2	Ant 1	Ant 2	SUM	Ant 1	Ant 2	Ant 1	Ant 2	
11a	6Mbps	2	149	5745	0.17	0.17	18.32	18.39	21.36	30.00		5.68		Pass
11a	6Mbps	2	157	5785	0.17	0.17	19.20	19.16	22.19	30.00		5.68		Pass
11a	6Mbps	2	165	5825	0.17	0.17	18.14	17.90	21.03	30.00		5.68		Pass
HT20	MCS0	2	149	5745	0.14	0.18	17.51	17.81	20.68	30.00		5.68		Pass
HT20	MCS0	2	157	5785	0.14	0.18	19.98	20.47	23.25	30.00		5.68		Pass
HT20	MCS0	2	165	5825	0.14	0.18	18.15	19.10	21.66	30.00		5.68		Pass
HT40	MCS0	2	151	5755	0.32	0.27	14.24	14.75	17.51	30.00		5.68		Pass
HT40	MCS0	2	159	5795	0.32	0.27	20.59	20.28	23.45	30.00		5.68		Pass
VHT20	MCS0	2	149	5745	0.18	0.18	17.85	17.91	20.89	30.00		5.68		Pass
VHT20	MCS0	2	157	5785	0.18	0.18	20.01	20.56	23.30	30.00		5.68		Pass
VHT20	MCS0	2	165	5825	0.18	0.18	18.42	18.92	21.69	30.00		5.68		Pass
VHT40	MCS0	2	151	5755	0.31	0.31	14.49	14.91	17.72	30.00		5.68		Pass
VHT40	MCS0	2	159	5795	0.31	0.31	20.63	20.50	23.58	30.00		5.68		Pass
VHT80	MCS0	2	155	5775	2.34	2.34	10.83	11.23	14.05	30.00		5.68		Pass

**TEST RESULTS DATA**  
**Power Spectral Density**

Band IV																
Mod.	Data Rate	NTX	CH.	Freq. (MHz)	Duty Factor (dB)		10log (500kHz /RBW) Factor (dB)		Average Power Density (dBm/500kHz)			Average PSD Limit (dBm/500kHz)		DG (dBi)		Pass /Fail
					Ant 1	Ant 2	Ant 1	Ant 2	Ant 1	Ant 2	SUM	Ant 1	Ant 2	Ant 1	Ant 2	
11a	6Mbps	2	149	5745	0.17	0.17	2.22				7.07	27.53	8.47		Pass	
11a	6Mbps	2	157	5785	0.17	0.17	2.22				8.02	27.53	8.47		Pass	
11a	6Mbps	2	165	5825	0.17	0.17	2.22				6.89	27.53	8.47		Pass	
HT20	MCS0	2	149	5745	0.14	0.18	2.22				6.60	27.53	8.47		Pass	
HT20	MCS0	2	157	5785	0.14	0.18	2.22				8.67	27.53	8.47		Pass	
HT20	MCS0	2	165	5825	0.14	0.18	2.22				6.64	27.53	8.47		Pass	
HT40	MCS0	2	151	5755	0.32	0.27	2.22				0.10	27.53	8.47		Pass	
HT40	MCS0	2	159	5795	0.32	0.27	2.22				5.96	27.53	8.47		Pass	
VHT20	MCS0	2	149	5745	0.18	0.18	2.22				6.39	27.53	8.47		Pass	
VHT20	MCS0	2	157	5785	0.18	0.18	2.22				8.54	27.53	8.47		Pass	
VHT20	MCS0	2	165	5825	0.18	0.18	2.22				6.40	27.53	8.47		Pass	
VHT40	MCS0	2	151	5755	0.31	0.31	2.22				0.13	27.53	8.47		Pass	
VHT40	MCS0	2	159	5795	0.31	0.31	2.22				6.27	27.53	8.47		Pass	
VHT80	MCS0	2	155	5775	2.34	2.34	2.22				-4.00	27.53	8.47		Pass	

**TEST RESULTS DATA**  
**Frequency Stability**

Band IV										
Mod.	Data Rate	NTX	CH.	Freq. (MHz)	Center Frequency (MHz)	Frequency Deviation (MHz)	Frequency Stability (ppm)	Temperature (°C)	Voltage (V)	Note
11a	6Mbps	1	149	5745	5745.000	0.000	0.00	20	3.2	
11a	6Mbps	1	149	5745	5745.000	0.000	0.00	20	4.2	
11a	6Mbps	1	149	5745	5745.000	0.000	0.00	20	3.7	
11a	6Mbps	1	149	5745	5745.025	0.025	4.35	-30	3.7	
11a	6Mbps	1	149	5745	5744.975	-0.025	-4.35	50	3.7	



## Appendix B. Radiated Spurious Emission

<b>Test Engineer :</b>	J.C. Liang, Ricky Su, and Nick Yu	<b>Temperature :</b>	23~25°C
		<b>Relative Humidity :</b>	55~60%

Band 4 - 5725~5850MHz

WIFI 802.11a (Band Edge @ 3m)

WIFI Ant. 1+2	Note	Frequency ( MHz )	Level ( dBμV/m )	Over Limit ( dB )	Limit Line ( dBμV/m )	Read Level ( dBμV )	Antenna Factor ( dB/m )	Cable Loss ( dB )	Preamp Factor ( dB )	Ant Pos ( cm )	Table Pos ( deg )	Peak Avg. ( P/A )	Pol. ( H/V )	
802.11a CH 149 5745MHz		5712.84	63.58	-10.42	74	53.61	32.29	11.84	34.16	357	235	P	H	
		5723	71.55	-6.75	78.3	61.56	32.31	11.84	34.16	357	235	P	H	
		5712.68	52.35	-1.65	54	42.38	32.29	11.84	34.16	357	235	A	H	
	*	5743	118.32	-	-	108.28	32.34	11.86	34.16	357	235	P	H	
	*	5743	108.4	-	-	98.36	32.34	11.86	34.16	357	235	A	H	
														H
														H
														H
			5711.88	59.47	-14.53	74	49.5	32.29	11.84	34.16	313	238	P	V
			5724.92	63.6	-14.7	78.3	53.61	32.31	11.84	34.16	313	238	P	V
			5714.92	48.74	-5.26	54	38.77	32.29	11.84	34.16	313	238	A	V
	*		5743	111.67	-	-	101.63	32.34	11.86	34.16	313	238	P	V
	*		5743	101.87	-	-	91.83	32.34	11.86	34.16	313	238	A	V
														V
														V
														V



WiFi Ant. 1+2	Note	Frequency ( MHz )	Level ( dBμV/m )	Over Limit ( dB )	Limit Line ( dBμV/m )	Read Level ( dBμV )	Antenna Factor ( dB/m )	Cable Loss ( dB )	Preamp Factor ( dB )	Ant Pos ( cm )	Table Pos ( deg )	Peak Avg. ( P/A )	Pol. ( H/V )
802.11a CH 157 5785MHz		5713.88	62.66	-11.34	74	52.69	32.29	11.84	34.16	266	234	P	H
		5724.6	61.21	-17.09	78.3	51.22	32.31	11.84	34.16	266	234	P	H
		5712.2	50.71	-3.29	54	40.74	32.29	11.84	34.16	266	234	A	H
	*	5785	120.07	-	-	109.97	32.39	11.88	34.17	266	234	P	H
	*	5785	111	-	-	100.9	32.39	11.88	34.17	266	234	A	H
		5850.72	59.87	-18.43	78.3	49.53	32.48	12.03	34.17	266	234	P	H
		5883.92	60.82	-13.18	74	50.3	32.53	12.17	34.18	266	234	P	H
		5881.92	48.85	-5.15	54	38.33	32.53	12.17	34.18	266	234	A	H
		5700.2	60.85	-13.15	74	50.9	32.27	11.84	34.16	323	212	P	V
		5715.08	59.88	-18.42	78.3	49.91	32.29	11.84	34.16	323	212	P	V
		5688.12	48.15	-5.85	54	38.22	32.27	11.82	34.16	323	212	A	V
	*	5785	116.03	-	-	105.93	32.39	11.88	34.17	323	212	P	V
	*	5785	106.89	-	-	96.79	32.39	11.88	34.17	323	212	A	V
		5859.36	58.63	-19.67	78.3	48.27	32.51	12.03	34.18	323	212	P	V
		5867.12	59.76	-14.24	74	49.26	32.51	12.17	34.18	323	212	P	V
		5876	47.61	-6.39	54	37.09	32.53	12.17	34.18	323	212	A	V



WiFi Ant. 1+2	Note	Frequency ( MHz )	Level ( dBμV/m )	Over Limit ( dB )	Limit Line ( dBμV/m )	Read Level ( dBμV )	Antenna Factor ( dB/m )	Cable Loss ( dB )	Preamp Factor ( dB )	Ant Pos ( cm )	Table Pos ( deg )	Peak Avg. ( P/A )	Pol. ( H/V )	
802.11a CH 165 5825MHz	*	5823	119.07	-	-	108.75	32.46	12.03	34.17	262	233	P	H	
	*	5823	109.49	-	-	99.17	32.46	12.03	34.17	262	233	A	H	
		5852.08	69.83	-8.47	78.3	59.49	32.48	12.03	34.17	262	233	P	H	
		5863.92	63.31	-10.69	74	52.81	32.51	12.17	34.18	262	233	P	H	
		5863.84	50.22	-3.78	54	39.72	32.51	12.17	34.18	262	233	A	H	
														H
														H
														H
	*	5823	114.54	-	-	104.22	32.46	12.03	34.17	310	177	P	V	
	*	5823	104.93	-	-	94.61	32.46	12.03	34.17	310	177	A	V	
		5850.24	65.29	-13.01	78.3	54.95	32.48	12.03	34.17	310	177	P	V	
		5860.56	59.87	-14.13	74	49.37	32.51	12.17	34.18	310	177	P	V	
		5860	48.27	-5.73	54	37.91	32.51	12.03	34.18	310	177	A	V	
														V
														V
														V
													V	
<b>Remark</b>	1. No other spurious found. 2. All results are PASS against Peak and Average limit line.													





Band 4 5725~5850MHz

WIFI 802.11a (Harmonic @ 3m)

WIFI Ant. 1+2	Note	Frequency ( MHz )	Level ( dBμV/m )	Over Limit ( dB )	Limit Line ( dBμV/m )	Read Level ( dBμV )	Antenna Factor ( dB/m )	Cable Loss ( dB )	Preamp Factor ( dB )	Ant Pos ( cm )	Table Pos ( deg )	Peak Avg. ( P/A )	Pol. ( H/V )
802.11a CH 149 5745MHz		11490	58.95	-15.05	74	58.22	40.11	18.4	57.78	243	121	P	H
		11490	49.22	-4.78	54	48.49	40.11	18.4	57.78	243	121	A	H
		17232	53.44	-20.56	74	45.79	41.65	23.14	57.14	376	324	P	H
		17232	41.67	-12.33	54	34.02	41.65	23.14	57.14	376	324	A	H
		11490	58.68	-15.32	74	57.95	40.11	18.4	57.78	240	342	P	V
		11490	45.62	-8.38	54	44.89	40.11	18.4	57.78	240	342	A	V
		17232	49.73	-24.27	74	42.08	41.65	23.14	57.14	100	0	P	V
802.11a CH 157 5785MHz		11570	65.65	-8.35	74	65.01	39.95	18.49	57.8	209	128	P	H
		11570	53.16	-0.84	54	52.52	39.95	18.49	57.8	209	128	A	H
		17355	60.49	-13.51	74	52.78	42.02	23.25	57.56	201	31	P	H
		17355	47.01	-6.99	54	39.3	42.02	23.25	57.56	201	31	A	H
		11570	64.17	-9.83	74	63.53	39.95	18.49	57.8	255	154	P	V
		11570	51.05	-2.95	54	50.41	39.95	18.49	57.8	255	154	A	V
		17355	53.29	-20.71	74	45.58	42.02	23.25	57.56	300	37	P	V
		17355	40.38	-13.62	54	32.67	42.02	23.25	57.56	300	37	A	V
802.11a CH 165 5825MHz		11650	66.03	-7.97	74	65.45	39.8	18.58	57.8	204	129	P	H
		11650	53.55	-0.45	54	52.97	39.8	18.58	57.8	204	129	A	H
		17475	57.86	-16.14	74	50.09	42.39	23.36	57.98	200	14	P	H
		17475	45.22	-8.78	54	37.45	42.39	23.36	57.98	200	14	A	H
		11655	62.94	-11.06	74	62.4	39.76	18.58	57.8	251	156	P	V
		11655	50.15	-3.85	54	49.61	39.76	18.58	57.8	251	156	A	V
		17472	50.14	-23.86	74	42.37	42.39	23.36	57.98	100	0	P	V
Remark	1. No other spurious found. 2. All results are PASS against Peak and Average limit line.												



Band 4 5725~5850MHz

WIFI 802.11ac VHT20 (Band Edge @ 3m)

WIFI Ant. 1+2	Note	Frequency ( MHz )	Level ( dBμV/m )	Over Limit ( dB )	Limit Line ( dBμV/m )	Read Level ( dBμV )	Antenna Factor ( dB/m )	Cable Loss ( dB )	Preamp Factor ( dB )	Ant Pos ( cm )	Table Pos ( deg )	Peak Avg. ( P/A )	Pol. ( H/V )	
802.11ac VHT20 CH 149 5745MHz		5712.04	65.27	-8.73	74	55.3	32.29	11.84	34.16	267	236	P	H	
		5724.84	68.68	-9.62	78.3	58.69	32.31	11.84	34.16	267	236	P	H	
		5713.16	52.51	-1.49	54	42.54	32.29	11.84	34.16	267	236	A	H	
	*	5747	118.02	-	-	107.98	32.34	11.86	34.16	267	236	P	H	
	*	5747	108.04	-	-	98	32.34	11.86	34.16	267	236	A	H	
														H
														H
														H
			5711	60.97	-13.03	74	51	32.29	11.84	34.16	329	220	P	V
			5724.68	63.56	-14.74	78.3	53.57	32.31	11.84	34.16	329	220	P	V
			5713	49.4	-4.6	54	39.43	32.29	11.84	34.16	329	220	A	V
	*		5747	112.71	-	-	102.67	32.34	11.86	34.16	329	220	P	V
	*		5747	103.29	-	-	93.25	32.34	11.86	34.16	329	220	A	V
														V
														V
													V	



WIFI Ant. 1+2	Note	Frequency ( MHz )	Level ( dBμV/m )	Over Limit ( dB )	Limit Line ( dBμV/m )	Read Level ( dBμV )	Antenna Factor ( dB/m )	Cable Loss ( dB )	Preamp Factor ( dB )	Ant Pos ( cm )	Table Pos ( deg )	Peak Avg. (P/A)	Pol. (H/V)
802.11ac VHT20 CH 157 5785MHz		5697.16	62.23	-11.77	74	52.3	32.27	11.82	34.16	266	236	P	H
		5722.92	63.34	-14.96	78.3	53.35	32.31	11.84	34.16	266	236	P	H
		5700.44	50.97	-3.03	54	41.02	32.27	11.84	34.16	266	236	A	H
	*	5785	121.03	-	-	110.93	32.39	11.88	34.17	266	236	P	H
	*	5785	111.19	-	-	101.09	32.39	11.88	34.17	266	236	A	H
		5855.28	60.29	-18.01	78.3	49.93	32.51	12.03	34.18	266	236	P	H
		5880.16	60.19	-13.81	74	49.67	32.53	12.17	34.18	266	236	P	H
		5886.56	49.11	-4.89	54	38.59	32.53	12.17	34.18	266	236	A	H
		5690.28	59.9	-14.1	74	49.97	32.27	11.82	34.16	323	212	P	V
		5718.68	59.34	-18.96	78.3	49.35	32.31	11.84	34.16	323	212	P	V
		5711.32	48.32	-5.68	54	38.35	32.29	11.84	34.16	323	212	A	V
	*	5785	116.43	-	-	106.33	32.39	11.88	34.17	323	212	P	V
	*	5785	106.28	-	-	96.18	32.39	11.88	34.17	323	212	A	V
		5851.76	59.59	-18.71	78.3	49.25	32.48	12.03	34.17	323	212	P	V
		5870.8	58.95	-15.05	74	48.43	32.53	12.17	34.18	323	212	P	V
	5864.88	47.69	-6.31	54	37.19	32.51	12.17	34.18	323	212	A	V	



WiFi Ant. 1+2	Note	Frequency ( MHz )	Level ( dBμV/m )	Over Limit ( dB )	Limit Line ( dBμV/m )	Read Level ( dBμV )	Antenna Factor ( dB/m )	Cable Loss ( dB )	Preamp Factor ( dB )	Ant Pos ( cm )	Table Pos ( deg )	Peak Avg. ( P/A )	Pol. ( H/V )	
802.11ac VHT20 CH 165 5825MHz	*	5827	118.53	-	-	108.21	32.46	12.03	34.17	271	235	P	H	
	*	5827	108.74	-	-	98.42	32.46	12.03	34.17	271	235	A	H	
		5851.68	71.68	-6.62	78.3	61.34	32.48	12.03	34.17	271	235	P	H	
		5860.4	62.3	-11.7	74	51.8	32.51	12.17	34.18	271	235	P	H	
		5865.44	49.56	-4.44	54	39.06	32.51	12.17	34.18	271	235	A	H	
														H
														H
														H
	*	5827	114.59	-	-	104.27	32.46	12.03	34.17	316	219	P	V	
	*	5827	104.53	-	-	94.21	32.46	12.03	34.17	316	219	A	V	
		5851.52	66.43	-11.87	78.3	56.09	32.48	12.03	34.17	316	219	P	V	
		5860.96	61.91	-12.09	74	51.41	32.51	12.17	34.18	316	219	P	V	
		5864.64	47.7	-6.3	54	37.2	32.51	12.17	34.18	316	219	A	V	
														V
														V
													V	
<b>Remark</b>	1. No other spurious found. 2. All results are PASS against Peak and Average limit line.													



Band 4 5725~5850MHz

WIFI 802.11ac VHT20 (Harmonic @ 3m)

WIFI Ant. 1+2	Note	Frequency ( MHz )	Level ( dBμV/m )	Over Limit ( dB )	Limit Line ( dBμV/m )	Read Level ( dBμV )	Antenna Factor ( dB/m )	Cable Loss ( dB )	Preamp Factor ( dB )	Ant Pos ( cm )	Table Pos ( deg )	Peak Avg. ( P/A )	Pol. ( H/V )
802.11ac VHT20 CH 149 5745MHz		11490	61.24	-12.76	74	60.51	40.11	18.4	57.78	200	132	P	H
		11490	47.95	-6.05	54	47.22	40.11	18.4	57.78	200	132	A	H
		17235	57.77	-16.23	74	50.12	41.65	23.14	57.14	200	12	P	H
		17235	43.82	-10.18	54	36.17	41.65	23.14	57.14	200	12	A	H
		11490	59.07	-14.93	74	58.34	40.11	18.4	57.78	265	154	P	V
		11490	46.39	-7.61	54	45.66	40.11	18.4	57.78	265	154	A	V
		17235	49.44	-24.56	74	41.79	41.65	23.14	57.14	100	0	P	V
													V
802.11ac VHT20 CH 157 5785MHz		11570	66.6	-7.4	74	65.96	39.95	18.49	57.8	195	131	P	H
		11570	53.45	-0.55	54	52.81	39.95	18.49	57.8	195	131	A	H
		17355	59.76	-14.24	74	52.05	42.02	23.25	57.56	200	14	P	H
		17355	47.02	-6.98	54	39.31	42.02	23.25	57.56	200	14	A	H
		11570	64.04	-9.96	74	63.4	39.95	18.49	57.8	265	155	P	V
		11570	50.45	-3.55	54	49.81	39.95	18.49	57.8	265	155	A	V
		17352	50.9	-23.1	74	43.19	42.02	23.25	57.56	100	0	P	V
													V
802.11ac VHT20 CH 165 5825MHz		11650	67.38	-6.62	74	66.8	39.8	18.58	57.8	200	131	P	H
		11650	53.06	-0.94	54	52.48	39.8	18.58	57.8	200	131	A	H
		17475	57.75	-16.25	74	49.98	42.39	23.36	57.98	200	12	P	H
		17475	45.34	-8.66	54	37.57	42.39	23.36	57.98	200	12	A	H
		11650	63.64	-10.36	74	63.06	39.8	18.58	57.8	260	154	P	V
		11650	49.7	-4.3	54	49.12	39.8	18.58	57.8	260	154	A	V
		17475	50.61	-23.39	74	42.84	42.39	23.36	57.98	100	0	P	V
													V
Remark	1. No other spurious found. 2. All results are PASS against Peak and Average limit line.												



Band 4 5725~5850MHz

WIFI 802.11ac VHT40 (Band Edge @ 3m)

WIFI Ant. 1+2	Note	Frequency ( MHz )	Level ( dBμV/m )	Over Limit ( dB )	Limit Line ( dBμV/m )	Read Level ( dBμV )	Antenna Factor ( dB/m )	Cable Loss ( dB )	Preamp Factor ( dB )	Ant Pos ( cm )	Table Pos ( deg )	Peak Avg. ( P/A )	Pol. ( H/V )
802.11ac VHT40 CH 151 5755MHz		5715	61.68	-12.32	74	51.71	32.29	11.84	34.16	268	235	P	H
		5723.88	72.6	-5.7	78.3	62.61	32.31	11.84	34.16	268	235	P	H
		5715	51.75	-2.25	54	41.78	32.29	11.84	34.16	268	235	A	H
	*	5753	112.77	-	-	102.72	32.36	11.86	34.17	268	235	P	H
	*	5753	102.67	-	-	92.62	32.36	11.86	34.17	268	235	A	H
		5850.4	57.99	-20.31	78.3	47.65	32.48	12.03	34.17	268	235	P	H
		5876.16	58.62	-15.38	74	48.1	32.53	12.17	34.18	268	235	P	H
		5879.12	47.55	-6.45	54	37.03	32.53	12.17	34.18	268	235	A	H
		5712.52	60.02	-13.98	74	50.05	32.29	11.84	34.16	334	175	P	V
		5724.52	69.26	-9.04	78.3	59.27	32.31	11.84	34.16	334	175	P	V
		5705.96	49.21	-4.79	54	39.24	32.29	11.84	34.16	334	175	A	V
	*	5753	108.27	-	-	98.22	32.36	11.86	34.17	334	175	P	V
	*	5753	98.67	-	-	88.62	32.36	11.86	34.17	334	175	A	V
		5856.64	57.78	-20.52	78.3	47.42	32.51	12.03	34.18	334	175	P	V
		5862.16	57.8	-16.2	74	47.3	32.51	12.17	34.18	334	175	P	V
		5871.52	47.39	-6.61	54	36.87	32.53	12.17	34.18	334	175	A	V



WiFi Ant. 1+2	Note	Frequency ( MHz )	Level ( dBμV/m )	Over Limit ( dB )	Limit Line ( dBμV/m )	Read Level ( dBμV )	Antenna Factor ( dB/m )	Cable Loss ( dB )	Preamp Factor ( dB )	Ant Pos ( cm )	Table Pos ( deg )	Peak Avg. ( P/A )	Pol. ( H/V )
802.11ac VHT40 CH 159 5795MHz		5714.68	63.29	-10.71	74	53.32	32.29	11.84	34.16	260	234	P	H
		5724.12	63.89	-14.41	78.3	53.9	32.31	11.84	34.16	260	234	P	H
		5713.32	52.67	-1.33	54	42.7	32.29	11.84	34.16	260	234	A	H
	*	5793	118.4	-	-	108.28	32.41	11.88	34.17	260	234	P	H
	*	5793	108.56	-	-	98.44	32.41	11.88	34.17	260	234	A	H
		5851.2	68.8	-9.5	78.3	58.46	32.48	12.03	34.17	260	234	P	H
		5867.52	64.96	-9.04	74	54.46	32.51	12.17	34.18	260	234	P	H
		5868.32	53.07	-0.93	54	42.57	32.51	12.17	34.18	260	234	A	H
		5711.88	61.18	-12.82	74	51.21	32.29	11.84	34.16	247	170	P	V
		5724.28	61.4	-16.9	78.3	51.41	32.31	11.84	34.16	247	170	P	V
		5712.28	50.12	-3.88	54	40.15	32.29	11.84	34.16	247	170	A	V
	*	5793	115.3	-	-	105.18	32.41	11.88	34.17	247	170	P	V
	*	5793	105.9	-	-	95.78	32.41	11.88	34.17	247	170	A	V
		5850.16	65.94	-12.36	78.3	55.6	32.48	12.03	34.17	247	170	P	V
		5865.44	61.29	-12.71	74	50.79	32.51	12.17	34.18	247	170	P	V
	5869.52	50.67	-3.33	54	40.17	32.51	12.17	34.18	247	170	A	V	
Remark	1. No other spurious found. 2. All results are PASS against Peak and Average limit line.												



Band 4 5725~5850MHz

WIFI 802.11ac VHT40 (Harmonic @ 3m)

WIFI Ant. 1+2	Note	Frequency ( MHz )	Level ( dBμV/m )	Over Limit ( dB )	Limit Line ( dBμV/m )	Read Level ( dBμV )	Antenna Factor ( dB/m )	Cable Loss ( dB )	Preamp Factor ( dB )	Ant Pos ( cm )	Table Pos ( deg )	Peak Avg. (P/A)	Pol. (H/V)	
802.11ac VHT40 CH 151 5755MHz		11510	55.35	-18.65	74	54.6	40.1	18.45	57.8	200	131	P	H	
		11510	43.28	-10.72	54	42.53	40.1	18.45	57.8	200	131	A	H	
		17265	49.35	-24.65	74	41.69	41.75	23.17	57.26	100	0	P	H	
		11510	50.25	-23.75	74	49.5	40.1	18.45	57.8	100	0	P	H	
		17265	49.42	-24.58	74	41.76	41.75	23.17	57.26	100	0	P	V	
														V
														V
802.11ac VHT40 CH 159 5795MHz		11590	65.8	-8.2	74	65.15	39.91	18.54	57.8	200	130	P	H	
		11590	52.78	-1.22	54	52.13	39.91	18.54	57.8	200	130	A	H	
		17385	57.34	-16.66	74	49.6	42.13	23.29	57.68	200	15	P	H	
		17385	45.16	-8.84	54	37.42	42.13	23.29	57.68	200	15	A	H	
		11590	61.93	-12.07	74	61.28	39.91	18.54	57.8	250	153	P	V	
		11590	49.18	-4.82	54	48.53	39.91	18.54	57.8	250	153	A	V	
		17385	49.46	-24.54	74	41.72	42.13	23.29	57.68	100	0	P	V	
													V	
Remark	1. No other spurious found. 2. All results are PASS against Peak and Average limit line.													





Band 4 5725~5850MHz

WIFI 802.11ac VHT80 (Band Edge @ 3m)

WIFI Ant. 1+2	Note	Frequency ( MHz )	Level ( dBμV/m )	Over Limit ( dB )	Limit Line ( dBμV/m )	Read Level ( dBμV )	Antenna Factor ( dB/m )	Cable Loss ( dB )	Preamp Factor ( dB )	Ant Pos ( cm )	Table Pos ( deg )	Peak Avg. ( P/A )	Pol. ( H/V )	
802.11ac VHT80 CH 155 5775MHz		5714.84	66.9	-1.4	68.3	56.93	32.29	11.84	34.16	368	238	P	H	
		5724.36	72.68	-5.62	78.3	62.69	32.31	11.84	34.16	368	238	P	H	
	*	5773	105.16	-	-	95.08	32.39	11.86	34.17	368	238	P	H	
	*	5773	96.89	-	-	86.81	32.39	11.86	34.17	368	238	A	H	
		5857.12	60.17	-18.13	78.3	49.81	32.51	12.03	34.18	368	238	P	H	
		5880.32	59.29	-9.01	68.3	48.77	32.53	12.17	34.18	368	238	P	H	
														H
														H
			5713	65.36	-2.94	68.3	55.39	32.29	11.84	34.16	328	209	P	V
			5724.12	69.76	-8.54	78.3	59.77	32.31	11.84	34.16	328	209	P	V
	*		5773	102.74	-	-	92.66	32.39	11.86	34.17	328	209	P	V
	*		5773	91.32	-	-	81.24	32.39	11.86	34.17	328	209	A	V
			5850.72	59.03	-19.27	78.3	48.69	32.48	12.03	34.17	328	209	P	V
			5861.04	58.36	-9.94	68.3	47.86	32.51	12.17	34.18	328	209	P	V
														V
													V	
Remark	1. No other spurious found. 2. All results are PASS against Peak and Average limit line.													



Band 4 5725~5850MHz

WIFI 802.11ac VHT80 (Harmonic @ 3m)

WIFI Ant. 1+2	Note	Frequency ( MHz )	Level ( dBμV/m )	Over Limit ( dB )	Limit Line ( dBμV/m )	Read Level ( dBμV )	Antenna Factor ( dB/m )	Cable Loss ( dB )	Preamp Factor ( dB )	Ant Pos ( cm )	Table Pos ( deg )	Peak Avg. (P/A)	Pol. (H/V)	
802.11ac VHT80 CH 155 5775MHz		11550	47.08	-26.92	74	46.4	39.99	18.49	57.8	100	0	P	H	
		17325	49.61	-24.39	74	41.93	41.91	23.21	57.44	100	0	P	H	
													H	
													H	
			11550	46.89	-27.11	74	46.21	39.99	18.49	57.8	100	0	P	V
			17325	49.32	-24.68	74	41.64	41.91	23.21	57.44	100	0	P	V
														V
													V	
Remark	1. No other spurious found. 2. All results are PASS against Peak and Average limit line.													



Emission below 1GHz

5GHz WIFI 802.11a Adapter mode (LF @ 3m)

WIFI	Note	Frequency	Level	Over	Limit	Read	Antenna	Cable	Preamp	Ant	Table	Peak	Pol.	
Ant.				Limit	Line	Level	Factor	Loss	Factor	Pos	Pos	Avg.		
1+2		( MHz )	( dBμV/m )	( dB )	( dBμV/m )	( dBμV )	( dB/m )	( dB )	( dB )	( cm )	( deg )	( P/A )	( H/V )	
5GHz 802.11a LF		94.26	37.06	-6.44	43.5	51.14	15.28	1.06	30.42	-	-	P	H	
		100.2	37.55	-5.95	43.5	50.53	16	1.43	30.41	117	48	P	H	
		150.69	31.65	-11.85	43.5	42.75	17.5	1.75	30.35	-	-	P	H	
		374.9	31.7	-14.3	46	37.71	21.61	2.44	30.06	-	-	P	H	
		624.8	35.53	-10.47	46	35.85	25.69	3.61	29.62	-	-	P	H	
		836.9	34.28	-11.72	46	30.95	28.4	4.28	29.35	-	-	P	H	
														H
														H
														H
														H
														H
														H
			40.26	36.3	-3.7	40	46.12	19.74	0.78	30.34	100	92	QP	V
			56.73	36.41	-3.59	40	53.36	12.73	0.78	30.46	-	-	P	V
			74.01	35.53	-4.47	40	52.1	12.81	1.06	30.44	-	-	P	V
			328	27.93	-18.07	46	35.37	20.34	2.34	30.12	-	-	P	V
			624.8	33.75	-12.25	46	34.07	25.69	3.61	29.62	-	-	P	V
			836.9	34.47	-11.53	46	31.14	28.4	4.28	29.35	-	-	P	V
														V
														V
													V	
													V	
													V	
													V	
Remark	1. No other spurious found. 2. All results are PASS against limit line.													



Emission below 1GHz

5GHz WIFI 802.11a POE mode (LF @ 3m)

WIFI	Note	Frequency	Level	Over	Limit	Read	Antenna	Cable	Preamp	Ant	Table	Peak	Pol.	
Ant.				Limit	Line	Level	Factor	Loss	Factor	Pos	Pos	Avg.		
1+2		( MHz )	( dBμV/m )	( dB )	( dBμV/m )	( dBμV )	( dB/m )	( dB )	( dB )	( cm )	( deg )	( P/A )	( H/V )	
5GHz 802.11a LF		72.66	28.21	-11.79	40	44.91	12.68	1.06	30.44	100	45	P	H	
		94.8	29.39	-14.11	43.5	43.35	15.4	1.06	30.42	-	-	P	H	
		112.08	30.61	-12.89	43.5	42.34	17.24	1.43	30.4	-	-	P	H	
		374.9	26.78	-19.22	46	32.79	21.61	2.44	30.06	-	-	P	H	
		800.5	29.63	-16.37	46	27.09	27.8	4.14	29.4	-	-	P	H	
		940.5	33.05	-12.95	46	27.38	30.05	4.75	29.13	-	-	P	H	
														H
														H
														H
														H
														H
														H
			38.37	36.8	-3.2	40	45.47	20.86	0.78	30.31	100	122	P	V
			49.17	32.39	-7.61	40	46.75	15.33	0.78	30.47	-	-	P	V
			73.74	32.04	-7.96	40	48.61	12.81	1.06	30.44	-	-	P	V
			374.9	27.59	-18.41	46	33.6	21.61	2.44	30.06	-	-	P	V
			500.2	27.01	-18.99	46	29.63	24	3.19	29.81	-	-	P	V
			736.1	29.2	-16.8	46	27.51	27.27	3.89	29.47	-	-	P	V
														V
														V
													V	
													V	
													V	
													V	
Remark	1. No other spurious found. 2. All results are PASS against limit line.													



**Note symbol**

*	<b>Fundamental Frequency</b> which can be ignored. However, the level of any unwanted emissions shall not exceed the level of the fundamental frequency.
!	Test result is <b>over limit</b> line.
P/A	<b>Peak</b> or <b>Average</b>
H/V	<b>Horizontal</b> or <b>Vertical</b>



A calculation example for radiated spurious emission is shown as below:

WIFI	Note	Frequency	Level	Over	Limit	Read	Antenna	Cable	Preamp	Ant	Table	Peak	Pol.
Ant.				Limit	Line	Level	Factor	Loss	Factor	Pos	Pos	Avg.	
1+2		( MHz )	( dBμV/m )	( dB )	( dBμV/m )	( dBμV )	( dB/m )	( dB )	( dB )	( cm )	( deg )	( P/A )	( H/V )
802.11b		2390	55.45	-18.55	74	54.51	32.22	4.58	35.86	103	308	P	H
CH 01													
2412MHz		2390	43.54	-10.46	54	42.6	32.22	4.58	35.86	103	308	A	H

- Level(dBμV/m) =  
Antenna Factor(dB/m) + Cable Loss(dB) + Read Level(dBμV) - Preamp Factor(dB)
- Over Limit(dB) = Level(dBμV/m) – Limit Line(dBμV/m)

**For Peak Limit @ 2390MHz:**

- Level(dBμV/m)  
= Antenna Factor(dB/m) + Cable Loss(dB) + Read Level(dBμV) - Preamp Factor(dB)  
= 32.22(dB/m) + 4.58(dB) + 54.51(dBμV) – 35.86 (dB)  
= 55.45 (dBμV/m)
- Over Limit(dB)  
= Level(dBμV/m) – Limit Line(dBμV/m)  
= 55.45(dBμV/m) – 74(dBμV/m)  
= -18.55(dB)

**For Average Limit @ 2390MHz:**

- Level(dBμV/m)  
= Antenna Factor(dB/m) + Cable Loss(dB) + Read Level(dBμV) - Preamp Factor(dB)  
= 32.22(dB/m) + 4.58(dB) + 42.6(dBμV) – 35.86 (dB)  
= 43.54 (dBμV/m)
- Over Limit(dB)  
= Level(dBμV/m) – Limit Line(dBμV/m)  
= 43.54(dBμV/m) – 54(dBμV/m)  
= -10.46(dB)

**Both peak and average measured complies with the limit line, so test result is “PASS”.**



## Appendix C. Radiated Spurious Emission Plots

<b>Test Engineer :</b>	J.C. Liang, Ricky Su, and Nick Yu	<b>Temperature :</b>	23~25°C
		<b>Relative Humidity :</b>	55~60%

### Note symbol

-L	Low channel location
-R	High channel location

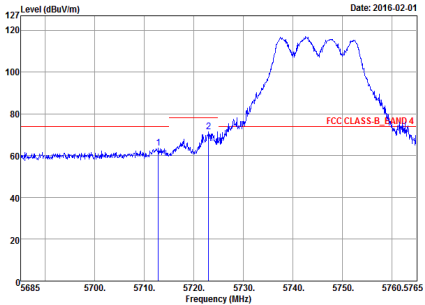
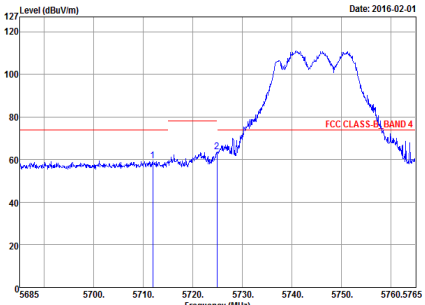
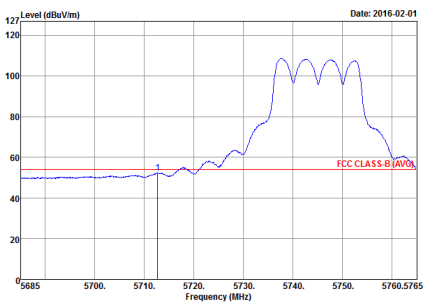
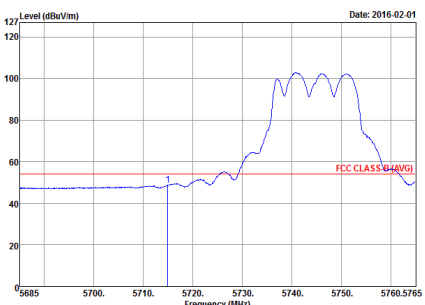

**Band 4 - 5725~5850MHz**  
**WIFI 802.11a (Band Edge @ 3m)**

WIFI	Band 4 5725~5850MHz Band Edge @ 3m	
ANT	802.11a CH149 5745MHz	
1+2	Horizontal	Vertical
<b>Peak</b>	 <p>Level (dBuV/m) vs Frequency (MHz) for Horizontal orientation. The plot shows a signal rising from ~60 dBuV/m at 5700 MHz to a peak of ~115 dBuV/m at 5745 MHz, then falling back to ~60 dBuV/m at 5765 MHz. A red horizontal line at ~75 dBuV/m is labeled 'FCC CLASS-B BAND 4'. Two vertical blue lines are marked with '1' and '2' at approximately 5715 MHz and 5725 MHz respectively. The date is 2016-02-01.</p> <p>Site : 03CH12-HY            Condition : FCC CLASS-B_BAND 4 3m HORN_9120D_1328 HORIZONTAL            RBW:1000.000KHz VBW:3000.000KHz SWT:Auto            Detector : Peak            Project : 5D2212            Mode : 12</p>	 <p>Level (dBuV/m) vs Frequency (MHz) for Vertical orientation. The plot shows a signal rising from ~60 dBuV/m at 5700 MHz to a peak of ~115 dBuV/m at 5745 MHz, then falling back to ~60 dBuV/m at 5765 MHz. A red horizontal line at ~75 dBuV/m is labeled 'FCC CLASS-B BAND 4'. Two vertical blue lines are marked with '1' and '2' at approximately 5715 MHz and 5725 MHz respectively. The date is 2016-02-01.</p> <p>Site : 03CH12-HY            Condition : FCC CLASS-B_BAND 4 3m HORN_9120D_1328 VERTICAL            RBW:1000.000KHz VBW:3000.000KHz SWT:Auto            Detector : Peak            Project : 5D2212            Mode : 12</p>
<b>Avg.</b>	 <p>Level (dBuV/m) vs Frequency (MHz) for Horizontal orientation (Average). The plot shows a smoothed signal rising from ~50 dBuV/m at 5700 MHz to a peak of ~105 dBuV/m at 5745 MHz, then falling back to ~50 dBuV/m at 5765 MHz. A red horizontal line at ~55 dBuV/m is labeled 'FCC CLASS-B (AVG)'. The date is 2016-02-01.</p> <p>Site : 03CH12-HY            Condition : FCC CLASS-B (AVG) 3m HORN_9120D_1328 HORIZONTAL            RBW:1000.000KHz VBW:1.000KHz SWT:Auto            Detector : Peak            Project : 5D2212            Mode : 12</p>	 <p>Level (dBuV/m) vs Frequency (MHz) for Vertical orientation (Average). The plot shows a smoothed signal rising from ~50 dBuV/m at 5700 MHz to a peak of ~105 dBuV/m at 5745 MHz, then falling back to ~50 dBuV/m at 5765 MHz. A red horizontal line at ~55 dBuV/m is labeled 'FCC CLASS-B (AVG)'. The date is 2016-02-01.</p> <p>Site : 03CH12-HY            Condition : FCC CLASS-B (AVG) 3m HORN_9120D_1328 VERTICAL            RBW:1000.000KHz VBW:1.000KHz SWT:Auto            Detector : Peak            Project : 5D2212            Mode : 12</p>



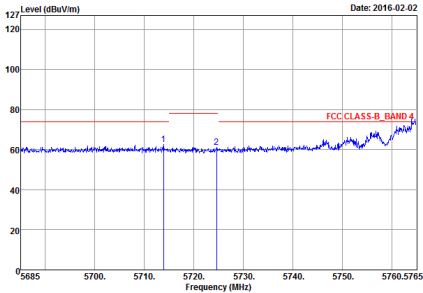
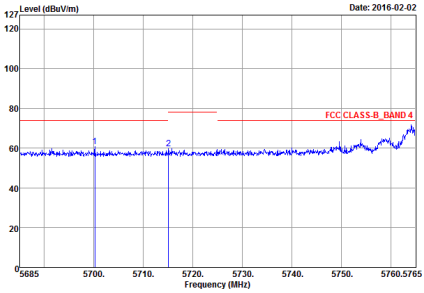
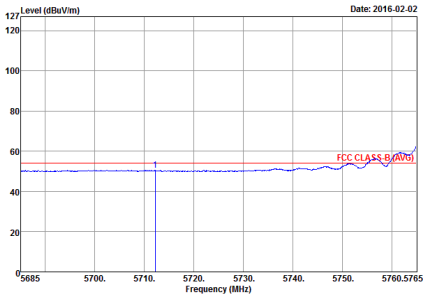
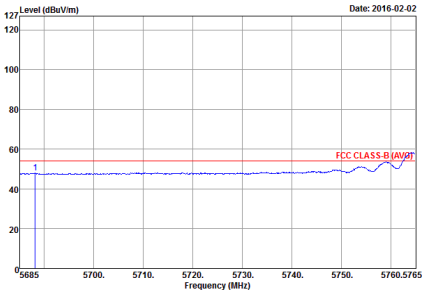

WIFI	Band 4 5725~5850MHz Band Edge @ 3m	
ANT	802.11a CH157 5785MHz - L	
1+2	Horizontal	Vertical
<p><b>Peak</b></p>	 <p>Level (dBuV/m) vs Frequency (MHz) plot for Horizontal orientation. The y-axis ranges from 0 to 127 dBuV/m, and the x-axis ranges from 5685 to 5765 MHz. A red horizontal line indicates the FCC CLASS-B_BAND 4 limit at approximately 75 dBuV/m. Two blue vertical lines are marked at approximately 5710 MHz and 5720 MHz. The signal level is mostly below the limit line.</p> <p>Site : 03CH12-HY            Condition : FCC CLASS-B_BAND 4 3m HORN_9120D_1328 HORIZONTAL            Detector : Peak            Project : SD2212            Mode : 13            Setting : 17.5</p>	 <p>Level (dBuV/m) vs Frequency (MHz) plot for Vertical orientation. The y-axis ranges from 0 to 127 dBuV/m, and the x-axis ranges from 5685 to 5765 MHz. A red horizontal line indicates the FCC CLASS-B_BAND 4 limit at approximately 75 dBuV/m. Two blue vertical lines are marked at approximately 5710 MHz and 5720 MHz. The signal level is mostly below the limit line.</p> <p>Site : 03CH12-HY            Condition : FCC CLASS-B_BAND 4 3m HORN_9120D_1328 VERTICAL            Detector : Peak            Project : SD2212            Mode : 13            Setting : 17.5</p>
<p><b>Avg.</b></p>	 <p>Level (dBuV/m) vs Frequency (MHz) plot for Horizontal orientation (Average). The y-axis ranges from 0 to 127 dBuV/m, and the x-axis ranges from 5685 to 5765 MHz. A red horizontal line indicates the FCC CLASS-B (AVG) limit at approximately 55 dBuV/m. A blue vertical line is marked at approximately 5710 MHz. The signal level is mostly below the limit line.</p> <p>Site : 03CH12-HY            Condition : FCC CLASS-B (AVG) 3m HORN_9120D_1328 HORIZONTAL            Detector : Peak            Project : SD2212            Mode : 13            Setting : 17.5</p>	 <p>Level (dBuV/m) vs Frequency (MHz) plot for Vertical orientation (Average). The y-axis ranges from 0 to 127 dBuV/m, and the x-axis ranges from 5685 to 5765 MHz. A red horizontal line indicates the FCC CLASS-B (AVG) limit at approximately 55 dBuV/m. A blue vertical line is marked at approximately 5710 MHz. The signal level is mostly below the limit line.</p> <p>Site : 03CH12-HY            Condition : FCC CLASS-B (AVG) 3m HORN_9120D_1328 VERTICAL            Detector : Peak            Project : SD2212            Mode : 13            Setting : 17.5</p>

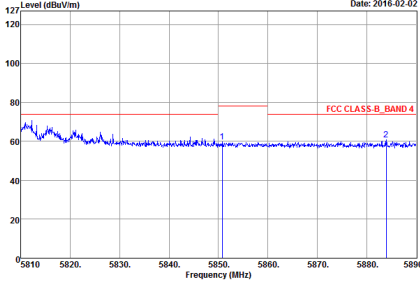
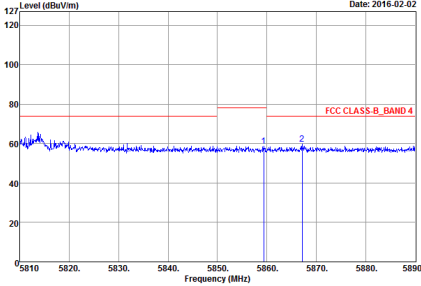
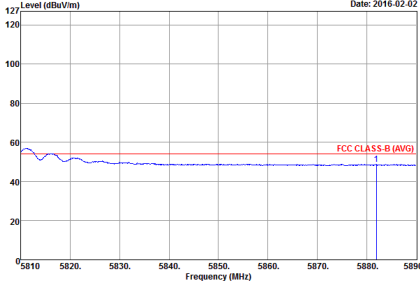
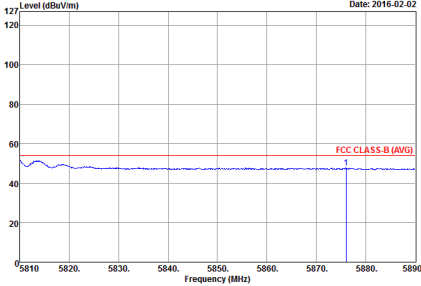

WIFI	Band 4 5725~5850MHz Band Edge @ 3m	
ANT	802.11a CH157 5785MHz - R	
1+2	Horizontal	Vertical
<p><b>Peak</b></p>	 <p>Level (dBuV/m) vs Frequency (MHz) plot for Horizontal orientation. The plot shows a signal level around 60 dBuV/m with two peaks marked at approximately 5855 MHz and 5885 MHz. A red line indicates the FCC CLASS-B_BAND 4 limit at approximately 75 dBuV/m.</p> <p>Site : 03CH12-HY            Condition : FCC CLASS-B_BAND 4 3m HORN_9120D_1328 HORIZONTAL            : RBW:1000.000KHz VBW:3000.000KHz SWT:Auto            Detector : Peak            Project : 5D2212            Mode : 13            Setting : 17.5</p>	 <p>Level (dBuV/m) vs Frequency (MHz) plot for Vertical orientation. The plot shows a signal level around 60 dBuV/m with two peaks marked at approximately 5855 MHz and 5885 MHz. A red line indicates the FCC CLASS-B_BAND 4 limit at approximately 75 dBuV/m.</p> <p>Site : 03CH12-HY            Condition : FCC CLASS-B_BAND 4 3m HORN_9120D_1328 VERTICAL            : RBW:1000.000KHz VBW:3000.000KHz SWT:Auto            Detector : Peak            Project : 5D2212            Mode : 13            Setting : 17.5</p>
<p><b>Avg.</b></p>	 <p>Level (dBuV/m) vs Frequency (MHz) plot for Horizontal orientation. The plot shows an average signal level around 50 dBuV/m. A red line indicates the FCC CLASS-B (AVG) limit at approximately 55 dBuV/m.</p> <p>Site : 03CH12-HY            Condition : FCC CLASS-B (AVG) 3m HORN_9120D_1328 HORIZONTAL            : RBW:1000.000KHz VBW:1.000KHz SWT:Auto            Detector : Peak            Project : 5D2212            Mode : 13            Setting : 17.5</p>	 <p>Level (dBuV/m) vs Frequency (MHz) plot for Vertical orientation. The plot shows an average signal level around 50 dBuV/m. A red line indicates the FCC CLASS-B (AVG) limit at approximately 55 dBuV/m.</p> <p>Site : 03CH12-HY            Condition : FCC CLASS-B (AVG) 3m HORN_9120D_1328 VERTICAL            : RBW:1000.000KHz VBW:1.000KHz SWT:Auto            Detector : Peak            Project : 5D2212            Mode : 13            Setting : 17.5</p>

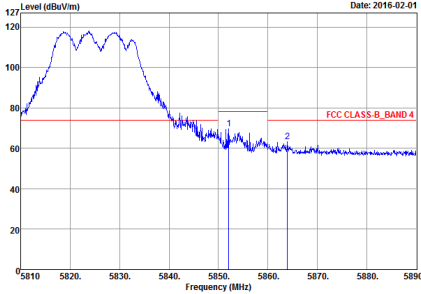
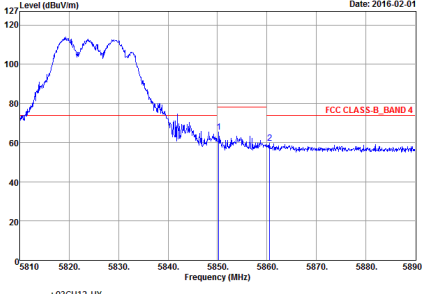
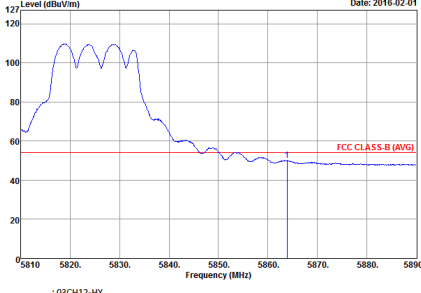
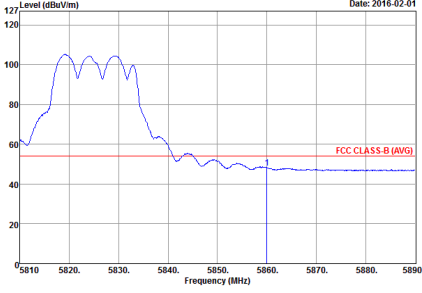

WIFI	Band 4 5725~5850MHz Band Edge @ 3m	
ANT	802.11a CH165 5825MHz	
1+2	Horizontal	Vertical
<p><b>Peak</b></p>	 <p>Site : 03CH12-HY            Condition : FCC CLASS-B_BAND 4 3m HORN_9120D_1328 HORIZONTAL            RBW:1000.000KHz VBW:3000.000KHz SWT:Auto            Detector : Peak            Preject : 502212            Mode : 14</p>	 <p>Site : 03CH12-HY            Condition : FCC CLASS-B_BAND 4 3m HORN_9120D_1328 VERTICAL            RBW:1000.000KHz VBW:3000.000KHz SWT:Auto            Detector : Peak            Preject : 502212            Mode : 14</p>
<p><b>Avg.</b></p>	 <p>Site : 03CH12-HY            Condition : FCC CLASS-B (AVG) 3m HORN_9120D_1328 HORIZONTAL            RBW:1000.000KHz VBW:1.000KHz SWT:Auto            Detector : Peak            Preject : 502212            Mode : 14</p>	 <p>Site : 03CH12-HY            Condition : FCC CLASS-B (AVG) 3m HORN_9120D_1328 VERTICAL            RBW:1000.000KHz VBW:1.000KHz SWT:Auto            Detector : Peak            Preject : 502212            Mode : 14</p>



Band 4 5725~5850MHz

WIFI 802.11ac VHT20 (Band Edge @ 3m)

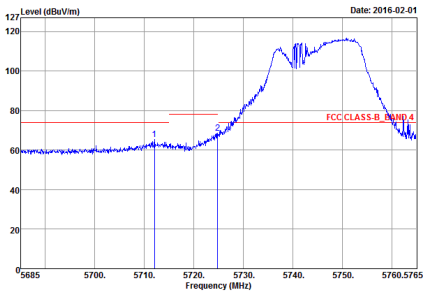
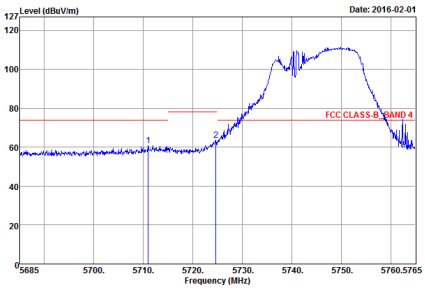
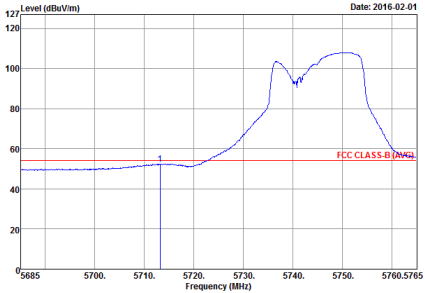
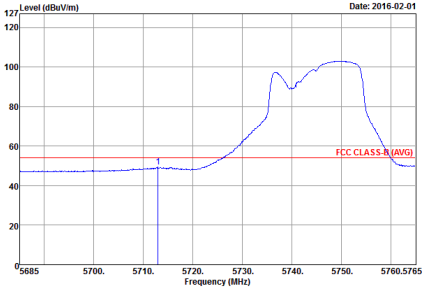
WIFI	Band 4 5725~5850MHz Band Edge @ 3m	
ANT	802.11ac VHT20 CH149 5745MHz	
1+2	Horizontal	Vertical
Peak	 <p>Site : 03CH12-HY            Condition : FCC CLASS-B_BAND 4 3m HORN_91200_1328 HORIZONTAL            RBW:1000.000KHz VBW:3000.000KHz SWT:Auto            Detector : Peak            Project : 5D2212            Mode : 15</p>	 <p>Site : 03CH12-HY            Condition : FCC CLASS-B_BAND 4 3m HORN_91200_1328 VERTICAL            RBW:1000.000KHz VBW:3000.000KHz SWT:Auto            Detector : Peak            Project : 5D2212            Mode : 15</p>
Avg.	 <p>Site : 03CH12-HY            Condition : FCC CLASS-B (AVG) 3m HORN_91200_1328 HORIZONTAL            RBW:1000.000KHz VBW:1.000KHz SWT:Auto            Detector : Peak            Project : 5D2212            Mode : 15</p>	 <p>Site : 03CH12-HY            Condition : FCC CLASS-B (AVG) 3m HORN_91200_1328 VERTICAL            RBW:1000.000KHz VBW:1.000KHz SWT:Auto            Detector : Peak            Project : 5D2212            Mode : 15</p>

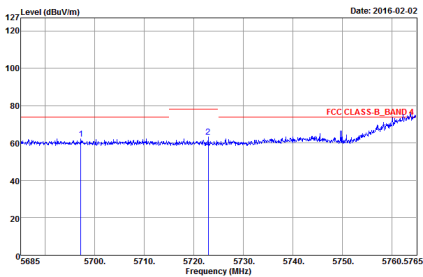
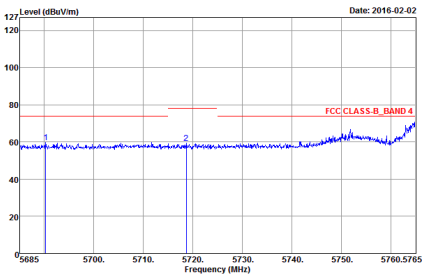
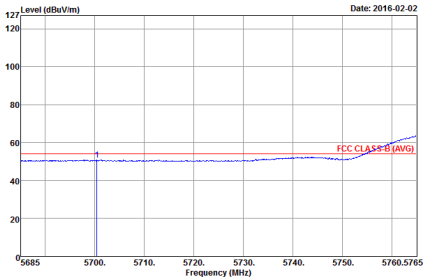
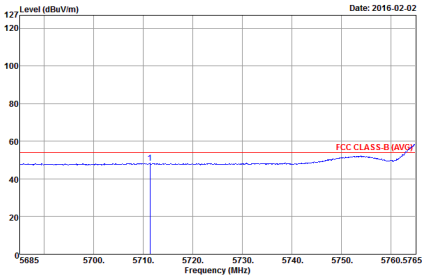

WIFI	Band 4 5725~5850MHz Band Edge @ 3m	
ANT	802.11ac VHT20 CH157 5785MHz - L	
1+2	Horizontal	Vertical
<p><b>Peak</b></p>	 <p>Site : 03CH12-HY            Condition : FCC CLASS-B_BAND 4 3m HORN_9120D_1328 HORIZONTAL            RBW:1000.000KHz VBW:3000.000KHz SWT:Auto            Detector : Peak            Project : 5D2212            Mode : 16            Setting : 18</p>	 <p>Site : 03CH12-HY            Condition : FCC CLASS-B_BAND 4 3m HORN_9120D_1328 VERTICAL            RBW:1000.000KHz VBW:3000.000KHz SWT:Auto            Detector : Peak            Project : 5D2212            Mode : 16            Setting : 18</p>
<p><b>Avg.</b></p>	 <p>Site : 03CH12-HY            Condition : FCC CLASS-B (AVG) 3m HORN_9120D_1328 HORIZONTAL            RBW:1000.000KHz VBW:1.000KHz SWT:Auto            Detector : Peak            Project : 5D2212            Mode : 16            Setting : 18</p>	 <p>Site : 03CH12-HY            Condition : FCC CLASS-B (AVG) 3m HORN_9120D_1328 VERTICAL            RBW:1000.000KHz VBW:1.000KHz SWT:Auto            Detector : Peak            Project : 5D2212            Mode : 16            Setting : 18</p>

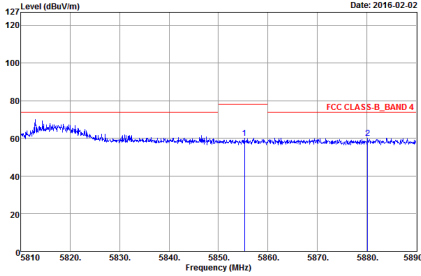
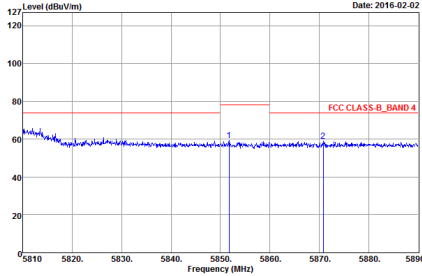
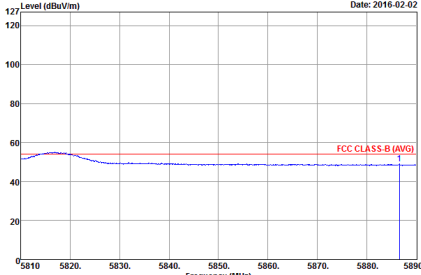
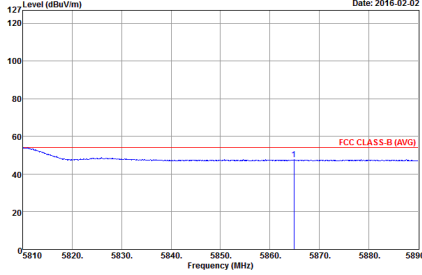

WIFI	Band 4 5725~5850MHz Band Edge @ 3m	
ANT	802.11ac VHT20 CH157 5785MHz - R	
1+2	Horizontal	Vertical
<p><b>Peak</b></p>	 <p>Date: 2016-02-02</p> <p>Site : 03CH12-HY            Condition : FCC CLASS-B_BAND 4 3m HORN_9120D_1328 HORIZONTAL            RBW:1000.000KHz VBW:3000.000KHz SWT:Auto            Detector : Peak            Project : 5D2212            Mode : 16            Setting : 18</p>	 <p>Date: 2016-02-02</p> <p>Site : 03CH12-HY            Condition : FCC CLASS-B_BAND 4 3m HORN_9120D_1328 VERTICAL            RBW:1000.000KHz VBW:3000.000KHz SWT:Auto            Detector : Peak            Project : 5D2212            Mode : 16            Setting : 18</p>
<p><b>Avg.</b></p>	 <p>Date: 2016-02-02</p> <p>Site : 03CH12-HY            Condition : FCC CLASS-B (AVG) 3m HORN_9120D_1328 HORIZONTAL            RBW:1000.000KHz VBW:1.000KHz SWT:Auto            Detector : Peak            Project : 5D2212            Mode : 16            Setting : 18</p>	 <p>Date: 2016-02-02</p> <p>Site : 03CH12-HY            Condition : FCC CLASS-B (AVG) 3m HORN_9120D_1328 VERTICAL            RBW:1000.000KHz VBW:1.000KHz SWT:Auto            Detector : Peak            Project : 5D2212            Mode : 16            Setting : 18</p>

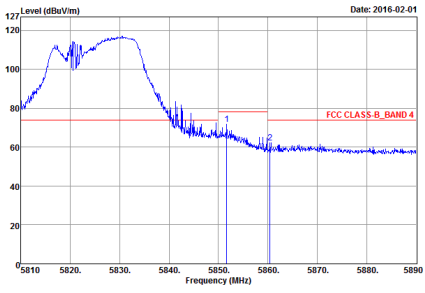
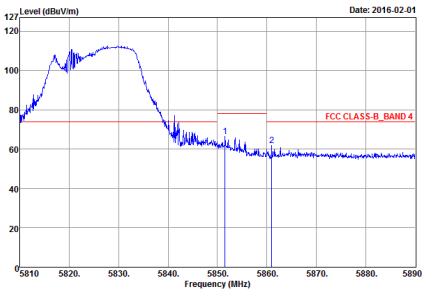
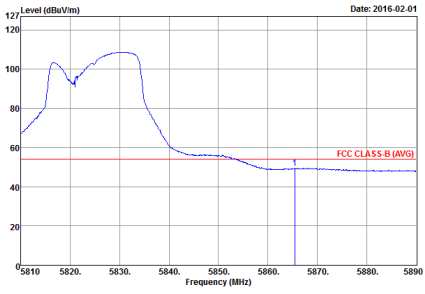
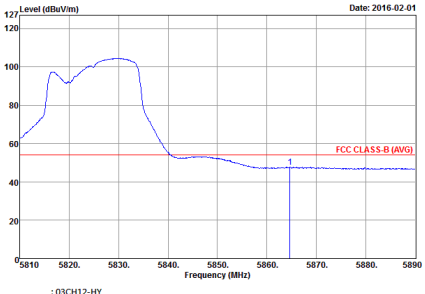

WIFI	Band 4 5725~5850MHz Band Edge @ 3m	
ANT	802.11ac VHT20 CH165 5825MHz	
1+2	Horizontal	Vertical
Peak	 <p>Site : 03CH12-HY            Condition : FCC CLASS-B_BAND 4 3m HORN_9120D_1328 HORIZONTAL            : RBW:1000.000KHz VBW:3000.000KHz SWT:Auto            Detector : Peak            Project : 5D2212            Mode : 17</p>	 <p>Site : 03CH12-HY            Condition : FCC CLASS-B_BAND 4 3m HORN_9120D_1328 VERTICAL            : RBW:1000.000KHz VBW:3000.000KHz SWT:Auto            Detector : Peak            Project : 5D2212            Mode : 17</p>
Avg.	 <p>Site : 03CH12-HY            Condition : FCC CLASS-B (AVG) 3m HORN_9120D_1328 HORIZONTAL            : RBW:1000.000KHz VBW:1.000KHz SWT:Auto            Detector : Peak            Project : 5D2212            Mode : 17</p>	 <p>Site : 03CH12-HY            Condition : FCC CLASS-B (AVG) 3m HORN_9120D_1328 VERTICAL            : RBW:1000.000KHz VBW:1.000KHz SWT:Auto            Detector : Peak            Project : 5D2212            Mode : 17</p>



Band 4 5725~5850MHz

WIFI 802.11ac VHT40 (Band Edge @ 3m)

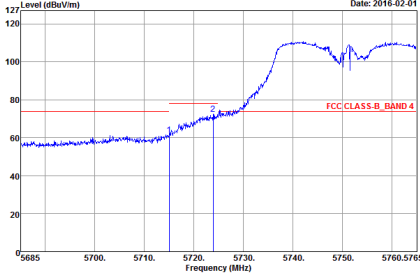
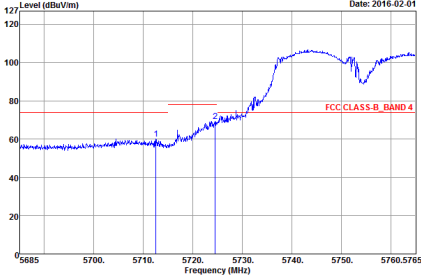
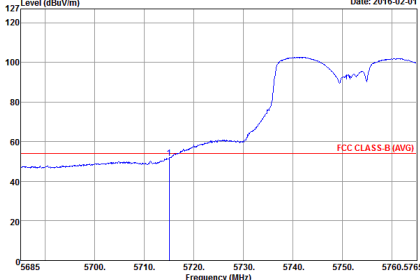
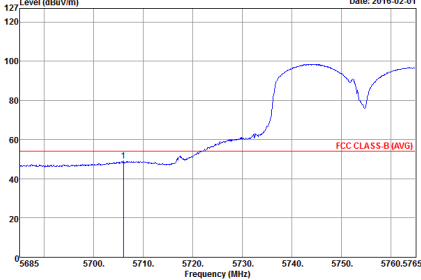
WIFI	Band 4 5725~5850MHz Band Edge @ 3m	
ANT	802.11ac VHT40 CH151 5755MHz	
1+2	Horizontal	Vertical
<p><b>Peak</b></p>	 <p>Site : 03CH12-HY            Condition : FCC CLASS-B_BAND 4 3m HORN_91200_1328 HORIZONTAL            Detector : Peak            Project : 5D2212            Mode : 18</p>	 <p>Site : 03CH12-HY            Condition : FCC CLASS-B_BAND 4 3m HORN_91200_1328 VERTICAL            Detector : Peak            Project : 5D2212            Mode : 18</p>
<p><b>Avg.</b></p>	 <p>Site : 03CH12-HY            Condition : FCC CLASS-B (AVG) 3m HORN_91200_1328 HORIZONTAL            Detector : Peak            Project : 5D2212            Mode : 18</p>	 <p>Site : 03CH12-HY            Condition : FCC CLASS-B (AVG) 3m HORN_91200_1328 VERTICAL            Detector : Peak            Project : 5D2212            Mode : 18</p>



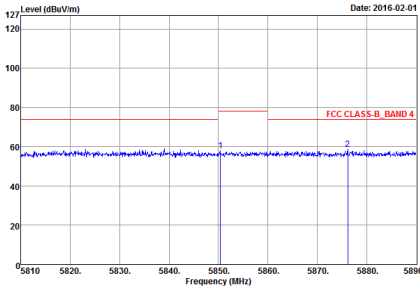
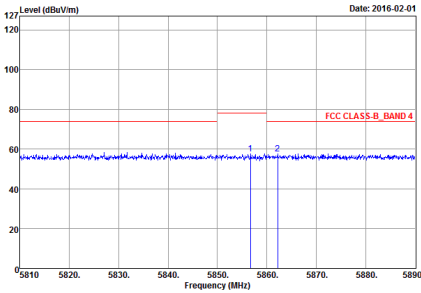
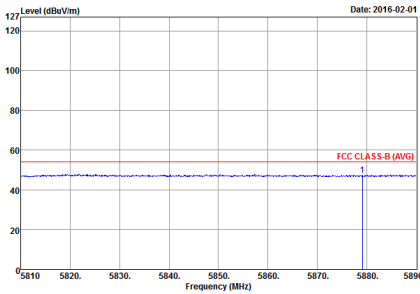
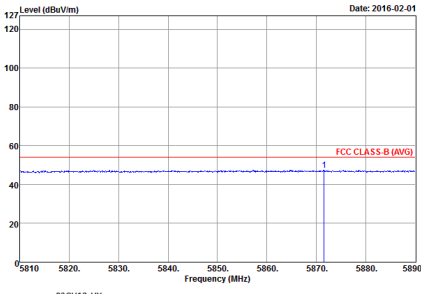

WIFI	Band 4 5725~5850MHz Band Edge @ 3m	
ANT	802.11ac VHT40 CH151 5755MHz	
1+2	Horizontal	Vertical
Peak	 <p>Site : 03CH12-HY            Condition : FCC CLASS-B, BAND 4 3m HORN_9120D_1328 HORIZONTAL            Detector : Peak            Project : 5D2212            Mode : 18</p>	 <p>Site : 03CH12-HY            Condition : FCC CLASS-B, BAND 4 3m HORN_9120D_1328 VERTICAL            Detector : Peak            Project : 5D2212            Mode : 18</p>
Avg.	 <p>Site : 03CH12-HY            Condition : FCC CLASS-B (AVG) 3m HORN_9120D_1328 HORIZONTAL            Detector : Peak            Project : 5D2212            Mode : 18</p>	 <p>Site : 03CH12-HY            Condition : FCC CLASS-B (AVG) 3m HORN_9120D_1328 VERTICAL            Detector : Peak            Project : 5D2212            Mode : 18</p>

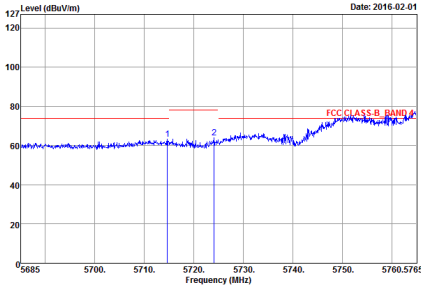
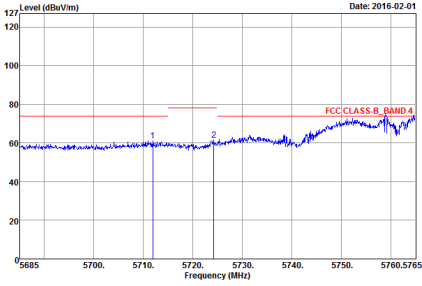
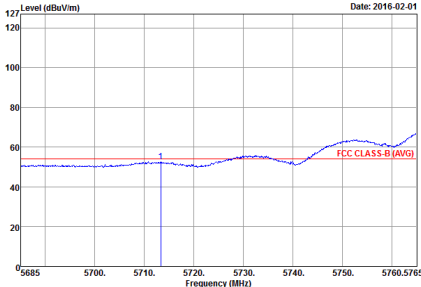
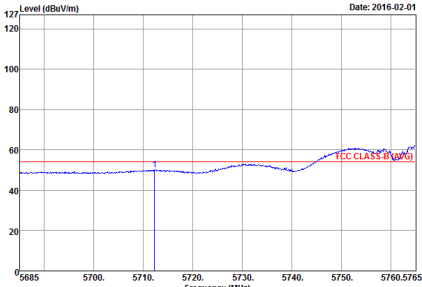

WIFI	Band 4 5725~5850MHz Band Edge @ 3m	
ANT	802.11ac VHT40 CH159 5795MHz	
1+2	Horizontal	Vertical
<p><b>Peak</b></p>	 <p>Site : 03CH12-HY            Condition : FCC CLASS-B_BAND 4 3m HORN_91200_1328 HORIZONTAL            RBW:1000.000KHz VBW:3000.000KHz SWT:Auto            Detector : Peak            Project : 502212            Mode : 19</p>	 <p>Site : 03CH12-HY            Condition : FCC CLASS-B_BAND 4 3m HORN_91200_1328 VERTICAL            RBW:1000.000KHz VBW:3000.000KHz SWT:Auto            Detector : Peak            Project : 502212            Mode : 19</p>
<p><b>Avg.</b></p>	 <p>Site : 03CH12-HY            Condition : FCC CLASS-B (AVG) 3m HORN_91200_1328 HORIZONTAL            RBW:1000.000KHz VBW:3.000KHz SWT:Auto            Detector : Peak            Project : 502212            Mode : 19</p>	 <p>Site : 03CH12-HY            Condition : FCC CLASS-B (AVG) 3m HORN_91200_1328 VERTICAL            RBW:1000.000KHz VBW:3.000KHz SWT:Auto            Detector : Peak            Project : 502212            Mode : 19</p>

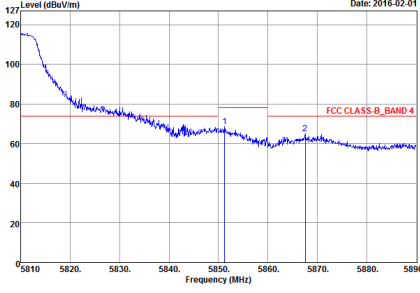
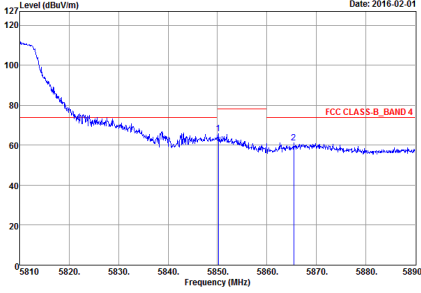
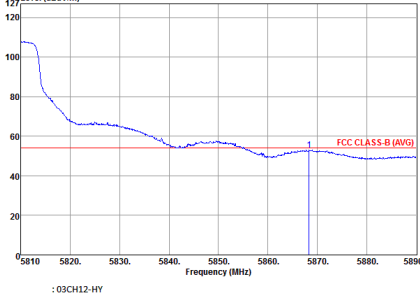
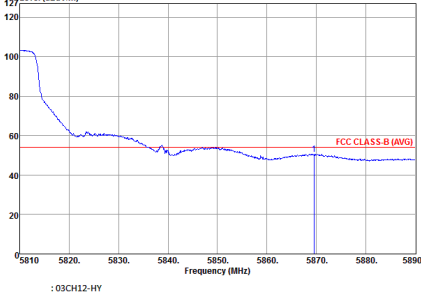

WIFI	Band 4 5725~5850MHz Band Edge @ 3m	
ANT	802.11ac VHT40 CH159 5795MHz	
1+2	Horizontal	Vertical
Peak	 <p>Level (dBuV/m) vs Frequency (MHz) plot for Horizontal orientation. The plot shows a signal level starting at approximately 110 dBuV/m at 5810 MHz and decreasing to about 60 dBuV/m at 5890 MHz. Two peaks are marked with vertical lines and labeled '1' and '2'. A red horizontal line indicates the FCC CLASS-B_BAND 4 limit at approximately 75 dBuV/m.</p> <p>Site : 03CH12-HY  Condition : FCC CLASS-B_BAND 4 3m HORN_91200_1328 HORIZONTAL  RBW:1000.000KHz VBW:3000.000KHz SWT:Auto  Detector : Peak  Project : 5D2212  Mode : 19</p>	 <p>Level (dBuV/m) vs Frequency (MHz) plot for Vertical orientation. The plot shows a signal level starting at approximately 110 dBuV/m at 5810 MHz and decreasing to about 60 dBuV/m at 5890 MHz. Two peaks are marked with vertical lines and labeled '1' and '2'. A red horizontal line indicates the FCC CLASS-B_BAND 4 limit at approximately 75 dBuV/m.</p> <p>Site : 03CH12-HY  Condition : FCC CLASS-B_BAND 4 3m HORN_91200_1328 VERTICAL  RBW:1000.000KHz VBW:3000.000KHz SWT:Auto  Detector : Peak  Project : 5D2212  Mode : 19</p>
Avg.	 <p>Level (dBuV/m) vs Frequency (MHz) plot for Horizontal orientation showing the average signal level. The signal level is consistently below the FCC CLASS-B (AVG) limit of approximately 55 dBuV/m across the entire frequency range.</p> <p>Site : 03CH12-HY  Condition : FCC CLASS-B (AVG) 3m HORN_91200_1328 HORIZONTAL  RBW:1000.000KHz VBW:3.000KHz SWT:Auto  Detector : Peak  Project : 5D2212  Mode : 19</p>	 <p>Level (dBuV/m) vs Frequency (MHz) plot for Vertical orientation showing the average signal level. The signal level is consistently below the FCC CLASS-B (AVG) limit of approximately 55 dBuV/m across the entire frequency range.</p> <p>Site : 03CH12-HY  Condition : FCC CLASS-B (AVG) 3m HORN_91200_1328 VERTICAL  RBW:1000.000KHz VBW:3.000KHz SWT:Auto  Detector : Peak  Project : 5D2212  Mode : 19</p>



Band 4 5725~5850MHz

WIFI 802.11ac VHT80 (Band Edge @ 3m)

WIFI	Band 4 5725~5850MHz Band Edge @ 3m	
ANT	802.11ac VHT80 CH155 5775MHz - L	
1+2	Horizontal	Vertical
Peak	<p>Site : 03CH12-HY Condition : FCC PART 15E_BAND4 3m HORN_91200_1328 HORIZONTAL RBW:1000.000KHz VBW:3000.000KHz SWT:Auto Detector : Peak Project : 502212 Mode : 20 Power : 10</p>	<p>Site : 03CH12-HY Condition : FCC PART 15E_BAND4 3m HORN_91200_1328 VERTICAL RBW:1000.000KHz VBW:3000.000KHz SWT:Auto Detector : Peak Project : 502212 Mode : 20 Power : 10</p>

WIFI	Band 4 5725~5850MHz Band Edge @ 3m	
ANT	802.11ac VHT80 CH155 5775MHz - R	
1+2	Horizontal	Vertical
Peak	<p>Site : 03CH12-HY Condition : FCC PART 15E_BAND4 3m HORN_91200_1328 HORIZONTAL RBW:1000.000KHz VBW:3000.000KHz SWT:Auto Detector : Peak Project : 502212 Mode : 20 Power : 10</p>	<p>Site : 03CH12-HY Condition : FCC PART 15E_BAND4 3m HORN_91200_1328 VERTICAL RBW:1000.000KHz VBW:3000.000KHz SWT:Auto Detector : Peak Project : 502212 Mode : 20 Power : 10</p>



Band 4 - 5725~5850MHz

WIFI 802.11a (Harmonic @ 3m)

WIFI	Band 4 5725~5850MHz Harmonic @ 3m	
ANT	802.11a CH149 5745MHz	
1+2	Horizontal	Vertical
Peak Avg.	<p>Site : 03CH12-HY Condition : FCC CLASS-B_BAND 4 3m HORN_9120D_1328 HORIZONTAL Detector : Peak Project : SD2212 Mode : 12</p>	<p>Site : 03CH12-HY Condition : FCC CLASS-B_BAND 4 3m HORN_9120D_1328 VERTICAL Detector : Peak Project : SD2212 Mode : 12</p>

WIFI	Band 4 5725~5850MHz Harmonic @ 3m	
ANT	802.11a CH157 5785MHz	
1+2	Horizontal	Vertical
Peak Avg.	<p>Site : 03CH12-HY Condition : FCC CLASS-B_BAND 4 3m HORN_9120D_1328 HORIZONTAL Detector : Peak Project : SD2212 Mode : 13 Setting : 17.5</p>	<p>Site : 03CH12-HY Condition : FCC CLASS-B_BAND 4 3m HORN_9120D_1328 VERTICAL Detector : Peak Project : SD2212 Mode : 13 Setting : 17.5</p>



WIFI	<b>Band 4 5725~5850MHz Harmonic @ 3m</b>	
ANT	<b>802.11a CH165 5825MHz</b>	
1+2	<b>Horizontal</b>	<b>Vertical</b>
<b>Peak Avg.</b>	<p>Site : 03CH12-HY          Condition : FCC CLASS-B_BAND 4 3m HORN_9120D_1328 HORIZONTAL          Detector : Peak          Project : 502212          Mode : 14</p>	<p>Site : 03CH12-HY          Condition : FCC CLASS-B_BAND 4 3m HORN_9120D_1328 VERTICAL          Detector : Peak          Project : 502212          Mode : 14</p>



Band 4 5725~5850MHz

WIFI 802.11ac VHT20 (Harmonic @ 3m)

WIFI	Band 4 5725~5850MHz Harmonic @ 3m	
ANT	802.11ac VHT20 CH149 5745MHz	
1+2	Horizontal	Vertical
Peak Avg.	<p>Site : 03CH12-HY Condition : FCC CLASS-B_BAND 4 3m HORN_9120D_1328 HORIZONTAL Detector : Peak Project : SD2212 Mode : 15</p>	<p>Site : 03CH12-HY Condition : FCC CLASS-B_BAND 4 3m HORN_9120D_1328 VERTICAL Detector : Peak Project : SD2212 Mode : 15</p>

WIFI	Band 4 5725~5850MHz Harmonic @ 3m	
ANT	802.11ac VHT20 CH157 5785MHz	
1+2	Horizontal	Vertical
Peak Avg.	<p>Site : 03CH12-HY Condition : FCC CLASS-B_BAND 4 3m HORN_9120D_1328 HORIZONTAL Detector : Peak Project : SD2212 Mode : 16 Setting : 18</p>	<p>Site : 03CH12-HY Condition : FCC CLASS-B_BAND 4 3m HORN_9120D_1328 VERTICAL Detector : Peak Project : SD2212 Mode : 16 Setting : 18</p>

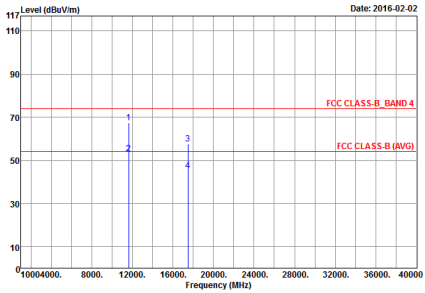
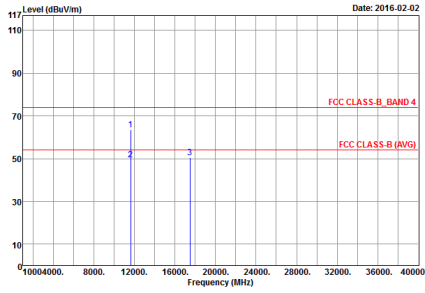

WIFI	Band 4 5725~5850MHz Harmonic @ 3m	
ANT	802.11ac VHT20 CH165 5825MHz	
1+2	Horizontal	Vertical
Peak Avg.	 <p>Site : 03CH12-HY Condition : FCC CLASS-B_BAND 4 3m HORN_9120D_1328 HORIZONTAL Detector : Peak Project : 502212 Mode : 17</p>	 <p>Site : 03CH12-HY Condition : FCC CLASS-B_BAND 4 3m HORN_9120D_1328 VERTICAL Detector : Peak Project : 502212 Mode : 17</p>





Band 4 5725~5850MHz

WIFI 802.11ac VHT40 (Harmonic @ 3m)

WIFI	Band 4 5725~5850MHz Harmonic @ 3m	
ANT	802.11ac VHT40 CH151 5755MHz	
1+2	Horizontal	Vertical
Peak Avg.	<p>Site : 03CH12-HY Condition : FCC CLASS-B_BAND 4 3m HORN_9120D_1328 HORIZONTAL Detector : Peak Project : 5D2212 Mode : 18</p>	<p>Site : 03CH12-HY Condition : FCC CLASS-B_BAND 4 3m HORN_9120D_1328 VERTICAL Detector : Peak Project : 5D2212 Mode : 18</p>

WIFI	Band 4 5725~5850MHz Harmonic @ 3m	
ANT	802.11ac VHT40 CH159 5795MHz	
1+2	Horizontal	Vertical
Peak Avg.	<p>Site : 03CH12-HY Condition : FCC CLASS-B_BAND 4 3m HORN_9120D_1328 HORIZONTAL Detector : Peak Project : 5D2212 Mode : 19</p>	<p>Site : 03CH12-HY Condition : FCC CLASS-B_BAND 4 3m HORN_9120D_1328 VERTICAL Detector : Peak Project : 5D2212 Mode : 19</p>



Band 4 5725~5850MHz

WIFI 802.11ac VHT80 (Harmonic @ 3m)

WIFI	Band 4 5725~5850MHz Harmonic @ 3m	
ANT	802.11ac VHT80 CH155 5775MHz	
1+2	Horizontal	Vertical
Peak Avg.	<p>Site : 03CH12-HY Condition : FCC CLASS-B_BAND 4 3m HORN_9120_1328 HORIZONTAL Detector : Peak Project : SD2212 Mode : 20</p>	<p>Site : 03CH12-HY Condition : FCC CLASS-B_BAND 4 3m HORN_9120_1328 VERTICAL Detector : Peak Project : SD2212 Mode : 20</p>



Emission below 1GHz

5GHz WIFI 802.11a Adapter mode (LF)

WIFI	5GHz 5725~5850MHz	
ANT	802.11a LF	
1+2	Horizontal	Vertical
QP / Peak	<p>Site : 03CH12-HY          Condition : FCC CLASS-B 3m BILOG_6111D_37059 HORIZONTAL          Detector : Peak          Project : 5D2212          Mode : 21</p>	<p>Site : 03CH12-HY          Condition : FCC CLASS-B 3m BILOG_6111D_37059 VERTICAL          Detector : Peak          Project : 5D2212          Mode : 21</p>

Emission below 1GHz

5GHz WIFI 802.11a POE mode (LF)

WIFI	5GHz 5725~5850MHz	
ANT	802.11a LF	
1+2	Horizontal	Vertical
QP / Peak	<p>Site : 03CH12-HY          Condition : FCC CLASS-B 3m BILOG_6111D_37059 HORIZONTAL          Detector : Peak          Project : 5D2212          Mode : 22</p>	<p>Site : 03CH12-HY          Condition : FCC CLASS-B 3m BILOG_6111D_37059 VERTICAL          Detector : Peak          Project : 5D2212          Mode : 22</p>