



FCC RF Test Report

APPLICANT : Senao Networks, Inc.
EQUIPMENT : Wireless 802.11 ac/a/b/g/n Access Point
BRAND NAME : Senao Networks
MODEL NAME : CAP7253AG
FCC ID : U2M-CAP7252AG
STANDARD : FCC Part 15 Subpart E §15.407
CLASSIFICATION : (NII) Unlicensed National Information Infrastructure

The product was received on Jan. 28, 2016 and testing was completed on Mar. 29, 2016. We, SPORTON INTERNATIONAL INC., would like to declare that the tested sample has been evaluated in accordance with the test procedures and has been in compliance with the applicable technical standards.

The test results in this report apply exclusively to the tested model / sample. Without written approval of SPORTON INTERNATIONAL INC., the test report shall not be reproduced except in full.

Reviewed by: Joseph Lin / Supervisor

Approved by: Jones Tsai / Manager



SPORTON INTERNATIONAL INC.

No. 52, Hwa Ya 1st Rd., Hwa Ya Technology Park, Kwei-Shan District, Tao Yuan City, Taiwan, R.O.C.

SPORTON INTERNATIONAL INC.

TEL : 886-3-327-3456

FAX : 886-3-328-4978

FCC ID : U2M-CAP7252AG

Page Number : 1 of 37

Report Issued Date : Sep. 30, 2016

Report Version : Rev. 02

Report Template No.: BU5-FR15EWLAC MA Version 1.3



TABLE OF CONTENTS

REVISION HISTORY 3

SUMMARY OF TEST RESULT 4

1 GENERAL DESCRIPTION 5

1.1 Applicant 5

1.2 Manufacturer 5

1.3 Product Feature of Equipment Under Test 5

1.4 Product Specification of Equipment Under Test 6

1.5 Modification of EUT 6

1.6 Testing Location 7

1.7 Applicable Standards 7

2 TEST CONFIGURATION OF EQUIPMENT UNDER TEST 8

2.1 Carrier Frequency and Channel 8

2.2 Pre-Scanned RF Power 9

2.3 Test Mode 10

2.4 Connection Diagram of Test System 11

2.5 Support Unit used in test configuration and system 12

2.6 EUT Operation Test Setup 12

2.7 Measurement Results Explanation Example 12

3 TEST RESULT 13

3.1 26dB & 99% Occupied Bandwidth Measurement 13

3.2 Maximum Conducted Output Power Measurement 15

3.3 Power Spectral Density Measurement 17

3.4 Unwanted Emissions Measurement 20

3.5 AC Conducted Emission Measurement 25

3.6 Frequency Stability Measurement 33

3.7 Automatically Discontinue Transmission 34

3.8 Antenna Requirements 35

4 LIST OF MEASURING EQUIPMENT 36

5 UNCERTAINTY OF EVALUATION 37

APPENDIX A. CONDUCTED TEST RESULTS

APPENDIX B. RADIATED TEST RESULTS

APPENDIX C. RADIATED SPURIOUS EMISSION PLOTS

APPENDIX D. SETUP PHOTOGRAPHS



SUMMARY OF TEST RESULT

Report Section	FCC Rule	Description	Limit	Result	Remark
3.1	2.1049 15.403(i)	26dB & 99% Bandwidth	-	Pass	-
3.2	15.407(a)	Maximum Conducted Output Power	≤ 30, 24 dBm (depend on band)	Pass	-
3.3	15.407(a)	Power Spectral Density	≤ 17, 11 dBm (depend on band)	Pass	-
3.4	15.407(b)	Unwanted Emissions	≤ -17, -27 dBm (depend on band)&15.209(a)	Pass	Under limit 0.28 dB at 65.640 MHz
3.5	15.207	AC Conducted Emission	15.207(a)	Pass	Under limit 2.10 dB at 0.414 MHz
3.6	15.407(g)	Frequency Stability	Within Operation Band	Pass	-
3.7	15.407(c)	Automatically Discontinue Transmission	Discontinue Transmission	Pass	-
3.8	15.203 & 15.407(a)	Antenna Requirement	N/A	Pass	-



1 General Description

1.1 Applicant

Senao Networks, Inc.

3F, No. 529, Chung Cheng Rd., Hsintien, Taipei, Taiwan, R.O.C

1.2 Manufacturer

Senao Networks, Inc.

3F, No. 529, Chung Cheng Rd., Hsintien, Taipei, Taiwan, R.O.C

1.3 Product Feature of Equipment Under Test

Product Feature	
Equipment	Wireless 802.11 ac/a/b/g/n Access Point
Brand Name	Senao Networks
Model Name	CAP7253AG
FCC ID	U2M-CAP7252AG
EUT supports Radios application	WLAN 11a/b/g/n HT20/HT40 WLAN 11ac VHT20/VHT40/VHT80
EUT Stage	Production Unit

Remark: The above EUT's information was declared by manufacturer. Please refer to the specifications or user's manual for more detailed description.



1.4 Product Specification of Equipment Under Test

Standards-related Product Specification							
Tx/Rx Channel Frequency Range	5180 MHz ~ 5240 MHz						
Maximum Output Power	MIMO <Ant. Port 1 + 2> 802.11a : 27.95 dBm / 0.6237 W 802.11n HT20 : 27.12 dBm / 0.5152 W 802.11n HT40 : 25.53 dBm / 0.3573 W 802.11ac VHT20: 27.86 dBm / 0.6109 W 802.11ac VHT40: 26.49 dBm / 0.4457 W 802.11ac VHT80: 16.57 dBm / 0.0454 W						
99% Occupied Bandwidth	802.11a : 17.75 MHz 802.11n HT20 : 19.05 MHz 802.11n HT40 : 36.90 MHz 802.11ac VHT20 : 18.85 MHz 802.11ac VHT40 : 36.80 MHz 802.11ac VHT80 : 75.96 MHz						
Type of Modulation	802.11a/n : OFDM (BPSK / QPSK / 16QAM / 64QAM) 802.11ac : OFDM (BPSK / QPSK / 16QAM / 64QAM / 256QAM)						
Antenna Type	<Ant 1> 802.11a/n/ac : Dipole Antenna with gain 3.18 dBi <Ant 2> 802.11a/n/ac : Dipole Antenna with gain 3.18 dBi						
Antenna Function Description	<table border="1"> <thead> <tr> <th></th> <th>Ant. 1</th> <th>Ant. 2</th> </tr> </thead> <tbody> <tr> <td>802.11 a/n/ac MIMO</td> <td>V</td> <td>V</td> </tr> </tbody> </table>		Ant. 1	Ant. 2	802.11 a/n/ac MIMO	V	V
	Ant. 1	Ant. 2					
802.11 a/n/ac MIMO	V	V					

1.5 Modification of EUT

No modifications are made to the EUT during all test items.



1.6 Testing Location

Sporton Lab is accredited to ISO 17025 by Taiwan Accreditation Foundation (TAF code : 1190) and the FCC designation No. TW1022 under the FCC 2.948(e) by Mutual Recognition Agreement (MRA) in FCC Test.

Test Site	SPORTON INTERNATIONAL INC.	
Test Site Location	No. 52, Hwa Ya 1 st Rd., Hwa Ya Technology Park, Kwei-Shan District, Tao Yuan City, Taiwan, R.O.C. TEL: +886-3-327-3456 FAX: +886-3-328-4978	
Test Site No.	Sporton Site No.	
	TH02-HY	CO05-HY

Note: The test site complies with ANSI C63.4 2014 requirement.

Test Site	SPORTON INTERNATIONAL INC.	
Test Site Location	No.58, Aly. 75, Ln. 564, Wenhua 3rd Rd. Guishan Dist, Taoyuan City, Taiwan (R.O.C.) TEL: +886-3-327-0868 FAX: +886-3-327-0855	
Test Site No.	Sporton Site No.	
	03CH12-HY	

Note: The test site complies with ANSI C63.4 2014 requirement.

1.7 Applicable Standards

According to the specifications of the manufacturer, the EUT must comply with the requirements of the following standards:

- ♦ FCC Part 15 Subpart E
- ♦ FCC KDB 789033 D02 General UNII Test Procedures New Rules v01r03.
- ♦ FCC KDB 662911 D01 Multiple Transmitter Output v02r01.
- ♦ FCC KDB 644545 D03 Guidance for IEEE 802 11ac New Rules v01
- ♦ ANSI C63.10-2013

Remark: All test items were verified and recorded according to the standards and without any deviation during the test.



2 Test Configuration of Equipment Under Test

The EUT has been associated with peripherals and configuration operated in a manner tended to maximize its emission characteristics in a typical application. Frequency range investigated: conducted emission (150 kHz to 30 MHz) and radiated emission (9 kHz to the 10th harmonic of the highest fundamental frequency or to 40 GHz, whichever is lower). For radiated measurement, pre-scanned in three orthogonal panels, X, Y, Z. The worst cases were recorded in this report.

The final configuration from all the combinations and the worst-case data rates were investigated by measuring the maximum power across all the data rates and modulation modes under section 2.2.

Based on the worst configuration found above, the RF power setting is set individually to meet FCC compliance limit for the final conducted and radiated tests shown in section 2.3.

2.1 Carrier Frequency and Channel

Frequency Band	Channel	Freq. (MHz)	Channel	Freq. (MHz)
5150-5250 MHz Band 1 (U-NII-1)	36	5180	44	5220
	38	5190	46	5230
	40	5200	48	5240
	42	5210		

Note: The above Frequency and Channel in boldface were 802.11n HT40.



2.2 Pre-Scanned RF Power

Preliminary tests were performed in different data rate and data rate associated with the highest power were chosen for full test in the following tables. Final Output Power equals to Measured Output Power adds the duty factor.

MIMO <Ant. 1+2>

5GHz 802.11a mode								
Data Rate (MHz)	6M bps	9M bps	12M bps	18M bps	24M bps	36M bps	48M bps	54M bps
Average Power (dBm)	27.95	27.85	27.88	27.91	27.61	27.63	27.49	27.50

5GHz 802.11n HT20 mode								
Data Rate (MHz)	MCS0	MCS1	MCS2	MCS3	MCS4	MCS5	MCS6	MCS7
Average Power (dBm)	27.12	27.00	26.93	26.93	26.89	27.06	27.08	26.99

5GHz 802.11n HT40 mode								
Data Rate (MHz)	MCS0	MCS1	MCS2	MCS3	MCS4	MCS5	MCS6	MCS7
Average Power (dBm)	25.53	25.40	25.37	25.33	25.46	25.50	25.45	25.38

5GHz 802.11ac VHT20 mode									
Data Rate (MHz)	MCS 0	MCS 1	MCS 2	MCS 3	MCS 4	MCS 5	MCS 6	MCS 7	MCS 8
Average Power (dBm)	27.86	27.62	27.66	27.58	27.59	27.48	27.42	27.51	27.47

5GHz 802.11ac VHT40 mode										
Data Rate (MHz)	MCS 0	MCS 1	MCS 2	MCS 3	MCS 4	MCS 5	MCS 6	MCS 7	MCS 8	MCS 9
Average Power (dBm)	26.49	26.33	26.33	26.46	26.01	26.43	26.21	26.18	26.16	26.33

5GHz 802.11ac VHT80 mode										
Data Rate (MHz)	MCS 0	MCS 1	MCS 2	MCS 3	MCS 4	MCS 5	MCS 6	MCS 7	MCS 8	MCS 9
Average Power (dBm)	16.57	16.53	16.47	16.46	16.51	16.47	16.35	16.16	16.01	15.97

Note: MIMO Ant. 1+2 is a calculated result from sum of the power MIMO Ant. 1 and MIMO Ant. 2.



2.3 Test Mode

Final test mode of conducted test items and radiated spurious emissions are considering the modulation and worse data rates from the power table described in section 2.2.

MIMO Antenna

Modulation	Data Rate
802.11a	6 Mbps
802.11n HT20	MCS0
802.11n HT40	MCS0
802.11ac VHT20	MCS0
802.11ac VHT40	MCS0
802.11ac VHT80	MCS0

Test Cases	
AC Conducted Emission	Mode 1 : 5G Tx + RJ-45 Link + Adapter Mode 2 : 5G Tx + RJ-45 Link + POE
Remark: The worst case of conducted emission is mode 1; only the test data of it was reported.	

Ch. #	Band I : 5150-5250 MHz		
	802.11a	802.11n HT20	802.11n HT40
L Low	36	36	38
M Middle	40	40	-
H High	48	48	46

Ch. #	Band I : 5150-5250 MHz		
	802.11ac VHT20	802.11ac VHT40	802.11ac VHT80
L Low	36	38	-
M Middle	40	-	42
H High	48	46	-

2.4 Connection Diagram of Test System

<EUT with Adapter Mode>

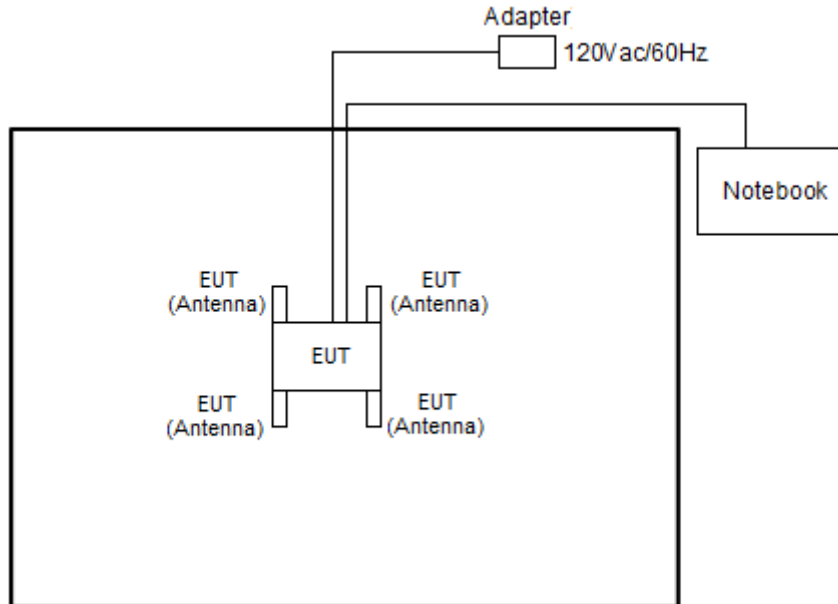

<EUT with POE Mode>

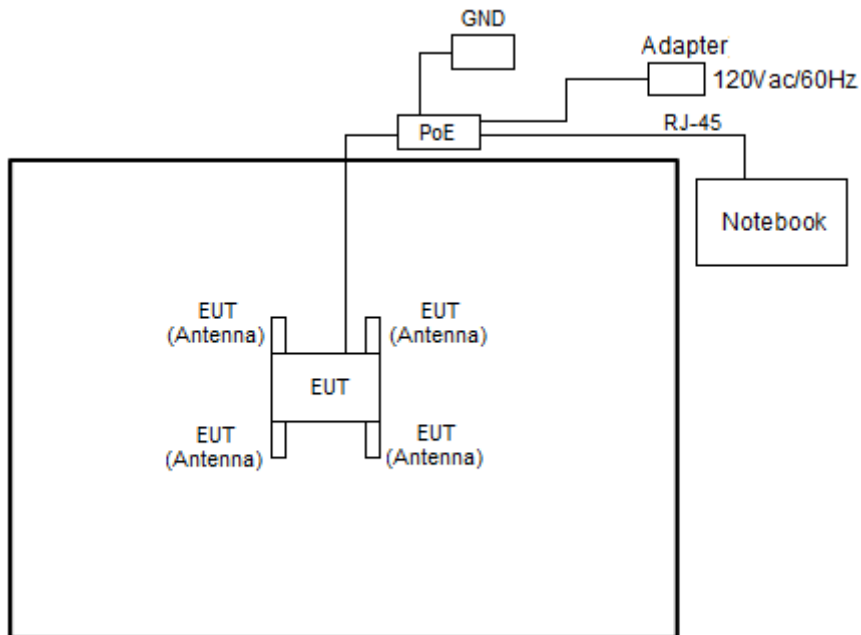



2.5 Support Unit used in test configuration and system

Item	Equipment	Trade Name	Model Name	FCC ID	Data Cable	Power Cord
1.	Notebook	DELL	Latitude E6320	FCC DoC/ Contains FCC ID: QDS-BRCM1054	N/A	AC I/P: Unshielded, 1.2 m DC O/P: Shielded, 1.8 m
2.	Notebook	Lenovo	IdeaPad (80Q7)	PPD-QCNFA	N/A	AC I/P: Unshielded, 1.2 m DC O/P: Shielded, 1.8 m
3.	POE Adapter	Powertron Electronics Corp	PA1040-480IB080	N/A	N/A	1.5m
4.	POE	N/A	NPE-5818	N/A	N/A	N/A
5.	Adapter	Powertron Electronics Corp.	PA1015-2I/ PA1015-2I PA1015-2I120125	N/A	N/A	1.2m

2.6 EUT Operation Test Setup

For WLAN function, programmed RF utility, "Art2-gui Tool" installed in the notebook make the EUT provide functions like channel selection and power level for continuous transmitting and receiving signals.

2.7 Measurement Results Explanation Example

For all conducted test items:

The offset level is set in the spectrum analyzer to compensate the RF cable loss and attenuator factor between EUT conducted output port and spectrum analyzer. With the offset compensation, the spectrum analyzer reading level is exactly the EUT RF output level.

Example :

The spectrum analyzer offset is derived from RF cable loss and attenuator factor.

Offset = RF cable loss + attenuator factor.

Following shows an offset computation example with cable loss 4.2 dB and 10dB attenuator.

$$\begin{aligned}
 \text{Offset(dB)} &= \text{RF cable loss(dB)} + \text{attenuator factor(dB)}. \\
 &= 4.2 + 10 = 14.2 \text{ (dB)}
 \end{aligned}$$

3 Test Result

3.1 26dB & 99% Occupied Bandwidth Measurement

3.1.1 Description of 26dB & 99% Occupied Bandwidth

This section is for reporting purpose only.

There is no restriction limits for bandwidth.

3.1.2 Measuring Instruments

The measuring equipment is listed in the section 4 of this test report.

3.1.3 Test Procedures

1. The testing follows FCC KDB 789033 D02 General UNII Test Procedures New Rules v01r03.
Section C) Emission bandwidth
2. Set RBW = approximately 1% of the emission bandwidth.
3. Set the VBW > RBW.
4. Detector = Peak.
5. Trace mode = max hold
6. Measure the maximum width of the emission that is 26 dB down from the peak of the emission.
Compare this with the RBW setting of the analyzer. Readjust RBW and repeat measurement as needed until the RBW/EBW ratio is approximately 1%.
7. For 99% Bandwidth Measurement, the spectrum analyzer's resolution bandwidth (RBW) is set 1MHz and set the Video bandwidth (VBW) $\geq 3 * RBW$.
8. Measure and record the results in the test report.

3.1.4 Test Setup

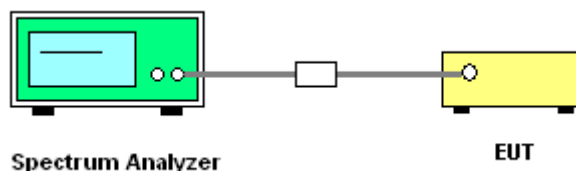



3.1.5 Test Result of 26dB & 99% Occupied Bandwidth

Please refer to Appendix A.

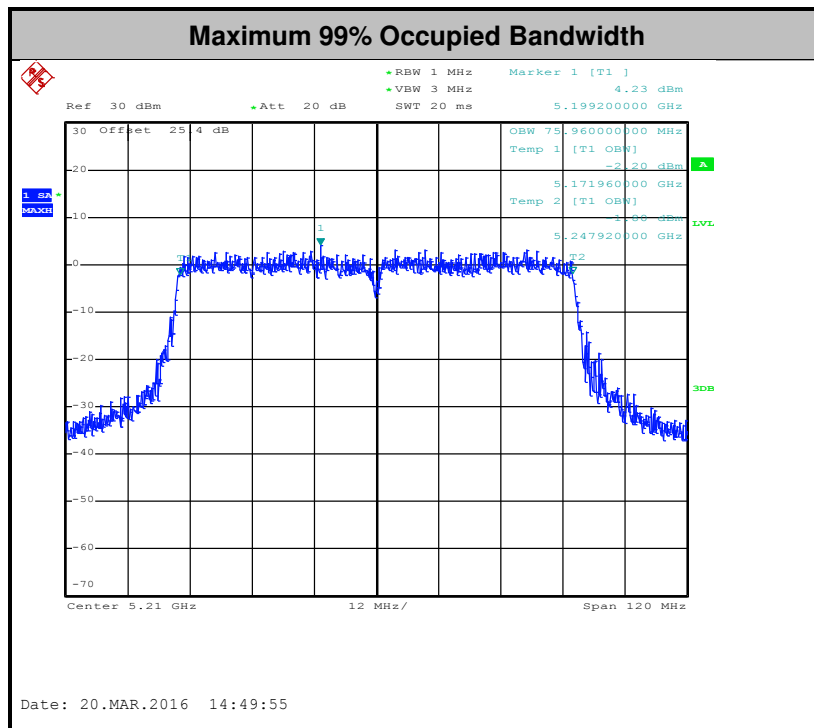
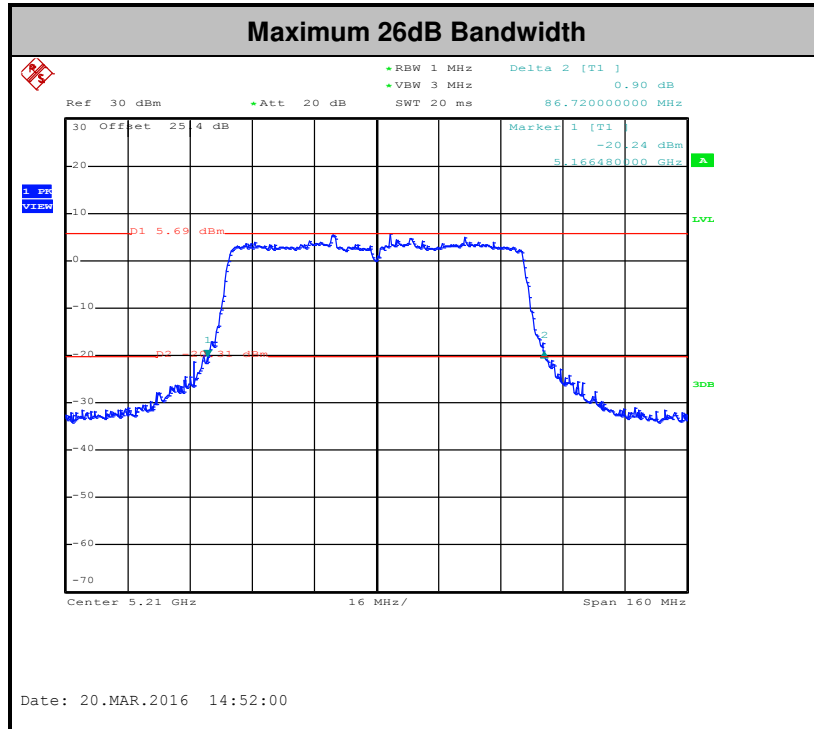

Note: The occupied channel bandwidth is maintained within the band of operation for all of the modulations.



3.2 Maximum Conducted Output Power Measurement

3.2.1 Limit of Maximum Conducted Output Power

<FCC 14-30 CFR 15.407>

For mobile and portable client devices in the 5.15–5.25 GHz band, the maximum conducted output power over the frequency band of operation shall not exceed 250 mW.

If transmitting antennas of directional gain greater than 6 dBi are used, the peak output power shall be reduced by the amount in dB that the directional gain of the antenna exceeds 6 dBi.

Note that U-NII-2 band, devices with a maximum e.i.r.p. greater than 500 mW shall implement TPC in order to have the capability to operate at least 6 dB below the maximum permitted e.i.r.p. of 1 W.

3.2.2 Measuring Instruments

The measuring equipment is listed in the section 4 of this test report.

3.2.3 Test Procedures

The testing follows Method PM of FCC KDB 789033 D02 General UNII Test Procedures New Rules v01r03

Method PM (Measurement using an RF average power meter):

1. Measurement is performed using a wideband RF power meter.
2. The EUT is configured to transmit continuously with a consistent duty cycle at its maximum power control level.
3. Measure the average power of the transmitter, and the average power is corrected with duty factor, $10 \log(1/x)$, where x is the duty cycle.

3.2.4 Test Setup

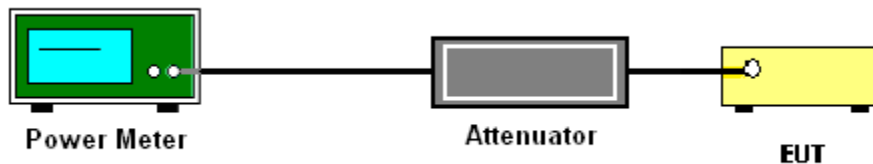

3.2.5 Test Result of Maximum Conducted Output Power

Please refer to Appendix A.



3.3 Power Spectral Density Measurement

3.3.1 Limit of Power Spectral Density

<FCC 14-30 CFR 15.407>

For mobile and portable client devices in the 5.15–5.25 GHz band, the maximum power spectral density shall not exceed 11dBm in any 1 megahertz band.

If transmitting antennas of directional gain greater than 6 dBi are used, the peak output power shall be reduced by the amount in dB that the directional gain of the antenna exceeds 6 dBi.

3.3.2 Measuring Instruments

The measuring equipment is listed in the section 4 of this test report.

3.3.3 Test Procedures

The testing follows FCC KDB 789033 D02 General UNII Test Procedures New Rules v01r03. Section F) Maximum power spectral density.

Method SA-2

(trace averaging across on and off times of the EUT transmissions, followed by duty cycle correction).

- Measure the duty cycle.
- Set span to encompass the entire emission bandwidth (EBW) of the signal.
- Set RBW = 1 MHz.
- Set VBW \geq 3 MHz.
- Number of points in sweep \geq 2 Span / RBW.
- Sweep time = auto.
- Detector = RMS
- Trace average at least 100 traces in power averaging mode.
- Add $10 \log(1/x)$, where x is the duty cycle, to the measured power in order to compute the average power during the actual transmission times. For example, add $10 \log(1/0.25) = 6$ dB if the duty cycle is 25 percent.

1. The RF output of EUT was connected to the spectrum analyzer by a low loss cable.
2. Each plot has already offset with cable loss, and attenuator loss. Measure the PPSD and record it.
3. For MIMO mode, calculation method follows FCC KDB 662911 D01 Multiple Transmitter Output v02r01.

Method (1): Measure and sum the spectra across the outputs.

The total final Power Spectral Density is from a device with 2 transmitter outputs. The spectrum measurements of the individual outputs are all performed with the same span and number of points, the spectrum value in the first spectral bin of output 1 is summed with that in the first spectral bin of output 2 to obtain the value for the first frequency bin of the summed spectrum.

3.3.4 Test Setup

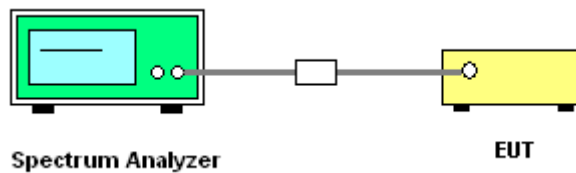



3.3.5 Test Result of Power Spectral Density

Please refer to Appendix A.

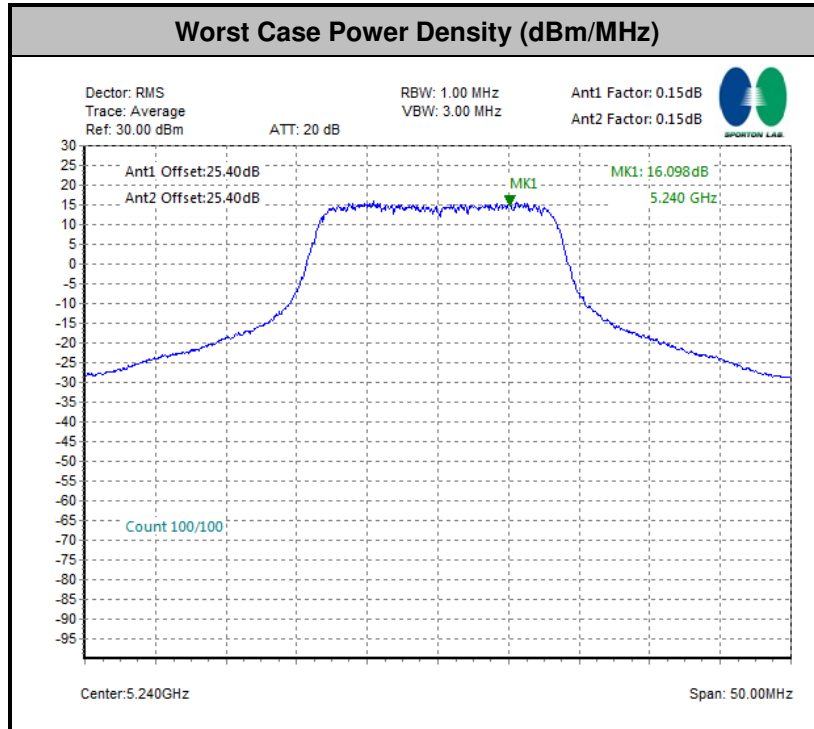

Note: Average Power Density (dB) = Measured value + Duty Factor



3.4 Unwanted Emissions Measurement

This section as specified in FCC Part 15.407(b) is to measure unwanted emissions through radiated measurement for band edge spurious emissions and out of band emissions measurement. The unwanted emissions shall comply with 15.407(b)(1) to (6), and restricted bands per FCC Part15.205.

3.4.1 Limit of Unwanted Emissions

- (1) For transmitters operating in the 5150-5250 MHz band: all emissions outside of the 5150-5350 MHz band shall not exceed an EIRP of -27dBm/MHz.
- (2) Unwanted spurious emissions fallen in restricted bands per FCC Part15.205 shall comply with the general field strength limits set forth in § 15.209 as below table,

Frequency (MHz)	Field Strength (microvolts/meter)	Measurement Distance (meters)
0.009 – 0.490	2400/F(kHz)	300
0.490 – 1.705	24000/F(kHz)	30
1.705 – 30.0	30	30
30 – 88	100	3
88 – 216	150	3
216 - 960	200	3
Above 960	500	3

Note: The following formula is used to convert the EIRP to field strength.

$$E = \frac{1000000\sqrt{30P}}{3} \mu V/m, \text{ where } P \text{ is the eirp (Watts)}$$

EIRP (dBm)	Field Strength at 3m (dBμV/m)
-17	78.3
- 27	68.3

- (1) KDB789033 D02 v01r03 G)2)c) As specified in 15.407(b), emissions above 1000 MHz that are outside of the restricted bands are subject to a peak emission limit of -27 dBm/MHz (or -17 dBm/MHz as specified in 15.407(b)(4)). However, an out-of-band emission that complies with both the average and peak limits of 15.209 is not required to satisfy the -27 dBm/MHz or -17 dBm/MHz peak emission limit.

3.4.2 Measuring Instruments

The measuring equipment is listed in the section 4 of this test report.



3.4.3 Test Procedures

1. The testing follows FCC KDB 789033 D02 General UNII Test Procedures New Rules v01r03. Section G) Unwanted emissions measurement.

(1) Procedure for Unwanted Emissions Measurements Below 1000MHz

- RBW = 120 kHz
- VBW = 300 kHz
- Detector = Peak
- Trace mode = max hold

(2) Procedure for Peak Unwanted Emissions Measurements Above 1000 MHz

- RBW = 1 MHz
- VBW ≥ 3 MHz
- Detector = Peak
- Sweep time = auto
- Trace mode = max hold

(3) Procedures for Average Unwanted Emissions Measurements Above 1000MHz

- RBW = 1 MHz
- VBW = 10 Hz, when duty cycle is no less than 98 percent.
- $VBW \geq 1/T$, when duty cycle is less than 98 percent where T is the minimum transmission duration over which the transmitter is on and is transmitting at its maximum power control level for the tested mode of operation.

Antenna	Band	Duty Cycle(%)	T(us)	1/T(kHz)	VBW Setting
1+2	5GHz 802.11a for Ant 1	96.68	2040.00	0.49	1kHz
1+2	5GHz 802.11a for Ant 2	96.68	2040.00	0.49	1kHz
1+2	5GHz 802.11ac VHT20 for Ant 1	96.47	1910.00	0.52	1kHz
1+2	5GHz 802.11ac VHT20 for Ant 2	96.45	1900.00	0.53	1kHz
1+2	5GHz 802.11ac VHT40 for Ant 1	93.07	940.00	1.06	3kHz
1+2	5GHz 802.11ac VHT40 for Ant 2	93.07	940.00	1.06	3kHz
1+2	5GHz 802.11ac VHT80 for Ant 1	87.36	456.00	2.19	3kHz
1+2	5GHz 802.11ac VHT80 for Ant 2	87.36	456.00	2.19	3kHz



2. The EUT was placed on a turntable with 0.8 meter for frequency below 1GHz and 1.5 meter for frequency above 1GHz respectively above ground.
3. The EUT was set 3 meters from the interference receiving antenna which was mounted on the top of a variable height antenna tower.
4. The antenna is a broadband antenna and its height is adjusted between one meter and four meters above ground to find the maximum value of the field strength for both horizontal polarization and vertical polarization of the antenna.
5. For each suspected emission, the EUT was arranged to its worst case and then adjust the antenna tower (from 1 m to 4 m) and turntable (from 0 degree to 360 degrees) to find the maximum reading.
6. For testing below 1GHz, if the emission level of the EUT in peak mode was 3 dB lower than the limit specified, then peak values of EUT will be reported, otherwise, the emissions will be repeated one by one using the CISPR quasi-peak method and reported.
7. For testing above 1GHz, the emission level of the EUT in peak mode was 20dB lower than average limit (that means the emission level in average mode also complies with the limit in average mode), then peak values of EUT will be reported, otherwise, the emissions will be measured in average mode again and reported.

3.4.4 Test Setup

For radiated emissions below 30MHz

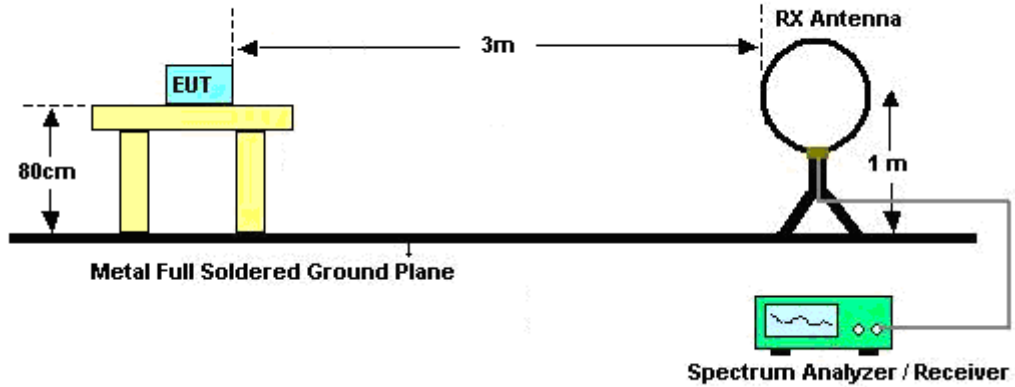

For radiated emissions from 30MHz to 1GHz

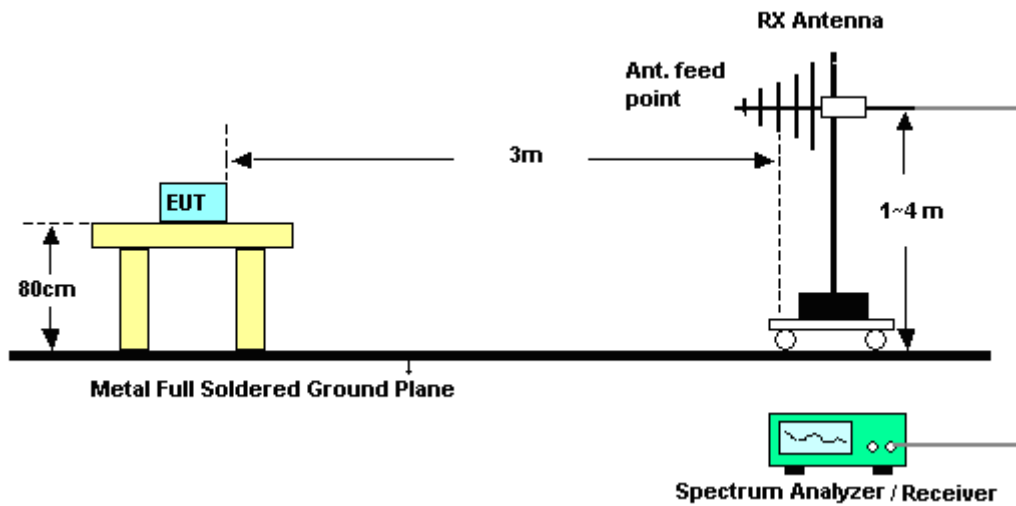

For radiated emissions above 1GHz

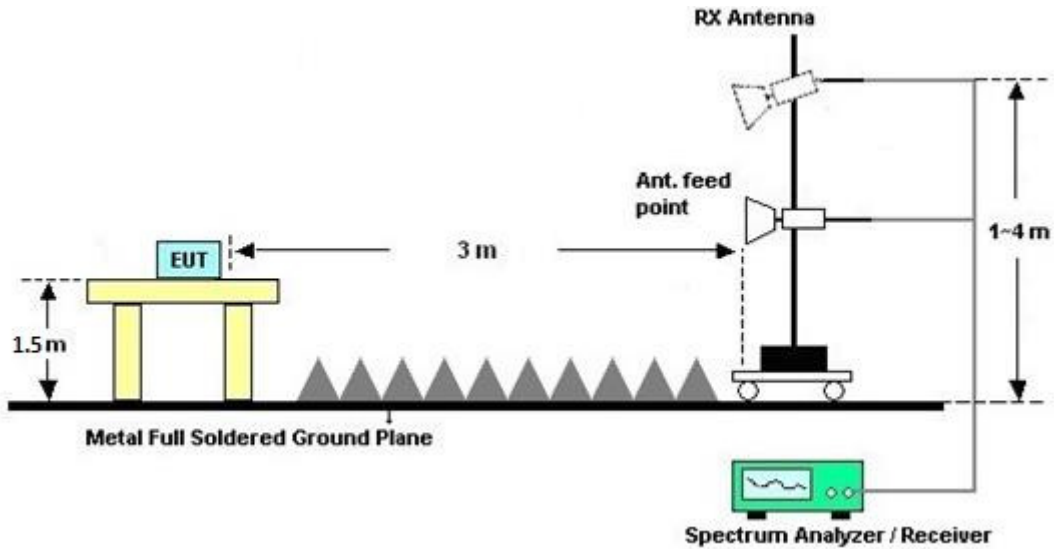

3.4.5 Test Results of Radiated Emissions (9 kHz ~ 30 MHz)

The low frequency, which started from 9 kHz to 30MHz, was pre-scanned and the result which was 20dB lower than the limit line per 15.31(o) was not reported.

3.4.6 Test Result of Radiated Band Edges

Please refer to Appendix B and C.

3.4.7 Test Result of Unwanted Radiated Emission (30MHz ~ 10th Harmonic)

Please refer to Appendix B and C.



3.5 AC Conducted Emission Measurement

3.5.1 Limit of AC Conducted Emission

For equipment that is designed to be connected to the public utility (AC) power line, the radio frequency voltage that is conducted back onto the AC power line on any frequency or frequencies within the band 150 kHz to 30 MHz shall not exceed the limits in the following table.

Frequency of emission (MHz)	Conducted limit (dBµV)	
	Quasi-peak	Average
0.15-0.5	66 to 56*	56 to 46*
0.5-5	56	46
5-30	60	50

*Decreases with the logarithm of the frequency.

3.5.2 Measuring Instruments

The measuring equipment is listed in the section 4 of this test report.

3.5.3 Test Procedures

1. The EUT was placed 0.4 meter from the conducting wall of the shielding room was kept at least 80 centimeters from any other grounded conducting surface.
2. Connect EUT to the power mains through a line impedance stabilization network (LISN).
3. All the support units are connecting to the other LISN.
4. The LISN provides 50 ohm coupling impedance for the measuring instrument.
5. The FCC states that a 50 ohm, 50 microhenry LISN should be used.
6. Both sides of AC line were checked for maximum conducted interference.
7. The frequency range from 150 kHz to 30 MHz was searched.
8. Set the test-receiver system to Peak Detect Function and specified bandwidth with Maximum Hold Mode.

3.5.4 Test Setup

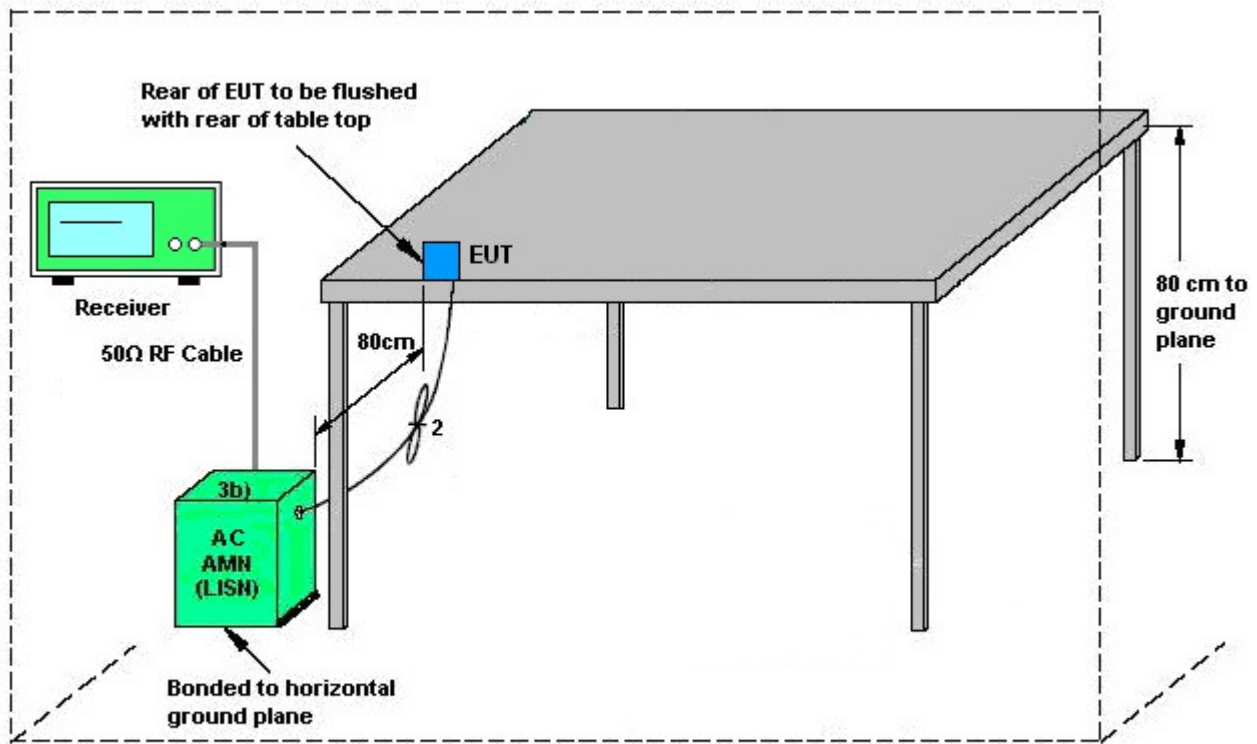

AMN = Artificial mains network (LISN)
AE = Associated equipment
EUT = Equipment under test
ISN = Impedance stabilization network



3.5.5 Test Result of AC Conducted Emission

Test Mode :	Mode 1	Temperature :	24~25°C
Test Engineer :	Kai-Chun Chu	Relative Humidity :	46~47%
Test Voltage :	120Vac / 60Hz	Phase :	Line
Function Type :	5G Tx + RJ-45 Link + Adapter		

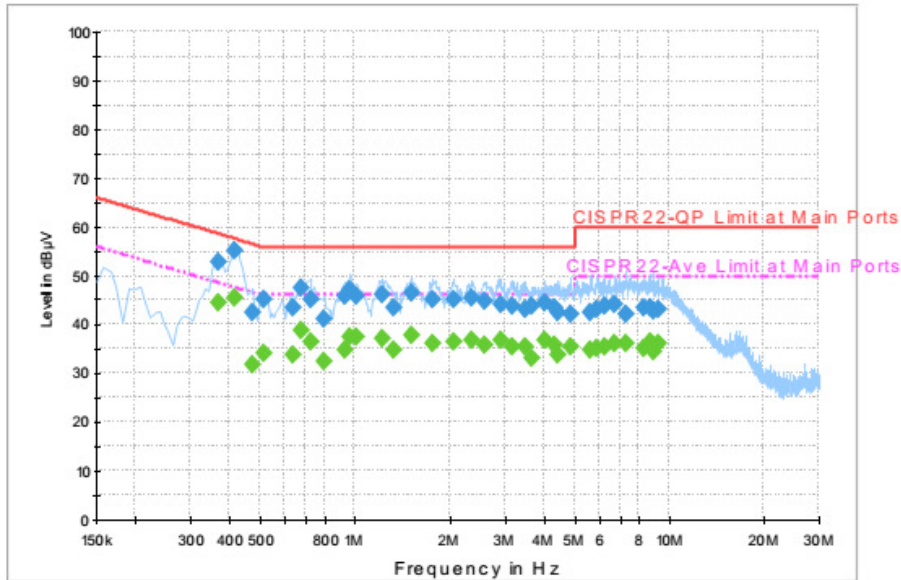

Final Result : QuasiPeak

Frequency (MHz)	QuasiPeak (dBµV)	Filter	Line	Corr. (dB)	Margin (dB)	Limit (dBµV)
0.366000	52.9	Off	L1	19.6	5.7	58.6
0.414000	55.0	Off	L1	19.6	2.6	57.6
0.470000	42.5	Off	L1	19.6	14.0	56.5
0.510000	45.2	Off	L1	19.6	10.8	56.0
0.630000	43.4	Off	L1	19.6	12.6	56.0
0.670000	47.6	Off	L1	19.6	8.4	56.0
0.718000	45.1	Off	L1	19.6	10.9	56.0
0.798000	41.3	Off	L1	19.6	14.7	56.0
0.926000	45.7	Off	L1	19.6	10.3	56.0
0.966000	47.1	Off	L1	19.6	8.9	56.0
1.006000	45.9	Off	L1	19.6	10.1	56.0
1.214000	46.2	Off	L1	19.6	9.8	56.0
1.326000	43.5	Off	L1	19.6	12.5	56.0
1.502000	46.3	Off	L1	19.6	9.7	56.0
1.766000	45.2	Off	L1	19.6	10.8	56.0
2.062000	45.2	Off	L1	19.5	10.8	56.0
2.334000	45.5	Off	L1	19.5	10.5	56.0
2.582000	44.8	Off	L1	19.6	11.2	56.0
2.894000	44.3	Off	L1	19.6	11.7	56.0



Test Mode :	Mode 1	Temperature :	24~25°C
Test Engineer :	Kai-Chun Chu	Relative Humidity :	46~47%
Test Voltage :	120Vac / 60Hz	Phase :	Line
Function Type :	5G Tx + RJ-45 Link + Adapter		

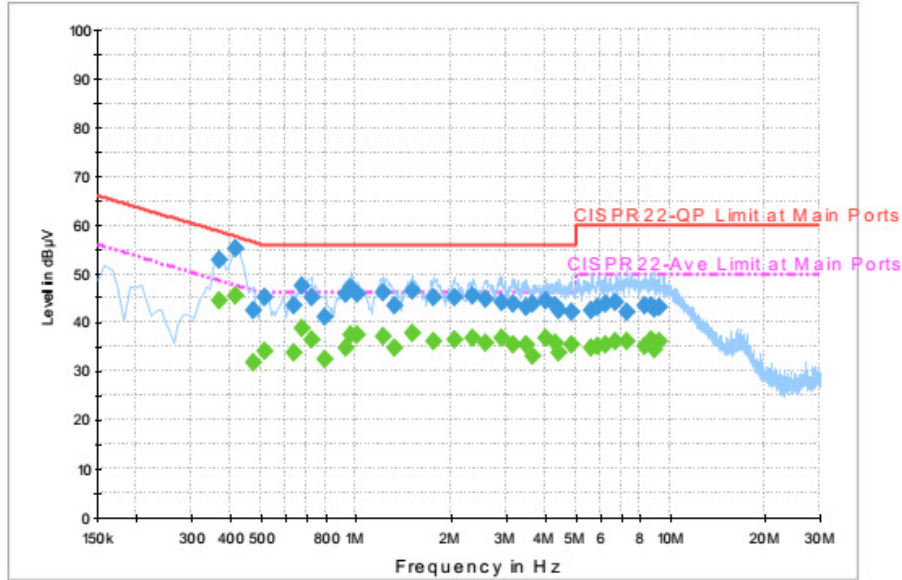

Final Result : QuasiPeak

Frequency (MHz)	QuasiPeak (dBµV)	Filter	Line	Corr. (dB)	Margin (dB)	Limit (dBµV)
3.150000	43.7	Off	L1	19.6	12.3	56.0
3.462000	43.2	Off	L1	19.6	12.8	56.0
3.646000	44.0	Off	L1	19.6	12.0	56.0
4.006000	44.6	Off	L1	19.7	11.4	56.0
4.286000	43.5	Off	L1	19.7	12.5	56.0
4.438000	42.3	Off	L1	19.7	13.7	56.0
4.838000	42.3	Off	L1	19.7	13.7	56.0
5.630000	42.5	Off	L1	19.7	17.5	60.0
5.902000	43.0	Off	L1	19.7	17.0	60.0
6.222000	43.7	Off	L1	19.7	16.3	60.0
6.718000	44.2	Off	L1	19.7	15.8	60.0
7.302000	42.0	Off	L1	19.7	18.0	60.0
8.254000	43.6	Off	L1	19.7	16.4	60.0
8.718000	43.4	Off	L1	19.7	16.6	60.0
8.910000	42.9	Off	L1	19.7	17.1	60.0
9.238000	43.3	Off	L1	19.7	16.7	60.0



Test Mode :	Mode 1	Temperature :	24~25°C
Test Engineer :	Kai-Chun Chu	Relative Humidity :	46~47%
Test Voltage :	120Vac / 60Hz	Phase :	Line
Function Type :	5G Tx + RJ-45 Link + Adapter		

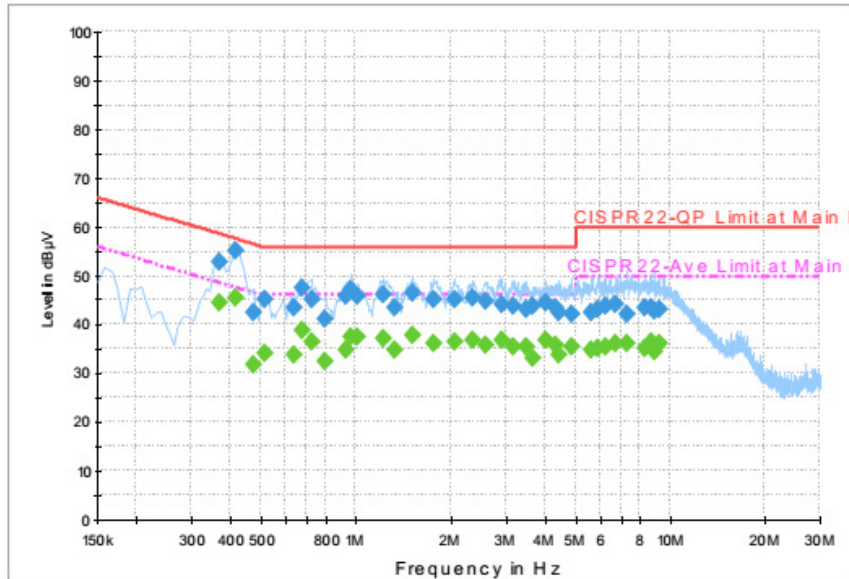

Final Result : Average

Frequency (MHz)	Average (dBµV)	Filter	Line	Corr. (dB)	Margin (dB)	Limit (dBµV)
0.366000	44.5	Off	L1	19.6	4.1	48.6
0.414000	45.5	Off	L1	19.6	2.1	47.6
0.470000	31.8	Off	L1	19.6	14.7	46.5
0.510000	34.2	Off	L1	19.6	11.8	46.0
0.630000	33.8	Off	L1	19.6	12.2	46.0
0.670000	38.8	Off	L1	19.6	7.2	46.0
0.718000	36.5	Off	L1	19.6	9.5	46.0
0.798000	32.5	Off	L1	19.6	13.5	46.0
0.926000	34.8	Off	L1	19.6	11.2	46.0
0.966000	37.5	Off	L1	19.6	8.5	46.0
1.006000	37.3	Off	L1	19.6	8.7	46.0
1.214000	37.2	Off	L1	19.6	8.8	46.0
1.326000	34.7	Off	L1	19.6	11.3	46.0
1.502000	37.6	Off	L1	19.6	8.4	46.0
1.766000	36.1	Off	L1	19.6	9.9	46.0
2.062000	36.6	Off	L1	19.5	9.4	46.0
2.334000	36.8	Off	L1	19.5	9.2	46.0
2.582000	35.7	Off	L1	19.6	10.3	46.0
2.894000	36.7	Off	L1	19.6	9.3	46.0



Test Mode :	Mode 1	Temperature :	24~25°C
Test Engineer :	Kai-Chun Chu	Relative Humidity :	46~47%
Test Voltage :	120Vac / 60Hz	Phase :	Line
Function Type :	5G Tx + RJ-45 Link + Adapter		

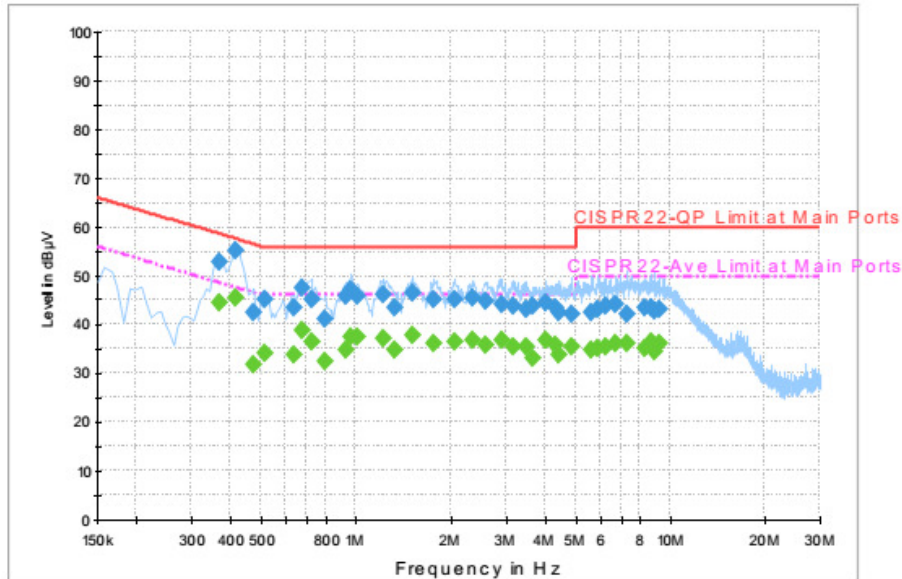

Final Result : Average

Frequency (MHz)	Average (dBµV)	Filter	Line	Corr. (dB)	Margin (dB)	Limit (dBµV)
3.150000	35.5	Off	L1	19.6	10.5	46.0
3.462000	35.4	Off	L1	19.6	10.6	46.0
3.646000	33.1	Off	L1	19.6	12.9	46.0
4.006000	36.8	Off	L1	19.7	9.2	46.0
4.286000	35.9	Off	L1	19.7	10.1	46.0
4.438000	33.9	Off	L1	19.7	12.1	46.0
4.838000	35.4	Off	L1	19.7	10.6	46.0
5.630000	34.9	Off	L1	19.7	15.1	50.0
5.902000	35.0	Off	L1	19.7	15.0	50.0
6.222000	35.5	Off	L1	19.7	14.5	50.0
6.718000	36.2	Off	L1	19.7	13.8	50.0
7.302000	36.1	Off	L1	19.7	13.9	50.0
8.254000	35.0	Off	L1	19.7	15.0	50.0
8.718000	36.4	Off	L1	19.7	13.6	50.0
8.910000	34.5	Off	L1	19.7	15.5	50.0
9.238000	36.1	Off	L1	19.7	13.9	50.0



Test Mode :	Mode 1	Temperature :	24~25°C
Test Engineer :	Kai-Chun Chu	Relative Humidity :	46~47%
Test Voltage :	120Vac / 60Hz	Phase :	Neutral
Function Type :	5G Tx + RJ-45 Link + Adapter		

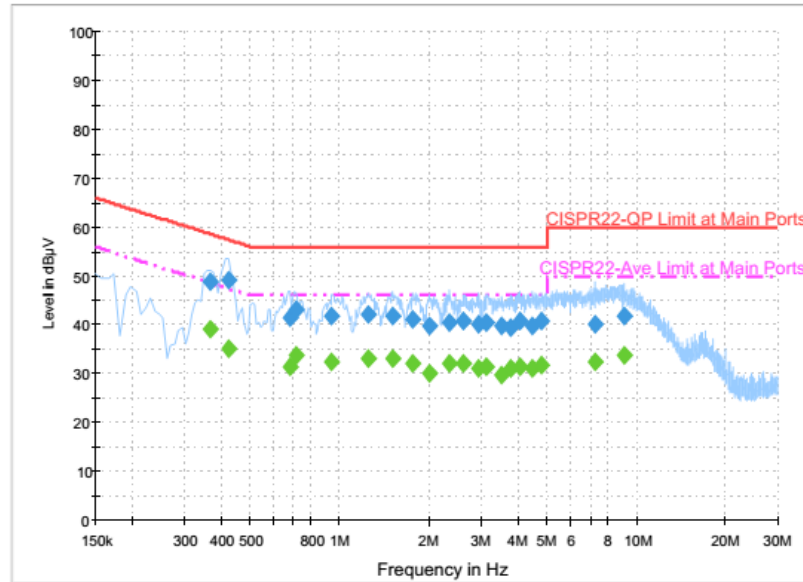

Final Result : QuasiPeak

Frequency (MHz)	QuasiPeak (dBµV)	Filter	Line	Corr. (dB)	Margin (dB)	Limit (dBµV)
0.366000	48.9	Off	N	19.6	9.7	58.6
0.422000	49.0	Off	N	19.6	8.4	57.4
0.678000	41.5	Off	N	19.6	14.5	56.0
0.710000	43.2	Off	N	19.6	12.8	56.0
0.942000	41.8	Off	N	19.6	14.2	56.0
1.246000	42.1	Off	N	19.6	13.9	56.0
1.510000	41.9	Off	N	19.6	14.1	56.0
1.758000	41.2	Off	N	19.6	14.8	56.0
2.006000	39.8	Off	N	19.6	16.2	56.0
2.350000	40.6	Off	N	19.6	15.4	56.0
2.622000	41.0	Off	N	19.6	15.0	56.0
2.958000	40.2	Off	N	19.6	15.8	56.0
3.142000	40.4	Off	N	19.6	15.6	56.0
3.534000	39.9	Off	N	19.6	16.1	56.0
3.798000	39.6	Off	N	19.6	16.4	56.0
4.054000	40.7	Off	N	19.6	15.3	56.0
4.454000	39.7	Off	N	19.6	16.3	56.0
4.806000	40.9	Off	N	19.6	15.1	56.0
7.278000	40.2	Off	N	19.7	19.8	60.0
9.142000	41.8	Off	N	19.7	18.2	60.0



Test Mode :	Mode 1	Temperature :	24~25°C
Test Engineer :	Kai-Chun Chu	Relative Humidity :	46~47%
Test Voltage :	120Vac / 60Hz	Phase :	Neutral
Function Type :	5G Tx + RJ-45 Link + Adapter		

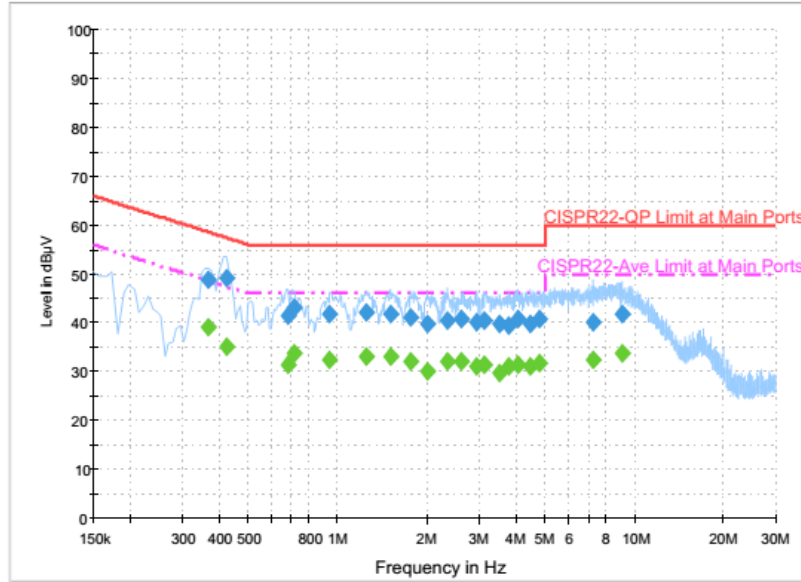

Final Result : Average

Frequency (MHz)	Average (dBµV)	Filter	Line	Corr. (dB)	Margin (dB)	Limit (dBµV)
0.366000	39.1	Off	N	19.6	9.5	48.6
0.422000	35.2	Off	N	19.6	12.2	47.4
0.678000	31.3	Off	N	19.6	14.7	46.0
0.710000	33.8	Off	N	19.6	12.2	46.0
0.942000	32.4	Off	N	19.6	13.6	46.0
1.246000	33.1	Off	N	19.6	12.9	46.0
1.510000	33.2	Off	N	19.6	12.8	46.0
1.758000	32.1	Off	N	19.6	13.9	46.0
2.006000	30.1	Off	N	19.6	15.9	46.0
2.350000	32.2	Off	N	19.6	13.8	46.0
2.622000	32.2	Off	N	19.6	13.8	46.0
2.958000	31.1	Off	N	19.6	14.9	46.0
3.142000	31.5	Off	N	19.6	14.5	46.0
3.534000	29.9	Off	N	19.6	16.1	46.0
3.798000	31.2	Off	N	19.6	14.8	46.0
4.054000	31.5	Off	N	19.6	14.5	46.0
4.454000	31.1	Off	N	19.6	14.9	46.0
4.806000	31.9	Off	N	19.6	14.1	46.0
7.278000	32.3	Off	N	19.7	17.7	50.0
9.142000	33.8	Off	N	19.7	16.2	50.0

3.6 Frequency Stability Measurement

3.6.1 Limit of Frequency Stability

Manufacturers of U-NII devices are responsible for ensuring frequency stability such that an emission is maintained within the band of operation under all conditions of normal operation as specified in the user's manual.

3.6.2 Measuring Instruments

The measuring equipment is listed in the section 4 of this test report.

3.6.3 Test Procedures

1. To ensure emission at the band edge is maintained within the authorized band, those values shall be measured by radiation emissions at upper and lower frequency points, and finally compensated by frequency deviation as procedures below.
2. The EUT was operated at the maximum output power, and connected to the spectrum analyzer, which is set to maximum hold function and peak detector. The peak value of the power envelope was measured and noted. The upper and lower frequency points were respectively measured relatively 10dB lower than the measured peak value.
3. The frequency deviation was calculated by adding the upper frequency point and the lower frequency point divided by two. Those detailed values of frequency deviation are provided in table below.

3.6.4 Test Setup



3.6.5 Test Result of Frequency Stability

Please refer to Appendix A.



3.7 Automatically Discontinue Transmission

3.7.1 Limit of Automatically Discontinue Transmission

The device shall automatically discontinue transmission in case of either absence of information to transmit or operational failure. These provisions are not intended to preclude the transmission of control or signaling information or the use of repetitive codes used by certain digital technologies to complete frame or burst intervals. Applicants shall include in their application for equipment authorization to describe how this requirement is met.

3.7.2 Measuring Instruments

The measuring equipment is listed in the section 4 of this test report.

3.7.3 Test Result of Automatically Discontinue Transmission

While the EUT is not transmitting any information, the EUT can automatically discontinue transmission and become standby mode for power saving. The EUT can detect the controlling signal of ACK message transmitting from remote device and verify whether it shall resend or discontinue transmission.



3.8 Antenna Requirements

3.8.1 Standard Applicable

According to FCC 47 CFR Section 15.407(a)(1)(2) ,if transmitting antenna directional gain is greater than 6 dBi, both the peak transmit power and the peak power spectral density shall be reduced by the amount in dB that the directional gain of the antenna exceeds 6 dBi.

3.8.2 Antenna Anti-Replacement Construction

Non-standard antenna connector is used.

3.8.3 Antenna Gain

FCC KDB 662911 D01 Multiple Transmitter Output v02r01

For CDD transmissions, directional gain is calculated as

Directional gain = $G_{ANT} + \text{Array Gain}$, where Array Gain is as follows.

For power spectral density (PSD) measurements on all devices,

Array Gain = $10 \log(N_{ANT}/N_{SS}=1)$ dB.

For power measurements on IEEE 802.11 devices,

Array Gain = 0 dB (i.e., no array gain) for $N_{ANT} \leq 4$.

Directional gain may be calculated by using the formulas applicable to equal gain antennas with G_{ANT} set equal to the gain of the antenna having the highest gain;

The EUT supports CDD mode.

The power and PSD limit should be modified if the directional gain of EUT is over 6 dBi,

The directional gain "DG" is calculated as following table.

			DG for Power (dBi)	DG for PSD (dBi)	Power Limit Reduction (dB)	PSD Limit Reduction (dB)
	Ant 1 (dBi)	Ant 2 (dBi)				
Band I	3.18	3.18	3.18	6.19	0.00	0.19

Power limit reduction = Composite gain – 6dBi, (min = 0)

PSD limit reduction = Composite gain + PSD Array gain – 6dBi, (min = 0)



4 List of Measuring Equipment

Instrument	Manufacturer	Model No.	Serial No.	Characteristics	Calibration Date	Test Date	Due Date	Remark
DC Power Supply	TOPWARD	3303D	740889	N/A	May 27, 2015	Feb. 22, 2016 ~ Mar. 21, 2016	May 26, 2016	Conducted (TH02-HY)
Power Meter	Agilent	E4416A	GB41292344	300MHz~40GHz	Jan. 08, 2016	Feb. 22, 2016 ~ Mar. 21, 2016	Jan. 07, 2017	Conducted (TH02-HY)
Power Meter	Anritsu	ML2495A	1036004	300MHz~40GHz	Jul. 29, 2015	Feb. 22, 2016 ~ Mar. 21, 2016	Jul. 28, 2016	Conducted (TH02-HY)
Power Sensor	Anritsu	MA2411B	1027253	300MHz~40GHz	Jul. 29, 2015	Feb. 22, 2016 ~ Mar. 21, 2016	Jul. 28, 2016	Conducted (TH02-HY)
Spectrum Analyzer	Rohde & Schwarz	FSP40	100055	9kHz~40GHz	Jun. 18, 2015	Feb. 22, 2016 ~ Mar. 21, 2016	Jun. 17, 2016	Conducted (TH02-HY)
Thermal Chamber	Ten Billion	TTH-D3SP	TBN-930701	N/A	Jul. 16, 2015	Feb. 22, 2016 ~ Mar. 21, 2016	Jul. 15, 2016	Conducted (TH02-HY)
Loop Antenna	Rohde & Schwarz	HFH2-Z2	100315	9 kHz~30 MHz	Sep. 02, 2015	Mar. 08, 2016 ~ Mar. 29, 2016	Sep. 01, 2016	Radiation (03CH12-HY)
Bilog Antenna	TESEQ	CBL 6111D	37059	30MHz~1GHz	Dec. 29, 2015	Mar. 08, 2016 ~ Mar. 29, 2016	Dec. 28, 2016	Radiation (03CH12-HY)
Spectrum Analyzer	Keysight	N9010A	MY54200486	10Hz ~ 44GHZ	Sep. 24, 2015	Mar. 08, 2016 ~ Mar. 29, 2016	Sep. 23, 2016	Radiation (03CH12-HY)
EMI Test Receiver	Rohde & Schwarz	ESU26	100390	20Hz~26.5GHz	Dec. 21, 2015	Mar. 08, 2016 ~ Mar. 29, 2016	Dec. 20, 2016	Radiation (03CH12-HY)
Horn Antenna	SCHWARZBECK	BBHA 9120D	9120D-1328	1GHz ~ 18GHz	Nov. 02, 2015	Mar. 08, 2016 ~ Mar. 29, 2016	Nov. 01, 2016	Radiation (03CH12-HY)
Horn Antenna	SCHWARZBECK	BBHA 9170	BBHA9170584	18GHz- 40GHz	Nov. 02, 2015	Mar. 08, 2016 ~ Mar. 29, 2016	Nov. 01, 2016	Radiation (03CH12-HY)
Preamplifier	COM-POWER	PA-103A	161075	10MHz~1GHz	Apr. 09, 2015	Mar. 08, 2016 ~ Mar. 29, 2016	Apr. 08, 2016	Radiation (03CH12-HY)
Preamplifier	MITEQ	AMF-7D-0010 1800-30-10P	1815698	1GHz~18GHz	Dec. 14, 2015	Mar. 08, 2016 ~ Mar. 29, 2016	Dec. 13, 2016	Radiation (03CH12-HY)
Preamplifier	Agilent	8449B	3008A02375	1GHz~26.5GHz	Jan. 05, 2016	Mar. 08, 2016 ~ Mar. 29, 2016	Jan. 04, 2017	Radiation (03CH12-HY)
Antenna Mast	EMEC	AM-BS-4500-B	N/A	1m~4m	N/A	Mar. 08, 2016 ~ Mar. 29, 2016	N/A	Radiation (03CH12-HY)
Turn Table	EMEC	TT2000	N/A	0-360 degre	N/A	Mar. 08, 2016 ~ Mar. 29, 2016	N/A	Radiation (03CH12-HY)
Preamplifier	MITEQ	JS44-1800400 0-33-8P	1840917	18GHz ~ 40GHz	Jun. 02, 2015	Mar. 08, 2016 ~ Mar. 29, 2016	Jun. 01, 2016	Radiation (03CH12-HY)
AC Power Source	ChainTek	APC-1000W	N/A	N/A	N/A	Mar. 27, 2016	N/A	Conduction (CO05-HY)
EMI Test Receiver	Rohde & Schwarz	ESCI 7	100724	9kHz~7GHz	Aug. 26, 2015	Mar. 27, 2016	Aug. 25, 2016	Conduction (CO05-HY)
LISN	Rohde & Schwarz	ENV216	100080	9kHz~30MHz	Dec. 02, 2015	Mar. 27, 2016	Dec. 01, 2016	Conduction (CO05-HY)



5 Uncertainty of Evaluation

Uncertainty of Conducted Emission Measurement (150kHz ~ 30MHz)

Measuring Uncertainty for a Level of Confidence of 95% ($U = 2Uc(y)$)	2.26
---	------

Uncertainty of Radiated Emission Measurement (30 MHz ~ 1000 MHz)

Measuring Uncertainty for a Level of Confidence of 95% ($U = 2Uc(y)$)	4.9
---	-----



Appendix A. Conducted Test Results

Test Engineer:	AC Chang	Temperature:	21~25	°C
Test Date:	2016/02/22~2016/03/21	Relative Humidity:	51~54	%

TEST RESULTS DATA
26dB and 99% OBW

Band I													
Mod.	Data Rate	NTX	CH.	Freq. (MHz)	99% Bandwidth (MHz)		26 dB Bandwidth (MHz)		IC 99% Bandwidth Power Limit (dBm)		IC 99% Bandwidth EIRP Limit (dBm)		Note
					Ant 1	Ant 2	Ant 1	Ant 2	Ant 1	Ant 2	Ant 1	Ant 2	
11a	6Mbps	2	36	5180	17.70	17.50	24.40	23.20	-	-	22.43		
11a	6Mbps	2	40	5200	17.75	17.60	26.60	24.80	-	-	22.46		
11a	6Mbps	2	48	5240	17.65	17.55	30.00	24.40	-	-	22.44		
HT20	MCS0	2	36	5180	18.70	18.65	25.10	25.90	-	-	22.71		
HT20	MCS0	2	40	5200	18.65	18.65	26.70	26.00	-	-	22.71		
HT20	MCS0	2	48	5240	19.05	18.70	26.90	26.10	-	-	22.72		
HT40	MCS0	2	38	5190	36.90	36.90	46.44	45.54	-	-	23.01		
HT40	MCS0	2	46	5230	36.80	36.90	48.42	50.22	-	-	23.01		
VHT20	MCS0	2	36	5180	18.55	18.60	24.70	24.40	-	-	22.68		
VHT20	MCS0	2	40	5200	18.85	18.70	24.50	25.70	-	-	22.72		
VHT20	MCS0	2	48	5240	18.70	18.65	26.10	24.80	-	-	22.71		
VHT40	MCS0	2	38	5190	36.80	36.70	46.62	47.70	-	-	23.01		
VHT40	MCS0	2	46	5230	36.70	36.80	47.52	47.52	-	-	23.01		
VHT80	MCS0	2	42	5210	75.96	75.96	86.08	86.72	-	-	23.01		

TEST RESULTS DATA
Average Power Table

FCC Band I														
Mod.	Data Rate	NTX	CH.	Freq. (MHz)	Duty Factor (dB)		Average Conducted Power (dBm)			FCC Conducted Power Limit (dBm)		DG (dBi)		Pass/Fail
					Ant 1	Ant 2	Ant 1	Ant 2	SUM	Ant 1	Ant 2	Ant 1	Ant 2	
11a	6Mbps	2	36	5180	0.15	0.15	21.46	20.11	23.84	30.00		3.18	Pass	
11a	6Mbps	2	40	5200	0.15	0.15	25.46	24.23	27.90	30.00		3.18	Pass	
11a	6Mbps	2	48	5240	0.15	0.15	25.51	24.30	27.95	30.00		3.18	Pass	
HT20	MCS0	2	36	5180	0.16	0.16	19.83	19.55	22.70	30.00		3.18	Pass	
HT20	MCS0	2	40	5200	0.16	0.16	24.26	23.77	27.03	30.00		3.18	Pass	
HT20	MCS0	2	48	5240	0.16	0.16	24.38	23.82	27.12	30.00		3.18	Pass	
HT40	MCS0	2	38	5190	0.32	0.32	16.14	15.96	19.06	30.00		3.18	Pass	
HT40	MCS0	2	46	5230	0.32	0.32	22.79	22.23	25.53	30.00		3.18	Pass	
VHT20	MCS0	2	36	5180	0.16	0.16	20.88	19.63	23.31	30.00		3.18	Pass	
VHT20	MCS0	2	40	5200	0.16	0.16	25.31	24.23	27.81	30.00		3.18	Pass	
VHT20	MCS0	2	48	5240	0.16	0.16	25.28	24.39	27.86	30.00		3.18	Pass	
VHT40	MCS0	2	38	5190	0.31	0.31	17.18	15.75	19.54	30.00		3.18	Pass	
VHT40	MCS0	2	46	5230	0.31	0.31	24.08	22.78	26.49	30.00		3.18	Pass	
VHT80	MCS0	2	42	5210	0.59	0.59	14.15	12.88	16.57	30.00		3.18	Pass	

TEST RESULTS DATA
Power Spectral Density

FCC Band I														
Mod.	Data Rate	NTX	CH.	Freq. (MHz)	Duty Factor (dB)		Average Power Density (dBm/MHz)			Average PSD Limit (dBm/MHz)		DG (dBi)		Pass /Fail
					Ant 1	Ant 2	Ant 1	Ant 2	SUM	Ant 1	Ant 2	Ant 1	Ant 2	
11a	6Mbps	2	36	5180	0.15	0.15			12.11	16.81	6.19			Pass
11a	6Mbps	2	40	5200	0.15	0.15			15.84	16.81	6.19			Pass
11a	6Mbps	2	48	5240	0.15	0.15			16.10	16.81	6.19			Pass
HT20	MCS0	2	36	5180	0.16	0.16			15.42	16.81	6.19			Pass
HT20	MCS0	2	40	5200	0.16	0.16			15.59	16.81	6.19			Pass
HT20	MCS0	2	48	5240	0.16	0.16			15.55	16.81	6.19			Pass
HT40	MCS0	2	38	5190	0.32	0.32			11.05	16.81	6.19			Pass
HT40	MCS0	2	46	5230	0.32	0.32			12.19	16.81	6.19			Pass
VHT20	MCS0	2	36	5180	0.16	0.16			11.12	16.81	6.19			Pass
VHT20	MCS0	2	40	5200	0.16	0.16			15.14	16.81	6.19			Pass
VHT20	MCS0	2	48	5240	0.16	0.16			15.42	16.81	6.19			Pass
VHT40	MCS0	2	38	5190	0.31	0.31			2.82	16.81	6.19			Pass
VHT40	MCS0	2	46	5230	0.31	0.31			11.09	16.81	6.19			Pass
VHT80	MCS0	2	42	5210	0.59	0.59			-1.97	16.81	6.19			Pass

TEST RESULTS DATA
Frequency Stability

Band I										
Mod.	Data Rate	NTX	CH.	Freq. (MHz)	Center Frequency (MHz)	Frequency Deviation (MHz)	Frequency Stability (ppm)	Temperature (°C)	Voltage (V)	Note
11a	6Mbps	1	36	5180	5180.000	0.000	0.00	20	3.2	
11a	6Mbps	1	36	5180	5180.000	0.000	0.00	20	4.2	
11a	6Mbps	1	36	5180	5180.000	0.000	0.00	20	3.7	
11a	6Mbps	1	36	5180	5180.075	0.075	14.48	-30	3.7	
11a	6Mbps	1	36	5180	5180.000	0.000	0.00	50	3.7	



Appendix B. Radiated Spurious Emission

Test Engineer :	Nick Yu, J.C. Liang, and Ricky Su	Temperature :	23~25°C
		Relative Humidity :	55~60%

Band 1 - 5150~5250MHz

WIFI 802.11a (Band Edge @ 3m)

WIFI Ant.	Note	Frequency (MHz)	Level (dBμV/m)	Over Limit (dB)	Limit Line (dBμV/m)	Read Level (dBμV)	Antenna Factor (dB/m)	Cable Loss (dB)	Preamp Factor (dB)	Ant Pos (cm)	Table Pos (deg)	Peak Avg. (P/A)	Pol. (H/V)	
802.11a CH 36 5180MHz		5147.75	62.33	-11.67	74	53.74	31.65	11.21	34.27	276	319	P	H	
		5146.85	49.84	-4.16	54	41.25	31.65	11.21	34.27	276	319	A	H	
	*	5182	114.16	-	-	105.56	31.68	11.18	34.26	276	319	P	H	
	*	5182	104.54	-	-	95.94	31.68	11.18	34.26	276	319	A	H	
													H	
														H
			5148.95	65.52	-8.48	74	56.93	31.65	11.21	34.27	400	327	P	V
			5148.05	52.81	-1.19	54	44.22	31.65	11.21	34.27	400	327	A	V
	*		5178	118.72	-	-	110.09	31.68	11.21	34.26	400	327	P	V
	*		5178	108.42	-	-	99.79	31.68	11.21	34.26	400	327	A	V
														V
														V
802.11a CH 40 5200MHz		5141.3	59.58	-14.42	74	50.99	31.65	11.21	34.27	144	315	P	H	
		5147.45	47.66	-6.34	54	39.07	31.65	11.21	34.27	144	315	A	H	
	*	5200	117.06	-	-	108.43	31.7	11.18	34.25	144	315	P	H	
	*	5200	107.03	-	-	98.4	31.7	11.18	34.25	144	315	A	H	
			5391.14	58.3	-15.7	74	49	31.88	11.6	34.18	144	315	P	H
			5402.03	46.33	-7.67	54	37.01	31.9	11.6	34.18	144	315	A	H
			5150	64.38	-9.62	74	55.79	31.65	11.21	34.27	382	345	P	V
			5150	51.35	-2.65	54	42.76	31.65	11.21	34.27	382	345	A	V
	*		5200	123.28	-	-	114.65	31.7	11.18	34.25	382	345	P	V
	*		5200	112.51	-	-	103.88	31.7	11.18	34.25	382	345	A	V
			5376.84	59.73	-14.27	74	50.53	31.87	11.52	34.19	382	345	P	V
			5372.88	48.41	-5.59	54	39.21	31.87	11.52	34.19	382	345	A	V



802.11a CH 48 5240MHz		5087.9	58.39	-15.61	74	49.84	31.58	11.27	34.3	275	315	P	H
		5072.3	47.61	-6.39	54	39.06	31.58	11.27	34.3	275	315	A	H
	*	5240	119.17	-	-	110.42	31.73	11.26	34.24	275	315	P	H
	*	5240	108.85	-	-	100.1	31.73	11.26	34.24	275	315	A	H
		5361	58.46	-15.54	74	49.26	31.87	11.52	34.19	275	315	P	H
		5367.82	46.83	-7.17	54	37.63	31.87	11.52	34.19	275	315	A	H
		5108.45	59.79	-14.21	74	51.22	31.62	11.24	34.29	392	341	P	V
		5118.8	48.98	-5.02	54	40.41	31.62	11.24	34.29	392	341	A	V
	*	5240	122.58	-	-	113.83	31.73	11.26	34.24	392	341	P	V
	*	5240	111.47	-	-	102.72	31.73	11.26	34.24	392	341	A	V
		5433.05	60.2	-13.8	74	50.8	31.93	11.64	34.17	392	341	P	V
		5407.64	48.89	-5.11	54	39.57	31.9	11.6	34.18	392	341	A	V
Remark	1. No other spurious found. 2. All results are PASS against Peak and Average limit line.												



Band 1 5150~5250MHz
WIFI 802.11a (Harmonic @ 3m)

WIFI Ant. 1+2	Note	Frequency (MHz)	Level (dBμV/m)	Over Limit (dB)	Limit Line (dBμV/m)	Read Level (dBμV)	Antenna Factor (dB/m)	Cable Loss (dB)	Preamp Factor (dB)	Ant Pos (cm)	Table Pos (deg)	Peak Avg. (P/A)	Pol. (H/V)
802.11a CH 36 5180MHz		10360	46.31	-27.69	74	47.06	17.13	39.59	57.47	100	0	P	H
		15540	55.6	-18.4	74	54.26	21.61	38.26	58.53	100	324	P	H
		15540	45.64	-8.36	54	44.3	21.61	38.26	58.53	100	324	A	H
													H
		10360	52.03	-21.97	74	52.78	17.13	39.59	57.47	100	0	P	V
		15540	54.35	-19.65	74	53.01	21.61	38.26	58.53	100	328	P	V
		15540	44.55	-9.45	54	43.21	21.61	38.26	58.53	100	328	A	V
													V
802.11a CH 40 5200MHz		10400	46.52	-27.48	74	47.1	39.64	17.18	57.4	100	0	P	H
		15600	45.39	-28.61	74	43.93	38.18	21.67	58.39	100	0	P	H
													H
													H
		10400	46.52	-27.48	74	47.1	39.64	17.18	57.4	100	0	P	V
		15600	45.16	-28.84	74	43.7	38.18	21.67	58.39	100	0	P	V
													V
													V
802.11a CH 48 5240MHz		10480	50.05	-23.95	74	50.24	39.77	17.27	57.23	100	0	P	H
		15720	56.49	-17.51	74	54.85	38.03	21.76	58.15	197	25	P	H
		15720	39.82	-14.18	54	38.18	38.03	21.76	58.15	197	25	A	H
													H
		10480	55.32	-18.68	74	55.51	39.77	17.27	57.23	100	147	P	V
		10480	44.97	-9.03	54	45.16	39.77	17.27	57.23	100	147	A	V
		15720	55.67	-18.33	74	54.03	38.03	21.76	58.15	100	145	P	V
		15720	41.89	-12.11	54	40.25	38.03	21.76	58.15	100	145	A	V
Remark	1. No other spurious found. 2. All results are PASS against Peak and Average limit line.												



Band 1 5150~5250MHz
WIFI 802.11ac VHT20 (Band Edge @ 3m)

WIFI Ant. 1+2	Note	Frequency (MHz)	Level (dBμV/m)	Over Limit (dB)	Limit Line (dBμV/m)	Read Level (dBμV)	Antenna Factor (dB/m)	Cable Loss (dB)	Preamp Factor (dB)	Ant Pos (cm)	Table Pos (deg)	Peak Avg. (P/A)	Pol. (H/V)	
802.11ac VHT20 CH 36 5180MHz		5148.95	62.27	-11.73	74	53.68	31.65	11.21	34.27	293	317	P	H	
		5148.95	50.83	-3.17	54	42.24	31.65	11.21	34.27	293	317	A	H	
	*	5182	113.62	-	-	105.02	31.68	11.18	34.26	293	317	P	H	
	*	5182	104.32	-	-	95.72	31.68	11.18	34.26	293	317	A	H	
													H	
														H
			5150	65.12	-8.88	74	56.53	31.65	11.21	34.27	400	333	P	V
			5150	53.14	-0.86	54	44.55	31.65	11.21	34.27	400	333	A	V
		*	5182	116.99	-	-	108.39	31.68	11.18	34.26	400	333	P	V
		*	5182	107.29	-	-	98.69	31.68	11.18	34.26	400	333	A	V
802.11ac VHT20 CH 40 5200MHz		5141.6	60.32	-13.68	74	51.73	31.65	11.21	34.27	280	315	P	H	
		5149.85	49.6	-4.4	54	41.01	31.65	11.21	34.27	280	315	A	H	
	*	5199	119.79	-	-	111.16	31.7	11.18	34.25	280	315	P	H	
	*	5199	111.27	-	-	102.64	31.7	11.18	34.25	280	315	A	H	
			5443.06	57.51	-16.49	74	48.11	31.93	11.64	34.17	280	315	P	H
			5350.11	46.24	-7.76	54	37.07	31.85	11.52	34.2	280	315	A	H
			5135	66.46	-7.54	74	57.87	31.63	11.24	34.28	392	338	P	V
			5149.7	53.41	-0.59	54	44.82	31.65	11.21	34.27	392	338	A	V
		*	5198	123.48	-	-	114.85	31.7	11.18	34.25	392	338	P	V
		*	5198	113.39	-	-	104.76	31.7	11.18	34.25	392	338	A	V
		5420.29	59.73	-14.27	74	50.34	31.92	11.64	34.17	392	338	P	V	
		5375.63	48.33	-5.67	54	39.13	31.87	11.52	34.19	392	338	A	V	



802.11ac VHT20 CH 48 5240MHz		5069.45	58.95	-15.05	74	50.41	31.57	11.27	34.3	282	313	P	H
		5087.45	47.27	-6.73	54	38.72	31.58	11.27	34.3	282	313	A	H
	*	5240	117.63	-	-	108.88	31.73	11.26	34.24	282	313	P	H
	*	5240	107.9	-	-	99.15	31.73	11.26	34.24	282	313	A	H
		5436.02	58.07	-15.93	74	48.67	31.93	11.64	34.17	282	313	P	H
		5421.72	46.54	-7.46	54	37.15	31.92	11.64	34.17	282	313	A	H
		5140.7	59.75	-14.25	74	51.16	31.65	11.21	34.27	378	344	P	V
		5086.1	48.93	-5.07	54	40.38	31.58	11.27	34.3	378	344	A	V
	*	5240	122.15	-	-	113.4	31.73	11.26	34.24	378	344	P	V
	*	5240	111.75	-	-	103	31.73	11.26	34.24	378	344	A	V
		5376.07	60.57	-13.43	74	51.37	31.87	11.52	34.19	378	344	P	V
		5414.68	48.81	-5.19	54	39.46	31.92	11.6	34.17	378	344	A	V
Remark	1. No other spurious found. 2. All results are PASS against Peak and Average limit line.												



Band 1 5150~5250MHz
WIFI 802.11ac VHT20 (Harmonic @ 3m)

WIFI Ant. 1+2	Note	Frequency (MHz)	Level (dBμV/m)	Over Limit (dB)	Limit Line (dBμV/m)	Read Level (dBμV)	Antenna Factor (dB/m)	Cable Loss (dB)	Preamp Factor (dB)	Ant Pos (cm)	Table Pos (deg)	Peak Avg. (P/A)	Pol. (H/V)	
802.11ac VHT20 CH 36 5180MHz		10360	46.86	-27.14	74	47.61	17.13	39.59	57.47	100	0	P	H	
		15540	47.76	-26.24	74	46.42	21.61	38.26	58.53	100	0	P	H	
													H	
													H	
			10360	51.66	-22.34	74	52.41	17.13	39.59	57.47	100	0	P	V
			15540	48.09	-25.91	74	46.75	21.61	38.26	58.53	100	0	P	V
														V
802.11ac VHT20 CH 40 5200MHz		10400	50.84	-23.16	74	51.42	39.64	17.18	57.4	100	0	P	H	
		15600	61.17	-12.83	74	59.71	38.18	21.67	58.39	100	290	P	H	
		15600	48.54	-5.46	54	47.08	38.18	21.67	58.39	100	290	A	H	
													H	
			10400	59.91	-14.09	74	60.49	39.64	17.18	57.4	100	225	P	V
			10400	48.02	-5.98	54	48.6	39.64	17.18	57.4	100	225	A	V
			15600	59.04	-14.96	74	57.58	38.18	21.67	58.39	100	312	P	V
802.11ac VHT20 CH 48 5240MHz		10480	46.21	-27.79	74	46.4	39.77	17.27	57.23	-	-	P	H	
		15720	45.7	-28.3	74	44.06	38.03	21.76	58.15	-	-	P	H	
													H	
													H	
			10480	47.44	-26.56	74	47.63	39.77	17.27	57.23	-	-	P	V
			15720	45.76	-28.24	74	44.12	38.03	21.76	58.15	-	-	P	V
														V
Remark	1. No other spurious found.													
	2. All results are PASS against Peak and Average limit line.													



Band 1 5150~5250MHz
WIFI 802.11ac VHT40 (Band Edge @ 3m)

WIFI Ant. 1+2	Note	Frequency (MHz)	Level (dBμV/m)	Over Limit (dB)	Limit Line (dBμV/m)	Read Level (dBμV)	Antenna Factor (dB/m)	Cable Loss (dB)	Preamp Factor (dB)	Ant Pos (cm)	Table Pos (deg)	Peak Avg. (P/A)	Pol. (H/V)
802.11ac VHT40 CH 38 5190MHz		5150	61.68	-12.32	74	53.09	31.65	11.21	34.27	274	313	P	H
		5148.8	52.02	-1.98	54	43.43	31.65	11.21	34.27	274	313	A	H
	*	5188	108.02	-	-	99.42	31.68	11.18	34.26	274	313	P	H
	*	5188	97.54	-	-	88.94	31.68	11.18	34.26	274	313	A	H
		5361.77	58.59	-15.41	74	49.39	31.87	11.52	34.19	274	313	P	H
		5456.04	46.68	-7.32	54	37.25	31.95	11.64	34.16	274	313	A	H
		5149.25	63.59	-10.41	74	55	31.65	11.21	34.27	375	344	P	V
		5149.85	53.43	-0.57	54	44.84	31.65	11.21	34.27	375	344	A	V
	*	5192	112.79	-	-	104.16	31.7	11.18	34.25	375	344	P	V
	*	5192	103.07	-	-	94.44	31.7	11.18	34.25	375	344	A	V
		5363.97	59.06	-14.94	74	49.86	31.87	11.52	34.19	375	344	P	V
		5367.27	48.55	-5.45	54	39.35	31.87	11.52	34.19	375	344	A	V
802.11ac VHT40 CH 46 5230MHz		5148.5	66.41	-7.59	74	57.82	31.65	11.21	34.27	290	313	P	H
		5149.55	52.09	-1.91	54	43.5	31.65	11.21	34.27	290	313	A	H
	*	5228	116.75	-	-	108	31.73	11.26	34.24	290	313	P	H
	*	5228	106.07	-	-	97.32	31.73	11.26	34.24	290	313	A	H
		5364.74	57.34	-16.66	74	48.14	31.87	11.52	34.19	290	313	P	H
		5350.77	47.16	-6.84	54	37.99	31.85	11.52	34.2	290	313	A	H
		5147.75	64.49	-9.51	74	55.9	31.65	11.21	34.27	391	343	P	V
		5150	53.4	-0.6	54	44.81	31.65	11.21	34.27	391	343	A	V
	*	5228	120.56	-	-	111.81	31.73	11.26	34.24	391	343	P	V
	*	5228	110.74	-	-	101.99	31.73	11.26	34.24	391	343	A	V
	5352.31	59.73	-14.27	74	50.56	31.85	11.52	34.2	391	343	P	V	
	5350.66	49.3	-4.7	54	40.13	31.85	11.52	34.2	391	343	A	V	
Remark	1. No other spurious found. 2. All results are PASS against Peak and Average limit line.												



Band 1 5150~5250MHz
WIFI 802.11ac VHT40 (Harmonic @ 3m)

WIFI Ant. 1+2	Note	Frequency (MHz)	Level (dBμV/m)	Over Limit (dB)	Limit Line (dBμV/m)	Read Level (dBμV)	Antenna Factor (dB/m)	Cable Loss (dB)	Preamp Factor (dB)	Ant Pos (cm)	Table Pos (deg)	Peak Avg. (P/A)	Pol. (H/V)	
802.11ac VHT40 CH 38 5190MHz		10380	46.46	-27.54	74	47.15	17.13	39.61	57.43	100	0	P	H	
		15570	44.36	-29.64	74	42.96	21.64	38.22	58.46	100	0	P	H	
													H	
													H	
			10380	48.18	-25.82	74	48.87	17.13	39.61	57.43	100	0	P	V
			15570	44.6	-29.4	74	43.2	21.64	38.22	58.46	100	0	P	V
														V
802.11ac VHT40 CH 46 5230MHz		10460	47.47	-26.53	74	47.83	17.22	39.72	57.3	100	0	P	H	
		15690	48.26	-25.74	74	46.68	21.73	38.07	58.22	100	0	P	H	
													H	
													H	
			10460	53.94	-20.06	74	54.3	17.22	39.72	57.3	100	0	P	V
			15690	50.75	-23.25	74	49.17	21.73	38.07	58.22	100	0	P	V
														V
Remark	1. No other spurious found.													
	2. All results are PASS against Peak and Average limit line.													



Band 1 5150~5250MHz
WIFI 802.11ac VHT80 (Band Edge @ 3m)

WIFI Ant. 1+2	Note	Frequency (MHz)	Level (dBμV/m)	Over Limit (dB)	Limit Line (dBμV/m)	Read Level (dBμV)	Antenna Factor (dB/m)	Cable Loss (dB)	Preamp Factor (dB)	Ant Pos (cm)	Table Pos (deg)	Peak Avg. (P/A)	Pol. (H/V)
802.11ac VHT80 CH 42 5210MHz		5147.6	63.78	-10.22	74	55.19	31.65	11.21	34.27	279	312	P	H
		5149.85	51.67	-2.33	54	43.08	31.65	11.21	34.27	279	312	A	H
	*	5208	104	-	-	95.35	31.72	11.18	34.25	279	312	P	H
	*	5208	91.15	-	-	82.5	31.72	11.18	34.25	279	312	A	H
		5439.54	56.72	-17.28	74	47.32	31.93	11.64	34.17	279	312	P	H
		5406.32	46.56	-7.44	54	37.24	31.9	11.6	34.18	279	312	A	H
		5135.3	63.86	-10.14	74	55.27	31.63	11.24	34.28	398	343	P	V
		5150	53.31	-0.69	54	44.72	31.65	11.21	34.27	398	343	A	V
	*	5208	106.89	-	-	98.24	31.72	11.18	34.25	398	343	P	V
	*	5208	97.26	-	-	88.61	31.72	11.18	34.25	398	343	A	V
		5432.61	57.28	-16.72	74	47.88	31.93	11.64	34.17	398	343	P	V
		5434.48	46.68	-7.32	54	37.28	31.93	11.64	34.17	398	343	A	V
Remark	1. No other spurious found. 2. All results are PASS against Peak and Average limit line.												



Band 1 5150~5250MHz
WIFI 802.11ac VHT80 (Harmonic @ 3m)

WIFI Ant. 1+2	Note	Frequency (MHz)	Level (dBμV/m)	Over Limit (dB)	Limit Line (dBμV/m)	Read Level (dBμV)	Antenna Factor (dB/m)	Cable Loss (dB)	Preamp Factor (dB)	Ant Pos (cm)	Table Pos (deg)	Peak Avg. (P/A)	Pol. (H/V)	
802.11ac VHT80 CH 42 5210MHz		10420	46.89	-27.11	74	47.41	17.18	39.67	57.37	100	0	P	H	
		15630	45.7	-28.3	74	44.19	21.7	38.13	58.32	100	0	P	H	
													H	
													H	
			10420	46.66	-27.34	74	47.18	17.18	39.67	57.37	100	0	P	V
			15630	45.27	-28.73	74	43.76	21.7	38.13	58.32	100	0	P	V
														V
														V
Remark	1. No other spurious found. 2. All results are PASS against Peak and Average limit line.													



Emission below 1GHz

WIFI 802.11ac VHT40 Adapter mode (LF @ 3m)

WIFI	Note	Frequency	Level	Over	Limit	Read	Antenna	Cable	Preamp	Ant	Table	Peak	Pol.	
Ant.				Limit	Line	Level	Factor	Loss	Factor	Pos	Pos	Avg.		
1+2		(MHz)	(dBμV/m)	(dB)	(dBμV/m)	(dBμV)	(dB/m)	(dB)	(dB)	(cm)	(deg)	(P/A)	(H/V)	
802.11ac VHT 40 LF		96.96	34.64	-8.86	43.5	48.35	15.64	1.06	30.41	-	-	P	H	
		206.85	34.58	-8.92	43.5	47.18	15.99	1.7	30.29	-	-	P	H	
		277.86	30.97	-15.03	46	39.8	19.1	2.25	30.18	-	-	P	H	
		496.7	41.07	-4.93	46	43.88	23.93	3.08	29.82	100	116	P	H	
		774.6	31.44	-14.56	46	29.2	27.7	3.97	29.43	-	-	P	H	
		939.1	32.24	-13.76	46	26.77	30	4.6	29.13	-	-	P	H	
														H
														H
														H
														H
														H
														V
			41.61	36.31	-3.69	40	46.71	19.18	0.78	30.36	100	51	P	V
			89.94	35.05	-8.45	43.5	49.61	14.8	1.06	30.42	-	-	P	V
			213.6	38.08	-5.42	43.5	50.59	16.07	1.7	30.28	-	-	P	V
			311.2	33.3	-12.7	46	41.25	19.85	2.34	30.14	-	-	P	V
			490.4	31.45	-14.55	46	34.37	23.83	3.08	29.83	-	-	P	V
			974.8	34.16	-19.84	54	28.42	30	4.75	29.01	-	-	P	V
														V
														V
													V	
													V	
													V	
Remark	1. No other spurious found. 2. All results are PASS against limit line.													



Emission below 1GHz

WIFI 802.11ac VHT40 POE mode (LF @ 3m)

WIFI	Note	Frequency	Level	Over	Limit	Read	Antenna	Cable	Preamp	Ant	Table	Peak	Pol.	
Ant.				Limit	Line	Level	Factor	Loss	Factor	Pos	Pos	Avg.		
1+2		(MHz)	(dBμV/m)	(dB)	(dBμV/m)	(dBμV)	(dB/m)	(dB)	(dB)	(cm)	(deg)	(P/A)	(H/V)	
802.11ac VHT 40 LF		66.45	36.02	-3.98	40	53.26	12.15	1.06	30.45	101	121	QP	H	
		66.45	38.95	-1.05	40	56.19	12.15	1.06	30.45	101	121	P	H	
		80.49	36.36	-3.64	40	52.03	13.7	1.06	30.43	-	-	P	H	
		145.83	35.08	-8.42	43.5	46.05	17.64	1.75	30.36	-	-	P	H	
		309.8	39.65	-6.35	46	47.66	19.79	2.34	30.14	-	-	P	H	
		329.4	30.19	-15.81	46	37.57	20.39	2.34	30.11	-	-	P	H	
		491.1	32.14	-13.86	46	35.06	23.83	3.08	29.83	-	-	P	H	
														H
														H
														H
														H
														H
														H
			51.06	35.32	-4.68	40	50.42	14.59	0.78	30.47	-	-	P	V
			65.64	36.59	-3.41	40	53.88	12.1	1.06	30.45	100	54	QP	V
			65.64	39.72	-0.28	40	57.01	12.1	1.06	30.45	100	54	P	V
			200.37	39.95	-3.55	43.5	52.72	15.83	1.7	30.3	-	-	P	V
			303.5	42.29	-3.71	46	50.48	19.62	2.34	30.15	-	-	P	V
			308.4	34.78	-11.22	46	42.82	19.76	2.34	30.14	-	-	P	V
			444.2	33.4	-12.6	46	37.44	23	2.89	29.93	-	-	P	V
													V	
													V	
													V	
													V	
													V	
Remark	1. No other spurious found. 2. All results are PASS against limit line.													



Note symbol

*	Fundamental Frequency which can be ignored. However, the level of any unwanted emissions shall not exceed the level of the fundamental frequency.
!	Test result is over limit line.
P/A	Peak or Average
H/V	Horizontal or Vertical



A calculation example for radiated spurious emission is shown as below:

WIFI	Note	Frequency	Level	Over	Limit	Read	Antenna	Cable	Preamp	Ant	Table	Peak	Pol.
Ant.				Limit	Line	Level	Factor	Loss	Factor	Pos	Pos	Avg.	
1+2		(MHz)	(dBμV/m)	(dB)	(dBμV/m)	(dBμV)	(dB/m)	(dB)	(dB)	(cm)	(deg)	(P/A)	(H/V)
802.11b		2390	55.45	-18.55	74	54.51	32.22	4.58	35.86	103	308	P	H
CH 01													
2412MHz		2390	43.54	-10.46	54	42.6	32.22	4.58	35.86	103	308	A	H

- Level(dBμV/m) =
Antenna Factor(dB/m) + Cable Loss(dB) + Read Level(dBμV) - Preamp Factor(dB)
- Over Limit(dB) = Level(dBμV/m) – Limit Line(dBμV/m)

For Peak Limit @ 2390MHz:

- Level(dBμV/m)
= Antenna Factor(dB/m) + Cable Loss(dB) + Read Level(dBμV) - Preamp Factor(dB)
= 32.22(dB/m) + 4.58(dB) + 54.51(dBμV) – 35.86 (dB)
= 55.45 (dBμV/m)
- Over Limit(dB)
= Level(dBμV/m) – Limit Line(dBμV/m)
= 55.45(dBμV/m) – 74(dBμV/m)
= -18.55(dB)

For Average Limit @ 2390MHz:

- Level(dBμV/m)
= Antenna Factor(dB/m) + Cable Loss(dB) + Read Level(dBμV) - Preamp Factor(dB)
= 32.22(dB/m) + 4.58(dB) + 42.6(dBμV) – 35.86 (dB)
= 43.54 (dBμV/m)
- Over Limit(dB)
= Level(dBμV/m) – Limit Line(dBμV/m)
= 43.54(dBμV/m) – 54(dBμV/m)
= -10.46(dB)

Both peak and average measured complies with the limit line, so test result is “PASS”.



Appendix C. Radiated Spurious Emission

Test Engineer :	J.C. Liang, Ricky Su, and Nick Yu	Temperature :	23~25°C
		Relative Humidity :	55~60%

Note symbol

-L	Low channel location
-R	High channel location

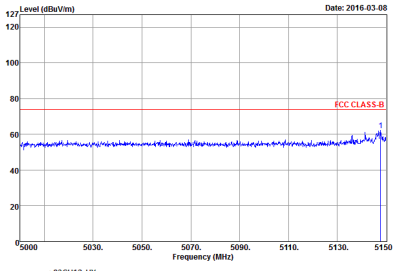
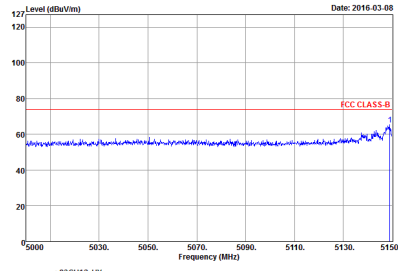
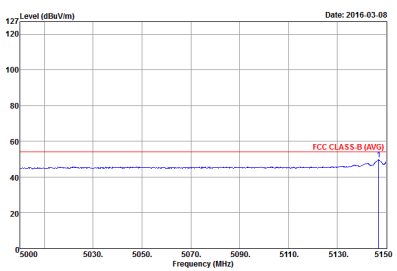
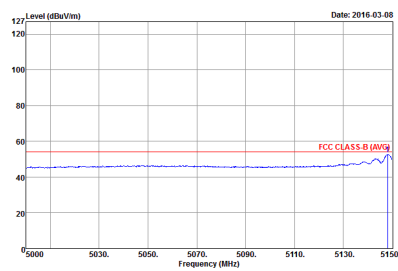

Band 1 - 5150~5250MHz
WIFI 802.11a (Band Edge @ 3m)

WIFI	Band 1 5150~5250MHz Band Edge @ 3m	
ANT	802.11a CH36 5180MHz	
1+2	Horizontal	Vertical
Peak	 <p>Site : 03CH12-HY Condition : FCC CLASS-B 3m HORN_91200_1328 HORIZONTAL RBW:1000.000KHz VBW:3000.000KHz SWT:Auto Detector : Peak Project : SD2212 Mode : 1</p>	 <p>Site : 03CH12-HY Condition : FCC CLASS-B 3m HORN_91200_1328 VERTICAL RBW:1000.000KHz VBW:3000.000KHz SWT:Auto Detector : Peak Project : SD2212 Mode : 1</p>
Avg.	 <p>Site : 03CH12-HY Condition : FCC CLASS-B (AVG) 3m HORN_91200_1328 HORIZONTAL RBW:1000.000KHz VBW:1.000KHz SWT:Auto Detector : Peak Project : SD2212 Mode : 1</p>	 <p>Site : 03CH12-HY Condition : FCC CLASS-B (AVG) 3m HORN_91200_1328 VERTICAL RBW:1000.000KHz VBW:1.000KHz SWT:Auto Detector : Peak Project : SD2212 Mode : 1</p>

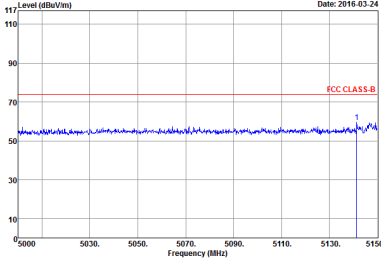
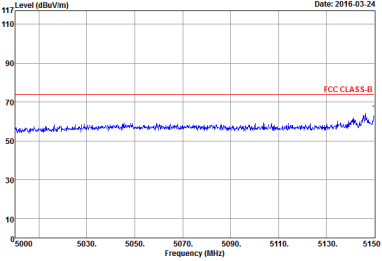
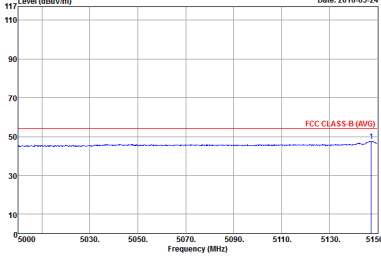
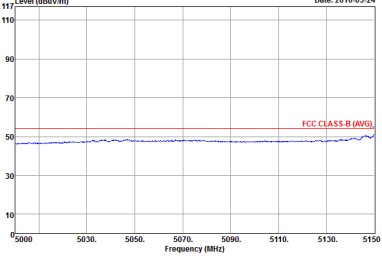

WIFI	Band 1 5150~5250MHz Band Edge @ 3m	
ANT	802.11a CH40 5200MHz - L	
1+2	Horizontal	Vertical
Peak	 <p>Date: 2016-03-24</p> <p>Site : 03CH12-HY Condition : FCC CLASS-B 3m HORN_91200_1328 HORIZONTAL RBW:1000.000KHz VBW:3000.000KHz SWT:Auto Detector : Peak Preject : 502212 Mode : 2</p>	 <p>Date: 2016-03-24</p> <p>Site : 03CH12-HY Condition : FCC CLASS-B 3m HORN_91200_1328 VERTICAL RBW:1000.000KHz VBW:3000.000KHz SWT:Auto Detector : Peak Preject : 502212 Mode : 2</p>
Avg.	 <p>Date: 2016-03-24</p> <p>Site : 03CH12-HY Condition : FCC CLASS-B (AVG) 3m HORN_91200_1328 HORIZONTAL RBW:1000.000KHz VBW:1.000KHz SWT:Auto Detector : Peak Preject : 502212 Mode : 2</p>	 <p>Date: 2016-03-24</p> <p>Site : 03CH12-HY Condition : FCC CLASS-B (AVG) 3m HORN_91200_1328 VERTICAL RBW:1000.000KHz VBW:1.000KHz SWT:Auto Detector : Peak Preject : 502212 Mode : 2</p>

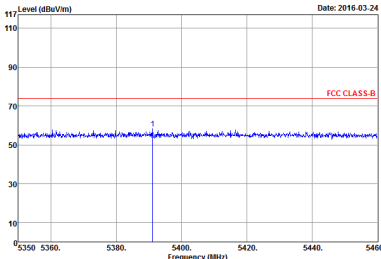
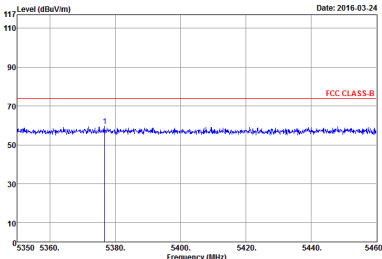
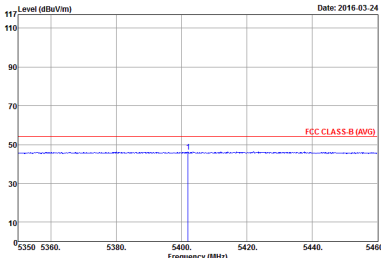
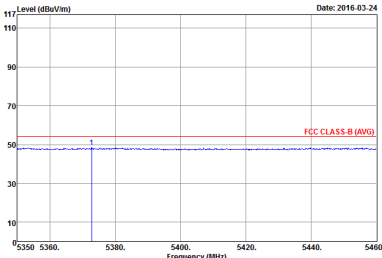

WIFI	Band 1 5150~5250MHz Band Edge @ 3m	
ANT	802.11a CH40 5200MHz - R	
1+2	Horizontal	Vertical
Peak	 <p>Date: 2016-03-24</p> <p>Level (dBuV/m) vs Frequency (MHz)</p> <p>FCC CLASS-B</p> <p>Site : 03CH12-HY Condition : FCC CLASS-B 3m HORN_91200_1328 HORIZONTAL Detector : Peak Project : 5D2212 Mode : 2</p>	 <p>Date: 2016-03-24</p> <p>Level (dBuV/m) vs Frequency (MHz)</p> <p>FCC CLASS-B</p> <p>Site : 03CH12-HY Condition : FCC CLASS-B 3m HORN_91200_1328 VERTICAL Detector : Peak Project : 5D2212 Mode : 2</p>
Avg.	 <p>Date: 2016-03-24</p> <p>Level (dBuV/m) vs Frequency (MHz)</p> <p>FCC CLASS-B (AVG)</p> <p>Site : 03CH12-HY Condition : FCC CLASS-B (AVG) 3m HORN_91200_1328 HORIZONTAL Detector : Peak Project : 5D2212 Mode : 2</p>	 <p>Date: 2016-03-24</p> <p>Level (dBuV/m) vs Frequency (MHz)</p> <p>FCC CLASS-B (AVG)</p> <p>Site : 03CH12-HY Condition : FCC CLASS-B (AVG) 3m HORN_91200_1328 VERTICAL Detector : Peak Project : 5D2212 Mode : 2</p>

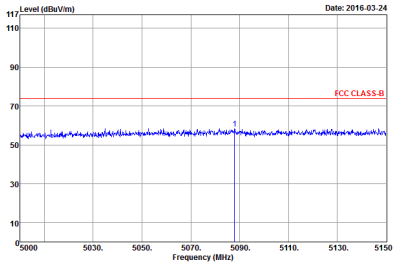
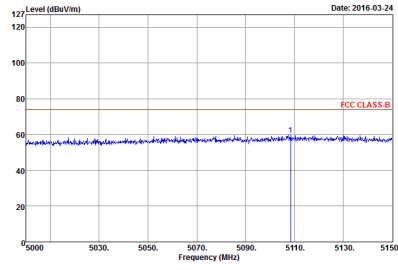
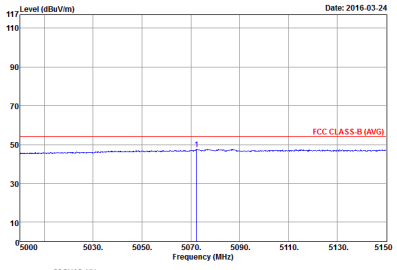
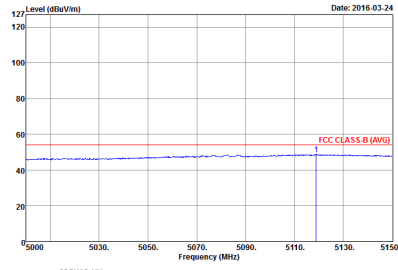

WIFI	Band 1 5150~5250MHz Band Edge @ 3m	
ANT	802.11a CH48 5240MHz - L	
1+2	Horizontal	Vertical
<p>Peak</p>	 <p>Date: 2016-03-24</p> <p>Level (dBuV/m) vs Frequency (MHz)</p> <p>FCC CLASS-B</p> <p>Site : 03CH12-HY Condition : FCC CLASS-B 3m HORN_91200_1328 HORIZONTAL Detector : Peak Project : 5D2212 Mode : 3</p>	 <p>Date: 2016-03-24</p> <p>Level (dBuV/m) vs Frequency (MHz)</p> <p>FCC CLASS-B</p> <p>Site : 03CH12-HY Condition : FCC CLASS-B 3m HORN_91200_1328 VERTICAL Detector : Peak Project : 5D2212 Mode : 3</p>
<p>Avg.</p>	 <p>Date: 2016-03-24</p> <p>Level (dBuV/m) vs Frequency (MHz)</p> <p>FCC CLASS-B (AVG)</p> <p>Site : 03CH12-HY Condition : FCC CLASS-B (AVG) 3m HORN_91200_1328 HORIZONTAL Detector : Peak Project : 5D2212 Mode : 3</p>	 <p>Date: 2016-03-24</p> <p>Level (dBuV/m) vs Frequency (MHz)</p> <p>FCC CLASS-B (AVG)</p> <p>Site : 03CH12-HY Condition : FCC CLASS-B (AVG) 3m HORN_91200_1328 VERTICAL Detector : Peak Project : 5D2212 Mode : 3</p>

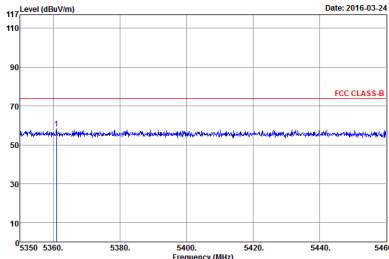
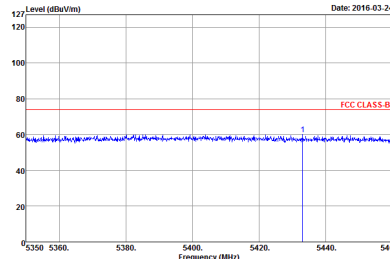
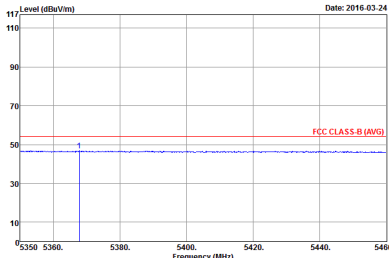
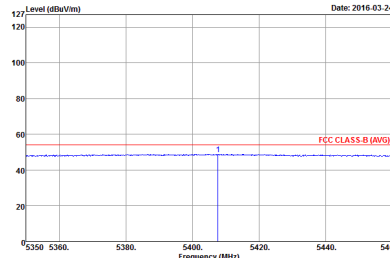

WIFI	Band 1 5150~5250MHz Band Edge @ 3m	
ANT	802.11a CH48 5240MHz - R	
1+2	Horizontal	Vertical
<p>Peak</p>	 <p>Date: 2016-03-24</p> <p>Level (dBu/Vm)</p> <p>Frequency (MHz)</p> <p>FCC CLASS-B</p> <p>Site : 03CH12-HY Condition : FCC CLASS-B 3m HORN_91200_1328 HORIZONTAL Detector : Peak Project : 5D2212 Mode : 3</p>	 <p>Date: 2016-03-24</p> <p>Level (dBu/Vm)</p> <p>Frequency (MHz)</p> <p>FCC CLASS-B</p> <p>Site : 03CH12-HY Condition : FCC CLASS-B 3m HORN_91200_1328 VERTICAL Detector : Peak Project : 5D2212 Mode : 3</p>
<p>Avg.</p>	 <p>Date: 2016-03-24</p> <p>Level (dBu/Vm)</p> <p>Frequency (MHz)</p> <p>FCC CLASS-B (AVG)</p> <p>Site : 03CH12-HY Condition : FCC CLASS-B (AVG) 3m HORN_91200_1328 HORIZONTAL Detector : Peak Project : 5D2212 Mode : 3</p>	 <p>Date: 2016-03-24</p> <p>Level (dBu/Vm)</p> <p>Frequency (MHz)</p> <p>FCC CLASS-B (AVG)</p> <p>Site : 03CH12-HY Condition : FCC CLASS-B (AVG) 3m HORN_91200_1328 VERTICAL Detector : Peak Project : 5D2212 Mode : 3</p>

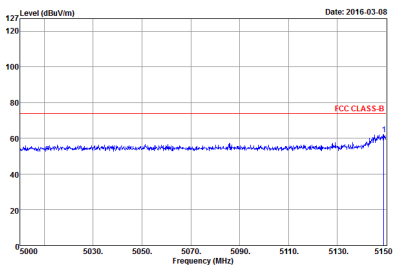
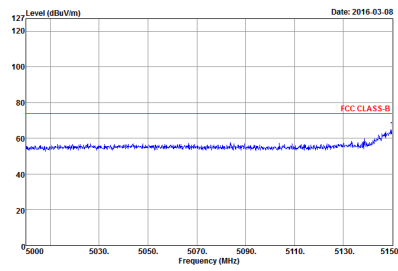
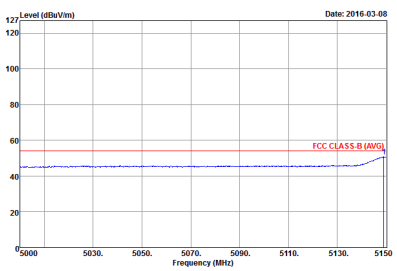
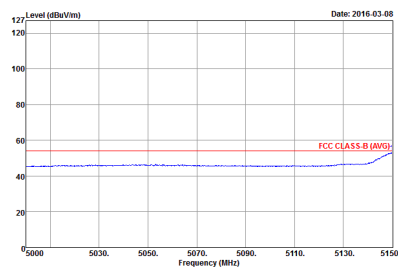

**Band 1 5150~5250MHz
WIFI 802.11ac VHT20 (Band Edge @ 3m)**

WIFI	Band 1 5150~5250MHz Band Edge @ 3m	
ANT	802.11ac VHT20 CH36 5180MHz	
1+2	Horizontal	Vertical
Peak	 <p>Date: 2016-03-08</p> <p>Level (dBuV/m) vs Frequency (MHz)</p> <p>FCC CLASS-B</p> <p>Site : 03CH12-HY Condition : FCC CLASS-B 3m HORN_91200_1328 HORIZONTAL Detector : Peak Project : SD2212 Mode : 4</p>	 <p>Date: 2016-03-08</p> <p>Level (dBuV/m) vs Frequency (MHz)</p> <p>FCC CLASS-B</p> <p>Site : 03CH12-HY Condition : FCC CLASS-B 3m HORN_91200_1328 VERTICAL Detector : Peak Project : SD2212 Mode : 4</p>
Avg.	 <p>Date: 2016-03-08</p> <p>Level (dBuV/m) vs Frequency (MHz)</p> <p>FCC CLASS-B (AVG)</p> <p>Site : 03CH12-HY Condition : FCC CLASS-B (AVG) 3m HORN_91200_1328 HORIZONTAL Detector : Peak Project : SD2212 Mode : 4</p>	 <p>Date: 2016-03-08</p> <p>Level (dBuV/m) vs Frequency (MHz)</p> <p>FCC CLASS-B (AVG)</p> <p>Site : 03CH12-HY Condition : FCC CLASS-B (AVG) 3m HORN_91200_1328 VERTICAL Detector : Peak Project : SD2212 Mode : 4</p>

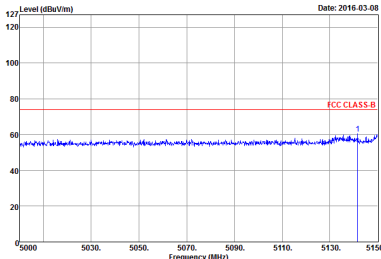
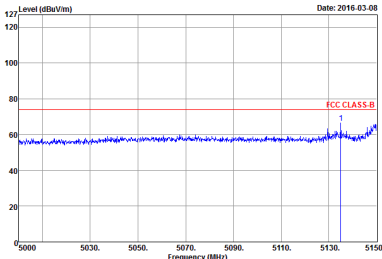
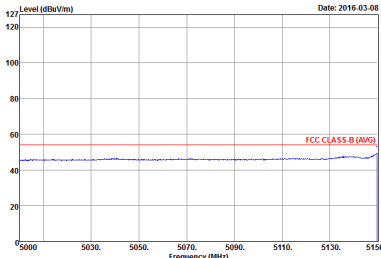
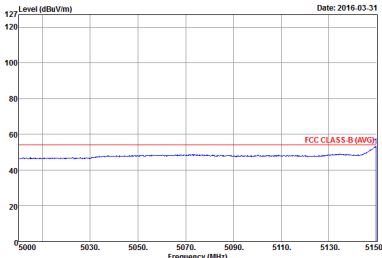

WIFI	Band 1 5150~5250MHz Band Edge @ 3m	
ANT	802.11ac VHT20 CH40 5200MHz - L	
1+2	Horizontal	Vertical
Peak	 <p>Date: 2016-03-08</p> <p>Level (dBuV/m) vs Frequency (MHz)</p> <p>FCC CLASS B</p> <p>Site : 03CH12-HY Condition : FCC CLASS-B 3m HORN_91200_1328 HORIZONTAL Detector : Peak Project : 502212 Mode : 5</p>	 <p>Date: 2016-03-08</p> <p>Level (dBuV/m) vs Frequency (MHz)</p> <p>FCC CLASS B</p> <p>Site : 03CH12-HY Condition : FCC CLASS-B 3m HORN_91200_1328 VERTICAL Detector : Peak Project : 502212 Mode : 5</p>
Avg.	 <p>Date: 2016-03-08</p> <p>Level (dBuV/m) vs Frequency (MHz)</p> <p>FCC CLASS B (AVG)</p> <p>Site : 03CH12-HY Condition : FCC CLASS-B (AVG) 3m HORN_91200_1328 HORIZONTAL Detector : Peak Project : 502212 Mode : 5</p>	 <p>Date: 2016-03-31</p> <p>Level (dBuV/m) vs Frequency (MHz)</p> <p>FCC CLASS B (AVG)</p> <p>Site : 03CH12-HY Condition : FCC CLASS-B (AVG) 3m HORN_91200_1328 VERTICAL Detector : Peak Project : 502212 Mode : 5</p>

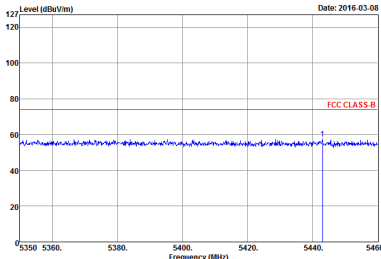
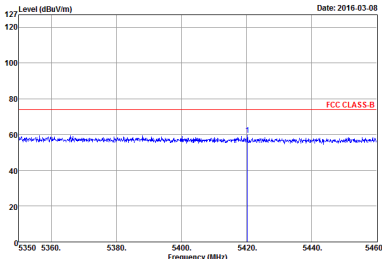
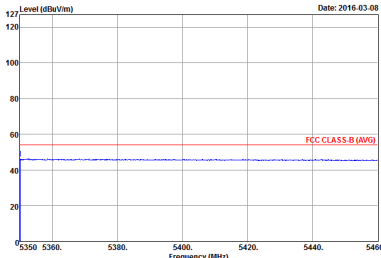
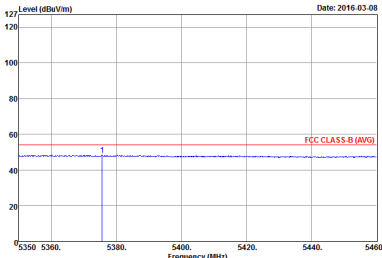

WIFI	Band 1 5150~5250MHz Band Edge @ 3m	
ANT	802.11ac VHT20 CH40 5200MHz - R	
1+2	Horizontal	Vertical
Peak	 <p>Date: 2016-03-08</p> <p>Level (dBuV/m) vs Frequency (MHz)</p> <p>FCC CLASS B</p> <p>Site : 03CH12-HY Condition : FCC CLASS-B 3m HORN_91200_1328 HORIZONTAL Detector : Peak Project : 502212 Mode : 5</p>	 <p>Date: 2016-03-08</p> <p>Level (dBuV/m) vs Frequency (MHz)</p> <p>FCC CLASS B</p> <p>Site : 03CH12-HY Condition : FCC CLASS-B 3m HORN_91200_1328 VERTICAL Detector : Peak Project : 502212 Mode : 5</p>
Avg.	 <p>Date: 2016-03-08</p> <p>Level (dBuV/m) vs Frequency (MHz)</p> <p>FCC CLASS B (AVG)</p> <p>Site : 03CH12-HY Condition : FCC CLASS-B (AVG) 3m HORN_91200_1328 HORIZONTAL Detector : Peak Project : 502212 Mode : 5</p>	 <p>Date: 2016-03-08</p> <p>Level (dBuV/m) vs Frequency (MHz)</p> <p>FCC CLASS B (AVG)</p> <p>Site : 03CH12-HY Condition : FCC CLASS-B (AVG) 3m HORN_91200_1328 VERTICAL Detector : Peak Project : 502212 Mode : 5</p>

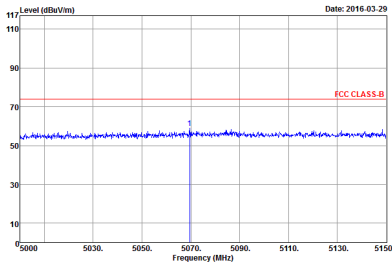
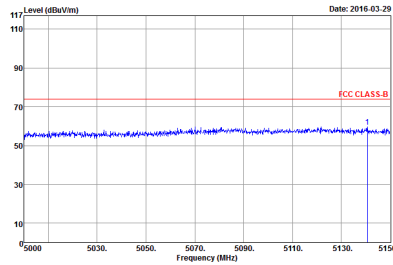
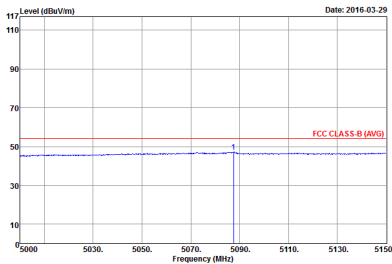
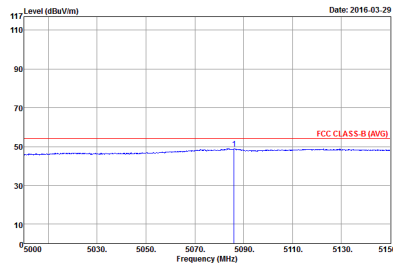

WIFI	Band 1 5150~5250MHz Band Edge @ 3m	
ANT	802.11ac VHT20 CH48 5240MHz - L	
1+2	Horizontal	Vertical
Peak	 <p>Date: 2016-03-29</p> <p>Level (dBuV/m) vs Frequency (MHz)</p> <p>FCC CLASS B</p> <p>Site : 03CH12-HY Condition : FCC CLASS-B 3m HORN_91200_1328 HORIZONTAL Detector : Peak Project : S02212 Mode : 6</p>	 <p>Date: 2016-03-29</p> <p>Level (dBuV/m) vs Frequency (MHz)</p> <p>FCC CLASS B</p> <p>Site : 03CH12-HY Condition : FCC CLASS-B 3m HORN_91200_1328 VERTICAL Detector : Peak Project : S02212 Mode : 6</p>
Avg.	 <p>Date: 2016-03-29</p> <p>Level (dBuV/m) vs Frequency (MHz)</p> <p>FCC CLASS-B (AVG)</p> <p>Site : 03CH12-HY Condition : FCC CLASS-B (AVG) 3m HORN_91200_1328 HORIZONTAL Detector : Peak Project : S02212 Mode : 6</p>	 <p>Date: 2016-03-29</p> <p>Level (dBuV/m) vs Frequency (MHz)</p> <p>FCC CLASS-B (AVG)</p> <p>Site : 03CH12-HY Condition : FCC CLASS-B (AVG) 3m HORN_91200_1328 VERTICAL Detector : Peak Project : S02212 Mode : 6</p>

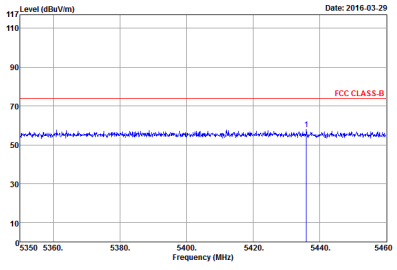
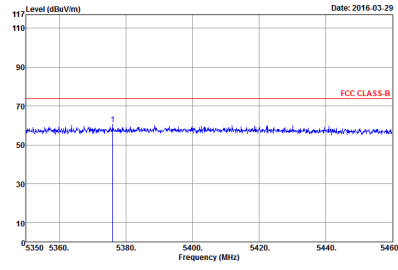
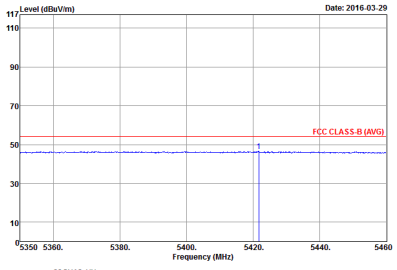
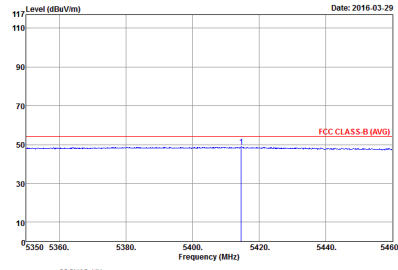

WIFI	Band 1 5150~5250MHz Band Edge @ 3m	
ANT	802.11ac VHT20 CH48 5240MHz - R	
1+2	Horizontal	Vertical
Peak	 <p>Date: 2016-03-29</p> <p>Level (dBuV/m) vs Frequency (MHz)</p> <p>FCC CLASS-B</p> <p>Site : 03CH12-HY Condition : FCC CLASS-B 3m HORN_91200_1328 HORIZONTAL Detector : Peak Project : S02212 Mode : 6</p>	 <p>Date: 2016-03-29</p> <p>Level (dBuV/m) vs Frequency (MHz)</p> <p>FCC CLASS-B</p> <p>Site : 03CH12-HY Condition : FCC CLASS-B 3m HORN_91200_1328 VERTICAL Detector : Peak Project : S02212 Mode : 6</p>
Avg.	 <p>Date: 2016-03-29</p> <p>Level (dBuV/m) vs Frequency (MHz)</p> <p>FCC CLASS-B (AVG)</p> <p>Site : 03CH12-HY Condition : FCC CLASS-B (AVG) 3m HORN_91200_1328 HORIZONTAL Detector : Peak Project : S02212 Mode : 6</p>	 <p>Date: 2016-03-29</p> <p>Level (dBuV/m) vs Frequency (MHz)</p> <p>FCC CLASS-B (AVG)</p> <p>Site : 03CH12-HY Condition : FCC CLASS-B (AVG) 3m HORN_91200_1328 VERTICAL Detector : Peak Project : S02212 Mode : 6</p>

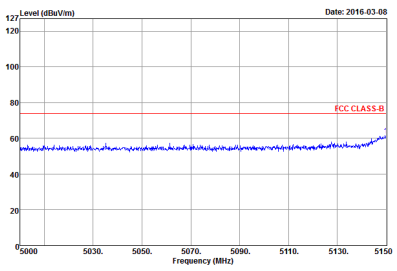
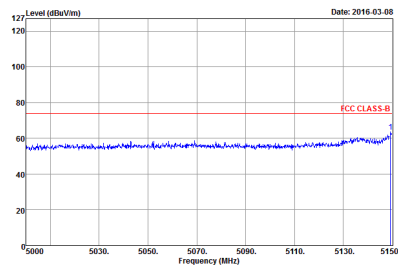
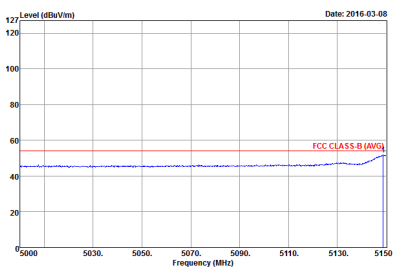
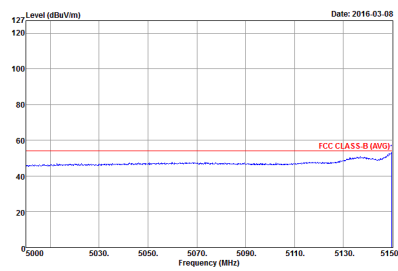

**Band 1 5150~5250MHz
WIFI 802.11ac VHT40 (Band Edge @ 3m)**

WIFI	Band 1 5150~5250MHz Band Edge @ 3m	
ANT	802.11ac VHT40 CH38 5190MHz - L	
1+2	Horizontal	Vertical
Peak	 <p>Date: 2016-03-08</p> <p>Level (dBuV/m) vs Frequency (MHz)</p> <p>FCC CLASS-B</p> <p>Site : 03CH12-HY Condition : FCC CLASS-B 3m HORN_91200_1328 HORIZONTAL Detector : Peak Project : 5D2212 Mode : 7</p>	 <p>Date: 2016-03-08</p> <p>Level (dBuV/m) vs Frequency (MHz)</p> <p>FCC CLASS-B</p> <p>Site : 03CH12-HY Condition : FCC CLASS-B 3m HORN_91200_1328 VERTICAL Detector : Peak Project : 5D2212 Mode : 7</p>
Avg.	 <p>Date: 2016-03-08</p> <p>Level (dBuV/m) vs Frequency (MHz)</p> <p>FCC CLASS-B (AVG)</p> <p>Site : 03CH12-HY Condition : FCC CLASS-B (AVG) 3m HORN_91200_1328 HORIZONTAL Detector : Peak Project : 5D2212 Mode : 7</p>	 <p>Date: 2016-03-08</p> <p>Level (dBuV/m) vs Frequency (MHz)</p> <p>FCC CLASS-B (AVG)</p> <p>Site : 03CH12-HY Condition : FCC CLASS-B (AVG) 3m HORN_91200_1328 VERTICAL Detector : Peak Project : 5D2212 Mode : 7</p>

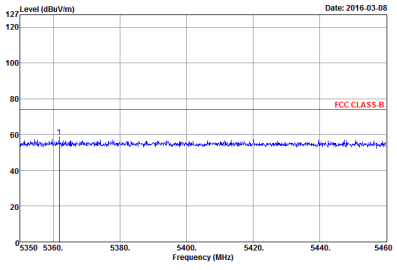
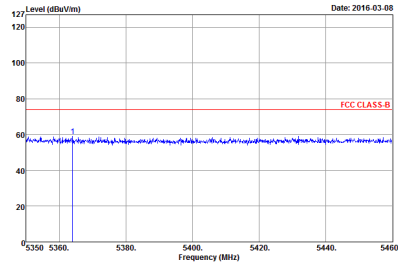
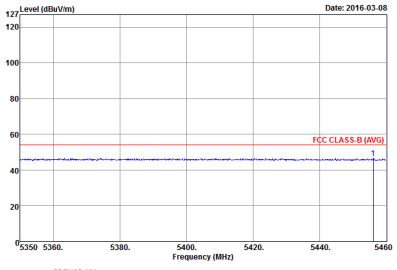
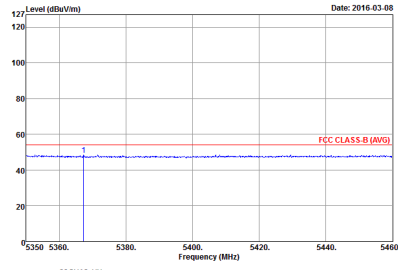

WIFI	Band 1 5150~5250MHz Band Edge @ 3m	
ANT	802.11ac VHT40 CH38 5190MHz - R	
1+2	Horizontal	Vertical
Peak	 <p>Date: 2016-03-08</p> <p>Level (dBu/Vm) vs Frequency (MHz)</p> <p>Site : 03CH12-HY Condition : FCC CLASS-B 3m HORN_91200_1328 HORIZONTAL Detector : Peak Project : 502212 Mode : 7</p>	 <p>Date: 2016-03-08</p> <p>Level (dBu/Vm) vs Frequency (MHz)</p> <p>Site : 03CH12-HY Condition : FCC CLASS-B 3m HORN_91200_1328 VERTICAL Detector : Peak Project : 502212 Mode : 7</p>
Avg.	 <p>Date: 2016-03-08</p> <p>Level (dBu/Vm) vs Frequency (MHz)</p> <p>Site : 03CH12-HY Condition : FCC CLASS-B (AVG) 3m HORN_91200_1328 HORIZONTAL Detector : Peak Project : 502212 Mode : 7</p>	 <p>Date: 2016-03-08</p> <p>Level (dBu/Vm) vs Frequency (MHz)</p> <p>Site : 03CH12-HY Condition : FCC CLASS-B (AVG) 3m HORN_91200_1328 VERTICAL Detector : Peak Project : 502212 Mode : 7</p>

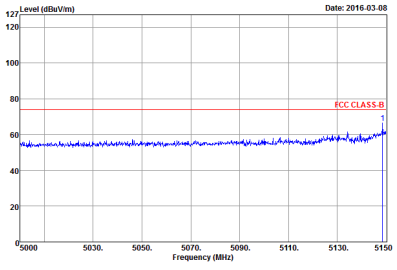
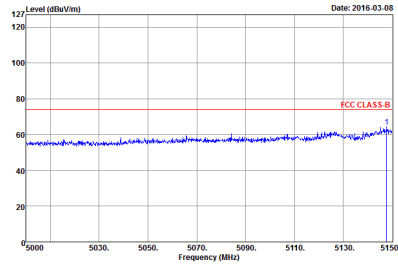
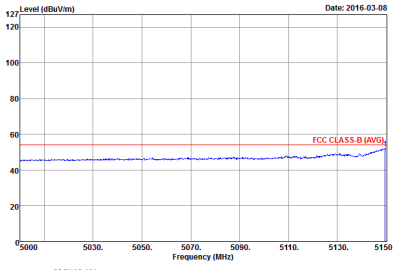
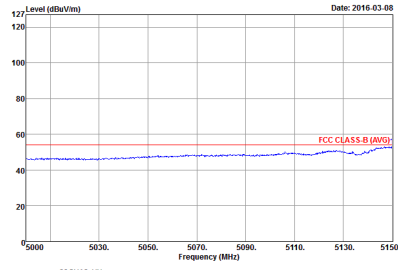

WIFI	Band 1 5150~5250MHz Band Edge @ 3m	
ANT	802.11ac VHT40 CH46 5230MHz - L	
1+2	Horizontal	Vertical
Peak	 <p>Date: 2016-03-08</p> <p>Level (dBuV/m) vs Frequency (MHz)</p> <p>FCC CLASS-B</p> <p>Site : 03CH12-HY Condition : FCC CLASS-B 3m HORN_91200_1328 HORIZONTAL Detector : Peak Project : 502212 Mode : 8</p>	 <p>Date: 2016-03-08</p> <p>Level (dBuV/m) vs Frequency (MHz)</p> <p>FCC CLASS-B</p> <p>Site : 03CH12-HY Condition : FCC CLASS-B 3m HORN_91200_1328 VERTICAL Detector : Peak Project : 502212 Mode : 8</p>
Avg.	 <p>Date: 2016-03-08</p> <p>Level (dBuV/m) vs Frequency (MHz)</p> <p>FCC CLASS-B (AVG)</p> <p>Site : 03CH12-HY Condition : FCC CLASS-B (AVG) 3m HORN_91200_1328 HORIZONTAL Detector : Peak Project : 502212 Mode : 8</p>	 <p>Date: 2016-03-08</p> <p>Level (dBuV/m) vs Frequency (MHz)</p> <p>FCC CLASS-B (AVG)</p> <p>Site : 03CH12-HY Condition : FCC CLASS-B (AVG) 3m HORN_91200_1328 VERTICAL Detector : Peak Project : 502212 Mode : 8</p>

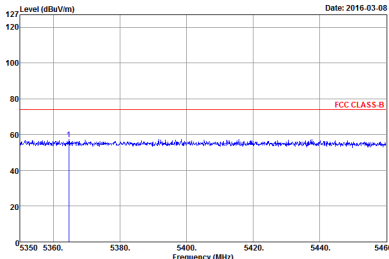
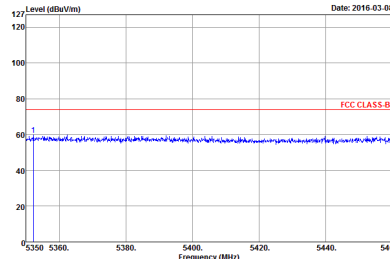
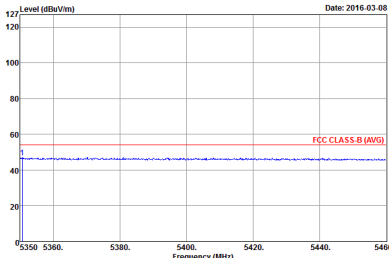
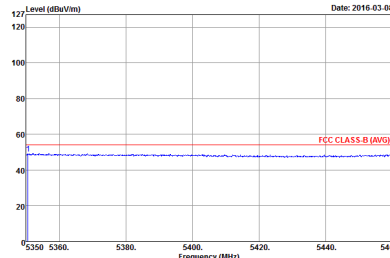

WIFI	Band 1 5150~5250MHz Band Edge @ 3m	
ANT	802.11ac VHT40 CH46 5230MHz - R	
1+2	Horizontal	Vertical
<p>Peak</p>	 <p>Date: 2016-03-08</p> <p>Level (dBuV/m) vs Frequency (MHz)</p> <p>FCC CLASS-B limit at ~75 dBuV/m</p> <p>Site : 03CH12-HY Condition : FCC CLASS-B 3m HORN_91200_1328 HORIZONTAL Detector : Peak Project : 5D2212 Mode : 8</p>	 <p>Date: 2016-03-08</p> <p>Level (dBuV/m) vs Frequency (MHz)</p> <p>FCC CLASS-B limit at ~75 dBuV/m</p> <p>Site : 03CH12-HY Condition : FCC CLASS-B 3m HORN_91200_1328 VERTICAL Detector : Peak Project : 5D2212 Mode : 8</p>
<p>Avg.</p>	 <p>Date: 2016-03-08</p> <p>Level (dBuV/m) vs Frequency (MHz)</p> <p>FCC CLASS-B (AVG) limit at ~55 dBuV/m</p> <p>Site : 03CH12-HY Condition : FCC CLASS-B (AVG) 3m HORN_91200_1328 HORIZONTAL Detector : Peak Project : 5D2212 Mode : 8</p>	 <p>Date: 2016-03-08</p> <p>Level (dBuV/m) vs Frequency (MHz)</p> <p>FCC CLASS-B (AVG) limit at ~55 dBuV/m</p> <p>Site : 03CH12-HY Condition : FCC CLASS-B (AVG) 3m HORN_91200_1328 VERTICAL Detector : Peak Project : 5D2212 Mode : 8</p>

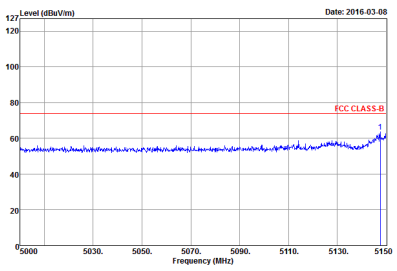
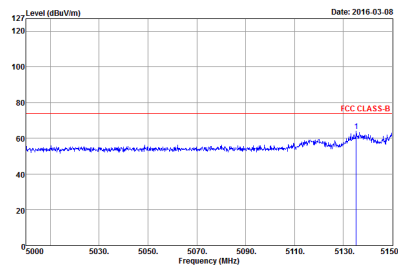
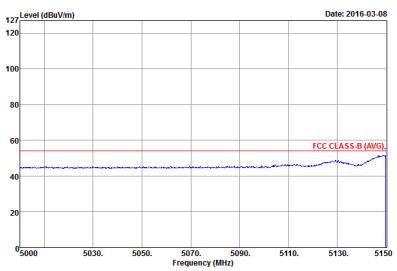
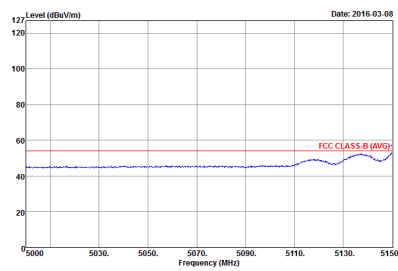

Band 1 5150~5250MHz
WIFI 802.11ac VHT80 (Band Edge @ 3m)

WIFI	Band 1 5150~5250MHz Band Edge @ 3m	
ANT	802.11ac VHT80 CH42 5210MHz - L	
1+2	Horizontal	Vertical
Peak	 <p>Date: 2016-03-08</p> <p>Level (dBuV/m) vs Frequency (MHz)</p> <p>FCC CLASS-B</p> <p>Site : 03CH12-HY Condition : FCC CLASS-B 3m HORN_91200_1328 HORIZONTAL Detector : Peak Project : 5D2212 Mode : 9</p>	 <p>Date: 2016-03-08</p> <p>Level (dBuV/m) vs Frequency (MHz)</p> <p>FCC CLASS-B</p> <p>Site : 03CH12-HY Condition : FCC CLASS-B 3m HORN_91200_1328 VERTICAL Detector : Peak Project : 5D2212 Mode : 9</p>
Avg.	 <p>Date: 2016-03-08</p> <p>Level (dBuV/m) vs Frequency (MHz)</p> <p>FCC CLASS-B (AVG)</p> <p>Site : 03CH12-HY Condition : FCC CLASS-B (AVG) 3m HORN_91200_1328 HORIZONTAL Detector : Peak Project : 5D2212 Mode : 9</p>	 <p>Date: 2016-03-08</p> <p>Level (dBuV/m) vs Frequency (MHz)</p> <p>FCC CLASS-B (AVG)</p> <p>Site : 03CH12-HY Condition : FCC CLASS-B (AVG) 3m HORN_91200_1328 VERTICAL Detector : Peak Project : 5D2212 Mode : 9</p>

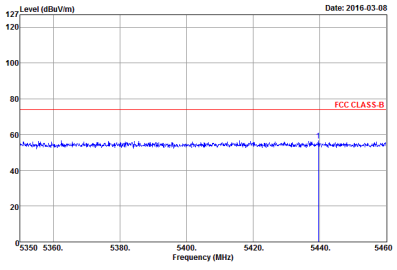
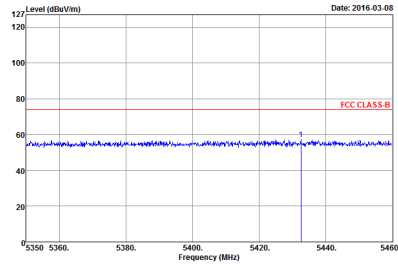
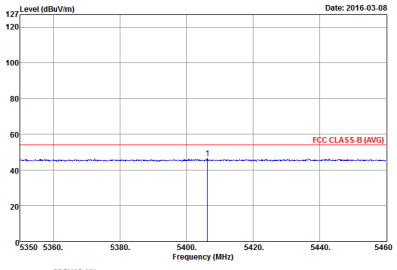
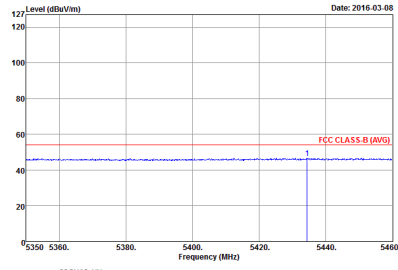

WIFI	Band 1 5150~5250MHz Band Edge @ 3m	
ANT	802.11ac VHT80 CH42 5210MHz - R	
1+2	Horizontal	Vertical
<p>Peak</p>	 <p>Date: 2016-03-08</p> <p>Level (dBuV/m) vs Frequency (MHz)</p> <p>FCC CLASS-B</p> <p>Site : 03CH12-HY Condition : FCC CLASS-B 3m HORN_91200_1328 HORIZONTAL Detector : Peak Project : 502212 Mode : 9</p>	 <p>Date: 2016-03-08</p> <p>Level (dBuV/m) vs Frequency (MHz)</p> <p>FCC CLASS-B</p> <p>Site : 03CH12-HY Condition : FCC CLASS-B 3m HORN_91200_1328 VERTICAL Detector : Peak Project : 502212 Mode : 9</p>
<p>Avg.</p>	 <p>Date: 2016-03-08</p> <p>Level (dBuV/m) vs Frequency (MHz)</p> <p>FCC CLASS-B (AVG)</p> <p>Site : 03CH12-HY Condition : FCC CLASS-B (AVG) 3m HORN_91200_1328 HORIZONTAL Detector : Peak Project : 502212 Mode : 9</p>	 <p>Date: 2016-03-08</p> <p>Level (dBuV/m) vs Frequency (MHz)</p> <p>FCC CLASS-B (AVG)</p> <p>Site : 03CH12-HY Condition : FCC CLASS-B (AVG) 3m HORN_91200_1328 VERTICAL Detector : Peak Project : 502212 Mode : 9</p>



Band 1 - 5150~5250MHz
WIFI 802.11a (Harmonic @ 3m)

Table with 2 columns: Horizontal and Vertical. Each column contains a spectral plot of Level (dBuV/m) vs Frequency (MHz) with FCC CLASS-B and FCC CLASS-B (AVG) limits. Includes metadata for Site, Condition, Detector, Project, and Mode.



WIFI	Band 1 5150~5250MHz Harmonic @ 3m	
ANT	802.11a CH40 5200MHz	
1+2	Horizontal	Vertical
Peak Avg.	<p>Site : 03CH12-HY Condition : FCC CLASS-B 3m HORN_91200_1328 HORIZONTAL Detector : Peak Project : 502212 Mode : 2</p>	<p>Site : 03CH12-HY Condition : FCC CLASS-B 3m HORN_91200_1328 VERTICAL Detector : Peak Project : 502212 Mode : 2</p>

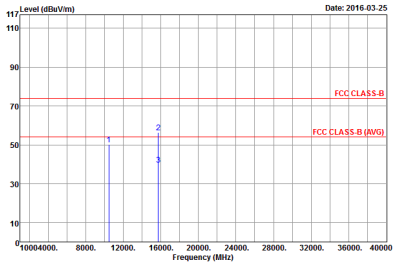
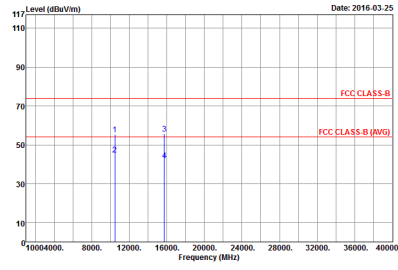

WIFI	Band 1 5150~5250MHz Harmonic @ 3m	
ANT	802.11a CH48 5240MHz	
1+2	Horizontal	Vertical
<p>Peak</p> <p>Avg.</p>	 <p>Date: 2016-03-25</p> <p>Site : 03CH12-HY Condition : FCC CLASS-B 3m HORN_91200_1328 HORIZONTAL Detector : Peak Project : 502212 Mode : 3</p>	 <p>Date: 2016-03-25</p> <p>Site : 03CH12-HY Condition : FCC CLASS-B 3m HORN_91200_1328 VERTICAL Detector : Peak Project : 502212 Mode : 3</p>



Band 1 5150~5250MHz
WIFI 802.11ac VHT20 (Harmonic @ 3m)

Table with 3 columns: WIFI, ANT, 1+2. It contains two graphs: Horizontal and Vertical. Each graph shows Level (dBuV/m) vs Frequency (MHz) with FCC CLASS-B and FCC CLASS-B (AVG) limits. Includes site and condition details for both orientations.



WIFI	Band 1 5150~5250MHz Harmonic @ 3m	
ANT	802.11ac VHT20 CH40 5200MHz	
1+2	Horizontal	Vertical
Peak Avg.	<p>Site : 03CH12-HF Condition : FCC CLASS-B_BAND 4 3m HORN_9120D_1328 HORIZONTAL Detector : Peak Preject : 502212 Mode : S</p>	<p>Site : 03CH12-HF Condition : FCC CLASS-B_BAND 4 3m HORN_9120D_1328 VERTICAL Detector : Peak Preject : 502212 Mode : S</p>

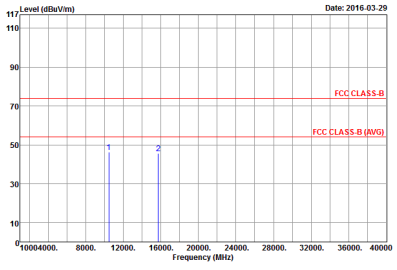
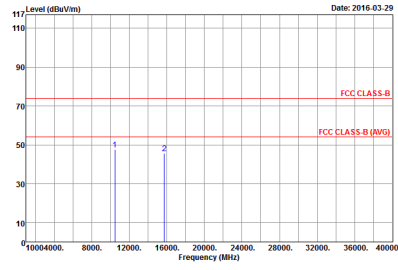

WIFI	Band 1 5150~5250MHz Harmonic @ 3m	
ANT	802.11ac VHT20 CH48 5240MHz	
1+2	Horizontal	Vertical
Peak Avg.	 <p>Date: 2016-03-29</p> <p>Site : 03CH12-HY Condition : FCC CLASS-B 3m HORN_91200_1328 HORIZONTAL Detector : Peak Project : 502212 Mode : 6</p>	 <p>Date: 2016-03-29</p> <p>Site : 03CH12-HY Condition : FCC CLASS-B 3m HORN_91200_1328 VERTICAL Detector : Peak Project : 502212 Mode : 6</p>

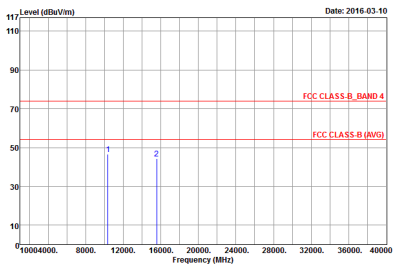
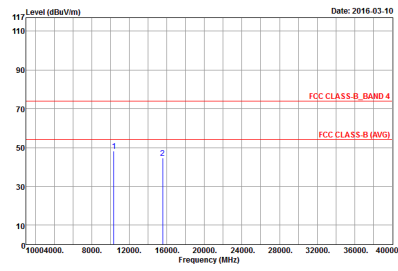

Band 1 5150~5250MHz
WIFI 802.11ac VHT40 (Harmonic @ 3m)

WIFI	Band 1 5150~5250MHz Harmonic @ 3m	
ANT	802.11ac VHT40 CH38 5190MHz	
1+2	Horizontal	Vertical
Peak Avg.	 <p>Date: 2016-03-10</p> <p>Site : 03CH12-HY Condition : FCC CLASS-B_BAND 4 3m HORN_9120D_1328 HORIZONTAL Detector : Peak Project : 5D2212 Mode : 7</p>	 <p>Date: 2016-03-10</p> <p>Site : 03CH12-HY Condition : FCC CLASS-B_BAND 4 3m HORN_9120D_1328 VERTICAL Detector : Peak Project : 5D2212 Mode : 7</p>

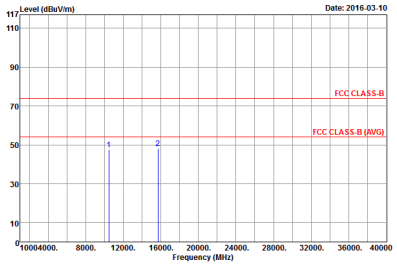
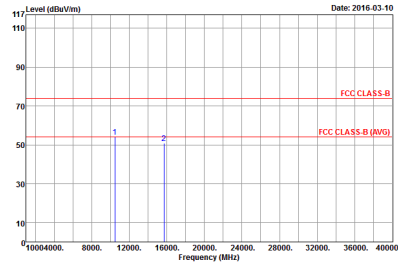

WIFI	Band 1 5150~5250MHz Harmonic @ 3m	
ANT	802.11ac VHT40 CH46 5230MHz	
1+2	Horizontal	Vertical
Peak Avg.	 <p>Site : 03CH12-HY Condition : FCC CLASS-B 3m HORN_91200_1328 HORIZONTAL Detector : Peak Project : 502212 Mode : 8</p>	 <p>Site : 03CH12-HY Condition : FCC CLASS-B 3m HORN_91200_1328 VERTICAL Detector : Peak Project : 502212 Mode : 8</p>



Band 1 5150~5250MHz
WIFI 802.11ac VHT80 (Harmonic @ 3m)

WIFI	Band 1 5150~5250MHz Harmonic @ 3m	
ANT	802.11ac VHT80 CH42 5210MHz	
1+2	Horizontal	Vertical
<p>Peak</p> <p>Avg.</p>	<p>Date: 2016-03-10</p> <p>Site : 03CH12-HY Condition : FCC CLASS-B 3m HORN_91200_1328 HORIZONTAL Detector : Peak Project : 5D2212 Mode : 9</p>	<p>Date: 2016-03-10</p> <p>Site : 03CH12-HY Condition : FCC CLASS-B 3m HORN_91200_1328 VERTICAL Detector : Peak Project : 5D2212 Mode : 9</p>



Emission below 1GHz

5GHz WIFI 802.11ac VHT40 Adapter Mode(LF)

WIFI	5GHz WIFI	
ANT	802.11ac VHT40 LF	
1+2	Horizontal	Vertical
QP / Peak	<p>Site : 68CH12-HY Condition : FCC CLASS-B 3m BILOG_6111D_37059 HORIZONTAL Detector : Peak Project : 5D2212 Mode : 10</p>	<p>Site : 68CH12-HY Condition : FCC CLASS-B 3m BILOG_6111D_37059 VERTICAL Detector : Peak Project : 5D2212 Mode : 10</p>



Emission below 1GHz
5GHz WIFI 802.11ac VHT40 POE Mode(LF)

WIFI	5GHz WIFI	
ANT	802.11ac VHT80 LF	
1+2	Horizontal	Vertical
QP / Peak	<p>Site : 03CM12-HY Condition : FCC CLASS-B 3m BILOG_6111D_37059 HORIZONTAL Detector : Peak Project : 5D2212 Mode : 11</p>	<p>Site : 03CM12-HY Condition : FCC CLASS-B 3m BILOG_6111D_37059 VERTICAL Detector : Peak Project : 5D2212 Mode : 11</p>