



# FCC RF Test Report

**APPLICANT** : Senao Networks, Inc.  
**EQUIPMENT** : Wireless 802.11 ac/a/b/g/n Access Point  
**BRAND NAME** : Senao Networks  
**MODEL NAME** : CAP7252AG  
**FCC ID** : U2M-CAP7252AG  
**STANDARD** : FCC Part 15 Subpart C §15.247  
**CLASSIFICATION** : (DTS) Digital Transmission System

The product was received on Jan. 28, 2016 and testing was completed on Feb. 03, 2016. We, SPORTON INTERNATIONAL INC., would like to declare that the tested sample has been evaluated in accordance with the test procedures and has been in compliance with the applicable technical standards.

The test results in this report apply exclusively to the tested model / sample. Without written approval of SPORTON INTERNATIONAL INC., the test report shall not be reproduced except in full.

Reviewed by: Joseph Lin / Supervisor

Approved by: Jones Tsai / Manager



## **SPORTON INTERNATIONAL INC.**

No. 52, Hwa Ya 1<sup>st</sup> Rd., Hwa Ya Technology Park, Kwei-Shan District, Tao Yuan City, Taiwan, R.O.C.



# TABLE OF CONTENTS

**REVISION HISTORY..... 3**

**SUMMARY OF TEST RESULT ..... 4**

**1 GENERAL DESCRIPTION ..... 5**

    1.1 Applicant ..... 5

    1.2 Manufacturer ..... 5

    1.3 Product Feature of Equipment Under Test..... 5

    1.4 Product Specification of Equipment Under Test..... 6

    1.5 Modification of EUT ..... 6

    1.6 Testing Location ..... 7

    1.7 Applicable Standards..... 7

**2 TEST CONFIGURATION OF EQUIPMENT UNDER TEST ..... 8**

    2.1 Carrier Frequency and Channel ..... 8

    2.2 Pre-Scanned RF Power ..... 9

    2.3 Test Mode ..... 9

    2.4 Connection Diagram of Test System ..... 10

    2.5 Support Unit used in test configuration and system ..... 11

    2.6 EUT Operation Test Setup ..... 11

    2.7 Measurement Results Explanation Example..... 11

**3 TEST RESULT ..... 12**

    3.1 6dB and 99% Bandwidth Measurement ..... 12

    3.2 Peak Output Power Measurement ..... 14

    3.3 Power Spectral Density Measurement ..... 15

    3.4 Conducted Band Edges and Spurious Emission Measurement ..... 17

    3.5 Radiated Band Edges and Spurious Emission Measurement ..... 42

    3.6 AC Conducted Emission Measurement..... 46

    3.7 Antenna Requirements ..... 56

**4 LIST OF MEASURING EQUIPMENT ..... 57**

**5 UNCERTAINTY OF EVALUATION ..... 58**

**APPENDIX A. CONDUCTED TEST RESULTS**

**APPENDIX B. RADIATED TEST RESULTS**

**APPENDIX C. RADIATED SPURIOUS EMISSION PLOTS**

**APPENDIX D. SETUP PHOTOGRAPHS**



### REVISION HISTORY

REPORT NO.	VERSION	DESCRIPTION	ISSUED DATE
FR5D2212A1	Rev. 01	Initial issue of report	Sep. 21, 2016
FR5D2212A1	Rev. 02	Revising FCC KDB Publication No. 558074 D01 DTS Meas. Guidance from v03r04 to v03r05	Sep. 30, 2016



### SUMMARY OF TEST RESULT

Report Section	FCC Rule	Description	Limit	Result	Remark
3.1	15.247(a)(2)	6dB Bandwidth	$\geq 0.5\text{MHz}$	Pass	-
3.1	-	99% Bandwidth	-	Pass	-
3.2	15.247(b)	Power Output Measurement	$\leq 30\text{dBm}$	Pass	-
3.3	15.247(e)	Power Spectral Density	$\leq 8\text{dBm}/3\text{kHz}$	Pass	-
3.4	15.247(d)	Conducted Band Edges	$\leq 20\text{dBc}$	Pass	-
		Conducted Spurious Emission		Pass	-
3.5	15.247(d)	Radiated Band Edges and Radiated Spurious Emission	15.209(a) & 15.247(d)	Pass	Under limit 0.14 dB at 2387.940 MHz
3.6	15.207	AC Conducted Emission	15.207(a)	Pass	Under limit 3.40 dB at 0.382 MHz
3.7	15.203 & 15.247(b)	Antenna Requirement	N/A	Pass	-



# 1 General Description

## 1.1 Applicant

**Senao Networks, Inc.**

3F, No. 529, Chung Cheng Rd., Hsintien, Taipei, Taiwan, R.O.C

## 1.2 Manufacturer

**Senao Networks, Inc.**

3F, No. 529, Chung Cheng Rd., Hsintien, Taipei, Taiwan, R.O.C

## 1.3 Product Feature of Equipment Under Test

Product Feature	
<b>Equipment</b>	Wireless 802.11 ac/a/b/g/n Access Point
<b>Brand Name</b>	Senao Networks
<b>Model Name</b>	CAP7252AG
<b>FCC ID</b>	U2M-CAP7252AG
<b>EUT supports Radios application</b>	WLAN 11a/b/g/n HT20/HT40 WLAN 11ac VHT20/VHT40/VHT80
<b>EUT Stage</b>	Production Unit

**Remark:** The above EUT's information was declared by manufacturer. Please refer to the specifications or user's manual for more detailed description.



### 1.4 Product Specification of Equipment Under Test

Standards-related Product Specification							
<b>Tx/Rx Channel Frequency Range</b>	802.11b/g/n : 2412 MHz ~ 2462 MHz						
<b>Maximum (Peak) Output Power to antenna</b>	<b>MIMO&lt;Ant. 1 + Ant. 2&gt;</b> 802.11b : 29.32 dBm (0.8551 W) 802.11g : 29.77 dBm (0.9484 W) 802.11n HT20 : 29.83 dBm (0.9616 W) 802.11n HT40 : 28.80 dBm (0.7586 W)						
<b>99% Occupied Bandwidth</b>	802.11b : 12.05MHz 802.11g : 18.80MHz 802.11n HT20 : 19.65MHz 802.11n HT40 : 37.20MHz						
<b>Antenna Type</b>	<b>&lt;Ant 1&gt;</b> 802.11b/g/n : PIFA Antenna type with gain 3.52 dBi <b>&lt;Ant 2&gt;</b> 802.11b/g/n : PIFA Antenna type with gain 3.16 dBi						
<b>Type of Modulation</b>	802.11b : DSSS (DBPSK / DQPSK / CCK) 802.11g/n : OFDM (BPSK / QPSK / 16QAM / 64QAM)						
<b>Antenna Function for Transmitter</b>	<table border="1"> <thead> <tr> <th></th> <th>Ant. 1</th> <th>Ant. 2</th> </tr> </thead> <tbody> <tr> <td>802.11 b/g/n MIMO</td> <td>V</td> <td>V</td> </tr> </tbody> </table>		Ant. 1	Ant. 2	802.11 b/g/n MIMO	V	V
	Ant. 1	Ant. 2					
802.11 b/g/n MIMO	V	V					

### 1.5 Modification of EUT

No modifications are made to the EUT during all test items.



### 1.6 Testing Location

Sporton Lab is accredited to ISO 17025 by Taiwan Accreditation Foundation (TAF code : 1190) and the FCC designation No. TW1022 under the FCC 2.948(e) by Mutual Recognition Agreement (MRA) in FCC Test.

<b>Test Site</b>	SPORTON INTERNATIONAL INC.	
<b>Test Site Location</b>	No. 52, Hwa Ya 1 <sup>st</sup> Rd., Hwa Ya Technology Park, Kwei-Shan District, Tao Yuan City, Taiwan, R.O.C. TEL: +886-3-327-3456 FAX: +886-3-328-4978	
<b>Test Site No.</b>	<b>Sporton Site No.</b>	
	TH02-HY	CO05-HY

**Note:** The test site complies with ANSI C63.4 2014 requirement.

<b>Test Site</b>	SPORTON INTERNATIONAL INC.	
<b>Test Site Location</b>	No.58, Aly. 75, Ln. 564, Wenhua 3rd Rd. Guishan Dist, Taoyuan City, Taiwan (R.O.C.) TEL: +886-3-327-0868 FAX: +886-3-327-0855	
<b>Test Site No.</b>	<b>Sporton Site No.</b>	
	03CH12-HY	

**Note:** The test site complies with ANSI C63.4 2014 requirement.

### 1.7 Applicable Standards

According to the specifications of the manufacturer, the EUT must comply with the requirements of the following standards:

- ♦ FCC Part 15 Subpart C §15.247
- ♦ FCC KDB Publication No. 558074 D01 DTS Meas. Guidance v03r05
- ♦ FCC KDB 662911 D01 Multiple Transmitter Output v02r01.
- ♦ FCC KDB 644545 D03 Guidance for IEEE 802 11ac New Rules v01
- ♦ ANSI C63.10-2013

**Remark:** All test items were verified and recorded according to the standards and without any deviation during the test.



## 2 Test Configuration of Equipment Under Test

The EUT has been associated with peripherals and configuration operated in a manner tended to maximize its emission characteristics in a typical application. Frequency range investigated: conducted emission (150 kHz to 30 MHz) and radiated emission (9 kHz to the 10th harmonic of the highest fundamental frequency or to 40 GHz, whichever is lower). For radiated measurement, pre-scanned in three orthogonal panels, X, Y, Z. The worst cases (Y plane) were recorded in this report.

The final configuration from all the combinations and the worst-case data rates were investigated by measuring the maximum power across all the data rates and modulation modes under section 2.2.

Based on the worst configuration found above, the RF power setting is set individually to meet FCC compliance limit for the final conducted and radiated tests shown in section 2.3.

### 2.1 Carrier Frequency and Channel

Frequency Band	Channel	Freq. (MHz)	Channel	Freq. (MHz)
2400-2483.5 MHz	1	2412	7	2442
	2	2417	8	2447
	3	2422	9	2452
	4	2427	10	2457
	5	2432	11	2462
	6	2437		





## 2.2 Pre-Scanned RF Power

Preliminary tests were performed in different data rate and data rate associated with the highest power were chosen for full test shown in the following tables.

### MIMO <Ant. 1+2>

802.11b				
Data Rate (MHz)	1M bps	2M bps	5.5M bps	11M bps
Peak Power (dBm)	29.32	29.14	28.90	28.98

802.11g								
Data Rate (MHz)	6M bps	9M bps	12M bps	18M bps	24M bps	36M bps	48M bps	54M bps
Peak Power (dBm)	29.77	29.56	29.63	29.59	29.70	29.67	29.50	29.61

2.4GHz 802.11n HT20								
Data Rate (MHz)	MCS0	MCS1	MCS2	MCS3	MCS4	MCS5	MCS6	MCS7
Peak Power (dBm)	29.83	29.83	29.83	29.83	29.77	29.80	29.78	29.82

2.4GHz 802.11n HT40								
Data Rate (MHz)	MCS0	MCS1	MCS2	MCS3	MCS4	MCS5	MCS6	MCS7
Peak Power (dBm)	28.80	28.63	28.54	28.58	28.44	28.54	28.54	28.62

Note: MIMO Ant. 1+2 is a calculated result from sum of the power MIMO Ant. 1 and MIMO Ant. 2.

## 2.3 Test Mode

Final test mode of conducted test items and radiated spurious emissions are considering the modulation and worse data rates from the power table described in section 2.2.

### MIMO Antenna

#### <2.4GHz>

Modulation	Data Rate
802.11b	1 Mbps
802.11g	6 Mbps
802.11n HT20	MCS0
802.11n HT40	MCS0

Test Cases	
AC Conducted	Mode 1 : 2.4G Tx + RJ-45 Link + Adapter
Emission	Mode 2 : 2.4G Tx + RJ-45 Link + POE
<b>Remark:</b> The worst case of conducted emission is mode 1; only the test data of it was reported.	

## 2.4 Connection Diagram of Test System

<EUT with Adapter Mode>

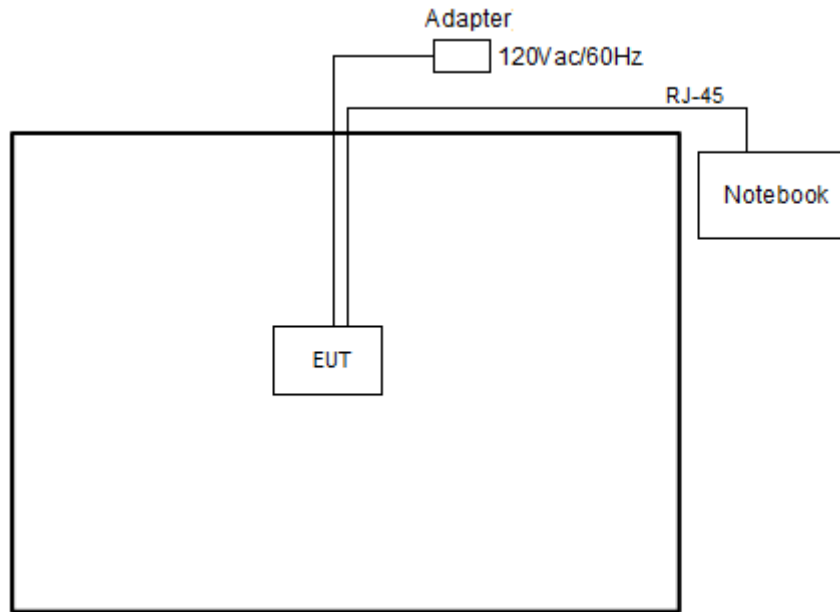

<EUT with POE Mode>

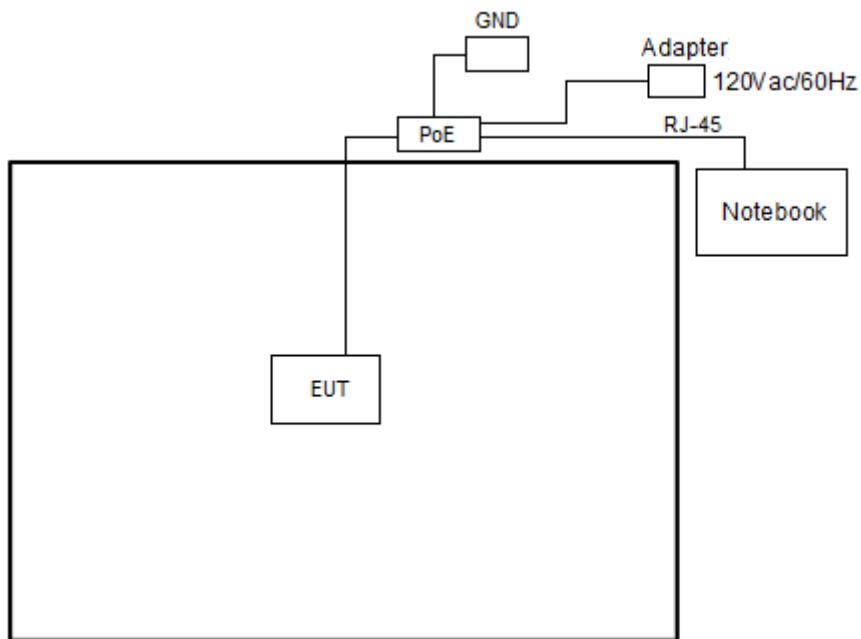



### 2.5 Support Unit used in test configuration and system

Item	Equipment	Trade Name	Model Name	FCC ID	Data Cable	Power Cord
1.	PoE Adapter	Powertron Electronics Corp	PA1040-480IB080	N/A	N/A	1.5m
2.	PoE	N/A	NPE-5818	N/A	N/A	N/A
3.	Notebook	Lenovo	M490S	FCC DoC	N/A	AC I/P: Unshielded, 1.2 m DC O/P: Shielded, 1.8 m
4.	Notebook	DELL	Latitude E6320	FCC DoC/ Contains FCC ID: QDS-BRCM1054	N/A	AC I/P: Unshielded, 1.2 m DC O/P: Shielded, 1.8 m
5.	Adapter	Powertron Electronics Corp.	PA1015-2I/PA1015-2I PA1015-2I120125	N/A	N/A	1.2m

### 2.6 EUT Operation Test Setup

For WLAN function, programmed RF utility, "Art2-gui Tool" installed in the notebook make the EUT provide functions like channel selection and power level for continuous transmitting and receiving signals.

### 2.7 Measurement Results Explanation Example

**For all conducted test items:**

The offset level is set in the spectrum analyzer to compensate the RF cable loss and attenuator factor between EUT conducted output port and spectrum analyzer. With the offset compensation, the spectrum analyzer reading level is exactly the EUT RF output level.

Example:

The spectrum analyzer offset is derived from RF cable loss and attenuator factor.

$$Offset = RF\ cable\ loss + attenuator\ factor.$$

Following shows an offset computation example with cable loss 4.2 dB and 10dB attenuator.

$$Offset(dB) = RF\ cable\ loss(dB) + attenuator\ factor(dB).$$

$$= 4.2 + 10 = 14.2 (dB)$$

### 3 Test Result

#### 3.1 6dB and 99% Bandwidth Measurement

##### 3.1.1 Limit of 6dB and 99% Bandwidth

The minimum 6 dB bandwidth shall be at least 500 kHz.

##### 3.1.2 Measuring Instruments

The measuring equipment is listed in the section 4 of this test report.

##### 3.1.3 Test Procedures

1. The testing follows FCC KDB Publication No. 558074 DTS D01 Meas. Guidance v03r05.
2. The RF output of EUT was connected to the spectrum analyzer by RF cable and attenuator. The path loss was compensated to the results for each measurement.
3. Set to the maximum power setting and enable the EUT transmit continuously.
4. Make the measurement with the spectrum analyzer's resolution bandwidth (RBW) = 100 kHz. Set the Video bandwidth (VBW) = 300 kHz. In order to make an accurate measurement. The 6 dB bandwidth must be greater than 500 kHz.
5. For 99% Bandwidth Measurement, the spectrum analyzer's resolution bandwidth (RBW) = 1MHz and set the Video bandwidth (VBW) = 3MHz.
6. Measure and record the results in the test report.

##### 3.1.4 Test Setup



##### 3.1.5 Test Result of 6dB and 99% Occupied Bandwidth

Please refer to Appendix A of this report.

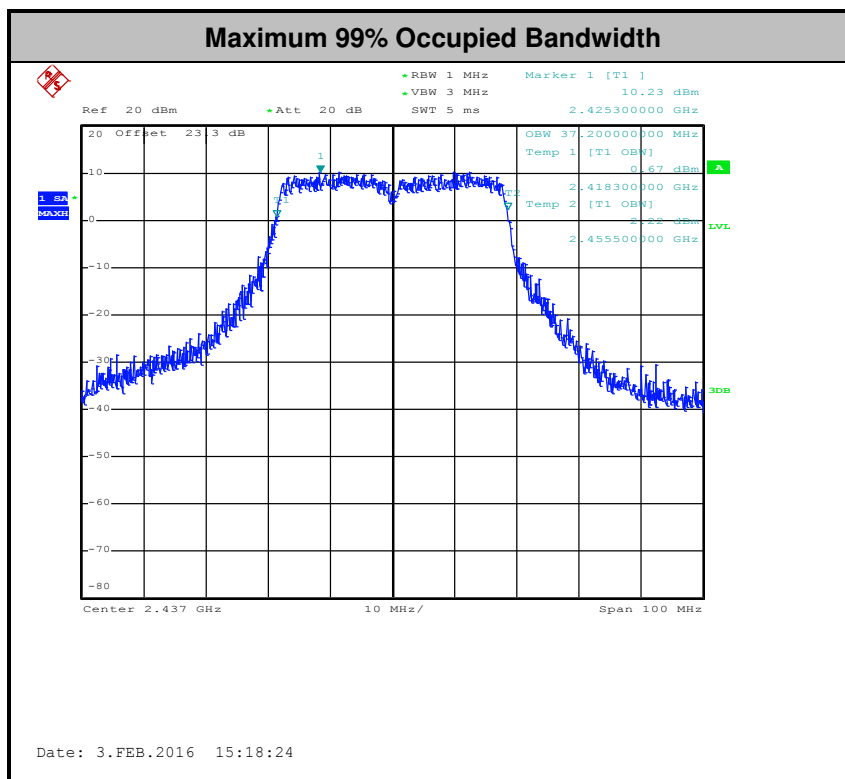
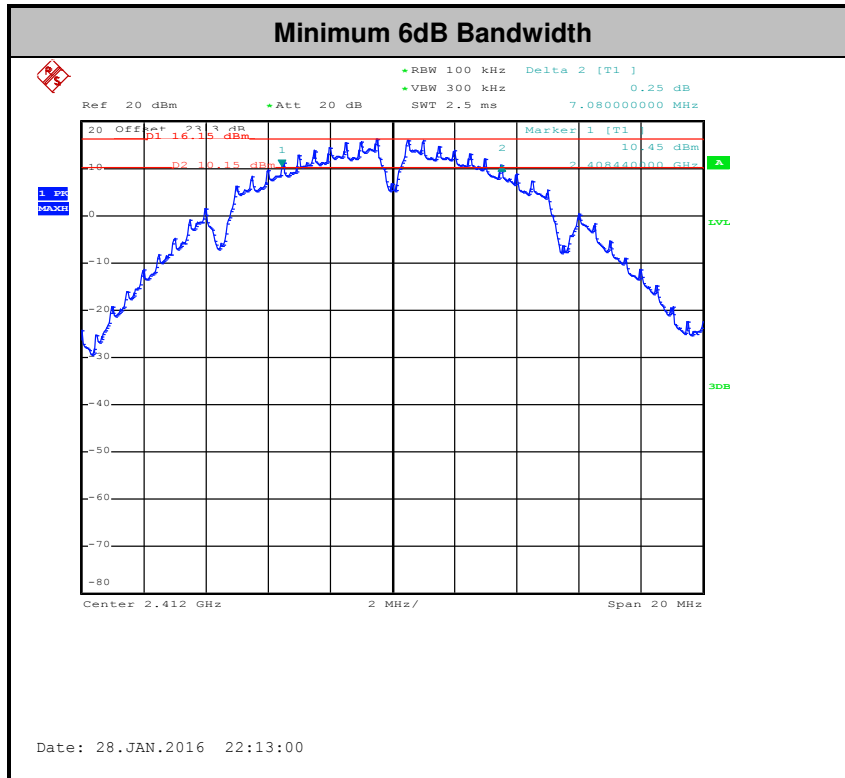

**Note:** The occupied channel bandwidth is maintained within the band of operation for all of the modulations.

## 3.2 Peak Output Power Measurement

### 3.2.1 Limit of Peak Output Power

For systems using digital modulation in the 2400-2483.5MHz, the limit for peak output power is 30dBm. If transmitting antenna with directional gain greater than 6dBi is used, the peak output power from the intentional radiator shall be reduced below the above stated value by the amount in dB that the directional gain of the antenna exceeds 6 dBi. In case of point-to-point operation, the limit has to be reduced by 1dB for every 3dB that the directional gain of the antenna exceeds 6dBi.

### 3.2.2 Measuring Instruments

The measuring equipment is listed in the section 4 of this test report.

### 3.2.3 Test Procedures

1. The testing follows the Measurement Procedure of FCC KDB No. 558074 DTS D01 Meas. Guidance v03r05 section 9.1.2 PKPM1 Peak power meter method.
2. The RF output of EUT was connected to the power meter by RF cable and attenuator. The path loss was compensated to the results for each measurement.
3. Set to the maximum power setting and enable the EUT transmit continuously.
4. Measure the conducted output power and record the results in the test report.
5. For MIMO mode, calculation method follows FCC KDB 662911 D01 Multiple Transmitter Output v02r01.

### 3.2.4 Test Setup

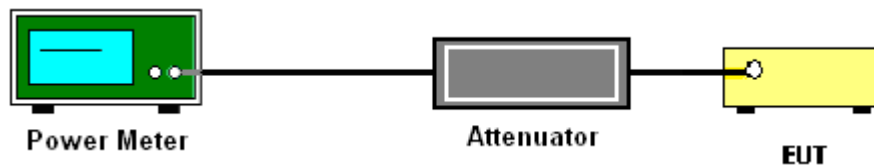

### 3.2.5 Test Result of Peak Output Power

Please refer to Appendix A of this report.

### 3.2.6 Test Result of Average output Power (Reporting Only)

Please refer to Appendix A of this report.



### 3.3 Power Spectral Density Measurement

#### 3.3.1 Limit of Power Spectral Density

The peak power spectral density shall not be greater than 8dBm in any 3kHz band at any time interval of continuous transmission.

#### 3.3.2 Measuring Instruments

The measuring equipment is listed in the section 4 of this test report.

#### 3.3.3 Test Procedures

1. The testing follows Measurement Procedure 10.2 Method PKPSD of FCC KDB Publication No. 558074 D01 DTS Meas. Guidance v03r05.
2. The RF output of EUT was connected to the spectrum analyzer by RF cable and attenuator. The path loss was compensated to the results for each measurement.
3. Set to the maximum power setting and enable the EUT transmit continuously.
4. Make the measurement with the spectrum analyzer's resolution bandwidth (RBW) = 3 kHz. Video bandwidth VBW = 10 kHz In order to make an accurate measurement, set the span to 1.5 times DTS Channel Bandwidth. (6dB BW)
5. Detector = peak, Sweep time = auto couple, Trace mode = max hold, Allow trace to fully stabilize. Use the peak marker function to determine the maximum power level.
6. Measure and record the results in the test report.
7. For MIMO mode, calculation method follows FCC KDB 662911 D01 Multiple Transmitter Output v02r01.

If measurements performed using method (2) plus  $10 \log(N)$  exceeds the emission limit, the test should choose method (1) before declaring that the device fails the emission limit.

Method (1): Measure and sum the spectra across the outputs.

The total final Power Spectral Density is from a device with 2 transmitter outputs. The spectrum measurements of the individual outputs are all performed with the same span and number of points, the spectrum value in the first spectral bin of output 1 is summed with that in the first spectral bin of output 2 to obtain the value for the first frequency bin of the summed spectrum.

Method (2): Measure and add  $10 \log(N)$  dB, where N is the number of outputs. (N=2)

### 3.3.4 Test Setup

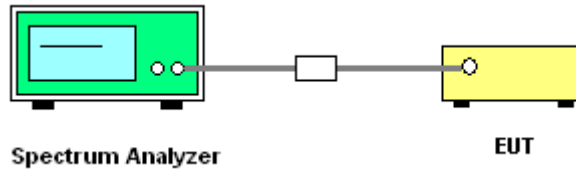

### 3.3.5 Test Result of Power Spectral Density

Please refer to Appendix A of this report.

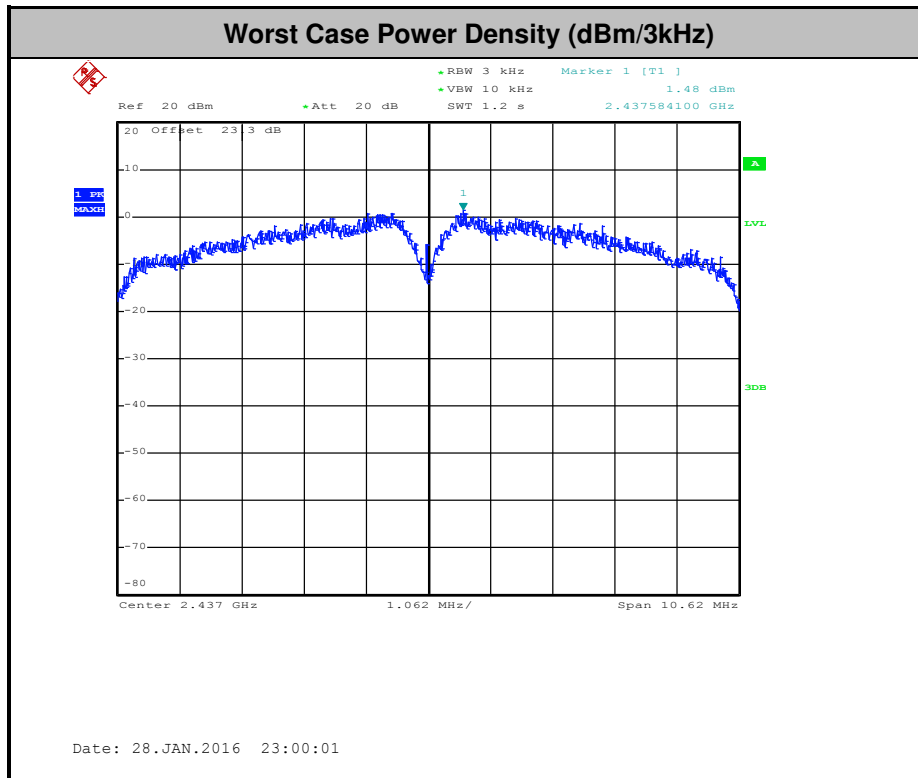



## 3.4 Conducted Band Edges and Spurious Emission Measurement

### 3.4.1 Limit of Conducted Band Edges and Spurious Emission Measurement

In any 100 kHz bandwidth outside of the authorized frequency band, the emissions which fall in the non-restricted bands shall be attenuated at least 20 dB / 30dB relative to the maximum PSD level in 100 kHz by RF conducted measurement and radiated emissions which fall in the restricted bands, as defined in Section 15.205(a), must also comply with the radiated emission limits specified in Section 15.209(a).

### 3.4.2 Measuring Instruments

The measuring equipment is listed in the section 4 of this test report.

### 3.4.3 Test Procedures

1. The testing follows FCC KDB Publication No. 558074 D01 DTS Meas. Guidance v03r05.
2. The RF output of EUT was connected to the spectrum analyzer by RF cable and attenuator. The path loss was compensated to the results for each measurement.
3. Set to the maximum power setting and enable the EUT transmit continuously.
4. Set RBW = 100 kHz, VBW=300 kHz, Peak Detector. Unwanted Emissions measured in any 100 kHz bandwidth outside of the authorized frequency band shall be attenuated by at least 20 dB relative to the maximum in-band peak PSD level in 100 kHz when maximum peak conducted output power procedure is used. If the transmitter complies with the conducted power limits based on the use of RMS averaging over a time interval, the attenuation required under this paragraph shall be 30 dB instead of 20 dB per 15.247(d).
5. Measure and record the results in the test report.
6. The RF fundamental frequency should be excluded against the limit line in the operating frequency band.

### 3.4.4 Test Setup

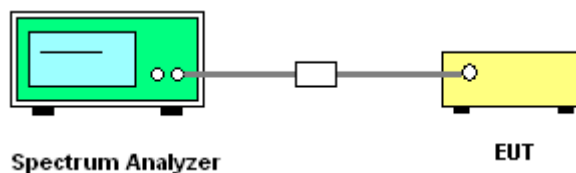



### 3.4.5 Test Result of Conducted Band Edges and Spurious Emission

Number of TX = 2, Ant. 1 (Measured)

Number of TX	2	Ant. :	1
Test Mode :	802.11b	Temperature :	21~25°C
Test Band :	2.4GHz Low	Relative Humidity :	58~61%
Test Channel :	01	Test Engineer :	osolemio Chang and Luffy

#### WLAN 802.11b Channel 01

##### 100kHz PSD reference Level

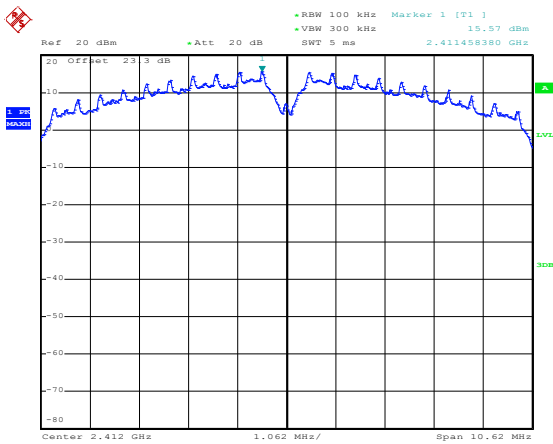

Date: 28.JAN.2016 22:13:38

##### Low Channel Plot

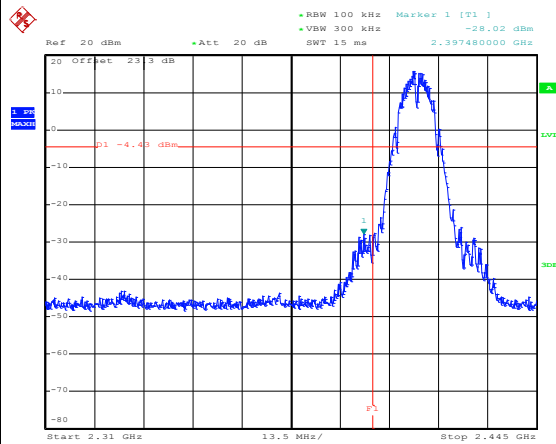

Date: 28.JAN.2016 22:28:16

##### Spurious Emission 30MHz~3GHz

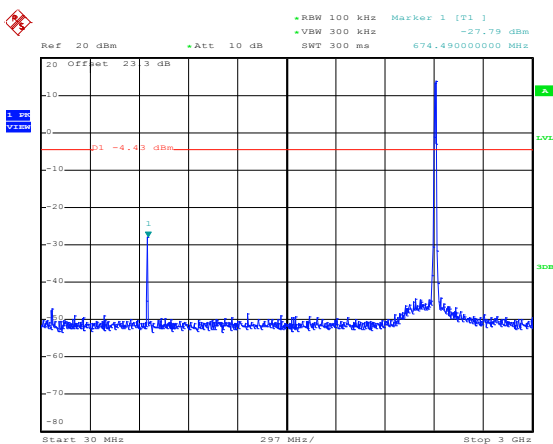

Date: 28.JAN.2016 22:15:09

##### Spurious Emission 2GHz~25GHz

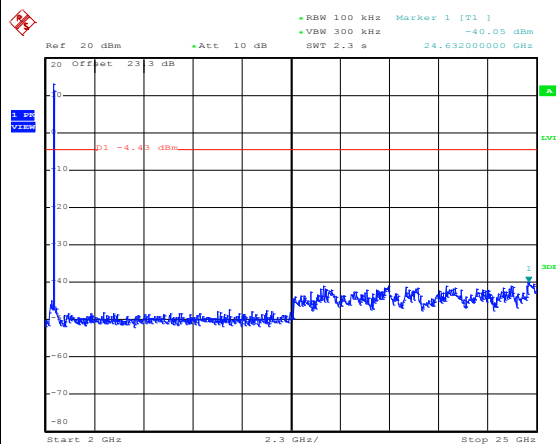

Date: 28.JAN.2016 22:15:18



Number of TX :	2	Ant. :	1
Test Mode :	802.11b	Temperature :	21~25°C
Test Band :	2.4GHz Mid	Relative Humidity :	58~61%
Test Channel :	06	Test Engineer :	osolemio Chang and Luffy

WLAN 802.11b Channel 06

100kHz PSD reference Level

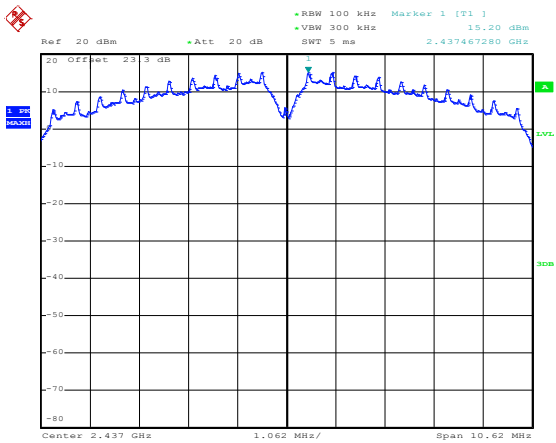

Date: 28.JAN.2016 22:55:07

Spurious Emission 30MHz~3GHz

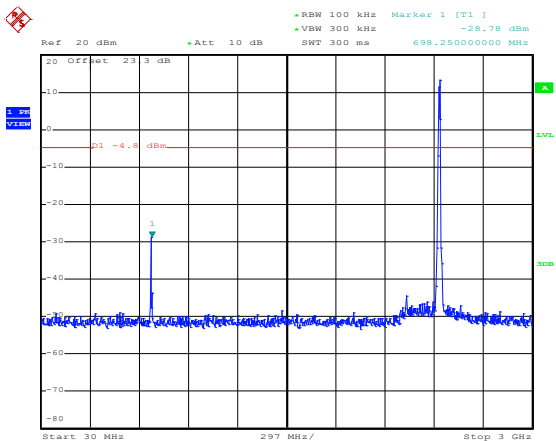

Date: 28.JAN.2016 22:55:39

Spurious Emission 2GHz~25GHz

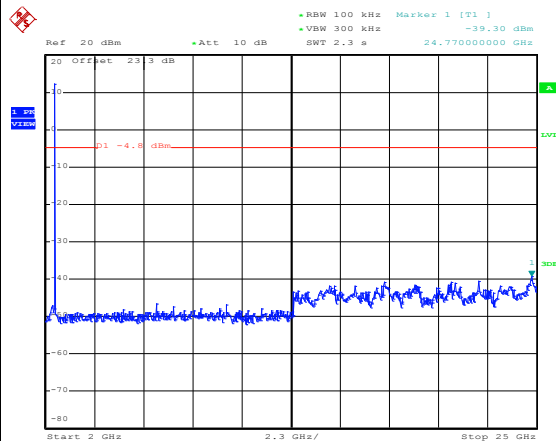

Date: 28.JAN.2016 22:55:47



Number of TX :	2	Ant. :	1
Test Mode :	802.11b	Temperature :	21~25°C
Test Band :	2.4GHz High	Relative Humidity :	58~61%
Test Channel :	11	Test Engineer :	osolemio Chang and Luffy

WLAN 802.11b Channel 11

100kHz PSD reference Level

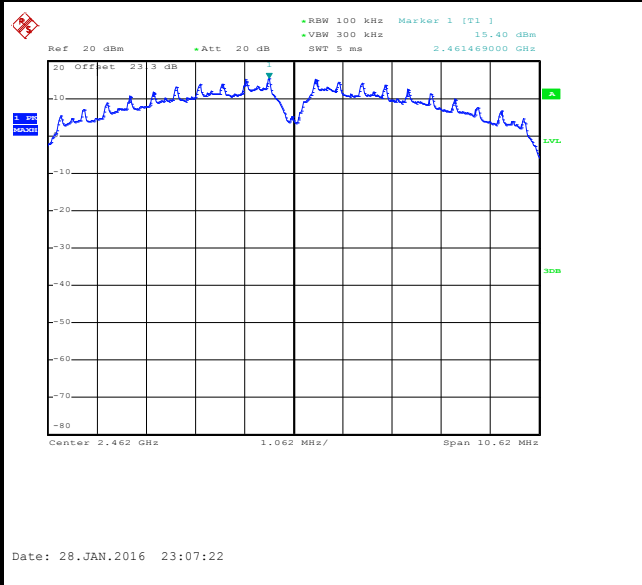

High Channel Plot

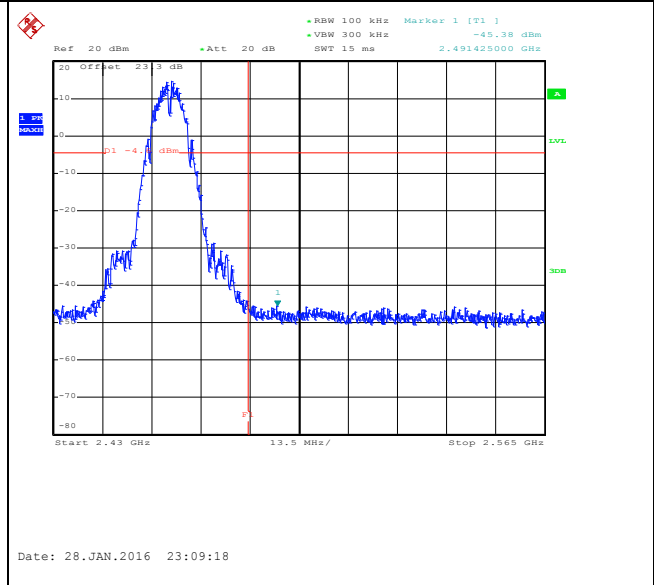

Spurious Emission 30MHz~3GHz

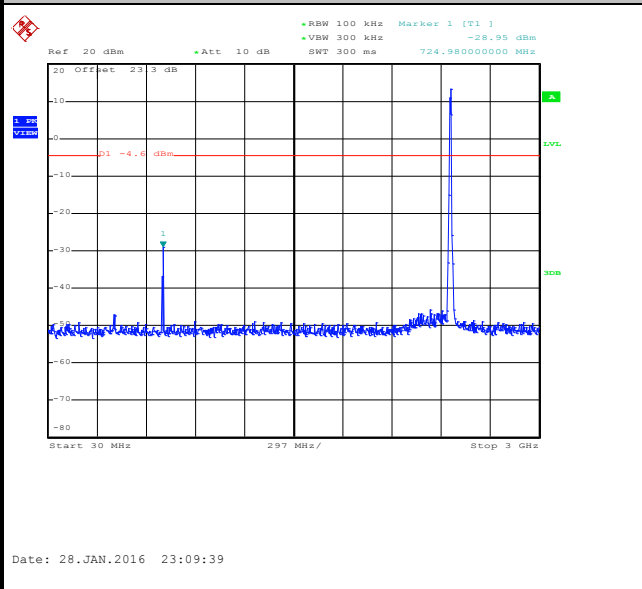

Spurious Emission 2GHz~25GHz

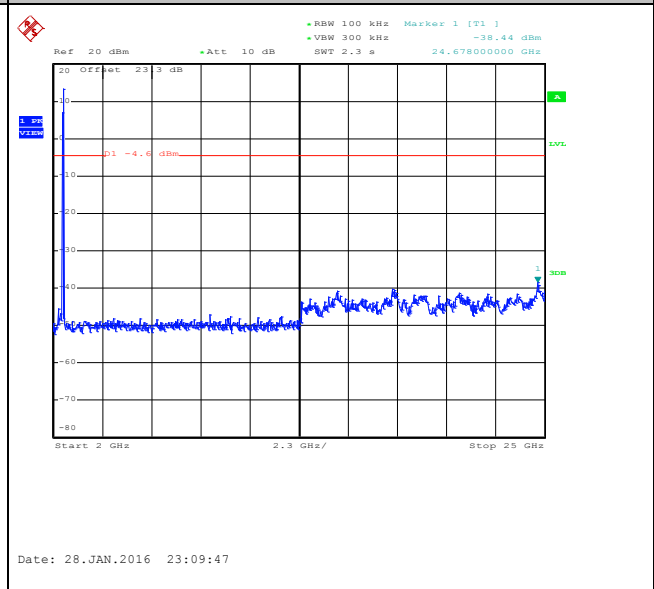



Number of TX :	2	Ant. :	1
Test Mode :	802.11g	Temperature :	21~25°C
Test Band :	2.4GHz Low	Relative Humidity :	58~61%
Test Channel :	01	Test Engineer :	osolemio Chang and Luffy

WLAN 802.11g Channel 01

100kHz PSD reference Level

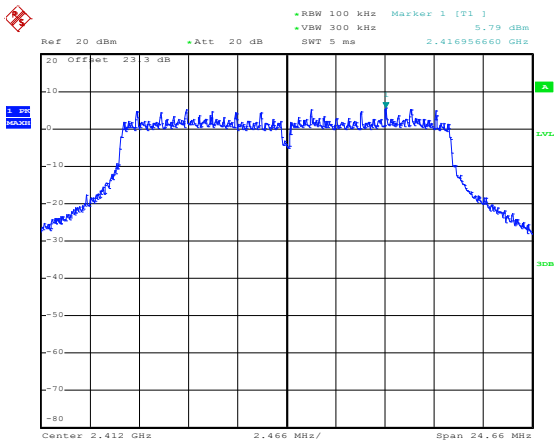

Date: 28.JAN.2016 23:20:39

Low Channel Plot

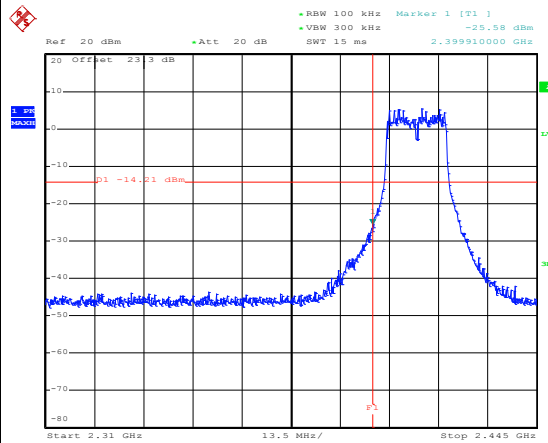

Date: 28.JAN.2016 23:20:58

Spurious Emission 30MHz~3GHz

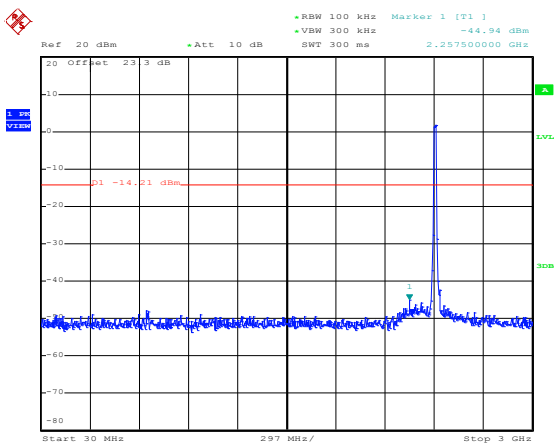

Date: 28.JAN.2016 23:21:16

Spurious Emission 2GHz~25GHz

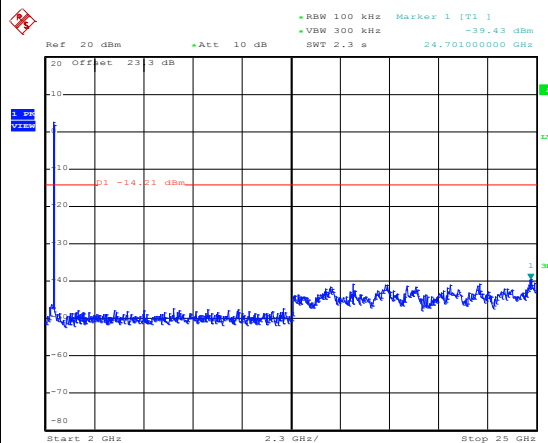

Date: 28.JAN.2016 23:21:25



Number of TX :	2	Ant. :	1
Test Mode :	802.11g	Temperature :	21~25°C
Test Band :	2.4GHz Mid	Relative Humidity :	58~61%
Test Channel :	06	Test Engineer :	osolemio Chang and Luffy

WLAN 802.11g Channel 06

100kHz PSD reference Level

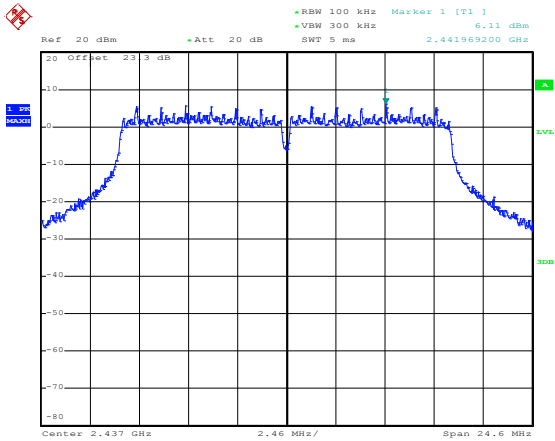

Date: 28.JAN.2016 23:30:09

Spurious Emission 30MHz~3GHz

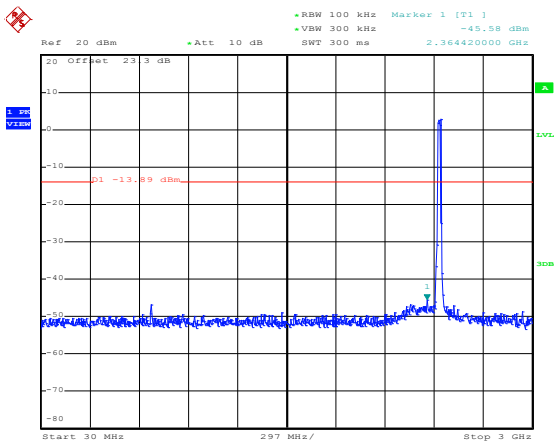

Date: 28.JAN.2016 23:30:29

Spurious Emission 2GHz~25GHz

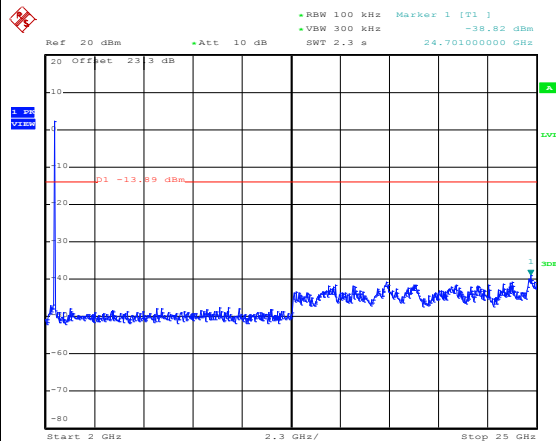

Date: 28.JAN.2016 23:30:37



Number of TX :	2	Ant. :	1
Test Mode :	802.11g	Temperature :	21~25°C
Test Band :	2.4GHz High	Relative Humidity :	58~61%
Test Channel :	11	Test Engineer :	osolemio Chang and Luffy

WLAN 802.11g Channel 11

100kHz PSD reference Level

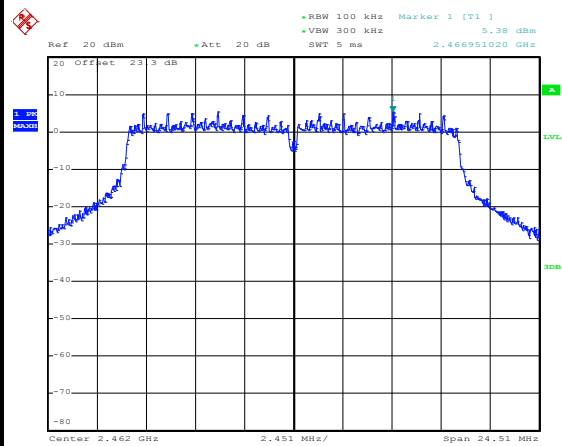

Date: 3.FEB.2016 14:39:44

High Channel Plot

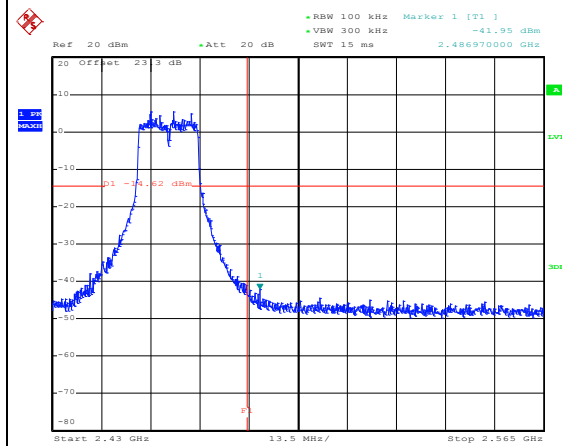

Date: 3.FEB.2016 14:40:01

Spurious Emission 30MHz~3GHz

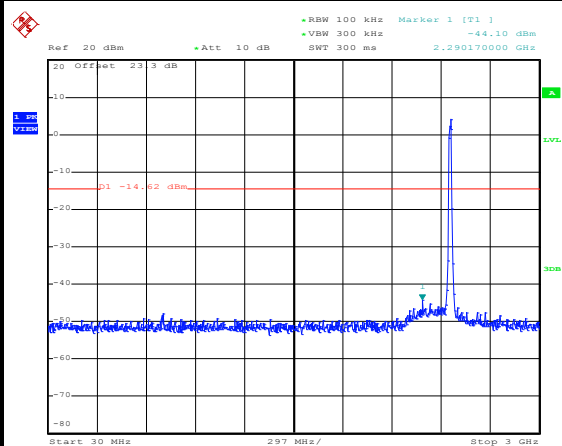

Date: 3.FEB.2016 14:40:13

Spurious Emission 2GHz~25GHz

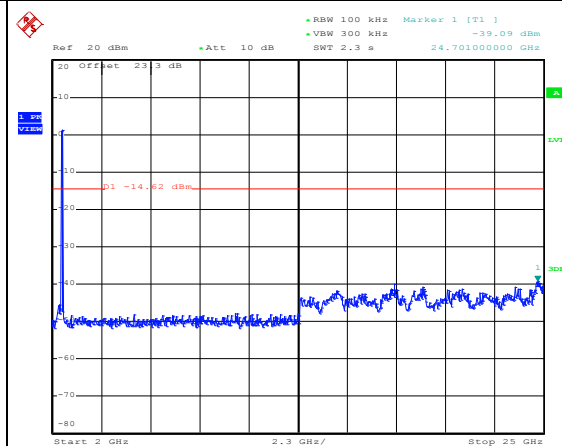

Date: 3.FEB.2016 14:40:21



Number of TX :	2	Ant. :	1
Test Mode :	802.11n HT20	Temperature :	21~25°C
Test Band :	2.4GHz Low	Relative Humidity :	58~61%
Test Channel :	01	Test Engineer :	osolemio Chang and Luffy

WLAN 802.11n HT20 Channel 01

100kHz PSD reference Level

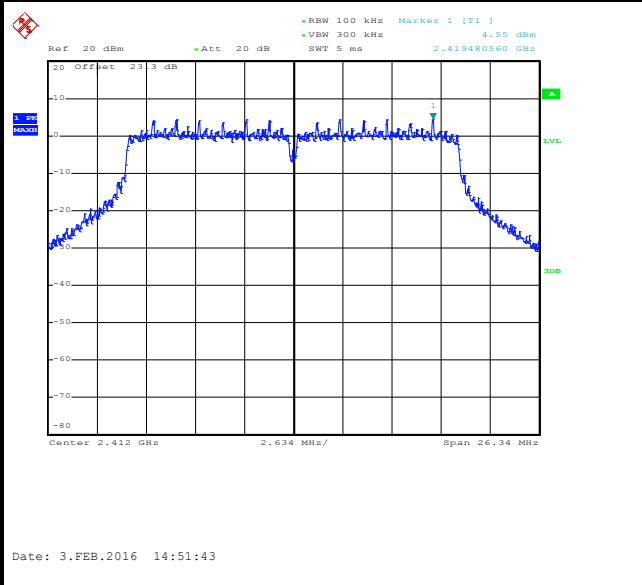

Low Channel Plot

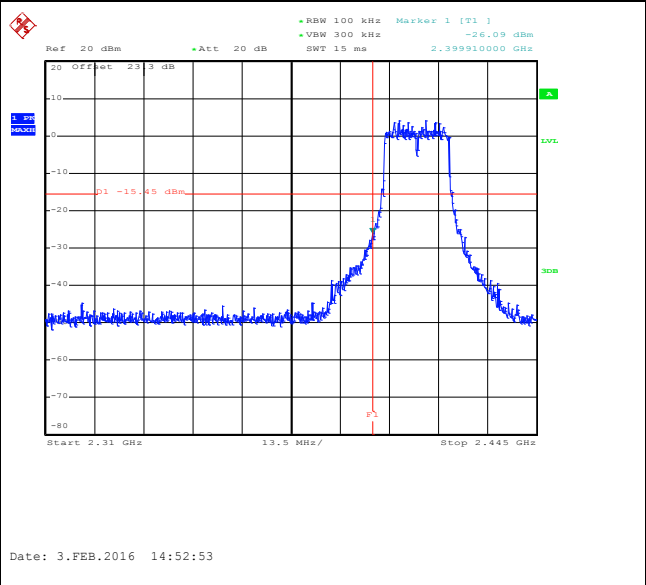

Spurious Emission 30MHz~3GHz

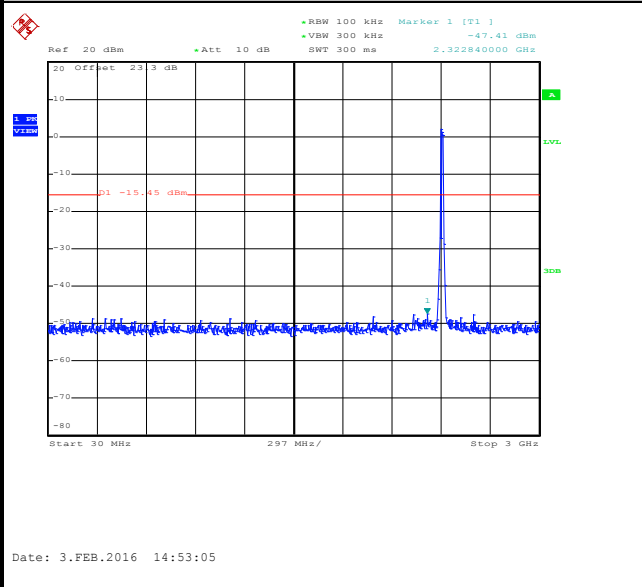

Spurious Emission 2GHz~25GHz

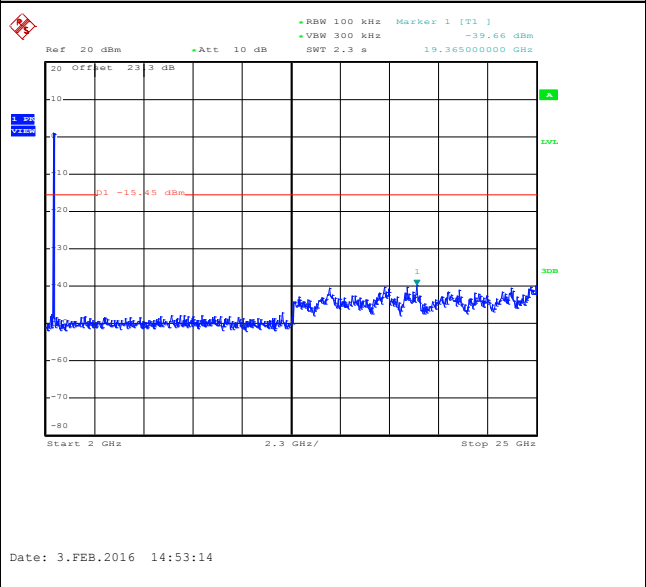





Number of TX :	2	Ant. :	1
Test Mode :	802.11n HT20	Temperature :	21~25°C
Test Band :	2.4GHz Mid	Relative Humidity :	58~61%
Test Channel :	06	Test Engineer :	osolemio Chang and Luffy

WLAN 802.11n HT20 Channel 06

100kHz PSD reference Level

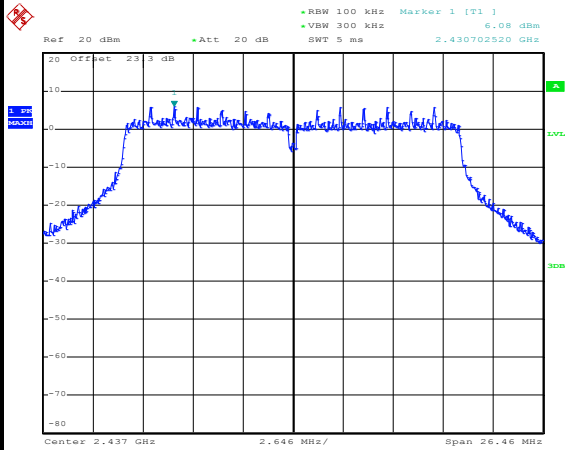

Date: 29.JAN.2016 00:06:23

Spurious Emission 30MHz~3GHz

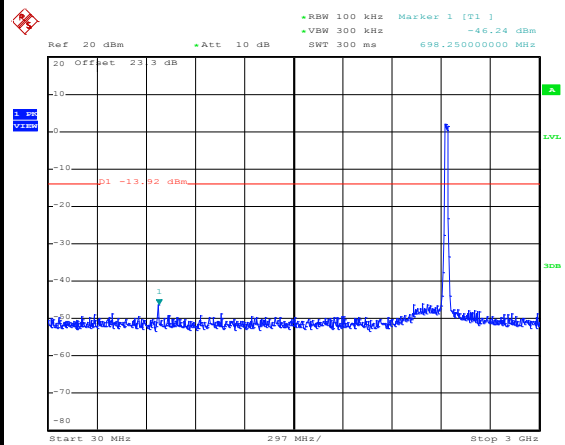

Date: 29.JAN.2016 00:06:47

Spurious Emission 2GHz~25GHz

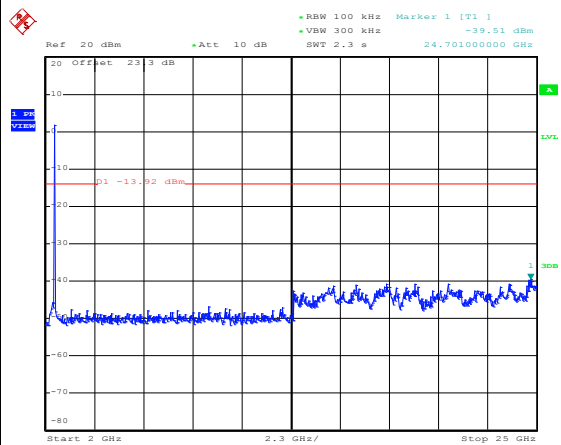

Date: 29.JAN.2016 00:06:55



Number of TX :	2	Ant. :	1
Test Mode :	802.11n HT20	Temperature :	21~25°C
Test Band :	2.4GHz High	Relative Humidity :	58~61%
Test Channel :	11	Test Engineer :	osolemio Chang and Luffy

WLAN 802.11n HT20 Channel 11

100kHz PSD reference Level

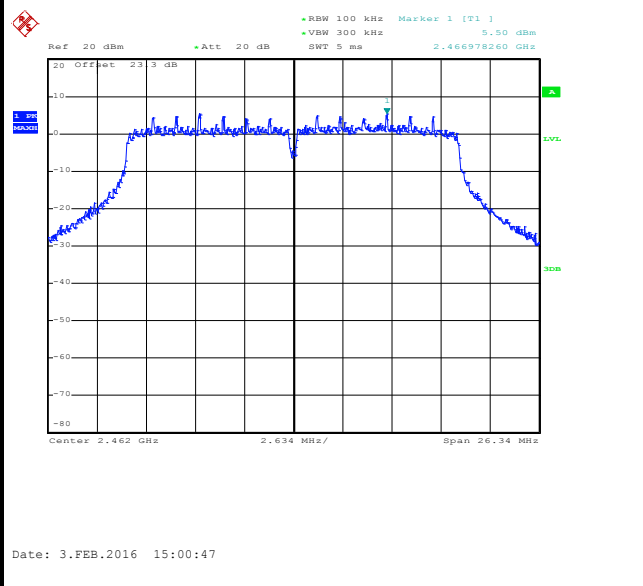

High Channel Plot

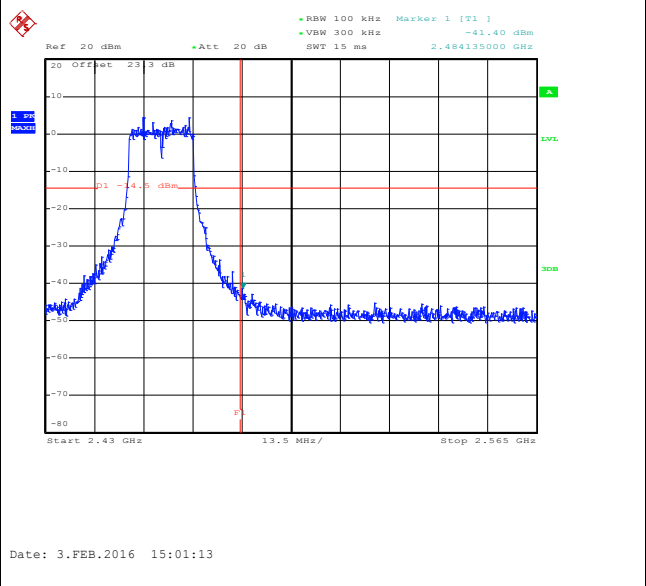

Spurious Emission 30MHz~3GHz

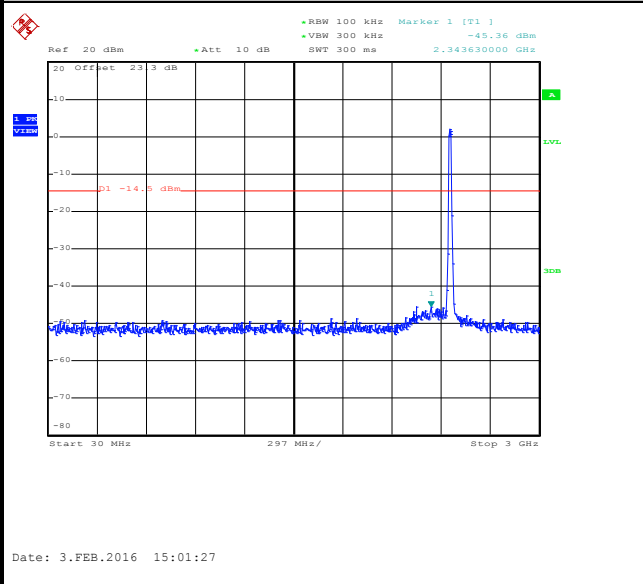

Spurious Emission 2GHz~25GHz

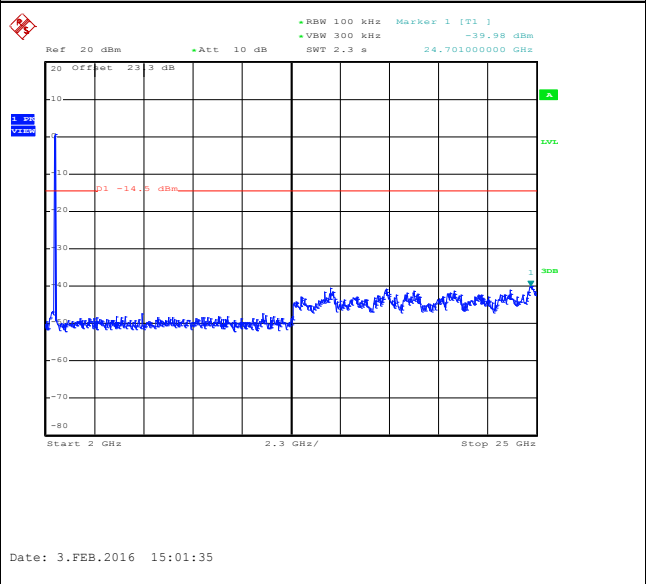



Number of TX :	2	Ant. :	1
Test Mode :	802.11n HT40	Temperature :	21~25°C
Test Band :	2.4GHz Low	Relative Humidity :	58~61%
Test Channel :	03	Test Engineer :	osolemio Chang and Luffy

WLAN 802.11n HT40 Channel 03

100kHz PSD reference Level

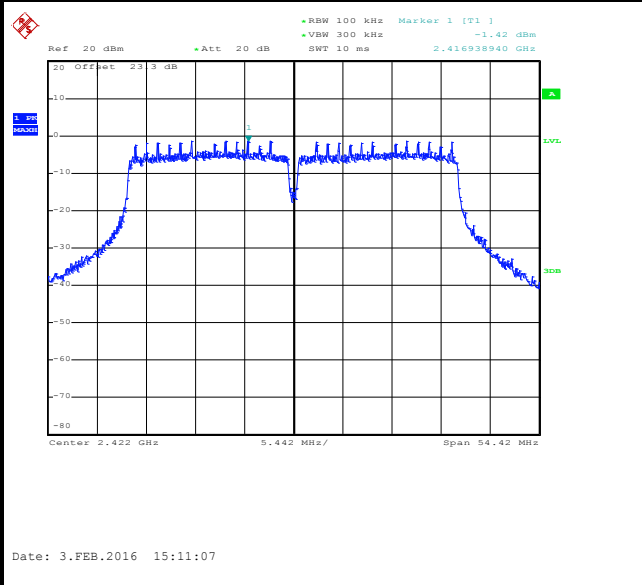

Low Channel Plot

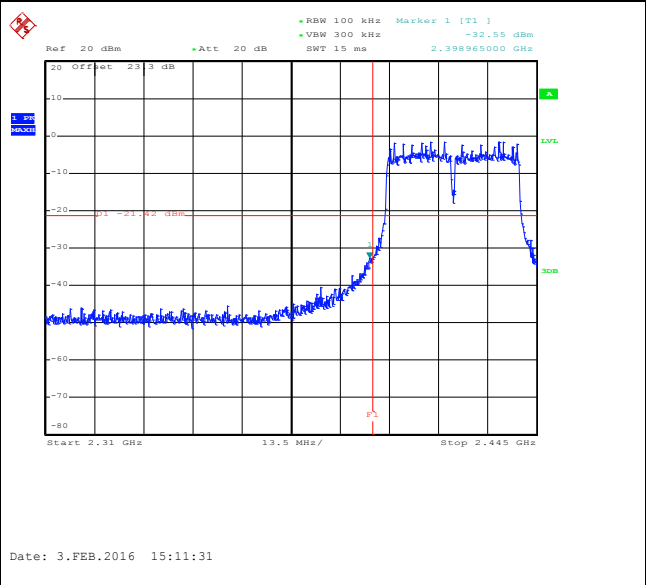

Spurious Emission 30MHz~3GHz

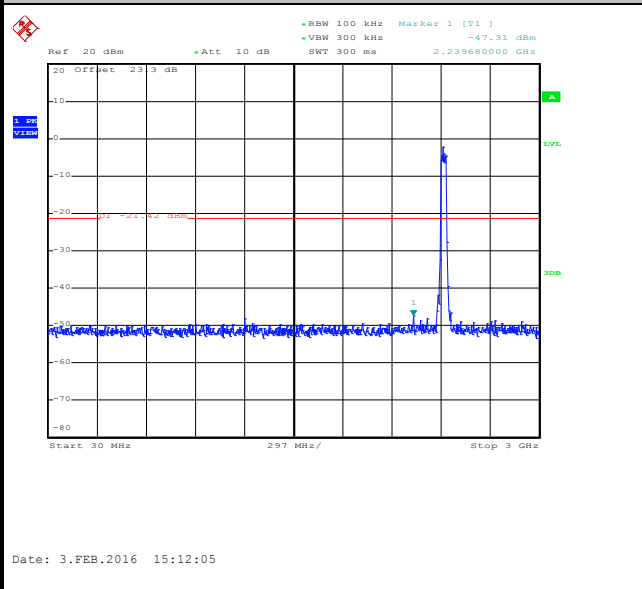

Spurious Emission 2GHz~25GHz

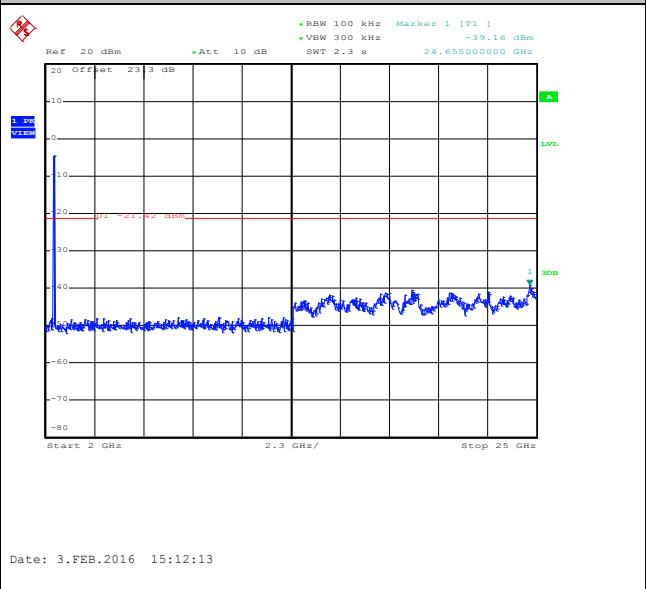



Number of TX :	2	Ant. :	1
Test Mode :	802.11n HT40	Temperature :	21~25°C
Test Band :	2.4GHz Mid	Relative Humidity :	58~61%
Test Channel :	06	Test Engineer :	osolemio Chang and Luffy

WLAN 802.11n HT40 Channel 06

100kHz PSD reference Level

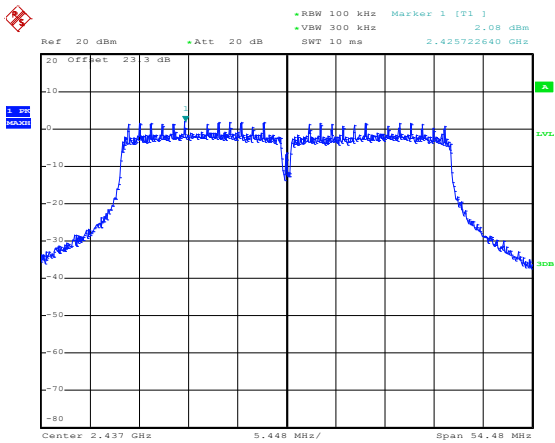

Date: 3.FEB.2016 15:19:41

Spurious Emission 30MHz~3GHz

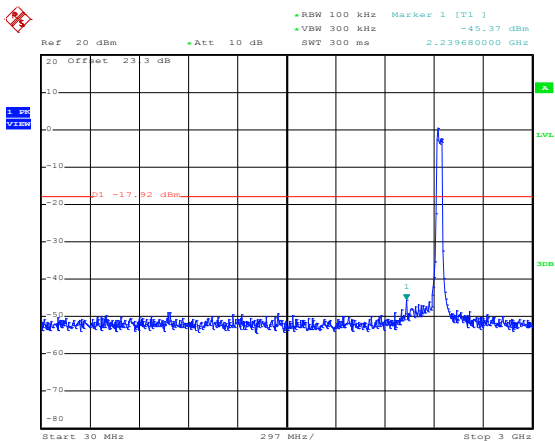

Date: 3.FEB.2016 15:19:59

Spurious Emission 2GHz~25GHz

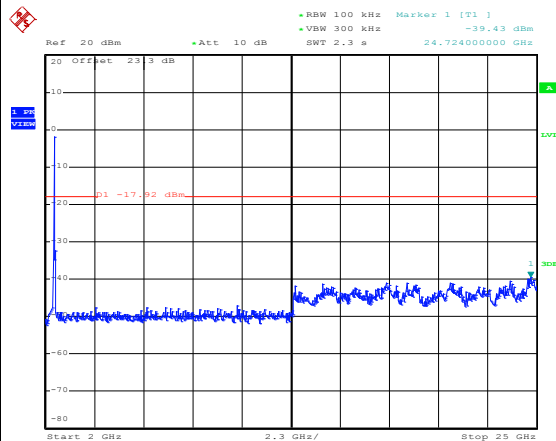

Date: 3.FEB.2016 15:20:08



Number of TX :	2	Ant. :	1
Test Mode :	802.11n HT40	Temperature :	21~25°C
Test Band :	2.4GHz High	Relative Humidity :	58~61%
Test Channel :	09	Test Engineer :	osolemio Chang and Luffy

WLAN 802.11n HT40 Channel 09

100kHz PSD reference Level

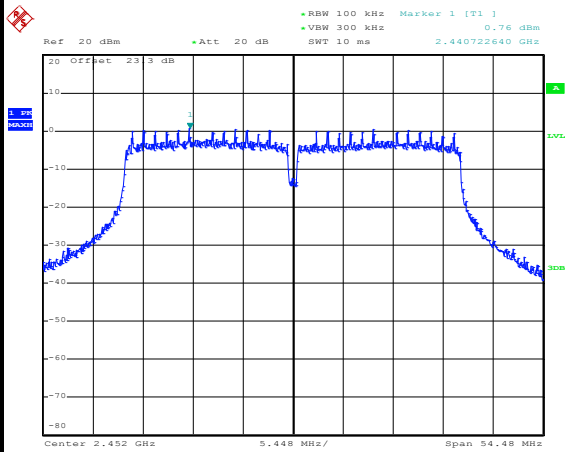

Date: 3.FEB.2016 15:27:42

High Channel Plot

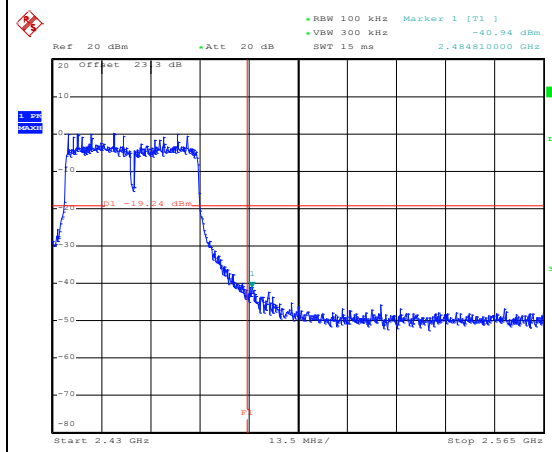

Date: 3.FEB.2016 15:28:05

Spurious Emission 30MHz~3GHz

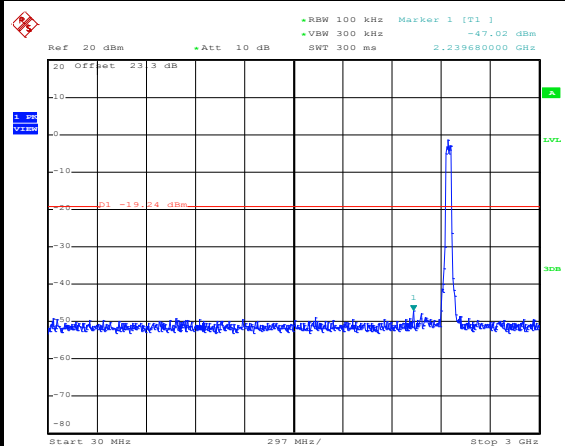

Date: 3.FEB.2016 15:28:38

Spurious Emission 2GHz~25GHz

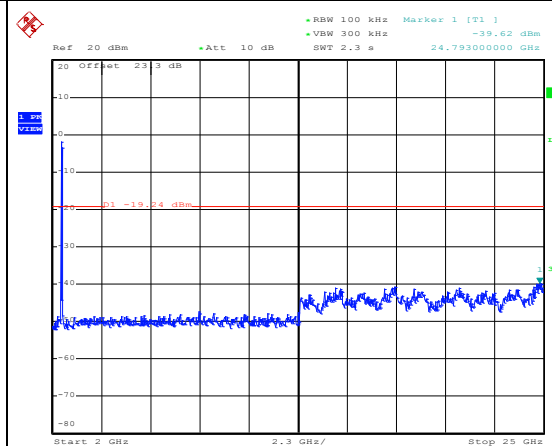

Date: 3.FEB.2016 15:28:47



Number of TX = 2, Ant. 2 (Measured)

Number of TX :	2	Ant. :	2
Test Mode :	802.11b	Temperature :	21~25°C
Test Band :	2.4GHz Low	Relative Humidity :	58~61%
Test Channel :	01	Test Engineer :	osolemio Chang and Luffy

WLAN 802.11b Channel 01

100kHz PSD reference Level

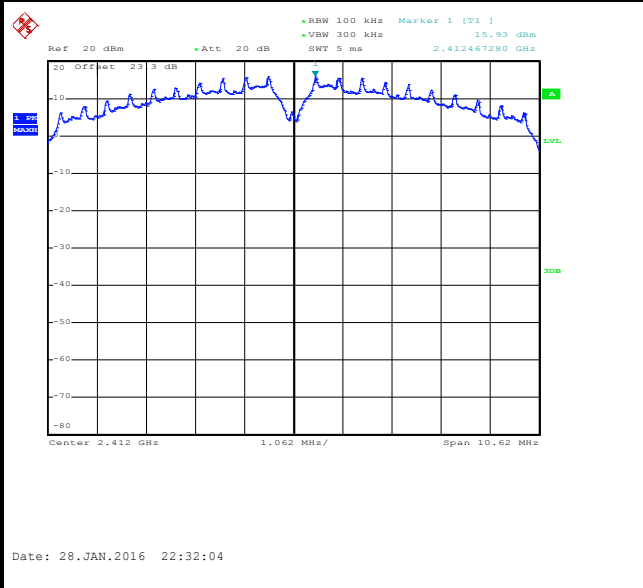

Low Channel Plot

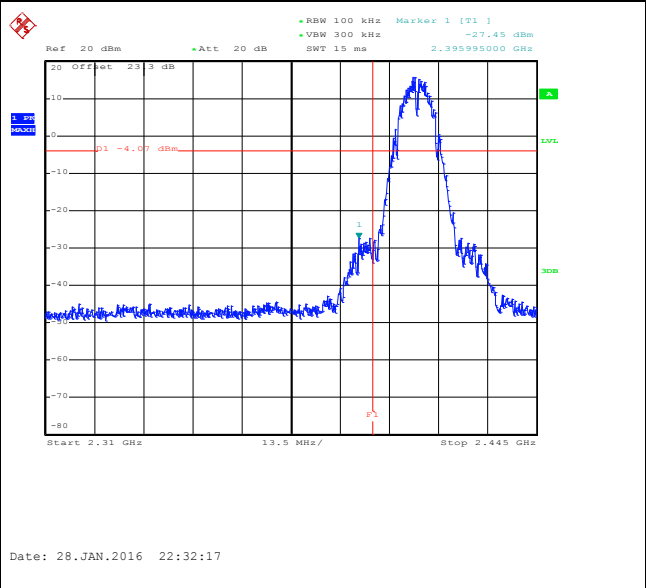

Spurious Emission 30MHz~3GHz

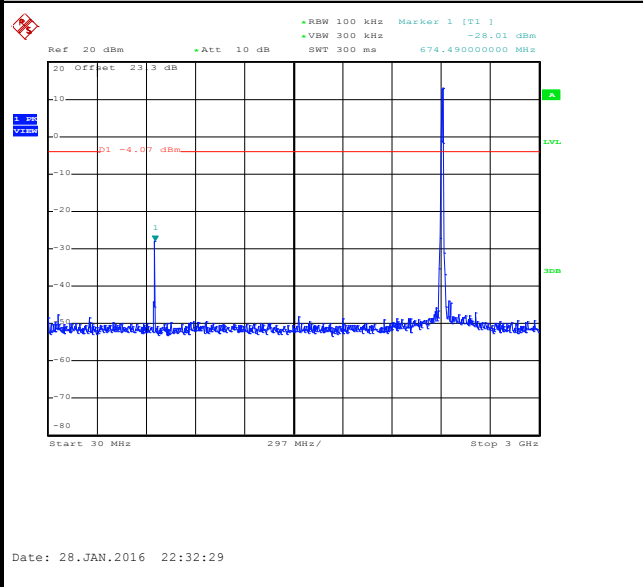

Spurious Emission 2GHz~25GHz

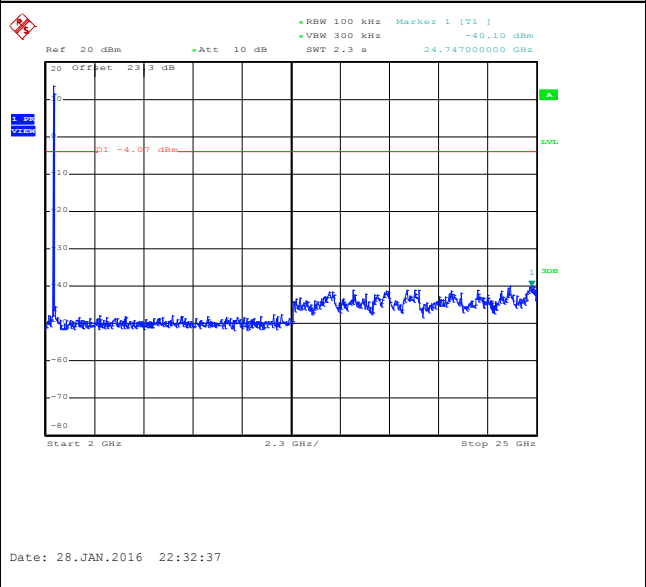



Number of TX :	2	Ant. :	2
Test Mode :	802.11b	Temperature :	21~25°C
Test Band :	2.4GHz Mid	Relative Humidity :	58~61%
Test Channel :	06	Test Engineer :	osolemio Chang and Luffy

WLAN 802.11b Channel 06

100kHz PSD reference Level

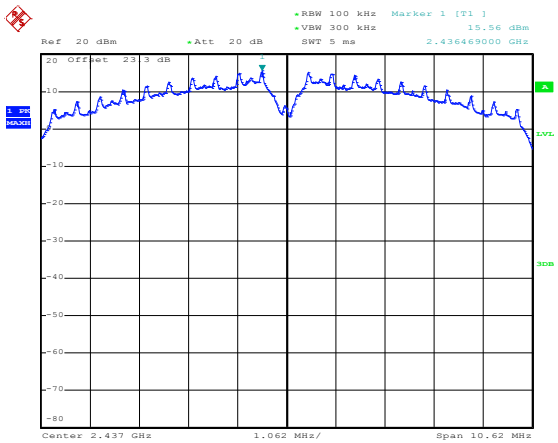

Date: 28.JAN.2016 23:00:15

Spurious Emission 30MHz~3GHz

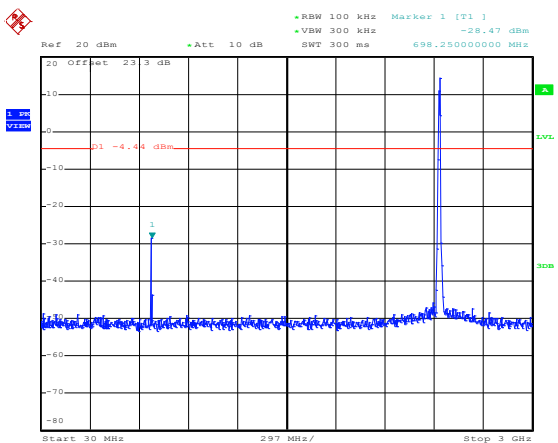

Date: 28.JAN.2016 23:00:43

Spurious Emission 2GHz~25GHz

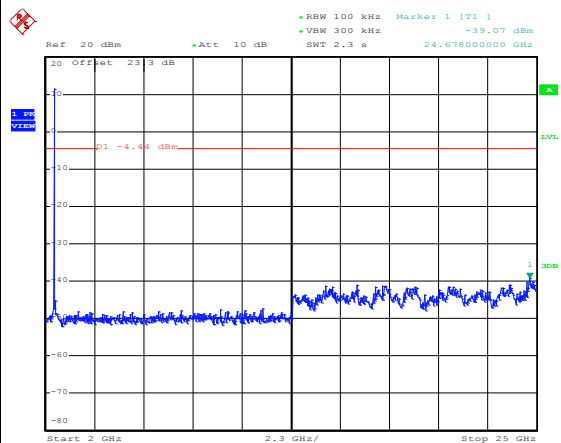

Date: 28.JAN.2016 23:00:52



Number of TX :	2	Ant. :	2
Test Mode :	802.11b	Temperature :	21~25°C
Test Band :	2.4GHz High	Relative Humidity :	58~61%
Test Channel :	11	Test Engineer :	osolemio Chang and Luffy

WLAN 802.11b Channel 11

100kHz PSD reference Level

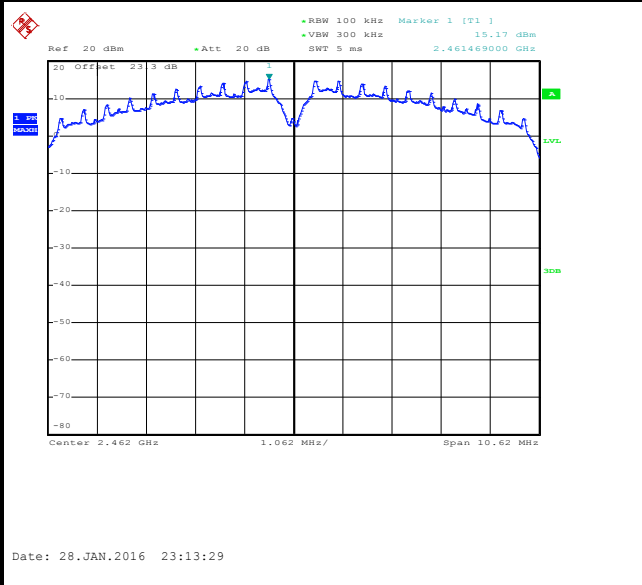

High Channel Plot

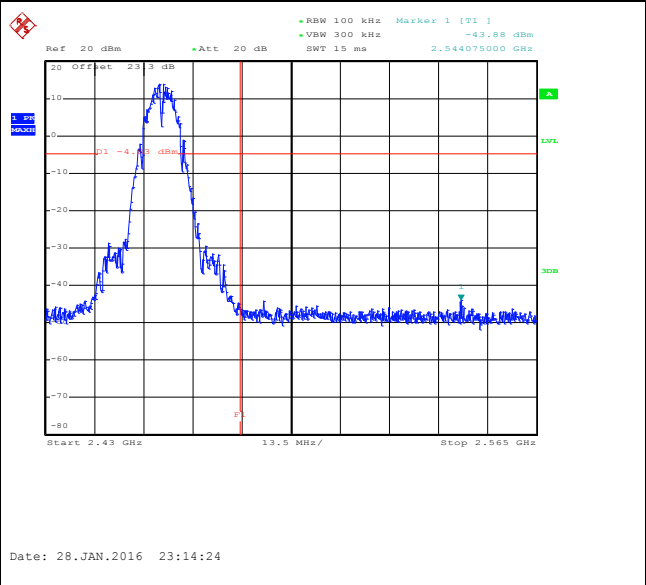

Spurious Emission 30MHz~3GHz

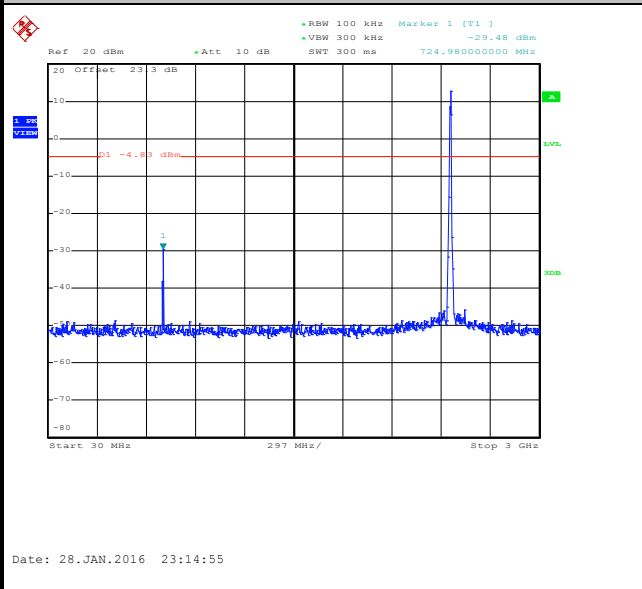

Spurious Emission 2GHz~25GHz

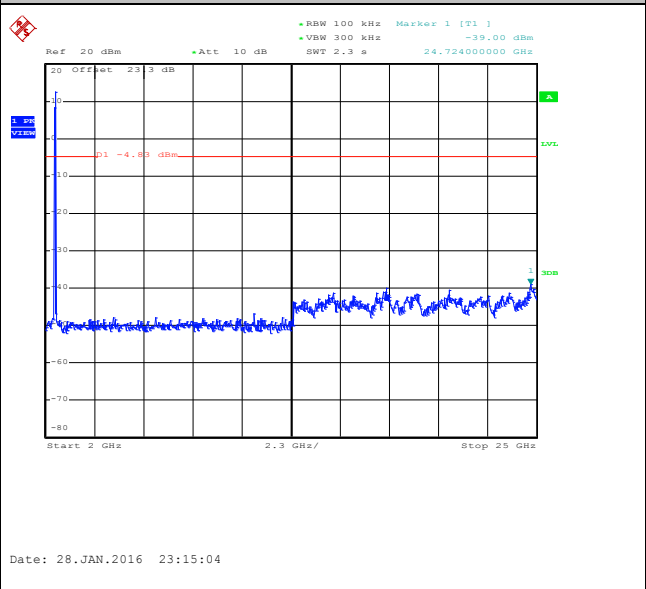





Number of TX :	2	Ant. :	2
Test Mode :	802.11g	Temperature :	21~25°C
Test Band :	2.4GHz Low	Relative Humidity :	58~61%
Test Channel :	01	Test Engineer :	osolemio Chang and Luffy

WLAN 802.11g Channel 01

100kHz PSD reference Level

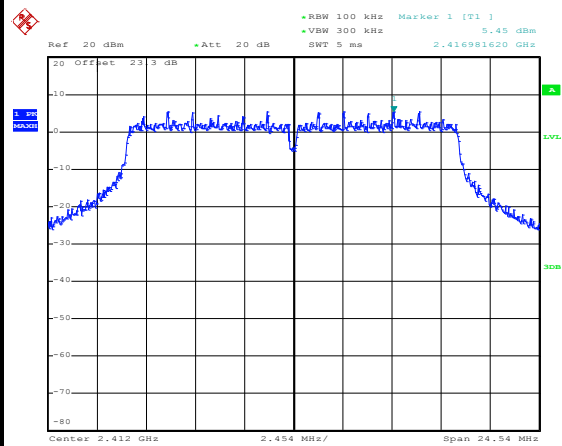

Date: 28.JAN.2016 23:23:57

Low Channel Plot

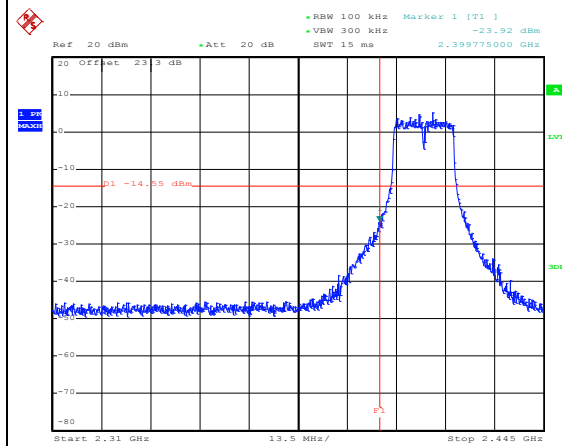

Date: 28.JAN.2016 23:24:14

Spurious Emission 30MHz~3GHz

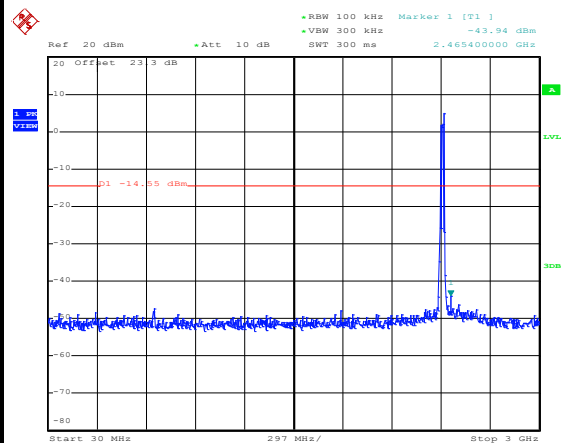

Date: 28.JAN.2016 23:24:29

Spurious Emission 2GHz~25GHz

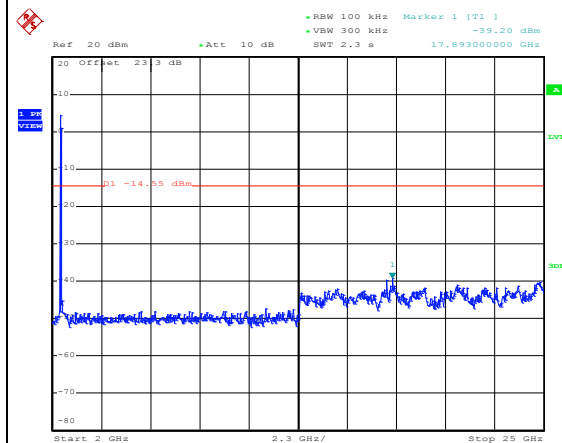

Date: 28.JAN.2016 23:24:38



Number of TX :	2	Ant. :	2
Test Mode :	802.11g	Temperature :	21~25°C
Test Band :	2.4GHz Mid	Relative Humidity :	58~61%
Test Channel :	06	Test Engineer :	osolemio Chang and Luffy

WLAN 802.11g Channel 06

100kHz PSD reference Level

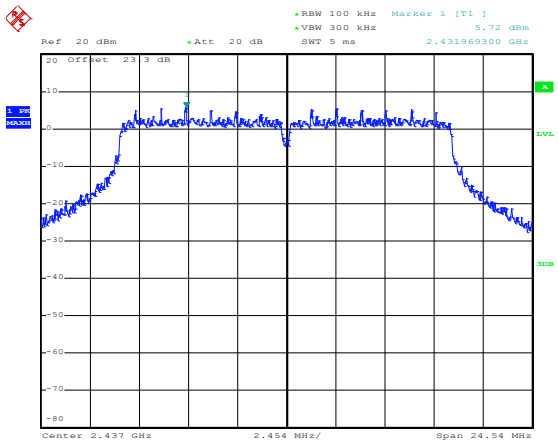

Date: 28.JAN.2016 23:34:12

Spurious Emission 30MHz~3GHz

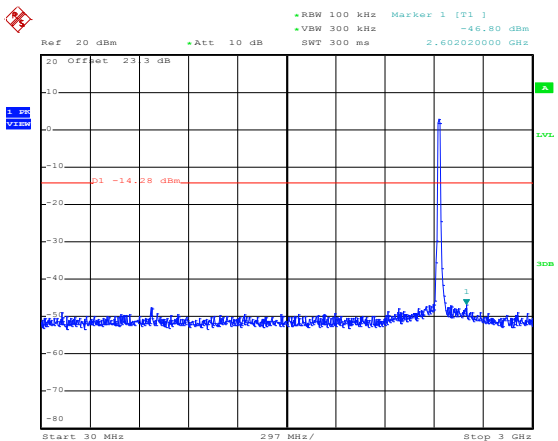

Date: 28.JAN.2016 23:34:24

Spurious Emission 2GHz~25GHz

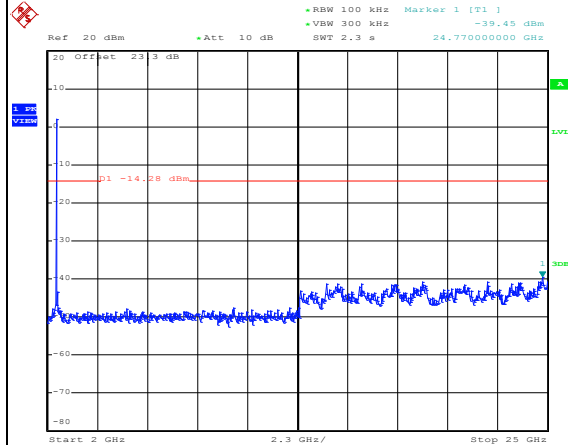

Date: 28.JAN.2016 23:34:33



Number of TX :	2	Ant. :	2
Test Mode :	802.11g	Temperature :	21~25°C
Test Band :	2.4GHz High	Relative Humidity :	58~61%
Test Channel :	11	Test Engineer :	osolemio Chang and Luffy

WLAN 802.11g Channel 11

100kHz PSD reference Level

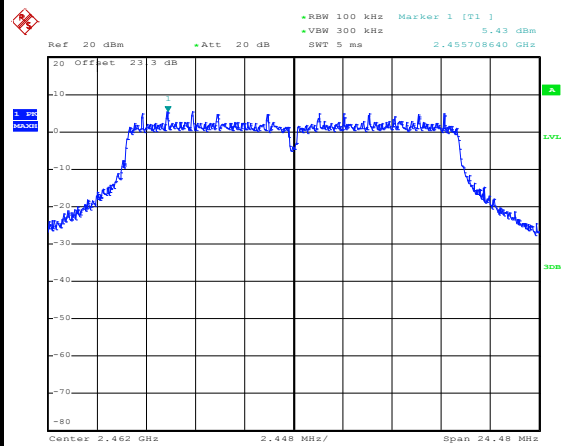

Date: 3.FEB.2016 14:44:40

High Channel Plot

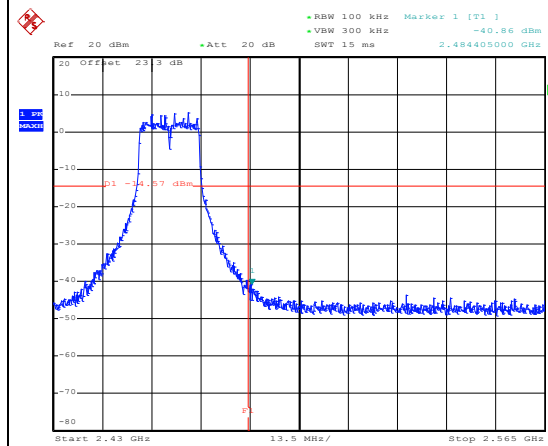

Date: 3.FEB.2016 14:44:58

Spurious Emission 30MHz~3GHz

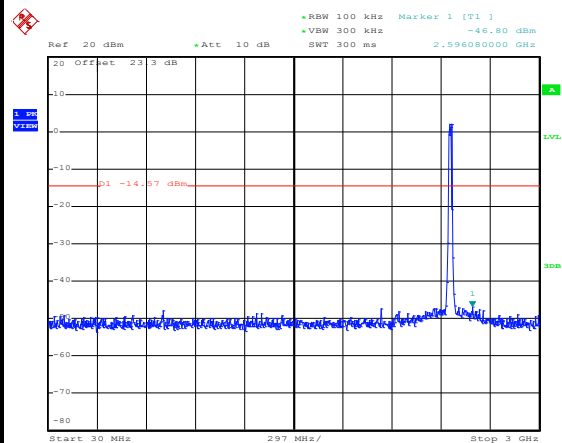

Date: 3.FEB.2016 14:45:23

Spurious Emission 2GHz~25GHz

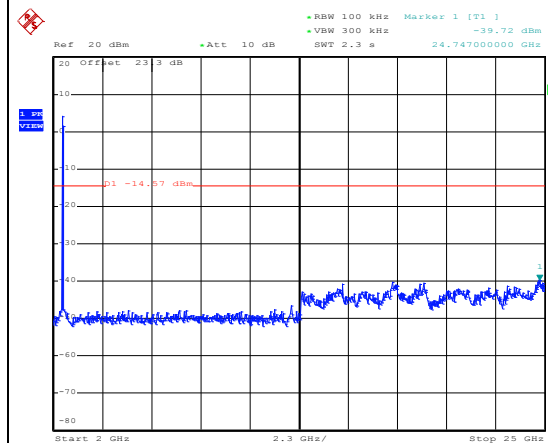

Date: 3.FEB.2016 14:45:31



Number of TX :	2	Ant. :	2
Test Mode :	802.11n HT20	Temperature :	21~25°C
Test Band :	2.4GHz Low	Relative Humidity :	58~61%
Test Channel :	01	Test Engineer :	osolemio Chang and Luffy

WLAN 802.11n HT20 Channel 01

100kHz PSD reference Level

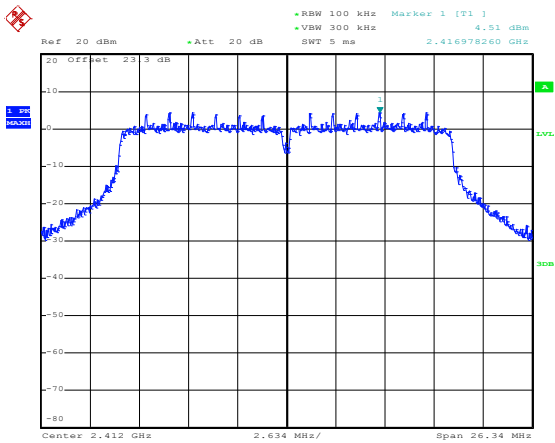

Date: 3.FEB.2016 14:55:38

Low Channel Plot

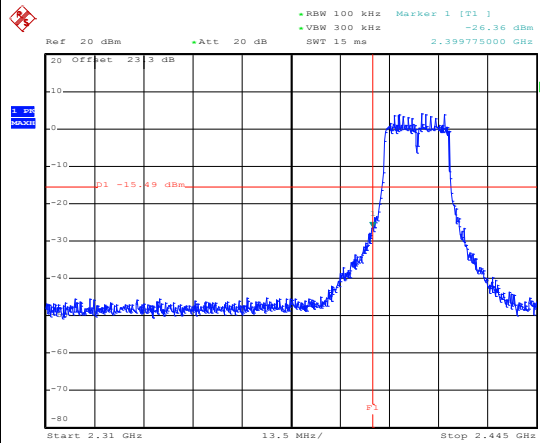

Date: 3.FEB.2016 14:56:18

Spurious Emission 30MHz~3GHz

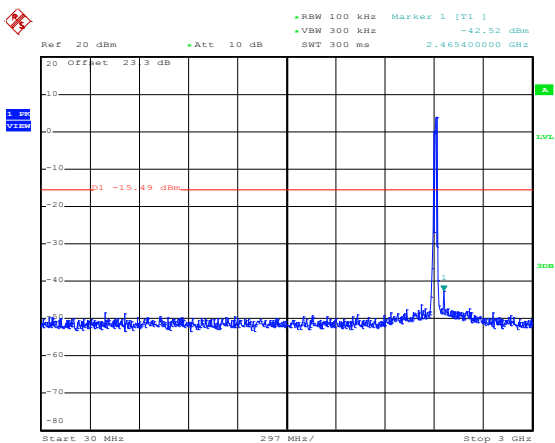

Date: 3.FEB.2016 14:57:14

Spurious Emission 2GHz~25GHz

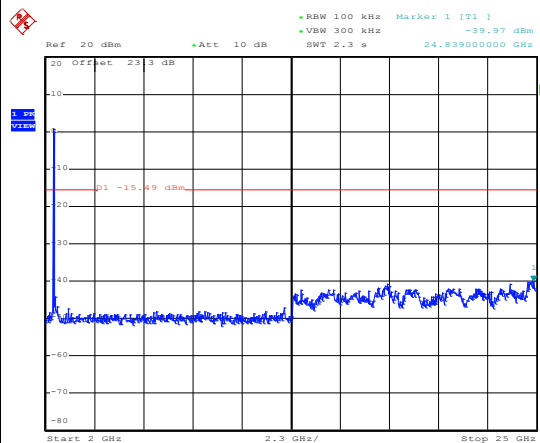

Date: 3.FEB.2016 14:57:22



Number of TX :	2	Ant. :	2
Test Mode :	802.11n HT20	Temperature :	21~25°C
Test Band :	2.4GHz Mid	Relative Humidity :	58~61%
Test Channel :	06	Test Engineer :	osolemio Chang and Luffy

WLAN 802.11n HT20 Channel 06

100kHz PSD reference Level

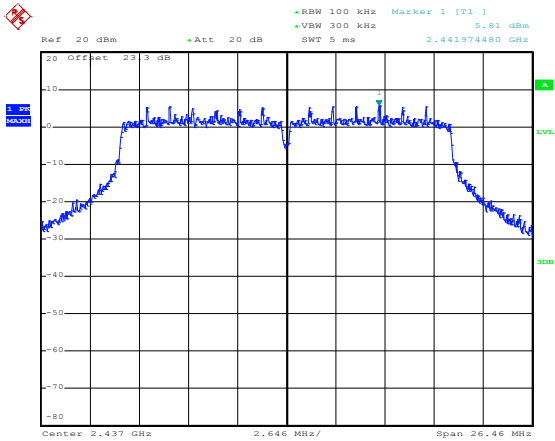

Date: 29.JAN.2016 00:10:50

Spurious Emission 30MHz~3GHz

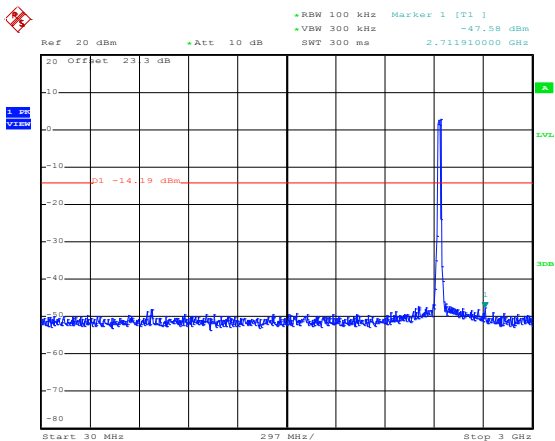

Date: 29.JAN.2016 00:11:10

Spurious Emission 2GHz~25GHz

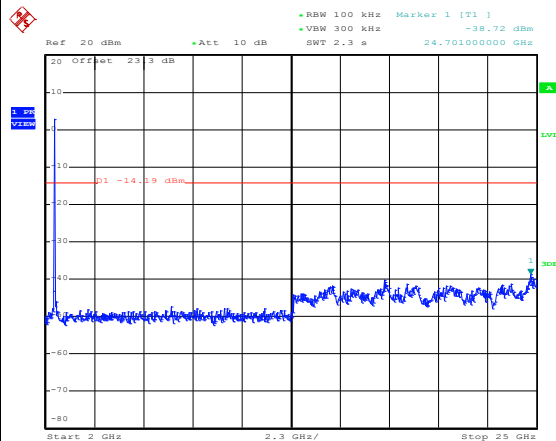

Date: 29.JAN.2016 00:11:18



Number of TX :	2	Ant. :	2
Test Mode :	802.11n HT20	Temperature :	21~25°C
Test Band :	2.4GHz High	Relative Humidity :	58~61%
Test Channel :	11	Test Engineer :	osolemio Chang and Luffy

WLAN 802.11n HT20 Channel 11

100kHz PSD reference Level

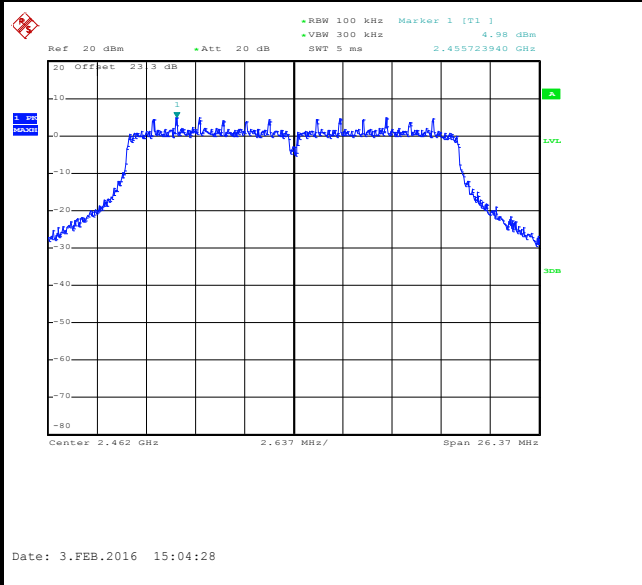

High Channel Plot

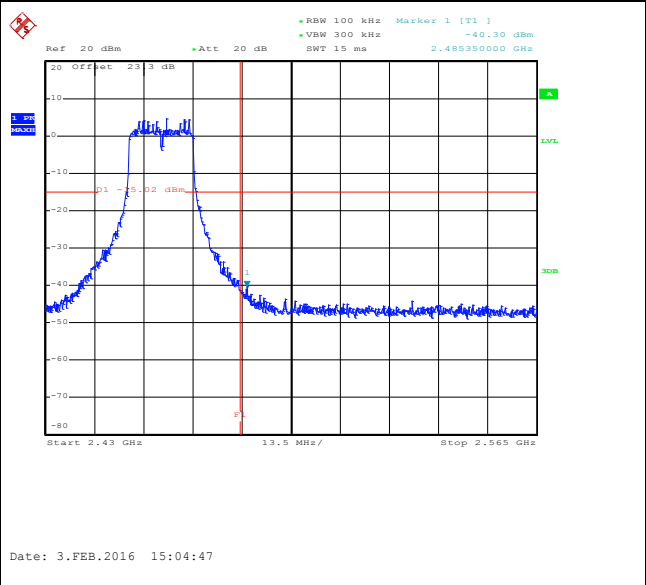

Spurious Emission 30MHz~3GHz

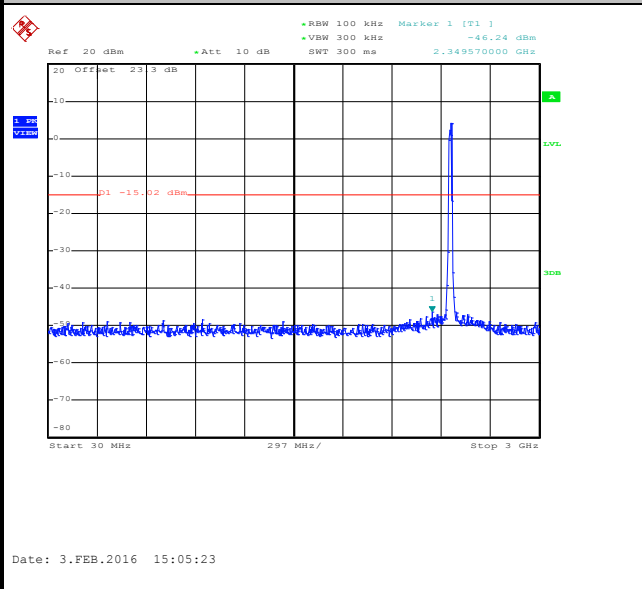

Spurious Emission 2GHz~25GHz

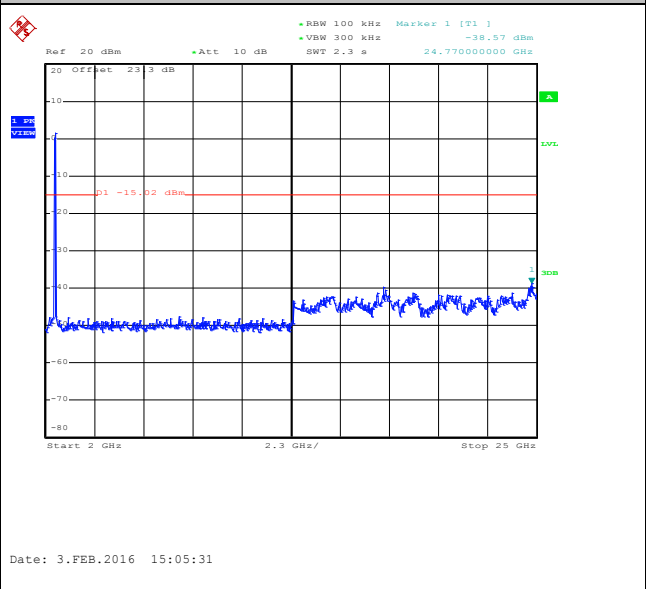



Number of TX :	2	Ant. :	2
Test Mode :	802.11n HT40	Temperature :	21~25°C
Test Band :	2.4GHz Low	Relative Humidity :	58~61%
Test Channel :	03	Test Engineer :	osolemio Chang and Luffy

WLAN 802.11n HT40 Channel 03

100kHz PSD reference Level

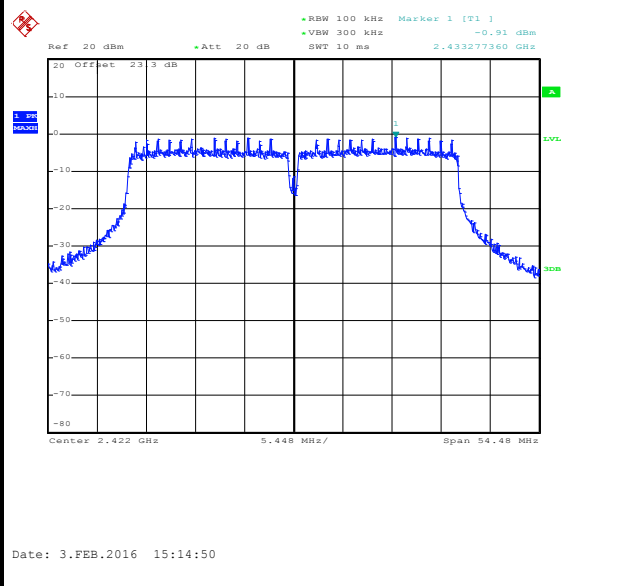

Low Channel Plot

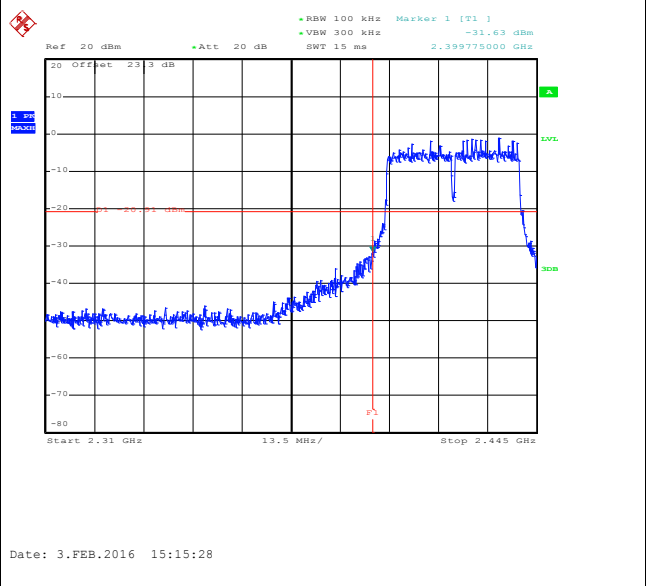

Spurious Emission 30MHz~3GHz

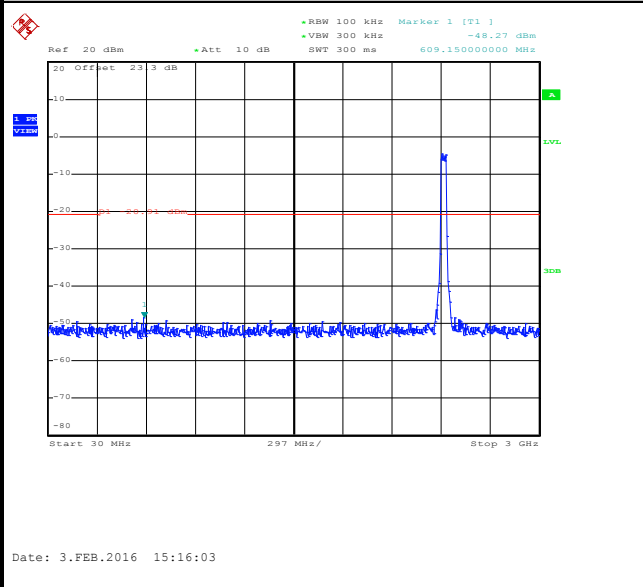

Spurious Emission 2GHz~25GHz

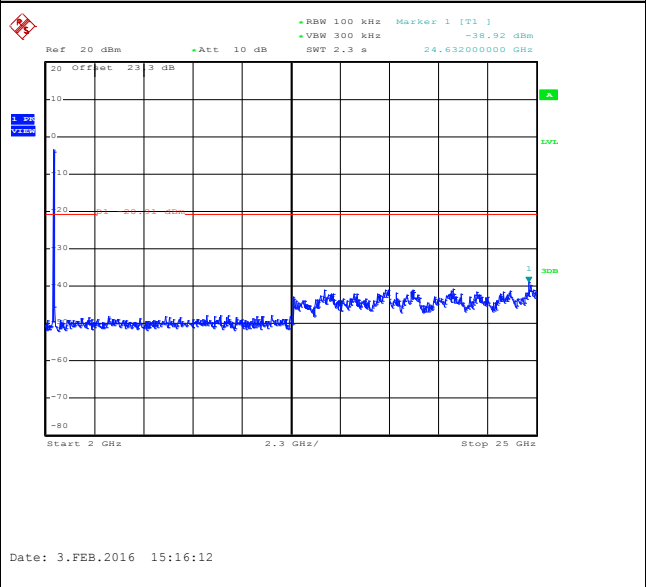



Number of TX :	2	Ant. :	2
Test Mode :	802.11n HT40	Temperature :	21~25°C
Test Band :	2.4GHz Mid	Relative Humidity :	58~61%
Test Channel :	06	Test Engineer :	osolemio Chang and Luffy

WLAN 802.11n HT40 Channel 06

100kHz PSD reference Level

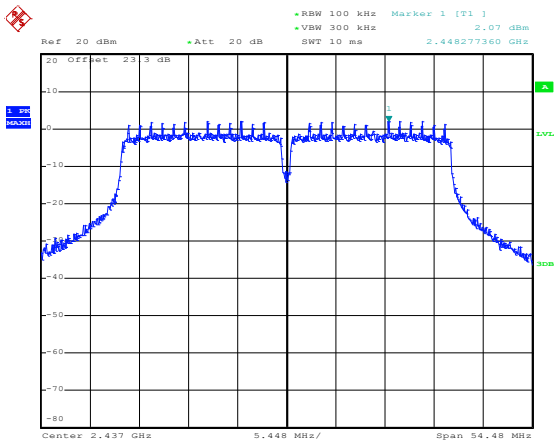

Date: 3.FEB.2016 15:22:52

Spurious Emission 30MHz~3GHz

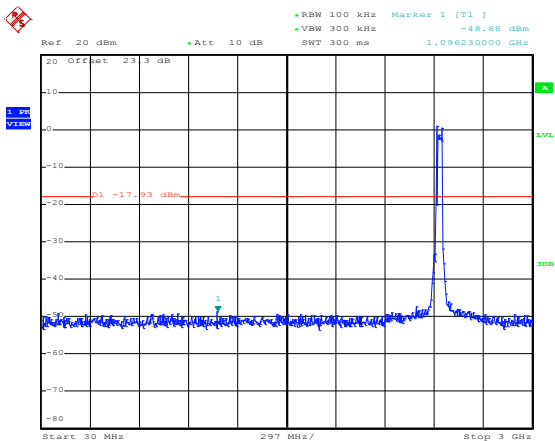

Date: 3.FEB.2016 15:23:10

Spurious Emission 2GHz~25GHz

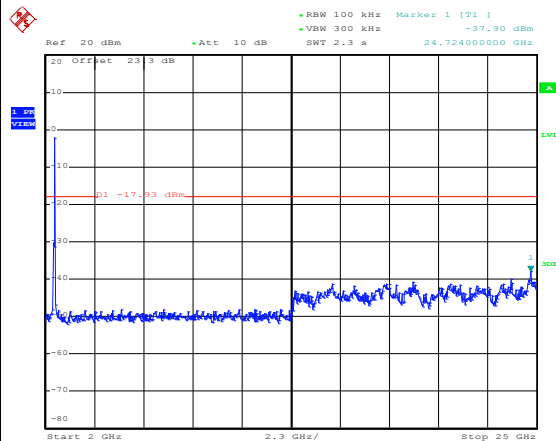

Date: 3.FEB.2016 15:23:19





Number of TX :	2	Ant. :	2
Test Mode :	802.11n HT40	Temperature :	21~25°C
Test Band :	2.4GHz High	Relative Humidity :	58~61%
Test Channel :	09	Test Engineer :	osolemio Chang and Luffy

WLAN 802.11n HT40 Channel 09

100kHz PSD reference Level

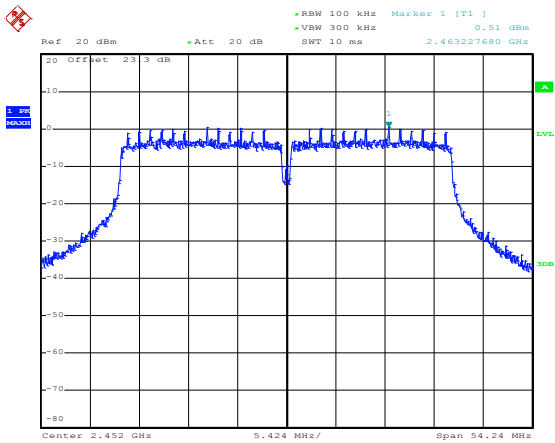

Date: 3.FEB.2016 15:31:41

High Channel Plot

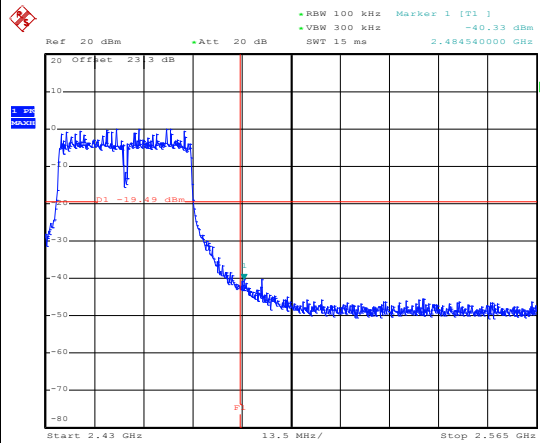

Date: 3.FEB.2016 15:31:52

Spurious Emission 30MHz~3GHz

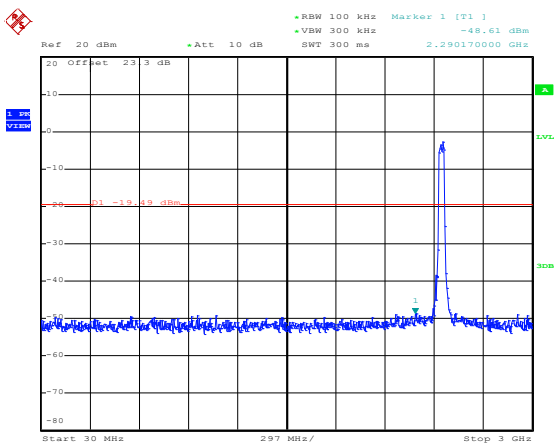

Date: 3.FEB.2016 15:32:29

Spurious Emission 2GHz~25GHz

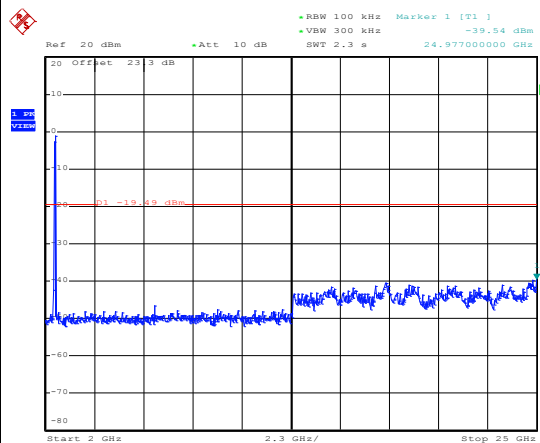

Date: 3.FEB.2016 15:32:37



### 3.5 Radiated Band Edges and Spurious Emission Measurement

#### 3.5.1 Limit of Radiated band edge and Spurious Emission Measurement

In any 100 kHz bandwidth outside the intentional radiator frequency band, all harmonics/spurious must be at least 20 dB below the highest emission level within the authorized band. If the output power of this device was measured by spectrum analyzer, the attenuation under this paragraph shall be 30 dB instead of 20 dB. In addition, radiated emissions which fall in the restricted bands must also comply with the FCC section 15.209 limits as below.

Frequency (MHz)	Field Strength (microvolts/meter)	Measurement Distance (meters)
0.009 – 0.490	2400/F(kHz)	300
0.490 – 1.705	24000/F(kHz)	30
1.705 – 30.0	30	30
30 – 88	100	3
88 – 216	150	3
216 - 960	200	3
Above 960	500	3

#### 3.5.2 Measuring Instruments

The measuring equipment is listed in the section 4 of this test report.



3.5.3 Test Procedure

1. The testing follows FCC KDB Publication No. 558074 D01 DTS Meas. Guidance v03r05.
2. The EUT was arranged to its worst case and then tune the antenna tower (from 1 m to 4 m) and turntable (from 0 degree to 360 degrees) to find the maximum reading. A pre-amp and a high pass filter are used for the test in order to get better signal level.
3. The EUT was placed on a turntable with 0.8 meter for frequency below 1GHz and 1.5 meter for frequency above 1GHz respectively above ground.
4. The EUT was set 3 meters from the interference receiving antenna, which was mounted on the top of a variable height antenna tower.
5. Corrected Reading: Antenna Factor + Cable Loss + Read Level - Preamp Factor = Level
6. For measurement below 1GHz, If the emission level of the EUT measured by the peak detector is 3 dB lower than the applicable limit, the peak emission level will be reported. Otherwise, the emission measurement will be repeated using the quasi-peak detector and reported.
7. Use the following spectrum analyzer settings:
  - (1) Span shall wide enough to fully capture the emission being measured;
  - (2) Set RBW=100 kHz for  $f < 1$  GHz;  $VBW \geq RBW$ ; Sweep = auto; Detector function = peak; Trace = max hold;
  - (3) Set RBW = 1 MHz, VBW= 3MHz for  $f \geq 1$  GHz for peak measurement.

For average measurement:

  - $VBW = 10$  Hz, when duty cycle is no less than 98 percent.
  - $VBW \geq 1/T$ , when duty cycle is less than 98 percent where T is the minimum transmission duration over which the transmitter is on and is transmitting at its maximum power control level for the tested mode of operation.

Antenna	Band	Duty Cycle(%)	T(us)	1/T(kHz)	VBW Setting
0+1	2.4GHz 802.11b for Ant 1	100	-	-	10Hz
0+1	2.4GHz 802.11b for Ant 2	100	-	-	10Hz
0+1	2.4GHz 802.11g for Ant 1	96.92	2016	0.50	1kHz
0+1	2.4GHz 802.11g for Ant 2	96.94	2026	0.49	1kHz
0+1	2.4GHz 802.11n HT20 for Ant 1	96.72	1888	0.53	1kHz
0+1	2.4GHz 802.11n HT20 for Ant 2	96.69	1872	0.53	1kHz
0+1	2.4GHz 802.11n HT40 for Ant 1	95.88	930	1.08	3kHz
0+1	2.4GHz 802.11n HT40 for Ant 2	94.9	930	1.08	3kHz

### 3.5.4 Test Setup

For radiated emissions below 30MHz

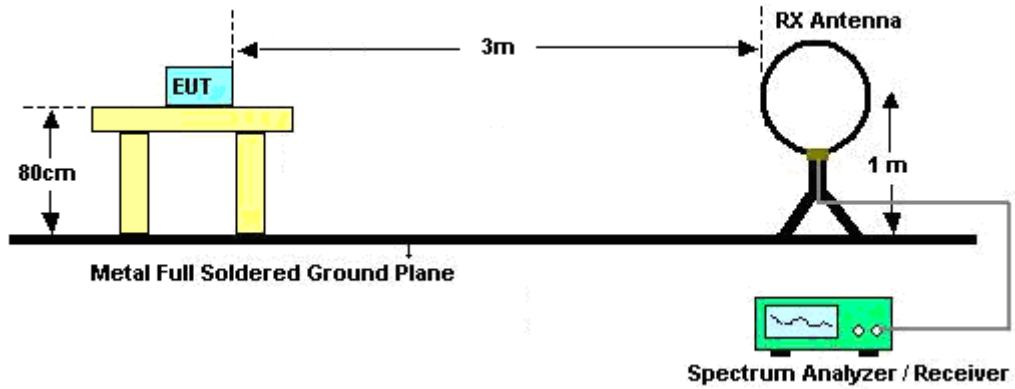

For radiated emissions from 30MHz to 1GHz

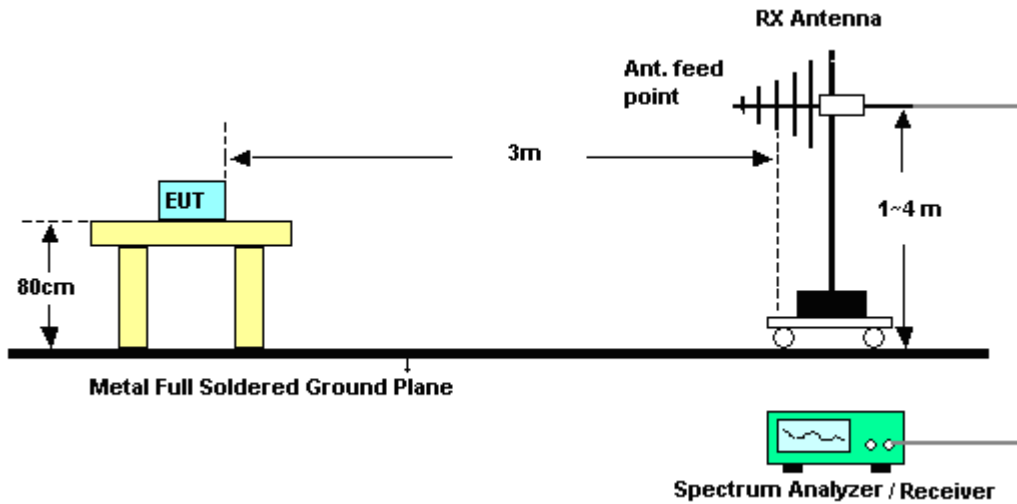

For radiated emissions above 1GHz

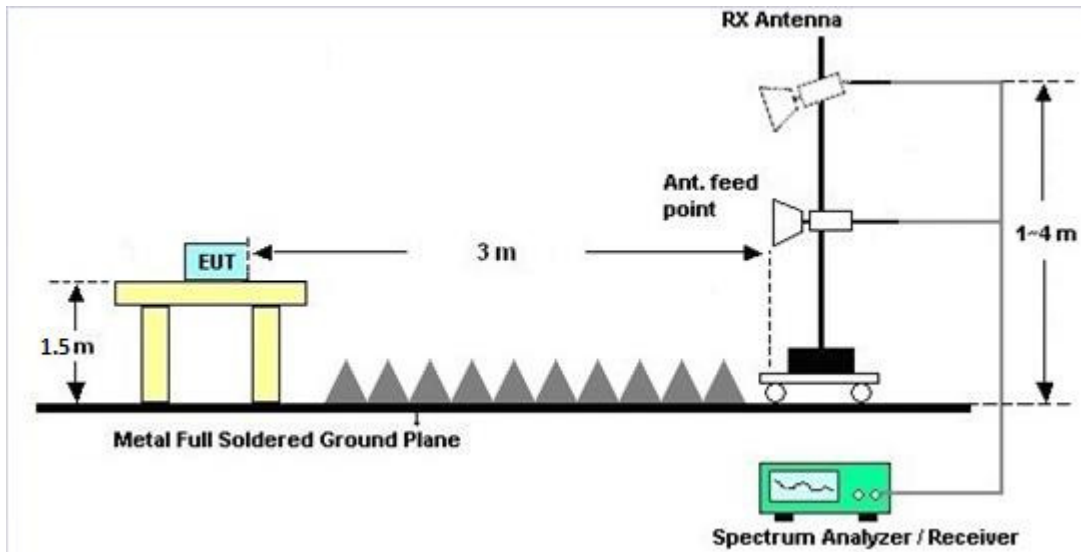

### 3.5.5 Test Results of Radiated Emissions (9kHz ~ 30MHz)

The low frequency, which started from 9 kHz to 30MHz, was pre-scanned and the result which was 20dB lower than the limit line per 15.31(o) was not reported.

### 3.5.6 Test Result of Radiated Spurious at Band Edges

Please refer to Appendix B and C of this report.

### 3.5.7 Test Result of Radiated Spurious Emission (30MHz ~ 10<sup>th</sup> Harmonic)

Please refer to Appendix B and C of this report.



### 3.6 AC Conducted Emission Measurement

#### 3.6.1 Limit of AC Conducted Emission

For equipment that is designed to be connected to the public utility (AC) power line, the radio frequency voltage that is conducted back onto the AC power line on any frequency or frequencies within the band 150 kHz to 30 MHz shall not exceed the limits in the following table.

Frequency of Emission (MHz)	Conducted Limit (dBµV)	
	Quasi-Peak	Average
0.15-0.5	66 to 56*	56 to 46*
0.5-5	56	46
5-30	60	50

\*Decreases with the logarithm of the frequency.

#### 3.6.2 Measuring Instruments

The measuring equipment is listed in the section 4 of this test report.

#### 3.6.3 Test Procedures

1. The EUT was placed 0.4 meter from the conducting wall of the shielding room, and it was kept at least 80 centimeters from any other grounded conducting surface.
2. Connect EUT to the power mains through a line impedance stabilization network (LISN).
3. All the support units are connecting to the other LISN.
4. The LISN provides 50 ohm coupling impedance for the measuring instrument.
5. The FCC states that a 50 ohm, 50 microhenry LISN should be used.
6. Both sides of AC line were checked for maximum conducted interference.
7. The frequency range from 150 kHz to 30 MHz was searched.
8. Set the test-receiver system to Peak Detect Function and specified bandwidth (IF bandwidth = 9kHz) with Maximum Hold Mode.

### 3.6.4 Test Setup

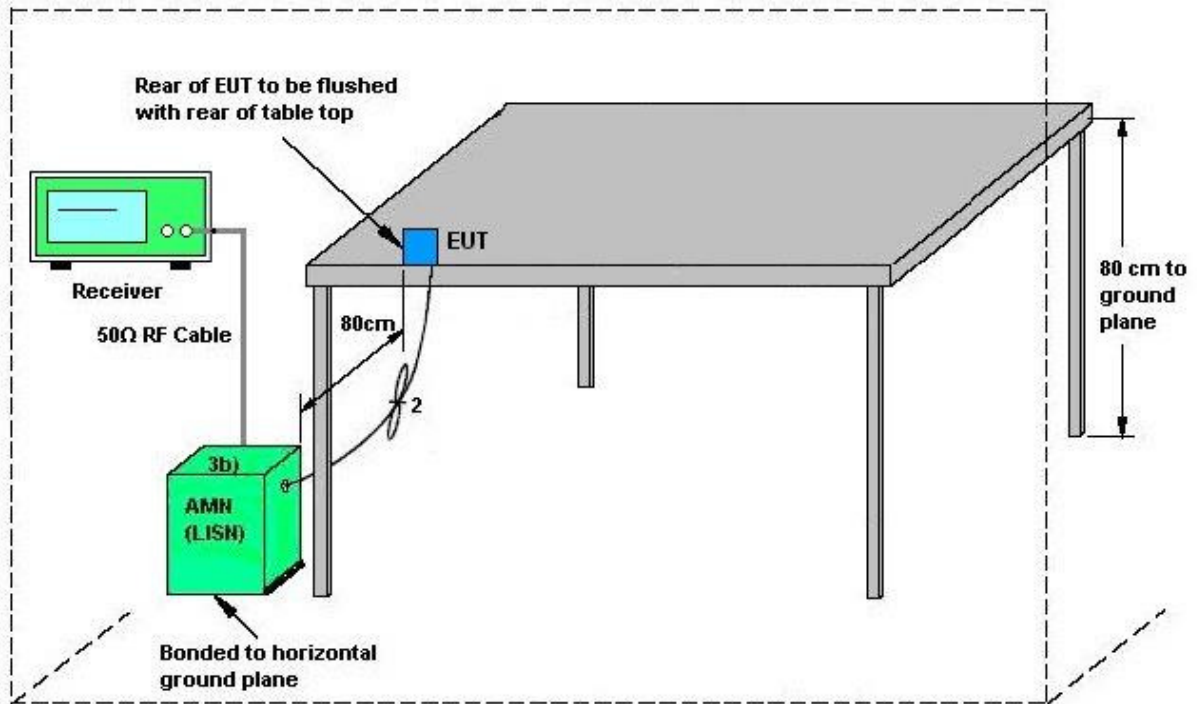

AMN = Artificial mains network (LISN)  
AE = Associated equipment  
EUT = Equipment under test  
ISN = Impedance stabilization network



3.6.5 Test Result of AC Conducted Emission

Test Mode :	Mode 1	Temperature :	24~25°C
Test Engineer :	Kai-Chun Chu	Relative Humidity :	53~54%
Test Voltage :	120Vac / 60Hz	Phase :	Line
Function Type :	2.4G Tx + RJ-45 Link + Adapter		

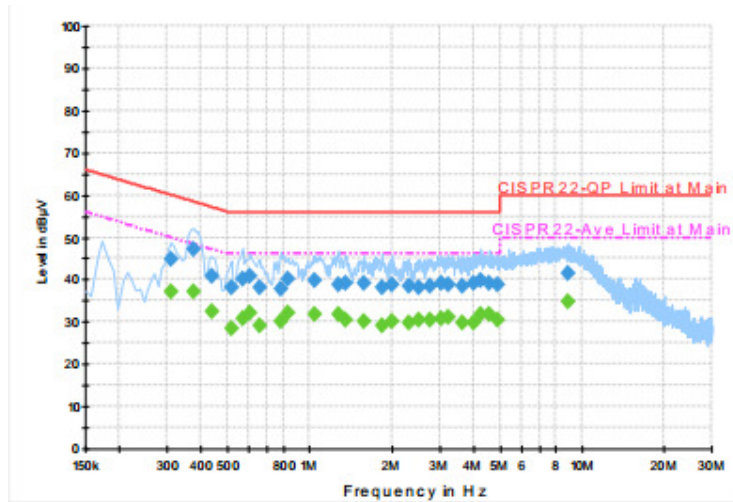

Final Result : QuasiPeak

Frequency (MHz)	QuasiPeak (dBµV)	Filter	Line	Corr. (dB)	Margin (dB)	Limit (dBµV)
0.310000	44.8	Off	L1	19.6	15.2	60.0
0.374000	47.2	Off	L1	19.6	11.2	58.4
0.438000	41.0	Off	L1	19.6	16.1	57.1
0.518000	38.1	Off	L1	19.6	17.9	56.0
0.566000	40.3	Off	L1	19.6	15.7	56.0
0.606000	40.8	Off	L1	19.6	15.2	56.0
0.654000	38.1	Off	L1	19.6	17.9	56.0
0.782000	37.9	Off	L1	19.6	18.1	56.0
0.838000	40.0	Off	L1	19.6	16.0	56.0
1.046000	39.8	Off	L1	19.6	16.2	56.0
1.278000	38.9	Off	L1	19.6	17.1	56.0
1.350000	39.0	Off	L1	19.6	17.0	56.0
1.590000	39.1	Off	L1	19.6	16.9	56.0
1.854000	38.1	Off	L1	19.6	17.9	56.0
2.022000	38.6	Off	L1	19.6	17.4	56.0
2.310000	38.6	Off	L1	18.9	17.4	56.0
2.510000	38.1	Off	L1	19.3	17.9	56.0





Test Mode :	Mode 1	Temperature :	24~25°C
Test Engineer :	Kai-Chun Chu	Relative Humidity :	53~54%
Test Voltage :	120Vac / 60Hz	Phase :	Line
Function Type :	2.4G Tx + RJ-45 Link + Adapter		

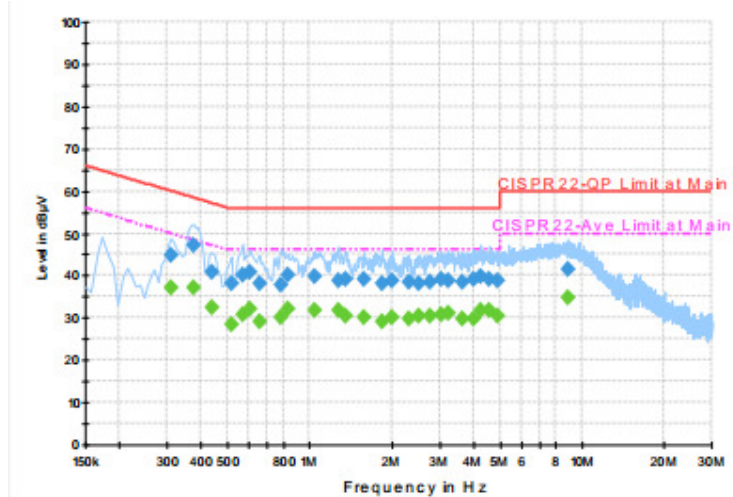

Final Result : QuasiPeak

Frequency (MHz)	QuasiPeak (dBµV)	Filter	Line	Corr. (dB)	Margin (dB)	Limit (dBµV)
2.766000	38.6	Off	L1	19.5	17.4	56.0
3.046000	39.3	Off	L1	19.6	16.7	56.0
3.238000	38.9	Off	L1	19.6	17.1	56.0
3.654000	38.5	Off	L1	19.7	17.5	56.0
4.014000	39.1	Off	L1	19.7	16.9	56.0
4.270000	39.7	Off	L1	19.7	16.3	56.0
4.582000	39.2	Off	L1	19.7	16.8	56.0
4.934000	38.8	Off	L1	19.7	17.2	56.0
8.910000	41.4	Off	L1	19.7	18.6	60.0



Test Mode :	Mode 1	Temperature :	24~25°C
Test Engineer :	Kai-Chun Chu	Relative Humidity :	53~54%
Test Voltage :	120Vac / 60Hz	Phase :	Line
Function Type :	2.4G Tx + RJ-45 Link + Adapter		

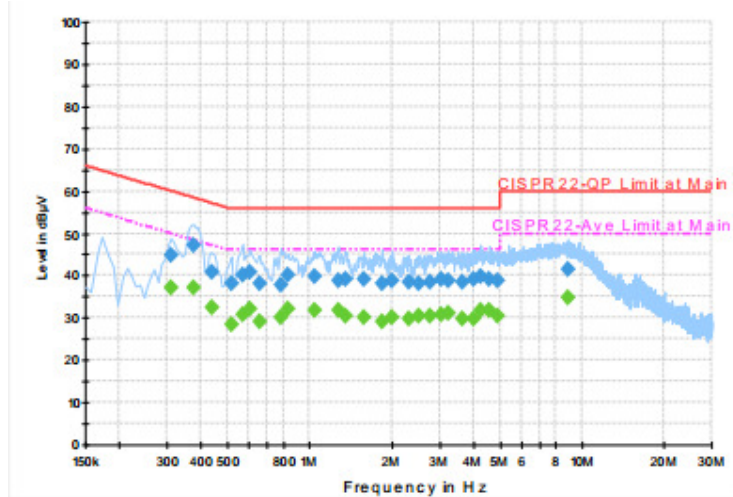

Final Result : Average

Frequency (MHz)	Average (dBµV)	Filter	Line	Corr. (dB)	Margin (dB)	Limit (dBµV)
0.310000	37.2	Off	L1	19.6	12.8	50.0
0.374000	37.0	Off	L1	19.6	11.4	48.4
0.438000	32.6	Off	L1	19.6	14.5	47.1
0.518000	28.4	Off	L1	19.6	17.6	46.0
0.566000	30.9	Off	L1	19.6	15.1	46.0
0.606000	31.9	Off	L1	19.6	14.1	46.0
0.654000	29.2	Off	L1	19.6	16.8	46.0
0.782000	30.0	Off	L1	19.6	16.0	46.0
0.838000	32.0	Off	L1	19.6	14.0	46.0
1.046000	31.6	Off	L1	19.6	14.4	46.0
1.278000	31.7	Off	L1	19.6	14.3	46.0
1.350000	30.3	Off	L1	19.6	15.7	46.0
1.590000	30.0	Off	L1	19.6	16.0	46.0
1.854000	29.0	Off	L1	19.6	17.0	46.0
2.022000	30.0	Off	L1	19.6	16.0	46.0
2.310000	29.7	Off	L1	18.9	16.3	46.0
2.510000	30.3	Off	L1	19.3	15.7	46.0



Test Mode :	Mode 1	Temperature :	24~25°C
Test Engineer :	Kai-Chun Chu	Relative Humidity :	53~54%
Test Voltage :	120Vac / 60Hz	Phase :	Line
Function Type :	2.4G Tx + RJ-45 Link + Adapter		

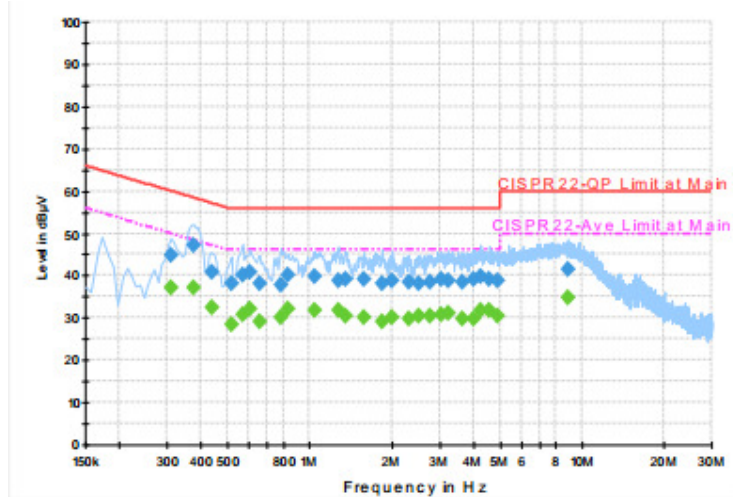

Final Result : Average

Frequency (MHz)	Average (dBµV)	Filter	Line	Corr. (dB)	Margin (dB)	Limit (dBµV)
2.766000	30.3	Off	L1	19.5	15.7	46.0
3.046000	30.6	Off	L1	19.6	15.4	46.0
3.238000	31.2	Off	L1	19.6	14.8	46.0
3.654000	29.6	Off	L1	19.7	16.4	46.0
4.014000	29.7	Off	L1	19.7	16.3	46.0
4.270000	31.6	Off	L1	19.7	14.4	46.0
4.582000	31.9	Off	L1	19.7	14.1	46.0
4.934000	30.6	Off	L1	19.7	15.4	46.0
8.910000	34.7	Off	L1	19.7	15.3	50.0



Test Mode :	Mode 1	Temperature :	24~25°C
Test Engineer :	Kai-Chun Chu	Relative Humidity :	53~54%
Test Voltage :	120Vac / 60Hz	Phase :	Neutral
Function Type :	2.4G Tx + RJ-45 Link + Adapter		

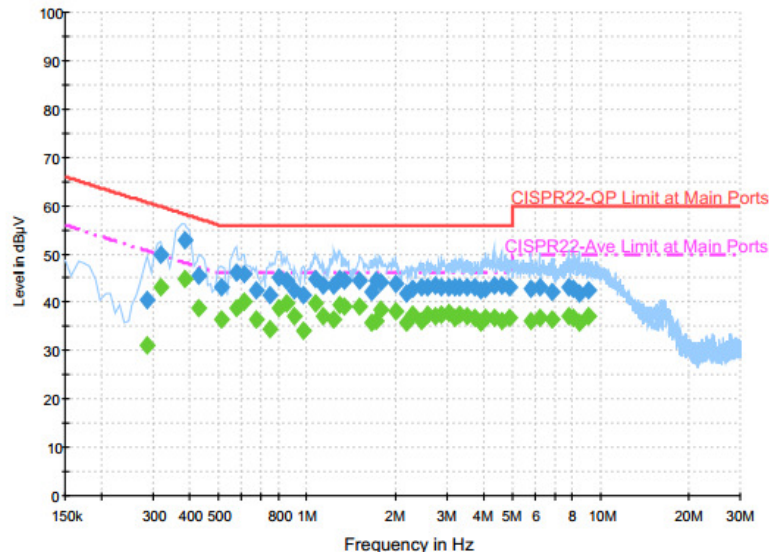

Final Result : QuasiPeak

Frequency (MHz)	QuasiPeak (dBµV)	Filter	Line	Corr. (dB)	Margin (dB)	Limit (dBµV)
0.286000	40.4	Off	N	19.6	20.2	60.6
0.318000	49.7	Off	N	19.6	10.1	59.8
0.382000	53.0	Off	N	19.6	5.2	58.2
0.430000	45.6	Off	N	19.6	11.7	57.3
0.510000	43.0	Off	N	19.6	13.0	56.0
0.574000	46.1	Off	N	19.6	9.9	56.0
0.614000	45.8	Off	N	19.6	10.2	56.0
0.670000	42.4	Off	N	19.6	13.6	56.0
0.750000	41.6	Off	N	19.6	14.4	56.0
0.806000	45.3	Off	N	19.6	10.7	56.0
0.854000	44.6	Off	N	19.6	11.4	56.0
0.910000	42.4	Off	N	19.6	13.6	56.0
0.974000	41.4	Off	N	19.6	14.6	56.0
1.070000	44.9	Off	N	19.6	11.1	56.0
1.142000	43.6	Off	N	19.6	12.4	56.0
1.238000	43.4	Off	N	19.6	12.6	56.0
1.294000	45.0	Off	N	19.6	11.0	56.0
1.342000	44.6	Off	N	19.6	11.4	56.0
1.518000	44.6	Off	N	19.6	11.4	56.0
1.662000	42.2	Off	N	19.6	13.8	56.0
1.726000	44.6	Off	N	19.6	11.4	56.0
1.790000	44.3	Off	N	19.6	11.7	56.0
2.006000	43.8	Off	N	19.6	12.2	56.0



Test Mode :	Mode 1	Temperature :	24~25°C
Test Engineer :	Kai-Chun Chu	Relative Humidity :	53~54%
Test Voltage :	120Vac / 60Hz	Phase :	Neutral
Function Type :	2.4G Tx + RJ-45 Link + Adapter		

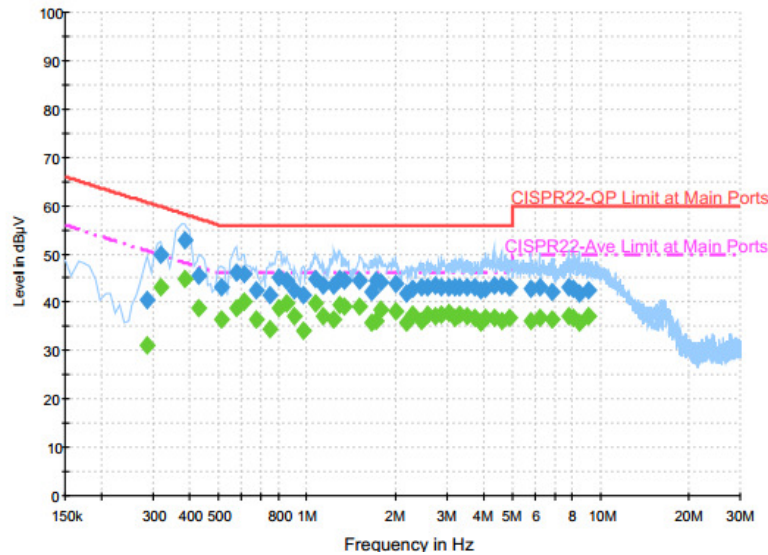

Final Result : QuasiPeak

Frequency (MHz)	QuasiPeak (dBµV)	Filter	Line	Corr. (dB)	Margin (dB)	Limit (dBµV)
2.182000	41.7	Off	N	18.6	14.3	56.0
2.302000	42.7	Off	N	18.9	13.3	56.0
2.462000	43.1	Off	N	19.2	12.9	56.0
2.574000	43.1	Off	N	19.3	12.9	56.0
2.742000	43.5	Off	N	19.5	12.5	56.0
2.878000	43.0	Off	N	19.5	13.0	56.0
3.046000	43.3	Off	N	19.6	12.7	56.0
3.190000	43.2	Off	N	19.6	12.8	56.0
3.326000	43.1	Off	N	19.6	12.9	56.0
3.526000	43.1	Off	N	19.6	12.9	56.0
3.742000	43.0	Off	N	19.6	13.0	56.0
3.918000	42.5	Off	N	19.6	13.5	56.0
4.078000	42.8	Off	N	19.6	13.2	56.0
4.334000	43.5	Off	N	19.6	12.5	56.0
4.606000	43.5	Off	N	19.7	12.5	56.0
4.926000	43.2	Off	N	19.7	12.8	56.0
5.782000	42.8	Off	N	19.7	17.2	60.0
6.198000	43.2	Off	N	19.7	16.8	60.0
6.862000	42.2	Off	N	19.7	17.8	60.0
7.822000	43.1	Off	N	19.7	16.9	60.0
8.070000	42.8	Off	N	19.7	17.2	60.0
8.486000	41.9	Off	N	19.7	18.1	60.0
9.126000	42.5	Off	N	19.8	17.5	60.0



Test Mode :	Mode 1	Temperature :	24~25°C
Test Engineer :	Kai-Chun Chu	Relative Humidity :	53~54%
Test Voltage :	120Vac / 60Hz	Phase :	Neutral
Function Type :	2.4G Tx + RJ-45 Link + Adapter		

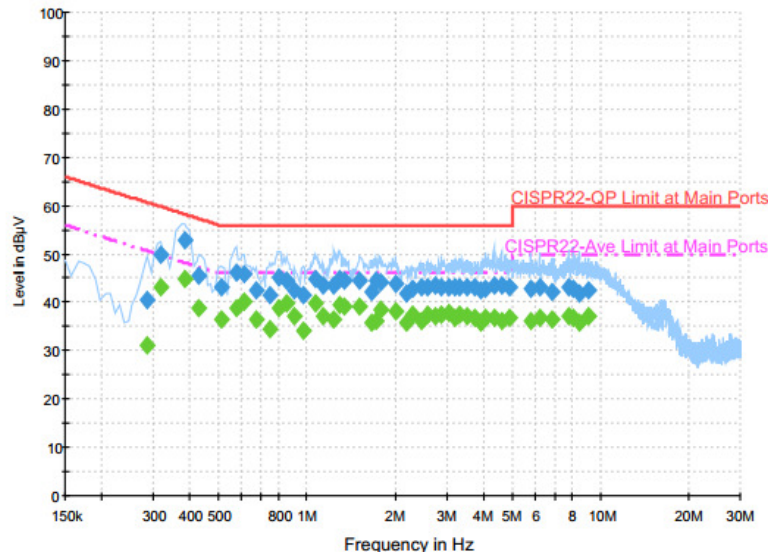

**Final Result : Average**

Frequency (MHz)	Average (dBµV)	Filter	Line	Corr. (dB)	Margin (dB)	Limit (dBµV)
0.286000	31.0	Off	N	19.6	19.6	50.6
0.318000	43.0	Off	N	19.6	6.8	49.8
0.382000	44.8	Off	N	19.6	3.4	48.2
0.430000	38.8	Off	N	19.6	8.5	47.3
0.510000	36.5	Off	N	19.6	9.5	46.0
0.574000	38.9	Off	N	19.6	7.1	46.0
0.614000	40.2	Off	N	19.6	5.8	46.0
0.670000	36.5	Off	N	19.6	9.5	46.0
0.750000	34.6	Off	N	19.6	11.4	46.0
0.806000	38.9	Off	N	19.6	7.1	46.0
0.854000	39.9	Off	N	19.6	6.1	46.0
0.910000	37.3	Off	N	19.6	8.7	46.0
0.974000	34.1	Off	N	19.6	11.9	46.0
1.070000	39.9	Off	N	19.6	6.1	46.0
1.142000	37.2	Off	N	19.6	8.8	46.0
1.238000	36.3	Off	N	19.6	9.7	46.0
1.294000	39.6	Off	N	19.6	6.4	46.0
1.342000	39.1	Off	N	19.6	6.9	46.0
1.518000	39.2	Off	N	19.6	6.8	46.0
1.662000	35.9	Off	N	19.6	10.1	46.0
1.726000	36.3	Off	N	19.6	9.7	46.0
1.790000	38.6	Off	N	19.6	7.4	46.0



Test Mode :	Mode 1	Temperature :	24~25°C
Test Engineer :	Kai-Chun Chu	Relative Humidity :	53~54%
Test Voltage :	120Vac / 60Hz	Phase :	Neutral
Function Type :	2.4G Tx + RJ-45 Link + Adapter		

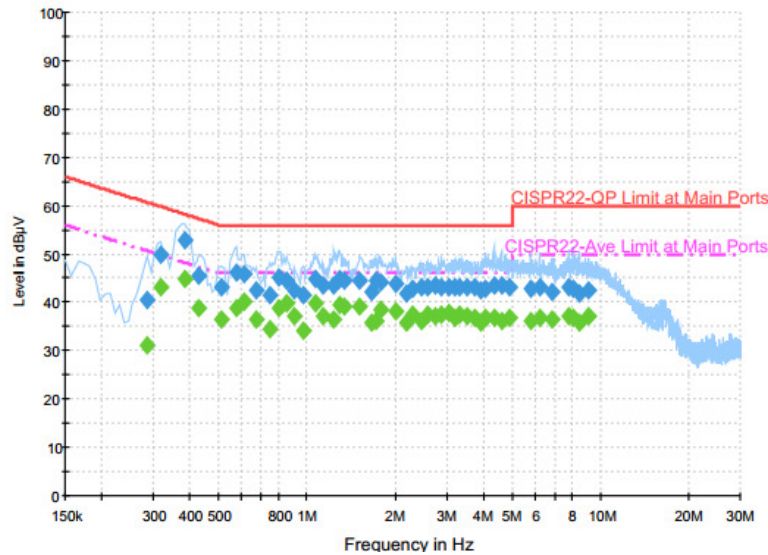

**Final Result : Average**

Frequency (MHz)	Average (dBµV)	Filter	Line	Corr. (dB)	Margin (dB)	Limit (dBµV)
2.006000	38.1	Off	N	19.6	7.9	46.0
2.182000	35.8	Off	N	18.6	10.2	46.0
2.302000	37.3	Off	N	18.9	8.7	46.0
2.462000	36.1	Off	N	19.2	9.9	46.0
2.574000	37.4	Off	N	19.3	8.6	46.0
2.742000	37.2	Off	N	19.5	8.8	46.0
2.878000	37.4	Off	N	19.5	8.6	46.0
3.046000	37.7	Off	N	19.6	8.3	46.0
3.190000	36.8	Off	N	19.6	9.2	46.0
3.326000	37.4	Off	N	19.6	8.6	46.0
3.526000	37.1	Off	N	19.6	8.9	46.0
3.742000	36.8	Off	N	19.6	9.2	46.0
3.918000	35.7	Off	N	19.6	10.3	46.0
4.078000	36.8	Off	N	19.6	9.2	46.0
4.334000	36.7	Off	N	19.6	9.3	46.0
4.606000	36.3	Off	N	19.7	9.7	46.0
4.926000	36.7	Off	N	19.7	9.3	46.0
5.782000	36.2	Off	N	19.7	13.8	50.0
6.198000	36.9	Off	N	19.7	13.1	50.0
6.862000	36.5	Off	N	19.7	13.5	50.0
7.822000	37.2	Off	N	19.7	12.8	50.0
8.070000	37.0	Off	N	19.7	13.0	50.0
8.486000	35.9	Off	N	19.7	14.1	50.0
9.126000	37.0	Off	N	19.8	13.0	50.0



### 3.7 Antenna Requirements

#### 3.7.1 Standard Applicable

If directional gain of transmitting Antennas is greater than 6dBi, the power shall be reduced by the same level in dB comparing to gain minus 6dBi. For the fixed point-to-point operation, the power shall be reduced by one dB for every 3 dB that the directional gain of the Antenna exceeds 6 dBi. The use of a permanently attached Antenna or of an Antenna that uses a unique coupling to the intentional radiator shall be considered sufficient to comply with the FCC rule.

#### 3.7.2 Antenna Anti-Replacement Construction

An embedded-in antenna design is used.

#### 3.7.3 Antenna Gain

FCC KDB 662911 D01 Multiple Transmitter Output v02r01.

For CDD transmissions, directional gain is calculated as

Directional gain =  $G_{ANT} + \text{Array Gain}$ , where Array Gain is as follows.

For power spectral density (PSD) measurements on all devices,

Array Gain =  $10 \log(N_{ANT}/N_{SS}=1)$  dB.

For power measurements on IEEE 802.11 devices,

Array Gain = 0 dB (i.e., no array gain) for  $N_{ANT} \leq 4$ .

Directional gain may be calculated by using the formulas applicable to equal gain antennas with  $G_{ANT}$  set equal to the gain of the antenna having the highest gain;

The EUT supports CDD mode.

The power and PSD limit should be modified if the directional gain of EUT is over 6 dBi,

The directional gain "DG" is calculated as following table.

			DG	DG	Power	PSD
	Ant. 1	Ant. 2	for	for	Limit	Limit
	(dBi)	(dBi)	Power	PSD	Reduction	Reduction
			(dBi)	(dBi)	(dB)	(dB)
2.4 GHz	3.52	3.16	3.52	6.35	0.00	0.35

$Power\ Limit\ Reduction = DG(Power) - 6dBi, (min = 0)$

$PSD\ Limit\ Reduction = DG(PSD) - 6dBi, (min = 0)$





## 4 List of Measuring Equipment

Instrument	Manufacturer	Model No.	Serial No.	Characteristics	Calibration Date	Test Date	Due Date	Remark
Power Meter	Anritsu	ML2495A	1036004	300MHz~40GHz	Jul. 29, 2015	Jan. 23, 2016 ~ Feb. 03, 2016	Jul. 28, 2016	Conducted (TH02-HY)
Power Sensor	Anritsu	MA2411B	1027253	300MHz~40GHz	Jul. 29, 2015	Jan. 23, 2016 ~ Feb. 03, 2016	Jul. 28, 2016	Conducted (TH02-HY)
Spectrum Analyzer	Rohde & Schwarz	FSP40	100055	9kHz~40GHz	Jun. 18, 2015	Jan. 23, 2016 ~ Feb. 03, 2016	Jun. 17, 2016	Conducted (TH02-HY)
Loop Antenna	Rohde & Schwarz	HFH2-Z2	100315	9 kHz~30 MHz	Sep. 02, 2015	Jan. 29, 2016 ~ Jan. 31, 2016	Sep. 01, 2016	Radiation (03CH12-HY)
Bilog Antenna	TESEQ	CBL 6111D	37059	30MHz~1GHz	Dec. 29, 2015	Jan. 29, 2016 ~ Jan. 31, 2016	Dec. 28, 2016	Radiation (03CH12-HY)
EMI Test Receiver	Rohde & Schwarz	ESU26	100390	20Hz~26.5GHz	Dec. 21, 2015	Jan. 29, 2016 ~ Jan. 31, 2016	Dec. 20, 2016	Radiation (03CH12-HY)
Horn Antenna	SCHWARZBECK	BBHA 9120D	9120D-1328	1GHz ~ 18GHz	Nov. 02, 2015	Jan. 29, 2016 ~ Jan. 31, 2016	Nov. 01, 2016	Radiation (03CH12-HY)
Horn Antenna	SCHWARZBECK	BBHA 9170	BBHA9170584	18GHz- 40GHz	Nov. 02, 2015	Jan. 29, 2016 ~ Jan. 31, 2016	Nov. 01, 2016	Radiation (03CH12-HY)
Preamplifier	COM-POWER	PA-103A	161075	10MHz~1GHz	Apr. 09, 2015	Jan. 29, 2016 ~ Jan. 31, 2016	Apr. 08, 2016	Radiation (03CH12-HY)
Preamplifier	MITEQ	AMF-7D-0010 1800-30-10P	1815698	1GHz~18GHz	Dec. 14, 2015	Jan. 29, 2016 ~ Jan. 31, 2016	Dec. 13, 2016	Radiation (03CH12-HY)
Preamplifier	Agilent	8449B	3008A02375	1GHz~26.5GHz	Jan. 05, 2016	Jan. 29, 2016 ~ Jan. 31, 2016	Jan. 04, 2017	Radiation (03CH12-HY)
Antenna Mast	EMEC	AM-BS-4500-B	N/A	1m~4m	N/A	Jan. 29, 2016 ~ Jan. 31, 2016	N/A	Radiation (03CH12-HY)
Turn Table	EMEC	TT2000	N/A	0-360 degree	N/A	Jan. 29, 2016 ~ Jan. 31, 2016	N/A	Radiation (03CH12-HY)
Preamplifier	MITEQ	JS44-180040 00-33-8P	1840917	18GHz ~ 40GHz	Jun. 02, 2015	Jan. 29, 2016 ~ Jan. 31, 2016	Jun. 01, 2016	Radiation (03CH12-HY)
AC Power Source	ChainTek	APC-1000W	N/A	N/A	N/A	Feb. 03, 2016	N/A	Conduction (CO05-HY)
EMI Test Receiver	Rohde & Schwarz	ESCI 7	100724	9kHz~7GHz	Aug. 26, 2015	Feb. 03, 2016	Aug. 25, 2016	Conduction (CO05-HY)
LISN	Rohde & Schwarz	ENV216	100080	9kHz~30MHz	Dec. 02, 2015	Feb. 03, 2016	Dec. 01, 2016	Conduction (CO05-HY)
Pulse Limiter	Rohde & Schwarz	ESH3-Z2	100851	N/A	Jan. 08, 2016	Feb. 03, 2016	Jan. 07, 2017	Conduction (CO05-HY)



## 5 Uncertainty of Evaluation

### Uncertainty of Conducted Emission Measurement (150kHz ~ 30MHz)

Measuring Uncertainty for a Level of Confidence of 95% ( $U = 2Uc(y)$ )	2.26
---	------

### Uncertainty of Radiated Emission Measurement (30 MHz ~ 1000 MHz)

Measuring Uncertainty for a Level of Confidence of 95% ( $U = 2Uc(y)$ )	5.10
---	------



## **Appendix A. Conducted Test Results**

Test Engineer:	Osolemio Chang and Luffy Lin	Temperature:	21~25	°C
Test Date:	2016/01/23 ~ 2016/02/03	Relative Humidity:	58~61	%

**TEST RESULTS DATA**  
**Peak Output Power**

2.4GHz Band																
Mod.	Data Rate	NTX	CH.	Freq. (MHz)	Peak Conducted Power (dBm)			Conducted Power Limit (dBm)		DG (dBi)		EIRP Power (dBm)		EIRP Power Limit (dBm)		Pass /Fail
					Ant 1	Ant 2	SUM	Ant 1	Ant 2	Ant 1	Ant 2	Ant 1	Ant 2	Ant 1	Ant 2	
11b	1Mbps	2	1	2412	26.67	25.92	29.32	30.00	30.00	3.52	3.52	32.84	36.00	36.00	Pass	
11b	1Mbps	2	6	2437	26.21	25.78	29.01	30.00	30.00	3.52	3.52	32.53	36.00	36.00	Pass	
11b	1Mbps	2	11	2462	26.07	25.82	28.96	30.00	30.00	3.52	3.52	32.48	36.00	36.00	Pass	
11g	6Mbps	2	1	2412	26.79	26.72	29.77	30.00	30.00	3.52	3.52	33.29	36.00	36.00	Pass	
11g	6Mbps	2	6	2437	26.62	26.43	29.54	30.00	30.00	3.52	3.52	33.06	36.00	36.00	Pass	
11g	6Mbps	2	11	2462	26.39	26.47	29.44	30.00	30.00	3.52	3.52	32.96	36.00	36.00	Pass	
HT20	MCS0	2	1	2412	25.83	25.57	28.71	30.00	30.00	3.52	3.52	32.23	36.00	36.00	Pass	
HT20	MCS0	2	6	2437	26.90	26.74	29.83	30.00	30.00	3.52	3.52	33.35	36.00	36.00	Pass	
HT20	MCS0	2	11	2462	26.38	26.26	29.33	30.00	30.00	3.52	3.52	32.85	36.00	36.00	Pass	
HT40	MCS0	2	3	2422	23.46	24.22	26.87	30.00	30.00	3.52	3.52	30.39	36.00	36.00	Pass	
HT40	MCS0	2	6	2437	25.85	25.72	28.80	30.00	30.00	3.52	3.52	32.32	36.00	36.00	Pass	
HT40	MCS0	2	9	2452	24.81	25.33	28.09	30.00	30.00	3.52	3.52	31.61	36.00	36.00	Pass	

Note: Measured power (dBm) has offset with cable loss.

**TEST RESULTS DATA**  
**6dB and 99% Occupied Bandwidth**

2.4GHz Band										
Mod.	Data Rate	N <sub>TX</sub>	CH.	Freq. (MHz)	99% Occupied BW (MHz)		6dB BW (MHz)		6dB BW Limit (MHz)	Pass/Fail
					Ant 1	Ant 2	Ant 1	Ant 2		
11b	1Mbps	2	1	2412	12.00	12.05	7.08	7.08	0.50	Pass
11b	1Mbps	2	6	2437	11.95	11.90	7.08	7.08	0.50	Pass
11b	1Mbps	2	11	2462	11.80	11.80	7.08	7.08	0.50	Pass
11g	6Mbps	2	1	2412	18.20	18.80	16.44	16.36	0.50	Pass
11g	6Mbps	2	6	2437	18.25	18.50	16.40	16.36	0.50	Pass
11g	6Mbps	2	11	2462	18.00	18.45	16.34	16.32	0.50	Pass
HT20	MCS0	2	1	2412	19.05	19.25	17.56	17.56	0.50	Pass
HT20	MCS0	2	6	2437	19.55	19.65	17.64	17.64	0.50	Pass
HT20	MCS0	2	11	2462	19.15	19.35	17.56	17.58	0.50	Pass
HT40	MCS0	2	3	2422	37.00	37.00	36.28	36.32	0.50	Pass
HT40	MCS0	2	6	2437	37.20	37.20	36.32	36.32	0.50	Pass
HT40	MCS0	2	9	2452	37.20	37.10	36.32	36.16	0.50	Pass

**TEST RESULTS DATA**  
**Average Output Power**

2.4GHz Band									
Mod.	Data Rate	N <sub>TX</sub>	CH.	Freq. (MHz)	Duty Factor (dB)		Average Conducted Power (dBm)		
					Ant 1	Ant 2	Ant 1	Ant 2	SUM
11b	1Mbps	2	1	2412	0.00	0.00	23.37	23.08	26.24
11b	1Mbps	2	6	2437	0.00	0.00	23.15	22.83	26.00
11b	1Mbps	2	11	2462	0.00	0.00	23.08	22.81	25.96
11g	6Mbps	2	1	2412	0.14	0.14	17.40	17.21	20.31
11g	6Mbps	2	6	2437	0.14	0.14	17.33	16.83	20.09
11g	6Mbps	2	11	2462	0.14	0.14	16.52	16.47	19.50
HT20	MCS0	2	1	2412	0.14	0.15	15.66	15.60	18.64
HT20	MCS0	2	6	2437	0.14	0.15	17.68	17.38	20.54
HT20	MCS0	2	11	2462	0.14	0.15	16.37	16.04	19.22
HT40	MCS0	2	3	2422	0.18	0.23	12.69	13.45	16.10
HT40	MCS0	2	6	2437	0.18	0.23	16.13	15.94	19.05
HT40	MCS0	2	9	2452	0.18	0.23	14.54	15.15	17.87

Note: Measured power (dBm) has offset with cable loss.

**TEST RESULTS DATA**  
**Peak Power Spectral Density**

2.4GHz Band												
Mod.	Data Rate	N <sub>TX</sub>	CH.	Freq. (MHz)	Peak PSD (dBm/3kHz)			DG (dBi)		Peak PSD Limit (dBm/3kHz)		Pass/Fail
					Ant 1	Ant 2	Worse + 3.01	Ant 1	Ant 2	Ant 1	Ant 2	
11b	1Mbps	2	1	2412	1.29	1.32	4.33	6.35		7.65		Pass
11b	1Mbps	2	6	2437	1.13	1.48	4.49	6.35		7.65		Pass
11b	1Mbps	2	11	2462	0.69	1.44	4.45	6.35		7.65		Pass
11g	6Mbps	2	1	2412	-8.70	-7.41	-4.40	6.35		7.65		Pass
11g	6Mbps	2	6	2437	-8.16	-8.06	-5.05	6.35		7.65		Pass
11g	6Mbps	2	11	2462	-7.95	-8.06	-4.94	6.35		7.65		Pass
HT20	MCS0	2	1	2412	-9.52	-9.92	-6.51	6.35		7.65		Pass
HT20	MCS0	2	6	2437	-8.56	-9.31	-5.55	6.35		7.65		Pass
HT20	MCS0	2	11	2462	-9.09	-9.22	-6.08	6.35		7.65		Pass
HT40	MCS0	2	3	2422	-16.09	-14.53	-11.52	6.35		7.65		Pass
HT40	MCS0	2	6	2437	-9.30	-12.72	-6.29	6.35		7.65		Pass
HT40	MCS0	2	9	2452	-13.77	-12.37	-9.36	6.35		7.65		Pass

Measured power density (dBm) has offset with cable loss.





## Appendix B. Radiated Spurious Emission

Test Engineer :	J.C. Liang, Ricky Su, and Nick Yu	Temperature :	23~25°C
		Relative Humidity :	55~60%

2.4GHz 2400~2483.5MHz

WIFI 802.11b (Band Edge @ 3m)

WIFI Ant.	Note	Frequency	Level	Over Limit	Limit Line	Read Level	Antenna Factor	Cable Loss	Preamp Factor	Ant Pos	Table Pos	Peak Avg.	Pol.	
1+2		( MHz )	( dBμV/m )	( dB )	( dBμV/m )	( dBμV )	( dB/m )	( dB )	( dB )	( cm )	( deg )	( P/A )	( H/V )	
802.11b CH 01 2412MHz		2332.05	64.15	-9.85	74	63.89	26.89	7.3	33.93	157	134	P	H	
		2388.21	52.52	-1.48	54	52.02	27.05	7.45	34	157	134	A	H	
	*	2412	121.36	-	-	120.83	27.09	7.45	34.01	157	134	P	H	
	*	2412	116.41	-	-	115.88	27.09	7.45	34.01	157	134	A	H	
													H	
														H
			2331.69	61.91	-12.09	74	61.65	26.89	7.3	33.93	127	225	P	V
			2388.12	50.39	-3.61	54	49.89	27.05	7.45	34	127	225	A	V
	*		2412	117.25	-	-	116.72	27.09	7.45	34.01	127	225	P	V
	*		2412	112.97	-	-	112.44	27.09	7.45	34.01	127	225	A	V
														V
														V
802.11b CH 06 2437MHz		2356.62	61.02	-12.98	74	60.64	26.97	7.37	33.96	315	150	P	H	
		2317.83	46.41	-7.59	54	46.15	26.89	7.3	33.93	315	150	A	H	
	*	2437	119.31	-	-	118.69	27.18	7.49	34.05	315	150	P	H	
	*	2437	114.61	-	-	113.99	27.18	7.49	34.05	315	150	A	H	
			2492.36	56.6	-17.4	74	55.87	27.3	7.53	34.1	315	150	P	H
			2483.56	44.83	-9.17	54	44.12	27.26	7.53	34.08	315	150	A	H
			2357.34	61.37	-12.63	74	60.99	26.97	7.37	33.96	103	205	P	V
			2359.95	45.97	-8.03	54	45.59	26.97	7.37	33.96	103	205	A	V
	*		2437	116.69	-	-	116.07	27.18	7.49	34.05	103	205	P	V
	*		2437	112.54	-	-	111.92	27.18	7.49	34.05	103	205	A	V
			2493.4	57.43	-16.57	74	56.7	27.3	7.53	34.1	103	205	P	V
			2499.96	45.18	-8.82	54	44.45	27.3	7.53	34.1	103	205	A	V



<b>802.11b</b> <b>CH 11</b> <b>2462MHz</b>	*	2462	118.43	-	-	117.75	27.22	7.53	34.07	273	153	P	H
	*	2462	114.18	-	-	113.5	27.22	7.53	34.07	273	153	A	H
		2483.68	60.83	-13.17	74	60.12	27.26	7.53	34.08	273	153	P	H
		2483.52	52	-2	54	51.29	27.26	7.53	34.08	273	153	A	H
													H
													H
	*	2462	116.6	-	-	115.92	27.22	7.53	34.07	100	193	P	V
	*	2462	112.56	-	-	111.88	27.22	7.53	34.07	100	193	A	V
		2483.6	59.98	-14.02	74	59.27	27.26	7.53	34.08	100	193	P	V
		2483.52	51.56	-2.44	54	50.85	27.26	7.53	34.08	100	193	A	V
													V
													V
<b>Remark</b>	1. No other spurious found. 2. All results are PASS against Peak and Average limit line.												



2.4GHz 2400~2483.5MHz

WIFI 802.11b (Harmonic @ 3m)

WIFI Ant. 1+2	Note	Frequency ( MHz )	Level ( dBμV/m )	Over Limit ( dB )	Limit Line ( dBμV/m )	Read Level ( dBμV )	Antenna Factor ( dB/m )	Cable Loss ( dB )	Preamp Factor ( dB )	Ant Pos ( cm )	Table Pos ( deg )	Peak Avg. ( P/A )	Pol. ( H/V )
802.11b CH 01 2412MHz		4824	46.44	-27.56	74	62.58	31.26	10.74	58.14	100	0	P	H
		12060	55.4	-18.6	74	55.29	38.92	19.02	57.83	100	217	P	H
		12060	45.96	-8.04	54	45.85	38.92	19.02	57.83	100	217	A	H
													H
		4824	47.25	-26.75	74	63.39	31.26	10.74	58.14	100	0	P	V
		12060	58.44	-15.56	74	58.33	38.92	19.02	57.83	100	158	P	V
		12060	51.02	-2.98	54	50.91	38.92	19.02	57.83	100	158	A	V
802.11b CH 06 2437MHz		4874	46.15	-27.85	74	62.03	31.33	10.89	58.1	100	0	P	H
		7311	51.92	-22.08	74	60.76	36.07	14.18	59.09	311	238	P	H
		7311	45.32	-8.68	54	54.16	36.07	14.18	59.09	311	238	A	H
		12186	53.55	-20.45	74	53.52	38.77	19.14	57.88	167	250	P	H
		4874	47.89	-26.11	74	63.77	31.33	10.89	58.1	100	0	P	V
		7311	48.13	-25.87	74	56.97	36.07	14.18	59.09	100	0	P	V
		12186	55.53	-18.47	74	55.5	38.77	19.14	57.88	184	163	P	V
		12186	46.46	-7.54	54	46.43	38.77	19.14	57.88	184	163	A	V
802.11b CH 11 2462MHz		4926	50.45	-23.55	74	66.07	31.4	11.04	58.06	100	0	P	H
		7386	52.28	-21.72	74	60.84	36.31	14.27	59.14	292	238	P	H
		7386	43.93	-10.07	54	52.49	36.31	14.27	59.14	292	238	A	H
		12312	50.55	-23.45	74	50.61	38.63	19.23	57.92	100	0	P	H
		4926	50.29	-23.71	74	65.91	31.4	11.04	58.06	100	0	P	V
		7386	48.13	-25.87	74	56.69	36.31	14.27	59.14	100	0	P	V
		12312	55.43	-18.57	74	55.49	38.63	19.23	57.92	237	183	P	V
		12312	46.83	-7.17	54	46.89	38.63	19.23	57.92	237	183	A	V
Remark	1. No other spurious found. 2. All results are PASS against Peak and Average limit line.												



2.4GHz 2400~2483.5MHz

WIFI 802.11g (Band Edge @ 3m)

WIFI Ant. 1+2	Note	Frequency ( MHz )	Level ( dBμV/m )	Over Limit ( dB )	Limit Line ( dBμV/m )	Read Level ( dBμV )	Antenna Factor ( dB/m )	Cable Loss ( dB )	Preamp Factor ( dB )	Ant Pos ( cm )	Table Pos ( deg )	Peak Avg. ( P/A )	Pol. ( H/V )	
802.11g CH 01 2412MHz		2387.49	70.96	-3.04	74	70.46	27.05	7.45	34	158	136	P	H	
		2387.94	53.86	-0.14	54	53.36	27.05	7.45	34	158	136	A	H	
	*	2412	114.68	-	-	114.15	27.09	7.45	34.01	158	136	P	H	
	*	2412	104.33	-	-	103.8	27.09	7.45	34.01	158	136	A	H	
													H	
														H
			2388.48	71.12	-2.88	74	70.62	27.05	7.45	34	100	205	P	V
			2388.21	53.62	-0.38	54	53.12	27.05	7.45	34	100	205	A	V
	*		2412	112	-	-	111.47	27.09	7.45	34.01	100	205	P	V
	*		2412	102.3	-	-	101.77	27.09	7.45	34.01	100	205	A	V
														V
														V
802.11g CH 06 2437MHz		2362.02	61.71	-12.29	74	61.33	26.97	7.37	33.96	174	137	P	H	
		2363.19	46.87	-7.13	54	46.49	26.97	7.37	33.96	174	137	A	H	
	*	2437	113.9	-	-	113.28	27.18	7.49	34.05	174	137	P	H	
	*	2437	103.92	-	-	103.3	27.18	7.49	34.05	174	137	A	H	
			2484.88	58.19	-15.81	74	57.48	27.26	7.53	34.08	174	137	P	H
			2483.52	46.93	-7.07	54	46.22	27.26	7.53	34.08	174	137	A	H
			2361.03	60.11	-13.89	74	59.73	26.97	7.37	33.96	105	209	P	V
			2390	46.34	-7.66	54	45.84	27.05	7.45	34	105	209	A	V
	*		2437	112.44	-	-	111.82	27.18	7.49	34.05	105	209	P	V
	*		2437	102.6	-	-	101.98	27.18	7.49	34.05	105	209	A	V
			2487.4	56.99	-17.01	74	56.28	27.26	7.53	34.08	105	209	P	V
			2484.28	45.35	-8.65	54	44.64	27.26	7.53	34.08	105	209	A	V



<b>802.11g CH 11 2462MHz</b>	*	2462	113.25	-	-	112.57	27.22	7.53	34.07	167	136	P	H
	*	2462	103.23	-	-	102.55	27.22	7.53	34.07	167	136	A	H
		2483.6	70.66	-3.34	74	69.95	27.26	7.53	34.08	167	136	P	H
		2484	52.72	-1.28	54	52.01	27.26	7.53	34.08	167	136	A	H
													H
													H
	*	2462	111.08	-	-	110.4	27.22	7.53	34.07	383	212	P	V
	*	2462	101.29	-	-	100.61	27.22	7.53	34.07	383	212	A	V
		2486.04	67.53	-6.47	74	66.82	27.26	7.53	34.08	383	212	P	V
		2485.12	49.93	-4.07	54	49.22	27.26	7.53	34.08	383	212	A	V
													V
													V
<b>Remark</b>	1. No other spurious found. 2. All results are PASS against Peak and Average limit line.												



2.4GHz 2400~2483.5MHz

WIFI 802.11g (Harmonic @ 3m)

WIFI Ant. 1+2	Note	Frequency ( MHz )	Level ( dBμV/m )	Over Limit ( dB )	Limit Line ( dBμV/m )	Read Level ( dBμV )	Antenna Factor ( dB/m )	Cable Loss ( dB )	Preamp Factor ( dB )	Ant Pos ( cm )	Table Pos ( deg )	Peak Avg. ( P/A )	Pol. ( H/V )	
802.11g CH 01 2412MHz		4824	39.51	-34.49	74	55.65	31.26	10.74	58.14	100	0	P	H	
													H	
													H	
													H	
			4824	39.17	-34.83	74	55.31	31.26	10.74	58.14	100	0	P	V
														V
														V
802.11g CH 06 2437MHz		4872	39.96	-34.04	74	55.84	31.33	10.89	58.1	100	0	P	H	
		7308	45.49	-28.51	74	54.33	36.07	14.18	59.09	100	0	P	H	
													H	
													H	
			4872	39.83	-34.17	74	55.71	31.33	10.89	58.1	100	0	P	V
			7308	43.48	-30.52	74	52.32	36.07	14.18	59.09	100	0	P	V
														V
802.11g CH 11 2462MHz		4926	40.13	-33.87	74	55.75	31.4	11.04	58.06	100	0	P	H	
		7386	44	-30	74	52.56	36.31	14.27	59.14	100	0	P	H	
													H	
													H	
			4926	40.54	-33.46	74	56.16	31.4	11.04	58.06	100	0	P	V
			7386	43.96	-30.04	74	52.52	36.31	14.27	59.14	100	0	P	V
														V
Remark	1. No other spurious found.													
	2. All results are PASS against Peak and Average limit line.													



2.4GHz 2400~2483.5MHz

WIFI 802.11n HT20 (Band Edge @ 3m)

WIFI Ant. 1+2	Note	Frequency ( MHz )	Level ( dBμV/m )	Over Limit ( dB )	Limit Line ( dBμV/m )	Read Level ( dBμV )	Antenna Factor ( dB/m )	Cable Loss ( dB )	Preamp Factor ( dB )	Ant Pos ( cm )	Table Pos ( deg )	Peak Avg. ( P/A )	Pol. ( H/V )	
802.11n HT20 CH 01 2412MHz		2389.38	67.07	-6.93	74	66.57	27.05	7.45	34	357	157	P	H	
		2390	53.32	-0.68	54	52.82	27.05	7.45	34	357	157	A	H	
	*	2412	112.47	-	-	111.94	27.09	7.45	34.01	357	157	P	H	
	*	2412	102.35	-	-	101.82	27.09	7.45	34.01	357	157	A	H	
													H	
														H
			2389.65	65.43	-8.57	74	64.93	27.05	7.45	34	100	210	P	V
			2389.92	51.72	-2.28	54	51.22	27.05	7.45	34	100	210	A	V
		*	2412	110.92	-	-	110.39	27.09	7.45	34.01	100	210	P	V
		*	2412	100.84	-	-	100.31	27.09	7.45	34.01	100	210	A	V
													V	
													V	
802.11n HT20 CH 06 2437MHz		2349.69	59.14	-14.86	74	58.78	26.93	7.37	33.94	312	136	P	H	
		2359.95	46.79	-7.21	54	46.41	26.97	7.37	33.96	312	136	A	H	
	*	2437	113.87	-	-	113.25	27.18	7.49	34.05	312	136	P	H	
	*	2437	104.01	-	-	103.39	27.18	7.49	34.05	312	136	A	H	
			2485.36	58.38	-15.62	74	57.67	27.26	7.53	34.08	312	136	P	H
			2484.28	47.02	-6.98	54	46.31	27.26	7.53	34.08	312	136	A	H
			2353.47	58.62	-15.38	74	58.24	26.97	7.37	33.96	108	209	P	V
			2389.47	47.42	-6.58	54	46.92	27.05	7.45	34	108	209	A	V
		*	2437	113.52	-	-	112.9	27.18	7.49	34.05	108	209	P	V
		*	2437	102.78	-	-	102.16	27.18	7.49	34.05	108	209	A	V
		2488.44	57.64	-16.36	74	56.91	27.3	7.53	34.1	108	209	P	V	
		2499.84	46.01	-7.99	54	45.28	27.3	7.53	34.1	108	209	A	V	



<b>802.11n</b> <b>HT20</b> <b>CH 11</b> <b>2462MHz</b>	*	2462	112.4	-	-	111.72	27.22	7.53	34.07	270	124	P	H
	*	2462	102.45	-	-	101.77	27.22	7.53	34.07	270	124	A	H
		2485.4	69.7	-4.3	74	68.99	27.26	7.53	34.08	270	124	P	H
		2483.52	53.07	-0.93	54	52.36	27.26	7.53	34.08	270	124	A	H
													H
													H
	*	2462	110.63	-	-	109.95	27.22	7.53	34.07	100	206	P	V
	*	2462	100.71	-	-	100.03	27.22	7.53	34.07	100	206	A	V
		2483.84	63.34	-10.66	74	62.63	27.26	7.53	34.08	100	206	P	V
		2483.56	49.49	-4.51	54	48.78	27.26	7.53	34.08	100	206	A	V
													V
												V	
<b>Remark</b>	1. No other spurious found. 2. All results are PASS against Peak and Average limit line.												





2.4GHz 2400~2483.5MHz

WIFI 802.11n HT20 (Harmonic @ 3m)

WIFI Ant. 1+2	Note	Frequency ( MHz )	Level ( dBμV/m )	Over Limit ( dB )	Limit Line ( dBμV/m )	Read Level ( dBμV )	Antenna Factor ( dB/m )	Cable Loss ( dB )	Preamp Factor ( dB )	Ant Pos ( cm )	Table Pos ( deg )	Peak Avg. ( P/A )	Pol. ( H/V )	
802.11n HT20 CH 01 2412MHz		4824	38.06	-35.94	74	54.2	31.26	10.74	58.14	100	0	P	H	
													H	
													H	
													H	
			4824	37.89	-36.11	74	54.03	31.26	10.74	58.14	100	0	P	V
														V
														V
802.11n HT20 CH 06 2437MHz		4872	39.62	-34.38	74	55.5	31.33	10.89	58.1	100	0	P	H	
		7308	44.49	-29.51	74	53.33	36.07	14.18	59.09	100	0	P	H	
													H	
													H	
			4872	38.68	-35.32	74	54.56	31.33	10.89	58.1	100	0	P	V
			7308	43.1	-30.9	74	51.94	36.07	14.18	59.09	100	0	P	V
														V
802.11n HT20 CH 11 2462MHz		4926	39.1	-34.9	74	54.72	31.4	11.04	58.06	100	0	P	H	
		7386	43.93	-30.07	74	52.49	36.31	14.27	59.14	100	0	P	H	
													H	
													H	
			4926	39.46	-34.54	74	55.08	31.4	11.04	58.06	100	0	P	V
			7386	43.51	-30.49	74	52.07	36.31	14.27	59.14	100	0	P	V
														V
Remark	1. No other spurious found.													
	2. All results are PASS against Peak and Average limit line.													



2.4GHz 2400~2483.5MHz

WIFI 802.11n HT40 (Band Edge @ 3m)

WIFI Ant. 1+2	Note	Frequency ( MHz )	Level ( dBμV/m )	Over Limit ( dB )	Limit Line ( dBμV/m )	Read Level ( dBμV )	Antenna Factor ( dB/m )	Cable Loss ( dB )	Preamp Factor ( dB )	Ant Pos ( cm )	Table Pos ( deg )	Peak Avg. ( P/A )	Pol. ( H/V )
802.11n HT40 CH 03 2422MHz		2383.08	66.61	-7.39	74	66.13	27.01	7.45	33.98	181	137	P	H
		2388.3	52.58	-1.42	54	52.08	27.05	7.45	34	181	137	A	H
	*	2422	105.9	-	-	105.31	27.13	7.49	34.03	181	137	P	H
	*	2422	96.66	-	-	96.07	27.13	7.49	34.03	181	137	A	H
		2485.36	58.51	-15.49	74	57.8	27.26	7.53	34.08	181	137	P	H
		2492.96	46.37	-7.63	54	45.64	27.3	7.53	34.1	181	137	A	H
		2389.65	69.1	-4.9	74	68.6	27.05	7.45	34	100	211	P	V
		2389.47	52.88	-1.12	54	52.38	27.05	7.45	34	100	211	A	V
	*	2422	104.63	-	-	104.04	27.13	7.49	34.03	100	211	P	V
	*	2422	95.34	-	-	94.75	27.13	7.49	34.03	100	211	A	V
		2486.28	56.8	-17.2	74	56.09	27.26	7.53	34.08	100	211	P	V
		2486.84	45.96	-8.04	54	45.25	27.26	7.53	34.08	100	211	A	V
802.11n HT40 CH 06 2437MHz		2389.92	65.75	-8.25	74	65.25	27.05	7.45	34	319	154	P	H
		2389.65	53.16	-0.84	54	52.66	27.05	7.45	34	319	154	A	H
	*	2437	109.83	-	-	109.21	27.18	7.49	34.05	319	154	P	H
	*	2437	100.23	-	-	99.61	27.18	7.49	34.05	319	154	A	H
		2486.8	63.22	-10.78	74	62.51	27.26	7.53	34.08	319	154	P	H
		2486.08	49	-5	54	48.29	27.26	7.53	34.08	319	154	A	H
		2389.56	64.92	-9.08	74	64.42	27.05	7.45	34	103	206	P	V
		2389.92	52.7	-1.3	54	52.2	27.05	7.45	34	103	206	A	V
	*	2437	107.9	-	-	107.28	27.18	7.49	34.05	103	206	P	V
	*	2437	98.29	-	-	97.67	27.18	7.49	34.05	103	206	A	V
	2486.44	61.93	-12.07	74	61.22	27.26	7.53	34.08	103	206	P	V	
	2490.16	47.95	-6.05	54	47.22	27.3	7.53	34.1	103	206	A	V	



<b>802.11n</b>  <b>HT40</b>  <b>CH 09</b>  <b>2452MHz</b>		2359.77	57.52	-16.48	74	57.14	26.97	7.37	33.96	385	129	P	H
		2359.77	47.7	-6.3	54	47.32	26.97	7.37	33.96	385	129	A	H
	*	2452	108.19	-	-	107.57	27.18	7.49	34.05	385	129	P	H
	*	2452	98.56	-	-	97.94	27.18	7.49	34.05	385	129	A	H
		2483.52	65.69	-8.31	74	64.98	27.26	7.53	34.08	385	129	P	H
		2483.6	53.52	-0.48	54	52.81	27.26	7.53	34.08	385	129	A	H
		2367.42	58.93	-15.07	74	58.55	26.97	7.37	33.96	117	203	P	V
		2360.04	47.88	-6.12	54	47.5	26.97	7.37	33.96	117	203	A	V
	*	2452	106.2	-	-	105.58	27.18	7.49	34.05	117	203	P	V
	*	2452	96.72	-	-	96.1	27.18	7.49	34.05	117	203	A	V
		2483.88	64.94	-9.06	74	64.23	27.26	7.53	34.08	117	203	P	V
		2483.52	53.1	-0.9	54	52.39	27.26	7.53	34.08	117	203	A	V
<b>Remark</b>	1. No other spurious found. 2. All results are PASS against Peak and Average limit line.												



2.4GHz 2400~2483.5MHz

WIFI 802.11n HT40 (Harmonic @ 3m)

WIFI Ant. 1+2	Note	Frequency ( MHz )	Level ( dBμV/m )	Over Limit ( dB )	Limit Line ( dBμV/m )	Read Level ( dBμV )	Antenna Factor ( dB/m )	Cable Loss ( dB )	Preamp Factor ( dB )	Ant Pos ( cm )	Table Pos ( deg )	Peak Avg. ( P/A )	Pol. ( H/V )
802.11n HT40 CH 03 2422MHz		4842	37.45	-36.55	74	53.55	31.28	10.74	58.12	100	0	P	H
		7266	43.08	-30.92	74	52.04	35.97	14.14	59.07	100	0	P	H
													H
													H
		4842	37.49	-36.51	74	53.59	31.28	10.74	58.12	100	0	P	V
		7266	43.52	-30.48	74	52.48	35.97	14.14	59.07	100	0	P	V
802.11n HT40 CH 06 2437MHz		4872	37.96	-36.04	74	53.84	31.33	10.89	58.1	100	0	P	H
		7308	43.51	-30.49	74	52.35	36.07	14.18	59.09	100	0	P	H
													H
													H
		4872	38.02	-35.98	74	53.9	31.33	10.89	58.1	100	0	P	V
		7308	43.17	-30.83	74	52.01	36.07	14.18	59.09	100	0	P	V
802.11n HT40 CH 09 2452MHz		4902	38.18	-35.82	74	53.83	31.38	11.04	58.07	100	0	P	H
		7356	43.83	-30.17	74	52.52	36.21	14.22	59.12	100	0	P	H
													H
													H
		4902	37.97	-36.03	74	53.62	31.38	11.04	58.07	100	0	P	V
		7356	43.48	-30.52	74	52.17	36.21	14.22	59.12	100	0	P	V
Remark	1. No other spurious found.												
	2. All results are PASS against Peak and Average limit line.												



2.4GHz 2400~2483.5MHz

Emission below 1GHz

2.4GHz WIFI 802.11b Adapter mode (LF)

WIFI Ant.	Note	Frequency	Level	Over Limit	Limit Line	Read Level	Antenna Factor	Cable Loss	Preamp Factor	Ant Pos	Table Pos	Peak Avg.	Pol.	
1+2		( MHz )	( dBμV/m )	( dB )	( dBμV/m )	( dBμV )	( dB/m )	( dB )	( dB )	( cm )	( deg )	( P/A )	( H/V )	
2.4GHz 802.11b LF		95.61	38.12	-5.38	43.5	51.96	15.52	1.06	30.42			P	H	
		122.88	36.84	-6.66	43.5	48.07	17.72	1.43	30.38			P	H	
		179.85	39.59	-3.91	43.5	52.81	15.35	1.75	30.32	123	253	P	H	
		374.9	29.16	-16.84	46	35.17	21.61	2.44	30.06			P	H	
		489.7	33.59	-12.41	46	36.53	23.81	3.08	29.83			P	H	
		624.8	34.53	-11.47	46	34.85	25.69	3.61	29.62			P	H	
														H
														H
														H
														H
														H
														H
			42.68	36.16	-3.84	40	47.13	18.62	0.78	30.37	100	72	QP	V
			58.35	29.41	-10.59	40	46.67	12.42	0.78	30.46	100	255	QP	V
			151.23	39.05	-4.45	43.5	50.2	17.45	1.75	30.35			P	V
			314	36.45	-9.55	46	44.31	19.93	2.34	30.13			P	V
			442.8	39.45	-6.55	46	43.52	22.98	2.89	29.94			P	V
			624.8	34.12	-11.88	46	34.44	25.69	3.61	29.62			P	V
														V
														V
													V	
													V	
													V	
													V	
<b>Remark</b>	1. No other spurious found. 2. All results are PASS against limit line.													



Emission below 1GHz

2.4GHz WIFI 802.11b POE mode (LF)

WIFI	Note	Frequency	Level	Over	Limit	Read	Antenna	Cable	Preamp	Ant	Table	Peak	Pol.	
Ant.				Limit	Line	Level	Factor	Loss	Factor	Pos	Pos	Avg.		
1+2		( MHz )	( dBμV/m )	( dB )	( dBμV/m )	( dBμV )	( dB/m )	( dB )	( dB )	( cm )	( deg )	( P/A )	( H/V )	
2.4GHz 802.11b LF		63.21	33.32	-6.68	40	50.76	11.95	1.06	30.45	124	241	P	H	
		93.72	35.14	-8.36	43.5	49.22	15.28	1.06	30.42			P	H	
		197.13	30.79	-12.71	43.5	43.74	15.65	1.7	30.3			P	H	
		328.7	28.73	-17.27	46	36.14	20.37	2.34	30.12			P	H	
		504.4	32.84	-13.16	46	35.41	24.04	3.19	29.8			P	H	
		624.8	37.27	-8.73	46	37.59	25.69	3.61	29.62			P	H	
														H
														H
														H
														H
														H
														H
			38.32	35.44	-4.56	40	44.11	20.86	0.78	30.31	100	152	QP	V
			62.49	29.91	-10.09	40	47.4	11.9	1.06	30.45	100	28	QP	V
			194.7	38.05	-5.45	43.5	51.11	15.55	1.7	30.31			P	V
			447	29.5	-16.5	46	33.49	23.05	2.89	29.93			P	V
			624.8	33.61	-12.39	46	33.93	25.69	3.61	29.62			P	V
			855.1	30.55	-15.45	46	26.97	28.63	4.28	29.33			P	V
														V
														V
													V	
													V	
													V	
													V	
<b>Remark</b>	1. No other spurious found. 2. All results are PASS against limit line.													



**Note symbol**

*	<b>Fundamental Frequency</b> which can be ignored. However, the level of any unwanted emissions shall not exceed the level of the fundamental frequency.
!	Test result is <b>over limit</b> line.
P/A	<b>Peak</b> or <b>Average</b>
H/V	<b>Horizontal</b> or <b>Vertical</b>



A calculation example for radiated spurious emission is shown as below:

WIFI	Note	Frequency	Level	Over	Limit	Read	Antenna	Cable	Preamp	Ant	Table	Peak	Pol.
Ant.				Limit	Line	Level	Factor	Loss	Factor	Pos	Pos	Avg.	
1+2		( MHz )	( dBμV/m )	( dB )	( dBμV/m )	( dBμV )	( dB/m )	( dB )	( dB )	( cm )	( deg )	( P/A )	( H/V )
802.11b		2390	55.45	-18.55	74	54.51	32.22	4.58	35.86	103	308	P	H
CH 01													
2412MHz		2390	43.54	-10.46	54	42.6	32.22	4.58	35.86	103	308	A	H

- Level(dBμV/m) =  
Antenna Factor(dB/m) + Cable Loss(dB) + Read Level(dBμV) - Preamp Factor(dB)
- Over Limit(dB) = Level(dBμV/m) – Limit Line(dBμV/m)

**For Peak Limit @ 2390MHz:**

- Level(dBμV/m)  
= Antenna Factor(dB/m) + Cable Loss(dB) + Read Level(dBμV) - Preamp Factor(dB)  
= 32.22(dB/m) + 4.58(dB) + 54.51(dBμV) – 35.86 (dB)  
= 55.45 (dBμV/m)
- Over Limit(dB)  
= Level(dBμV/m) – Limit Line(dBμV/m)  
= 55.45(dBμV/m) – 74(dBμV/m)  
= -18.55(dB)

**For Average Limit @ 2390MHz:**

- Level(dBμV/m)  
= Antenna Factor(dB/m) + Cable Loss(dB) + Read Level(dBμV) - Preamp Factor(dB)  
= 32.22(dB/m) + 4.58(dB) + 42.6(dBμV) – 35.86 (dB)  
= 43.54 (dBμV/m)
- Over Limit(dB)  
= Level(dBμV/m) – Limit Line(dBμV/m)  
= 43.54(dBμV/m) – 54(dBμV/m)  
= -10.46(dB)

**Both peak and average measured complies with the limit line, so test result is “PASS”.**





## Appendix C. Radiated Spurious Emission Plots

Test Engineer :	J.C. Liang, Ricky Su, and Nick Yu	Temperature :	23~25°C
		Relative Humidity :	55~60%

### Note symbol

-L	Low channel location
-R	High channel location



2.4GHz 2400~2483.5MHz  
WIFI 802.11b (Band Edge @ 3m)

WIFI	2.4GHz 2400~2483.5MHz Band Edge @ 3m	
ANT	802.11b CH01 2412MHz	
1+2	Horizontal	Vertical
Peak	<p>Site : 03CH12-HY Condition : FCC CLASS-B 3m HORN_91200_1328 HORIZONTAL RBW:1000.000KHz VBW:3000.000KHz SWT:Auto Detector : Peak Project : 5D2212 Mode : 1</p>	<p>Site : 03CH12-HY Condition : FCC CLASS-B 3m HORN_91200_1328 VERTICAL RBW:1000.000KHz VBW:3000.000KHz SWT:Auto Detector : Peak Project : 5D2212 Mode : 1</p>
Avg.	<p>Site : 03CH12-HY Condition : FCC CLASS-B (AVG) 3m HORN_91200_1328 HORIZONTAL RBW:1000.000KHz VBW:0.010KHz SWT:Auto Detector : Peak Project : 5D2212 Mode : 1</p>	<p>Site : 03CH12-HY Condition : FCC CLASS-B (AVG) 3m HORN_91200_1328 VERTICAL RBW:1000.000KHz VBW:0.010KHz SWT:Auto Detector : Peak Project : 5D2212 Mode : 1</p>



WIFI	2.4GHz 2400~2483.5MHz Band Edge @ 3m	
ANT	802.11b CH06 2437MHz - L	
1+2	Horizontal	Vertical
Peak		
Avg.		



WIFI	2.4GHz 2400~2483.5MHz Band Edge @ 3m	
ANT	802.11b CH06 2437MHz - R	
1+2	Horizontal	Vertical
Peak	<p>Site : 03CH12-HY            Condition : FCC CLASS-B 3m HORN_91200_1328 HORIZONTAL            Detector : Peak            Project : 502212            Mode : 2</p>	<p>Site : 03CH12-HY            Condition : FCC CLASS-B 3m HORN_91200_1328 VERTICAL            Detector : Peak            Project : 502212            Mode : 2</p>
Avg.	<p>Site : 03CH12-HY            Condition : FCC CLASS-B (AVG) 3m HORN_91200_1328 HORIZONTAL            Detector : Peak            Project : 502212            Mode : 2</p>	<p>Site : 03CH12-HY            Condition : FCC CLASS-B (AVG) 3m HORN_91200_1328 VERTICAL            Detector : Peak            Project : 502212            Mode : 2</p>



WIFI	2.4GHz 2400~2483.5MHz Band Edge @ 3m	
ANT	802.11b CH11 2462MHz	
1+2	Horizontal	Vertical
Peak	<p>Date: 2016-01-30</p> <p>Site : 03CH12-HY            Condition : FCC CLASS-B 3m HORN_91200_1328 HORIZONTAL            RBW:1000.000KHz VBW:3000.000KHz SWT:Auto            Detector : Peak            Project : 5D2212            Mode : 3</p>	<p>Date: 2016-01-30</p> <p>Site : 03CH12-HY            Condition : FCC CLASS-B 3m HORN_91200_1328 VERTICAL            RBW:1000.000KHz VBW:3000.000KHz SWT:Auto            Detector : Peak            Project : 5D2212            Mode : 3</p>
Avg.	<p>Date: 2016-01-30</p> <p>Site : 03CH12-HY            Condition : FCC CLASS-B (AVG) 3m HORN_91200_1328 HORIZONTAL            RBW:1000.000KHz VBW:0.010KHz SWT:Auto            Detector : Peak            Project : 5D2212            Mode : 3</p>	<p>Date: 2016-01-30</p> <p>Site : 03CH12-HY            Condition : FCC CLASS-B (AVG) 3m HORN_91200_1328 VERTICAL            RBW:1000.000KHz VBW:0.010KHz SWT:Auto            Detector : Peak            Project : 5D2212            Mode : 3</p>

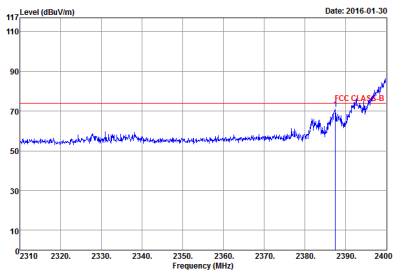
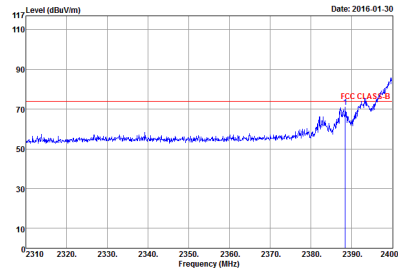
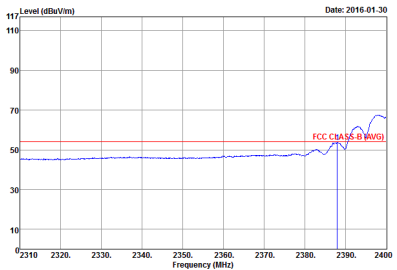
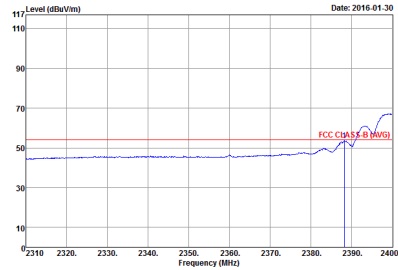

2.4GHz 2400~2483.5MHz  
WIFI 802.11g (Band Edge @ 3m)

WIFI	2.4GHz 2400~2483.5MHz Band Edge @ 3m	
ANT	802.11g CH01 2412MHz	
1+2	Horizontal	Vertical
Peak	 <p>Date: 2016-01-30</p> <p>Site : 03CH12-HY Condition : FCC CLASS-B 3m HORN_91200_1328 HORIZONTAL RBW:1000.000KHz VBW:3000.000KHz SWT:Auto Detector : Peak Project : 502212 Mode : 4</p>	 <p>Date: 2016-01-30</p> <p>Site : 03CH12-HY Condition : FCC CLASS-B 3m HORN_91200_1328 VERTICAL RBW:1000.000KHz VBW:3000.000KHz SWT:Auto Detector : Peak Project : 502212 Mode : 4</p>
Avg.	 <p>Date: 2016-01-30</p> <p>Site : 03CH12-HY Condition : FCC CLASS-B (AVG) 3m HORN_91200_1328 HORIZONTAL RBW:1000.000KHz VBW:1.000KHz SWT:Auto Detector : Peak Project : 502212 Mode : 4</p>	 <p>Date: 2016-01-30</p> <p>Site : 03CH12-HY Condition : FCC CLASS-B (AVG) 3m HORN_91200_1328 VERTICAL RBW:1000.000KHz VBW:1.000KHz SWT:Auto Detector : Peak Project : 502212 Mode : 4</p>

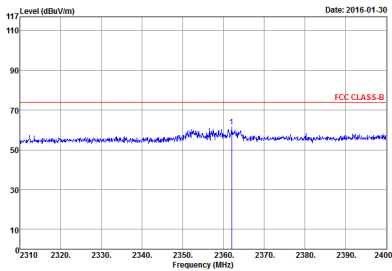
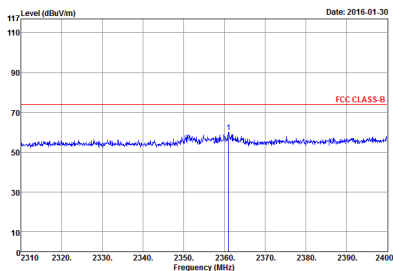
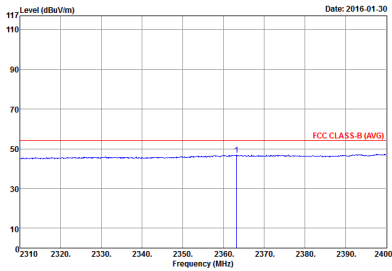
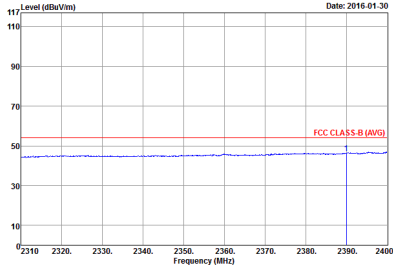

WIFI	2.4GHz 2400~2483.5MHz Band Edge @ 3m	
ANT	802.11g CH06 2437MHz - L	
1+2	Horizontal	Vertical
Peak	 <p>Site : 03CH12-HY            Condition : FCC CLASS-B 3m HORN_91200_1328 HORIZONTAL            RBW:1000.000KHz VBW:3000.000KHz SWT:Auto            Detector : Peak            Project : 5D2212            Mode : 5</p>	 <p>Site : 03CH12-HY            Condition : FCC CLASS-B 3m HORN_91200_1328 VERTICAL            RBW:1000.000KHz VBW:3000.000KHz SWT:Auto            Detector : Peak            Project : 5D2212            Mode : 5</p>
Avg.	 <p>Site : 03CH12-HY            Condition : FCC CLASS-B (AVG) 3m HORN_91200_1328 HORIZONTAL            RBW:1000.000KHz VBW:1.000KHz SWT:Auto            Detector : Peak            Project : 5D2212            Mode : 5</p>	 <p>Site : 03CH12-HY            Condition : FCC CLASS-B (AVG) 3m HORN_91200_1328 VERTICAL            RBW:1000.000KHz VBW:1.000KHz SWT:Auto            Detector : Peak            Project : 5D2212            Mode : 5</p>

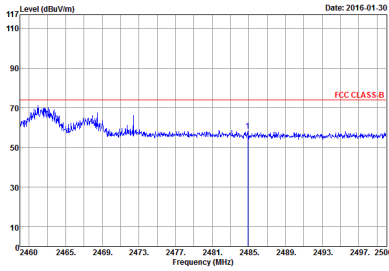
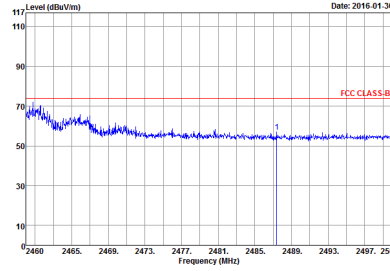
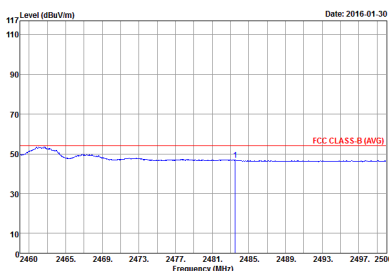
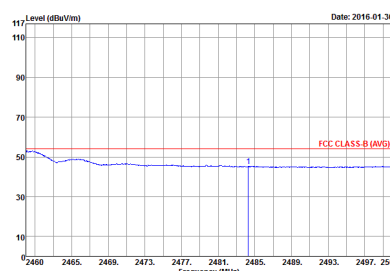

WIFI	2.4GHz 2400~2483.5MHz Band Edge @ 3m	
ANT	802.11g CH06 2437MHz - R	
1+2	Horizontal	Vertical
Peak	 <p>Date: 2016-01-30</p> <p>Site : 03CH12-HY Condition : FCC CLASS-B 3m HORN_91200_1328 HORIZONTAL Detector : Peak Project : SD2212 Mode : S</p>	 <p>Date: 2016-01-30</p> <p>Site : 03CH12-HY Condition : FCC CLASS-B 3m HORN_91200_1328 VERTICAL Detector : Peak Project : SD2212 Mode : S</p>
Avg.	 <p>Date: 2016-01-30</p> <p>Site : 03CH12-HY Condition : FCC CLASS-B (AVG) 3m HORN_91200_1328 HORIZONTAL Detector : Peak Project : SD2212 Mode : S</p>	 <p>Date: 2016-01-30</p> <p>Site : 03CH12-HY Condition : FCC CLASS-B (AVG) 3m HORN_91200_1328 VERTICAL Detector : Peak Project : SD2212 Mode : S</p>



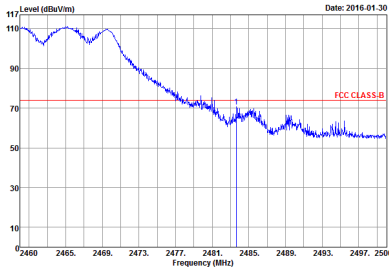
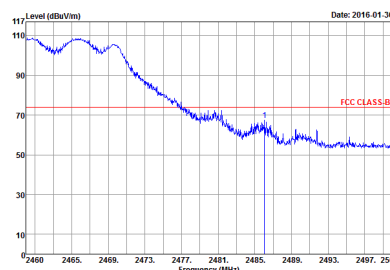
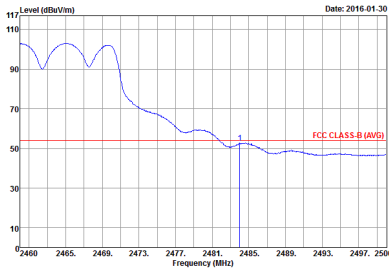
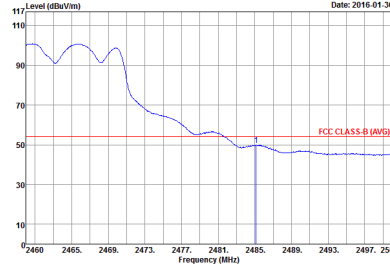

WIFI	2.4GHz 2400~2483.5MHz Band Edge @ 3m	
ANT	802.11g CH11 2462MHz	
1+2	Horizontal	Vertical
Peak	 <p>Site : 03CH12-HY  Condition : FCC CLASS-B 3m HORN_91200_1328 HORIZONTAL  RBW:1000.000KHz VBW:3000.000KHz SWT:Auto  Detector : Peak  Project : S02212  Mode : 6  Setting : 15</p>	 <p>Site : 03CH12-HY  Condition : FCC CLASS-B 3m HORN_91200_1328 VERTICAL  RBW:1000.000KHz VBW:3000.000KHz SWT:Auto  Detector : Peak  Project : S02212  Mode : 6  Setting : 15</p>
Avg.	 <p>Site : 03CH12-HY  Condition : FCC CLASS-B (AVG) 3m HORN_91200_1328 HORIZONTAL  RBW:1000.000KHz VBW:1.000KHz SWT:Auto  Detector : Peak  Project : S02212  Mode : 6  Setting : 15</p>	 <p>Site : 03CH12-HY  Condition : FCC CLASS-B (AVG) 3m HORN_91200_1328 VERTICAL  RBW:1000.000KHz VBW:1.000KHz SWT:Auto  Detector : Peak  Project : S02212  Mode : 6  Setting : 15</p>

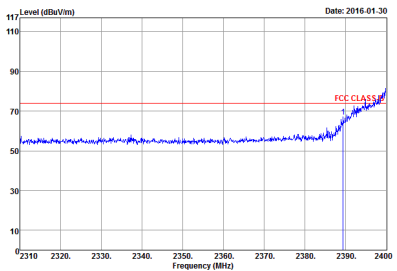
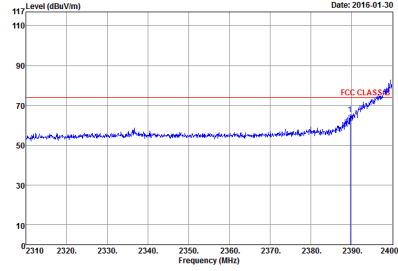
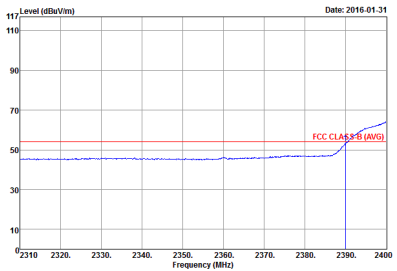
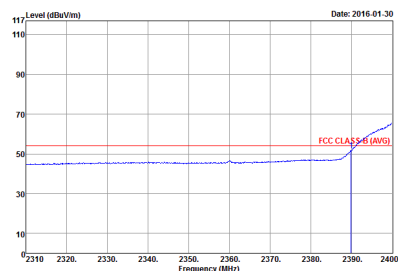

2.4GHz 2400~2483.5MHz  
WIFI 802.11n HT20 (Band Edge @ 3m)

WIFI	2.4GHz 2400~2483.5MHz Band Edge @ 3m	
ANT	802.11n HT20 CH01 2412MHz	
1+2	Horizontal	Vertical
Peak	 <p>Date: 2016-01-30</p> <p>Site : 03CH12-HY Condition : FCC CLASS-B 3m HORN_91200_1328 HORIZONTAL RBW:1000.000kHz VBW:3000.000kHz SWT:Auto Detector : Peak Project : 502212 Mode : 7 Setting : 14.5</p>	 <p>Date: 2016-01-30</p> <p>Site : 03CH12-HY Condition : FCC CLASS-B 3m HORN_91200_1328 VERTICAL RBW:1000.000kHz VBW:3000.000kHz SWT:Auto Detector : Peak Project : 502212 Mode : 7 Setting : 14.5</p>
Avg.	 <p>Date: 2016-01-31</p> <p>Site : 03CH12-HY Condition : FCC CLASS-B (AVG) 3m HORN_91200_1328 HORIZONTAL RBW:1000.000kHz VBW:1.000kHz SWT:Auto Detector : Peak Project : 502212 Mode : 7 Setting : 14.5</p>	 <p>Date: 2016-01-30</p> <p>Site : 03CH12-HY Condition : FCC CLASS-B (AVG) 3m HORN_91200_1328 VERTICAL RBW:1000.000kHz VBW:1.000kHz SWT:Auto Detector : Peak Project : 502212 Mode : 7 Setting : 14.5</p>



WIFI	2.4GHz 2400~2483.5MHz Band Edge @ 3m	
ANT	802.11n HT20 CH06 2437MHz - L	
1+2	Horizontal	Vertical
Peak		
Avg.		

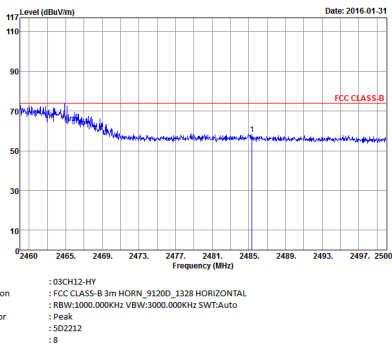
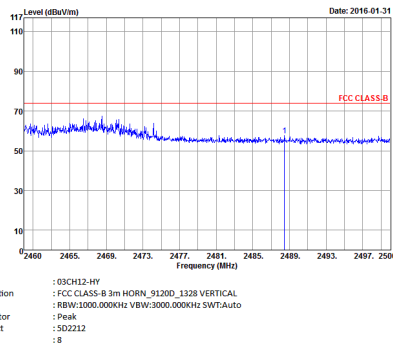
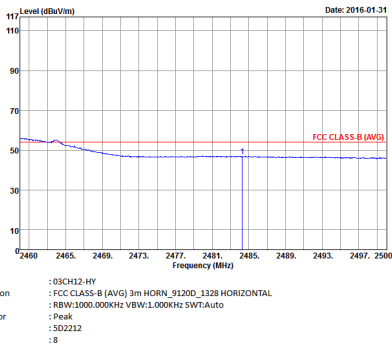
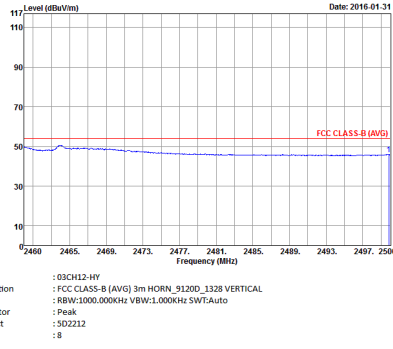

WIFI	2.4GHz 2400~2483.5MHz Band Edge @ 3m	
ANT	802.11n HT20 CH06 2437MHz - R	
1+2	Horizontal	Vertical
Peak	 <p>Site : 03CH12-HY Condition : FCC CLASS-B 3m HORN_91200_1328 HORIZONTAL Detector : Peak Project : 5D2212 Mode : S</p>	 <p>Site : 03CH12-HY Condition : FCC CLASS-B 3m HORN_91200_1328 VERTICAL Detector : Peak Project : 5D2212 Mode : S</p>
Avg.	 <p>Site : 03CH12-HY Condition : FCC CLASS-B (AVG) 3m HORN_91200_1328 HORIZONTAL Detector : Peak Project : 5D2212 Mode : S</p>	 <p>Site : 03CH12-HY Condition : FCC CLASS-B (AVG) 3m HORN_91200_1328 VERTICAL Detector : Peak Project : 5D2212 Mode : S</p>



WIFI	2.4GHz 2400~2483.5MHz Band Edge @ 3m	
ANT	802.11n HT20 CH11 2462MHz	
1+2	Horizontal	Vertical
Peak	<p>Site : 03CH12-HY            Condition : FCC CLASS-B 3m HORN_91200_1328 HORIZONTAL            : RBW:1000.000KHz VBW:3000.000KHz SWT:Auto            Detector : Peak            Project : 502212            Mode : 9            Setting : 14.5</p>	<p>Site : 03CH12-HY            Condition : FCC CLASS-B 3m HORN_91200_1328 VERTICAL            : RBW:1000.000KHz VBW:3000.000KHz SWT:Auto            Detector : Peak            Project : 502212            Mode : 9            Setting : 14.5</p>
Avg.	<p>Site : 03CH12-HY            Condition : FCC CLASS-B (AVG) 3m HORN_91200_1328 HORIZONTAL            : RBW:1000.000KHz VBW:1.000KHz SWT:Auto            Detector : Peak            Project : 502212            Mode : 9            Setting : 14.5</p>	<p>Site : 03CH12-HY            Condition : FCC CLASS-B (AVG) 3m HORN_91200_1328 VERTICAL            : RBW:1000.000KHz VBW:1.000KHz SWT:Auto            Detector : Peak            Project : 502212            Mode : 9            Setting : 14.5</p>

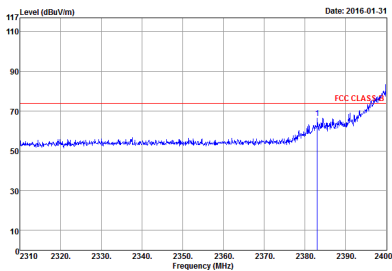
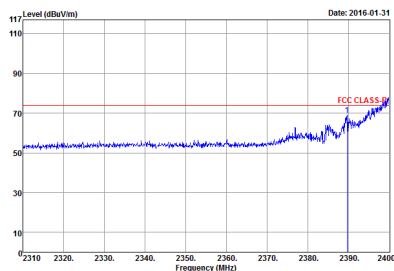
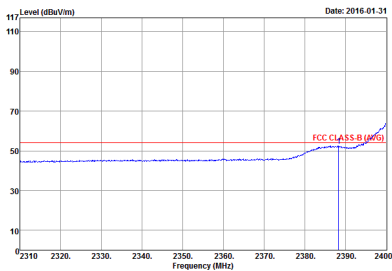
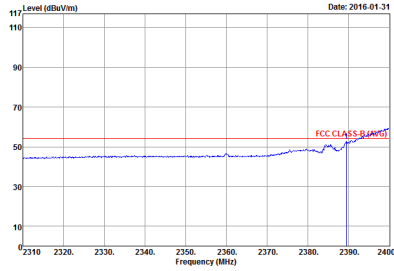

2.4GHz 2400~2483.5MHz  
WIFI 802.11n HT40 (Band Edge @ 3m)

WIFI	2.4GHz 2400~2483.5MHz Band Edge @ 3m	
ANT	802.11n HT40 CH03 2422MHz - L	
1+2	Horizontal	Vertical
Peak	 <p>Site : 03CH12-HY Condition : FCC CLASS-B 3m HORN_91200_1328 HORIZONTAL RBW:1000.000KHz VBW:3000.000KHz SWT:Auto Detector : Peak Project : 502212 Mode : 10 Setting : 11.5</p>	 <p>Site : 03CH12-HY Condition : FCC CLASS-B 3m HORN_91200_1328 VERTICAL RBW:1000.000KHz VBW:3000.000KHz SWT:Auto Detector : Peak Project : 502212 Mode : 10 Setting : 11.5</p>
Avg.	 <p>Site : 03CH12-HY Condition : FCC CLASS-B (AVG) 3m HORN_91200_1328 HORIZONTAL RBW:1000.000KHz VBW:3.000KHz SWT:Auto Detector : Peak Project : 502212 Mode : 10 Setting : 11.5</p>	 <p>Site : 03CH12-HY Condition : FCC CLASS-B (AVG) 3m HORN_91200_1328 VERTICAL RBW:1000.000KHz VBW:3.000KHz SWT:Auto Detector : Peak Project : 502212 Mode : 10 Setting : 11.5</p>



WIFI	2.4GHz 2400~2483.5MHz Band Edge @ 3m	
ANT	802.11n HT40 CH03 2422MHz - R	
1+2	Horizontal	Vertical
Peak	<p>Site : 03CH12-HY            Condition : FCC CLASS-B 3m HORN_91200_1328 HORIZONTAL            Detector : Peak            Project : 5D2212            Mode : 10            Setting : 11.5</p>	<p>Site : 03CH12-HY            Condition : FCC CLASS-B 3m HORN_91200_1328 VERTICAL            Detector : Peak            Project : 5D2212            Mode : 10            Setting : 11.5</p>
Avg.	<p>Site : 03CH12-HY            Condition : FCC CLASS-B (AVG) 3m HORN_91200_1328 HORIZONTAL            Detector : Peak            Project : 5D2212            Mode : 10            Setting : 11.5</p>	<p>Site : 03CH12-HY            Condition : FCC CLASS-B (AVG) 3m HORN_91200_1328 VERTICAL            Detector : Peak            Project : 5D2212            Mode : 10            Setting : 11.5</p>

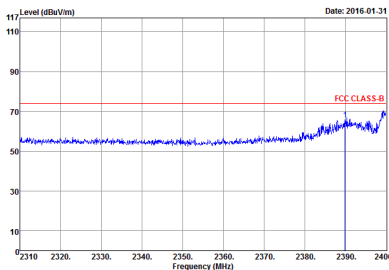
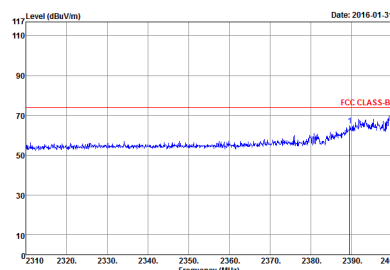
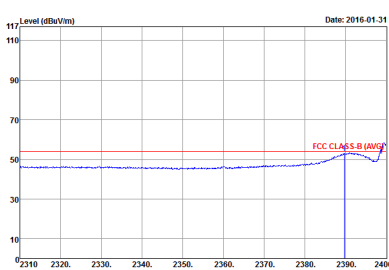
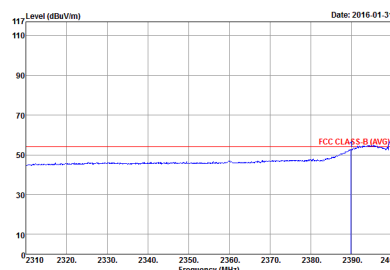

WIFI	2.4GHz 2400~2483.5MHz Band Edge @ 3m	
ANT	802.11n HT40 CH06 2437MHz - L	
1+2	Horizontal	Vertical
Peak	 <p>Date: 2016-01-31</p> <p>Site : 03CH12-HY            Condition : FCC CLASS-B 3m HORN_91200_1328 HORIZONTAL            RBW:1000.000KHz VBW:3000.000KHz SWT:Auto            Detector : Peak            Project : S02212            Mode : 11            Setting : 14.5</p>	 <p>Date: 2016-01-31</p> <p>Site : 03CH12-HY            Condition : FCC CLASS-B 3m HORN_91200_1328 VERTICAL            RBW:1000.000KHz VBW:3000.000KHz SWT:Auto            Detector : Peak            Project : S02212            Mode : 11            Setting : 14.5</p>
Avg.	 <p>Date: 2016-01-31</p> <p>Site : 03CH12-HY            Condition : FCC CLASS-B (AVG) 3m HORN_91200_1328 HORIZONTAL            RBW:1000.000KHz VBW:3.000KHz SWT:Auto            Detector : Peak            Project : S02212            Mode : 11            Setting : 14.5</p>	 <p>Date: 2016-01-31</p> <p>Site : 03CH12-HY            Condition : FCC CLASS-B (AVG) 3m HORN_91200_1328 VERTICAL            RBW:1000.000KHz VBW:3.000KHz SWT:Auto            Detector : Peak            Project : S02212            Mode : 11            Setting : 14.5</p>



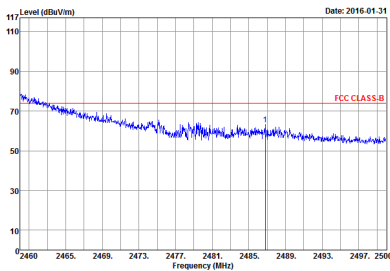
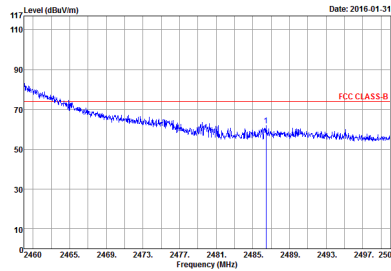
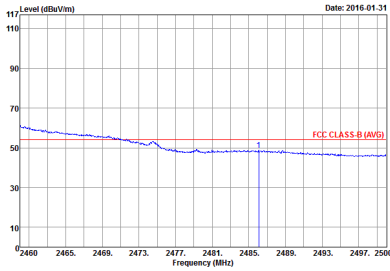
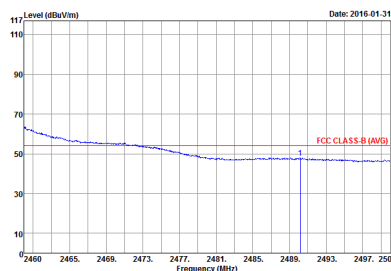

WIFI	2.4GHz 2400~2483.5MHz Band Edge @ 3m	
ANT	802.11n HT40 CH06 2437MHz - R	
1+2	Horizontal	Vertical
Peak	 <p>Date: 2016-01-31</p> <p>Site : 03CH12-HY Condition : FCC CLASS-B 3m HORN_91200_1328 HORIZONTAL Detector : Peak Project : S02212 Mode : 11 Setting : 14.5</p>	 <p>Date: 2016-01-31</p> <p>Site : 03CH12-HY Condition : FCC CLASS-B 3m HORN_91200_1328 VERTICAL Detector : Peak Project : S02212 Mode : 11 Setting : 14.5</p>
Avg.	 <p>Date: 2016-01-31</p> <p>Site : 03CH12-HY Condition : FCC CLASS-B (AVG) 3m HORN_91200_1328 HORIZONTAL Detector : Peak Project : S02212 Mode : 11 Setting : 14.5</p>	 <p>Date: 2016-01-31</p> <p>Site : 03CH12-HY Condition : FCC CLASS-B (AVG) 3m HORN_91200_1328 VERTICAL Detector : Peak Project : S02212 Mode : 11 Setting : 14.5</p>

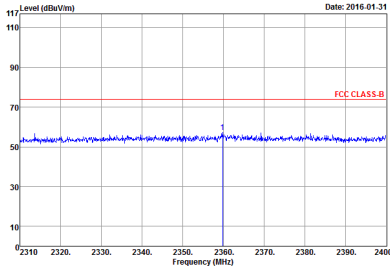
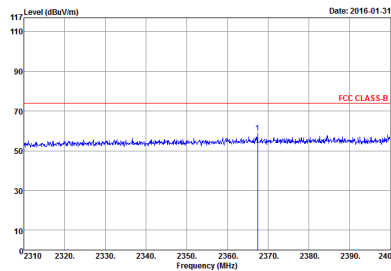
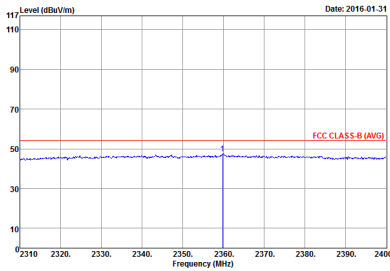
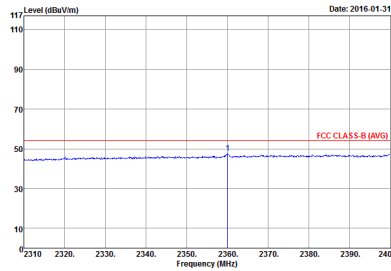

WIFI	2.4GHz 2400~2483.5MHz Band Edge @ 3m	
ANT	802.11n HT40 CH09 2452MHz - L	
1+2	Horizontal	Vertical
Peak	 <p>Date: 2016.01.31</p> <p>Site : 03CH12-HY Condition : FCC CLASS-B 3m HORN_91200_1328 HORIZONTAL RBW:1000.000KHz VBW:3000.000KHz SWT:Auto Detector : Peak Project : 502212 Mode : 12 Setting : 13</p>	 <p>Date: 2016.01.31</p> <p>Site : 03CH12-HY Condition : FCC CLASS-B 3m HORN_91200_1328 VERTICAL RBW:1000.000KHz VBW:3000.000KHz SWT:Auto Detector : Peak Project : 502212 Mode : 12 Setting : 13</p>
Avg.	 <p>Date: 2016.01.31</p> <p>Site : 03CH12-HY Condition : FCC CLASS-B (AVG) 3m HORN_91200_1328 HORIZONTAL RBW:1000.000KHz VBW:3.000KHz SWT:Auto Detector : Peak Project : 502212 Mode : 12 Setting : 13</p>	 <p>Date: 2016.01.31</p> <p>Site : 03CH12-HY Condition : FCC CLASS-B (AVG) 3m HORN_91200_1328 VERTICAL RBW:1000.000KHz VBW:3.000KHz SWT:Auto Detector : Peak Project : 502212 Mode : 12 Setting : 13</p>



WIFI	2.4GHz 2400~2483.5MHz Band Edge @ 3m	
ANT	802.11n HT40 CH09 2452MHz - R	
1+2	Horizontal	Vertical
Peak	<p>Site : 03CH12-HY            Condition : FCC CLASS-B 3m HORN_91200_1328 HORIZONTAL            : RBW:1000.000KHz VBW:3000.000KHz SWT:Auto            Detector : Peak            Project : 502212            Mode : 12            Setting : 13</p>	<p>Site : 03CH12-HY            Condition : FCC CLASS-B 3m HORN_91200_1328 VERTICAL            : RBW:1000.000KHz VBW:3000.000KHz SWT:Auto            Detector : Peak            Project : 502212            Mode : 12            Setting : 13</p>
Avg.	<p>Site : 03CH12-HY            Condition : FCC CLASS-B (AVG) 3m HORN_91200_1328 HORIZONTAL            : RBW:1000.000KHz VBW:3.000KHz SWT:Auto            Detector : Peak            Project : 502212            Mode : 12            Setting : 13</p>	<p>Site : 03CH12-HY            Condition : FCC CLASS-B (AVG) 3m HORN_91200_1328 VERTICAL            : RBW:1000.000KHz VBW:3.000KHz SWT:Auto            Detector : Peak            Project : 502212            Mode : 12            Setting : 13</p>



2.4GHz 2400~2483.5MHz  
WIFI 802.11b (Harmonic @ 3m)

WIFI	2.4GHz 2400~2483.5MHz Harmonic @ 3m	
ANT	802.11b CH01 2412MHz	
1+2	Horizontal	Vertical
Peak Avg.	<p>Site : 03CH12-HY Condition : FCC CLASS-B 3m HORN_91200_1328 HORIZONTAL Detector : Peak Project : 502212 Mode : 1</p>	<p>Site : 03CH12-HY Condition : FCC CLASS-B 3m HORN_91200_1328 VERTICAL Detector : Peak Project : 502212 Mode : 1</p>

WIFI	2.4GHz 2400~2483.5MHz Harmonic @ 3m	
ANT	802.11b CH06 2437MHz	
1+2	Horizontal	Vertical
Peak Avg.	<p>Site : 03CH12-HY Condition : FCC CLASS-B 3m HORN_91200_1328 HORIZONTAL Detector : Peak Project : 502212 Mode : 2</p>	<p>Site : 03CH12-HY Condition : FCC CLASS-B 3m HORN_91200_1328 VERTICAL Detector : Peak Project : 502212 Mode : 2</p>



WIFI	2.4GHz 2400~2483.5MHz Harmonic @ 3m	
ANT	802.11b CH11 2462MHz	
1+2	Horizontal	Vertical
Peak Avg.	<p>Site : 03CH12-HY Condition : FCC CLASS-B 3m HORN_91200_1328 HORIZONTAL Detector : Peak Project : 5D2212 Mode : 3</p>	<p>Site : 03CH12-HY Condition : FCC CLASS-B 3m HORN_91200_1328 VERTICAL Detector : Peak Project : 5D2212 Mode : 3</p>



2.4GHz 2400~2483.5MHz  
WIFI 802.11g (Harmonic @ 3m)

WIFI	2.4GHz 2400~2483.5MHz Harmonic @ 3m	
ANT	802.11g CH01 2412MHz	
1+2	Horizontal	Vertical
Peak Avg.	<p>Site : 03CH12-HY Condition : FCC CLASS-B 3m HORN_91200_1328 HORIZONTAL Detector : Peak Project : SD2212 Mode : 4</p>	<p>Site : 03CH12-HY Condition : FCC CLASS-B 3m HORN_91200_1328 VERTICAL Detector : Peak Project : SD2212 Mode : 4</p>

WIFI	2.4GHz 2400~2483.5MHz Harmonic @ 3m	
ANT	802.11g CH06 2437MHz	
1+2	Horizontal	Vertical
Peak Avg.	<p>Site : 03CH12-HY Condition : FCC CLASS-B 3m HORN_91200_1328 HORIZONTAL Detector : Peak Project : SD2212 Mode : 5</p>	<p>Site : 03CH12-HY Condition : FCC CLASS-B 3m HORN_91200_1328 VERTICAL Detector : Peak Project : SD2212 Mode : 5</p>



WIFI	2.4GHz 2400~2483.5MHz Harmonic @ 3m	
ANT	802.11g CH11 2462MHz	
1+2	Horizontal	Vertical
Peak Avg.	<p>Site : 03CH12-HY Condition : FCC CLASS-B 3m HORN_9120D_1328 HORIZONTAL Detector : Peak Project : 502212 Mode : 6 Setting : 15</p>	<p>Site : 03CH12-HY Condition : FCC CLASS-B 3m HORN_9120D_1328 VERTICAL Detector : Peak Project : 502212 Mode : 6 Setting : 15</p>



2.4GHz 2400~2483.5MHz

WIFI 802.11n HT20 (Harmonic @ 3m)

WIFI	2.4GHz 2400~2483.5MHz Harmonic @ 3m	
ANT	802.11n HT20 CH01 2412MHz	
1+2	Horizontal	Vertical
Peak Avg.	<p>Site : 03CH12-HY Condition : FCC CLASS-B 3m HORN_91200_1328 HORIZONTAL Detector : Peak Project : 5D2212 Mode : 7 Setting : 14.5</p>	<p>Site : 03CH12-HY Condition : FCC CLASS-B 3m HORN_91200_1328 VERTICAL Detector : Peak Project : 5D2212 Mode : 7 Setting : 14.5</p>

WIFI	2.4GHz 2400~2483.5MHz Harmonic @ 3m	
ANT	802.11n HT20 CH06 2437MHz	
1+2	Horizontal	Vertical
Peak Avg.	<p>Site : 03CH12-HY Condition : FCC CLASS-B 3m HORN_91200_1328 HORIZONTAL Detector : Peak Project : 5D2212 Mode : 8</p>	<p>Site : 03CH12-HY Condition : FCC CLASS-B 3m HORN_91200_1328 VERTICAL Detector : Peak Project : 5D2212 Mode : 8</p>



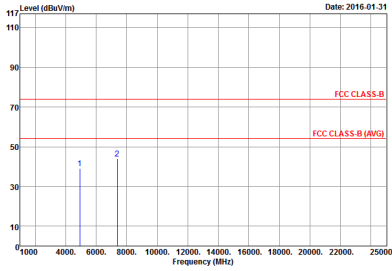
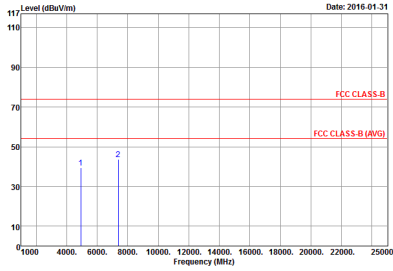

WIFI	2.4GHz 2400~2483.5MHz Harmonic @ 3m	
ANT	802.11n HT20 CH11 2462MHz	
1+2	Horizontal	Vertical
Peak Avg.	 <p>Site : 03CH12-HY Condition : FCC CLASS-B 3m HORN_91200_1328 HORIZONTAL Detector : Peak Project : 502212 Mode : 19 Setting : 14.5</p>	 <p>Site : 03CH12-HY Condition : FCC CLASS-B 3m HORN_91200_1328 VERTICAL Detector : Peak Project : 502212 Mode : 19 Setting : 14.5</p>



2.4GHz 2400~2483.5MHz

WIFI 802.11n HT40 (Harmonic @ 3m)

WIFI	2.4GHz 2400~2483.5MHz Harmonic @ 3m	
ANT	802.11n HT40 CH03 2422MHz	
1+2	Horizontal	Vertical
Peak Avg.	<p>Site : 03CH12-HY Condition : FCC CLASS-B 3m HORN_91200_1328 HORIZONTAL Detector : Peak Project : 5D2212 Mode : 10 Setting : 11.5</p>	<p>Site : 03CH12-HY Condition : FCC CLASS-B 3m HORN_91200_1328 VERTICAL Detector : Peak Project : 5D2212 Mode : 10 Setting : 11.5</p>

WIFI	2.4GHz 2400~2483.5MHz Harmonic @ 3m	
ANT	802.11n HT40 CH06 2437MHz	
1+2	Horizontal	Vertical
Peak Avg.	<p>Site : 03CH12-HY Condition : FCC CLASS-B 3m HORN_91200_1328 HORIZONTAL Detector : Peak Project : 5D2212 Mode : 11 Setting : 14.5</p>	<p>Site : 03CH12-HY Condition : FCC CLASS-B 3m HORN_91200_1328 VERTICAL Detector : Peak Project : 5D2212 Mode : 11 Setting : 14.5</p>



WIFI	2.4GHz 2400~2483.5MHz Harmonic @ 3m	
ANT	802.11n HT40 CH09 2452MHz	
1+2	Horizontal	Vertical
Peak Avg.	<p>Site : 03CH12-HY Condition : FCC CLASS-B 3m HORN_91200_1328 HORIZONTAL Detector : Peak Project : 50ZZ12 Mode : 12 Setting : 13</p>	<p>Site : 03CH12-HY Condition : FCC CLASS-B 3m HORN_91200_1328 VERTICAL Detector : Peak Project : 50ZZ12 Mode : 12 Setting : 13</p>



2.4GHz 2400~2483.5MHz

Emission below 1GHz

2.4GHz WIFI 802.11b Adapter mode (LF)

WIFI	2.4GHz 2400~2483.5MHz	
ANT	802.11b LF	
1+2	Horizontal	Vertical
QP / Peak	<p>Site : 03CH12-HY Condition : FCC CLASS-B 3m BILOG_6111D_37059 HORIZONTAL Detector : Peak Project : 5D2212 Mode : 13</p>	<p>Site : 03CH12-HY Condition : FCC CLASS-B 3m BILOG_6111D_37059 VERTICAL Detector : Peak Project : 5D2212 Mode : 13</p>

2.4GHz 2400~2483.5MHz

Emission below 1GHz

2.4GHz WIFI 802.11b POE mode (LF)

WIFI	2.4GHz 2400~2483.5MHz	
ANT	802.11b LF	
1+2	Horizontal	Vertical
QP / Peak	<p>Site : 03CH12-HY Condition : FCC CLASS-B 3m BILOG_6111D_37059 HORIZONTAL Detector : Peak Project : 5D2212 Mode : 14</p>	<p>Site : 03CH12-HY Condition : FCC CLASS-B 3m BILOG_6111D_37059 VERTICAL Detector : Peak Project : 5D2212 Mode : 14</p>