



FCC RF Test Report

APPLICANT : Senao Networks, Inc.
EQUIPMENT : Wireless 802.11 ac/a/b/g/n Access Point
BRAND NAME : Senao Network
MODEL NAME : CAP7253AG
FCC ID : U2M-CAP7252AG
STANDARD : FCC Part 15 Subpart C §15.247
CLASSIFICATION : (DTS) Digital Transmission System

The product was received on Jan. 28, 2016 and testing was completed on Apr. 05, 2016. We, SPORTON INTERNATIONAL INC., would like to declare that the tested sample has been evaluated in accordance with the test procedures and has been in compliance with the applicable technical standards.

The test results in this report apply exclusively to the tested model / sample. Without written approval of SPORTON INTERNATIONAL INC., the test report shall not be reproduced except in full.

Reviewed by: Joseph Lin / Supervisor

Approved by: Jones Tsai / Manager



SPORTON INTERNATIONAL INC.

No. 52, Hwa Ya 1st Rd., Hwa Ya Technology Park, Kwei-Shan District, Tao Yuan City, Taiwan, R.O.C.



TABLE OF CONTENTS

REVISION HISTORY 3

SUMMARY OF TEST RESULT 4

1 GENERAL DESCRIPTION 5

 1.1 Applicant 5

 1.2 Manufacturer 5

 1.3 Product Feature of Equipment Under Test 5

 1.4 Product Specification of Equipment Under Test 6

 1.5 Modification of EUT 6

 1.6 Testing Location 7

 1.7 Applicable Standards 7

2 TEST CONFIGURATION OF EQUIPMENT UNDER TEST 8

 2.1 Carrier Frequency and Channel 8

 2.2 Pre-Scanned RF Power 9

 2.3 Test Mode 9

 2.4 Connection Diagram of Test System 10

 2.5 Support Unit used in test configuration and system 11

 2.6 EUT Operation Test Setup 11

 2.7 Measurement Results Explanation Example 11

3 TEST RESULT 12

 3.1 6dB and 99% Bandwidth Measurement 12

 3.2 Peak Output Power Measurement 14

 3.3 Power Spectral Density Measurement 15

 3.4 Conducted Band Edges and Spurious Emission Measurement 18

 3.5 Radiated Band Edges and Spurious Emission Measurement 43

 3.6 AC Conducted Emission Measurement 47

 3.7 Antenna Requirements 57

4 LIST OF MEASURING EQUIPMENT 58

5 UNCERTAINTY OF EVALUATION 59

APPENDIX A. CONDUCTED TEST RESULTS

APPENDIX B. RADIATED SPURIOUS EMISSION

APPENDIX C. RADIATED SPURIOUS EMISSION PLOTS

APPENDIX D. SETUP PHOTOGRAPHS



REVISION HISTORY

REPORT NO.	VERSION	DESCRIPTION	ISSUED DATE
FR5D2212A2	Rev. 01	Initial issue of report	Sep. 21, 2016
FR5D2212A2	Rev. 02	Revising FCC KDB Publication No. 558074 D01 DTS Meas. Guidance from v03r04 to v03r05	Sep. 30, 2016



SUMMARY OF TEST RESULT

Report Section	FCC Rule	Description	Limit	Result	Remark
3.1	15.247(a)(2)	6dB Bandwidth	≥ 0.5MHz	Pass	-
3.1	-	99% Bandwidth	-	Pass	-
3.2	15.247(b)	Power Output Measurement	≤ 30dBm	Pass	-
3.3	15.247(e)	Power Spectral Density	≤ 8dBm/3kHz	Pass	-
3.4	15.247(d)	Conducted Band Edges	≤ 20dBc	Pass	-
		Conducted Spurious Emission		Pass	-
3.5	15.247(d)	Radiated Band Edges and Radiated Spurious Emission	15.209(a) & 15.247(d)	Pass	Under limit 0.40 dB at 2389.920 MHz
3.6	15.207	AC Conducted Emission	15.207(a)	Pass	Under limit 2.00 dB at 0.398 MHz
3.7	15.203 & 15.247(b)	Antenna Requirement	N/A	Pass	-



1 General Description

1.1 Applicant

Senao Networks, Inc.

3F, No. 529, Chung Cheng Rd., Hsintien, Taipei, Taiwan, R.O.C

1.2 Manufacturer

Senao Networks, Inc.

3F, No. 529, Chung Cheng Rd., Hsintien, Taipei, Taiwan, R.O.C

1.3 Product Feature of Equipment Under Test

Product Feature	
Equipment	Wireless 802.11 ac/a/b/g/n Access Point
Brand Name	Senao Network
Model Name	CAP7253AG
FCC ID	U2M-CAP7252AG
EUT supports Radios application	WLAN 11a/b/g/n HT20/HT40 WLAN 11ac VHT20/VHT40/VHT80
EUT Stage	Production Unit

Remark: The above EUT's information was declared by manufacturer. Please refer to the specifications or user's manual for more detailed description.



1.4 Product Specification of Equipment Under Test

Standards-related Product Specification							
Tx/Rx Channel Frequency Range	2412 MHz ~ 2462 MHz						
Maximum (Peak) Output Power to antenna	MIMO<Ant. 1 + Ant. 2> 802.11b : 25.12 dBm (0.3251 W) 802.11g : 29.33 dBm (0.8570 W) 802.11n HT20 : 28.93 dBm (0.7816 W) 802.11n HT40 : 26.92 dBm (0.4920 W)						
99% Occupied Bandwidth	802.11b : 14.20MHz 802.11g : 18.75MHz 802.11n HT20 : 19.50MHz 802.11n HT40 : 37.60MHz						
Antenna Type	<Ant 1> 802.11b/g/n : Dipole Antenna type with gain 4.42 dBi <Ant 2> 802.11b/g/n : Dipole Antenna type with gain 4.42 dBi						
Type of Modulation	802.11b : DSSS (DBPSK / DQPSK / CCK) 802.11a/g/n : OFDM (BPSK / QPSK / 16QAM / 64QAM)						
Antenna Function for Transmitter	<table border="1"> <thead> <tr> <th></th> <th>Ant. 1</th> <th>Ant. 2</th> </tr> </thead> <tbody> <tr> <td>802.11 b/g/n MIMO</td> <td>V</td> <td>V</td> </tr> </tbody> </table>		Ant. 1	Ant. 2	802.11 b/g/n MIMO	V	V
	Ant. 1	Ant. 2					
802.11 b/g/n MIMO	V	V					

1.5 Modification of EUT

No modifications are made to the EUT during all test items.



1.6 Testing Location

Sporton Lab is accredited to ISO 17025 by Taiwan Accreditation Foundation (TAF code : 1190) and the FCC designation No. TW1022 under the FCC 2.948(e) by Mutual Recognition Agreement (MRA) in FCC Test.

Test Site	SPORTON INTERNATIONAL INC.	
Test Site Location	No. 52, Hwa Ya 1 st Rd., Hwa Ya Technology Park, Kwei-Shan District, Tao Yuan City, Taiwan, R.O.C. TEL: +886-3-327-3456 FAX: +886-3-328-4978	
Test Site No.	Sporton Site No.	
	TH05-HY	CO05-HY

Note: The test site complies with ANSI C63.4 2014 requirement.

Test Site	SPORTON INTERNATIONAL INC.	
Test Site Location	No.58, Aly. 75, Ln. 564, Wenhua 3rd Rd. Guishan Dist, Taoyuan City, Taiwan (R.O.C.) TEL: +886-3-327-0868 FAX: +886-3-327-0855	
Test Site No.	Sporton Site No.	
	03CH12-HY	

Note: The test site complies with ANSI C63.4 2014 requirement.

1.7 Applicable Standards

According to the specifications of the manufacturer, the EUT must comply with the requirements of the following standards:

- ♦ FCC Part 15 Subpart C §15.247
- ♦ FCC KDB Publication No. 558074 D01 DTS Meas. Guidance v03r05
- ♦ FCC KDB 662911 D01 Multiple Transmitter Output v02r01.
- ♦ ANSI C63.10-2013

Remark: All test items were verified and recorded according to the standards and without any deviation during the test.



2 Test Configuration of Equipment Under Test

The EUT has been associated with peripherals and configuration operated in a manner tended to maximize its emission characteristics in a typical application. Frequency range investigated: conducted emission (150 kHz to 30 MHz) and radiated emission (9 kHz to the 10th harmonic of the highest fundamental frequency or to 40 GHz, whichever is lower).

The final configuration from all the combinations and the worst-case data rates were investigated by measuring the maximum power across all the data rates and modulation modes under section 2.2.

Based on the worst configuration found above, the RF power setting is set individually to meet FCC compliance limit for the final conducted and radiated tests shown in section 2.3.

2.1 Carrier Frequency and Channel

Frequency Band	Channel	Freq. (MHz)	Channel	Freq. (MHz)
2400-2483.5 MHz	1	2412	7	2442
	2	2417	8	2447
	3	2422	9	2452
	4	2427	10	2457
	5	2432	11	2462
	6	2437		



2.2 Pre-Scanned RF Power

Preliminary tests were performed in different data rate and data rate associated with the highest power were chosen for full test shown in the following tables.

MIMO <Ant. 1+2>

802.11b				
Data Rate (MHz)	1M bps	2M bps	5.5M bps	11M bps
Peak Power (dBm)	25.12	24.79	24.92	25.03

802.11g								
Data Rate (MHz)	6M bps	9M bps	12M bps	18M bps	24M bps	36M bps	48M bps	54M bps
Peak Power (dBm)	29.33	29.07	28.95	28.98	29.03	28.91	28.89	28.79

2.4GHz 802.11n HT20								
Data Rate (MHz)	MCS0	MCS1	MCS2	MCS3	MCS4	MCS5	MCS6	MCS7
Peak Power (dBm)	28.93	28.80	28.67	28.67	28.54	28.81	28.59	28.67

2.4GHz 802.11n HT40								
Data Rate (MHz)	MCS0	MCS1	MCS2	MCS3	MCS4	MCS5	MCS6	MCS7
Peak Power (dBm)	26.92	26.78	26.84	26.82	26.74	26.86	26.67	26.89

Note: MIMO Ant. 1+2 is a calculated result from sum of the power MIMO Ant. 1 and MIMO Ant. 2.

2.3 Test Mode

Final test mode of conducted test items and radiated spurious emissions are considering the modulation and worse data rates from the power table described in section 2.2.

MIMO Antenna

<2.4GHz>

Modulation	Data Rate
802.11b	1 Mbps
802.11g	6 Mbps
802.11n HT20	MCS0
802.11n HT40	MCS0

Test Cases	
AC Conducted Emission	Mode 1 :2.4G Tx + RJ-45 Link + Adapter Mode 2 :2.4G Tx + RJ-45 Link + POE
Remark: The worst case of conducted emission is mode 1; only the test data of it was reported.	

2.4 Connection Diagram of Test System

<EUT with Adapter Mode>

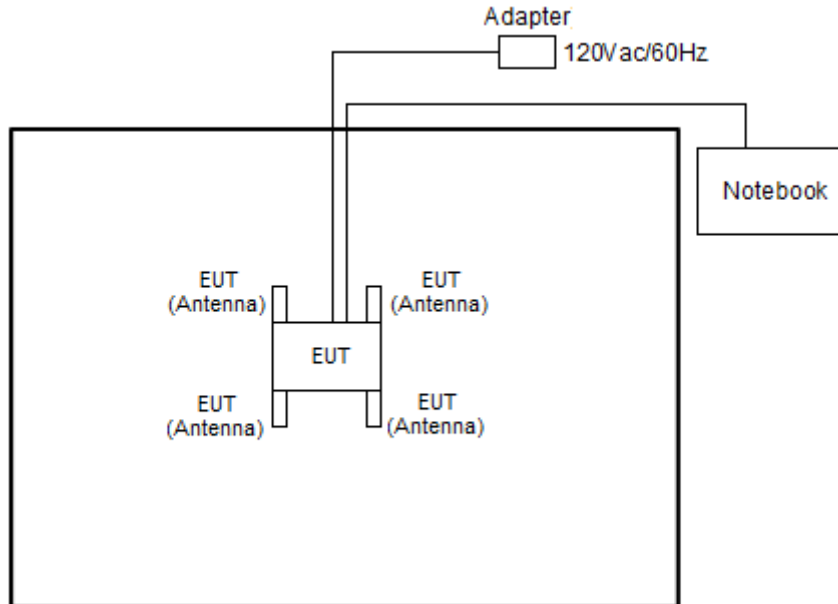

<EUT with POE Mode>

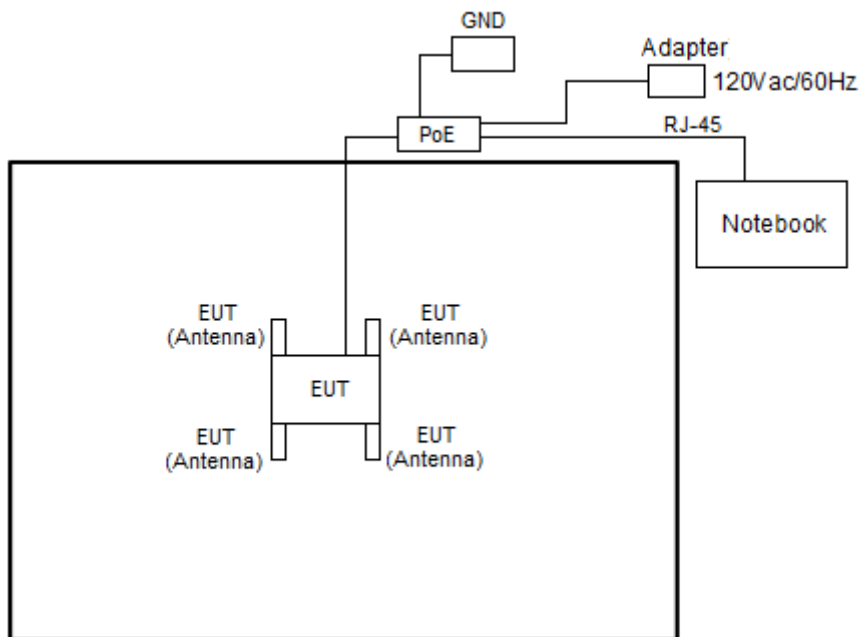



2.5 Support Unit used in test configuration and system

Item	Equipment	Trade Name	Model Name	FCC ID	Data Cable	Power Cord
1.	PoE Adapter	Powertron Electronics Corp	PA1040-480IB080	N/A	N/A	1.5m
2.	PoE	N/A	NPE-5818	N/A	N/A	N/A
3.	Notebook	Lenovo	IdeaPad(80Q7)	PPD-QCNFA435	N/A	AC I/P: Unshielded, 1.2 m DC O/P: Shielded, 1.8 m
4.	Notebook	DELL	Latitude E6320	FCC DoC/ Contains FCC ID: QDS-BRCM1054	N/A	AC I/P: Unshielded, 1.2 m DC O/P: Shielded, 1.8 m
5.	Adapter	Powertron Electronics Corp.	PA1015-2I/PA1015-2I PA1015-2I120125	N/A	N/A	1.2m

2.6 EUT Operation Test Setup

For WLAN function, programmed RF utility, "Art2-gui Tool" installed in the notebook make the EUT provide functions like channel selection and power level for continuous transmitting and receiving signals.

2.7 Measurement Results Explanation Example

For all conducted test items:

The offset level is set in the spectrum analyzer to compensate the RF cable loss and attenuator factor between EUT conducted output port and spectrum analyzer. With the offset compensation, the spectrum analyzer reading level is exactly the EUT RF output level.

Example:

The spectrum analyzer offset is derived from RF cable loss and attenuator factor.

Offset = RF cable loss + attenuator factor.

Following shows an offset computation example with cable loss 4.2 dB and 10dB attenuator.

$$\begin{aligned}
 \text{Offset(dB)} &= \text{RF cable loss(dB)} + \text{attenuator factor(dB)}. \\
 &= 4.2 + 10 = 14.2 \text{ (dB)}
 \end{aligned}$$

3 Test Result

3.1 6dB and 99% Bandwidth Measurement

3.1.1 Limit of 6dB and 99% Bandwidth

The minimum 6 dB bandwidth shall be at least 500 kHz.

3.1.2 Measuring Instruments

The measuring equipment is listed in the section 4 of this test report.

3.1.3 Test Procedures

1. The testing follows FCC KDB Publication No. 558074 DTS D01 Meas. Guidance v03r05.
2. The RF output of EUT was connected to the spectrum analyzer by RF cable and attenuator. The path loss was compensated to the results for each measurement.
3. Set to the maximum power setting and enable the EUT transmit continuously.
4. Make the measurement with the spectrum analyzer's resolution bandwidth (RBW) = 100 kHz. Set the Video bandwidth (VBW) = 300 kHz. In order to make an accurate measurement. The 6 dB bandwidth must be greater than 500 kHz.
5. For 99% Bandwidth Measurement, the spectrum analyzer's resolution bandwidth (RBW) = 1MHz and set the Video bandwidth (VBW) = 3MHz.
6. Measure and record the results in the test report.

3.1.4 Test Setup



3.1.5 Test Result of 6dB and 99% Occupied Bandwidth

Please refer to Appendix A of this test report.

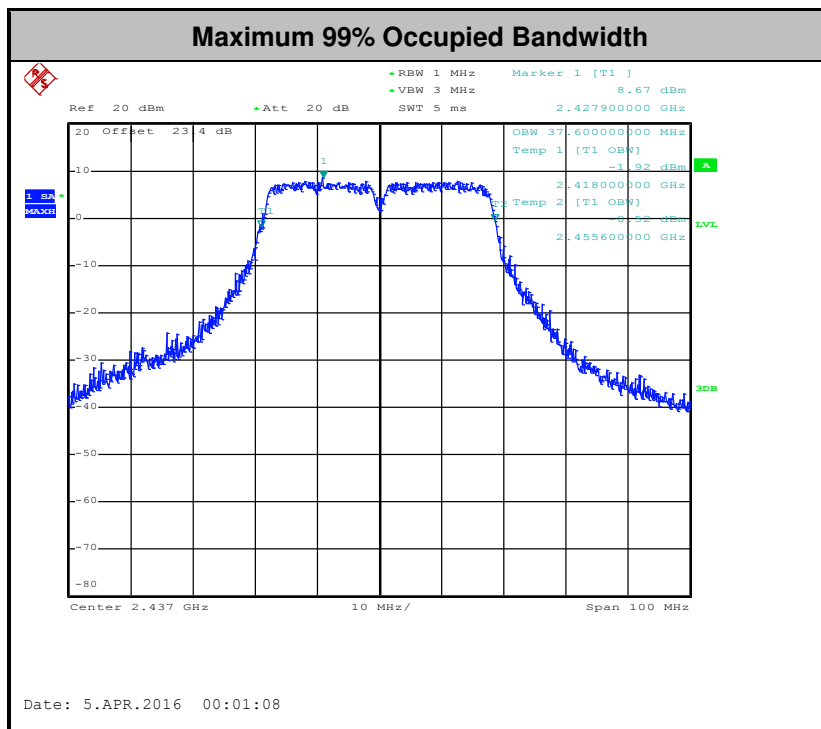
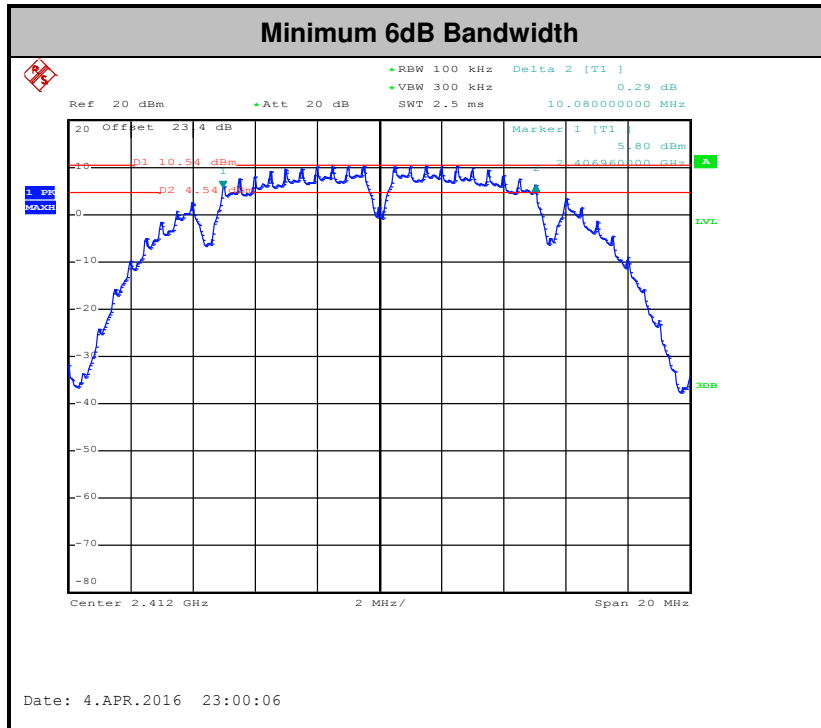

Note: The occupied channel bandwidth is maintained within the band of operation for all of the modulations.

3.2 Peak Output Power Measurement

3.2.1 Limit of Peak Output Power

For systems using digital modulation in the 2400-2483.5MHz, the limit for peak output power is 30dBm. If transmitting antenna with directional gain greater than 6dBi is used, the peak output power from the intentional radiator shall be reduced below the above stated value by the amount in dB that the directional gain of the antenna exceeds 6 dBi. In case of point-to-point operation, the limit has to be reduced by 1dB for every 3dB that the directional gain of the antenna exceeds 6dBi.

3.2.2 Measuring Instruments

The measuring equipment is listed in the section 4 of this test report.

3.2.3 Test Procedures

1. The testing follows the Measurement Procedure of FCC KDB No. 558074 DTS D01 Meas. Guidance v03r05 section 9.1.2 PKPM1 Peak power meter method.
2. The RF output of EUT was connected to the power meter by RF cable and attenuator. The path loss was compensated to the results for each measurement.
3. Set to the maximum power setting and enable the EUT transmit continuously.
4. Measure the conducted output power and record the results in the test report.
5. For MIMO mode, calculation method follows FCC KDB 662911 D01 Multiple Transmitter Output v02r01.

3.2.4 Test Setup

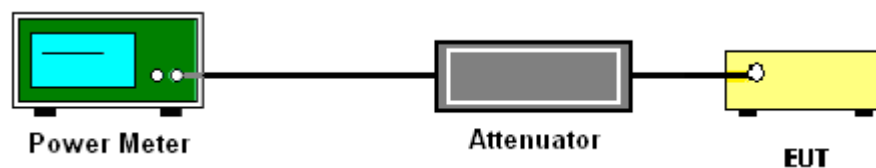

3.2.5 Test Result of Peak Output Power

Please refer to Appendix A of this test report.

3.2.6 Test Result of Average output Power (Reporting Only)

Please refer to Appendix A of this test report.



3.3 Power Spectral Density Measurement

3.3.1 Limit of Power Spectral Density

The peak power spectral density shall not be greater than 8dBm in any 3kHz band at any time interval of continuous transmission.

3.3.2 Measuring Instruments

The measuring equipment is listed in the section 4 of this test report.

3.3.3 Test Procedures

1. The testing follows Measurement Procedure 10.2 Method PKPSD of FCC KDB Publication No. 558074 D01 DTS Meas. Guidance v03r05.
2. The RF output of EUT was connected to the spectrum analyzer by RF cable and attenuator. The path loss was compensated to the results for each measurement.
3. Set to the maximum power setting and enable the EUT transmit continuously.
4. Make the measurement with the spectrum analyzer's resolution bandwidth (RBW) = 3 kHz. Video bandwidth VBW = 10 kHz In order to make an accurate measurement, set the span to 1.5 times DTS Channel Bandwidth. (6dB BW)
5. Detector = peak, Sweep time = auto couple, Trace mode = max hold, Allow trace to fully stabilize. Use the peak marker function to determine the maximum power level.
6. Measure and record the results in the test report.
7. For MIMO mode, calculation method follows FCC KDB 662911 D01 Multiple Transmitter Output v02r01.

If measurements performed using method (2) plus $10 \log(N)$ exceeds the emission limit, the test should choose method (1) before declaring that the device fails the emission limit.

Method (1): Measure and sum the spectra across the outputs.

The total final Power Spectral Density is from a device with 2 transmitter outputs. The spectrum measurements of the individual outputs are all performed with the same span and number of points, the spectrum value in the first spectral bin of output 1 is summed with that in the first spectral bin of output 2 to obtain the value for the first frequency bin of the summed spectrum.

Method (2): Measure and add $10 \log(N)$ dB, where N is the number of outputs. (N=2)

3.3.4 Test Setup

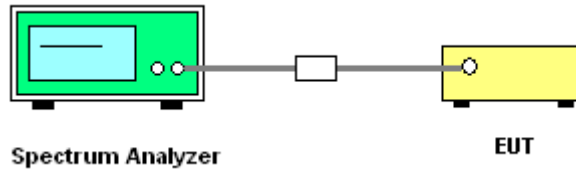



3.3.5 Test Result of Power Spectral Density

Please refer to Appendix A of this test report.

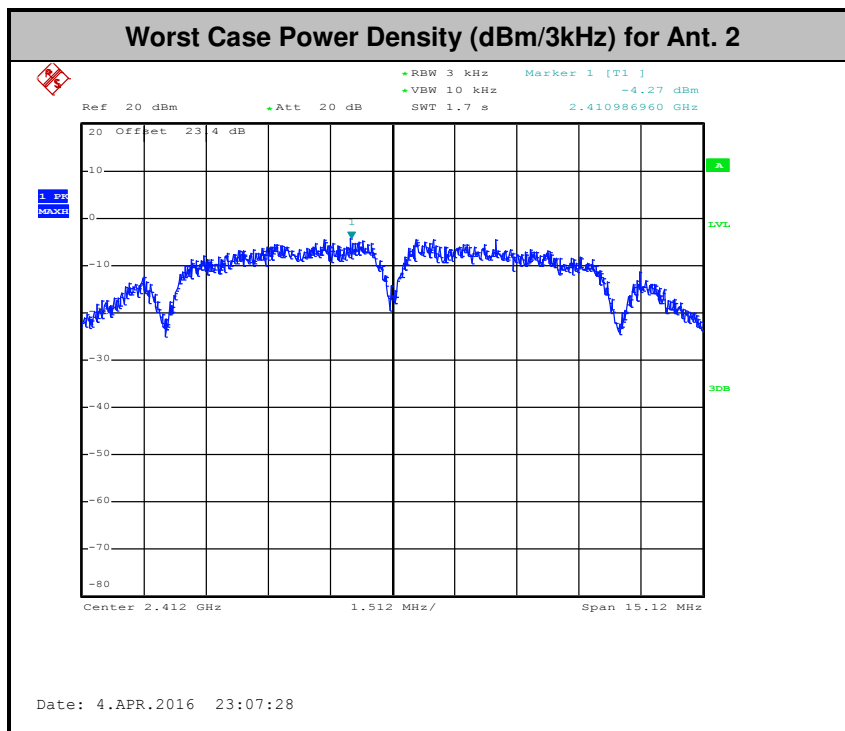
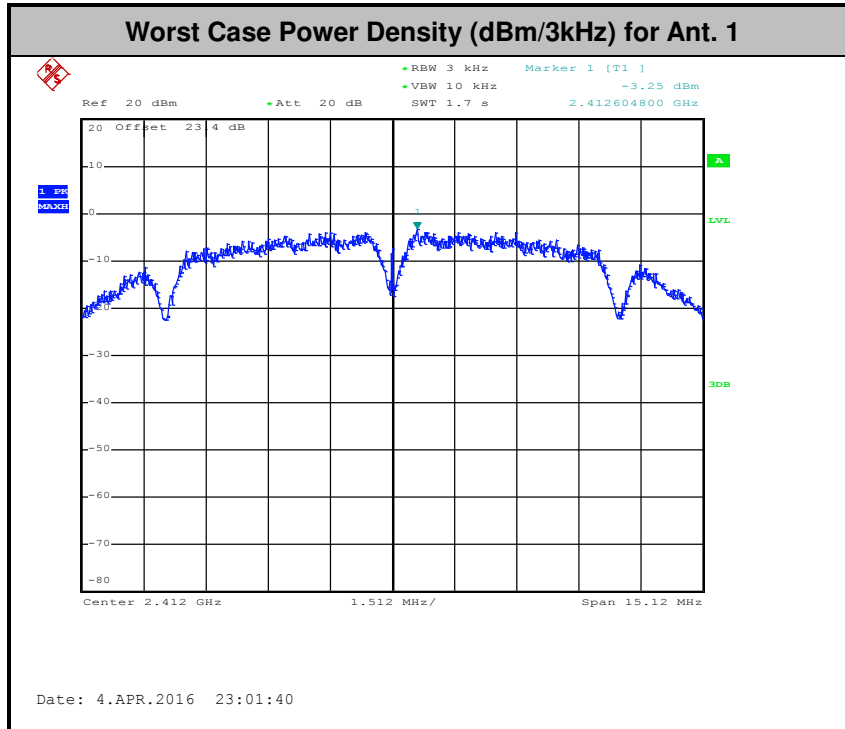

3.4 Conducted Band Edges and Spurious Emission Measurement

3.4.1 Limit of Conducted Band Edges and Spurious Emission Measurement

In any 100 kHz bandwidth outside of the authorized frequency band, the emissions which fall in the non-restricted bands shall be attenuated at least 20 dB / 30dB relative to the maximum PSD level in 100 kHz by RF conducted measurement and radiated emissions which fall in the restricted bands, as defined in Section 15.205(a), must also comply with the radiated emission limits specified in Section 15.209(a).

3.4.2 Measuring Instruments

The measuring equipment is listed in the section 4 of this test report.

3.4.3 Test Procedures

1. The testing follows FCC KDB Publication No. 558074 D01 DTS Meas. Guidance v03r05.
2. The RF output of EUT was connected to the spectrum analyzer by RF cable and attenuator. The path loss was compensated to the results for each measurement.
3. Set to the maximum power setting and enable the EUT transmit continuously.
4. Set RBW = 100 kHz, VBW=300 kHz, Peak Detector. Unwanted Emissions measured in any 100 kHz bandwidth outside of the authorized frequency band shall be attenuated by at least 20 dB relative to the maximum in-band peak PSD level in 100 kHz when maximum peak conducted output power procedure is used. If the transmitter complies with the conducted power limits based on the use of RMS averaging over a time interval, the attenuation required under this paragraph shall be 30 dB instead of 20 dB per 15.247(d).
5. Measure and record the results in the test report.
6. The RF fundamental frequency should be excluded against the limit line in the operating frequency band.

3.4.4 Test Setup

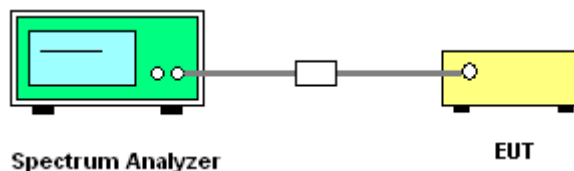



3.4.5 Test Result of Conducted Band Edges and Spurious Emission

Number of TX = 2, Ant. 1 (Measured)

Number of TX :	2	Ant. :	1
Test Mode :	802.11b	Temperature :	21~25°C
Test Band :	2.4GHz Low	Relative Humidity :	58~61%
Test Channel :	01	Test Engineer :	AC Chang

WLAN 802.11b Channel 01

100kHz PSD reference Level

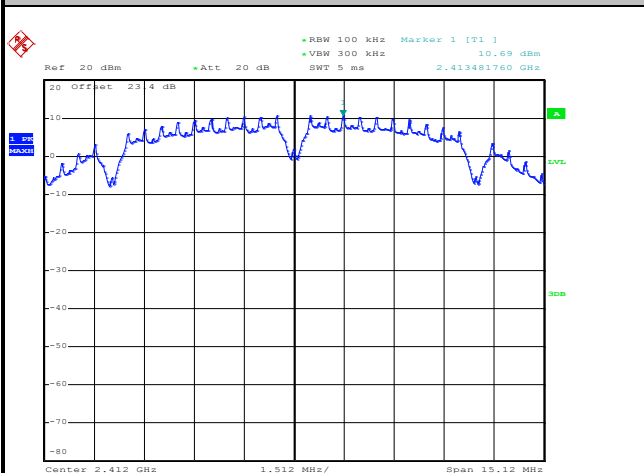

Date: 4.APR.2016 23:02:09

Low Channel Plot

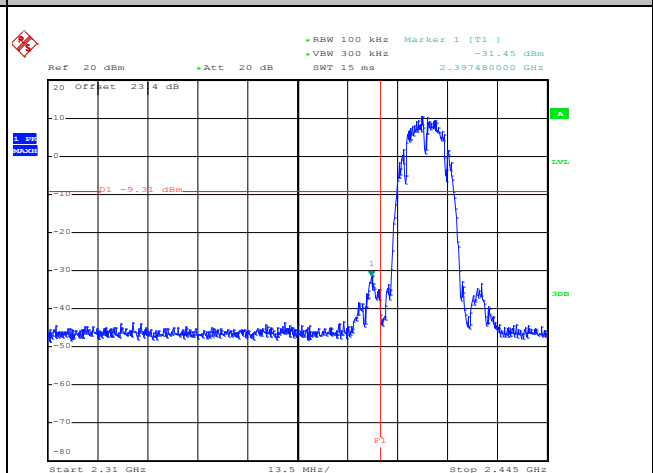

Date: 4.APR.2016 23:02:22

Spurious Emission 30MHz~3GHz

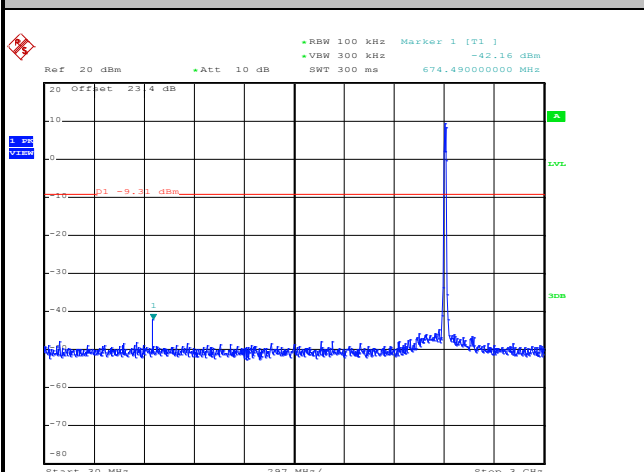

Date: 4.APR.2016 23:03:04

Spurious Emission 2GHz~25GHz

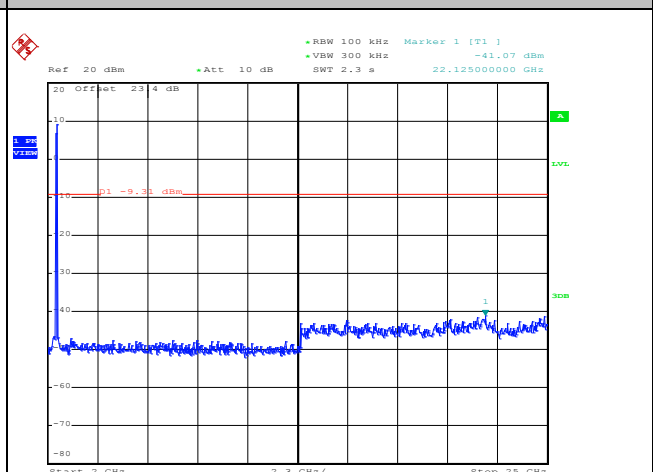

Date: 4.APR.2016 23:03:12



Number of TX :	2	Ant. :	1
Test Mode :	802.11b	Temperature :	21~25°C
Test Band :	2.4GHz Mid	Relative Humidity :	58~61%
Test Channel :	06	Test Engineer :	AC Chang

WLAN 802.11b Channel 06

100kHz PSD reference Level

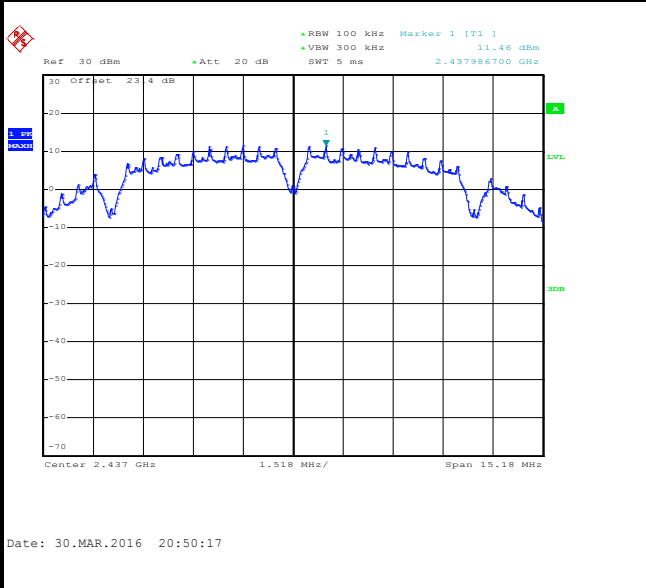

Spurious Emission 30MHz~3GHz

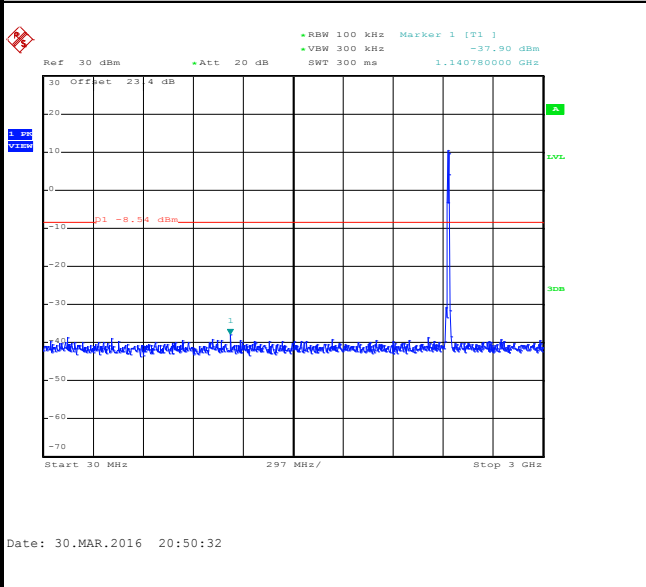

Spurious Emission 2GHz~25GHz

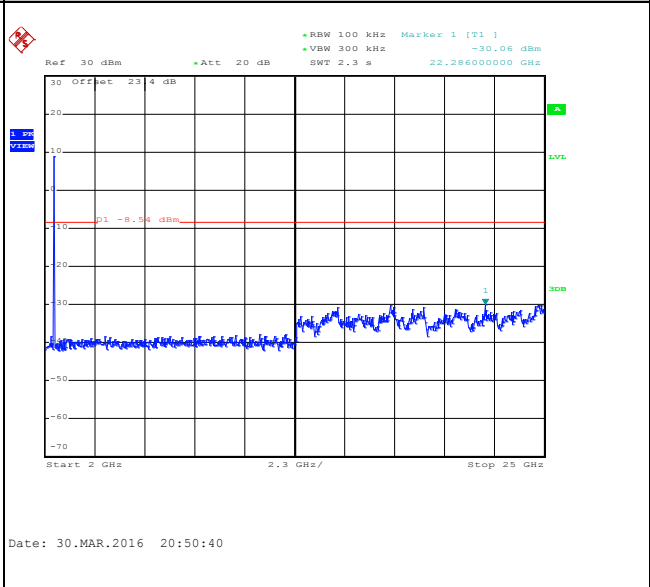



Number of TX :	2	Ant. :	1
Test Mode :	802.11b	Temperature :	21~25°C
Test Band :	2.4GHz High	Relative Humidity :	58~61%
Test Channel :	11	Test Engineer :	AC Chang

WLAN 802.11b Channel 11

100kHz PSD reference Level

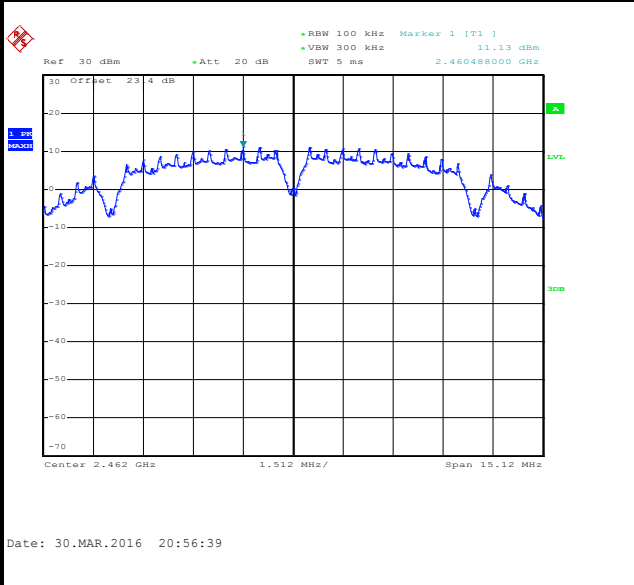

High Channel Plot

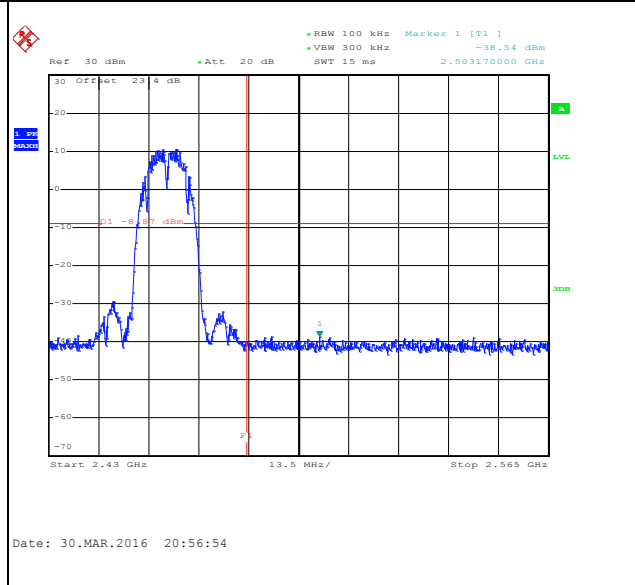

Spurious Emission 30MHz~3GHz

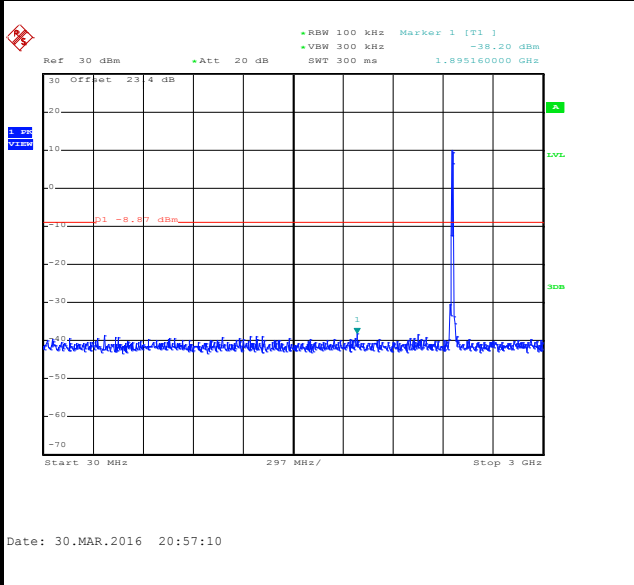

Spurious Emission 2GHz~25GHz

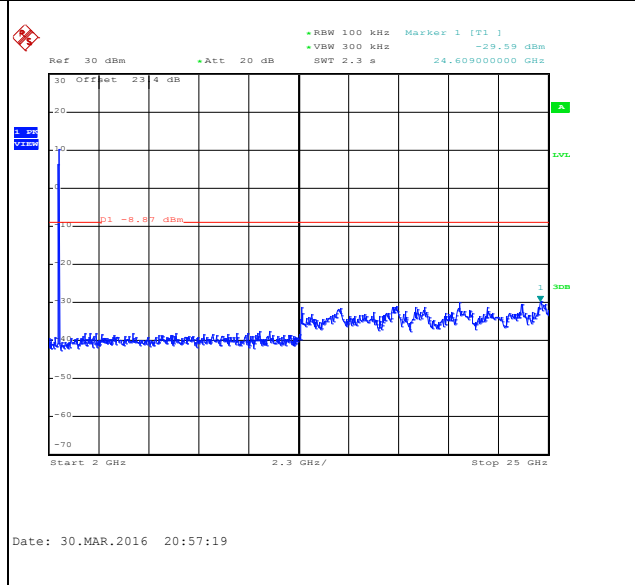



Number of TX :	2	Ant. :	1
Test Mode :	802.11g	Temperature :	21~25°C
Test Band :	2.4GHz Low	Relative Humidity :	58~61%
Test Channel :	01	Test Engineer :	AC Chang

WLAN 802.11g Channel 01

100kHz PSD reference Level

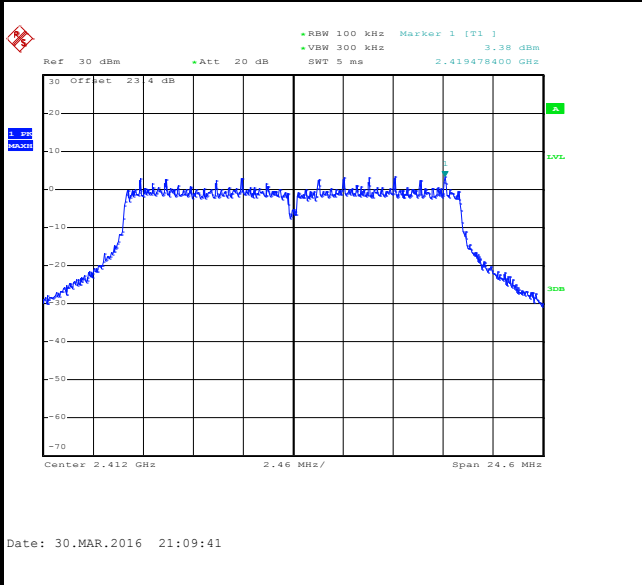

Low Channel Plot

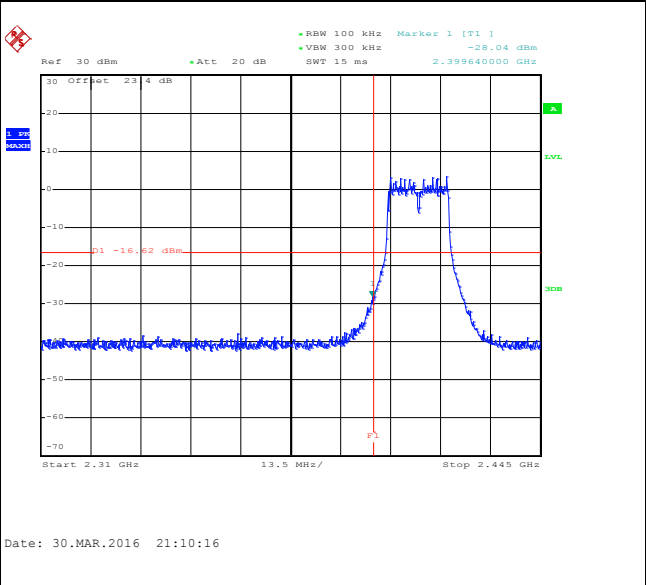

Spurious Emission 30MHz~3GHz

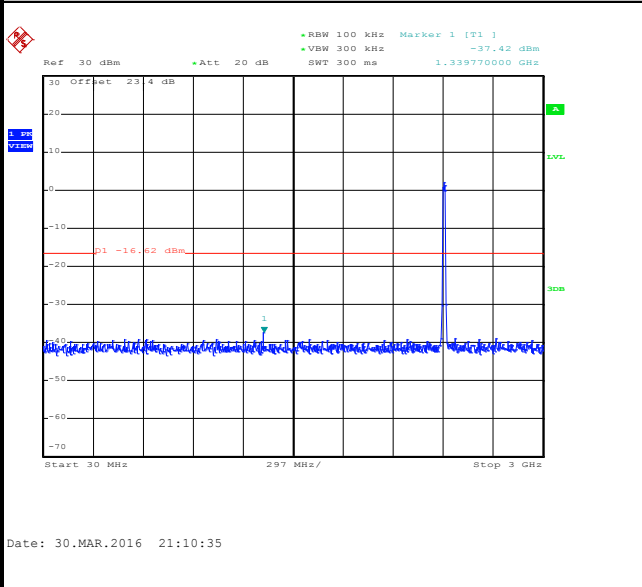

Spurious Emission 2GHz~25GHz

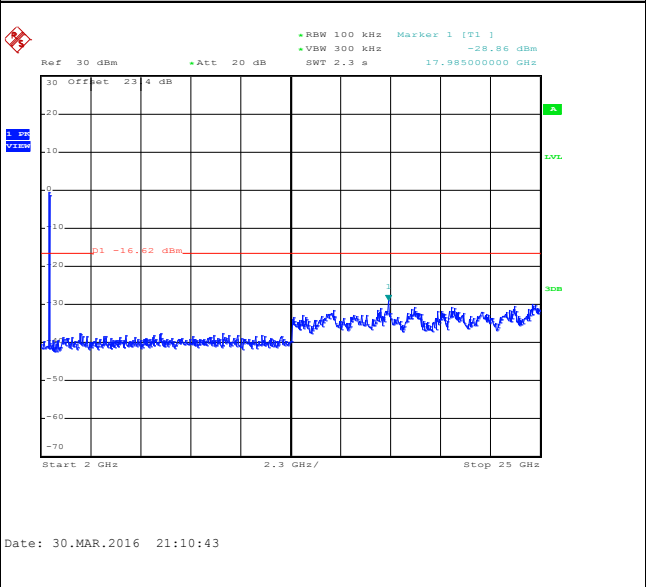



Number of TX :	2	Ant. :	1
Test Mode :	802.11g	Temperature :	21~25°C
Test Band :	2.4GHz Mid	Relative Humidity :	58~61%
Test Channel :	06	Test Engineer :	AC Chang

WLAN 802.11g Channel 06

100kHz PSD reference Level

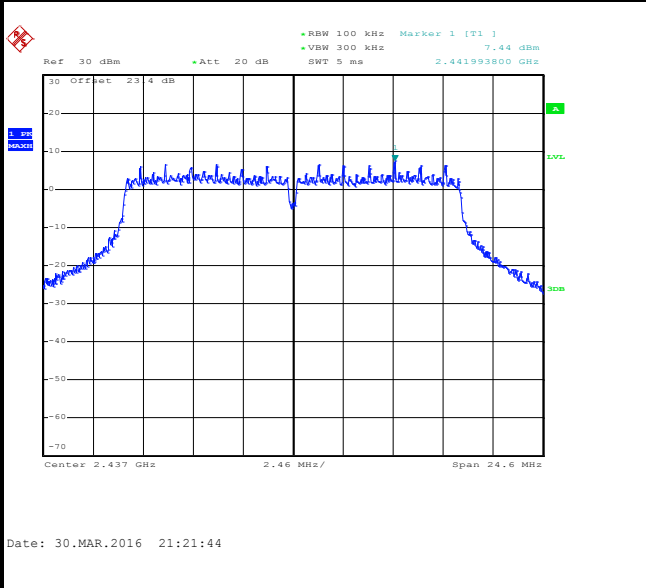

Spurious Emission 30MHz~3GHz

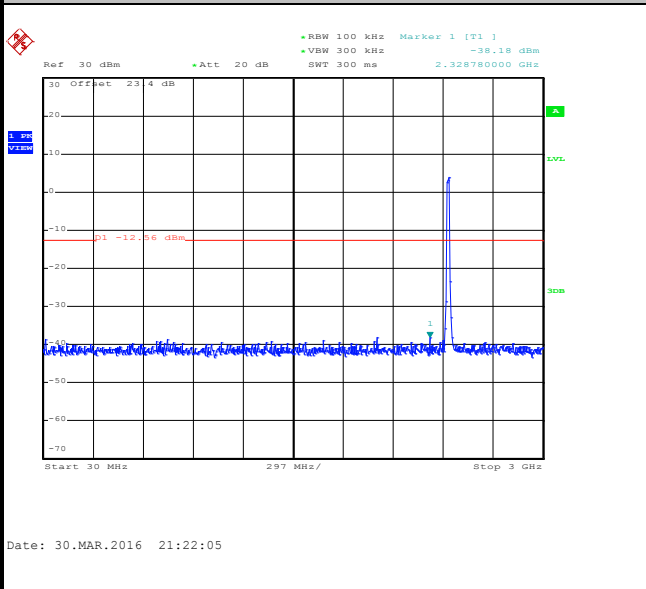

Spurious Emission 2GHz~25GHz

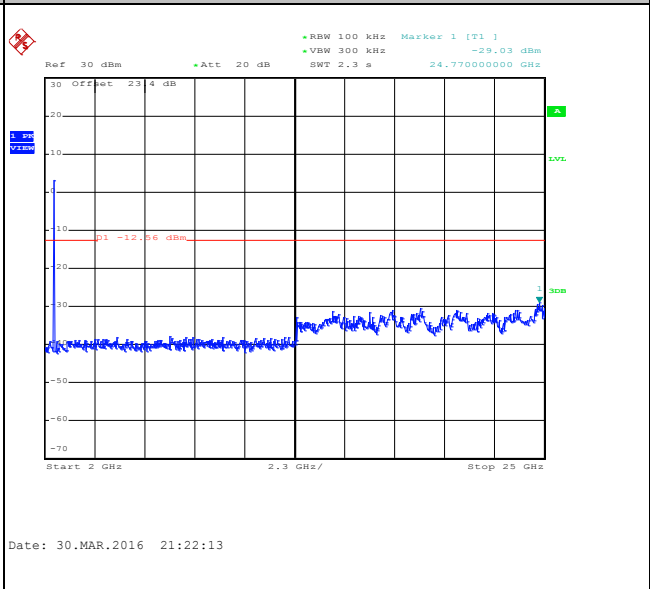



Number of TX :	2	Ant. :	1
Test Mode :	802.11g	Temperature :	21~25°C
Test Band :	2.4GHz High	Relative Humidity :	58~61%
Test Channel :	11	Test Engineer :	AC Chang

WLAN 802.11g Channel 11

100kHz PSD reference Level

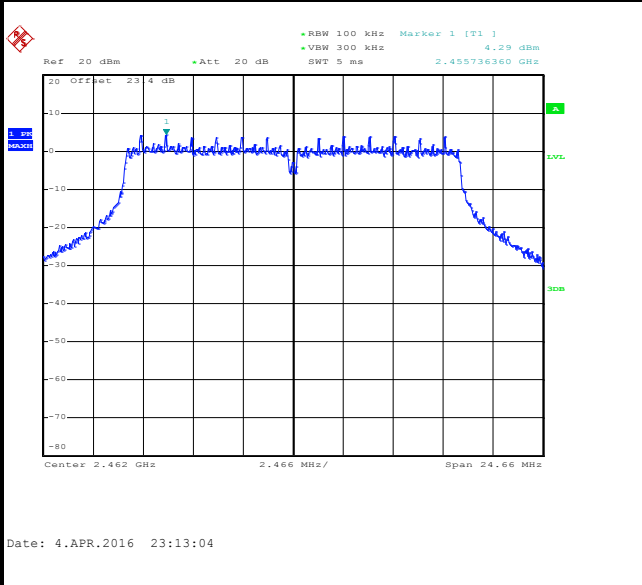

High Channel Plot

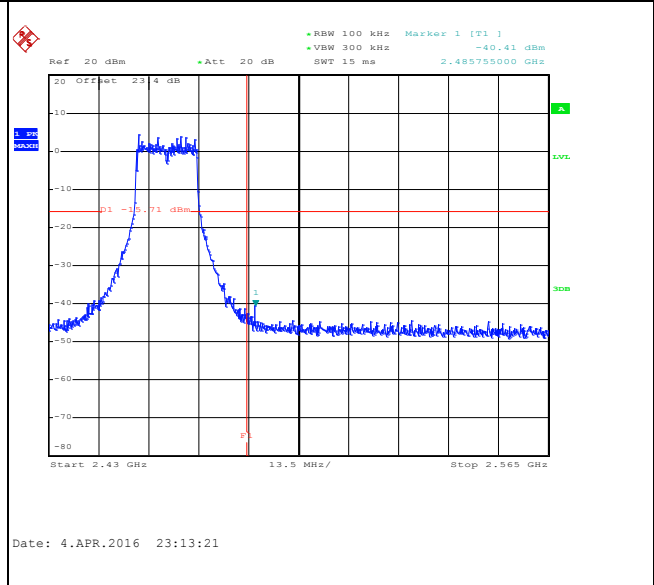

Spurious Emission 30MHz~3GHz

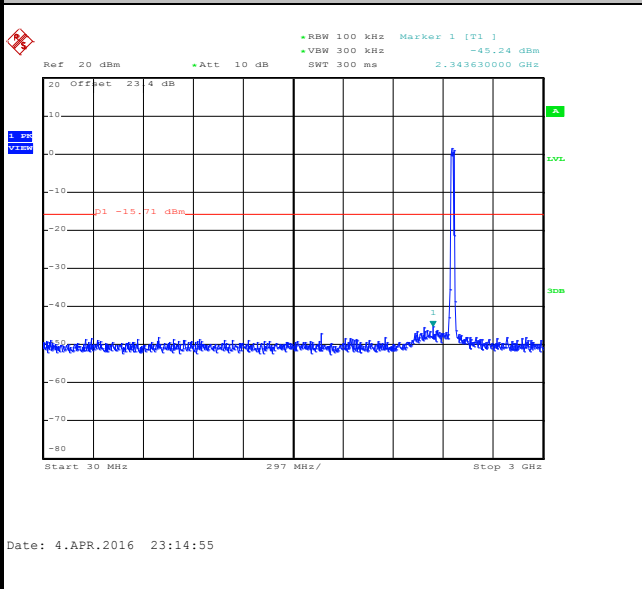

Spurious Emission 2GHz~25GHz

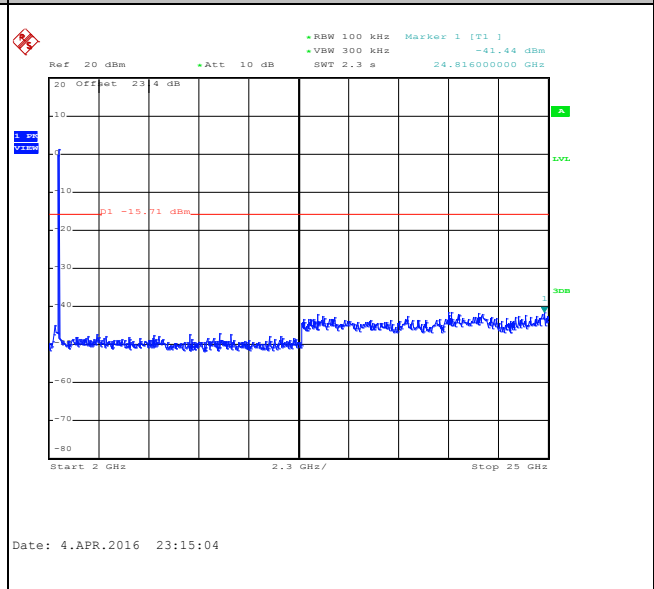



Number of TX :	2	Ant. :	1
Test Mode :	802.11n HT20	Temperature :	21~25°C
Test Band :	2.4GHz Low	Relative Humidity :	58~61%
Test Channel :	01	Test Engineer :	AC Chang

WLAN 802.11n HT20 Channel 01

100kHz PSD reference Level

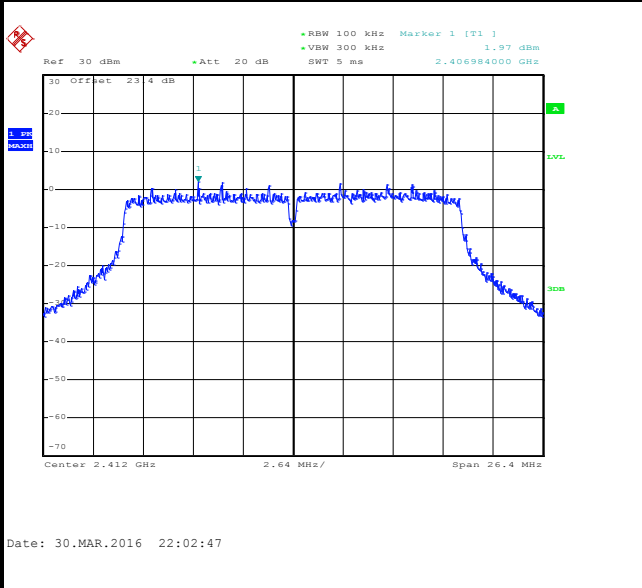

Low Channel Plot

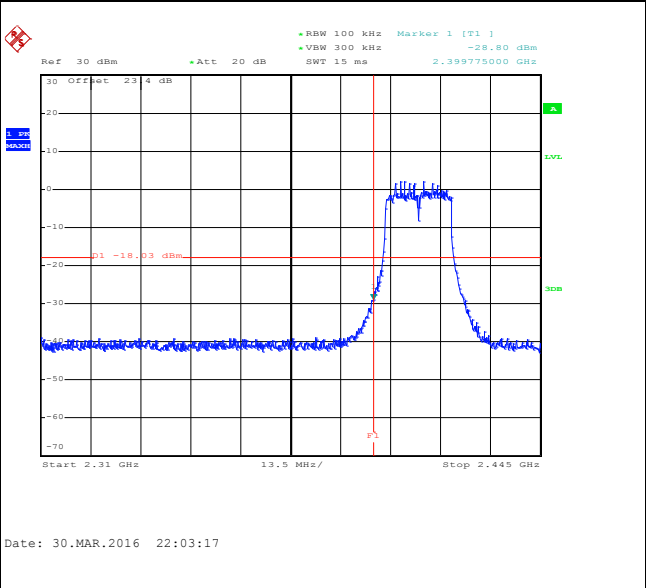

Spurious Emission 30MHz~3GHz

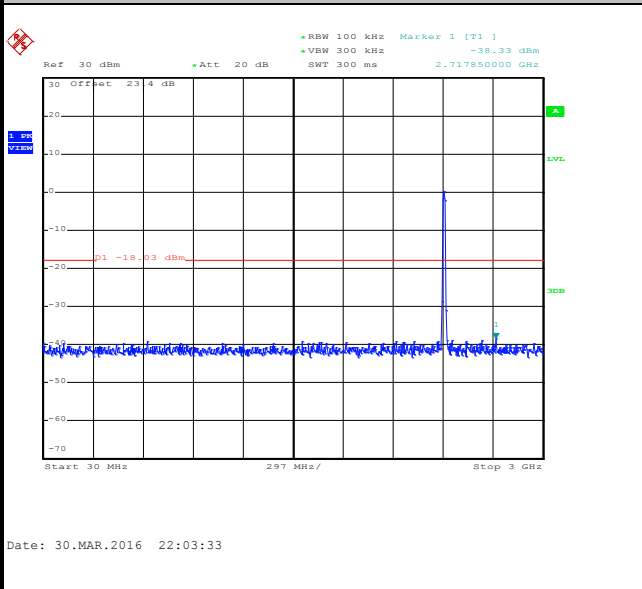

Spurious Emission 2GHz~25GHz

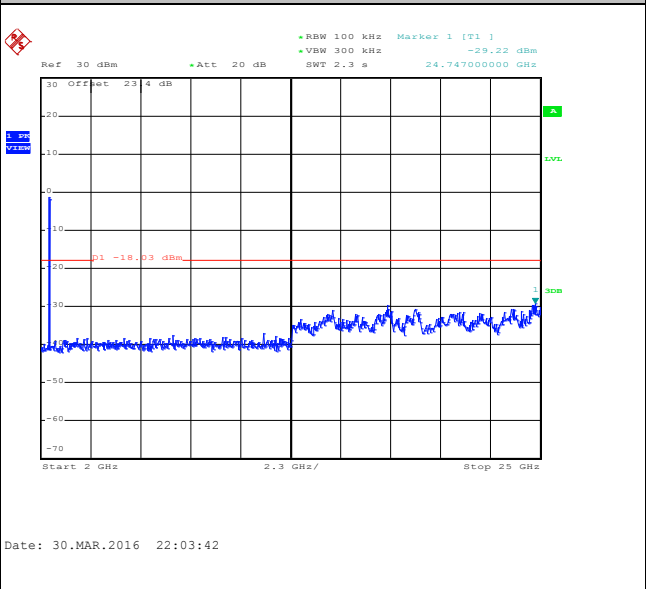



Number of TX :	2	Ant. :	1
Test Mode :	802.11n HT20	Temperature :	21~25°C
Test Band :	2.4GHz Mid	Relative Humidity :	58~61%
Test Channel :	06	Test Engineer :	AC Chang

WLAN 802.11n HT20 Channel 06

100kHz PSD reference Level

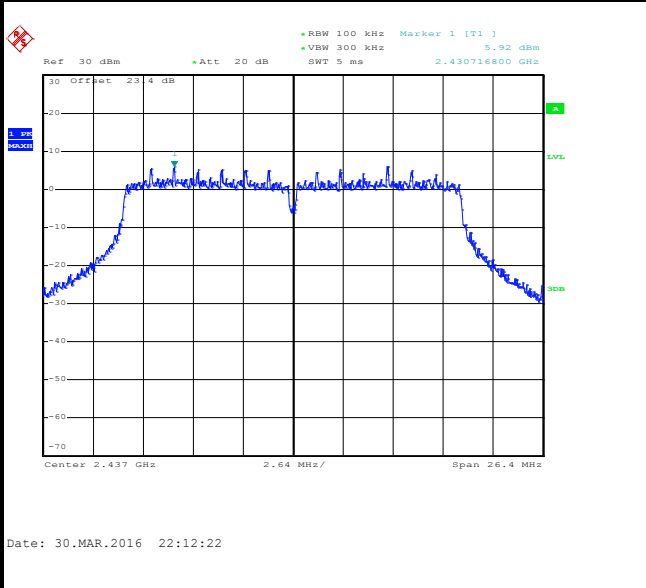

Spurious Emission 30MHz~3GHz

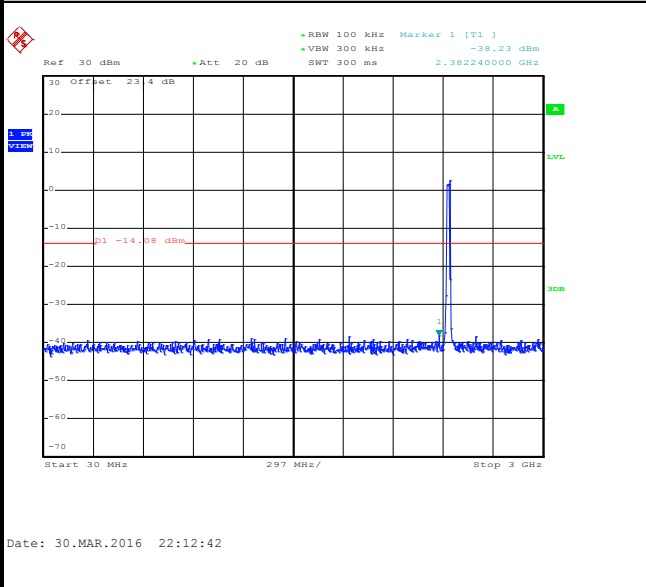

Spurious Emission 2GHz~25GHz

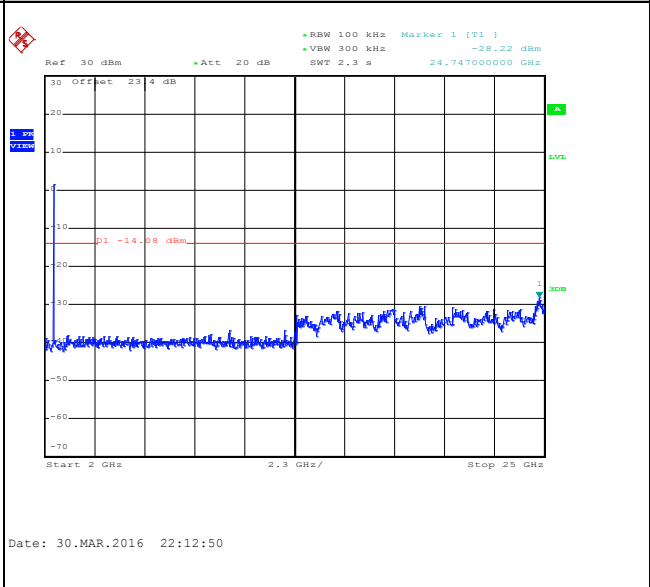



Number of TX :	2	Ant. :	1
Test Mode :	802.11n HT20	Temperature :	21~25°C
Test Band :	2.4GHz High	Relative Humidity :	58~61%
Test Channel :	11	Test Engineer :	AC Chang

WLAN 802.11n HT20 Channel 11

100kHz PSD reference Level

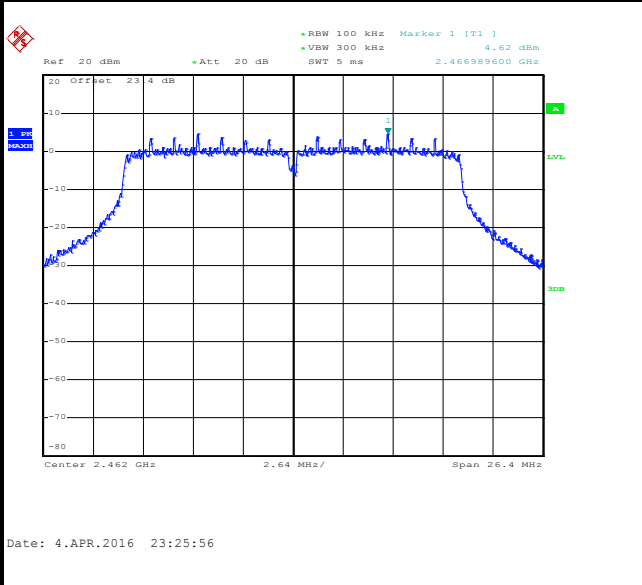

High Channel Plot

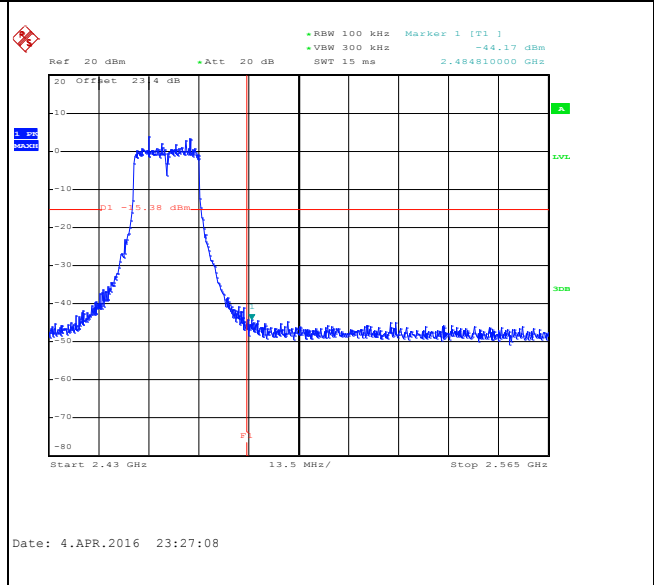

Spurious Emission 30MHz~3GHz

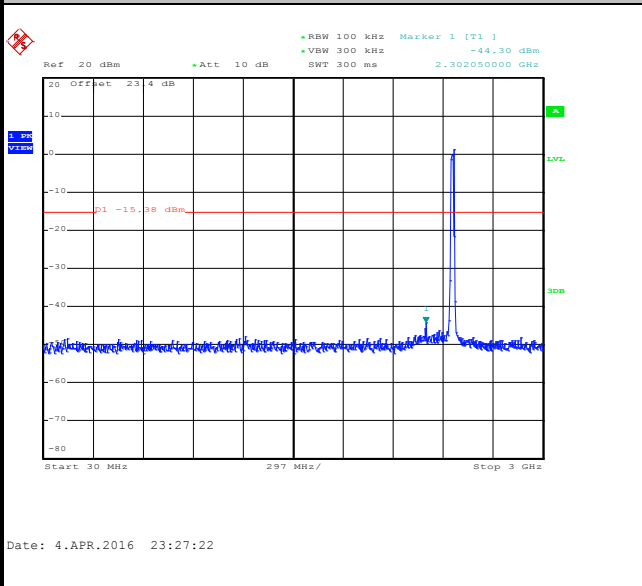

Spurious Emission 2GHz~25GHz

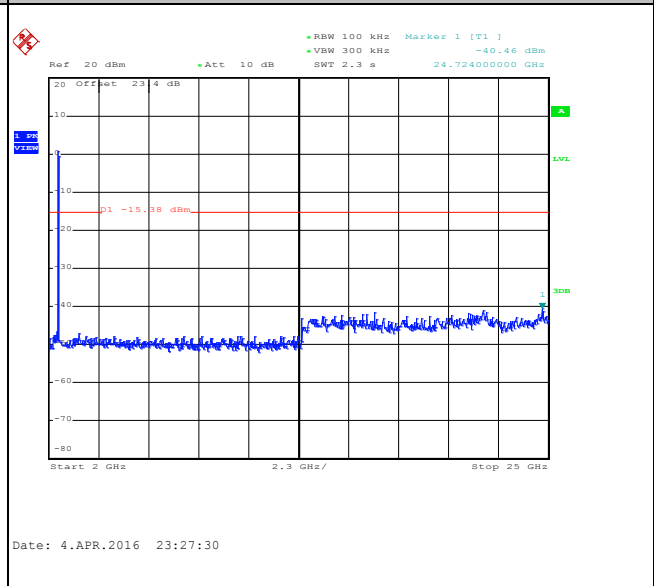



Number of TX :	2	Ant. :	1
Test Mode :	802.11n HT40	Temperature :	21~25°C
Test Band :	2.4GHz Low	Relative Humidity :	58~61%
Test Channel :	03	Test Engineer :	AC Chang

WLAN 802.11n HT40 Channel 03

100kHz PSD reference Level

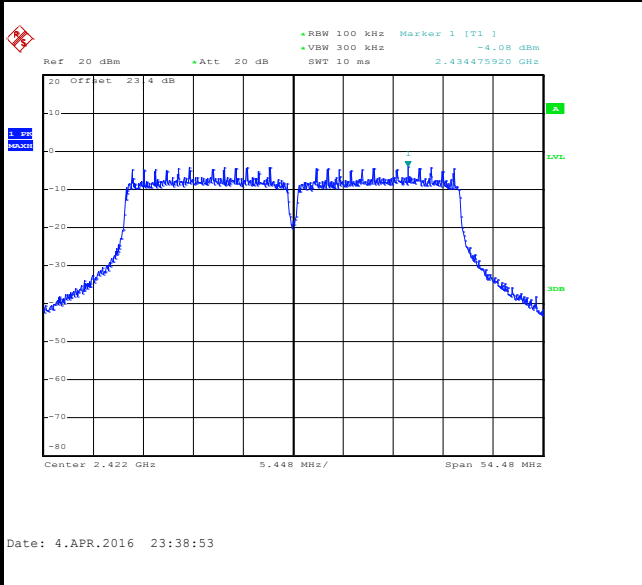

Low Channel Plot

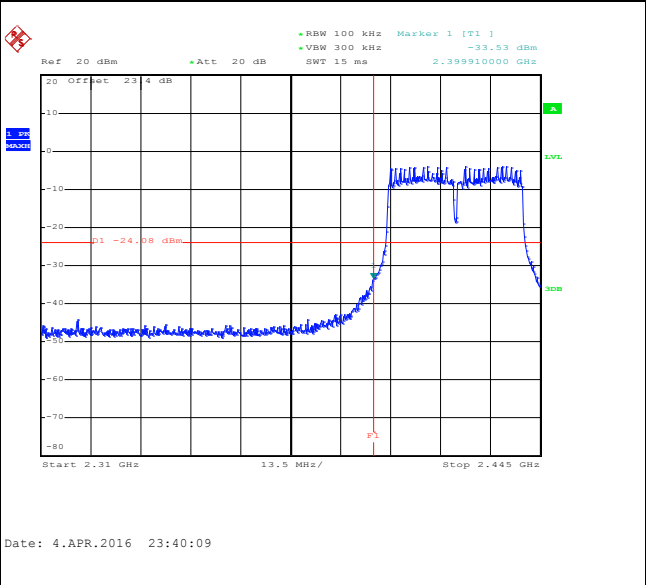

Spurious Emission 30MHz~3GHz

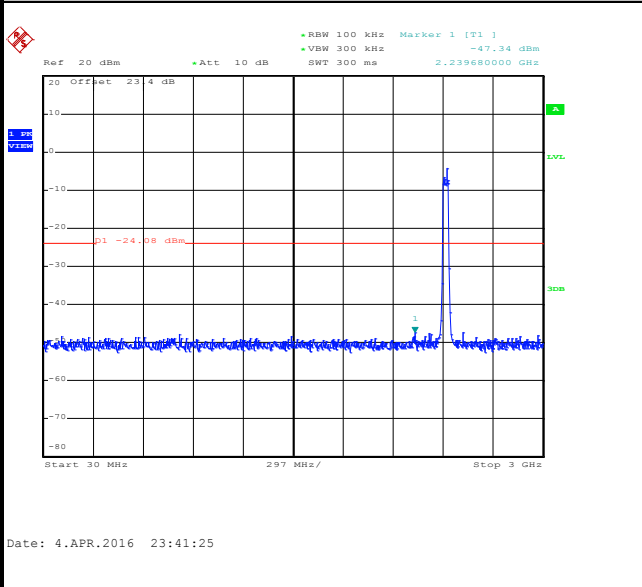

Spurious Emission 2GHz~25GHz

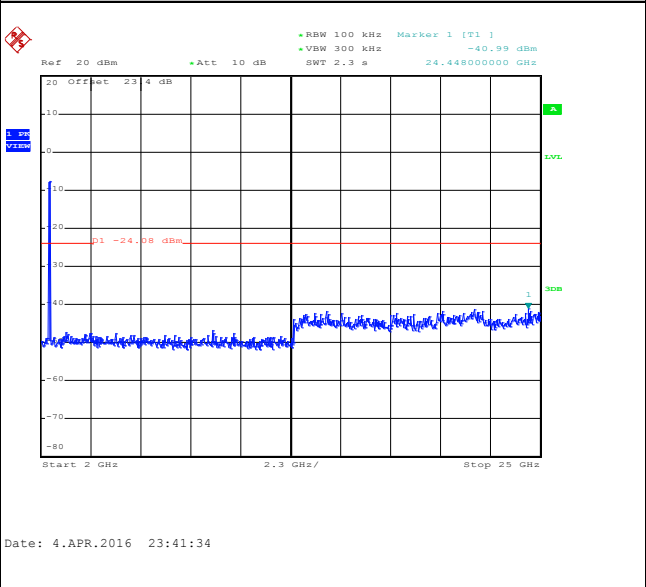



Number of TX :	2	Ant. :	1
Test Mode :	802.11n HT40	Temperature :	21~25°C
Test Band :	2.4GHz Mid	Relative Humidity :	58~61%
Test Channel :	06	Test Engineer :	AC Chang

WLAN 802.11n HT40 Channel 06

100kHz PSD reference Level

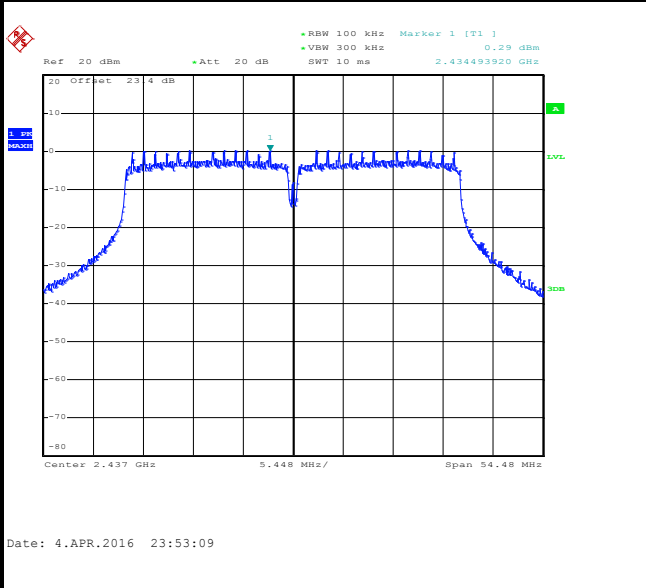

Spurious Emission 30MHz~3GHz

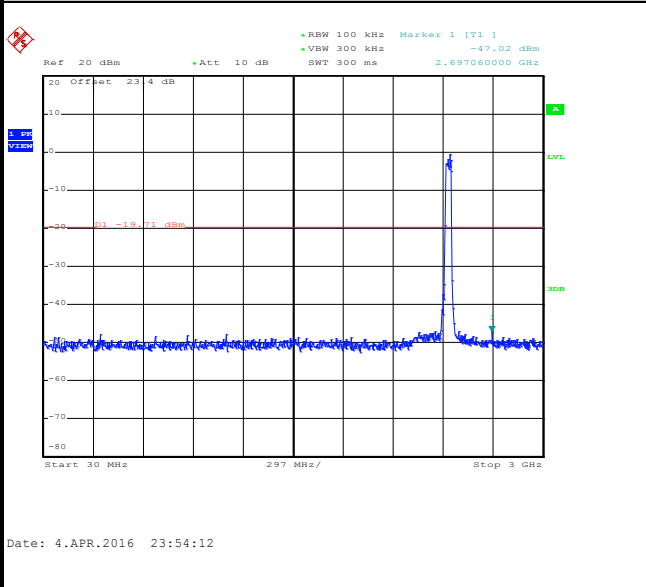

Spurious Emission 2GHz~25GHz

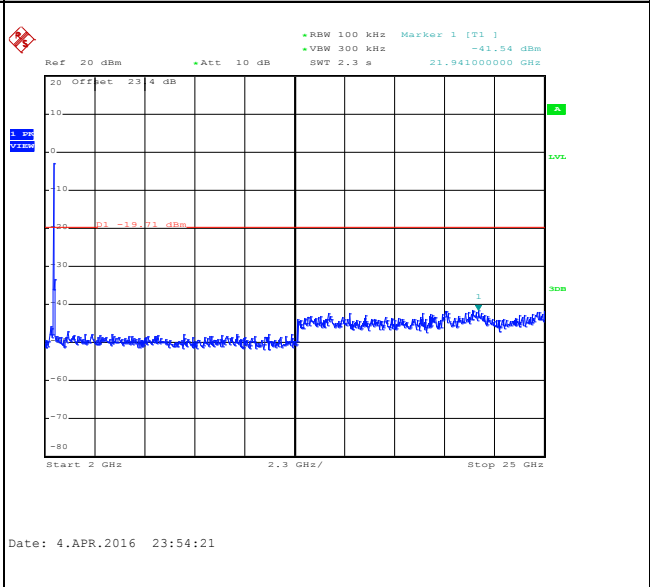



Number of TX :	2	Ant. :	1
Test Mode :	802.11n HT40	Temperature :	21~25°C
Test Band :	2.4GHz High	Relative Humidity :	58~61%
Test Channel :	09	Test Engineer :	AC Chang

WLAN 802.11n HT40 Channel 09

100kHz PSD reference Level

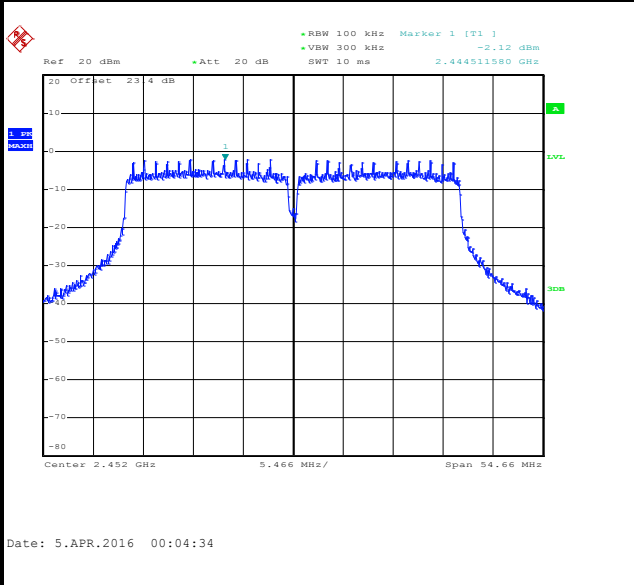

High Channel Plot

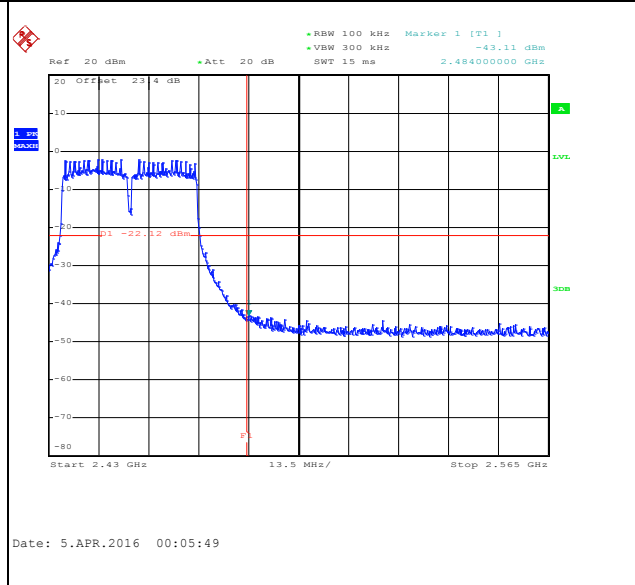

Spurious Emission 30MHz~3GHz

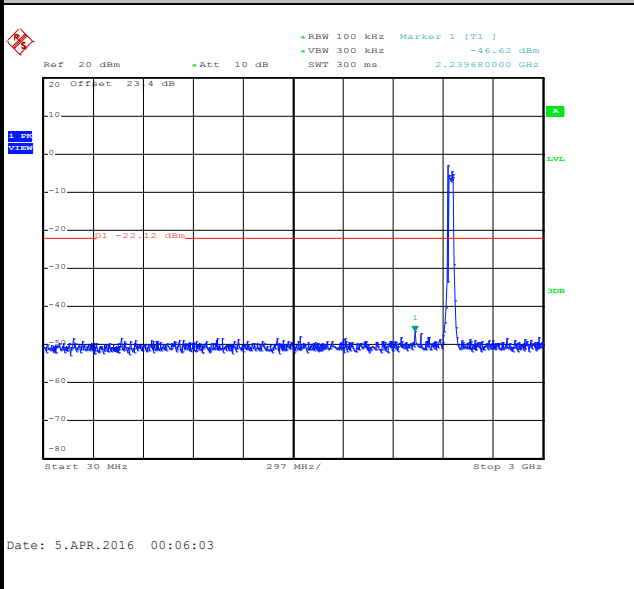

Spurious Emission 2GHz~25GHz

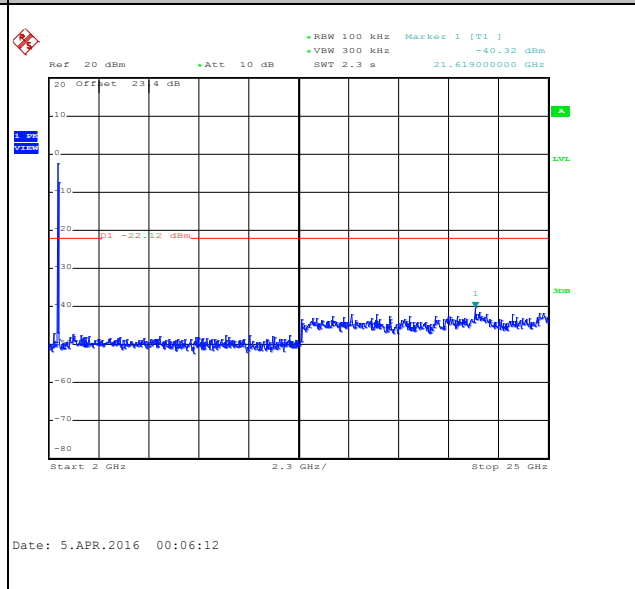



Number of TX = 2, Ant. 2 (Measured)

Number of TX :	2	Ant. :	2
Test Mode :	802.11b	Temperature :	21~25°C
Test Band :	2.4GHz Low	Relative Humidity :	58~61%
Test Channel :	01	Test Engineer :	AC Chang

WLAN 802.11b Channel 01

100kHz PSD reference Level

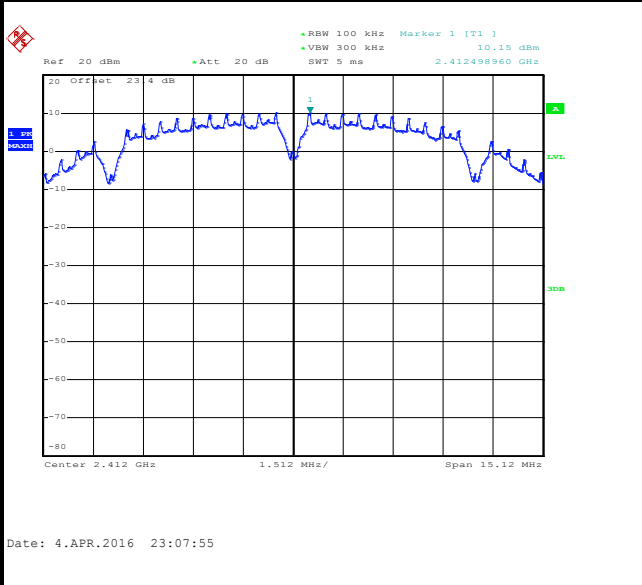

Low Channel Plot

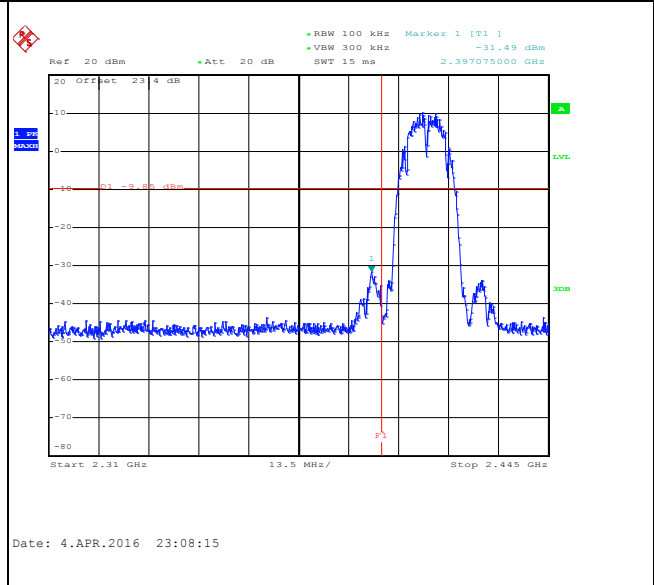

Spurious Emission 30MHz~3GHz

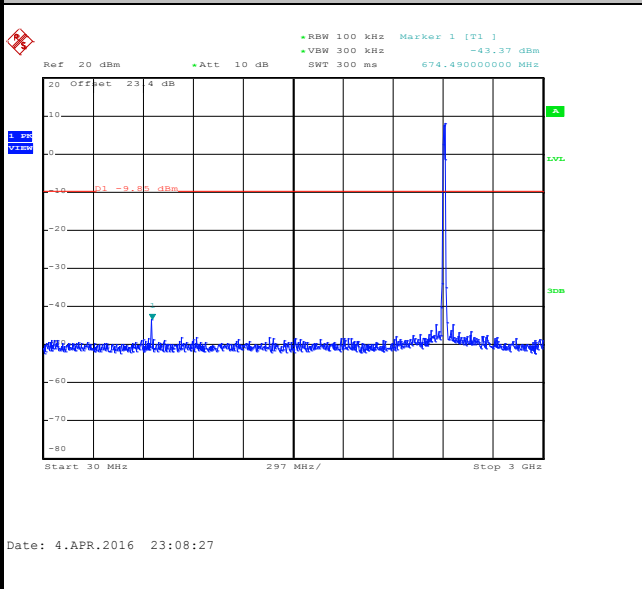

Spurious Emission 2GHz~25GHz

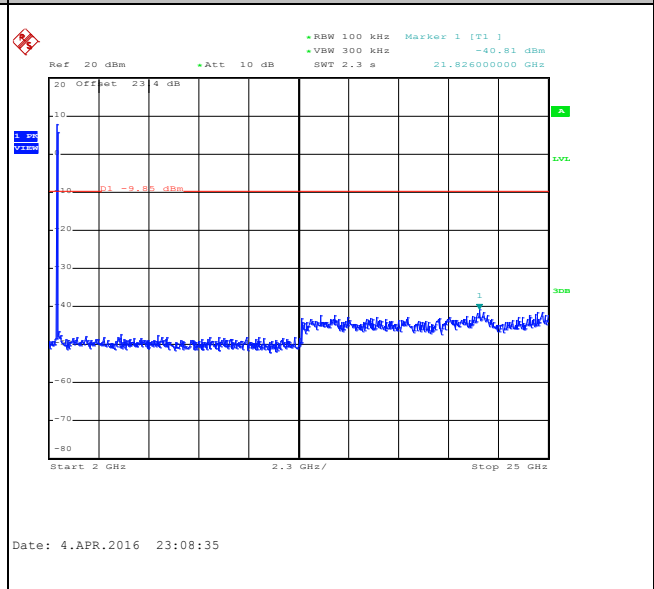



Number of TX :	2	Ant. :	2
Test Mode :	802.11b	Temperature :	21~25°C
Test Band :	2.4GHz Mid	Relative Humidity :	58~61%
Test Channel :	06	Test Engineer :	AC Chang

WLAN 802.11b Channel 06

100kHz PSD reference Level

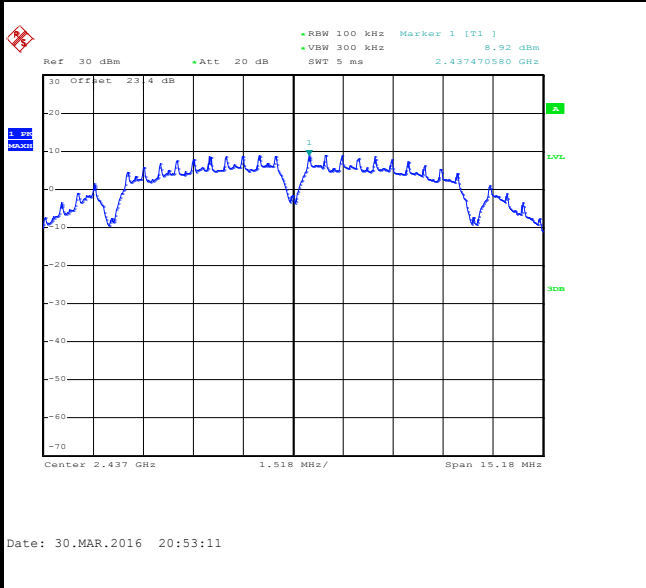

Spurious Emission 30MHz~3GHz

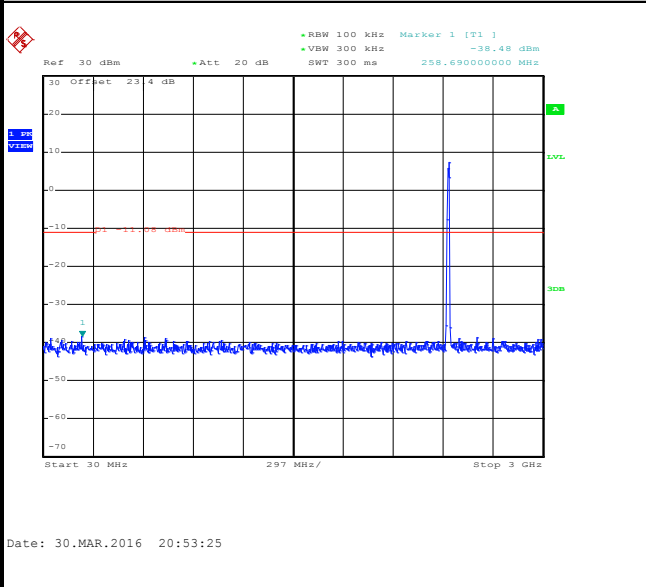

Spurious Emission 2GHz~25GHz

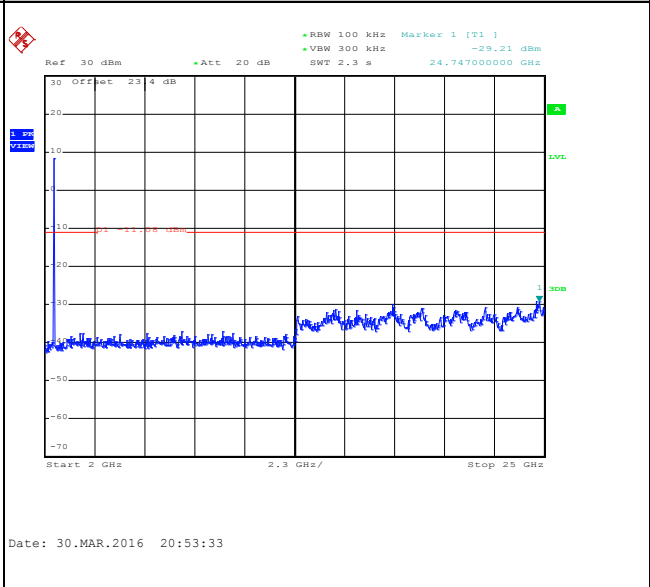



Number of TX :	2	Ant. :	2
Test Mode :	802.11b	Temperature :	21~25°C
Test Band :	2.4GHz High	Relative Humidity :	58~61%
Test Channel :	11	Test Engineer :	AC Chang

WLAN 802.11b Channel 11

100kHz PSD reference Level

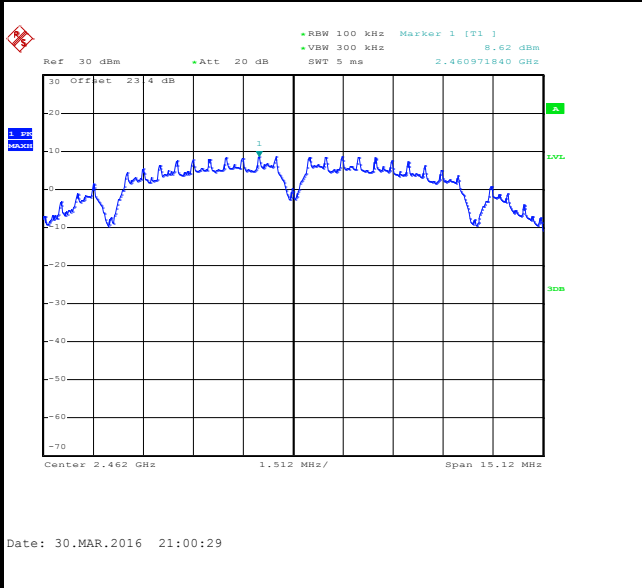

High Channel Plot

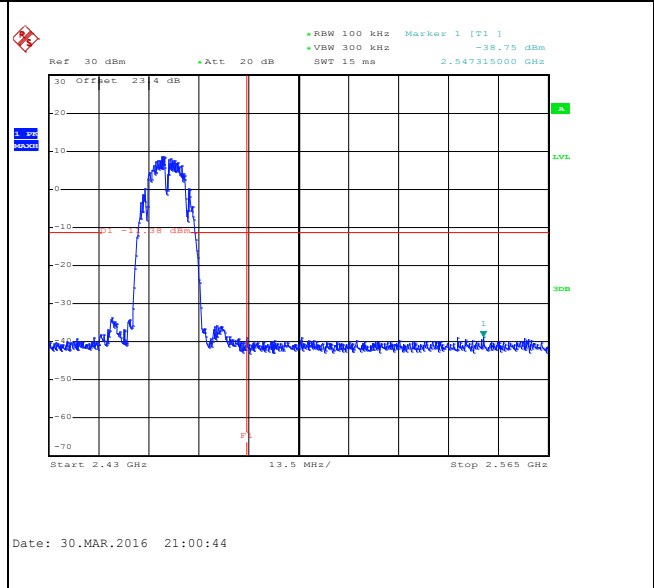

Spurious Emission 30MHz~3GHz

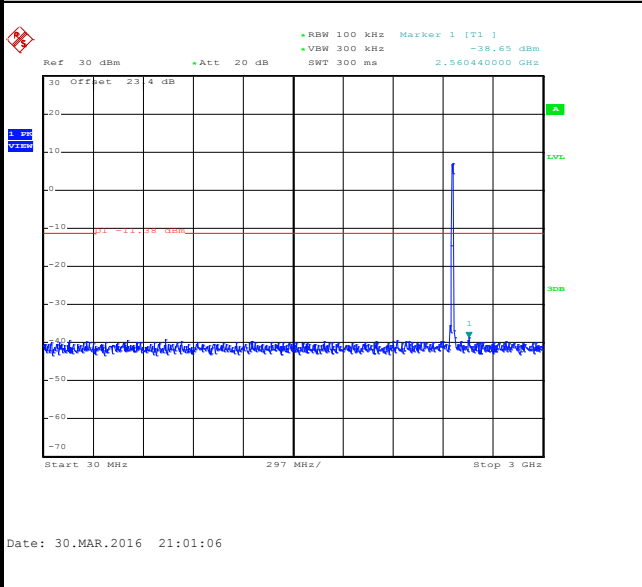

Spurious Emission 2GHz~25GHz

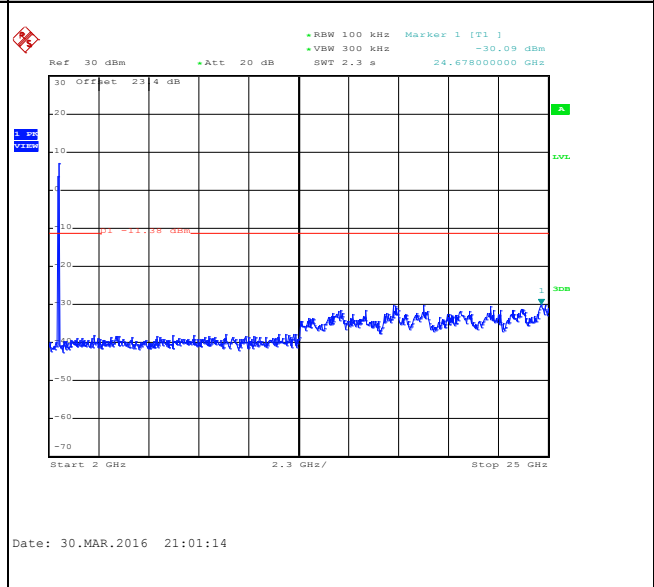



Number of TX :	2	Ant. :	2
Test Mode :	802.11g	Temperature :	21~25°C
Test Band :	2.4GHz Low	Relative Humidity :	58~61%
Test Channel :	01	Test Engineer :	AC Chang

WLAN 802.11g Channel 01

100kHz PSD reference Level

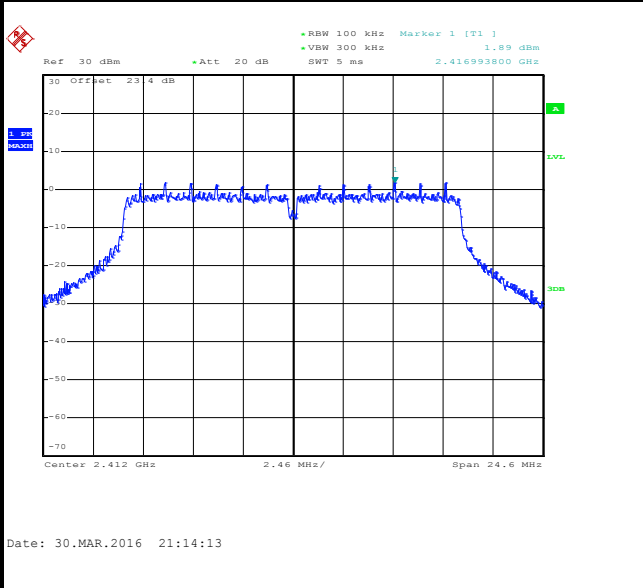

Low Channel Plot

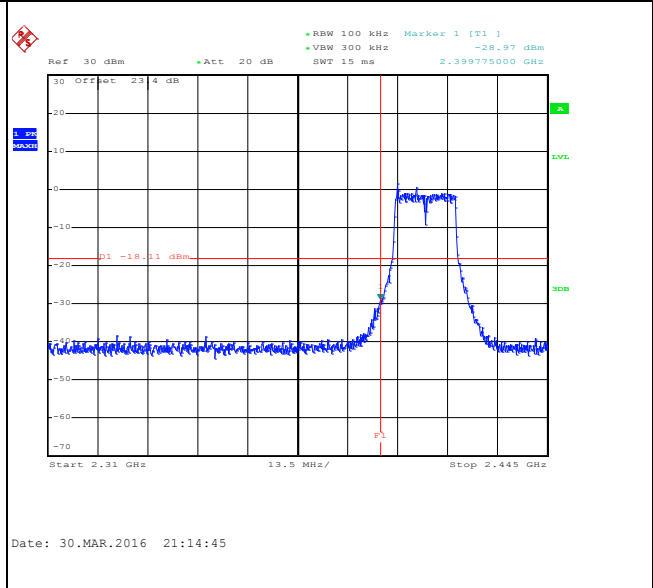

Spurious Emission 30MHz~3GHz

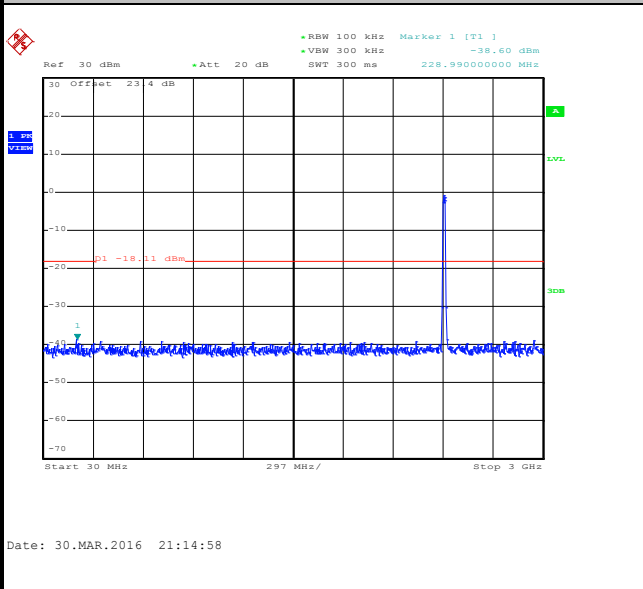

Spurious Emission 2GHz~25GHz

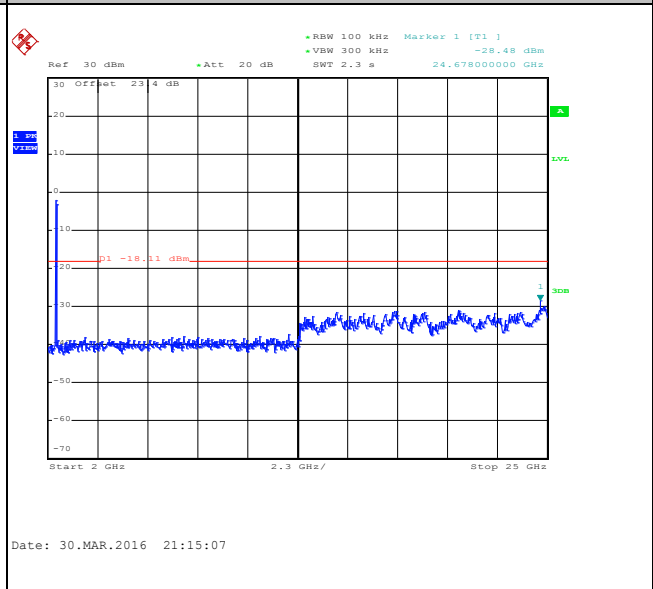



Number of TX :	2	Ant. :	2
Test Mode :	802.11g	Temperature :	21~25°C
Test Band :	2.4GHz Mid	Relative Humidity :	58~61%
Test Channel :	06	Test Engineer :	AC Chang

WLAN 802.11g Channel 06

100kHz PSD reference Level

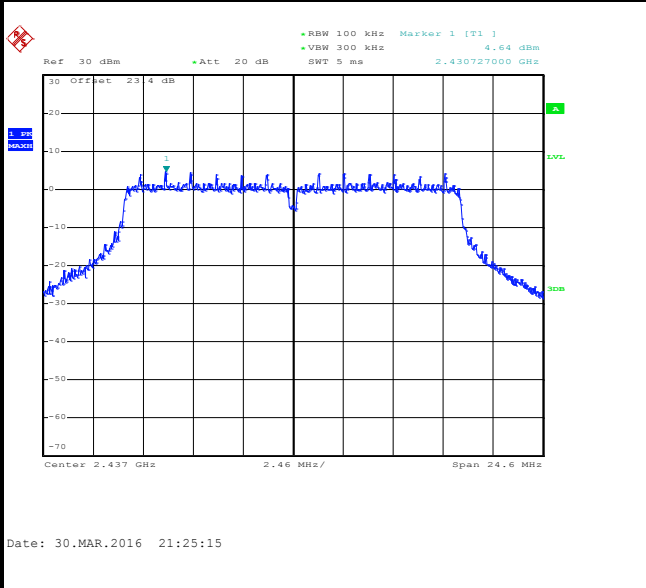

Spurious Emission 30MHz~3GHz

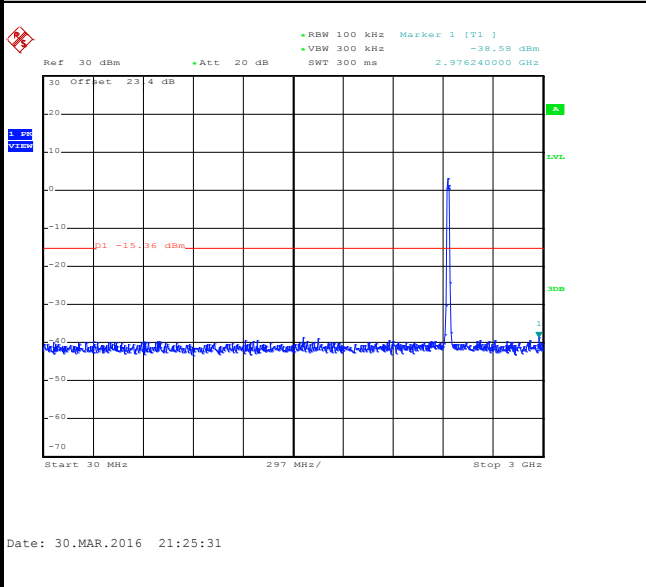

Spurious Emission 2GHz~25GHz

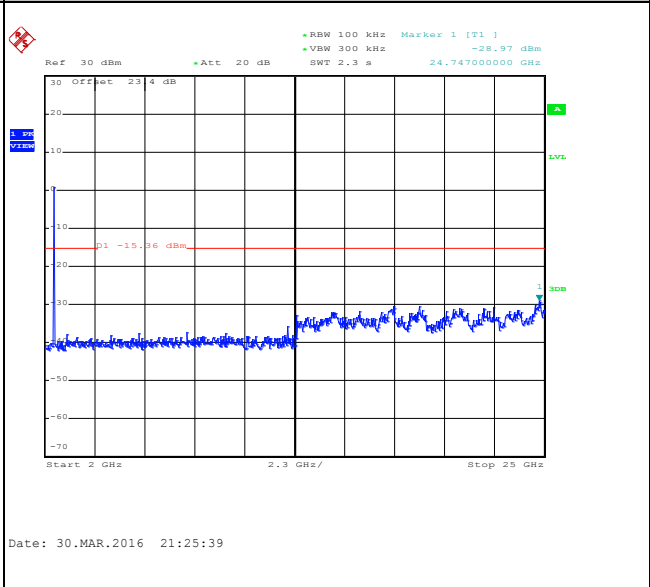



Number of TX :	2	Ant. :	2
Test Mode :	802.11g	Temperature :	21~25°C
Test Band :	2.4GHz High	Relative Humidity :	58~61%
Test Channel :	11	Test Engineer :	AC Chang

WLAN 802.11g Channel 11

100kHz PSD reference Level

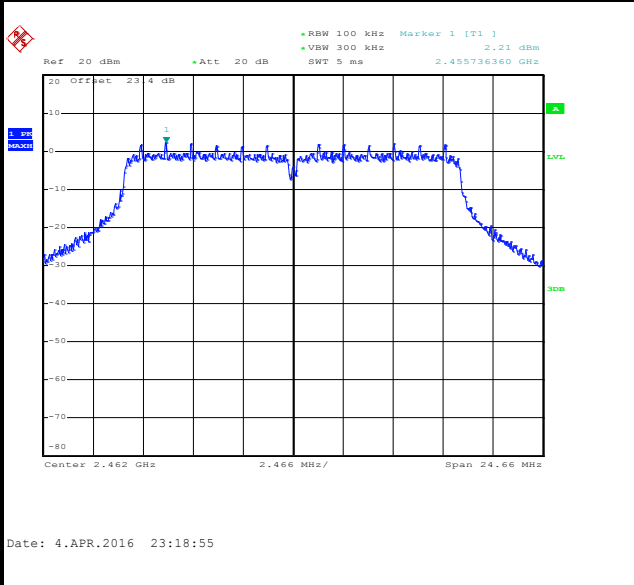

High Channel Plot

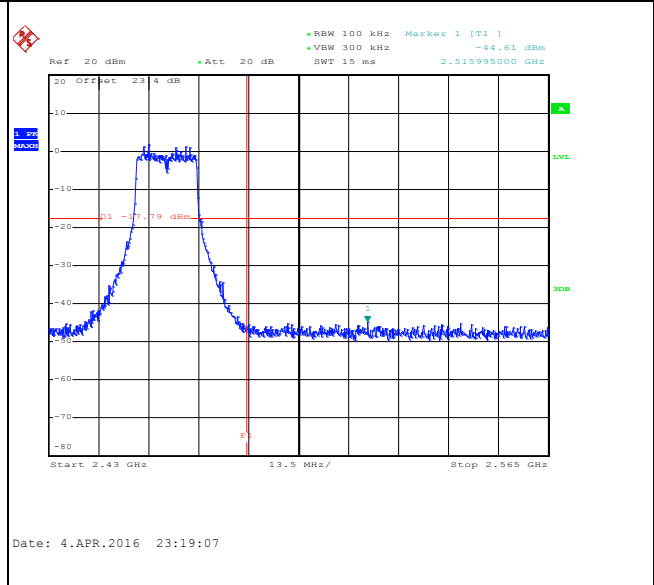

Spurious Emission 30MHz~3GHz

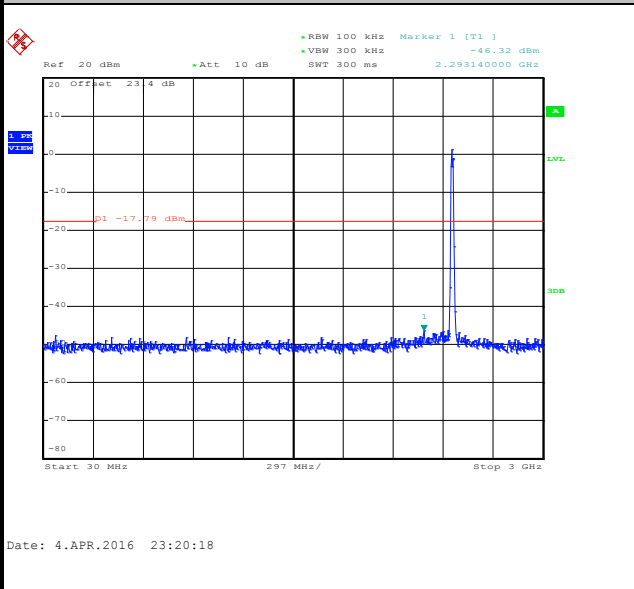

Spurious Emission 2GHz~25GHz

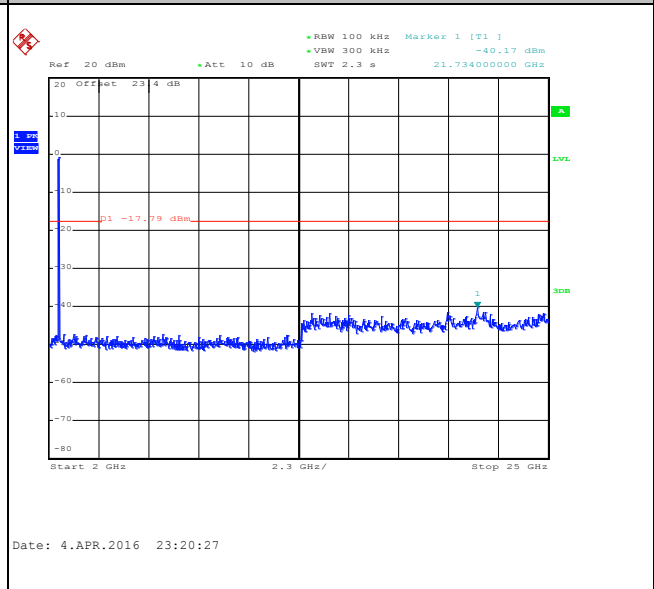



Number of TX :	2	Ant. :	2
Test Mode :	802.11n HT20	Temperature :	21~25°C
Test Band :	2.4GHz Low	Relative Humidity :	58~61%
Test Channel :	01	Test Engineer :	AC Chang

WLAN 802.11n HT20 Channel 01

100kHz PSD reference Level

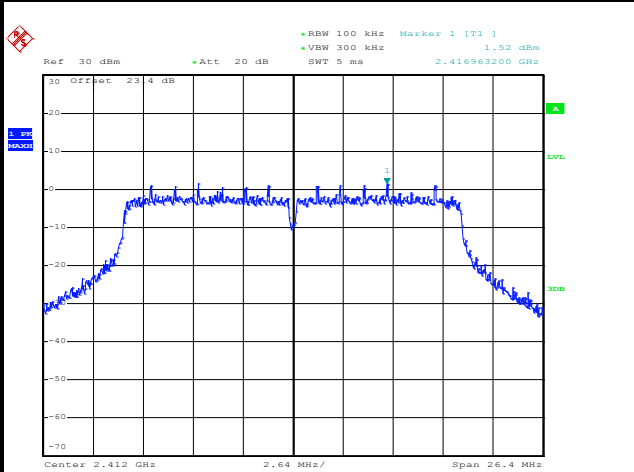

Date: 30.MAR.2016 22:06:39

Low Channel Plot

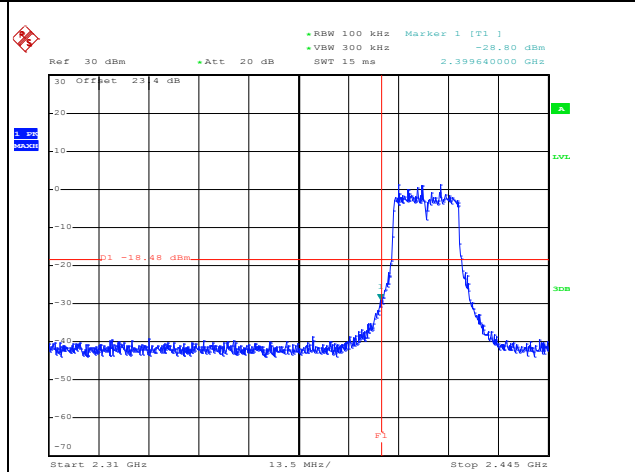

Date: 30.MAR.2016 22:07:44

Spurious Emission 30MHz~3GHz

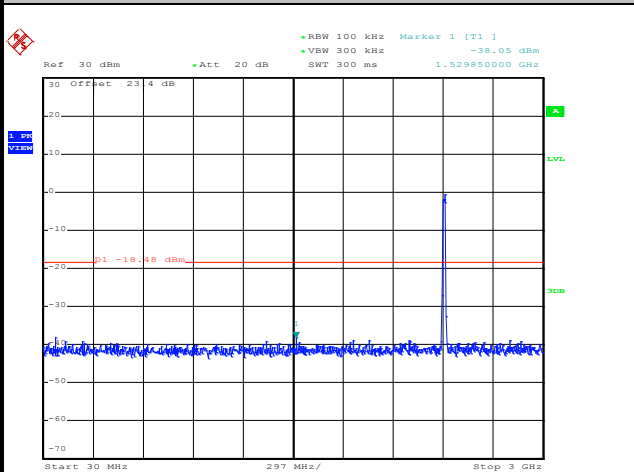

Date: 30.MAR.2016 22:08:11

Spurious Emission 2GHz~25GHz

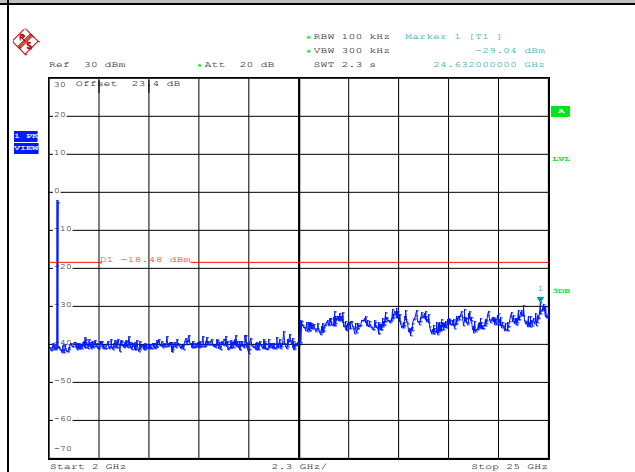

Date: 30.MAR.2016 22:08:19



Number of TX :	2	Ant. :	2
Test Mode :	802.11n HT20	Temperature :	21~25°C
Test Band :	2.4GHz Mid	Relative Humidity :	58~61%
Test Channel :	06	Test Engineer :	AC Chang

WLAN 802.11n HT20 Channel 06

100kHz PSD reference Level

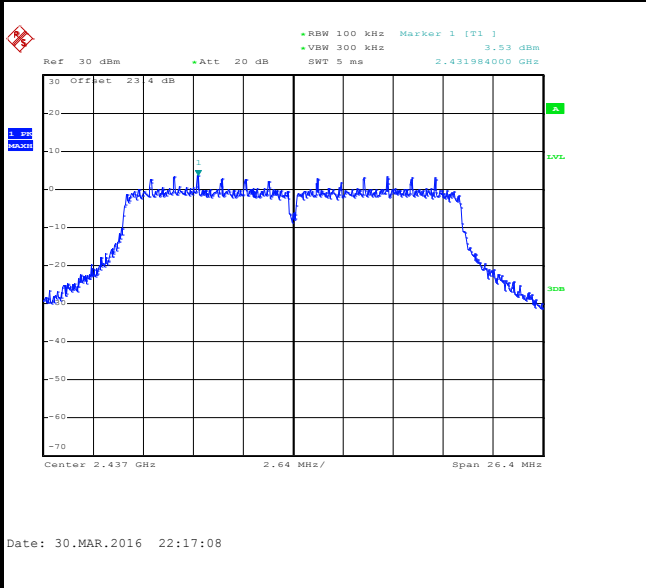

Spurious Emission 30MHz~3GHz

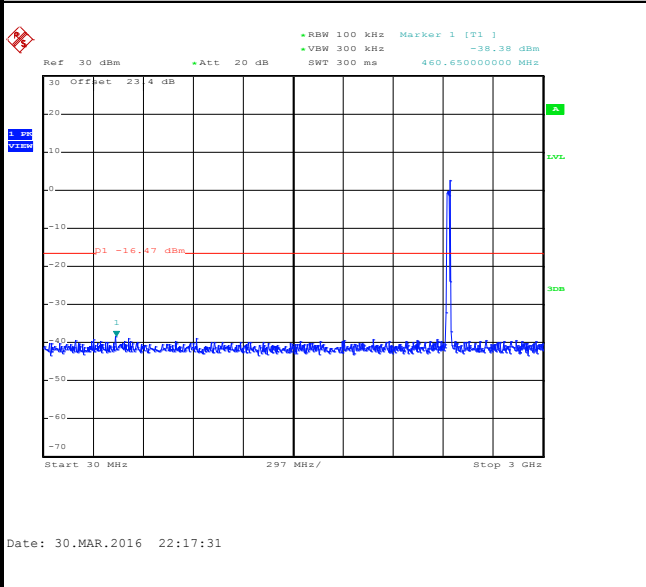

Spurious Emission 2GHz~25GHz

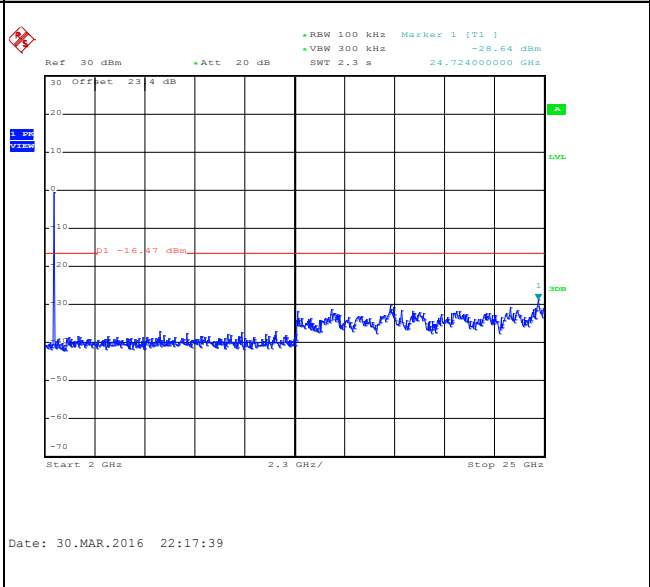



Number of TX :	2	Ant. :	2
Test Mode :	802.11n HT20	Temperature :	21~25°C
Test Band :	2.4GHz High	Relative Humidity :	58~61%
Test Channel :	11	Test Engineer :	AC Chang

WLAN 802.11n HT20 Channel 11

100kHz PSD reference Level

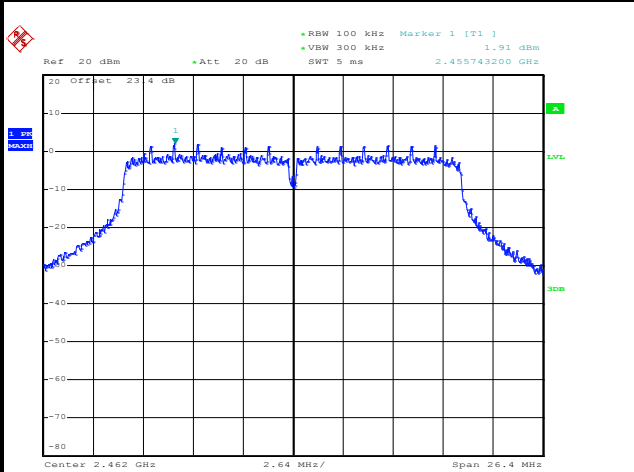

Date: 4.APR.2016 23:31:52

High Channel Plot

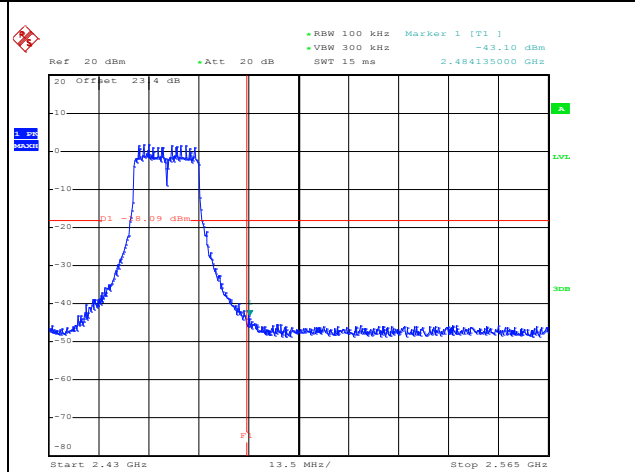

Date: 4.APR.2016 23:32:52

Spurious Emission 30MHz~3GHz

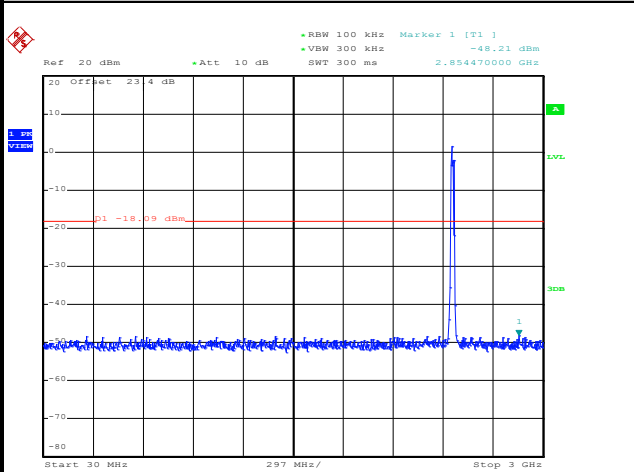

Date: 4.APR.2016 23:33:06

Spurious Emission 2GHz~25GHz

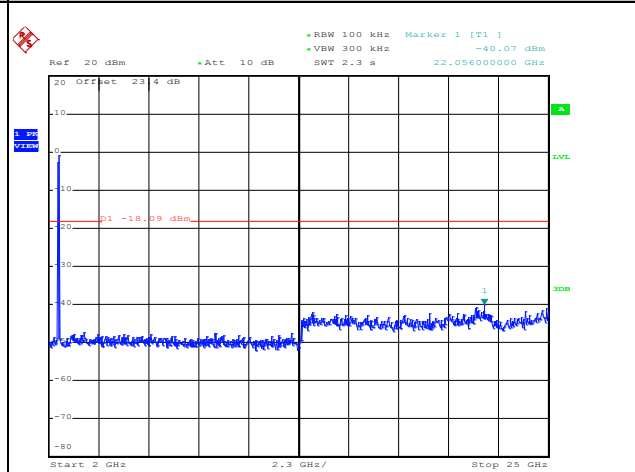

Date: 4.APR.2016 23:33:15



Number of TX :	2	Ant. :	2
Test Mode :	802.11n HT40	Temperature :	21~25°C
Test Band :	2.4GHz Low	Relative Humidity :	58~61%
Test Channel :	03	Test Engineer :	AC Chang

WLAN 802.11n HT40 Channel 03

100kHz PSD reference Level

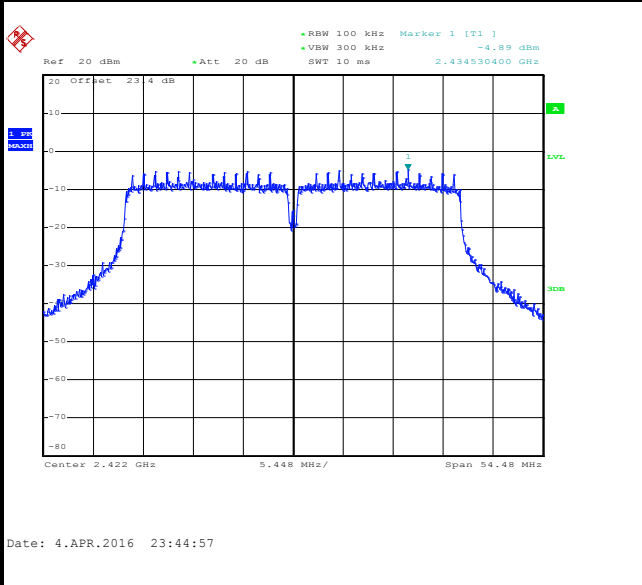

Low Channel Plot

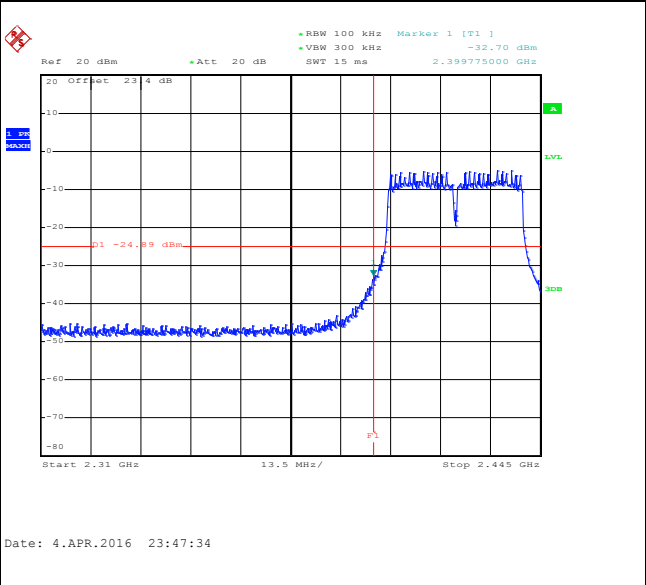

Spurious Emission 30MHz~3GHz

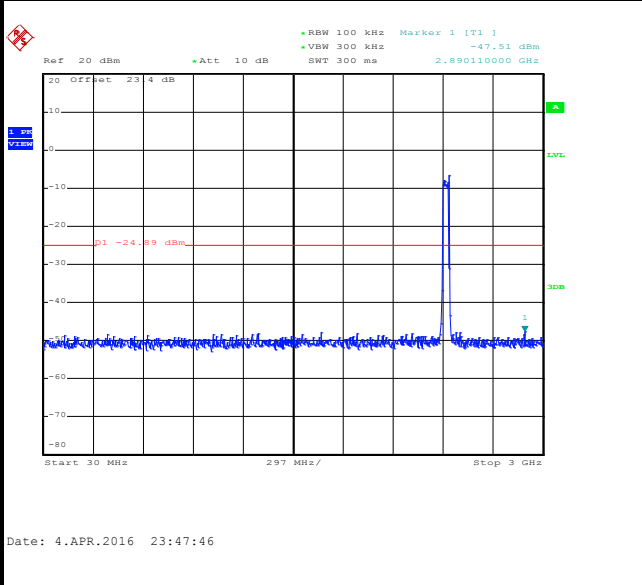

Spurious Emission 2GHz~25GHz

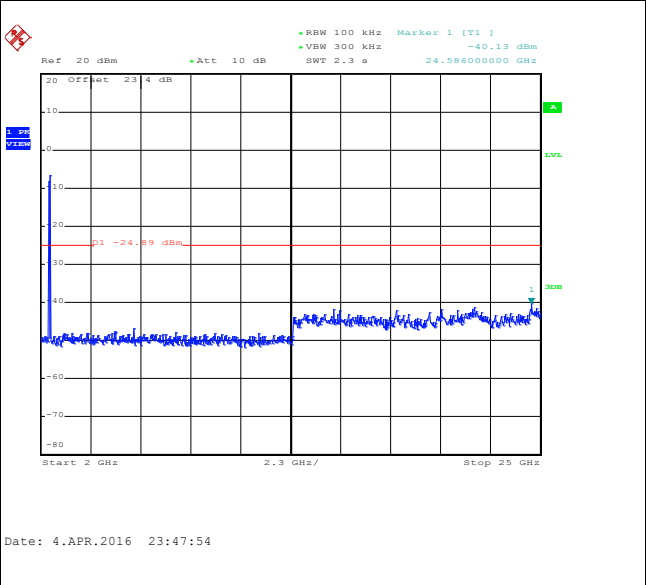



Number of TX :	2	Ant. :	2
Test Mode :	802.11n HT40	Temperature :	21~25°C
Test Band :	2.4GHz Mid	Relative Humidity :	58~61%
Test Channel :	06	Test Engineer :	AC Chang

WLAN 802.11n HT40 Channel 06

100kHz PSD reference Level

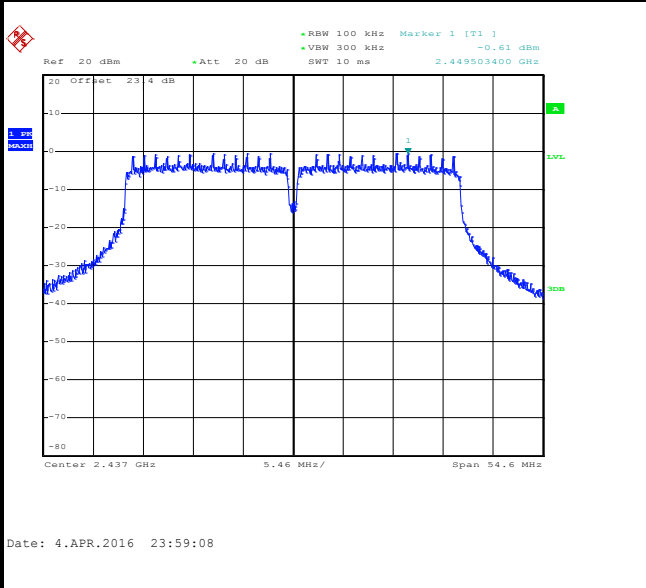

Spurious Emission 30MHz~3GHz

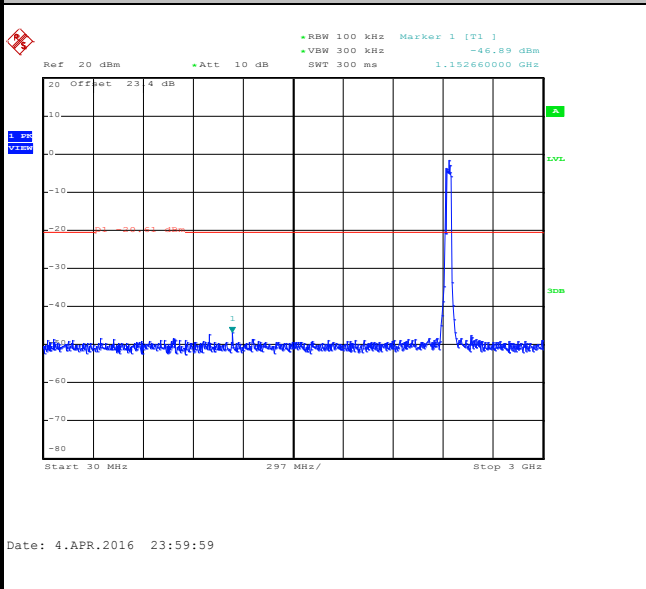

Spurious Emission 2GHz~25GHz

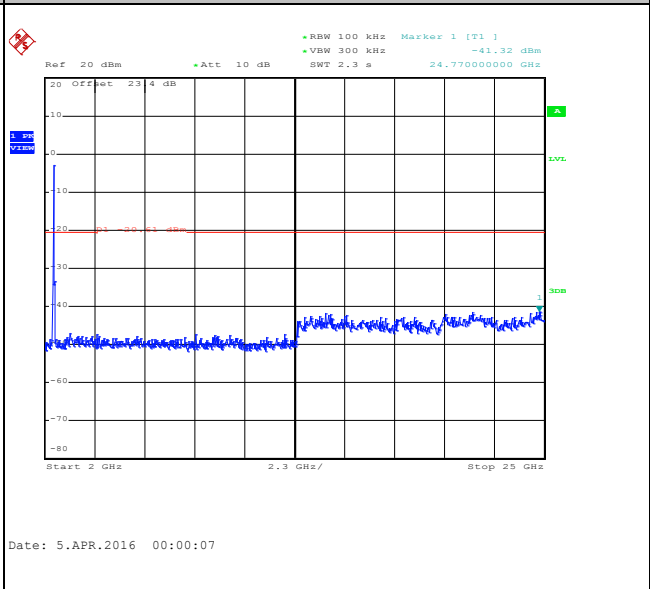



Number of TX :	2	Ant. :	2
Test Mode :	802.11n HT40	Temperature :	21~25°C
Test Band :	2.4GHz High	Relative Humidity :	58~61%
Test Channel :	09	Test Engineer :	AC Chang

WLAN 802.11n HT40 Channel 09

100kHz PSD reference Level

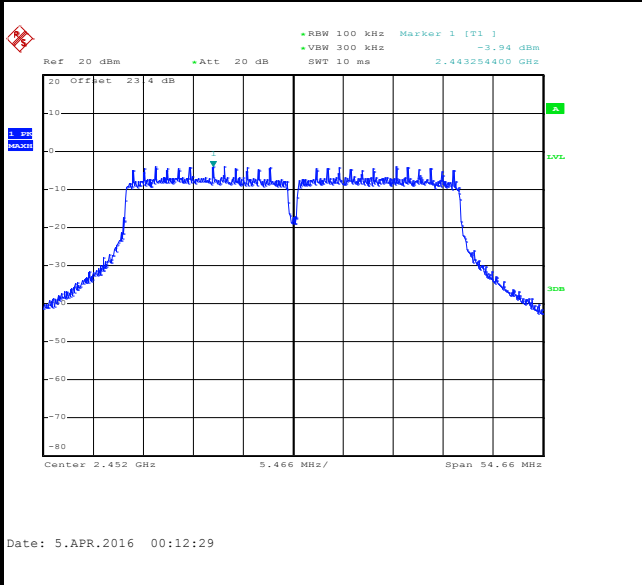

High Channel Plot

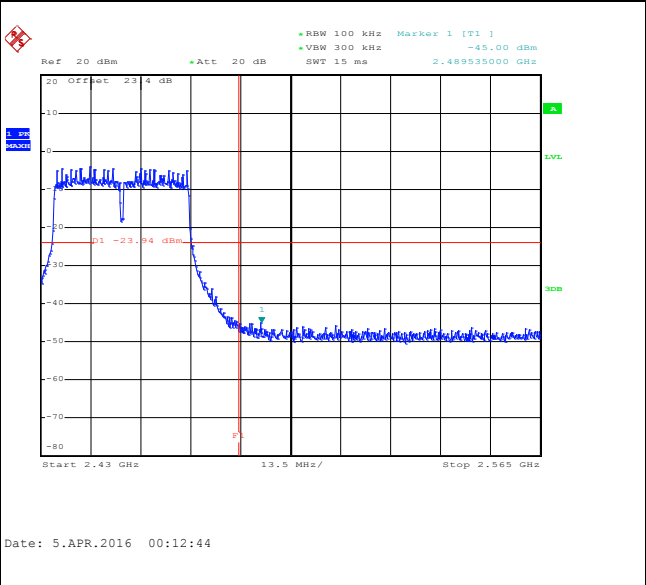

Spurious Emission 30MHz~3GHz

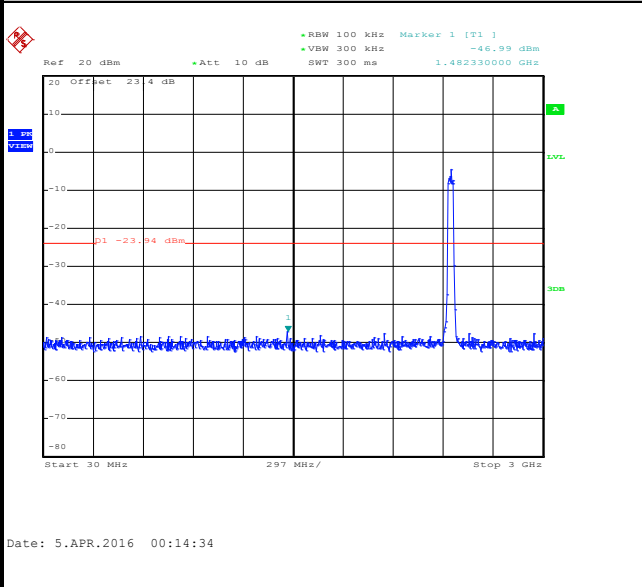

Spurious Emission 2GHz~25GHz

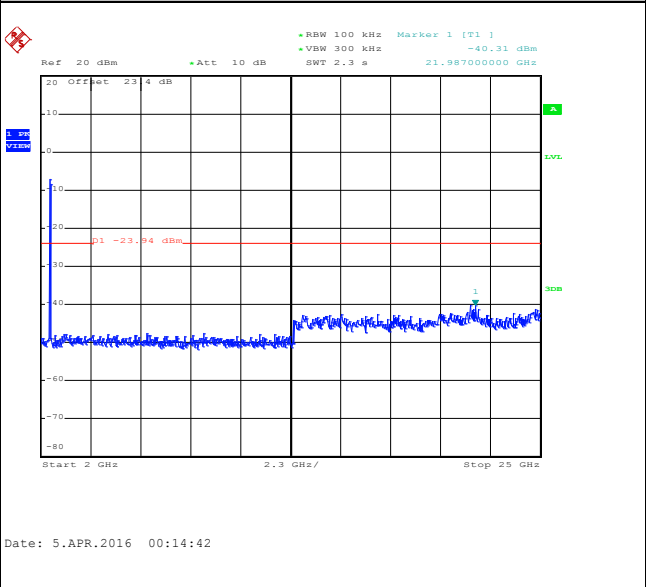



3.5 Radiated Band Edges and Spurious Emission Measurement

3.5.1 Limit of Radiated band edge and Spurious Emission Measurement

In any 100 kHz bandwidth outside the intentional radiator frequency band, all harmonics/spurious must be at least 20 dB below the highest emission level within the authorized band. If the output power of this device was measured by spectrum analyzer, the attenuation under this paragraph shall be 30 dB instead of 20 dB. In addition, radiated emissions which fall in the restricted bands must also comply with the FCC section 15.209 limits as below.

Frequency (MHz)	Field Strength (microvolts/meter)	Measurement Distance (meters)
0.009 – 0.490	2400/F(kHz)	300
0.490 – 1.705	24000/F(kHz)	30
1.705 – 30.0	30	30
30 – 88	100	3
88 – 216	150	3
216 - 960	200	3
Above 960	500	3

3.5.2 Measuring Instruments

The measuring equipment is listed in the section 4 of this test report.



3.5.3 Test Procedure

1. The testing follows FCC KDB Publication No. 558074 D01 DTS Meas. Guidance v03r05.
2. The EUT was arranged to its worst case and then tune the antenna tower (from 1 m to 4 m) and turntable (from 0 degree to 360 degrees) to find the maximum reading. A pre-amp and a high pass filter are used for the test in order to get better signal level.
3. The EUT was placed on a turntable with 0.8 meter for frequency below 1GHz and 1.5 meter for frequency above 1GHz respectively above ground.
4. The EUT was set 3 meters from the interference receiving antenna, which was mounted on the top of a variable height antenna tower.
5. Corrected Reading: Antenna Factor + Cable Loss + Read Level - Preamp Factor = Level
6. For measurement below 1GHz, If the emission level of the EUT measured by the peak detector is 3 dB lower than the applicable limit, the peak emission level will be reported. Otherwise, the emission measurement will be repeated using the quasi-peak detector and reported.
7. Use the following spectrum analyzer settings:
 - (1) Span shall wide enough to fully capture the emission being measured;
 - (2) Set RBW=100 kHz for $f < 1$ GHz; $VBW \geq RBW$; Sweep = auto; Detector function = peak; Trace = max hold;
 - (3) Set RBW = 1 MHz, VBW= 3MHz for $f \geq 1$ GHz for peak measurement.

For average measurement:

 - $VBW = 10$ Hz, when duty cycle is no less than 98 percent.
 - $VBW \geq 1/T$, when duty cycle is less than 98 percent where T is the minimum transmission duration over which the transmitter is on and is transmitting at its maximum power control level for the tested mode of operation.

Antenna	Band	Duty Cycle(%)	T(us)	1/T(kHz)	VBW Setting
1+2	802.11b for Ant. 1	100	-	-	10Hz
1+2	802.11b for Ant. 2	100	-	-	
1+2	802.11g for Ant. 1	97.60	2030.00	0.49	1kHz
1+2	802.11g for Ant. 2	97.60	2030.00	0.49	
1+2	2.4GHz 802.11n HT20 for Ant. 1	96.91	1880.00	0.53	1kHz
1+2	2.4GHz 802.11n HT20 for Ant. 2	96.91	1880.00	0.53	
1+2	2.4GHz 802.11n HT40 for Ant. 1	95.88	930.00	1.08	3kHz
1+2	2.4GHz 802.11n HT40 for Ant. 2	95.88	930.00	1.08	

3.5.4 Test Setup

For radiated emissions below 30MHz



For radiated emissions from 30MHz to 1GHz

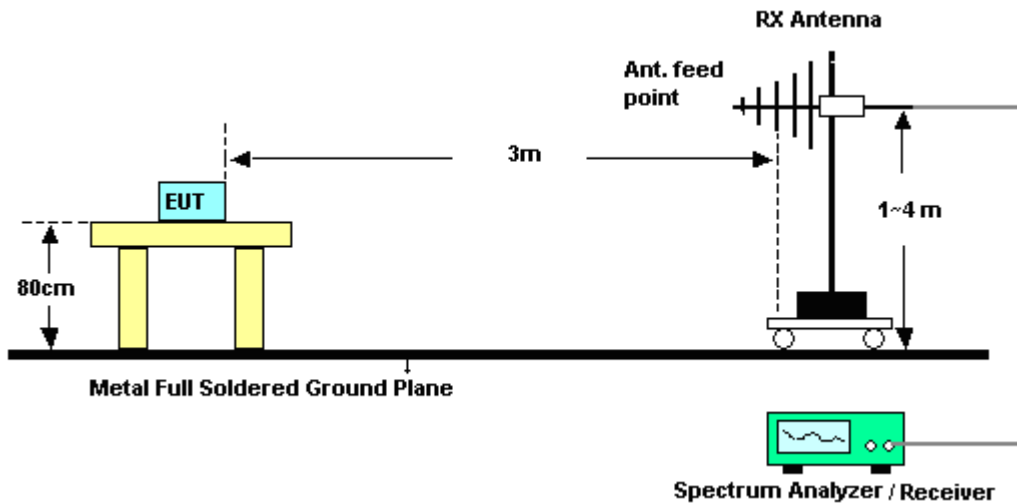

For radiated emissions above 1GHz

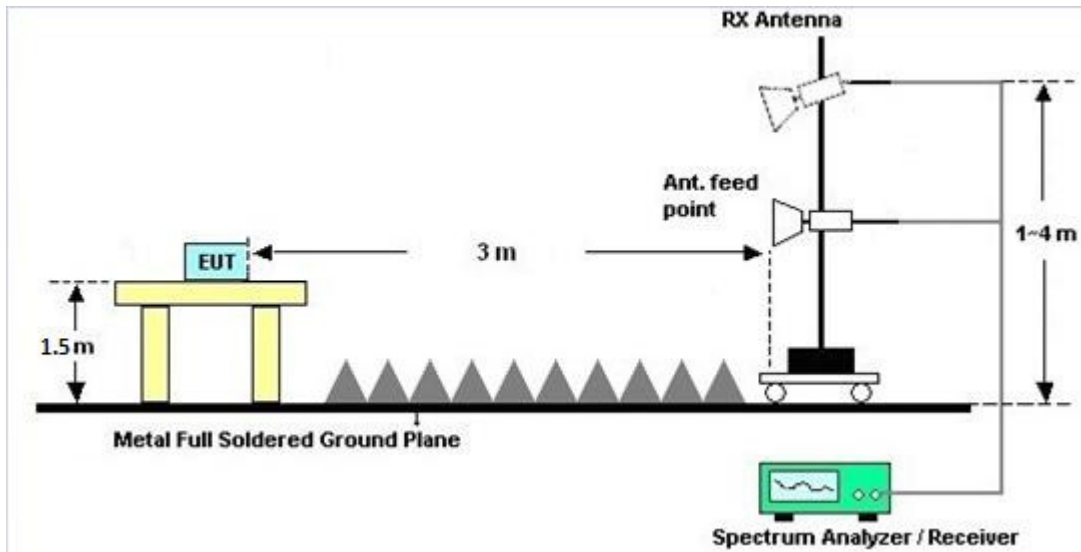

3.5.5 Test Results of Radiated Emissions (9kHz ~ 30MHz)

The low frequency, which started from 9 kHz to 30MHz, was pre-scanned and the result which was 20dB lower than the limit line per 15.31(o) was not reported.

3.5.6 Test Result of Radiated Spurious at Band Edges

Please refer to Appendix B and C of this report.

3.5.7 Test Result of Radiated Spurious Emission (30MHz ~ 10th Harmonic)

Please refer to Appendix B and C of this report.



3.6 AC Conducted Emission Measurement

3.6.1 Limit of AC Conducted Emission

For equipment that is designed to be connected to the public utility (AC) power line, the radio frequency voltage that is conducted back onto the AC power line on any frequency or frequencies within the band 150 kHz to 30 MHz shall not exceed the limits in the following table.

Frequency of Emission (MHz)	Conducted Limit (dB μ V)	
	Quasi-Peak	Average
0.15-0.5	66 to 56*	56 to 46*
0.5-5	56	46
5-30	60	50

*Decreases with the logarithm of the frequency.

3.6.2 Measuring Instruments

The measuring equipment is listed in the section 4 of this test report.

3.6.3 Test Procedures

1. The EUT was placed 0.4 meter from the conducting wall of the shielding room, and it was kept at least 80 centimeters from any other grounded conducting surface.
2. Connect EUT to the power mains through a line impedance stabilization network (LISN).
3. All the support units are connecting to the other LISN.
4. The LISN provides 50 ohm coupling impedance for the measuring instrument.
5. The FCC states that a 50 ohm, 50 microhenry LISN should be used.
6. Both sides of AC line were checked for maximum conducted interference.
7. The frequency range from 150 kHz to 30 MHz was searched.
8. Set the test-receiver system to Peak Detect Function and specified bandwidth (IF bandwidth = 9kHz) with Maximum Hold Mode.

3.6.4 Test Setup

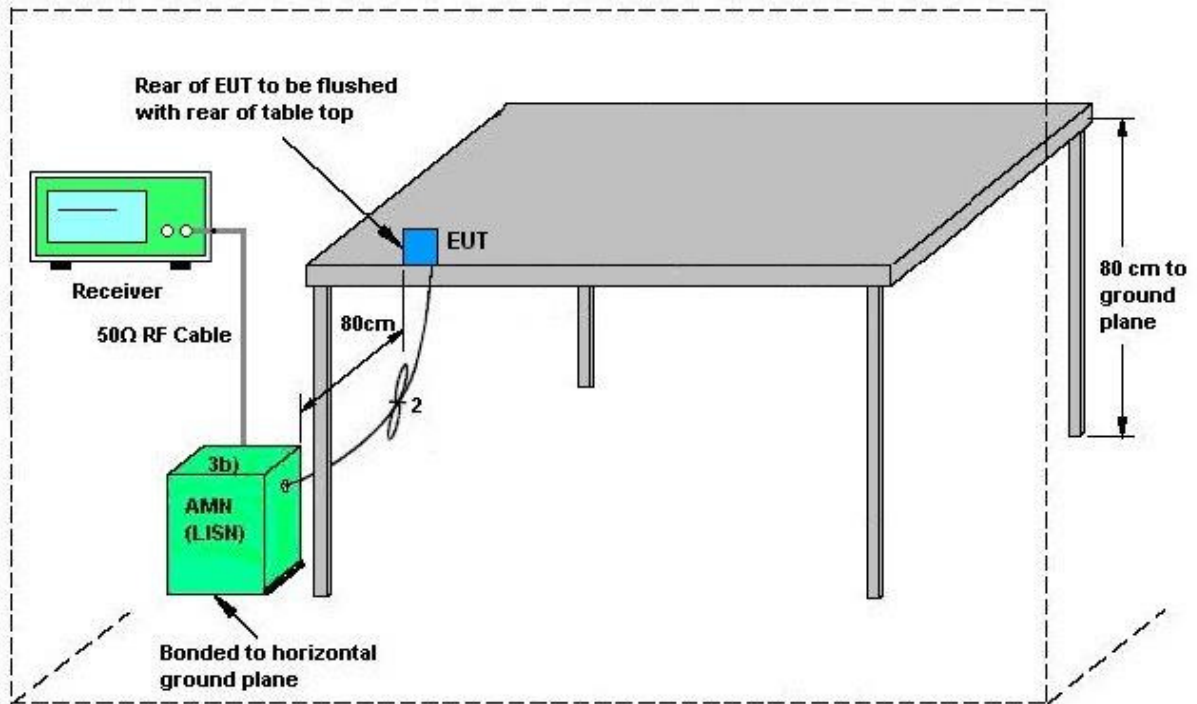

AMN = Artificial mains network (LISN)
AE = Associated equipment
EUT = Equipment under test
ISN = Impedance stabilization network



3.6.5 Test Result of AC Conducted Emission

Test Mode :	Mode 1	Temperature :	24~25°C
Test Engineer :	Kai-Chun Chu	Relative Humidity :	46~47%
Test Voltage :	120Vac / 60Hz	Phase :	Line
Function Type :	2.4G Tx + RJ-45 Link + Adapter		

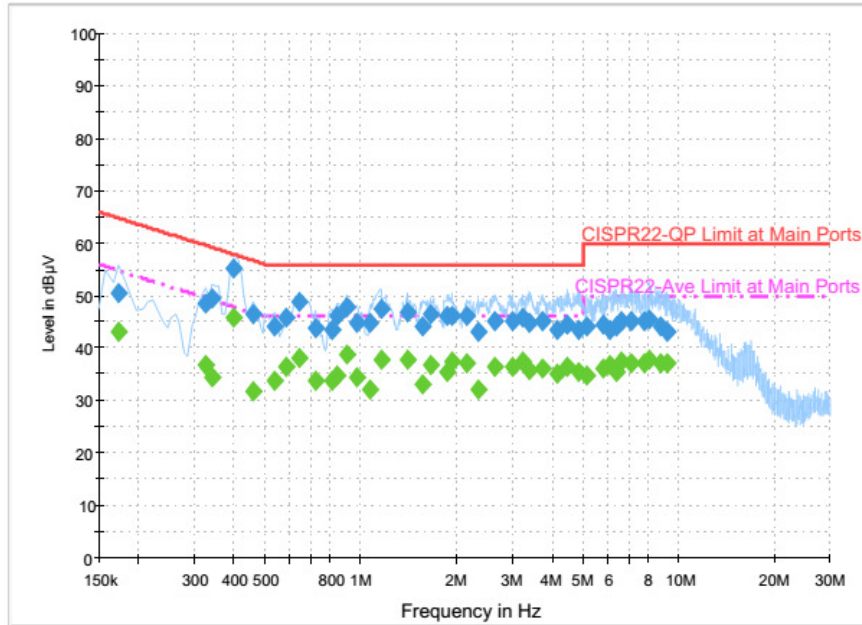

Final Result : QuasiPeak

Frequency (MHz)	QuasiPeak (dBµV)	Filter	Line	Corr. (dB)	Margin (dB)	Limit (dBµV)
0.174000	50.6	Off	L1	19.6	14.2	64.8
0.326000	48.4	Off	L1	19.6	11.2	59.6
0.342000	49.6	Off	L1	19.6	9.6	59.2
0.398000	55.0	Off	L1	19.6	2.9	57.9
0.462000	46.5	Off	L1	19.6	10.2	56.7
0.534000	44.1	Off	L1	19.6	11.9	56.0
0.582000	45.7	Off	L1	19.6	10.3	56.0
0.638000	49.0	Off	L1	19.6	7.0	56.0
0.718000	43.7	Off	L1	19.6	12.3	56.0
0.814000	43.6	Off	L1	19.6	12.4	56.0
0.846000	46.1	Off	L1	19.6	9.9	56.0
0.902000	47.9	Off	L1	19.6	8.1	56.0
0.974000	45.0	Off	L1	19.6	11.0	56.0
1.070000	44.9	Off	L1	19.6	11.1	56.0
1.158000	47.4	Off	L1	19.6	8.6	56.0
1.406000	46.9	Off	L1	19.6	9.1	56.0
1.574000	44.2	Off	L1	19.6	11.8	56.0
1.662000	46.4	Off	L1	19.6	9.6	56.0
1.878000	46.0	Off	L1	19.6	10.0	56.0
1.942000	46.3	Off	L1	19.6	9.7	56.0



Test Mode :	Mode 1	Temperature :	24~25°C
Test Engineer :	Kai-Chun Chu	Relative Humidity :	46~47%
Test Voltage :	120Vac / 60Hz	Phase :	Line
Function Type :	2.4G Tx + RJ-45 Link + Adapter		

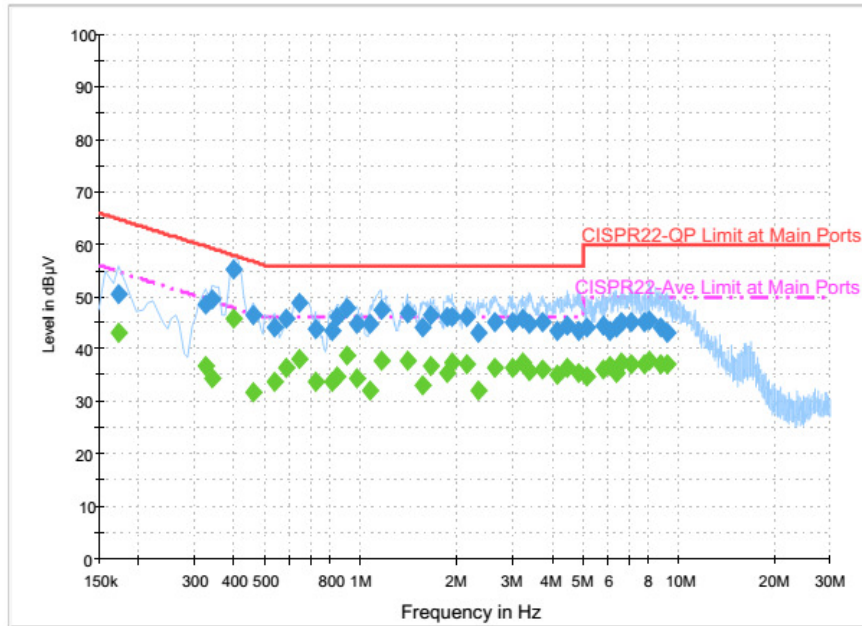

Final Result : QuasiPeak

Frequency (MHz)	QuasiPeak (dBµV)	Filter	Line	Corr. (dB)	Margin (dB)	Limit (dBµV)
2.166000	46.1	Off	L1	19.5	9.9	56.0
2.342000	43.2	Off	L1	19.5	12.8	56.0
2.654000	45.0	Off	L1	19.6	11.0	56.0
2.998000	45.3	Off	L1	19.6	10.7	56.0
3.222000	45.7	Off	L1	19.6	10.3	56.0
3.414000	44.8	Off	L1	19.6	11.2	56.0
3.718000	45.2	Off	L1	19.6	10.8	56.0
4.174000	43.5	Off	L1	19.7	12.5	56.0
4.478000	44.4	Off	L1	19.7	11.6	56.0
4.830000	43.6	Off	L1	19.7	12.4	56.0
5.158000	44.3	Off	L1	19.7	15.7	60.0
5.774000	44.4	Off	L1	19.7	15.6	60.0
6.070000	43.6	Off	L1	19.7	16.4	60.0
6.366000	44.2	Off	L1	19.7	15.8	60.0
6.638000	45.2	Off	L1	19.7	14.8	60.0
7.078000	45.2	Off	L1	19.7	14.8	60.0
7.838000	45.3	Off	L1	19.7	14.7	60.0
8.094000	45.5	Off	L1	19.7	14.5	60.0
8.782000	44.1	Off	L1	19.7	15.9	60.0
9.238000	43.2	Off	L1	19.7	16.8	60.0



Test Mode :	Mode 1	Temperature :	24~25°C
Test Engineer :	Kai-Chun Chu	Relative Humidity :	46~47%
Test Voltage :	120Vac / 60Hz	Phase :	Line
Function Type :	2.4G Tx + RJ-45 Link + Adapter		

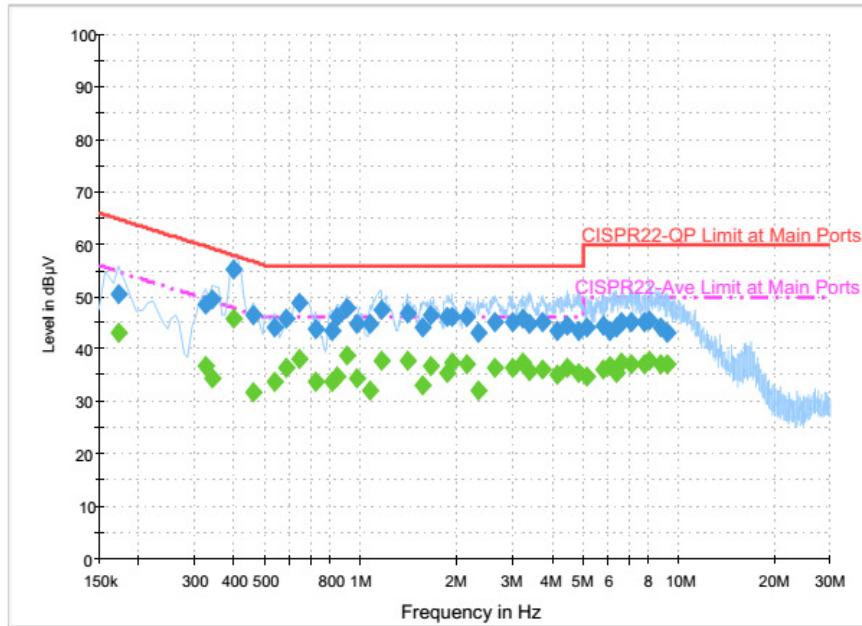

Final Result : Average

Frequency (MHz)	Average (dBµV)	Filter	Line	Corr. (dB)	Margin (dB)	Limit (dBµV)
0.174000	43.1	Off	L1	19.6	11.7	54.8
0.326000	36.8	Off	L1	19.6	12.8	49.6
0.342000	34.3	Off	L1	19.6	14.9	49.2
0.398000	45.9	Off	L1	19.6	2.0	47.9
0.462000	31.9	Off	L1	19.6	14.8	46.7
0.534000	33.9	Off	L1	19.6	12.1	46.0
0.582000	36.4	Off	L1	19.6	9.6	46.0
0.638000	38.3	Off	L1	19.6	7.7	46.0
0.718000	33.9	Off	L1	19.6	12.1	46.0
0.814000	33.8	Off	L1	19.6	12.2	46.0
0.846000	34.7	Off	L1	19.6	11.3	46.0
0.902000	38.9	Off	L1	19.6	7.1	46.0
0.974000	34.3	Off	L1	19.6	11.7	46.0
1.070000	32.1	Off	L1	19.6	13.9	46.0
1.158000	37.7	Off	L1	19.6	8.3	46.0
1.406000	37.7	Off	L1	19.6	8.3	46.0
1.574000	33.1	Off	L1	19.6	12.9	46.0
1.662000	36.9	Off	L1	19.6	9.1	46.0
1.878000	35.5	Off	L1	19.6	10.5	46.0
1.942000	37.6	Off	L1	19.6	8.4	46.0



Test Mode :	Mode 1	Temperature :	24~25°C
Test Engineer :	Kai-Chun Chu	Relative Humidity :	46~47%
Test Voltage :	120Vac / 60Hz	Phase :	Line
Function Type :	2.4G Tx + RJ-45 Link + Adapter		

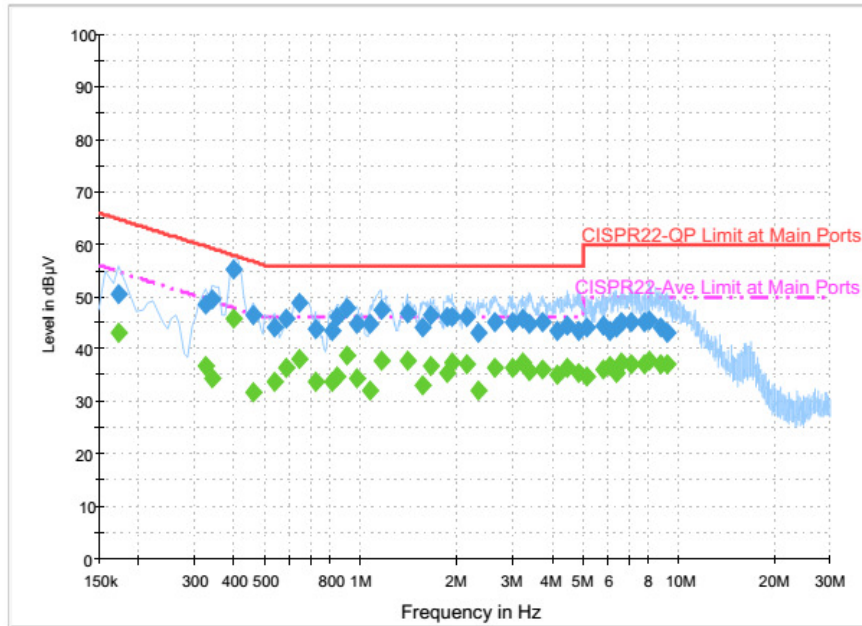

Final Result : Average

Frequency (MHz)	Average (dBµV)	Filter	Line	Corr. (dB)	Margin (dB)	Limit (dBµV)
2.166000	37.0	Off	L1	19.5	9.0	46.0
2.342000	32.2	Off	L1	19.5	13.8	46.0
2.654000	36.6	Off	L1	19.6	9.4	46.0
2.998000	36.6	Off	L1	19.6	9.4	46.0
3.222000	37.4	Off	L1	19.6	8.6	46.0
3.414000	35.7	Off	L1	19.6	10.3	46.0
3.718000	36.1	Off	L1	19.6	9.9	46.0
4.174000	35.2	Off	L1	19.7	10.8	46.0
4.478000	36.6	Off	L1	19.7	9.4	46.0
4.830000	35.4	Off	L1	19.7	10.6	46.0
5.158000	34.9	Off	L1	19.7	15.1	50.0
5.774000	36.1	Off	L1	19.7	13.9	50.0
6.070000	36.9	Off	L1	19.7	13.1	50.0
6.366000	35.5	Off	L1	19.7	14.5	50.0
6.638000	37.4	Off	L1	19.7	12.6	50.0
7.078000	37.1	Off	L1	19.7	12.9	50.0
7.838000	37.2	Off	L1	19.7	12.8	50.0
8.094000	37.8	Off	L1	19.7	12.2	50.0
8.782000	37.2	Off	L1	19.7	12.8	50.0
9.238000	37.1	Off	L1	19.7	12.9	50.0



Test Mode :	Mode 1	Temperature :	24~25°C
Test Engineer :	Kai-Chun Chu	Relative Humidity :	46~47%
Test Voltage :	120Vac / 60Hz	Phase :	Neutral
Function Type :	2.4G Tx + RJ-45 Link + Adapter		

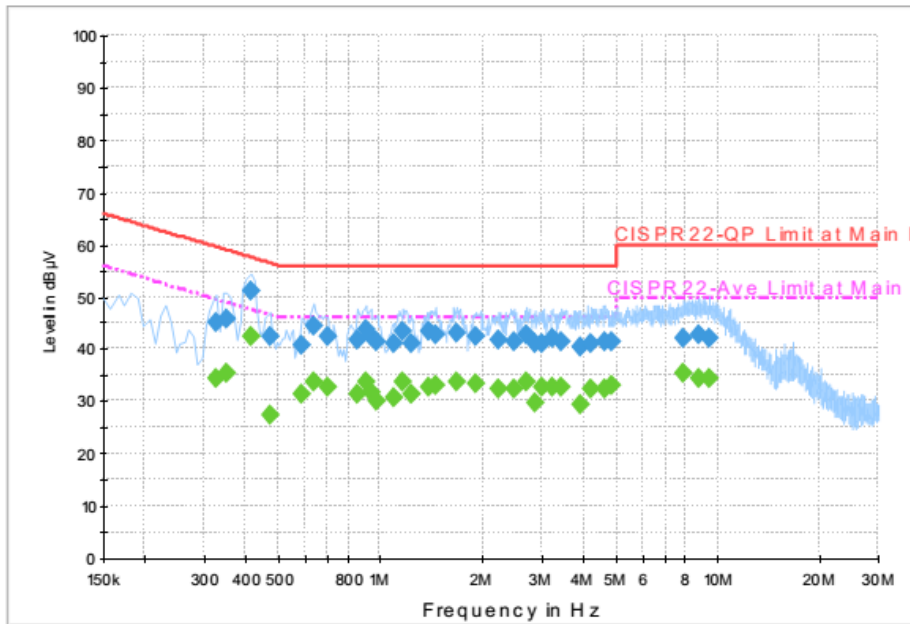

Final Result : QuasiPeak

Frequency (MHz)	QuasiPeak (dBµV)	Filter	Line	Corr. (dB)	Margin (dB)	Limit (dBµV)
0.326000	45.2	Off	N	19.6	14.4	59.6
0.350000	45.8	Off	N	19.6	13.2	59.0
0.414000	51.1	Off	N	19.6	6.5	57.6
0.470000	42.5	Off	N	19.6	14.0	56.5
0.582000	40.7	Off	N	19.6	15.3	56.0
0.630000	44.4	Off	N	19.6	11.6	56.0
0.694000	42.3	Off	N	19.6	13.7	56.0
0.854000	42.0	Off	N	19.6	14.0	56.0
0.902000	43.8	Off	N	19.6	12.2	56.0
0.934000	42.5	Off	N	19.6	13.5	56.0
0.974000	41.3	Off	N	19.6	14.7	56.0
1.094000	41.1	Off	N	19.6	14.9	56.0
1.166000	43.4	Off	N	19.6	12.6	56.0
1.230000	41.1	Off	N	19.6	14.9	56.0
1.390000	43.6	Off	N	19.6	12.4	56.0
1.454000	42.7	Off	N	19.6	13.3	56.0
1.678000	43.0	Off	N	19.6	13.0	56.0
1.918000	42.6	Off	N	19.6	13.4	56.0



Test Mode :	Mode 1	Temperature :	24~25°C
Test Engineer :	Kai-Chun Chu	Relative Humidity :	46~47%
Test Voltage :	120Vac / 60Hz	Phase :	Neutral
Function Type :	2.4G Tx + RJ-45 Link + Adapter		

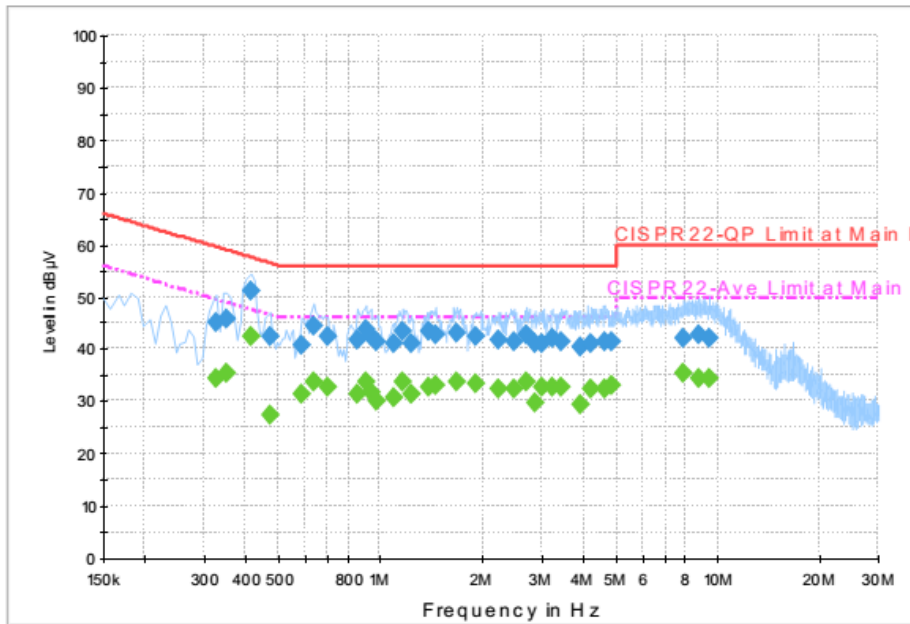

Final Result : QuasiPeak

Frequency (MHz)	QuasiPeak (dBµV)	Filter	Line	Corr. (dB)	Margin (dB)	Limit (dBµV)
2.238000	41.7	Off	N	19.5	14.3	56.0
2.486000	41.6	Off	N	19.6	14.4	56.0
2.718000	42.7	Off	N	19.6	13.3	56.0
2.862000	41.2	Off	N	19.6	14.8	56.0
3.014000	41.3	Off	N	19.6	14.7	56.0
3.238000	42.1	Off	N	19.6	13.9	56.0
3.454000	41.6	Off	N	19.6	14.4	56.0
3.902000	40.6	Off	N	19.6	15.4	56.0
4.198000	41.2	Off	N	19.6	14.8	56.0
4.622000	41.5	Off	N	19.6	14.5	56.0
4.870000	41.6	Off	N	19.6	14.4	56.0
7.950000	42.0	Off	N	19.7	18.0	60.0
8.750000	42.9	Off	N	19.7	17.1	60.0
9.438000	42.0	Off	N	19.7	18.0	60.0



Test Mode :	Mode 1	Temperature :	24~25°C
Test Engineer :	Kai-Chun Chu	Relative Humidity :	46~47%
Test Voltage :	120Vac / 60Hz	Phase :	Neutral
Function Type :	2.4G Tx + RJ-45 Link + Adapter		

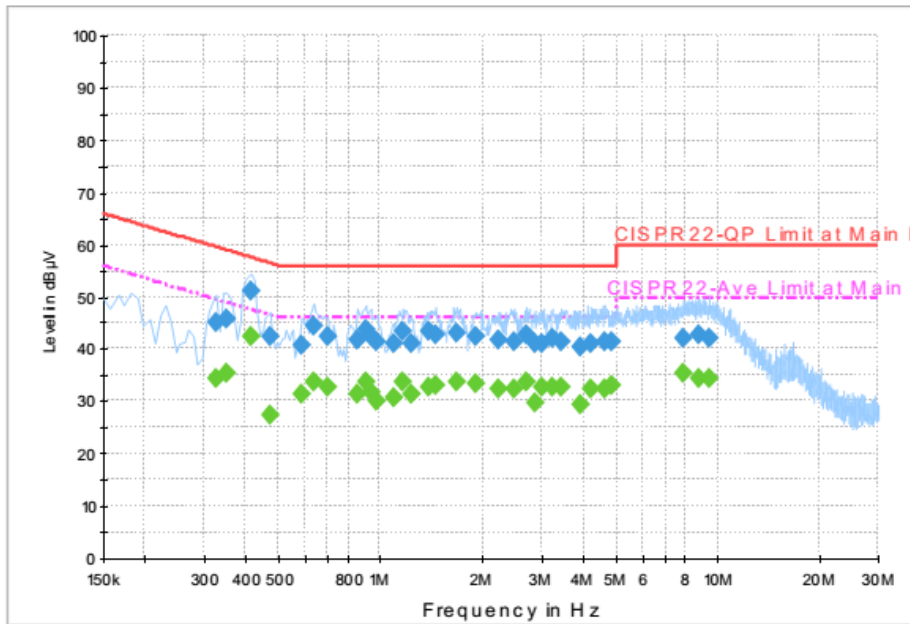

Final Result : Average

Frequency (MHz)	Average (dBµV)	Filter	Line	Corr. (dB)	Margin (dB)	Limit (dBµV)
0.326000	34.6	Off	N	19.6	15.0	49.6
0.350000	35.5	Off	N	19.6	13.5	49.0
0.414000	42.5	Off	N	19.6	5.1	47.6
0.470000	27.3	Off	N	19.6	19.2	46.5
0.582000	31.5	Off	N	19.6	14.5	46.0
0.630000	33.8	Off	N	19.6	12.2	46.0
0.694000	32.6	Off	N	19.6	13.4	46.0
0.854000	31.6	Off	N	19.6	14.4	46.0
0.902000	33.7	Off	N	19.6	12.3	46.0
0.934000	31.8	Off	N	19.6	14.2	46.0
0.974000	30.0	Off	N	19.6	16.0	46.0
1.094000	30.8	Off	N	19.6	15.2	46.0
1.166000	33.9	Off	N	19.6	12.1	46.0
1.230000	31.5	Off	N	19.6	14.5	46.0
1.390000	32.9	Off	N	19.6	13.1	46.0
1.454000	33.1	Off	N	19.6	12.9	46.0
1.678000	33.7	Off	N	19.6	12.3	46.0
1.918000	33.3	Off	N	19.6	12.7	46.0



Test Mode :	Mode 1	Temperature :	24~25°C
Test Engineer :	Kai-Chun Chu	Relative Humidity :	46~47%
Test Voltage :	120Vac / 60Hz	Phase :	Neutral
Function Type :	2.4G Tx + RJ-45 Link + Adapter		

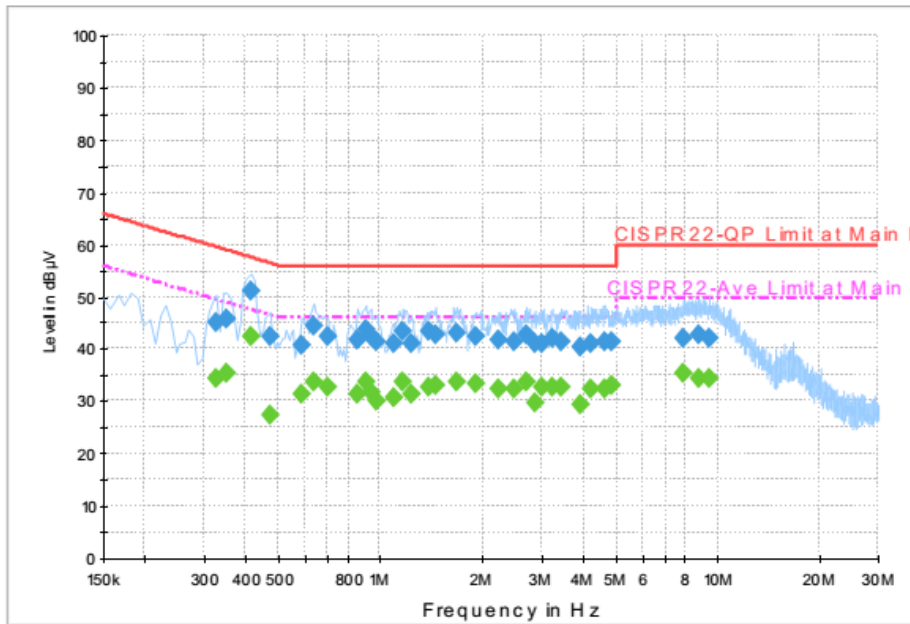

Final Result : Average

Frequency (MHz)	Average (dBµV)	Filter	Line	Corr. (dB)	Margin (dB)	Limit (dBµV)
2.238000	32.5	Off	N	19.5	13.5	46.0
2.486000	32.4	Off	N	19.6	13.6	46.0
2.718000	33.6	Off	N	19.6	12.4	46.0
2.862000	29.8	Off	N	19.6	16.2	46.0
3.014000	32.6	Off	N	19.6	13.4	46.0
3.238000	32.8	Off	N	19.6	13.2	46.0
3.454000	32.7	Off	N	19.6	13.3	46.0
3.902000	29.5	Off	N	19.6	16.5	46.0
4.198000	32.5	Off	N	19.6	13.5	46.0
4.622000	32.6	Off	N	19.6	13.4	46.0
4.870000	33.0	Off	N	19.6	13.0	46.0
7.950000	35.6	Off	N	19.7	14.4	50.0
8.750000	34.4	Off	N	19.7	15.6	50.0
9.438000	34.5	Off	N	19.7	15.5	50.0



3.7 Antenna Requirements

3.7.1 Standard Applicable

If directional gain of transmitting Antennas is greater than 6dBi, the power shall be reduced by the same level in dB comparing to gain minus 6dBi. For the fixed point-to-point operation, the power shall be reduced by one dB for every 3 dB that the directional gain of the Antenna exceeds 6 dBi. The use of a permanently attached Antenna or of an Antenna that uses a unique coupling to the intentional radiator shall be considered sufficient to comply with the FCC rule.

3.7.2 Antenna Anti-Replacement Construction

Non-standard antenna connector is used.

3.7.3 Antenna Gain

FCC KDB 662911 D01 Multiple Transmitter Output v02r01.

For CDD transmissions, directional gain is calculated as

Directional gain = $G_{ANT} + \text{Array Gain}$, where Array Gain is as follows.

For power spectral density (PSD) measurements on all devices,

Array Gain = $10 \log(N_{ANT}/N_{SS}=1)$ dB.

For power measurements on IEEE 802.11 devices,

Array Gain = 0 dB (i.e., no array gain) for $N_{ANT} \leq 4$.

Directional gain may be calculated by using the formulas applicable to equal gain antennas with G_{ANT} set equal to the gain of the antenna having the highest gain;

The EUT supports CDD mode.

The power and PSD limit should be modified if the directional gain of EUT is over 6 dBi,

The directional gain "DG" is calculated as following table.

			DG	DG	Power	PSD
	Ant. 1	Ant. 2	for	for	Limit	Limit
	(dBi)	(dBi)	Power	PSD	Reduction	Reduction
	(dBi)	(dBi)	(dBi)	(dBi)	(dB)	(dB)
2.4 GHz	4.42	4.42	4.42	7.43	0.00	1.43

$Power\ Limit\ Reduction = DG(Power) - 6dBi, (min = 0)$

$PSD\ Limit\ Reduction = DG(PSD) - 6dBi, (min = 0)$



4 List of Measuring Equipment

Instrument	Manufacturer	Model No.	Serial No.	Characteristics	Calibration Date	Test Date	Due Date	Remark
Power Meter	Anritsu	ML2495A	1132003	300MHz~40GHz	Aug. 12, 2015	Feb. 22, 2016~ Apr. 05, 2016	Aug. 11, 2016	Conducted (TH05-HY)
Power Sensor	Anritsu	MA2411B	1126017	300MHz~40GHz	Aug. 12, 2015	Feb. 22, 2016~ Apr. 05, 2016	Aug. 11, 2016	Conducted (TH05-HY)
Spectrum Analyzer	Rohde & Schwarz	FSP40	100057	9kHz-40GHz	Nov. 23, 2015	Feb. 22, 2016~ Apr. 05, 2016	Nov. 22, 2016	Conducted (TH05-HY)
Loop Antenna	Rohde & Schwarz	HFH2-Z2	100315	9 kHz~30 MHz	Sep. 02, 2015	Apr. 02, 2016 ~ Apr. 04, 2016	Sep. 01, 2016	Radiation (03CH12-HY)
Bilog Antenna	TESEQ	CBL 6111D	37059	30MHz~1GHz	Dec. 29, 2015	Apr. 02, 2016 ~ Apr. 04, 2016	Dec. 28, 2016	Radiation (03CH12-HY)
EMI Test Receiver	Rohde & Schwarz	ESU26	100390	20Hz~26.5GHz	Dec. 21, 2015	Apr. 02, 2016 ~ Apr. 04, 2016	Dec. 20, 2016	Radiation (03CH12-HY)
Horn Antenna	SCHWARZBECK	BBHA 9120D	9120D-1328	1GHz ~ 18GHz	Nov. 02, 2015	Apr. 02, 2016 ~ Apr. 04, 2016	Nov. 01, 2016	Radiation (03CH12-HY)
Horn Antenna	SCHWARZBECK	BBHA 9170	BBHA9170584	18GHz- 40GHz	Nov. 02, 2015	Apr. 02, 2016 ~ Apr. 04, 2016	Nov. 01, 2016	Radiation (03CH12-HY)
Preamplifier	COM-POWER	PA-103A	161075	10MHz~1GHz	Apr. 09, 2015	Apr. 02, 2016 ~ Apr. 04, 2016	Apr. 08, 2016	Radiation (03CH12-HY)
Preamplifier	MITEQ	AMF-7D-0010 1800-30-10P	1815698	1GHz~18GHz	Dec. 14, 2015	Apr. 02, 2016 ~ Apr. 04, 2016	Dec. 13, 2016	Radiation (03CH12-HY)
Preamplifier	Agilent	8449B	3008A02375	1GHz~26.5GHz	Jan. 05, 2016	Apr. 02, 2016 ~ Apr. 04, 2016	Jan. 04, 2017	Radiation (03CH12-HY)
Antenna Mast	EMEC	AM-BS-4500-B	N/A	1m~4m	N/A	Apr. 02, 2016 ~ Apr. 04, 2016	N/A	Radiation (03CH12-HY)
Turn Table	EMEC	TT2000	N/A	0-360 degree	N/A	Apr. 02, 2016 ~ Apr. 04, 2016	N/A	Radiation (03CH12-HY)
Preamplifier	MITEQ	JS44-180040 00-33-8P	1840917	18GHz ~ 40GHz	Jun. 02, 2015	Apr. 02, 2016 ~ Apr. 04, 2016	Jun. 01, 2016	Radiation (03CH12-HY)
AC Power Source	ChainTek	APC-1000W	N/A	N/A	N/A	Mar. 27, 2016	N/A	Conduction (CO05-HY)
EMI Test Receiver	Rohde & Schwarz	ESCI 7	100724	9kHz~7GHz	Aug. 26, 2015	Mar. 27, 2016	Aug. 25, 2016	Conduction (CO05-HY)
LISN	Rohde & Schwarz	ENV216	100080	9kHz~30MHz	Dec. 02, 2015	Mar. 27, 2016	Dec. 01, 2016	Conduction (CO05-HY)



5 Uncertainty of Evaluation

Uncertainty of Conducted Emission Measurement (150kHz ~ 30MHz)

Measuring Uncertainty for a Level of Confidence of 95% ($U = 2Uc(y)$)	2.26
---	------

Uncertainty of Radiated Emission Measurement (30 MHz ~ 1000 MHz)

Measuring Uncertainty for a Level of Confidence of 95% ($U = 2Uc(y)$)	5.10
---	------



Appendix A. Conducted Test Results

Test Engineer:	AC Chang	Temperature:	21~25	°C
Test Date:	2016/02/22 ~ 2016/04/05	Relative Humidity:	58~61	%

TEST RESULTS DATA
6dB and 99% Occupied Bandwidth

2.4GHz Band										
Mod.	Data Rate	N _{TX}	CH.	Freq. (MHz)	99% Occupied BW (MHz)		6dB BW (MHz)		6dB BW Limit (MHz)	Pass/Fail
					Ant 1	Ant 2	Ant 1	Ant 2		
11b	1Mbps	2	1	2412	14.15	14.05	10.08	10.08	0.50	Pass
11b	1Mbps	2	6	2437	14.05	14.10	10.12	10.12	0.50	Pass
11b	1Mbps	2	11	2462	14.20	14.05	10.08	10.08	0.50	Pass
11g	6Mbps	2	1	2412	18.30	18.30	16.40	16.40	0.50	Pass
11g	6Mbps	2	6	2437	18.05	18.75	16.40	16.40	0.50	Pass
11g	6Mbps	2	11	2462	18.25	18.65	16.44	16.44	0.50	Pass
HT20	MCS0	2	1	2412	19.20	19.25	17.60	17.60	0.50	Pass
HT20	MCS0	2	6	2437	19.30	19.35	17.60	17.60	0.50	Pass
HT20	MCS0	2	11	2462	19.45	19.50	17.60	17.60	0.50	Pass
HT40	MCS0	2	3	2422	37.20	37.40	36.32	36.32	0.50	Pass
HT40	MCS0	2	6	2437	37.20	37.60	36.32	36.40	0.50	Pass
HT40	MCS0	2	9	2452	37.30	37.20	36.44	36.44	0.50	Pass

TEST RESULTS DATA
Peak Output Power

2.4GHz Band																
Mod.	Data Rate	N _{TX}	CH.	Freq. (MHz)	Peak Conducted Power (dBm)			Conducted Power Limit (dBm)		DG (dBi)		EIRP Power (dBm)		EIRP Power Limit (dBm)		Pass /Fail
					Ant 1	Ant 2	SUM	Ant 1	Ant 2	Ant 1	Ant 2	Ant 1	Ant 2	Ant 1	Ant 2	
11b	1Mbps	2	1	2412	22.22	21.23	24.76	30.00		4.42		29.18		36.00		Pass
11b	1Mbps	2	6	2437	23.06	20.89	25.12	30.00		4.42		29.54		36.00		Pass
11b	1Mbps	2	11	2462	23.01	20.65	25.00	30.00		4.42		29.42		36.00		Pass
11g	6Mbps	2	1	2412	24.94	23.46	27.27	30.00		4.42		31.69		36.00		Pass
11g	6Mbps	2	6	2437	26.80	25.77	29.33	30.00		4.42		33.75		36.00		Pass
11g	6Mbps	2	11	2462	25.18	23.42	27.40	30.00		4.42		31.82		36.00		Pass
HT20	MCS0	2	1	2412	24.17	24.06	27.13	30.00		4.42		31.55		36.00		Pass
HT20	MCS0	2	6	2437	26.51	25.23	28.93	30.00		4.42		33.35		36.00		Pass
HT20	MCS0	2	11	2462	25.07	23.95	27.56	30.00		4.42		31.98		36.00		Pass
HT40	MCS0	2	3	2422	20.44	19.32	22.93	30.00		4.42		27.35		36.00		Pass
HT40	MCS0	2	6	2437	24.62	23.07	26.92	30.00		4.42		31.34		36.00		Pass
HT40	MCS0	2	9	2452	22.96	20.48	24.90	30.00		4.42		29.32		36.00		Pass

Note: Measured power (dBm) has offset with cable loss.

TEST RESULTS DATA
Average Output Power

2.4GHz Band									
Mod.	Data Rate	N _{TX}	CH.	Freq. (MHz)	Duty Factor (dB)		Average Conducted Power (dBm)		
					Ant 1	Ant 2	Ant 1	Ant 2	SUM
11b	1Mbps	2	1	2412	0.00	0.00	19.91	18.85	22.42
11b	1Mbps	2	6	2437	0.00	0.00	20.65	18.52	22.72
11b	1Mbps	2	11	2462	0.00	0.00	20.64	18.33	22.65
11g	6Mbps	2	1	2412	0.11	0.11	14.86	13.51	17.24
11g	6Mbps	2	6	2437	0.11	0.11	18.15	15.97	20.20
11g	6Mbps	2	11	2462	0.11	0.11	15.33	13.28	17.43
HT20	MCS0	2	1	2412	0.14	0.14	14.26	13.62	16.96
HT20	MCS0	2	6	2437	0.14	0.14	17.44	15.02	19.40
HT20	MCS0	2	11	2462	0.14	0.14	15.39	13.39	17.51
HT40	MCS0	2	3	2422	0.18	0.18	10.65	9.40	13.08
HT40	MCS0	2	6	2437	0.18	0.18	14.60	13.12	16.94
HT40	MCS0	2	9	2452	0.18	0.18	12.45	10.12	14.45

Note: Measured power (dBm) has offset with cable loss.

TEST RESULTS DATA
Peak Power Spectral Density

2.4GHz Band												
Mod.	Data Rate	N _{TX}	CH.	Freq. (MHz)	Peak PSD (dBm/3kHz)			DG (dBi)		Peak PSD Limit (dBm/3kHz)		Pass/Fail
					Ant 1	Ant 2	Worse + 3.01	Ant 1	Ant 2	Ant 1	Ant 2	
11b	1Mbps	2	1	2412	-3.25	-4.27	-0.24	7.43		6.57		Pass
11b	1Mbps	2	6	2437	-3.77	-5.21	-0.76	7.43		6.57		Pass
11b	1Mbps	2	11	2462	-3.41	-5.52	-0.40	7.43		6.57		Pass
11g	6Mbps	2	1	2412	-10.04	-10.97	-7.03	7.43		6.57		Pass
11g	6Mbps	2	6	2437	-7.09	-9.53	-4.08	7.43		6.57		Pass
11g	6Mbps	2	11	2462	-7.90	-11.14	-4.89	7.43		6.57		Pass
HT20	MCS0	2	1	2412	-11.88	-13.26	-8.87	7.43		6.57		Pass
HT20	MCS0	2	6	2437	-8.19	-11.19	-5.18	7.43		6.57		Pass
HT20	MCS0	2	11	2462	-9.79	-11.52	-6.78	7.43		6.57		Pass
HT40	MCS0	2	3	2422	-18.66	-19.71	-15.65	7.43		6.57		Pass
HT40	MCS0	2	6	2437	-13.49	-13.69	-10.48	7.43		6.57		Pass
HT40	MCS0	2	9	2452	-15.47	-16.42	-12.46	7.43		6.57		Pass

Measured power density (dBm) has offset with cable loss.



Appendix B. Radiated Spurious Emission

Test Engineer :	Citta Ke, Ricky Su, and Nick Yu	Temperature :	23~25°C
		Relative Humidity :	55~60%

2.4GHz 2400~2483.5MHz
WIFI 802.11b (Band Edge @ 3m)

WIFI Ant. 1+2	Note	Frequency (MHz)	Level (dBμV/m)	Over Limit (dB)	Limit Line (dBμV/m)	Read Level (dBμV)	Antenna Factor (dB/m)	Cable Loss (dB)	Preamp Factor (dB)	Ant Pos (cm)	Table Pos (deg)	Peak Avg. (P/A)	Pol. (H/V)	
802.11b CH 01 2412MHz		2330.34	57.31	-16.69	74	57.05	26.89	7.3	33.93	100	165	P	H	
		2386.5	45.33	-8.67	54	44.83	27.05	7.45	34	100	165	A	H	
	*	2412	107.13	-	-	106.6	27.09	7.45	34.01	100	165	P	H	
	*	2412	102.04	-	-	101.51	27.09	7.45	34.01	100	165	A	H	
													H	
														H
			2330.34	65.57	-8.43	74	65.31	26.89	7.3	33.93	100	83	P	V
			2386.23	53.07	-0.93	54	52.57	27.05	7.45	34	100	83	A	V
	*		2412	118.19	-	-	117.66	27.09	7.45	34.01	100	83	P	V
	*		2412	113.24	-	-	112.71	27.09	7.45	34.01	100	83	A	V
														V
														V
802.11b CH 06 2437MHz		2356.89	57.69	-16.31	74	57.31	26.97	7.37	33.96	111	162	P	H	
		2360.13	43.91	-10.09	54	43.53	26.97	7.37	33.96	111	162	A	H	
	*	2437	107.06	-	-	106.44	27.18	7.49	34.05	111	162	P	H	
	*	2437	101.91	-	-	101.29	27.18	7.49	34.05	111	162	A	H	
			2491.4	55.37	-18.63	74	54.64	27.3	7.53	34.1	111	162	P	H
			2499.64	43.53	-10.47	54	42.8	27.3	7.53	34.1	111	162	A	H
			2355.72	65.55	-8.45	74	65.17	26.97	7.37	33.96	100	83	P	V
			2360.04	50.95	-3.05	54	50.57	26.97	7.37	33.96	100	83	A	V
	*		2437	117.32	-	-	116.7	27.18	7.49	34.05	100	83	P	V
	*		2437	112.32	-	-	111.7	27.18	7.49	34.05	100	83	A	V
			2493.96	59.74	-14.26	74	59.01	27.3	7.53	34.1	100	83	P	V
			2499.96	47.98	-6.02	54	47.25	27.3	7.53	34.1	100	83	A	V



802.11b CH 11 2462MHz	*	2462	107.39	-	-	106.71	27.22	7.53	34.07	134	4	P	H
	*	2462	102.48	-	-	101.8	27.22	7.53	34.07	134	4	A	H
		2499.72	56.24	-17.76	74	55.51	27.3	7.53	34.1	134	4	P	H
		2487.76	44.24	-9.76	54	43.51	27.3	7.53	34.1	134	4	A	H
													H
													H
	*	2462	117.46	-	-	116.78	27.22	7.53	34.07	107	85	P	V
	*	2462	112.75	-	-	112.07	27.22	7.53	34.07	107	85	A	V
		2486.68	62.13	-11.87	74	61.42	27.26	7.53	34.08	107	85	P	V
		2487.8	52.55	-1.45	54	51.82	27.3	7.53	34.1	107	85	A	V
													V
													V
Remark	1. No other spurious found. 2. All results are PASS against Peak and Average limit line.												



2.4GHz 2400~2483.5MHz
WIFI 802.11b (Harmonic @ 3m)

WIFI Ant. 1+2	Note	Frequency (MHz)	Level (dBμV/m)	Over Limit (dB)	Limit Line (dBμV/m)	Read Level (dBμV)	Antenna Factor (dB/m)	Cable Loss (dB)	Preamp Factor (dB)	Ant Pos (cm)	Table Pos (deg)	Peak Avg. (P/A)	Pol. (H/V)	
802.11b CH 01 2412MHz		4824	39.91	-34.09	74	56.05	31.26	10.74	58.14	100	0	P	H	
													H	
													H	
													H	
			4824	42.5	-31.5	74	58.64	31.26	10.74	58.14	100	0	P	V
														V
														V
802.11b CH 06 2437MHz		4872	42.68	-31.32	74	58.56	31.33	10.89	58.1	100	0	P	H	
		7308	42.23	-31.77	74	51.07	36.07	14.18	59.09	100	0	P	H	
													H	
													H	
			4872	46.2	-27.8	74	62.08	31.33	10.89	58.1	100	0	P	V
			7308	44.95	-29.05	74	53.79	36.07	14.18	59.09	100	0	P	V
														V
802.11b CH 11 2462MHz		4926	43.26	-30.74	74	58.88	31.4	11.04	58.06	100	0	P	H	
		7386	43.53	-30.47	74	52.09	36.31	14.27	59.14	100	0	P	H	
													H	
													H	
			4926	47.27	-26.73	74	62.89	31.4	11.04	58.06	100	0	P	V
			7386	45.52	-28.48	74	54.08	36.31	14.27	59.14	100	0	P	V
														V
Remark	1. No other spurious found.													
	2. All results are PASS against Peak and Average limit line.													



2.4GHz 2400~2483.5MHz
WIFI 802.11g (Band Edge @ 3m)

WIFI Ant. 1+2	Note	Frequency (MHz)	Level (dBμV/m)	Over Limit (dB)	Limit Line (dBμV/m)	Read Level (dBμV)	Antenna Factor (dB/m)	Cable Loss (dB)	Preamp Factor (dB)	Ant Pos (cm)	Table Pos (deg)	Peak Avg. (P/A)	Pol. (H/V)	
802.11g CH 01 2412MHz		2353.83	55.31	-18.69	74	54.93	26.97	7.37	33.96	124	4	P	H	
		2376.96	44.85	-9.15	54	44.45	27.01	7.37	33.98	124	4	A	H	
	*	2412	103.61	-	-	103.08	27.09	7.45	34.01	124	4	P	H	
	*	2412	93.71	-	-	93.18	27.09	7.45	34.01	124	4	A	H	
													H	
														H
			2389.65	66.65	-7.35	74	66.15	27.05	7.45	34	100	86	P	V
			2389.83	53.27	-0.73	54	52.77	27.05	7.45	34	100	86	A	V
	*		2412	114.03	-	-	113.5	27.09	7.45	34.01	100	86	P	V
	*		2412	104.35	-	-	103.82	27.09	7.45	34.01	100	86	A	V
														V
														V
802.11g CH 06 2437MHz		2368.05	56.19	-17.81	74	55.81	26.97	7.37	33.96	113	4	P	H	
		2371.65	44.75	-9.25	54	44.35	27.01	7.37	33.98	113	4	A	H	
	*	2437	107.15	-	-	106.53	27.18	7.49	34.05	113	4	P	H	
	*	2437	97.26	-	-	96.64	27.18	7.49	34.05	113	4	A	H	
			2499.84	56.42	-17.58	74	55.69	27.3	7.53	34.1	113	4	P	H
			2487.24	44.93	-9.07	54	44.22	27.26	7.53	34.08	113	4	A	H
			2356.17	64.09	-9.91	74	63.71	26.97	7.37	33.96	109	86	P	V
			2360.13	51.32	-2.68	54	50.94	26.97	7.37	33.96	109	86	A	V
	*		2437	117.37	-	-	116.75	27.18	7.49	34.05	109	86	P	V
	*		2437	107.46	-	-	106.84	27.18	7.49	34.05	109	86	A	V
			2491.76	60.3	-13.7	74	59.57	27.3	7.53	34.1	109	86	P	V
			2499.72	49.52	-4.48	54	48.79	27.3	7.53	34.1	109	86	A	V



802.11g CH 11 2462MHz	*	2462	104.15	-	-	103.47	27.22	7.53	34.07	131	4	P	H
	*	2462	94.28	-	-	93.6	27.22	7.53	34.07	131	4	A	H
		2484.92	59.96	-14.04	74	59.25	27.26	7.53	34.08	131	4	P	H
		2483.64	45.76	-8.24	54	45.05	27.26	7.53	34.08	131	4	A	H
													H
													H
	*	2462	116.55	-	-	115.87	27.22	7.53	34.07	100	85	P	V
	*	2462	105.67	-	-	104.99	27.22	7.53	34.07	100	85	A	V
		2484.36	69.81	-4.19	74	69.1	27.26	7.53	34.08	100	85	P	V
		2483.72	53.09	-0.91	54	52.38	27.26	7.53	34.08	100	85	A	V
													V
													V
Remark	1. No other spurious found. 2. All results are PASS against Peak and Average limit line.												



2.4GHz 2400~2483.5MHz
WIFI 802.11g (Harmonic @ 3m)

WIFI Ant. 1+2	Note	Frequency (MHz)	Level (dBμV/m)	Over Limit (dB)	Limit Line (dBμV/m)	Read Level (dBμV)	Antenna Factor (dB/m)	Cable Loss (dB)	Preamp Factor (dB)	Ant Pos (cm)	Table Pos (deg)	Peak Avg. (P/A)	Pol. (H/V)
802.11g CH 01 2412MHz		4824	36.75	-37.25	74	52.89	31.26	10.74	58.14	100	0	P	H
													H
													H
													H
													V
													V
													V
802.11g CH 06 2437MHz		4872	38.56	-35.44	74	54.44	31.33	10.89	58.1	100	0	P	H
		7308	42.28	-31.72	74	51.12	36.07	14.18	59.09	100	0	P	H
													H
													H
													V
													V
													V
802.11g CH 11 2462MHz		4926	38.1	-35.9	74	53.72	31.4	11.04	58.06	100	0	P	H
		7386	42.4	-31.6	74	50.96	36.31	14.27	59.14	100	0	P	H
													H
													H
													V
													V
													V
Remark	1. No other spurious found. 2. All results are PASS against Peak and Average limit line.												



**2.4GHz 2400~2483.5MHz
WIFI 802.11n HT20 (Band Edge @ 3m)**

WIFI Ant. 1+2	Note	Frequency (MHz)	Level (dBµV/m)	Over Limit (dB)	Limit Line (dBµV/m)	Read Level (dBµV)	Antenna Factor (dB/m)	Cable Loss (dB)	Preamp Factor (dB)	Ant Pos (cm)	Table Pos (deg)	Peak Avg. (P/A)	Pol. (H/V)	
802.11n HT20 CH 01 2412MHz		2389.11	56.67	-17.33	74	56.17	27.05	7.45	34	100	163	P	H	
		2389.92	44.81	-9.19	54	44.31	27.05	7.45	34	100	163	A	H	
	*	2412	102.37	-	-	101.84	27.09	7.45	34.01	100	163	P	H	
	*	2412	92.41	-	-	91.88	27.09	7.45	34.01	100	163	A	H	
													H	
														H
			2389.11	68.39	-5.61	74	67.89	27.05	7.45	34	100	85	P	V
			2390	53.52	-0.48	54	53.02	27.05	7.45	34	100	85	A	V
	*		2412	114.28	-	-	113.75	27.09	7.45	34.01	100	85	P	V
	*		2412	104.14	-	-	103.61	27.09	7.45	34.01	100	85	A	V
														V
														V
802.11n HT20 CH 06 2437MHz		2378.58	56.14	-17.86	74	55.74	27.01	7.37	33.98	100	163	P	H	
		2374.26	44.51	-9.49	54	44.11	27.01	7.37	33.98	100	163	A	H	
	*	2437	105.02	-	-	104.4	27.18	7.49	34.05	100	163	P	H	
	*	2437	94.89	-	-	94.27	27.18	7.49	34.05	100	163	A	H	
			2493.2	55.73	-18.27	74	55	27.3	7.53	34.1	100	163	P	H
			2499.28	44.44	-9.56	54	43.71	27.3	7.53	34.1	100	163	A	H
			2353.56	65.67	-8.33	74	65.29	26.97	7.37	33.96	100	86	P	V
			2359.86	52.05	-1.95	54	51.67	26.97	7.37	33.96	100	86	A	V
	*		2437	116.42	-	-	115.8	27.18	7.49	34.05	100	86	P	V
	*		2437	106.51	-	-	105.89	27.18	7.49	34.05	100	86	A	V
			2492.68	59.64	-14.36	74	58.91	27.3	7.53	34.1	100	86	P	V
			2498.72	48.6	-5.4	54	47.87	27.3	7.53	34.1	100	86	A	V



802.11n HT20 CH 11 2462MHz	*	2462	104.03	-	-	103.35	27.22	7.53	34.07	100	164	P	H
	*	2462	93.92	-	-	93.24	27.22	7.53	34.07	100	164	A	H
		2484.68	61.01	-12.99	74	60.3	27.26	7.53	34.08	100	164	P	H
		2483.56	46.68	-7.32	54	45.97	27.26	7.53	34.08	100	164	A	H
													H
													H
	*	2462	115.55	-	-	114.87	27.22	7.53	34.07	100	87	P	V
	*	2462	105.75	-	-	105.07	27.22	7.53	34.07	100	87	A	V
		2485.6	69.23	-4.77	74	68.52	27.26	7.53	34.08	100	87	P	V
		2483.52	53.23	-0.77	54	52.52	27.26	7.53	34.08	100	87	A	V
													V
												V	
Remark	1. No other spurious found. 2. All results are PASS against Peak and Average limit line.												



**2.4GHz 2400~2483.5MHz
WIFI 802.11n HT20 (Harmonic @ 3m)**

WIFI Ant. 1+2	Note	Frequency (MHz)	Level (dBμV/m)	Over Limit (dB)	Limit Line (dBμV/m)	Read Level (dBμV)	Antenna Factor (dB/m)	Cable Loss (dB)	Preamp Factor (dB)	Ant Pos (cm)	Table Pos (deg)	Peak Avg. (P/A)	Pol. (H/V)	
802.11n HT20 CH 01 2412MHz		4824	36.93	-37.07	74	53.07	31.26	10.74	58.14	100	0	P	H	
													H	
													H	
													H	
			4824	37.39	-36.61	74	53.53	31.26	10.74	58.14	100	0	P	V
														V
														V
802.11n HT20 CH 06 2437MHz		4872	38.3	-35.7	74	54.18	31.33	10.89	58.1	100	0	P	H	
		7308	41.91	-32.09	74	50.75	36.07	14.18	59.09	100	0	P	H	
													H	
													H	
			4872	40.08	-33.92	74	55.96	31.33	10.89	58.1	100	0	P	V
			7308	42.3	-31.7	74	51.14	36.07	14.18	59.09	100	0	P	V
														V
802.11n HT20 CH 11 2462MHz		4926	37.56	-36.44	74	53.18	31.4	11.04	58.06	100	0	P	H	
		7386	43.03	-30.97	74	51.59	36.31	14.27	59.14	100	0	P	H	
													H	
													H	
			4926	38.08	-35.92	74	53.7	31.4	11.04	58.06	100	0	P	V
			7386	42.7	-31.3	74	51.26	36.31	14.27	59.14	100	0	P	V
														V
Remark	1. No other spurious found.													
	2. All results are PASS against Peak and Average limit line.													



2.4GHz 2400~2483.5MHz
WIFI 802.11n HT40 (Band Edge @ 3m)

WIFI Ant. 1+2	Note	Frequency (MHz)	Level (dBμV/m)	Over Limit (dB)	Limit Line (dBμV/m)	Read Level (dBμV)	Antenna Factor (dB/m)	Cable Loss (dB)	Preamp Factor (dB)	Ant Pos (cm)	Table Pos (deg)	Peak Avg. (P/A)	Pol. (H/V)
802.11n HT40 CH 03 2422MHz		2386.68	56.28	-17.72	74	55.78	27.05	7.45	34	100	162	P	H
		2386.86	45.31	-8.69	54	44.81	27.05	7.45	34	100	162	A	H
	*	2422	97.37	-	-	96.78	27.13	7.49	34.03	100	162	P	H
	*	2422	86.27	-	-	85.68	27.13	7.49	34.03	100	162	A	H
		2497.96	55.17	-18.83	74	54.44	27.3	7.53	34.1	100	162	P	H
		2484.6	44.69	-9.31	54	43.98	27.26	7.53	34.08	100	162	A	H
		2388.84	66.21	-7.79	74	65.71	27.05	7.45	34	128	89	P	V
		2389.47	53.48	-0.52	54	52.98	27.05	7.45	34	128	89	A	V
	*	2422	107.32	-	-	106.73	27.13	7.49	34.03	128	89	P	V
	*	2422	97.46	-	-	96.87	27.13	7.49	34.03	128	89	A	V
		2487.8	57.73	-16.27	74	57	27.3	7.53	34.1	128	89	P	V
		2500	46.1	-7.9	54	45.37	27.3	7.53	34.1	128	89	A	V
802.11n HT40 CH 06 2437MHz		2389.56	56.4	-17.6	74	55.9	27.05	7.45	34	108	163	P	H
		2386.77	45.97	-8.03	54	45.47	27.05	7.45	34	108	163	A	H
	*	2437	101.16	-	-	100.54	27.18	7.49	34.05	108	163	P	H
	*	2437	91.41	-	-	90.79	27.18	7.49	34.05	108	163	A	H
		2493.8	56.41	-17.59	74	55.68	27.3	7.53	34.1	108	163	P	H
		2495.84	45.29	-8.71	54	44.56	27.3	7.53	34.1	108	163	A	H
		2389.92	67.28	-6.72	74	66.78	27.05	7.45	34	100	85	P	V
		2389.92	53.6	-0.4	54	53.1	27.05	7.45	34	100	85	A	V
	*	2437	110.99	-	-	110.37	27.18	7.49	34.05	100	85	P	V
	*	2437	101.4	-	-	100.78	27.18	7.49	34.05	100	85	A	V
		2487	62.81	-11.19	74	62.1	27.26	7.53	34.08	100	85	P	V
		2483.8	50.6	-3.4	54	49.89	27.26	7.53	34.08	100	85	A	V



802.11n HT40 CH 09 2452MHz		2379.93	55.88	-18.12	74	55.48	27.01	7.37	33.98	113	162	P	H
		2371.56	44.87	-9.13	54	44.47	27.01	7.37	33.98	113	162	A	H
	*	2452	98.52	-	-	97.9	27.18	7.49	34.05	113	162	P	H
	*	2452	88.44	-	-	87.82	27.18	7.49	34.05	113	162	A	H
		2483.56	56.86	-17.14	74	56.15	27.26	7.53	34.08	113	162	P	H
		2483.68	45.98	-8.02	54	45.27	27.26	7.53	34.08	113	162	A	H
		2385.78	59.59	-14.41	74	59.09	27.05	7.45	34	100	86	P	V
		2359.95	49.73	-4.27	54	49.35	26.97	7.37	33.96	100	86	A	V
	*	2452	109.12	-	-	108.5	27.18	7.49	34.05	100	86	P	V
	*	2452	99.56	-	-	98.94	27.18	7.49	34.05	100	86	A	V
		2483.72	67.33	-6.67	74	66.62	27.26	7.53	34.08	100	86	P	V
		2483.92	53.55	-0.45	54	52.84	27.26	7.53	34.08	100	86	A	V
Remark	1. No other spurious found. 2. All results are PASS against Peak and Average limit line.												



2.4GHz 2400~2483.5MHz
WIFI 802.11n HT40 (Harmonic @ 3m)

WIFI Ant. 1+2	Note	Frequency (MHz)	Level (dBμV/m)	Over Limit (dB)	Limit Line (dBμV/m)	Read Level (dBμV)	Antenna Factor (dB/m)	Cable Loss (dB)	Preamp Factor (dB)	Ant Pos (cm)	Table Pos (deg)	Peak Avg. (P/A)	Pol. (H/V)	
802.11n HT40 CH 03 2422MHz		4842	36.81	-37.19	74	52.91	31.28	10.74	58.12	100	0	P	H	
		7266	42.29	-31.71	74	51.25	35.97	14.14	59.07	100	0	P	H	
													H	
													H	
			4842	36.65	-37.35	74	52.75	31.28	10.74	58.12	100	0	P	V
			7266	42.33	-31.67	74	51.29	35.97	14.14	59.07	100	0	P	V
														V
802.11n HT40 CH 06 2437MHz		4872	37.97	-36.03	74	53.85	31.33	10.89	58.1	100	0	P	H	
		7308	41.92	-32.08	74	50.76	36.07	14.18	59.09	100	0	P	H	
													H	
													H	
			4872	38.27	-35.73	74	54.15	31.33	10.89	58.1	100	0	P	V
			7308	42.39	-31.61	74	51.23	36.07	14.18	59.09	100	0	P	V
														V
802.11n HT40 CH 09 2452MHz		4902	38.72	-35.28	74	54.37	31.38	11.04	58.07	100	0	P	H	
		7356	42.65	-31.35	74	51.34	36.21	14.22	59.12	100	0	P	H	
													H	
													H	
			4902	37.06	-36.94	74	52.71	31.38	11.04	58.07	100	0	P	V
			7356	42.06	-31.94	74	50.75	36.21	14.22	59.12	100	0	P	V
														V
Remark	1. No other spurious found.													
	2. All results are PASS against Peak and Average limit line.													



Emission below 1GHz
2.4GHz WIFI 802.11n HT40 Adapter mode (LF)

WIFI Ant. 1+2	Note	Frequency (MHz)	Level (dBμV/m)	Over Limit (dB)	Limit Line (dBμV/m)	Read Level (dBμV)	Antenna Factor (dB/m)	Cable Loss (dB)	Preamp Factor (dB)	Ant Pos (cm)	Table Pos (deg)	Peak Avg. (P/A)	Pol. (H/V)	
2.4GHz 802.11n HT40 LF		84	31.81	-8.19	40	49.05	14.14	1.06	32.44	145	245	P	H	
		289.2	33.6	-12.4	46	44.32	19.28	2.25	32.25	-	-	P	H	
		298.38	33.47	-12.53	46	43.97	19.48	2.25	32.23	-	-	P	H	
		400.1	23.84	-22.16	46	31.31	22.22	2.68	32.37	-	-	P	H	
		666.1	27.95	-18.05	46	30.41	26.13	3.82	32.41	-	-	P	H	
		958.7	33.5	-12.5	46	29.6	30.2	4.75	31.05	-	-	P	H	
														H
														H
														H
														H
														H
														H
			40.53	36.15	-3.85	40	48.09	19.74	0.78	32.46	112	321	P	V
			64.83	28.9	-11.1	40	48.24	12.05	1.06	32.45	-	-	P	V
			121.8	27.38	-16.12	43.5	40.7	17.68	1.43	32.43	-	-	P	V
			309.1	23.89	-22.11	46	34	19.79	2.34	32.24	-	-	P	V
			636	27.34	-18.66	46	30.29	25.84	3.61	32.4	-	-	P	V
			946.1	33.4	-12.6	46	29.63	30.19	4.75	31.17	-	-	P	V
														V
														V
													V	
													V	
													V	
													V	
Remark	1. No other spurious found. 2. All results are PASS against limit line.													



**Emission below 1GHz
2.4GHz WIFI 802.11n HT40 POE mode (LF)**

WiFi Ant. 1+2	Note	Frequency (MHz)	Level (dBμV/m)	Over Limit (dB)	Limit Line (dBμV/m)	Read Level (dBμV)	Antenna Factor (dB/m)	Cable Loss (dB)	Preamp Factor (dB)	Ant Pos (cm)	Table Pos (deg)	Peak Avg. (P/A)	Pol. (H/V)
		86.43	29.27	-10.73	40	46.29	14.36	1.06	32.44	100	30	P	H
		154.47	24.94	-18.56	43.5	38.31	17.3	1.75	32.42	-	-	P	H
		259.5	20.1	-25.9	46	31.07	19.5	1.83	32.3	-	-	P	H
		427.4	23.54	-22.46	46	30.33	22.7	2.89	32.38	-	-	P	H
		689.9	28.06	-17.94	46	30.33	26.32	3.82	32.41	-	-	P	H
		967.1	34.06	-19.94	54	30.2	30.09	4.75	30.98	-	-	P	H
													H
													H
													H
													H
													H
													H
2.4GHz													H
802.11n													H
HT40													H
LF		40.26	36.03	-3.97	40	47.97	19.74	0.78	32.46	147	312	P	V
		156.36	25.62	-17.88	43.5	39.09	17.2	1.75	32.42	-	-	P	V
		267.6	25.53	-20.47	46	36.39	19.18	2.25	32.29	-	-	P	V
		429.5	23.21	-22.79	46	29.96	22.74	2.89	32.38	-	-	P	V
		615.7	27.98	-18.02	46	31.29	25.59	3.5	32.4	-	-	P	V
		934.2	32.89	-13.11	46	29.7	29.86	4.6	31.27	-	-	P	V
													V
													V
													V
													V
													V
													V
													V
													V
													V
													V
													V
													V
Remark	1. No other spurious found. 2. All results are PASS against limit line.												



Note symbol

*	Fundamental Frequency which can be ignored. However, the level of any unwanted emissions shall not exceed the level of the fundamental frequency.
!	Test result is over limit line.
P/A	Peak or Average
H/V	Horizontal or Vertical



A calculation example for radiated spurious emission is shown as below:

WIFI Ant. 1+2	Note	Frequency (MHz)	Level (dBμV/m)	Over Limit (dB)	Limit Line (dBμV/m)	Read Level (dBμV)	Antenna Factor (dB/m)	Cable Loss (dB)	Preamp Factor (dB)	Ant Pos (cm)	Table Pos (deg)	Peak Avg. (P/A)	Pol. (H/V)
802.11b CH 01 2412MHz		2390	55.45	-18.55	74	54.51	32.22	4.58	35.86	103	308	P	H
		2390	43.54	-10.46	54	42.6	32.22	4.58	35.86	103	308	A	H

- 1. Level(dBμV/m) =
Antenna Factor(dB/m) + Cable Loss(dB) + Read Level(dBμV) - Preamp Factor(dB)
- 2. Over Limit(dB) = Level(dBμV/m) – Limit Line(dBμV/m)

For Peak Limit @ 2390MHz:

- 1. Level(dBμV/m)
= Antenna Factor(dB/m) + Cable Loss(dB) + Read Level(dBμV) - Preamp Factor(dB)
= 32.22(dB/m) + 4.58(dB) + 54.51(dBμV) – 35.86 (dB)
= 55.45 (dBμV/m)
- 2. Over Limit(dB)
= Level(dBμV/m) – Limit Line(dBμV/m)
= 55.45(dBμV/m) – 74(dBμV/m)
= -18.55(dB)

For Average Limit @ 2390MHz:

- 1. Level(dBμV/m)
= Antenna Factor(dB/m) + Cable Loss(dB) + Read Level(dBμV) - Preamp Factor(dB)
= 32.22(dB/m) + 4.58(dB) + 42.6(dBμV) – 35.86 (dB)
= 43.54 (dBμV/m)
- 2. Over Limit(dB)
= Level(dBμV/m) – Limit Line(dBμV/m)
= 43.54(dBμV/m) – 54(dBμV/m)
= -10.46(dB)

Both peak and average measured complies with the limit line, so test result is “PASS”.



Appendix C. Radiated Spurious Emission Plots

Test Engineer :	Citta Ke, Ricky Su, and Nick Yu	Temperature :	23~25°C
		Relative Humidity :	55~60%

Note symbol

-L	Low channel location
-R	High channel location

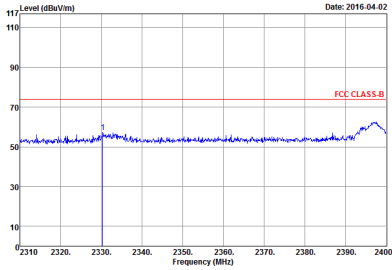
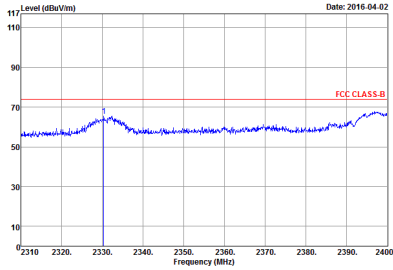
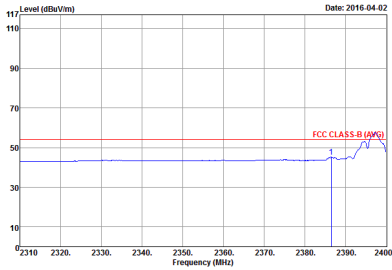
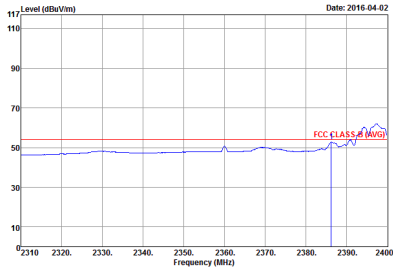

2.4GHz 2400~2483.5MHz
WIFI 802.11b (Band Edge @ 3m)

WIFI	2.4GHz 2400~2483.5MHz Band Edge @ 3m	
ANT	802.11b CH01 2412MHz	
1	Horizontal	Vertical
Peak	 <p>Date: 2016-04-02</p> <p>Level (dBuV/m) vs Frequency (MHz)</p> <p>FCC CLASS B</p> <p>Site : 03CH12-HY Condition : FCC CLASS-B 3m HORN_91200_1328 HORIZONTAL Detector : Peak Project : 502212 Mode : 1</p>	 <p>Date: 2016-04-02</p> <p>Level (dBuV/m) vs Frequency (MHz)</p> <p>FCC CLASS B</p> <p>Site : 03CH12-HY Condition : FCC CLASS-B 3m HORN_91200_1328 VERTICAL Detector : Peak Project : 502212 Mode : 1</p>
Avg.	 <p>Date: 2016-04-02</p> <p>Level (dBuV/m) vs Frequency (MHz)</p> <p>FCC CLASS-B (AVG)</p> <p>Site : 03CH12-HY Condition : FCC CLASS-B (AVG) 3m HORN_91200_1328 HORIZONTAL Detector : Peak Project : 502212 Mode : 1</p>	 <p>Date: 2016-04-02</p> <p>Level (dBuV/m) vs Frequency (MHz)</p> <p>FCC CLASS-B (AVG)</p> <p>Site : 03CH12-HY Condition : FCC CLASS-B (AVG) 3m HORN_91200_1328 VERTICAL Detector : Peak Project : 502212 Mode : 1</p>

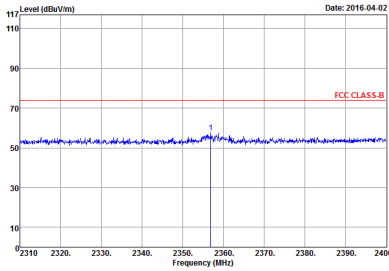
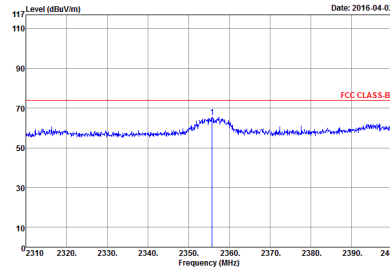
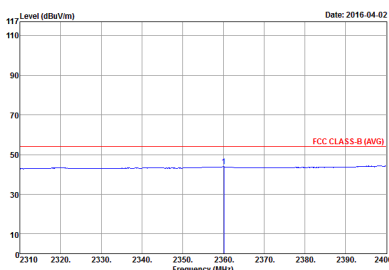
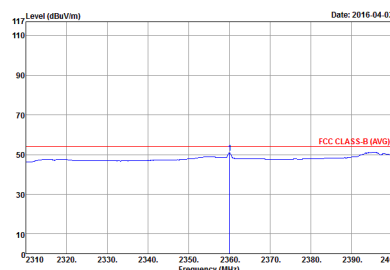

WIFI	2.4GHz 2400~2483.5MHz Band Edge @ 3m	
ANT	802.11b CH06 2437MHz - L	
1	<p style="text-align: center;">Horizontal</p>  <p>Peak</p> <pre> Site : 03CH12-HY Condition : FCC CLASS-B 3m HORN_91200_1328 HORIZONTAL Detector : Peak Project : 502212 Mode : 2 </pre>	<p style="text-align: center;">Vertical</p>  <pre> Site : 03CH12-HY Condition : FCC CLASS-B 3m HORN_91200_1328 VERTICAL Detector : Peak Project : 502212 Mode : 2 </pre>
	<p style="text-align: center;">Avg.</p>  <pre> Site : 03CH12-HY Condition : FCC CLASS-B (AVG) 3m HORN_91200_1328 HORIZONTAL Detector : Peak Project : 502212 Mode : 2 </pre>	 <pre> Site : 03CH12-HY Condition : FCC CLASS-B (AVG) 3m HORN_91200_1328 VERTICAL Detector : Peak Project : 502212 Mode : 2 </pre>

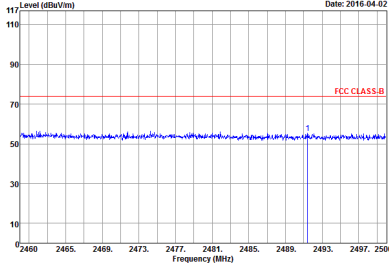
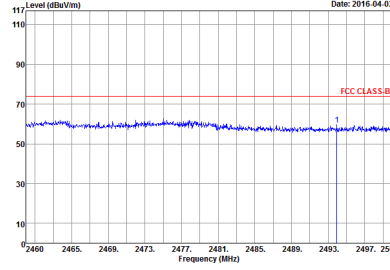
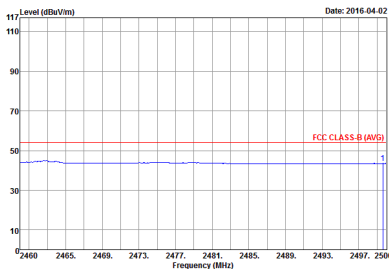
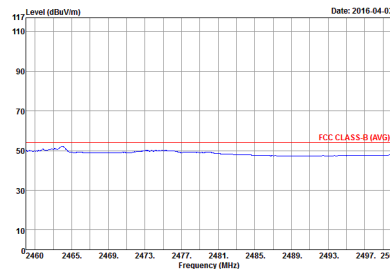

WIFI	2.4GHz 2400~2483.5MHz Band Edge @ 3m	
ANT	802.11b CH06 2437MHz - R	
1	Horizontal	Vertical
Peak	 <p>Date: 2016-04-02</p> <p>Level (dBuV/m) vs Frequency (MHz)</p> <p>FCC CLASS:B</p> <p>Site : 03CH12-HY Condition : FCC CLASS-B 3m HORN_91200_1328 HORIZONTAL Detector : Peak Project : 5D2212 Mode : 2</p>	 <p>Date: 2016-04-02</p> <p>Level (dBuV/m) vs Frequency (MHz)</p> <p>FCC CLASS:B</p> <p>Site : 03CH12-HY Condition : FCC CLASS-B 3m HORN_91200_1328 VERTICAL Detector : Peak Project : 5D2212 Mode : 2</p>
Avg.	 <p>Date: 2016-04-02</p> <p>Level (dBuV/m) vs Frequency (MHz)</p> <p>FCC CLASS-B (AVG)</p> <p>Site : 03CH12-HY Condition : FCC CLASS-B (AVG) 3m HORN_91200_1328 HORIZONTAL Detector : Peak Project : 5D2212 Mode : 2</p>	 <p>Date: 2016-04-02</p> <p>Level (dBuV/m) vs Frequency (MHz)</p> <p>FCC CLASS-B (AVG)</p> <p>Site : 03CH12-HY Condition : FCC CLASS-B (AVG) 3m HORN_91200_1328 VERTICAL Detector : Peak Project : 5D2212 Mode : 2</p>

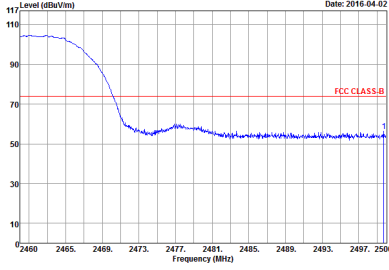
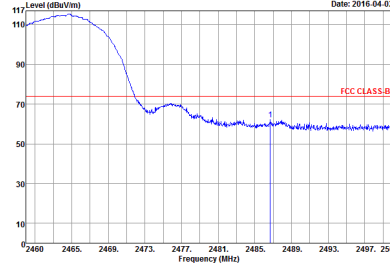
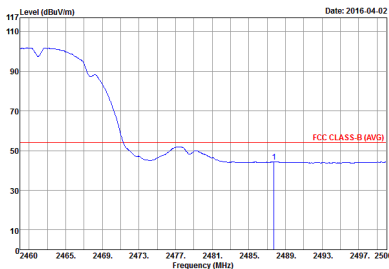
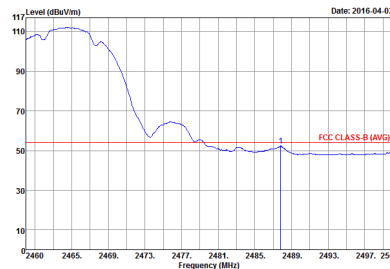

WIFI	2.4GHz 2400~2483.5MHz Band Edge @ 3m	
ANT	802.11b CH11 2462MHz	
1	Horizontal	Vertical
Peak	 <p>Date: 2016-04-02</p> <p>Level (dBuV/m)</p> <p>Frequency (MHz)</p> <p>FCC CLASS:B</p> <p>Site : 03CH12-HY Condition : FCC CLASS-B 3m HORN_91200_1328 HORIZONTAL RBW:1000.000KHz VBW:3000.000KHz SWT:Auto Detector : Peak Project : 5D2212 Mode : 3</p>	 <p>Date: 2016-04-02</p> <p>Level (dBuV/m)</p> <p>Frequency (MHz)</p> <p>FCC CLASS:B</p> <p>Site : 03CH12-HY Condition : FCC CLASS-B 3m HORN_91200_1328 VERTICAL RBW:1000.000KHz VBW:3000.000KHz SWT:Auto Detector : Peak Project : 5D2212 Mode : 3</p>
Avg.	 <p>Date: 2016-04-02</p> <p>Level (dBuV/m)</p> <p>Frequency (MHz)</p> <p>FCC CLASS-B (AVG)</p> <p>Site : 03CH12-HY Condition : FCC CLASS-B (AVG) 3m HORN_91200_1328 HORIZONTAL RBW:1000.000KHz VBW:0.010KHz SWT:Auto Detector : Peak Project : 5D2212 Mode : 3</p>	 <p>Date: 2016-04-02</p> <p>Level (dBuV/m)</p> <p>Frequency (MHz)</p> <p>FCC CLASS-B (AVG)</p> <p>Site : 03CH12-HY Condition : FCC CLASS-B (AVG) 3m HORN_91200_1328 VERTICAL RBW:1000.000KHz VBW:0.010KHz SWT:Auto Detector : Peak Project : 5D2212 Mode : 3</p>

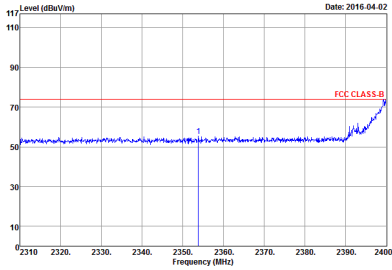
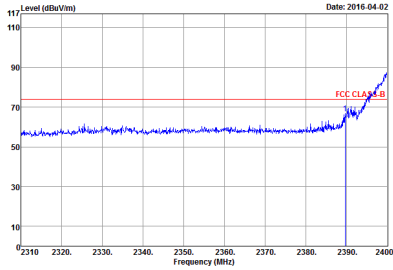
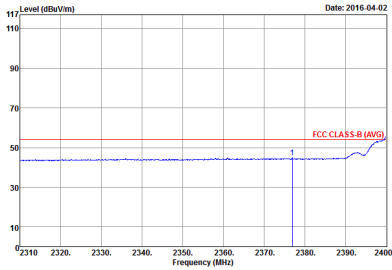
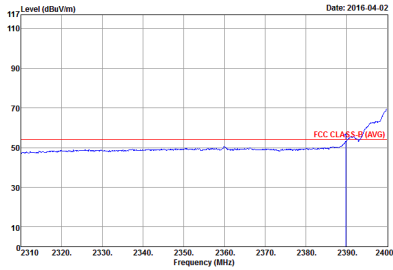

2.4GHz 2400~2483.5MHz
WIFI 802.11g (Band Edge @ 3m)

WIFI	2.4GHz 2400~2483.5MHz Band Edge @ 3m	
ANT	802.11g CH01 2412MHz	
1	Horizontal	Vertical
Peak	 <p>Site : 03CH12-HY Condition : FCC CLASS-B 3m HORN_91200_1328 HORIZONTAL Detector : Peak Project : 502212 Mode : 4</p>	 <p>Site : 03CH12-HY Condition : FCC CLASS-B 3m HORN_91200_1328 VERTICAL Detector : Peak Project : 502212 Mode : 4</p>
Avg.	 <p>Site : 03CH12-HY Condition : FCC CLASS-B (AVG) 3m HORN_91200_1328 HORIZONTAL Detector : Peak Project : 502212 Mode : 4</p>	 <p>Site : 03CH12-HY Condition : FCC CLASS-B (AVG) 3m HORN_91200_1328 VERTICAL Detector : Peak Project : 502212 Mode : 4</p>

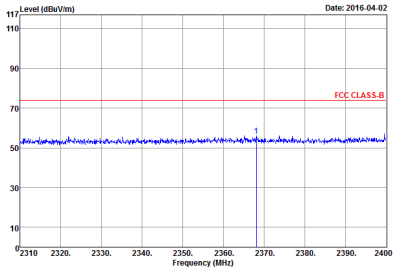
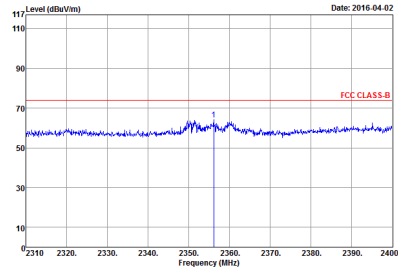
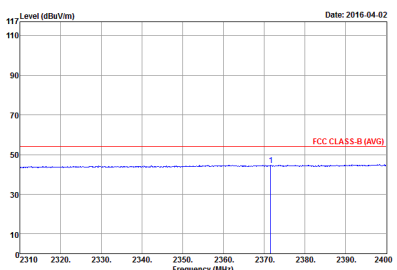
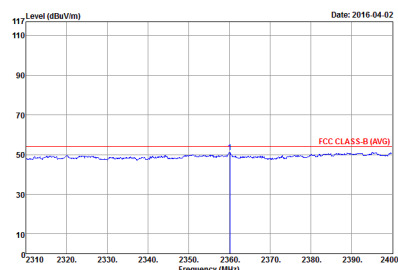

WIFI	2.4GHz 2400~2483.5MHz Band Edge @ 3m	
ANT	802.11g CH06 2437MHz - L	
1	Horizontal	Vertical
Peak	 <p>Site : 03CH12-HY Condition : FCC CLASS-B 3m HORN_91200_1328 HORIZONTAL Detector : Peak Project : 5D2212 Mode : 5</p>	 <p>Site : 03CH12-HY Condition : FCC CLASS-B 3m HORN_91200_1328 VERTICAL Detector : Peak Project : 5D2212 Mode : 5</p>
Avg.	 <p>Site : 03CH12-HY Condition : FCC CLASS-B (AVG) 3m HORN_91200_1328 HORIZONTAL Detector : Peak Project : 5D2212 Mode : 5</p>	 <p>Site : 03CH12-HY Condition : FCC CLASS-B (AVG) 3m HORN_91200_1328 VERTICAL Detector : Peak Project : 5D2212 Mode : 5</p>

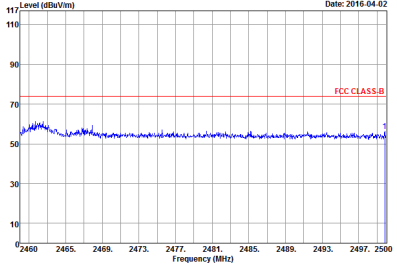
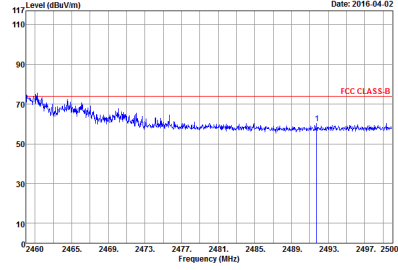
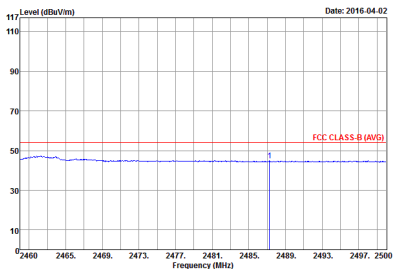
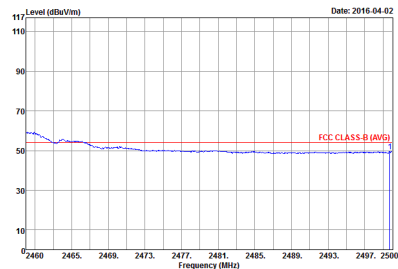

WIFI	2.4GHz 2400~2483.5MHz Band Edge @ 3m	
ANT	802.11g CH06 2437MHz - R	
1	Horizontal	Vertical
Peak	 <p>Date: 2016-04-02</p> <p>Site : 03CH12-HY Condition : FCC CLASS-B 3m HORN_91200_1328 HORIZONTAL Detector : Peak Project : 5D2212 Mode : 5</p>	 <p>Date: 2016-04-02</p> <p>Site : 03CH12-HY Condition : FCC CLASS-B 3m HORN_91200_1328 VERTICAL Detector : Peak Project : 5D2212 Mode : 5</p>
Avg.	 <p>Date: 2016-04-02</p> <p>Site : 03CH12-HY Condition : FCC CLASS-B (AVG) 3m HORN_91200_1328 HORIZONTAL Detector : Peak Project : 5D2212 Mode : 5</p>	 <p>Date: 2016-04-02</p> <p>Site : 03CH12-HY Condition : FCC CLASS-B (AVG) 3m HORN_91200_1328 VERTICAL Detector : Peak Project : 5D2212 Mode : 5</p>

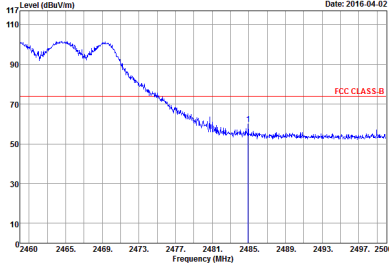
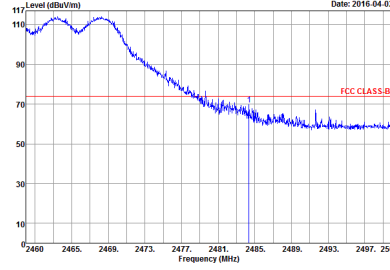
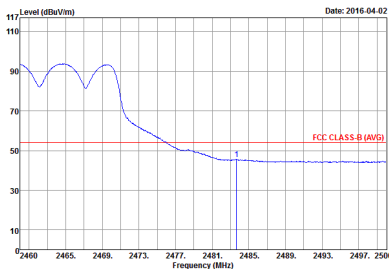
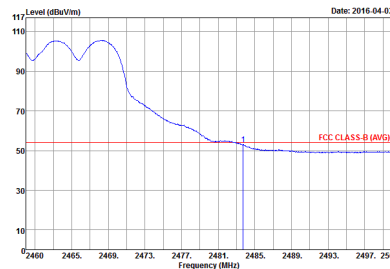

WIFI	2.4GHz 2400~2483.5MHz Band Edge @ 3m	
ANT	802.11g CH11 2462MHz	
1	Horizontal	Vertical
Peak	 <p>Date: 2016-04-02</p> <p>Level (dBuV/m)</p> <p>Frequency (MHz)</p> <p>FCC CLASS:B</p> <p>Site : 03CH12-HY Condition : FCC CLASS-B 3m HORN_91200_1328 HORIZONTAL Detector : Peak Project : 5D2212 Mode : 6</p>	 <p>Date: 2016-04-02</p> <p>Level (dBuV/m)</p> <p>Frequency (MHz)</p> <p>FCC CLASS:B</p> <p>Site : 03CH12-HY Condition : FCC CLASS-B 3m HORN_91200_1328 VERTICAL Detector : Peak Project : 5D2212 Mode : 6</p>
Avg.	 <p>Date: 2016-04-02</p> <p>Level (dBuV/m)</p> <p>Frequency (MHz)</p> <p>FCC CLASS-B (AVG)</p> <p>Site : 03CH12-HY Condition : FCC CLASS-B (AVG) 3m HORN_91200_1328 HORIZONTAL Detector : Peak Project : 5D2212 Mode : 6</p>	 <p>Date: 2016-04-02</p> <p>Level (dBuV/m)</p> <p>Frequency (MHz)</p> <p>FCC CLASS-B (AVG)</p> <p>Site : 03CH12-HY Condition : FCC CLASS-B (AVG) 3m HORN_91200_1328 VERTICAL Detector : Peak Project : 5D2212 Mode : 6</p>

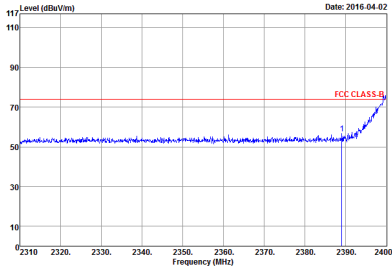
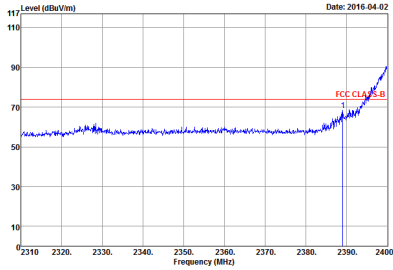
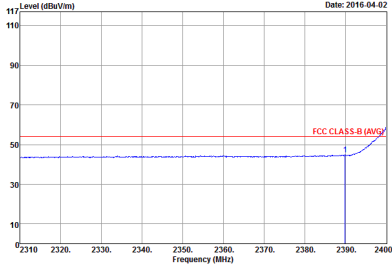
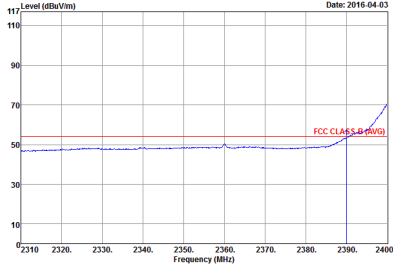

2.4GHz 2400~2483.5MHz
WIFI 802.11n HT20 (Band Edge @ 3m)

WIFI	2.4GHz 2400~2483.5MHz Band Edge @ 3m	
ANT	802.11n HT20 CH01 2412MHz	
1	Horizontal	Vertical
Peak	 <p>Site : 03CH12-HY Condition : FCC CLASS-B 3m HORN_91200_1328 HORIZONTAL Detector : Peak Project : 502212 Mode : 7</p>	 <p>Site : 03CH12-HY Condition : FCC CLASS-B 3m HORN_91200_1328 VERTICAL Detector : Peak Project : 502212 Mode : 7</p>
Avg.	 <p>Site : 03CH12-HY Condition : FCC CLASS-B (AVG) 3m HORN_91200_1328 HORIZONTAL Detector : Peak Project : 502212 Mode : 7</p>	 <p>Site : 03CH12-HY Condition : FCC CLASS-B (AVG) 3m HORN_91200_1328 VERTICAL Detector : Peak Project : 502212 Mode : 7</p>

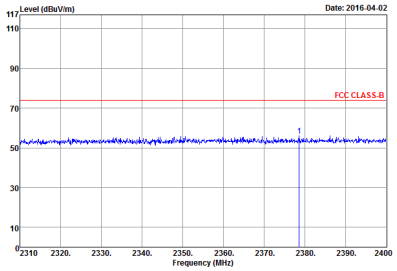
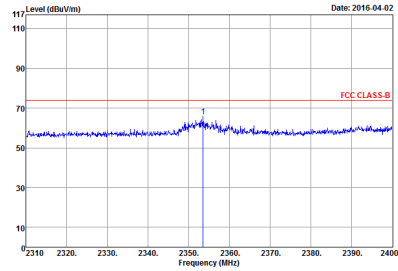
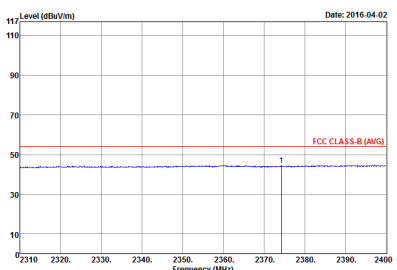
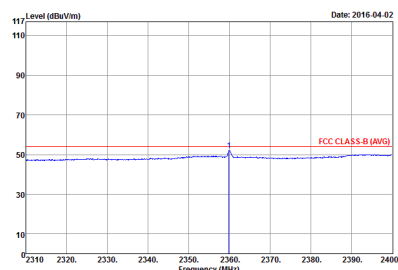

WIFI	2.4GHz 2400~2483.5MHz Band Edge @ 3m	
ANT	802.11n HT20 CH06 2437MHz - L	
1	Horizontal	Vertical
Peak	 <p>Site : 03CH12-HY Condition : FCC CLASS-B 3m HORN_91200_1328 HORIZONTAL RBW:1000.000KHz VBW:3000.000KHz SWT:Auto Detector : Peak Project : 5D2212 Mode : 8</p>	 <p>Site : 03CH12-HY Condition : FCC CLASS-B 3m HORN_91200_1328 VERTICAL RBW:1000.000KHz VBW:3000.000KHz SWT:Auto Detector : Peak Project : 5D2212 Mode : 8</p>
Avg.	 <p>Site : 03CH12-HY Condition : FCC CLASS-B (AVG) 3m HORN_91200_1328 HORIZONTAL RBW:1000.000KHz VBW:1.000KHz SWT:Auto Detector : Peak Project : 5D2212 Mode : 8</p>	 <p>Site : 03CH12-HY Condition : FCC CLASS-B (AVG) 3m HORN_91200_1328 VERTICAL RBW:1000.000KHz VBW:1.000KHz SWT:Auto Detector : Peak Project : 5D2212 Mode : 8</p>

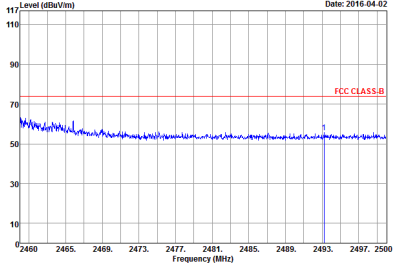
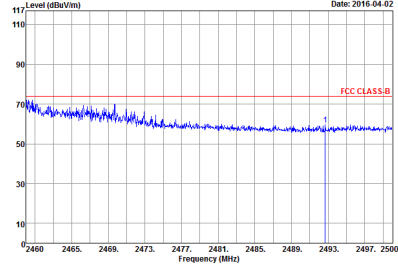
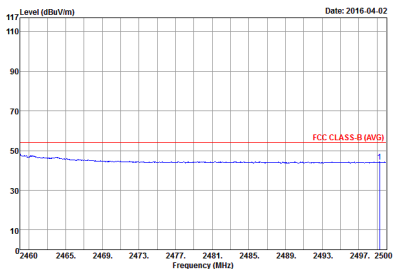
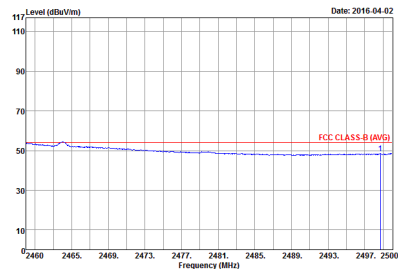

WIFI	2.4GHz 2400~2483.5MHz Band Edge @ 3m	
ANT	802.11n HT20 CH06 2437MHz - R	
1	Horizontal	Vertical
Peak	 <p>Date: 2016-04-02</p> <p>Site : 03CH12-HY Condition : FCC CLASS-B 3m HORN_91200_1328 HORIZONTAL Detector : Peak Project : 5D2212 Mode : 8</p>	 <p>Date: 2016-04-02</p> <p>Site : 03CH12-HY Condition : FCC CLASS-B 3m HORN_91200_1328 VERTICAL Detector : Peak Project : 5D2212 Mode : 8</p>
Avg.	 <p>Date: 2016-04-02</p> <p>Site : 03CH12-HY Condition : FCC CLASS-B (AVG) 3m HORN_91200_1328 HORIZONTAL Detector : Peak Project : 5D2212 Mode : 8</p>	 <p>Date: 2016-04-02</p> <p>Site : 03CH12-HY Condition : FCC CLASS-B (AVG) 3m HORN_91200_1328 VERTICAL Detector : Peak Project : 5D2212 Mode : 8</p>

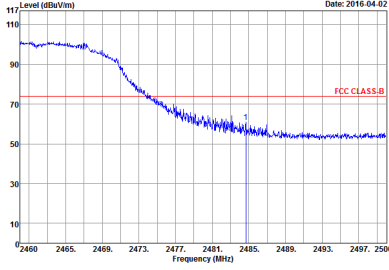
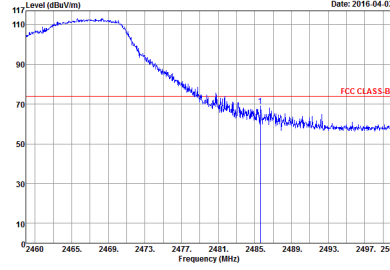
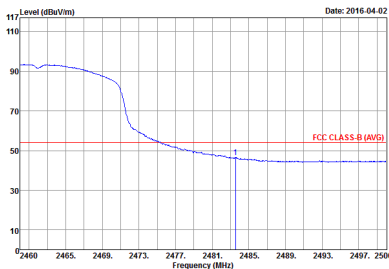
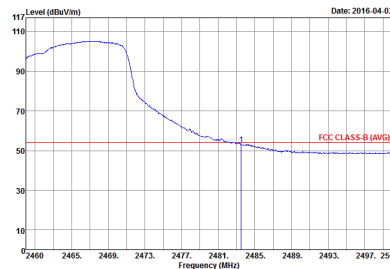

WIFI	2.4GHz 2400~2483.5MHz Band Edge @ 3m	
ANT	802.11n HT20 CH11 2462MHz	
1	Horizontal	Vertical
Peak	 <p>Date: 2016-04-02</p> <p>Level (dBuV/m) vs Frequency (MHz)</p> <p>FCC CLASS B</p> <p>Site : 03CH12-HY Condition : FCC CLASS-B 3m HORN_91200_1328 HORIZONTAL RBW:1000.000KHz VBW:3000.000KHz SWT:Auto Detector : Peak Project : 5D2212 Mode : 9</p>	 <p>Date: 2016-04-02</p> <p>Level (dBuV/m) vs Frequency (MHz)</p> <p>FCC CLASS B</p> <p>Site : 03CH12-HY Condition : FCC CLASS-B 3m HORN_91200_1328 VERTICAL RBW:1000.000KHz VBW:3000.000KHz SWT:Auto Detector : Peak Project : 5D2212 Mode : 9</p>
Avg.	 <p>Date: 2016-04-02</p> <p>Level (dBuV/m) vs Frequency (MHz)</p> <p>FCC CLASS-B (AVG)</p> <p>Site : 03CH12-HY Condition : FCC CLASS-B (AVG) 3m HORN_91200_1328 HORIZONTAL RBW:1000.000KHz VBW:1.000KHz SWT:Auto Detector : Peak Project : 5D2212 Mode : 9</p>	 <p>Date: 2016-04-02</p> <p>Level (dBuV/m) vs Frequency (MHz)</p> <p>FCC CLASS-B (AVG)</p> <p>Site : 03CH12-HY Condition : FCC CLASS-B (AVG) 3m HORN_91200_1328 VERTICAL RBW:1000.000KHz VBW:1.000KHz SWT:Auto Detector : Peak Project : 5D2212 Mode : 9</p>

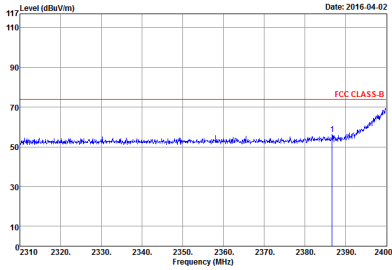
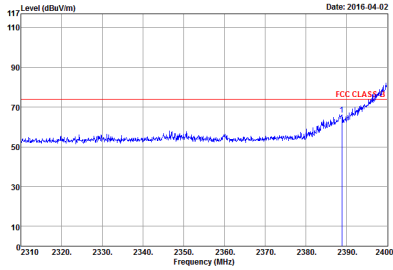
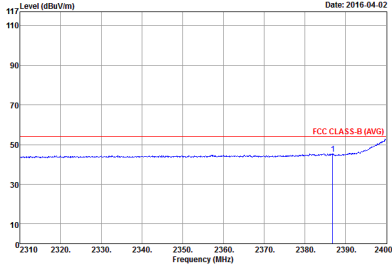
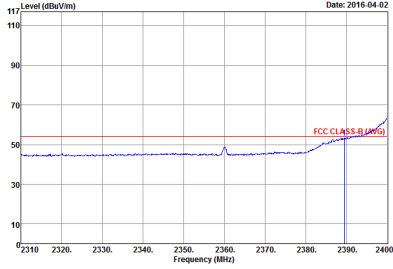

2.4GHz 2400~2483.5MHz
WIFI 802.11n HT40 (Band Edge @ 3m)

WIFI	2.4GHz 2400~2483.5MHz Band Edge @ 3m	
ANT	802.11n HT40 CH03 2422MHz - L	
1	Horizontal	Vertical
Peak	 <p>Site : 03CH12-HY Condition : FCC CLASS-B 3m HORN_91200_1328 HORIZONTAL Detector : Peak Project : 5D2212 Mode : 10</p>	 <p>Site : 03CH12-HY Condition : FCC CLASS-B 3m HORN_91200_1328 VERTICAL Detector : Peak Project : 5D2212 Mode : 10</p>
Avg.	 <p>Site : 03CH12-HY Condition : FCC CLASS-B (AVG) 3m HORN_91200_1328 HORIZONTAL Detector : Peak Project : 5D2212 Mode : 10</p>	 <p>Site : 03CH12-HY Condition : FCC CLASS-B (AVG) 3m HORN_91200_1328 VERTICAL Detector : Peak Project : 5D2212 Mode : 10</p>

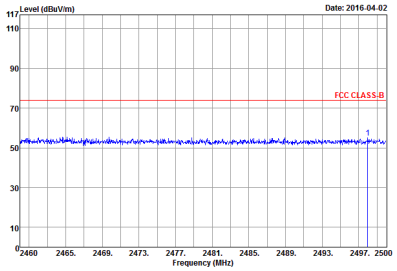
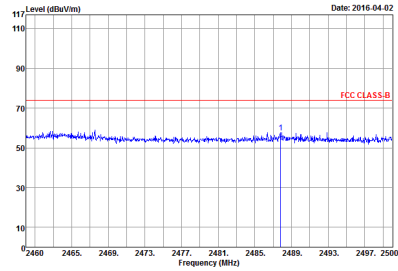
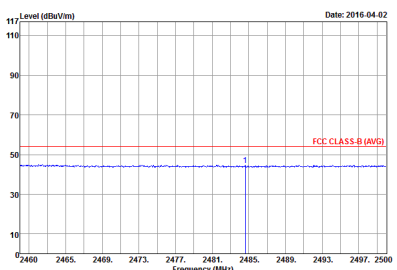
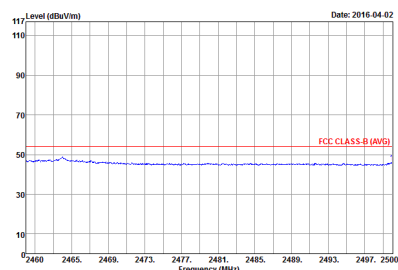

WIFI	2.4GHz 2400~2483.5MHz Band Edge @ 3m	
ANT	802.11n HT40 CH03 2422MHz - R	
1	Horizontal	Vertical
Peak	 <p>Date: 2016-04-02</p> <p>Level (dBuV/m) vs Frequency (MHz)</p> <p>FCC CLASS B</p> <p>Site : 03CH12-HY Condition : FCC CLASS-B 3m HORN_91200_1328 HORIZONTAL RBW:1000.000KHz VBW:3000.000KHz SWT:Auto Detector : Peak Project : 5D2212 Mode : 10</p>	 <p>Date: 2016-04-02</p> <p>Level (dBuV/m) vs Frequency (MHz)</p> <p>FCC CLASS B</p> <p>Site : 03CH12-HY Condition : FCC CLASS-B 3m HORN_91200_1328 VERTICAL RBW:1000.000KHz VBW:3000.000KHz SWT:Auto Detector : Peak Project : 5D2212 Mode : 10</p>
Avg.	 <p>Date: 2016-04-02</p> <p>Level (dBuV/m) vs Frequency (MHz)</p> <p>FCC CLASS-B (AVG)</p> <p>Site : 03CH12-HY Condition : FCC CLASS-B (AVG) 3m HORN_91200_1328 HORIZONTAL RBW:1000.000KHz VBW:3.000KHz SWT:Auto Detector : Peak Project : 5D2212 Mode : 10</p>	 <p>Date: 2016-04-02</p> <p>Level (dBuV/m) vs Frequency (MHz)</p> <p>FCC CLASS-B (AVG)</p> <p>Site : 03CH12-HY Condition : FCC CLASS-B (AVG) 3m HORN_91200_1328 VERTICAL RBW:1000.000KHz VBW:3.000KHz SWT:Auto Detector : Peak Project : 5D2212 Mode : 10</p>

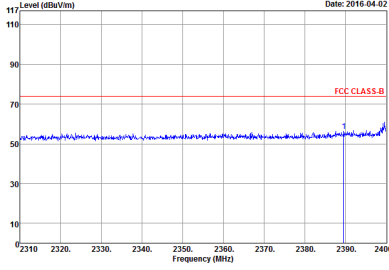
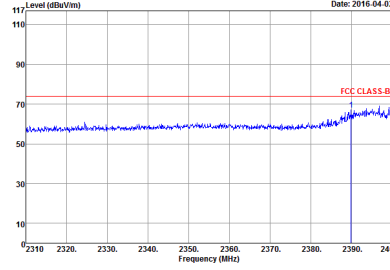
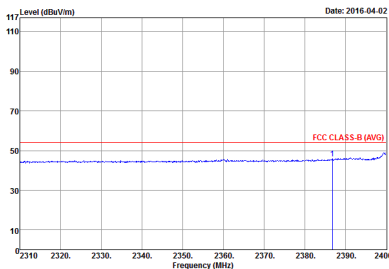
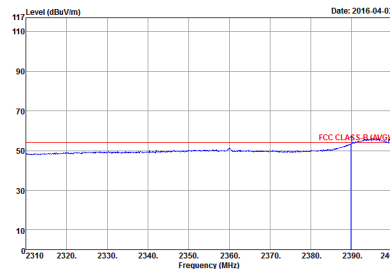

WIFI	2.4GHz 2400~2483.5MHz Band Edge @ 3m	
ANT	802.11n HT40 CH06 2437MHz - L	
1	Horizontal	Vertical
Peak	 <p>Date: 2016-04-02</p> <p>Site : 03CH12-HY Condition : FCC CLASS-B 3m HORN_91200_1328 HORIZONTAL Detector : Peak Project : 502212 Mode : 11</p>	 <p>Date: 2016-04-02</p> <p>Site : 03CH12-HY Condition : FCC CLASS-B 3m HORN_91200_1328 VERTICAL Detector : Peak Project : 502212 Mode : 11</p>
Avg.	 <p>Date: 2016-04-02</p> <p>Site : 03CH12-HY Condition : FCC CLASS-B (AVG) 3m HORN_91200_1328 HORIZONTAL Detector : Peak Project : 502212 Mode : 11</p>	 <p>Date: 2016-04-02</p> <p>Site : 03CH12-HY Condition : FCC CLASS-B (AVG) 3m HORN_91200_1328 VERTICAL Detector : Peak Project : 502212 Mode : 11</p>

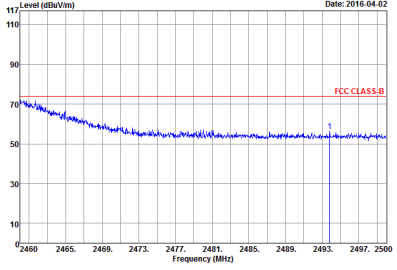
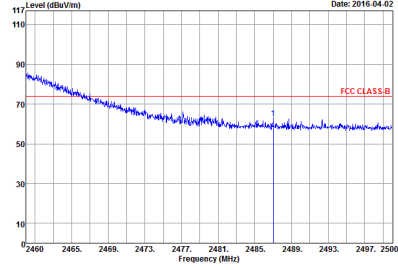
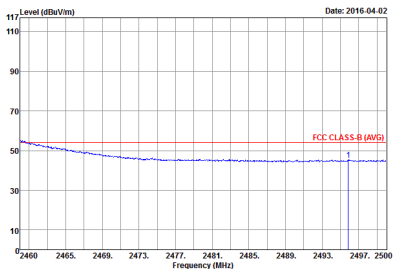
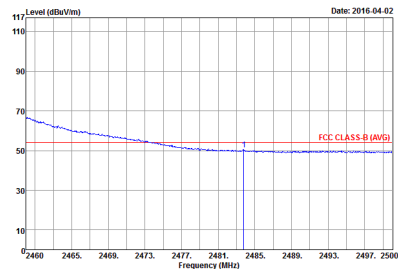

WIFI	2.4GHz 2400~2483.5MHz Band Edge @ 3m	
ANT	802.11n HT40 CH06 2437MHz - R	
1	Horizontal	Vertical
Peak	 <p>Date: 2016-04-02</p> <p>Level (dBuV/m) vs Frequency (MHz)</p> <p>FCC CLASS:B</p> <p>Site : 03CH12-HY Condition : FCC CLASS-B 3m HORN_91200_1328 HORIZONTAL RBW:1000.000KHz VBW:3000.000KHz SWT:Auto Detector : Peak Project : 5D2212 Mode : 11</p>	 <p>Date: 2016-04-02</p> <p>Level (dBuV/m) vs Frequency (MHz)</p> <p>FCC CLASS:B</p> <p>Site : 03CH12-HY Condition : FCC CLASS-B 3m HORN_91200_1328 VERTICAL RBW:1000.000KHz VBW:3000.000KHz SWT:Auto Detector : Peak Project : 5D2212 Mode : 11</p>
Avg.	 <p>Date: 2016-04-02</p> <p>Level (dBuV/m) vs Frequency (MHz)</p> <p>FCC CLASS-B (AVG)</p> <p>Site : 03CH12-HY Condition : FCC CLASS-B (AVG) 3m HORN_91200_1328 HORIZONTAL RBW:1000.000KHz VBW:3.000KHz SWT:Auto Detector : Peak Project : 5D2212 Mode : 11</p>	 <p>Date: 2016-04-02</p> <p>Level (dBuV/m) vs Frequency (MHz)</p> <p>FCC CLASS-B (AVG)</p> <p>Site : 03CH12-HY Condition : FCC CLASS-B (AVG) 3m HORN_91200_1328 VERTICAL RBW:1000.000KHz VBW:3.000KHz SWT:Auto Detector : Peak Project : 5D2212 Mode : 11</p>

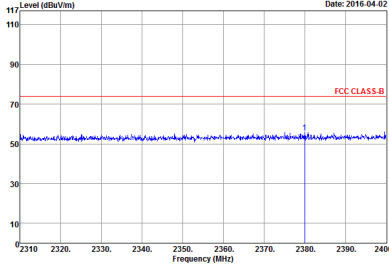
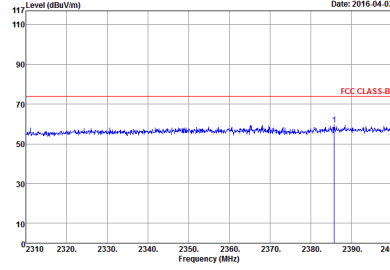
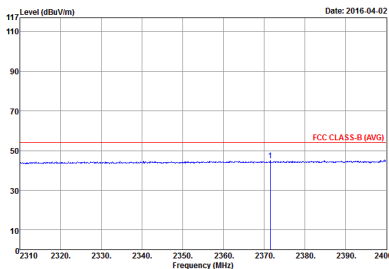
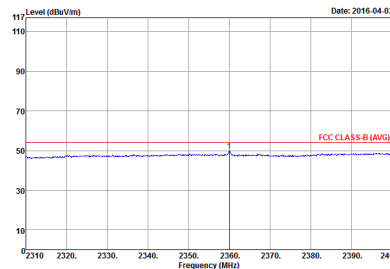

WIFI	2.4GHz 2400~2483.5MHz Band Edge @ 3m	
ANT	802.11n HT40 CH09 2452MHz - L	
1	Horizontal	Vertical
Peak	 <p>Date: 2016-04-02</p> <p>Site : 03CH12-HY Condition : FCC CLASS-B 3m HORN_91200_1328 HORIZONTAL Detector : Peak Project : 5D2212 Mode : 12</p>	 <p>Date: 2016-04-02</p> <p>Site : 03CH12-HY Condition : FCC CLASS-B 3m HORN_91200_1328 VERTICAL Detector : Peak Project : 5D2212 Mode : 12</p>
Avg.	 <p>Date: 2016-04-02</p> <p>Site : 03CH12-HY Condition : FCC CLASS-B (AVG) 3m HORN_91200_1328 HORIZONTAL Detector : Peak Project : 5D2212 Mode : 12</p>	 <p>Date: 2016-04-02</p> <p>Site : 03CH12-HY Condition : FCC CLASS-B (AVG) 3m HORN_91200_1328 VERTICAL Detector : Peak Project : 5D2212 Mode : 12</p>

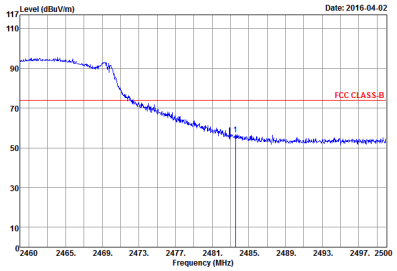
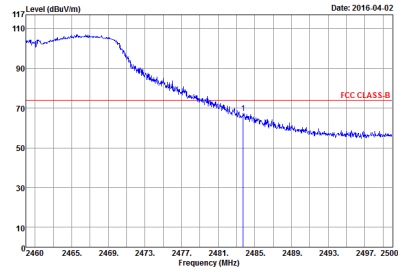
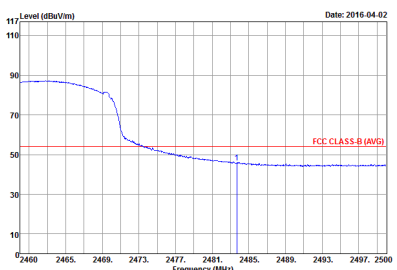
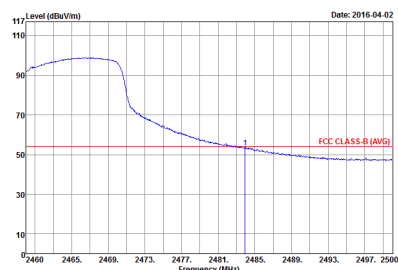

WIFI	2.4GHz 2400~2483.5MHz Band Edge @ 3m	
ANT	802.11n HT40 CH09 2452MHz - R	
1	Horizontal	Vertical
Peak	 <p>Date: 2016-04-02</p> <p>Site : 03CH12-HY Condition : FCC CLASS-B 3m HORN_91200_1328 HORIZONTAL RBW:1000.000KHz VBW:3000.000KHz SWT:Auto Detector : Peak Project : 5D2212 Mode : 12</p>	 <p>Date: 2016-04-02</p> <p>Site : 03CH12-HY Condition : FCC CLASS-B 3m HORN_91200_1328 VERTICAL RBW:1000.000KHz VBW:3000.000KHz SWT:Auto Detector : Peak Project : 5D2212 Mode : 12</p>
Avg.	 <p>Date: 2016-04-02</p> <p>Site : 03CH12-HY Condition : FCC CLASS-B (AVG) 3m HORN_91200_1328 HORIZONTAL RBW:1000.000KHz VBW:3.000KHz SWT:Auto Detector : Peak Project : 5D2212 Mode : 12</p>	 <p>Date: 2016-04-02</p> <p>Site : 03CH12-HY Condition : FCC CLASS-B (AVG) 3m HORN_91200_1328 VERTICAL RBW:1000.000KHz VBW:3.000KHz SWT:Auto Detector : Peak Project : 5D2212 Mode : 12</p>



2.4GHz 2400~2483.5MHz
WIFI 802.11b (Harmonic @ 3m)

WIFI	2.4GHz 2400~2483.5MHz Harmonic @ 3m	
ANT	802.11b CH01 2412MHz	
1	Horizontal	Vertical
Peak Avg.	<p>Date: 2016-04-02</p> <p>Site : 03CH12-HY Condition : FCC CLASS-B 3m HORN_91200_1328 HORIZONTAL Detector : Peak Project : 5D2212 Mode : 1</p>	<p>Date: 2016-04-02</p> <p>Site : 03CH12-HY Condition : FCC CLASS-B 3m HORN_91200_1328 VERTICAL Detector : Peak Project : 5D2212 Mode : 1</p>

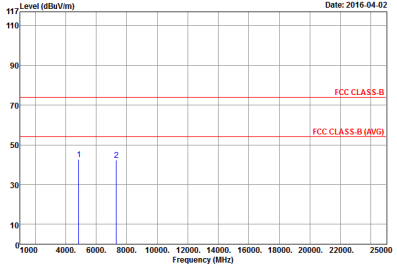
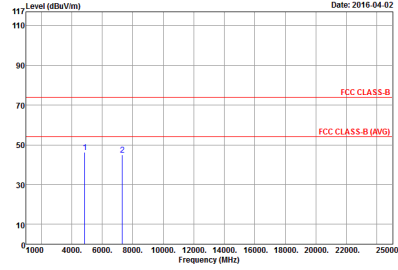

WIFI	2.4GHz 2400~2483.5MHz Harmonic @ 3m	
ANT	802.11b CH06 2437MHz	
1	Horizontal	Vertical
Peak Avg.	 <p>Date: 2016-04-02</p> <p>Site : 03CH12-HY Condition : FCC CLASS-B 3m HORN_91200_1328 HORIZONTAL Detector : Peak Project : 5D2212 Mode : 2</p>	 <p>Date: 2016-04-02</p> <p>Site : 03CH12-HY Condition : FCC CLASS-B 3m HORN_91200_1328 VERTICAL Detector : Peak Project : 5D2212 Mode : 2</p>



WIFI	2.4GHz 2400~2483.5MHz Harmonic @ 3m	
ANT	802.11b CH11 2462MHz	
1	Horizontal	Vertical
Peak Avg.	<p>Date: 2016-04-02</p> <p>Site : 03CH12-HY Condition : FCC CLASS-B 3m HORN_91200_1328 HORIZONTAL Detector : Peak Project : 5D2212 Mode : 3</p>	<p>Date: 2016-04-03</p> <p>Site : 03CH12-HY Condition : FCC CLASS-B 3m HORN_91200_1328 VERTICAL Detector : Peak Project : 5D2212 Mode : 3</p>



2.4GHz 2400~2483.5MHz
WIFI 802.11g (Harmonic @ 3m)

WIFI	2.4GHz 2400~2483.5MHz Harmonic @ 3m	
ANT	802.11g CH01 2412MHz	
1	Horizontal	Vertical
Peak Avg.	<p>Date: 2016-04-03</p> <p>Site : 03CH12-HY Condition : FCC CLASS-B 3m HORN_91200_1328 HORIZONTAL Detector : Peak Project : 5D2212 Mode : 4</p>	<p>Date: 2016-04-03</p> <p>Site : 03CH12-HY Condition : FCC CLASS-B 3m HORN_91200_1328 VERTICAL Detector : Peak Project : 5D2212 Mode : 4</p>

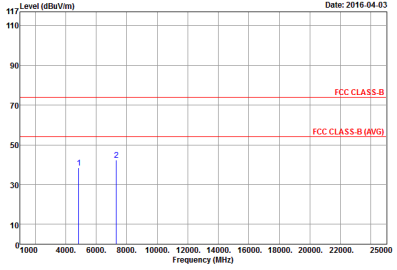
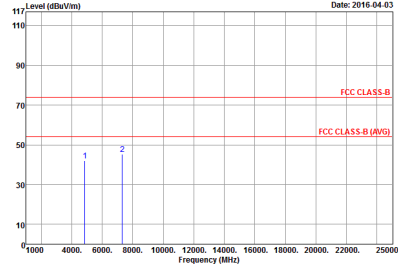

WIFI	2.4GHz 2400~2483.5MHz Harmonic @ 3m	
ANT	802.11g CH06 2437MHz	
1	Horizontal	Vertical
<p>Peak</p> <p>Avg.</p>	 <p>Date: 2016-04-03</p> <p>Site : 03CH12-HY Condition : FCC CLASS-B 3m HORN_91200_1328 HORIZONTAL Detector : Peak Project : 5D2212 Mode : 5</p>	 <p>Date: 2016-04-03</p> <p>Site : 03CH12-HY Condition : FCC CLASS-B 3m HORN_91200_1328 VERTICAL Detector : Peak Project : 5D2212 Mode : 5</p>



WIFI	2.4GHz 2400~2483.5MHz Harmonic @ 3m	
ANT	802.11g CH11 2462MHz	
1	Horizontal	Vertical
Peak Avg.	<p>Site : 03CH12-HY Condition : FCC CLASS-B 3m HORN_91200_1328 HORIZONTAL Detector : Peak Project : 5D2212 Mode : 6</p>	<p>Site : 03CH12-HY Condition : FCC CLASS-B 3m HORN_91200_1328 VERTICAL Detector : Peak Project : 5D2212 Mode : 6</p>

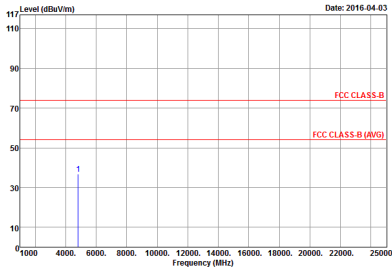
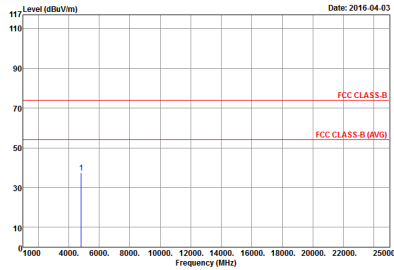

2.4GHz 2400~2483.5MHz
 WIFI 802.11n HT20 (Harmonic @ 3m)

WIFI	2.4GHz 2400~2483.5MHz Harmonic @ 3m	
ANT	802.11n HT20 CH01 2412MHz	
1	Horizontal	Vertical
Peak Avg.	 <p>Date: 2016-04-03</p> <p>Site : 03CH12-HY Condition : FCC CLASS-B 3m HORN_91200_1328 HORIZONTAL Detector : Peak Project : 5D2212 Mode : 7</p>	 <p>Date: 2016-04-03</p> <p>Site : 03CH12-HY Condition : FCC CLASS-B 3m HORN_91200_1328 VERTICAL Detector : Peak Project : 5D2212 Mode : 7</p>



WIFI	2.4GHz 2400~2483.5MHz Harmonic @ 3m	
ANT	802.11n HT20 CH06 2437MHz	
1	Horizontal	Vertical
Peak Avg.	<p>Site : 03CH12-HY Condition : FCC CLASS-B 3m HORN_91200_1328 HORIZONTAL Detector : Peak Project : 5D2212 Mode : 8</p>	<p>Site : 03CH12-HY Condition : FCC CLASS-B 3m HORN_91200_1328 VERTICAL Detector : Peak Project : 5D2212 Mode : 8</p>

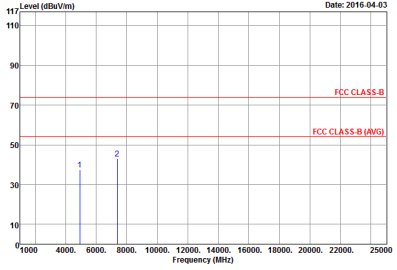
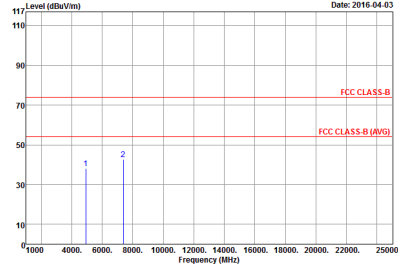

WIFI	2.4GHz 2400~2483.5MHz Harmonic @ 3m	
ANT	802.11n HT20 CH11 2462MHz	
1	Horizontal	Vertical
Peak Avg.	 <p>Date: 2016-04-03</p> <p>Site : 03CH12-HY Condition : FCC CLASS-B 3m HORN_91200_1328 HORIZONTAL Detector : Peak Project : 5D2212 Mode : 9</p>	 <p>Date: 2016-04-03</p> <p>Site : 03CH12-HY Condition : FCC CLASS-B 3m HORN_91200_1328 VERTICAL Detector : Peak Project : 5D2212 Mode : 9</p>

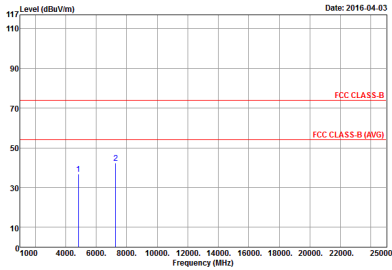
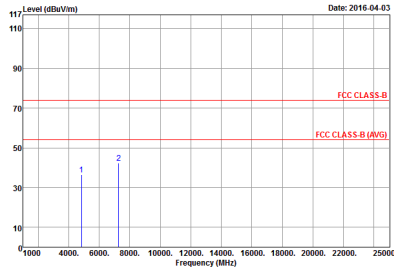

2.4GHz 2400~2483.5MHz
WIFI 802.11n HT40 (Harmonic @ 3m)

WIFI	2.4GHz 2400~2483.5MHz Harmonic @ 3m	
ANT	802.11n HT40 CH03 2422MHz	
1	Horizontal	Vertical
Peak Avg.	 <p>Date: 2016-04-03</p> <p>Site : 03CH12-HY Condition : FCC CLASS-B 3m HORN_91200_1328 HORIZONTAL Detector : Peak Project : 5D2212 Mode : 10</p>	 <p>Date: 2016-04-03</p> <p>Site : 03CH12-HY Condition : FCC CLASS-B 3m HORN_91200_1328 VERTICAL Detector : Peak Project : 5D2212 Mode : 10</p>

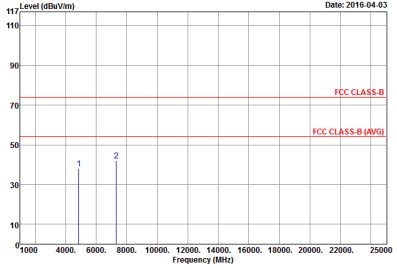
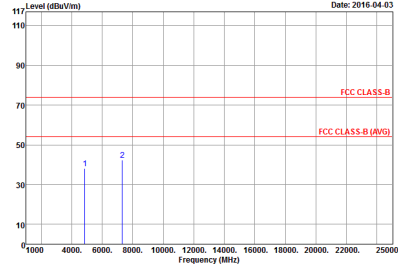

WIFI	2.4GHz 2400~2483.5MHz Harmonic @ 3m	
ANT	802.11n HT40 CH06 2437MHz	
1	Horizontal	Vertical
Peak Avg.	 <p>Date: 2016-04-03</p> <p>Site : 03CH12-HY Condition : FCC CLASS-B 3m HORN_91200_1328 HORIZONTAL Detector : Peak Project : 5D2212 Mode : 11</p>	 <p>Date: 2016-04-03</p> <p>Site : 03CH12-HY Condition : FCC CLASS-B 3m HORN_91200_1328 VERTICAL Detector : Peak Project : 5D2212 Mode : 11</p>

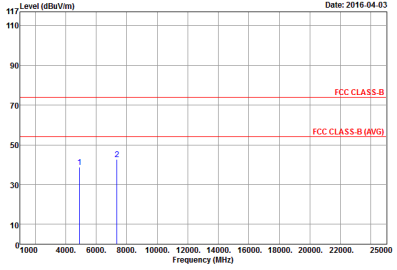
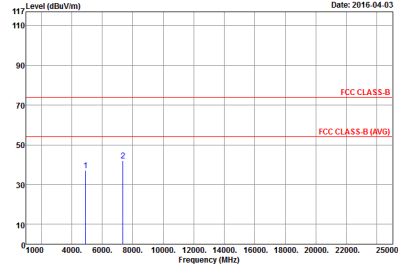

WIFI	2.4GHz 2400~2483.5MHz Harmonic @ 3m	
ANT	802.11n HT40 CH09 2452MHz	
1	Horizontal	Vertical
Peak Avg.	 <p>Date: 2016-04-03</p> <p>Site : 03CH12-HY Condition : FCC CLASS-B 3m HORN_91200_1328 HORIZONTAL Detector : Peak Project : 5D2212 Mode : 12</p>	 <p>Date: 2016-04-03</p> <p>Site : 03CH12-HY Condition : FCC CLASS-B 3m HORN_91200_1328 VERTICAL Detector : Peak Project : 5D2212 Mode : 12</p>

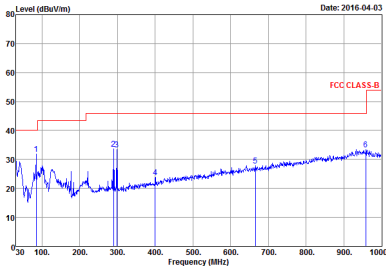
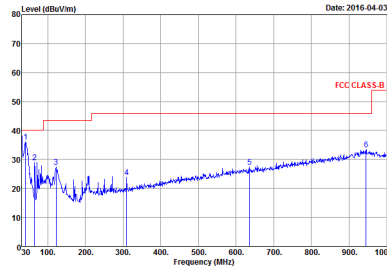

2.4GHz 2400~2483.5MHz
Emission below 1GHz
2.4GHz WIFI 802.11n HT40 Adapter Mode(LF)

WIFI	2.4GHz 2400~2483.5MHz	
ANT	802.11n HT40	
1	Horizontal	Vertical
QP / Peak	 <p>Date: 2016-04-03</p> <p>Site : 03CH12-HY Condition : FCC CLASS-B 3m BILOG_6111D_37059 HORIZONTAL Detector : Peak Project : 502212 Mode : 13</p>	 <p>Date: 2016-04-03</p> <p>Site : 03CH12-HY Condition : FCC CLASS-B 3m BILOG_6111D_37059 VERTICAL Detector : Peak Project : 502212 Mode : 13</p>



2.4GHz 2400~2483.5MHz
Emission below 1GHz
2.4GHz WIFI 802.11n HT40 POE Mode(LF)

WIFI	2.4GHz 2400~2483.5MHz	
ANT	802.11n HT40	
1	Horizontal	Vertical
QP / Peak	<p>Site : 03CH12-HY Condition : FCC CLASS-B 3m BILOG_6111D_37059 HORIZONTAL Detector : Peak Project : 5D2212 Mode : 13</p>	<p>Site : 03CH12-HY Condition : FCC CLASS-B 3m BILOG_6111D_37059 VERTICAL Detector : Peak Project : 5D2212 Mode : 13</p>