



FCC TEST REPORT (15.247)

REPORT NO.: RF110721C33

MODEL NO.: FAP-221B (Refer to 3.1 for more details)

FCC ID: U2M-CAP4100AG

RECEIVED: Jul. 21, 2011

TESTED: Oct. 27 ~ Dec. 30, 2011

ISSUED: Jan. 06, 2012

APPLICANT: Senao Networks, Inc.

ADDRESS: 3F, No. 529, Chung Cheng Rd., Hsintien, Taipei,
Taiwan, R.O.C.

ISSUED BY: Bureau Veritas Consumer Products Services (H.K.)
Ltd., Taoyuan Branch

LAB ADDRESS: No. 47, 14th Ling, Chia Pau Vil., Lin Kou Dist., New
Taipei City, Taiwan (R.O.C)

TEST LOCATION: No. 19, Hwa Ya 2nd Rd, Wen Hwa Tsuen, Kwei
Shan Hsiang, Taoyuan Hsien 333, Taiwan, R.O.C.

This test report consists of 114 pages in total. It may be duplicated completely for legal use with the approval of the applicant. It should not be reproduced except in full, without the written approval of our laboratory. The client should not use it to claim product certification, approval or endorsement by TAF or any government agency. The test results in the report only apply to the tested sample.





TABLE OF CONTENTS

RELEASE CONTROL RECORD.....	5
1. CERTIFICATION	6
2. SUMMARY OF TEST RESULTS	7
2.1 MEASUREMENT UNCERTAINTY	7
3. GENERAL INFORMATION.....	8
3.1 GENERAL DESCRIPTION OF EUT	8
3.2 DESCRIPTION OF TEST MODES	10
3.2.1 CONFIGURATION OF SYSTEM UNDER TEST	11
3.2.2 DESCRIPTION OF SUPPORT UNITS	12
3.2.3 TEST MODE APPLICABILITY AND TESTED CHANNEL DETAIL	13
3.3 GENERAL DESCRIPTION OF APPLIED STANDARDS	17
4. TEST TYPES AND RESULTS (FOR 2.4GHz BAND)	18
4.1 RADIATED EMISSION AND BANDEDGE MEASUREMENT.....	18
4.1.1 LIMITS OF RADIATED AND BANDEDGE EMISSION MEASUREMENT	18
4.1.2 TEST INSTRUMENTS.....	19
4.1.3 TEST PROCEDURES	20
4.1.4 DEVIATION FROM TEST STANDARD	20
4.1.5 TEST SETUP.....	21
4.1.6 EUT OPERATING CONDITIONS	21
4.1.7 TEST RESULTS	22
4.2 CONDUCTED EMISSION MEASUREMENT	50
4.2.1 LIMITS OF CONDUCTED EMISSION MEASUREMENT	50
4.2.2 TEST INSTRUMENTS.....	50
4.2.3 TEST PROCEDURES	51
4.2.4 DEVIATION FROM TEST STANDARD	51
4.2.5 TEST SETUP.....	52
4.2.6 EUT OPERATING CONDITIONS	52
4.2.7 TEST RESULTS	53
4.3 6dB BANDWIDTH MEASUREMENT.....	61
4.3.1 LIMITS OF 6dB BANDWIDTH MEASUREMENT	61
4.3.2 TEST SETUP.....	61
4.3.3 TEST INSTRUMENTS.....	61
4.3.4 TEST PROCEDURE.....	61
4.3.5 DEVIATION FROM TEST STANDARD	61
4.3.6 EUT OPERATING CONDITIONS	61
4.3.7 TEST RESULTS	62
4.4 CONDUCTED OUTPUT POWER	64
4.4.1 LIMITS OF CONDUCTED OUTPUT POWER MEASUREMENT	64
4.4.2 TEST SETUP.....	64
4.4.3 TEST INSTRUMENTS.....	64
4.4.4 TEST PROCEDURES	64
4.4.5 DEVIATION FROM TEST STANDARD	64
4.4.6 EUT OPERATING CONDITIONS	64
4.4.7 TEST RESULTS	65
4.5 POWER SPECTRAL DENSITY MEASUREMENT.....	67
4.5.1 LIMITS OF POWER SPECTRAL DENSITY MEASUREMENT	67
4.5.2 TEST SETUP.....	67
4.5.3 TEST INSTRUMENTS.....	67



4.5.4	TEST PROCEDURE.....	67
4.5.5	DEVIATION FROM TEST STANDARD	67
4.5.6	EUT OPERATING CONDITION.....	67
4.5.7	TEST RESULTS	68
4.6	CONDUCTED EMISSION MEASUREMENT	70
4.6.1	LIMITS OF BAND EDGES MEASUREMENT.....	70
4.6.2	TEST SETUP.....	70
4.6.3	TEST INSTRUMENTS.....	70
4.6.4	TEST PROCEDURE.....	70
4.6.5	DEVIATION FROM TEST STANDARD	71
4.6.6	EUT OPERATING CONDITION.....	71
4.6.7	TEST RESULTS	71
5.	TEST TYPES AND RESULTS (FOR 5.0GHz BAND).....	80
5.1	RADIATED EMISSION AND BANDEDGE MEASUREMENT.....	80
5.1.1	LIMITS OF RADIATED EMISSION AND BANDEDGE MEASUREMENT	80
5.1.2	TEST INSTRUMENTS.....	81
5.1.3	TEST PROCEDURES	82
5.1.4	DEVIATION FROM TEST STANDARD	82
5.1.5	TEST SETUP.....	83
5.1.6	EUT OPERATING CONDITIONS	83
5.1.7	TEST RESULTS	84
5.2	CONDUCTED EMISSION MEASUREMENT	94
5.2.1	LIMITS OF CONDUCTED EMISSION MEASUREMENT.....	94
5.2.2	TEST INSTRUMENTS.....	94
5.2.3	TEST PROCEDURES	95
5.2.4	DEVIATION FROM TEST STANDARD	95
5.2.5	TEST SETUP.....	96
5.2.6	EUT OPERATING CONDITIONS	96
5.2.7	TEST RESULTS	97
5.3	6dB BANDWIDTH MEASUREMENT.....	101
5.3.1	LIMITS OF 6dB BANDWIDTH MEASUREMENT	101
5.3.2	TEST SETUP.....	101
5.3.3	TEST INSTRUMENTS.....	101
5.3.4	TEST PROCEDURE.....	101
5.3.5	DEVIATION FROM TEST STANDARD	101
5.3.6	EUT OPERATING CONDITIONS	101
5.3.7	TEST RESULTS	102
5.4	CONDUCTED OUTPUT POWER	103
5.4.1	LIMITS OF MAXIMUM OUTPUT POWER MEASUREMENT	103
5.4.2	TEST SETUP.....	103
5.4.3	INSTRUMENTS.....	103
5.4.4	TEST PROCEDURES	103
5.4.5	DEVIATION FROM TEST STANDARD	103
5.4.6	EUT OPERATING CONDITIONS	103
5.4.7	TEST RESULTS	104
5.5	POWER SPECTRAL DENSITY MEASUREMENT.....	105
5.5.1	LIMITS OF POWER SPECTRAL DENSITY MEASUREMENT	105
5.5.2	TEST SETUP.....	105
5.5.3	TEST INSTRUMENTS.....	105
5.5.4	TEST PROCEDURE.....	105
5.5.5	DEVIATION FROM TEST STANDARD	105



A D T

5.5.6	EUT OPERATING CONDITION.....	105
5.5.7	TEST RESULTS	106
5.6	CONDUCTED EMISSION MEASUREMENT	107
5.6.1	LIMITS OF BAND EDGES MEASUREMENT	107
5.6.2	TEST SETUP.....	107
5.6.3	TEST INSTRUMENTS.....	107
5.6.4	TEST PROCEDURE.....	107
5.6.5	DEVIATION FROM TEST STANDARD	108
5.6.6	EUT OPERATING CONDITION.....	108
5.6.7	TEST RESULTS	108
6.	PHOTOGRAPHS OF THE TEST CONFIGURATION.....	112
7.	INFORMATION ON THE TESTING LABORATORIES	113
8.	APPENDIX A - MODIFICATIONS RECORDERS FOR ENGINEERING CHANGES TO THE EUT BY THE LAB.....	114



RELEASE CONTROL RECORD

ISSUE NO.	REASON FOR CHANGE	DATE ISSUED
Original release	NA	Jan. 06, 2012



1. CERTIFICATION

PRODUCT: FORTIAP-221B

MODEL: FAP-221B (Refer to 3.1 for more details)

BRAND: Fortinet (Refer to 3.1 for more details)

APPLICANT: Senao Networks, Inc.

TESTED: Oct. 27 ~ Dec. 30, 2011

TEST SAMPLE: ENGINEERING SAMPLE

STANDARDS: **FCC Part 15, Subpart C (Section 15.247)**

ANSI C63.4-2003

ANSI C63.10-2009

The above equipment (model: FAP-221B) has been tested by **Bureau Veritas Consumer Products Services (H.K.) Ltd., Taoyuan Branch**, and found compliance with the requirement of the above standards. The test record, data evaluation & Equipment Under Test (EUT) configurations represented herein are true and accurate accounts of the measurements of the sample's EMC characteristics under the conditions specified in this report.

PREPARED BY : Andrea Hsia , DATE : Jan. 06, 2012
Andrea Hsia / Specialist

APPROVED BY : Gary Chang , DATE : Jan. 06, 2012
Gary Chang / Technical Manager

2. SUMMARY OF TEST RESULTS

The EUT has been tested according to the following specifications:

APPLIED STANDARD: FCC PART 15, SUBPART C (SECTION 15.247)			
STANDARD SECTION	TEST TYPE	RESULT	REMARK
15.207	AC Power Conducted Emission	PASS	Meet the requirement of limit. Minimum passing margin is -2.50dB at 0.380MHz.
15.247(d) 15.209	Radiated Emissions	PASS	Meet the requirement of limit. Minimum passing margin is -0.7dB at 360.43MHz.
15.247(d)	Band Edge Measurement	PASS	Meet the requirement of limit.
15.247(a)(2)	6dB bandwidth	PASS	Meet the requirement of limit.
15.247(b)	Conducted power	PASS	Meet the requirement of limit.
15.247(e)	Power Spectral Density	PASS	Meet the requirement of limit.
15.203	Antenna Requirement	PASS	Antenna connector is UFL not a standard connector.

2.1 MEASUREMENT UNCERTAINTY

Where relevant, the following measurement uncertainty levels have been estimated for tests performed on the EUT as specified in CISPR 16-4-2:

MEASUREMENT	FREQUENCY	UNCERTAINTY
Conducted emissions	9kHz~30MHz	2.44 dB
Radiated emissions	30MHz ~ 200MHz	3.34 dB
	200MHz ~1000MHz	3.35 dB
	1GHz ~ 18GHz	2.26 dB
	18GHz ~ 40GHz	1.94 dB

This uncertainty represents an expanded uncertainty expressed at approximately the 95% confidence level using a coverage factor of $k = 2$.

3. GENERAL INFORMATION

3.1 GENERAL DESCRIPTION OF EUT

EUT	FORTIAP-221B
MODEL NO.	FAP-221B
FCC ID	U2M-CAP4100AG
POWER SUPPLY	48Vdc (POE) 12Vdc (Adapter)
MODULATION TYPE	CCK, DQPSK, DBPSK for DSSS 64QAM, 16QAM, QPSK, BPSK for OFDM
MODULATION TECHNOLOGY	DSSS, OFDM
TRANSFER RATE	802.11b: 11.0/ 5.5/ 2.0/ 1.0Mbps 802.11g: 54.0/ 48.0/ 36.0/ 24.0/ 18.0/ 12.0/ 9.0/ 6.0Mbps 802.11a: 54.0/ 48.0/ 36.0/ 24.0/ 18.0/ 12.0/ 9.0/ 6.0Mbps 802.11n: up to 300.0Mbps
OPERATING FREQUENCY	2.4GHz: 2412.0 ~ 2462.0MHz 5.0GHz: 5745.0 ~ 5825.0MHz
NUMBER OF CHANNEL	2.4GHz: 11 for 802.11b, 802.11g, 802.11n (20MHz) 7 for 802.11n (40MHz) 5.0GHz: 5 for 802.11a, 802.11n (20MHz) 2 for 802.11n (40MHz)
OUTPUT POWER	915.2mW for 2412.0 ~ 2462.0MHz 504.1mW for 5745.0 ~ 5825.0MHz
ANTENNA TYPE	2.4GHz: Embedded antenna with 3dBi gain 5.0GHz: Embedded antenna with 4dBi gain
ANTENNA CONNECTOR	UFL
DATA CABLE	NA
I/O PORTS	RJ45
ACCESSORY DEVICES	Adapter

NOTE:

- The models as below are identical to each other except for their model designation and brand name due to marketing purpose.

Brand	Model
Senao	CAP4200AG
Senao	CAP2100AG
Fortinet	FAP-221B

- For EUT with two RF IC as below:

Model	FREQUENCY BAND
AR9382	2.4G only
AR9344	2.4G / 5.0G

3. The frequency bands used in this EUT are listed as follows:

Frequency Band (MHz)	2412~2462	5180~5240	5745~5825
802.11b	√		
802.11g	√		
802.11a		√	√
802.11n (20MHz)	√	√	√
802.11n (40MHz)	√	√	√

4. The EUT incorporates a MIMO function. Physically, the EUT provides 2 completed transmitters and 2 receivers.

MODULATION MODE	TX FUNCTION
802.11b	2TX
802.11g	2TX
802.11a	2TX
802.11n (20MHz)	2TX
802.11n (40MHz)	2TX

5. The EUT were powered by the following adapter and POE.

ADAPTER	
BRAND:	Powertron
MODEL:	PA1015-2I/PA1015-2I120125
INPUT:	100-240Vac~, 50-60Hz, 0.4A
OUTPUT:	12Vdc, 1.25A, 15W
POWER LINE:	1.5m non-shielded cable w/o core

POE'S ADAPTER	
BRAND:	Powertron
MODEL:	PA1024-4T1
OUTPUT:	48Vdc, 0.5A, 24W

POE	
BRAND:	EnGenius
MODEL:	EPE-48GR

**POE & POE'S adapter as above are provided as support unit only.

6. The above EUT information is declared by manufacturer and for more detailed features description, please refer to the manufacturer's specifications or user's manual.

3.2 DESCRIPTION OF TEST MODES

FOR 2.4GHz:

11 channels are provided for 802.11b, 802.11g and 802.11n (20MHz):

CHANNEL	FREQUENCY	CHANNEL	FREQUENCY
1	2412MHz	7	2442MHz
2	2417MHz	8	2447MHz
3	2422MHz	9	2452MHz
4	2427MHz	10	2457MHz
5	2432MHz	11	2462MHz
6	2437MHz		

7 channels are provided for 802.11n (40MHz):

CHANNEL	FREQUENCY	CHANNEL	FREQUENCY
1	2422MHz	5	2442MHz
2	2427MHz	6	2447MHz
3	2432MHz	7	2452MHz
4	2437MHz		

FOR 5.0GHz (5745 ~ 5825MHz):

5 channels are provided for 802.11a, 802.11n (20MHz):

CHANNEL	FREQUENCY	CHANNEL	FREQUENCY
149	5745MHz	161	5805MHz
153	5765MHz	165	5825MHz
157	5785MHz		

2 channels are provided for 802.11n (40MHz):

CHANNEL	FREQUENCY	CHANNEL	FREQUENCY
151	5755MHz	159	5795MHz

3.2.1 CONFIGURATION OF SYSTEM UNDER TEST
POWER FROM AC ADAPTER

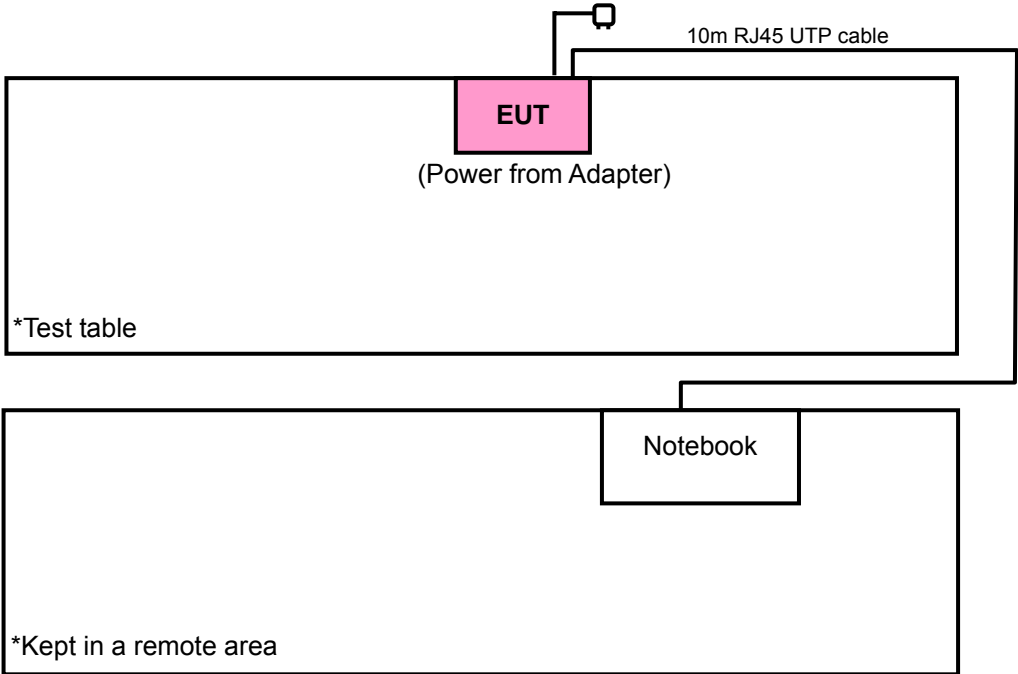

POWER FROM POE

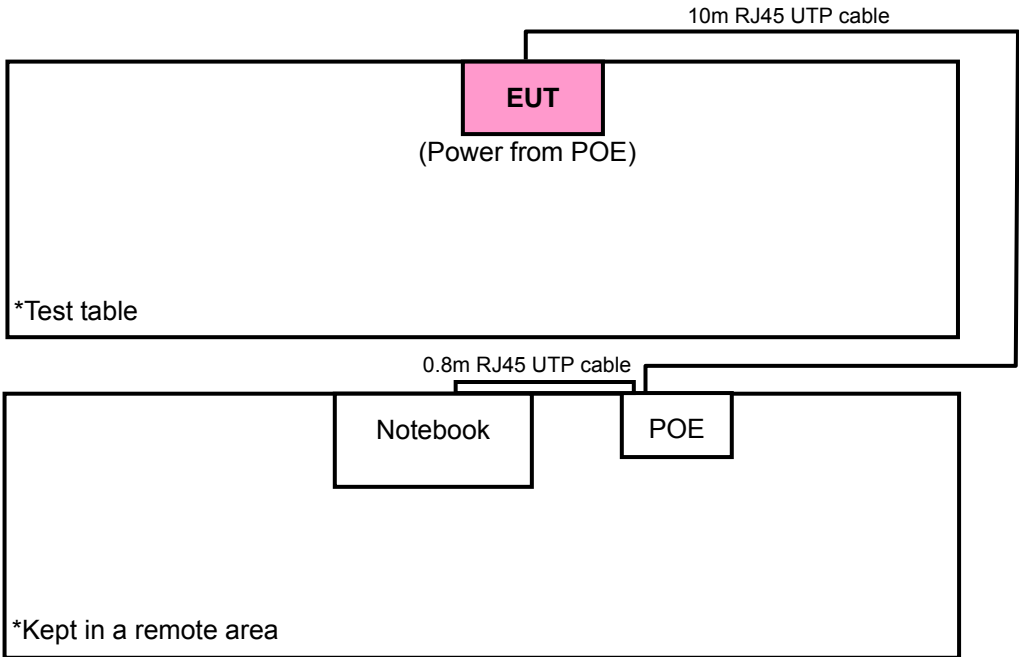

3.2.2 DESCRIPTION OF SUPPORT UNITS

The EUT has been tested as an independent unit together with other necessary accessories or support units. The following support units or accessories were used to form a representative test configuration during the tests.

NO.	PRODUCT	BRAND	MODEL NO.	SERIAL NO.	FCC ID
1	NOTEBOOK	DELL	D600	CN-0G5152-48643-487-0068	NA

NO.	SIGNAL CABLE DESCRIPTION OF THE ABOVE SUPPORT UNITS
1	10m RJ45 UTP cable.

NOTE:

1. All power cords of the above support units are non shielded (1.8m).
2. Items 1 acted as communication partners to transfer data.

3.2.3 TEST MODE APPLICABILITY AND TESTED CHANNEL DETAIL

FOR 2.4GHz:

EUT CONFIGURE MODE	APPLICABLE TO				DESCRIPTION
	RE \geq 1G	RE<1G	PLC	APCM	
A1	√	√	√	√	RF IC: AR9382 & Power from AC Adapter
A2	-	√	√	-	RF IC: AR9382 & Power from POE
B1	√	√	√	√	RF IC: AR9344 & Power from AC Adapter
B2	-	√	√	-	RF IC: AR9344 & Power from POE

Where **RE \geq 1G**: Radiated Emission above 1GHz

RE<1G: Radiated Emission below 1GHz

PLC: Power Line Conducted Emission

APCM: Antenna Port Conducted Measurement

NOTE: "-" means no effect.

RADIATED EMISSION TEST (ABOVE 1GHz):

- Pre-Scan has been conducted to determine the worst-case mode from all possible combinations between available modulations, data rates and antenna ports (if EUT with antenna diversity architecture).
- Following channel(s) was (were) selected for the final test as listed below.

EUT CONFIGURE MODE	MODE	AVAILABLE CHANNEL	TESTED CHANNEL	MODULATION TECHNOLOGY	MODULATION TYPE	DATA RATE (Mbps)
A1 & B1	802.11b	1 to 11	1, 6, 11	DSSS	DBPSK	1.0
A1 & B1	802.11g	1 to 11	1, 6, 11	OFDM	BPSK	6.0
A1 & B1	802.11n (20MHz)	1 to 11	1, 6, 11	OFDM	BPSK	7.2
A1 & B1	802.11n (40MHz)	1 to 7	1, 4, 7	OFDM	BPSK	15.0

RADIATED EMISSION TEST (BELOW 1GHz):

- Pre-Scan has been conducted to determine the worst-case mode from all possible combinations between available modulations, data rates and antenna ports (if EUT with antenna diversity architecture).
- Following channel(s) was (were) selected for the final test as listed below.

EUT CONFIGURE MODE	MODE	AVAILABLE CHANNEL	TESTED CHANNEL	MODULATION TECHNOLOGY	MODULATION TYPE	DATA RATE (Mbps)
A1, A2, B1 & B2	802.11g	1 to 11	6	OFDM	BPSK	6.0

POWER LINE CONDUCTED EMISSION TEST:

- Pre-Scan has been conducted to determine the worst-case mode from all possible combinations between available modulations, data rates and antenna ports (if EUT with antenna diversity architecture).
- Following channel(s) was (were) selected for the final test as listed below.

EUT CONFIGURE MODE	MODE	AVAILABLE CHANNEL	TESTED CHANNEL	MODULATION TECHNOLOGY	MODULATION TYPE	DATA RATE (Mbps)
A1, A2, B1 & B2	802.11g	1 to 11	6	OFDM	BPSK	6.0

BANDEDGE MEASUREMENT:

- Pre-Scan has been conducted to determine the worst-case mode from all possible combinations between available modulations, data rates and antenna ports (if EUT with antenna diversity architecture).
- Following channel(s) was (were) selected for the final test as listed below.

EUT CONFIGURE MODE	MODE	AVAILABLE CHANNEL	TESTED CHANNEL	MODULATION TECHNOLOGY	MODULATION TYPE	DATA RATE (Mbps)
A1 & B1	802.11b	1 to 11	1, 11	DSSS	DBPSK	1.0
A1 & B1	802.11g	1 to 11	1, 11	OFDM	BPSK	6.0
A1 & B1	802.11n (20MHz)	1 to 11	1, 11	OFDM	BPSK	7.2
A1 & B1	802.11n (40MHz)	1 to 7	1, 7	OFDM	BPSK	15.0

ANTENNA PORT CONDUCTED MEASUREMENT:

- This item includes all test value of each mode, but only includes spectrum plot of worst value of each mode.
- Pre-Scan has been conducted to determine the worst-case mode from all possible combinations between available modulations, data rates and antenna ports (if EUT with antenna diversity architecture).
- Following channel(s) was (were) selected for the final test as listed below.

EUT CONFIGURE MODE	MODE	AVAILABLE CHANNEL	TESTED CHANNEL	MODULATION TECHNOLOGY	MODULATION TYPE	DATA RATE (Mbps)
A1 & B1	802.11b	1 to 11	1, 6, 11	DSSS	DBPSK	1.0
A1 & B1	802.11g	1 to 11	1, 6, 11	OFDM	BPSK	6.0
A1 & B1	802.11n (20MHz)	1 to 11	1, 6, 11	OFDM	BPSK	7.2
A1 & B1	802.11n (40MHz)	1 to 7	1, 4, 7	OFDM	BPSK	15.0

TEST CONDITION:

APPLICABLE TO	ENVIRONMENTAL CONDITIONS	INPUT POWER	TESTED BY
RE _≥ 1G	25deg. C, 65%RH	120Vac, 60Hz	Kay Wu
RE _{<} 1G	25deg. C, 65%RH	120Vac, 60Hz 48Vdc	Kay Wu Antony Lee
PLC	24deg. C, 65%RH 23deg. C, 65%RH	120Vac, 60Hz 48Vdc	Peter Lin Antony Lee
APCM	25deg. C, 65%RH	120Vac, 60Hz	Kay Wu

FOR 5.0GHz:

EUT CONFIGURE MODE	APPLICABLE TO				DESCRIPTION
	RE≥1G	RE<1G	PLC	APCM	
A	√	√	√	√	Power from AC Adapter
B	-	√	√	-	Power from POE

Where **RE≥1G**: Radiated Emission above 1GHz **RE<1G**: Radiated Emission below 1GHz
PLC: Power Line Conducted Emission **APCM**: Antenna Port Conducted Measurement

NOTE: “-” means no effect.

RADIATED EMISSION TEST (ABOVE 1GHz):

- Pre-Scan has been conducted to determine the worst-case mode from all possible combinations between available modulations, data rates and antenna ports (if EUT with antenna diversity architecture).
- Following channel(s) was (were) selected for the final test as listed below.

EUT CONFIGURE MODE	MODE	AVAILABLE CHANNEL	TESTED CHANNEL	MODULATION TECHNOLOGY	MODULATION TYPE	DATA RATE (Mbps)
A	802.11a	149 to 165	149, 157, 165	OFDM	BPSK	6.0
A	802.11n (20MHz)	149 to 165	149, 157, 165	OFDM	BPSK	7.2
A	802.11n (40MHz)	151 to 159	151, 159	OFDM	BPSK	15.0

RADIATED EMISSION TEST (BELOW 1GHz):

- Pre-Scan has been conducted to determine the worst-case mode from all possible combinations between available modulations, data rates and antenna ports (if EUT with antenna diversity architecture).
- Following channel(s) was (were) selected for the final test as listed below.

EUT CONFIGURE MODE	MODE	AVAILABLE CHANNEL	TESTED CHANNEL	MODULATION TECHNOLOGY	MODULATION TYPE	DATA RATE (Mbps)
A & B	802.11a	149 to 165	149	OFDM	BPSK	6.0

POWER LINE CONDUCTED EMISSION TEST:

- Pre-Scan has been conducted to determine the worst-case mode from all possible combinations between available modulations, data rates and antenna ports (if EUT with antenna diversity architecture).
- Following channel(s) was (were) selected for the final test as listed below.

EUT CONFIGURE MODE	MODE	AVAILABLE CHANNEL	TESTED CHANNEL	MODULATION TECHNOLOGY	MODULATION TYPE	DATA RATE (Mbps)
A & B	802.11a	149 to 165	149	OFDM	BPSK	6.0

BANDEDGE MEASUREMENT:

- Pre-Scan has been conducted to determine the worst-case mode from all possible combinations between available modulations, data rates and antenna ports (if EUT with antenna diversity architecture).
- Following channel(s) was (were) selected for the final test as listed below.

EUT CONFIGURE MODE	MODE	AVAILABLE CHANNEL	TESTED CHANNEL	MODULATION TECHNOLOGY	MODULATION TYPE	DATA RATE (Mbps)
A	802.11a	149 to 165	149, 165	OFDM	BPSK	6.0
A	802.11n (20MHz)	149 to 165	149, 165	OFDM	BPSK	7.2
A	802.11n (40MHz)	151 to 159	151, 159	OFDM	BPSK	15.0

ANTENNA PORT CONDUCTED MEASUREMENT:

- This item includes all test value of each mode, but only includes spectrum plot of worst value of each mode.
- Pre-Scan has been conducted to determine the worst-case mode from all possible combinations between available modulations, data rates and antenna ports (if EUT with antenna diversity architecture).
- Following channel(s) was (were) selected for the final test as listed below.

EUT CONFIGURE MODE	MODE	AVAILABLE CHANNEL	TESTED CHANNEL	MODULATION TECHNOLOGY	MODULATION TYPE	DATA RATE (Mbps)
A	802.11a	149 to 165	149, 157, 165	OFDM	BPSK	6.0
A	802.11n (20MHz)	149 to 165	149, 157, 165	OFDM	BPSK	7.2
A	802.11n (40MHz)	151 to 159	151, 159	OFDM	BPSK	15.0

APPLICABLE TO	ENVIRONMENTAL CONDITIONS	INPUT POWER	TESTED BY
RE≥1G	25deg. C, 65%RH	120Vac, 60Hz	Kay Wu
RE<1G	25deg. C, 65%RH	120Vac, 60Hz 48Vdc	Kay Wu
PLC	24deg. C, 65%RH	120Vac, 60Hz 48Vdc	Peter Lin
APCM	25deg. C, 65%RH	120Vac, 60Hz	Kay Wu



3.3 GENERAL DESCRIPTION OF APPLIED STANDARDS

The EUT is a RF Product. According to the specifications of the manufacturer, it must comply with the requirements of the following standards:

FCC Part 15, Subpart C (15.247)

ANSI C63.4-2003

ANSI C63.10-2009

All test items have been performed and recorded as per the above standards.

NOTE: The EUT is also considered as a kind of computer peripheral, because the connection to computer is necessary for typical use. It has been verified to comply with the requirements of FCC Part 15, Subpart B, Class B (DoC). The test report has been issued separately.

4. TEST TYPES AND RESULTS (FOR 2.4GHz BAND)

4.1 RADIATED EMISSION AND BANDEDGE MEASUREMENT

4.1.1 LIMITS OF RADIATED AND BANDEDGE EMISSION MEASUREMENT

Radiated emissions which fall in the restricted bands, as defined in Section 15.205(a), must also comply with the radiated emission limits specified in Section 15.209(a). Other emissions shall be at least 20dB below the highest level of the desired power:

FREQUENCIES (MHz)	FIELD STRENGTH (microvolts/meter)	MEASUREMENT DISTANCE (meters)
0.009 ~ 0.490	2400/F(kHz)	300
0.490 ~ 1.705	24000/F(kHz)	30
1.705 ~ 30.0	30	30
30 ~ 88	100	3
88 ~ 216	150	3
216 ~ 960	200	3
Above 960	500	3

NOTE:

1. The lower limit shall apply at the transition frequencies.
2. Emission level (dBuV/m) = 20 log Emission level (uV/m).
3. As shown in 15.35(b), for frequencies above 1000MHz, the field strength limits are based on average detector, however, the peak field strength of any emission shall not exceed the maximum permitted average limits, specified above by more than 20dB under any condition of modulation.



4.1.2 TEST INSTRUMENTS

DESCRIPTION & MANUFACTURER	MODEL NO.	SERIAL NO.	DATE OF CALIBRATION	DUE DATE OF CALIBRATION
Test Receiver ROHDE & SCHWARZ	ESIB7	100212	Aug. 02, 2011	Aug. 01, 2012
Spectrum Analyzer ROHDE & SCHWARZ	FSP 40	100041	Jul. 21, 2011	Jul. 20, 2012
BILOG Antenna SCHWARZBECK	VULB9168	9168-160	Apr. 13, 2011	Apr. 12, 2012
HORN Antenna SCHWARZBECK	9120D	209	Aug. 25, 2011	Aug. 24, 2012
HORN Antenna SCHWARZBECK	BBHA 9170	148	Jul. 20, 2011	Jul. 19, 2012
Preamplifier Agilent	8447D	2944A10633	Oct. 29, 2011	Oct. 28, 2012
Preamplifier Agilent	8449B	3008A01964	Oct. 29, 2011	Oct. 28, 2012
RF signal cable HUBER+SUHNNER	SUCOFLEX 104	295014/4	Aug. 19, 2011	Aug. 18, 2012
RF signal cable HUBER+SUHNNER	SUCOFLEX 104	12738/6	Aug. 19, 2011	Aug. 18, 2012
Software ADT.	ADT_Radiated_ V7.6.15.9.2	NA	NA	NA
Antenna Tower inn-co GmbH	MA 4000	013303	NA	NA
Antenna Tower Controller inn-co GmbH	CO2000	017303	NA	NA
Turn Table ADT.	TT100.	TT93021703	NA	NA
Turn Table Controller ADT.	SC100.	SC93021703	NA	NA
High Speed Peak Power Meter	ML2495A	0842014	Apr. 26, 2011	Apr. 25, 2012
Power Sensor	MA2411B	0738404	Apr. 26, 2011	Apr. 25, 2012

NOTE: 1. The calibration interval of the above test instruments is 12 months and the calibrations are traceable to NML/ROC and NIST/USA.

2. The test was performed in HwaYa Chamber 3.

3. The horn antenna and HP preamplifier (model: 8449B) are used only for the measurement of emission frequency above 1GHz if tested.

4. The FCC Site Registration No. is 988962.

5. The IC Site Registration No. is IC 7450F-3.

4.1.3 TEST PROCEDURES

- a. The EUT was placed on the top of a rotating table 0.8 meters above the ground at a 3 meters semi-anechoic chamber. The table was rotated 360 degrees to determine the position of the highest radiation.
- b. The EUT was set 3 meters away from the interference-receiving antenna, which was mounted on the top of a variable-height antenna tower.
- c. Height of receiving antenna is varied from one meter to four meters above the ground to determine the maximum value of the field strength. Both horizontal and vertical polarizations of the antenna are set to make the measurement.
- d. For each suspected emission, the EUT was arranged to its worst case and then the antenna was tuned to heights from 1 meter to 4 meters and the rotatable table was turned from 0 degrees to 360 degrees to find the maximum reading.
- e. The test-receiver system was set to Peak Detect Function and Specified Bandwidth with Maximum Hold Mode.
- f. If the emission level of the EUT in peak mode was lower than the limit specified, then testing could be stopped and the peak values of the EUT would be reported. Otherwise the emissions would be re-tested one by one using peak, quasi-peak or average method as specified and then reported in a data sheet.

NOTE:

1. The resolution bandwidth and video bandwidth of test receiver/spectrum analyzer is 120kHz for Quasi-peak detection at frequency below 1GHz.
2. The resolution bandwidth of test receiver/spectrum analyzer is 1MHz and video bandwidth is 3MHz for Peak detection at frequency above 1GHz.
3. The resolution bandwidth of test receiver/spectrum analyzer is 1MHz and the video bandwidth is 10Hz for Average detection (AV) at frequency above 1GHz.
4. All modes of operation were investigated and the worst-case emissions are reported.

4.1.4 DEVIATION FROM TEST STANDARD

No deviation.

4.1.5 TEST SETUP

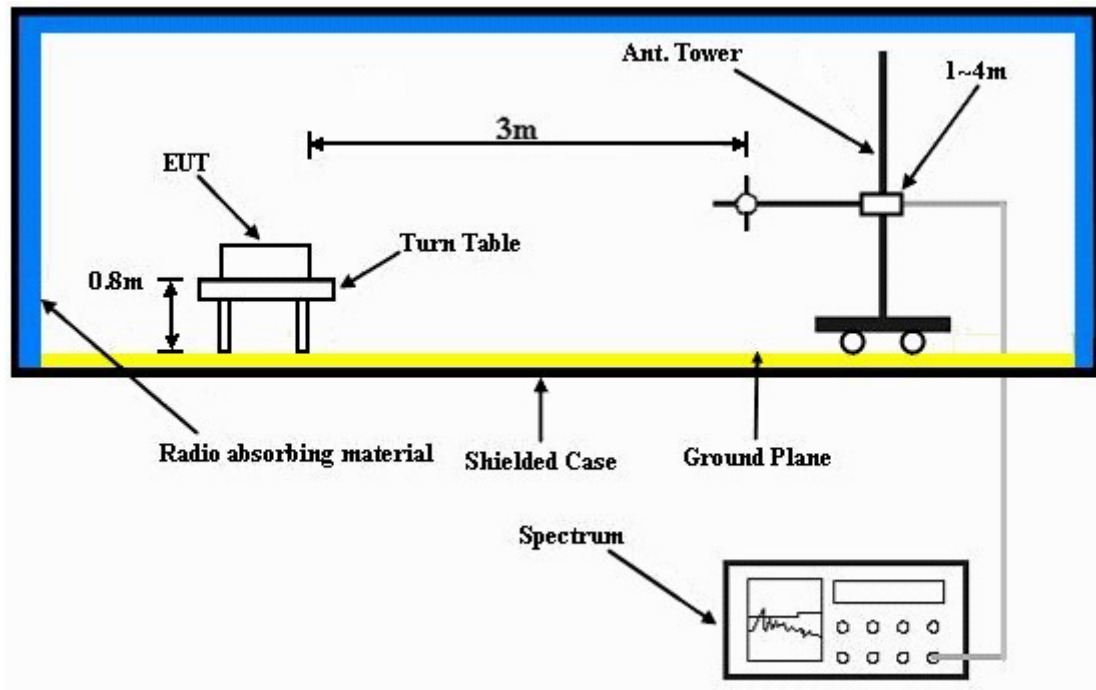

For the actual test configuration, please refer to the attached file (Test Setup Photo).

4.1.6 EUT OPERATING CONDITIONS

- Placed the EUT on the testing table.
- Prepared notebook outside of testing area to act as communication partners.
- The communication partners connected with EUT via a RJ45 cable and run a test program (provided by manufacturer) to enable EUT under transmission condition continuously at specific channel frequency.
- The necessary accessories enable the system in full functions

4.1.7 TEST RESULTS

ABOVE 1GHz: 802.11b

EUT TEST CONDITION		MEASUREMENT DETAIL	
CHANNEL	Channel 1	FREQUENCY RANGE	1 ~ 25GHz
INPUT POWER (SYSTEM)	120Vac, 60 Hz	DETECTOR FUNCTION	Peak (PK) Average (AV)
ENVIRONMENTAL CONDITIONS	25deg. C, 65%RH	TEST MODE	A1
TESTED BY	Kay Wu		

ANTENNA POLARITY & TEST DISTANCE: HORIZONTAL AT 3 M								
NO.	FREQ. (MHz)	EMISSION LEVEL (dBuV/m)	LIMIT (dBuV/m)	MARGIN (dB)	ANTENNA HEIGHT (m)	TABLE ANGLE (Degree)	RAW VALUE (dBuV)	CORRECTION FACTOR (dB/m)
1	2360.00	48.7 PK	74.0	-25.3	1.61 H	336	17.70	31.00
2	2360.00	37.6 AV	54.0	-16.4	1.61 H	336	6.60	31.00
3	*2412.00	102.3 PK			1.00 H	340	71.10	31.20
4	*2412.00	98.7 AV			1.00 H	340	67.50	31.20
5	4824.00	53.3 PK	74.0	-20.7	1.00 H	168	16.40	36.90
6	4824.00	49.9 AV	54.0	-4.1	1.00 H	168	13.00	36.90
ANTENNA POLARITY & TEST DISTANCE: VERTICAL AT 3 M								
NO.	FREQ. (MHz)	EMISSION LEVEL (dBuV/m)	LIMIT (dBuV/m)	MARGIN (dB)	ANTENNA HEIGHT (m)	TABLE ANGLE (Degree)	RAW VALUE (dBuV)	CORRECTION FACTOR (dB/m)
1	2376.00	54.0 PK	74.0	-20.0	1.44 V	10	23.00	31.00
2	2376.00	40.8 AV	54.0	-13.2	1.44 V	10	9.80	31.00
3	*2412.00	108.2 PK			1.16 V	8	77.00	31.20
4	*2412.00	104.3 AV			1.16 V	8	73.10	31.20
5	4824.00	56.2 PK	74.0	-17.8	1.74 V	291	19.30	36.90
6	4824.00	53.0 AV	54.0	-1.0	1.74 V	291	16.10	36.90

- REMARKS:**
1. Emission level (dBuV/m) = Raw Value (dBuV) + Correction Factor (dB/m).
 2. Correction Factor (dB/m) = Antenna Factor (dB/m) + Cable Factor (dB).
 3. The other emission levels were very low against the limit.
 4. Margin value = Emission level – Limit value.
 5. “ * “: Fundamental frequency.

EUT TEST CONDITION		MEASUREMENT DETAIL	
CHANNEL	Channel 6	FREQUENCY RANGE	1 ~ 25GHz
INPUT POWER (SYSTEM)	120Vac, 60 Hz	DETECTOR FUNCTION	Peak (PK) Average (AV)
ENVIRONMENTAL CONDITIONS	25deg. C, 65%RH	TEST MODE	A1
TESTED BY	Kay Wu		

ANTENNA POLARITY & TEST DISTANCE: HORIZONTAL AT 3 M								
NO.	FREQ. (MHz)	EMISSION LEVEL (dBuV/m)	LIMIT (dBuV/m)	MARGIN (dB)	ANTENNA HEIGHT (m)	TABLE ANGLE (Degree)	RAW VALUE (dBuV)	CORRECTION FACTOR (dB/m)
1	*2437.00	101.3 PK			1.30 H	213	70.00	31.30
2	*2437.00	97.2 AV			1.30 H	213	65.90	31.30
3	4874.00	53.5 PK	74.0	-20.5	1.00 H	199	16.50	37.00
4	4874.00	50.4 AV	54.0	-3.6	1.00 H	199	13.40	37.00
5	7311.00	51.4 PK	74.0	-22.6	1.00 H	25	8.30	43.10
6	7311.00	37.8 AV	54.0	-16.2	1.00 H	25	-5.30	43.10
ANTENNA POLARITY & TEST DISTANCE: VERTICAL AT 3 M								
NO.	FREQ. (MHz)	EMISSION LEVEL (dBuV/m)	LIMIT (dBuV/m)	MARGIN (dB)	ANTENNA HEIGHT (m)	TABLE ANGLE (Degree)	RAW VALUE (dBuV)	CORRECTION FACTOR (dB/m)
1	*2437.00	107.1 PK			1.14 V	325	75.80	31.30
2	*2437.00	103.2 AV			1.14 V	325	71.90	31.30
3	4874.00	54.9 PK	74.0	-19.1	1.04 V	200	17.90	37.00
4	4874.00	53.0 AV	54.0	-1.0	1.04 V	200	16.00	37.00
5	7311.00	51.0 PK	74.0	-23.0	1.00 V	153	7.90	43.10
6	7311.00	40.1 AV	54.0	-13.9	1.00 V	153	-3.00	43.10

- REMARKS:**
1. Emission level (dBuV/m) = Raw Value (dBuV) + Correction Factor (dB/m).
 2. Correction Factor (dB/m) = Antenna Factor (dB/m) + Cable Factor (dB).
 3. The other emission levels were very low against the limit.
 4. Margin value = Emission level – Limit value.
 5. “ * “: Fundamental frequency.

EUT TEST CONDITION		MEASUREMENT DETAIL	
CHANNEL	Channel 11	FREQUENCY RANGE	1 ~ 25GHz
INPUT POWER (SYSTEM)	120Vac, 60 Hz	DETECTOR FUNCTION	Peak (PK) Average (AV)
ENVIRONMENTAL CONDITIONS	25deg. C, 65%RH	TEST MODE	A1
TESTED BY	Kay Wu		

ANTENNA POLARITY & TEST DISTANCE: HORIZONTAL AT 3 M								
NO.	FREQ. (MHz)	EMISSION LEVEL (dBuV/m)	LIMIT (dBuV/m)	MARGIN (dB)	ANTENNA HEIGHT (m)	TABLE ANGLE (Degree)	RAW VALUE (dBuV)	CORRECTION FACTOR (dB/m)
1	*2462.00	96.5 PK			1.00 H	356	65.10	31.40
2	*2462.00	92.8 AV			1.00 H	356	61.40	31.40
3	2483.50	44.3 PK	74.0	-29.7	1.00 H	339	12.90	31.40
4	2483.50	33.0 AV	54.0	-21.0	1.00 H	339	1.60	31.40
5	4924.00	54.0 PK	74.0	-20.0	1.00 H	200	16.90	37.10
6	4924.00	51.2 AV	54.0	-2.8	1.00 H	200	14.10	37.10
7	7386.00	49.8 PK	74.0	-24.2	1.00 H	25	6.50	43.30
8	7386.00	37.4 AV	54.0	-16.6	1.00 H	25	-5.90	43.30
ANTENNA POLARITY & TEST DISTANCE: VERTICAL AT 3 M								
NO.	FREQ. (MHz)	EMISSION LEVEL (dBuV/m)	LIMIT (dBuV/m)	MARGIN (dB)	ANTENNA HEIGHT (m)	TABLE ANGLE (Degree)	RAW VALUE (dBuV)	CORRECTION FACTOR (dB/m)
1	*2462.00	101.4 PK			1.74 V	277	70.00	31.40
2	*2462.00	97.6 AV			1.74 V	277	66.20	31.40
3	2483.50	49.4 PK	74.0	-24.6	1.05 V	54	18.00	31.40
4	2483.50	39.3 AV	54.0	-14.7	1.05 V	54	7.90	31.40
5	4924.00	56.0 PK	74.0	-18.0	1.03 V	198	18.90	37.10
6	4924.00	53.0 AV	54.0	-1.0	1.03 V	198	15.90	37.10
7	7386.00	51.8 PK	74.0	-22.2	2.00 V	153	8.50	43.30
8	7386.00	40.0 AV	54.0	-14.0	2.00 V	153	-3.30	43.30

- REMARKS:**
1. Emission level (dBuV/m) = Raw Value (dBuV) + Correction Factor (dB/m).
 2. Correction Factor (dB/m) = Antenna Factor (dB/m) + Cable Factor (dB).
 3. The other emission levels were very low against the limit.
 4. Margin value = Emission level – Limit value.
 5. “ * “: Fundamental frequency.

EUT TEST CONDITION		MEASUREMENT DETAIL	
CHANNEL	Channel 1	FREQUENCY RANGE	1 ~ 25GHz
INPUT POWER (SYSTEM)	120Vac, 60 Hz	DETECTOR FUNCTION	Peak (PK) Average (AV)
ENVIRONMENTAL CONDITIONS	25deg. C, 65%RH	TEST MODE	B1
TESTED BY	Kay Wu		

ANTENNA POLARITY & TEST DISTANCE: HORIZONTAL AT 3 M								
NO.	FREQ. (MHz)	EMISSION LEVEL (dBuV/m)	LIMIT (dBuV/m)	MARGIN (dB)	ANTENNA HEIGHT (m)	TABLE ANGLE (Degree)	RAW VALUE (dBuV)	CORRECTION FACTOR (dB/m)
1	2390.00	60.0 PK	74.0	-14.0	1.00 H	59	28.90	31.10
2	2390.00	48.2 AV	54.0	-5.8	1.00 H	59	17.10	31.10
3	*2412.00	103.5 PK			1.01 H	59	72.30	31.20
4	*2412.00	99.8 AV			1.01 H	59	68.60	31.20
5	4824.00	52.1 PK	74.0	-21.9	1.36 H	207	15.20	36.90
6	4824.00	48.5 AV	54.0	-5.5	1.36 H	207	11.60	36.90
ANTENNA POLARITY & TEST DISTANCE: VERTICAL AT 3 M								
NO.	FREQ. (MHz)	EMISSION LEVEL (dBuV/m)	LIMIT (dBuV/m)	MARGIN (dB)	ANTENNA HEIGHT (m)	TABLE ANGLE (Degree)	RAW VALUE (dBuV)	CORRECTION FACTOR (dB/m)
1	2390.00	65.1 PK	74.0	-8.9	1.20 V	36	34.00	31.10
2	2390.00	48.7 AV	54.0	-5.3	1.20 V	36	17.60	31.10
3	*2412.00	109.8 PK			1.18 V	36	78.60	31.20
4	*2412.00	105.0 AV			1.18 V	36	73.80	31.20
5	4824.00	55.8 PK	74.0	-18.2	1.19 V	350	18.90	36.90
6	4824.00	52.5 AV	54.0	-1.5	1.19 V	350	15.60	36.90

- REMARKS:**
1. Emission level (dBuV/m) = Raw Value (dBuV) + Correction Factor (dB/m).
 2. Correction Factor (dB/m) = Antenna Factor (dB/m) + Cable Factor (dB).
 3. The other emission levels were very low against the limit.
 4. Margin value = Emission level – Limit value.
 5. “ * “: Fundamental frequency.

EUT TEST CONDITION		MEASUREMENT DETAIL	
CHANNEL	Channel 6	FREQUENCY RANGE	1 ~ 25GHz
INPUT POWER (SYSTEM)	120Vac, 60 Hz	DETECTOR FUNCTION	Peak (PK) Average (AV)
ENVIRONMENTAL CONDITIONS	25deg. C, 65%RH	TEST MODE	B1
TESTED BY	Kay Wu		

ANTENNA POLARITY & TEST DISTANCE: HORIZONTAL AT 3 M								
NO.	FREQ. (MHz)	EMISSION LEVEL (dBuV/m)	LIMIT (dBuV/m)	MARGIN (dB)	ANTENNA HEIGHT (m)	TABLE ANGLE (Degree)	RAW VALUE (dBuV)	CORRECTION FACTOR (dB/m)
1	*2437.00	104.0 PK			1.00 H	134	72.70	31.30
2	*2437.00	100.1 AV			1.00 H	134	68.80	31.30
3	4874.00	50.9 PK	74.0	-23.1	1.15 H	187	13.90	37.00
4	4874.00	46.7 AV	54.0	-7.3	1.15 H	187	9.70	37.00
5	7311.00	54.0 PK	74.0	-20.0	1.60 H	241	10.90	43.10
6	7311.00	45.9 AV	54.0	-8.1	1.60 H	241	2.80	43.10
ANTENNA POLARITY & TEST DISTANCE: VERTICAL AT 3 M								
NO.	FREQ. (MHz)	EMISSION LEVEL (dBuV/m)	LIMIT (dBuV/m)	MARGIN (dB)	ANTENNA HEIGHT (m)	TABLE ANGLE (Degree)	RAW VALUE (dBuV)	CORRECTION FACTOR (dB/m)
1	*2437.00	112.5 PK			1.25 V	154	81.20	31.30
2	*2437.00	108.6 AV			1.25 V	154	77.30	31.30
3	4874.00	55.5 PK	74.0	-18.5	1.18 V	175	18.50	37.00
4	4874.00	52.5 AV	54.0	-1.5	1.18 V	175	15.50	37.00
5	7311.00	59.5 PK	74.0	-14.5	1.82 V	155	16.40	43.10
6	7311.00	53.0 AV	54.0	-1.0	1.82 V	155	9.90	43.10

- REMARKS:**
1. Emission level (dBuV/m) = Raw Value (dBuV) + Correction Factor (dB/m).
 2. Correction Factor (dB/m) = Antenna Factor (dB/m) + Cable Factor (dB).
 3. The other emission levels were very low against the limit.
 4. Margin value = Emission level – Limit value.
 5. “ * “: Fundamental frequency.

EUT TEST CONDITION		MEASUREMENT DETAIL	
CHANNEL	Channel 11	FREQUENCY RANGE	1 ~ 25GHz
INPUT POWER (SYSTEM)	120Vac, 60 Hz	DETECTOR FUNCTION	Peak (PK) Average (AV)
ENVIRONMENTAL CONDITIONS	25deg. C, 65%RH	TEST MODE	B1
TESTED BY	Kay Wu		

ANTENNA POLARITY & TEST DISTANCE: HORIZONTAL AT 3 M								
NO.	FREQ. (MHz)	EMISSION LEVEL (dBuV/m)	LIMIT (dBuV/m)	MARGIN (dB)	ANTENNA HEIGHT (m)	TABLE ANGLE (Degree)	RAW VALUE (dBuV)	CORRECTION FACTOR (dB/m)
1	*2462.00	104.7 PK			1.00 H	124	73.30	31.40
2	*2462.00	101.3 AV			1.00 H	124	69.90	31.40
3	2483.50	53.3 PK	74.0	-20.7	1.00 H	118	21.90	31.40
4	2483.50	45.4 AV	54.0	-8.6	1.00 H	118	14.00	31.40
5	4924.00	50.8 PK	74.0	-23.2	1.30 H	177	13.70	37.10
6	4924.00	45.7 AV	54.0	-8.3	1.30 H	177	8.60	37.10
7	7386.00	54.4 PK	74.0	-19.6	1.75 H	236	11.10	43.30
8	7386.00	46.8 AV	54.0	-7.2	1.75 H	236	3.50	43.30
ANTENNA POLARITY & TEST DISTANCE: VERTICAL AT 3 M								
NO.	FREQ. (MHz)	EMISSION LEVEL (dBuV/m)	LIMIT (dBuV/m)	MARGIN (dB)	ANTENNA HEIGHT (m)	TABLE ANGLE (Degree)	RAW VALUE (dBuV)	CORRECTION FACTOR (dB/m)
1	*2462.00	110.5 PK			1.08 V	123	79.10	31.40
2	*2462.00	108.0 AV			1.08 V	123	76.60	31.40
3	2483.50	56.3 PK	74.0	-17.7	1.00 V	154	24.90	31.40
4	2483.50	47.4 AV	54.0	-6.6	1.00 V	154	16.00	31.40
5	4924.00	53.3 PK	74.0	-20.7	1.10 V	124	16.20	37.10
6	4924.00	52.2 AV	54.0	-1.8	1.10 V	124	15.10	37.10
7	7386.00	58.6 PK	74.0	-15.4	1.75 V	191	15.30	43.30
8	7386.00	52.8 AV	54.0	-1.2	1.75 V	191	9.50	43.30

- REMARKS:**
1. Emission level (dBuV/m) = Raw Value (dBuV) + Correction Factor (dB/m).
 2. Correction Factor (dB/m) = Antenna Factor (dB/m) + Cable Factor (dB).
 3. The other emission levels were very low against the limit.
 4. Margin value = Emission level – Limit value.
 5. “ * “: Fundamental frequency.

802.11g

EUT TEST CONDITION		MEASUREMENT DETAIL	
CHANNEL	Channel 1	FREQUENCY RANGE	1 ~ 25GHz
INPUT POWER (SYSTEM)	120Vac, 60 Hz	DETECTOR FUNCTION	Peak (PK) Average (AV)
ENVIRONMENTAL CONDITIONS	25deg. C, 65%RH	TEST MODE	A1
TESTED BY	Kay Wu		

ANTENNA POLARITY & TEST DISTANCE: HORIZONTAL AT 3 M

NO.	FREQ. (MHz)	EMISSION LEVEL (dBuV/m)	LIMIT (dBuV/m)	MARGIN (dB)	ANTENNA HEIGHT (m)	TABLE ANGLE (Degree)	RAW VALUE (dBuV)	CORRECTION FACTOR (dB/m)
1	2390.00	66.5 PK	74.0	-7.5	1.02 H	343	35.40	31.10
2	2390.00	49.5 AV	54.0	-4.5	1.02 H	343	18.40	31.10
3	*2412.00	107.1 PK			1.00 H	344	75.90	31.20
4	*2412.00	96.0 AV			1.00 H	344	64.80	31.20
5	4824.00	59.5 PK	74.0	-14.5	1.00 H	184	22.60	36.90
6	4824.00	44.6 AV	54.0	-9.4	1.00 H	184	7.70	36.90

ANTENNA POLARITY & TEST DISTANCE: VERTICAL AT 3 M

NO.	FREQ. (MHz)	EMISSION LEVEL (dBuV/m)	LIMIT (dBuV/m)	MARGIN (dB)	ANTENNA HEIGHT (m)	TABLE ANGLE (Degree)	RAW VALUE (dBuV)	CORRECTION FACTOR (dB/m)
1	2390.00	71.3 PK	74.0	-2.7	1.18 V	349	40.20	31.10
2	2390.00	52.2 AV	54.0	-1.8	1.18 V	349	21.10	31.10
3	*2412.00	111.0 PK			1.15 V	358	79.80	31.20
4	*2412.00	100.0 AV			1.15 V	358	68.80	31.20
5	4824.00	62.0 PK	74.0	-12.0	1.04 V	200	25.10	36.90
6	4824.00	48.2 AV	54.0	-5.8	1.04 V	200	11.30	36.90

- REMARKS:**
1. Emission level (dBuV/m) = Raw Value (dBuV) + Correction Factor (dB/m).
 2. Correction Factor (dB/m) = Antenna Factor (dB/m) + Cable Factor (dB).
 3. The other emission levels were very low against the limit.
 4. Margin value = Emission level – Limit value.
 5. “ * “: Fundamental frequency.

EUT TEST CONDITION		MEASUREMENT DETAIL	
CHANNEL	Channel 6	FREQUENCY RANGE	1 ~ 25GHz
INPUT POWER (SYSTEM)	120Vac, 60 Hz	DETECTOR FUNCTION	Peak (PK) Average (AV)
ENVIRONMENTAL CONDITIONS	25deg. C, 65%RH	TEST MODE	A1
TESTED BY	Kay Wu		

ANTENNA POLARITY & TEST DISTANCE: HORIZONTAL AT 3 M								
NO.	FREQ. (MHz)	EMISSION LEVEL (dBuV/m)	LIMIT (dBuV/m)	MARGIN (dB)	ANTENNA HEIGHT (m)	TABLE ANGLE (Degree)	RAW VALUE (dBuV)	CORRECTION FACTOR (dB/m)
1	*2437.00	108.4 PK			1.00 H	345	77.10	31.30
2	*2437.00	97.1 AV			1.00 H	345	65.80	31.30
3	4874.00	64.0 PK	74.0	-10.0	1.00 H	198	27.00	37.00
4	4874.00	50.5 AV	54.0	-3.5	1.00 H	198	13.50	37.00
5	7311.00	53.2 PK	74.0	-20.8	1.04 H	188	10.10	43.10
6	7311.00	39.7 AV	54.0	-14.3	1.04 H	188	-3.40	43.10
ANTENNA POLARITY & TEST DISTANCE: VERTICAL AT 3 M								
NO.	FREQ. (MHz)	EMISSION LEVEL (dBuV/m)	LIMIT (dBuV/m)	MARGIN (dB)	ANTENNA HEIGHT (m)	TABLE ANGLE (Degree)	RAW VALUE (dBuV)	CORRECTION FACTOR (dB/m)
1	*2437.00	112.3 PK			1.09 V	50	81.00	31.30
2	*2437.00	102.0 AV			1.09 V	50	70.70	31.30
3	4874.00	66.6 PK	74.0	-7.4	1.02 V	200	29.60	37.00
4	4874.00	52.6 AV	54.0	-1.4	1.02 V	200	15.60	37.00
5	7311.00	59.2 PK	74.0	-14.8	1.89 V	152	16.10	43.10
6	7311.00	44.6 AV	54.0	-9.4	1.89 V	152	1.50	43.10

- REMARKS:**
1. Emission level (dBuV/m) = Raw Value (dBuV) + Correction Factor (dB/m).
 2. Correction Factor (dB/m) = Antenna Factor (dB/m) + Cable Factor (dB).
 3. The other emission levels were very low against the limit.
 4. Margin value = Emission level – Limit value.
 5. “ * “: Fundamental frequency.



EUT TEST CONDITION		MEASUREMENT DETAIL	
CHANNEL	Channel 11	FREQUENCY RANGE	1 ~ 25GHz
INPUT POWER (SYSTEM)	120Vac, 60 Hz	DETECTOR FUNCTION	Peak (PK) Average (AV)
ENVIRONMENTAL CONDITIONS	25deg. C, 65%RH	TEST MODE	A1
TESTED BY	Kay Wu		

ANTENNA POLARITY & TEST DISTANCE: HORIZONTAL AT 3 M

NO.	FREQ. (MHz)	EMISSION LEVEL (dBuV/m)	LIMIT (dBuV/m)	MARGIN (dB)	ANTENNA HEIGHT (m)	TABLE ANGLE (Degree)	RAW VALUE (dBuV)	CORRECTION FACTOR (dB/m)
1	*2462.00	105.9 PK			1.00 H	344	74.50	31.40
2	*2462.00	95.3 AV			1.00 H	344	63.90	31.40
3	2483.50	68.2 PK	74.0	-5.8	1.00 H	334	36.80	31.40
4	2483.50	47.8 AV	54.0	-6.2	1.00 H	334	16.40	31.40
5	4924.00	63.5 PK	74.0	-10.5	1.00 H	199	26.40	37.10
6	4924.00	49.4 AV	54.0	-4.6	1.00 H	199	12.30	37.10
7	7311.00	51.6 PK	74.0	-22.4	1.00 H	48	8.50	43.10
8	7311.00	38.4 AV	54.0	-15.6	1.00 H	48	-4.70	43.10

ANTENNA POLARITY & TEST DISTANCE: VERTICAL AT 3 M

NO.	FREQ. (MHz)	EMISSION LEVEL (dBuV/m)	LIMIT (dBuV/m)	MARGIN (dB)	ANTENNA HEIGHT (m)	TABLE ANGLE (Degree)	RAW VALUE (dBuV)	CORRECTION FACTOR (dB/m)
1	*2462.00	109.6 PK			1.40 V	326	78.20	31.40
2	*2462.00	99.6 AV			1.40 V	326	68.20	31.40
3	2483.50	73.0 PK	74.0	-1.0	1.05 V	58	41.60	31.40
4	2483.50	53.0 AV	54.0	-1.0	1.05 V	58	21.60	31.40
5	4924.00	66.5 PK	74.0	-7.5	1.04 V	348	29.40	37.10
6	4924.00	52.6 AV	54.0	-1.4	1.04 V	348	15.50	37.10
7	7311.00	56.1 PK	74.0	-17.9	1.80 V	154	13.00	43.10
8	7311.00	43.4 AV	54.0	-10.6	1.80 V	154	0.30	43.10

- REMARKS:**
1. Emission level (dBuV/m) = Raw Value (dBuV) + Correction Factor (dB/m).
 2. Correction Factor (dB/m) = Antenna Factor (dB/m) + Cable Factor (dB).
 3. The other emission levels were very low against the limit.
 4. Margin value = Emission level – Limit value.
 5. “ * “: Fundamental frequency.

EUT TEST CONDITION		MEASUREMENT DETAIL	
CHANNEL	Channel 1	FREQUENCY RANGE	1 ~ 25GHz
INPUT POWER (SYSTEM)	120Vac, 60 Hz	DETECTOR FUNCTION	Peak (PK) Average (AV)
ENVIRONMENTAL CONDITIONS	25deg. C, 65%RH	TEST MODE	B1
TESTED BY	Kay Wu		

ANTENNA POLARITY & TEST DISTANCE: HORIZONTAL AT 3 M								
NO.	FREQ. (MHz)	EMISSION LEVEL (dBuV/m)	LIMIT (dBuV/m)	MARGIN (dB)	ANTENNA HEIGHT (m)	TABLE ANGLE (Degree)	RAW VALUE (dBuV)	CORRECTION FACTOR (dB/m)
1	2390.00	62.6 PK	74.0	-11.4	1.05 H	151	31.50	31.10
2	2390.00	43.8 AV	54.0	-10.2	1.05 H	151	12.70	31.10
3	*2412.00	103.5 PK			1.04 H	154	72.30	31.20
4	*2412.00	93.5 AV			1.04 H	154	62.30	31.20
5	4824.00	55.6 PK	74.0	-18.4	1.25 H	162	18.70	36.90
6	4824.00	39.4 AV	54.0	-14.6	1.25 H	162	2.50	36.90
ANTENNA POLARITY & TEST DISTANCE: VERTICAL AT 3 M								
NO.	FREQ. (MHz)	EMISSION LEVEL (dBuV/m)	LIMIT (dBuV/m)	MARGIN (dB)	ANTENNA HEIGHT (m)	TABLE ANGLE (Degree)	RAW VALUE (dBuV)	CORRECTION FACTOR (dB/m)
1	2390.00	72.6 PK	74.0	-1.4	1.19 V	219	41.50	31.10
2	2390.00	52.8 AV	54.0	-1.2	1.19 V	219	21.70	31.10
3	*2412.00	108.5 PK			1.20 V	169	77.30	31.20
4	*2412.00	98.4 AV			1.20 V	169	67.20	31.20
5	4824.00	57.9 PK	74.0	-16.1	1.14 V	121	21.00	36.90
6	4824.00	40.1 AV	54.0	-13.9	1.14 V	121	3.20	36.90
7	#7236.00	60.2 PK	88.5	-28.3	1.94 V	147	17.30	42.90
8	#7236.00	43.3 AV	78.4	-35.1	1.94 V	147	0.40	42.90

- REMARKS:**
1. Emission level (dBuV/m) = Raw Value (dBuV) + Correction Factor (dB/m).
 2. Correction Factor (dB/m) = Antenna Factor (dB/m) + Cable Factor (dB).
 3. The other emission levels were very low against the limit.
 4. Margin value = Emission level – Limit value.
 5. “ * “: Fundamental frequency.
 6. “#”: The radiated frequency is out the restricted band.

EUT TEST CONDITION		MEASUREMENT DETAIL	
CHANNEL	Channel 6	FREQUENCY RANGE	1 ~ 25GHz
INPUT POWER (SYSTEM)	120Vac, 60 Hz	DETECTOR FUNCTION	Peak (PK) Average (AV)
ENVIRONMENTAL CONDITIONS	25deg. C, 65%RH	TEST MODE	B1
TESTED BY	Kay Wu		

ANTENNA POLARITY & TEST DISTANCE: HORIZONTAL AT 3 M								
NO.	FREQ. (MHz)	EMISSION LEVEL (dBuV/m)	LIMIT (dBuV/m)	MARGIN (dB)	ANTENNA HEIGHT (m)	TABLE ANGLE (Degree)	RAW VALUE (dBuV)	CORRECTION FACTOR (dB/m)
1	*2437.00	106.8 PK			1.00 H	202	75.50	31.30
2	*2437.00	96.3 AV			1.00 H	202	65.00	31.30
3	4874.00	58.4 PK	74.0	-15.6	1.00 H	360	21.40	37.00
4	4874.00	41.7 AV	54.0	-12.3	1.00 H	360	4.70	37.00
5	7311.00	59.6 PK	74.0	-14.4	1.00 H	165	16.50	43.10
6	7311.00	42.7 AV	54.0	-11.3	1.00 H	165	-0.40	43.10
ANTENNA POLARITY & TEST DISTANCE: VERTICAL AT 3 M								
NO.	FREQ. (MHz)	EMISSION LEVEL (dBuV/m)	LIMIT (dBuV/m)	MARGIN (dB)	ANTENNA HEIGHT (m)	TABLE ANGLE (Degree)	RAW VALUE (dBuV)	CORRECTION FACTOR (dB/m)
1	*2437.00	110.4 PK			1.44 V	182	79.10	31.30
2	*2437.00	100.4 AV			1.44 V	182	69.10	31.30
3	4874.00	60.3 PK	74.0	-13.7	1.00 V	354	23.30	37.00
4	4874.00	43.3 AV	54.0	-10.7	1.00 V	354	6.30	37.00
5	7311.00	63.9 PK	74.0	-10.1	1.90 V	145	20.80	43.10
6	7311.00	47.4 AV	54.0	-6.6	1.90 V	145	4.30	43.10

- REMARKS:**
1. Emission level (dBuV/m) = Raw Value (dBuV) + Correction Factor (dB/m).
 2. Correction Factor (dB/m) = Antenna Factor (dB/m) + Cable Factor (dB).
 3. The other emission levels were very low against the limit.
 4. Margin value = Emission level – Limit value.
 5. “ * “: Fundamental frequency.

EUT TEST CONDITION		MEASUREMENT DETAIL	
CHANNEL	Channel 11	FREQUENCY RANGE	1 ~ 25GHz
INPUT POWER (SYSTEM)	120Vac, 60 Hz	DETECTOR FUNCTION	Peak (PK) Average (AV)
ENVIRONMENTAL CONDITIONS	25deg. C, 65%RH	TEST MODE	B1
TESTED BY	Kay Wu		

ANTENNA POLARITY & TEST DISTANCE: HORIZONTAL AT 3 M								
NO.	FREQ. (MHz)	EMISSION LEVEL (dBuV/m)	LIMIT (dBuV/m)	MARGIN (dB)	ANTENNA HEIGHT (m)	TABLE ANGLE (Degree)	RAW VALUE (dBuV)	CORRECTION FACTOR (dB/m)
1	*2462.00	104.0 PK			1.00 H	156	72.60	31.40
2	*2462.00	93.6 AV			1.00 H	156	62.20	31.40
3	2483.50	67.5 PK	74.0	-6.5	1.00 H	158	36.10	31.40
4	2483.50	48.3 AV	54.0	-5.7	1.00 H	158	16.90	31.40
5	4924.00	51.5 PK	74.0	-22.5	1.00 H	158	14.40	37.10
6	4924.00	35.4 AV	54.0	-18.6	1.00 H	158	-1.70	37.10
7	7386.00	57.4 PK	74.0	-16.6	1.00 H	124	14.10	43.30
8	7386.00	42.3 AV	54.0	-11.7	1.00 H	124	-1.00	43.30
ANTENNA POLARITY & TEST DISTANCE: VERTICAL AT 3 M								
NO.	FREQ. (MHz)	EMISSION LEVEL (dBuV/m)	LIMIT (dBuV/m)	MARGIN (dB)	ANTENNA HEIGHT (m)	TABLE ANGLE (Degree)	RAW VALUE (dBuV)	CORRECTION FACTOR (dB/m)
1	*2462.00	108.7 PK			1.31 V	98	77.30	31.40
2	*2462.00	98.9 AV			1.31 V	98	67.50	31.40
3	2483.50	71.2 PK	74.0	-2.8	1.32 V	100	39.80	31.40
4	2483.50	52.6 AV	54.0	-1.4	1.32 V	100	21.20	31.40
5	4924.00	56.8 PK	74.0	-17.2	1.00 V	348	19.70	37.10
6	4924.00	38.0 AV	54.0	-16.0	1.00 V	348	0.90	37.10
7	7386.00	63.8 PK	74.0	-10.2	1.86 V	194	20.50	43.30
8	7386.00	45.4 AV	54.0	-8.6	1.86 V	194	2.10	43.30

- REMARKS:**
1. Emission level (dBuV/m) = Raw Value (dBuV) + Correction Factor (dB/m).
 2. Correction Factor (dB/m) = Antenna Factor (dB/m) + Cable Factor (dB).
 3. The other emission levels were very low against the limit.
 4. Margin value = Emission level – Limit value.
 5. “ * “: Fundamental frequency.

802.11n (20MHz)

EUT TEST CONDITION		MEASUREMENT DETAIL	
CHANNEL	Channel 1	FREQUENCY RANGE	1 ~ 25GHz
INPUT POWER (SYSTEM)	120Vac, 60 Hz	DETECTOR FUNCTION	Peak (PK) Average (AV)
ENVIRONMENTAL CONDITIONS	25deg. C, 65%RH	TEST MODE	A1
TESTED BY	Kay Wu		

ANTENNA POLARITY & TEST DISTANCE: HORIZONTAL AT 3 M								
NO.	FREQ. (MHz)	EMISSION LEVEL (dBuV/m)	LIMIT (dBuV/m)	MARGIN (dB)	ANTENNA HEIGHT (m)	TABLE ANGLE (Degree)	RAW VALUE (dBuV)	CORRECTION FACTOR (dB/m)
1	2390.00	66.6 PK	74.0	-7.4	1.00 H	344	35.50	31.10
2	2390.00	48.5 AV	54.0	-5.5	1.00 H	344	17.40	31.10
3	*2412.00	106.1 PK			1.00 H	0	74.90	31.20
4	*2412.00	95.3 AV			1.00 H	0	64.10	31.20
5	4824.00	60.0 PK	74.0	-14.0	1.00 H	182	23.10	36.90
6	4824.00	45.2 AV	54.0	-8.8	1.00 H	182	8.30	36.90
7	#7236.00	51.3 PK	86.1	-34.8	1.00 H	25	8.40	42.90
8	#7236.00	38.4 AV	75.3	-36.9	1.00 H	25	-4.50	42.90

ANTENNA POLARITY & TEST DISTANCE: VERTICAL AT 3 M								
NO.	FREQ. (MHz)	EMISSION LEVEL (dBuV/m)	LIMIT (dBuV/m)	MARGIN (dB)	ANTENNA HEIGHT (m)	TABLE ANGLE (Degree)	RAW VALUE (dBuV)	CORRECTION FACTOR (dB/m)
1	2390.00	70.2 PK	74.0	-3.8	1.45 V	298	39.10	31.10
2	2390.00	52.5 AV	54.0	-1.5	1.45 V	298	21.40	31.10
3	*2412.00	110.2 PK			1.16 V	357	79.00	31.20
4	*2412.00	99.9 AV			1.16 V	357	68.70	31.20
5	4824.00	60.8 PK	74.0	-13.2	1.44 V	200	23.90	36.90
6	4824.00	46.9 AV	54.0	-7.1	1.44 V	200	10.00	36.90
7	#7236.00	54.4 PK	90.2	-35.8	2.00 V	150	11.50	42.90
8	#7236.00	40.1 AV	79.9	-39.8	2.00 V	150	-2.80	42.90

- REMARKS:**
1. Emission level (dBuV/m) = Raw Value (dBuV) + Correction Factor (dB/m).
 2. Correction Factor (dB/m) = Antenna Factor (dB/m) + Cable Factor (dB).
 3. The other emission levels were very low against the limit.
 4. Margin value = Emission level – Limit value.
 5. “ * “: Fundamental frequency.
 6. “#”: The radiated frequency is out the restricted band.

EUT TEST CONDITION		MEASUREMENT DETAIL	
CHANNEL	Channel 6	FREQUENCY RANGE	1 ~ 25GHz
INPUT POWER (SYSTEM)	120Vac, 60 Hz	DETECTOR FUNCTION	Peak (PK) Average (AV)
ENVIRONMENTAL CONDITIONS	25deg. C, 65%RH	TEST MODE	A1
TESTED BY	Kay Wu		

ANTENNA POLARITY & TEST DISTANCE: HORIZONTAL AT 3 M								
NO.	FREQ. (MHz)	EMISSION LEVEL (dBuV/m)	LIMIT (dBuV/m)	MARGIN (dB)	ANTENNA HEIGHT (m)	TABLE ANGLE (Degree)	RAW VALUE (dBuV)	CORRECTION FACTOR (dB/m)
1	*2437.00	107.1 PK			1.00 H	344	75.80	31.30
2	*2437.00	96.9 AV			1.00 H	344	65.60	31.30
3	4874.00	62.6 PK	74.0	-11.4	1.10 H	197	25.60	37.00
4	4874.00	49.1 AV	54.0	-4.9	1.10 H	197	12.10	37.00
5	7311.00	52.6 PK	74.0	-21.4	1.18 H	188	9.50	43.10
6	7311.00	39.5 AV	54.0	-14.5	1.18 H	188	-3.60	43.10
ANTENNA POLARITY & TEST DISTANCE: VERTICAL AT 3 M								
NO.	FREQ. (MHz)	EMISSION LEVEL (dBuV/m)	LIMIT (dBuV/m)	MARGIN (dB)	ANTENNA HEIGHT (m)	TABLE ANGLE (Degree)	RAW VALUE (dBuV)	CORRECTION FACTOR (dB/m)
1	*2437.00	112.1 PK			1.70 V	0	80.80	31.30
2	*2437.00	102.3 AV			1.70 V	0	71.00	31.30
3	4874.00	66.3 PK	74.0	-7.7	1.05 V	199	29.30	37.00
4	4874.00	51.0 AV	54.0	-3.0	1.05 V	199	14.00	37.00
5	7311.00	61.8 PK	74.0	-12.2	1.90 V	170	18.70	43.10
6	7311.00	46.7 AV	54.0	-7.3	1.90 V	170	3.60	43.10

- REMARKS:**
1. Emission level (dBuV/m) = Raw Value (dBuV) + Correction Factor (dB/m).
 2. Correction Factor (dB/m) = Antenna Factor (dB/m) + Cable Factor (dB).
 3. The other emission levels were very low against the limit.
 4. Margin value = Emission level – Limit value.
 5. “ * “: Fundamental frequency.

EUT TEST CONDITION		MEASUREMENT DETAIL	
CHANNEL	Channel 11	FREQUENCY RANGE	1 ~ 25GHz
INPUT POWER (SYSTEM)	120Vac, 60 Hz	DETECTOR FUNCTION	Peak (PK) Average (AV)
ENVIRONMENTAL CONDITIONS	25deg. C, 65%RH	TEST MODE	A1
TESTED BY	Kay Wu		

ANTENNA POLARITY & TEST DISTANCE: HORIZONTAL AT 3 M								
NO.	FREQ. (MHz)	EMISSION LEVEL (dBuV/m)	LIMIT (dBuV/m)	MARGIN (dB)	ANTENNA HEIGHT (m)	TABLE ANGLE (Degree)	RAW VALUE (dBuV)	CORRECTION FACTOR (dB/m)
1	*2462.00	104.7 PK			1.00 H	339	73.30	31.40
2	*2462.00	94.3 AV			1.00 H	339	62.90	31.40
3	2483.50	68.6 PK	74.0	-5.4	1.00 H	332	37.20	31.40
4	2483.50	46.9 AV	54.0	-7.1	1.00 H	332	15.50	31.40
5	4924.00	61.9 PK	74.0	-12.1	1.00 H	199	24.80	37.10
6	4924.00	46.2 AV	54.0	-7.8	1.00 H	199	9.10	37.10
ANTENNA POLARITY & TEST DISTANCE: VERTICAL AT 3 M								
NO.	FREQ. (MHz)	EMISSION LEVEL (dBuV/m)	LIMIT (dBuV/m)	MARGIN (dB)	ANTENNA HEIGHT (m)	TABLE ANGLE (Degree)	RAW VALUE (dBuV)	CORRECTION FACTOR (dB/m)
1	*2462.00	109.0 PK			1.14 V	328	77.60	31.40
2	*2462.00	98.6 AV			1.14 V	328	67.20	31.40
3	2483.50	73.1 PK	74.0	-0.9	1.06 V	53	41.70	31.40
4	2483.50	52.7 AV	54.0	-1.3	1.06 V	53	21.30	31.40
5	4924.00	64.6 PK	74.0	-9.4	1.00 V	199	27.50	37.10
6	4924.00	48.3 AV	54.0	-5.7	1.00 V	199	11.20	37.10

- REMARKS:**
1. Emission level (dBuV/m) = Raw Value (dBuV) + Correction Factor (dB/m).
 2. Correction Factor (dB/m) = Antenna Factor (dB/m) + Cable Factor (dB).
 3. The other emission levels were very low against the limit.
 4. Margin value = Emission level – Limit value.
 5. “ * “: Fundamental frequency.

EUT TEST CONDITION		MEASUREMENT DETAIL	
CHANNEL	Channel 1	FREQUENCY RANGE	1 ~ 25GHz
INPUT POWER (SYSTEM)	120Vac, 60 Hz	DETECTOR FUNCTION	Peak (PK) Average (AV)
ENVIRONMENTAL CONDITIONS	25deg. C, 65%RH	TEST MODE	B1
TESTED BY	Kay Wu		

ANTENNA POLARITY & TEST DISTANCE: HORIZONTAL AT 3 M								
NO.	FREQ. (MHz)	EMISSION LEVEL (dBuV/m)	LIMIT (dBuV/m)	MARGIN (dB)	ANTENNA HEIGHT (m)	TABLE ANGLE (Degree)	RAW VALUE (dBuV)	CORRECTION FACTOR (dB/m)
1	2390.00	60.9 PK	74.0	-13.1	1.61 H	201	29.80	31.10
2	2390.00	44.8 AV	54.0	-9.2	1.61 H	201	13.70	31.10
3	*2412.00	103.2 PK			1.02 H	155	72.00	31.20
4	*2412.00	92.5 AV			1.02 H	155	61.30	31.20
5	4824.00	55.8 PK	74.0	-18.2	1.24 H	163	18.90	36.90
6	4824.00	39.0 AV	54.0	-15.0	1.24 H	163	2.10	36.90
ANTENNA POLARITY & TEST DISTANCE: VERTICAL AT 3 M								
NO.	FREQ. (MHz)	EMISSION LEVEL (dBuV/m)	LIMIT (dBuV/m)	MARGIN (dB)	ANTENNA HEIGHT (m)	TABLE ANGLE (Degree)	RAW VALUE (dBuV)	CORRECTION FACTOR (dB/m)
1	2390.00	70.3 PK	74.0	-3.7	1.23 V	66	39.20	31.10
2	2390.00	52.4 AV	54.0	-1.6	1.23 V	66	21.30	31.10
3	*2412.00	108.0 PK			1.00 V	170	76.80	31.20
4	*2412.00	97.4 AV			1.00 V	170	66.20	31.20
5	4824.00	58.0 PK	74.0	-16.0	1.27 V	121	21.10	36.90
6	4824.00	39.2 AV	54.0	-14.8	1.27 V	121	2.30	36.90
7	#7236.00	57.8 PK	88.0	-30.2	2.00 V	143	14.90	42.90
8	#7236.00	42.8 AV	77.4	-34.6	2.00 V	143	-0.10	42.90

- REMARKS:**
1. Emission level (dBuV/m) = Raw Value (dBuV) + Correction Factor (dB/m).
 2. Correction Factor (dB/m) = Antenna Factor (dB/m) + Cable Factor (dB).
 3. The other emission levels were very low against the limit.
 4. Margin value = Emission level – Limit value.
 5. “ * “: Fundamental frequency.
 6. “#”: The radiated frequency is out the restricted band.

EUT TEST CONDITION		MEASUREMENT DETAIL	
CHANNEL	Channel 6	FREQUENCY RANGE	1 ~ 25GHz
INPUT POWER (SYSTEM)	120Vac, 60 Hz	DETECTOR FUNCTION	Peak (PK) Average (AV)
ENVIRONMENTAL CONDITIONS	25deg. C, 65%RH	TEST MODE	B1
TESTED BY	Kay Wu		

ANTENNA POLARITY & TEST DISTANCE: HORIZONTAL AT 3 M								
NO.	FREQ. (MHz)	EMISSION LEVEL (dBuV/m)	LIMIT (dBuV/m)	MARGIN (dB)	ANTENNA HEIGHT (m)	TABLE ANGLE (Degree)	RAW VALUE (dBuV)	CORRECTION FACTOR (dB/m)
1	*2437.00	107.1 PK			1.01 H	176	75.80	31.30
2	*2437.00	97.1 AV			1.01 H	176	65.80	31.30
3	4874.00	59.2 PK	74.0	-14.8	1.00 H	154	22.20	37.00
4	4874.00	41.4 AV	54.0	-12.6	1.00 H	154	4.40	37.00
5	7311.00	58.7 PK	74.0	-15.3	1.00 H	166	15.60	43.10
6	7311.00	43.0 AV	54.0	-11.0	1.00 H	166	-0.10	43.10
ANTENNA POLARITY & TEST DISTANCE: VERTICAL AT 3 M								
NO.	FREQ. (MHz)	EMISSION LEVEL (dBuV/m)	LIMIT (dBuV/m)	MARGIN (dB)	ANTENNA HEIGHT (m)	TABLE ANGLE (Degree)	RAW VALUE (dBuV)	CORRECTION FACTOR (dB/m)
1	*2437.00	111.1 PK			1.45 V	163	79.80	31.30
2	*2437.00	100.7 AV			1.45 V	163	69.40	31.30
3	4874.00	60.8 PK	74.0	-13.2	1.02 V	347	23.80	37.00
4	4874.00	43.8 AV	54.0	-10.2	1.02 V	347	6.80	37.00
5	7311.00	63.9 PK	74.0	-10.1	1.89 V	147	20.80	43.10
6	7311.00	47.0 AV	54.0	-7.0	1.89 V	147	3.90	43.10

- REMARKS:**
1. Emission level (dBuV/m) = Raw Value (dBuV) + Correction Factor (dB/m).
 2. Correction Factor (dB/m) = Antenna Factor (dB/m) + Cable Factor (dB).
 3. The other emission levels were very low against the limit.
 4. Margin value = Emission level – Limit value.
 5. “ * “: Fundamental frequency.

EUT TEST CONDITION		MEASUREMENT DETAIL	
CHANNEL	Channel 11	FREQUENCY RANGE	1 ~ 25GHz
INPUT POWER (SYSTEM)	120Vac, 60 Hz	DETECTOR FUNCTION	Peak (PK) Average (AV)
ENVIRONMENTAL CONDITIONS	25deg. C, 65%RH	TEST MODE	B1
TESTED BY	Kay Wu		

ANTENNA POLARITY & TEST DISTANCE: HORIZONTAL AT 3 M								
NO.	FREQ. (MHz)	EMISSION LEVEL (dBuV/m)	LIMIT (dBuV/m)	MARGIN (dB)	ANTENNA HEIGHT (m)	TABLE ANGLE (Degree)	RAW VALUE (dBuV)	CORRECTION FACTOR (dB/m)
1	*2462.00	104.6 PK			1.00 H	158	73.20	31.40
2	*2462.00	94.3 AV			1.00 H	158	62.90	31.40
3	2483.50	67.3 PK	74.0	-6.7	1.00 H	202	35.90	31.40
4	2483.50	50.5 AV	54.0	-3.5	1.00 H	202	19.10	31.40
5	4924.00	50.7 PK	74.0	-23.3	1.25 H	158	13.60	37.10
6	4924.00	33.8 AV	54.0	-20.2	1.25 H	158	-3.30	37.10
ANTENNA POLARITY & TEST DISTANCE: VERTICAL AT 3 M								
NO.	FREQ. (MHz)	EMISSION LEVEL (dBuV/m)	LIMIT (dBuV/m)	MARGIN (dB)	ANTENNA HEIGHT (m)	TABLE ANGLE (Degree)	RAW VALUE (dBuV)	CORRECTION FACTOR (dB/m)
1	*2462.00	109.8 PK			1.08 V	97	78.40	31.40
2	*2462.00	99.7 AV			1.08 V	97	68.30	31.40
3	2483.50	71.7 PK	74.0	-2.3	1.05 V	100	40.30	31.40
4	2483.50	52.8 AV	54.0	-1.2	1.05 V	100	21.40	31.40
5	4924.00	50.7 PK	74.0	-23.3	1.00 V	355	13.60	37.10
6	4924.00	35.8 AV	54.0	-18.2	1.00 V	355	-1.30	37.10
7	7386.00	59.6 PK	74.0	-14.4	1.96 V	145	16.30	43.30
8	7386.00	42.0 AV	54.0	-12.0	1.96 V	145	-1.30	43.30

- REMARKS:**
1. Emission level (dBuV/m) = Raw Value (dBuV) + Correction Factor (dB/m).
 2. Correction Factor (dB/m) = Antenna Factor (dB/m) + Cable Factor (dB).
 3. The other emission levels were very low against the limit.
 4. Margin value = Emission level – Limit value.
 5. “ * “: Fundamental frequency.

802.11n (40MHz)

EUT TEST CONDITION		MEASUREMENT DETAIL	
CHANNEL	Channel 1	FREQUENCY RANGE	1 ~ 25GHz
INPUT POWER (SYSTEM)	120Vac, 60 Hz	DETECTOR FUNCTION	Peak (PK) Average (AV)
ENVIRONMENTAL CONDITIONS	25deg. C, 65%RH	TEST MODE	A1
TESTED BY	Kay Wu		

ANTENNA POLARITY & TEST DISTANCE: HORIZONTAL AT 3 M								
NO.	FREQ. (MHz)	EMISSION LEVEL (dBuV/m)	LIMIT (dBuV/m)	MARGIN (dB)	ANTENNA HEIGHT (m)	TABLE ANGLE (Degree)	RAW VALUE (dBuV)	CORRECTION FACTOR (dB/m)
1	2390.00	62.3 PK	74.0	-11.7	1.04 H	348	31.20	31.10
2	2390.00	44.2 AV	54.0	-9.8	1.04 H	348	13.10	31.10
3	*2422.00	100.9 PK			1.00 H	346	69.70	31.20
4	*2422.00	90.3 AV			1.00 H	346	59.10	31.20
5	4844.00	53.7 PK	74.0	-20.3	1.00 H	180	16.80	36.90
6	4844.00	38.4 AV	54.0	-15.6	1.00 H	180	1.50	36.90
ANTENNA POLARITY & TEST DISTANCE: VERTICAL AT 3 M								
NO.	FREQ. (MHz)	EMISSION LEVEL (dBuV/m)	LIMIT (dBuV/m)	MARGIN (dB)	ANTENNA HEIGHT (m)	TABLE ANGLE (Degree)	RAW VALUE (dBuV)	CORRECTION FACTOR (dB/m)
1	2390.00	71.4 PK	74.0	-2.6	1.17 V	20	40.30	31.10
2	2390.00	52.8 AV	54.0	-1.2	1.17 V	20	21.70	31.10
3	*2422.00	105.7 PK			1.15 V	360	74.50	31.20
4	*2422.00	94.6 AV			1.15 V	360	63.40	31.20
5	4844.00	55.6 PK	74.0	-18.4	1.29 V	200	18.70	36.90
6	4844.00	40.7 AV	54.0	-13.3	1.29 V	200	3.80	36.90

- REMARKS:**
1. Emission level (dBuV/m) = Raw Value (dBuV) + Correction Factor (dB/m).
 2. Correction Factor (dB/m) = Antenna Factor (dB/m) + Cable Factor (dB).
 3. The other emission levels were very low against the limit.
 4. Margin value = Emission level – Limit value.
 5. “ * “: Fundamental frequency.



EUT TEST CONDITION		MEASUREMENT DETAIL	
CHANNEL	Channel 4	FREQUENCY RANGE	1 ~ 25GHz
INPUT POWER (SYSTEM)	120Vac, 60 Hz	DETECTOR FUNCTION	Peak (PK) Average (AV)
ENVIRONMENTAL CONDITIONS	25deg. C, 65%RH	TEST MODE	A1
TESTED BY	Kay Wu		

ANTENNA POLARITY & TEST DISTANCE: HORIZONTAL AT 3 M

NO.	FREQ. (MHz)	EMISSION LEVEL (dBuV/m)	LIMIT (dBuV/m)	MARGIN (dB)	ANTENNA HEIGHT (m)	TABLE ANGLE (Degree)	RAW VALUE (dBuV)	CORRECTION FACTOR (dB/m)
1	2390.00	59.0 PK	74.0	-15.0	1.00 H	0	27.90	31.10
2	2390.00	42.7 AV	54.0	-11.3	1.00 H	0	11.60	31.10
3	*2437.00	101.4 PK			1.00 H	347	70.10	31.30
4	*2437.00	91.7 AV			1.00 H	347	60.40	31.30
5	2483.50	64.7 PK	74.0	-9.3	1.00 H	360	33.30	31.40
6	2483.50	46.5 AV	54.0	-7.5	1.00 H	360	15.10	31.40
7	4874.00	57.6 PK	74.0	-16.4	1.00 H	198	20.60	37.00
8	4874.00	43.6 AV	54.0	-10.4	1.00 H	198	6.60	37.00

ANTENNA POLARITY & TEST DISTANCE: VERTICAL AT 3 M

NO.	FREQ. (MHz)	EMISSION LEVEL (dBuV/m)	LIMIT (dBuV/m)	MARGIN (dB)	ANTENNA HEIGHT (m)	TABLE ANGLE (Degree)	RAW VALUE (dBuV)	CORRECTION FACTOR (dB/m)
1	2390.00	70.8 PK	74.0	-3.2	1.19 V	321	39.70	31.10
2	2390.00	52.8 AV	54.0	-1.2	1.19 V	321	21.70	31.10
3	*2437.00	105.7 PK			1.38 V	360	74.40	31.30
4	*2437.00	95.4 AV			1.38 V	360	64.10	31.30
5	2483.50	68.7 PK	74.0	-5.3	1.11 V	321	37.30	31.40
6	2483.50	50.7 AV	54.0	-3.3	1.11 V	321	19.30	31.40
7	4874.00	59.6 PK	74.0	-14.4	1.57 V	200	22.60	37.00
8	4874.00	45.8 AV	54.0	-8.2	1.57 V	200	8.80	37.00

- REMARKS:**
1. Emission level (dBuV/m) = Raw Value (dBuV) + Correction Factor (dB/m).
 2. Correction Factor (dB/m) = Antenna Factor (dB/m) + Cable Factor (dB).
 3. The other emission levels were very low against the limit.
 4. Margin value = Emission level – Limit value.
 5. “ * “: Fundamental frequency.

EUT TEST CONDITION		MEASUREMENT DETAIL	
CHANNEL	Channel 7	FREQUENCY RANGE	1 ~ 25GHz
INPUT POWER (SYSTEM)	120Vac, 60 Hz	DETECTOR FUNCTION	Peak (PK) Average (AV)
ENVIRONMENTAL CONDITIONS	25deg. C, 65%RH	TEST MODE	A1
TESTED BY	Kay Wu		

ANTENNA POLARITY & TEST DISTANCE: HORIZONTAL AT 3 M								
NO.	FREQ. (MHz)	EMISSION LEVEL (dBuV/m)	LIMIT (dBuV/m)	MARGIN (dB)	ANTENNA HEIGHT (m)	TABLE ANGLE (Degree)	RAW VALUE (dBuV)	CORRECTION FACTOR (dB/m)
1	*2452.00	97.9 PK			1.00 H	346	66.60	31.30
2	*2452.00	88.0 AV			1.00 H	346	56.70	31.30
3	2483.50	63.6 PK	74.0	-10.4	1.04 H	345	32.20	31.40
4	2483.50	47.0 AV	54.0	-7.0	1.04 H	345	15.60	31.40
5	4904.00	54.0 PK	74.0	-20.0	1.00 H	200	17.00	37.00
6	4904.00	39.9 AV	54.0	-14.1	1.00 H	200	2.90	37.00
ANTENNA POLARITY & TEST DISTANCE: VERTICAL AT 3 M								
NO.	FREQ. (MHz)	EMISSION LEVEL (dBuV/m)	LIMIT (dBuV/m)	MARGIN (dB)	ANTENNA HEIGHT (m)	TABLE ANGLE (Degree)	RAW VALUE (dBuV)	CORRECTION FACTOR (dB/m)
1	*2452.00	102.5 PK			1.70 V	360	71.20	31.30
2	*2452.00	92.5 AV			1.70 V	360	61.20	31.30
3	2483.50	68.5 PK	74.0	-5.5	1.30 V	50	37.10	31.40
4	2483.50	52.8 AV	54.0	-1.2	1.30 V	50	21.40	31.40
5	4904.00	56.8 PK	74.0	-17.2	1.41 V	200	19.80	37.00
6	4904.00	42.9 AV	54.0	-11.1	1.41 V	200	5.90	37.00

- REMARKS:**
1. Emission level (dBuV/m) = Raw Value (dBuV) + Correction Factor (dB/m).
 2. Correction Factor (dB/m) = Antenna Factor (dB/m) + Cable Factor (dB).
 3. The other emission levels were very low against the limit.
 4. Margin value = Emission level – Limit value.
 5. “ * “: Fundamental frequency.

EUT TEST CONDITION		MEASUREMENT DETAIL	
CHANNEL	Channel 1	FREQUENCY RANGE	1 ~ 25GHz
INPUT POWER (SYSTEM)	120Vac, 60 Hz	DETECTOR FUNCTION	Peak (PK) Average (AV)
ENVIRONMENTAL CONDITIONS	25deg. C, 65%RH	TEST MODE	B1
TESTED BY	Kay Wu		

ANTENNA POLARITY & TEST DISTANCE: HORIZONTAL AT 3 M								
NO.	FREQ. (MHz)	EMISSION LEVEL (dBuV/m)	LIMIT (dBuV/m)	MARGIN (dB)	ANTENNA HEIGHT (m)	TABLE ANGLE (Degree)	RAW VALUE (dBuV)	CORRECTION FACTOR (dB/m)
1	2390.00	62.7 PK	74.0	-11.3	1.32 H	283	31.60	31.10
2	2390.00	47.1 AV	54.0	-6.9	1.32 H	283	16.00	31.10
3	*2422.00	98.0 PK			1.00 H	202	66.80	31.20
4	*2422.00	88.0 AV			1.00 H	202	56.80	31.20
5	4844.00	48.6 PK	74.0	-25.4	1.00 H	154	11.70	36.90
6	4844.00	33.3 AV	54.0	-20.7	1.00 H	154	-3.60	36.90
ANTENNA POLARITY & TEST DISTANCE: VERTICAL AT 3 M								
NO.	FREQ. (MHz)	EMISSION LEVEL (dBuV/m)	LIMIT (dBuV/m)	MARGIN (dB)	ANTENNA HEIGHT (m)	TABLE ANGLE (Degree)	RAW VALUE (dBuV)	CORRECTION FACTOR (dB/m)
1	2390.00	68.9 PK	74.0	-5.1	1.18 V	221	37.80	31.10
2	2390.00	53.0 AV	54.0	-1.0	1.18 V	221	21.90	31.10
3	*2422.00	103.5 PK			1.00 V	166	72.30	31.20
4	*2422.00	92.9 AV			1.00 V	166	61.70	31.20
5	4844.00	48.8 PK	74.0	-25.2	1.40 V	358	11.90	36.90
6	4844.00	33.9 AV	54.0	-20.1	1.40 V	358	-3.00	36.90

- REMARKS:**
1. Emission level (dBuV/m) = Raw Value (dBuV) + Correction Factor (dB/m).
 2. Correction Factor (dB/m) = Antenna Factor (dB/m) + Cable Factor (dB).
 3. The other emission levels were very low against the limit.
 4. Margin value = Emission level – Limit value.
 5. “ * “: Fundamental frequency.

EUT TEST CONDITION		MEASUREMENT DETAIL	
CHANNEL	Channel 4	FREQUENCY RANGE	1 ~ 25GHz
INPUT POWER (SYSTEM)	120Vac, 60 Hz	DETECTOR FUNCTION	Peak (PK) Average (AV)
ENVIRONMENTAL CONDITIONS	25deg. C, 65%RH	TEST MODE	B1
TESTED BY	Kay Wu		

ANTENNA POLARITY & TEST DISTANCE: HORIZONTAL AT 3 M								
NO.	FREQ. (MHz)	EMISSION LEVEL (dBuV/m)	LIMIT (dBuV/m)	MARGIN (dB)	ANTENNA HEIGHT (m)	TABLE ANGLE (Degree)	RAW VALUE (dBuV)	CORRECTION FACTOR (dB/m)
1	2390.00	63.1 PK	74.0	-10.9	1.59 H	201	32.00	31.10
2	2390.00	41.9 AV	54.0	-12.1	1.59 H	201	10.80	31.10
3	*2437.00	101.1 PK			1.56 H	157	69.80	31.30
4	*2437.00	90.4 AV			1.56 H	157	59.10	31.30
5	2483.50	61.7 PK	74.0	-12.3	1.00 H	175	30.30	31.40
6	2483.50	45.8 AV	54.0	-8.2	1.00 H	175	14.40	31.40
7	4874.00	45.0 PK	74.0	-29.0	1.00 H	174	8.00	37.00
8	4874.00	34.4 AV	54.0	-19.6	1.00 H	174	-2.60	37.00
ANTENNA POLARITY & TEST DISTANCE: VERTICAL AT 3 M								
NO.	FREQ. (MHz)	EMISSION LEVEL (dBuV/m)	LIMIT (dBuV/m)	MARGIN (dB)	ANTENNA HEIGHT (m)	TABLE ANGLE (Degree)	RAW VALUE (dBuV)	CORRECTION FACTOR (dB/m)
1	2390.00	71.6 PK	74.0	-2.4	1.18 V	220	40.50	31.10
2	2390.00	52.8 AV	54.0	-1.2	1.18 V	220	21.70	31.10
3	*2437.00	105.4 PK			1.47 V	170	74.10	31.30
4	*2437.00	95.7 AV			1.47 V	170	64.40	31.30
5	2483.50	66.4 PK	74.0	-7.6	1.28 V	164	35.00	31.40
6	2483.50	49.6 AV	54.0	-4.4	1.28 V	164	18.20	31.40
7	4874.00	48.5 PK	74.0	-25.5	1.92 V	153	11.50	37.00
8	4874.00	34.6 AV	54.0	-19.4	1.92 V	153	-2.40	37.00

- REMARKS:**
1. Emission level (dBuV/m) = Raw Value (dBuV) + Correction Factor (dB/m).
 2. Correction Factor (dB/m) = Antenna Factor (dB/m) + Cable Factor (dB).
 3. The other emission levels were very low against the limit.
 4. Margin value = Emission level – Limit value.
 5. “ * “: Fundamental frequency.

EUT TEST CONDITION		MEASUREMENT DETAIL	
CHANNEL	Channel 7	FREQUENCY RANGE	1 ~ 25GHz
INPUT POWER (SYSTEM)	120Vac, 60 Hz	DETECTOR FUNCTION	Peak (PK) Average (AV)
ENVIRONMENTAL CONDITIONS	25deg. C, 65%RH	TEST MODE	B1
TESTED BY	Kay Wu		

ANTENNA POLARITY & TEST DISTANCE: HORIZONTAL AT 3 M								
NO.	FREQ. (MHz)	EMISSION LEVEL (dBuV/m)	LIMIT (dBuV/m)	MARGIN (dB)	ANTENNA HEIGHT (m)	TABLE ANGLE (Degree)	RAW VALUE (dBuV)	CORRECTION FACTOR (dB/m)
1	*2452.00	96.9 PK			1.00 H	154	65.60	31.30
2	*2452.00	86.6 AV			1.00 H	154	55.30	31.30
3	2483.50	64.8 PK	74.0	-9.2	1.00 H	201	33.40	31.40
4	2483.50	49.6 AV	54.0	-4.4	1.00 H	201	18.20	31.40
5	4904.00	44.5 PK	74.0	-29.5	1.00 H	55	7.50	37.00
6	4904.00	33.4 AV	54.0	-20.6	1.00 H	55	-3.60	37.00
ANTENNA POLARITY & TEST DISTANCE: VERTICAL AT 3 M								
NO.	FREQ. (MHz)	EMISSION LEVEL (dBuV/m)	LIMIT (dBuV/m)	MARGIN (dB)	ANTENNA HEIGHT (m)	TABLE ANGLE (Degree)	RAW VALUE (dBuV)	CORRECTION FACTOR (dB/m)
1	*2452.00	100.0 PK			1.17 V	159	68.70	31.30
2	*2452.00	89.4 AV			1.17 V	159	58.10	31.30
3	2483.50	70.1 PK	74.0	-3.9	1.04 V	98	38.70	31.40
4	2483.50	52.9 AV	54.0	-1.1	1.04 V	98	21.50	31.40
5	4904.00	45.5 PK	74.0	-28.5	1.00 V	66	8.50	37.00
6	4904.00	33.9 AV	54.0	-20.1	1.00 V	66	-3.10	37.00

- REMARKS:**
1. Emission level (dBuV/m) = Raw Value (dBuV) + Correction Factor (dB/m).
 2. Correction Factor (dB/m) = Antenna Factor (dB/m) + Cable Factor (dB).
 3. The other emission levels were very low against the limit.
 4. Margin value = Emission level – Limit value.
 5. “ * “: Fundamental frequency.

BELOW 1GHz WORST-CASE DATA : 802.11g

EUT TEST CONDITION		MEASUREMENT DETAIL	
CHANNEL	Channel 6	FREQUENCY RANGE	1 ~ 25GHz
INPUT POWER (SYSTEM)	120Vac, 60 Hz	DETECTOR FUNCTION	Peak (PK) Average (AV)
ENVIRONMENTAL CONDITIONS	25deg. C, 65%RH	TEST MODE	A1
TESTED BY	Kay Wu		

ANTENNA POLARITY & TEST DISTANCE: HORIZONTAL AT 3 M								
NO.	FREQ. (MHz)	EMISSION LEVEL (dBuV/m)	LIMIT (dBuV/m)	MARGIN (dB)	ANTENNA HEIGHT (m)	TABLE ANGLE (Degree)	RAW VALUE (dBuV)	CORRECTION FACTOR (dB/m)
1	45.45	31.1 QP	40.0	-8.9	2.00 H	49	16.70	14.40
2	249.60	33.9 QP	46.0	-12.1	1.00 H	241	20.90	13.00
3	360.43	45.3 QP	46.0	-0.7	1.00 H	226	28.90	16.40
4	374.04	41.0 QP	46.0	-5.0	1.00 H	154	24.20	16.80
5	624.85	42.6 QP	46.0	-3.4	1.00 H	199	19.70	22.90
6	751.23	39.6 QP	46.0	-6.4	1.00 H	289	14.90	24.70
ANTENNA POLARITY & TEST DISTANCE: VERTICAL AT 3 M								
NO.	FREQ. (MHz)	EMISSION LEVEL (dBuV/m)	LIMIT (dBuV/m)	MARGIN (dB)	ANTENNA HEIGHT (m)	TABLE ANGLE (Degree)	RAW VALUE (dBuV)	CORRECTION FACTOR (dB/m)
1	43.51	38.8 QP	40.0	-1.2	1.00 V	313	24.40	14.40
2	125.17	32.0 QP	43.5	-11.5	1.00 V	10	19.10	12.90
3	249.60	29.5 QP	46.0	-16.5	1.00 V	136	16.50	13.00
4	360.43	42.4 QP	46.0	-3.6	1.00 V	187	26.00	16.40
5	374.04	41.6 QP	46.0	-4.4	1.00 V	172	24.80	16.80
6	624.85	42.7 QP	46.0	-3.3	1.00 V	91	19.80	22.90

- REMARKS:**
1. Emission level (dBuV/m) = Raw Value (dBuV) + Correction Factor (dB/m).
 2. Correction Factor (dB/m) = Antenna Factor (dB/m) + Cable Factor (dB).
 3. The other emission levels were very low against the limit.
 4. Margin value = Emission level – Limit value.

EUT TEST CONDITION		MEASUREMENT DETAIL	
CHANNEL	Channel 6	FREQUENCY RANGE	1 ~ 25GHz
INPUT POWER (SYSTEM)	120Vac, 60 Hz	DETECTOR FUNCTION	Peak (PK) Average (AV)
ENVIRONMENTAL CONDITIONS	25deg. C, 65%RH	TEST MODE	A2
TESTED BY	Kay Wu		

ANTENNA POLARITY & TEST DISTANCE: HORIZONTAL AT 3 M								
NO.	FREQ. (MHz)	EMISSION LEVEL (dBuV/m)	LIMIT (dBuV/m)	MARGIN (dB)	ANTENNA HEIGHT (m)	TABLE ANGLE (Degree)	RAW VALUE (dBuV)	CORRECTION FACTOR (dB/m)
1	360.43	42.3 QP	46.0	-3.7	1.00 H	154	25.90	16.40
2	374.04	29.2 QP	46.0	-16.8	1.00 H	157	12.40	16.80
3	475.14	27.8 QP	46.0	-18.2	2.00 H	148	8.30	19.50
4	599.58	32.2 QP	46.0	-13.8	3.00 H	304	9.80	22.40
5	751.23	33.4 QP	46.0	-12.6	1.00 H	322	8.70	24.70
6	840.67	31.0 QP	46.0	-15.0	1.00 H	10	5.10	25.90

ANTENNA POLARITY & TEST DISTANCE: VERTICAL AT 3 M								
NO.	FREQ. (MHz)	EMISSION LEVEL (dBuV/m)	LIMIT (dBuV/m)	MARGIN (dB)	ANTENNA HEIGHT (m)	TABLE ANGLE (Degree)	RAW VALUE (dBuV)	CORRECTION FACTOR (dB/m)
1	43.51	33.8 QP	40.0	-6.2	1.00 V	304	19.40	14.40
2	125.17	26.6 QP	43.5	-16.9	1.00 V	1	13.70	12.90
3	348.76	30.5 QP	46.0	-15.5	2.00 V	268	14.40	16.10
4	360.43	38.3 QP	46.0	-7.7	2.00 V	118	21.90	16.40
5	550.97	25.1 QP	46.0	-20.9	1.00 V	256	3.80	21.30
6	599.58	31.1 QP	46.0	-14.9	1.00 V	100	8.70	22.40

- REMARKS:**
1. Emission level (dBuV/m) = Raw Value (dBuV) + Correction Factor (dB/m).
 2. Correction Factor (dB/m) = Antenna Factor (dB/m) + Cable Factor (dB).
 3. The other emission levels were very low against the limit.
 4. Margin value = Emission level – Limit value.

EUT TEST CONDITION		MEASUREMENT DETAIL	
CHANNEL	Channel 6	FREQUENCY RANGE	Below 1000MHz
INPUT POWER (SYSTEM)	120Vac, 60 Hz	DETECTOR FUNCTION	Quasi-Peak
ENVIRONMENTAL CONDITIONS	25deg. C, 65%RH	TEST MODE	B1
TESTED BY	Antony Lee		

ANTENNA POLARITY & TEST DISTANCE: HORIZONTAL AT 3 M								
NO.	FREQ. (MHz)	EMISSION LEVEL (dBuV/m)	LIMIT (dBuV/m)	MARGIN (dB)	ANTENNA HEIGHT (m)	TABLE ANGLE (Degree)	RAW VALUE (dBuV)	CORRECTION FACTOR (dB/m)
1	99.89	30.7 QP	43.5	-12.8	1.75 H	301	19.50	11.20
2	239.88	34.5 QP	46.0	-11.5	1.25 H	262	21.30	13.20
3	360.43	39.4 QP	46.0	-6.6	1.00 H	223	22.10	17.30
4	601.52	42.2 QP	46.0	-3.8	1.50 H	211	18.50	23.70
5	626.80	42.4 QP	46.0	-3.6	1.25 H	214	18.40	24.00
6	877.61	41.8 QP	46.0	-4.2	1.75 H	115	13.40	28.40
ANTENNA POLARITY & TEST DISTANCE: VERTICAL AT 3 M								
NO.	FREQ. (MHz)	EMISSION LEVEL (dBuV/m)	LIMIT (dBuV/m)	MARGIN (dB)	ANTENNA HEIGHT (m)	TABLE ANGLE (Degree)	RAW VALUE (dBuV)	CORRECTION FACTOR (dB/m)
1	43.51	36.4 QP	40.0	-3.6	1.00 V	10	21.70	14.70
2	125.17	38.5 QP	43.5	-5.0	1.00 V	145	25.40	13.10
3	360.43	42.7 QP	46.0	-3.3	2.00 V	169	25.40	17.30
4	601.52	42.1 QP	46.0	-3.9	1.50 V	196	18.40	23.70
5	626.80	41.5 QP	46.0	-4.5	1.00 V	67	17.50	24.00
6	877.61	40.5 QP	46.0	-5.5	1.75 V	175	12.10	28.40

- REMARKS:**
1. Emission level (dBuV/m) = Raw Value (dBuV) + Correction Factor (dB/m).
 2. Correction Factor (dB/m) = Antenna Factor (dB/m) + Cable Factor (dB).
 3. The other emission levels were very low against the limit.
 4. Margin value = Emission level – Limit value.

EUT TEST CONDITION		MEASUREMENT DETAIL	
CHANNEL	Channel 6	FREQUENCY RANGE	Below 1000MHz
INPUT POWER (SYSTEM)	120Vac, 60 Hz	DETECTOR FUNCTION	Quasi-Peak
ENVIRONMENTAL CONDITIONS	25deg. C, 65%RH	TEST MODE	B2
TESTED BY	Antony Lee		

ANTENNA POLARITY & TEST DISTANCE: HORIZONTAL AT 3 M								
NO.	FREQ. (MHz)	EMISSION LEVEL (dBuV/m)	LIMIT (dBuV/m)	MARGIN (dB)	ANTENNA HEIGHT (m)	TABLE ANGLE (Degree)	RAW VALUE (dBuV)	CORRECTION FACTOR (dB/m)
1	99.89	40.0 QP	43.5	-3.5	2.00 H	325	28.80	11.20
2	179.61	34.1 QP	43.5	-9.4	1.25 H	37	20.40	13.70
3	360.43	38.4 QP	46.0	-7.6	1.00 H	223	21.10	17.30
4	601.52	40.6 QP	46.0	-5.4	1.50 H	214	16.90	23.70
5	626.80	42.0 QP	46.0	-4.0	1.25 H	214	18.00	24.00
6	877.61	41.9 QP	46.0	-4.1	1.75 H	103	13.50	28.40
ANTENNA POLARITY & TEST DISTANCE: VERTICAL AT 3 M								
NO.	FREQ. (MHz)	EMISSION LEVEL (dBuV/m)	LIMIT (dBuV/m)	MARGIN (dB)	ANTENNA HEIGHT (m)	TABLE ANGLE (Degree)	RAW VALUE (dBuV)	CORRECTION FACTOR (dB/m)
1	43.51	37.0 QP	40.0	-3.0	1.00 V	10	22.30	14.70
2	99.89	33.9 QP	43.5	-9.6	1.25 V	232	22.70	11.20
3	360.43	42.0 QP	46.0	-4.0	1.50 V	49	24.70	17.30
4	601.52	42.0 QP	46.0	-4.0	1.00 V	250	18.30	23.70
5	626.80	42.6 QP	46.0	-3.4	1.00 V	253	18.60	24.00
6	877.61	41.7 QP	46.0	-4.3	1.00 V	163	13.30	28.40

- REMARKS:**
1. Emission level (dBuV/m) = Raw Value (dBuV) + Correction Factor (dB/m).
 2. Correction Factor (dB/m) = Antenna Factor (dB/m) + Cable Factor (dB).
 3. The other emission levels were very low against the limit.
 4. Margin value = Emission level – Limit value.

4.2 CONDUCTED EMISSION MEASUREMENT

4.2.1 LIMITS OF CONDUCTED EMISSION MEASUREMENT

FREQUENCY OF EMISSION (MHz)	CONDUCTED LIMIT (dB μ V)	
	Quasi-peak	Average
0.15 ~ 0.5	66 to 56	56 to 46
0.5 ~ 5	56	46
5 ~ 30	60	50

- NOTE:** 1. The lower limit shall apply at the transition frequencies.
2. The limit decreases in line with the logarithm of the frequency in the range of 0.15 to 0.50MHz.
3. All emanations from a class A/B digital device or system, including any network of conductors and apparatus connected thereto, shall not exceed the level of field strengths specified above.

4.2.2 TEST INSTRUMENTS

DESCRIPTION & MANUFACTURER	MODEL NO.	SERIAL NO.	DATE OF CALIBRATION	DUE DATE OF CALIBRATION
Test Receiver ROHDE & SCHWARZ	ESCS30	100288	Oct. 04, 2011	Oct. 03, 2012
RF signal cable Woken	5D-FB	Cable-C02.01	Jan. 08, 2011	Jan. 07, 2012
LISN ROHDE & SCHWARZ	ESH2-Z5	100100	Jan. 06, 2011	Jan. 05, 2012
LISN ROHDE & SCHWARZ	ESH3-Z5	100312	Jul. 07, 2011	Jul. 06, 2012
V-LISN SCHWARZBECK	NNBL 8226-2	8226-142	Jun. 30, 2011	Jun. 29, 2012
LISN ROHDE & SCHWARZ	ENV216	100072	Jun. 10, 2011	Jun. 09, 2012
Software ADT	ADT_Cond_ V7.3.7	NA	NA	NA

- NOTE:** 1. The calibration interval of the above test instruments is 12 months and the calibrations are traceable to NML/ROC and NIST/USA.
2. The test was performed in HwaYa Shielded Room 2.
3. The VCCI Site Registration No. is C-2047.

4.2.3 TEST PROCEDURES

- a. The EUT was placed 0.4 meters from the conducting wall of the shielded room with EUT being connected to the power mains through a line impedance stabilization network (LISN). Other support units were connected to the power mains through another LISN. The two LISNs provide 50 ohm/ 50uH of coupling impedance for the measuring instrument.
- b. Both lines of the power mains connected to the EUT were checked for maximum conducted interference.
- c. The frequency range from 150kHz to 30MHz was searched. Emission levels under (Limit - 20dB) was not recorded.

NOTE: All modes of operation were investigated and the worst-case emissions are reported.

4.2.4 DEVIATION FROM TEST STANDARD

No deviation.

4.2.5 TEST SETUP

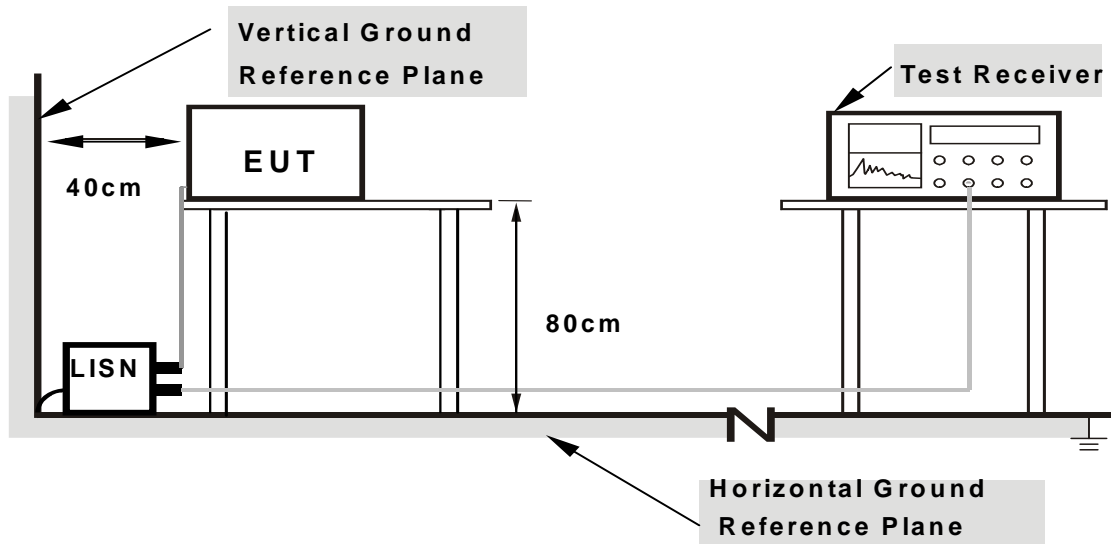

- Note:**
1. Support units were connected to second LISN.
 2. Both of LISNs (AMN) are 80 cm from EUT and at least 80 cm from other units and other metal planes

For the actual test configuration, please refer to the attached file (Test Setup Photo).

4.2.6 EUT OPERATING CONDITIONS

Same as 4.1.6.

4.2.7 TEST RESULTS

CONDUCTED WORST-CASE DATA : 802.11g

PHASE	Line 1	6dB BANDWIDTH	9kHz
TEST MODE	A1		

No	Freq. [MHz]	Corr. Factor (dB)	Reading Value [dB (uV)]		Emission Level [dB (uV)]		Limit [dB (uV)]		Margin (dB)	
			Q.P.	AV.	Q.P.	AV.	Q.P.	AV.	Q.P.	AV.
1	0.380	0.20	52.22	45.57	52.42	45.77	58.27	48.27	-5.85	-2.50
2	0.662	0.21	41.78	-	41.99	-	56.00	46.00	-14.01	-
3	0.939	0.23	42.37	-	42.60	-	56.00	46.00	-13.40	-
4	1.230	0.24	42.16	-	42.40	-	56.00	46.00	-13.60	-
5	1.508	0.25	41.60	-	41.85	-	56.00	46.00	-14.15	-
6	2.285	0.28	41.22	-	41.50	-	56.00	46.00	-14.50	-

- REMARKS:**
1. Q.P. and AV. are abbreviations of quasi-peak and average individually.
 2. "-": The Quasi-peak reading value also meets average limit and measurement with the average detector is unnecessary.
 3. The emission levels of other frequencies were very low against the limit.
 4. Margin value = Emission level - Limit value
 5. Correction factor = Insertion loss + Cable loss
 6. Emission Level = Correction Factor + Reading Value.

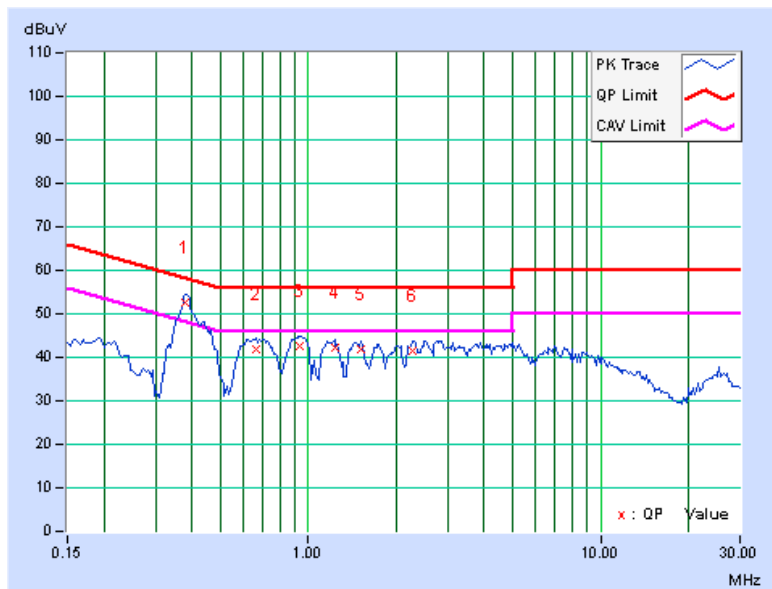

PHASE	Line 2	6dB BANDWIDTH	9kHz
TEST MODE	A1		

No	Freq. [MHz]	Corr. Factor (dB)	Reading Value [dB (uV)]		Emission Level [dB (uV)]		Limit [dB (uV)]		Margin (dB)	
			Q.P.	AV.	Q.P.	AV.	Q.P.	AV.	Q.P.	AV.
1	0.388	0.21	46.15	-	46.36	-	58.10	48.10	-11.74	-
2	0.627	0.21	36.04	-	36.25	-	56.00	46.00	-19.75	-
3	0.943	0.21	36.77	-	36.98	-	56.00	46.00	-19.02	-
4	2.531	0.27	35.95	-	36.22	-	56.00	46.00	-19.78	-
5	3.668	0.33	34.92	-	35.25	-	56.00	46.00	-20.75	-
6	5.219	0.40	34.32	-	34.72	-	60.00	50.00	-25.28	-

- REMARKS:**
1. Q.P. and AV. are abbreviations of quasi-peak and average individually.
 2. "-": The Quasi-peak reading value also meets average limit and measurement with the average detector is unnecessary.
 3. The emission levels of other frequencies were very low against the limit.
 4. Margin value = Emission level - Limit value
 5. Correction factor = Insertion loss + Cable loss
 6. Emission Level = Correction Factor + Reading Value.

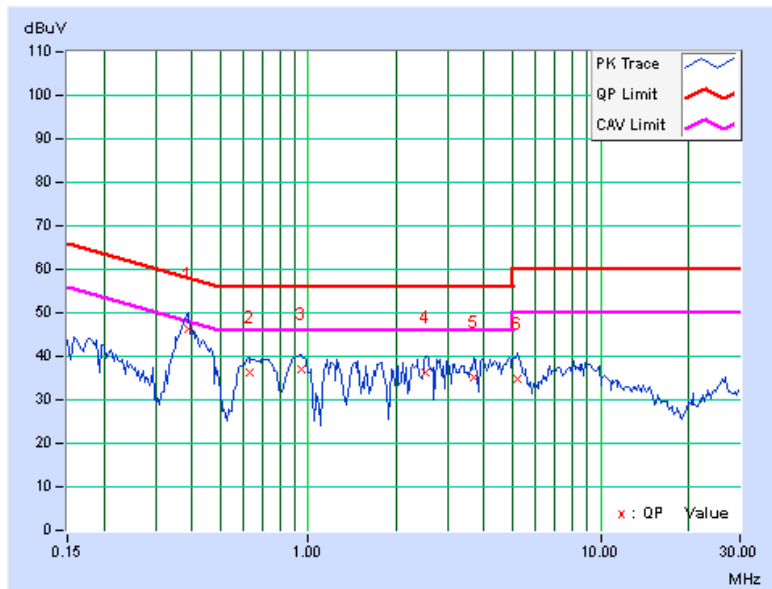

PHASE	Line 1	6dB BANDWIDTH	9kHz
TEST MODE	A2		

No	Freq. [MHz]	Corr. Factor (dB)	Reading Value [dB (uV)]		Emission Level [dB (uV)]		Limit [dB (uV)]		Margin (dB)	
			Q.P.	AV.	Q.P.	AV.	Q.P.	AV.	Q.P.	AV.
1	0.173	0.17	58.46	46.97	58.63	47.14	64.79	54.79	-6.17	-7.66
2	0.205	0.17	54.18	41.86	54.35	42.03	63.42	53.42	-9.07	-11.39
3	0.509	0.21	50.33	42.58	50.54	42.79	56.00	46.00	-5.46	-3.21
4	1.410	0.24	44.83	-	45.07	-	56.00	46.00	-10.93	-
5	1.770	0.25	44.66	-	44.91	-	56.00	46.00	-11.09	-
6	2.227	0.27	45.24	-	45.51	-	56.00	46.00	-10.49	-
7	2.594	0.29	44.34	-	44.63	-	56.00	46.00	-11.37	-
8	3.863	0.36	43.32	-	43.68	-	56.00	46.00	-12.32	-

- REMARKS:**
1. Q.P. and AV. are abbreviations of quasi-peak and average individually.
 2. "-": The Quasi-peak reading value also meets average limit and measurement with the average detector is unnecessary.
 3. The emission levels of other frequencies were very low against the limit.
 4. Margin value = Emission level - Limit value
 5. Correction factor = Insertion loss + Cable loss
 6. Emission Level = Correction Factor + Reading Value.

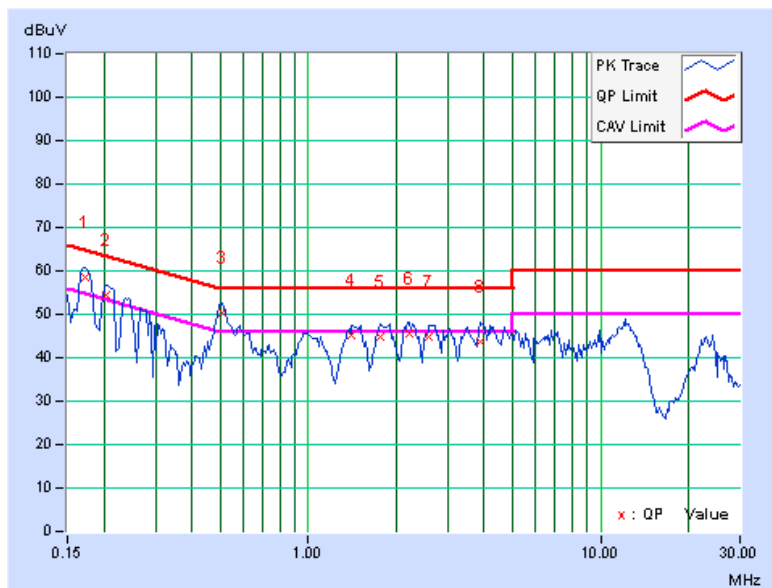

PHASE	Line 2	6dB BANDWIDTH	9kHz
TEST MODE	A2		

No	Freq. [MHz]	Corr. Factor (dB)	Reading Value		Emission Level		Limit		Margin	
			[dB (uV)]		[dB (uV)]		[dB (uV)]		(dB)	
			Q.P.	AV.	Q.P.	AV.	Q.P.	AV.	Q.P.	AV.
1	0.170	0.19	58.46	45.02	58.65	45.21	64.98	54.98	-6.33	-9.77
2	0.209	0.18	53.45	41.22	53.63	41.40	63.26	53.26	-9.63	-11.86
3	0.502	0.21	48.86	38.66	49.07	38.87	56.00	46.00	-6.93	-7.13
4	1.887	0.24	45.82	38.83	46.06	39.07	56.00	46.00	-9.94	-6.93
5	2.160	0.25	45.37	-	45.62	-	56.00	46.00	-10.38	-
6	2.684	0.28	45.92	39.57	46.20	39.85	56.00	46.00	-9.80	-6.15
7	3.988	0.35	45.14	-	45.49	-	56.00	46.00	-10.51	-
8	4.715	0.38	44.73	-	45.11	-	56.00	46.00	-10.89	-
9	12.086	0.69	51.04	45.99	51.73	46.68	60.00	50.00	-8.27	-3.32

- REMARKS:**
1. Q.P. and AV. are abbreviations of quasi-peak and average individually.
 2. "-": The Quasi-peak reading value also meets average limit and measurement with the average detector is unnecessary.
 3. The emission levels of other frequencies were very low against the limit.
 4. Margin value = Emission level - Limit value
 5. Correction factor = Insertion loss + Cable loss
 6. Emission Level = Correction Factor + Reading Value.

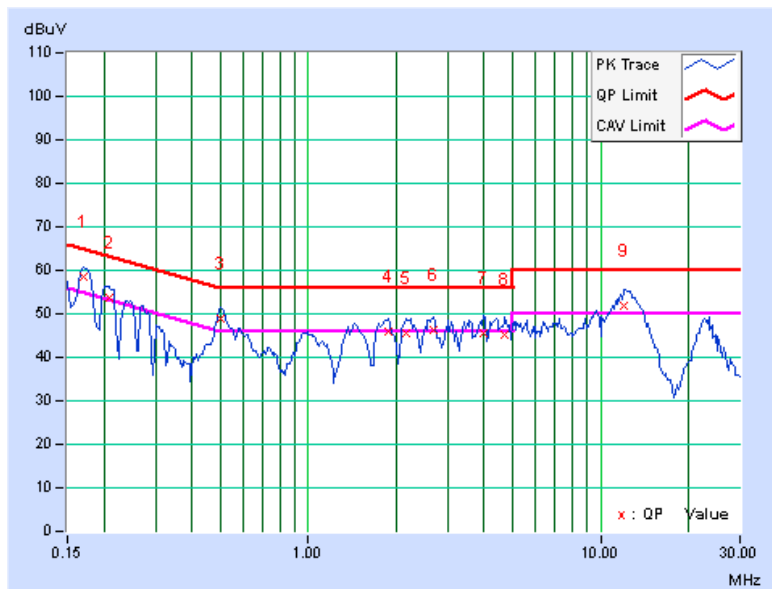

PHASE	Line 1	6dB BANDWIDTH	9kHz
TEST MODE	B1		

No	Freq. [MHz]	Corr. Factor (dB)	Reading Value [dB (uV)]		Emission Level [dB (uV)]		Limit [dB (uV)]		Margin (dB)	
			Q.P.	AV.	Q.P.	AV.	Q.P.	AV.	Q.P.	AV.
1	0.166	0.15	42.32	-	42.47	-	65.18	55.18	-22.71	-
2	0.392	0.17	42.30	-	42.47	-	58.02	48.02	-15.55	-
3	0.791	0.18	35.32	-	35.50	-	56.00	46.00	-20.50	-
4	1.496	0.20	32.91	-	33.11	-	56.00	46.00	-22.89	-
5	3.109	0.28	31.84	-	32.12	-	56.00	46.00	-23.88	-
6	7.914	0.48	26.85	-	27.33	-	60.00	50.00	-32.67	-

- REMARKS:**
1. Q.P. and AV. are abbreviations of quasi-peak and average individually.
 2. "-": The Quasi-peak reading value also meets average limit and measurement with the average detector is unnecessary.
 3. The emission levels of other frequencies were very low against the limit.
 4. Margin value = Emission level - Limit value
 5. Correction factor = Insertion loss + Cable loss
 6. Emission Level = Correction Factor + Reading Value.

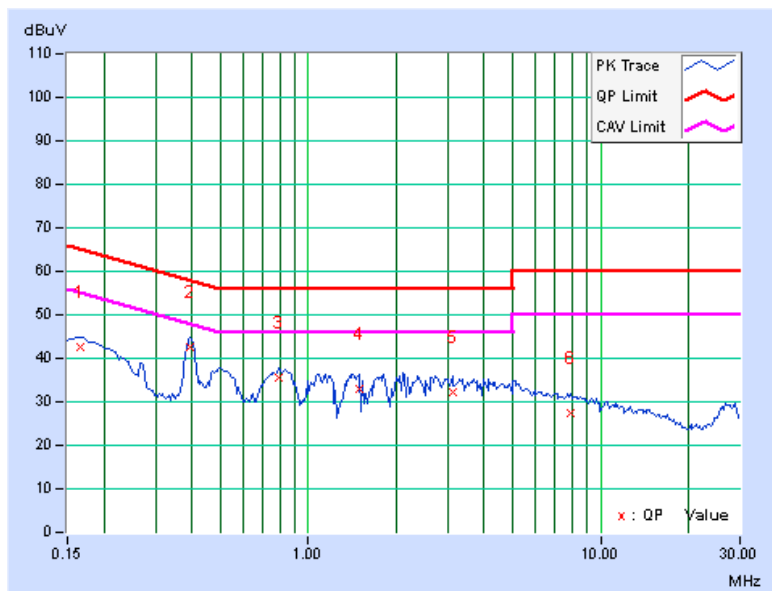

PHASE	Line 2	6dB BANDWIDTH	9kHz
TEST MODE	B1		

No	Freq. [MHz]	Corr. Factor (dB)	Reading Value [dB (uV)]		Emission Level [dB (uV)]		Limit [dB (uV)]		Margin (dB)	
			Q.P.	AV.	Q.P.	AV.	Q.P.	AV.	Q.P.	AV.
1	0.232	0.17	39.44	-	39.61	-	62.38	52.38	-22.76	-
2	0.396	0.19	50.13	42.80	50.32	42.99	57.93	47.93	-7.62	-4.95
3	0.517	0.19	40.19	-	40.38	-	56.00	46.00	-15.62	-
4	0.779	0.20	39.20	-	39.40	-	56.00	46.00	-16.60	-
5	2.090	0.23	37.67	-	37.90	-	56.00	46.00	-18.10	-
6	4.125	0.32	34.98	-	35.30	-	56.00	46.00	-20.70	-

- REMARKS:**
1. Q.P. and AV. are abbreviations of quasi-peak and average individually.
 2. "-": The Quasi-peak reading value also meets average limit and measurement with the average detector is unnecessary.
 3. The emission levels of other frequencies were very low against the limit.
 4. Margin value = Emission level - Limit value
 5. Correction factor = Insertion loss + Cable loss
 6. Emission Level = Correction Factor + Reading Value.

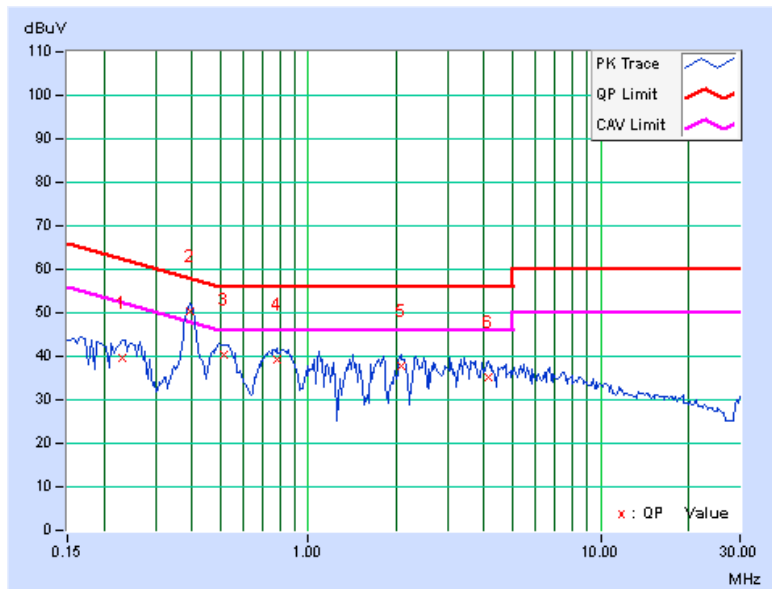

PHASE	Line 1	6dB BANDWIDTH	9kHz
TEST MODE	B2		

No	Freq. [MHz]	Corr. Factor (dB)	Reading Value		Emission Level		Limit		Margin	
			[dB (uV)]		[dB (uV)]		[dB (uV)]		(dB)	
			Q.P.	AV.	Q.P.	AV.	Q.P.	AV.	Q.P.	AV.
1	0.162	0.15	58.13	43.08	58.28	43.23	65.38	55.38	-7.10	-12.15
2	0.205	0.15	53.11	-	53.26	-	63.42	53.42	-10.16	-
3	0.517	0.17	48.75	40.23	48.92	40.40	56.00	46.00	-7.08	-5.60
4	2.801	0.26	44.85	-	45.11	-	56.00	46.00	-10.89	-
5	4.465	0.34	42.84	-	43.18	-	56.00	46.00	-12.82	-
6	12.477	0.71	51.49	46.69	52.20	47.40	60.00	50.00	-7.80	-2.60

- REMARKS:**
1. Q.P. and AV. are abbreviations of quasi-peak and average individually.
 2. "-": The Quasi-peak reading value also meets average limit and measurement with the average detector is unnecessary.
 3. The emission levels of other frequencies were very low against the limit.
 4. Margin value = Emission level - Limit value
 5. Correction factor = Insertion loss + Cable loss
 6. Emission Level = Correction Factor + Reading Value.

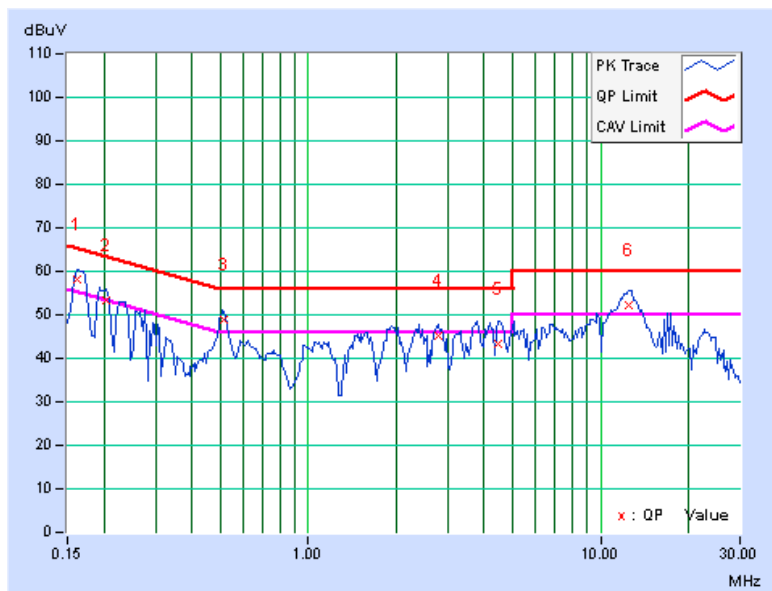

PHASE	Line 2	6dB BANDWIDTH	9kHz
TEST MODE	B2		

No	Freq. [MHz]	Corr. Factor (dB)	Reading Value		Emission Level		Limit		Margin	
			[dB (uV)]		[dB (uV)]		[dB (uV)]		(dB)	
			Q.P.	AV.	Q.P.	AV.	Q.P.	AV.	Q.P.	AV.
1	0.165	0.16	58.06	45.99	58.22	46.15	65.22	55.22	-7.00	-9.07
2	0.205	0.17	52.73	-	52.90	-	63.42	53.42	-10.52	-
3	0.505	0.19	50.35	42.51	50.54	42.70	56.00	46.00	-5.46	-3.30
4	2.371	0.25	44.63	-	44.88	-	56.00	46.00	-11.12	-
5	4.238	0.33	42.56	-	42.89	-	56.00	46.00	-13.11	-
6	11.824	0.58	44.71	-	45.29	-	60.00	50.00	-14.71	-

- REMARKS:**
1. Q.P. and AV. are abbreviations of quasi-peak and average individually.
 2. "-": The Quasi-peak reading value also meets average limit and measurement with the average detector is unnecessary.
 3. The emission levels of other frequencies were very low against the limit.
 4. Margin value = Emission level - Limit value
 5. Correction factor = Insertion loss + Cable loss
 6. Emission Level = Correction Factor + Reading Value.

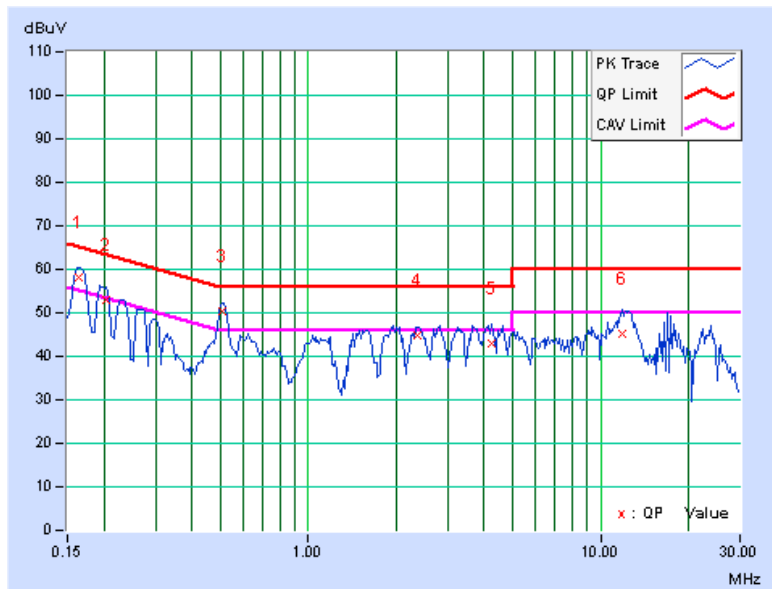

4.3 6dB BANDWIDTH MEASUREMENT

4.3.1 LIMITS OF 6dB BANDWIDTH MEASUREMENT

The minimum of 6dB Bandwidth Measurement is 0.5 MHz.

4.3.2 TEST SETUP

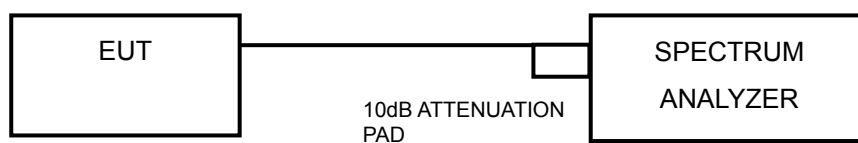

4.3.3 TEST INSTRUMENTS

Refer to section 4.1.2 to get information of above instrument.

4.3.4 TEST PROCEDURE

1. Set resolution bandwidth (RBW) = approximately 1% of the emission bandwidth
2. Set the video bandwidth (VBW) $\geq 3 \times$ RBW, Detector = Peak.
3. Trace mode = max hold.
4. Sweep = auto couple.
5. Measure the maximum width of the emission that is constrained by the frequencies associated with the two amplitude points (upper and lower) that are attenuated by 6 dB relative to the maximum level measured in the fundamental emission

4.3.5 DEVIATION FROM TEST STANDARD

No deviation.

4.3.6 EUT OPERATING CONDITIONS

The software provided by client to enable the EUT under transmission condition continuously at lowest, middle and highest channel frequencies individually.

4.3.7 TEST RESULTS

TEST MODE A1

802.11b

CHANNEL	FREQUENCY (MHz)	6dB BANDWIDTH (MHz)		MINIMUM LIMIT (MHz)	PASS / FAIL
		CHAIN 0	CHAIN 1		
1	2412	10.27	10.29	0.5	PASS
6	2437	10.25	10.27	0.5	PASS
11	2462	10.31	10.29	0.5	PASS

802.11g

CHANNEL	FREQUENCY (MHz)	6dB BANDWIDTH (MHz)		MINIMUM LIMIT (MHz)	PASS / FAIL
		CHAIN 0	CHAIN 1		
1	2412	16.59	16.54	0.5	PASS
6	2437	16.51	16.58	0.5	PASS
11	2462	16.48	16.59	0.5	PASS

802.11n (20MHz)

CHANNEL	FREQUENCY (MHz)	6dB BANDWIDTH (MHz)		MINIMUM LIMIT (MHz)	PASS / FAIL
		CHAIN 0	CHAIN 1		
1	2412	17.72	17.80	0.5	PASS
6	2437	17.84	17.82	0.5	PASS
11	2462	17.75	17.72	0.5	PASS

802.11n (40MHz)

CHANNEL	FREQUENCY (MHz)	6dB BANDWIDTH (MHz)		MINIMUM LIMIT (MHz)	PASS / FAIL
		CHAIN 0	CHAIN 1		
1	2422	37.41	36.99	0.5	PASS
4	2437	37.38	37.09	0.5	PASS
7	2452	37.43	37.34	0.5	PASS

TEST MODE B1

802.11b

CHANNEL	FREQUENCY (MHz)	6dB BANDWIDTH (MHz)		MINIMUM LIMIT (MHz)	PASS / FAIL
		CHAIN 0	CHAIN 1		
1	2412	10.29	10.29	0.5	PASS
6	2437	10.27	10.27	0.5	PASS
11	2462	10.30	10.30	0.5	PASS

802.11g

CHANNEL	FREQUENCY (MHz)	6dB BANDWIDTH (MHz)		MINIMUM LIMIT (MHz)	PASS / FAIL
		CHAIN 0	CHAIN 1		
1	2412	16.54	16.59	0.5	PASS
6	2437	16.57	16.55	0.5	PASS
11	2462	16.47	16.54	0.5	PASS

802.11n (20MHz)

CHANNEL	FREQUENCY (MHz)	6dB BANDWIDTH (MHz)		MINIMUM LIMIT (MHz)	PASS / FAIL
		CHAIN 0	CHAIN 1		
1	2412	17.77	17.83	0.5	PASS
6	2437	17.69	17.80	0.5	PASS
11	2462	17.77	17.86	0.5	PASS

802.11n (40MHz)

CHANNEL	FREQUENCY (MHz)	6dB BANDWIDTH (MHz)		MINIMUM LIMIT (MHz)	PASS / FAIL
		CHAIN 0	CHAIN 1		
1	2422	37.45	37.05	0.5	PASS
4	2437	36.92	37.02	0.5	PASS
7	2452	37.01	36.87	0.5	PASS

4.4 CONDUCTED OUTPUT POWER

4.4.1 LIMITS OF CONDUCTED OUTPUT POWER MEASUREMENT

For systems using digital modulation in the 2400–2483.5 MHz: 1 Watt (30dBm)

4.4.2 TEST SETUP

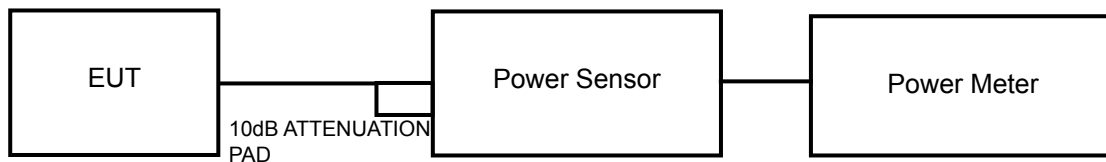

4.4.3 TEST INSTRUMENTS

Refer to section 4.1.2 to get information of above instrument.

4.4.4 TEST PROCEDURES

A power sensor was used on the output port of the EUT. A power meter was used to read the response of the power sensor. Record the power level.

4.4.5 DEVIATION FROM TEST STANDARD

No deviation.

4.4.6 EUT OPERATING CONDITIONS

Same as Item 4.3.6.

4.4.7 TEST RESULTS

TEST MODE A1

802.11b

CHAN.	FREQUENCY (MHz)	PEAK POWER (dBm)		TOTAL POWER (mW)	TOTAL POWER (dBm)	LIMIT (dBm)	PASS / FAIL
		CHAIN 0	CHAIN 1				
1	2412	16.50	16.70	91.4	19.6	30	PASS
6	2437	15.30	15.40	68.6	18.4	30	PASS
11	2462	13.60	14.10	48.6	16.9	30	PASS

NOTE: Directional gain = 3dBi + 10log(2)=6dBi, so the limit is not reduced.

802.11g

CHAN.	FREQUENCY (MHz)	PEAK POWER (dBm)		TOTAL POWER (mW)	TOTAL POWER (dBm)	LIMIT (dBm)	PASS / FAIL
		CHAIN 0	CHAIN 1				
1	2412	24.80	25.00	618.2	27.9	30	PASS
6	2437	25.20	25.40	677.9	28.3	30	PASS
11	2462	23.90	24.10	502.5	27.0	30	PASS

NOTE: Directional gain = 3dBi + 10log(2)=6dBi, so the limit is not reduced.

802.11n (20MHz)

CHAN.	FREQUENCY (MHz)	PEAK POWER (dBm)		TOTAL POWER (mW)	TOTAL POWER (dBm)	LIMIT (dBm)	PASS / FAIL
		CHAIN 0	CHAIN 1				
1	2412	24.50	24.80	583.8	27.7	30	PASS
6	2437	25.10	25.20	654.7	28.2	30	PASS
11	2462	23.40	23.60	447.9	26.5	30	PASS

802.11n (40MHz)

CHAN.	FREQUENCY (MHz)	PEAK POWER (dBm)		TOTAL POWER (mW)	TOTAL POWER (dBm)	LIMIT (dBm)	PASS / FAIL
		CHAIN 0	CHAIN 1				
1	2422	23.50	23.60	453.0	26.6	30	PASS
4	2437	24.50	24.70	577.0	27.6	30	PASS
7	2452	22.40	22.60	355.8	25.5	30	PASS

TEST MODE B1

802.11b

CHAN.	FREQUENCY (MHz)	PEAK POWER (dBm)		TOTAL POWER (mW)	TOTAL POWER (dBm)	LIMIT (dBm)	PASS / FAIL
		CHAIN 0	CHAIN 1				
1	2412	16.04	15.67	77.1	18.9	30	PASS
6	2437	19.69	21.20	224.9	23.5	30	PASS
11	2462	20.61	21.68	262.3	24.2	30	PASS

NOTE: Directional gain = 3dBi + 10log(2)=6dBi, so the limit is not reduced.

802.11g

CHAN.	FREQUENCY (MHz)	PEAK POWER (dBm)		TOTAL POWER (mW)	TOTAL POWER (dBm)	LIMIT (dBm)	PASS / FAIL
		CHAIN 0	CHAIN 1				
1	2412	25.91	25.86	775.4	28.9	30	PASS
6	2437	26.60	26.61	915.2	29.6	30	PASS
11	2462	24.28	25.43	617.1	27.9	30	PASS

NOTE: Directional gain = 3dBi + 10log(2)=6dBi, so the limit is not reduced.

802.11n (20MHz)

CHAN.	FREQUENCY (MHz)	PEAK POWER (dBm)		TOTAL POWER (mW)	TOTAL POWER (dBm)	LIMIT (dBm)	PASS / FAIL
		CHAIN 0	CHAIN 1				
1	2412	25.84	25.52	740.2	28.7	30	PASS
6	2437	26.52	26.68	914.3	29.6	30	PASS
11	2462	25.24	25.24	668.4	28.3	30	PASS

802.11n (40MHz)

CHAN.	FREQUENCY (MHz)	PEAK POWER (dBm)		TOTAL POWER (mW)	TOTAL POWER (dBm)	LIMIT (dBm)	PASS / FAIL
		CHAIN 0	CHAIN 1				
1	2422	25.12	25.21	657.0	28.2	30	PASS
4	2437	25.63	25.52	722.0	28.6	30	PASS
7	2452	22.64	22.67	368.6	25.7	30	PASS

4.5 POWER SPECTRAL DENSITY MEASUREMENT

4.5.1 LIMITS OF POWER SPECTRAL DENSITY MEASUREMENT

The Maximum of Power Spectral Density Measurement is 8dBm.

4.5.2 TEST SETUP

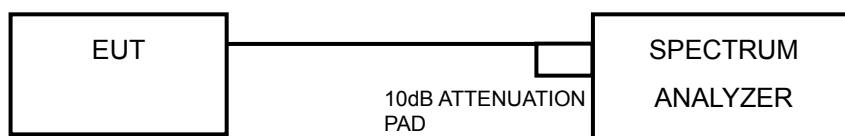

4.5.3 TEST INSTRUMENTS

Refer to section 4.1.2 to get information of above instrument.

4.5.4 TEST PROCEDURE

1. Set the RBW = 100 kHz, VBW = 300 kHz, Detector = peak.
2. Sweep time = auto couple, Trace mode = max hold, allow trace to fully stabilize.
3. Use the peak marker function to determine the maximum power level in any 100 kHz band segment within the fundamental EBW.
4. Scale the observed power level to an equivalent value in 3 kHz by adjusting (reducing) the measured power by a bandwidth correction factor (BWCF) where $BWCF = 10\log(3 \text{ kHz}/100\text{kHz})$

4.5.5 DEVIATION FROM TEST STANDARD

No deviation.

4.5.6 EUT OPERATING CONDITION

Same as Item 4.3.6

4.5.7 TEST RESULTS

TEST MODE A1

802.11b

TX chain	Channel	FREQ. (MHz)	PSD (dBm/100kHz)	PSD (dBm/3kHz)	10 log (N=2) dB	Total PSD (dBm/3kHz)	Limit (dBm/3kHz)	PASS /FAIL
0	1	2412	3.98	-11.25	3.01	-8.24	8	PASS
	6	2437	2.95	-12.28	3.01	-9.27	8	PASS
	11	2462	1.01	-14.22	3.01	-11.21	8	PASS
1	1	2412	3.97	-11.26	3.01	-8.25	8	PASS
	6	2437	2.72	-12.51	3.01	-9.50	8	PASS
	11	2462	1.13	-14.10	3.01	-11.09	8	PASS

NOTE: Directional gain =5dBi + 10log(2)=6dBi, so the limit is not reduced.

802.11g

TX chain	Channel	FREQ. (MHz)	PSD (dBm/100kHz)	PSD (dBm/3kHz)	10 log (N=2) dB	Total PSD (dBm/3kHz)	Limit (dBm/3kHz)	PASS /FAIL
0	1	2412	2.94	-12.29	3.01	-9.28	8	PASS
	6	2437	3.50	-11.73	3.01	-8.72	8	PASS
	11	2462	2.26	-12.97	3.01	-9.96	8	PASS
1	1	2412	4.17	-11.06	3.01	-8.05	8	PASS
	6	2437	4.47	-10.76	3.01	-7.75	8	PASS
	11	2462	3.22	-12.01	3.01	-9.00	8	PASS

NOTE: Directional gain =5dBi + 10log(2)=6dBi, so the limit is not reduced.

802.11n (20MHz)

TX chain	Channel	FREQ. (MHz)	PSD (dBm/100kHz)	PSD (dBm/3kHz)	10 log (N=2) dB	Total PSD (dBm/3kHz)	Limit (dBm/3kHz)	PASS /FAIL
0	1	2412	2.76	-12.47	3.01	-9.46	8	PASS
	6	2437	3.17	-12.06	3.01	-9.05	8	PASS
	11	2462	1.90	-13.33	3.01	-10.32	8	PASS
1	1	2412	5.34	-9.89	3.01	-6.88	8	PASS
	6	2437	5.76	-9.47	3.01	-6.46	8	PASS
	11	2462	4.00	-11.23	3.01	-8.22	8	PASS

802.11n (40MHz)

TX chain	Channel	FREQ. (MHz)	PSD (dBm/100kHz)	PSD (dBm/3kHz)	10 log (N=2) dB	Total PSD (dBm/3kHz)	Limit (dBm/3kHz)	PASS /FAIL
0	1	2422	-2.50	-17.73	3.01	-14.72	8	PASS
	4	2437	-1.67	-16.90	3.01	-13.89	8	PASS
	7	2452	-3.45	-18.68	3.01	-15.67	8	PASS
1	1	2422	-1.70	-16.93	3.01	-13.92	8	PASS
	4	2437	-0.82	-16.05	3.01	-13.04	8	PASS
	7	2452	-2.77	-18.00	3.01	-14.99	8	PASS

TEST MODE B1

802.11b

TX chain	Channel	FREQ. (MHz)	PSD (dBm/100kHz)	PSD (dBm/3kHz)	10 log (N=2) dB	Total PSD (dBm/3kHz)	Limit (dBm/3kHz)	PASS /FAIL
0	1	2412	3.69	-11.54	3.01	-8.53	8	PASS
	6	2437	7.30	-7.93	3.01	-4.92	8	PASS
	11	2462	8.23	-7.00	3.01	-3.99	8	PASS
1	1	2412	3.15	-12.08	3.01	-9.07	8	PASS
	6	2437	8.86	-6.37	3.01	-3.36	8	PASS
	11	2462	9.10	-6.13	3.01	-3.12	8	PASS

NOTE: Directional gain =5dBi + 10log(2)=6dBi, so the limit is not reduced.

802.11g

TX chain	Channel	FREQ. (MHz)	PSD (dBm/100kHz)	PSD (dBm/3kHz)	10 log (N=2) dB	Total PSD (dBm/3kHz)	Limit (dBm/3kHz)	PASS /FAIL
0	1	2412	2.97	-12.26	3.01	-9.25	8	PASS
	6	2437	3.89	-11.34	3.01	-8.33	8	PASS
	11	2462	1.53	-13.70	3.01	-10.69	8	PASS
1	1	2412	2.18	-13.05	3.01	-10.04	8	PASS
	6	2437	3.14	-12.09	3.01	-9.08	8	PASS
	11	2462	1.96	-13.27	3.01	-10.26	8	PASS

NOTE: Directional gain =5dBi + 10log(2)=6dBi, so the limit is not reduced.

802.11n (20MHz)

TX chain	Channel	FREQ. (MHz)	PSD (dBm/100kHz)	PSD (dBm/3kHz)	10 log (N=2) dB	Total PSD (dBm/3kHz)	Limit (dBm/3kHz)	PASS /FAIL
0	1	2412	2.87	-12.36	3.01	-9.35	8	PASS
	6	2437	3.45	-11.78	3.01	-8.77	8	PASS
	11	2462	2.51	-12.72	3.01	-9.71	8	PASS
1	1	2412	2.33	-12.90	3.01	-9.89	8	PASS
	6	2437	3.27	-11.96	3.01	-8.95	8	PASS
	11	2462	1.85	-13.38	3.01	-10.37	8	PASS

802.11n (40MHz)

TX chain	Channel	FREQ. (MHz)	PSD (dBm/100kHz)	PSD (dBm/3kHz)	10 log (N=2) dB	Total PSD (dBm/3kHz)	Limit (dBm/3kHz)	PASS /FAIL
0	1	2422	-1.51	-16.74	3.01	-13.73	8	PASS
	4	2437	-1.15	-16.38	3.01	-13.37	8	PASS
	7	2452	-3.88	-19.11	3.01	-16.10	8	PASS
1	1	2422	-3.02	-18.25	3.01	-15.24	8	PASS
	4	2437	-2.59	-17.82	3.01	-14.81	8	PASS
	7	2452	-5.46	-20.69	3.01	-17.68	8	PASS

4.6 CONDUCTED EMISSION MEASUREMENT

4.6.1 LIMITS OF BAND EDGES MEASUREMENT

Below -20dB of the highest emission level of operating band (in 100kHz Resolution Bandwidth).

4.6.2 TEST SETUP

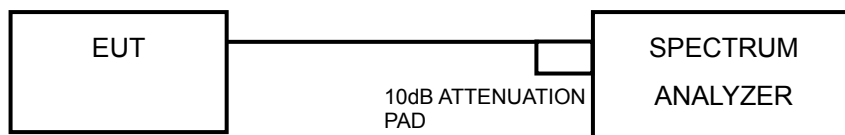

4.6.3 TEST INSTRUMENTS

Refer to section 4.1.2 to get information of above instrument.

4.6.4 TEST PROCEDURE

MEASUREMENT PROCEDURE REF

1. Set the RBW = 100 kHz .
2. Set the VBW $\geq 300\text{ kHz}$.
3. Detector = peak.
4. Sweep time = auto couple.
5. Trace mode = max hold.
6. Allow trace to fully stabilize.
7. Use the peak marker function to determine the maximum power level in any 100 kHz band segment within the fundamental EBW.



MEASUREMENT PROCEDURE OOB

1. Set RBW = 100 kHz.
2. Set VBW \geq 300 kHz.
3. Set span to encompass the spectrum to be examined.
4. Detector = peak.
5. Trace Mode = max hold.
6. Sweep = auto couple.

4.6.5 DEVIATION FROM TEST STANDARD

No deviation.

4.6.6 EUT OPERATING CONDITION

Same as Item 4.3.6

4.6.7 TEST RESULTS

The conducted emission test is performed on each TX port of operating mode without summing or adding $10\log(N)$ since the limit is relative emission limit. Only worst data of each operating mode is presented.

The spectrum plots are attached on the following pages. D1 line indicates the highest level, and D2 line indicates the 20dB offset below D1. It shows compliance with the requirement in part 15.247(d).



A D T

TEST MODE A1

802.11b

CH 1

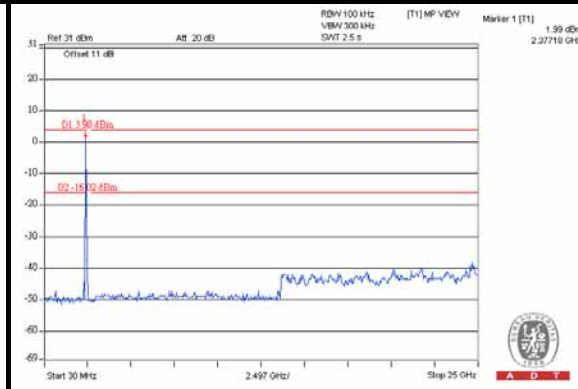
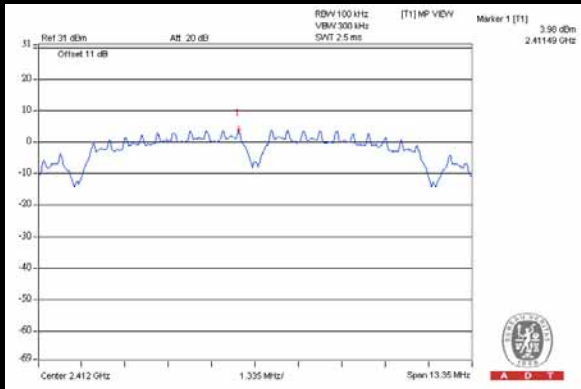

CH 6

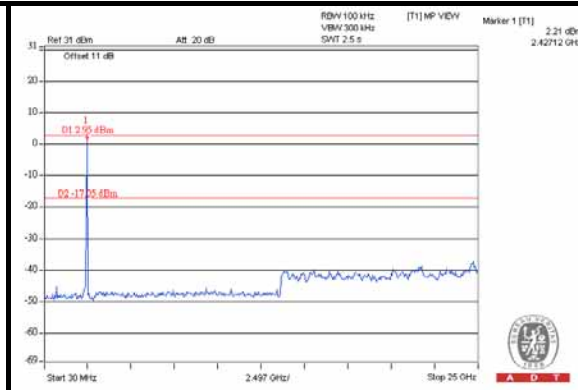
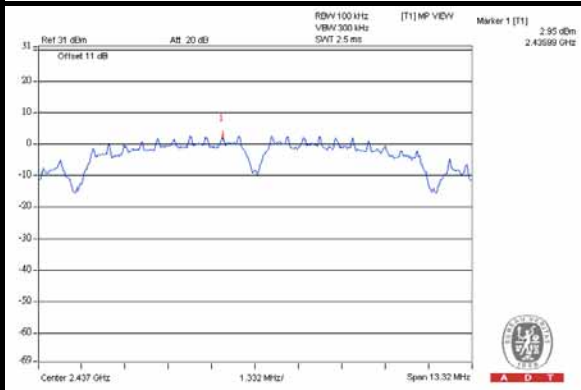

CH 11

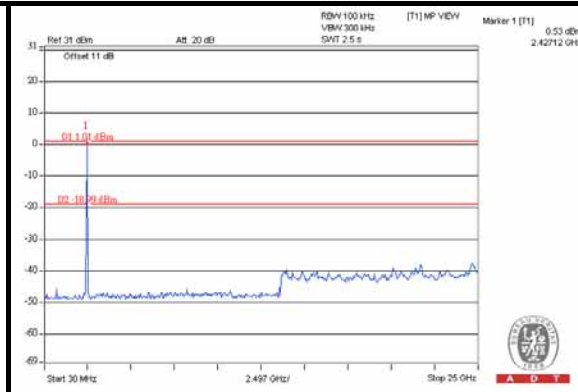
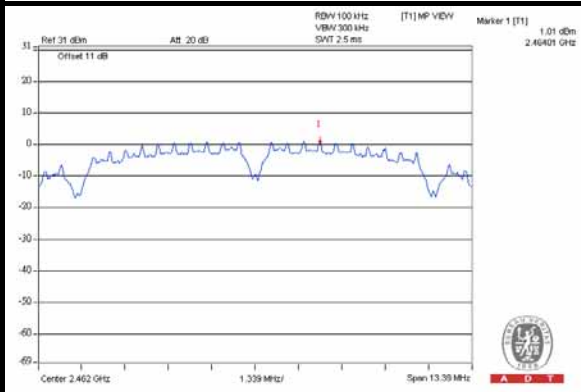

802.11g

CH 1

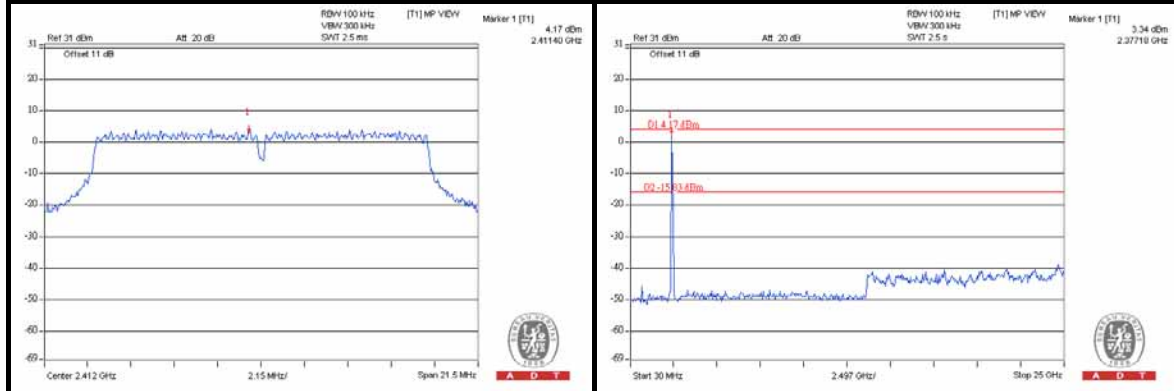

CH 6

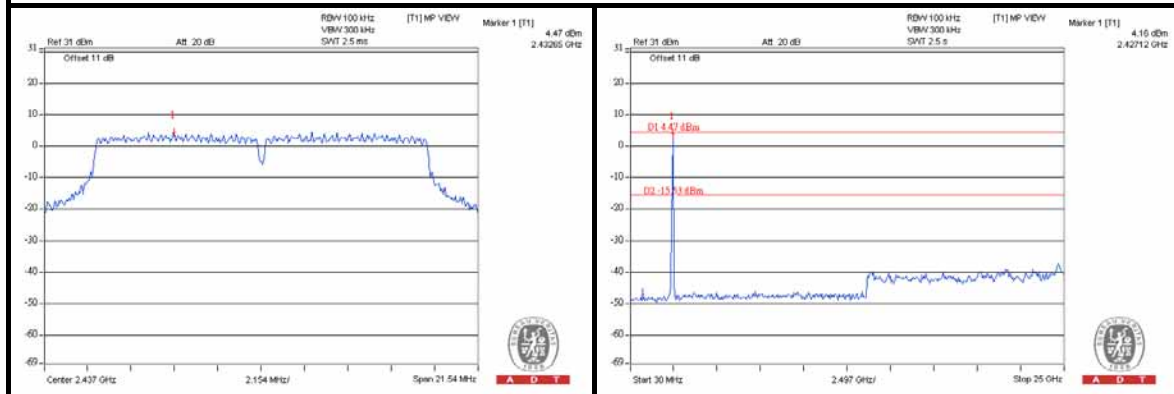

CH 11

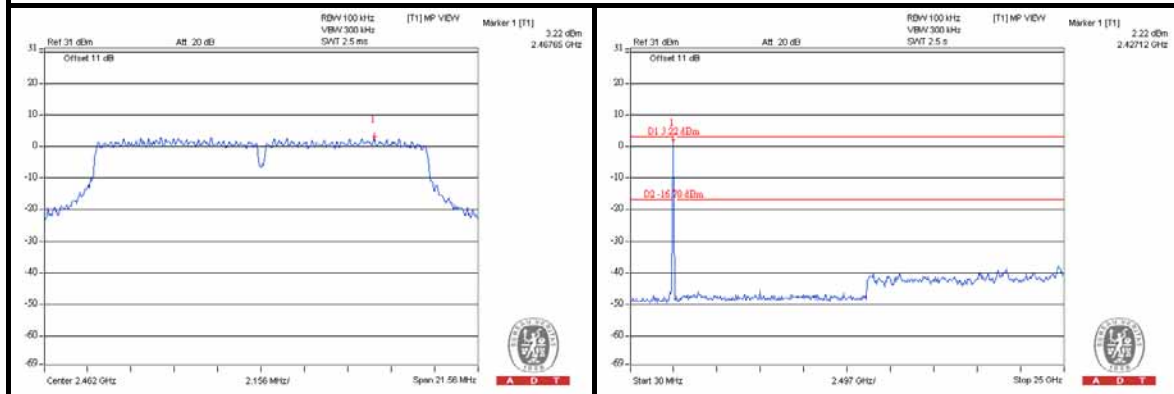



A D T

802.11n (20MHz)

CH 1

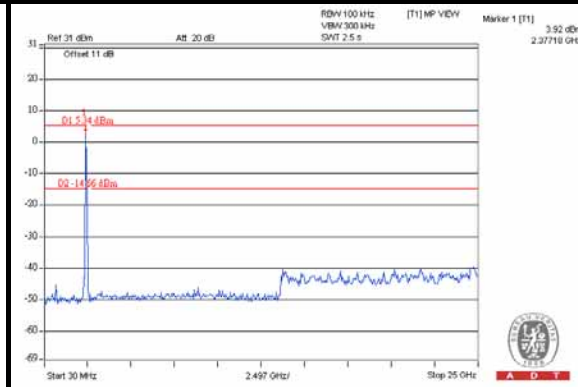
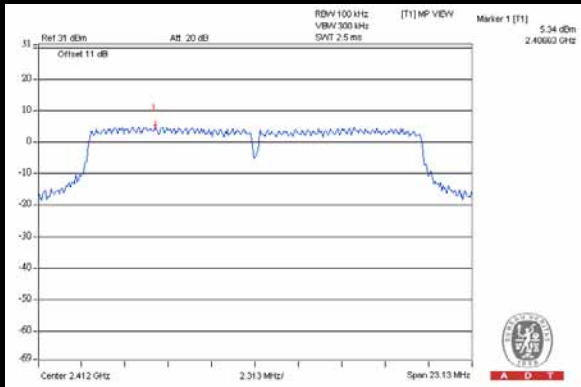

CH 6

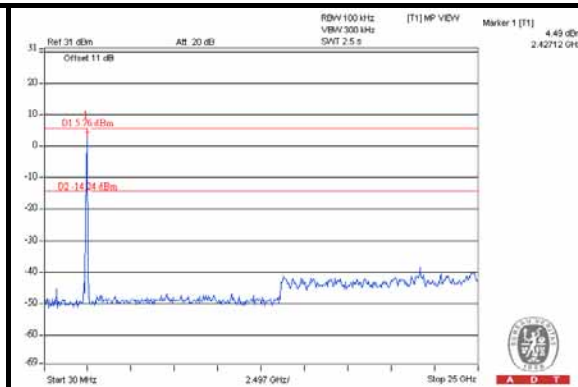
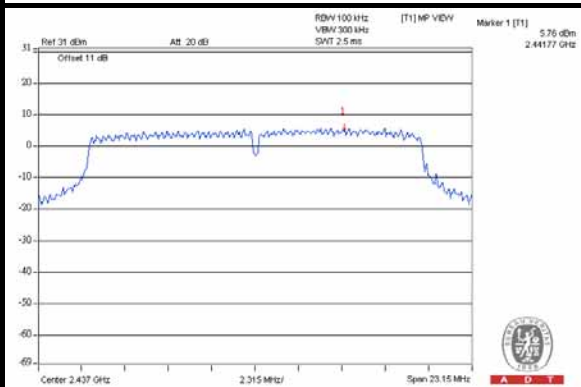

CH 11

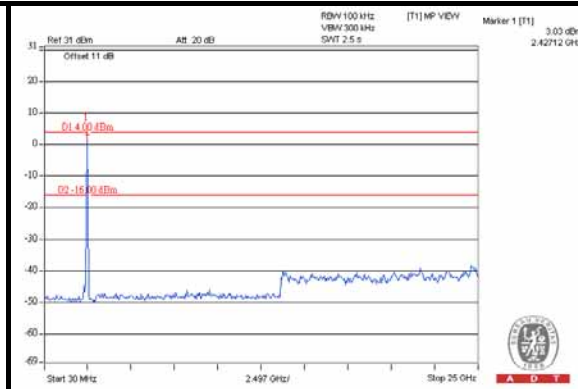
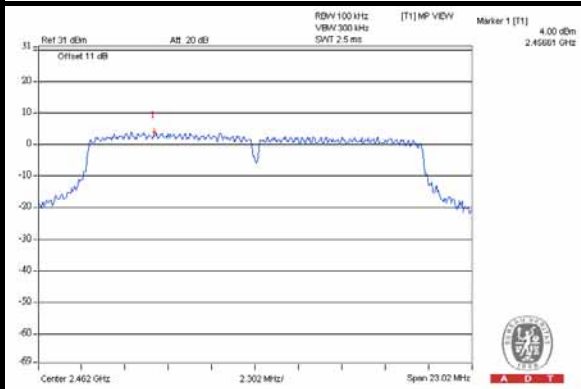



A D T

802.11n (40MHz)

CH 1

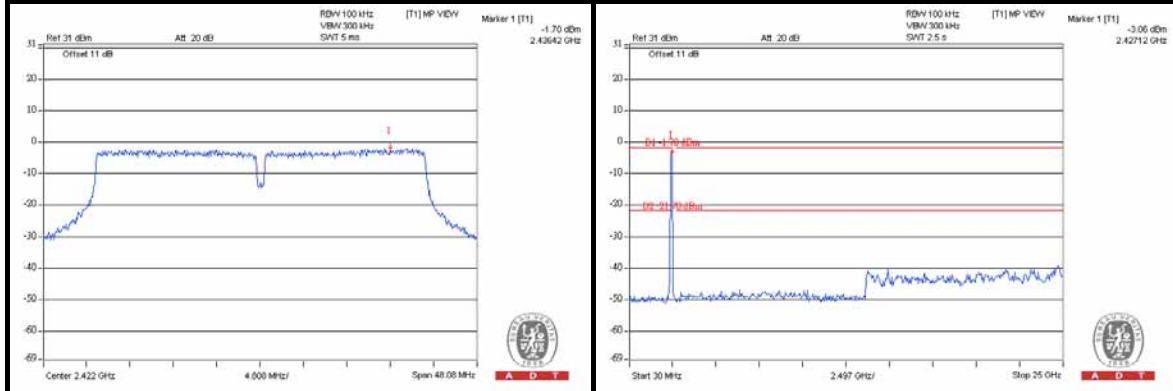

CH 4

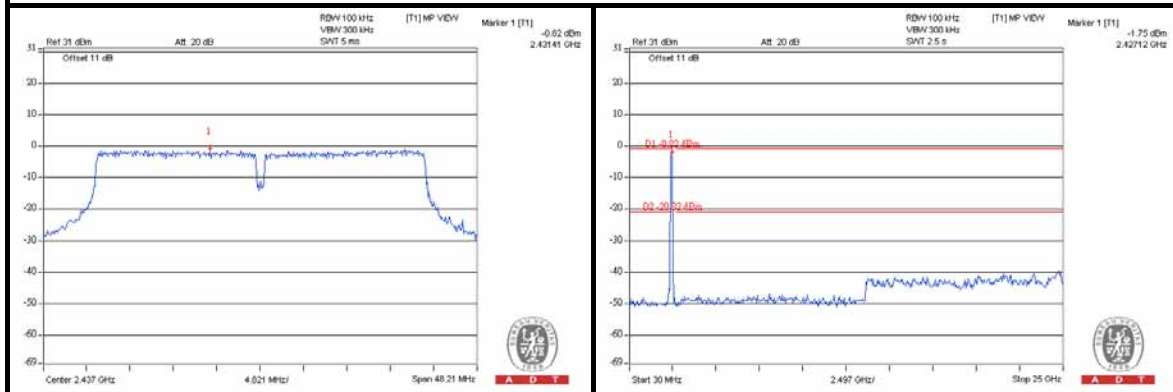

CH 7

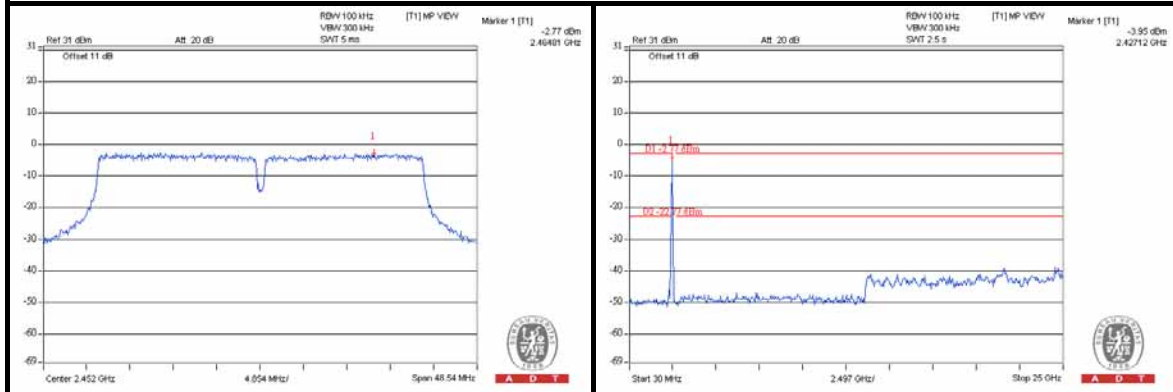



TEST MODE B1

802.11b

CH 1

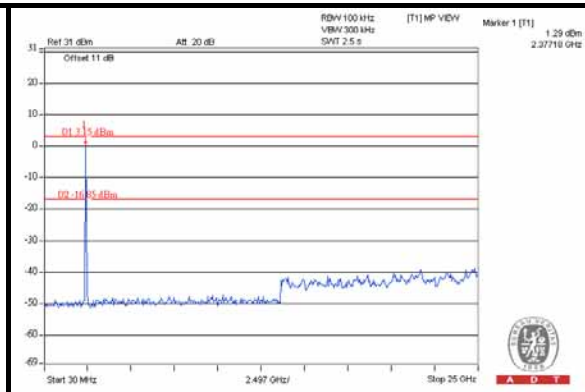
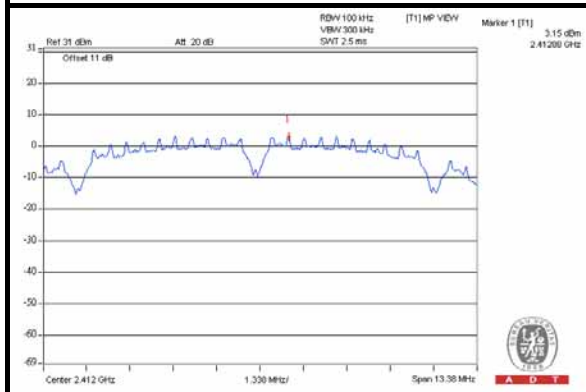

CH 6

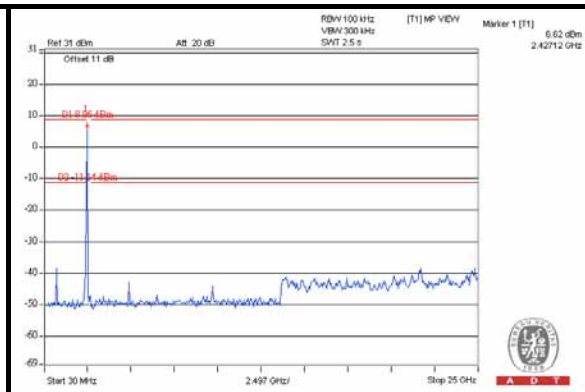
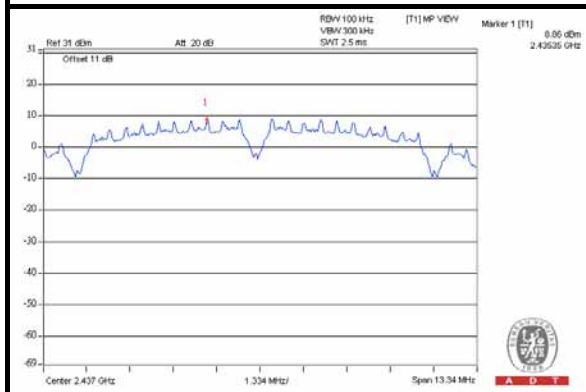

CH 11

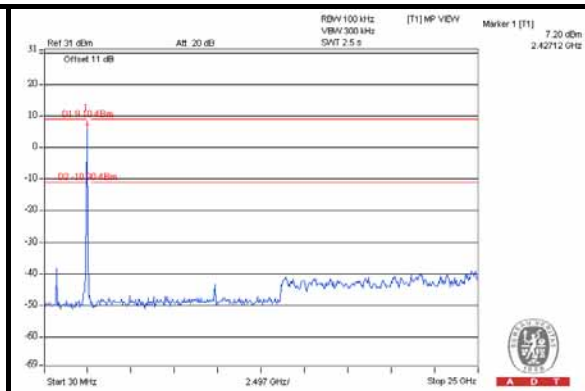
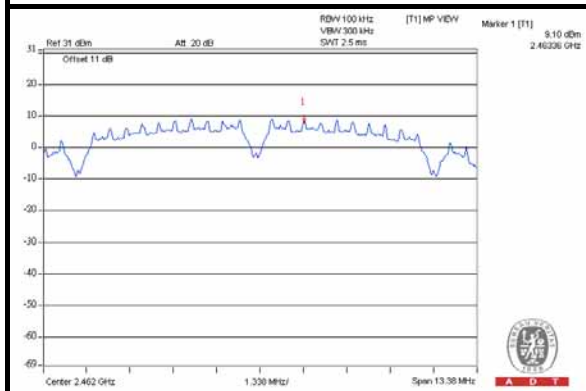



A D T

802.11g

CH 1

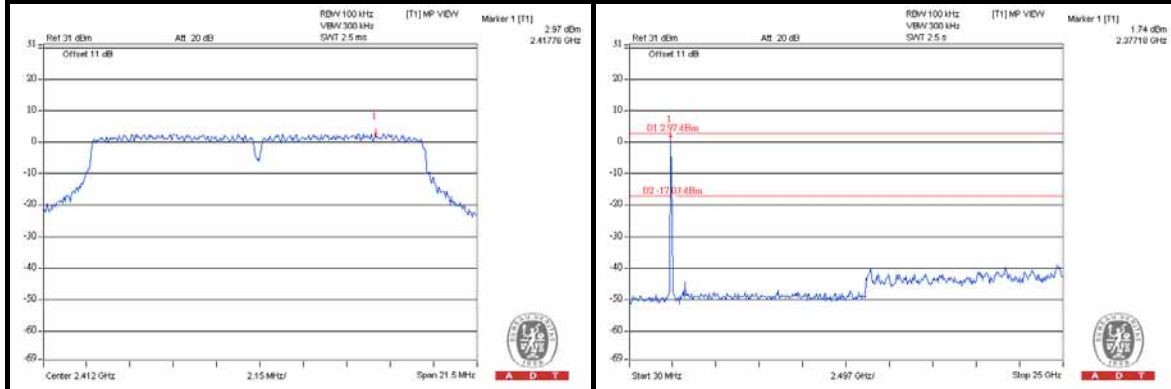

CH 6

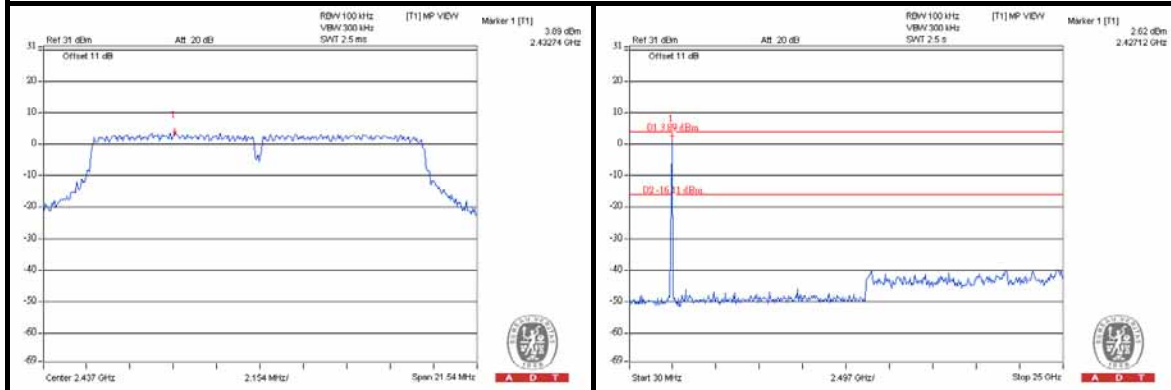

CH 11

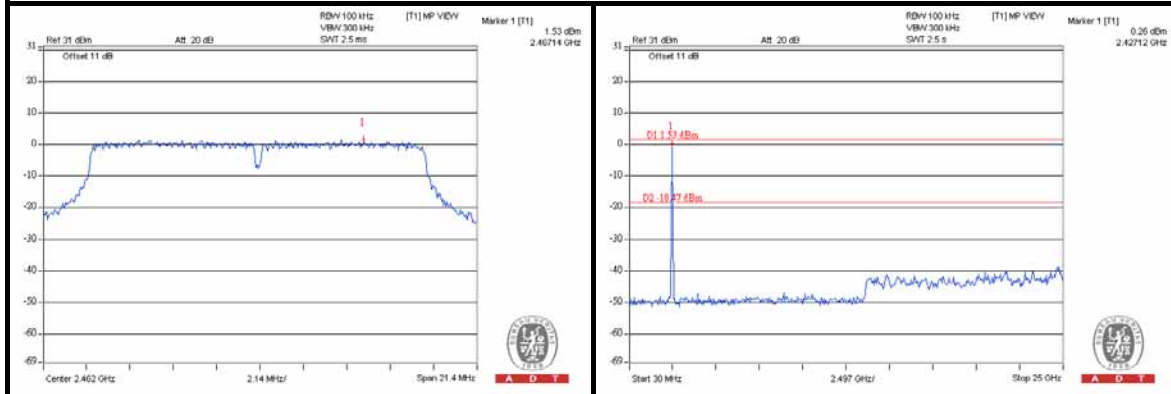



A D T

802.11n (20MHz)

CH 1

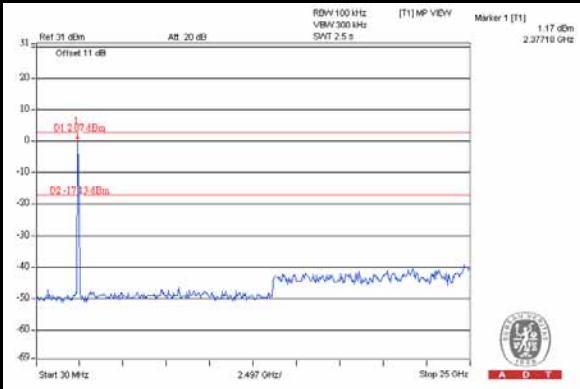
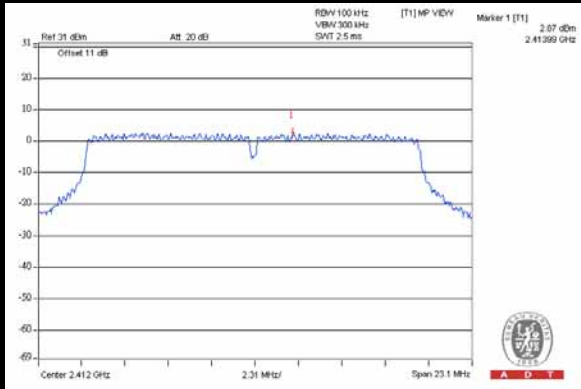

CH 6

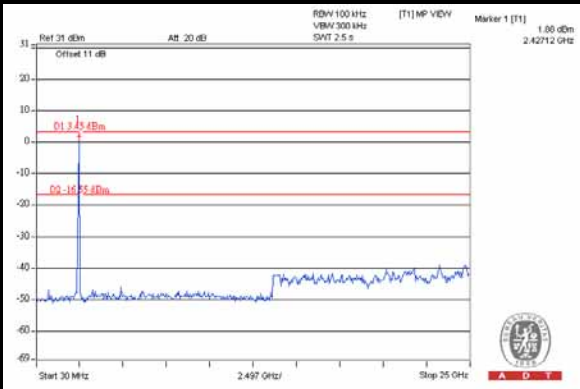
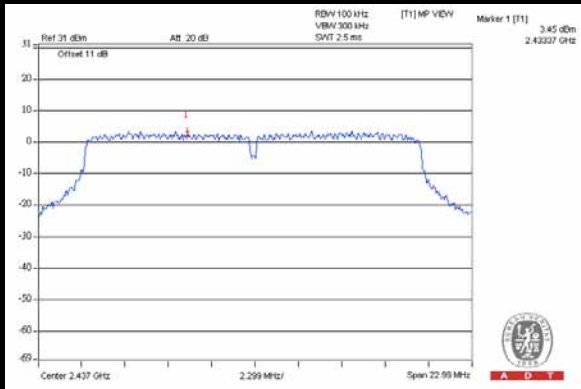

CH 11

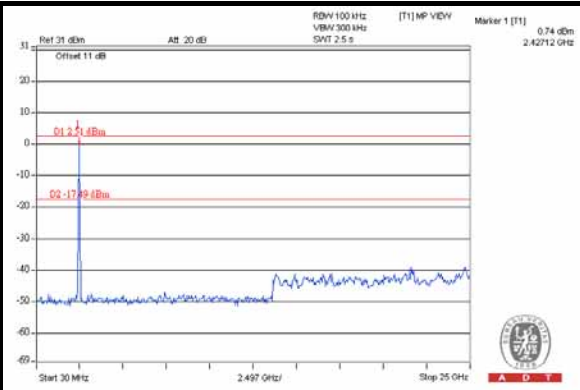
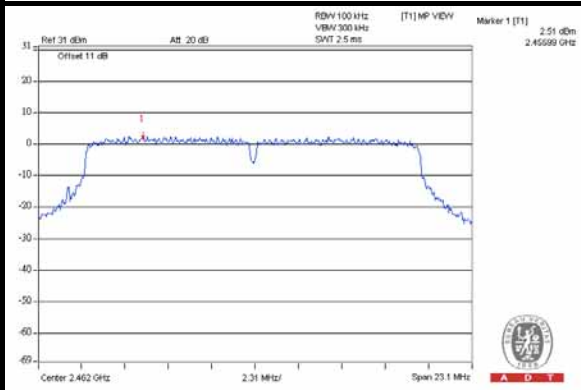



A D T

802.11n (40MHz)

CH 1

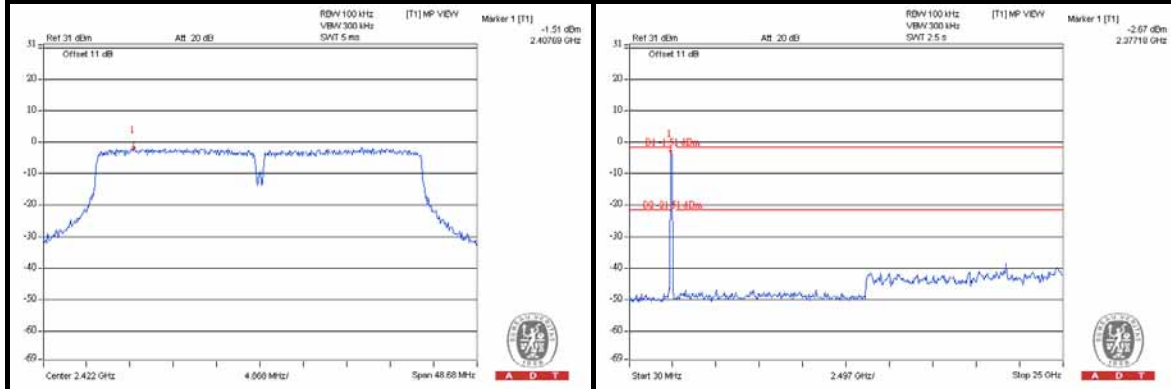

CH 4

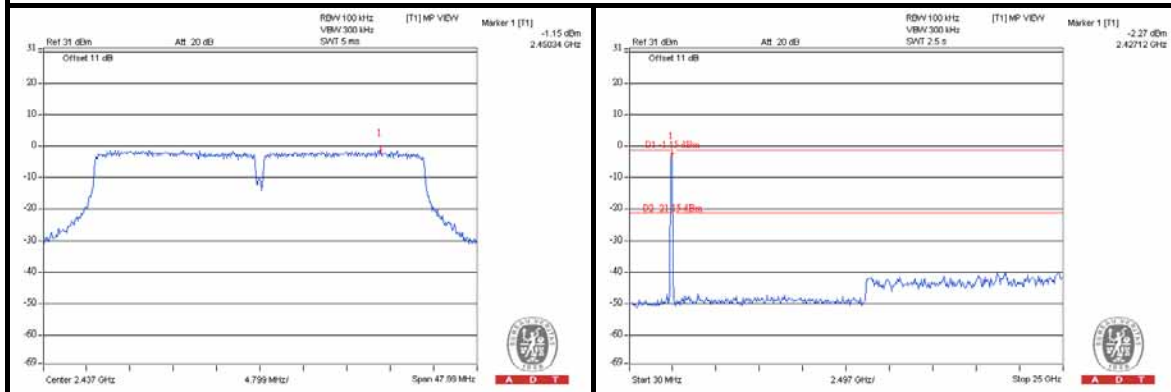

CH 7

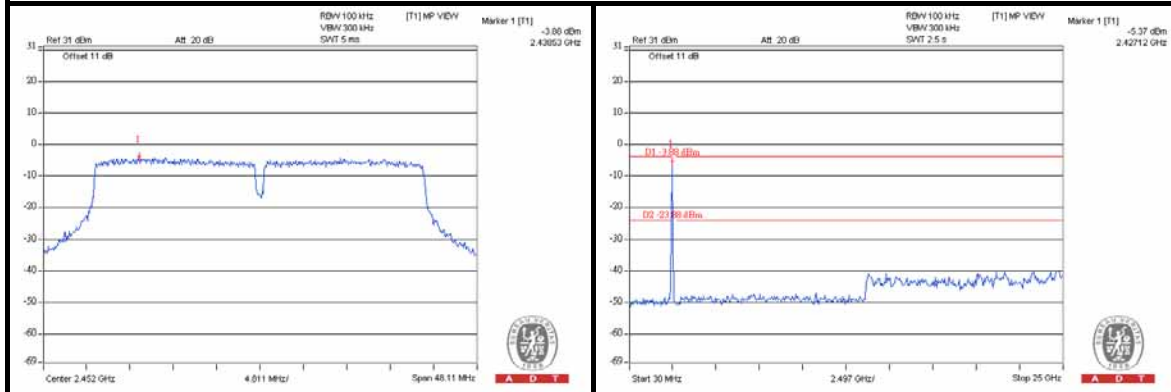

5. TEST TYPES AND RESULTS (FOR 5.0GHz BAND)

5.1 RADIATED EMISSION AND BANDEDGE MEASUREMENT

5.1.1 LIMITS OF RADIATED EMISSION AND BANDEDGE MEASUREMENT

Radiated emissions which fall in the restricted bands, as defined in Section 15.205(a), must also comply with the radiated emission limits specified in Section 15.209(a). Other emissions shall be at least 20dB below the highest level of the desired power.

FREQUENCIES (MHz)	FIELD STRENGTH (microvolts/meter)	MEASUREMENT DISTANCE (meters)
0.009 ~ 0.490	2400/F(kHz)	300
0.490 ~ 1.705	24000/F(kHz)	30
1.705 ~ 30.0	30	30
30 ~ 88	100	3
88 ~ 216	150	3
216 ~ 960	200	3
Above 960	500	3

NOTE:

1. The lower limit shall apply at the transition frequencies.
2. Emission level (dBuV/m) = 20 log Emission level (uV/m).
3. As shown in 15.35(b), for frequencies above 1000MHz, the field strength limits are based on average detector, however, the peak field strength of any emission shall not exceed the maximum permitted average limits, specified above by more than 20dB under any condition of modulation.

5.1.2 TEST INSTRUMENTS

DESCRIPTION & MANUFACTURER	MODEL NO.	SERIAL NO.	DATE OF CALIBRATION	DUE DATE OF CALIBRATION
Test Receiver ROHDE & SCHWARZ	ESIB7	100212	Aug. 02, 2011	Aug. 01, 2012
Spectrum Analyzer ROHDE & SCHWARZ	FSP 40	100041	Jul. 21, 2011	Jul. 20, 2012
BILOG Antenna SCHWARZBECK	VULB9168	9168-160	Apr. 13, 2011	Apr. 12, 2012
HORN Antenna SCHWARZBECK	9120D	209	Aug. 25, 2011	Aug. 24, 2012
HORN Antenna SCHWARZBECK	BBHA 9170	BBHA9170243	Dec. 27, 2010	Dec. 26, 2011
Preamplifier Agilent	8447D	2944A10633	Oct. 29, 2011	Oct. 28, 2012
Preamplifier Agilent	8449B	3008A01964	Oct. 29, 2011	Oct. 28, 2012
RF signal cable HUBER+SUHNNER	SUCOFLEX 104	295014/4	Aug. 19, 2011	Aug. 18, 2012
RF signal cable HUBER+SUHNNER	SUCOFLEX 104	12738/6	Aug. 19, 2011	Aug. 18, 2012
Software ADT.	ADT_Radiated_ V7.6.15.9.2	NA	NA	NA
Antenna Tower inn-co GmbH	MA 4000	013303	NA	NA
Antenna Tower Controller inn-co GmbH	CO2000	017303	NA	NA
Turn Table ADT.	TT100.	TT93021703	NA	NA
Turn Table Controller ADT.	SC100.	SC93021703	NA	NA
26GHz ~ 40GHz Amplifier	EM26400	815221	Oct. 29, 2011	Oct. 28, 2012
High Speed Peak Power Meter	ML2495A	0842014	Apr. 26, 2011	Apr. 25, 2012
Power Sensor	MA2411B	0738404	Apr. 26, 2011	Apr. 25, 2012

- NOTE:**
1. The calibration interval of the above test instruments is 12 months and the calibrations are traceable to NML/ROC and NIST/USA.
 2. The test was performed in HwaYa Chamber 3.
 3. The horn antenna and HP preamplifier (model: 8449B) are used only for the measurement of emission frequency above 1GHz if tested.
 4. The FCC Site Registration No. is 988962.
 5. The IC Site Registration No. is IC 7450F-3.

5.1.3 TEST PROCEDURES

- a. The EUT was placed on the top of a rotating table 0.8 meters above the ground at a 3 meters semi-anechoic chamber. The table was rotated 360 degrees to determine the position of the highest radiation.
- b. The EUT was set 3 meters away from the interference-receiving antenna, which was mounted on the top of a variable-height antenna tower.
- c. The antenna is a broadband antenna, and its height is varied from one meter to four meters above the ground to determine the maximum value of the field strength. Both horizontal and vertical polarizations of the antenna are set to make the measurement.
- d. For each suspected emission, the EUT was arranged to its worst case and then the antenna was tuned to heights from 1 meter to 4 meters and the rotatable table was turned from 0 degrees to 360 degrees to find the maximum reading.
- e. The test-receiver system was set to Peak Detect Function and Specified Bandwidth with Maximum Hold Mode.
- f. If the emission level of the EUT in peak mode was lower than the limit specified, then testing could be stopped and the peak values of the EUT would be reported. Otherwise the emissions would be re-tested one by one using peak, quasi-peak or average method as specified and then reported in a data sheet.

NOTE:

1. The resolution bandwidth and video bandwidth of test receiver/spectrum analyzer is 120kHz for Quasi-peak detection at frequency below 1GHz.
2. The resolution bandwidth of test receiver/spectrum analyzer is 100kHz and video bandwidth is 300kHz for Peak detection at frequency above 1GHz.
3. The resolution bandwidth of test receiver/spectrum analyzer is 1MHz and the video bandwidth is 10Hz for Average detection (AV) at frequency above 1GHz.
4. All modes of operation were investigated and the worst-case emissions are reported.

5.1.4 DEVIATION FROM TEST STANDARD

No deviation.

5.1.5 TEST SETUP

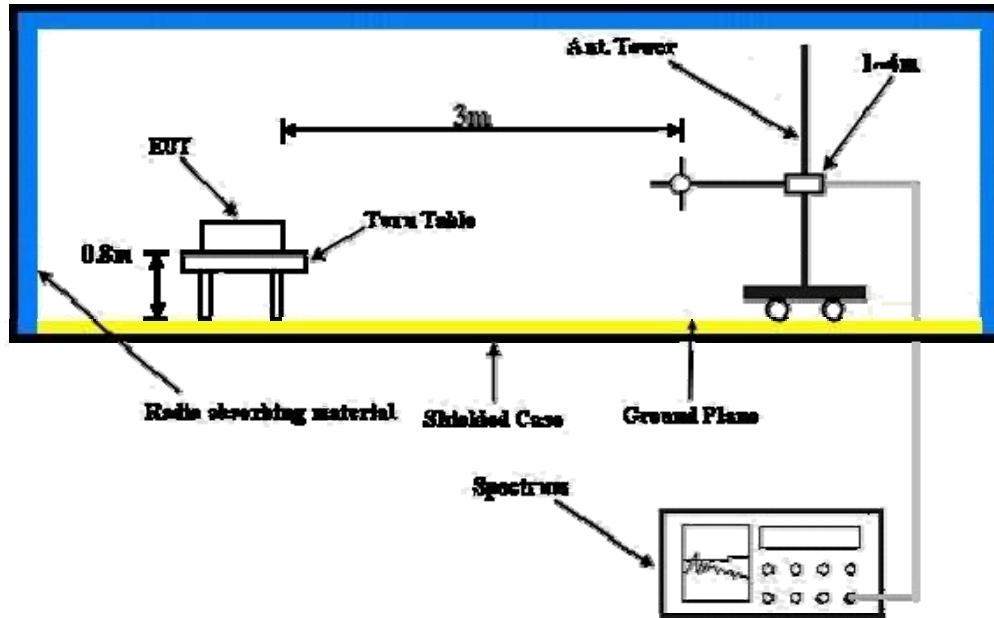

For the actual test configuration, please refer to the attached file (Test Setup Photo).

5.1.6 EUT OPERATING CONDITIONS

Same as 4.1.6

5.1.7 TEST RESULTS

ABOVE 1GHz: 802.11a

EUT TEST CONDITION		MEASUREMENT DETAIL	
CHANNEL	Channel 149	FREQUENCY RANGE	1 ~ 40GHz
INPUT POWER (SYSTEM)	120Vac, 60 Hz	DETECTOR FUNCTION	Peak (PK) Average (AV)
ENVIRONMENTAL CONDITIONS	25deg. C, 65%RH	TESTED BY	Kay Wu

ANTENNA POLARITY & TEST DISTANCE: HORIZONTAL AT 3 M								
NO.	FREQ. (MHz)	EMISSION LEVEL (dBuV/m)	LIMIT (dBuV/m)	MARGIN (dB)	ANTENNA HEIGHT (m)	TABLE ANGLE (Degree)	RAW VALUE (dBuV)	CORRECTION FACTOR (dB/m)
1	5104.00	52.9 PK	74.0	-21.1	1.00 H	316	15.50	37.40
2	5104.00	44.9 AV	54.0	-9.1	1.00 H	316	7.50	37.40
3	#5725.00	82.2 PK	88.3	-6.1	1.27 H	170	43.80	38.40
4	#5725.00	61.0 AV	77.8	-16.8	1.27 H	170	22.60	38.40
5	*5745.00	108.3 PK			1.02 H	171	69.90	38.40
6	*5745.00	97.8 AV			1.02 H	171	59.40	38.40
7	11490.00	59.7 PK	74.0	-14.3	1.14 H	59	10.70	49.00
8	11490.00	46.2 AV	54.0	-7.8	1.14 H	59	-2.80	49.00
ANTENNA POLARITY & TEST DISTANCE: VERTICAL AT 3 M								
NO.	FREQ. (MHz)	EMISSION LEVEL (dBuV/m)	LIMIT (dBuV/m)	MARGIN (dB)	ANTENNA HEIGHT (m)	TABLE ANGLE (Degree)	RAW VALUE (dBuV)	CORRECTION FACTOR (dB/m)
1	5104.00	58.2 PK	74.0	-15.8	1.00 V	352	20.80	37.40
2	5104.00	48.6 AV	54.0	-5.4	1.00 V	352	11.20	37.40
3	#5725.00	83.2 PK	92.3	-9.1	1.00 V	136	44.80	38.40
4	#5725.00	61.3 AV	81.8	-20.5	1.00 V	136	22.90	38.40
5	*5745.00	112.3 PK			1.02 V	171	73.90	38.40
6	*5745.00	101.8 AV			1.02 V	171	63.40	38.40
7	11490.00	63.7 PK	74.0	-10.3	1.14 V	59	14.70	49.00
8	11490.00	50.2 AV	54.0	-3.8	1.14 V	59	1.20	49.00

- REMARKS:**
1. Emission level (dBuV/m) = Raw Value (dBuV) + Correction Factor (dB/m).
 2. Correction Factor (dB/m) = Antenna Factor (dB/m) + Cable Factor (dB).
 3. The other emission levels were very low against the limit.
 4. Margin value = Emission level – Limit value.
 5. “ * “: Fundamental frequency.
 6. The limit value is defined as per 15.247.
 7. “#”:The radiated frequency is out the restricted band.

EUT TEST CONDITION		MEASUREMENT DETAIL	
CHANNEL	Channel 157	FREQUENCY RANGE	1 ~ 40GHz
INPUT POWER (SYSTEM)	120Vac, 60 Hz	DETECTOR FUNCTION	Peak (PK) Average (AV)
ENVIRONMENTAL CONDITIONS	25deg. C, 65%RH	TESTED BY	Kay Wu

ANTENNA POLARITY & TEST DISTANCE: HORIZONTAL AT 3 M								
NO.	FREQ. (MHz)	EMISSION LEVEL (dBuV/m)	LIMIT (dBuV/m)	MARGIN (dB)	ANTENNA HEIGHT (m)	TABLE ANGLE (Degree)	RAW VALUE (dBuV)	CORRECTION FACTOR (dB/m)
1	5104.00	52.4 PK	74.0	-21.6	1.00 H	317	15.00	37.40
2	5104.00	44.0 AV	54.0	-10.0	1.00 H	317	6.60	37.40
3	*5785.00	108.9 PK			1.36 H	176	70.40	38.50
4	*5785.00	98.3 AV			1.36 H	176	59.80	38.50
5	11570.00	61.3 PK	74.0	-12.7	1.13 H	65	12.50	48.80
6	11570.00	47.7 AV	54.0	-6.3	1.13 H	65	-1.10	48.80
ANTENNA POLARITY & TEST DISTANCE: VERTICAL AT 3 M								
NO.	FREQ. (MHz)	EMISSION LEVEL (dBuV/m)	LIMIT (dBuV/m)	MARGIN (dB)	ANTENNA HEIGHT (m)	TABLE ANGLE (Degree)	RAW VALUE (dBuV)	CORRECTION FACTOR (dB/m)
1	5104.00	56.8 PK	74.0	-17.2	1.11 V	190	19.30	37.50
2	5104.00	47.6 AV	54.0	-6.4	1.11 V	190	10.10	37.50
3	*5785.00	113.6 PK			1.02 V	226	75.00	38.60
4	*5785.00	102.6 AV			1.02 V	226	64.00	38.60
5	11570.00	67.0 PK	74.0	-7.0	1.00 V	202	18.10	48.90
6	11570.00	52.3 AV	54.0	-1.7	1.00 V	202	3.40	48.90
7	#17355.00	68.1 PK	93.6	-25.5	1.06 V	8	15.50	52.60
8	#17355.00	54.1 AV	82.6	-28.5	1.06 V	8	1.50	52.60

- REMARKS:**
1. Emission level (dBuV/m) = Raw Value (dBuV) + Correction Factor (dB/m).
 2. Correction Factor (dB/m) = Antenna Factor (dB/m) + Cable Factor (dB).
 3. The other emission levels were very low against the limit.
 4. Margin value = Emission level – Limit value.
 5. “ * “: Fundamental frequency.
 6. The limit value is defined as per 15.247.
 7. “#”: The radiated frequency is out the restricted band.

EUT TEST CONDITION		MEASUREMENT DETAIL	
CHANNEL	Channel 165	FREQUENCY RANGE	1 ~ 40GHz
INPUT POWER (SYSTEM)	120Vac, 60 Hz	DETECTOR FUNCTION	Peak (PK) Average (AV)
ENVIRONMENTAL CONDITIONS	25deg. C, 65%RH	TESTED BY	Kay Wu

ANTENNA POLARITY & TEST DISTANCE: HORIZONTAL AT 3 M								
NO.	FREQ. (MHz)	EMISSION LEVEL (dBuV/m)	LIMIT (dBuV/m)	MARGIN (dB)	ANTENNA HEIGHT (m)	TABLE ANGLE (Degree)	RAW VALUE (dBuV)	CORRECTION FACTOR (dB/m)
1	5104.00	52.4 PK	74.0	-21.6	1.00 H	316	15.00	37.40
2	5104.00	43.7 AV	54.0	-10.3	1.00 H	316	6.30	37.40
3	*5825.00	108.5 PK			1.00 H	173	69.90	38.60
4	*5825.00	97.8 AV			1.00 H	173	59.20	38.60
5	#5850.00	73.0 PK	88.5	-15.5	1.00 H	180	34.40	38.60
6	#5850.00	49.5 AV	77.8	-28.3	1.00 H	180	10.90	38.60
7	11650.00	60.1 PK	74.0	-13.9	1.10 H	67	11.40	48.70
8	11650.00	42.7 AV	54.0	-11.3	1.10 H	67	-6.00	48.70
ANTENNA POLARITY & TEST DISTANCE: VERTICAL AT 3 M								
NO.	FREQ. (MHz)	EMISSION LEVEL (dBuV/m)	LIMIT (dBuV/m)	MARGIN (dB)	ANTENNA HEIGHT (m)	TABLE ANGLE (Degree)	RAW VALUE (dBuV)	CORRECTION FACTOR (dB/m)
1	5104.00	57.0 PK	74.0	-17.0	1.00 V	349	19.60	37.40
2	5104.00	47.2 AV	54.0	-6.8	1.00 V	349	9.80	37.40
3	*5825.00	113.1 PK			1.00 V	224	74.50	38.60
4	*5825.00	102.1 AV			1.00 V	224	63.50	38.60
5	#5850.00	75.5 PK	93.1	-17.6	1.00 V	257	36.90	38.60
6	#5850.00	54.4 AV	82.1	-27.7	1.00 V	257	15.80	38.60
7	11650.00	64.5 PK	74.0	-9.5	1.00 V	195	15.80	48.70
8	11650.00	50.3 AV	54.0	-3.7	1.00 V	195	1.60	48.70

- REMARKS:**
1. Emission level (dBuV/m) = Raw Value (dBuV) + Correction Factor (dB/m).
 2. Correction Factor (dB/m) = Antenna Factor (dB/m) + Cable Factor (dB).
 3. The other emission levels were very low against the limit.
 4. Margin value = Emission level – Limit value.
 5. “ * “: Fundamental frequency.
 6. The limit value is defined as per 15.247.
 7. “#”: The radiated frequency is out the restricted band.

802.11n (20MHz)

EUT TEST CONDITION		MEASUREMENT DETAIL	
CHANNEL	Channel 149	FREQUENCY RANGE	1 ~ 40GHz
INPUT POWER (SYSTEM)	120Vac, 60 Hz	DETECTOR FUNCTION	Peak (PK) Average (AV)
ENVIRONMENTAL CONDITIONS	25deg. C, 65%RH	TESTED BY	Kay Wu

ANTENNA POLARITY & TEST DISTANCE: HORIZONTAL AT 3 M								
NO.	FREQ. (MHz)	EMISSION LEVEL (dBuV/m)	LIMIT (dBuV/m)	MARGIN (dB)	ANTENNA HEIGHT (m)	TABLE ANGLE (Degree)	RAW VALUE (dBuV)	CORRECTION FACTOR (dB/m)
1	5104.00	51.4 PK	74.0	-22.6	1.00 H	200	14.00	37.40
2	5104.00	44.1 AV	54.0	-9.9	1.00 H	200	6.70	37.40
3	#5725.00	81.0 PK	88.0	-7.0	1.20 H	320	42.60	38.40
4	#5725.00	59.7 AV	78.1	-18.4	1.20 H	320	21.30	38.40
5	*5745.00	108.0 PK			1.10 H	161	69.60	38.40
6	*5745.00	98.1 AV			1.10 H	161	59.70	38.40
7	11490.00	58.6 PK	74.0	-15.4	1.05 H	152	9.60	49.00
8	11490.00	45.1 AV	54.0	-8.9	1.05 H	152	-3.90	49.00
ANTENNA POLARITY & TEST DISTANCE: VERTICAL AT 3 M								
NO.	FREQ. (MHz)	EMISSION LEVEL (dBuV/m)	LIMIT (dBuV/m)	MARGIN (dB)	ANTENNA HEIGHT (m)	TABLE ANGLE (Degree)	RAW VALUE (dBuV)	CORRECTION FACTOR (dB/m)
1	5104.00	59.7 PK	74.0	-14.3	1.10 V	265	22.30	37.40
2	5104.00	49.5 AV	54.0	-4.5	1.10 V	265	12.10	37.40
3	#5725.00	82.0 PK	92.0	-10.0	1.00 V	169	43.60	38.40
4	#5725.00	60.1 AV	81.3	-21.2	1.00 V	169	21.70	38.40
5	*5745.00	112.0 PK			1.05 V	195	73.60	38.40
6	*5745.00	101.3 AV			1.05 V	195	62.90	38.40
7	11490.00	64.9 PK	74.0	-9.1	1.20 V	273	15.90	49.00
8	11490.00	51.3 AV	54.0	-2.7	1.20 V	273	2.30	49.00

- REMARKS:**
1. Emission level (dBuV/m) = Raw Value (dBuV) + Correction Factor (dB/m).
 2. Correction Factor (dB/m) = Antenna Factor (dB/m) + Cable Factor (dB).
 3. The other emission levels were very low against the limit.
 4. Margin value = Emission level – Limit value.
 5. “ * “: Fundamental frequency.
 6. The limit value is defined as per 15.247.
 7. “#”: The radiated frequency is out the restricted band.

EUT TEST CONDITION		MEASUREMENT DETAIL	
CHANNEL	Channel 157	FREQUENCY RANGE	1 ~ 40GHz
INPUT POWER (SYSTEM)	120Vac, 60 Hz	DETECTOR FUNCTION	Peak (PK) Average (AV)
ENVIRONMENTAL CONDITIONS	25deg. C, 65%RH	TESTED BY	Kay Wu

ANTENNA POLARITY & TEST DISTANCE: HORIZONTAL AT 3 M								
NO.	FREQ. (MHz)	EMISSION LEVEL (dBuV/m)	LIMIT (dBuV/m)	MARGIN (dB)	ANTENNA HEIGHT (m)	TABLE ANGLE (Degree)	RAW VALUE (dBuV)	CORRECTION FACTOR (dB/m)
1	5104.00	51.6 PK	74.0	-22.4	1.10 H	241	14.20	37.40
2	5104.00	43.7 AV	54.0	-10.3	1.10 H	241	6.30	37.40
3	*5785.00	108.1 PK			1.30 H	204	69.60	38.50
4	*5785.00	97.8 AV			1.30 H	204	59.30	38.50
5	11570.00	60.1 PK	74.0	-13.9	1.10 H	243	11.30	48.80
6	11570.00	46.7 AV	54.0	-7.3	1.10 H	243	-2.10	48.80
ANTENNA POLARITY & TEST DISTANCE: VERTICAL AT 3 M								
NO.	FREQ. (MHz)	EMISSION LEVEL (dBuV/m)	LIMIT (dBuV/m)	MARGIN (dB)	ANTENNA HEIGHT (m)	TABLE ANGLE (Degree)	RAW VALUE (dBuV)	CORRECTION FACTOR (dB/m)
1	5104.00	57.5 PK	74.0	-16.5	1.20 V	163	20.10	37.40
2	5104.00	48.7 AV	54.0	-5.3	1.20 V	163	11.30	37.40
3	*5785.00	113.2 PK			1.05 V	274	74.70	38.50
4	*5785.00	102.3 AV			1.05 V	274	63.80	38.50
5	11570.00	64.3 PK	74.0	-9.7	1.00 V	197	15.50	48.80
6	11570.00	52.2 AV	54.0	-1.8	1.00 V	197	3.40	48.80

- REMARKS:**
1. Emission level (dBuV/m) = Raw Value (dBuV) + Correction Factor (dB/m).
 2. Correction Factor (dB/m) = Antenna Factor (dB/m) + Cable Factor (dB).
 3. The other emission levels were very low against the limit.
 4. Margin value = Emission level – Limit value.
 5. “ * “: Fundamental frequency.
 6. The limit value is defined as per 15.247.

EUT TEST CONDITION		MEASUREMENT DETAIL	
CHANNEL	Channel 165	FREQUENCY RANGE	1 ~ 40GHz
INPUT POWER (SYSTEM)	120Vac, 60 Hz	DETECTOR FUNCTION	Peak (PK) Average (AV)
ENVIRONMENTAL CONDITIONS	25deg. C, 65%RH	TESTED BY	Kay Wu

ANTENNA POLARITY & TEST DISTANCE: HORIZONTAL AT 3 M								
NO.	FREQ. (MHz)	EMISSION LEVEL (dBuV/m)	LIMIT (dBuV/m)	MARGIN (dB)	ANTENNA HEIGHT (m)	TABLE ANGLE (Degree)	RAW VALUE (dBuV)	CORRECTION FACTOR (dB/m)
1	5104.00	53.6 PK	74.0	-20.4	1.10 H	269	16.20	37.40
2	5104.00	45.4 AV	54.0	-8.6	1.10 H	269	8.00	37.40
3	*5825.00	107.9 PK			1.00 H	193	69.30	38.60
4	*5825.00	97.1 AV			1.00 H	193	58.50	38.60
5	#5850.00	72.1 PK	87.9	-15.8	1.10 H	234	33.50	38.60
6	#5850.00	48.7 AV	77.1	-28.4	1.10 H	234	10.10	38.60
7	11650.00	59.4 PK	74.0	-14.6	1.20 H	114	10.70	48.70
8	11650.00	42.1 AV	54.0	-11.9	1.20 H	114	-6.60	48.70
ANTENNA POLARITY & TEST DISTANCE: VERTICAL AT 3 M								
NO.	FREQ. (MHz)	EMISSION LEVEL (dBuV/m)	LIMIT (dBuV/m)	MARGIN (dB)	ANTENNA HEIGHT (m)	TABLE ANGLE (Degree)	RAW VALUE (dBuV)	CORRECTION FACTOR (dB/m)
1	5104.00	56.5 PK	74.0	-17.5	1.00 V	315	19.10	37.40
2	5104.00	46.4 AV	54.0	-7.6	1.00 V	315	9.00	37.40
3	*5825.00	112.6 PK			1.00 V	269	74.00	38.60
4	*5825.00	101.7 AV			1.00 V	269	63.10	38.60
5	#5850.00	74.6 PK	92.6	-18.0	1.00 V	241	36.00	38.60
6	#5850.00	53.5 AV	81.7	-28.2	1.00 V	241	14.90	38.60
7	11650.00	65.3 PK	74.0	-8.7	1.00 V	198	16.60	48.70
8	11650.00	51.4 AV	54.0	-2.6	1.00 V	198	2.70	48.70

- REMARKS:**
1. Emission level (dBuV/m) = Raw Value (dBuV) + Correction Factor (dB/m).
 2. Correction Factor (dB/m) = Antenna Factor (dB/m) + Cable Factor (dB).
 3. The other emission levels were very low against the limit.
 4. Margin value = Emission level – Limit value.
 5. “ * “: Fundamental frequency.
 6. The limit value is defined as per 15.247.
 7. “#”: The radiated frequency is out the restricted band.

802.11n (40MHz)

EUT TEST CONDITION		MEASUREMENT DETAIL	
CHANNEL	Channel 151	FREQUENCY RANGE	1 ~ 40GHz
INPUT POWER (SYSTEM)	120Vac, 60 Hz	DETECTOR FUNCTION	Peak (PK) Average (AV)
ENVIRONMENTAL CONDITIONS	25deg. C, 65%RH	TESTED BY	Kay Wu

ANTENNA POLARITY & TEST DISTANCE: HORIZONTAL AT 3 M								
NO.	FREQ. (MHz)	EMISSION LEVEL (dBuV/m)	LIMIT (dBuV/m)	MARGIN (dB)	ANTENNA HEIGHT (m)	TABLE ANGLE (Degree)	RAW VALUE (dBuV)	CORRECTION FACTOR (dB/m)
1	5104.00	52.1 PK	74.0	-21.9	1.00 H	317	14.70	37.40
2	5104.00	44.0 AV	54.0	-10.0	1.00 H	317	6.60	37.40
3	#5725.00	79.7 PK	82.6	-2.9	1.00 H	159	41.30	38.40
4	#5725.00	67.3 AV	72.5	-5.2	1.00 H	159	28.90	38.40
5	*5755.00	102.6 PK			1.36 H	172	64.10	38.50
6	*5755.00	92.5 AV			1.36 H	172	54.00	38.50
7	11510.00	61.2 PK	74.0	-12.8	1.17 H	60	12.20	49.00
8	11510.00	46.8 AV	54.0	-7.2	1.17 H	60	-2.20	49.00
ANTENNA POLARITY & TEST DISTANCE: VERTICAL AT 3 M								
NO.	FREQ. (MHz)	EMISSION LEVEL (dBuV/m)	LIMIT (dBuV/m)	MARGIN (dB)	ANTENNA HEIGHT (m)	TABLE ANGLE (Degree)	RAW VALUE (dBuV)	CORRECTION FACTOR (dB/m)
1	5104.00	56.7 PK	74.0	-17.3	1.00 V	350	19.20	37.50
2	5104.00	47.3 AV	54.0	-6.7	1.00 V	350	9.80	37.50
3	#5725.00	83.6 PK	85.6	-2.0	1.18 V	159	45.20	38.40
4	#5725.00	71.8 AV	75.9	-4.1	1.18 V	159	33.40	38.40
5	*5755.00	105.6 PK			1.32 V	139	67.10	38.50
6	*5755.00	95.9 AV			1.32 V	139	57.40	38.50
7	11510.00	63.0 PK	74.0	-11.0	1.00 V	200	14.00	49.00
8	11510.00	49.8 AV	54.0	-4.2	1.00 V	200	0.80	49.00
9	#17265.00	65.3 PK	85.6	-20.3	1.03 V	8	13.20	52.10
10	#17265.00	53.6 AV	75.9	-22.3	1.03 V	8	1.50	52.10

- REMARKS:**
1. Emission level (dBuV/m) = Raw Value (dBuV) + Correction Factor (dB/m).
 2. Correction Factor (dB/m) = Antenna Factor (dB/m) + Cable Factor (dB).
 3. The other emission levels were very low against the limit.
 4. Margin value = Emission level – Limit value.
 5. “ * “: Fundamental frequency.
 6. The limit value is defined as per 15.247.
 7. "#":The radiated frequency is out the restricted band.

EUT TEST CONDITION		MEASUREMENT DETAIL	
CHANNEL	Channel 159	FREQUENCY RANGE	1 ~ 40GHz
INPUT POWER (SYSTEM)	120Vac, 60 Hz	DETECTOR FUNCTION	Peak (PK) Average (AV)
ENVIRONMENTAL CONDITIONS	25deg. C, 65%RH	TESTED BY	Kay Wu

ANTENNA POLARITY & TEST DISTANCE: HORIZONTAL AT 3 M								
NO.	FREQ. (MHz)	EMISSION LEVEL (dBuV/m)	LIMIT (dBuV/m)	MARGIN (dB)	ANTENNA HEIGHT (m)	TABLE ANGLE (Degree)	RAW VALUE (dBuV)	CORRECTION FACTOR (dB/m)
1	5104.00	52.1 PK	74.0	-21.9	1.00 H	316	14.70	37.40
2	5104.00	43.8 AV	54.0	-10.2	1.00 H	316	6.40	37.40
3	*5795.00	106.1 PK			1.00 H	172	67.60	38.50
4	*5795.00	95.3 AV			1.00 H	172	56.80	38.50
5	#5850.00	71.9 PK	86.1	-14.2	1.00 H	180	33.30	38.60
6	#5850.00	50.5 AV	75.3	-24.8	1.00 H	180	11.90	38.60
7	11590.00	57.2 PK	74.0	-16.8	1.02 H	63	8.40	48.80
8	11590.00	44.4 AV	54.0	-9.6	1.02 H	63	-4.40	48.80
ANTENNA POLARITY & TEST DISTANCE: VERTICAL AT 3 M								
NO.	FREQ. (MHz)	EMISSION LEVEL (dBuV/m)	LIMIT (dBuV/m)	MARGIN (dB)	ANTENNA HEIGHT (m)	TABLE ANGLE (Degree)	RAW VALUE (dBuV)	CORRECTION FACTOR (dB/m)
1	5104.00	56.5 PK	74.0	-17.5	1.00 V	350	19.00	37.50
2	5104.00	47.4 AV	54.0	-6.6	1.00 V	350	9.90	37.50
3	*5795.00	109.4 PK			1.33 V	225	70.80	38.60
4	*5795.00	99.3 AV			1.33 V	225	60.70	38.60
5	#5850.00	76.9 PK	89.4	-12.5	1.10 V	226	38.20	38.70
6	#5850.00	55.5 AV	79.3	-23.8	1.10 V	226	16.80	38.70
7	11590.00	63.3 PK	74.0	-10.7	1.00 V	197	14.50	48.80
8	11590.00	49.3 AV	54.0	-4.7	1.00 V	197	0.50	48.80
9	#17358.00	65.1 PK	89.4	-24.3	1.06 V	9	12.40	52.70
10	#17358.00	53.3 AV	79.3	-26.0	1.06 V	9	0.60	52.70

- REMARKS:**
1. Emission level (dBuV/m) = Raw Value (dBuV) + Correction Factor (dB/m).
 2. Correction Factor (dB/m) = Antenna Factor (dB/m) + Cable Factor (dB).
 3. The other emission levels were very low against the limit.
 4. Margin value = Emission level – Limit value.
 5. “ * “: Fundamental frequency.
 6. The limit value is defined as per 15.247.
 7. “#”: The radiated frequency is out the restricted band.

BELOW 1GHz WORST-CASE DATA : 802.11a

EUT TEST CONDITION		MEASUREMENT DETAIL	
CHANNEL	Channel 149	FREQUENCY RANGE	Below 1000MHz
INPUT POWER (SYSTEM)	120Vac, 60 Hz	DETECTOR FUNCTION	Quasi-Peak
ENVIRONMENTAL CONDITIONS	25deg. C, 65%RH	TEST MODE	A
TESTED BY	Kay Wu		

ANTENNA POLARITY & TEST DISTANCE: HORIZONTAL AT 3 M								
NO.	FREQ. (MHz)	EMISSION LEVEL (dBuV/m)	LIMIT (dBuV/m)	MARGIN (dB)	ANTENNA HEIGHT (m)	TABLE ANGLE (Degree)	RAW VALUE (dBuV)	CORRECTION FACTOR (dB/m)
1	43.51	28.3 QP	40.0	-11.7	2.00 H	43	13.90	14.40
2	249.60	34.8 QP	46.0	-11.2	1.00 H	238	21.80	13.00
3	360.43	44.8 QP	46.0	-1.2	1.00 H	238	28.40	16.40
4	374.04	43.8 QP	46.0	-2.2	1.00 H	142	27.00	16.80
5	624.85	43.8 QP	46.0	-2.2	1.00 H	142	20.90	22.90
6	751.23	39.7 QP	46.0	-6.3	1.00 H	292	15.00	24.70
ANTENNA POLARITY & TEST DISTANCE: VERTICAL AT 3 M								
NO.	FREQ. (MHz)	EMISSION LEVEL (dBuV/m)	LIMIT (dBuV/m)	MARGIN (dB)	ANTENNA HEIGHT (m)	TABLE ANGLE (Degree)	RAW VALUE (dBuV)	CORRECTION FACTOR (dB/m)
1	45.45	37.9 QP	40.0	-2.1	1.00 V	319	23.50	14.40
2	360.43	41.5 QP	46.0	-4.5	1.00 V	187	25.10	16.40
3	374.04	42.1 QP	46.0	-3.9	1.00 V	181	25.30	16.80
4	500.42	33.3 QP	46.0	-12.7	2.00 V	190	13.10	20.20
5	599.58	32.5 QP	46.0	-13.5	1.00 V	55	10.10	22.40
6	624.85	41.8 QP	46.0	-4.2	1.00 V	88	18.90	22.90

- REMARKS:**
1. Emission level (dBuV/m) = Raw Value (dBuV) + Correction Factor (dB/m).
 2. Correction Factor (dB/m) = Antenna Factor (dB/m) + Cable Factor (dB).
 3. The other emission levels were very low against the limit.
 4. Margin value = Emission level – Limit value.

EUT TEST CONDITION		MEASUREMENT DETAIL	
CHANNEL	Channel 149	FREQUENCY RANGE	Below 1000MHz
INPUT POWER (SYSTEM)	120Vac, 60 Hz	DETECTOR FUNCTION	Quasi-Peak
ENVIRONMENTAL CONDITIONS	25deg. C, 65%RH	TEST MODE	B
TESTED BY	Kay Wu		

ANTENNA POLARITY & TEST DISTANCE: HORIZONTAL AT 3 M								
NO.	FREQ. (MHz)	EMISSION LEVEL (dBuV/m)	LIMIT (dBuV/m)	MARGIN (dB)	ANTENNA HEIGHT (m)	TABLE ANGLE (Degree)	RAW VALUE (dBuV)	CORRECTION FACTOR (dB/m)
1	43.51	22.9 QP	40.0	-17.1	2.00 H	118	8.50	14.40
2	94.06	28.2 QP	43.5	-15.3	2.00 H	277	19.00	9.20
3	146.56	25.4 QP	43.5	-18.1	1.00 H	295	11.00	14.40
4	348.76	31.6 QP	46.0	-14.4	1.00 H	157	15.50	16.10
5	475.14	27.0 QP	46.0	-19.0	2.00 H	145	7.50	19.50
6	720.12	34.4 QP	46.0	-11.6	1.00 H	130	10.10	24.30
ANTENNA POLARITY & TEST DISTANCE: VERTICAL AT 3 M								
NO.	FREQ. (MHz)	EMISSION LEVEL (dBuV/m)	LIMIT (dBuV/m)	MARGIN (dB)	ANTENNA HEIGHT (m)	TABLE ANGLE (Degree)	RAW VALUE (dBuV)	CORRECTION FACTOR (dB/m)
1	49.34	32.5 QP	40.0	-7.5	1.00 V	310	18.00	14.50
2	97.95	27.2 QP	43.5	-16.3	1.00 V	244	17.30	9.90
3	239.88	22.2 QP	46.0	-23.8	2.00 V	220	9.70	12.50
4	348.76	30.5 QP	46.0	-15.5	2.00 V	268	14.40	16.10
5	525.69	25.2 QP	46.0	-20.8	1.00 V	247	4.40	20.80
6	574.30	26.5 QP	46.0	-19.5	1.00 V	244	4.70	21.80

- REMARKS:**
1. Emission level (dBuV/m) = Raw Value (dBuV) + Correction Factor (dB/m).
 2. Correction Factor (dB/m) = Antenna Factor (dB/m) + Cable Factor (dB).
 3. The other emission levels were very low against the limit.
 4. Margin value = Emission level – Limit value.

5.2 CONDUCTED EMISSION MEASUREMENT

5.2.1 LIMITS OF CONDUCTED EMISSION MEASUREMENT

FREQUENCY OF EMISSION (MHz)	CONDUCTED LIMIT (dB μ V)	
	Quasi-peak	Average
0.15 ~ 0.5	66 to 56	56 to 46
0.5 ~ 5	56	46
5 ~ 30	60	50

- NOTE:** 1. The lower limit shall apply at the transition frequencies.
2. The limit decreases in line with the logarithm of the frequency in the range of 0.15 to 0.50MHz.
3. All emanations from a class A/B digital device or system, including any network of conductors and apparatus connected thereto, shall not exceed the level of field strengths specified above.

5.2.2 TEST INSTRUMENTS

DESCRIPTION & MANUFACTURER	MODEL NO.	SERIAL NO.	DATE OF CALIBRATION	DUE DATE OF CALIBRATION
Test Receiver ROHDE & SCHWARZ	ESCS30	100288	Oct. 04, 2011	Oct. 03, 2012
RF signal cable Woken	5D-FB	Cable-HYCO2-01	Dec. 30, 2010	Dec. 29, 2011
LISN ROHDE & SCHWARZ	ESH2-Z5	100100	Jan. 06, 2011	Jan. 05, 2012
LISN ROHDE & SCHWARZ	ESH3-Z5	100312	Jul. 07, 2011	Jul. 06, 2012
V-LISN SCHWARZBECK	NNBL 8226-2	8226-142	Jun. 30, 2011	Jun. 29, 2012
LISN ROHDE & SCHWARZ	ENV216	100072	Jun. 10, 2011	Jun. 09, 2012
Software ADT	ADT_Cond_ V7.3.7	NA	NA	NA

- NOTE:** 1. The calibration interval of the above test instruments is 12 months and the calibrations are traceable to NML/ROC and NIST/USA.
2. The test was performed in HwaYa Shielded Room 2.
3. The VCCI Site Registration No. is C-2047.

5.2.3 TEST PROCEDURES

- a. The EUT was placed 0.4 meters from the conducting wall of the shielded room with EUT being connected to the power mains through a line impedance stabilization network (LISN). Other support units were connected to the power mains through another LISN. The two LISNs provide 50 ohm/ 50uH of coupling impedance for the measuring instrument.
- b. Both lines of the power mains connected to the EUT were checked for maximum conducted interference.
- c. The frequency range from 150kHz to 30MHz was searched. Emission levels under (Limit - 20dB) was not recorded.

NOTE: All modes of operation were investigated and the worst-case emissions are reported.

5.2.4 DEVIATION FROM TEST STANDARD

No deviation.

5.2.5 TEST SETUP

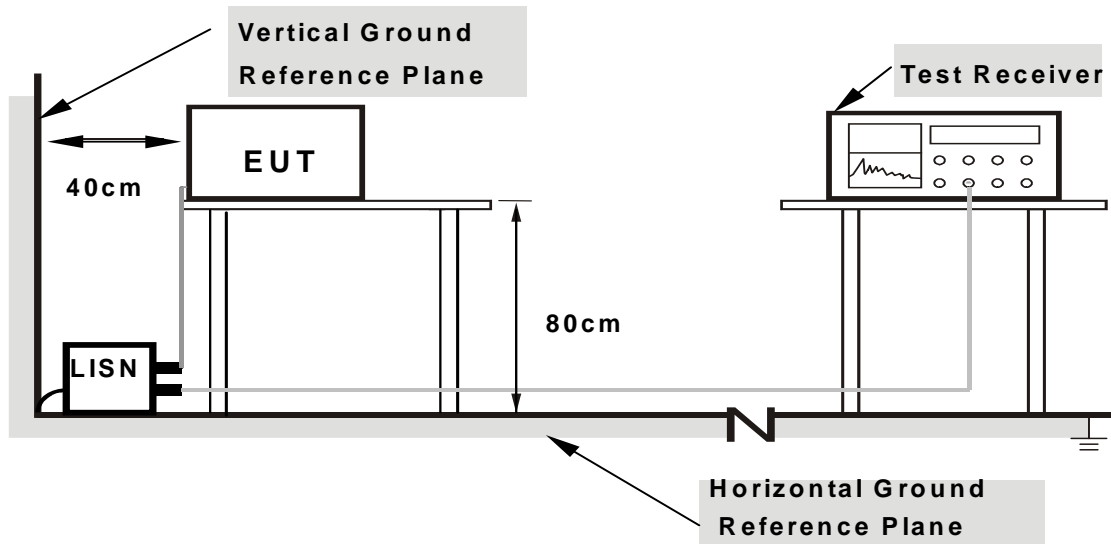

- Note:**
1. Support units were connected to second LISN.
 2. Both of LISNs (AMN) are 80 cm from EUT and at least 80 cm from other units and other metal planes

For the actual test configuration, please refer to the attached file (Test Setup Photo).

5.2.6 EUT OPERATING CONDITIONS

Same as 4.1.6.

5.2.7 TEST RESULTS

CONDUCTED WORST-CASE DATA : 802.11a

PHASE	Line 1	6dB BANDWIDTH	9kHz
TEST MODE	A		

No	Freq. [MHz]	Corr. Factor (dB)	Reading Value [dB (uV)]		Emission Level [dB (uV)]		Limit [dB (uV)]		Margin (dB)	
			Q.P.	AV.	Q.P.	AV.	Q.P.	AV.	Q.P.	AV.
1	0.384	0.20	53.31	45.45	53.51	45.65	58.18	48.18	-4.68	-2.54
2	0.662	0.21	42.00	-	42.21	-	56.00	46.00	-13.79	-
3	0.955	0.23	42.07	-	42.30	-	56.00	46.00	-13.70	-
4	1.215	0.24	41.64	-	41.88	-	56.00	46.00	-14.12	-
5	2.355	0.28	41.35	-	41.63	-	56.00	46.00	-14.37	-
6	4.727	0.40	39.08	-	39.48	-	56.00	46.00	-16.52	-

- REMARKS:**
1. Q.P. and AV. are abbreviations of quasi-peak and average individually.
 2. "-": The Quasi-peak reading value also meets average limit and measurement with the average detector is unnecessary.
 3. The emission levels of other frequencies were very low against the limit.
 4. Margin value = Emission level - Limit value
 5. Correction factor = Insertion loss + Cable loss
 6. Emission Level = Correction Factor + Reading Value.

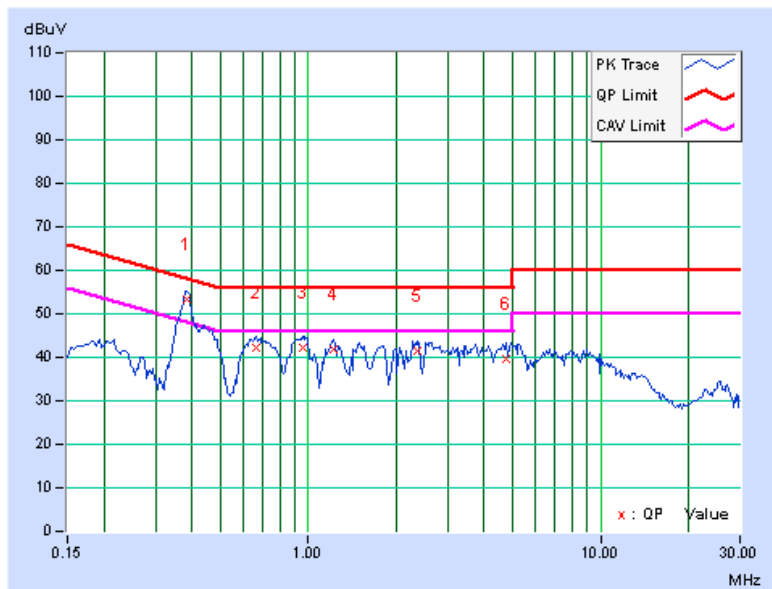

PHASE	Line 2	6dB BANDWIDTH	9kHz
TEST MODE	A		

No	Freq. [MHz]	Corr. Factor (dB)	Reading Value [dB (uV)]		Emission Level [dB (uV)]		Limit [dB (uV)]		Margin (dB)	
			Q.P.	AV.	Q.P.	AV.	Q.P.	AV.	Q.P.	AV.
1	0.390	0.21	46.55	-	46.76	-	58.07	48.07	-11.31	-
2	0.685	0.21	36.05	-	36.26	-	56.00	46.00	-19.74	-
3	0.974	0.21	36.78	-	36.99	-	56.00	46.00	-19.01	-
4	1.301	0.22	34.90	-	35.12	-	56.00	46.00	-20.88	-
5	2.621	0.27	35.43	-	35.70	-	56.00	46.00	-20.30	-
6	4.797	0.38	33.95	-	34.33	-	56.00	46.00	-21.67	-

- REMARKS:**
1. Q.P. and AV. are abbreviations of quasi-peak and average individually.
 2. "-": The Quasi-peak reading value also meets average limit and measurement with the average detector is unnecessary.
 3. The emission levels of other frequencies were very low against the limit.
 4. Margin value = Emission level - Limit value
 5. Correction factor = Insertion loss + Cable loss
 6. Emission Level = Correction Factor + Reading Value.

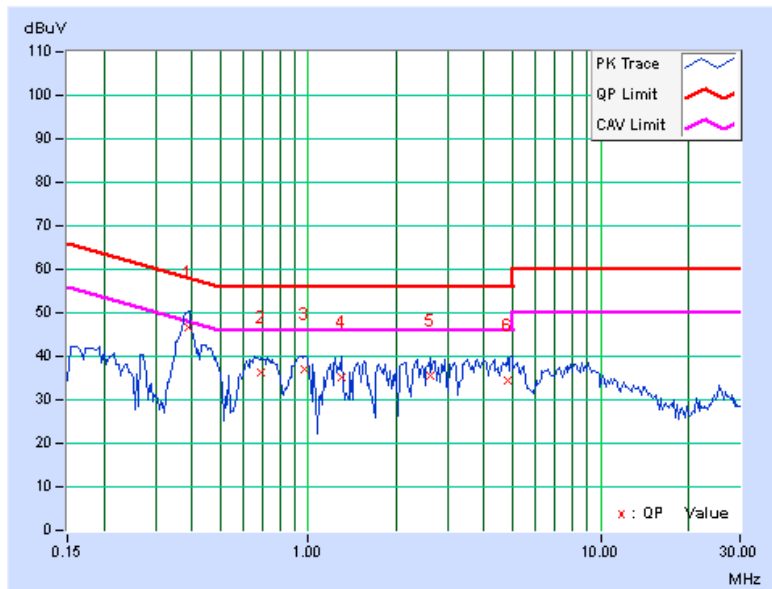

PHASE	Line 1	6dB BANDWIDTH	9kHz
TEST MODE	B		

No	Freq.	Corr.	Reading Value		Emission Level		Limit		Margin	
	[MHz]	Factor	[dB (uV)]		[dB (uV)]		[dB (uV)]		(dB)	
		(dB)	Q.P.	AV.	Q.P.	AV.	Q.P.	AV.	Q.P.	AV.
1	0.173	0.17	56.44	45.10	56.61	45.27	64.79	54.79	-8.19	-9.53
2	0.498	0.20	50.78	40.70	50.98	40.90	56.04	46.04	-5.05	-5.13
3	1.492	0.24	44.49	-	44.73	-	56.00	46.00	-11.27	-
4	2.164	0.27	44.05	-	44.32	-	56.00	46.00	-11.68	-
5	2.668	0.30	44.70	-	45.00	-	56.00	46.00	-11.00	-
6	4.277	0.38	43.12	-	43.50	-	56.00	46.00	-12.50	-

- REMARKS:**
1. Q.P. and AV. are abbreviations of quasi-peak and average individually.
 2. "-": The Quasi-peak reading value also meets average limit and measurement with the average detector is unnecessary.
 3. The emission levels of other frequencies were very low against the limit.
 4. Margin value = Emission level - Limit value
 5. Correction factor = Insertion loss + Cable loss
 6. Emission Level = Correction Factor + Reading Value.

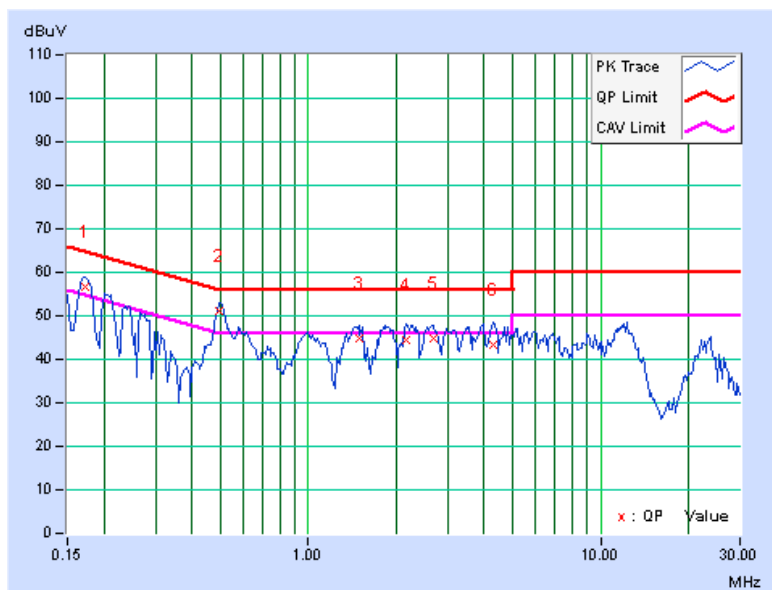

PHASE	Line 2	6dB BANDWIDTH	9kHz
TEST MODE	B		

No	Freq. [MHz]	Corr. Factor (dB)	Reading Value		Emission Level		Limit		Margin	
			[dB (uV)]		[dB (uV)]		[dB (uV)]		(dB)	
			Q.P.	AV.	Q.P.	AV.	Q.P.	AV.	Q.P.	AV.
1	0.173	0.19	56.42	44.47	56.61	44.66	64.79	54.79	-8.19	-10.14
2	0.498	0.21	49.67	39.47	49.88	39.68	56.04	46.04	-6.16	-6.36
3	2.230	0.25	46.35	39.75	46.60	40.00	56.00	46.00	-9.40	-6.00
4	4.156	0.36	41.20	-	41.56	-	56.00	46.00	-14.44	-
5	4.801	0.38	44.76	-	45.14	-	56.00	46.00	-10.86	-
6	11.898	0.68	50.59	45.68	51.27	46.36	60.00	50.00	-8.73	-3.64

- REMARKS:**
1. Q.P. and AV. are abbreviations of quasi-peak and average individually.
 2. "-": The Quasi-peak reading value also meets average limit and measurement with the average detector is unnecessary.
 3. The emission levels of other frequencies were very low against the limit.
 4. Margin value = Emission level - Limit value
 5. Correction factor = Insertion loss + Cable loss
 6. Emission Level = Correction Factor + Reading Value.

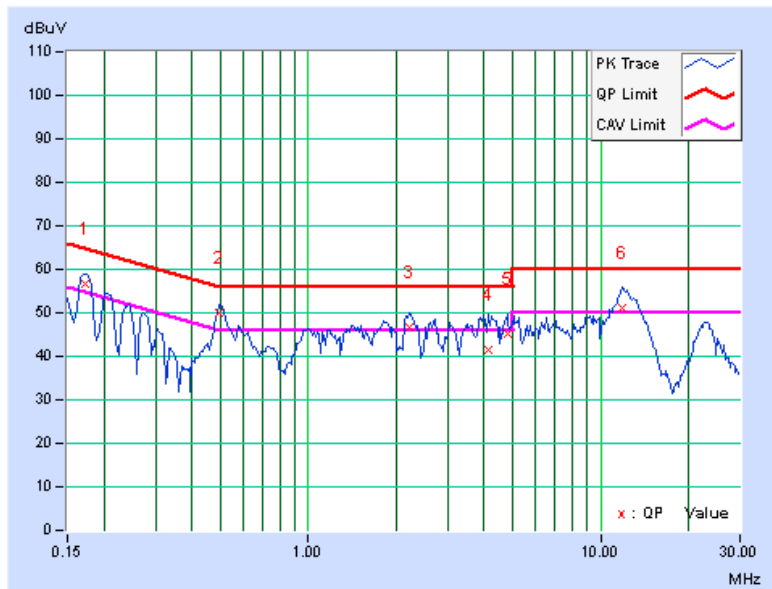

5.3 6dB BANDWIDTH MEASUREMENT

5.3.1 LIMITS OF 6dB BANDWIDTH MEASUREMENT

The minimum of 6dB Bandwidth Measurement is 0.5MHz.

5.3.2 TEST SETUP

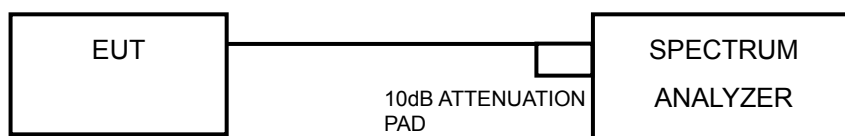

5.3.3 TEST INSTRUMENTS

Refer to section 4.1.2 to get information of above instrument.

5.3.4 TEST PROCEDURE

1. Set resolution bandwidth (RBW) = approximately 1% of the emission bandwidth
2. Set the video bandwidth (VBW) $\geq 3 \times$ RBW, Detector = Peak.
3. Trace mode = max hold.
4. Sweep = auto couple.
5. Measure the maximum width of the emission that is constrained by the frequencies associated with the two amplitude points (upper and lower) that are attenuated by 6 dB relative to the maximum level measured in the fundamental emission

5.3.5 DEVIATION FROM TEST STANDARD

No deviation.

5.3.6 EUT OPERATING CONDITIONS

The software provided by client to enable the EUT under transmission condition continuously at lowest, middle and highest channel frequencies individually.

5.3.7 TEST RESULTS

802.11a

CHANNEL	CHANNEL FREQUENCY (MHz)	6dB BANDWIDTH (MHz)		MINIMUM LIMIT (MHz)	PASS / FAIL
		CHAIN 0	CHAIN 1		
149	5745	16.45	16.57	0.5	PASS
157	5785	16.75	16.49	0.5	PASS
165	5825	16.66	16.59	0.5	PASS

802.11n (20MHz)

CHANNEL	CHANNEL FREQUENCY (MHz)	6dB BANDWIDTH (MHz)		MINIMUM LIMIT (MHz)	PASS / FAIL
		CHAIN 0	CHAIN 1		
149	5745	17.72	17.80	0.5	PASS
157	5785	17.84	17.82	0.5	PASS
165	5825	17.75	17.72	0.5	PASS

802.11n (40MHz)

CHANNEL	CHANNEL FREQUENCY (MHz)	6dB BANDWIDTH (MHz)		MINIMUM LIMIT (MHz)	PASS / FAIL
		CHAIN 0	CHAIN 1		
151	5755	36.75	36.88	0.5	PASS
159	5795	37.17	37.30	0.5	PASS

5.4 CONDUCTED OUTPUT POWER

5.4.1 LIMITS OF MAXIMUM OUTPUT POWER MEASUREMENT

For systems using digital modulation in the 5725 –5850 MHz bands: 1 Watt (30dBm)

5.4.2 TEST SETUP

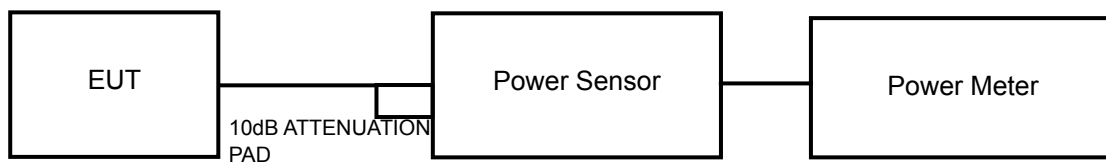

5.4.3 INSTRUMENTS

Refer to section 4.1.2 to get information of above instrument.

5.4.4 TEST PROCEDURES

A power sensor was used on the output port of the EUT. A power meter was used to read the response of the power sensor. Record the power level.

5.4.5 DEVIATION FROM TEST STANDARD

No deviation.

5.4.6 EUT OPERATING CONDITIONS

Same as Item 4.3.6.

5.4.7 TEST RESULTS

802.11a

CHAN.	FREQUENCY (MHz)	PEAK POWER (dBm)		TOTAL POWER (mW)	TOTAL POWER (dBm)	LIMIT (dBm)	PASS / FAIL
		CHAIN 0	CHAIN 1				
149	5745	24.7	23.2	504.1	27.0	29	PASS
157	5785	24.6	23.1	492.6	26.9	29	PASS
165	5825	24.7	23.1	499.3	27.0	29	PASS

NOTE: Directional gain = $4\text{dBi} + 10\log(2) = 7\text{dBi} > 6\text{dBi}$, so the limit shall be reduced to $30 - (7 - 6) = 29\text{dBm}$.

802.11n (20MHz)

CHAN.	FREQUENCY (MHz)	PEAK POWER (dBm)		TOTAL POWER (mW)	TOTAL POWER (dBm)	LIMIT (dBm)	PASS / FAIL
		CHAIN 0	CHAIN 1				
149	5745	24.4	23	474.9	26.8	30	PASS
157	5785	24.3	23.2	478.1	26.8	30	PASS
165	5825	24.4	23.1	479.6	26.8	30	PASS

802.11n (40MHz)

CHAN.	FREQUENCY (MHz)	PEAK POWER (dBm)		TOTAL POWER (mW)	TOTAL POWER (dBm)	LIMIT (dBm)	PASS / FAIL
		CHAIN 0	CHAIN 1				
151	5755	22.0	23.3	372.3	25.7	30	PASS
159	5795	24.4	23.1	479.6	26.8	30	PASS

5.5 POWER SPECTRAL DENSITY MEASUREMENT

5.5.1 LIMITS OF POWER SPECTRAL DENSITY MEASUREMENT

The Maximum of Power Spectral Density Measurement is 8dBm.

5.5.2 TEST SETUP

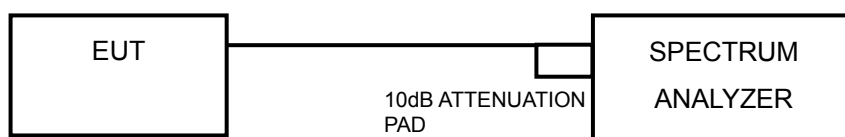

5.5.3 TEST INSTRUMENTS

Refer to section 4.1.2 to get information of above instrument.

5.5.4 TEST PROCEDURE.

1. Set the RBW = 100 kHz, VBW =300 kHz, Detector = peak.
2. Sweep time = auto couple, Trace mode = max hold, allow trace to fully stabilize.
3. Use the peak marker function to determine the maximum power level in any 100 kHz band segment within the fundamental EBW.
4. Scale the observed power level to an equivalent value in 3 kHz by adjusting (reducing) the measured power by a bandwidth correction factor (BWCF) where $BWCF = 10\log(3 \text{ kHz}/100\text{kHz})$

5.5.5 DEVIATION FROM TEST STANDARD

No deviation.

5.5.6 EUT OPERATING CONDITION

Same as Item 5.3.6.

5.5.7 TEST RESULTS

802.11a

TX chain	Channel	FREQ. (MHz)	PSD (dBm/100kHz)	PSD (dBm/3kHz)	10 log (N=2) dB	Total PSD (dBm/3kHz)	Limit (dBm/3kHz)	PASS /FAIL
0	149	5745	7.94	-7.29	3.01	-4.28	7	PASS
	157	5785	7.97	-7.26	3.01	-4.25	7	PASS
	165	5825	7.89	-7.34	3.01	-4.33	7	PASS
1	149	5745	8.56	-6.67	3.01	-3.66	7	PASS
	157	5785	8.41	-6.82	3.01	-3.81	7	PASS
	165	5825	8.44	-6.79	3.01	-3.78	7	PASS

NOTE: Directional gain = $4\text{dBi} + 10\log(2) = 7\text{dBi} > 6\text{dBi}$, so the limit shall be reduced to $8 - (7 - 6) = 7\text{dBm}$.

802.11n (20MHz)

TX chain	Channel	FREQ. (MHz)	PSD (dBm/100kHz)	PSD (dBm/3kHz)	10 log (N=2) dB	Total PSD (dBm/3kHz)	Limit (dBm/3kHz)	PASS /FAIL
0	149	5745	7.95	-7.28	3.01	-4.27	8	PASS
	157	5785	7.92	-7.31	3.01	-4.30	8	PASS
	165	5825	8.14	-7.09	3.01	-4.08	8	PASS
1	149	5745	7.51	-7.72	3.01	-4.71	8	PASS
	157	5785	7.85	-7.38	3.01	-4.37	8	PASS
	165	5825	7.78	-7.45	3.01	-4.44	8	PASS

802.11n (40MHz)

TX chain	Channel	FREQ. (MHz)	PSD (dBm/100kHz)	PSD (dBm/3kHz)	10 log (N=2) dB	Total PSD (dBm/3kHz)	Limit (dBm/3kHz)	PASS /FAIL
0	151	5755	2.06	-13.17	3.01	-10.16	8	PASS
	159	5795	5.50	-9.73	3.01	-6.72	8	PASS
1	151	5755	2.25	-12.98	3.01	-9.97	8	PASS
	159	5795	4.93	-10.30	3.01	-7.29	8	PASS

5.6 CONDUCTED EMISSION MEASUREMENT

5.6.1 LIMITS OF BAND EDGES MEASUREMENT

Below -20dB of the highest emission level of operating band (in 100kHz Resolution Bandwidth).

5.6.2 TEST SETUP

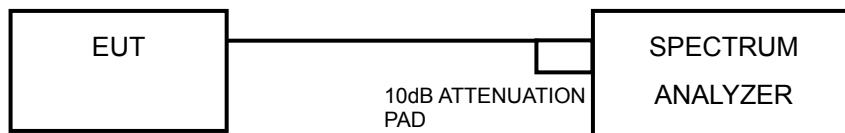

5.6.3 TEST INSTRUMENTS

Refer to section 4.1.2 to get information of above instrument.

5.6.4 TEST PROCEDURE

MEASUREMENT PROCEDURE REF

1. Set the RBW = 100 kHz.
2. Set the VBW \geq 300 kHz.
3. Detector = peak.
4. Sweep time = auto couple.
5. Trace mode = max hold.
6. Allow trace to fully stabilize.
7. Use the peak marker function to determine the maximum power level in any 100 kHz band segment within the fundamental EBW.

MEASUREMENT PROCEDURE OOB

1. Set RBW = 100 kHz.
2. Set VBW \geq 300 kHz.
3. Set span to encompass the spectrum to be examined.
4. Detector = peak.
5. Trace Mode = max hold.
6. Sweep = auto couple.

5.6.5 DEVIATION FROM TEST STANDARD

No deviation.

5.6.6 EUT OPERATING CONDITION

Same as Item 5.3.6

5.6.7 TEST RESULTS

The conducted emission test is performed on each TX port of operating mode without summing or adding $10\log(N)$ since the limit is relative emission limit. Only worst data of each operating mode is presented.

The spectrum plots are attached on the following pages. D1 line indicates the highest level, and D2 line indicates the 20dB offset below D1. It shows compliance with the requirement in part 15.247(d).



A D T

802.11a

CH 149

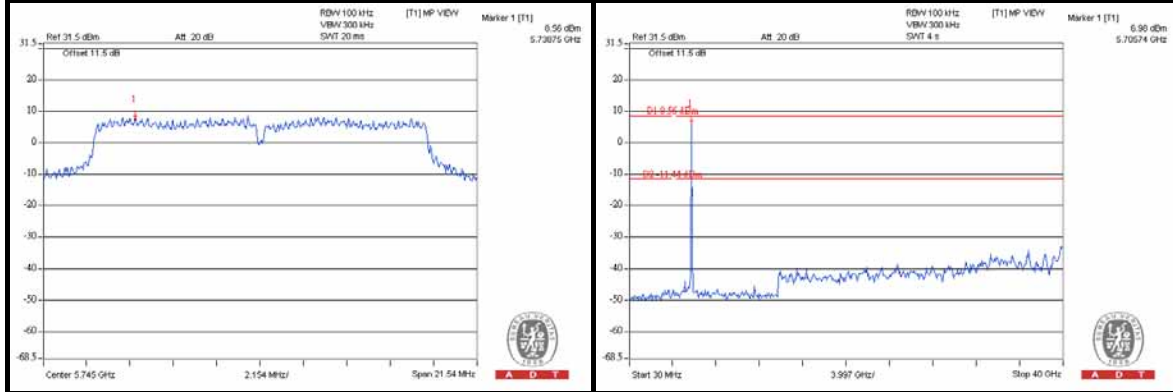

CH 157

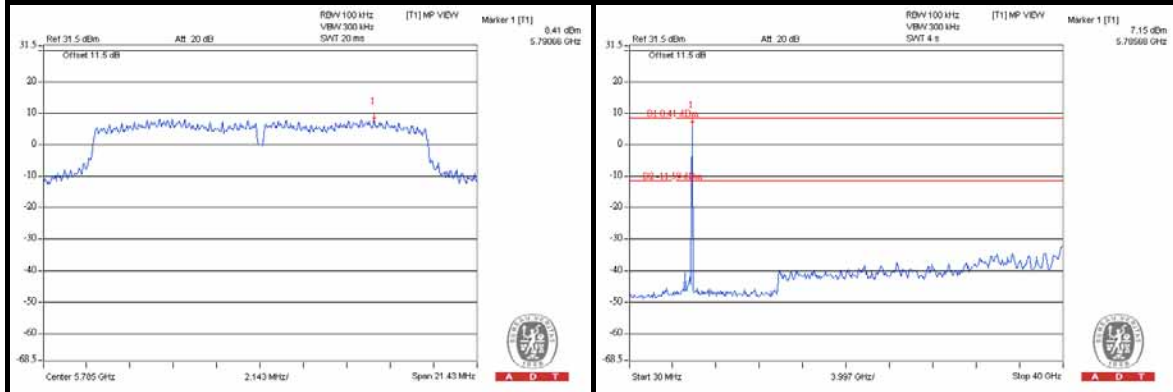

CH 165

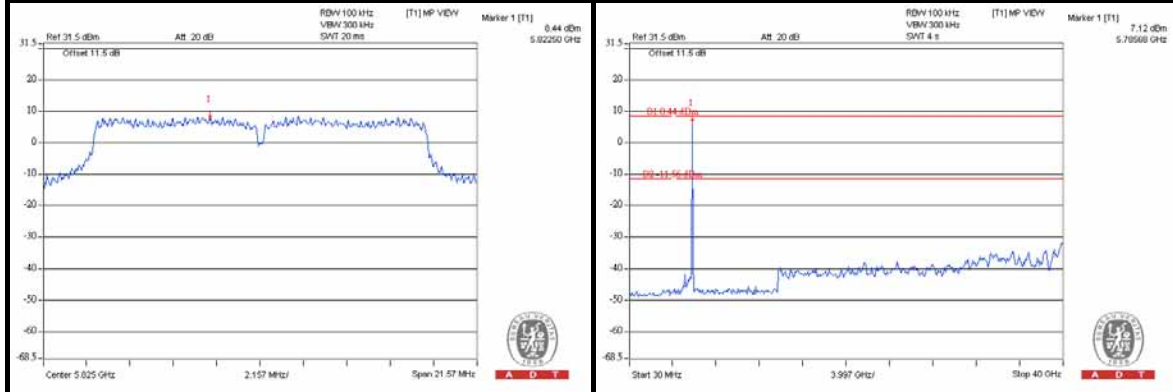



A D T

802.11n(20MHz)

CH 149

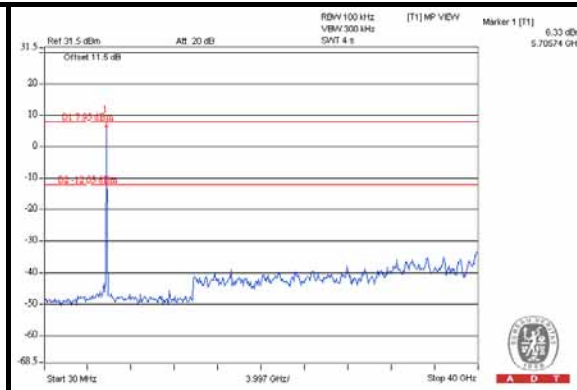
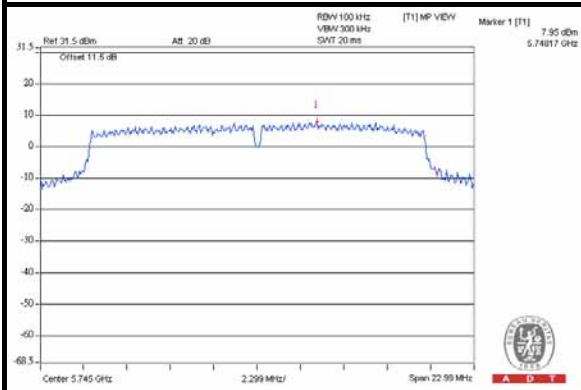

CH 157

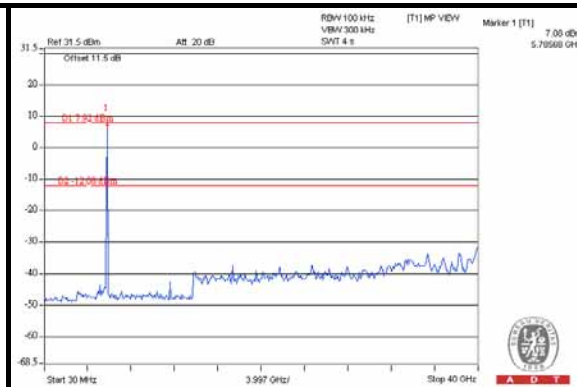
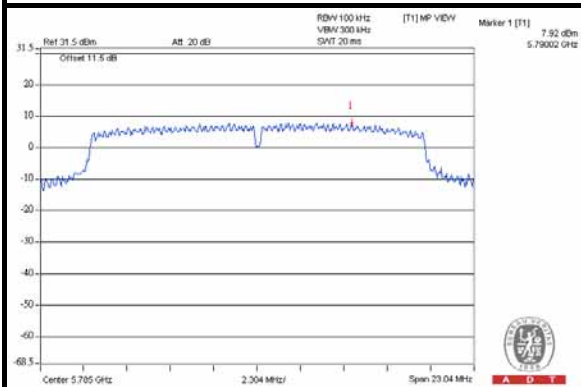

CH 165

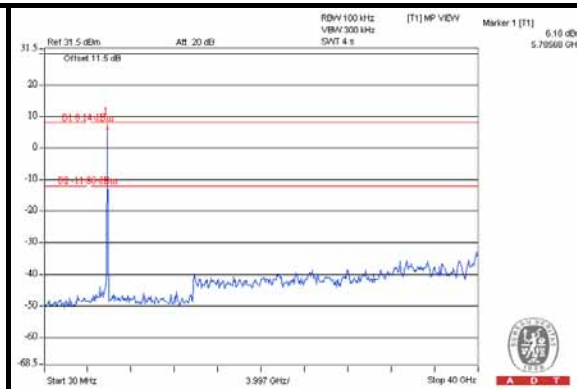
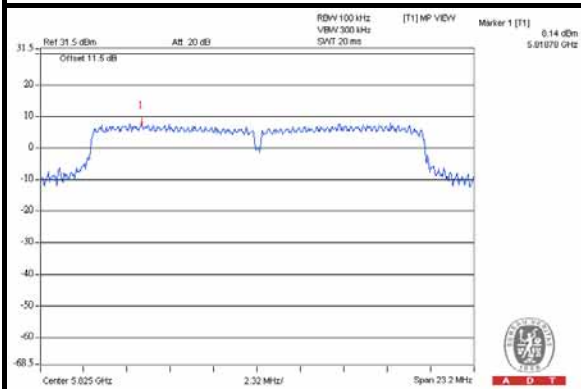



A D T

802.11n(40MHz)

CH 151

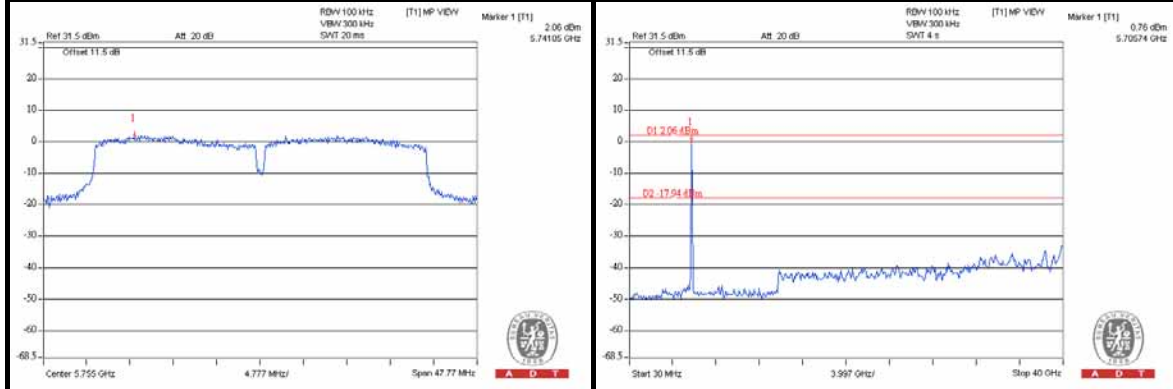

CH 159

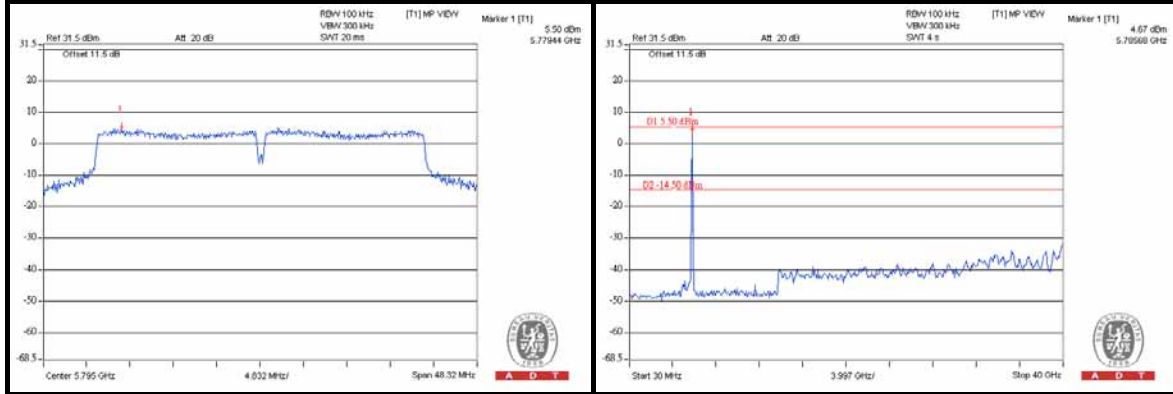



6. PHOTOGRAPHS OF THE TEST CONFIGURATION

Please refer to the attached file (Test Setup Photo).



7. INFORMATION ON THE TESTING LABORATORIES

We, Bureau Veritas Consumer Products Services (H.K.) Ltd., Taoyuan Branch, were founded in 1988 to provide our best service in EMC, Radio, Telecom and Safety consultation. Our laboratories are accredited and approved according to ISO/IEC 17025.

Copies of accreditation and authorization certificates of our laboratories obtained from approval agencies can be downloaded from our web site: www.adt.com.tw/index.5.phtml. If you have any comments, please feel free to contact us at the following:

Linko EMC/RF Lab:

Tel: 886-2-26052180

Fax: 886-2-26051924

Hsin Chu EMC/RF Lab:

Tel: 886-3-5935343

Fax: 886-3-5935342

Hwa Ya EMC/RF/Safety Telecom Lab:

Tel: 886-3-3183232

Fax: 886-3-3185050

Email: service.adt@tw.bureauveritas.com

Web Site: www.adt.com.tw

The address and road map of all our labs can be found in our web site also.



8. APPENDIX A - MODIFICATIONS RECORDERS FOR ENGINEERING CHANGES TO THE EUT BY THE LAB

No modifications were made to the EUT by the lab during the test.

---END---