



A D T

# FCC TEST REPORT

**REPORT NO.:** RF980720L09

**MODEL NO.:** EAP9550 (refer to item 3.1 for more detail)

**RECEIVED:** Jul. 09, 2009

**TESTED:** Jul. 24 ~ Aug. 10, 2009

**ISSUED:** Aug. 24, 2009

**APPLICANT:** Senao Networks Inc.

**ADDRESS:** 3F, No. 529, Chung Cheng Rd., Hsintien, Taipei,  
Taiwan, R.O.C.

**ISSUED BY:** Bureau Veritas Consumer Products Services  
(H.K.) Ltd., Taoyuan Branch

**LAB ADDRESS:** No. 47, 14th Ling, Chia Pau Tsuen, Lin Kou  
Hsiang, Taipei Hsien 244, Taiwan, R.O.C.

**TEST LOCATION:** No. 19, Hwa Ya 2nd Rd, Wen Hwa Tsuen, Kwei  
Shan Hsiang, Taoyuan Hsien 333, Taiwan,  
R.O.C.

This test report consists of 103 pages in total. It may be duplicated completely for legal use with the approval of the applicant. It should not be reproduced except in full, without the written approval of our laboratory. The client should not use it to claim product endorsement by TAF or any government agencies. The test results in the report only apply to the tested sample.





A D T

## TABLE OF CONTENTS

1.	CERTIFICATION.....	4
2.	SUMMARY OF TEST RESULTS .....	5
2.1	MEASUREMENT UNCERTAINTY .....	5
3.	GENERAL INFORMATION .....	6
3.1	GENERAL DESCRIPTION OF EUT .....	6
3.2	DESCRIPTION OF TEST MODES .....	8
3.2.1	CONFIGURATION OF SYSTEM UNDER TEST .....	9
3.2.2	TEST MODE APPLICABILITY AND TESTED CHANNEL DETAIL .....	10
3.3	GENERAL DESCRIPTION OF APPLIED STANDARDS .....	12
3.4	DESCRIPTION OF SUPPORT UNITS .....	12
4.	TEST TYPES AND RESULTS .....	13
4.1	RADIATED EMISSION MEASUREMENT .....	13
4.1.1	LIMITS OF RADIATED EMISSION MEASUREMENT .....	13
4.1.2	TEST INSTRUMENTS.....	14
4.1.3	TEST PROCEDURES .....	15
4.1.4	DEVIATION FROM TEST STANDARD.....	15
4.1.5	TEST SETUP .....	16
4.1.6	EUT OPERATING CONDITIONS .....	16
4.1.7	TEST RESULTS .....	17
4.2	CONDUCTED EMISSION MEASUREMENT .....	32
4.2.1	LIMITS OF CONDUCTED EMISSION MEASUREMENT .....	32
4.2.2	TEST INSTRUMENTS.....	32
4.2.3	TEST PROCEDURES .....	33
4.2.4	DEVIATION FROM TEST STANDARD.....	33
4.2.5	TEST SETUP .....	34
4.2.6	EUT OPERATING CONDITIONS .....	34
4.2.7	TEST RESULTS .....	35
4.3	6dB BANDWIDTH MEASUREMENT .....	41
4.3.1	LIMITS OF 6dB BANDWIDTH MEASUREMENT .....	41
4.3.2	TEST INSTRUMENTS.....	41
4.3.3	TEST PROCEDURE.....	41
4.3.4	DEVIATION FROM TEST STANDARD.....	41
4.3.5	TEST SETUP .....	42
4.3.6	EUT OPERATING CONDITIONS .....	42
4.3.7	TEST RESULTS .....	43
4.4	MAXIMUM PEAK OUTPUT POWER.....	59



A D T

4.4.1	LIMITS OF MAXIMUM PEAK OUTPUT POWER MEASUREMENT .....	59
4.4.2	INSTRUMENTS .....	59
4.4.3	TEST PROCEDURES .....	59
4.4.4	DEVIATION FROM TEST STANDARD.....	60
4.4.5	TEST SETUP .....	60
4.4.6	EUT OPERATING CONDITIONS .....	60
4.4.7	TEST RESULTS .....	61
4.5	POWER SPECTRAL DENSITY MEASUREMENT .....	63
4.5.1	LIMITS OF POWER SPECTRAL DENSITY MEASUREMENT .....	63
4.5.2	TEST INSTRUMENTS.....	63
4.5.3	TEST PROCEDURE.....	63
4.5.4	DEVIATION FROM TEST STANDARD.....	64
4.5.5	TEST SETUP.....	64
4.5.6	EUT OPERATING CONDITION.....	64
4.5.7	TEST RESULTS .....	65
4.6	BAND EDGES MEASUREMENT .....	81
4.6.1	LIMITS OF BAND EDGES MEASUREMENT .....	81
4.6.2	TEST INSTRUMENTS.....	81
4.6.3	TEST PROCEDURE.....	82
4.6.4	DEVIATION FROM TEST STANDARD.....	83
4.6.5	EUT OPERATING CONDITION.....	83
4.6.6	TEST RESULTS .....	84
4.7	ANTENNA REQUIREMENT .....	100
4.7.1	STANDARD APPLICABLE .....	100
4.7.2	ANTENNA CONNECTED CONSTRUCTION .....	100
5.	PHOTOGRAPHS OF THE TEST CONFIGURATION.....	101
6.	INFORMATION ON THE TESTING LABORATORIES .....	102
7.	APPENDIX A - MODIFICATIONS RECORDERS FOR ENGINEERING CHANGES TO THE EUT BY THE LAB.....	103



A D T

## 1. CERTIFICATION

**PRODUCT:** 11N Multi-Function AP/Repeater  
**MODEL:** EAP9550 (refer to item 3.1 for more detail)  
**BRAND:** EnGenius (refer to item 3.1 for more detail)  
**APPLICANT:** Senao Networks Inc.  
**TEST SAMPLE:** R&D SAMPLE  
**TESTED:** Jul. 24 ~ Aug. 10, 2009  
**STANDARDS:** **FCC Part 15, Subpart C (Section 15.247)**  
ANSI C63.4-2003

The above equipment (Model: EAP9550) has been tested by **Bureau Veritas Consumer Products Services (H.K.) Ltd., Taoyuan Branch**, and found compliance with the requirement of the above standards. The test record, data evaluation & Equipment Under Test (EUT) configurations represented herein are true and accurate accounts of the measurements of the sample's EMC characteristics under the conditions specified in this report.

**PREPARED BY** : Polly Chien , **DATE** : Aug. 24, 2009  
Polly Chien / Specialist

**TECHNICAL ACCEPTANCE** : Long Chen , **DATE** : Aug. 24, 2009  
Responsible for RF Long Chen / Senior Engineer

**APPROVED BY** : Gary Chang , **DATE** : Aug. 24, 2009  
Gary Chang / Assistant Manager



## 2. SUMMARY OF TEST RESULTS

The EUT has been tested according to the following specifications:

APPLIED STANDARD: FCC PART 15, SUBPART C (SECTION 15.247)			
STANDARD SECTION	TEST TYPE AND LIMIT	RESULT	REMARK
15.207	AC Power Conducted Emission	PASS	Meet the requirement of limit. Minimum passing margin is -6.10dB at 0.439MHz.
15.247(a)(2)	Spectrum Bandwidth of a Direct Sequence Spread Spectrum System Limit: min. 500kHz	PASS	Meet the requirement of limit.
15.247(b)	Maximum Peak Output Power Limit: max. 30dBm	PASS	Meet the requirement of limit.
15.247(d)	Radiated Emissions Limit: Table 15.209	PASS	Meet the requirement of limit. Minimum passing margin is -1.09dB at 2390.00MHz.
15.247(e)	Power Spectral Density Limit: max. 8dBm	PASS	Meet the requirement of limit.
15.247(d)	Band Edge Measurement Limit: 20dB less than the peak value of fundamental frequency	PASS	Meet the requirement of limit.

### 2.1 MEASUREMENT UNCERTAINTY

Where relevant, the following measurement uncertainty levels have been estimated for tests performed on the EUT as specified in CISPR 16-4-2:

MEASUREMENT	FREQUENCY	UNCERTAINTY
Conducted emissions	150kHz~30MHz	2.44 dB
Radiated emissions	30MHz ~ 200MHz	3.34 dB
	200MHz ~1000MHz	3.35 dB
	1GHz ~ 18GHz	2.26 dB
	18GHz ~ 40GHz	1.94 dB

This uncertainty represents an expanded uncertainty expressed at approximately the 95% confidence level using a coverage factor of  $k = 2$ .



### 3. GENERAL INFORMATION

#### 3.1 GENERAL DESCRIPTION OF EUT

<b>EUT</b>	11N Multi-Function AP/Repeater
<b>MODEL NO.</b>	EAP9550 (refer to note as below)
<b>FCC ID</b>	U2M-AP9550
<b>POWER SUPPLY</b>	12Vdc from AC adapter 48Vdc from POE
<b>MODULATION TYPE</b>	CCK, DQPSK, DBPSK for DSSS 64QAM, 16QAM, QPSK, BPSK for OFDM
<b>MODULATION TECHNOLOGY</b>	DSSS, OFDM
<b>TRANSFER RATE</b>	802.11b: 11.0/ 5.5/ 2.0/ 1.0Mbps 802.11g: 54.0/ 48.0/ 36.0/ 24.0/ 18.0/ 12.0/ 9.0/ 6.0Mbps Draft 802.11n: up to 300.0Mbps
<b>OPERATING FREQUENCY</b>	2412.0 ~ 2462.0MHz
<b>NUMBER OF CHANNEL</b>	11 for 802.11b, 802.11g, draft 802.11n (20MHz) 7 for draft 802.11n (40MHz)
<b>OUTPUT POWER</b>	324.37mW
<b>ANTENNA TYPE</b>	Internal directional antenna with 4dBi gain
<b>DATA CABLE</b>	NA
<b>I/O PORTS</b>	RJ45
<b>ACCESSORY DEVICES</b>	Adapter

**NOTE:**

1. The EUT incorporates a MIMO function. Physically, the EUT provides two completed transmitters and two receivers.

<b>MODULATION MODE</b>	<b>TX FUNCTION</b>
<b>802.11b</b>	2TX
<b>802.11g</b>	2TX
<b>Draft 802.11n (20MHz)</b>	2TX
<b>Draft 802.11n (40MHz)</b>	2TX

2. All models are electrically identical, different model names and brands are for marketing purpose.

<b>BRAND</b>	<b>MODEL</b>	<b>DIFFERENCE</b>
EnGenius	EAP9550	Marketing different
TRENDnet	TEW-653AP	



A D T

3. The EUT was powered by the following adapters:

Adapter 1	
<b>BRAND:</b>	DVE
<b>MODEL:</b>	DSA-12G-12 FUS 120120
<b>INPUT:</b>	100-240Vac, 50/60Hz, 0.3A
<b>OUTPUT:</b>	12Vdc, 1.0A
<b>POWER LINE:</b>	1.8 m non-shielded cable without core

Adapter 2	
<b>BRAND:</b>	AMIGO
<b>MODEL:</b>	AMS9-1201000FU2
<b>INPUT:</b>	100-240Vac, 50/60Hz, 0.5A
<b>OUTPUT:</b>	12Vdc, 1.0A
<b>POWER LINE:</b>	1.8m non-shielded cable without core

4. The above EUT information was declared by manufacturer and for more detailed features description, please refer to the manufacturer's specifications or user's manual.



### 3.2 DESCRIPTION OF TEST MODES

11 channels are provided for 802.11b, 802.11g and draft 802.11n (20MHz):

CHANNEL	FREQUENCY	CHANNEL	FREQUENCY
1	2412MHz	7	2442MHz
2	2417MHz	8	2447MHz
3	2422MHz	9	2452MHz
4	2427MHz	10	2457MHz
5	2432MHz	11	2462MHz
6	2437MHz		

7 channels are provided for draft 802.11n (40MHz):

CHANNEL	FREQUENCY	CHANNEL	FREQUENCY
1	2422MHz	5	2442MHz
2	2427MHz	6	2447MHz
3	2432MHz	7	2452MHz
4	2437MHz		



### 3.2.1 CONFIGURATION OF SYSTEM UNDER TEST

#### Test Mode A & B:

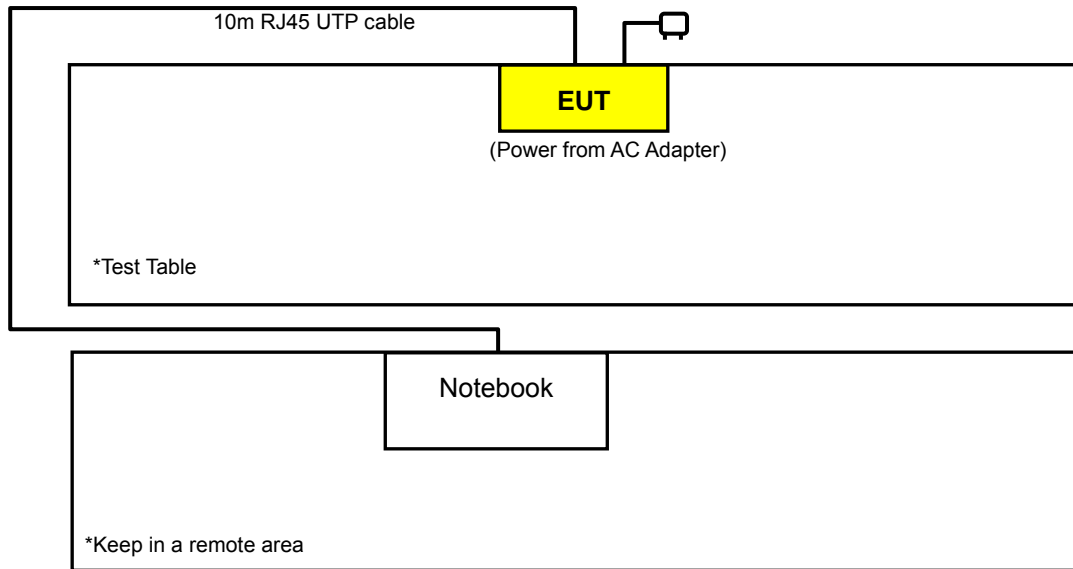

#### Test Mode C:

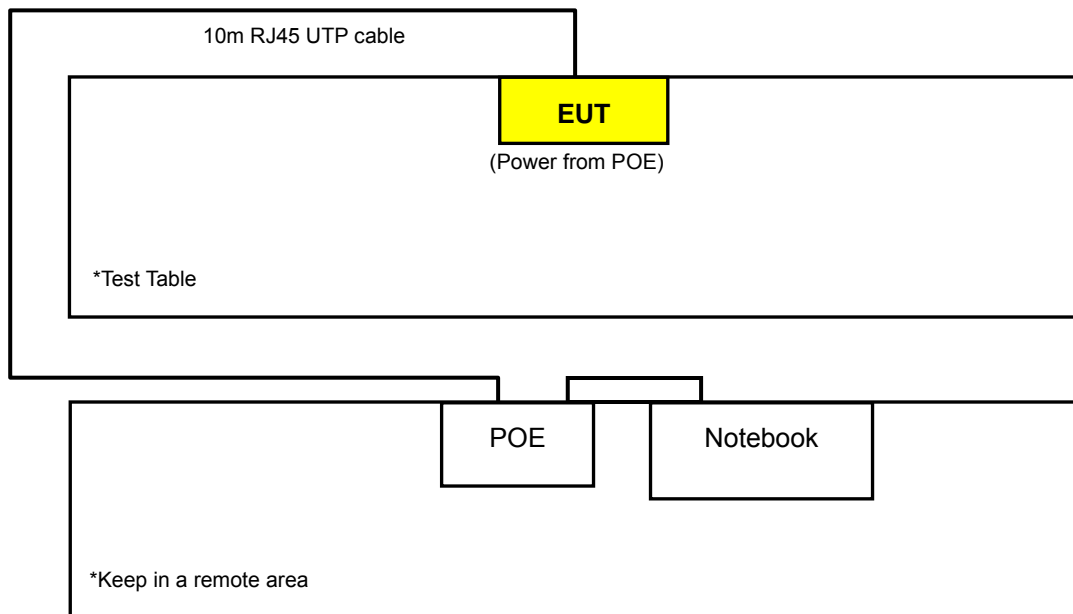



### 3.2.2 TEST MODE APPLICABILITY AND TESTED CHANNEL DETAIL

EUT CONFIGURE MODE	APPLICABLE TO				DESCRIPTION
	RE≥1G	RE<1G	PLC	APCM	
A	√	√	√	√	Power from Adapter 1: DSA-12G-12 FUS 120120
B	-	√	√	-	Power from Adapter 2: AMS9-1201000FU2
C	-	√	√	-	Power from POE

Where **RE≥1G**: Radiated Emission above 1GHz      **RE<1G**: Radiated Emission below 1GHz  
**PLC**: Power Line Conducted Emission      **APCM**: Antenna Port Conducted Measurement

**NOTE**: "-": Means no effect.

#### **RADIATED EMISSION TEST (ABOVE 1GHz):**

- Pre-Scan has been conducted to determine the worst-case mode from all possible combinations between available modulations, data rates, XYZ axis and antenna ports (if EUT with antenna diversity architecture).
- Following channel(s) was (were) selected for the final test as listed below.

EUT CONFIGURE MODE	MODE	AVAILABLE CHANNEL	TESTED CHANNEL	MODULATION TECHNOLOGY	MODULATION TYPE	DATA RATE (Mbps)	AXIS
A	802.11b	1 to 11	1, 6, 11	DSSS	DBPSK	1.0	Z
A	802.11g	1 to 11	1, 6, 11	OFDM	BPSK	6.0	
A	Draft 802.11n (20MHz)	1 to 11	1, 6, 11	OFDM	BPSK	7.2	
A	Draft 802.11n (40MHz)	1 to 7	1, 4, 7	OFDM	BPSK	15.0	

#### **RADIATED EMISSION TEST (BELOW 1GHz):**

- Pre-Scan has been conducted to determine the worst-case mode from all possible combinations between available modulations, data rates, XYZ axis and antenna ports (if EUT with antenna diversity architecture).
- Following channel(s) was (were) selected for the final test as listed below.

EUT CONFIGURE MODE	MODE	AVAILABLE CHANNEL	TESTED CHANNEL	MODULATION TECHNOLOGY	MODULATION TYPE	DATA RATE (Mbps)	AXIS
A, B, C	Draft 802.11n (20MHz)	1 to 11	6	OFDM	BPSK	7.2	Z



**POWER LINE CONDUCTED EMISSION TEST:**

- Pre-Scan has been conducted to determine the worst-case mode from all possible combinations between available modulations, data rates and antenna ports (if EUT with antenna diversity architecture).
- Following channel(s) was (were) selected for the final test as listed below.

EUT CONFIGURE MODE	MODE	AVAILABLE CHANNEL	TESTED CHANNEL	MODULATION TECHNOLOGY	MODULATION TYPE	DATA RATE (Mbps)
A, B, C	Draft 802.11n (20MHz)	1 to 11	6	OFDM	BPSK	7.2

**BANDEDGE MEASUREMENT:**

- Pre-Scan has been conducted to determine the worst-case mode from all possible combinations between available modulations, data rates and antenna ports (if EUT with antenna diversity architecture).
- Following channel(s) was (were) selected for the final test as listed below.

EUT CONFIGURE MODE	MODE	AVAILABLE CHANNEL	TESTED CHANNEL	MODULATION TECHNOLOGY	MODULATION TYPE	DATA RATE (Mbps)
A	802.11b	1 to 11	1, 11	DSSS	DBPSK	1.0
A	802.11g	1 to 11	1, 11	OFDM	BPSK	6.0
A	Draft 802.11n (20MHz)	1 to 11	1, 11	OFDM	BPSK	7.2
A	Draft 802.11n (40MHz)	1 to 7	1, 7	OFDM	BPSK	15.0

**ANTENNA PORT CONDUCTED MEASUREMENT:**

- Pre-Scan has been conducted to determine the worst-case mode from all possible combinations between available modulations, data rates and antenna ports (if EUT with antenna diversity architecture).
- Following channel(s) was (were) selected for the final test as listed below.

EUT CONFIGURE MODE	MODE	AVAILABLE CHANNEL	TESTED CHANNEL	MODULATION TECHNOLOGY	MODULATION TYPE	DATA RATE (Mbps)
A	802.11b	1 to 11	1, 6, 11	DSSS	DBPSK	1.0
A	802.11g	1 to 11	1, 6, 11	OFDM	BPSK	6.0
A	Draft 802.11n (20MHz)	1 to 11	1, 6, 11	OFDM	BPSK	7.2
A	Draft 802.11n (40MHz)	1 to 7	1, 4, 7	OFDM	BPSK	15.0



### 3.3 GENERAL DESCRIPTION OF APPLIED STANDARDS

The EUT is a RF Product. According to the specifications of the manufacturer, it must comply with the requirements of the following standards:

#### FCC Part 15, Subpart C (15.247)

#### ANSI C63.4-2003

All test items have been performed and recorded as per the above standards.

**NOTE:** The EUT is also considered as a kind of computer peripheral, because the connection to computer is necessary for typical use. It has been verified to comply with the requirements of FCC Part 15, Subpart B, Class B (DoC). The test report has been issued separately.

### 3.4 DESCRIPTION OF SUPPORT UNITS

The EUT has been tested as an independent unit together with other necessary accessories or support units. The following support units or accessories were used to form a representative test configuration during the tests.

NO.	PRODUCT	BRAND	MODEL NO.	SERIAL NO.	FCC ID
1	NOTEBOOK	DELL	PP05L	12130898320	E2K24CLNS
2	POE	SonicWall	PD-6083G300	NA	NA

NO.	SIGNAL CABLE DESCRIPTION OF THE ABOVE SUPPORT UNITS
1	10m RJ45 UTP cable.
2	10m RJ45 UTP cable.

**NOTE:**

1. All power cords of the above support units are non shielded (1.8m).
2. Item 1 acted as communication partners to transfer data.
3. Item 2 was provided by the client and for test mode C.



A D T

## 4. TEST TYPES AND RESULTS

### 4.1 RADIATED EMISSION MEASUREMENT

#### 4.1.1 LIMITS OF RADIATED EMISSION MEASUREMENT

Emissions radiated outside of the specified bands, shall be according to the general radiated limits in 15.209 as following:

FREQUENCIES (MHz)	FIELD STRENGTH (microvolts/meter)	MEASUREMENT DISTANCE (meters)
0.009 ~ 0.490	2400/F(kHz)	300
0.490 ~ 1.705	24000/F(kHz)	30
1.705 ~ 30.0	30	30
30 ~ 88	100	3
88 ~ 216	150	3
216 ~ 960	200	3
Above 960	500	3

**NOTE:**

1. The lower limit shall apply at the transition frequencies.
2. Emission level (dBuV/m) = 20 log Emission level (uV/m).
3. As shown in 15.35(b), for frequencies above 1000MHz, the field strength limits are based on average detector, however, the peak field strength of any emission shall not exceed the maximum permitted average limits, specified above by more than 20dB under any condition of modulation.



ADT

#### 4.1.2 TEST INSTRUMENTS

DESCRIPTION & MANUFACTURER	MODEL NO.	SERIAL NO.	DATE OF CALIBRATION	DUE DATE OF CALIBRATION
Test Receiver ROHDE & SCHWARZ	ESI7	100033	Jul. 06, 2009	Jul. 05, 2010
Spectrum Analyzer ROHDE & SCHWARZ	FSP40	100076	May. 26, 2009	May. 25, 2010
BILOG Antenna SCHWARZBECK	VULB9168	9168-160	Apr. 27, 2009	Apr. 26, 2010
HORN Antenna SCHWARZBECK	9120D	9120D-209	Jul. 01, 2009	Jun. 30, 2010
HORN Antenna SCHWARZBECK	BBHA 9170	BBHA9170243	Dec. 25, 2008	Dec. 24, 2009
Preamplifier Agilent	8447D	2944A10633	Nov. 03, 2008	Nov. 02, 2009
Preamplifier Agilent	8449B	3008A01964	Oct. 23, 2008	Oct. 22, 2009
RF signal cable HUBER+SUHNNER	SUCOFLEX 104	238141/4	May 13, 2009	May 12, 2010
RF signal cable HUBER+SUHNNER	SUCOFLEX 104	12738/6	May 13, 2009	May 12, 2010
Software ADT.	ADT_Radiated_ V7.6.15.9.2	NA	NA	NA
Antenna Tower inn-co GmbH	MA 4000	013303	NA	NA
Antenna Tower Controller inn-co GmbH	CO2000	017303	NA	NA
Turn Table ADT.	TT100.	TT93021703	NA	NA
Turn Table Controller ADT.	SC100.	SC93021703	NA	NA

- NOTE:**
1. The calibration interval of the above test instruments is 12 months and the calibrations are traceable to NML/ROC and NIST/USA.
  2. The test was performed in HwaYa Chamber 3.
  3. The horn antenna and HP preamplifier (model: 8449B) are used only for the measurement of emission frequency above 1GHz if tested.
  4. The FCC Site Registration No. is 988962.
  5. The IC Site Registration No. is IC 7450F-3.



#### 4.1.3 TEST PROCEDURES

- a. The EUT was placed on the top of a rotating table 0.8 meters above the ground at a 3 meters semi-anechoic chamber. The table was rotated 360 degrees to determine the position of the highest radiation.
- b. The EUT was set 3 meters away from the interference-receiving antenna, which was mounted on the top of a variable-height antenna tower.
- c. The antenna is a broadband antenna, and its height is varied from one meter to four meters above the ground to determine the maximum value of the field strength. Both horizontal and vertical polarizations of the antenna are set to make the measurement.
- d. For each suspected emission, the EUT was arranged to its worst case and then the antenna was tuned to heights from 1 meter to 4 meters and the rotatable table was turned from 0 degrees to 360 degrees to find the maximum reading.
- e. The test-receiver system was set to Peak Detect Function and Specified Bandwidth with Maximum Hold Mode.
- f. If the emission level of the EUT in peak mode was lower than the limit specified, then testing could be stopped and the peak values of the EUT would be reported. Otherwise the emissions would be re-tested one by one using peak, quasi-peak or average method as specified and then reported in a data sheet.

**NOTE:**

1. The resolution bandwidth and video bandwidth of test receiver/spectrum analyzer is 120kHz for Quasi-peak detection at frequency below 1GHz.
2. The resolution bandwidth of test receiver/spectrum analyzer is 1MHz and video bandwidth is 3MHz for Peak detection at frequency above 1GHz.
3. The resolution bandwidth of test receiver/spectrum analyzer is 1MHz and the video bandwidth is 10Hz for Average detection (AV) at frequency above 1GHz.
4. All modes of operation were investigated and the worst-case emissions are reported.

#### 4.1.4 DEVIATION FROM TEST STANDARD

No deviation.

#### 4.1.5 TEST SETUP

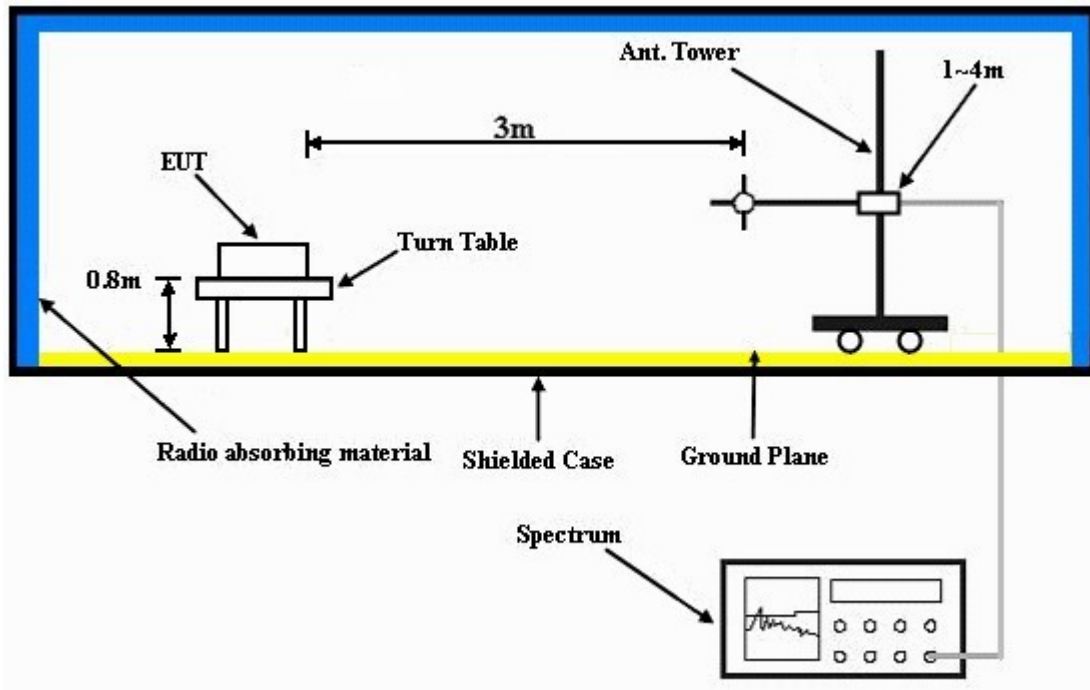

For the actual test configuration, please refer to the attached file (Test Setup Photo).

#### 4.1.6 EUT OPERATING CONDITIONS

- a. Placed the EUT on the testing table.
- b. Prepared the notebook computer and placed it outside of testing area to act as communication partner for EUT.
- c. The EUT ran a test program (provided by manufacturer) to enable all functions under transmission condition continuously at specific channel frequency.





A D T

#### 4.1.7 TEST RESULTS

##### 802.11b DSSS MODULATION

EUT TEST CONDITION		MEASUREMENT DETAIL	
CHANNEL	Channel 1	FREQUENCY RANGE	1 ~ 25GHz
INPUT POWER	120Vac, 60 Hz	DETECTOR FUNCTION	Peak (PK) Average (AV)
ENVIRONMENTAL CONDITIONS	24deg. C, 64%RH 1000 hPa	TESTED BY	Sun Lin
TEST MODE	A		

ANTENNA POLARITY & TEST DISTANCE: HORIZONTAL AT 3 M								
NO.	FREQ. (MHz)	EMISSION LEVEL (dBuV/m)	LIMIT (dBuV/m)	MARGIN (dB)	ANTENNA HEIGHT (m)	TABLE ANGLE (Degree)	RAW VALUE (dBuV)	CORRECTION FACTOR (dB/m)
1	2360.00	58.61 PK	74.00	-15.39	1.27 H	284	28.06	30.55
2	2360.00	50.09 AV	54.00	-3.91	1.27 H	284	19.54	30.55
3	*2412.00	110.30 PK			1.02 H	310	79.57	30.73
4	*2412.00	106.09 AV			1.02 H	310	75.36	30.73
5	2494.00	62.84 PK	74.00	-11.16	1.21 H	34	31.85	30.99
6	2494.00	52.89 AV	54.00	-1.11	1.21 H	34	21.90	30.99
7	4824.00	50.78 PK	74.00	-23.22	1.12 H	219	14.36	36.42
8	4824.00	44.13 AV	54.00	-9.87	1.12 H	219	7.71	36.42
ANTENNA POLARITY & TEST DISTANCE: VERTICAL AT 3 M								
NO.	FREQ. (MHz)	EMISSION LEVEL (dBuV/m)	LIMIT (dBuV/m)	MARGIN (dB)	ANTENNA HEIGHT (m)	TABLE ANGLE (Degree)	RAW VALUE (dBuV)	CORRECTION FACTOR (dB/m)
1	2390.00	57.65 PK	74.00	-16.35	1.55 V	209	27.00	30.65
2	2390.00	47.80 AV	54.00	-6.20	1.55 V	209	17.15	30.65
3	*2412.00	103.28 PK			1.20 V	33	72.55	30.73
4	*2412.00	99.03 AV			1.20 V	33	68.30	30.73
5	2494.00	59.12 PK	74.00	-14.88	1.07 V	339	28.13	30.99
6	2494.00	49.34 AV	54.00	-4.66	1.07 V	339	18.35	30.99
7	4824.00	50.15 PK	74.00	-23.85	1.00 V	345	13.73	36.42
8	4824.00	42.09 AV	54.00	-11.91	1.00 V	345	5.67	36.42

- REMARKS:**
1. Emission level (dBuV/m) = Raw Value (dBuV) + Correction Factor (dB/m).
  2. Correction Factor (dB/m) = Antenna Factor (dB/m) + Cable Factor (dB).
  3. The other emission levels were very low against the limit.
  4. Margin value = Emission level – Limit value.
  5. “ \* “: Fundamental frequency.



A D T

EUT TEST CONDITION		MEASUREMENT DETAIL	
CHANNEL	Channel 6	FREQUENCY RANGE	1 ~ 25GHz
INPUT POWER	120Vac, 60 Hz	DETECTOR FUNCTION	Peak (PK) Average (AV)
ENVIRONMENTAL CONDITIONS	24deg. C, 64%RH 1000 hPa	TESTED BY	Sun Lin
TEST MODE	A		

ANTENNA POLARITY & TEST DISTANCE: HORIZONTAL AT 3 M								
NO.	FREQ. (MHz)	EMISSION LEVEL (dBuV/m)	LIMIT (dBuV/m)	MARGIN (dB)	ANTENNA HEIGHT (m)	TABLE ANGLE (Degree)	RAW VALUE (dBuV)	CORRECTION FACTOR (dB/m)
1	2390.00	59.64 PK	74.00	-14.36	1.24 H	284	28.99	30.65
2	2390.00	50.72 AV	54.00	-3.28	1.24 H	284	20.07	30.65
3	*2437.00	110.25 PK			1.00 H	216	79.44	30.81
4	*2437.00	105.84 AV			1.00 H	216	75.03	30.81
5	2483.50	58.65 PK	74.00	-15.35	1.77 H	21	27.69	30.96
6	2483.50	46.71 AV	54.00	-7.29	1.77 H	21	15.75	30.96
7	4874.00	52.52 PK	74.00	-21.48	1.00 H	228	16.05	36.47
8	4874.00	47.03 AV	54.00	-6.97	1.00 H	228	10.56	36.47
ANTENNA POLARITY & TEST DISTANCE: VERTICAL AT 3 M								
NO.	FREQ. (MHz)	EMISSION LEVEL (dBuV/m)	LIMIT (dBuV/m)	MARGIN (dB)	ANTENNA HEIGHT (m)	TABLE ANGLE (Degree)	RAW VALUE (dBuV)	CORRECTION FACTOR (dB/m)
1	2360.00	57.31 PK	74.00	-16.69	1.20 V	18	26.76	30.55
2	2360.00	47.09 AV	54.00	-6.91	1.20 V	18	16.54	30.55
3	*2437.00	103.19 PK			1.15 V	12	72.38	30.81
4	*2437.00	98.75 AV			1.15 V	12	67.94	30.81
5	2483.50	58.07 PK	74.00	-15.93	1.38 V	140	27.11	30.96
6	2483.50	45.93 AV	54.00	-8.07	1.38 V	140	14.97	30.96
7	4874.00	51.44 PK	74.00	-22.56	1.02 V	140	14.97	36.47
8	4874.00	45.35 AV	54.00	-8.65	1.02 V	140	8.88	36.47

- REMARKS:**
1. Emission level (dBuV/m) = Raw Value (dBuV) + Correction Factor (dB/m).
  2. Correction Factor (dB/m) = Antenna Factor (dB/m) + Cable Factor (dB).
  3. The other emission levels were very low against the limit.
  4. Margin value = Emission level – Limit value.
  5. “ \* “: Fundamental frequency.



A D T

EUT TEST CONDITION		MEASUREMENT DETAIL	
CHANNEL	Channel 11	FREQUENCY RANGE	1 ~ 25GHz
INPUT POWER	120Vac, 60 Hz	DETECTOR FUNCTION	Peak (PK) Average (AV)
ENVIRONMENTAL CONDITIONS	24deg. C, 64%RH 1000 hPa	TESTED BY	Sun Lin
TEST MODE	A		

ANTENNA POLARITY & TEST DISTANCE: HORIZONTAL AT 3 M								
NO.	FREQ. (MHz)	EMISSION LEVEL (dBuV/m)	LIMIT (dBuV/m)	MARGIN (dB)	ANTENNA HEIGHT (m)	TABLE ANGLE (Degree)	RAW VALUE (dBuV)	CORRECTION FACTOR (dB/m)
1	2384.00	58.95 PK	74.00	-15.05	1.00 H	12	28.32	30.63
2	2384.00	49.15 AV	54.00	-4.85	1.00 H	12	18.52	30.63
3	*2462.00	110.73 PK			1.00 H	14	79.84	30.89
4	*2462.00	105.92 AV			1.00 H	14	75.03	30.89
5	2483.50	58.12 PK	74.00	-15.88	1.02 H	28	27.16	30.96
6	2483.50	46.93 AV	54.00	-7.07	1.02 H	28	15.97	30.96
7	4924.00	52.94 PK	74.00	-21.06	1.38 H	228	16.36	36.58
8	4924.00	48.28 AV	54.00	-5.72	1.38 H	228	11.70	36.58
ANTENNA POLARITY & TEST DISTANCE: VERTICAL AT 3 M								
NO.	FREQ. (MHz)	EMISSION LEVEL (dBuV/m)	LIMIT (dBuV/m)	MARGIN (dB)	ANTENNA HEIGHT (m)	TABLE ANGLE (Degree)	RAW VALUE (dBuV)	CORRECTION FACTOR (dB/m)
1	2384.00	56.33 PK	74.00	-17.67	1.15 V	40	25.70	30.63
2	2384.00	46.18 AV	54.00	-7.82	1.15 V	40	15.55	30.63
3	*2462.00	103.63 PK			1.43 V	0	72.74	30.89
4	*2462.00	98.84 AV			1.43 V	0	67.95	30.89
5	2483.50	57.89 PK	74.00	-16.11	1.09 V	328	26.93	30.96
6	2483.50	46.12 AV	54.00	-7.88	1.09 V	328	15.16	30.96
7	4924.00	51.19 PK	74.00	-22.81	1.35 V	13	14.61	36.58
8	4924.00	44.64 AV	54.00	-9.36	1.35 V	13	8.06	36.58

- REMARKS:**
1. Emission level (dBuV/m) = Raw Value (dBuV) + Correction Factor (dB/m).
  2. Correction Factor (dB/m) = Antenna Factor (dB/m) + Cable Factor (dB).
  3. The other emission levels were very low against the limit.
  4. Margin value = Emission level – Limit value.
  5. “ \* “: Fundamental frequency.



A D T

**802.11g OFDM MODULATION**

EUT TEST CONDITION		MEASUREMENT DETAIL	
CHANNEL	Channel 1	FREQUENCY RANGE	1 ~ 25GHz
INPUT POWER	120Vac, 60 Hz	DETECTOR FUNCTION	Peak (PK) Average (AV)
ENVIRONMENTAL CONDITIONS	24deg. C, 64%RH 1000 hPa	TESTED BY	Sun Lin
TEST MODE	A		

ANTENNA POLARITY & TEST DISTANCE: HORIZONTAL AT 3 M								
NO.	FREQ. (MHz)	EMISSION LEVEL (dBuV/m)	LIMIT (dBuV/m)	MARGIN (dB)	ANTENNA HEIGHT (m)	TABLE ANGLE (Degree)	RAW VALUE (dBuV)	CORRECTION FACTOR (dB/m)
1	2390.00	72.73 PK	74.00	-1.27	1.00 H	312	42.08	30.65
2	2390.00	52.59 AV	54.00	-1.41	1.00 H	312	21.94	30.65
3	*2412.00	110.89 PK			1.01 H	309	80.16	30.73
4	*2412.00	100.90 AV			1.01 H	309	70.17	30.73
5	2488.00	63.44 PK	74.00	-10.56	1.18 H	48	32.47	30.97
6	2488.00	51.92 AV	54.00	-2.08	1.18 H	48	20.95	30.97
7	4824.00	53.13 PK	74.00	-20.87	1.43 H	266	16.71	36.42
8	4824.00	38.78 AV	54.00	-15.22	1.43 H	266	2.36	36.42
ANTENNA POLARITY & TEST DISTANCE: VERTICAL AT 3 M								
NO.	FREQ. (MHz)	EMISSION LEVEL (dBuV/m)	LIMIT (dBuV/m)	MARGIN (dB)	ANTENNA HEIGHT (m)	TABLE ANGLE (Degree)	RAW VALUE (dBuV)	CORRECTION FACTOR (dB/m)
1	2390.00	57.58 PK	74.00	-16.42	1.41 V	302	26.93	30.65
2	2390.00	49.18 AV	54.00	-4.82	1.41 V	302	18.53	30.65
3	*2412.00	102.69 PK			1.45 V	5	71.96	30.73
4	*2412.00	92.79 AV			1.45 V	5	62.06	30.73
5	2495.00	61.77 PK	74.00	-12.23	1.42 V	9	30.78	30.99
6	2495.00	50.81 AV	54.00	-3.19	1.42 V	9	19.82	30.99
7	4824.00	50.28 PK	74.00	-23.72	1.03 V	140	13.86	36.42
8	4824.00	36.46 AV	54.00	-17.54	1.03 V	140	0.04	36.42

- REMARKS:**
1. Emission level (dBuV/m) = Raw Value (dBuV) + Correction Factor (dB/m).
  2. Correction Factor (dB/m) = Antenna Factor (dB/m) + Cable Factor (dB).
  3. The other emission levels were very low against the limit.
  4. Margin value = Emission level – Limit value.
  5. “ \* “: Fundamental frequency.



A D T

EUT TEST CONDITION		MEASUREMENT DETAIL	
CHANNEL	Channel 6	FREQUENCY RANGE	1 ~ 25GHz
INPUT POWER	120Vac, 60 Hz	DETECTOR FUNCTION	Peak (PK) Average (AV)
ENVIRONMENTAL CONDITIONS	24deg. C, 64%RH 1000 hPa	TESTED BY	Sun Lin
TEST MODE	A		

ANTENNA POLARITY & TEST DISTANCE: HORIZONTAL AT 3 M								
NO.	FREQ. (MHz)	EMISSION LEVEL (dBuV/m)	LIMIT (dBuV/m)	MARGIN (dB)	ANTENNA HEIGHT (m)	TABLE ANGLE (Degree)	RAW VALUE (dBuV)	CORRECTION FACTOR (dB/m)
1	2390.00	59.63 PK	74.00	-14.37	1.00 H	310	28.98	30.65
2	2390.00	49.57 AV	54.00	-4.43	1.00 H	310	18.92	30.65
3	*2437.00	110.42 PK			1.00 H	308	79.61	30.81
4	*2437.00	100.31 AV			1.00 H	308	69.50	30.81
5	2490.00	59.45 PK	74.00	-14.55	1.00 H	24	28.47	30.98
6	2490.00	47.89 AV	54.00	-6.11	1.00 H	24	16.91	30.98
7	4874.00	51.61 PK	74.00	-22.39	1.47 H	79	15.14	36.47
8	4874.00	38.36 AV	54.00	-15.64	1.47 H	79	1.89	36.47
ANTENNA POLARITY & TEST DISTANCE: VERTICAL AT 3 M								
NO.	FREQ. (MHz)	EMISSION LEVEL (dBuV/m)	LIMIT (dBuV/m)	MARGIN (dB)	ANTENNA HEIGHT (m)	TABLE ANGLE (Degree)	RAW VALUE (dBuV)	CORRECTION FACTOR (dB/m)
1	2390.00	57.33 PK	74.00	-16.67	1.52 V	132	26.68	30.65
2	2390.00	46.31 AV	54.00	-7.69	1.52 V	132	15.66	30.65
3	*2437.00	102.31 PK			1.07 V	36	71.50	30.81
4	*2437.00	92.22 AV			1.07 V	36	61.41	30.81
5	2490.00	57.45 PK	74.00	-16.55	1.03 V	210	26.47	30.98
6	2490.00	45.86 AV	54.00	-8.14	1.03 V	210	14.88	30.98
7	4874.00	47.12 PK	74.00	-26.88	1.26 V	307	10.65	36.47
8	4874.00	34.21 AV	54.00	-19.79	1.26 V	307	-2.26	36.47

- REMARKS:**
1. Emission level (dBuV/m) = Raw Value (dBuV) + Correction Factor (dB/m).
  2. Correction Factor (dB/m) = Antenna Factor (dB/m) + Cable Factor (dB).
  3. The other emission levels were very low against the limit.
  4. Margin value = Emission level – Limit value.
  5. “ \* “: Fundamental frequency.



A D T

EUT TEST CONDITION		MEASUREMENT DETAIL	
CHANNEL	Channel 11	FREQUENCY RANGE	1 ~ 25GHz
INPUT POWER	120Vac, 60 Hz	DETECTOR FUNCTION	Peak (PK) Average (AV)
ENVIRONMENTAL CONDITIONS	24deg. C, 64%RH 1000 hPa	TESTED BY	Sun Lin
TEST MODE	A		

ANTENNA POLARITY & TEST DISTANCE: HORIZONTAL AT 3 M								
NO.	FREQ. (MHz)	EMISSION LEVEL (dBuV/m)	LIMIT (dBuV/m)	MARGIN (dB)	ANTENNA HEIGHT (m)	TABLE ANGLE (Degree)	RAW VALUE (dBuV)	CORRECTION FACTOR (dB/m)
1	2360.00	60.28 PK	74.00	-13.72	1.01 H	312	29.73	30.55
2	2360.00	49.08 AV	54.00	-4.92	1.01 H	312	18.53	30.55
3	*2462.00	110.61 PK			1.00 H	326	79.72	30.89
4	*2462.00	100.51 AV			1.00 H	326	69.62	30.89
5	2483.50	70.94 PK	74.00	-3.06	1.20 H	49	39.98	30.96
6	2483.50	51.63 AV	54.00	-2.37	1.20 H	49	20.67	30.96
7	4924.00	51.05 PK	74.00	-22.95	1.24 H	246	14.47	36.58
8	4924.00	38.09 AV	54.00	-15.91	1.24 H	246	1.51	36.58
ANTENNA POLARITY & TEST DISTANCE: VERTICAL AT 3 M								
NO.	FREQ. (MHz)	EMISSION LEVEL (dBuV/m)	LIMIT (dBuV/m)	MARGIN (dB)	ANTENNA HEIGHT (m)	TABLE ANGLE (Degree)	RAW VALUE (dBuV)	CORRECTION FACTOR (dB/m)
1	2390.00	57.30 PK	74.00	-16.70	1.06 V	47	26.65	30.65
2	2390.00	48.28 AV	54.00	-5.72	1.06 V	47	17.63	30.65
3	*2462.00	102.46 PK			1.08 V	341	71.57	30.89
4	*2462.00	92.39 AV			1.08 V	341	61.50	30.89
5	2483.50	68.38 PK	74.00	-5.62	1.24 V	315	37.42	30.96
6	2483.50	50.25 AV	54.00	-3.75	1.24 V	315	19.29	30.96
7	4924.00	51.60 PK	74.00	-22.40	1.32 V	35	15.02	36.58
8	4924.00	38.14 AV	54.00	-15.86	1.32 V	35	1.56	36.58

- REMARKS:**
1. Emission level (dBuV/m) = Raw Value (dBuV) + Correction Factor (dB/m).
  2. Correction Factor (dB/m) = Antenna Factor (dB/m) + Cable Factor (dB).
  3. The other emission levels were very low against the limit.
  4. Margin value = Emission level – Limit value.
  5. “ \* “: Fundamental frequency.



A D T

**DRAFT 802.11n (20MHz) OFDM MODULATION**

EUT TEST CONDITION		MEASUREMENT DETAIL	
CHANNEL	Channel 1	FREQUENCY RANGE	1 ~ 25GHz
INPUT POWER	120Vac, 60 Hz	DETECTOR FUNCTION	Peak (PK) Average (AV)
ENVIRONMENTAL CONDITIONS	24deg. C, 64%RH 1000 hPa	TESTED BY	Sun Lin
TEST MODE	A		

ANTENNA POLARITY & TEST DISTANCE: HORIZONTAL AT 3 M								
NO.	FREQ. (MHz)	EMISSION LEVEL (dBuV/m)	LIMIT (dBuV/m)	MARGIN (dB)	ANTENNA HEIGHT (m)	TABLE ANGLE (Degree)	RAW VALUE (dBuV)	CORRECTION FACTOR (dB/m)
1	2390.00	72.91 PK	74.00	-1.09	1.94 H	315	42.26	30.65
2	2390.00	51.70 AV	54.00	-2.30	1.94 H	315	21.05	30.65
3	*2412.00	110.18 PK			1.27 H	317	79.45	30.73
4	*2412.00	100.37 AV			1.27 H	317	69.64	30.73
5	2497.00	61.73 PK	74.00	-12.27	1.00 H	175	30.73	31.00
6	2497.00	50.37 AV	54.00	-3.63	1.00 H	175	19.37	31.00
7	4824.00	52.16 PK	74.00	-21.84	1.38 H	336	15.74	36.42
8	4824.00	37.42 AV	54.00	-16.58	1.38 H	336	1.00	36.42
ANTENNA POLARITY & TEST DISTANCE: VERTICAL AT 3 M								
NO.	FREQ. (MHz)	EMISSION LEVEL (dBuV/m)	LIMIT (dBuV/m)	MARGIN (dB)	ANTENNA HEIGHT (m)	TABLE ANGLE (Degree)	RAW VALUE (dBuV)	CORRECTION FACTOR (dB/m)
1	2390.00	61.69 PK	74.00	-12.31	1.28 V	314	31.04	30.65
2	2390.00	48.34 AV	54.00	-5.66	1.28 V	314	17.69	30.65
3	*2412.00	102.03 PK			1.17 V	31	71.30	30.73
4	*2412.00	92.26 AV			1.17 V	31	61.53	30.73
5	2486.00	61.77 PK	74.00	-12.23	1.41 V	103	30.80	30.97
6	2486.00	49.95 AV	54.00	-4.05	1.41 V	103	18.98	30.97
7	4824.00	50.23 PK	74.00	-23.77	1.08 V	144	13.81	36.42
8	4824.00	35.47 AV	54.00	-18.53	1.08 V	144	-0.95	36.42

- REMARKS:**
1. Emission level (dBuV/m) = Raw Value (dBuV) + Correction Factor (dB/m).
  2. Correction Factor (dB/m) = Antenna Factor (dB/m) + Cable Factor (dB).
  3. The other emission levels were very low against the limit.
  4. Margin value = Emission level – Limit value.
  5. “ \* “: Fundamental frequency.



A D T

EUT TEST CONDITION		MEASUREMENT DETAIL	
CHANNEL	Channel 6	FREQUENCY RANGE	1 ~ 25GHz
INPUT POWER	120Vac, 60 Hz	DETECTOR FUNCTION	Peak (PK) Average (AV)
ENVIRONMENTAL CONDITIONS	24deg. C, 64%RH 1000 hPa	TESTED BY	Sun Lin
TEST MODE	A		

ANTENNA POLARITY & TEST DISTANCE: HORIZONTAL AT 3 M								
NO.	FREQ. (MHz)	EMISSION LEVEL (dBuV/m)	LIMIT (dBuV/m)	MARGIN (dB)	ANTENNA HEIGHT (m)	TABLE ANGLE (Degree)	RAW VALUE (dBuV)	CORRECTION FACTOR (dB/m)
1	2385.00	60.99 PK	74.00	-13.01	1.01 H	315	30.35	30.64
2	2385.00	49.59 AV	54.00	-4.41	1.01 H	315	18.95	30.64
3	*2437.00	110.09 PK			1.00 H	317	79.28	30.81
4	*2437.00	100.06 AV			1.00 H	317	69.25	30.81
5	2483.50	59.42 PK	74.00	-14.58	1.24 H	323	28.46	30.96
6	2483.50	48.71 AV	54.00	-5.29	1.24 H	323	17.75	30.96
7	4874.00	49.61 PK	74.00	-24.39	1.36 H	127	13.14	36.47
8	4874.00	36.01 AV	54.00	-17.99	1.36 H	127	-0.46	36.47
ANTENNA POLARITY & TEST DISTANCE: VERTICAL AT 3 M								
NO.	FREQ. (MHz)	EMISSION LEVEL (dBuV/m)	LIMIT (dBuV/m)	MARGIN (dB)	ANTENNA HEIGHT (m)	TABLE ANGLE (Degree)	RAW VALUE (dBuV)	CORRECTION FACTOR (dB/m)
1	2385.00	57.25 PK	74.00	-16.75	1.40 V	103	26.61	30.64
2	2385.00	47.51 AV	54.00	-6.49	1.40 V	103	16.87	30.64
3	*2437.00	101.98 PK			1.18 V	30	71.17	30.81
4	*2437.00	91.96 AV			1.18 V	30	61.15	30.81
5	2483.50	57.23 PK	74.00	-16.77	1.04 V	53	26.27	30.96
6	2483.50	47.02 AV	54.00	-6.98	1.04 V	53	16.06	30.96
7	4874.00	47.53 PK	74.00	-26.47	1.41 V	303	11.06	36.47
8	4874.00	34.69 AV	54.00	-19.31	1.41 V	303	-1.78	36.47

- REMARKS:**
1. Emission level (dBuV/m) = Raw Value (dBuV) + Correction Factor (dB/m).
  2. Correction Factor (dB/m) = Antenna Factor (dB/m) + Cable Factor (dB).
  3. The other emission levels were very low against the limit.
  4. Margin value = Emission level – Limit value.
  5. “ \* “: Fundamental frequency.





A D T

EUT TEST CONDITION		MEASUREMENT DETAIL	
CHANNEL	Channel 11	FREQUENCY RANGE	1 ~ 25GHz
INPUT POWER	120Vac, 60 Hz	DETECTOR FUNCTION	Peak (PK) Average (AV)
ENVIRONMENTAL CONDITIONS	24deg. C, 64%RH 1000 hPa	TESTED BY	Sun Lin
TEST MODE	A		

ANTENNA POLARITY & TEST DISTANCE: HORIZONTAL AT 3 M								
NO.	FREQ. (MHz)	EMISSION LEVEL (dBuV/m)	LIMIT (dBuV/m)	MARGIN (dB)	ANTENNA HEIGHT (m)	TABLE ANGLE (Degree)	RAW VALUE (dBuV)	CORRECTION FACTOR (dB/m)
1	2360.00	58.55 PK	74.00	-15.45	1.31 H	306	28.00	30.55
2	2360.00	49.08 AV	54.00	-4.92	1.31 H	306	18.53	30.55
3	*2462.00	109.36 PK			1.00 H	312	78.47	30.89
4	*2462.00	99.33 AV			1.00 H	312	68.44	30.89
5	2483.50	71.88 PK	74.00	-2.12	1.27 H	249	40.92	30.96
6	2483.50	52.70 AV	54.00	-1.30	1.27 H	249	21.74	30.96
7	4924.00	50.12 PK	74.00	-23.88	1.03 H	263	13.54	36.58
8	4924.00	37.14 AV	54.00	-16.86	1.03 H	263	0.56	36.58
ANTENNA POLARITY & TEST DISTANCE: VERTICAL AT 3 M								
NO.	FREQ. (MHz)	EMISSION LEVEL (dBuV/m)	LIMIT (dBuV/m)	MARGIN (dB)	ANTENNA HEIGHT (m)	TABLE ANGLE (Degree)	RAW VALUE (dBuV)	CORRECTION FACTOR (dB/m)
1	2390.00	57.53 PK	74.00	-16.47	1.18 V	32	26.88	30.65
2	2390.00	46.69 AV	54.00	-7.31	1.18 V	32	16.04	30.65
3	*2462.00	101.28 PK			1.12 V	359	70.39	30.89
4	*2462.00	91.21 AV			1.12 V	359	60.32	30.89
5	2483.50	66.01 PK	74.00	-7.99	1.86 V	21	35.05	30.96
6	2483.50	49.60 AV	54.00	-4.40	1.86 V	21	18.64	30.96
7	4924.00	51.03 PK	74.00	-22.97	1.43 V	57	14.45	36.58
8	4924.00	38.56 AV	54.00	-15.44	1.43 V	57	1.98	36.58

- REMARKS:**
1. Emission level (dBuV/m) = Raw Value (dBuV) + Correction Factor (dB/m).
  2. Correction Factor (dB/m) = Antenna Factor (dB/m) + Cable Factor (dB).
  3. The other emission levels were very low against the limit.
  4. Margin value = Emission level – Limit value.
  5. “ \* “: Fundamental frequency.



A D T

**DRAFT 802.11n (40MHz) OFDM MODULATION**

EUT TEST CONDITION		MEASUREMENT DETAIL	
CHANNEL	Channel 1	FREQUENCY RANGE	1 ~ 25GHz
INPUT POWER	120Vac, 60 Hz	DETECTOR FUNCTION	Peak (PK) Average (AV)
ENVIRONMENTAL CONDITIONS	24deg. C, 64%RH 1000 hPa	TESTED BY	Sun Lin
TEST MODE	A		

ANTENNA POLARITY & TEST DISTANCE: HORIZONTAL AT 3 M								
NO.	FREQ. (MHz)	EMISSION LEVEL (dBuV/m)	LIMIT (dBuV/m)	MARGIN (dB)	ANTENNA HEIGHT (m)	TABLE ANGLE (Degree)	RAW VALUE (dBuV)	CORRECTION FACTOR (dB/m)
1	2382.00	68.75 PK	74.00	-5.25	1.17 H	77	38.12	30.63
2	2382.00	52.78 AV	54.00	-1.22	1.17 H	77	22.15	30.63
3	*2422.00	106.28 PK			1.15 H	33	75.52	30.76
4	*2422.00	96.12 AV			1.15 H	33	65.36	30.76
5	2495.00	56.23 PK	74.00	-17.77	1.29 H	217	25.24	30.99
6	2495.00	46.21 AV	54.00	-7.79	1.29 H	217	15.22	30.99
7	4844.00	48.30 PK	74.00	-25.70	1.07 H	15	11.86	36.44
8	4844.00	34.87 AV	54.00	-19.13	1.07 H	15	-1.57	36.44
ANTENNA POLARITY & TEST DISTANCE: VERTICAL AT 3 M								
NO.	FREQ. (MHz)	EMISSION LEVEL (dBuV/m)	LIMIT (dBuV/m)	MARGIN (dB)	ANTENNA HEIGHT (m)	TABLE ANGLE (Degree)	RAW VALUE (dBuV)	CORRECTION FACTOR (dB/m)
1	2390.00	61.28 PK	74.00	-12.72	1.02 V	315	30.63	30.65
2	2390.00	48.39 AV	54.00	-5.61	1.02 V	315	17.74	30.65
3	*2422.00	100.12 PK			1.29 V	312	69.36	30.76
4	*2422.00	90.08 AV			1.29 V	312	59.32	30.76
5	2495.00	58.65 PK	74.00	-15.35	1.79 V	313	27.66	30.99
6	2495.00	47.10 AV	54.00	-6.90	1.79 V	313	16.11	30.99
7	4844.00	50.32 PK	74.00	-23.68	1.03 V	348	13.88	36.44
8	4844.00	35.42 AV	54.00	-18.58	1.03 V	348	-1.02	36.44

- REMARKS:**
1. Emission level (dBuV/m) = Raw Value (dBuV) + Correction Factor (dB/m).
  2. Correction Factor (dB/m) = Antenna Factor (dB/m) + Cable Factor (dB).
  3. The other emission levels were very low against the limit.
  4. Margin value = Emission level – Limit value.
  5. “ \* “: Fundamental frequency.



A D T

EUT TEST CONDITION		MEASUREMENT DETAIL	
CHANNEL	Channel 4	FREQUENCY RANGE	1 ~ 25GHz
INPUT POWER	120Vac, 60 Hz	DETECTOR FUNCTION	Peak (PK) Average (AV)
ENVIRONMENTAL CONDITIONS	24deg. C, 64%RH 1000 hPa	TESTED BY	Sun Lin
TEST MODE	A		

ANTENNA POLARITY & TEST DISTANCE: HORIZONTAL AT 3 M								
NO.	FREQ. (MHz)	EMISSION LEVEL (dBuV/m)	LIMIT (dBuV/m)	MARGIN (dB)	ANTENNA HEIGHT (m)	TABLE ANGLE (Degree)	RAW VALUE (dBuV)	CORRECTION FACTOR (dB/m)
1	2360.00	59.63 PK	74.00	-14.37	1.77 H	130	29.08	30.55
2	2360.00	49.52 AV	54.00	-4.48	1.77 H	130	18.97	30.55
3	*2437.00	106.14 PK			1.14 H	30	75.33	30.81
4	*2437.00	96.03 AV			1.14 H	30	65.22	30.81
5	2483.50	55.00 PK	74.00	-19.00	1.12 H	308	24.04	30.96
6	2483.50	47.23 AV	54.00	-6.77	1.12 H	308	16.27	30.96
7	4874.00	47.25 PK	74.00	-26.75	1.02 H	11	10.78	36.47
8	4874.00	35.07 AV	54.00	-18.93	1.02 H	11	-1.40	36.47
ANTENNA POLARITY & TEST DISTANCE: VERTICAL AT 3 M								
NO.	FREQ. (MHz)	EMISSION LEVEL (dBuV/m)	LIMIT (dBuV/m)	MARGIN (dB)	ANTENNA HEIGHT (m)	TABLE ANGLE (Degree)	RAW VALUE (dBuV)	CORRECTION FACTOR (dB/m)
1	2360.00	57.09 PK	74.00	-16.91	1.33 V	311	26.54	30.55
2	2360.00	47.42 AV	54.00	-6.58	1.33 V	311	16.87	30.55
3	*2437.00	100.05 PK			1.26 V	315	69.24	30.81
4	*2437.00	90.01 AV			1.26 V	315	59.20	30.81
5	2483.50	57.20 PK	74.00	-16.80	1.20 V	102	26.24	30.96
6	2483.50	50.37 AV	54.00	-3.63	1.20 V	102	19.41	30.96
7	4874.00	49.88 PK	74.00	-24.12	1.20 V	338	13.41	36.47
8	4874.00	38.64 AV	54.00	-15.36	1.20 V	338	2.17	36.47

- REMARKS:**
1. Emission level (dBuV/m) = Raw Value (dBuV) + Correction Factor (dB/m).
  2. Correction Factor (dB/m) = Antenna Factor (dB/m) + Cable Factor (dB).
  3. The other emission levels were very low against the limit.
  4. Margin value = Emission level – Limit value.
  5. “ \* “: Fundamental frequency.



A D T

EUT TEST CONDITION		MEASUREMENT DETAIL	
CHANNEL	Channel 7	FREQUENCY RANGE	1 ~ 25GHz
INPUT POWER	120Vac, 60 Hz	DETECTOR FUNCTION	Peak (PK) Average (AV)
ENVIRONMENTAL CONDITIONS	24deg. C, 64%RH 1000 hPa	TESTED BY	Sun Lin
TEST MODE	A		

ANTENNA POLARITY & TEST DISTANCE: HORIZONTAL AT 3 M								
NO.	FREQ. (MHz)	EMISSION LEVEL (dBuV/m)	LIMIT (dBuV/m)	MARGIN (dB)	ANTENNA HEIGHT (m)	TABLE ANGLE (Degree)	RAW VALUE (dBuV)	CORRECTION FACTOR (dB/m)
1	2360.00	59.23 PK	74.00	-14.77	1.23 H	230	28.68	30.55
2	2360.00	48.60 AV	54.00	-5.40	1.23 H	230	18.05	30.55
3	*2452.00	106.22 PK			1.14 H	19	75.36	30.86
4	*2452.00	96.11 AV			1.14 H	19	65.25	30.86
5	2483.50	66.83 PK	74.00	-7.17	1.79 H	29	35.87	30.96
6	2483.50	52.80 AV	54.00	-1.20	1.79 H	29	21.84	30.96
7	4904.00	46.39 PK	74.00	-27.61	1.07 H	118	9.88	36.51
8	4904.00	32.98 AV	54.00	-21.02	1.07 H	118	-3.53	36.51
ANTENNA POLARITY & TEST DISTANCE: VERTICAL AT 3 M								
NO.	FREQ. (MHz)	EMISSION LEVEL (dBuV/m)	LIMIT (dBuV/m)	MARGIN (dB)	ANTENNA HEIGHT (m)	TABLE ANGLE (Degree)	RAW VALUE (dBuV)	CORRECTION FACTOR (dB/m)
1	2360.00	57.84 PK	74.00	-16.16	1.24 V	269	27.29	30.55
2	2360.00	47.45 AV	54.00	-6.55	1.24 V	269	16.90	30.55
3	*2452.00	100.12 PK			1.27 V	309	69.26	30.86
4	*2452.00	90.06 AV			1.27 V	309	59.20	30.86
5	2483.50	55.13 PK	74.00	-18.87	1.20 V	317	24.17	30.96
6	2483.50	47.26 AV	54.00	-6.74	1.20 V	317	16.30	30.96
7	4904.00	47.88 PK	74.00	-26.12	1.37 V	180	11.37	36.51
8	4904.00	36.49 AV	54.00	-17.51	1.37 V	180	-0.02	36.51

- REMARKS:**
1. Emission level (dBuV/m) = Raw Value (dBuV) + Correction Factor (dB/m).
  2. Correction Factor (dB/m) = Antenna Factor (dB/m) + Cable Factor (dB).
  3. The other emission levels were very low against the limit.
  4. Margin value = Emission level – Limit value.
  5. “ \* “: Fundamental frequency.



A D T

**BELOW 1GHz WORST-CASE DATA : DRAFT 802.11n (20MHz) OFDM MODULATION**

EUT TEST CONDITION		MEASUREMENT DETAIL	
CHANNEL	Channel 6	FREQUENCY RANGE	Below 1000MHz
INPUT POWER	120Vac, 60 Hz	DETECTOR FUNCTION	Quasi-Peak
ENVIRONMENTAL CONDITIONS	24deg. C, 64%RH 999 hPa	TESTED BY	Brad Wu
TEST MODE	A		

ANTENNA POLARITY & TEST DISTANCE: HORIZONTAL AT 3 M								
NO.	FREQ. (MHz)	EMISSION LEVEL (dBuV/m)	LIMIT (dBuV/m)	MARGIN (dB)	ANTENNA HEIGHT (m)	TABLE ANGLE (Degree)	RAW VALUE (dBuV)	CORRECTION FACTOR (dB/m)
1	125.17	36.12 QP	43.50	-7.38	1.50 H	253	24.39	11.73
2	249.60	44.85 QP	46.00	-1.15	1.00 H	259	31.05	13.80
3	383.76	35.84 QP	46.00	-10.16	1.00 H	124	18.47	17.36
4	512.08	36.66 QP	46.00	-9.34	1.50 H	220	15.98	20.68
5	640.41	35.33 QP	46.00	-10.67	1.25 H	208	11.80	23.53
6	897.05	39.32 QP	46.00	-6.68	1.50 H	178	11.47	27.85
ANTENNA POLARITY & TEST DISTANCE: VERTICAL AT 3 M								
NO.	FREQ. (MHz)	EMISSION LEVEL (dBuV/m)	LIMIT (dBuV/m)	MARGIN (dB)	ANTENNA HEIGHT (m)	TABLE ANGLE (Degree)	RAW VALUE (dBuV)	CORRECTION FACTOR (dB/m)
1	125.17	42.40 QP	43.50	-1.10	1.00 V	274	30.67	11.73
2	249.60	39.63 QP	46.00	-6.37	1.00 V	295	25.82	13.80
3	383.76	39.05 QP	46.00	-6.95	1.00 V	193	21.68	17.36
4	512.08	39.23 QP	46.00	-6.77	1.00 V	298	18.55	20.68
5	640.41	32.78 QP	46.00	-13.22	1.50 V	175	9.25	23.53
6	768.73	35.47 QP	46.00	-10.53	1.25 V	154	9.77	25.69

- REMARKS:**
1. Emission level (dBuV/m) = Raw Value (dBuV) + Correction Factor (dB/m).
  2. Correction Factor (dB/m) = Antenna Factor (dB/m) + Cable Factor (dB).
  3. The other emission levels were very low against the limit.
  4. Margin value = Emission level – Limit value.



A D T

EUT TEST CONDITION		MEASUREMENT DETAIL	
CHANNEL	Channel 6	FREQUENCY RANGE	Below 1000MHz
INPUT POWER	120Vac, 60 Hz	DETECTOR FUNCTION	Quasi-Peak
ENVIRONMENTAL CONDITIONS	24deg. C, 64%RH 999 hPa	TESTED BY	Brad Wu
TEST MODE	B		

ANTENNA POLARITY & TEST DISTANCE: HORIZONTAL AT 3 M								
NO.	FREQ. (MHz)	EMISSION LEVEL (dBuV/m)	LIMIT (dBuV/m)	MARGIN (dB)	ANTENNA HEIGHT (m)	TABLE ANGLE (Degree)	RAW VALUE (dBuV)	CORRECTION FACTOR (dB/m)
1	125.17	32.79 QP	43.50	-10.71	1.50 H	109	21.06	11.73
2	249.60	44.23 QP	46.00	-1.77	1.00 H	274	30.42	13.80
3	383.76	32.84 QP	46.00	-13.16	1.25 H	124	15.48	17.36
4	512.08	42.95 QP	46.00	-3.05	1.50 H	130	22.27	20.68
5	640.41	32.87 QP	46.00	-13.13	1.00 H	157	9.34	23.53
6	768.73	34.02 QP	46.00	-11.98	1.00 H	199	8.33	25.69
ANTENNA POLARITY & TEST DISTANCE: VERTICAL AT 3 M								
NO.	FREQ. (MHz)	EMISSION LEVEL (dBuV/m)	LIMIT (dBuV/m)	MARGIN (dB)	ANTENNA HEIGHT (m)	TABLE ANGLE (Degree)	RAW VALUE (dBuV)	CORRECTION FACTOR (dB/m)
1	42.11	37.32 QP	40.00	-2.68	1.50 V	16	22.56	14.77
2	72.67	35.12 QP	40.00	-4.88	1.25 V	190	23.25	11.87
3	249.60	38.68 QP	46.00	-7.32	1.00 V	100	24.87	13.80
4	512.08	41.65 QP	46.00	-4.35	1.00 V	166	20.97	20.68
5	640.41	32.77 QP	46.00	-13.23	1.50 V	235	9.24	23.53
6	768.73	32.85 QP	46.00	-13.15	1.25 V	190	7.15	25.69

- REMARKS:**
1. Emission level (dBuV/m) = Raw Value (dBuV) + Correction Factor (dB/m).
  2. Correction Factor (dB/m) = Antenna Factor (dB/m) + Cable Factor (dB).
  3. The other emission levels were very low against the limit.
  4. Margin value = Emission level – Limit value.



A D T

EUT TEST CONDITION		MEASUREMENT DETAIL	
CHANNEL	Channel 6	FREQUENCY RANGE	Below 1000MHz
INPUT POWER	120Vac, 60 Hz	DETECTOR FUNCTION	Quasi-Peak
ENVIRONMENTAL CONDITIONS	24deg. C, 64%RH 999 hPa	TESTED BY	Brad Wu
TEST MODE	C		

ANTENNA POLARITY & TEST DISTANCE: HORIZONTAL AT 3 M								
NO.	FREQ. (MHz)	EMISSION LEVEL (dBuV/m)	LIMIT (dBuV/m)	MARGIN (dB)	ANTENNA HEIGHT (m)	TABLE ANGLE (Degree)	RAW VALUE (dBuV)	CORRECTION FACTOR (dB/m)
1	125.17	30.58 QP	43.50	-12.92	1.50 H	244	18.85	11.73
2	249.60	41.35 QP	46.00	-4.65	1.00 H	250	27.55	13.80
3	383.76	37.84 QP	46.00	-8.16	1.00 H	130	20.48	17.36
4	512.08	31.96 QP	46.00	-14.04	1.50 H	235	11.28	20.68
5	640.41	34.15 QP	46.00	-11.85	1.25 H	139	10.62	23.53
6	897.05	35.35 QP	46.00	-10.65	1.50 H	157	7.50	27.85
ANTENNA POLARITY & TEST DISTANCE: VERTICAL AT 3 M								
NO.	FREQ. (MHz)	EMISSION LEVEL (dBuV/m)	LIMIT (dBuV/m)	MARGIN (dB)	ANTENNA HEIGHT (m)	TABLE ANGLE (Degree)	RAW VALUE (dBuV)	CORRECTION FACTOR (dB/m)
1	51.29	30.10 QP	40.00	-9.90	1.25 V	346	16.94	13.16
2	125.17	41.24 QP	43.50	-2.26	1.00 V	253	29.51	11.73
3	249.60	43.42 QP	46.00	-2.58	1.00 V	304	29.62	13.80
4	383.76	43.22 QP	46.00	-2.78	1.25 V	193	25.85	17.36
5	512.08	35.04 QP	46.00	-10.96	1.00 V	184	14.36	20.68
6	640.41	31.15 QP	46.00	-14.85	1.50 V	205	7.63	23.53

- REMARKS:**
1. Emission level (dBuV/m) = Raw Value (dBuV) + Correction Factor (dB/m).
  2. Correction Factor (dB/m) = Antenna Factor (dB/m) + Cable Factor (dB).
  3. The other emission levels were very low against the limit.
  4. Margin value = Emission level – Limit value.

## 4.2 CONDUCTED EMISSION MEASUREMENT

### 4.2.1 LIMITS OF CONDUCTED EMISSION MEASUREMENT

FREQUENCY OF EMISSION (MHz)	CONDUCTED LIMIT (dB $\mu$ V)	
	Quasi-peak	Average
0.15 ~ 0.5	66 to 56	56 to 46
0.5 ~ 5	56	46
5 ~ 30	60	50

- NOTE:** 1. The lower limit shall apply at the transition frequencies.  
 2. The limit decreases in line with the logarithm of the frequency in the range of 0.15 to 0.50MHz.  
 3. All emanations from a class A/B digital device or system, including any network of conductors and apparatus connected thereto, shall not exceed the level of field strengths specified above.

### 4.2.2 TEST INSTRUMENTS

DESCRIPTION & MANUFACTURER	MODEL NO.	SERIAL NO.	DATE OF CALIBRATION	DUE DATE OF CALIBRATION
Test Receiver ROHDE & SCHWARZ	ESCS30	100291	Nov. 19, 2008	Nov. 18, 2009
RF signal cable Woken	5D-FB	Cable-HYC01-01	Dec. 31, 2008	Dec. 30, 2009
LISN SCHWARZBECK	NNBL 8226-2	8226-142	Jun. 03, 2009	Jun. 02, 2010
LISN ROHDE & SCHWARZ	ESH2-Z5	100104	Dec. 04, 2008	Dec. 03, 2009
Software ADT	ADT_Cond_ V7.3.7	NA	NA	NA

- NOTE:** 1. The calibration interval of the above test instruments is 12 months and the calibrations are traceable to NML/ROC and NIST/USA.  
 2. The test was performed in HwaYa Shielded Room 1.  
 3. The VCCI Site Registration No. is C-2040.





A D T

#### 4.2.3 TEST PROCEDURES

- a. The EUT was placed 0.4 meters from the conducting wall of the shielded room with EUT being connected to the power mains through a line impedance stabilization network (LISN). Other support units were connected to the power mains through another LISN. The two LISNs provide 50 ohm/ 50uH of coupling impedance for the measuring instrument.
- b. Both lines of the power mains connected to the EUT were checked for maximum conducted interference.
- c. The frequency range from 150kHz to 30MHz was searched. Emission levels under (Limit - 20dB) was not recorded.

**NOTE:** All modes of operation were investigated and the worst-case emissions are reported.

#### 4.2.4 DEVIATION FROM TEST STANDARD

No deviation.

#### 4.2.5 TEST SETUP

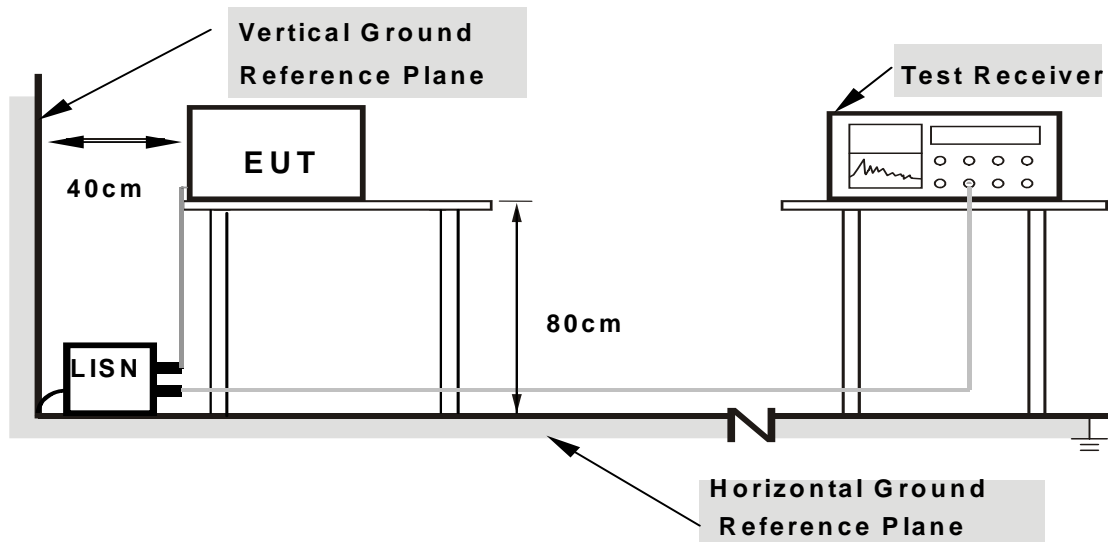

- Note:**
1. Support units were connected to second LISN.
  2. Both of LISNs (AMN) are 80 cm from EUT and at least 80 from other units and other metal planes

For the actual test configuration, please refer to the attached file (Test Setup Photo).

#### 4.2.6 EUT OPERATING CONDITIONS

Same as 4.1.6.

### 4.2.7 TEST RESULTS

#### CONDUCTED WORST-CASE DATA : DRAFT 802.11n (20MHz) OFDM MODULATION

EUT TEST CONDITION		MEASUREMENT DETAIL	
CHANNEL	Channel 6	PHASE	Line 1
MODULATION TYPE	BPSK	INPUT POWER	120Vac, 60Hz
TRANSFER RATE	7.2Mbps	6dB BANDWIDTH	9kHz
ENVIRONMENTAL CONDITIONS	20deg. C, 60%RH, 1011hPa	TESTED BY	Match Tsui
TEST MODE	A		

No	Freq. [MHz]	Corr. Factor (dB)	Reading Value		Emission Level		Limit		Margin	
			[dB (uV)]		[dB (uV)]		[dB (uV)]		(dB)	
			Q.P.	AV.	Q.P.	AV.	Q.P.	AV.	Q.P.	AV.
1	0.205	0.13	49.58	-	49.71	-	63.42	53.42	-13.71	-
2	0.271	0.13	44.18	-	44.31	-	61.08	51.08	-16.77	-
3	0.338	0.14	44.19	-	44.33	-	59.26	49.26	-14.94	-
4	0.630	0.16	34.19	-	34.35	-	56.00	46.00	-21.65	-
5	5.383	0.44	32.36	-	32.80	-	60.00	50.00	-27.20	-
6	9.801	0.65	29.10	-	29.75	-	60.00	50.00	-30.25	-

- REMARKS:**
1. Q.P. and AV. are abbreviations of quasi-peak and average individually.
  2. "-": The Quasi-peak reading value also meets average limit and measurement with the average detector is unnecessary.
  3. The emission levels of other frequencies were very low against the limit.
  4. Margin value = Emission level - Limit value
  5. Correction factor = Insertion loss + Cable loss
  6. Emission Level = Correction Factor + Reading Value.

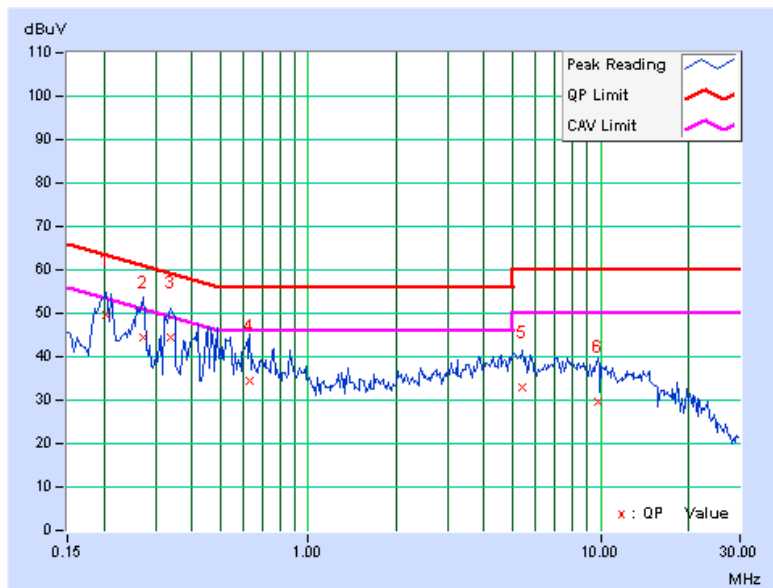

EUT TEST CONDITION		MEASUREMENT DETAIL	
CHANNEL	Channel 6	PHASE	Line 2
MODULATION TYPE	BPSK	INPUT POWER	120Vac, 60Hz
TRANSFER RATE	7.2Mbps	6dB BANDWIDTH	9kHz
ENVIRONMENTAL CONDITIONS	20deg. C, 60%RH, 1011hPa	TESTED BY	Match Tsui
TEST MODE	A		

No	Freq. [MHz]	Corr. Factor (dB)	Reading Value		Emission Level		Limit		Margin	
			[dB (uV)]		[dB (uV)]		[dB (uV)]		(dB)	
			Q.P.	AV.	Q.P.	AV.	Q.P.	AV.	Q.P.	AV.
1	0.193	0.15	48.96	-	49.11	-	63.91	53.91	-14.80	-
2	0.271	0.15	44.54	-	44.69	-	61.08	51.08	-16.39	-
3	0.345	0.16	43.10	-	43.26	-	59.07	49.07	-15.82	-
4	0.623	0.17	32.84	-	33.01	-	56.00	46.00	-22.99	-
5	4.852	0.43	32.27	-	32.70	-	56.00	46.00	-23.30	-
6	7.684	0.56	31.72	-	32.28	-	60.00	50.00	-27.72	-

- REMARKS:**
1. Q.P. and AV. are abbreviations of quasi-peak and average individually.
  2. "-": The Quasi-peak reading value also meets average limit and measurement with the average detector is unnecessary.
  3. The emission levels of other frequencies were very low against the limit.
  4. Margin value = Emission level - Limit value
  5. Correction factor = Insertion loss + Cable loss
  6. Emission Level = Correction Factor + Reading Value.

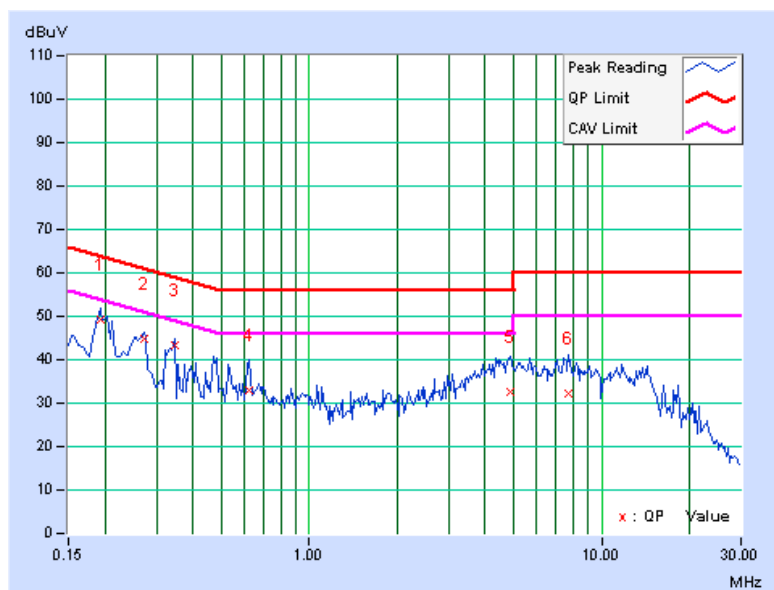



A D T

EUT TEST CONDITION		MEASUREMENT DETAIL	
CHANNEL	Channel 6	PHASE	Line 1
MODULATION TYPE	BPSK	INPUT POWER	120Vac, 60Hz
TRANSFER RATE	7.2Mbps	6dB BANDWIDTH	9kHz
ENVIRONMENTAL CONDITIONS	20deg. C, 60%RH, 1011hPa	TESTED BY	Match Tsui
TEST MODE	B		

No	Freq. [MHz]	Corr. Factor (dB)	Reading Value		Emission Level		Limit		Margin	
			[dB (uV)]		[dB (uV)]		[dB (uV)]		(dB)	
			Q.P.	AV.	Q.P.	AV.	Q.P.	AV.	Q.P.	AV.
1	0.213	0.13	44.86	-	44.99	-	63.11	53.11	-18.12	-
2	0.431	0.14	47.29	39.95	47.43	40.09	57.23	47.23	-9.80	-7.14
3	0.974	0.18	40.28	-	40.46	-	56.00	46.00	-15.54	-
4	1.383	0.20	39.80	-	40.00	-	56.00	46.00	-16.00	-
5	2.551	0.27	34.90	-	35.17	-	56.00	46.00	-20.83	-
6	10.938	0.71	32.87	-	33.58	-	60.00	50.00	-26.42	-

- REMARKS:**
1. Q.P. and AV. are abbreviations of quasi-peak and average individually.
  2. "-": The Quasi-peak reading value also meets average limit and measurement with the average detector is unnecessary.
  3. The emission levels of other frequencies were very low against the limit.
  4. Margin value = Emission level - Limit value
  5. Correction factor = Insertion loss + Cable loss
  6. Emission Level = Correction Factor + Reading Value.

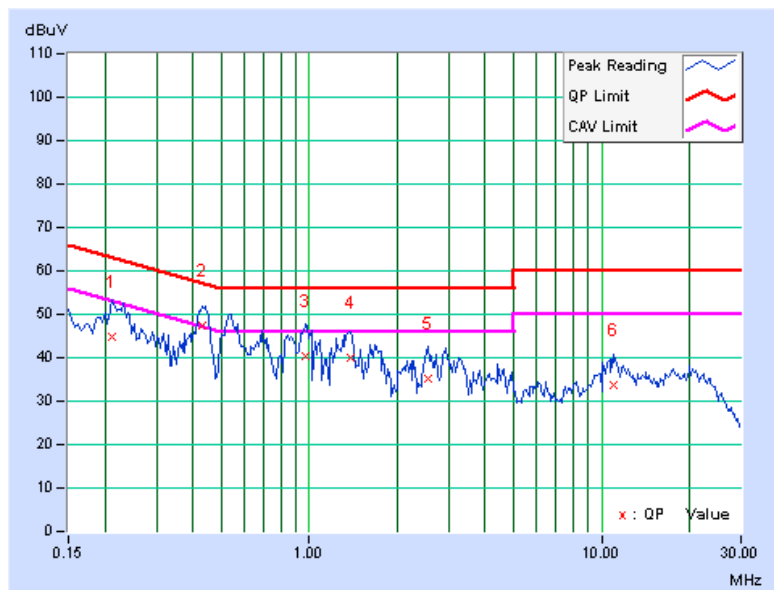

EUT TEST CONDITION		MEASUREMENT DETAIL	
CHANNEL	Channel 6	PHASE	Line 2
MODULATION TYPE	BPSK	INPUT POWER	120Vac, 60Hz
TRANSFER RATE	7.2Mbps	6dB BANDWIDTH	9kHz
ENVIRONMENTAL CONDITIONS	20deg. C, 60%RH, 1011hPa	TESTED BY	Match Tsui
TEST MODE	B		

No	Freq. [MHz]	Corr. Factor (dB)	Reading Value		Emission Level		Limit		Margin	
			[dB (uV)]		[dB (uV)]		[dB (uV)]		(dB)	
			Q.P.	AV.	Q.P.	AV.	Q.P.	AV.	Q.P.	AV.
1	0.181	0.15	48.35	-	48.50	-	64.43	54.43	-15.93	-
2	<b>0.439</b>	<b>0.16</b>	<b>49.56</b>	<b>40.82</b>	<b>49.72</b>	<b>40.98</b>	<b>57.08</b>	<b>47.08</b>	<b>-7.36</b>	<b>-6.10</b>
3	0.920	0.19	44.21	-	44.40	-	56.00	46.00	-11.60	-
4	1.574	0.23	46.20	36.88	46.43	37.11	56.00	46.00	-9.57	-8.89
5	3.246	0.34	38.54	-	38.88	-	56.00	46.00	-17.12	-
6	11.059	0.69	35.57	-	36.26	-	60.00	50.00	-23.74	-

- REMARKS:**
1. Q.P. and AV. are abbreviations of quasi-peak and average individually.
  2. "-": The Quasi-peak reading value also meets average limit and measurement with the average detector is unnecessary.
  3. The emission levels of other frequencies were very low against the limit.
  4. Margin value = Emission level - Limit value
  5. Correction factor = Insertion loss + Cable loss
  6. Emission Level = Correction Factor + Reading Value.

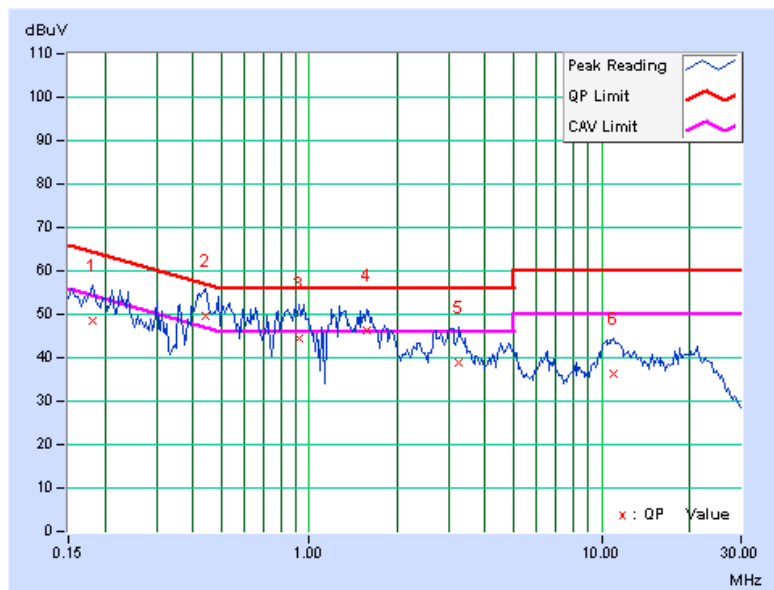

EUT TEST CONDITION		MEASUREMENT DETAIL	
CHANNEL	Channel 6	PHASE	Line 1
MODULATION TYPE	BPSK	INPUT POWER	120Vac, 60Hz
TRANSFER RATE	7.2Mbps	6dB BANDWIDTH	9kHz
ENVIRONMENTAL CONDITIONS	20deg. C, 60%RH, 1011hPa	TESTED BY	Match Tsui
TEST MODE	C		

No	Freq. [MHz]	Corr. Factor (dB)	Reading Value		Emission Level		Limit		Margin	
			[dB (uV)]		[dB (uV)]		[dB (uV)]		(dB)	
			Q.P.	AV.	Q.P.	AV.	Q.P.	AV.	Q.P.	AV.
1	0.181	0.13	42.86	-	42.99	-	64.43	54.43	-21.44	-
2	0.365	0.14	38.02	-	38.16	-	58.62	48.62	-20.46	-
3	0.642	0.16	37.19	-	37.35	-	56.00	46.00	-18.65	-
4	1.465	0.20	35.25	-	35.45	-	56.00	46.00	-20.55	-
5	4.031	0.37	39.26	-	39.63	-	56.00	46.00	-16.37	-
6	12.137	0.76	44.14	-	44.90	-	60.00	50.00	-15.10	-

- REMARKS:**
1. Q.P. and AV. are abbreviations of quasi-peak and average individually.
  2. "-": The Quasi-peak reading value also meets average limit and measurement with the average detector is unnecessary.
  3. The emission levels of other frequencies were very low against the limit.
  4. Margin value = Emission level - Limit value
  5. Correction factor = Insertion loss + Cable loss
  6. Emission Level = Correction Factor + Reading Value.

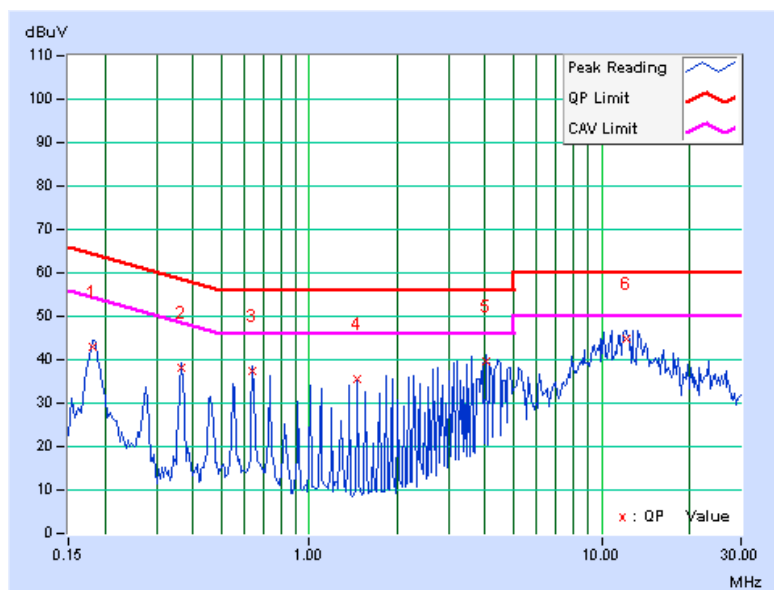



A D T

EUT TEST CONDITION		MEASUREMENT DETAIL	
CHANNEL	Channel 6	PHASE	Line 2
MODULATION TYPE	BPSK	INPUT POWER	120Vac, 60Hz
TRANSFER RATE	7.2Mbps	6dB BANDWIDTH	9kHz
ENVIRONMENTAL CONDITIONS	20deg. C, 60%RH, 1011hPa	TESTED BY	Match Tsui
TEST MODE	C		

No	Freq. [MHz]	Corr. Factor (dB)	Reading Value		Emission Level		Limit		Margin	
			[dB (uV)]		[dB (uV)]		[dB (uV)]		(dB)	
			Q.P.	AV.	Q.P.	AV.	Q.P.	AV.	Q.P.	AV.
1	0.183	0.15	44.11	-	44.26	-	64.36	54.36	-20.10	-
2	0.365	0.16	37.82	-	37.98	-	58.62	48.62	-20.64	-
3	0.642	0.18	34.90	-	35.08	-	56.00	46.00	-20.92	-
4	1.465	0.22	34.70	-	34.92	-	56.00	46.00	-21.08	-
5	4.031	0.39	39.44	-	39.83	-	56.00	46.00	-16.17	-
6	11.895	0.72	44.12	-	44.84	-	60.00	50.00	-15.16	-

- REMARKS:**
1. Q.P. and AV. are abbreviations of quasi-peak and average individually.
  2. "-": The Quasi-peak reading value also meets average limit and measurement with the average detector is unnecessary.
  3. The emission levels of other frequencies were very low against the limit.
  4. Margin value = Emission level - Limit value
  5. Correction factor = Insertion loss + Cable loss
  6. Emission Level = Correction Factor + Reading Value.

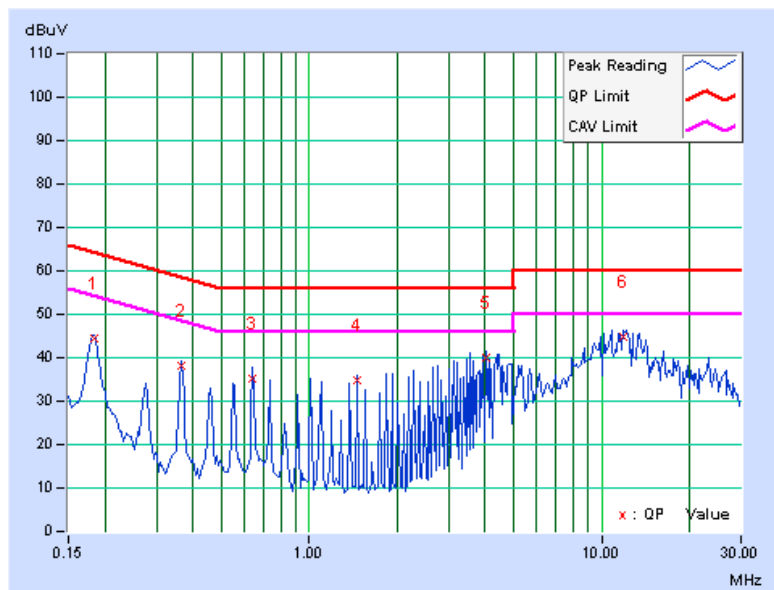



### 4.3 6dB BANDWIDTH MEASUREMENT

#### 4.3.1 LIMITS OF 6dB BANDWIDTH MEASUREMENT

The minimum of 6dB Bandwidth Measurement is 0.5 MHz.

#### 4.3.2 TEST INSTRUMENTS

DESCRIPTION & MANUFACTURER	MODEL NO.	SERIAL NO.	DATE OF CALIBRATION	DUE DATE OF CALIBRATION
R&S SPECTRUM ANALYZER	FSP40	100041	May 13, 2009	May 12, 2010

**NOTE:** The calibration interval of the above test instruments is 12 months and the calibrations are traceable to NML/ROC and NIST/USA.

#### 4.3.3 TEST PROCEDURE

The transmitter output was connected to the spectrum analyzer through an attenuator. The bandwidth of the fundamental frequency was measured by spectrum analyzer with 100kHz RBW and 300kHz VBW. The 6dB bandwidth is defined as the total spectrum the power of which is higher than peak power minus 6dB.

#### 4.3.4 DEVIATION FROM TEST STANDARD

No deviation.

#### 4.3.5 TEST SETUP

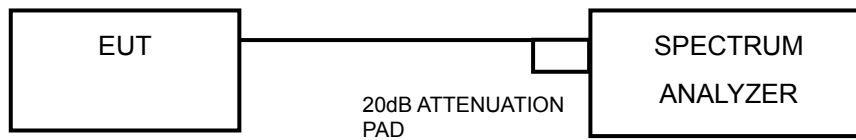

#### 4.3.6 EUT OPERATING CONDITIONS

The software provided by client to enable the EUT under transmission condition continuously at lowest, middle and highest channel frequencies individually.



A D T

### 4.3.7 TEST RESULTS

#### 802.11b DSSS MODULATION

<b>MODULATION TYPE</b>	DBPSK	<b>TRANSFER RATE</b>	1.0Mbps
<b>INPUT POWER</b>	120Vac, 60Hz	<b>ENVIRONMENTAL CONDITIONS</b>	24 deg.C, 64 %RH, 1009hPa
<b>TESTED BY</b>	Sun Lin		

CHANNEL	CHANNEL FREQUENCY (MHz)	6dB BANDWIDTH (MHz)		MINIMUM LIMIT (MHz)	PASS / FAIL
		CHAIN 0	CHAIN 1		
1	2412	12.08	12.07	0.5	PASS
6	2437	11.17	12.08	0.5	PASS
11	2462	11.15	12.07	0.5	PASS



A D T

### FOR CHAIN 0: CH 1

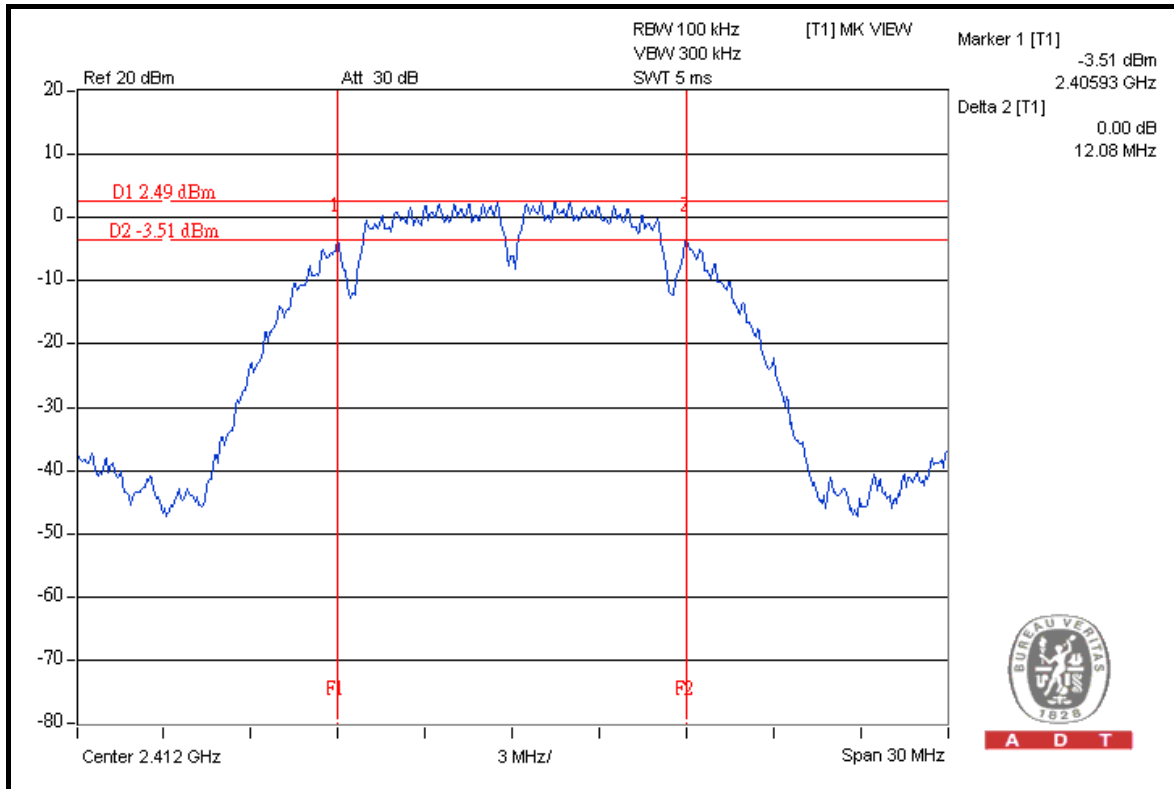

### CH 6

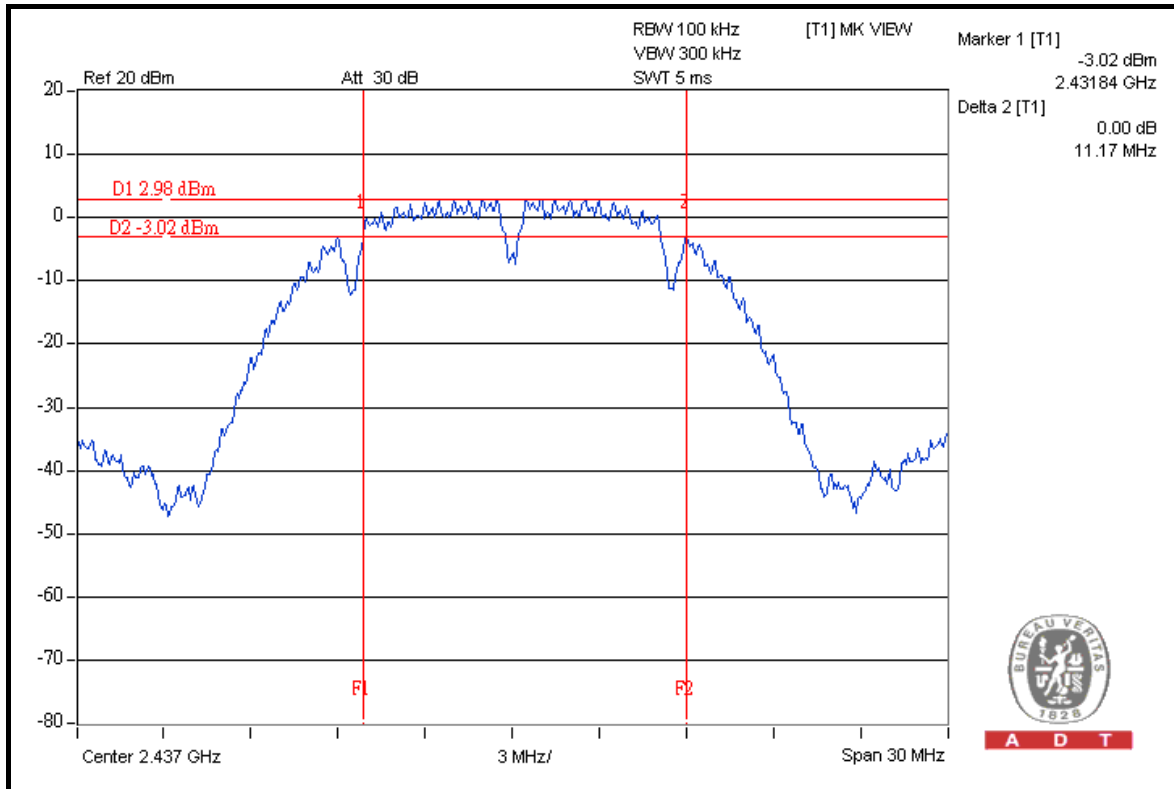



A D T

### CH 11

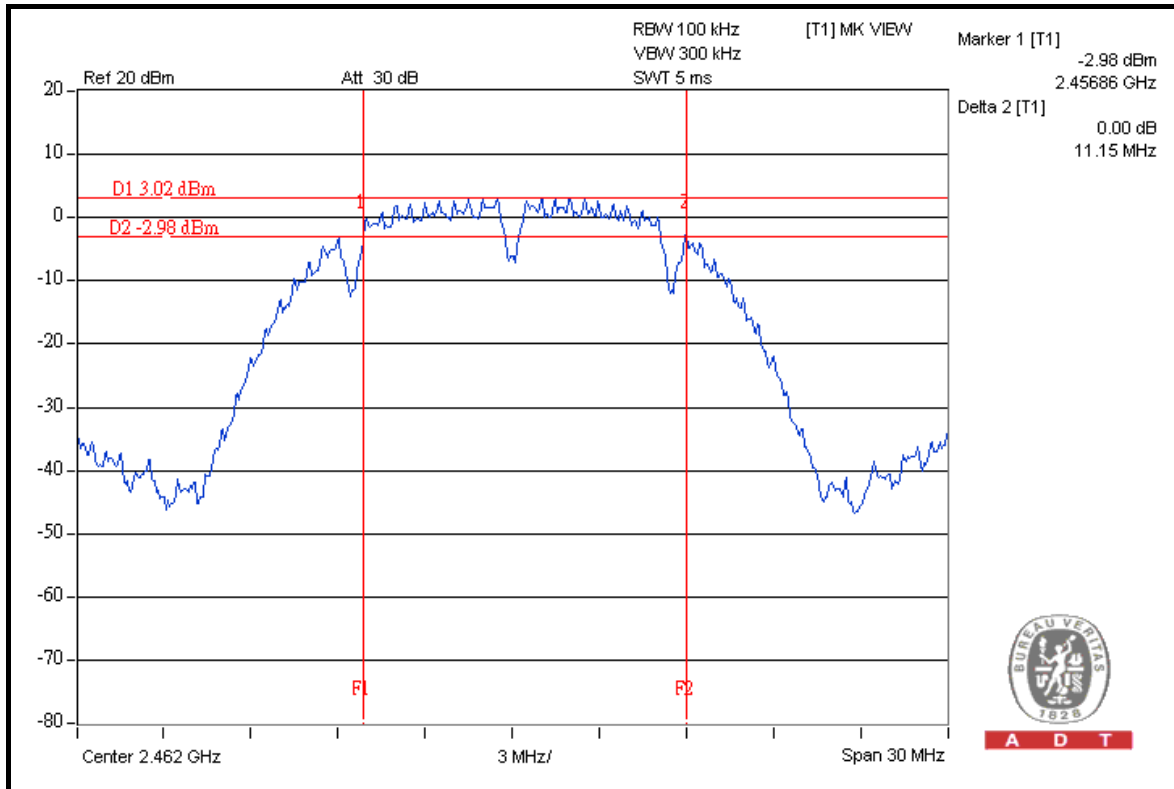

### FOR CHAIN 1: CH 1

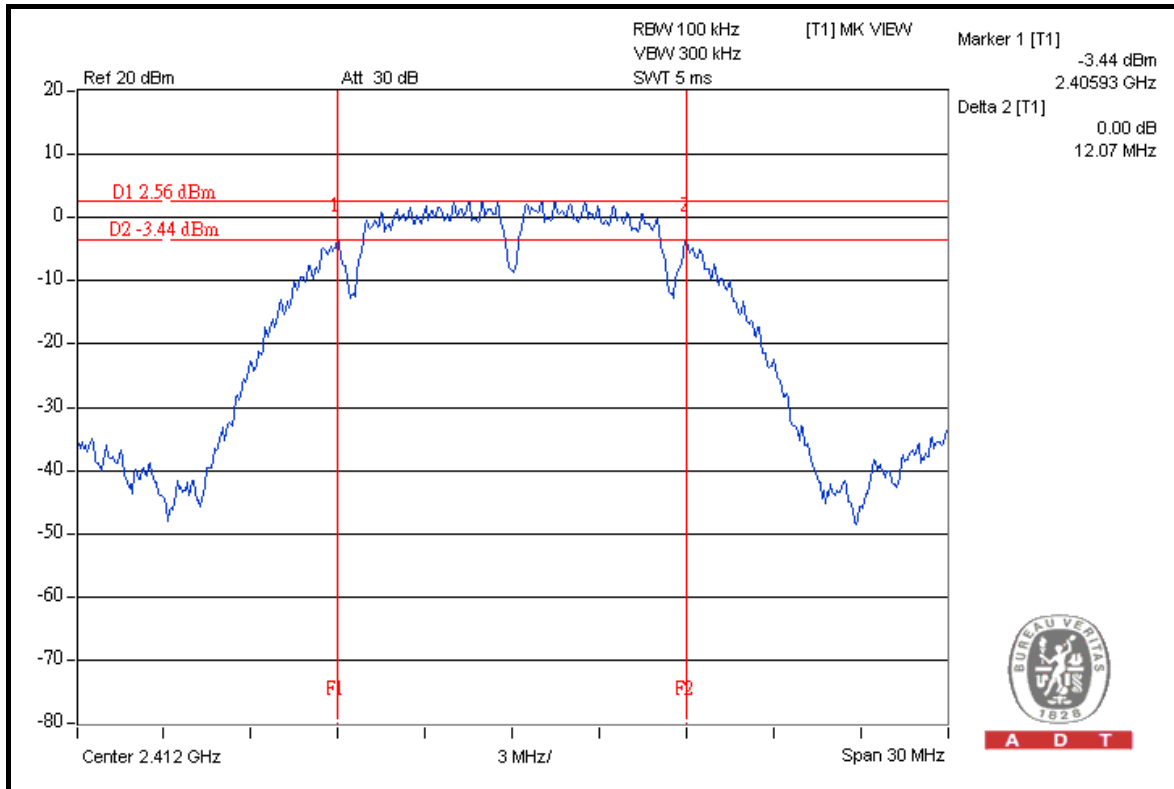



A D T

### CH 6

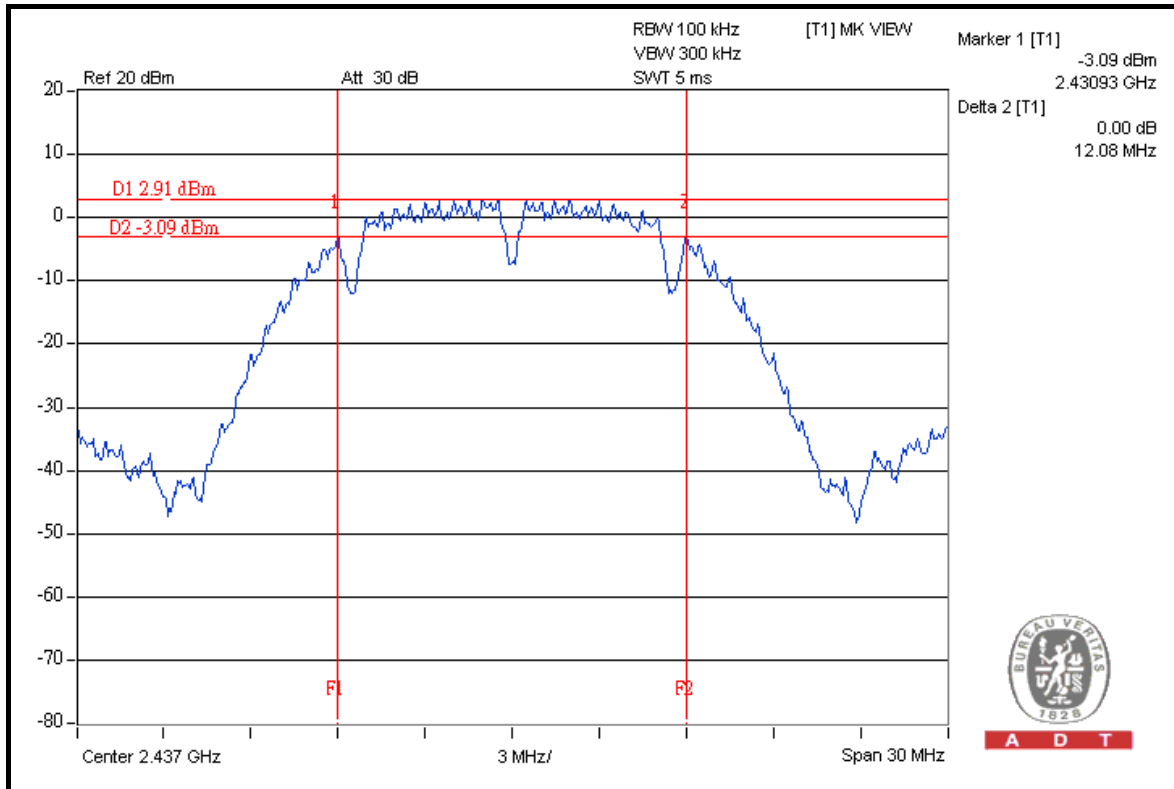

### CH 11

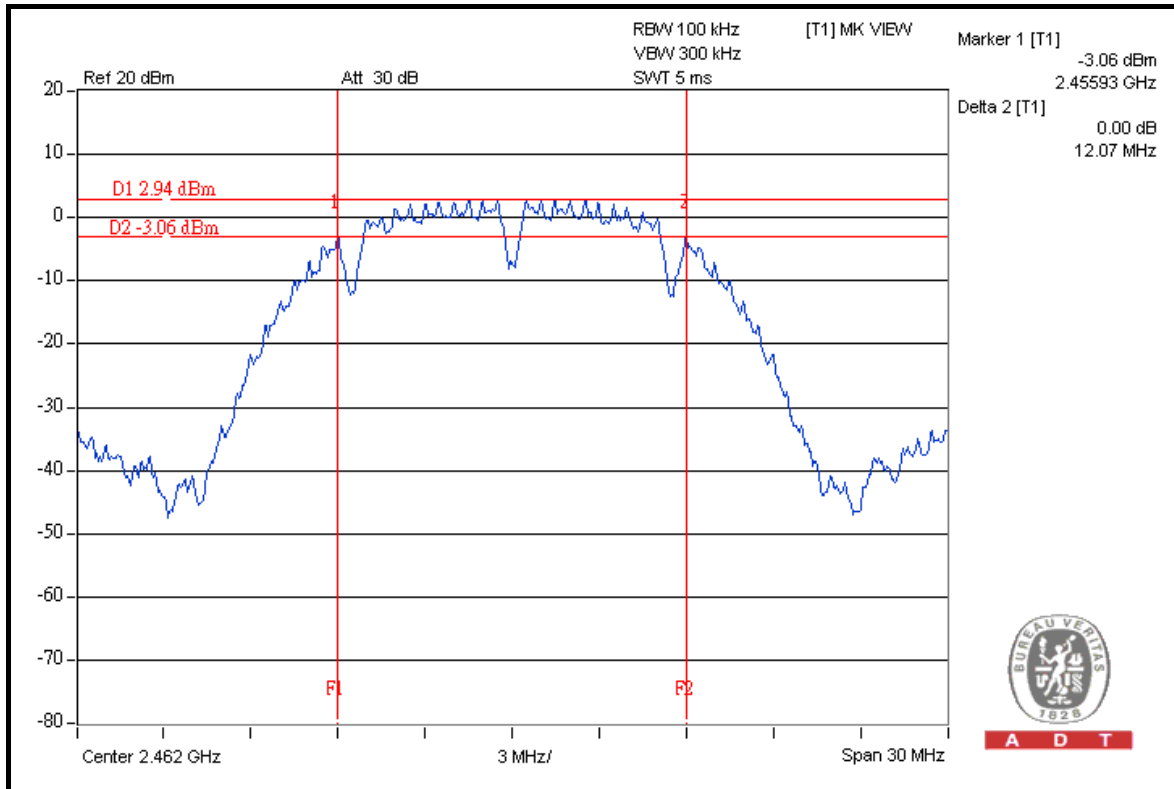



A D T

### 802.11g OFDM MODULATION

<b>MODULATION TYPE</b>	BPSK	<b>TRANSFER RATE</b>	6.0Mbps
<b>INPUT POWER</b>	120Vac, 60Hz	<b>ENVIRONMENTAL CONDITIONS</b>	24 deg.C, 64 %RH, 1009hPa
<b>TESTED BY</b>	Sun Lin		

CHANNEL	CHANNEL FREQUENCY (MHz)	6dB BANDWIDTH (MHz)		MINIMUM LIMIT (MHz)	PASS / FAIL
		CHAIN 0	CHAIN 1		
1	2412	16.05	15.85	0.5	PASS
6	2437	16.33	16.17	0.5	PASS
11	2462	16.32	15.81	0.5	PASS



A D T

### FOR CHAIN 0: CH 1

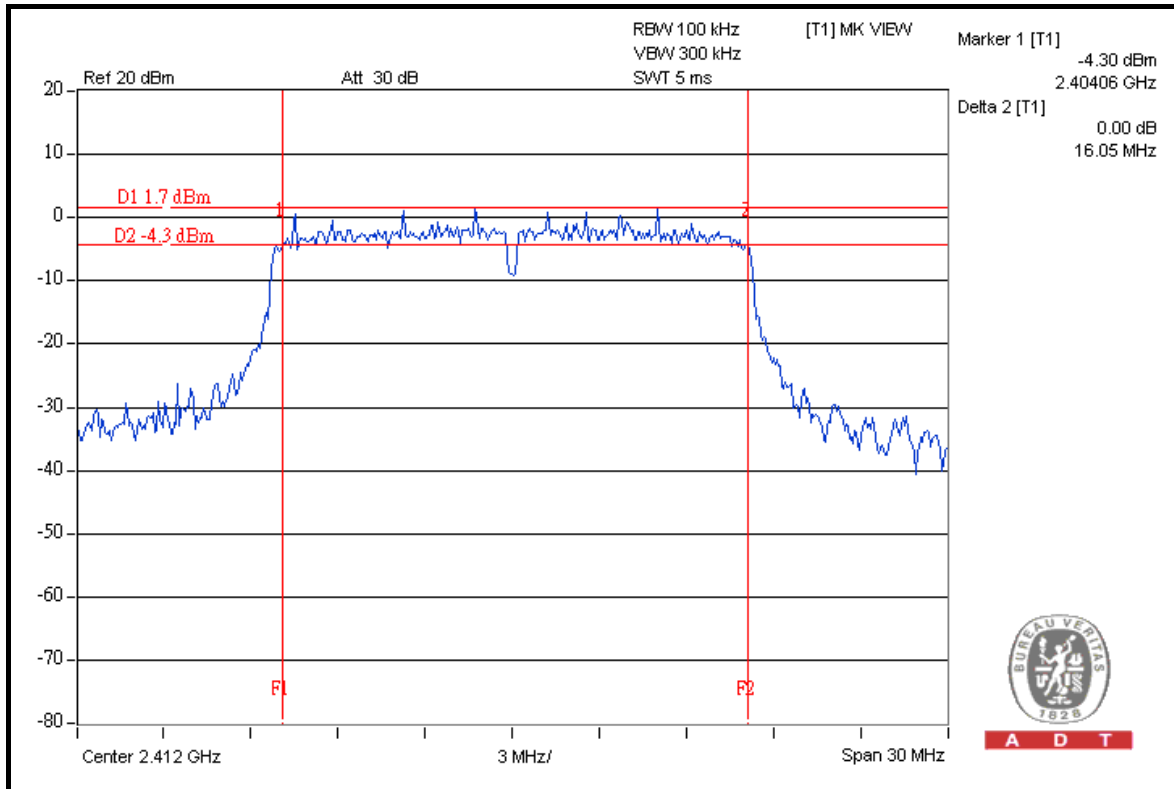

### CH 6

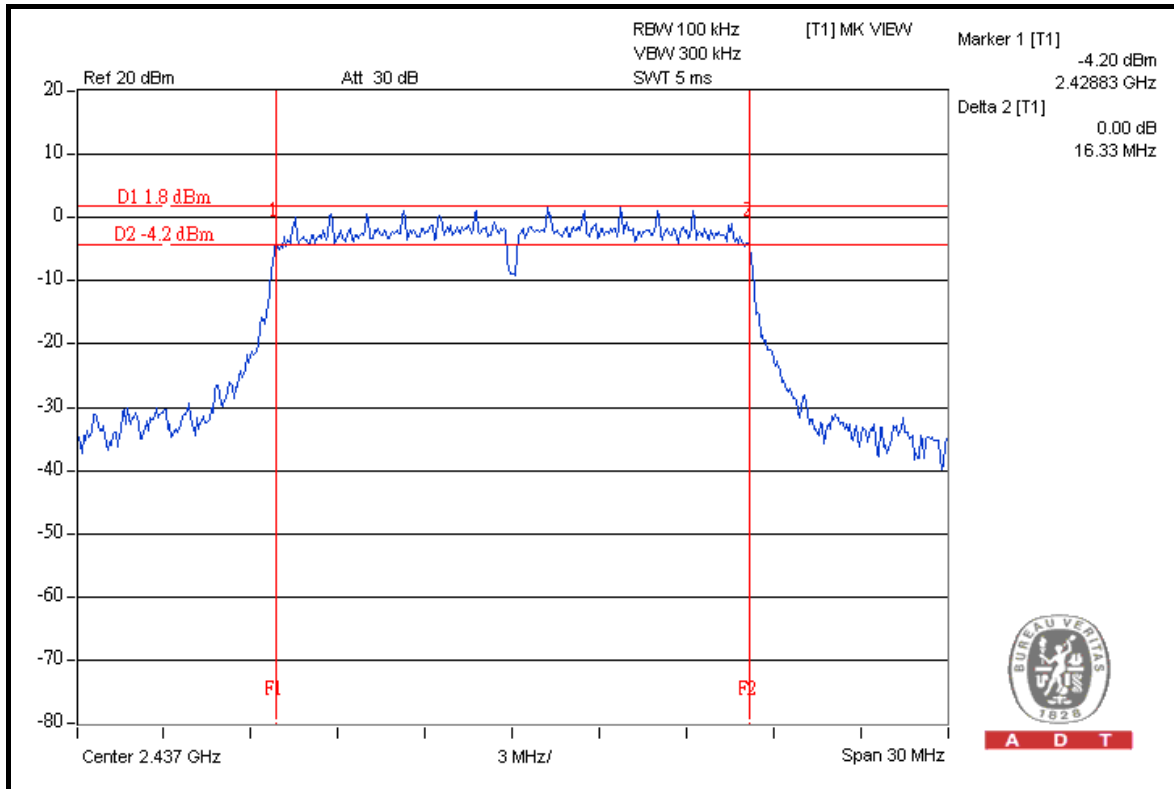





A D T

### CH 11

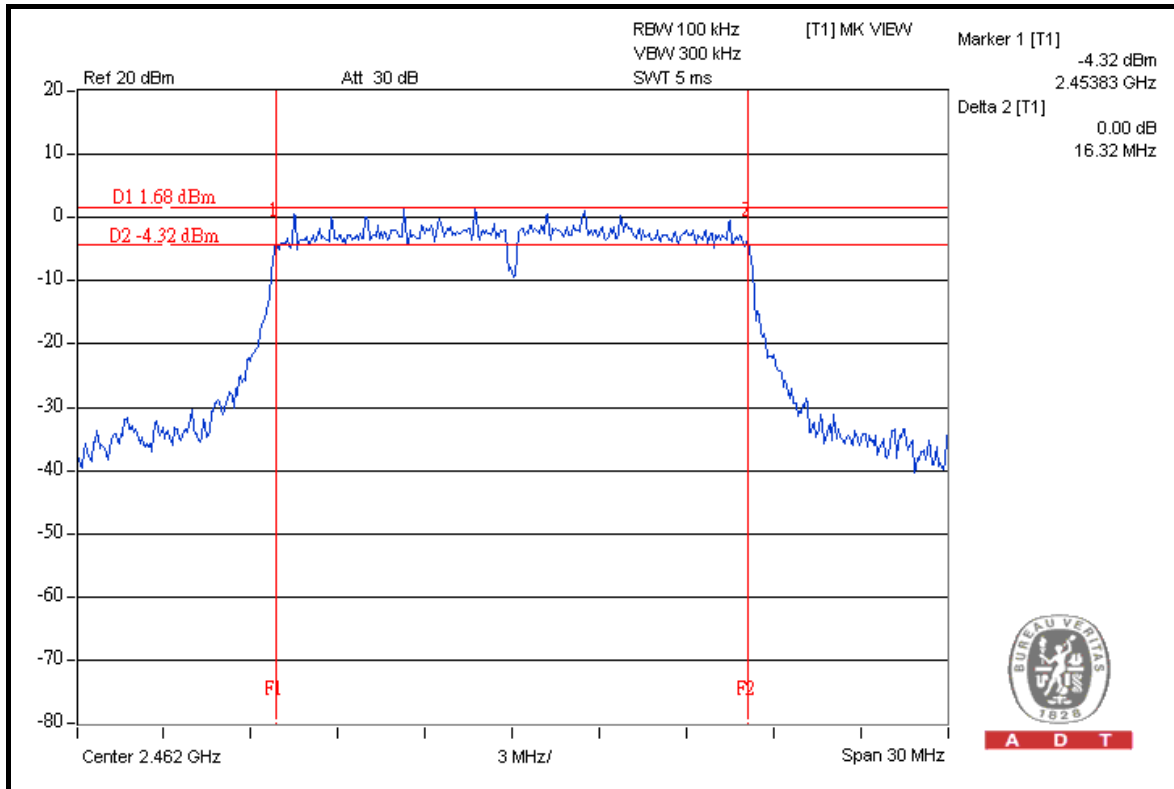

### FOR CHAIN 1: CH 1

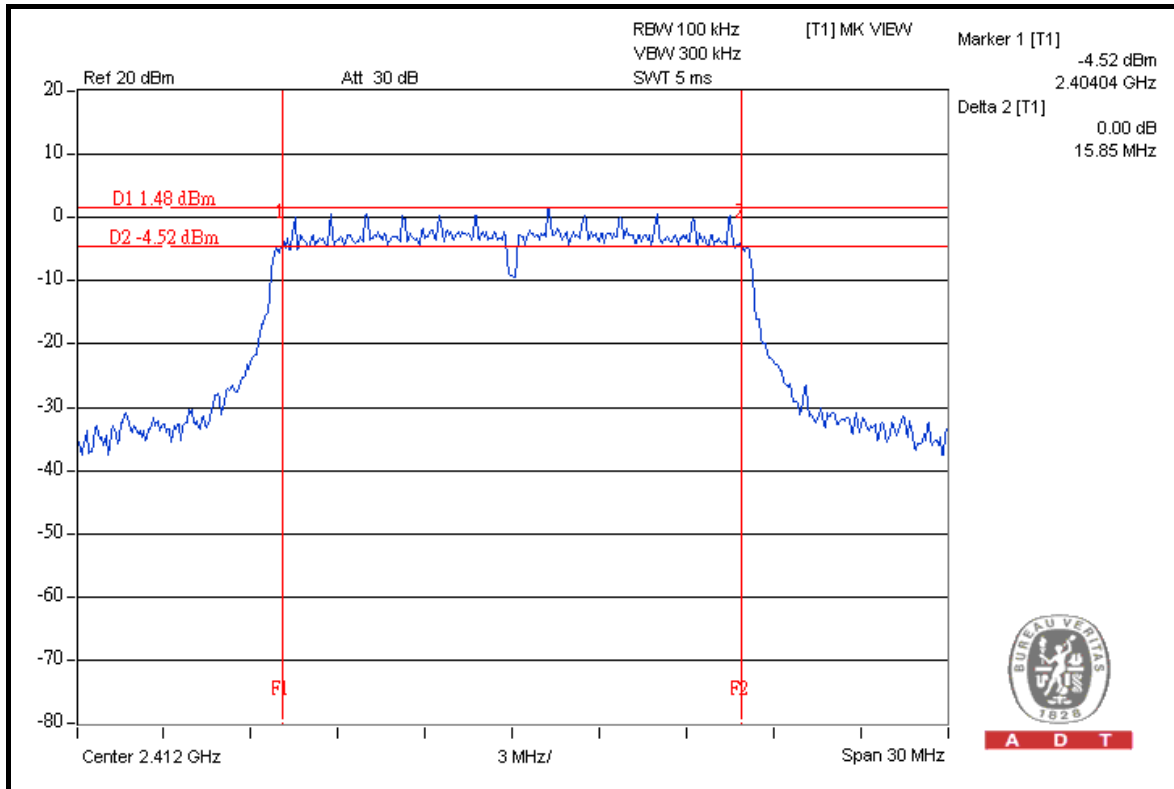



A D T

### CH 6

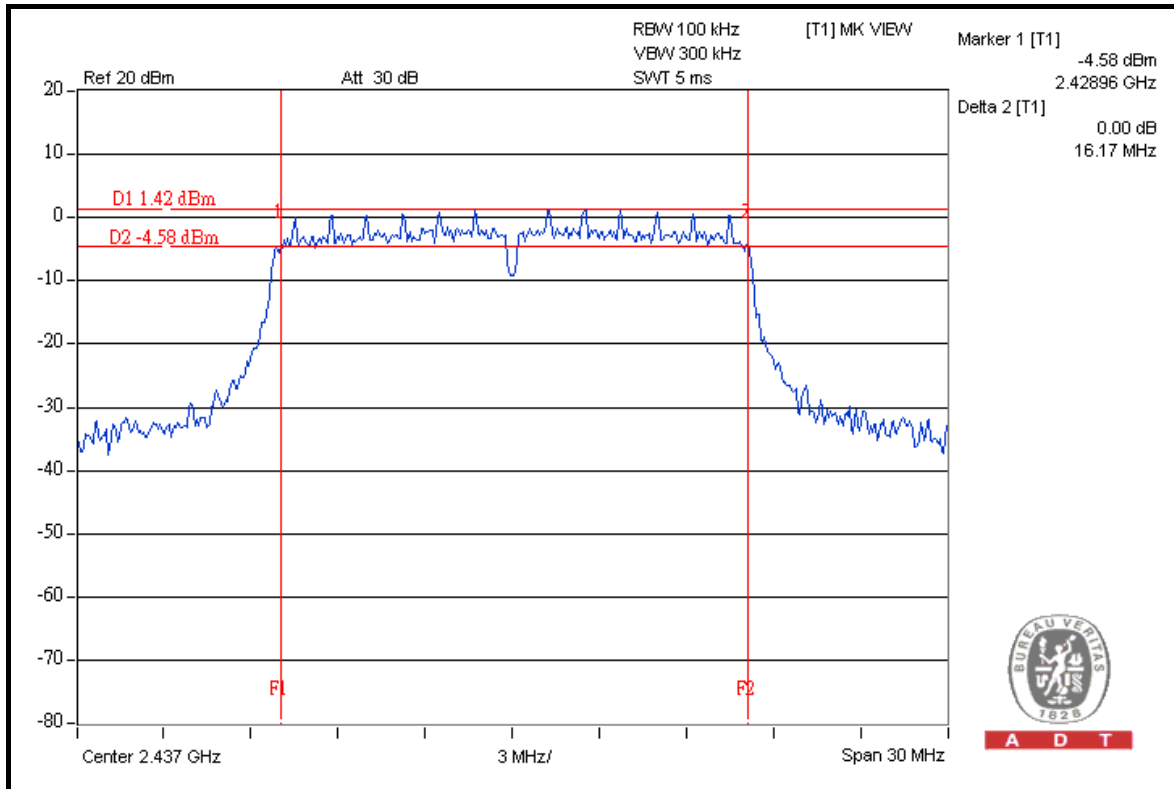

### CH 11

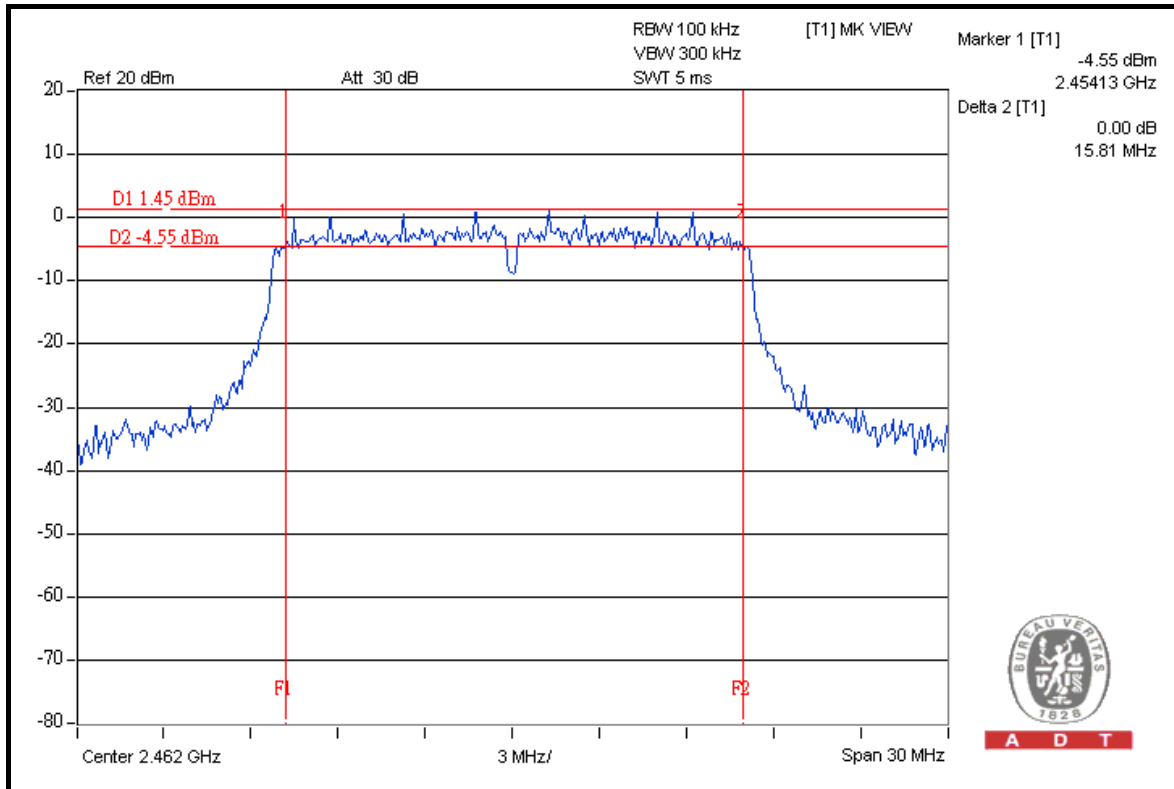



A D T

### DRAFT 802.11n (20MHz) OFDM MODULATION

<b>MODULATION TYPE</b>	BPSK	<b>TRANSFER RATE</b>	7.2Mbps
<b>INPUT POWER</b>	120Vac, 60Hz	<b>ENVIRONMENTAL CONDITIONS</b>	24 deg.C, 64 %RH, 1009hPa
<b>TESTED BY</b>	Sun Lin		

CHANNEL	CHANNEL FREQUENCY (MHz)	6dB BANDWIDTH (MHz)		MINIMUM LIMIT (MHz)	PASS / FAIL
		CHAIN 0	CHAIN 1		
1	2412	16.35	16.05	0.5	PASS
6	2437	16.15	15.96	0.5	PASS
11	2462	16.37	16.10	0.5	PASS



A D T

### FOR CHAIN 0: CH 1

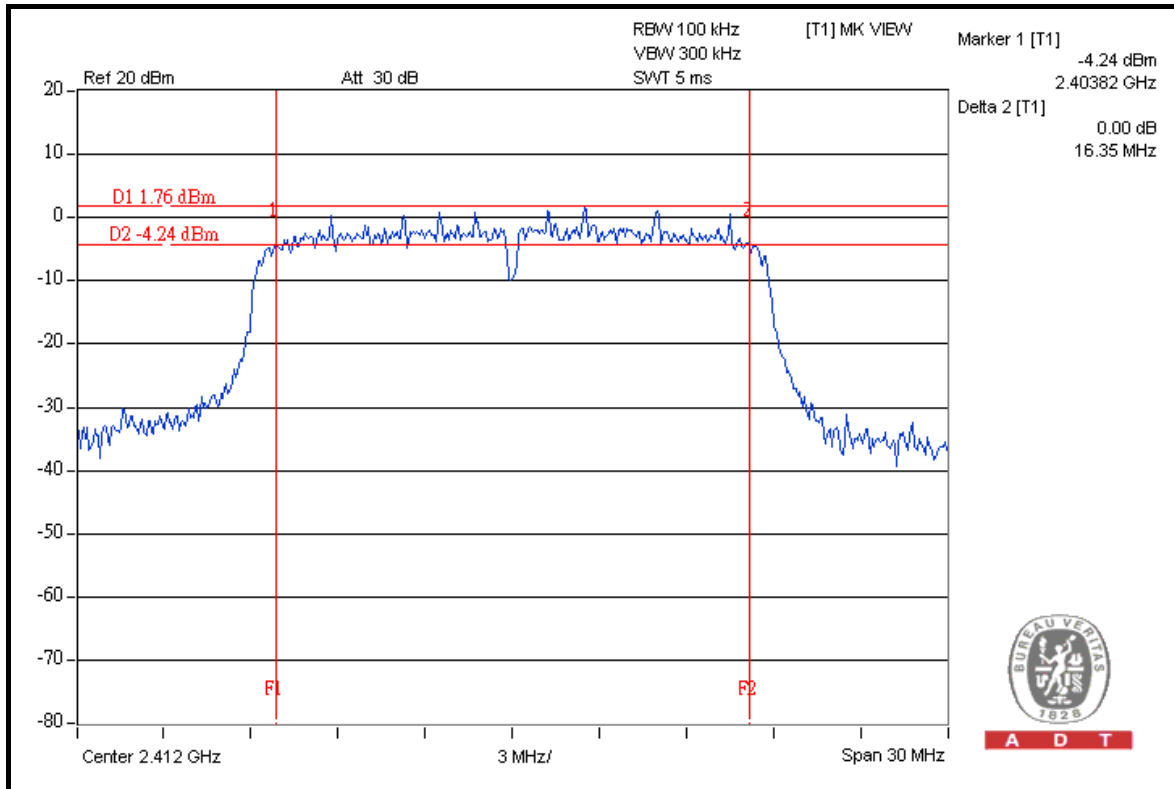

### CH 6

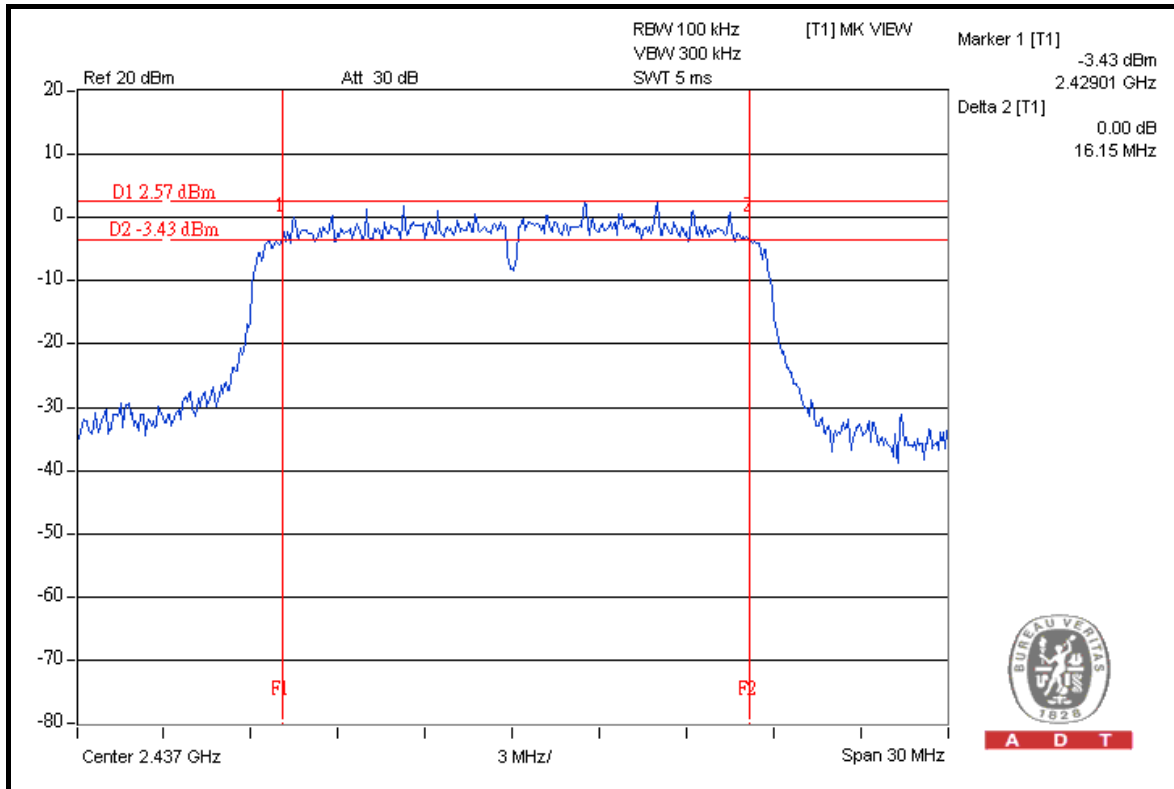



A D T

### CH 11

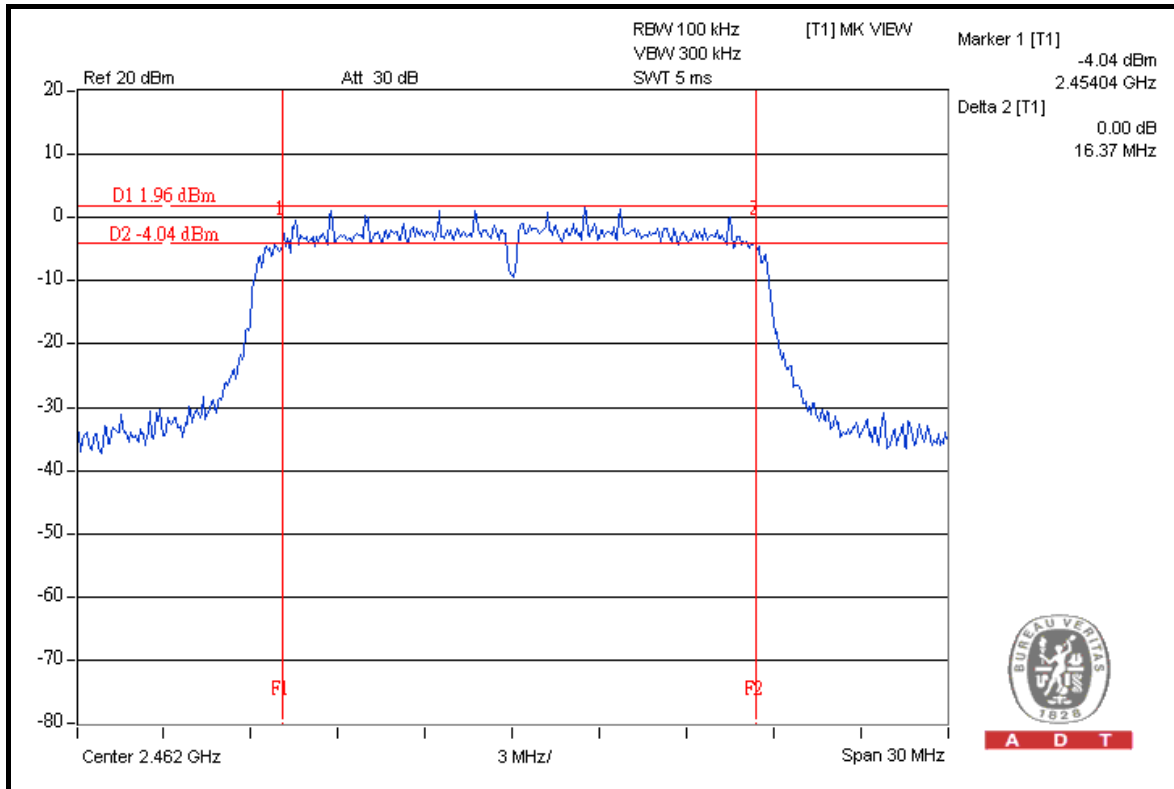

### FOR CHAIN 1: CH 1

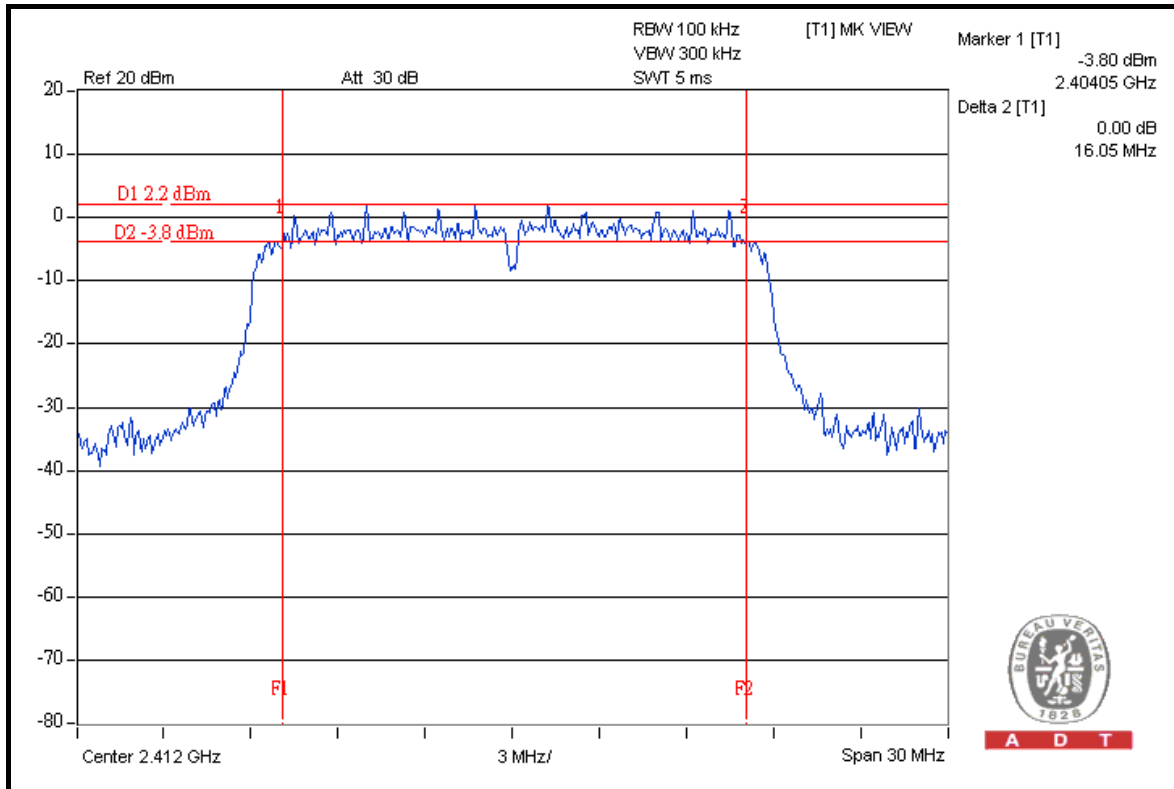



A D T

### CH 6

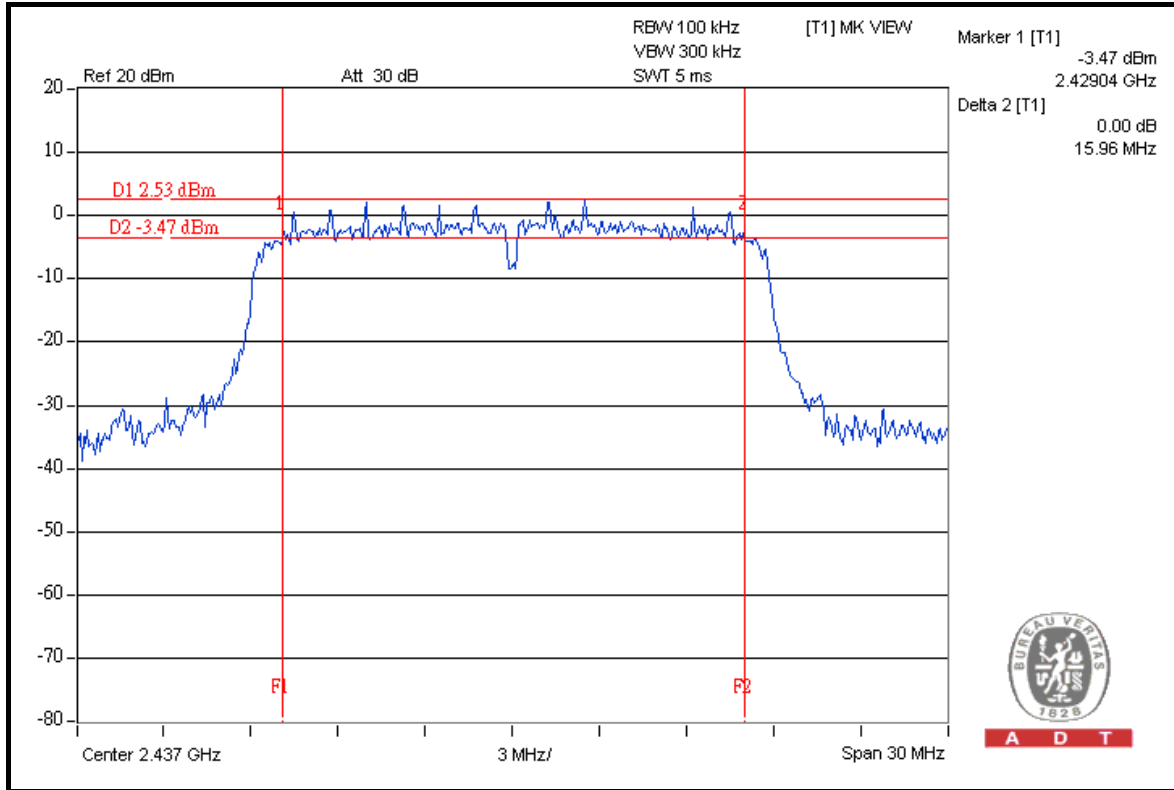

### CH 11

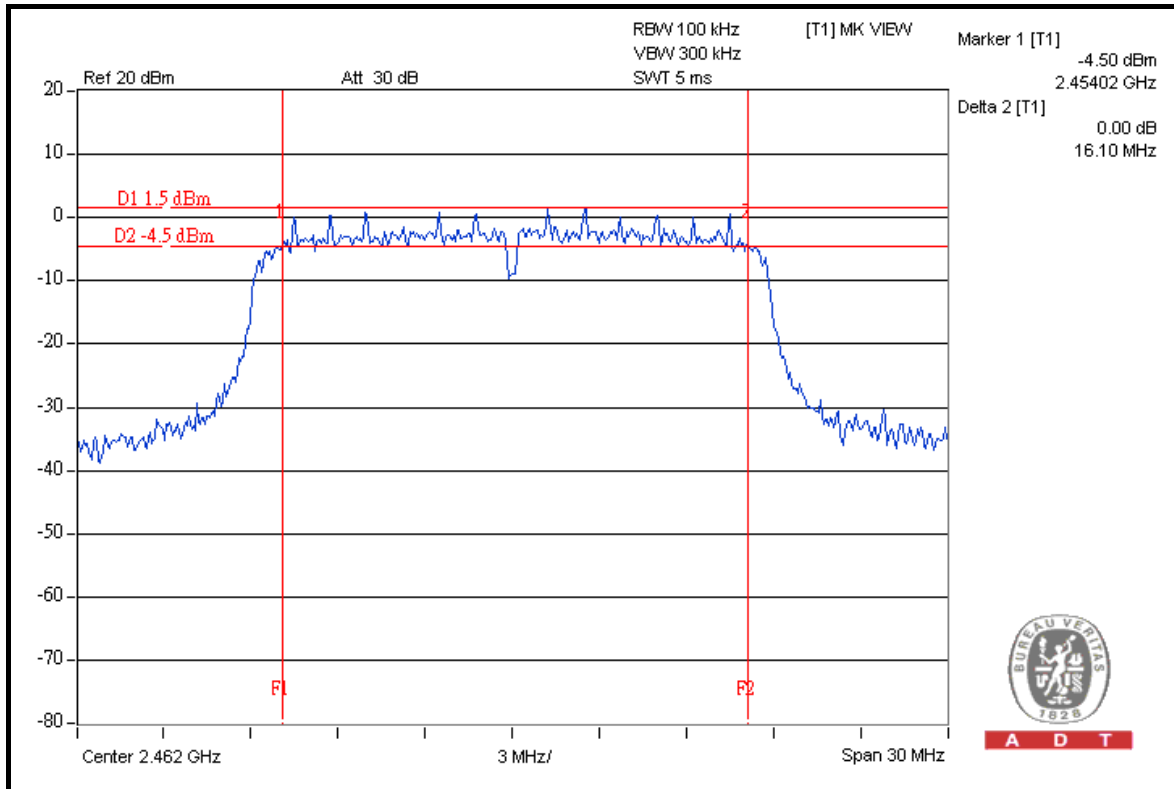



A D T

### DRAFT 802.11n (40MHz) OFDM MODULATION

<b>MODULATION TYPE</b>	BPSK	<b>TRANSFER RATE</b>	15.0Mbps
<b>INPUT POWER</b>	120Vac, 60Hz	<b>ENVIRONMENTAL CONDITIONS</b>	24 deg.C, 64 %RH, 1009hPa
<b>TESTED BY</b>	Sun Lin		

CHANNEL	CHANNEL FREQUENCY (MHz)	6dB BANDWIDTH (MHz)		MINIMUM LIMIT (MHz)	PASS / FAIL
		CHAIN 0	CHAIN 1		
1	2422	35.29	35.16	0.5	PASS
4	2437	35.18	35.33	0.5	PASS
7	2452	35.30	35.13	0.5	PASS



A D T

### FOR CHAIN 0: CH 1

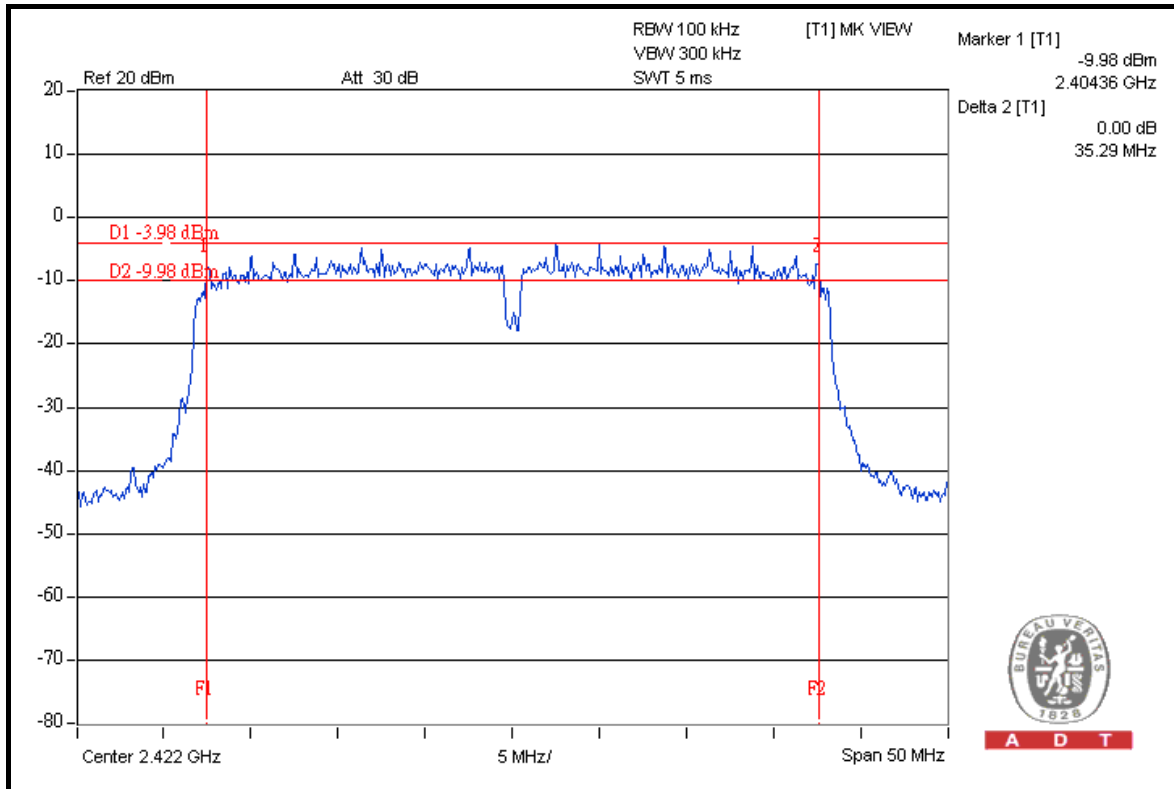

### CH 4

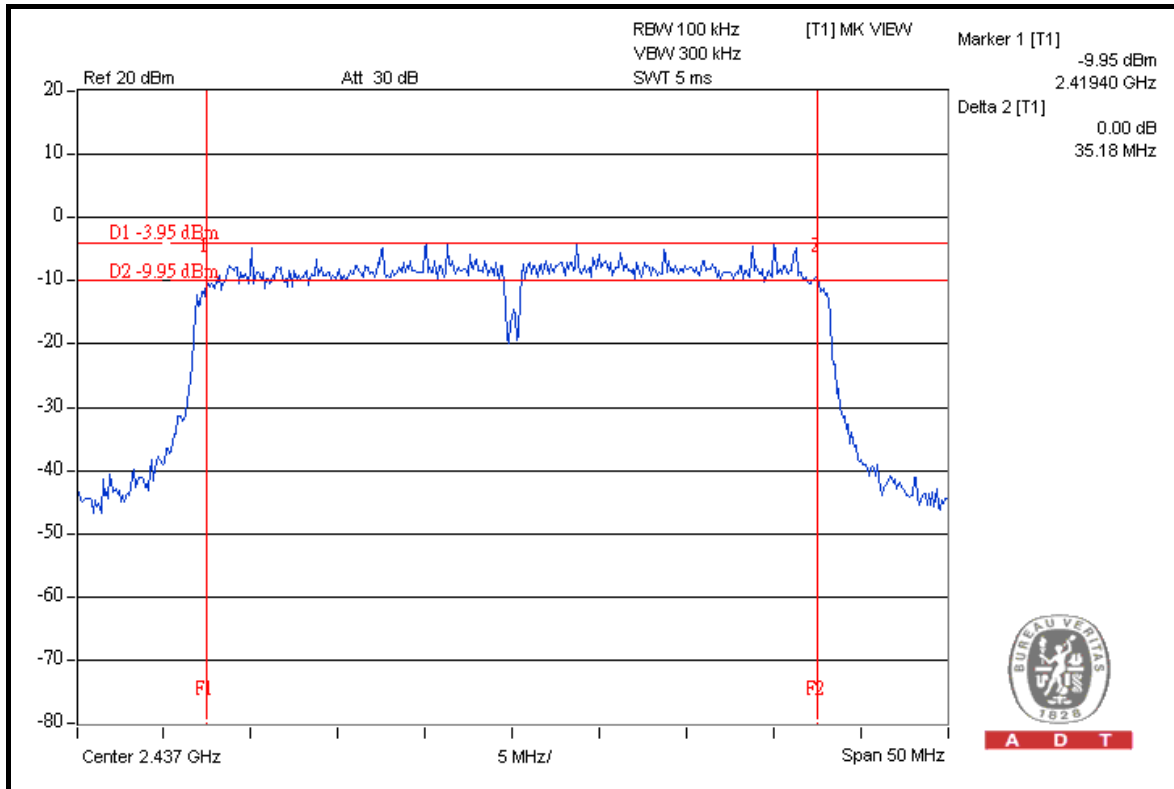





A D T

### CH 7

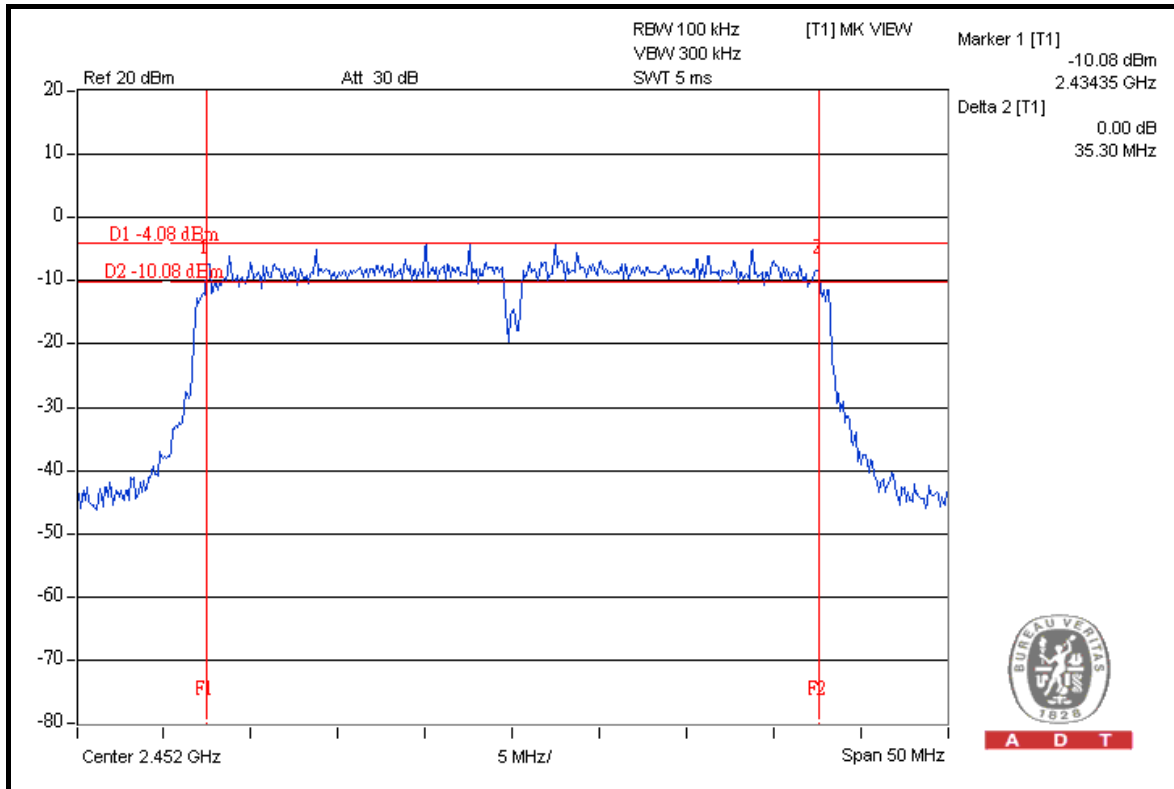

### FOR CHAIN 1: CH 1

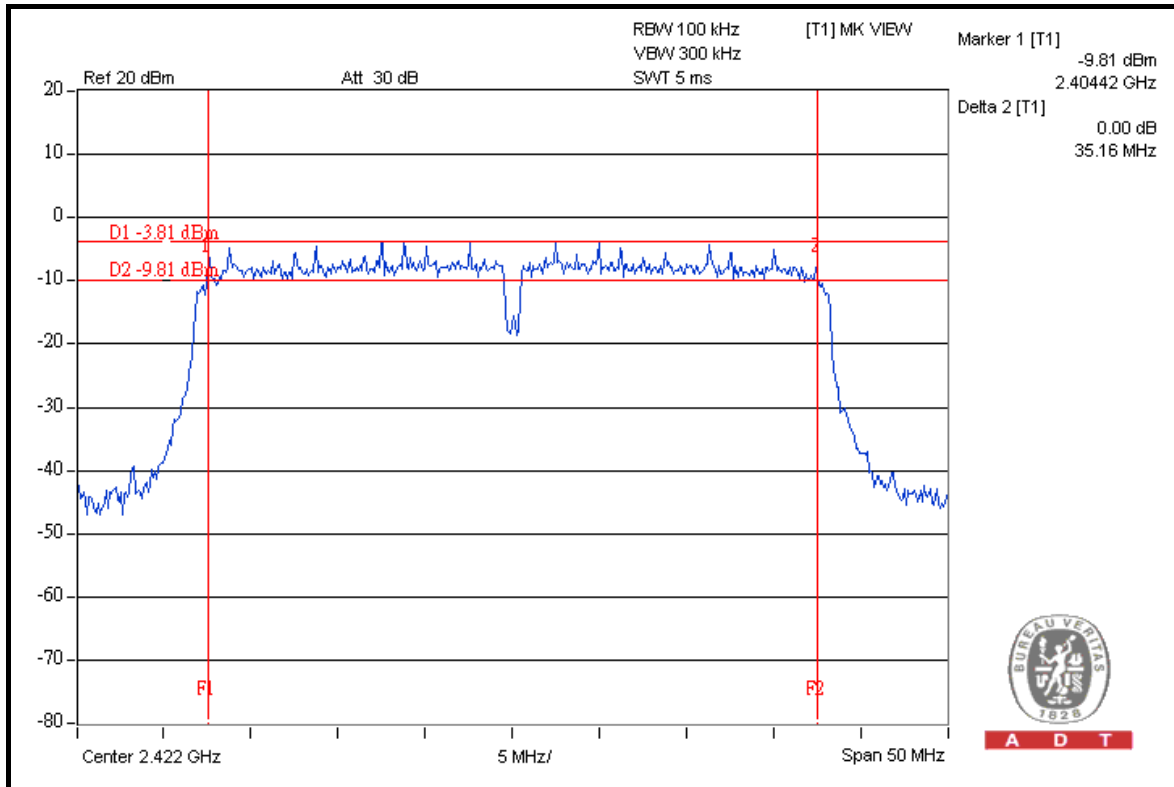



A D T

### CH 4

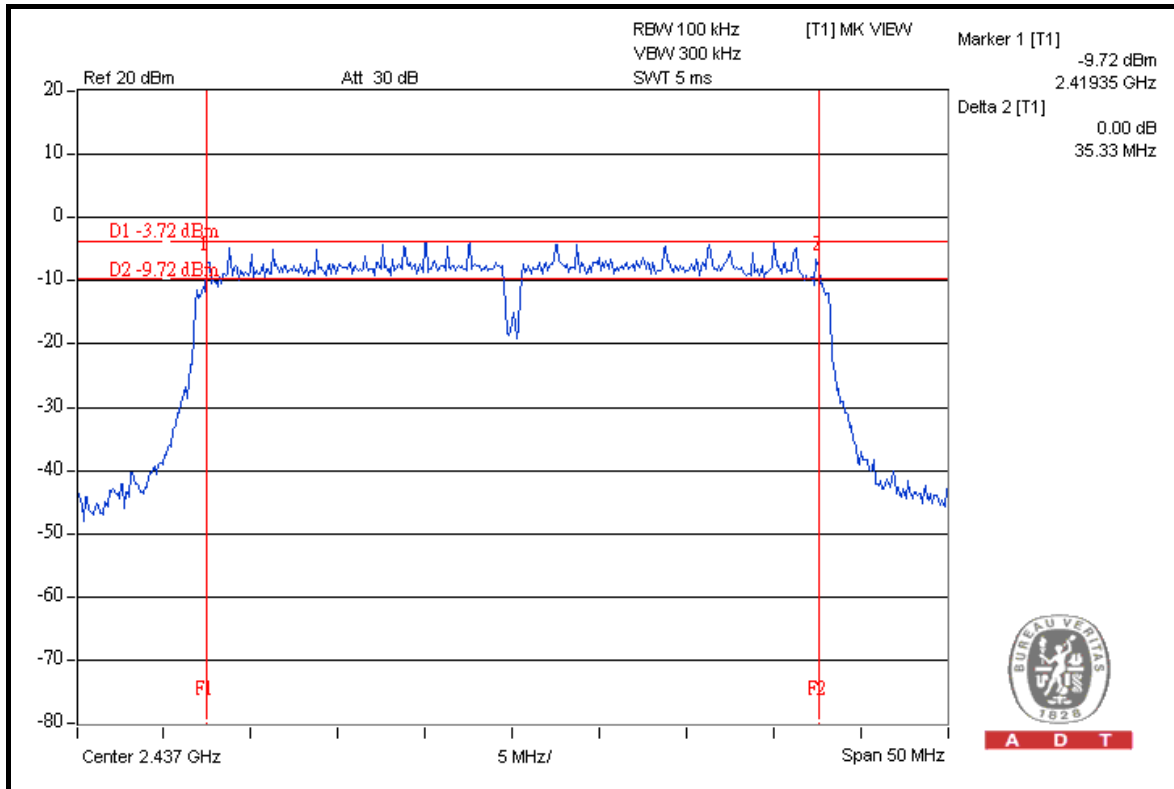

### CH 7

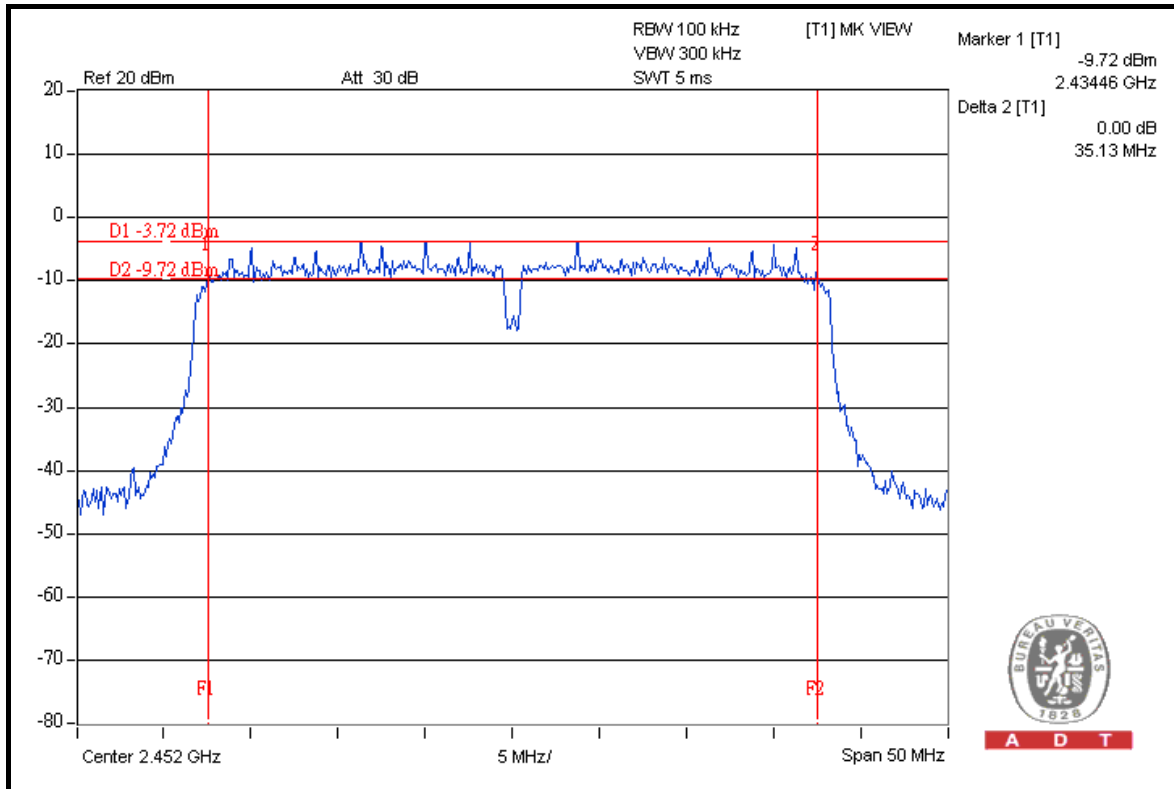



A D T

#### 4.4 MAXIMUM PEAK OUTPUT POWER

##### 4.4.1 LIMITS OF MAXIMUM PEAK OUTPUT POWER MEASUREMENT

The Maximum Peak Output Power Measurement is 30dBm.

##### 4.4.2 INSTRUMENTS

DESCRIPTION & MANUFACTURER	MODEL NO.	SERIAL NO.	DATE OF CALIBRATION	DUE DATE OF CALIBRATION
High Speed Peak Power Meter	ML2495A	0824011	Jul. 30, 2009	Jul. 29, 2010
Power Sensor	MA2411B	0738171	Jul. 30, 2009	Jul. 29, 2010

**NOTE:**

1. The calibration interval of the above test instruments is 12 months and the calibrations are traceable to NML/ROC and NIST/USA.
2. Measurement Bandwidth of ML2495A is 65MHz greater than 6dB bandwidth of emission.

##### 4.4.3 TEST PROCEDURES

A power sensor was used on the output port of the EUT. A power meter was used to read the response of the power sensor. Record the power level.

#### 4.4.4 DEVIATION FROM TEST STANDARD

No deviation.

#### 4.4.5 TEST SETUP

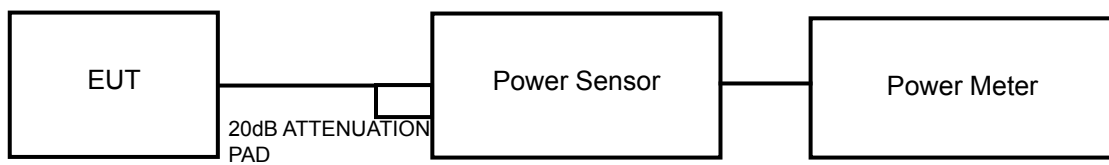

#### 4.4.6 EUT OPERATING CONDITIONS

Same as Item 4.3.6.



A D T

#### 4.4.7 TEST RESULTS

##### 802.11b DSSS MODULATION

<b>MODULATION TYPE</b>	DBPSK	<b>TRANSFER RATE</b>	1.0Mbps
<b>INPUT POWER</b>	120Vac, 60Hz	<b>ENVIRONMENTAL CONDITIONS</b>	24 deg.C, 64 %RH, 1009hPa
<b>TESTED BY</b>	Sun Lin		

CHAN.	CHAN. FREQ. (MHz)	PEAK POWER OUTPUT (dBm)		TOTAL PEAK POWER (mW)	TOTAL PEAK POWER (dBm)	PEAK POWER LIMIT (dBm)	PASS / FAIL
		CHAIN 0	CHAIN 1				
1	2412	15.86	16.07	79.01	18.98	30	PASS
6	2437	16.59	16.56	90.89	19.59	30	PASS
11	2462	16.52	16.54	89.96	19.54	30	PASS

##### 802.11g OFDM MODULATION

<b>MODULATION TYPE</b>	BPSK	<b>TRANSFER RATE</b>	6.0Mbps
<b>INPUT POWER</b>	120Vac, 60Hz	<b>ENVIRONMENTAL CONDITIONS</b>	24 deg.C, 64 %RH, 1009hPa
<b>TESTED BY</b>	Sun Lin		

CHAN.	CHAN. FREQ. (MHz)	PEAK POWER OUTPUT (dBm)		TOTAL PEAK POWER (mW)	TOTAL PEAK POWER (dBm)	PEAK POWER LIMIT (dBm)	PASS / FAIL
		CHAIN 0	CHAIN 1				
1	2412	22.03	22.06	320.28	25.06	30	PASS
6	2437	22.12	22.08	<b>324.37</b>	25.11	30	PASS
11	2462	22.06	22.02	319.92	25.05	30	PASS



A D T

### DRAFT 802.11n (20MHz) OFDM MODULATION

<b>MODULATION TYPE</b>	BPSK	<b>TRANSFER RATE</b>	7.2Mbps
<b>INPUT POWER</b>	120Vac, 60Hz	<b>ENVIRONMENTAL CONDITIONS</b>	24 deg.C, 64 %RH, 1009hPa
<b>TESTED BY</b>	Sun Lin		

CHAN.	CHAN. FREQ. (MHz)	PEAK POWER OUTPUT (dBm)		TOTAL PEAK POWER (mW)	TOTAL PEAK POWER (dBm)	PEAK POWER LIMIT (dBm)	PASS / FAIL
		CHAIN 0	CHAIN 1				
1	2412	21.09	21.74	277.81	24.44	30	PASS
6	2437	22.05	22.08	321.76	25.08	30	PASS
11	2462	21.06	21.03	254.41	24.06	30	PASS

### DRAFT 802.11n (40MHz) OFDM MODULATION

<b>MODULATION TYPE</b>	BPSK	<b>TRANSFER RATE</b>	15.0Mbps
<b>INPUT POWER</b>	120Vac, 60Hz	<b>ENVIRONMENTAL CONDITIONS</b>	24 deg.C, 64 %RH, 1009hPa
<b>TESTED BY</b>	Sun Lin		

CHAN.	CHAN. FREQ. (MHz)	PEAK POWER OUTPUT (dBm)		TOTAL PEAK POWER (mW)	TOTAL PEAK POWER (dBm)	PEAK POWER LIMIT (dBm)	PASS / FAIL
		CHAIN 0	CHAIN 1				
1	2422	20.07	20.04	202.55	23.07	30	PASS
4	2437	20.05	20.11	203.72	23.09	30	PASS
7	2452	20.03	20.07	202.32	23.06	30	PASS

## 4.5 POWER SPECTRAL DENSITY MEASUREMENT

### 4.5.1 LIMITS OF POWER SPECTRAL DENSITY MEASUREMENT

The Maximum of Power Spectral Density Measurement is 8dBm.

### 4.5.2 TEST INSTRUMENTS

DESCRIPTION & MANUFACTURER	MODEL NO.	SERIAL NO.	DATE OF CALIBRATION	DUE DATE OF CALIBRATION
R&S SPECTRUM ANALYZER	FSP40	100041	May 13, 2009	May 12, 2010

**NOTE:** The calibration interval of the above test instruments is 12 months and the calibrations are traceable to NML/ROC and NIST/USA.

### 4.5.3 TEST PROCEDURE

The transmitter output was connected to the spectrum analyzer through an attenuator, the bandwidth of the fundamental frequency was measured with the spectrum analyzer using 3kHz RBW and 30kHz VBW, set sweep time = span/3kHz. The power spectral density was measured and recorded.

The sweep time is allowed to be longer than span/3kHz for a full response of the mixer in the spectrum analyzer.

#### 4.5.4 DEVIATION FROM TEST STANDARD

No deviation.

#### 4.5.5 TEST SETUP

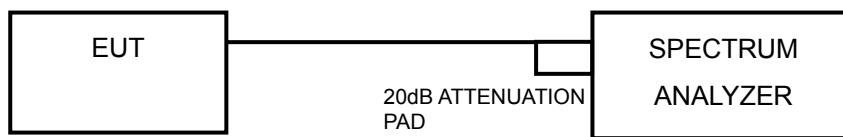

#### 4.5.6 EUT OPERATING CONDITION

Same as Item 4.3.6





A D T

#### 4.5.7 TEST RESULTS

##### 802.11b DSSS MODULATION

<b>MODULATION TYPE</b>	DBPSK	<b>TRANSFER RATE</b>	1.0Mbps
<b>INPUT POWER</b>	120Vac, 60Hz	<b>ENVIRONMENTAL CONDITIONS</b>	24 deg.C, 64 %RH, 1009hPa
<b>TESTED BY</b>	Sun Lin		

CHAN.	CHAN. FREQ. (MHz)	RF POWER LEVEL IN 3kHz BW (dBm)		TOTAL POWER DENSITY (mW)	TOTAL POWER DENSITY (dBm)	MAX. LIMIT (dBm)	PASS / FAIL
		CHAIN 0	CHAIN 1				
1	2412	-13.11	-12.71	0.10	-9.91	8	PASS
6	2437	-12.18	-12.07	0.12	-9.10	8	PASS
11	2462	-12.50	-12.05	0.12	-9.24	8	PASS



A D T

### FOR CHAIN 0: CH 1

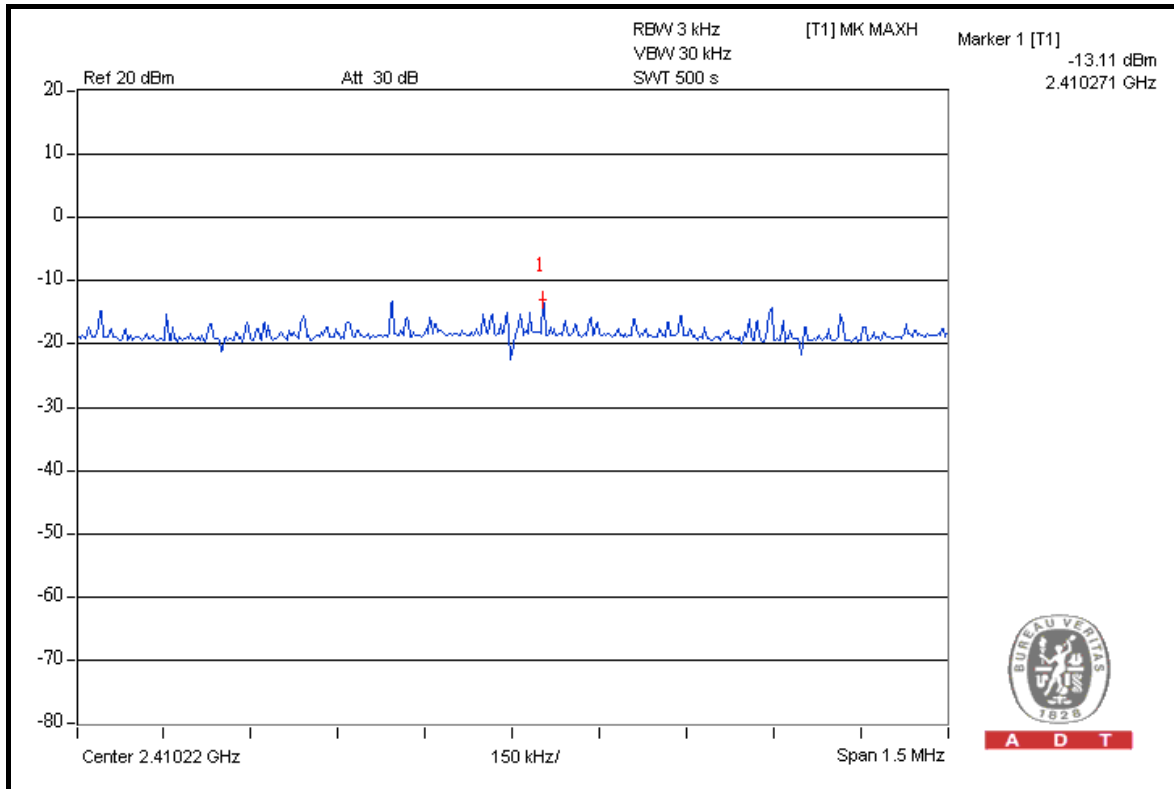

### CH 6

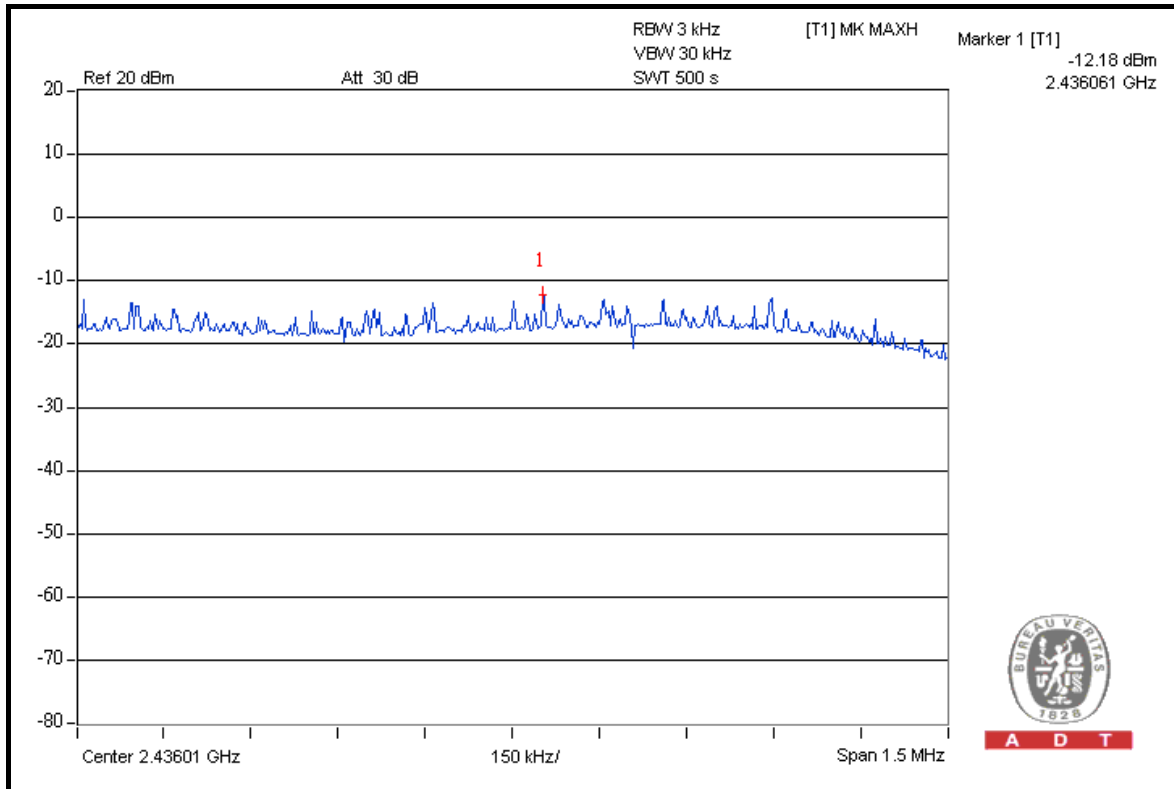



A D T

### CH 11

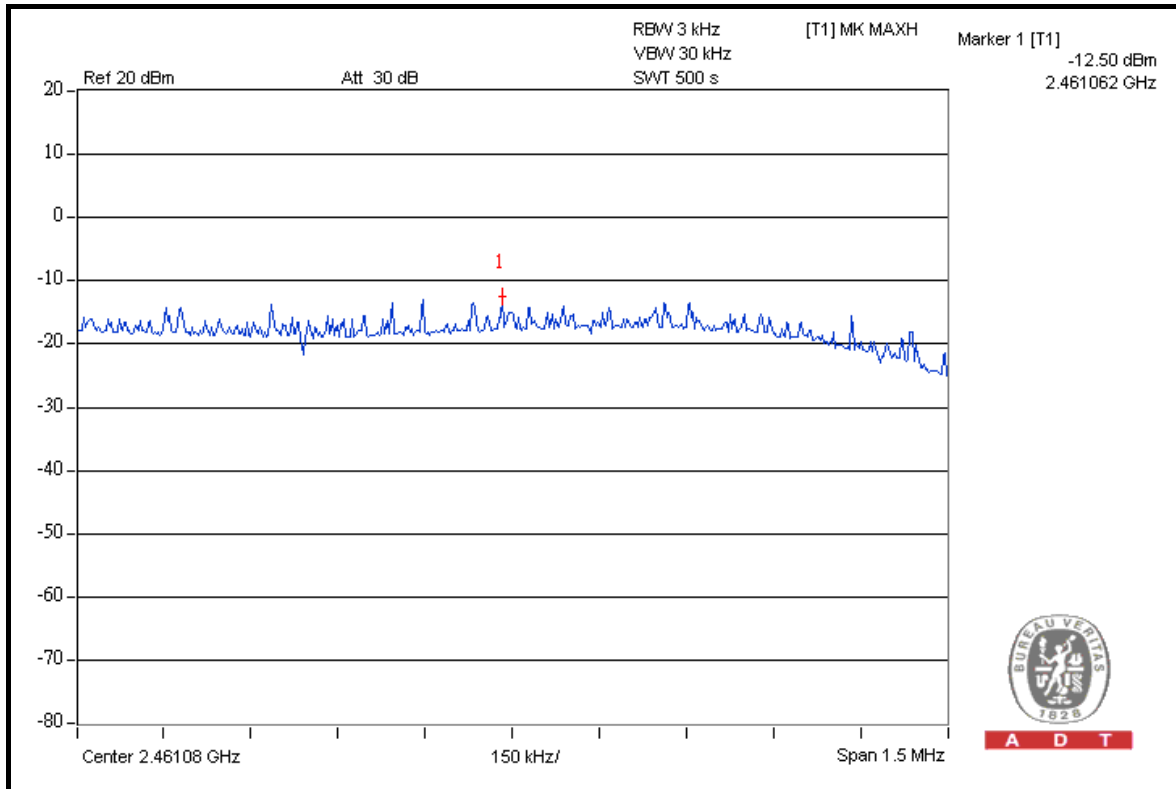

A D T

### FOR CHAIN 1: CH 1

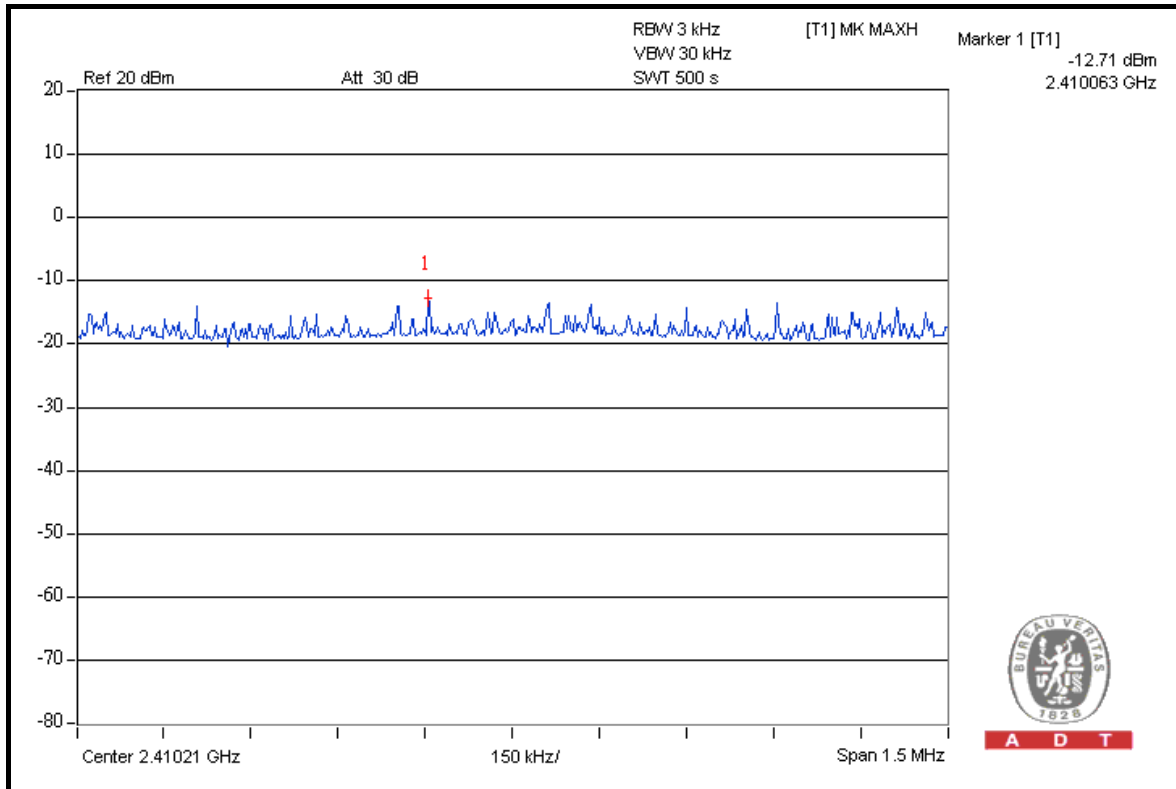

A D T



A D T

### CH 6

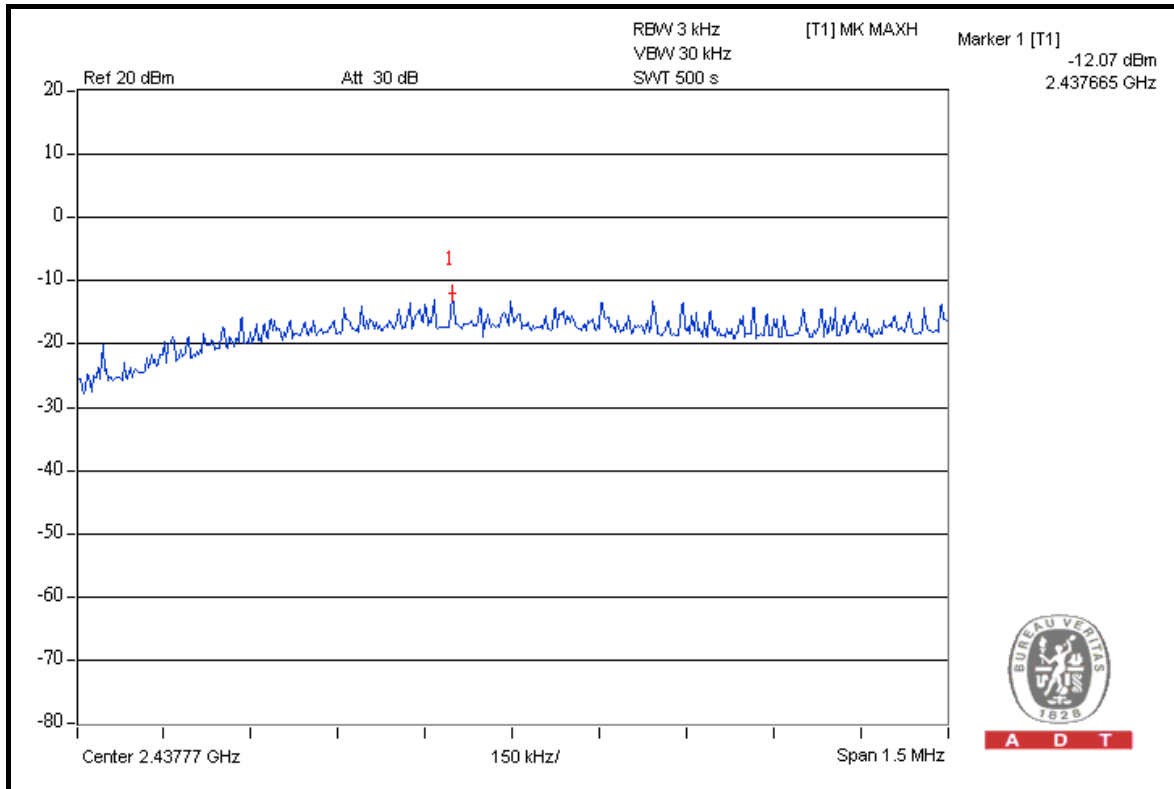

### CH 11

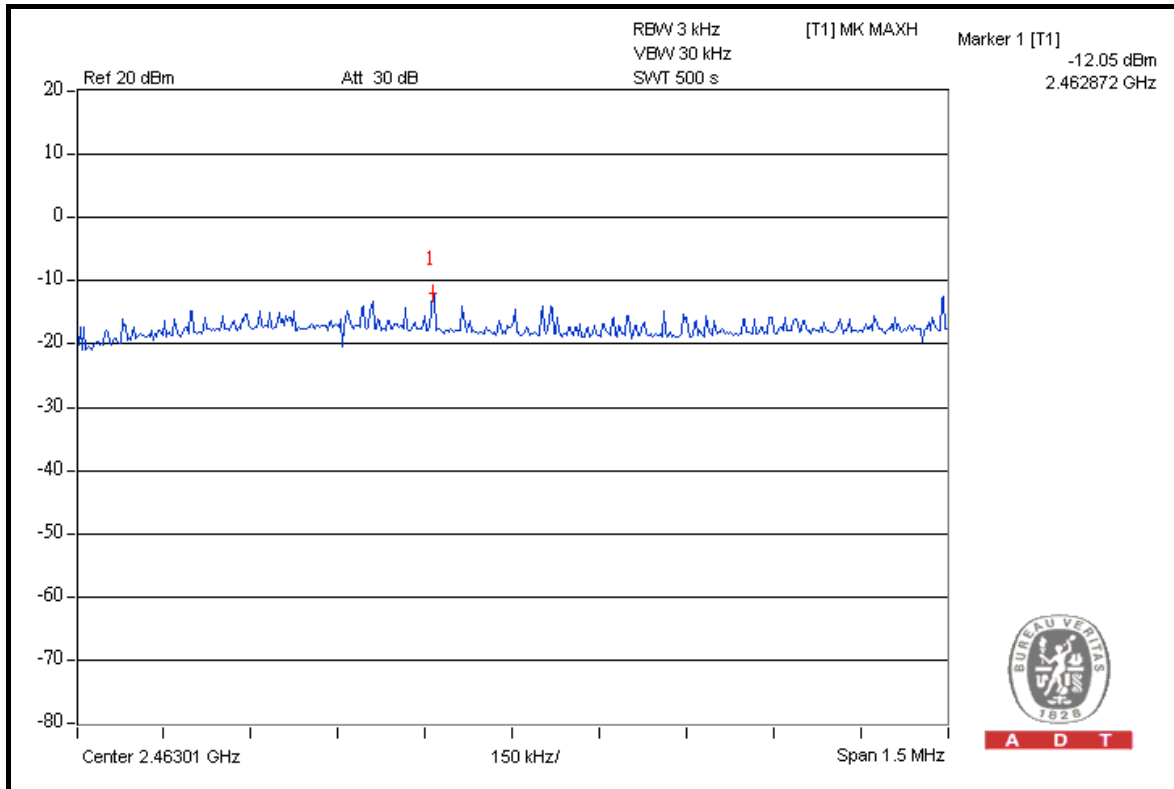



A D T

### 802.11g OFDM MODULATION

<b>MODULATION TYPE</b>	BPSK	<b>TRANSFER RATE</b>	6.0Mbps
<b>INPUT POWER</b>	120Vac, 60Hz	<b>ENVIRONMENTAL CONDITIONS</b>	24 deg.C, 64 %RH, 1009hPa
<b>TESTED BY</b>	Sun Lin		

CHAN.	CHAN. FREQ. (MHz)	RF POWER LEVEL IN 3kHz BW (dBm)		TOTAL POWER DENSITY (mW)	TOTAL POWER DENSITY (dBm)	MAX. LIMIT (dBm)	PASS / FAIL
		CHAIN 0	CHAIN 1				
1	2412	-15.33	-15.15	0.06	-12.22	8	PASS
6	2437	-15.04	-15.25	0.06	-12.15	8	PASS
11	2462	-15.09	-15.39	0.06	-12.22	8	PASS



A D T

### FOR CHAIN 0: CH 1

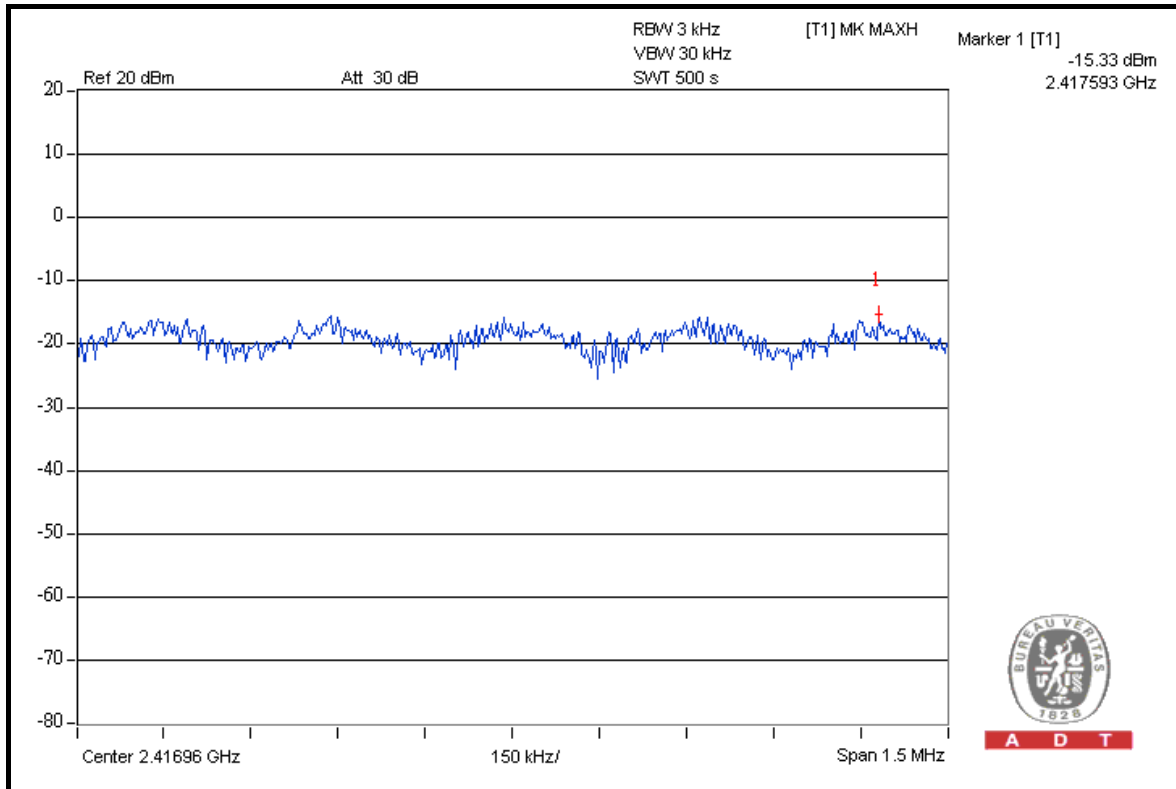

### CH 6

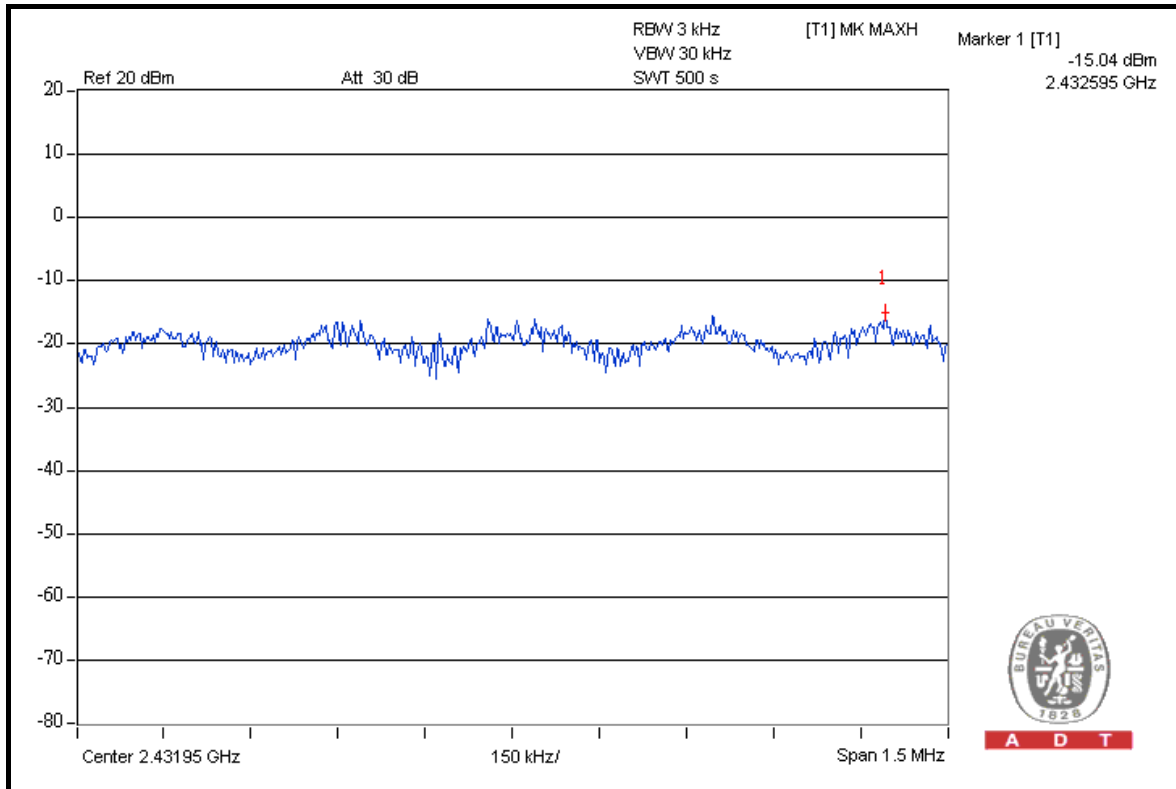



A D T

### CH 11

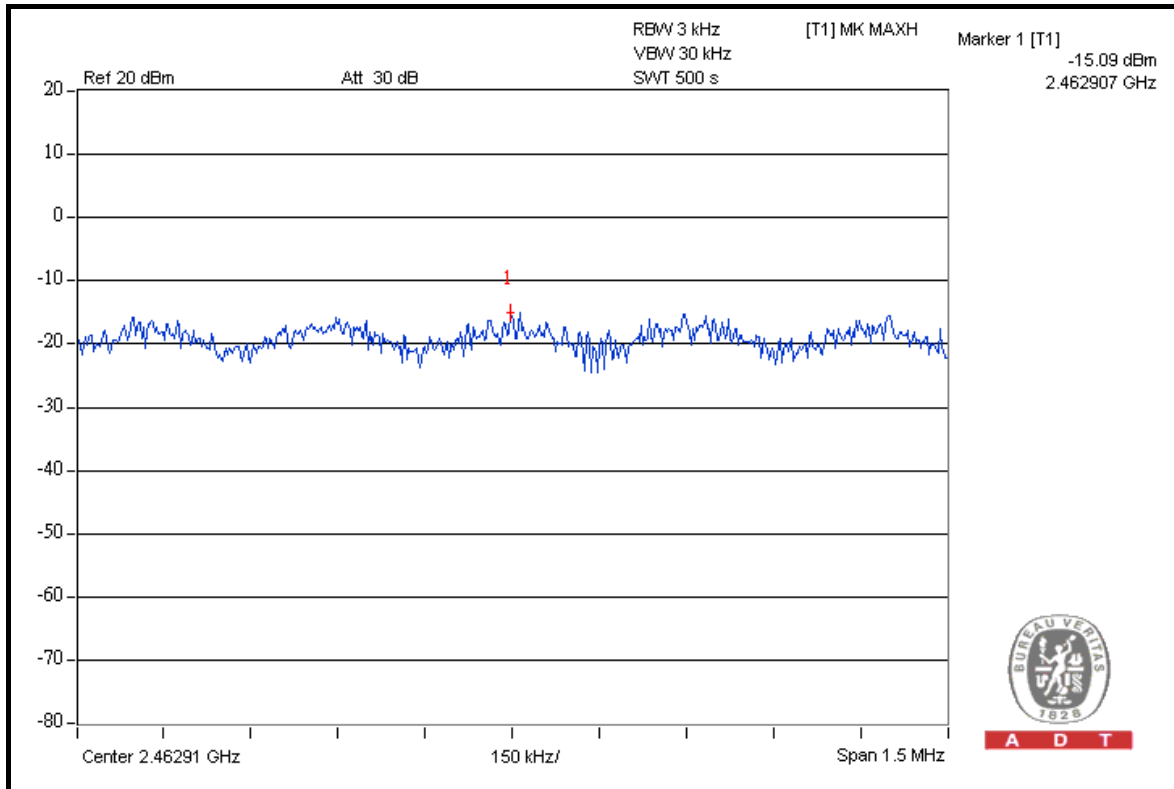

### FOR CHAIN 1: CH 1

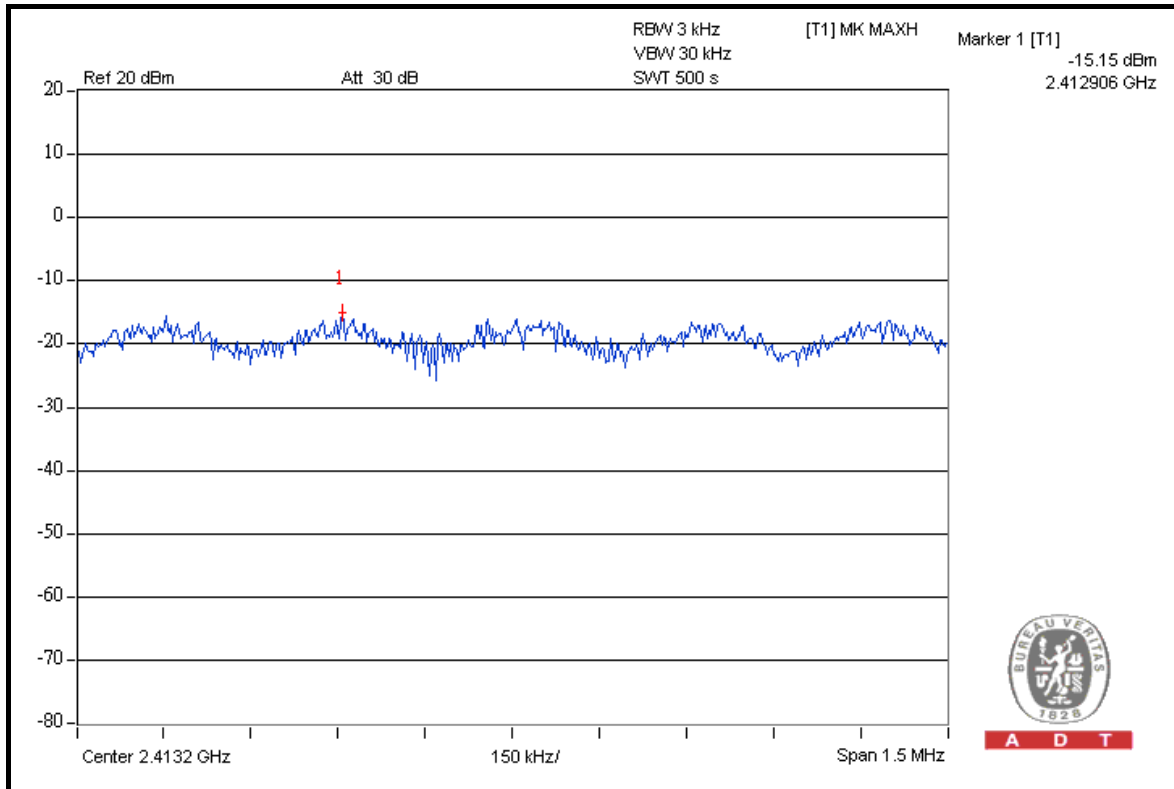



A D T

### CH 6

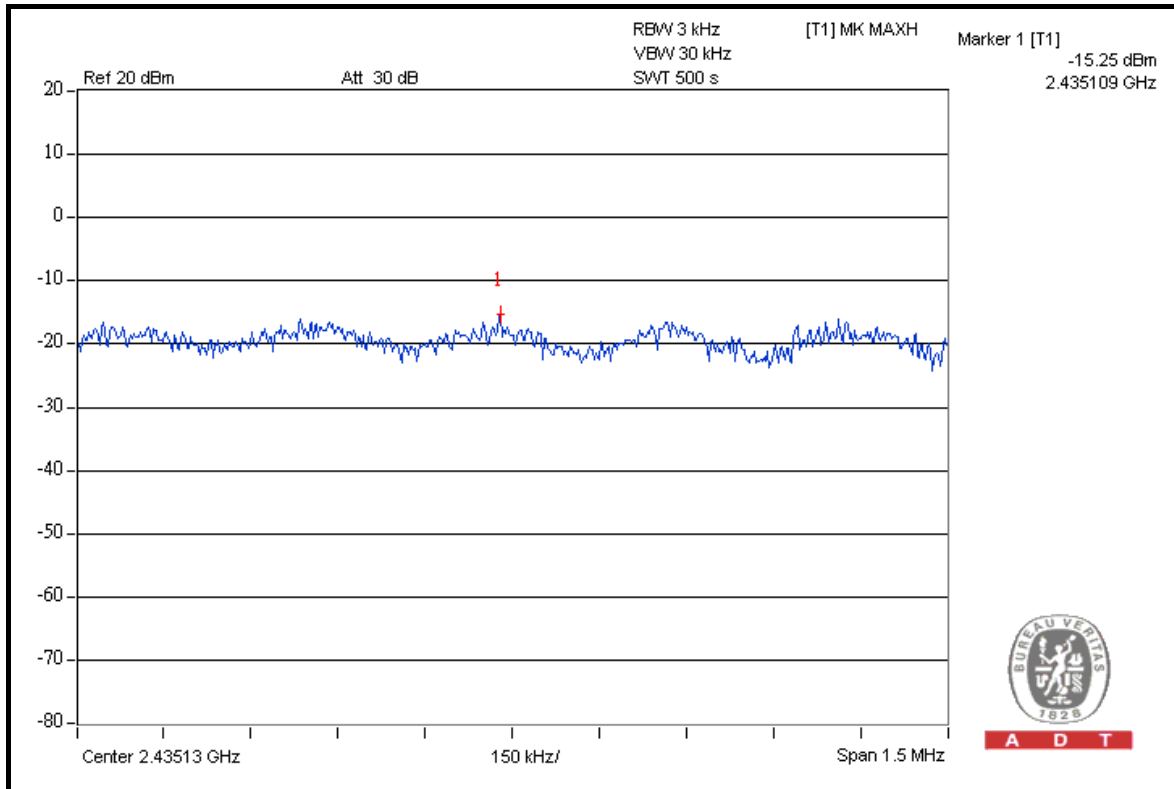

### CH 11

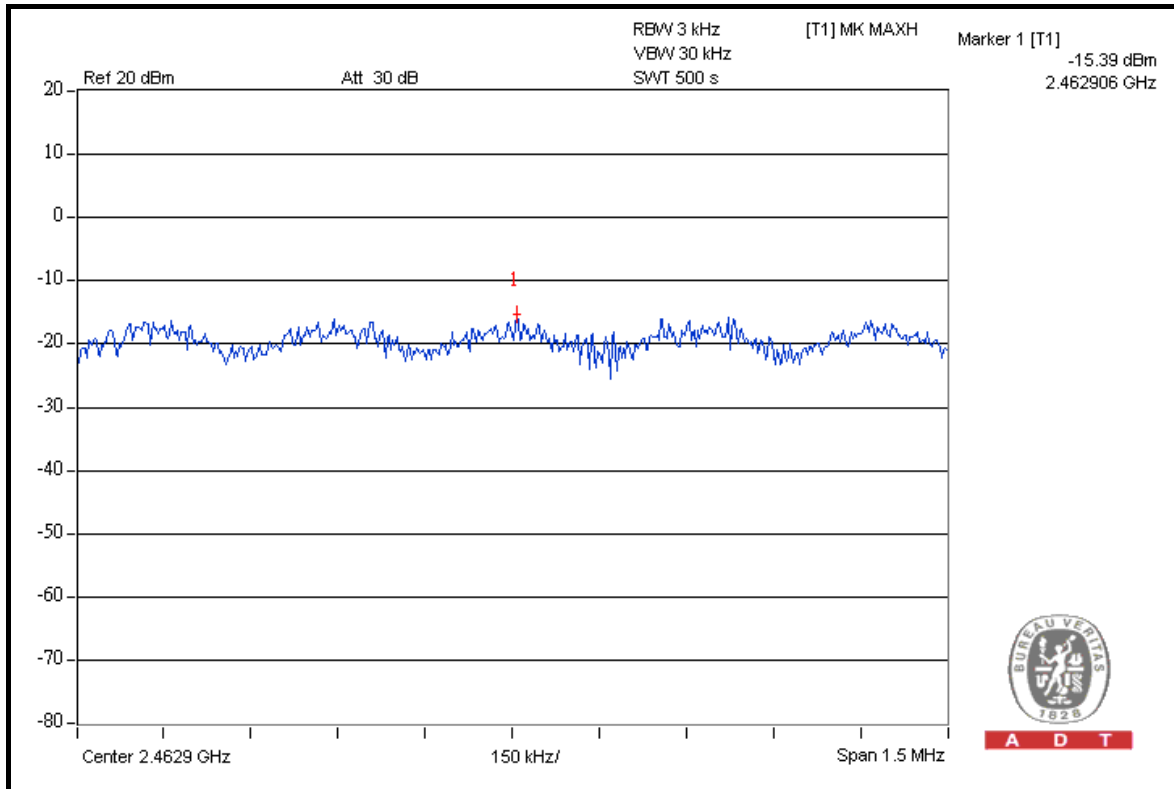





A D T

### DRAFT 802.11n (20MHz) OFDM MODULATION

<b>MODULATION TYPE</b>	BPSK	<b>TRANSFER RATE</b>	7.2Mbps
<b>INPUT POWER</b>	120Vac, 60Hz	<b>ENVIRONMENTAL CONDITIONS</b>	24 deg.C, 64 %RH, 1009hPa
<b>TESTED BY</b>	Sun Lin		

CHAN.	CHAN. FREQ. (MHz)	RF POWER LEVEL IN 3kHz BW (dBm)		TOTAL POWER DENSITY (mW)	TOTAL POWER DENSITY (dBm)	MAX. LIMIT (dBm)	PASS / FAIL
		CHAIN 0	CHAIN 1				
1	2412	-15.10	-14.03	0.07	-11.55	8	PASS
6	2437	-13.91	-13.89	0.08	-10.92	8	PASS
11	2462	-14.91	-14.56	0.07	-11.74	8	PASS



A D T

### FOR CHAIN 0: CH 1

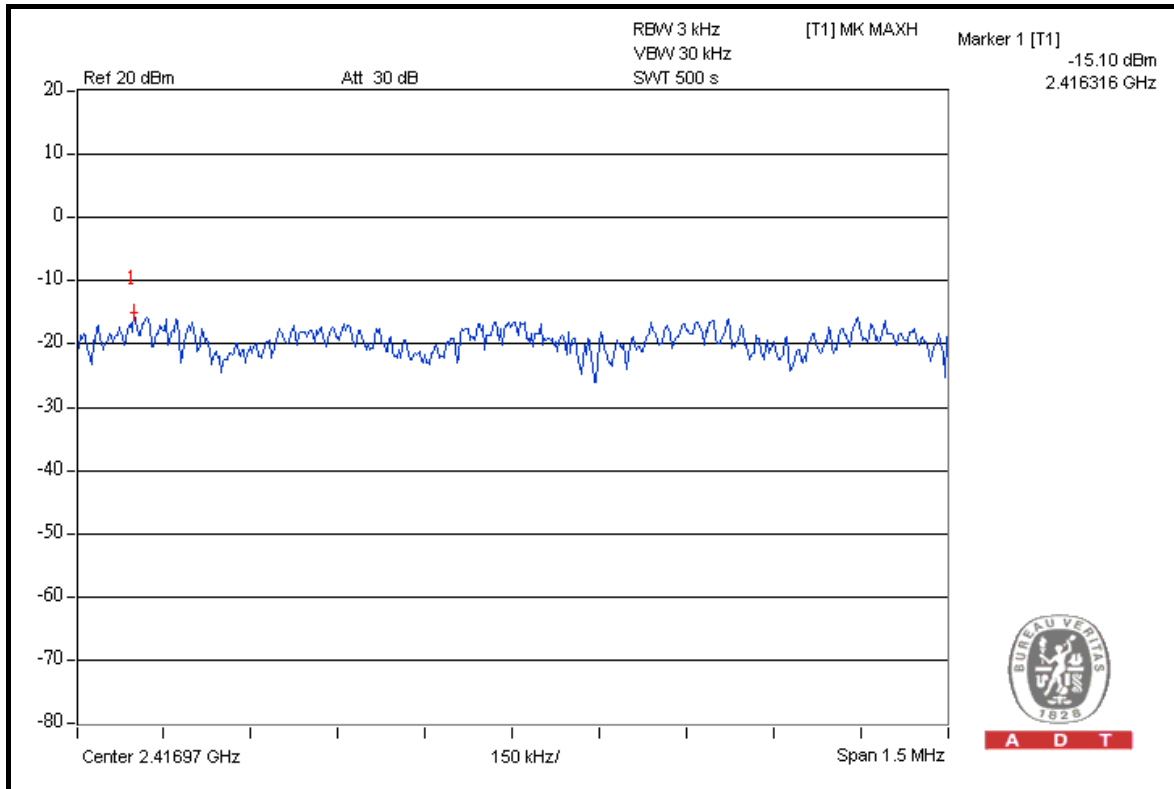

A D T

### CH 6

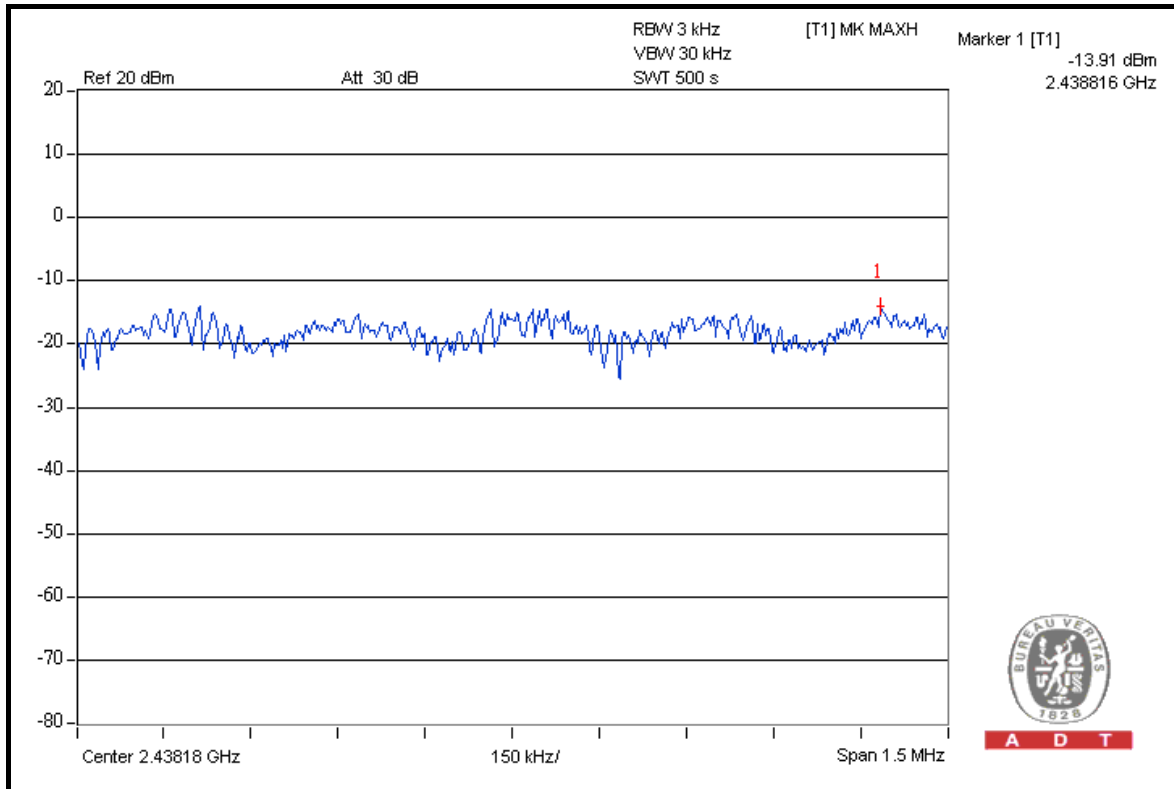

A D T



A D T

### CH 11

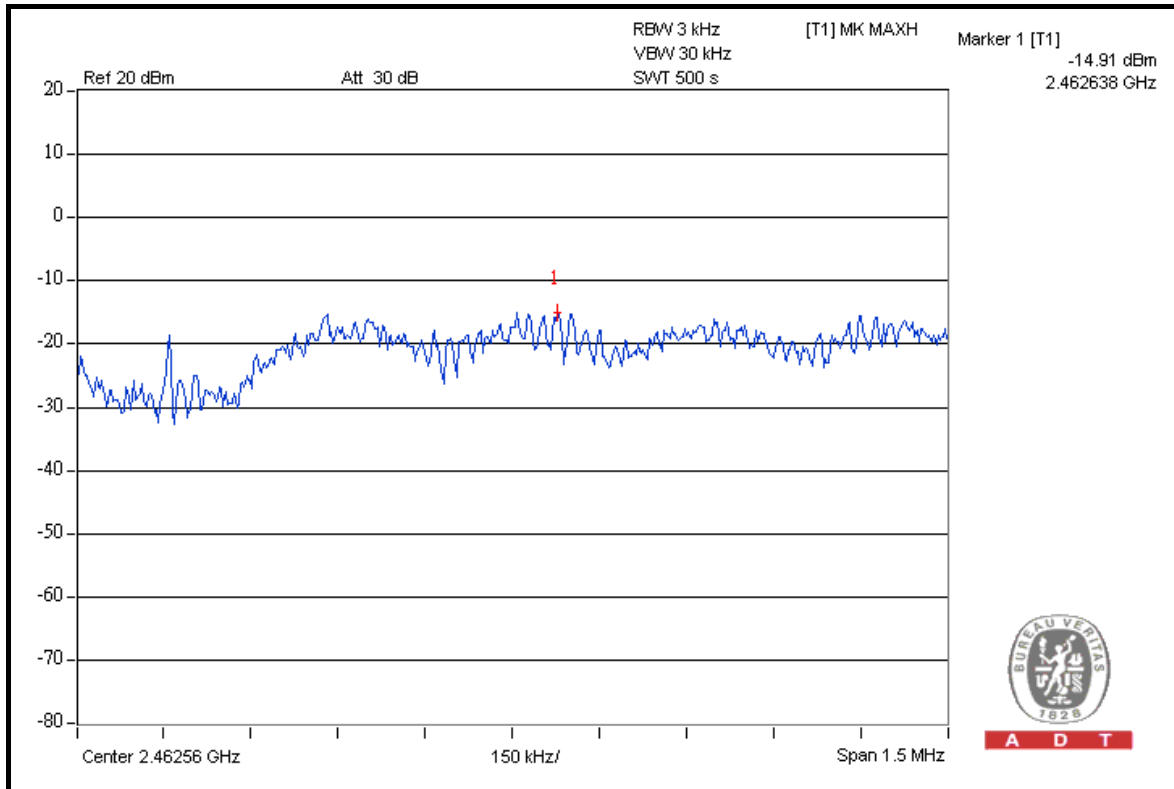

### FOR CHAIN 1: CH 1

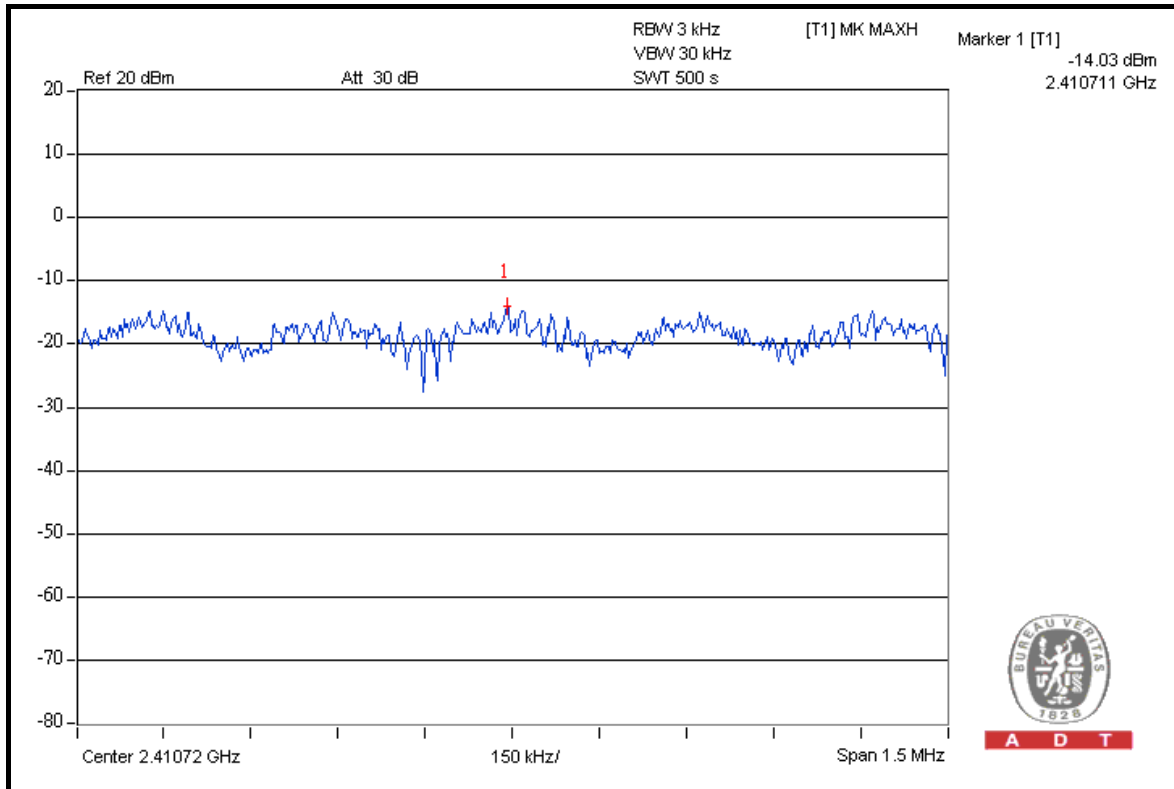



A D T

### CH 6

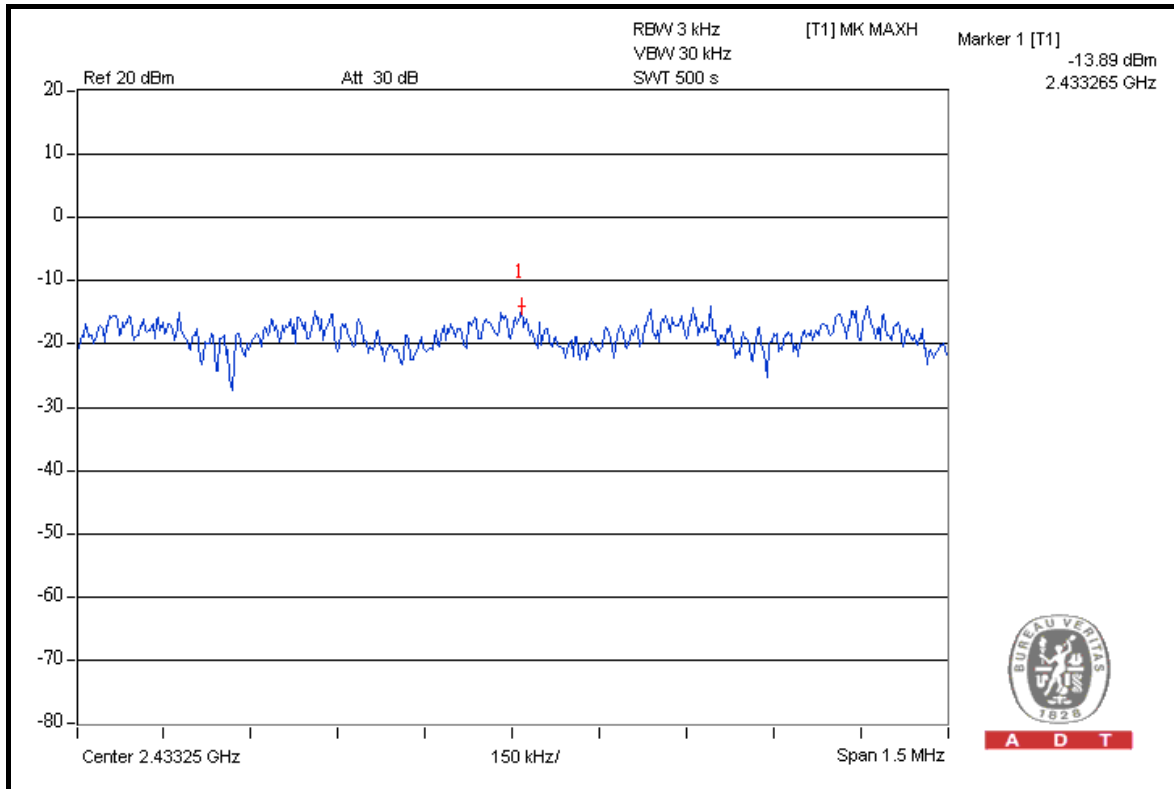

### CH 11

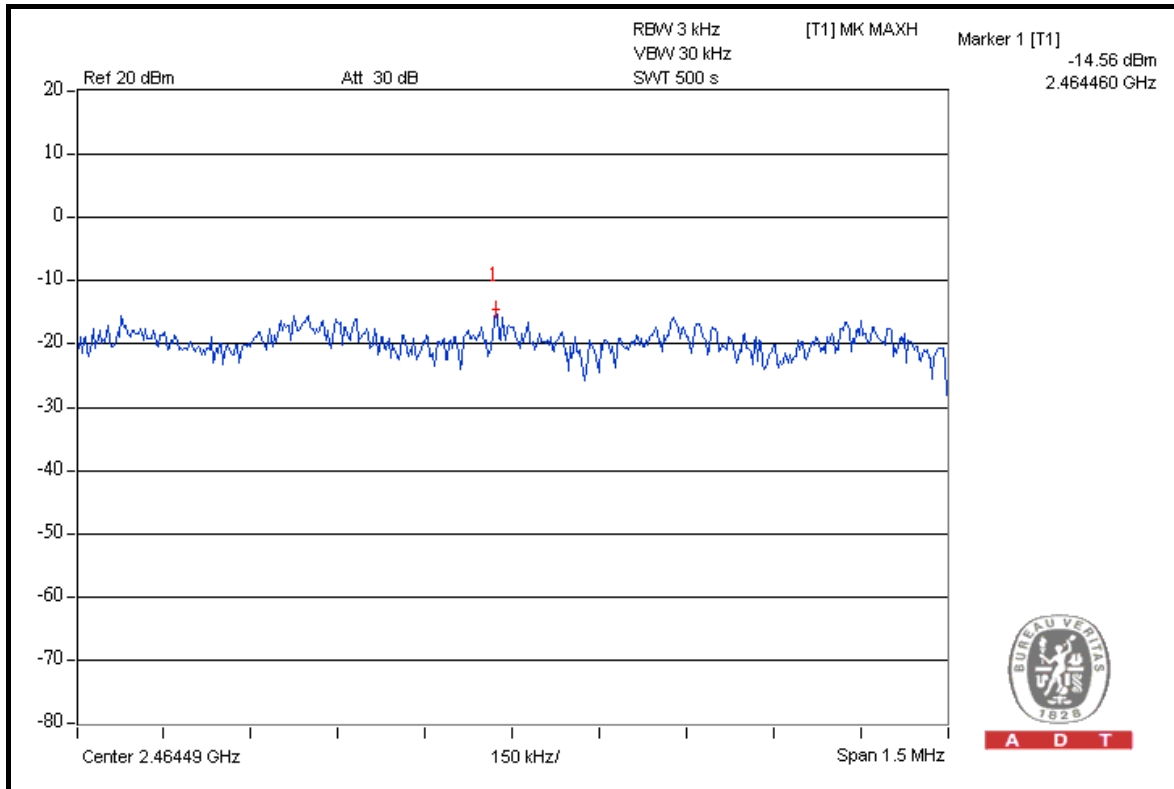



A D T

### DRAFT 802.11n (40MHz) OFDM MODULATION

<b>MODULATION TYPE</b>	BPSK	<b>TRANSFER RATE</b>	15.0Mbps
<b>INPUT POWER</b>	120Vac, 60Hz	<b>ENVIRONMENTAL CONDITIONS</b>	24 deg.C, 64 %RH, 1009hPa
<b>TESTED BY</b>	Sun Lin		

CHAN.	CHAN. FREQ. (MHz)	RF POWER LEVEL IN 3kHz BW (dBm)		TOTAL POWER DENSITY (mW)	TOTAL POWER DENSITY (dBm)	MAX. LIMIT (dBm)	PASS / FAIL
		CHAIN 0	CHAIN 1				
1	2422	-18.62	-19.61	0.03	-16.02	8	PASS
4	2437	-18.48	-19.48	0.03	-16.02	8	PASS
7	2452	-18.71	-19.34	0.03	-16.02	8	PASS



A D T

### FOR CHAIN 0: CH 1

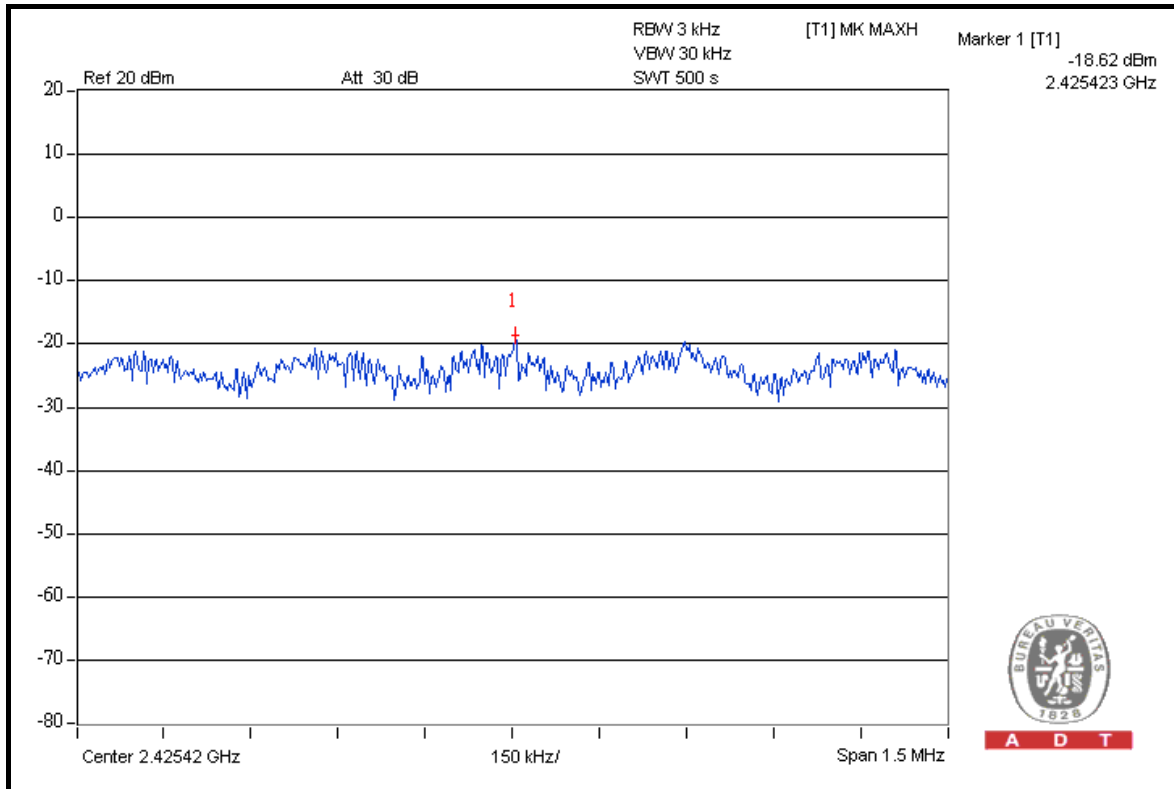

### CH 4

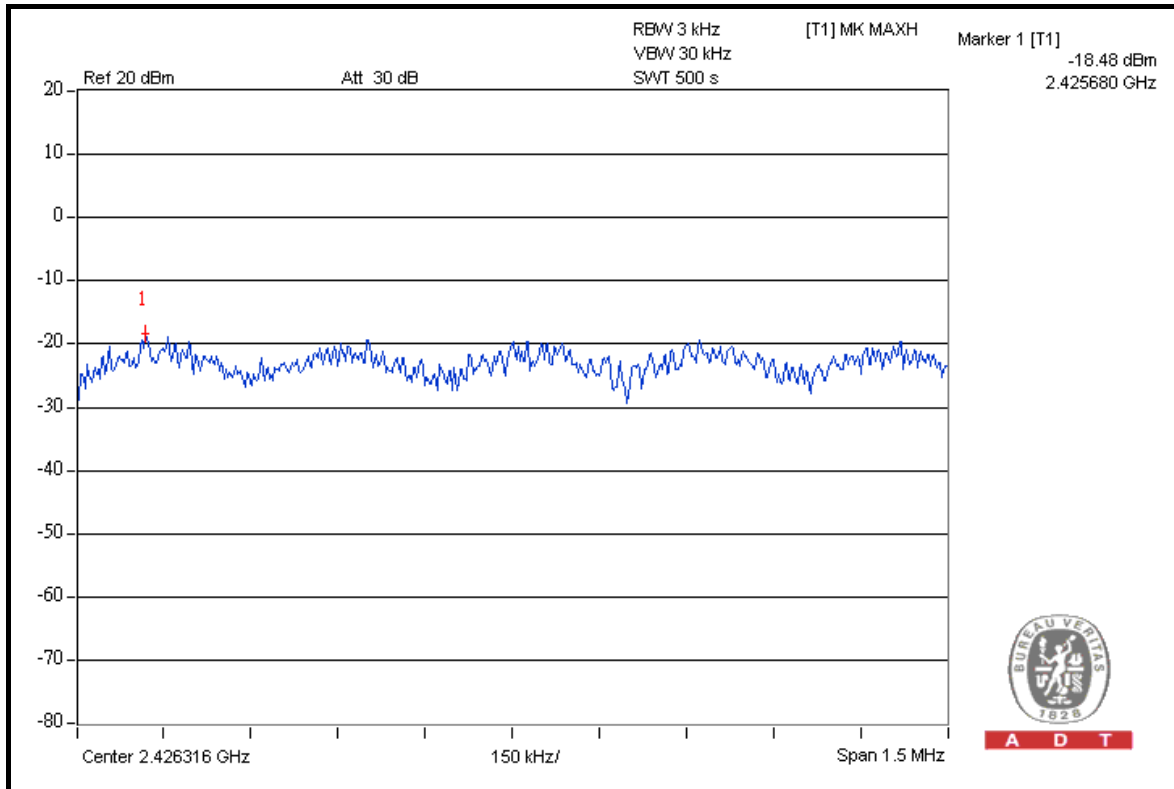



A D T

### CH 7

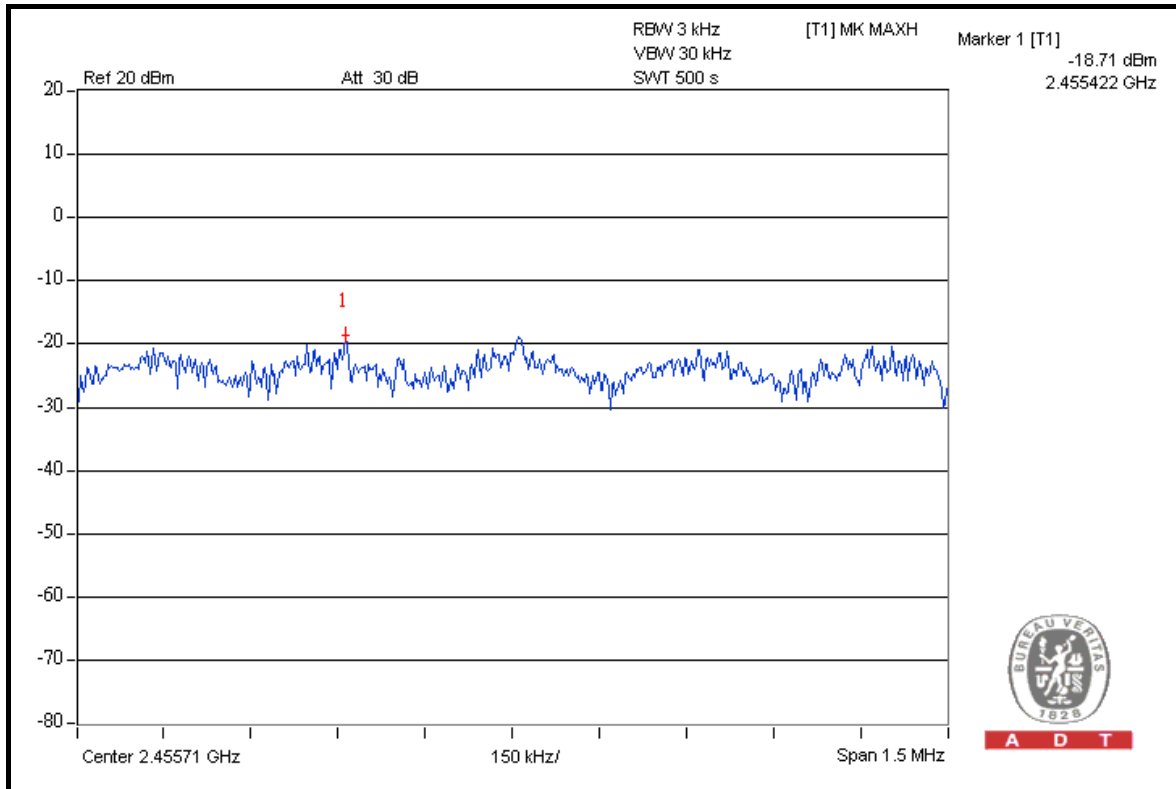

### FOR CHAIN 1: CH 1

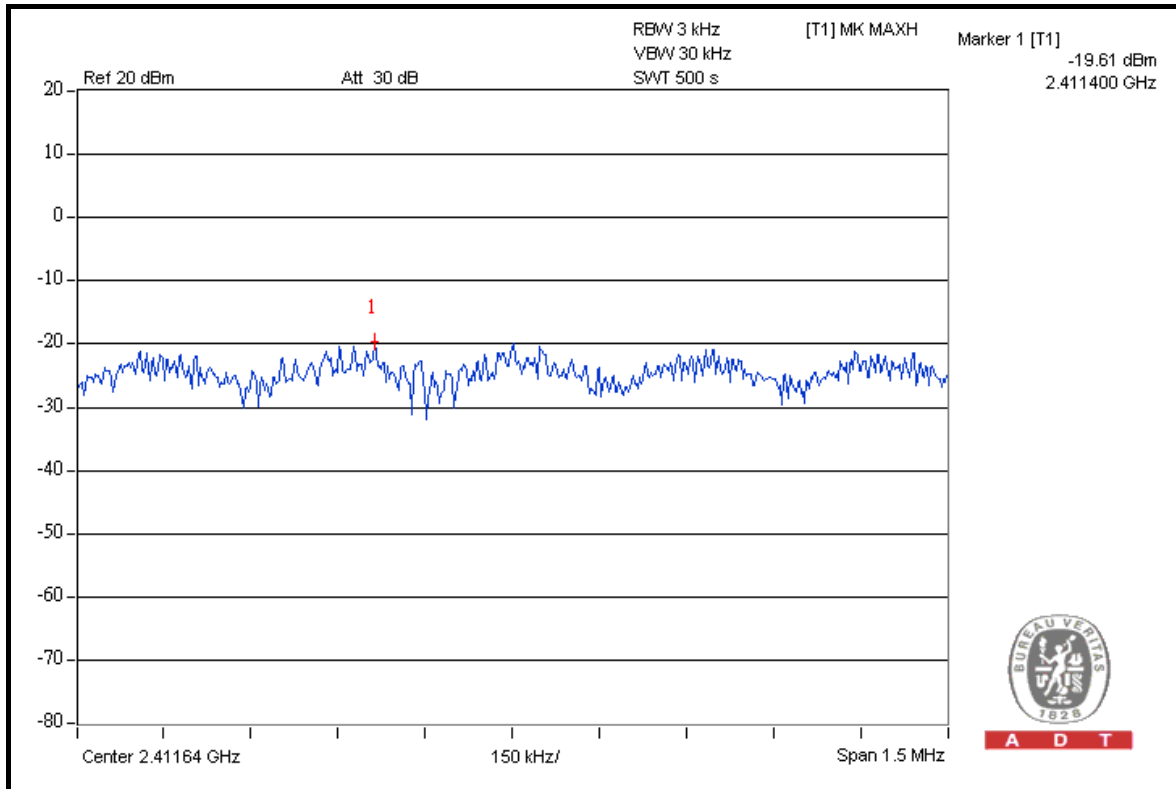



A D T

### CH 4

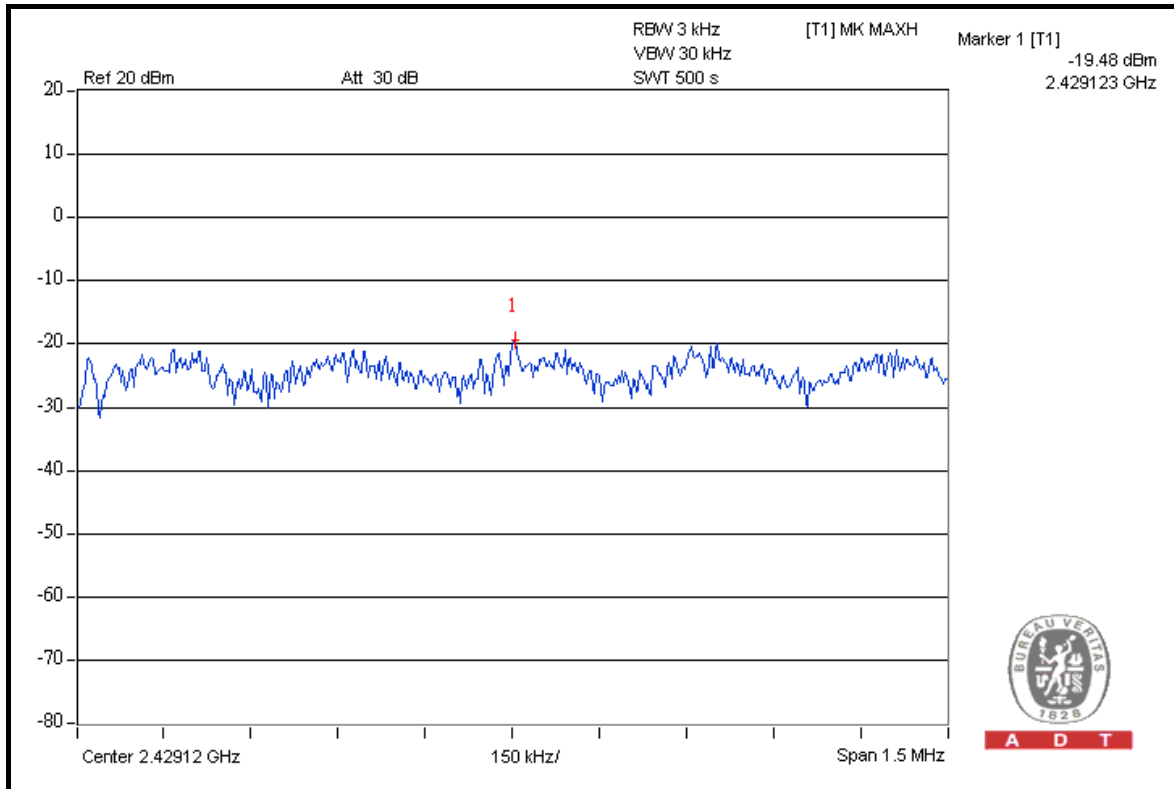

### CH 7

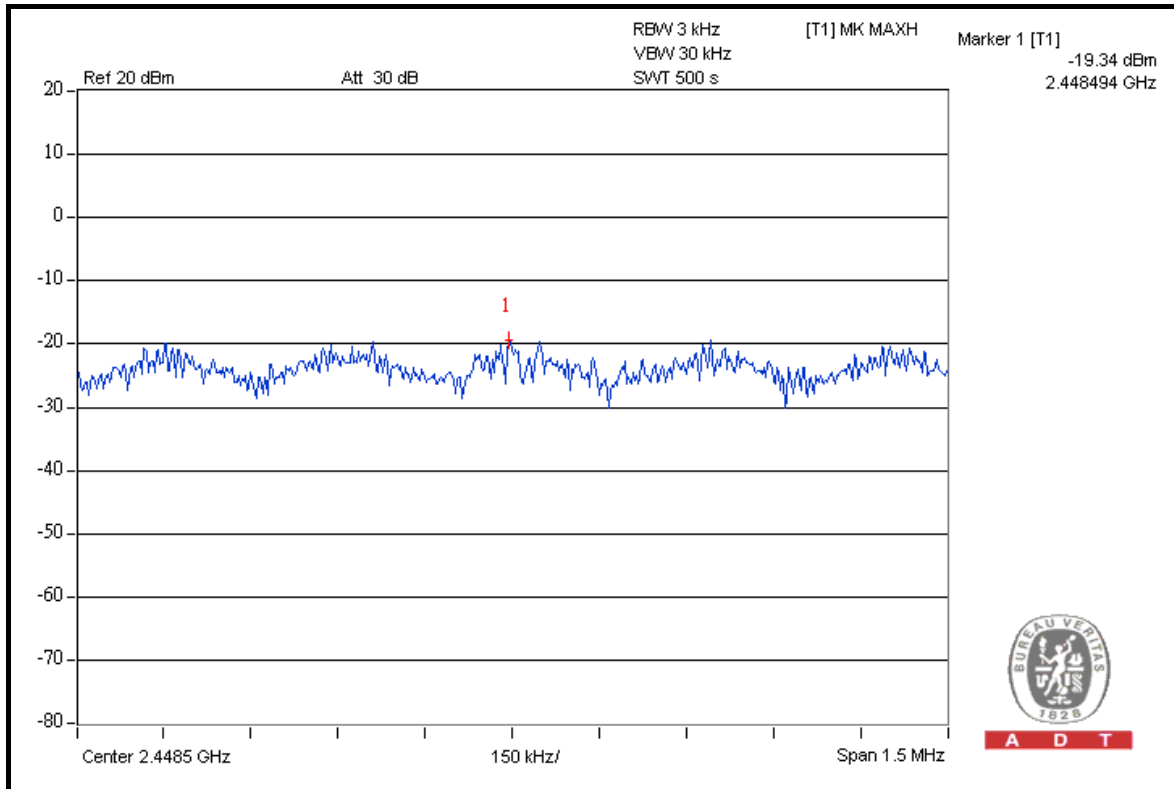



## 4.6 BAND EDGES MEASUREMENT

### 4.6.1 LIMITS OF BAND EDGES MEASUREMENT

Below  $-20\text{dB}$  of the highest emission level of operating band (in 100kHz Resolution Bandwidth).

### 4.6.2 TEST INSTRUMENTS

DESCRIPTION & MANUFACTURER	MODEL NO.	SERIAL NO.	DATE OF CALIBRATION	DUE DATE OF CALIBRATION
Test Receiver ROHDE & SCHWARZ	ESI7	100033	Jul. 06, 2009	Jul. 05, 2010
Spectrum Analyzer ROHDE & SCHWARZ	FSP40	100076	May. 26, 2009	May. 25, 2010
BILOG Antenna SCHWARZBECK	VULB9168	9168-160	Apr. 27, 2009	Apr. 26, 2010
HORN Antenna SCHWARZBECK	9120D	9120D-209	Jul. 01, 2009	Jun. 30, 2010
HORN Antenna SCHWARZBECK	BBHA 9170	BBHA9170243	Dec. 25, 2008	Dec. 24, 2009
Preamplifier Agilent	8447D	2944A10633	Nov. 03, 2008	Nov. 02, 2009
Preamplifier Agilent	8449B	3008A01964	Oct. 23, 2008	Oct. 22, 2009
RF signal cable HUBER+SUHNNER	SUCOFLEX 104	238141/4	May 13, 2009	May 12, 2010
RF signal cable HUBER+SUHNNER	SUCOFLEX 104	12738/6	May 13, 2009	May 12, 2010
Software ADT.	ADT_Radiated_ V7.6.15.9.2	NA	NA	NA
Antenna Tower inn-co GmbH	MA 4000	013303	NA	NA
Antenna Tower Controller inn-co GmbH	CO2000	017303	NA	NA
Turn Table ADT.	TT100.	TT93021703	NA	NA
Turn Table Controller ADT.	SC100.	SC93021703	NA	NA

**NOTE:** The calibration interval of the above test instruments is 12 months and the calibrations are traceable to NML/ROC and NIST/USA.



#### 4.6.3 TEST PROCEDURE

- a. The EUT was placed on the top of a rotating table 0.8 meters above the ground at a 3 meter semi-anechoic chamber. The table was rotated 360 degrees to determine the position of the highest radiation.
- b. The EUT was set 3 meters away from the interference-receiving antenna, which was mounted on the top of a variable-height antenna tower.
- c. The antenna is a broadband antenna, and its height is varied from one meter to four meters above the ground to determine the maximum value of the field strength. Both horizontal and vertical polarizations of the antenna are set to make the measurement.
- d. For each suspected emission, the EUT was arranged to its worst case and then the antenna was tuned to heights from 1 meter to 4 meters and the rotatable table was turned from 0 degrees to 360 degrees to find the maximum reading.
- e. Set both RBW and VBW of spectrum analyzer to 100kHz and 300kHz with suitable frequency span including 100MHz bandwidth from band edge. The band edges was measured and recorded.

The spectrum plots (Peak RBW = 100kHz, VBW = 300kHz) are attached on the following pages.

**NOTE:** The resolution bandwidth of test receiver/spectrum analyzer is 1MHz and the video bandwidth is 10Hz for Average detection (AV) at frequency above 1GHz.



A D T

#### 4.6.4 DEVIATION FROM TEST STANDARD

No deviation.

#### 4.6.5 EUT OPERATING CONDITION

Same as Item 4.3.6.

#### 4.6.6 TEST RESULTS

The spectrum plots are attached on the following pages. D1 line indicates the highest level, and D2 line indicates the 20dB offset below D1. It shows compliance with the requirement in part 15.247(d).

#### 802.11b DSSS MODULATION

**NOTE 1:** The band edge emission plot on the next page shows 53.50dBc between carrier maximum power and local maximum emission in restrict band (2.36000GHz). The emission of carrier strength list in the test result of channel 1 at the item 4.1.7 is 110.30dBuV/m (Peak), so the maximum field strength in restrict band is  $110.30 - 53.50 = 56.80$ dBuV/m which is under 74dBuV/m limit.

The band edge emission plot of on the next page shows 62.01dBc between carrier maximum power and local maximum emission in restrict band (2.39000GHz). The emission of carrier strength list in the test result of channel 1 at the item 4.1.7 is 106.09dBuV/m (Average), so the maximum field strength in restrict band is  $106.09 - 62.01 = 44.08$ dBuV/m which is under 54dBuV/m limit.

**NOTE 2:** The band edge emission plot on the next second page shows 54.94dBc between carrier maximum power and local maximum emission in restrict band (2.48440GHz). The emission of carrier strength list in the test result of channel 11 at the item 4.1.7 is 110.73dBuV/m (Peak), so the maximum field strength in restrict band is  $110.73 - 54.94 = 55.79$ dBuV/m which is under 74dBuV/m limit.

The band edge emission plot on the next third page shows 62.26dBc between carrier maximum power and local maximum emission in restrict band (2.48400GHz). The emission of carrier strength list in the test result of channel 11 at the item 4.1.7 is 105.92dBuV/m (Average), so the maximum field strength in restrict band is  $105.92 - 62.26 = 43.66$ dBuV/m which is under 54dBuV/m limit.



A D T

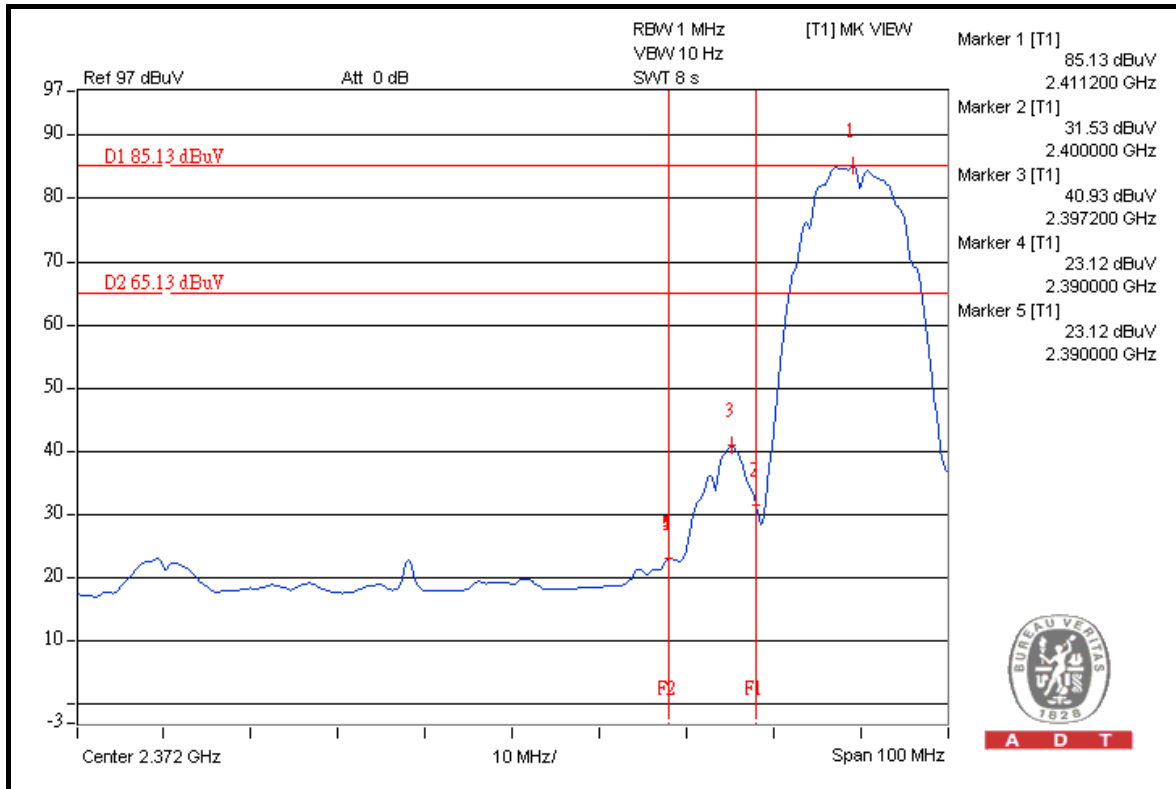
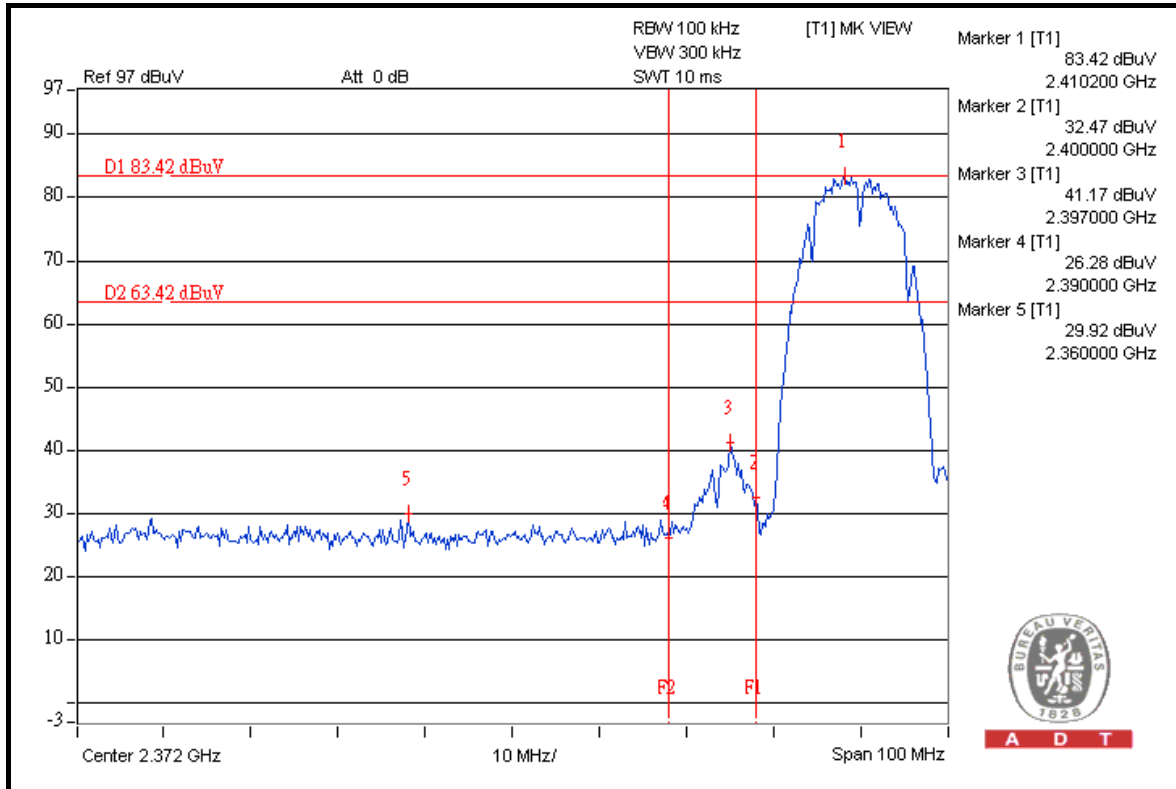



A D T

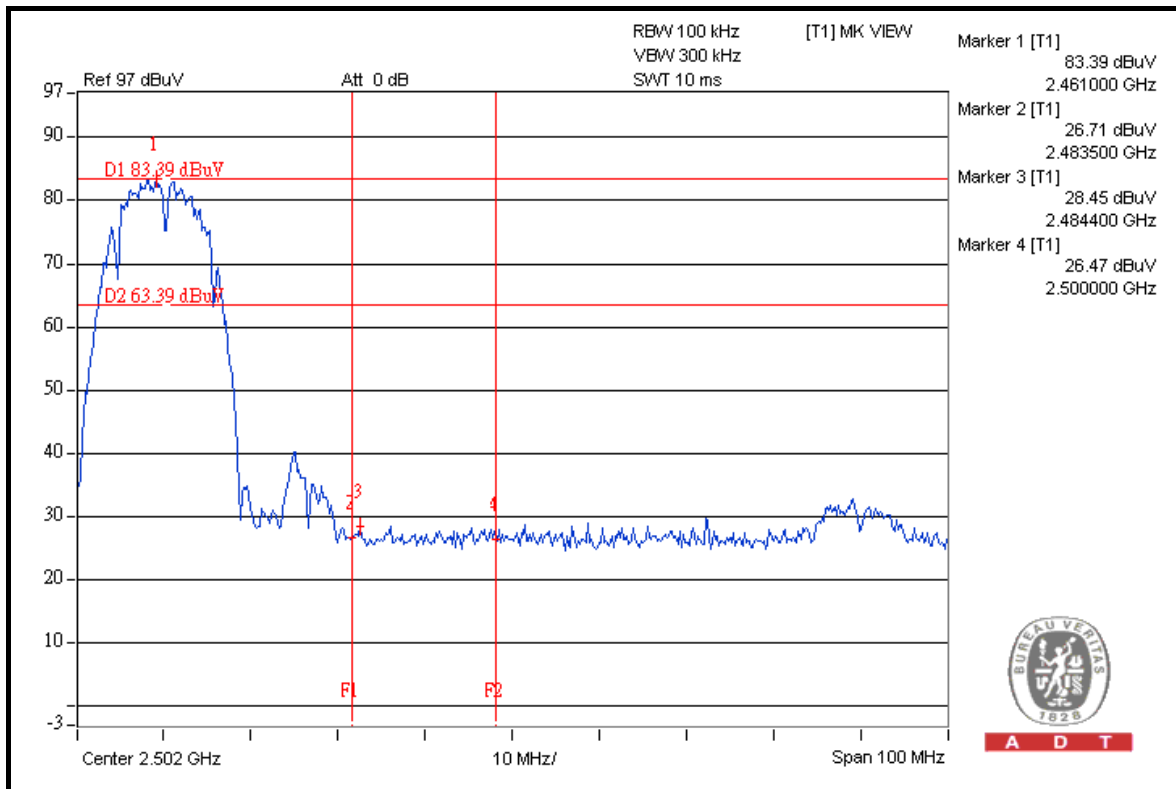
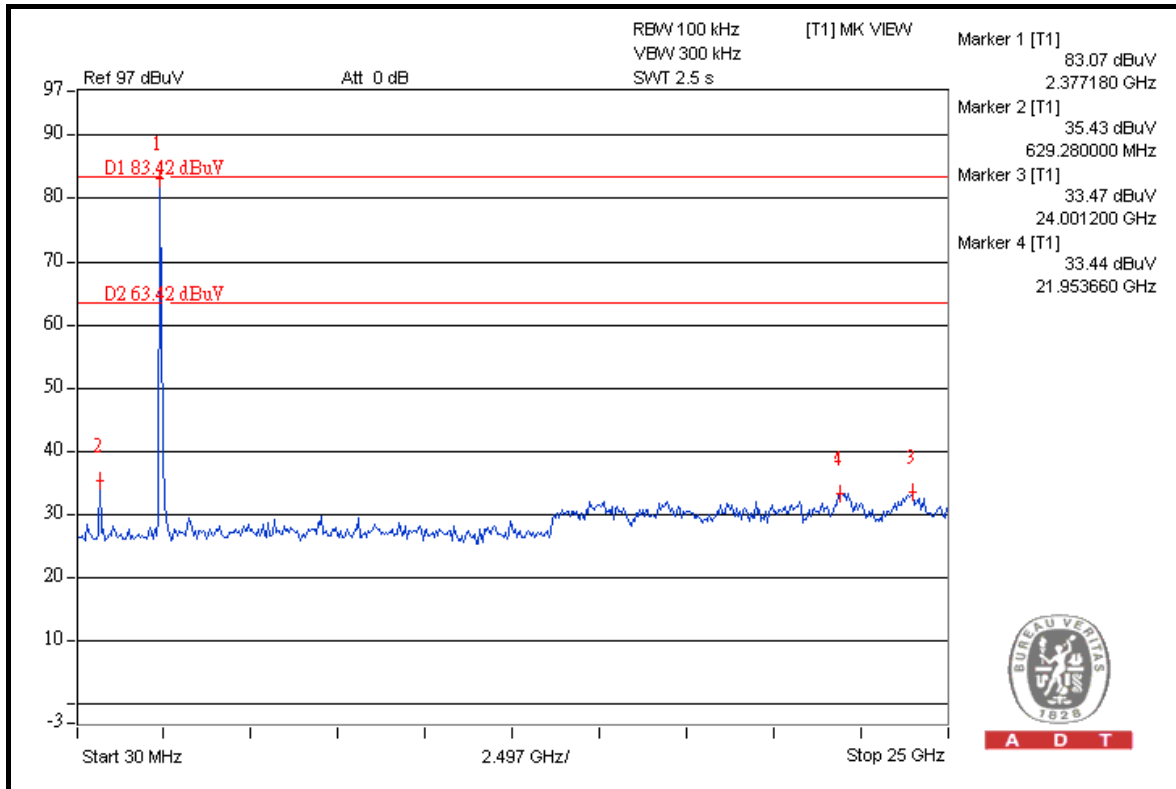



A D T

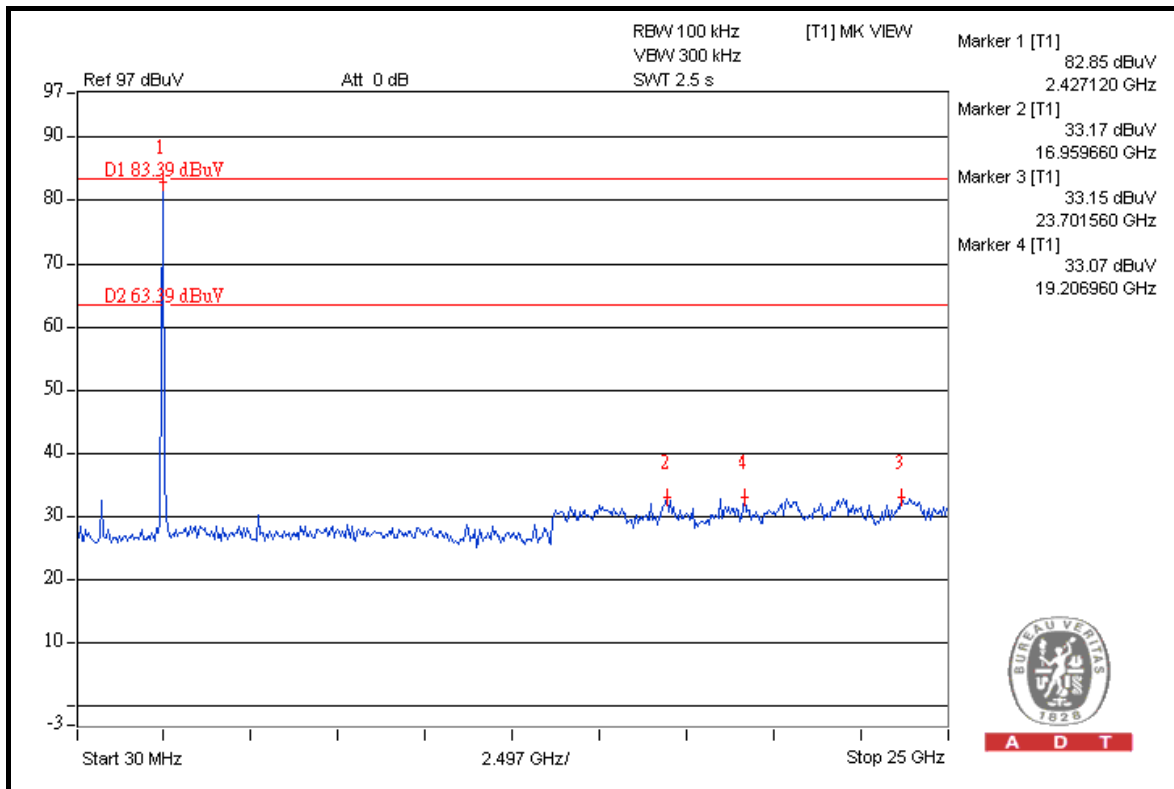
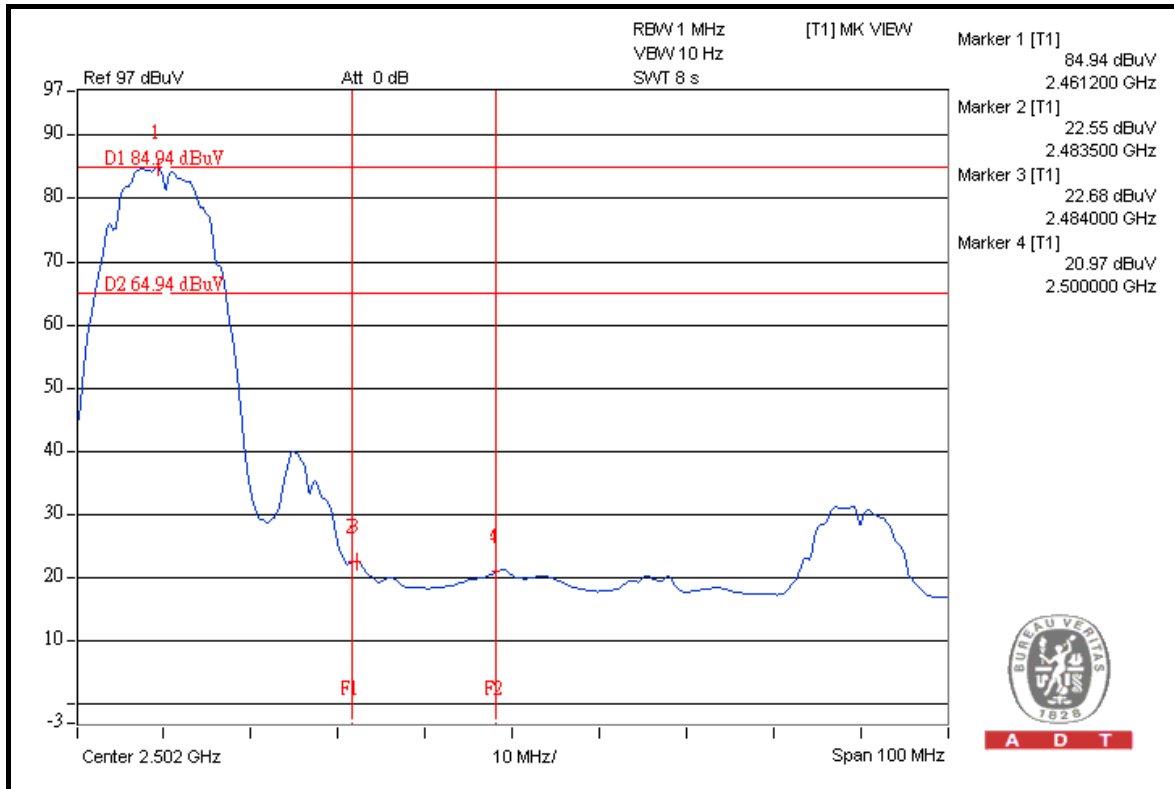



A D T

## 802.11g OFDM MODULATION

**NOTE 1:** The band edge emission plot on the next page shows 48.15dBc between carrier maximum power and local maximum emission in restrict band (2.36020GHz). The emission of carrier strength list in the test result of channel 1 at the item 4.1.7 is 110.89dBuV/m (Peak), so the maximum field strength in restrict band is  $110.89 - 48.15 = 62.74$ dBuV/m which is under 74dBuV/m limit.

The band edge emission plot of on the next page shows 54.08dBc between carrier maximum power and local maximum emission in restrict band (2.35940GHz). The emission of carrier strength list in the test result of channel 1 at the item 4.1.7 is 100.90dBuV/m (Average), so the maximum field strength in restrict band is  $100.90 - 54.08 = 46.82$ dBuV/m which is under 54dBuV/m limit.

**NOTE 2:** The band edge emission plot on the next second page shows 49.19dBc between carrier maximum power and local maximum emission in restrict band (2.48360GHz). The emission of carrier strength list in the test result of channel 11 at the item 4.1.7 is 110.61dBuV/m (Peak), so the maximum field strength in restrict band is  $110.61 - 49.19 = 61.42$ dBuV/m which is under 74dBuV/m limit.

The band edge emission plot on the next third page shows 54.31dBc between carrier maximum power and local maximum emission in restrict band (2.48350GHz). The emission of carrier strength list in the test result of channel 11 at the item 4.1.7 is 100.51dBuV/m (Average), so the maximum field strength in restrict band is  $100.51 - 54.31 = 46.20$ dBuV/m which is under 54dBuV/m limit.





A D T

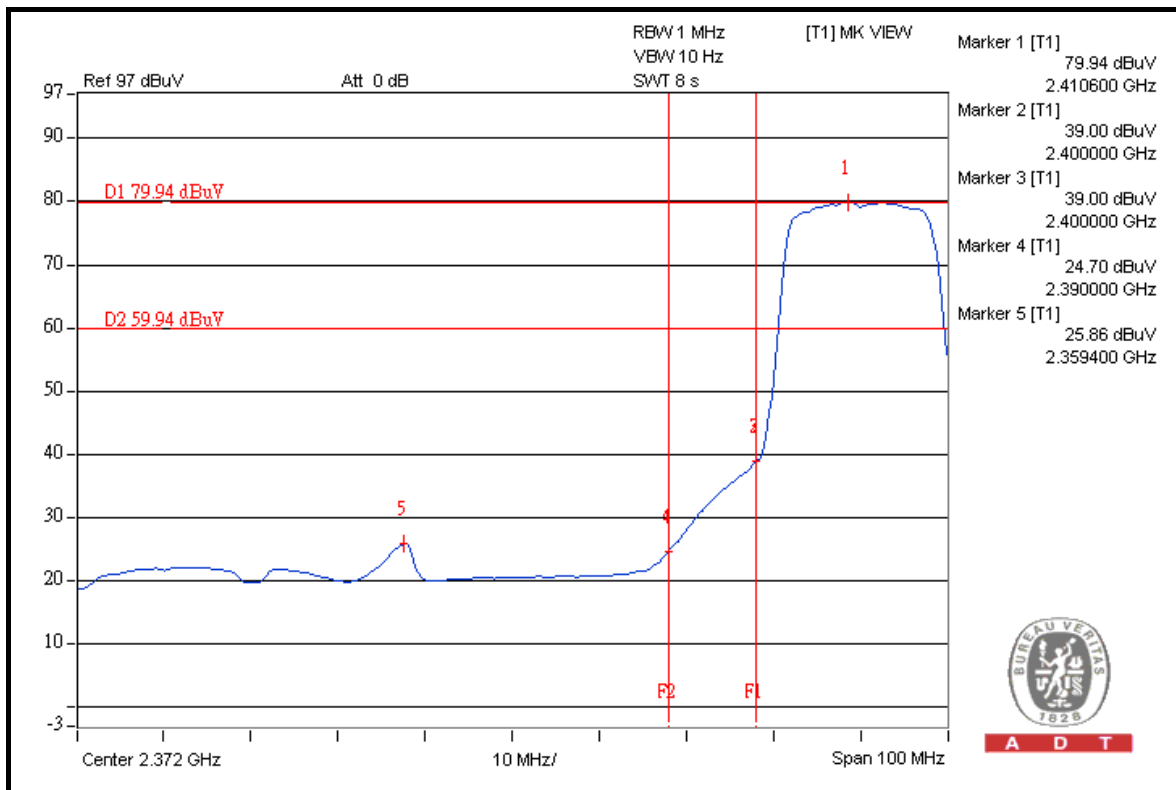
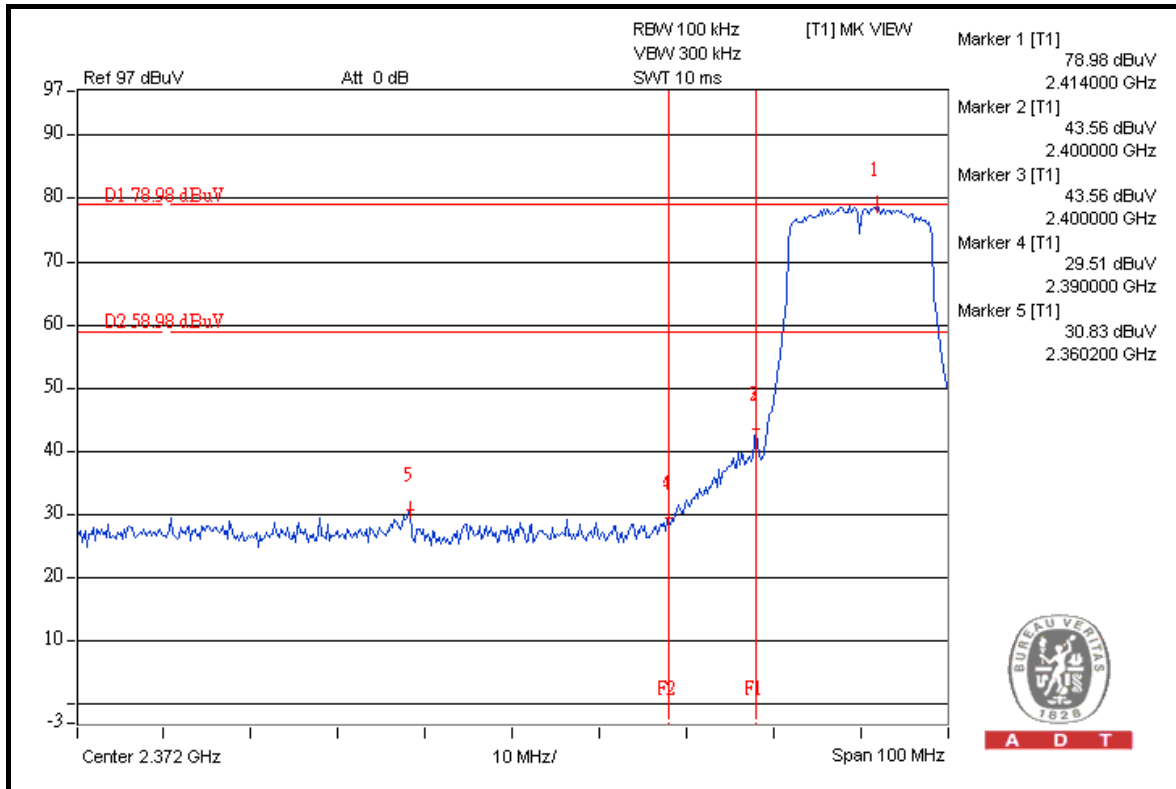



A D T

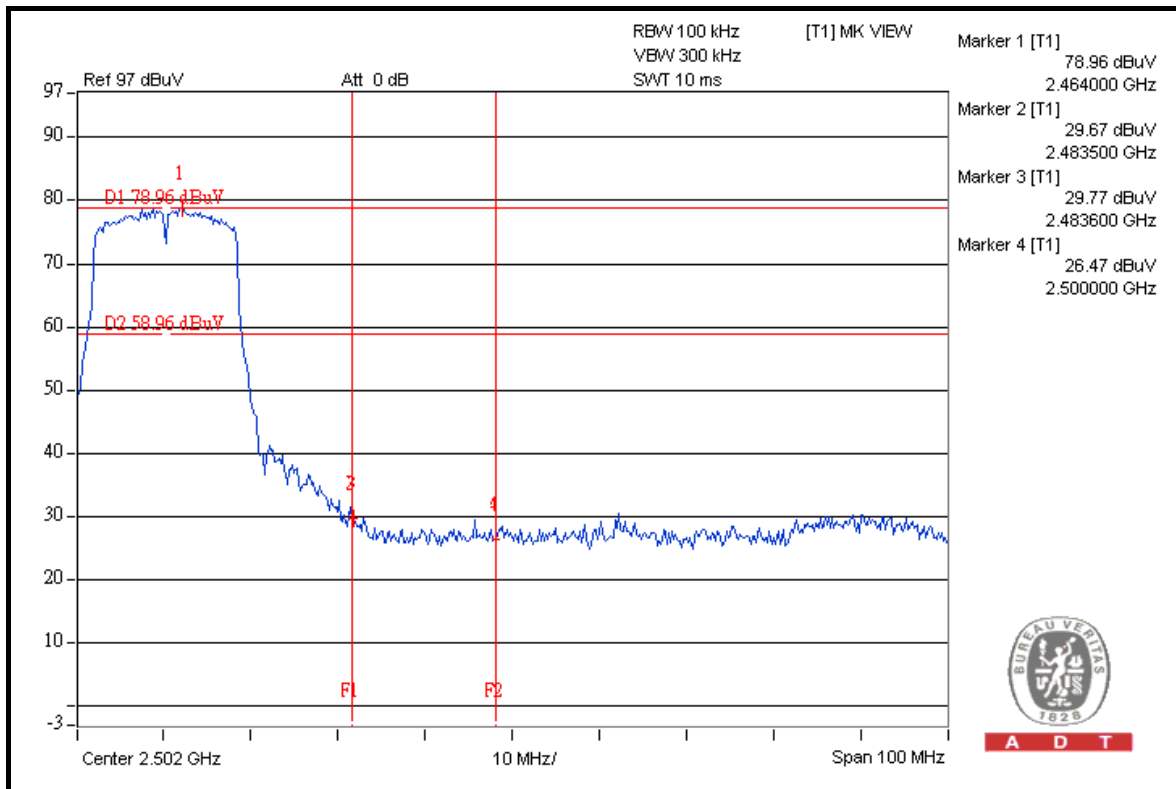
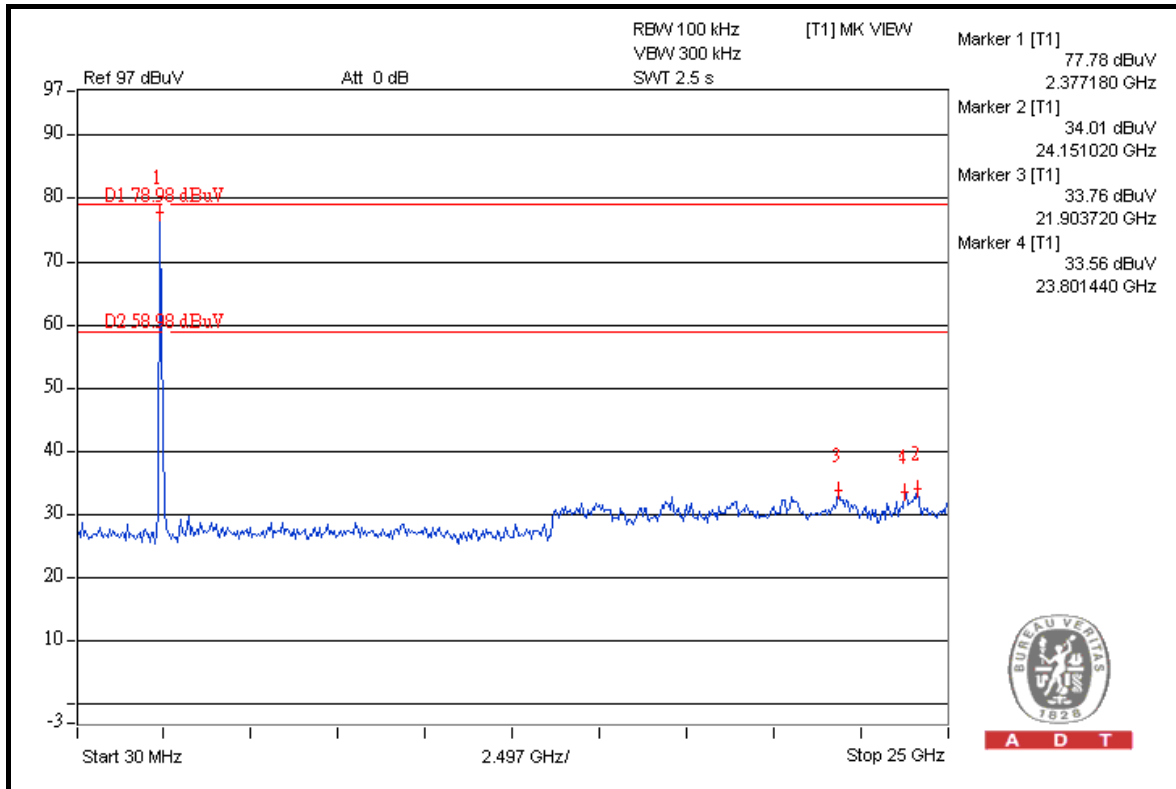



A D T

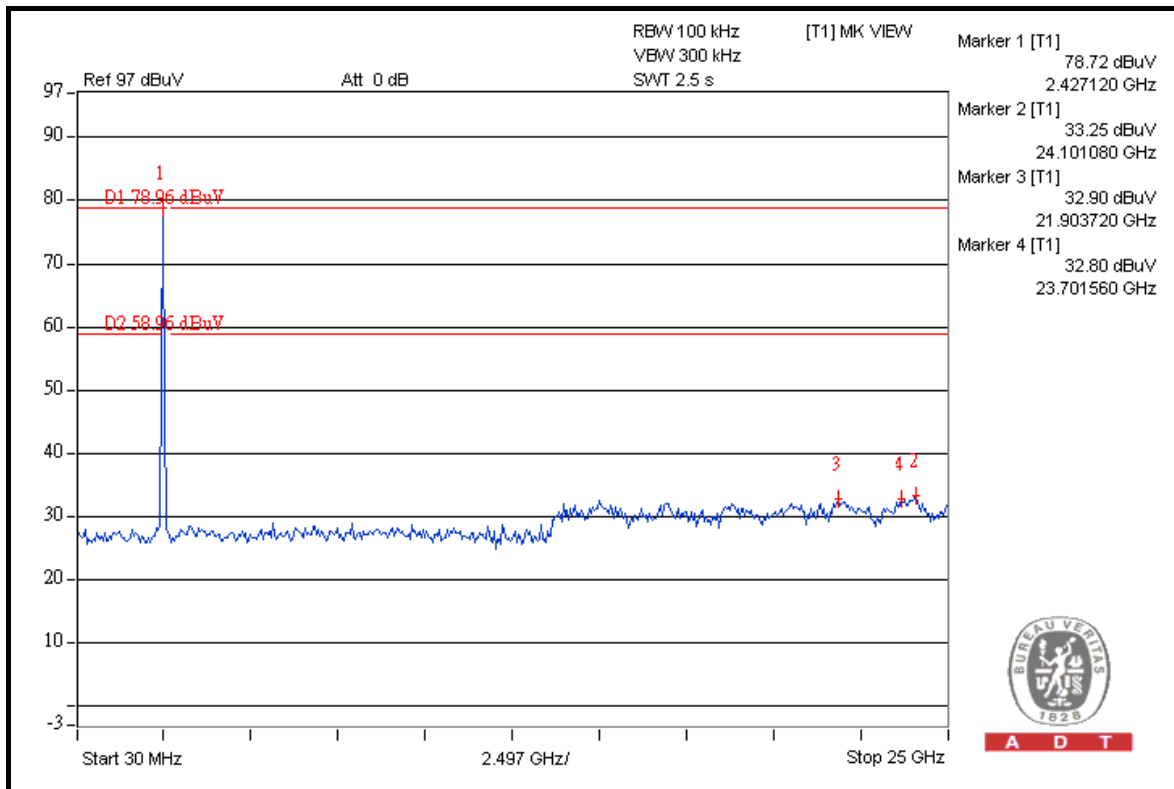
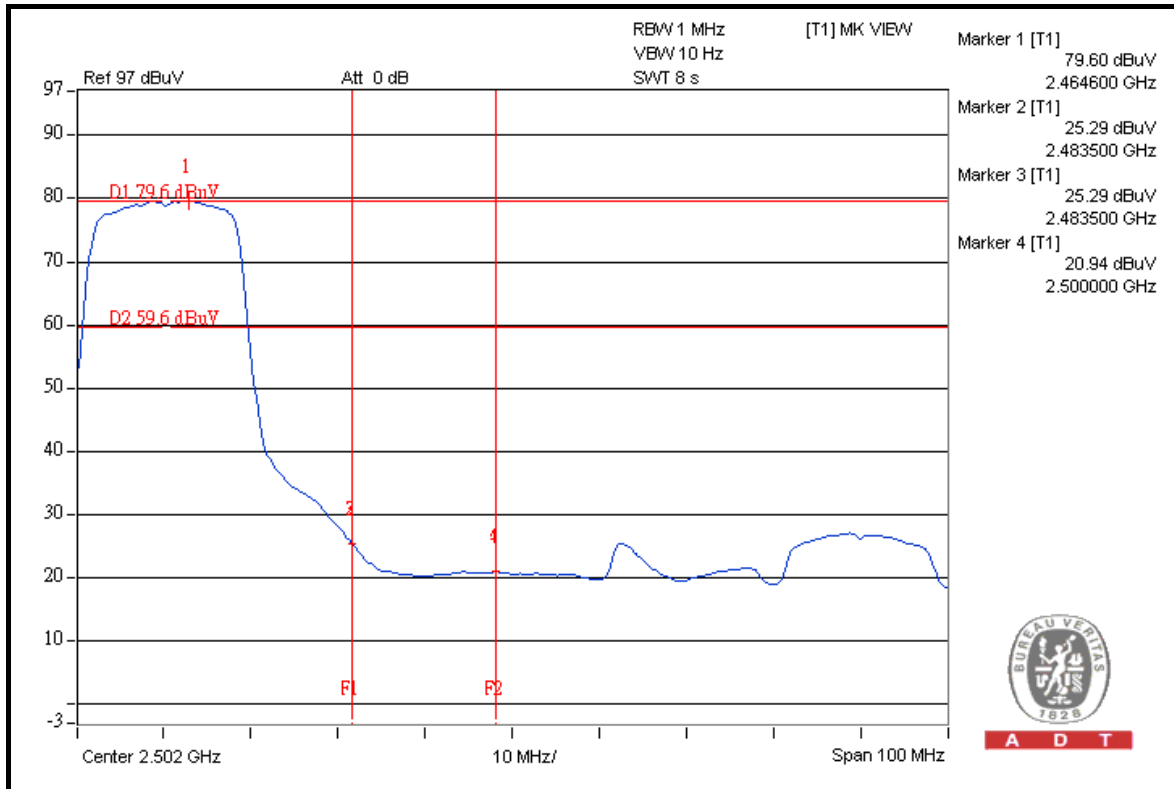

## DRAFT 802.11n (20MHz) OFDM MODULATION

**NOTE 1:** The band edge emission plot on the next page shows 49.03dBc between carrier maximum power and local maximum emission in restrict band (2.34760GHz). The emission of carrier strength list in the test result of channel 1 at the item 4.1.7 is 110.18dBuV/m (Peak), so the maximum field strength in restrict band is  $110.18 - 49.03 = 61.15$ dBuV/m which is under 74dBuV/m limit.

The band edge emission plot of on the next page shows 53.73dBc between carrier maximum power and local maximum emission in restrict band (2.39000GHz). The emission of carrier strength list in the test result of channel 1 at the item 4.1.7 is 100.37dBuV/m (Average), so the maximum field strength in restrict band is  $100.37 - 53.73 = 46.64$ dBuV/m which is under 54dBuV/m limit.

**NOTE 2:** The band edge emission plot on the next second page shows 47.03dBc between carrier maximum power and local maximum emission in restrict band (2.48360GHz). The emission of carrier strength list in the test result of channel 11 at the item 4.1.7 is 109.36dBuV/m (Peak), so the maximum field strength in restrict band is  $109.36 - 47.03 = 62.33$ dBuV/m which is under 74dBuV/m limit.

The band edge emission plot on the next third page shows 53.27dBc between carrier maximum power and local maximum emission in restrict band (2.48350GHz). The emission of carrier strength list in the test result of channel 11 at the item 4.1.7 is 99.33dBuV/m (Average), so the maximum field strength in restrict band is  $99.33 - 53.27 = 46.06$ dBuV/m which is under 54dBuV/m limit.



A D T

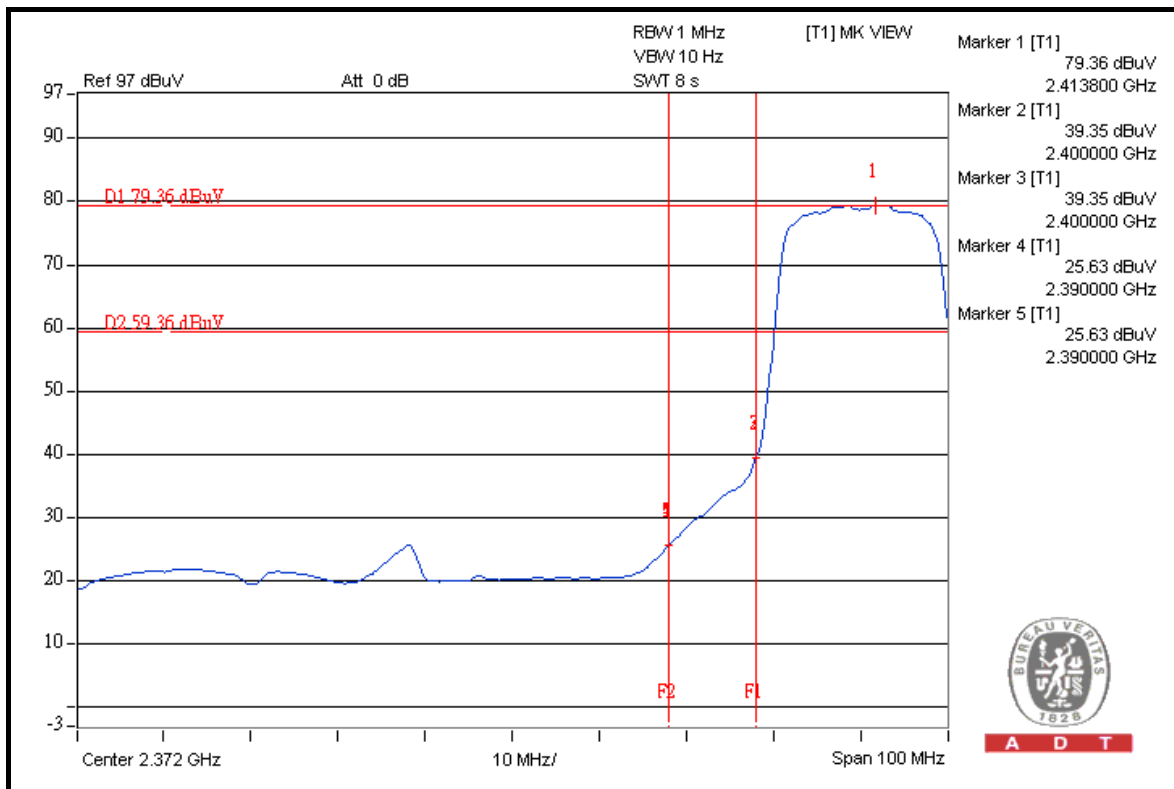
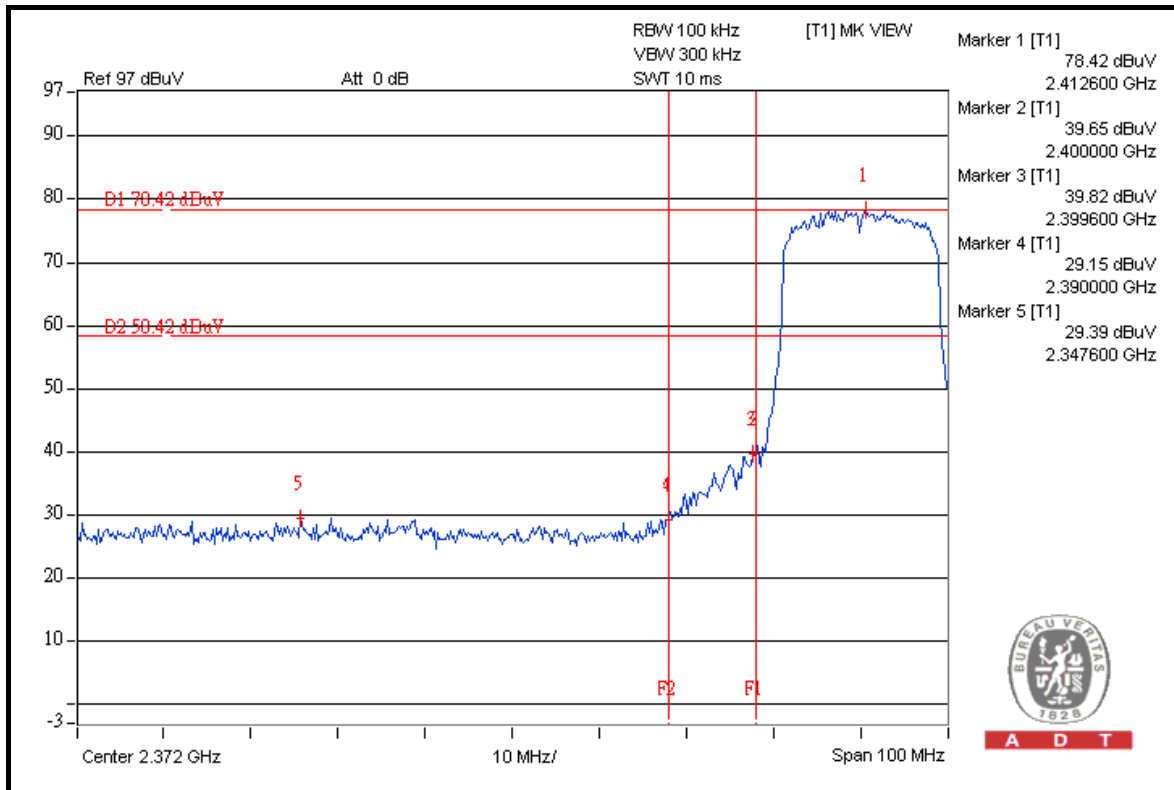



A D T

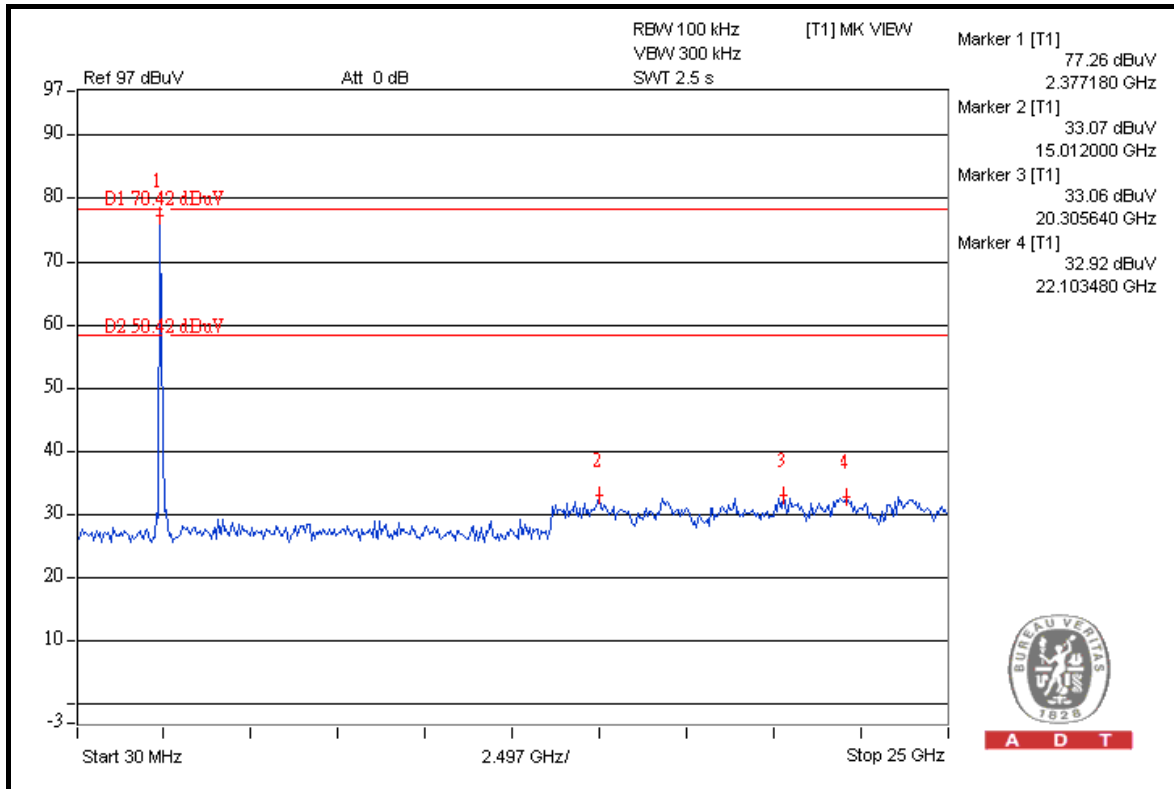

A D T

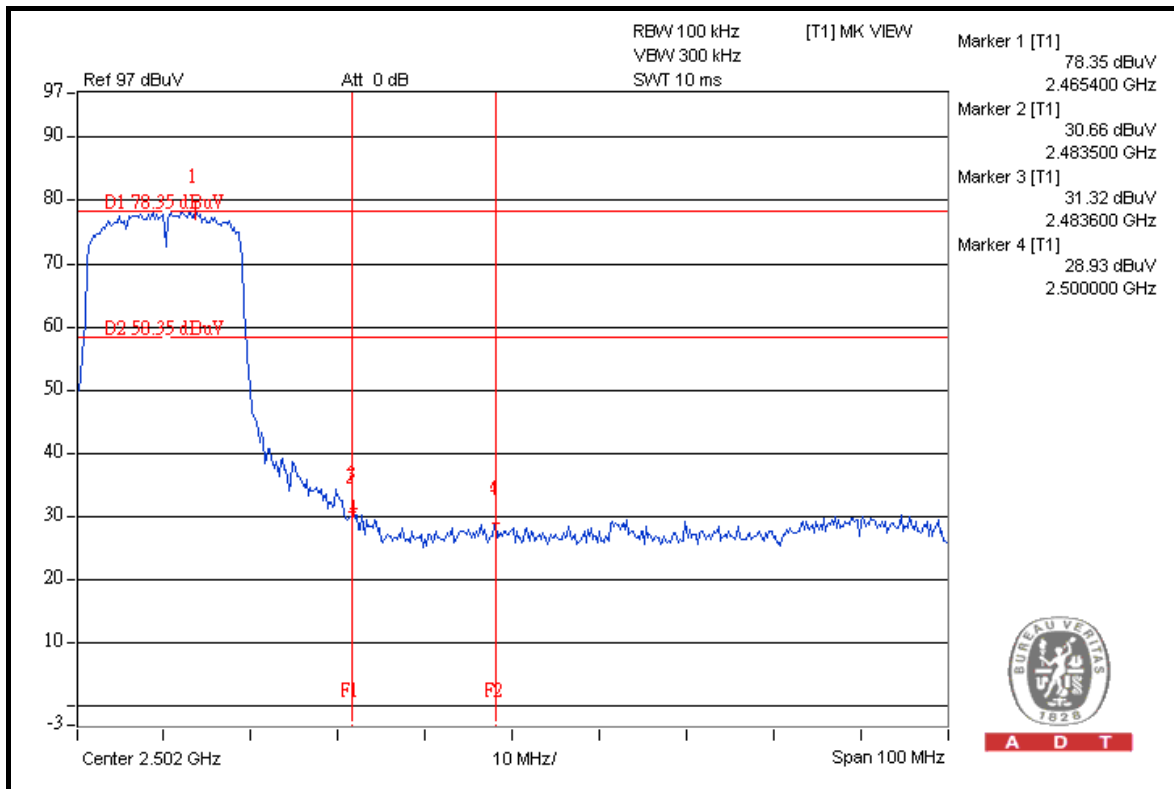

A D T



A D T

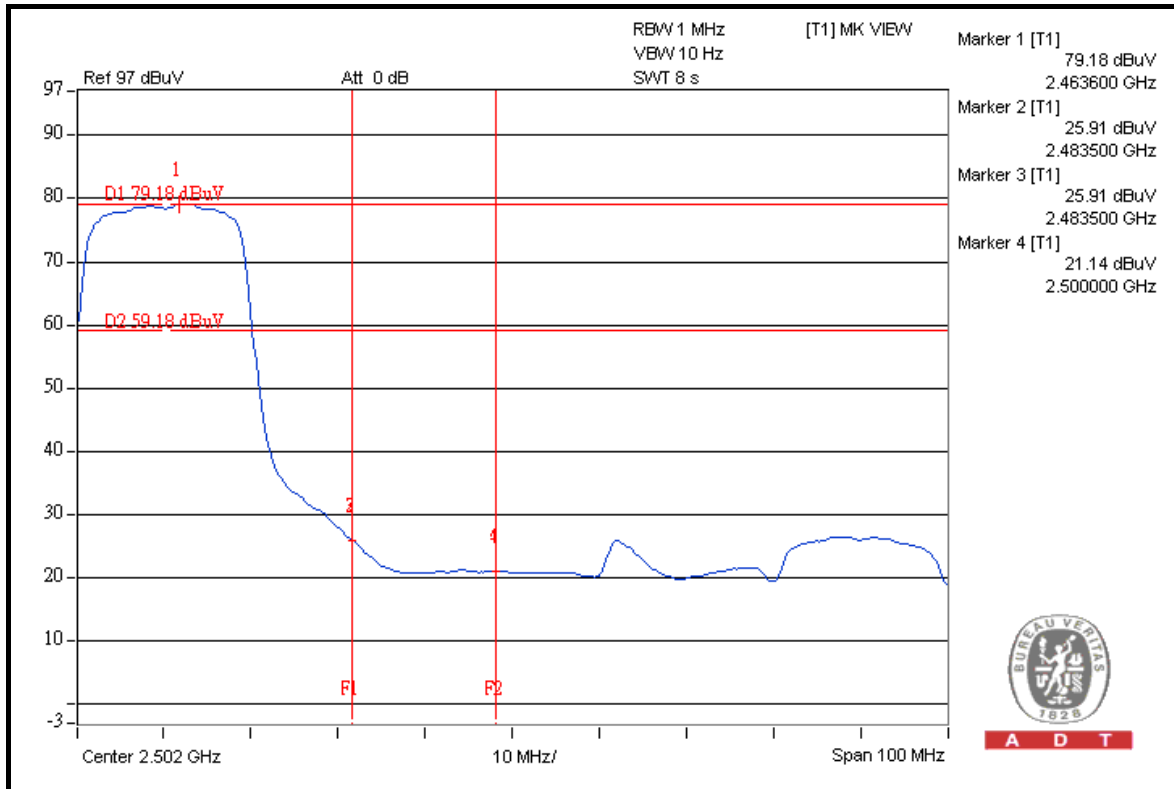

A D T

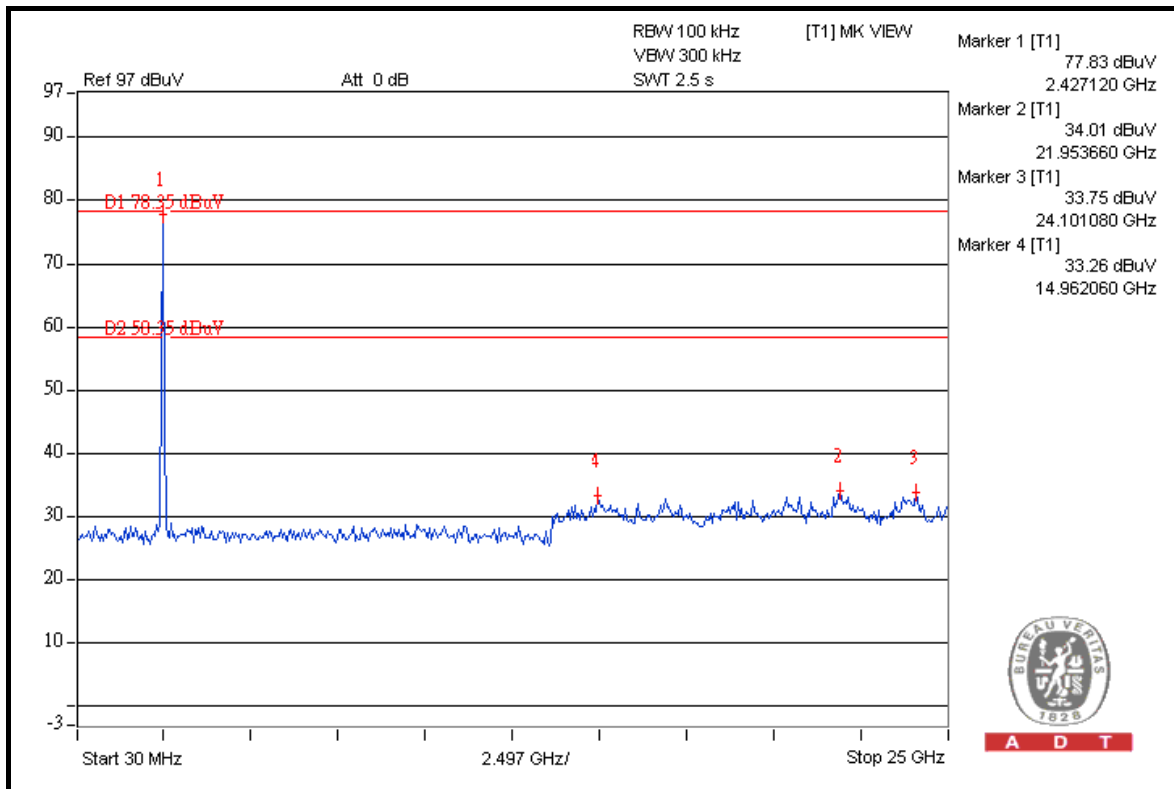

A D T

## DRAFT 802.11n (40MHz) OFDM MODULATION

**NOTE 1:** The band edge emission plot on the next page shows 43.65dBc between carrier maximum power and local maximum emission in restrict band (2.32000GHz). The emission of carrier strength list in the test result of channel 1 at the item 4.1.7 is 106.28dBuV/m (Peak), so the maximum field strength in restrict band is  $106.28 - 43.65 = 62.63$ dBuV/m which is under 74dBuV/m limit.

The band edge emission plot of on the next page shows 47.25dBc between carrier maximum power and local maximum emission in restrict band (2.39000GHz). The emission of carrier strength list in the test result of channel 1 at the item 4.1.7 is 96.12dBuV/m (Average), so the maximum field strength in restrict band is  $96.12 - 47.25 = 48.87$ dBuV/m which is under 54dBuV/m limit.

**NOTE 2:** The band edge emission plot on the next second page shows 43.21dBc between carrier maximum power and local maximum emission in restrict band (2.48480GHz). The emission of carrier strength list in the test result of channel 7 at the item 4.1.7 is 106.22dBuV/m (Peak), so the maximum field strength in restrict band is  $106.22 - 43.21 = 63.01$ dBuV/m which is under 74dBuV/m limit.

The band edge emission plot on the next third page shows 47.75dBc between carrier maximum power and local maximum emission in restrict band (2.48350GHz). The emission of carrier strength list in the test result of channel 7 at the item 4.1.7 is 96.11dBuV/m (Average), so the maximum field strength in restrict band is  $96.11 - 47.75 = 48.36$ dBuV/m which is under 54dBuV/m limit.





A D T

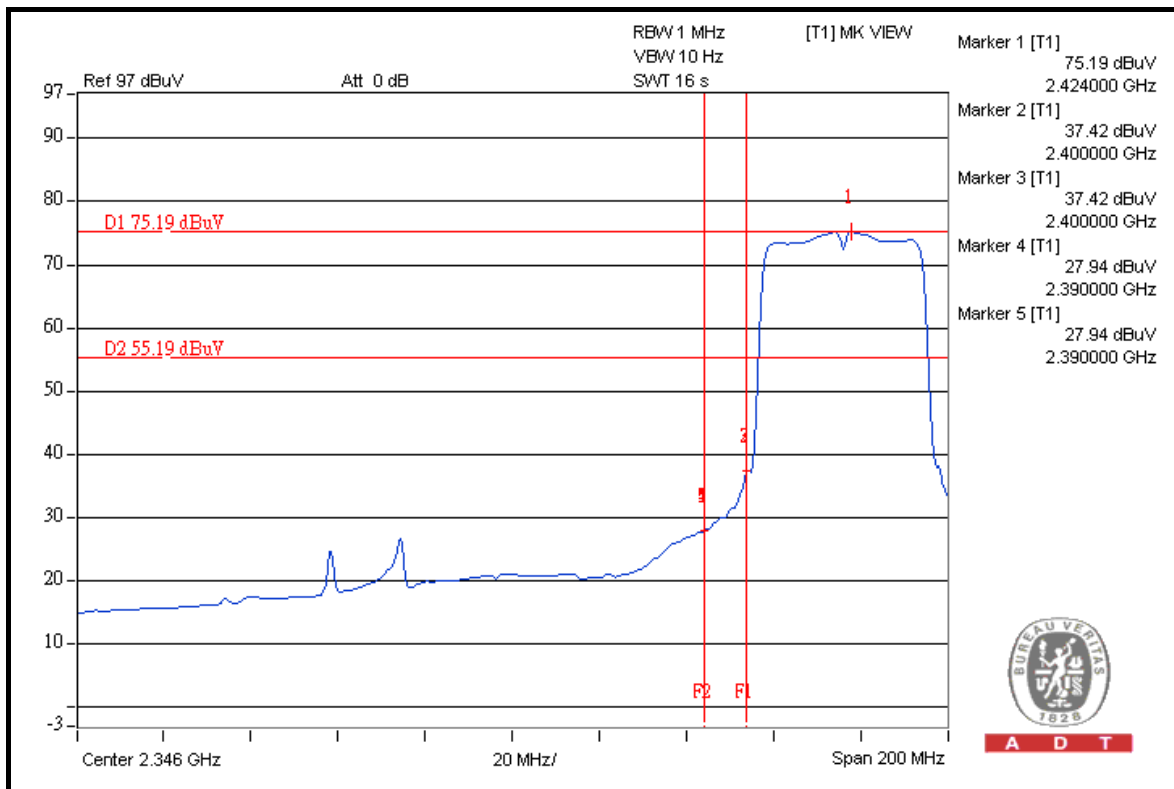
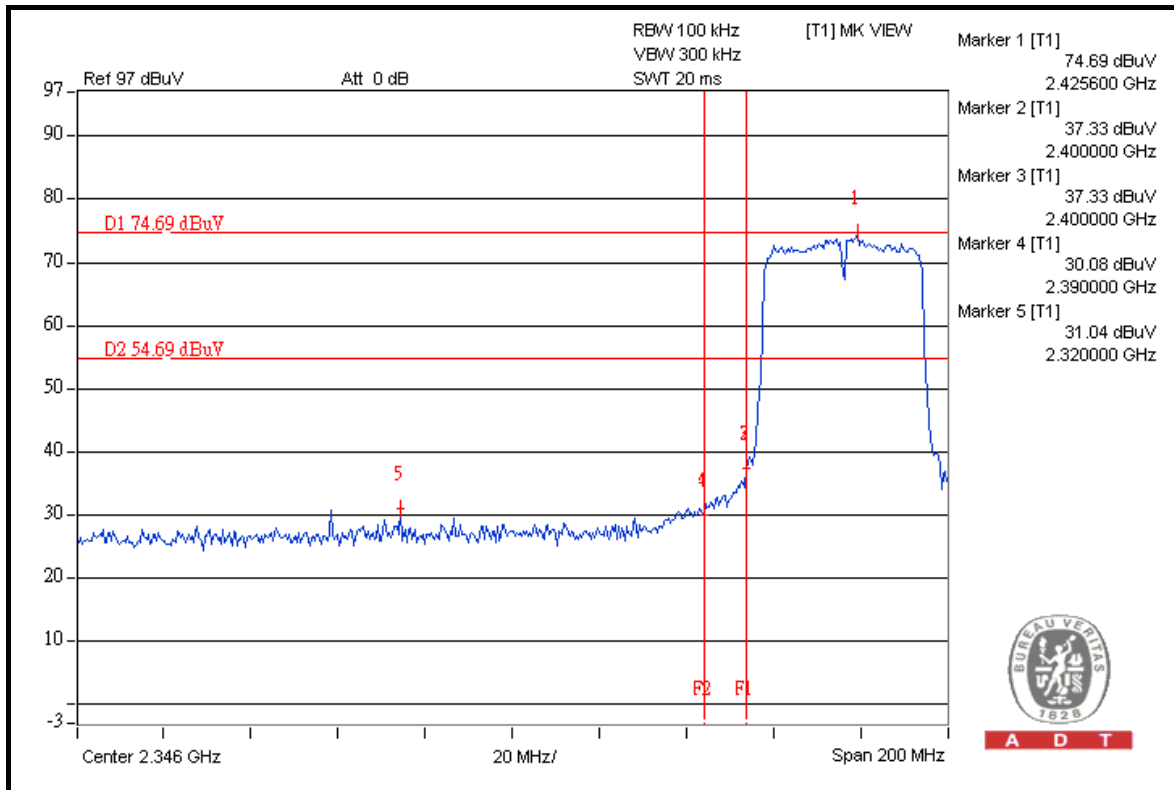



A D T

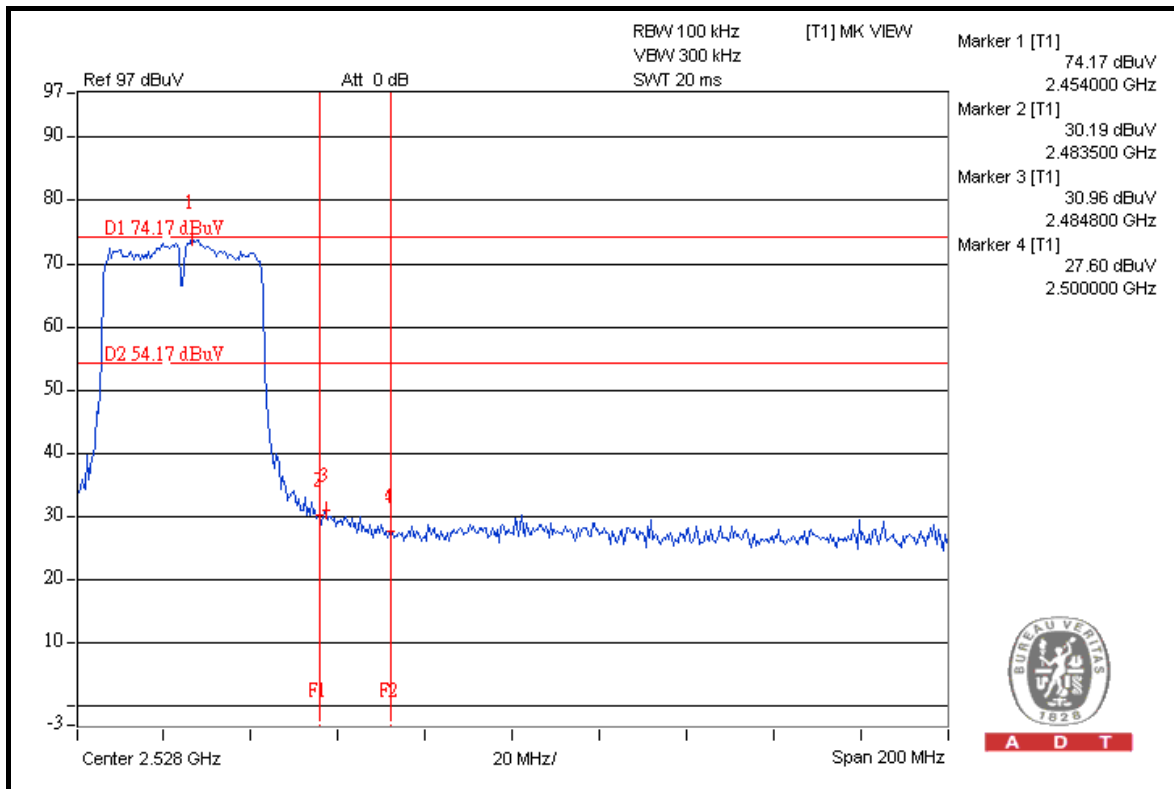
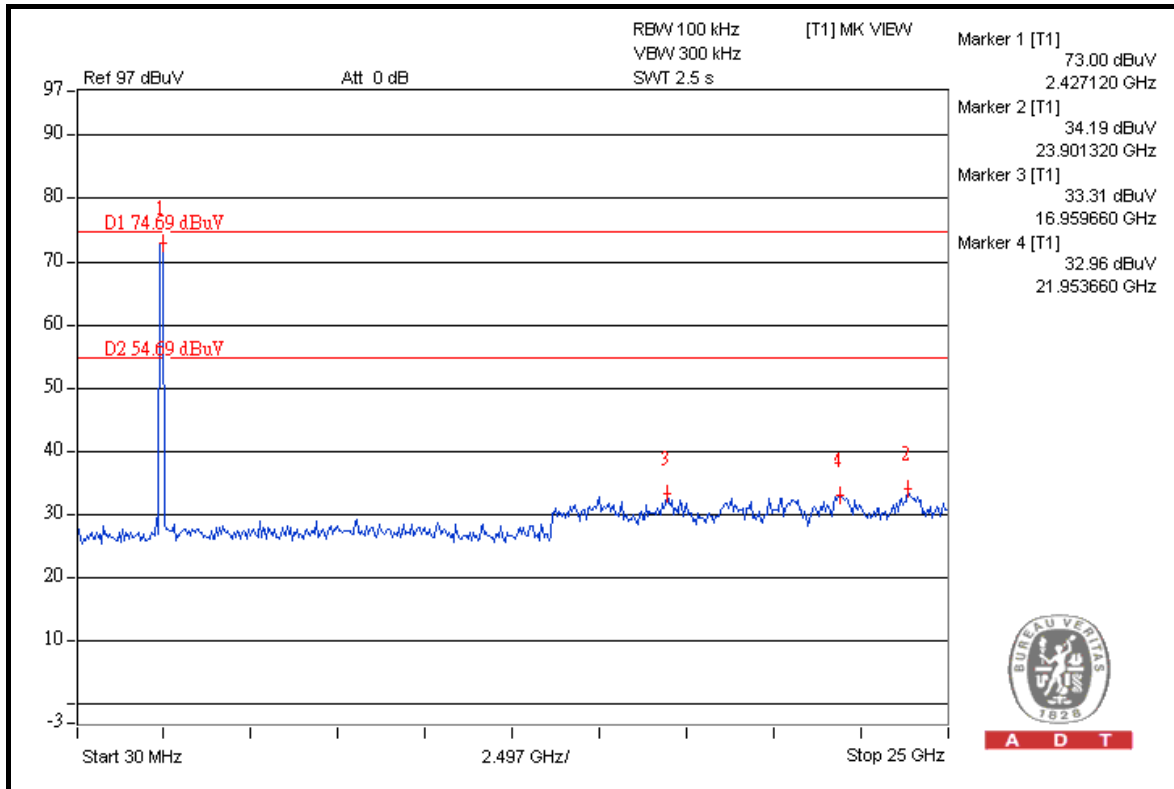



A D T

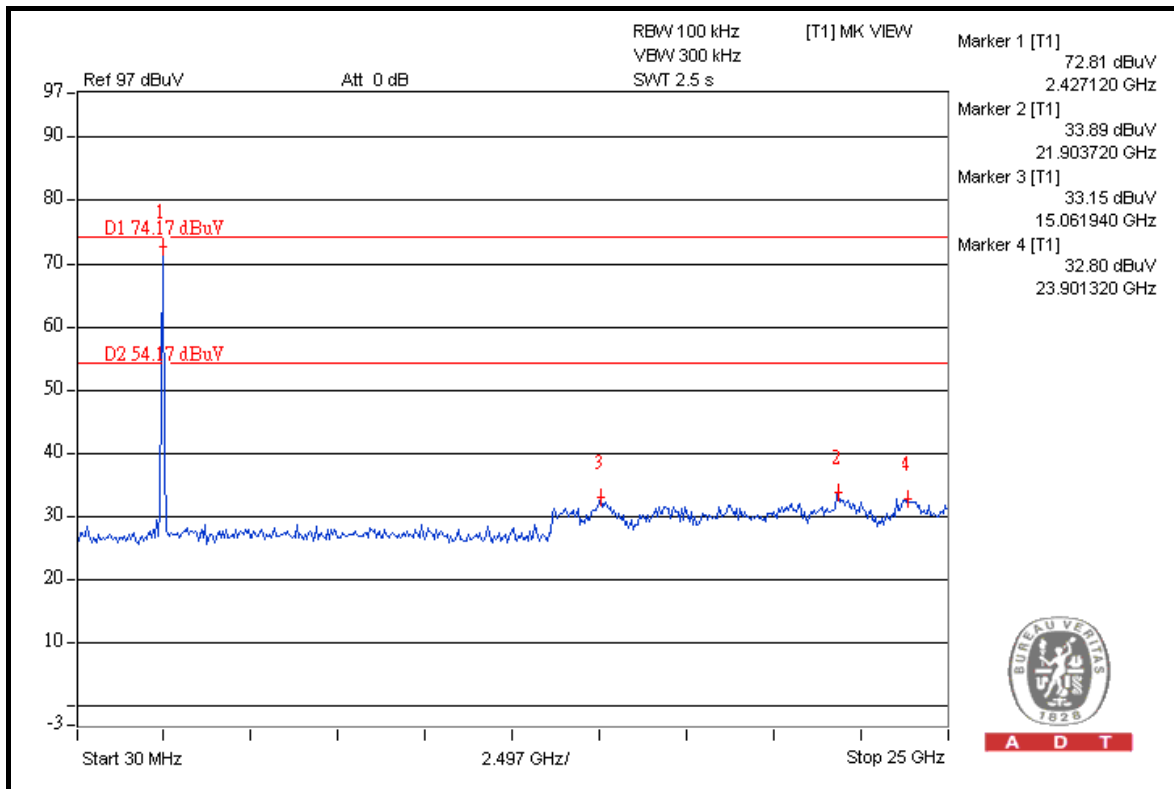
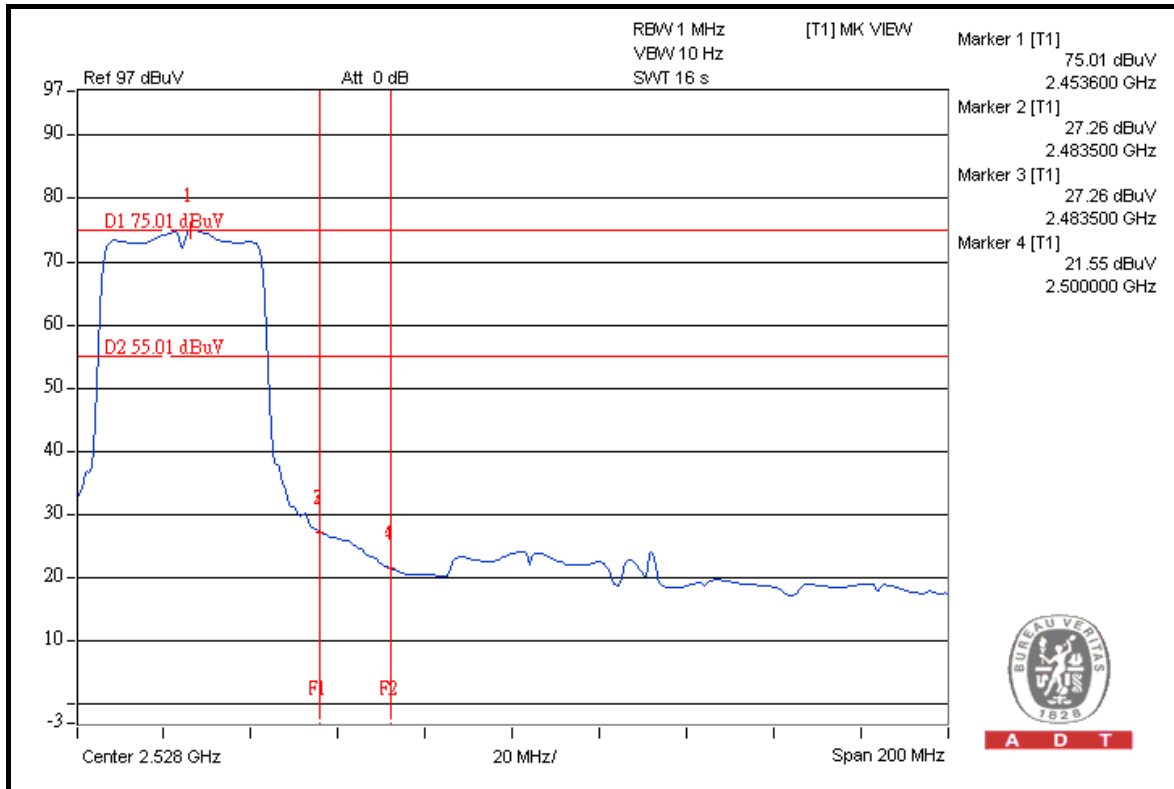



A D T

## **4.7 ANTENNA REQUIREMENT**

### **4.7.1 STANDARD APPLICABLE**

For intentional device, according to FCC 47 CFR Section 15.203, an intentional radiator shall be designed to ensure that no antenna other than that furnished by the responsible party shall be used with the device.

And according to FCC 47 CFR Section 15.247 (b), if transmitting antennas of directional gain greater than 6dBi are used, the power shall be reduced by the amount in dB that the directional gain of the antenna exceeds 6dBi.

### **4.7.2 ANTENNA CONNECTED CONSTRUCTION**

The antenna used in this product is internal directional antenna with IPEX connector. The maximum gain of the antenna is 4dBi.



A D T

## 5. PHOTOGRAPHS OF THE TEST CONFIGURATION

Please refer to the attached file (Test Setup Photo).



A D T

## 6. INFORMATION ON THE TESTING LABORATORIES

We, Bureau Veritas Consumer Products Services (H.K.) Ltd., Taoyuan Branch, were founded in 1988 to provide our best service in EMC, Radio, Telecom and Safety consultation. Our laboratories are accredited and approved by the following approval agencies according to ISO/IEC 17025.

<b>USA</b>	FCC, NVLAP
<b>Germany</b>	TUV Rheinland
<b>Japan</b>	VCCI
<b>Norway</b>	NEMKO
<b>Canada</b>	INDUSTRY CANADA, CSA
<b>R.O.C.</b>	TAF, BSMI, NCC
<b>Netherlands</b>	Telefication
<b>Singapore</b>	GOST-ASIA(MOU)
<b>Russia</b>	CERTIS(MOU)

Copies of accreditation certificates of our laboratories obtained from approval agencies can be downloaded from our web site:

[www.adt.com.tw/index.5/phtml](http://www.adt.com.tw/index.5/phtml). If you have any comments, please feel free to contact us at the following:

**Linko EMC/RF Lab:**  
Tel: 886-2-26052180  
Fax: 886-2-26051924

**Hsin Chu EMC/RF Lab:**  
Tel: 886-3-5935343  
Fax: 886-3-5935342

**Hwa Ya EMC/RF/Safety Telecom Lab:**  
Tel: 886-3-3183232  
Fax: 886-3-3185050

**Web Site:** [www.adt.com.tw](http://www.adt.com.tw)

The address and road map of all our labs can be found in our web site also.



A D T

## **7. APPENDIX A - MODIFICATIONS RECORDERS FOR ENGINEERING CHANGES TO THE EUT BY THE LAB**

No any modifications are made to the EUT by the lab during the test.

**---END---**