



A D T

FCC TEST REPORT (15.247)

REPORT NO.: RF140102C03

MODEL NO.: AP102

FCC ID: U2M-AP102

RECEIVED: Jan. 02, 2014

TESTED: Jan. 02 ~ Jan. 09, 2014

ISSUED: Feb. 14, 2014

APPLICANT: Senao Networks, Inc.

ADDRESS: 3F, No. 529, Chung Cheng Rd., Hsintien, Taipei, Taiwan

ISSUED BY: Bureau Veritas Consumer Products Services (H.K.) Ltd., Taoyuan Branch

LAB ADDRESS: No. 47, 14th Ling, Chia Pau Vil., Lin Kou Dist., New Taipei City, Taiwan, R.O.C.

TEST LOCATION: No. 19, Hwa Ya 2nd Rd, Wen Hwa Tsuen, Kwei Shan Hsiang, Taoyuan Hsien 333, Taiwan, R.O.C.

This report should not be used by the client to claim product certification, approval, or endorsement by TAF or any government agencies.



This report is for your exclusive use. Any copying or replication of this report to or for any other person or entity, or use of our name or trademark, is permitted only with our prior written permission. This report sets forth our findings solely with respect to the test samples identified herein. The results set forth in this report are not indicative or representative of the quality or characteristics of the lot from which a test sample was taken or any similar or identical product unless specifically and expressly noted. Our report includes all of the tests requested by you and the results thereof based upon the information that you provided to us. You have 60 days from date of issuance of this report to notify us of any material error or omission caused by our negligence, provided, however, that such notice shall be in writing and shall specifically address the issue you wish to raise. A failure to raise such issue within the prescribed time shall constitute your unqualified acceptance of the completeness of this report, the tests conducted and the correctness of the report contents. Unless specific mention, the uncertainty of measurement has been explicitly taken into account to declare the compliance or non-compliance to the specification.



A D T

TABLE OF CONTENTS

RELEASE CONTROL RECORD.....	5
1. CERTIFICATION.....	6
2. SUMMARY OF TEST RESULTS	7
2.1 MEASUREMENT UNCERTAINTY.....	7
3. GENERAL INFORMATION.....	8
3.1 GENERAL DESCRIPTION OF EUT	8
3.2 DESCRIPTION OF TEST MODES	10
3.2.1 TEST MODE APPLICABILITY AND TESTED CHANNEL DETAIL	11
3.3 DUTY CYCLE OF TEST SIGNAL.....	15
3.4 DESCRIPTION OF SUPPORT UNITS	17
3.4.1 CONFIGURATION OF SYSTEM UNDER TEST	17
3.5 GENERAL DESCRIPTION OF APPLIED STANDARDS	19
4. TEST TYPES AND RESULTS (FOR 2.4GHz BAND).....	20
4.1 RADIATED EMISSION AND BANDEDGE MEASUREMENT	20
4.1.1 LIMITS OF RADIATED EMISSION AND BANDEDGE MEASUREMENT	20
4.1.2 TEST INSTRUMENTS.....	21
4.1.3 TEST PROCEDURES	22
4.1.4 DEVIATION FROM TEST STANDARD.....	22
4.1.5 TEST SETUP.....	23
4.1.6 EUT OPERATING CONDITIONS	24
4.1.7 TEST RESULTS	25
4.2 CONDUCTED EMISSION MEASUREMENT	39
4.2.1 LIMITS OF CONDUCTED EMISSION MEASUREMENT	39
4.2.2 TEST INSTRUMENTS.....	39
4.2.3 TEST PROCEDURES	40
4.2.4 DEVIATION FROM TEST STANDARD.....	40
4.2.5 TEST SETUP.....	40
4.2.6 EUT OPERATING CONDITIONS	40
4.2.7 TEST RESULTS	41
4.3 6dB BANDWIDTH MEASUREMENT	45
4.3.1 LIMITS OF 6dB BANDWIDTH MEASUREMENT	45
4.3.2 TEST SETUP.....	45
4.3.3 TEST INSTRUMENTS.....	45
4.3.4 TEST PROCEDURE.....	45
4.3.5 DEVIATION FROM TEST STANDARD.....	45
4.3.6 EUT OPERATING CONDITIONS	45
4.3.7 TEST RESULTS	46



A D T

4.4	CONDUCTED OUTPUT POWER.....	48
4.4.1	LIMITS OF CONDUCTED OUTPUT POWER MEASUREMENT	48
4.4.2	TEST SETUP.....	48
4.4.3	TEST INSTRUMENTS.....	48
4.4.4	TEST PROCEDURES	48
4.4.5	DEVIATION FROM TEST STANDARD.....	49
4.4.6	EUT OPERATING CONDITIONS	49
4.4.7	TEST RESULTS	50
4.5	POWER SPECTRAL DENSITY MEASUREMENT	52
4.5.1	LIMITS OF POWER SPECTRAL DENSITY MEASUREMENT	52
4.5.2	TEST SETUP.....	52
4.5.3	TEST INSTRUMENTS.....	52
4.5.4	TEST PROCEDURE.....	52
4.5.5	DEVIATION FROM TEST STANDARD.....	52
4.5.6	EUT OPERATING CONDITION.....	52
4.5.7	TEST RESULTS	53
4.6	CONDUCTED OUT OF BAND EMISSION MEASUREMENT.....	55
4.6.1	LIMITS OF CONDUCTED OUT OF BAND EMISSION MEASUREMENT	55
4.6.2	TEST SETUP.....	55
4.6.3	TEST INSTRUMENTS.....	55
4.6.4	TEST PROCEDURE.....	56
4.6.5	DEVIATION FROM TEST STANDARD.....	56
4.6.6	EUT OPERATING CONDITION.....	56
4.6.7	TEST RESULTS	56
5.	TEST TYPES AND RESULTS (FOR 5.0GHz BAND).....	65
5.1	RADIATED EMISSION MEASUREMENT	65
5.1.1	LIMITS OF RADIATED EMISSION MEASUREMENT	65
5.1.2	TEST INSTRUMENTS.....	66
5.1.3	TEST PROCEDURES	66
5.1.4	DEVIATION FROM TEST STANDARD.....	66
5.1.5	TEST SETUP.....	66
5.1.6	EUT OPERATING CONDITIONS	66
5.1.7	TEST RESULTS	67
5.2	CONDUCTED EMISSION MEASUREMENT	77
5.2.1	LIMITS OF CONDUCTED EMISSION MEASUREMENT	77
5.2.2	TEST INSTRUMENTS.....	77
5.2.3	TEST PROCEDURES	77
5.2.4	DEVIATION FROM TEST STANDARD.....	77
5.2.5	TEST SETUP.....	77



A D T

5.2.6	EUT OPERATING CONDITIONS	77
5.2.7	TEST RESULTS	78
5.3	6dB BANDWIDTH MEASUREMENT	82
5.3.1	LIMITS OF 6dB BANDWIDTH MEASUREMENT	82
5.3.2	TEST SETUP	82
5.3.3	TEST INSTRUMENTS.....	82
5.3.4	TEST PROCEDURE.....	82
5.3.5	DEVIATION FROM TEST STANDARD.....	82
5.3.6	EUT OPERATING CONDITIONS	82
5.3.7	TEST RESULTS	83
5.4	CONDUCTED OUTPUT POWER.....	85
5.4.1	LIMITS OF CONDUCTED OUTPUT POWER MEASUREMENT	85
5.4.2	TEST SETUP	85
5.4.3	INSTRUMENTS.....	85
5.4.4	TEST PROCEDURES	85
5.4.5	DEVIATION FROM TEST STANDARD.....	85
5.4.6	EUT OPERATING CONDITIONS	85
5.4.7	TEST RESULTS	86
5.5	POWER SPECTRAL DENSITY MEASUREMENT	88
5.5.1	LIMITS OF POWER SPECTRAL DENSITY MEASUREMENT	88
5.5.2	TEST SETUP.....	88
5.5.3	TEST INSTRUMENTS.....	88
5.5.4	TEST PROCEDURE.....	88
5.5.5	DEVIATION FROM TEST STANDARD.....	88
5.5.6	EUT OPERATING CONDITION.....	88
5.5.7	TEST RESULTS	89
5.6	CONDUCTED OUT OF BAND EMISSION MEASUREMENT	91
5.6.1	LIMITS OF CONDUCTED OUT OF BAND EMISSION MEASUREMENT	91
5.6.2	TEST SETUP.....	91
5.6.3	TEST INSTRUMENTS.....	91
5.6.4	TEST PROCEDURE.....	91
5.6.5	DEVIATION FROM TEST STANDARD.....	91
5.6.6	EUT OPERATING CONDITION.....	91
5.6.7	TEST RESULTS	91
6.	PHOTOGRAPHS OF THE TEST CONFIGURATION.....	98
7.	INFORMATION ON THE TESTING LABORATORIES	99
8.	APPENDIX A – MODIFICATIONS RECORDERS FOR ENGINEERING CHANGES TO THE EUT BY THE LAB.....	100



A D T

RELEASE CONTROL RECORD

ISSUE NO.	REASON FOR CHANGE	DATE ISSUED
RF140102C03	Original release	Feb. 14, 2014



A D T

1. CERTIFICATION

PRODUCT: Wireless 802.11abgn Access Point
MODEL NO.: AP102
BRAND: WatchGuard
APPLICANT: Senao Networks, Inc.
TESTED: Jan. 02 ~ Jan. 09, 2014
TEST SAMPLE: ENGINEERING SAMPLE
STANDARDS: **FCC Part 15, Subpart C (Section 15.247)**
ANSI C63.10-2009

The above equipment (model: AP102) has been tested by **Bureau Veritas Consumer Products Services (H.K.) Ltd., Taoyuan Branch**, and found compliance with the requirement of the above standards. The test record, data evaluation & Equipment Under Test (EUT) configurations represented herein are true and accurate accounts of the measurements of the sample's EMC characteristics under the conditions specified in this report.

PREPARED BY : Celine Chou , **DATE :** Feb. 14, 2014
Celine Chou / Specialist

APPROVED BY : Ken Liu , **DATE :** Feb. 14, 2014
Ken Liu / Senior Manager



2. SUMMARY OF TEST RESULTS

The EUT has been tested according to the following specifications:

APPLIED STANDARD: FCC PART 15, SUBPART C (SECTION 15.247)			
STANDARD SECTION	TEST TYPE	RESULT	REMARK
15.207	AC Power Conducted Emission	PASS	Meet the requirement of limit. Minimum passing margin is -2.26dB at 0.36913MHz.
15.247(d) 15.209	Radiated Emissions	PASS	Meet the requirement of limit. Minimum passing margin is -1.0dB at 11570.00 and 11650.00MHz.
15.247(d)	Band Edge Measurement	PASS	Meet the requirement of limit.
15.247(a)(2)	6dB bandwidth	PASS	Meet the requirement of limit.
15.247(b)	Conducted power	PASS	Meet the requirement of limit.
15.247(e)	Power Spectral Density	PASS	Meet the requirement of limit.
15.203	Antenna Requirement	PASS	Antenna connector is I-PEX not a standard connector.

2.1 MEASUREMENT UNCERTAINTY

Where relevant, the following measurement uncertainty levels have been estimated for tests performed on the EUT as specified in CISPR 16-4-2:

MEASUREMENT	FREQUENCY	UNCERTAINTY
Conducted emissions	9kHz~30MHz	2.44 dB
Radiated emissions	30MHz ~ 200MHz	3.34 dB
	200MHz ~1000MHz	3.35 dB
	1GHz ~ 18GHz	2.26 dB
	18GHz ~ 40GHz	1.94 dB

This uncertainty represents an expanded uncertainty expressed at approximately the 95% confidence level using a coverage factor of $k = 2$.



3. GENERAL INFORMATION

3.1 GENERAL DESCRIPTION OF EUT

EUT	Wireless 802.11abgn Access Point
MODEL NO.	AP102
POWER SUPPLY	12Vdc from adapter 48Vdc from POE
MODULATION TYPE	CCK, DQPSK, DBPSK for DSSS 64QAM, 16QAM, QPSK, BPSK for OFDM
MODULATION TECHNOLOGY	DSSS, OFDM
TRANSFER RATE	802.11b: 11.0/ 5.5/ 2.0/ 1.0Mbps 802.11g: 54.0/ 48.0/ 36.0/ 24.0/ 18.0/ 12.0/ 9.0/ 6.0Mbps 802.11a: 54.0/ 48.0/ 36.0/ 24.0/ 18.0/ 12.0/ 9.0/ 6.0Mbps 802.11n: up to 300.0Mbps
OPERATING FREQUENCY	2.4GHz: 2412 ~ 2462MHz 5.0GHz: 5745 ~ 5825MHz
NUMBER OF CHANNEL	2.4GHz: 11 for 802.11b, 802.11g, 802.11n (20MHz) 7 for 802.11n (40MHz) 5.0GHz: 5 for 802.11a, 802.11n (20MHz) 2 for 802.11n (40MHz)
OUTPUT POWER	530.665mW for 2412 ~ 2462MHz 340.419mW for 5745 ~ 5825MHz
ANTENNA TYPE	2.4GHz: PIFA antenna with 3.5dBi gain 5GHz: PIFA antenna with 6dBi gain
ANTENNA CONNECTOR	I-PEX
DATA CABLE	NA
I/O PORTS	Refer to user's manual
ACCESSORY DEVICES	Adapter

NOTE:

1. The EUT incorporates a MIMO function. Physically, the EUT provides two completed transmitters and two receivers.

MODULATION MODE	TX FUNCTION
802.11b	2TX
802.11g	2TX
802.11a	2TX
802.11n (20MHz) MCS 0-15	2TX
802.11n (40MHz) MCS 0-15	2TX



A D T

2. The EUT consumes power from the following adapter.

ADAPTER	
BRAND:	Powertron Electronics Corp.
MODEL:	PA1015-2I
INPUT:	100-240Vac, 50-60Hz, 0.4A
OUTPUT:	12Vdc, 1.25A
POWER LINE:	1.5m cable without core attached on adapter

3. The following POE & POE's adapter are supports only.

POE	
BRAND	EnGenius
MODEL	EPE-48GR
INPUT POWER	48Vdc, 0.8A, 38.4W Max

ADAPTER For POE USED	
BRAND	Powertron Electronics Corp.
MODEL	PA1024-4HU
INPUT POWER	100-240Vac, 50-60Hz, 0.6A
OUTPUT POWER	48Vdc, 0.42A, 21W Max
POWER LINE	1.5m cable without core attached on adapter

4. The above EUT information is declared by manufacturer and for more detailed features description, please refer to the manufacturer's specifications or user's manual.



3.2 DESCRIPTION OF TEST MODES

FOR 2.4GHz:

11 channels are provided for 802.11b, 802.11g and 802.11n (20MHz):

CHANNEL	FREQUENCY	CHANNEL	FREQUENCY
1	2412MHz	7	2442MHz
2	2417MHz	8	2447MHz
3	2422MHz	9	2452MHz
4	2427MHz	10	2457MHz
5	2432MHz	11	2462MHz
6	2437MHz		

7 channels are provided for 802.11n (40MHz):

CHANNEL	FREQUENCY	CHANNEL	FREQUENCY
3	2422MHz	7	2442MHz
4	2427MHz	8	2447MHz
5	2432MHz	9	2452MHz
6	2437MHz		

FOR 5.0GHz (5745 ~ 5825MHz):

5 channels are provided for 802.11a, 802.11n (20MHz):

CHANNEL	FREQUENCY	CHANNEL	FREQUENCY
149	5745MHz	161	5805MHz
153	5765MHz	165	5825MHz
157	5785MHz		

2 channels are provided for 802.11n (40MHz):

CHANNEL	FREQUENCY	CHANNEL	FREQUENCY
151	5755MHz	159	5795MHz



3.2.1 TEST MODE APPLICABILITY AND TESTED CHANNEL DETAIL

FOR 2.4GHz:

EUT CONFIGURE MODE	APPLICABLE TO				DESCRIPTION
	RE≥1G	RE<1G	PLC	APCM	
A	√	√	√	√	Powered by adapter
B	-	√	√	-	Powered by POE

Where **RE≥1G**: Radiated Emission above 1GHz **RE<1G**: Radiated Emission below 1GHz
PLC: Power Line Conducted Emission **APCM**: Antenna Port Conducted Measurement

NOTE:

1. The EUT had been pre-tested on the positioned of each 3 axis. The worst case was found when positioned on **Z-plane**.
2. "-" means no effect.

RADIATED EMISSION TEST (ABOVE 1GHz):

- Pre-Scan has been conducted to determine the worst-case mode from all possible combinations between available modulations, data rates and antenna ports (if EUT with antenna diversity architecture).
- Following channel(s) was (were) selected for the final test as listed below.

EUT CONFIGURE MODE	MODE	AVAILABLE CHANNEL	TESTED CHANNEL	MODULATION TECHNOLOGY	MODULATION TYPE	DATA RATE (Mbps)
A	802.11b	1 to 11	1, 6, 11	DSSS	DBPSK	1.0
A	802.11g	1 to 11	1, 6, 11	OFDM	BPSK	6.0
A	802.11n (20MHz)	1 to 11	1, 6, 11	OFDM	BPSK	7.2
A	802.11n (40MHz)	3 to 9	3, 6, 9	OFDM	BPSK	15.0

RADIATED EMISSION TEST (BELOW 1GHz):

- Pre-Scan has been conducted to determine the worst-case mode from all possible combinations between available modulations, data rates and antenna ports (if EUT with antenna diversity architecture).
- Following channel(s) was (were) selected for the final test as listed below.

EUT CONFIGURE MODE	MODE	AVAILABLE CHANNEL	TESTED CHANNEL	MODULATION TECHNOLOGY	MODULATION TYPE	DATA RATE (Mbps)
A & B	802.11g	1 to 11	6	OFDM	BPSK	6.0

POWER LINE CONDUCTED EMISSION TEST:

- Pre-Scan has been conducted to determine the worst-case mode from all possible combinations between available modulations, data rates and antenna ports (if EUT with antenna diversity architecture).
- Following channel(s) was (were) selected for the final test as listed below.

EUT CONFIGURE MODE	MODE	AVAILABLE CHANNEL	TESTED CHANNEL	MODULATION TECHNOLOGY	MODULATION TYPE	DATA RATE (Mbps)
A & B	802.11g	1 to 11	6	OFDM	BPSK	6.0



BANDEDGE MEASUREMENT:

- Pre-Scan has been conducted to determine the worst-case mode from all possible combinations between available modulations, data rates and antenna ports (if EUT with antenna diversity architecture).
- Following channel(s) was (were) selected for the final test as listed below.

EUT CONFIGURE MODE	MODE	AVAILABLE CHANNEL	TESTED CHANNEL	MODULATION TECHNOLOGY	MODULATION TYPE	DATA RATE (Mbps)
A	802.11b	1 to 11	1, 11	DSSS	DBPSK	1.0
A	802.11g	1 to 11	1, 11	OFDM	BPSK	6.0
A	802.11n (20MHz)	1 to 11	1, 11	OFDM	BPSK	7.2
A	802.11n (40MHz)	3 to 9	3, 9	OFDM	BPSK	15.0

ANTENNA PORT CONDUCTED MEASUREMENT:

- This item includes all test value of each mode, but only includes spectrum plot of worst value of each mode.
- Pre-Scan has been conducted to determine the worst-case mode from all possible combinations between available modulations, data rates and antenna ports (if EUT with antenna diversity architecture).
- Following channel(s) was (were) selected for the final test as listed below.

EUT CONFIGURE MODE	MODE	AVAILABLE CHANNEL	TESTED CHANNEL	MODULATION TECHNOLOGY	MODULATION TYPE	DATA RATE (Mbps)
A	802.11b	1 to 11	1, 6, 11	DSSS	DBPSK	1.0
A	802.11g	1 to 11	1, 6, 11	OFDM	BPSK	6.0
A	802.11n (20MHz)	1 to 11	1, 6, 11	OFDM	BPSK	7.2
A	802.11n (40MHz)	3 to 9	3, 6, 9	OFDM	BPSK	15.0

TEST CONDITION:

APPLICABLE TO	ENVIRONMENTAL CONDITIONS	INPUT POWER	TESTED BY
RE≥1G	25deg. C, 65%RH	120Vac, 60Hz	Chris Lin
RE<1G	25deg. C, 65%RH	120Vac, 60Hz	Chris Lin
PLC	25deg. C, 68%RH	120Vac, 60Hz	Sun Lin
APCM	25deg. C, 60%RH	120Vac, 60Hz	Antony Lee



A D T

FOR 5.0GHz (5745 ~ 5825MHz):

EUT CONFIGURE MODE	APPLICABLE TO				DESCRIPTION
	RE≥1G	RE<1G	PLC	APCM	
A	√	√	√	√	Powered by adapter
B	-	√	√	-	Powered by POE

Where **RE≥1G**: Radiated Emission above 1GHz **RE<1G**: Radiated Emission below 1GHz
PLC: Power Line Conducted Emission **APCM**: Antenna Port Conducted Measurement

NOTE:

1. The EUT had been pre-tested on the positioned of each 3 axis. The worst case was found when positioned on **Z-plane**.
2. "-" means no effect.

RADIATED EMISSION TEST (ABOVE 1GHz):

- Pre-Scan has been conducted to determine the worst-case mode from all possible combinations between available modulations, data rates and antenna ports (if EUT with antenna diversity architecture).
- Following channel(s) was (were) selected for the final test as listed below.

EUT CONFIGURE MODE	MODE	AVAILABLE CHANNEL	TESTED CHANNEL	MODULATION TECHNOLOGY	MODULATION TYPE	DATA RATE (Mbps)
A	802.11a	149 to 165	149, 157, 165	OFDM	BPSK	6.0
A	802.11n (20MHz)	149 to 165	149, 157, 165	OFDM	BPSK	7.2
A	802.11n (40MHz)	151 to 159	151, 159	OFDM	BPSK	15.0

RADIATED EMISSION TEST (BELOW 1GHz):

- Pre-Scan has been conducted to determine the worst-case mode from all possible combinations between available modulations, data rates and antenna ports (if EUT with antenna diversity architecture).
- Following channel(s) was (were) selected for the final test as listed below.

EUT CONFIGURE MODE	MODE	AVAILABLE CHANNEL	TESTED CHANNEL	MODULATION TECHNOLOGY	MODULATION TYPE	DATA RATE (Mbps)
A & B	802.11n (20MHz)	149 to 165	165	OFDM	BPSK	7.2

POWER LINE CONDUCTED EMISSION TEST:

- Pre-Scan has been conducted to determine the worst-case mode from all possible combinations between available modulations, data rates and antenna ports (if EUT with antenna diversity architecture).
- Following channel(s) was (were) selected for the final test as listed below.

EUT CONFIGURE MODE	MODE	AVAILABLE CHANNEL	TESTED CHANNEL	MODULATION TECHNOLOGY	MODULATION TYPE	DATA RATE (Mbps)
A & B	802.11n (20MHz)	149 to 165	165	OFDM	BPSK	7.2



BANDEDGE MEASUREMENT:

- Pre-Scan has been conducted to determine the worst-case mode from all possible combinations between available modulations, data rates and antenna ports (if EUT with antenna diversity architecture).
- Following channel(s) was (were) selected for the final test as listed below.

EUT CONFIGURE MODE	MODE	AVAILABLE CHANNEL	TESTED CHANNEL	MODULATION TECHNOLOGY	MODULATION TYPE	DATA RATE (Mbps)
A	802.11a	149 to 165	149, 165	OFDM	BPSK	6.0
A	802.11n (20MHz)	149 to 165	149, 165	OFDM	BPSK	7.2
A	802.11n (40MHz)	151 to 159	151, 159	OFDM	BPSK	15.0

ANTENNA PORT CONDUCTED MEASUREMENT:

- This item includes all test value of each mode, but only includes spectrum plot of worst value of each mode.
- Pre-Scan has been conducted to determine the worst-case mode from all possible combinations between available modulations, data rates and antenna ports (if EUT with antenna diversity architecture).
- Following channel(s) was (were) selected for the final test as listed below.

EUT CONFIGURE MODE	MODE	AVAILABLE CHANNEL	TESTED CHANNEL	MODULATION TECHNOLOGY	MODULATION TYPE	DATA RATE (Mbps)
A	802.11a	149 to 165	149, 157, 165	OFDM	BPSK	6.0
A	802.11n (20MHz)	149 to 165	149, 157, 165	OFDM	BPSK	7.2
A	802.11n (40MHz)	151 to 159	151, 159	OFDM	BPSK	15.0

TEST CONDITION:

APPLICABLE TO	ENVIRONMENTAL CONDITIONS	INPUT POWER	TESTED BY
RE≥1G	25deg. C, 65%RH	120Vac, 60Hz	Jones Chang
RE<1G	25deg. C, 65%RH	120Vac, 60Hz	Chris Lin
PLC	25deg. C, 68%RH	120Vac, 60Hz	Sun Lin
APCM	25deg. C, 60%RH	120Vac, 60Hz	Antony Lee

3.3 DUTY CYCLE OF TEST SIGNAL

2.4GHz Band:

802.11b: Duty cycle of test signal is > 98 %

802.11g, 802.11n (20MHz), 802.11n (40MHz): Duty cycle of test signal is < 98%

802.11g: Duty cycle = $1.359/1.411 = 0.962$, Duty factor = $10 * \log(1/0.962) = 0.17$

802.11n (20MHz): Duty cycle = $1.269/1.323 = 0.958$, Duty factor = $10 * \log(1/0.958) = 0.19$

802.11n (40MHz): Duty cycle = $0.625/0.671 = 0.931$, Duty factor = $10 * \log(1/0.931) = 0.31$

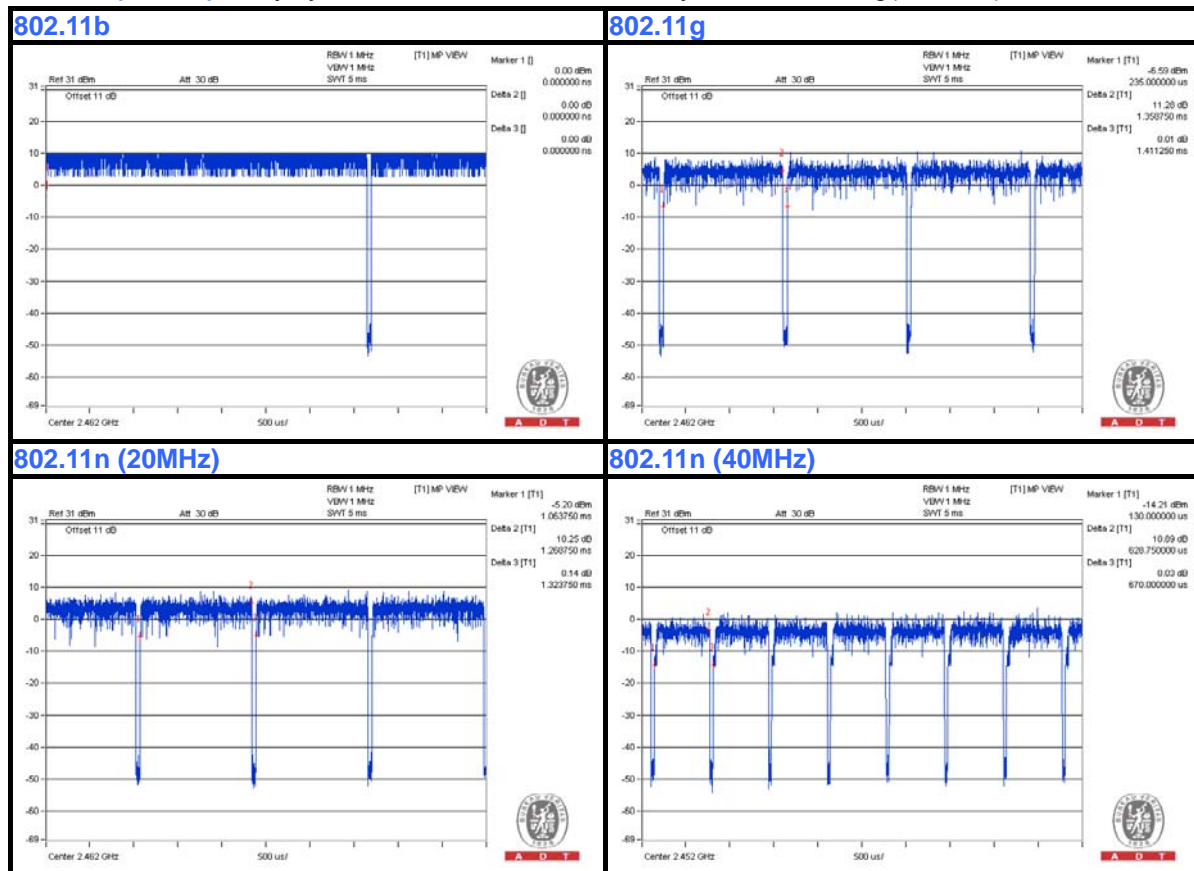



A D T

5.0GHz Band:

Duty cycle of test signal is < 98%

802.11a: Duty cycle = $1.357/1.405 = 0.966$, Duty factor = $10 * \log(1/0.966) = 0.15$

802.11n (20MHz): Duty cycle = $1.270/1.310 = 0.969$, Duty factor = $10 * \log(1/0.969) = 0.14$

802.11n (40MHz): Duty cycle = $0.631/0.666 = 0.947$, Duty factor = $10 * \log(1/0.947) = 0.24$

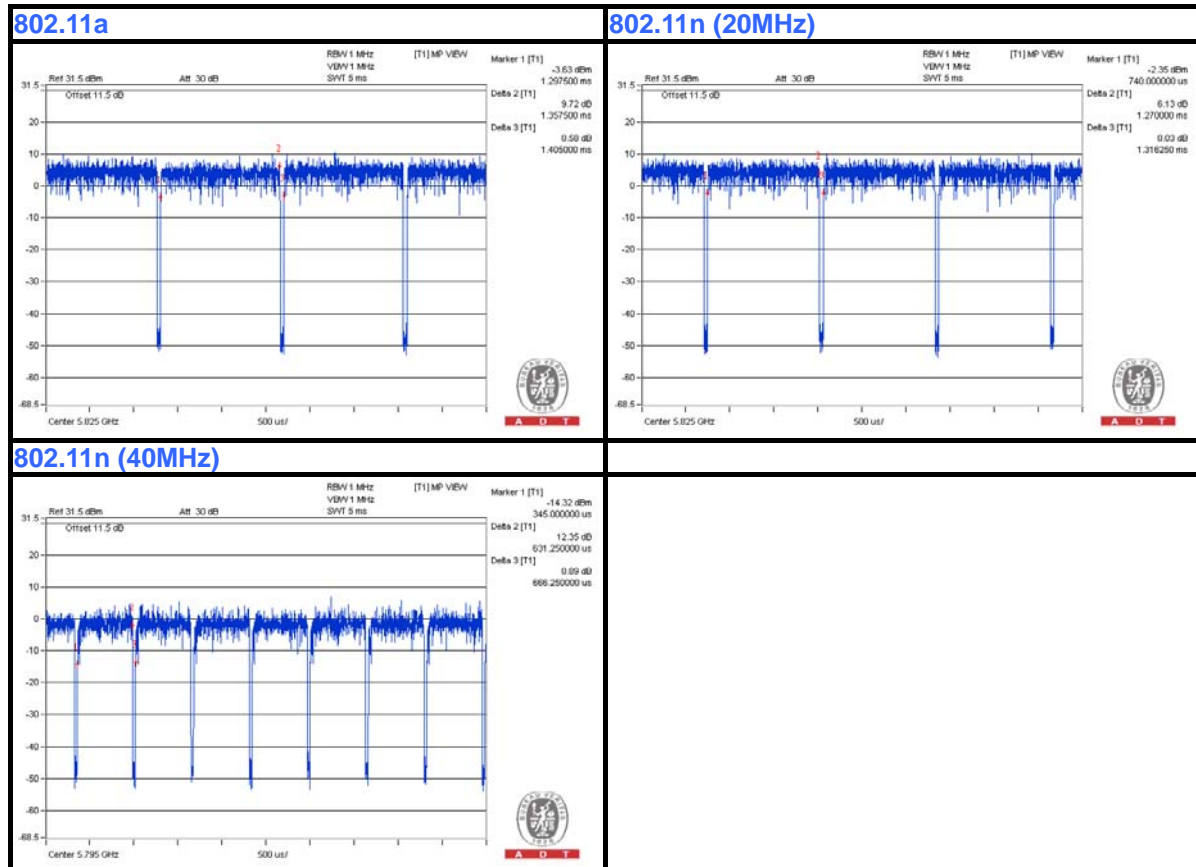

3.4 DESCRIPTION OF SUPPORT UNITS

The EUT has been tested as an independent unit together with other necessary accessories or support units. The following support units or accessories were used to form a representative test configuration during the tests.

NO.	PRODUCT	BRAND	MODEL NO.	SERIAL NO.	FCC ID
1	NOTEBOOK	DELL	E5410	1HC2XM1	FCC Doc Approved
2	POE	EnGenius	EPE-48GR	NA	NA

NO.	SIGNAL CABLE DESCRIPTION OF THE ABOVE SUPPORT UNITS
1	3m LAN cable for mode A only, 1.8m LAN cable for mode B only
2	3m LAN cable for mode B only

NOTE:

1. All power cords of the above support units are non-shielded (1.8m).
2. Item 1-2 acted as a communication partner to transfer data.
3. Item 2 was provided by client and for mode B tested only.

3.4.1 CONFIGURATION OF SYSTEM UNDER TEST

TEST MODE A

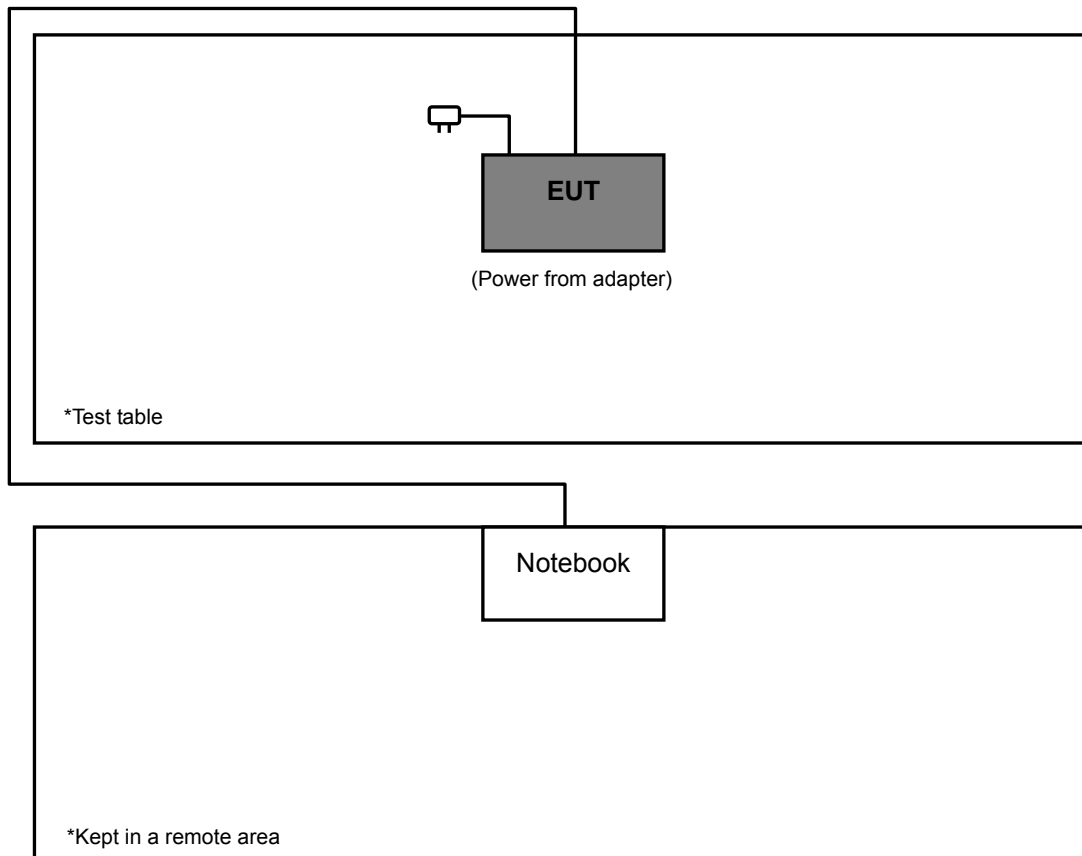



TEST MODE B

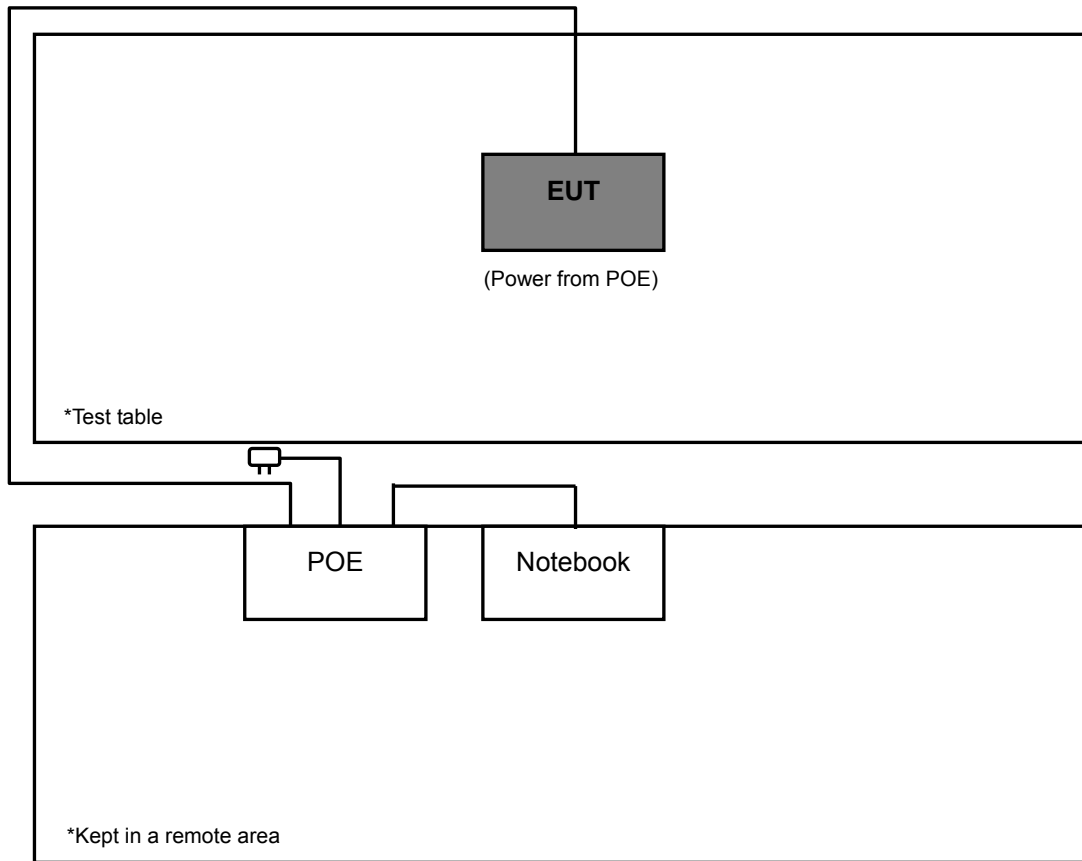



A D T

3.5 GENERAL DESCRIPTION OF APPLIED STANDARDS

The EUT is a RF Product. According to the specifications of the manufacturer, it must comply with the requirements of the following standards:

FCC Part 15, Subpart C (15.247)

558074 D01 DTS Meas Guidance v03r01

662911 D01 Multiple Transmitter Output v02

ANSI C63.10-2009

All test items have been performed and recorded as per the above standards.

NOTE: The EUT is also considered as a kind of computer peripheral, because the connection to computer is necessary for typical use. It has been verified to comply with the requirements of FCC Part 15, Subpart B, Class B (DoC). The test report has been issued separately.



A D T

4. TEST TYPES AND RESULTS (FOR 2.4GHz BAND)

4.1 RADIATED EMISSION AND BANDEDGE MEASUREMENT

4.1.1 LIMITS OF RADIATED EMISSION AND BANDEDGE MEASUREMENT

Radiated emissions which fall in the restricted bands must comply with the radiated emission limits specified as below table. Other emissions shall be at least 20dB below the highest level of the desired power:

FREQUENCIES (MHz)	FIELD STRENGTH (microvolts/meter)	MEASUREMENT DISTANCE (meters)
0.009 ~ 0.490	2400/F(kHz)	300
0.490 ~ 1.705	24000/F(kHz)	30
1.705 ~ 30.0	30	30
30 ~ 88	100	3
88 ~ 216	150	3
216 ~ 960	200	3
Above 960	500	3

NOTE:

1. The lower limit shall apply at the transition frequencies.
2. Emission level (dBuV/m) = 20 log Emission level (uV/m).
3. For frequencies above 1000MHz, the field strength limits are based on average detector, however, the peak field strength of any emission shall not exceed the maximum permitted average limits, specified above by more than 20dB under any condition of modulation.



A D T

4.1.2 TEST INSTRUMENTS

DESCRIPTION & MANUFACTURER	MODEL NO.	SERIAL NO.	DATE OF CALIBRATION	DUE DATE OF CALIBRATION
Test Receiver ROHDE & SCHWARZ	ESIB7	100187	Jan. 02, 2014	Jan. 01, 2015
Spectrum Analyzer ROHDE & SCHWARZ	FSP40	100039	Jan. 31, 2013	Jan. 30, 2014
BILOG Antenna SCHWARZBECK	VULB9168	9168-160	Mar. 20, 2013	Mar. 19, 2014
HORN Antenna SCHWARZBECK	9120D	209	Sep. 12, 2013	Sep. 11, 2014
HORN Antenna SCHWARZBECK	BBHA 9170	148	Jul. 15, 2013	Jul. 14, 2014
Preamplifier Agilent	8447D	2944A10633	Oct. 07, 2013	Oct. 06, 2014
Preamplifier Agilent	8449B	3008A01964	Aug. 26, 2013	Aug. 25, 2014
RF signal cable HUBER+SUHNNER	SUCOFLEX 104	214378/4	Aug. 26, 2013	Aug. 25, 2014
RF signal cable HUBER+SUHNNER	SUCOFLEX 106	12738/6+309224/4	Aug. 26, 2013	Aug. 25, 2014
Software BV ADT	ADT_Radiated_ V7.6.15.9.4	NA	NA	NA
Antenna Tower inn-co GmbH	MA 4000	013303	NA	NA
Antenna Tower Controller inn-co GmbH	CO2000	017303	NA	NA
Turn Table BV ADT	TT100	TT93021703	NA	NA
Turn Table Controller BV ADT	SC100	SC93021703	NA	NA
26GHz ~ 40GHz Amplifier	EM26400	815221	Oct. 18, 2013	Oct. 17, 2014
High Speed Peak Power Meter	ML2495A	0824012	Aug. 22, 2013	Aug. 21, 2014
Power Sensor	MA2411B	0738171	Jul. 30, 2013	Jul. 29, 2014

- NOTE:**
1. The calibration interval of the above test instruments is 12 months and the calibrations are traceable to NML/ROC and NIST/USA.
 2. The test was performed in HwaYa Chamber 3.
 3. The horn antenna and HP preamplifier (model: 8449B) are used only for the measurement of emission frequency above 1GHz if tested.
 4. The FCC Site Registration No. is 988962.
 5. The IC Site Registration No. is IC 7450F-3.



A D T

4.1.3 TEST PROCEDURES

- a. The EUT was placed on the top of a rotating table 0.8 meters above the ground at a 3 meters semi-anechoic chamber. The table was rotated 360 degrees to determine the position of the highest radiation.
- b. The EUT was set 3 meters away from the interference-receiving antenna, which was mounted on the top of a variable-height antenna tower.
- c. The antenna is a broadband antenna, and its height is varied from one meter to four meters above the ground to determine the maximum value of the field strength. Both horizontal and vertical polarizations of the antenna are set to make the measurement.
- d. For each suspected emission, the EUT was arranged to its worst case and then the antenna was tuned to heights from 1 meter to 4 meters and the rotatable table was turned from 0 degrees to 360 degrees to find the maximum reading.
- e. The test-receiver system was set to Peak Detect Function and Specified Bandwidth with Maximum Hold Mode.
- f. If the emission level of the EUT in peak mode was lower than the limit specified, then testing could be stopped and the peak values of the EUT would be reported. Otherwise the emissions would be re-tested one by one using peak, quasi-peak or average method as specified and then reported in a data sheet.

NOTE:

1. The resolution bandwidth and video bandwidth of test receiver/spectrum analyzer is 120kHz for Quasi-peak detection at frequency below 1GHz.
2. The resolution bandwidth of test receiver/spectrum analyzer is 1MHz and video bandwidth is 3MHz for Peak detection at frequency above 1GHz.
3. The resolution bandwidth of test receiver/spectrum analyzer is 1MHz and the video bandwidth is $\geq 1/T$ (Duty cycle < 98%) or 10Hz (Duty cycle > 98%) for Average detection (AV) at frequency above 1GHz.
4. All modes of operation were investigated and the worst-case emissions are reported.

4.1.4 DEVIATION FROM TEST STANDARD

No deviation.

4.1.5 TEST SETUP

Frequency range 30MHz~1GHz

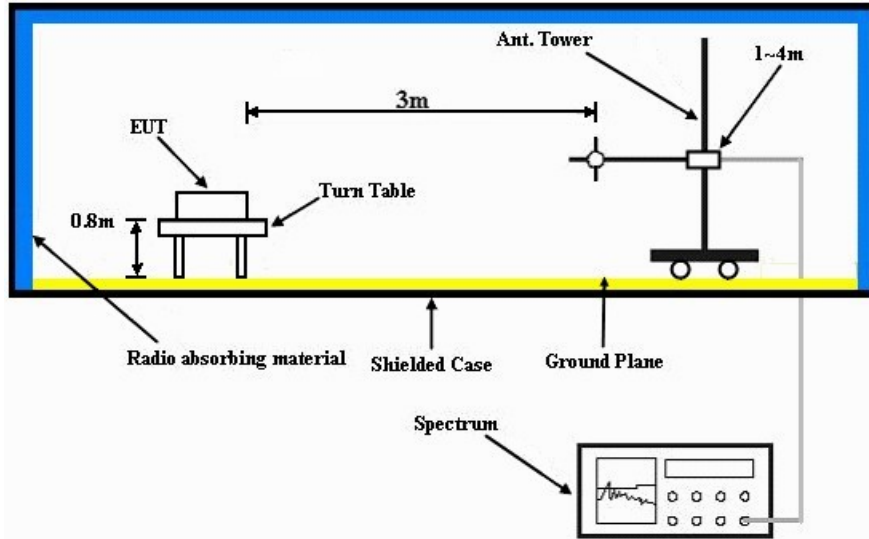

Frequency range above 1GHz

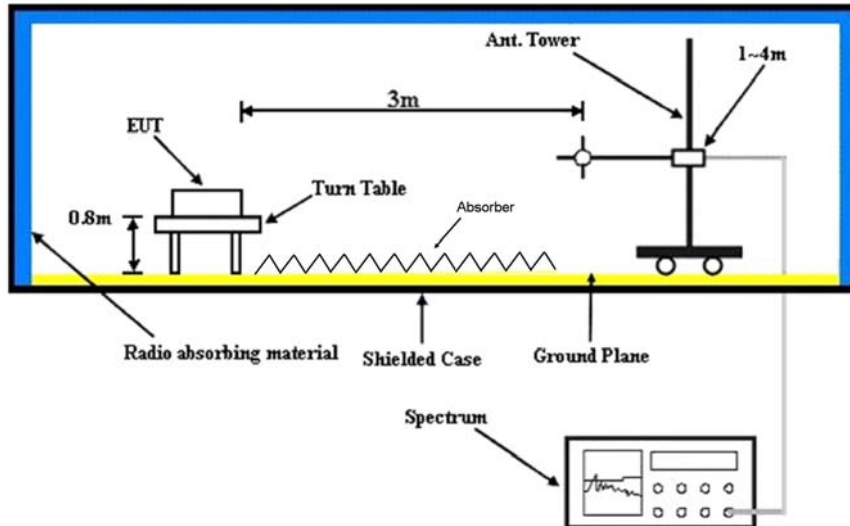

For the actual test configuration, please refer to the attached file (Test Setup Photo).



A D T

4.1.6 EUT OPERATING CONDITIONS

- a. Placed the EUT on the testing table.
- b. Prepared notebook to act as communication partner and placed it outside of testing area.
- c. The communication partner connected with EUT via a LAN cable and ran a test program (provided by manufacturer) to enable EUT under transmission condition continuously at specific channel frequency.
- d. The communication partner sent data to EUT by command "PING".



A D T

4.1.7 TEST RESULTS

ABOVE 1GHz DATA :

802.11b

EUT TEST CONDITION		MEASUREMENT DETAIL	
CHANNEL	Channel 1	FREQUENCY RANGE	1 ~ 25GHz
INPUT POWER	120Vac, 60Hz	DETECTOR FUNCTION	Peak (PK) Average (AV)
ENVIRONMENTAL CONDITIONS	25deg. C, 65%RH	TESTED BY	Chris Lin

ANTENNA POLARITY & TEST DISTANCE: HORIZONTAL AT 3 M								
NO.	FREQ. (MHz)	EMISSION LEVEL (dBuV/m)	LIMIT (dBuV/m)	MARGIN (dB)	ANTENNA HEIGHT (m)	TABLE ANGLE (Degree)	RAW VALUE (dBuV)	CORRECTION FACTOR (dB/m)
1	2386.00	71.7 PK	74.0	-2.3	1.03 H	308	40.70	31.00
2	2386.00	51.3 AV	54.0	-2.7	1.03 H	308	20.30	31.00
3	*2412.00	111.4 PK			1.01 H	308	80.30	31.10
4	*2412.00	107.6 AV			1.01 H	308	76.50	31.10
5	4824.00	51.9 PK	74.0	-22.1	1.07 H	18	47.00	4.90
6	4824.00	48.1 AV	54.0	-5.9	1.07 H	18	43.20	4.90

ANTENNA POLARITY & TEST DISTANCE: VERTICAL AT 3 M								
NO.	FREQ. (MHz)	EMISSION LEVEL (dBuV/m)	LIMIT (dBuV/m)	MARGIN (dB)	ANTENNA HEIGHT (m)	TABLE ANGLE (Degree)	RAW VALUE (dBuV)	CORRECTION FACTOR (dB/m)
1	2386.00	69.5 PK	74.0	-4.5	1.16 V	13	38.50	31.00
2	2386.00	49.3 AV	54.0	-4.7	1.16 V	13	18.30	31.00
3	*2412.00	106.1 PK			1.16 V	0	75.00	31.10
4	*2412.00	102.3 AV			1.16 V	0	71.20	31.10
5	4824.00	51.2 PK	74.0	-22.8	1.13 V	301	46.30	4.90
6	4824.00	46.6 AV	54.0	-7.4	1.13 V	301	41.70	4.90

REMARKS:

- Emission Level(dBuV/m) = Raw Value(dBuV) + Correction Factor(dB/m)
- Correction Factor(dB/m) = Antenna Factor(dB/m) + Cable Factor(dB) – Pre-Amplifier Factor(dB)
- The other emission levels were very low against the limit.
- Margin value = Emission Level – Limit value
- “ * “: Fundamental frequency.



A D T

EUT TEST CONDITION		MEASUREMENT DETAIL	
CHANNEL	Channel 6	FREQUENCY RANGE	1 ~ 25GHz
INPUT POWER	120Vac, 60Hz	DETECTOR FUNCTION	Peak (PK) Average (AV)
ENVIRONMENTAL CONDITIONS	25deg. C, 65%RH	TESTED BY	Chris Lin

ANTENNA POLARITY & TEST DISTANCE: HORIZONTAL AT 3 M								
NO.	FREQ. (MHz)	EMISSION LEVEL (dBuV/m)	LIMIT (dBuV/m)	MARGIN (dB)	ANTENNA HEIGHT (m)	TABLE ANGLE (Degree)	RAW VALUE (dBuV)	CORRECTION FACTOR (dB/m)
1	*2437.00	112.3 PK			1.23 H	292	81.10	31.20
2	*2437.00	108.4 AV			1.23 H	292	77.20	31.20
3	4874.00	52.8 PK	74.0	-21.2	1.05 H	10	47.80	5.00
4	4874.00	48.7 AV	54.0	-5.3	1.05 H	10	43.70	5.00
ANTENNA POLARITY & TEST DISTANCE: VERTICAL AT 3 M								
NO.	FREQ. (MHz)	EMISSION LEVEL (dBuV/m)	LIMIT (dBuV/m)	MARGIN (dB)	ANTENNA HEIGHT (m)	TABLE ANGLE (Degree)	RAW VALUE (dBuV)	CORRECTION FACTOR (dB/m)
1	*2437.00	107.6 PK			1.14 V	339	76.40	31.20
2	*2437.00	103.9 AV			1.14 V	339	72.70	31.20
3	4874.00	53.7 PK	74.0	-20.3	1.12 V	26	48.70	5.00
4	4874.00	50.2 AV	54.0	-3.8	1.12 V	26	45.20	5.00

REMARKS:

1. Emission Level(dBuV/m) = Raw Value(dBuV) + Correction Factor(dB/m)
2. Correction Factor(dB/m) = Antenna Factor(dB/m) + Cable Factor(dB) – Pre-Amplifier Factor(dB)
3. The other emission levels were very low against the limit.
4. Margin value = Emission Level – Limit value
5. “ * “: Fundamental frequency.



A D T

EUT TEST CONDITION		MEASUREMENT DETAIL	
CHANNEL	Channel 11	FREQUENCY RANGE	1 ~ 25GHz
INPUT POWER	120Vac, 60Hz	DETECTOR FUNCTION	Peak (PK) Average (AV)
ENVIRONMENTAL CONDITIONS	25deg. C, 65%RH	TESTED BY	Chris Lin

ANTENNA POLARITY & TEST DISTANCE: HORIZONTAL AT 3 M								
NO.	FREQ. (MHz)	EMISSION LEVEL (dBuV/m)	LIMIT (dBuV/m)	MARGIN (dB)	ANTENNA HEIGHT (m)	TABLE ANGLE (Degree)	RAW VALUE (dBuV)	CORRECTION FACTOR (dB/m)
1	*2462.00	110.7 PK			1.00 H	293	79.40	31.30
2	*2462.00	107.0 AV			1.00 H	293	75.70	31.30
3	2483.50	69.0 PK	74.0	-5.0	1.01 H	315	37.60	31.40
4	2483.50	49.0 AV	54.0	-5.0	1.01 H	315	17.60	31.40
5	4924.00	51.9 PK	74.0	-22.1	1.01 H	59	46.70	5.20
6	4924.00	48.7 AV	54.0	-5.3	1.01 H	59	43.50	5.20
ANTENNA POLARITY & TEST DISTANCE: VERTICAL AT 3 M								
NO.	FREQ. (MHz)	EMISSION LEVEL (dBuV/m)	LIMIT (dBuV/m)	MARGIN (dB)	ANTENNA HEIGHT (m)	TABLE ANGLE (Degree)	RAW VALUE (dBuV)	CORRECTION FACTOR (dB/m)
1	*2462.00	109.0 PK			1.14 V	335	77.70	31.30
2	*2462.00	105.1 AV			1.14 V	335	73.80	31.30
3	2483.50	71.6 PK	74.0	-2.4	1.20 V	340	40.20	31.40
4	2483.50	49.7 AV	54.0	-4.3	1.20 V	340	18.30	31.40
5	4924.00	55.2 PK	74.0	-18.8	1.01 V	13	50.00	5.20
6	4924.00	52.7 AV	54.0	-1.3	1.01 V	13	47.50	5.20

REMARKS:

1. Emission Level(dBuV/m) = Raw Value(dBuV) + Correction Factor(dB/m)
2. Correction Factor(dB/m) = Antenna Factor(dB/m) + Cable Factor(dB)
– Pre-Amplifier Factor(dB)
3. The other emission levels were very low against the limit.
4. Margin value = Emission Level – Limit value
5. “ * “: Fundamental frequency.



A D T

802.11g

EUT TEST CONDITION		MEASUREMENT DETAIL	
CHANNEL	Channel 1	FREQUENCY RANGE	1 ~ 25GHz
INPUT POWER	120Vac, 60Hz	DETECTOR FUNCTION	Peak (PK) Average (AV)
ENVIRONMENTAL CONDITIONS	25deg. C, 65%RH	TESTED BY	Chris Lin

ANTENNA POLARITY & TEST DISTANCE: HORIZONTAL AT 3 M								
NO.	FREQ. (MHz)	EMISSION LEVEL (dBuV/m)	LIMIT (dBuV/m)	MARGIN (dB)	ANTENNA HEIGHT (m)	TABLE ANGLE (Degree)	RAW VALUE (dBuV)	CORRECTION FACTOR (dB/m)
1	2390.00	70.4 PK	74.0	-3.6	1.25 H	292	39.40	31.00
2	2390.00	52.2 AV	54.0	-1.8	1.25 H	292	21.20	31.00
3	*2412.00	111.3 PK			1.25 H	296	80.20	31.10
4	*2412.00	101.8 AV			1.25 H	296	70.70	31.10
5	4824.00	55.1 PK	74.0	-18.9	1.19 H	25	50.20	4.90
6	4824.00	37.0 AV	54.0	-17.0	1.19 H	25	32.10	4.90
ANTENNA POLARITY & TEST DISTANCE: VERTICAL AT 3 M								
NO.	FREQ. (MHz)	EMISSION LEVEL (dBuV/m)	LIMIT (dBuV/m)	MARGIN (dB)	ANTENNA HEIGHT (m)	TABLE ANGLE (Degree)	RAW VALUE (dBuV)	CORRECTION FACTOR (dB/m)
1	2390.00	68.9 PK	74.0	-5.1	1.43 V	7	37.90	31.00
2	2390.00	52.1 AV	54.0	-1.9	1.43 V	7	21.10	31.00
3	*2412.00	110.1 PK			1.44 V	0	79.00	31.10
4	*2412.00	100.2 AV			1.44 V	0	69.10	31.10
5	4824.00	57.9 PK	74.0	-16.1	1.03 V	354	53.00	4.90
6	4824.00	39.4 AV	54.0	-14.6	1.03 V	354	34.50	4.90

REMARKS:

1. Emission Level(dBuV/m) = Raw Value(dBuV) + Correction Factor(dB/m)
2. Correction Factor(dB/m) = Antenna Factor(dB/m) + Cable Factor(dB)
– Pre-Amplifier Factor(dB)
3. The other emission levels were very low against the limit.
4. Margin value = Emission Level – Limit value
5. “ * “: Fundamental frequency.



A D T

EUT TEST CONDITION		MEASUREMENT DETAIL	
CHANNEL	Channel 6	FREQUENCY RANGE	1 ~ 25GHz
INPUT POWER	120Vac, 60Hz	DETECTOR FUNCTION	Peak (PK) Average (AV)
ENVIRONMENTAL CONDITIONS	25deg. C, 65%RH	TESTED BY	Chris Lin

ANTENNA POLARITY & TEST DISTANCE: HORIZONTAL AT 3 M								
NO.	FREQ. (MHz)	EMISSION LEVEL (dBuV/m)	LIMIT (dBuV/m)	MARGIN (dB)	ANTENNA HEIGHT (m)	TABLE ANGLE (Degree)	RAW VALUE (dBuV)	CORRECTION FACTOR (dB/m)
1	*2437.00	113.8 PK			1.20 H	290	82.60	31.20
2	*2437.00	103.7 AV			1.20 H	290	72.50	31.20
3	4874.00	60.3 PK	74.0	-13.7	1.19 H	18	55.30	5.00
4	4874.00	41.4 AV	54.0	-12.6	1.19 H	18	36.40	5.00
ANTENNA POLARITY & TEST DISTANCE: VERTICAL AT 3 M								
NO.	FREQ. (MHz)	EMISSION LEVEL (dBuV/m)	LIMIT (dBuV/m)	MARGIN (dB)	ANTENNA HEIGHT (m)	TABLE ANGLE (Degree)	RAW VALUE (dBuV)	CORRECTION FACTOR (dB/m)
1	*2437.00	113.9 PK			1.15 V	7	82.70	31.20
2	*2437.00	103.4 AV			1.15 V	7	72.20	31.20
3	4874.00	62.1 PK	74.0	-11.9	1.14 V	357	57.10	5.00
4	4874.00	44.8 AV	54.0	-9.2	1.14 V	357	39.80	5.00

REMARKS:

1. Emission Level(dBuV/m) = Raw Value(dBuV) + Correction Factor(dB/m)
2. Correction Factor(dB/m) = Antenna Factor(dB/m) + Cable Factor(dB) – Pre-Amplifier Factor(dB)
3. The other emission levels were very low against the limit.
4. Margin value = Emission Level – Limit value
5. “ * “: Fundamental frequency.



A D T

EUT TEST CONDITION		MEASUREMENT DETAIL	
CHANNEL	Channel 11	FREQUENCY RANGE	1 ~ 25GHz
INPUT POWER	120Vac, 60Hz	DETECTOR FUNCTION	Peak (PK) Average (AV)
ENVIRONMENTAL CONDITIONS	25deg. C, 65%RH	TESTED BY	Chris Lin

ANTENNA POLARITY & TEST DISTANCE: HORIZONTAL AT 3 M								
NO.	FREQ. (MHz)	EMISSION LEVEL (dBuV/m)	LIMIT (dBuV/m)	MARGIN (dB)	ANTENNA HEIGHT (m)	TABLE ANGLE (Degree)	RAW VALUE (dBuV)	CORRECTION FACTOR (dB/m)
1	*2462.00	111.5 PK			1.00 H	304	80.20	31.30
2	*2462.00	102.0 AV			1.00 H	304	70.70	31.30
3	2483.50	71.5 PK	74.0	-2.5	1.01 H	18	40.10	31.40
4	2483.50	52.5 AV	54.0	-1.5	1.01 H	18	21.10	31.40
5	4924.00	56.4 PK	74.0	-17.6	1.32 H	14	51.20	5.20
6	4924.00	40.1 AV	54.0	-13.9	1.32 H	14	34.90	5.20
ANTENNA POLARITY & TEST DISTANCE: VERTICAL AT 3 M								
NO.	FREQ. (MHz)	EMISSION LEVEL (dBuV/m)	LIMIT (dBuV/m)	MARGIN (dB)	ANTENNA HEIGHT (m)	TABLE ANGLE (Degree)	RAW VALUE (dBuV)	CORRECTION FACTOR (dB/m)
1	*2462.00	111.0 PK			1.41 V	1	79.70	31.30
2	*2462.00	101.1 AV			1.41 V	1	69.80	31.30
3	2483.50	72.6 PK	74.0	-1.4	1.12 V	342	41.20	31.40
4	2483.50	52.2 AV	54.0	-1.8	1.12 V	342	20.80	31.40
5	4924.00	60.3 PK	74.0	-13.7	1.03 V	354	55.10	5.20
6	4924.00	42.8 AV	54.0	-11.2	1.03 V	354	37.60	5.20

REMARKS:

1. Emission Level(dBuV/m) = Raw Value(dBuV) + Correction Factor(dB/m)
2. Correction Factor(dB/m) = Antenna Factor(dB/m) + Cable Factor(dB)
– Pre-Amplifier Factor(dB)
3. The other emission levels were very low against the limit.
4. Margin value = Emission Level – Limit value
5. “ * ”: Fundamental frequency.



A D T

802.11n (20MHz)

EUT TEST CONDITION		MEASUREMENT DETAIL	
CHANNEL	Channel 1	FREQUENCY RANGE	1 ~ 25GHz
INPUT POWER	120Vac, 60Hz	DETECTOR FUNCTION	Peak (PK) Average (AV)
ENVIRONMENTAL CONDITIONS	25deg. C, 65%RH	TESTED BY	Chris Lin

ANTENNA POLARITY & TEST DISTANCE: HORIZONTAL AT 3 M								
NO.	FREQ. (MHz)	EMISSION LEVEL (dBuV/m)	LIMIT (dBuV/m)	MARGIN (dB)	ANTENNA HEIGHT (m)	TABLE ANGLE (Degree)	RAW VALUE (dBuV)	CORRECTION FACTOR (dB/m)
1	2390.00	72.5 PK	74.0	-1.5	1.30 H	311	41.50	31.00
2	2390.00	51.8 AV	54.0	-2.2	1.30 H	311	20.80	31.00
3	*2412.00	109.4 PK			1.23 H	294	78.30	31.10
4	*2412.00	99.7 AV			1.23 H	294	68.60	31.10
5	4824.00	50.7 PK	74.0	-23.3	1.48 H	24	45.80	4.90
6	4824.00	35.0 AV	54.0	-19.0	1.48 H	24	30.10	4.90
ANTENNA POLARITY & TEST DISTANCE: VERTICAL AT 3 M								
NO.	FREQ. (MHz)	EMISSION LEVEL (dBuV/m)	LIMIT (dBuV/m)	MARGIN (dB)	ANTENNA HEIGHT (m)	TABLE ANGLE (Degree)	RAW VALUE (dBuV)	CORRECTION FACTOR (dB/m)
1	2390.00	64.2 PK	74.0	-9.8	1.43 V	7	33.20	31.00
2	2390.00	50.9 AV	54.0	-3.1	1.43 V	7	19.90	31.00
3	*2412.00	108.7 PK			1.40 V	1	77.60	31.10
4	*2412.00	98.8 AV			1.40 V	1	67.70	31.10
5	4824.00	51.9 PK	74.0	-22.1	1.30 V	346	47.00	4.90
6	4824.00	35.0 AV	54.0	-19.0	1.30 V	346	30.10	4.90

REMARKS:

1. Emission Level(dBuV/m) = Raw Value(dBuV) + Correction Factor(dB/m)
2. Correction Factor(dB/m) = Antenna Factor(dB/m) + Cable Factor(dB)
– Pre-Amplifier Factor(dB)
3. The other emission levels were very low against the limit.
4. Margin value = Emission Level – Limit value
5. “ * “: Fundamental frequency.



A D T

EUT TEST CONDITION		MEASUREMENT DETAIL	
CHANNEL	Channel 6	FREQUENCY RANGE	1 ~ 25GHz
INPUT POWER	120Vac, 60Hz	DETECTOR FUNCTION	Peak (PK) Average (AV)
ENVIRONMENTAL CONDITIONS	25deg. C, 65%RH	TESTED BY	Chris Lin

ANTENNA POLARITY & TEST DISTANCE: HORIZONTAL AT 3 M								
NO.	FREQ. (MHz)	EMISSION LEVEL (dBuV/m)	LIMIT (dBuV/m)	MARGIN (dB)	ANTENNA HEIGHT (m)	TABLE ANGLE (Degree)	RAW VALUE (dBuV)	CORRECTION FACTOR (dB/m)
1	*2437.00	112.4 PK			1.23 H	292	81.20	31.20
2	*2437.00	102.7 AV			1.23 H	292	71.50	31.20
3	4874.00	59.6 PK	74.0	-14.4	1.19 H	19	54.60	5.00
4	4874.00	40.7 AV	54.0	-13.3	1.19 H	19	35.70	5.00
ANTENNA POLARITY & TEST DISTANCE: VERTICAL AT 3 M								
NO.	FREQ. (MHz)	EMISSION LEVEL (dBuV/m)	LIMIT (dBuV/m)	MARGIN (dB)	ANTENNA HEIGHT (m)	TABLE ANGLE (Degree)	RAW VALUE (dBuV)	CORRECTION FACTOR (dB/m)
1	*2437.00	112.7 PK			1.17 V	1	81.50	31.20
2	*2437.00	102.9 AV			1.17 V	1	71.70	31.20
3	4874.00	60.0 PK	74.0	-14.0	1.13 V	18	55.00	5.00
4	4874.00	41.8 AV	54.0	-12.2	1.13 V	18	36.80	5.00

REMARKS:

1. Emission Level(dBuV/m) = Raw Value(dBuV) + Correction Factor(dB/m)
2. Correction Factor(dB/m) = Antenna Factor(dB/m) + Cable Factor(dB)
– Pre-Amplifier Factor(dB)
3. The other emission levels were very low against the limit.
4. Margin value = Emission Level – Limit value
5. “ * “: Fundamental frequency.



A D T

EUT TEST CONDITION		MEASUREMENT DETAIL	
CHANNEL	Channel 11	FREQUENCY RANGE	1 ~ 25GHz
INPUT POWER	120Vac, 60Hz	DETECTOR FUNCTION	Peak (PK) Average (AV)
ENVIRONMENTAL CONDITIONS	25deg. C, 65%RH	TESTED BY	Chris Lin

ANTENNA POLARITY & TEST DISTANCE: HORIZONTAL AT 3 M								
NO.	FREQ. (MHz)	EMISSION LEVEL (dBuV/m)	LIMIT (dBuV/m)	MARGIN (dB)	ANTENNA HEIGHT (m)	TABLE ANGLE (Degree)	RAW VALUE (dBuV)	CORRECTION FACTOR (dB/m)
1	*2462.00	110.1 PK			1.20 H	289	78.80	31.30
2	*2462.00	100.4 AV			1.20 H	289	69.10	31.30
3	2483.50	72.9 PK	74.0	-1.1	1.00 H	21	41.50	31.40
4	2483.50	49.8 AV	54.0	-4.2	1.00 H	21	18.40	31.40
5	4924.00	49.8 PK	74.0	-24.2	1.18 H	15	44.60	5.20
6	4924.00	35.6 AV	54.0	-18.4	1.18 H	15	30.40	5.20
ANTENNA POLARITY & TEST DISTANCE: VERTICAL AT 3 M								
NO.	FREQ. (MHz)	EMISSION LEVEL (dBuV/m)	LIMIT (dBuV/m)	MARGIN (dB)	ANTENNA HEIGHT (m)	TABLE ANGLE (Degree)	RAW VALUE (dBuV)	CORRECTION FACTOR (dB/m)
1	*2462.00	108.5 PK			1.69 V	0	77.20	31.30
2	*2462.00	98.4 AV			1.69 V	0	67.10	31.30
3	2483.50	69.6 PK	74.0	-4.4	1.70 V	20	38.20	31.40
4	2483.50	49.7 AV	54.0	-4.3	1.70 V	20	18.30	31.40
5	4924.00	53.8 PK	74.0	-20.2	1.13 V	15	48.60	5.20
6	4924.00	36.8 AV	54.0	-17.2	1.13 V	15	31.60	5.20

REMARKS:

1. Emission Level(dBuV/m) = Raw Value(dBuV) + Correction Factor(dB/m)
2. Correction Factor(dB/m) = Antenna Factor(dB/m) + Cable Factor(dB)
– Pre-Amplifier Factor(dB)
3. The other emission levels were very low against the limit.
4. Margin value = Emission Level – Limit value
5. “ * “: Fundamental frequency.



A D T

802.11n (40MHz)

EUT TEST CONDITION		MEASUREMENT DETAIL	
CHANNEL	Channel 3	FREQUENCY RANGE	1 ~ 25GHz
INPUT POWER	120Vac, 60Hz	DETECTOR FUNCTION	Peak (PK) Average (AV)
ENVIRONMENTAL CONDITIONS	25deg. C, 65%RH	TESTED BY	Chris Lin

ANTENNA POLARITY & TEST DISTANCE: HORIZONTAL AT 3 M								
NO.	FREQ. (MHz)	EMISSION LEVEL (dBuV/m)	LIMIT (dBuV/m)	MARGIN (dB)	ANTENNA HEIGHT (m)	TABLE ANGLE (Degree)	RAW VALUE (dBuV)	CORRECTION FACTOR (dB/m)
1	2390.00	72.8 PK	74.0	-1.2	1.23 H	294	41.80	31.00
2	2390.00	52.1 AV	54.0	-1.9	1.23 H	294	21.10	31.00
3	*2422.00	105.2 PK			1.23 H	292	74.00	31.20
4	*2422.00	94.6 AV			1.23 H	292	63.40	31.20
5	4844.00	48.0 PK	74.0	-26.0	1.05 H	99	43.00	5.00
6	4844.00	35.4 AV	54.0	-18.6	1.05 H	99	30.40	5.00

ANTENNA POLARITY & TEST DISTANCE: VERTICAL AT 3 M								
NO.	FREQ. (MHz)	EMISSION LEVEL (dBuV/m)	LIMIT (dBuV/m)	MARGIN (dB)	ANTENNA HEIGHT (m)	TABLE ANGLE (Degree)	RAW VALUE (dBuV)	CORRECTION FACTOR (dB/m)
1	2390.00	70.4 PK	74.0	-3.6	1.16 V	5	39.40	31.00
2	2390.00	51.6 AV	54.0	-2.4	1.16 V	5	20.60	31.00
3	*2422.00	104.0 PK			1.16 V	358	72.80	31.20
4	*2422.00	94.4 AV			1.16 V	358	63.20	31.20
5	4844.00	47.0 PK	74.0	-27.0	1.14 V	136	42.00	5.00
6	4844.00	34.0 AV	54.0	-20.0	1.14 V	136	29.00	5.00

REMARKS:

1. Emission Level(dBuV/m) = Raw Value(dBuV) + Correction Factor(dB/m)
2. Correction Factor(dB/m) = Antenna Factor(dB/m) + Cable Factor(dB)
– Pre-Amplifier Factor(dB)
3. The other emission levels were very low against the limit.
4. Margin value = Emission Level – Limit value
5. “ * “: Fundamental frequency.



A D T

EUT TEST CONDITION		MEASUREMENT DETAIL	
CHANNEL	Channel 6	FREQUENCY RANGE	1 ~ 25GHz
INPUT POWER	120Vac, 60Hz	DETECTOR FUNCTION	Peak (PK) Average (AV)
ENVIRONMENTAL CONDITIONS	25deg. C, 65%RH	TESTED BY	Chris Lin

ANTENNA POLARITY & TEST DISTANCE: HORIZONTAL AT 3 M								
NO.	FREQ. (MHz)	EMISSION LEVEL (dBuV/m)	LIMIT (dBuV/m)	MARGIN (dB)	ANTENNA HEIGHT (m)	TABLE ANGLE (Degree)	RAW VALUE (dBuV)	CORRECTION FACTOR (dB/m)
1	2390.00	71.1 PK	74.0	-2.9	1.25 H	294	40.10	31.00
2	2390.00	52.9 AV	54.0	-1.1	1.25 H	294	21.90	31.00
3	*2437.00	107.8 PK			1.25 H	298	76.60	31.20
4	*2437.00	97.7 AV			1.25 H	298	66.50	31.20
5	4874.00	54.4 PK	74.0	-19.6	1.06 H	17	49.40	5.00
6	4874.00	36.8 AV	54.0	-17.2	1.06 H	17	31.80	5.00
ANTENNA POLARITY & TEST DISTANCE: VERTICAL AT 3 M								
NO.	FREQ. (MHz)	EMISSION LEVEL (dBuV/m)	LIMIT (dBuV/m)	MARGIN (dB)	ANTENNA HEIGHT (m)	TABLE ANGLE (Degree)	RAW VALUE (dBuV)	CORRECTION FACTOR (dB/m)
1	2390.00	69.6 PK	74.0	-4.4	1.16 V	0	38.60	31.00
2	2390.00	52.7 AV	54.0	-1.3	1.16 V	0	21.70	31.00
3	*2437.00	106.9 PK			1.16 V	4	75.70	31.20
4	*2437.00	96.3 AV			1.16 V	4	65.10	31.20
5	4874.00	56.5 PK	74.0	-17.5	1.13 V	25	51.50	5.00
6	4874.00	36.7 AV	54.0	-17.3	1.13 V	25	31.70	5.00

REMARKS:

1. Emission Level(dBuV/m) = Raw Value(dBuV) + Correction Factor(dB/m)
2. Correction Factor(dB/m) = Antenna Factor(dB/m) + Cable Factor(dB)
– Pre-Amplifier Factor(dB)
3. The other emission levels were very low against the limit.
4. Margin value = Emission Level – Limit value
5. “ * “: Fundamental frequency.



A D T

EUT TEST CONDITION		MEASUREMENT DETAIL	
CHANNEL	Channel 9	FREQUENCY RANGE	1 ~ 25GHz
INPUT POWER	120Vac, 60Hz	DETECTOR FUNCTION	Peak (PK) Average (AV)
ENVIRONMENTAL CONDITIONS	25deg. C, 65%RH	TESTED BY	Chris Lin

ANTENNA POLARITY & TEST DISTANCE: HORIZONTAL AT 3 M								
NO.	FREQ. (MHz)	EMISSION LEVEL (dBuV/m)	LIMIT (dBuV/m)	MARGIN (dB)	ANTENNA HEIGHT (m)	TABLE ANGLE (Degree)	RAW VALUE (dBuV)	CORRECTION FACTOR (dB/m)
1	*2452.00	104.2 PK			1.00 H	303	72.90	31.30
2	*2452.00	94.8 AV			1.00 H	303	63.50	31.30
3	2483.50	72.6 PK	74.0	-1.4	1.18 H	290	41.20	31.40
4	2483.50	51.9 AV	54.0	-2.1	1.18 H	290	20.50	31.40
5	4904.00	47.8 PK	74.0	-26.3	1.15 H	230	42.70	5.10
6	4904.00	35.5 AV	54.0	-18.5	1.15 H	230	30.40	5.10
ANTENNA POLARITY & TEST DISTANCE: VERTICAL AT 3 M								
NO.	FREQ. (MHz)	EMISSION LEVEL (dBuV/m)	LIMIT (dBuV/m)	MARGIN (dB)	ANTENNA HEIGHT (m)	TABLE ANGLE (Degree)	RAW VALUE (dBuV)	CORRECTION FACTOR (dB/m)
1	*2452.00	104.9 PK			1.14 V	0	73.60	31.30
2	*2452.00	93.9 AV			1.14 V	0	62.60	31.30
3	2483.50	72.6 PK	74.0	-1.4	1.12 V	10	41.20	31.40
4	2483.50	51.5 AV	54.0	-2.5	1.12 V	10	20.10	31.40
5	4904.00	46.7 PK	74.0	-27.3	1.14 V	57	41.60	5.10
6	4904.00	34.1 AV	54.0	-19.9	1.14 V	57	29.00	5.10

REMARKS:

1. Emission Level(dBuV/m) = Raw Value(dBuV) + Correction Factor(dB/m)
2. Correction Factor(dB/m) = Antenna Factor(dB/m) + Cable Factor(dB)
– Pre-Amplifier Factor(dB)
3. The other emission levels were very low against the limit.
4. Margin value = Emission Level – Limit value
5. “ * “: Fundamental frequency.



A D T

BELOW 1GHz WORST-CASE DATA : 802.11g

EUT TEST CONDITION		MEASUREMENT DETAIL	
CHANNEL	Channel 6	FREQUENCY RANGE	Below 1000MHz
INPUT POWER	120Vac, 60Hz	DETECTOR FUNCTION	Quasi-Peak
ENVIRONMENTAL CONDITIONS	25deg. C, 65%RH	TESTED BY	Chris Lin
TEST MODE	A		

ANTENNA POLARITY & TEST DISTANCE: HORIZONTAL AT 3 M

NO.	FREQ. (MHz)	EMISSION LEVEL (dBuV/m)	LIMIT (dBuV/m)	MARGIN (dB)	ANTENNA HEIGHT (m)	TABLE ANGLE (Degree)	RAW VALUE (dBuV)	CORRECTION FACTOR (dB/m)
1	57.07	25.6 QP	40.0	-14.4	1.25 H	316	40.50	-14.90
2	115.28	27.7 QP	43.5	-15.8	1.00 H	291	44.50	-16.80
3	243.34	35.1 QP	46.0	-10.9	1.50 H	232	49.60	-14.50
4	286.03	33.5 QP	46.0	-12.5	1.25 H	169	46.30	-12.80
5	375.29	29.6 QP	46.0	-16.4	1.00 H	92	40.50	-10.90
6	625.60	30.9 QP	46.0	-15.1	1.50 H	166	36.40	-5.50

ANTENNA POLARITY & TEST DISTANCE: VERTICAL AT 3 M

NO.	FREQ. (MHz)	EMISSION LEVEL (dBuV/m)	LIMIT (dBuV/m)	MARGIN (dB)	ANTENNA HEIGHT (m)	TABLE ANGLE (Degree)	RAW VALUE (dBuV)	CORRECTION FACTOR (dB/m)
1	55.13	35.6 QP	40.0	-4.4	1.25 V	12	49.90	-14.30
2	115.28	32.7 QP	43.5	-10.8	1.00 V	209	49.50	-16.80
3	243.34	34.1 QP	46.0	-11.9	1.50 V	160	48.60	-14.50
4	499.48	34.1 QP	46.0	-11.9	1.00 V	197	42.40	-8.30
5	625.60	31.4 QP	46.0	-14.6	1.25 V	163	36.90	-5.50
6	901.14	32.3 QP	46.0	-13.7	1.50 V	170	32.60	-0.30

REMARKS:

1. Emission Level(dBuV/m) = Raw Value(dBuV) + Correction Factor(dB/m)
2. Correction Factor(dB/m) = Antenna Factor(dB/m) + Cable Factor(dB) – Pre-Amplifier Factor (dB)
3. The other emission levels were very low against the limit.
4. Margin value = Emission Level – Limit value



A D T

EUT TEST CONDITION		MEASUREMENT DETAIL	
CHANNEL	Channel 6	FREQUENCY RANGE	Below 1000MHz
INPUT POWER	120Vac, 60Hz	DETECTOR FUNCTION	Quasi-Peak
ENVIRONMENTAL CONDITIONS	25deg. C, 65%RH	TESTED BY	Chris Lin
TEST MODE	B		

ANTENNA POLARITY & TEST DISTANCE: HORIZONTAL AT 3 M								
NO.	FREQ. (MHz)	EMISSION LEVEL (dBuV/m)	LIMIT (dBuV/m)	MARGIN (dB)	ANTENNA HEIGHT (m)	TABLE ANGLE (Degree)	RAW VALUE (dBuV)	CORRECTION FACTOR (dB/m)
1	212.66	29.1 QP	43.5	-14.4	1.25 H	197	45.40	-16.30
2	249.60	30.4 QP	46.0	-15.6	1.00 H	213	44.60	-14.20
3	374.04	32.7 QP	46.0	-13.3	1.50 H	174	43.60	-10.90
4	624.85	36.5 QP	46.0	-9.5	1.25 H	180	42.00	-5.50
5	751.23	32.6 QP	46.0	-13.4	1.00 H	44	35.60	-3.00
6	875.67	37.1 QP	46.0	-8.9	1.50 H	18	38.10	-1.00
ANTENNA POLARITY & TEST DISTANCE: VERTICAL AT 3 M								
NO.	FREQ. (MHz)	EMISSION LEVEL (dBuV/m)	LIMIT (dBuV/m)	MARGIN (dB)	ANTENNA HEIGHT (m)	TABLE ANGLE (Degree)	RAW VALUE (dBuV)	CORRECTION FACTOR (dB/m)
1	80.45	32.0 QP	40.0	-8.0	1.25 V	125	50.40	-18.40
2	166.00	26.6 QP	43.5	-16.9	1.00 V	249	41.00	-14.40
3	374.04	27.5 QP	46.0	-18.5	1.50 V	170	38.40	-10.90
4	500.42	29.0 QP	46.0	-17.0	1.00 V	86	37.30	-8.30
5	624.85	34.8 QP	46.0	-11.2	1.25 V	187	40.30	-5.50
6	875.67	33.3 QP	46.0	-12.7	1.50 V	136	34.30	-1.00

REMARKS:

1. Emission Level(dBuV/m) = Raw Value(dBuV) + Correction Factor(dB/m)
2. Correction Factor(dB/m) = Antenna Factor(dB/m) + Cable Factor(dB) – Pre-Amplifier Factor (dB)
3. The other emission levels were very low against the limit.
4. Margin value = Emission Level – Limit value



4.2 CONDUCTED EMISSION MEASUREMENT

4.2.1 LIMITS OF CONDUCTED EMISSION MEASUREMENT

FREQUENCY OF EMISSION (MHz)	CONDUCTED LIMIT (dBµV)	
	Quasi-peak	Average
0.15 ~ 0.5	66 to 56	56 to 46
0.5 ~ 5	56	46
5 ~ 30	60	50

- NOTE:**
1. The lower limit shall apply at the transition frequencies.
 2. The limit decreases in line with the logarithm of the frequency in the range of 0.15 to 0.50MHz.
 3. All emanations from a class A/B digital device or system, including any network of conductors and apparatus connected thereto, shall not exceed the level of field strengths specified above.

4.2.2 TEST INSTRUMENTS

DESCRIPTION & MANUFACTURER	MODEL NO.	SERIAL NO.	DATE OF CALIBRATION	DUE DATE OF CALIBRATION
Test Receiver ROHDE & SCHWARZ	ESCS30	100289	Nov. 29, 2013	Nov. 28, 2014
RF signal cable Woken	5D-FB	Cable-HYC01-01	Dec. 27, 2013	Dec. 26, 2014
LISN ROHDE & SCHWARZ (Peripheral)	ESH3-Z5	100311	Jul. 17, 2013	Jul. 16, 2014
LISN ROHDE & SCHWARZ (EUT)	ESH3-Z5	835239/001	Feb. 04, 2013	Feb. 03, 2014
Software ADT	BV ADT_Cond_ V7.3.7.3	NA	NA	NA

- NOTE:**
1. The calibration interval of the above test instruments is 12 months and the calibrations are traceable to NML/ROC and NIST/USA.
 2. The test was performed in HwaYa Shielded Room 1.
 3. The VCCI Site Registration No. is C-2040.

4.2.3 TEST PROCEDURES

- a. The EUT was placed 0.4 meters from the conducting wall of the shielded room with EUT being connected to the power mains through a line impedance stabilization network (LISN). Other support units were connected to the power mains through another LISN. The two LISNs provide 50 ohm/ 50uH of coupling impedance for the measuring instrument.
- b. Both lines of the power mains connected to the EUT were checked for maximum conducted interference.
- c. The frequency range from 150kHz to 30MHz was searched. Emission levels under (Limit - 20dB) was not recorded.

NOTE: All modes of operation were investigated and the worst-case emissions are reported.

4.2.4 DEVIATION FROM TEST STANDARD

No deviation.

4.2.5 TEST SETUP

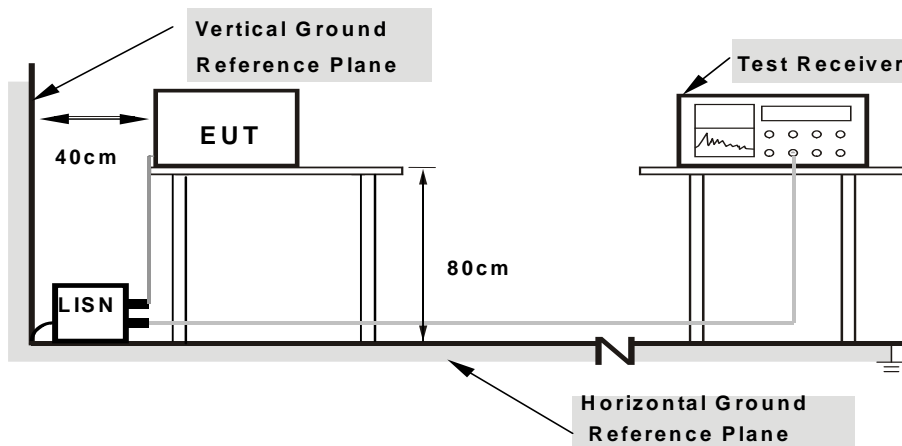

- Note:**
1. Support units were connected to second LISN.
 2. Both of LISNs (AMN) are 80 cm from EUT and at least 80 cm from other units and other metal planes

For the actual test configuration, please refer to the attached file (Test Setup Photo).

4.2.6 EUT OPERATING CONDITIONS

Same as 4.1.6.

4.2.7 TEST RESULTS

CONDUCTED WORST-CASE DATA : 802.11g

PHASE	Line 1	6dB BANDWIDTH	9kHz
TEST MODE	A		

No	Freq. [MHz]	Corr. Factor (dB)	Reading Value		Emission Level		Limit		Margin	
			[dB (uV)]		[dB (uV)]		[dB (uV)]		(dB)	
			Q.P.	AV.	Q.P.	AV.	Q.P.	AV.	Q.P.	AV.
1	0.17744	0.10	48.64	35.84	48.74	35.94	64.60	54.60	-15.86	-18.66
2	0.32959	0.11	46.22	35.43	46.33	35.54	59.46	49.46	-13.13	-13.92
3	0.36913	0.12	51.06	46.14	51.18	46.26	58.52	48.52	-7.34	-2.26
4	0.83816	0.13	42.07	33.96	42.20	34.09	56.00	46.00	-13.80	-11.91
5	1.49895	0.15	41.75	34.79	41.90	34.94	56.00	46.00	-14.10	-11.06
6	3.32101	0.21	40.48	33.80	40.69	34.01	56.00	46.00	-15.31	-11.99

REMARKS:

1. Q.P. and AV. are abbreviations of quasi-peak and average individually.
2. The emission levels of other frequencies were very low against the limit.
3. Margin value = Emission level - Limit value
4. Correction factor = Insertion loss + Cable loss
5. Emission Level = Correction Factor + Reading Value

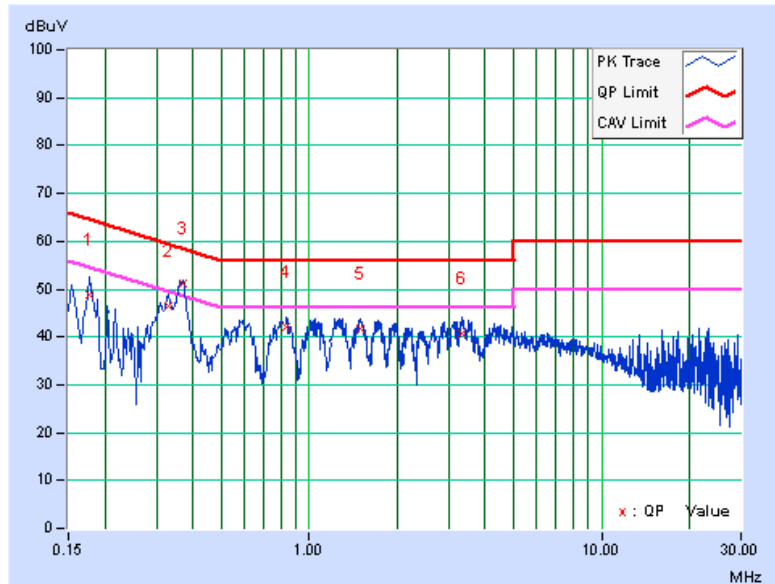

PHASE	Line 2	6dB BANDWIDTH	9kHz
TEST MODE	A		

No	Freq. [MHz]	Corr. Factor (dB)	Reading Value		Emission Level		Limit		Margin	
			[dB (uV)]		[dB (uV)]		[dB (uV)]		(dB)	
			Q.P.	AV.	Q.P.	AV.	Q.P.	AV.	Q.P.	AV.
1	0.15000	0.11	53.00	38.41	53.11	38.52	66.00	56.00	-12.89	-17.48
2	0.17737	0.11	47.77	31.45	47.88	31.56	64.61	54.61	-16.73	-23.05
3	0.32986	0.12	41.17	26.32	41.29	26.44	59.45	49.45	-18.16	-23.01
4	0.37287	0.13	44.70	32.47	44.83	32.60	58.44	48.44	-13.61	-15.84
5	0.58401	0.13	37.12	25.17	37.25	25.30	56.00	46.00	-18.75	-20.70
6	1.25653	0.15	35.83	23.45	35.98	23.60	56.00	46.00	-20.02	-22.40

REMARKS:

1. Q.P. and AV. are abbreviations of quasi-peak and average individually.
2. The emission levels of other frequencies were very low against the limit.
3. Margin value = Emission level - Limit value
4. Correction factor = Insertion loss + Cable loss
5. Emission Level = Correction Factor + Reading Value

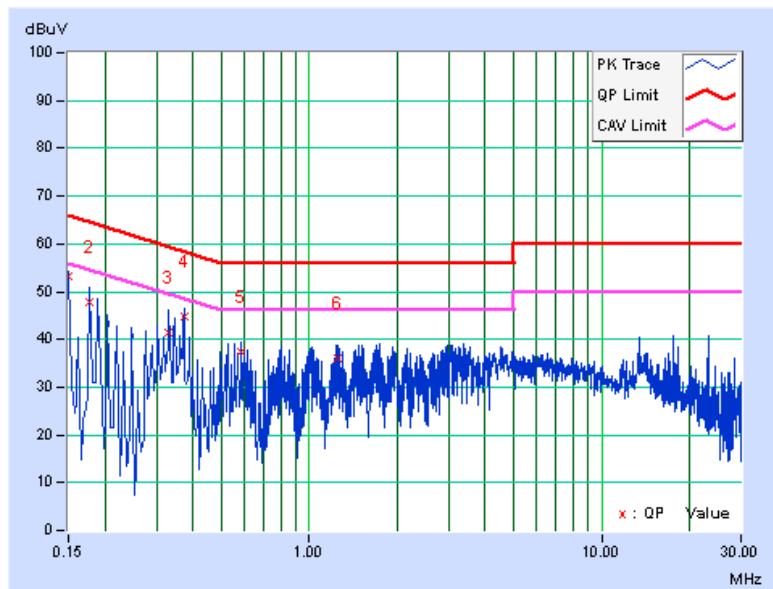

PHASE	Line 1	6dB BANDWIDTH	9kHz
TEST MODE	B		

No	Freq. [MHz]	Corr. Factor (dB)	Reading Value		Emission Level		Limit		Margin	
			[dB (uV)]		[dB (uV)]		[dB (uV)]		(dB)	
			Q.P.	AV.	Q.P.	AV.	Q.P.	AV.	Q.P.	AV.
1	0.15000	0.10	54.45	38.06	54.55	38.16	66.00	56.00	-11.45	-17.84
2	0.17744	0.10	51.72	36.83	51.82	36.93	64.60	54.60	-12.78	-17.67
3	0.47453	0.12	46.96	39.21	47.08	39.33	56.43	46.43	-9.35	-7.10
4	2.62894	0.19	40.81	35.35	41.00	35.54	56.00	46.00	-15.00	-10.46
5	4.39235	0.25	40.15	34.10	40.40	34.35	56.00	46.00	-15.60	-11.65
6	10.17133	0.50	40.14	34.27	40.64	34.77	60.00	50.00	-19.36	-15.23

REMARKS:

1. Q.P. and AV. are abbreviations of quasi-peak and average individually.
2. The emission levels of other frequencies were very low against the limit.
3. Margin value = Emission level - Limit value
4. Correction factor = Insertion loss + Cable loss
5. Emission Level = Correction Factor + Reading Value

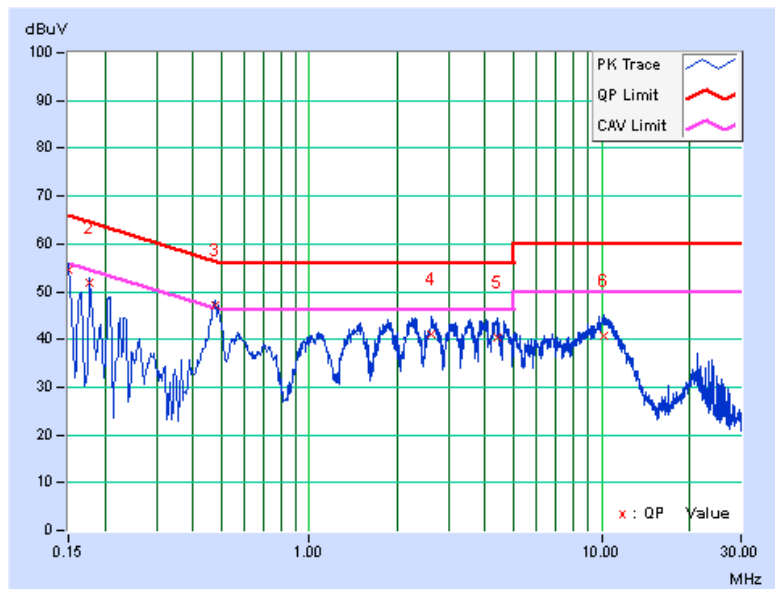



A D T

PHASE	Line 2	6dB BANDWIDTH	9kHz
TEST MODE	B		

No	Freq. [MHz]	Corr. Factor (dB)	Reading Value		Emission Level		Limit		Margin	
			[dB (uV)]		[dB (uV)]		[dB (uV)]		(dB)	
			Q.P.	AV.	Q.P.	AV.	Q.P.	AV.	Q.P.	AV.
1	0.17374	0.11	52.29	40.34	52.40	40.45	64.78	54.78	-12.38	-14.33
2	0.26339	0.12	43.82	32.05	43.94	32.17	61.32	51.32	-17.39	-19.16
3	0.47789	0.13	47.13	39.24	47.26	39.37	56.38	46.38	-9.11	-7.00
4	2.70714	0.18	40.33	34.91	40.51	35.09	56.00	46.00	-15.49	-10.91
5	4.51356	0.22	38.62	31.75	38.84	31.97	56.00	46.00	-17.16	-14.03
6	21.50642	0.64	36.57	30.83	37.21	31.47	60.00	50.00	-22.79	-18.53

REMARKS:

1. Q.P. and AV. are abbreviations of quasi-peak and average individually.
2. The emission levels of other frequencies were very low against the limit.
3. Margin value = Emission level - Limit value
4. Correction factor = Insertion loss + Cable loss
5. Emission Level = Correction Factor + Reading Value

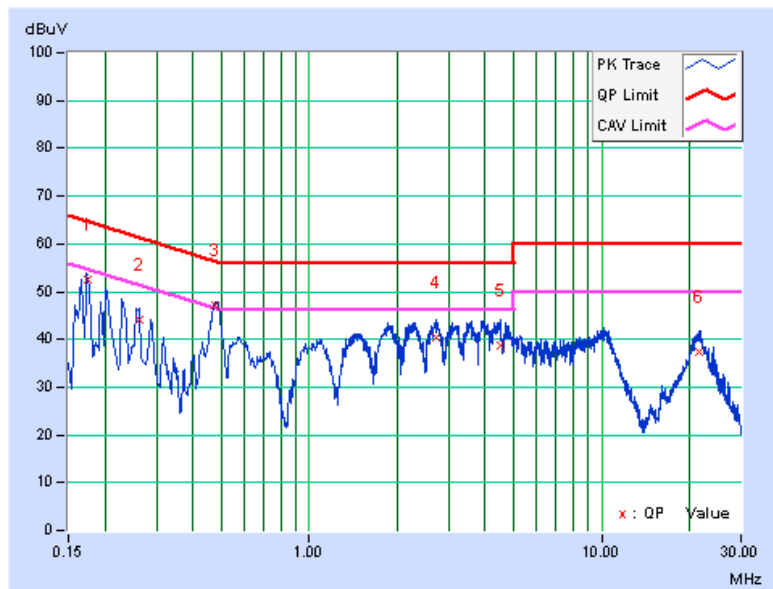

4.3 6dB BANDWIDTH MEASUREMENT

4.3.1 LIMITS OF 6dB BANDWIDTH MEASUREMENT

The minimum of 6dB Bandwidth Measurement is 0.5 MHz.

4.3.2 TEST SETUP

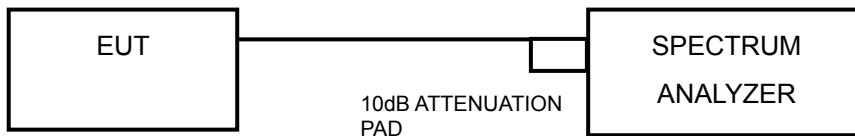

4.3.3 TEST INSTRUMENTS

Refer to section 4.1.2 to get information of above instrument.

4.3.4 TEST PROCEDURE

- a. Set resolution bandwidth (RBW) = 100kHz
- b. Set the video bandwidth (VBW) $\geq 3 \times$ RBW, Detector = Peak.
- c. Trace mode = max hold.
- d. Sweep = auto couple.
- e. Measure the maximum width of the emission that is constrained by the frequencies associated with the two amplitude points (upper and lower) that are attenuated by 6 dB relative to the maximum level measured in the fundamental emission

4.3.5 DEVIATION FROM TEST STANDARD

No deviation.

4.3.6 EUT OPERATING CONDITIONS

The software provided by client to enable the EUT under transmission condition continuously at lowest, middle and highest channel frequencies individually.



4.3.7 TEST RESULTS

802.11b

CHANNEL	FREQUENCY (MHz)	6dB BANDWIDTH (MHz)		MINIMUM LIMIT (MHz)	PASS / FAIL
		CHAIN 0	CHAIN 1		
1	2412	10.12	10.11	0.5	PASS
6	2437	10.12	10.10	0.5	PASS
11	2462	10.10	10.12	0.5	PASS

802.11g

CHANNEL	FREQUENCY (MHz)	6dB BANDWIDTH (MHz)		MINIMUM LIMIT (MHz)	PASS / FAIL
		CHAIN 0	CHAIN 1		
1	2412	16.40	16.39	0.5	PASS
6	2437	16.42	16.39	0.5	PASS
11	2462	16.38	16.39	0.5	PASS

802.11n (20MHz)

CHANNEL	FREQUENCY (MHz)	6dB BANDWIDTH (MHz)		MINIMUM LIMIT (MHz)	PASS / FAIL
		CHAIN 0	CHAIN 1		
1	2412	17.62	17.61	0.5	PASS
6	2437	17.62	17.60	0.5	PASS
11	2462	17.65	17.61	0.5	PASS

802.11n (40MHz)

CHANNEL	FREQUENCY (MHz)	6dB BANDWIDTH (MHz)		MINIMUM LIMIT (MHz)	PASS / FAIL
		CHAIN 0	CHAIN 1		
3	2422	36.44	36.41	0.5	PASS
6	2437	36.46	36.48	0.5	PASS
9	2452	36.45	36.50	0.5	PASS



A D T

SPECTRUM PLOT OF WORST VALUE

802.11b

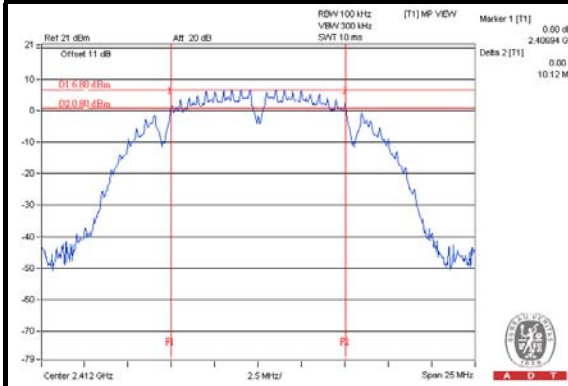

802.11g

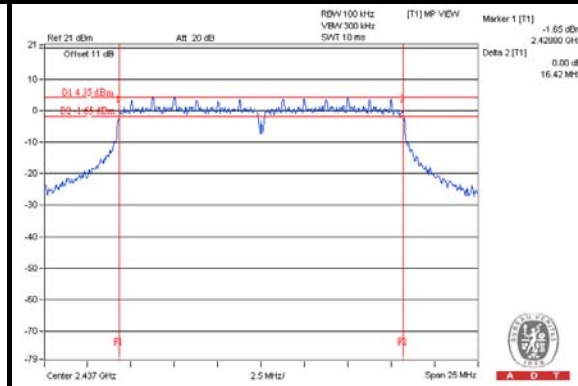

802.11n (20MHz)

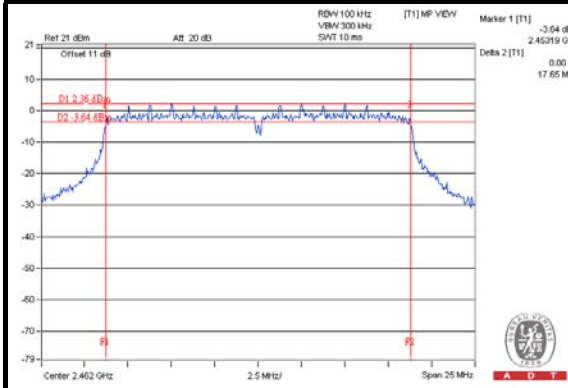

802.11n (40MHz)

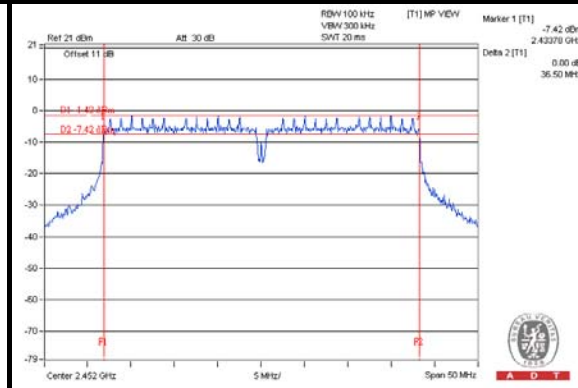

4.4 CONDUCTED OUTPUT POWER

4.4.1 LIMITS OF CONDUCTED OUTPUT POWER MEASUREMENT

For systems using digital modulation in the 2400–2483.5 MHz bands: 1 Watt (30dBm)

Per KDB 662911 D01 Multiple Transmitter Output v02 Method of conducted output power measurement on IEEE 802.11 devices,

Array Gain = 0 dB (i.e., no array gain) for NANT \leq 4;

Array Gain = 0 dB (i.e., no array gain) for channel widths \geq 40 MHz for any NANT;

Array Gain = $5 \log(\text{NANT}/\text{NSS})$ dB or 3 dB, whichever is less for 20-MHz channel widths with NANT \geq 5.

For power measurements on all other devices: Array Gain = $10 \log(\text{NANT}/\text{NSS})$ dB.

4.4.2 TEST SETUP

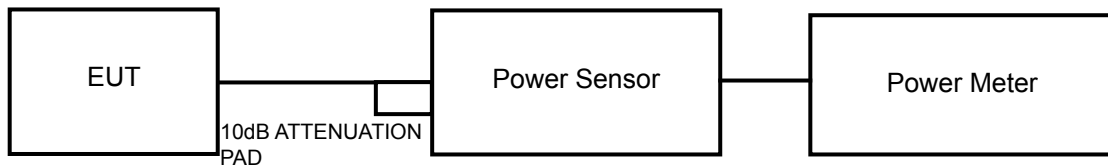

4.4.3 TEST INSTRUMENTS

Refer to section 4.1.2 to get information of above instrument.

4.4.4 TEST PROCEDURES

A peak / average power sensor was used on the output port of the EUT. A power meter was used to read the response of the peak / average power sensor. Record the peak power level.



A D T

4.4.5 DEVIATION FROM TEST STANDARD

No deviation.

4.4.6 EUT OPERATING CONDITIONS

Same as Item 4.3.6.



A D T

4.4.7 TEST RESULTS

FOR PEAK POWER

802.11b

CHAN.	FREQ. (MHz)	PEAK POWER (dBm)		TOTAL POWER (mW)	TOTAL POWER (dBm)	LIMIT (dBm)	PASS / FAIL
		CHAIN 0	CHAIN 1				
1	2412	19.14	20.12	184.837	22.67	30	PASS
6	2437	18.74	20.72	192.849	22.85	30	PASS
11	2462	18.77	20.71	193.097	22.86	30	PASS

802.11g

CHAN.	FREQ. (MHz)	PEAK POWER (dBm)		TOTAL POWER (mW)	TOTAL POWER (dBm)	LIMIT (dBm)	PASS / FAIL
		CHAIN 0	CHAIN 1				
1	2412	22.20	23.25	377.308	25.77	30	PASS
6	2437	23.40	24.94	530.665	27.25	30	PASS
11	2462	22.80	23.88	434.889	26.38	30	PASS

802.11n (20MHz)

CHAN.	FREQ. (MHz)	PEAK POWER (dBm)		TOTAL POWER (mW)	TOTAL POWER (dBm)	LIMIT (dBm)	PASS / FAIL
		CHAIN 0	CHAIN 1				
1	2412	20.81	22.41	294.685	24.69	30	PASS
6	2437	23.43	24.67	513.382	27.10	30	PASS
11	2462	23.14	23.71	441.026	26.44	30	PASS

802.11n (40MHz)

CHAN.	FREQ. (MHz)	PEAK POWER (dBm)		TOTAL POWER (mW)	TOTAL POWER (dBm)	LIMIT (dBm)	PASS / FAIL
		CHAIN 0	CHAIN 1				
3	2422	20.74	22.43	293.562	24.68	30	PASS
6	2437	22.81	24.16	451.600	26.55	30	PASS
9	2452	19.36	22.23	253.407	24.04	30	PASS



FOR AVERAGE POWER

802.11b

CHAN.	FREQUENCY (MHz)	AVG. POWER (dBm)		TOTAL POWER (mW)	TOTAL POWER (dBm)
		CHAIN 0	CHAIN 1		
1	2412	16.63	17.57	103.174	20.14
6	2437	16.20	18.29	109.140	20.38
11	2462	16.28	17.71	101.482	20.06

802.11g

CHAN.	FREQUENCY (MHz)	AVG. POWER (dBm)		TOTAL POWER (mW)	TOTAL POWER (dBm)
		CHAIN 0	CHAIN 1		
1	2412	14.84	15.75	68.063	18.33
6	2437	16.23	18.00	105.072	20.21
11	2462	15.17	16.78	80.528	19.06

802.11n (20MHz)

CHAN.	FREQUENCY (MHz)	AVG. POWER (dBm)		TOTAL POWER (mW)	TOTAL POWER (dBm)
		CHAIN 0	CHAIN 1		
1	2412	13.63	15.16	55.877	17.47
6	2437	16.08	18.40	109.734	20.40
11	2462	14.77	15.73	67.403	18.29

802.11n (40MHz)

CHAN.	FREQUENCY (MHz)	AVG. POWER (dBm)		TOTAL POWER (mW)	TOTAL POWER (dBm)
		CHAIN 0	CHAIN 1		
3	2422	12.36	13.96	42.108	16.24
6	2437	14.27	16.29	69.290	18.41
9	2452	11.52	12.95	33.915	15.30

4.5 POWER SPECTRAL DENSITY MEASUREMENT

4.5.1 LIMITS OF POWER SPECTRAL DENSITY MEASUREMENT

The Maximum of Power Spectral Density Measurement is 8dBm.

4.5.2 TEST SETUP

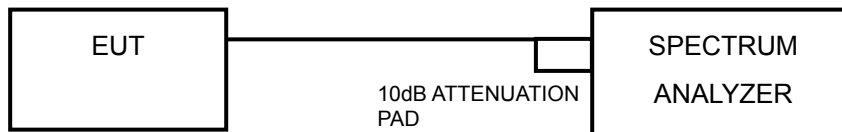

4.5.3 TEST INSTRUMENTS

Refer to section 4.1.2 to get information of above instrument.

4.5.4 TEST PROCEDURE

- Set the RBW = 3 kHz, VBW = 10 kHz, Detector = peak.
- Sweep time = auto couple, Trace mode = max hold, allow trace to fully stabilize.
- Use the peak marker function to determine the maximum power level in any 100 kHz band segment within the fundamental EBW.

4.5.5 DEVIATION FROM TEST STANDARD

No deviation.

4.5.6 EUT OPERATING CONDITION

Same as Item 4.3.6



4.5.7 TEST RESULTS

802.11b

TX chain	Channel	Freq. (MHz)	PSD (dBm/3kHz)	10 log (N=2) dB	Total PSD (dBm/3kHz)	Limit (dBm/3kHz)	PASS /FAIL
0	1	2412	-6.58	3.01	-3.57	7.49	PASS
	6	2437	-7.78	3.01	-4.77	7.49	PASS
	11	2462	-8.45	3.01	-5.44	7.49	PASS
1	1	2412	-6.85	3.01	-3.84	7.49	PASS
	6	2437	-6.72	3.01	-3.71	7.49	PASS
	11	2462	-7.31	3.01	-4.30	7.49	PASS

NOTE: Directional gain = 3.5dBi + 10log(2) = 6.51dBi > 6dBi , so the power density limit shall be reduced to 8-(6.51-6) = 7.49dBm.

802.11g

TX chain	Channel	Freq. (MHz)	PSD (dBm/3kHz)	10 log (N=2) dB	Total PSD (dBm/3kHz)	Limit (dBm/3kHz)	PASS /FAIL
0	1	2412	-11.97	3.01	-8.79	7.49	PASS
	6	2437	-9.90	3.01	-6.72	7.49	PASS
	11	2462	-10.50	3.01	-7.32	7.49	PASS
1	1	2412	-10.47	3.01	-7.29	7.49	PASS
	6	2437	-8.17	3.01	-4.99	7.49	PASS
	11	2462	-8.35	3.01	-5.17	7.49	PASS

NOTE: Directional gain = 3.5dBi + 10log(2) = 6.51dBi > 6dBi , so the power density limit shall be reduced to 8-(6.51-6) = 7.49dBm.

802.11n (20MHz)

TX chain	Channel	Freq. (MHz)	PSD (dBm/3kHz)	10 log (N=2) dB	Total PSD (dBm/3kHz)	Limit (dBm/3kHz)	PASS /FAIL
0	1	2412	-12.44	3.01	-9.24	7.49	PASS
	6	2437	-10.20	3.01	-7.00	7.49	PASS
	11	2462	-11.03	3.01	-7.83	7.49	PASS
1	1	2412	-11.19	3.01	-7.99	7.49	PASS
	6	2437	-7.87	3.01	-4.67	7.49	PASS
	11	2462	-10.35	3.01	-7.15	7.49	PASS

NOTE: Directional gain = 3.5dBi + 10log(2) = 6.51dBi > 6dBi , so the power density limit shall be reduced to 8-(6.51-6) = 7.49dBm.



A D T

802.11n (40MHz)

TX chain	Channel	Freq. (MHz)	PSD (dBm/3kHz)	10 log (N=2) dB	Total PSD (dBm/3kHz)	Limit (dBm/3kHz)	PASS /FAIL
0	3	2422	-12.38	3.01	-9.06	7.49	PASS
	6	2437	-11.08	3.01	-7.76	7.49	PASS
	9	2452	-13.55	3.01	-10.23	7.49	PASS
1	3	2422	-16.16	3.01	-12.84	7.49	PASS
	6	2437	-13.44	3.01	-10.12	7.49	PASS
	9	2452	-14.18	3.01	-10.86	7.49	PASS

NOTE: Directional gain = 3.5dBi + 10log(2) = 6.51dBi > 6dBi , so the power density limit shall be reduced to 8-(6.51-6) = 7.49dBm.

SPECTRUM PLOT OF WORST VALUE

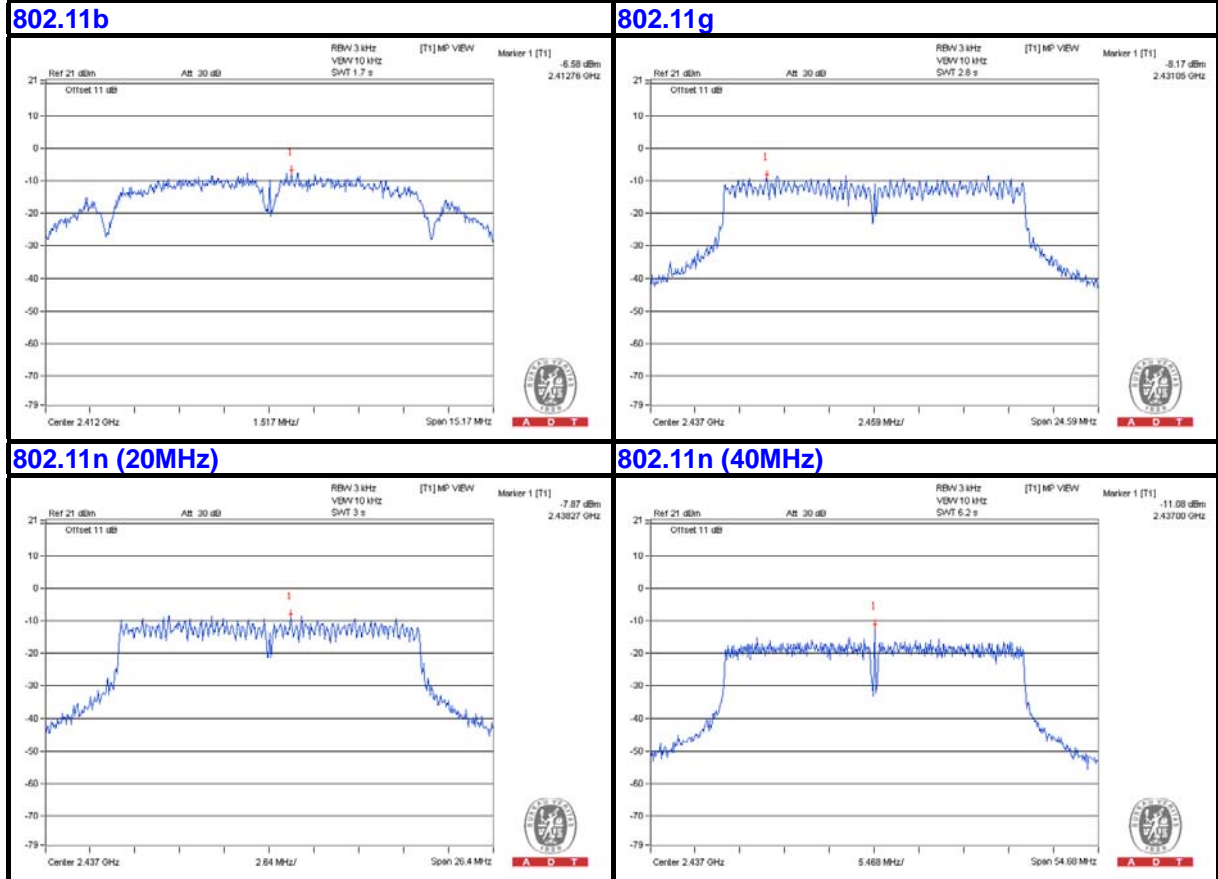

4.6 CONDUCTED OUT OF BAND EMISSION MEASUREMENT

4.6.1 LIMITS OF CONDUCTED OUT OF BAND EMISSION MEASUREMENT

Below -20dB of the highest emission level of operating band (in 100kHz Resolution Bandwidth).

4.6.2 TEST SETUP

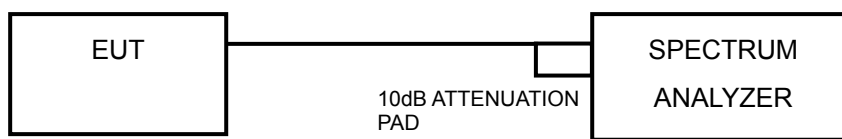

4.6.3 TEST INSTRUMENTS

Refer to section 4.1.2 to get information of above instrument.



A D T

4.6.4 TEST PROCEDURE

MEASUREMENT PROCEDURE REF

1. Set the RBW = 100 kHz.
2. Set the VBW \geq 300 kHz.
3. Detector = peak.
4. Sweep time = auto couple.
5. Trace mode = max hold.
6. Allow trace to fully stabilize.
7. Use the peak marker function to determine the maximum power level in any 100 kHz band segment within the fundamental EBW.

MEASUREMENT PROCEDURE OOB

1. Set RBW = 100 kHz.
2. Set VBW \geq 300 kHz.
3. Ensure that the number of measurement points \geq span/RBW
4. According to measurement points to set differ measurement span.
5. Detector = peak.
6. Trace Mode = max hold.
7. Sweep = auto couple.

4.6.5 DEVIATION FROM TEST STANDARD

No deviation.

4.6.6 EUT OPERATING CONDITION

Same as Item 4.3.6

4.6.7 TEST RESULTS

The conducted emission test is performed on each TX port of operating mode without summing or adding $10\log(N)$ since the limit is relative emission limit.

The spectrum plots are attached on the following pages. D1 line indicates the highest level, and D2 line indicates the 20dB offset below D1. It shows compliance with the requirement.



A D T

802.11b CHAIN 0

CH 1

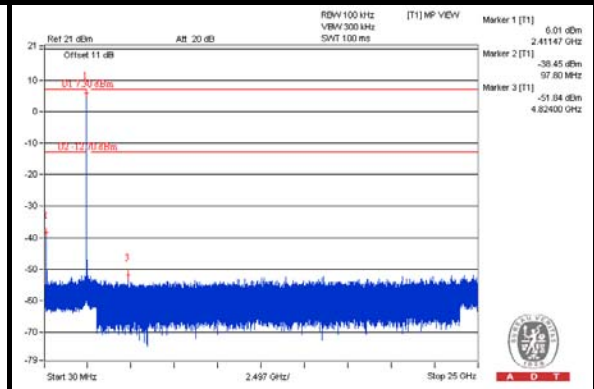
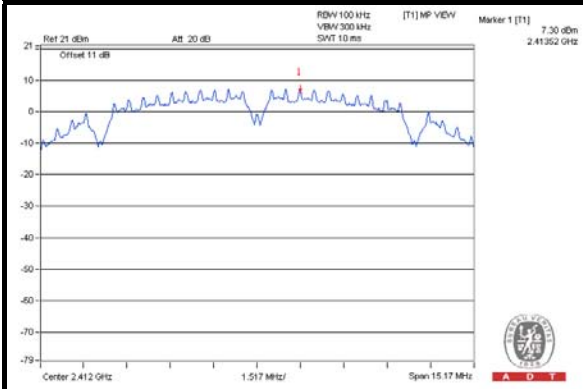

CH 6

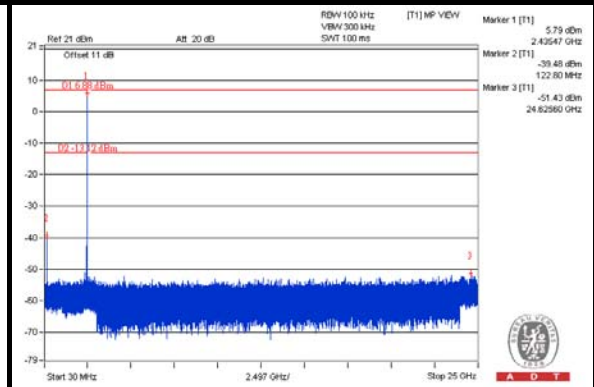
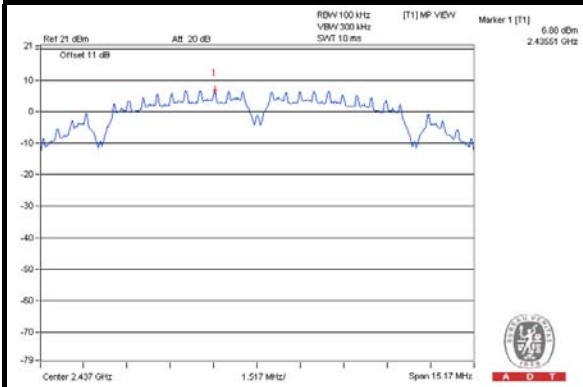

CH 11

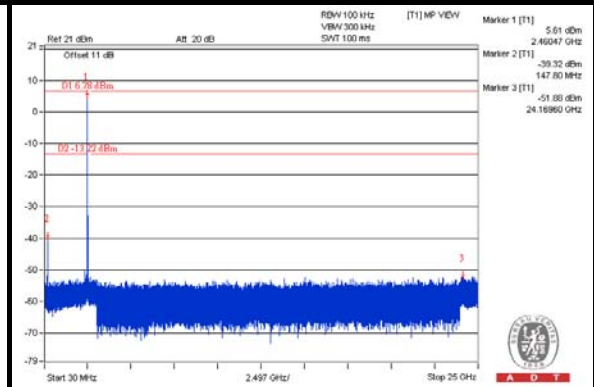
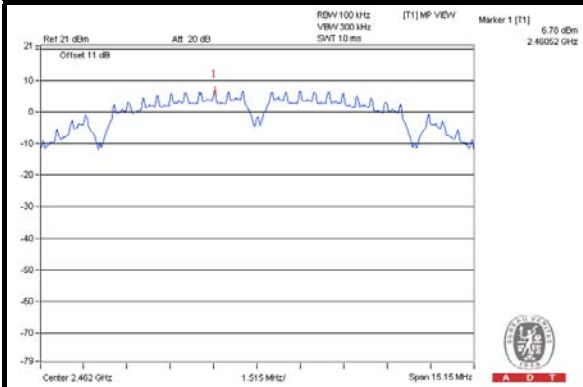

CH 1 Band edge

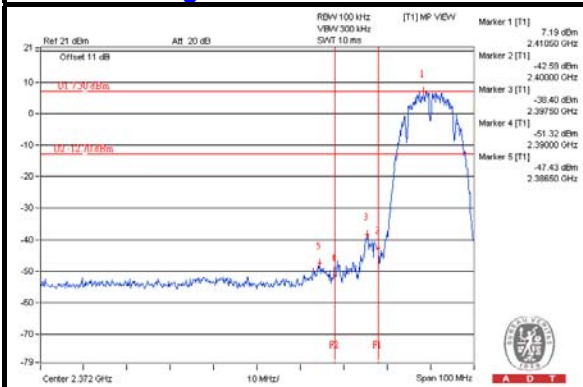

CH 11 Band edge

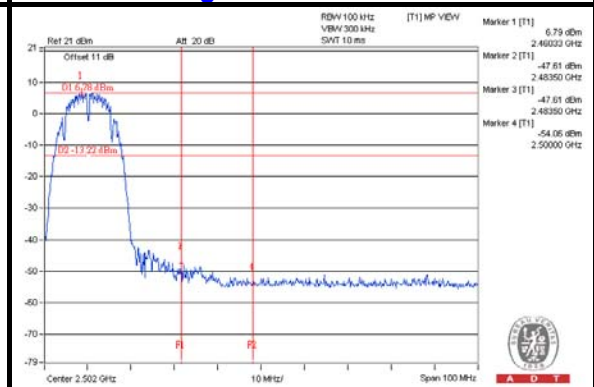



A D T

CHAIN 1

CH 1

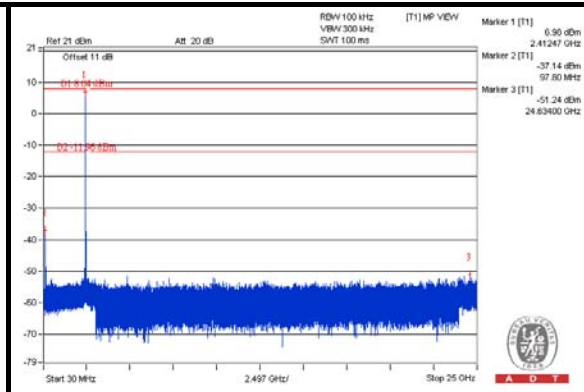
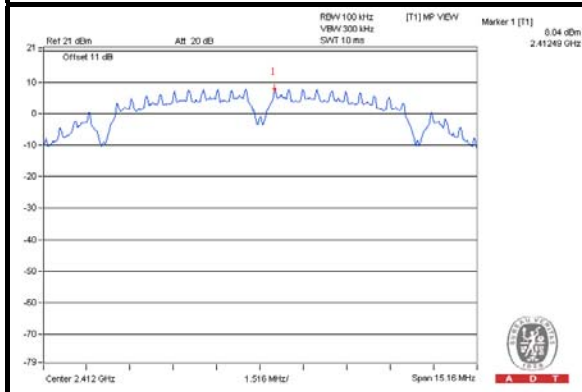

CH 6

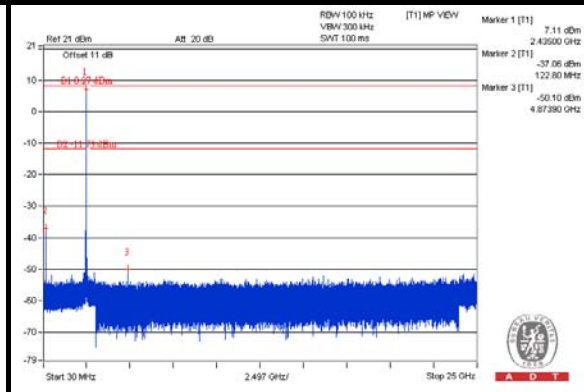
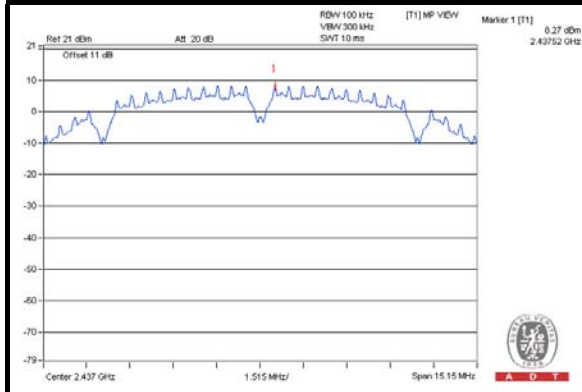

CH 11

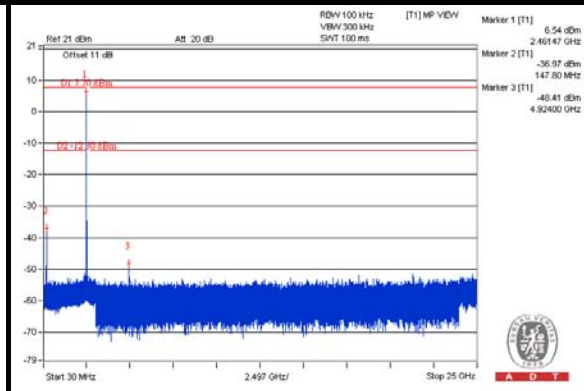
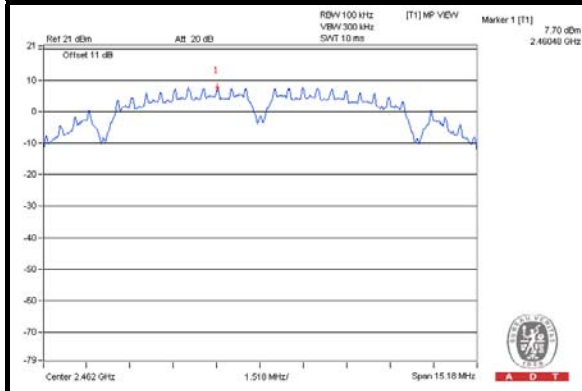

CH 1 Band edge

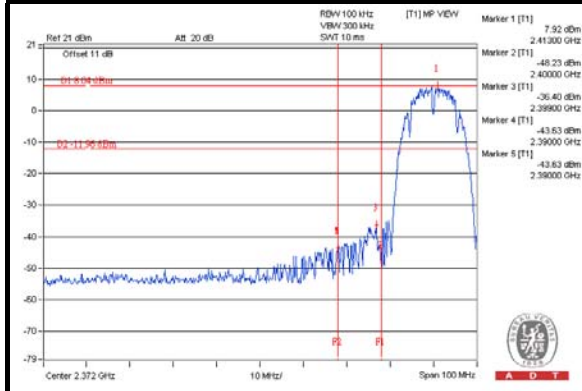

CH 11 Band edge

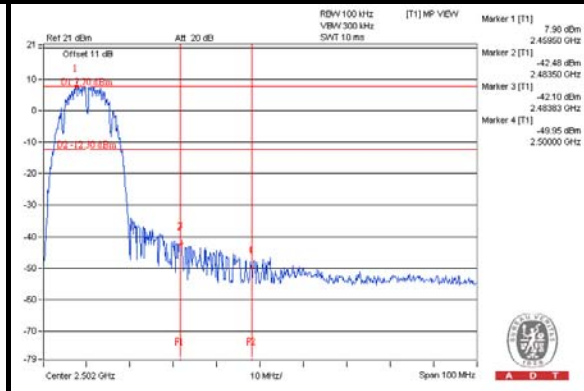



A D T

802.11g CHAIN 0

CH 1

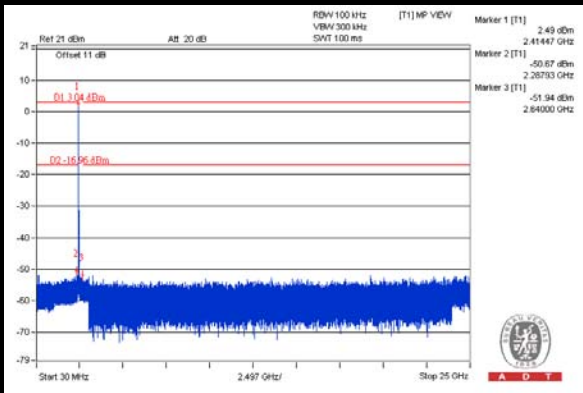
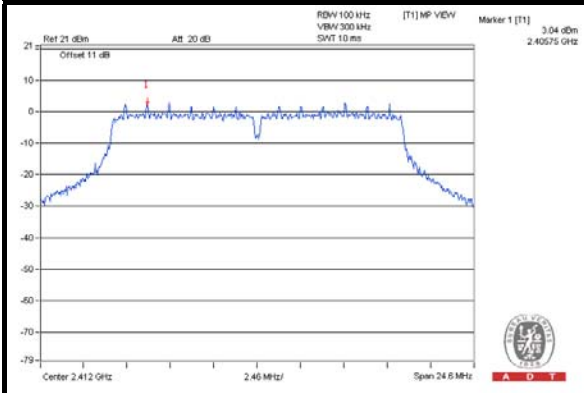

CH 6

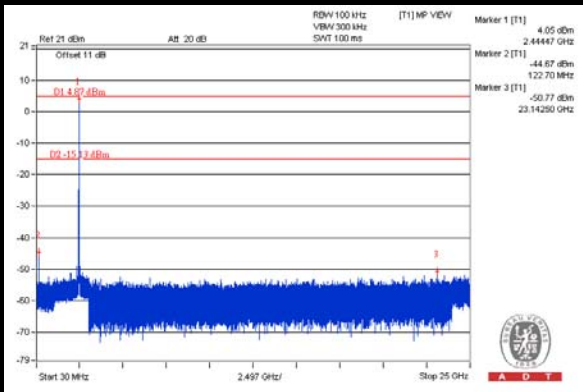
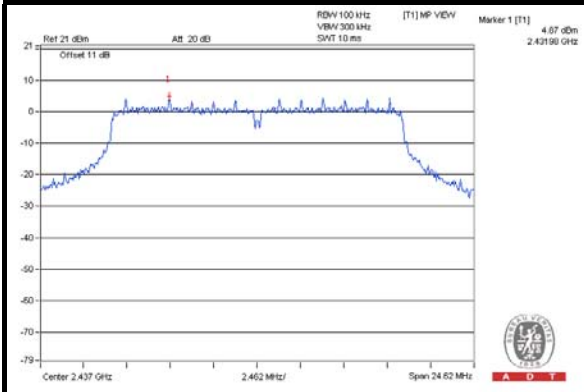

CH 11

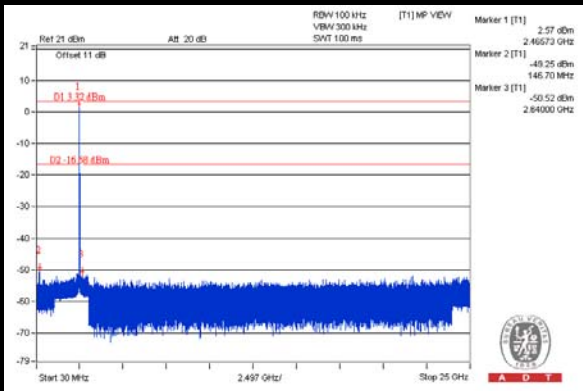
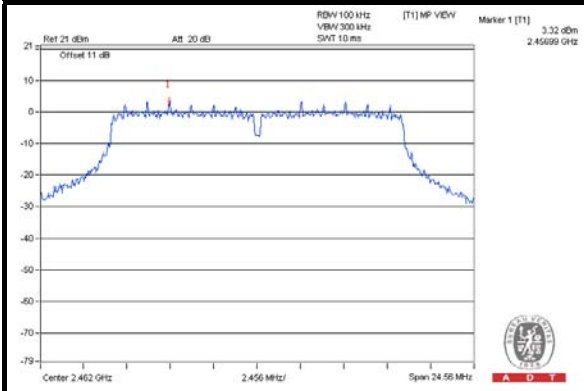

CH 1 Band edge

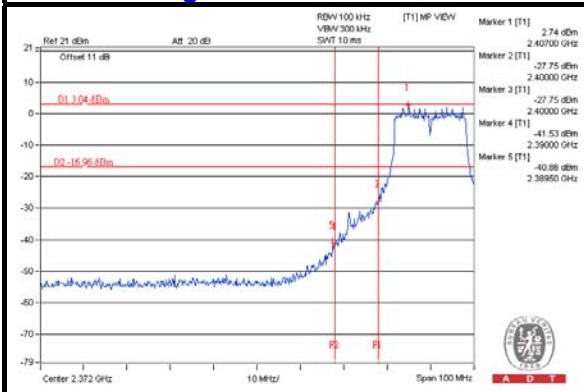

CH 11 Band edge

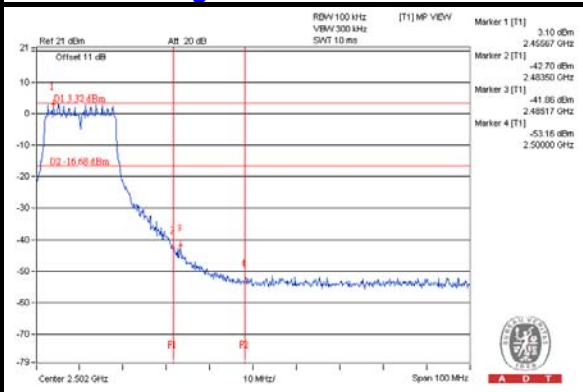



A D T

CHAIN 1

CH 1

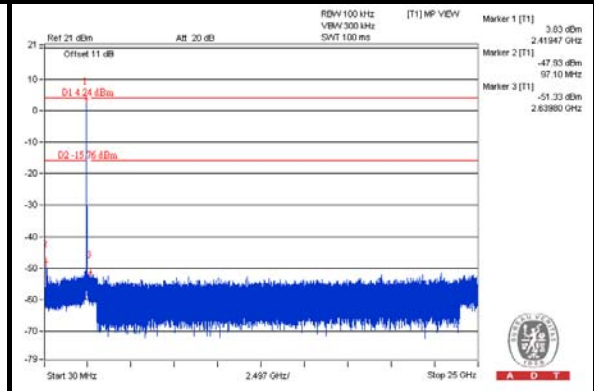
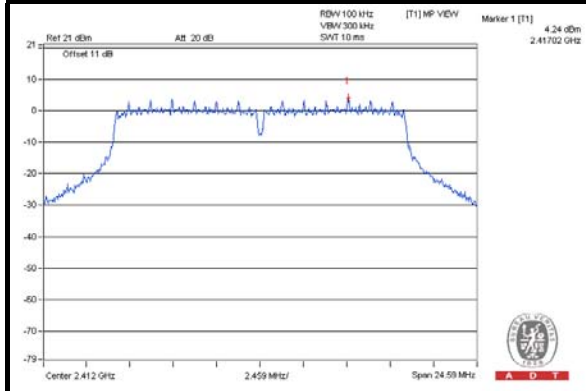

CH 6

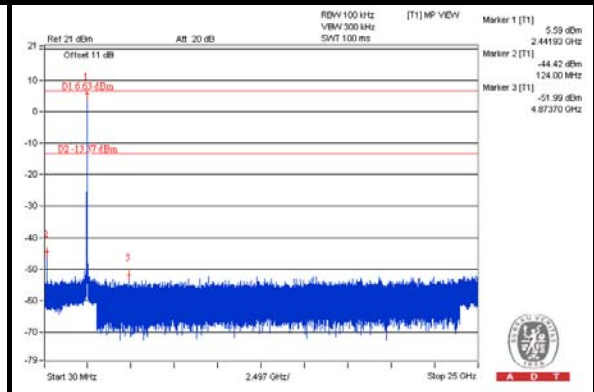
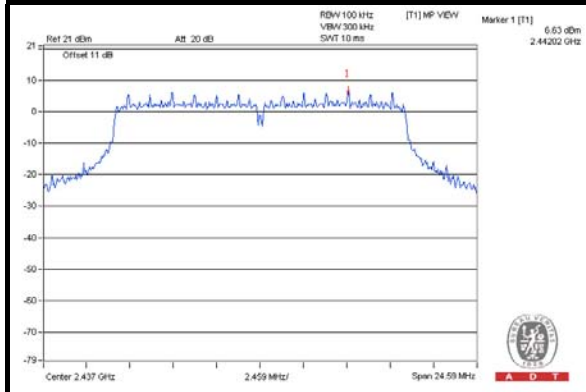

CH 11

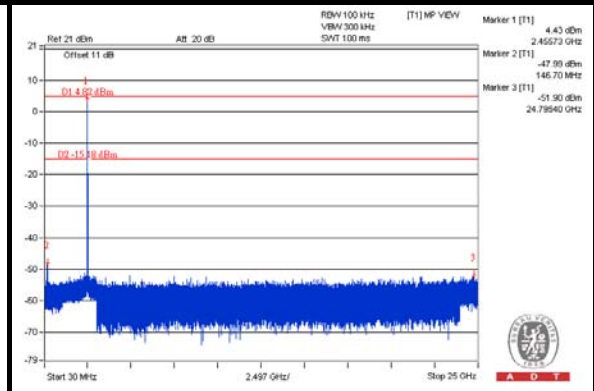
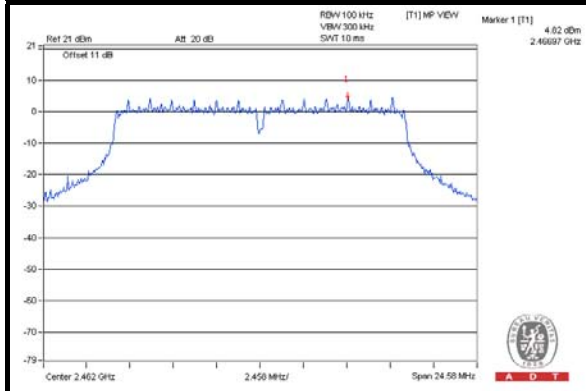

CH 1 Band edge

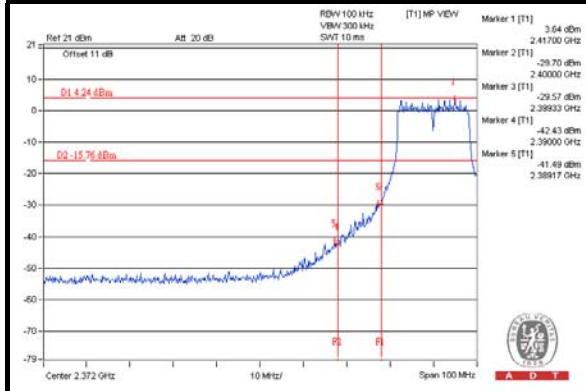

CH 11 Band edge

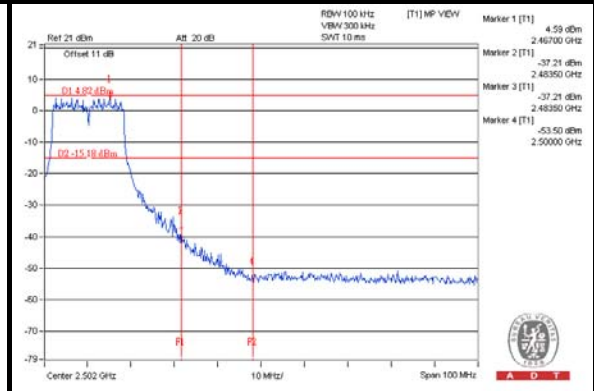



A D T

802.11n (20MHz) CHAIN 0

CH 1

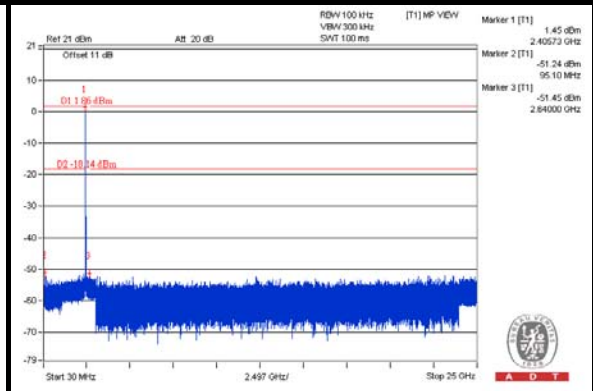
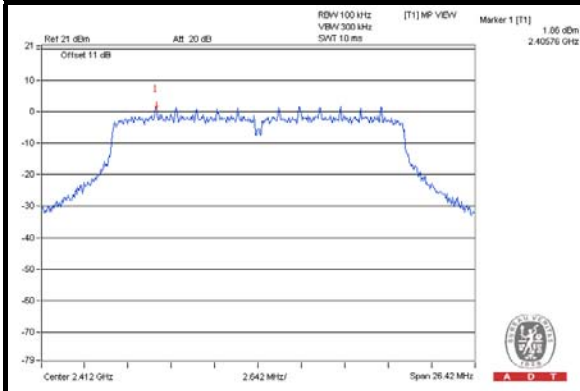

CH 6

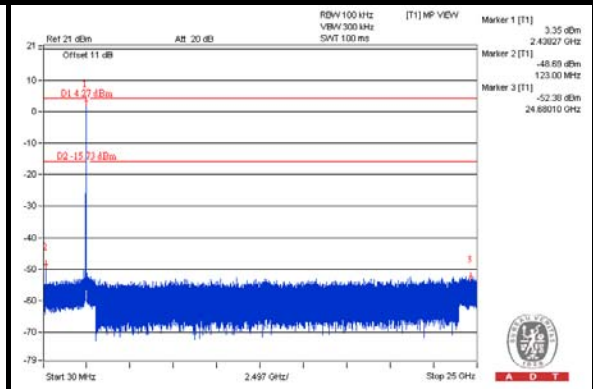
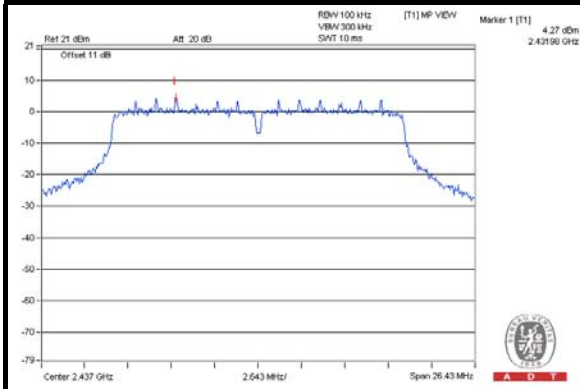

CH 11

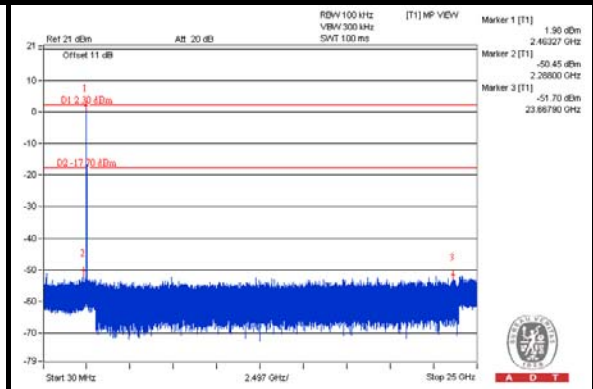
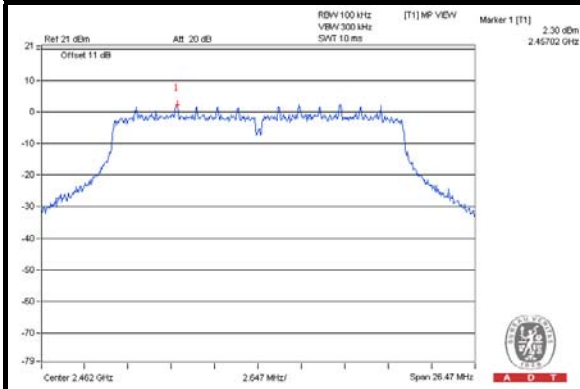

CH 1 Band edge

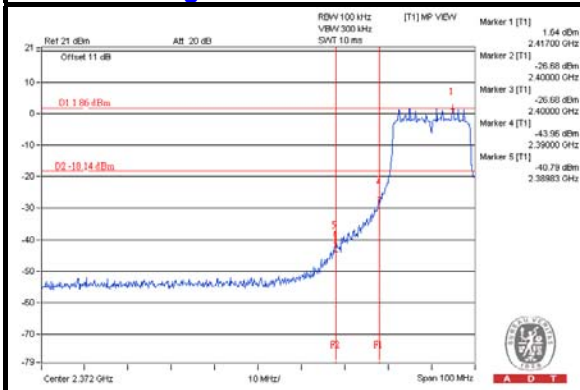

CH 11 Band edge

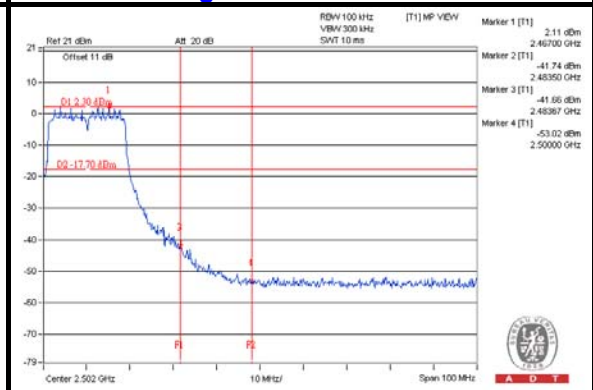



A D T

CHAIN 1

CH 1

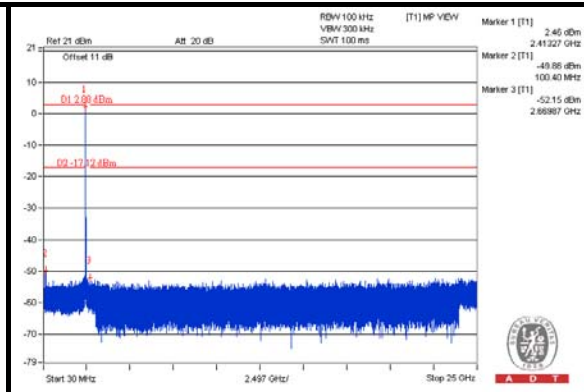
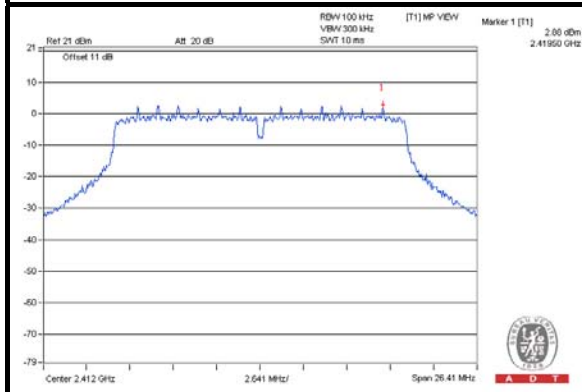

CH 6

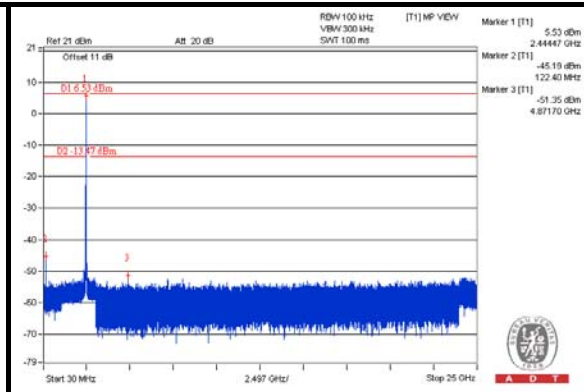
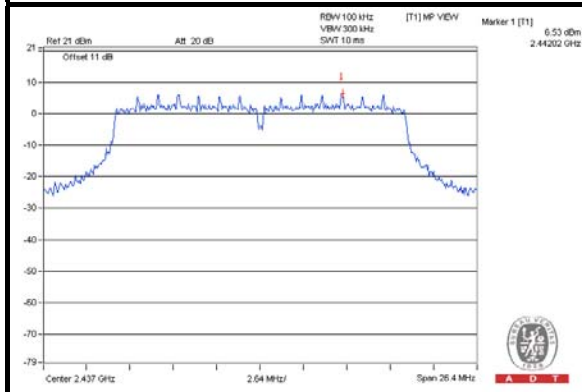

CH 11

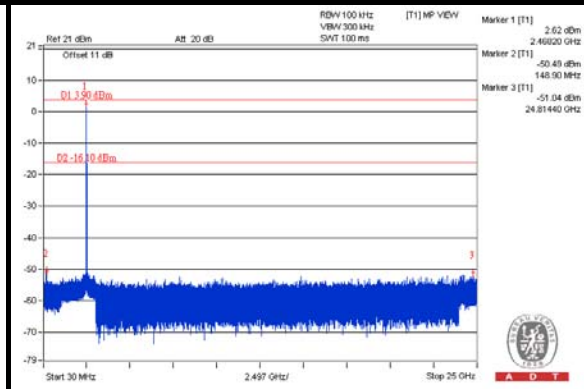
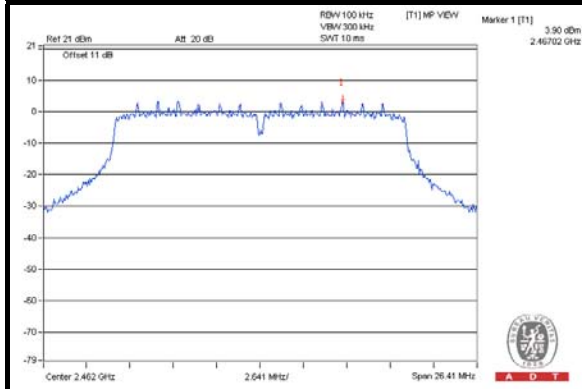

CH 1 Band edge

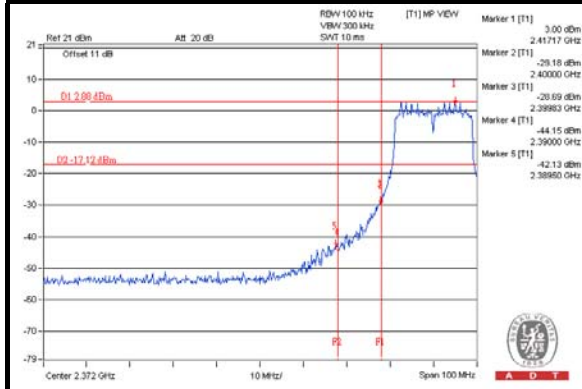

CH 11 Band edge

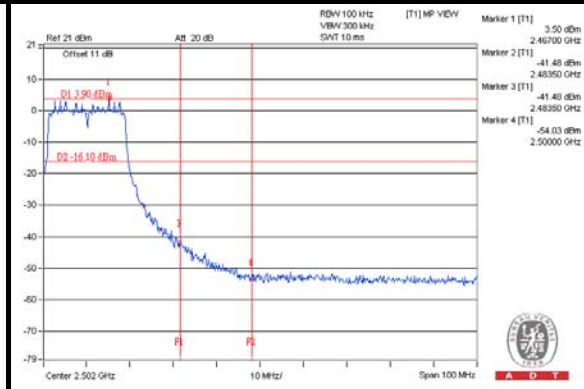



A D T

802.11n (40MHz) CHAIN 0

CH 3

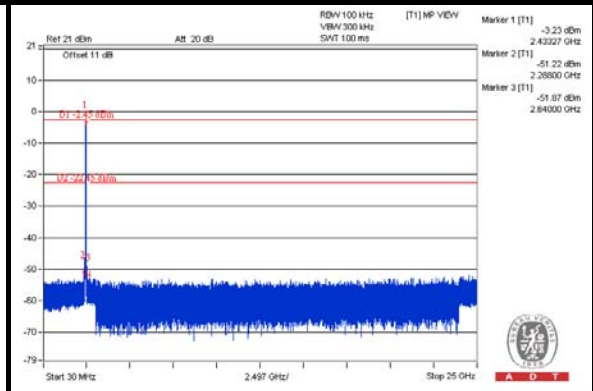
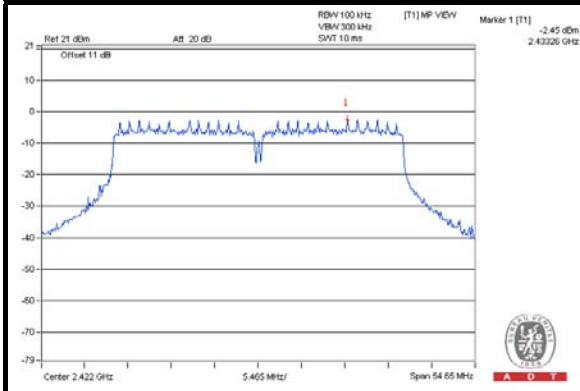

CH 6

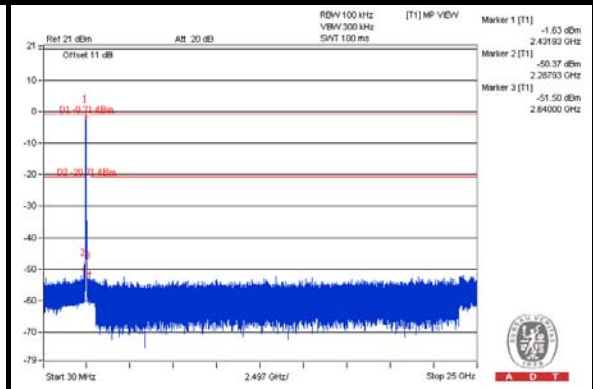
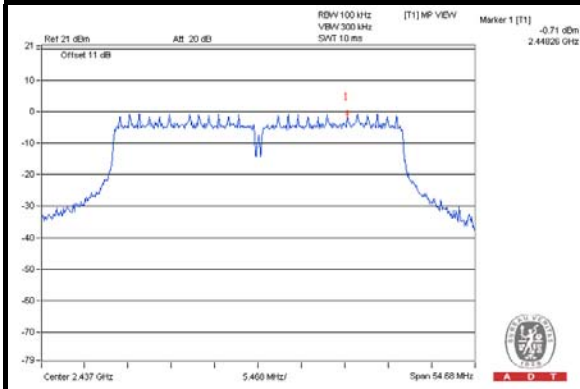

CH 9

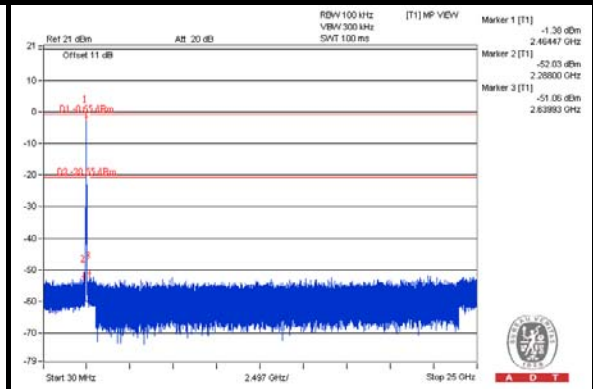
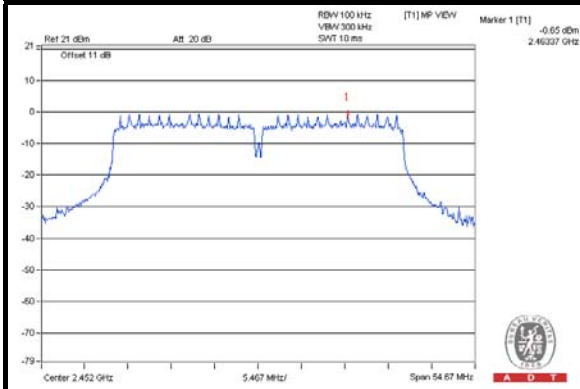

CH 3 Band edge

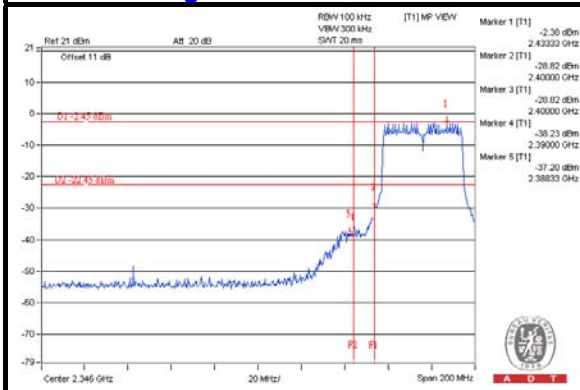

CH 9 Band edge

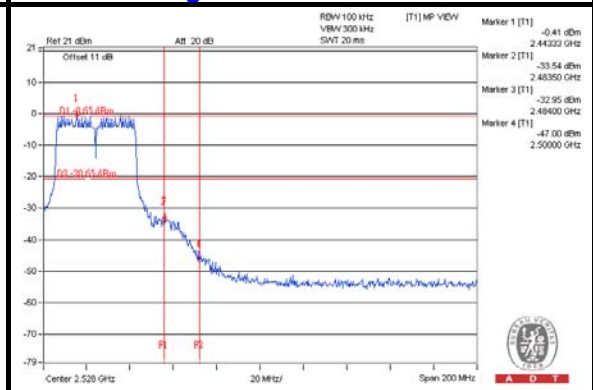



A D T

CHAIN 1

CH 3

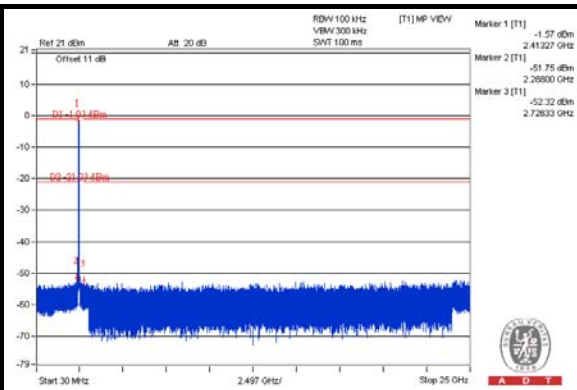
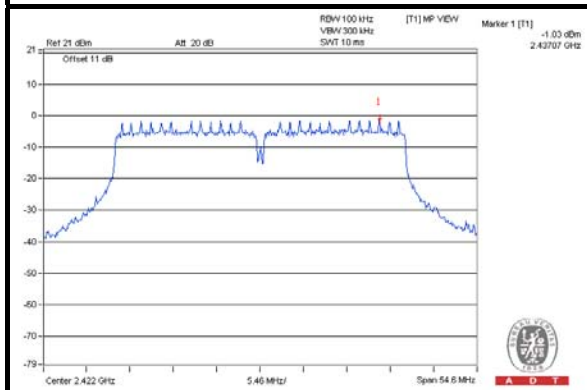

CH 6

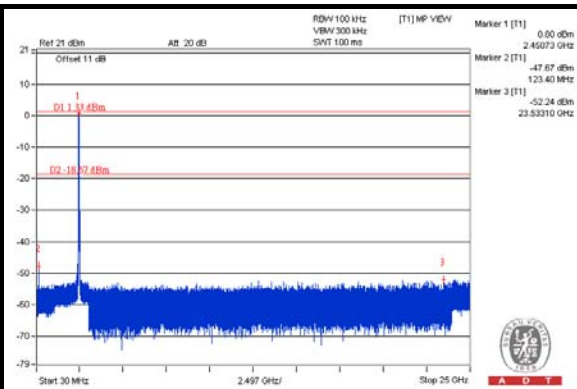
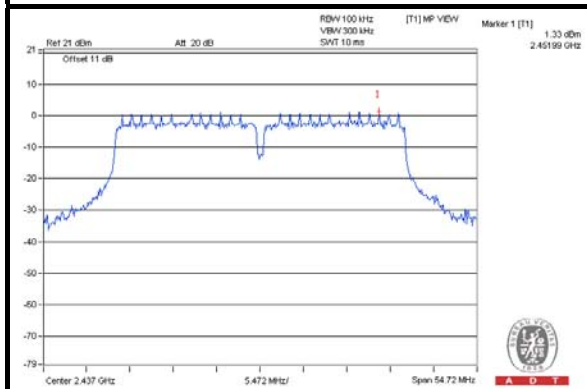

CH 9

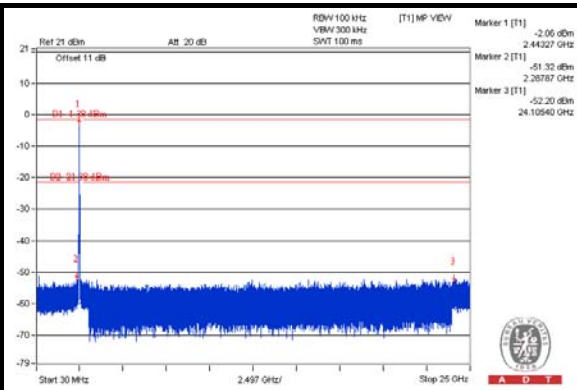
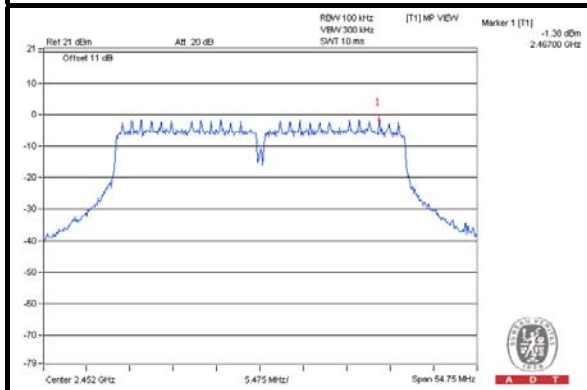

CH 3 Band edge

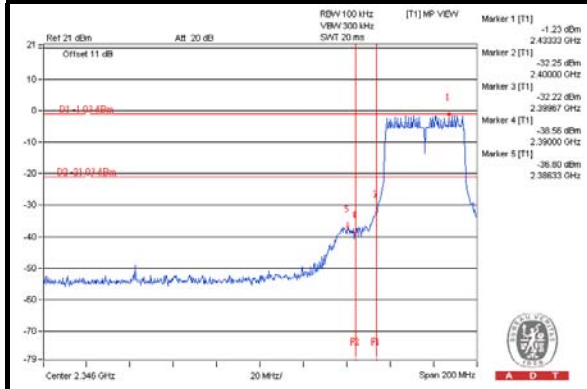

CH 9 Band edge

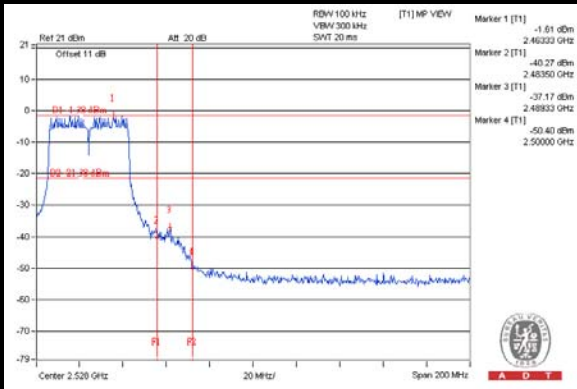



5. TEST TYPES AND RESULTS (FOR 5.0GHz BAND)

5.1 RADIATED EMISSION MEASUREMENT

5.1.1 LIMITS OF RADIATED EMISSION MEASUREMENT

Radiated emissions which fall in the restricted bands must comply with the radiated emission limits specified as below table. Other emissions shall be at least 20dB below the highest level of the desired power:

FREQUENCIES (MHz)	FIELD STRENGTH (microvolts/meter)	MEASUREMENT DISTANCE (meters)
0.009 ~ 0.490	2400/F(kHz)	300
0.490 ~ 1.705	24000/F(kHz)	30
1.705 ~ 30.0	30	30
30 ~ 88	100	3
88 ~ 216	150	3
216 ~ 960	200	3
Above 960	500	3

NOTE:

1. The lower limit shall apply at the transition frequencies.
2. Emission level (dBuV/m) = 20 log Emission level (uV/m).
3. For frequencies above 1000MHz, the field strength limits are based on average detector, however, the peak field strength of any emission shall not exceed the maximum permitted average limits, specified above by more than 20dB under any condition of modulation.



A D T

5.1.2 TEST INSTRUMENTS

Same as item 4.1.2.

5.1.3 TEST PROCEDURES

Same as item 4.1.3.

5.1.4 DEVIATION FROM TEST STANDARD

No deviation.

5.1.5 TEST SETUP

Same as item 4.1.5.

5.1.6 EUT OPERATING CONDITIONS

Same as item 4.1.6.



A D T

5.1.7 TEST RESULTS

ABOVE 1GHz DATA :

802.11a

EUT TEST CONDITION		MEASUREMENT DETAIL	
CHANNEL	Channel 149	FREQUENCY RANGE	1 ~ 40GHz
INPUT POWER	120Vac, 60Hz	DETECTOR FUNCTION	Peak (PK) Average (AV)
ENVIRONMENTAL CONDITIONS	25deg. C, 65%RH	TESTED BY	Jones Chang

ANTENNA POLARITY & TEST DISTANCE: HORIZONTAL AT 3 M								
NO.	FREQ. (MHz)	EMISSION LEVEL (dBuV/m)	LIMIT (dBuV/m)	MARGIN (dB)	ANTENNA HEIGHT (m)	TABLE ANGLE (Degree)	RAW VALUE (dBuV)	CORRECTION FACTOR (dB/m)
1	#5725.00	89.7 PK	94.7	-5.0	1.00 H	30	83.70	6.00
2	#5725.00	79.9 AV	84.9	-5.0	1.00 H	30	73.90	6.00
3	*5745.00	114.7 PK			1.00 H	30	76.20	38.50
4	*5745.00	104.9 AV			1.00 H	30	66.40	38.50
5	11490.00	66.8 PK	74.0	-7.2	1.45 H	355	46.40	20.40
6	11490.00	52.7 AV	54.0	-1.3	1.45 H	341	32.30	20.40

ANTENNA POLARITY & TEST DISTANCE: VERTICAL AT 3 M								
NO.	FREQ. (MHz)	EMISSION LEVEL (dBuV/m)	LIMIT (dBuV/m)	MARGIN (dB)	ANTENNA HEIGHT (m)	TABLE ANGLE (Degree)	RAW VALUE (dBuV)	CORRECTION FACTOR (dB/m)
1	#5725.00	92.7 PK	97.7	-5.0	1.07 V	12	86.70	6.00
2	#5725.00	82.3 AV	87.3	-5.0	1.07 V	12	76.30	6.00
3	*5745.00	117.7 PK			1.07 V	12	79.20	38.50
4	*5745.00	107.3 AV			1.07 V	12	68.80	38.50
5	11490.00	66.0 PK	74.0	-8.0	1.03 V	341	45.60	20.40
6	11490.00	52.9 AV	54.0	-1.1	1.03 V	341	32.50	20.40

REMARKS:

- Emission Level(dBuV/m) = Raw Value(dBuV) + Correction Factor(dB/m)
- Correction Factor(dB/m) = Antenna Factor(dB/m) + Cable Factor(dB) – Pre-Amplifier Factor(dB)
- The other emission levels were very low against the limit.
- Margin value = Emission Level – Limit value
- " * ": Fundamental frequency.
- The limit value is defined as per 15.247.
- "#":The radiated frequency is out the restricted band.



A D T

EUT TEST CONDITION		MEASUREMENT DETAIL	
CHANNEL	Channel 157	FREQUENCY RANGE	1 ~ 40GHz
INPUT POWER	120Vac, 60Hz	DETECTOR FUNCTION	Peak (PK) Average (AV)
ENVIRONMENTAL CONDITIONS	25deg. C, 65%RH	TESTED BY	Jones Chang

ANTENNA POLARITY & TEST DISTANCE: HORIZONTAL AT 3 M								
NO.	FREQ. (MHz)	EMISSION LEVEL (dBuV/m)	LIMIT (dBuV/m)	MARGIN (dB)	ANTENNA HEIGHT (m)	TABLE ANGLE (Degree)	RAW VALUE (dBuV)	CORRECTION FACTOR (dB/m)
1	*5785.00	115.0 PK			1.00 H	27	76.40	38.60
2	*5785.00	105.4 AV			1.00 H	27	66.80	38.60
3	11570.00	69.2 PK	74.0	-4.8	1.10 H	291	48.80	20.40
4	11570.00	53.0 AV	54.0	-1.0	1.14 H	291	32.60	20.40
ANTENNA POLARITY & TEST DISTANCE: VERTICAL AT 3 M								
NO.	FREQ. (MHz)	EMISSION LEVEL (dBuV/m)	LIMIT (dBuV/m)	MARGIN (dB)	ANTENNA HEIGHT (m)	TABLE ANGLE (Degree)	RAW VALUE (dBuV)	CORRECTION FACTOR (dB/m)
1	*5785.00	116.2 PK			1.05 V	12	77.60	38.60
2	*5785.00	105.8 AV			1.05 V	12	67.20	38.60
3	11570.00	66.7 PK	74.0	-7.3	1.02 V	335	46.30	20.40
4	11570.00	51.8 AV	54.0	-2.2	1.02 V	335	31.40	20.40

REMARKS:

1. Emission Level(dBuV/m) = Raw Value(dBuV) + Correction Factor(dB/m)
2. Correction Factor(dB/m) = Antenna Factor(dB/m) + Cable Factor(dB) – Pre-Amplifier Factor(dB)
3. The other emission levels were very low against the limit.
4. Margin value = Emission Level – Limit value
5. “ * “: Fundamental frequency.
6. The limit value is defined as per 15.247.



A D T

EUT TEST CONDITION		MEASUREMENT DETAIL	
CHANNEL	Channel 165	FREQUENCY RANGE	1 ~ 40GHz
INPUT POWER	120Vac, 60Hz	DETECTOR FUNCTION	Peak (PK) Average (AV)
ENVIRONMENTAL CONDITIONS	25deg. C, 65%RH	TESTED BY	Jones Chang

ANTENNA POLARITY & TEST DISTANCE: HORIZONTAL AT 3 M								
NO.	FREQ. (MHz)	EMISSION LEVEL (dBuV/m)	LIMIT (dBuV/m)	MARGIN (dB)	ANTENNA HEIGHT (m)	TABLE ANGLE (Degree)	RAW VALUE (dBuV)	CORRECTION FACTOR (dB/m)
1	*5825.00	114.0 PK			1.00 H	27	75.30	38.70
2	*5825.00	103.9 AV			1.00 H	27	65.20	38.70
3	#5850.00	77.0 PK	94.0	-17.0	1.00 H	27	70.80	6.20
4	#5850.00	66.9 AV	83.9	-17.0	1.00 H	27	60.70	6.20
5	11650.00	68.1 PK	74.0	-5.9	1.49 H	285	47.80	20.30
6	11650.00	53.0 AV	54.0	-1.0	1.49 H	285	32.70	20.30
ANTENNA POLARITY & TEST DISTANCE: VERTICAL AT 3 M								
NO.	FREQ. (MHz)	EMISSION LEVEL (dBuV/m)	LIMIT (dBuV/m)	MARGIN (dB)	ANTENNA HEIGHT (m)	TABLE ANGLE (Degree)	RAW VALUE (dBuV)	CORRECTION FACTOR (dB/m)
1	*5825.00	116.2 PK			1.07 V	6	77.50	38.70
2	*5825.00	105.9 AV			1.07 V	6	67.20	38.70
3	#5850.00	79.2 PK	96.2	-17.0	1.06 V	6	73.00	6.20
4	#5850.00	68.9 AV	85.9	-17.0	1.06 V	6	62.70	6.20
5	11650.00	66.3 PK	74.0	-7.7	1.01 V	343	46.00	20.30
6	11650.00	52.1 AV	54.0	-1.9	1.01 V	343	31.80	20.30

REMARKS:

1. Emission Level(dBuV/m) = Raw Value(dBuV) + Correction Factor(dB/m)
2. Correction Factor(dB/m) = Antenna Factor(dB/m) + Cable Factor(dB)
– Pre-Amplifier Factor(dB)
3. The other emission levels were very low against the limit.
4. Margin value = Emission Level – Limit value
5. “ * “: Fundamental frequency.
6. The limit value is defined as per 15.247.
7. “#”:The radiated frequency is out the restricted band.



A D T

802.11n (20MHz)

EUT TEST CONDITION		MEASUREMENT DETAIL	
CHANNEL	Channel 149	FREQUENCY RANGE	1 ~ 40GHz
INPUT POWER	120Vac, 60Hz	DETECTOR FUNCTION	Peak (PK) Average (AV)
ENVIRONMENTAL CONDITIONS	25deg. C, 65%RH	TESTED BY	Jones Chang

ANTENNA POLARITY & TEST DISTANCE: HORIZONTAL AT 3 M								
NO.	FREQ. (MHz)	EMISSION LEVEL (dBuV/m)	LIMIT (dBuV/m)	MARGIN (dB)	ANTENNA HEIGHT (m)	TABLE ANGLE (Degree)	RAW VALUE (dBuV)	CORRECTION FACTOR (dB/m)
1	#5725.00	90.9 PK	95.0	-4.1	1.05 H	3	84.90	6.00
2	#5725.00	80.8 AV	84.9	-4.1	1.05 H	3	74.80	6.00
3	*5745.00	115.0 PK			1.16 H	27	76.50	38.50
4	*5745.00	104.9 AV			1.16 H	27	66.40	38.50
5	11490.00	68.5 PK	74.0	-5.5	1.09 H	296	48.10	20.40
6	11490.00	52.2 AV	54.0	-1.8	1.09 H	296	31.80	20.40
ANTENNA POLARITY & TEST DISTANCE: VERTICAL AT 3 M								
NO.	FREQ. (MHz)	EMISSION LEVEL (dBuV/m)	LIMIT (dBuV/m)	MARGIN (dB)	ANTENNA HEIGHT (m)	TABLE ANGLE (Degree)	RAW VALUE (dBuV)	CORRECTION FACTOR (dB/m)
1	#5725.00	93.7 PK	97.8	-4.1	1.05 V	3	87.70	6.00
2	#5725.00	83.1 AV	87.2	-4.1	1.05 V	3	77.10	6.00
3	*5745.00	117.8 PK			1.06 V	8	79.30	38.50
4	*5745.00	107.2 AV			1.06 V	8	68.70	38.50
5	11490.00	65.5 PK	74.0	-8.5	1.05 V	178	45.10	20.40
6	11490.00	51.2 AV	54.0	-2.8	1.05 V	178	30.80	20.40

REMARKS:

1. Emission Level(dBuV/m) = Raw Value(dBuV) + Correction Factor(dB/m)
2. Correction Factor(dB/m) = Antenna Factor(dB/m) + Cable Factor(dB) – Pre-Amplifier Factor(dB)
3. The other emission levels were very low against the limit.
4. Margin value = Emission Level – Limit value
5. “ * “: Fundamental frequency.
6. The limit value is defined as per 15.247.
7. "#":The radiated frequency is out the restricted band.



A D T

EUT TEST CONDITION		MEASUREMENT DETAIL	
CHANNEL	Channel 157	FREQUENCY RANGE	1 ~ 40GHz
INPUT POWER	120Vac, 60Hz	DETECTOR FUNCTION	Peak (PK) Average (AV)
ENVIRONMENTAL CONDITIONS	25deg. C, 65%RH	TESTED BY	Jones Chang

ANTENNA POLARITY & TEST DISTANCE: HORIZONTAL AT 3 M								
NO.	FREQ. (MHz)	EMISSION LEVEL (dBuV/m)	LIMIT (dBuV/m)	MARGIN (dB)	ANTENNA HEIGHT (m)	TABLE ANGLE (Degree)	RAW VALUE (dBuV)	CORRECTION FACTOR (dB/m)
1	*5785.00	115.0 PK			1.24 H	30	76.40	38.60
2	*5785.00	105.3 AV			1.24 H	30	66.70	38.60
3	11570.00	62.3 PK	74.0	-11.7	1.14 H	128	41.90	20.40
4	11570.00	49.0 AV	54.0	-5.0	1.14 H	128	28.60	20.40
ANTENNA POLARITY & TEST DISTANCE: VERTICAL AT 3 M								
NO.	FREQ. (MHz)	EMISSION LEVEL (dBuV/m)	LIMIT (dBuV/m)	MARGIN (dB)	ANTENNA HEIGHT (m)	TABLE ANGLE (Degree)	RAW VALUE (dBuV)	CORRECTION FACTOR (dB/m)
1	*5785.00	116.9 PK			1.05 V	6	78.30	38.60
2	*5785.00	107.3 AV			1.05 V	6	68.70	38.60
3	11570.00	63.1 PK	74.0	-10.9	1.15 V	62	42.70	20.40
4	11570.00	50.8 AV	54.0	-3.2	1.15 V	62	30.40	20.40

REMARKS:

1. Emission Level(dBuV/m) = Raw Value(dBuV) + Correction Factor(dB/m)
2. Correction Factor(dB/m) = Antenna Factor(dB/m) + Cable Factor(dB) – Pre-Amplifier Factor(dB)
3. The other emission levels were very low against the limit.
4. Margin value = Emission Level – Limit value
5. “ * “: Fundamental frequency.
6. The limit value is defined as per 15.247.



A D T

EUT TEST CONDITION		MEASUREMENT DETAIL	
CHANNEL	Channel 165	FREQUENCY RANGE	1 ~ 40GHz
INPUT POWER	120Vac, 60Hz	DETECTOR FUNCTION	Peak (PK) Average (AV)
ENVIRONMENTAL CONDITIONS	25deg. C, 65%RH	TESTED BY	Jones Chang

ANTENNA POLARITY & TEST DISTANCE: HORIZONTAL AT 3 M								
NO.	FREQ. (MHz)	EMISSION LEVEL (dBuV/m)	LIMIT (dBuV/m)	MARGIN (dB)	ANTENNA HEIGHT (m)	TABLE ANGLE (Degree)	RAW VALUE (dBuV)	CORRECTION FACTOR (dB/m)
1	*5825.00	115.0 PK			1.07 H	28	76.30	38.70
2	*5825.00	104.8 AV			1.07 H	28	66.10	38.70
3	#5850.00	77.1 PK	95.0	-17.9	1.22 H	289	70.90	6.20
4	#5850.00	66.9 AV	84.8	-17.9	1.22 H	289	60.70	6.20
5	11650.00	62.1 PK	74.0	-11.9	1.25 H	321	41.80	20.30
6	11650.00	49.0 AV	54.0	-5.0	1.25 H	321	28.70	20.30
ANTENNA POLARITY & TEST DISTANCE: VERTICAL AT 3 M								
NO.	FREQ. (MHz)	EMISSION LEVEL (dBuV/m)	LIMIT (dBuV/m)	MARGIN (dB)	ANTENNA HEIGHT (m)	TABLE ANGLE (Degree)	RAW VALUE (dBuV)	CORRECTION FACTOR (dB/m)
1	*5825.00	117.5 PK			1.00 V	285	78.80	38.70
2	*5825.00	107.6 AV			1.00 V	285	68.90	38.70
3	#5850.00	79.6 PK	97.5	-17.9	1.22 V	289	73.40	6.20
4	#5850.00	69.7 AV	87.6	-17.9	1.22 V	289	63.50	6.20
5	11650.00	62.2 PK	74.0	-11.8	1.10 V	233	41.90	20.30
6	11650.00	50.0 AV	54.0	-4.0	1.10 V	233	29.70	20.30

REMARKS:

1. Emission Level(dBuV/m) = Raw Value(dBuV) + Correction Factor(dB/m)
2. Correction Factor(dB/m) = Antenna Factor(dB/m) + Cable Factor(dB)
– Pre-Amplifier Factor(dB)
3. The other emission levels were very low against the limit.
4. Margin value = Emission Level – Limit value
5. “ * “: Fundamental frequency.
6. The limit value is defined as per 15.247.
7. "#":The radiated frequency is out the restricted band.



A D T

802.11n (40MHz)

EUT TEST CONDITION		MEASUREMENT DETAIL	
CHANNEL	Channel 151	FREQUENCY RANGE	1 ~ 40GHz
INPUT POWER	120Vac, 60Hz	DETECTOR FUNCTION	Peak (PK) Average (AV)
ENVIRONMENTAL CONDITIONS	25deg. C, 65%RH	TESTED BY	Jones Chang

ANTENNA POLARITY & TEST DISTANCE: HORIZONTAL AT 3 M								
NO.	FREQ. (MHz)	EMISSION LEVEL (dBuV/m)	LIMIT (dBuV/m)	MARGIN (dB)	ANTENNA HEIGHT (m)	TABLE ANGLE (Degree)	RAW VALUE (dBuV)	CORRECTION FACTOR (dB/m)
1	#5725.00	90.3 PK	91.6	-1.3	1.05 H	11	84.30	6.00
2	#5725.00	80.9 AV	82.2	-1.3	1.05 H	11	74.90	6.00
3	*5755.00	111.6 PK			1.00 H	31	73.00	38.60
4	*5755.00	102.2 AV			1.00 H	31	63.60	38.60
5	11510.00	61.7 PK	74.0	-12.3	1.18 H	54	41.30	20.40
6	11510.00	49.4 AV	54.0	-4.6	1.18 H	54	29.00	20.40
ANTENNA POLARITY & TEST DISTANCE: VERTICAL AT 3 M								
NO.	FREQ. (MHz)	EMISSION LEVEL (dBuV/m)	LIMIT (dBuV/m)	MARGIN (dB)	ANTENNA HEIGHT (m)	TABLE ANGLE (Degree)	RAW VALUE (dBuV)	CORRECTION FACTOR (dB/m)
1	#5725.00	92.8 PK	94.1	-1.3	1.05 V	11	86.80	6.00
2	#5725.00	81.9 AV	83.2	-1.3	1.05 V	11	75.90	6.00
3	*5755.00	114.1 PK			1.06 V	6	75.50	38.60
4	*5755.00	103.2 AV			1.06 V	6	64.60	38.60
5	11510.00	63.0 PK	74.0	-11.0	1.14 V	85	42.60	20.40
6	11510.00	50.8 AV	54.0	-3.2	1.14 V	85	30.40	20.40

REMARKS:

1. Emission Level(dBuV/m) = Raw Value(dBuV) + Correction Factor(dB/m)
2. Correction Factor(dB/m) = Antenna Factor(dB/m) + Cable Factor(dB)
– Pre-Amplifier Factor(dB)
3. The other emission levels were very low against the limit.
4. Margin value = Emission Level – Limit value
5. " * ": Fundamental frequency.
6. The limit value is defined as per 15.247.
7. "#":The radiated frequency is out the restricted band.



A D T

EUT TEST CONDITION		MEASUREMENT DETAIL	
CHANNEL	Channel 159	FREQUENCY RANGE	1 ~ 40GHz
INPUT POWER	120Vac, 60Hz	DETECTOR FUNCTION	Peak (PK) Average (AV)
ENVIRONMENTAL CONDITIONS	25deg. C, 65%RH	TESTED BY	Jones Chang

ANTENNA POLARITY & TEST DISTANCE: HORIZONTAL AT 3 M								
NO.	FREQ. (MHz)	EMISSION LEVEL (dBuV/m)	LIMIT (dBuV/m)	MARGIN (dB)	ANTENNA HEIGHT (m)	TABLE ANGLE (Degree)	RAW VALUE (dBuV)	CORRECTION FACTOR (dB/m)
1	*5795.00	112.3 PK			1.00 H	33	73.70	38.60
2	*5795.00	102.5 AV			1.00 H	33	63.90	38.60
3	#5850.00	73.7 PK	92.3	-18.6	1.01 H	289	67.50	6.20
4	#5850.00	63.9 AV	82.5	-18.6	1.01 H	289	57.70	6.20
5	11590.00	62.0 PK	74.0	-12.0	1.37 H	146	41.60	20.40
6	11590.00	49.0 AV	54.0	-5.0	1.37 H	146	28.60	20.40
ANTENNA POLARITY & TEST DISTANCE: VERTICAL AT 3 M								
NO.	FREQ. (MHz)	EMISSION LEVEL (dBuV/m)	LIMIT (dBuV/m)	MARGIN (dB)	ANTENNA HEIGHT (m)	TABLE ANGLE (Degree)	RAW VALUE (dBuV)	CORRECTION FACTOR (dB/m)
1	*5795.00	114.4 PK			1.00 V	285	75.80	38.60
2	*5795.00	104.7 AV			1.00 V	285	66.10	38.60
3	#5850.00	75.8 PK	94.4	-18.6	1.01 V	289	69.60	6.20
4	#5850.00	66.1 AV	84.7	-18.6	1.01 V	289	59.90	6.20
5	11590.00	62.9 PK	74.0	-11.1	1.33 V	225	42.50	20.40
6	11590.00	50.7 AV	54.0	-3.3	1.33 V	225	30.30	20.40

REMARKS:

1. Emission Level(dBuV/m) = Raw Value(dBuV) + Correction Factor(dB/m)
2. Correction Factor(dB/m) = Antenna Factor(dB/m) + Cable Factor(dB)
– Pre-Amplifier Factor(dB)
3. The other emission levels were very low against the limit.
4. Margin value = Emission Level – Limit value
5. “ * “: Fundamental frequency.
6. The limit value is defined as per 15.247.
7. “#”:The radiated frequency is out the restricted band.



A D T

BELOW 1GHz WORST-CASE DATA : 802.11n (20MHz)

EUT TEST CONDITION		MEASUREMENT DETAIL	
CHANNEL	Channel 165	FREQUENCY RANGE	Below 1000MHz
INPUT POWER	120Vac, 60Hz	DETECTOR FUNCTION	Quasi-Peak
ENVIRONMENTAL CONDITIONS	25deg. C, 65%RH	TESTED BY	Chris Lin
TEST MODE	A		

ANTENNA POLARITY & TEST DISTANCE: HORIZONTAL AT 3 M

NO.	FREQ. (MHz)	EMISSION LEVEL (dBuV/m)	LIMIT (dBuV/m)	MARGIN (dB)	ANTENNA HEIGHT (m)	TABLE ANGLE (Degree)	RAW VALUE (dBuV)	CORRECTION FACTOR (dB/m)
1	115.28	28.1 QP	43.5	-15.4	1.25 H	263	44.90	-16.80
2	243.34	35.1 QP	46.0	-10.9	1.00 H	240	49.60	-14.50
3	280.21	33.0 QP	46.0	-13.0	1.50 H	154	45.70	-12.70
4	375.29	29.0 QP	46.0	-17.0	1.00 H	92	39.90	-10.90
5	499.48	30.9 QP	46.0	-15.1	1.25 H	214	39.20	-8.30
6	625.60	30.2 QP	46.0	-15.8	1.50 H	167	35.70	-5.50

ANTENNA POLARITY & TEST DISTANCE: VERTICAL AT 3 M

NO.	FREQ. (MHz)	EMISSION LEVEL (dBuV/m)	LIMIT (dBuV/m)	MARGIN (dB)	ANTENNA HEIGHT (m)	TABLE ANGLE (Degree)	RAW VALUE (dBuV)	CORRECTION FACTOR (dB/m)
1	55.13	34.3 QP	40.0	-5.7	1.25 V	21	48.60	-14.30
2	115.28	32.6 QP	43.5	-10.9	1.25 V	155	49.40	-16.80
3	243.34	34.5 QP	46.0	-11.5	1.00 V	170	49.00	-14.50
4	499.48	33.9 QP	46.0	-12.1	1.50 V	207	42.20	-8.30
5	600.38	30.7 QP	46.0	-15.3	1.00 V	158	36.80	-6.10
6	802.18	29.9 QP	46.0	-16.1	1.50 V	163	32.10	-2.20

REMARKS:

1. Emission Level(dBuV/m) = Raw Value(dBuV) + Correction Factor(dB/m)
2. Correction Factor(dB/m) = Antenna Factor(dB/m) + Cable Factor(dB) – Pre-Amplifier Factor (dB)
3. The other emission levels were very low against the limit.
4. Margin value = Emission Level – Limit value



A D T

EUT TEST CONDITION		MEASUREMENT DETAIL	
CHANNEL	Channel 165	FREQUENCY RANGE	Below 1000MHz
INPUT POWER	120Vac, 60Hz	DETECTOR FUNCTION	Quasi-Peak
ENVIRONMENTAL CONDITIONS	25deg. C, 65%RH	TESTED BY	Chris Lin
TEST MODE	B		

ANTENNA POLARITY & TEST DISTANCE: HORIZONTAL AT 3 M								
NO.	FREQ. (MHz)	EMISSION LEVEL (dBuV/m)	LIMIT (dBuV/m)	MARGIN (dB)	ANTENNA HEIGHT (m)	TABLE ANGLE (Degree)	RAW VALUE (dBuV)	CORRECTION FACTOR (dB/m)
1	57.12	24.2 QP	40.0	-15.8	1.25 H	343	39.10	-14.90
2	212.66	28.7 QP	43.5	-14.8	1.00 H	181	45.00	-16.30
3	374.04	33.1 QP	46.0	-12.9	1.50 H	183	44.00	-10.90
4	624.85	37.1 QP	46.0	-8.9	1.00 H	175	42.60	-5.50
5	751.23	32.5 QP	46.0	-13.5	1.25 H	95	35.50	-3.00
6	875.67	37.6 QP	46.0	-8.4	1.50 H	52	38.60	-1.00

ANTENNA POLARITY & TEST DISTANCE: VERTICAL AT 3 M								
NO.	FREQ. (MHz)	EMISSION LEVEL (dBuV/m)	LIMIT (dBuV/m)	MARGIN (dB)	ANTENNA HEIGHT (m)	TABLE ANGLE (Degree)	RAW VALUE (dBuV)	CORRECTION FACTOR (dB/m)
1	249.60	24.8 QP	46.0	-21.2	1.25 V	210	39.00	-14.20
2	374.04	27.7 QP	46.0	-18.3	1.00 V	188	38.60	-10.90
3	500.42	27.4 QP	46.0	-18.6	1.50 V	82	35.70	-8.30
4	624.85	34.7 QP	46.0	-11.3	1.00 V	186	40.20	-5.50
5	751.23	28.2 QP	46.0	-17.8	1.50 V	142	31.20	-3.00
6	875.67	33.5 QP	46.0	-12.5	1.25 V	94	34.50	-1.00

REMARKS:

1. Emission Level(dBuV/m) = Raw Value(dBuV) + Correction Factor(dB/m)
2. Correction Factor(dB/m) = Antenna Factor(dB/m) + Cable Factor(dB) – Pre-Amplifier Factor (dB)
3. The other emission levels were very low against the limit.
4. Margin value = Emission Level – Limit value



A D T

5.2 CONDUCTED EMISSION MEASUREMENT

5.2.1 LIMITS OF CONDUCTED EMISSION MEASUREMENT

FREQUENCY OF EMISSION (MHz)	CONDUCTED LIMIT (dB μ V)	
	Quasi-peak	Average
0.15 ~ 0.5	66 to 56	56 to 46
0.5 ~ 5	56	46
5 ~ 30	60	50

- NOTE:**
1. The lower limit shall apply at the transition frequencies.
 2. The limit decreases in line with the logarithm of the frequency in the range of 0.15 to 0.50MHz.
 3. All emanations from a class A/B digital device or system, including any network of conductors and apparatus connected thereto, shall not exceed the level of field strengths specified above.

5.2.2 TEST INSTRUMENTS

Same as item 4.2.2.

5.2.3 TEST PROCEDURES

Same as item 4.2.3.

5.2.4 DEVIATION FROM TEST STANDARD

No deviation.

5.2.5 TEST SETUP

Same as item 4.2.5.

5.2.6 EUT OPERATING CONDITIONS

Same as item 4.1.6.

5.2.7 TEST RESULTS

CONDUCTED WORST-CASE DATA : 802.11n (20MHz)

PHASE	Line 1	6dB BANDWIDTH	9kHz
TEST MODE	A		

No	Freq. [MHz]	Corr. Factor (dB)	Reading Value		Emission Level		Limit		Margin	
			[dB (uV)]		[dB (uV)]		[dB (uV)]		(dB)	
			Q.P.	AV.	Q.P.	AV.	Q.P.	AV.	Q.P.	AV.
1	0.17744	0.10	49.42	35.74	49.52	35.84	64.60	54.60	-15.08	-18.76
2	0.32959	0.11	46.45	34.88	46.56	34.99	59.46	49.46	-12.90	-14.47
3	0.36816	0.12	51.26	46.11	51.38	46.23	58.54	48.54	-7.17	-2.32
4	0.58792	0.13	42.69	36.50	42.82	36.63	56.00	46.00	-13.18	-9.37
5	1.23307	0.15	41.82	33.86	41.97	34.01	56.00	46.00	-14.03	-11.99
6	3.12942	0.20	40.69	33.80	40.89	34.00	56.00	46.00	-15.11	-12.00

REMARKS:

1. Q.P. and AV. are abbreviations of quasi-peak and average individually.
2. The emission levels of other frequencies were very low against the limit.
3. Margin value = Emission level - Limit value
4. Correction factor = Insertion loss + Cable loss
5. Emission Level = Correction Factor + Reading Value

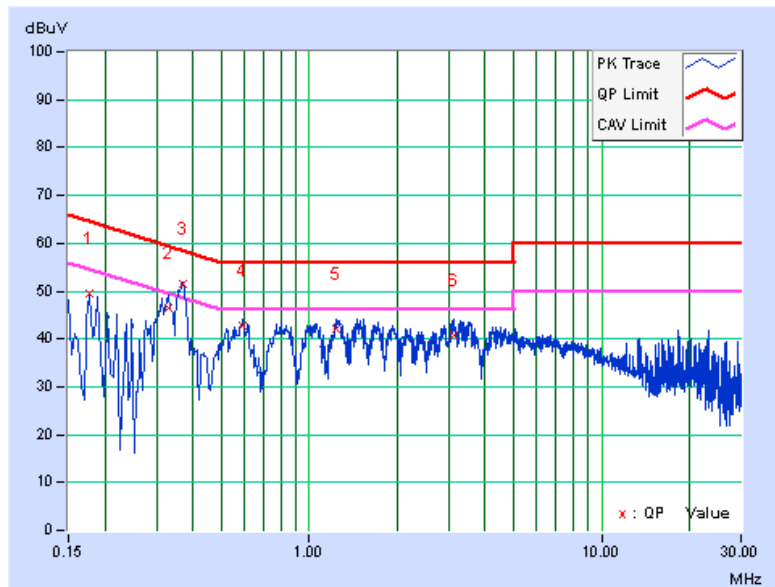



A D T

PHASE	Line 2	6dB BANDWIDTH	9kHz
TEST MODE	A		

No	Freq. [MHz]	Corr. Factor (dB)	Reading Value		Emission Level		Limit		Margin	
			[dB (uV)]		[dB (uV)]		[dB (uV)]		(dB)	
			Q.P.	AV.	Q.P.	AV.	Q.P.	AV.	Q.P.	AV.
1	0.15000	0.11	54.88	40.23	54.99	40.34	66.00	56.00	-11.01	-15.66
2	0.17744	0.11	50.35	33.77	50.46	33.88	64.60	54.60	-14.14	-20.72
3	0.32986	0.12	42.61	27.12	42.73	27.24	59.45	49.45	-16.72	-22.21
4	0.58792	0.13	37.40	24.43	37.53	24.56	56.00	46.00	-18.47	-21.44
5	1.23065	0.14	35.16	22.51	35.30	22.65	56.00	46.00	-20.70	-23.35
6	3.33274	0.19	35.18	24.21	35.37	24.40	56.00	46.00	-20.63	-21.60

REMARKS:

1. Q.P. and AV. are abbreviations of quasi-peak and average individually.
2. The emission levels of other frequencies were very low against the limit.
3. Margin value = Emission level - Limit value
4. Correction factor = Insertion loss + Cable loss
5. Emission Level = Correction Factor + Reading Value

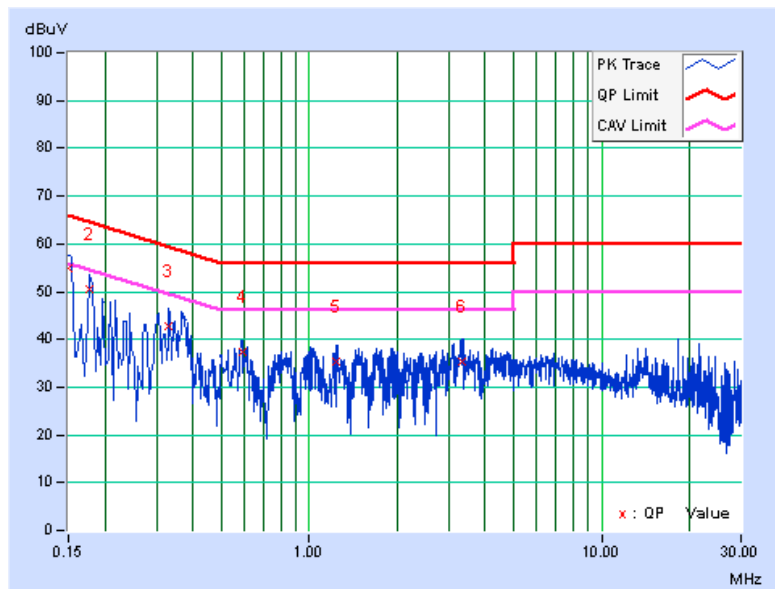

PHASE	Line 1	6dB BANDWIDTH	9kHz
TEST MODE	B		

No	Freq. [MHz]	Corr. Factor (dB)	Reading Value		Emission Level		Limit		Margin	
			[dB (uV)]		[dB (uV)]		[dB (uV)]		(dB)	
			Q.P.	AV.	Q.P.	AV.	Q.P.	AV.	Q.P.	AV.
1	0.15000	0.10	52.68	35.79	52.78	35.89	66.00	56.00	-13.22	-20.11
2	0.16745	0.10	51.90	36.79	52.00	36.89	65.09	55.09	-13.09	-18.20
3	0.47844	0.12	47.05	39.17	47.17	39.29	56.37	46.37	-9.19	-7.07
4	1.89386	0.17	41.53	35.66	41.70	35.83	56.00	46.00	-14.30	-10.17
5	4.03263	0.23	40.68	35.47	40.91	35.70	56.00	46.00	-15.09	-10.30
6	10.02275	0.49	40.09	34.17	40.58	34.66	60.00	50.00	-19.42	-15.34

REMARKS:

1. Q.P. and AV. are abbreviations of quasi-peak and average individually.
2. The emission levels of other frequencies were very low against the limit.
3. Margin value = Emission level - Limit value
4. Correction factor = Insertion loss + Cable loss
5. Emission Level = Correction Factor + Reading Value

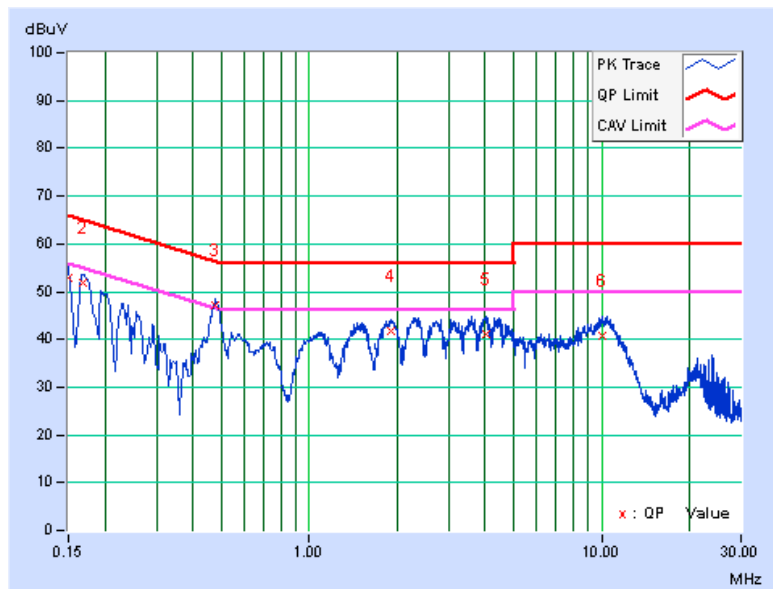

PHASE	Line 2	6dB BANDWIDTH	9kHz
TEST MODE	B		

No	Freq. [MHz]	Corr. Factor (dB)	Reading Value		Emission Level		Limit		Margin	
			[dB (uV)]		[dB (uV)]		[dB (uV)]		(dB)	
			Q.P.	AV.	Q.P.	AV.	Q.P.	AV.	Q.P.	AV.
1	0.16955	0.11	52.57	39.83	52.68	39.94	64.98	54.98	-12.30	-15.04
2	0.48041	0.13	47.33	39.32	47.46	39.45	56.33	46.33	-8.87	-6.88
3	1.47549	0.15	39.62	33.24	39.77	33.39	56.00	46.00	-16.23	-12.61
4	2.67195	0.18	40.28	34.75	40.46	34.93	56.00	46.00	-15.54	-11.07
5	4.33370	0.22	39.60	33.51	39.82	33.73	56.00	46.00	-16.18	-12.27
6	10.06185	0.37	37.12	31.47	37.49	31.84	60.00	50.00	-22.51	-18.16

REMARKS:

1. Q.P. and AV. are abbreviations of quasi-peak and average individually.
2. The emission levels of other frequencies were very low against the limit.
3. Margin value = Emission level - Limit value
4. Correction factor = Insertion loss + Cable loss
5. Emission Level = Correction Factor + Reading Value

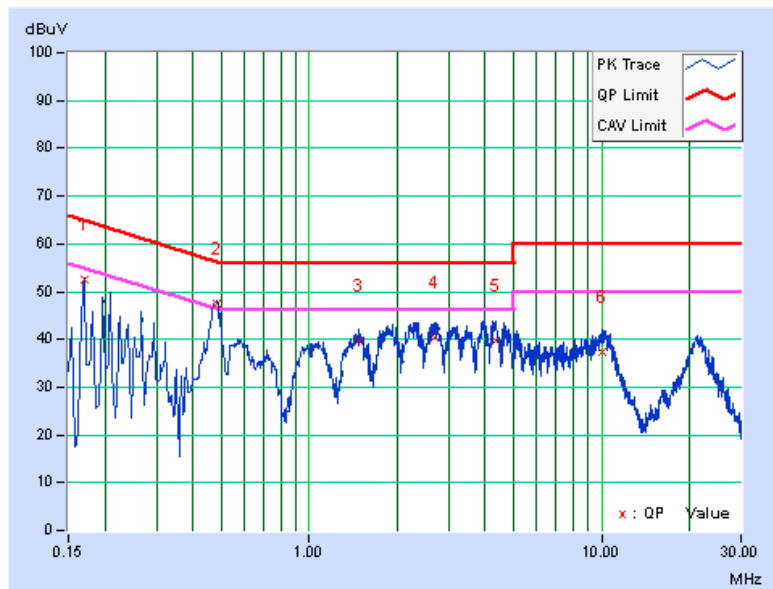



A D T

5.3 6dB BANDWIDTH MEASUREMENT

5.3.1 LIMITS OF 6dB BANDWIDTH MEASUREMENT

The minimum of 6dB Bandwidth Measurement is 0.5MHz.

5.3.2 TEST SETUP

Same as item 4.3.2.

5.3.3 TEST INSTRUMENTS

Refer to section 4.1.2 to get information of above instrument.

5.3.4 TEST PROCEDURE

Same as item 4.3.4.

5.3.5 DEVIATION FROM TEST STANDARD

No deviation.

5.3.6 EUT OPERATING CONDITIONS

Same as item 4.3.6.



5.3.7 TEST RESULTS

802.11a

CHANNEL	FREQUENCY (MHz)	6dB BANDWIDTH (MHz)		MINIMUM LIMIT (MHz)	PASS / FAIL
		CHAIN 0	CHAIN 1		
149	5745	16.37	15.79	0.5	PASS
157	5785	15.13	15.75	0.5	PASS
165	5825	16.38	16.39	0.5	PASS

802.11n (20MHz)

CHANNEL	FREQUENCY (MHz)	6dB BANDWIDTH (MHz)		MINIMUM LIMIT (MHz)	PASS / FAIL
		CHAIN 0	CHAIN 1		
149	5745	17.60	15.73	0.5	PASS
157	5785	17.59	17.60	0.5	PASS
165	5825	17.57	15.71	0.5	PASS

802.11n (40MHz)

CHANNEL	FREQUENCY (MHz)	6dB BANDWIDTH (MHz)		MINIMUM LIMIT (MHz)	PASS / FAIL
		CHAIN 0	CHAIN 1		
151	5755	36.18	36.11	0.5	PASS
159	5795	35.54	35.82	0.5	PASS



A D T

SPECTRUM PLOT OF WORST VALUE

802.11a

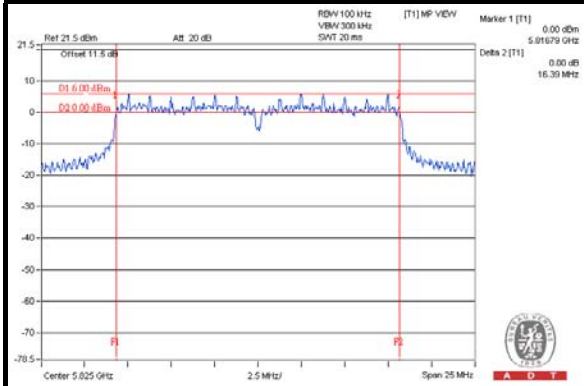

802.11n (20MHz)

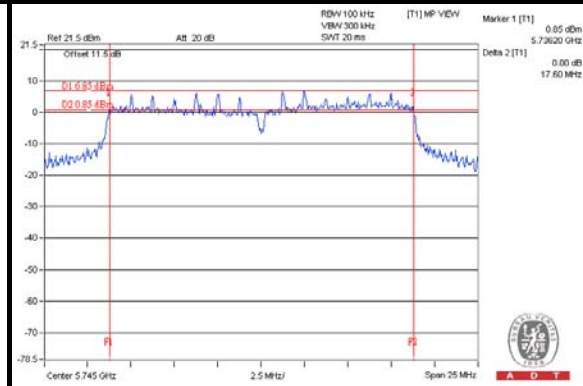

802.11n (40MHz)

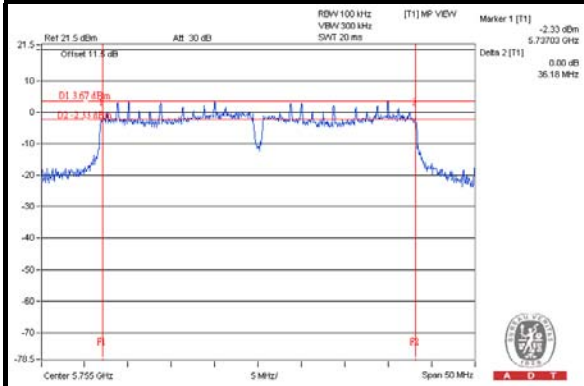



A D T

5.4 CONDUCTED OUTPUT POWER

5.4.1 LIMITS OF CONDUCTED OUTPUT POWER MEASUREMENT

For systems using digital modulation in the 5725 –5850 MHz bands: 1 Watt (30dBm)

Per KDB 662911 D01 Multiple Transmitter Output v02 Method of conducted output power measurement on IEEE 802.11 devices,

Array Gain = 0 dB (i.e., no array gain) for $NANT \leq 4$;

Array Gain = 0 dB (i.e., no array gain) for channel widths ≥ 40 MHz for any NANT;

Array Gain = $5 \log(NANT/NSS)$ dB or 3 dB, whichever is less for 20-MHz channel widths with $NANT \geq 5$.

For power measurements on all other devices: Array Gain = $10 \log(NANT/NSS)$ dB.

5.4.2 TEST SETUP

Same as Item 4.4.2.

5.4.3 INSTRUMENTS

Refer to section 4.1.2 to get information of above instrument.

5.4.4 TEST PROCEDURES

Same as Item 4.4.4.

5.4.5 DEVIATION FROM TEST STANDARD

No deviation.

5.4.6 EUT OPERATING CONDITIONS

Same as Item 4.3.6.



5.4.7 TEST RESULTS

FOR PEAK POWER

802.11a

CHAN.	FREQ. (MHz)	PEAK POWER (dBm)		TOTAL POWER (mW)	TOTAL POWER (dBm)	LIMIT (dBm)	PASS / FAIL
		CHAIN 0	CHAIN 1				
149	5745	21.79	21.68	298.239	24.75	30	PASS
157	5785	21.59	22.15	308.271	24.89	30	PASS
165	5825	21.56	22.10	305.400	24.85	30	PASS

802.11n (20MHz)

CHAN.	FREQ. (MHz)	PEAK POWER (dBm)		TOTAL POWER (mW)	TOTAL POWER (dBm)	LIMIT (dBm)	PASS / FAIL
		CHAIN 0	CHAIN 1				
149	5745	21.58	22.25	311.760	24.94	30	PASS
157	5785	21.91	22.20	321.198	25.07	30	PASS
165	5825	22.51	22.10	340.419	25.32	30	PASS

802.11n (40MHz)

CHAN.	FREQ. (MHz)	PEAK POWER (dBm)		TOTAL POWER (mW)	TOTAL POWER (dBm)	LIMIT (dBm)	PASS / FAIL
		CHAIN 0	CHAIN 1				
151	5755	21.79	22.17	315.824	24.99	30	PASS
159	5795	22.35	22.20	337.750	25.29	30	PASS

**FOR AVERAGE POWER****802.11a**

CHANNEL	FREQUENCY (MHz)	AVG. POWER (dBm)		TOTAL POWER (mW)	TOTAL POWER (dBm)
		CHAIN 0	CHAIN 1		
149	5745	17.25	17.12	104.611	20.20
157	5785	16.43	17.16	95.954	19.82
165	5825	16.08	17.17	92.670	19.67

802.11n (20MHz)

CHANNEL	FREQUENCY (MHz)	AVG. POWER (dBm)		TOTAL POWER (mW)	TOTAL POWER (dBm)
		CHAIN 0	CHAIN 1		
149	5745	17.39	18.36	123.377	20.91
157	5785	17.93	18.66	135.538	21.32
165	5825	17.16	18.09	116.417	20.66

802.11n (40MHz)

CHANNEL	FREQUENCY (MHz)	AVG. POWER (dBm)		TOTAL POWER (mW)	TOTAL POWER (dBm)
		CHAIN 0	CHAIN 1		
151	5755	17.52	17.89	118.012	20.72
159	5795	17.33	18.00	117.171	20.69



A D T

5.5 POWER SPECTRAL DENSITY MEASUREMENT

5.5.1 LIMITS OF POWER SPECTRAL DENSITY MEASUREMENT

The Maximum of Power Spectral Density Measurement is 8dBm.

5.5.2 TEST SETUP

Same as item 4.5.2.

5.5.3 TEST INSTRUMENTS

Refer to section 4.1.2 to get information of above instrument.

5.5.4 TEST PROCEDURE.

Same as item 4.5.4.

5.5.5 DEVIATION FROM TEST STANDARD

No deviation.

5.5.6 EUT OPERATING CONDITION

Same as item 4.3.6.



A D T

5.5.7 TEST RESULTS

802.11a

TX chain	Channel	Freq. (MHz)	PSD (dBm/3kHz)	10 log (N=2) dB	Total PSD (dBm/3kHz)	Limit (dBm/3kHz)	PASS /FAIL
0	149	5745	-8.70	3.01	-5.54	4.99	PASS
	157	5785	-8.31	3.01	-5.15	4.99	PASS
	165	5825	-9.84	3.01	-6.68	4.99	PASS
1	149	5745	-8.54	3.01	-5.38	4.99	PASS
	157	5785	-9.41	3.01	-6.25	4.99	PASS
	165	5825	-9.38	3.01	-6.22	4.99	PASS

NOTE: Directional gain = 6dBi + 10log(2) = 9.01dBi > 6dBi , so the power density limit shall be reduced to 8-(9.01-6) = 4.99dBm.

802.11n (20MHz)

TX chain	Channel	Freq. (MHz)	PSD (dBm/3kHz)	10 log (N=2) dB	Total PSD (dBm/3kHz)	Limit (dBm/3kHz)	PASS /FAIL
0	149	5745	-9.31	3.01	-6.16	4.99	PASS
	157	5785	-8.80	3.01	-5.65	4.99	PASS
	165	5825	-8.99	3.01	-5.84	4.99	PASS
1	149	5745	-8.38	3.01	-5.23	4.99	PASS
	157	5785	-7.82	3.01	-4.67	4.99	PASS
	165	5825	-8.10	3.01	-4.95	4.99	PASS

NOTE: Directional gain = 6dBi + 10log(2) = 9.01dBi > 6dBi , so the power density limit shall be reduced to 8-(9.01-6) = 4.99dBm.

802.11n (40MHz)

TX chain	Channel	Freq. (MHz)	PSD (dBm/3kHz)	10 log (N=2) dB	Total PSD (dBm/3kHz)	Limit (dBm/3kHz)	PASS /FAIL
0	151	5755	-12.57	3.01	-9.32	4.99	PASS
	159	5795	-10.38	3.01	-7.13	4.99	PASS
1	151	5755	-11.34	3.01	-8.09	4.99	PASS
	159	5795	-10.40	3.01	-7.15	4.99	PASS

NOTE: Directional gain = 6dBi + 10log(2) = 9.01dBi > 6dBi , so the power density limit shall be reduced to 8-(9.01-6) = 4.99dBm.



A D T

SPECTRUM PLOT OF WORST VALUE

802.11a

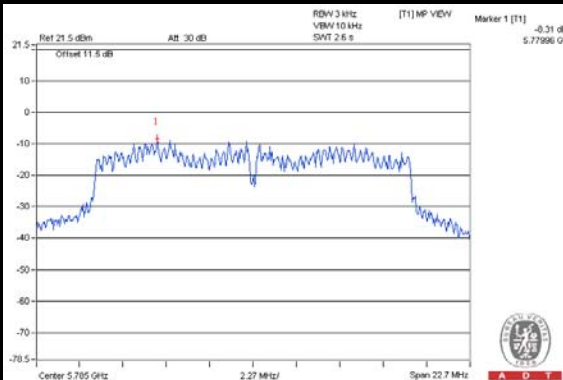

802.11n (20MHz)

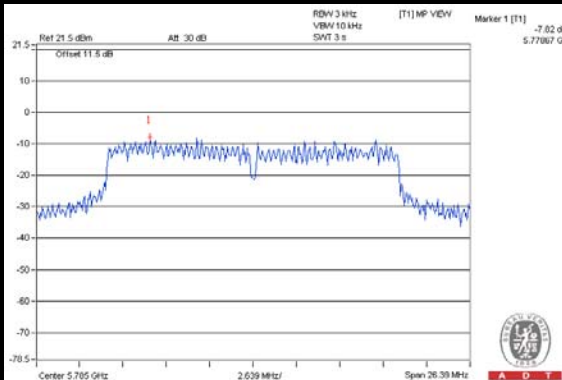

802.11n (40MHz)

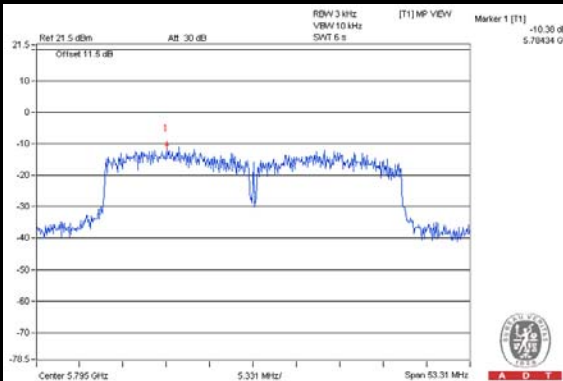



A D T

5.6 CONDUCTED OUT OF BAND EMISSION MEASUREMENT

5.6.1 LIMITS OF CONDUCTED OUT OF BAND EMISSION MEASUREMENT

Below -20dB of the highest emission level of operating band (in 100kHz Resolution Bandwidth).

5.6.2 TEST SETUP

Same as Item 4.6.2

5.6.3 TEST INSTRUMENTS

Refer to section 4.1.2 to get information of above instrument.

5.6.4 TEST PROCEDURE

Same as Item 4.6.4

5.6.5 DEVIATION FROM TEST STANDARD

No deviation.

5.6.6 EUT OPERATING CONDITION

Same as Item 4.3.6

5.6.7 TEST RESULTS

The conducted emission test is performed on each TX port of operating mode without summing or adding $10\log(N)$ since the limit is relative emission limit.

The spectrum plots are attached on the following pages. D1 line indicates the highest level, and D2 line indicates the 20dB offset below D1. It shows compliance with the requirement.



A D T

802.11a CHAIN 0

CH 149

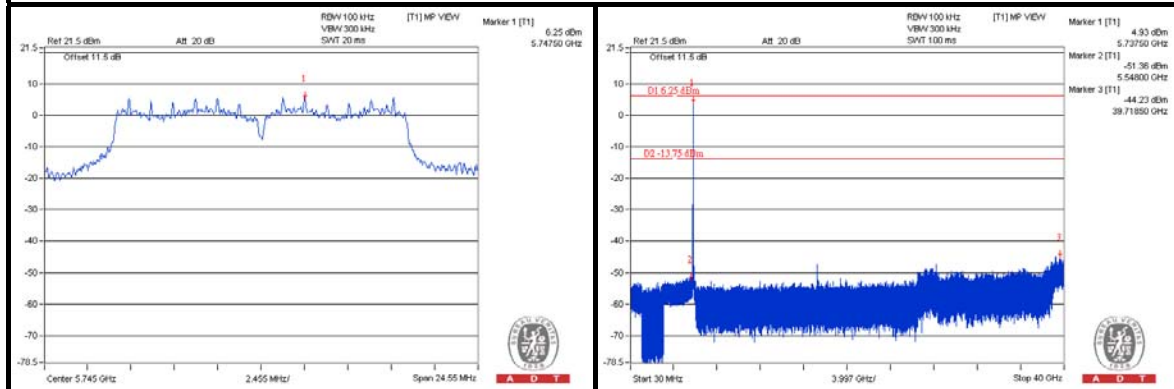

CH 157

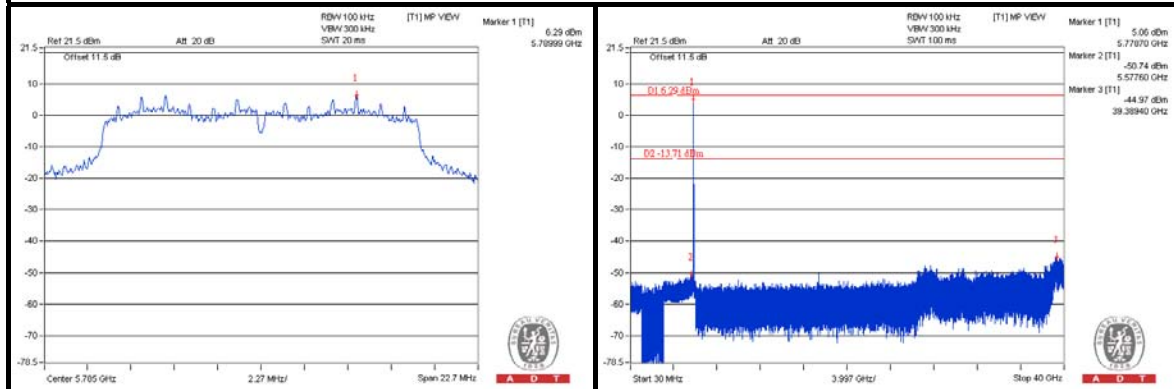

CH 165

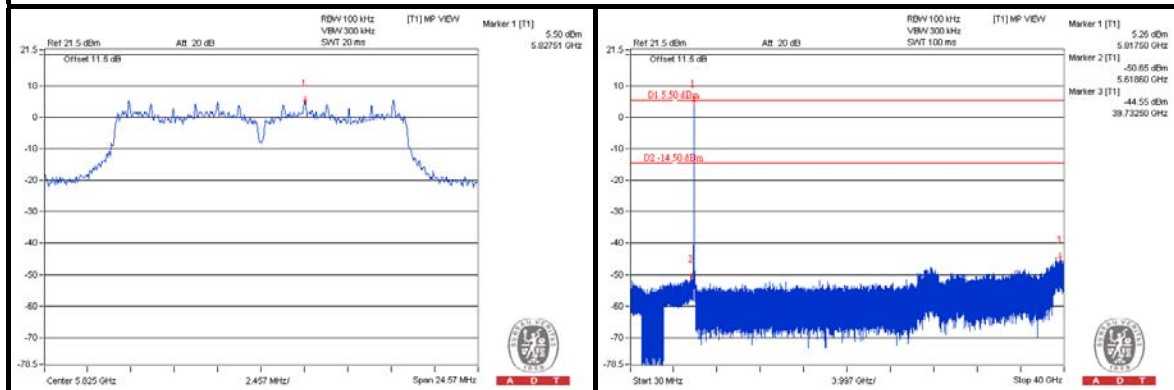

CH 149 Band edge

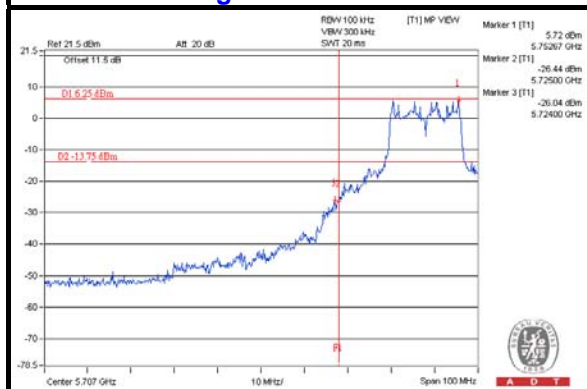

CH 165 Band edge

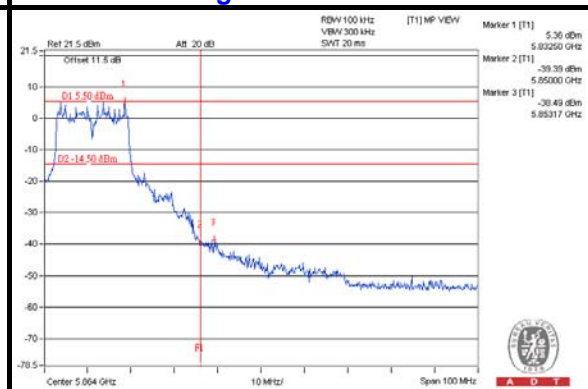



A D T

CHAIN 1 CH 149

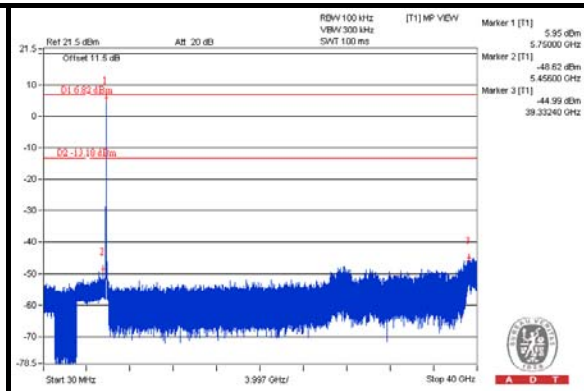
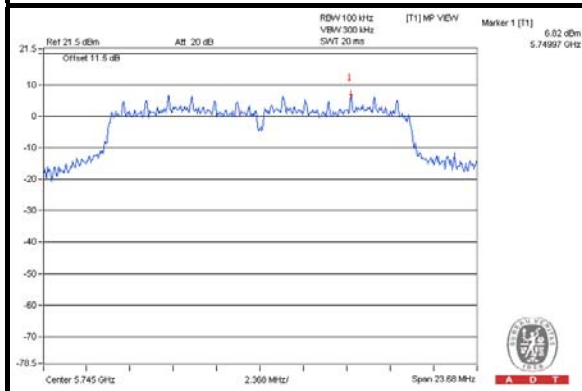

CH 157

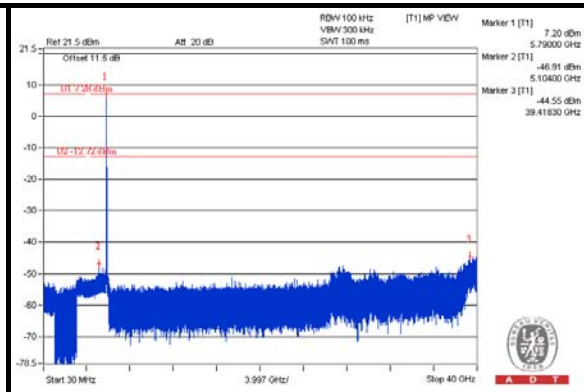
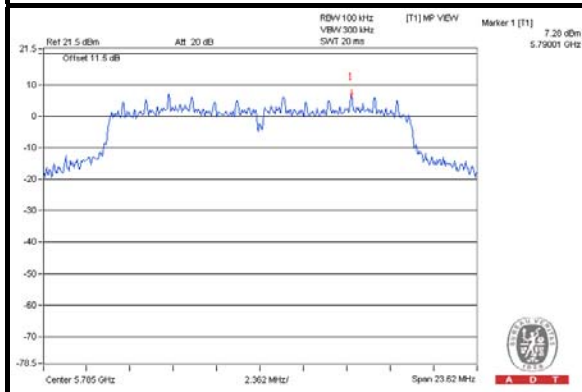

CH 165

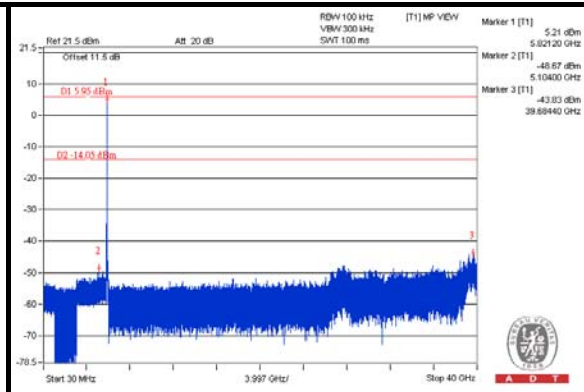
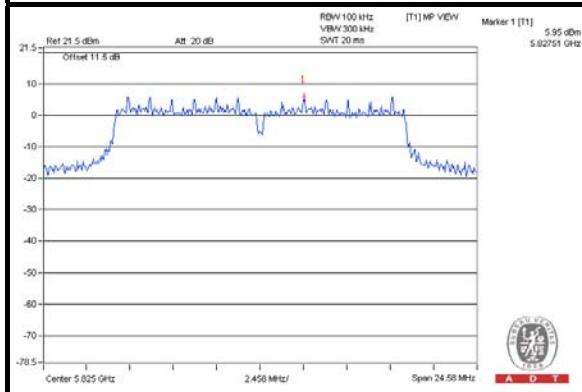

CH 149 Band edge

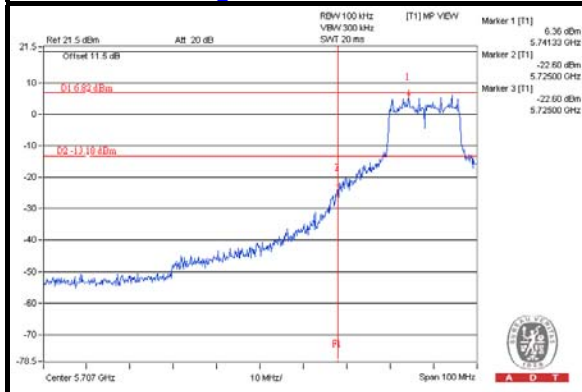

CH 165 Band edge

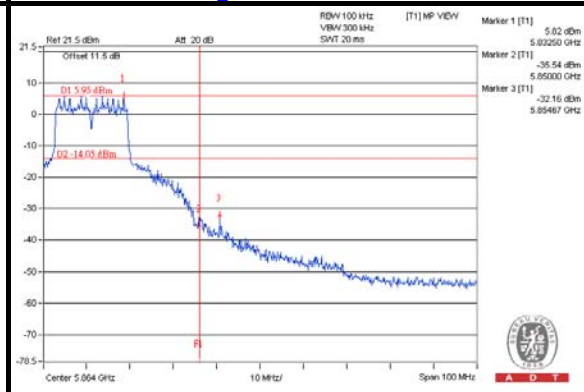



A D T

802.11n (20MHz) CHAIN 0

CH 149

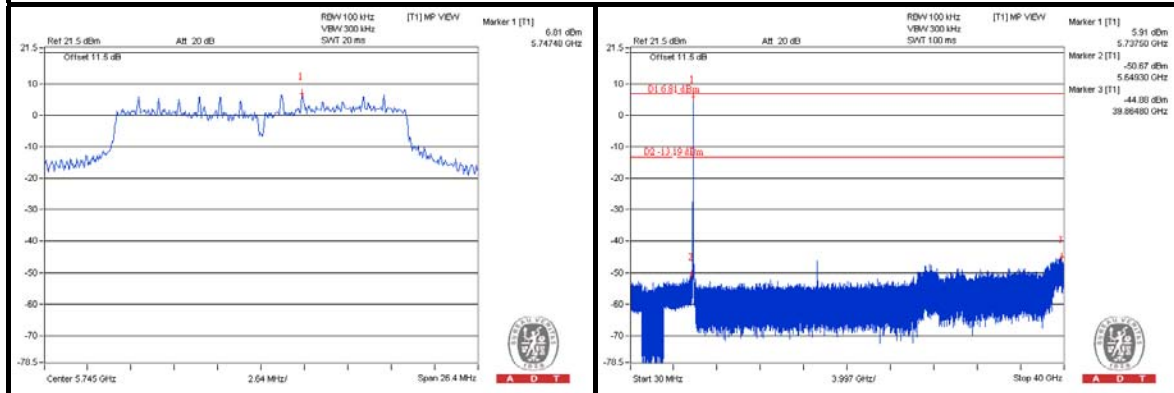

CH 157

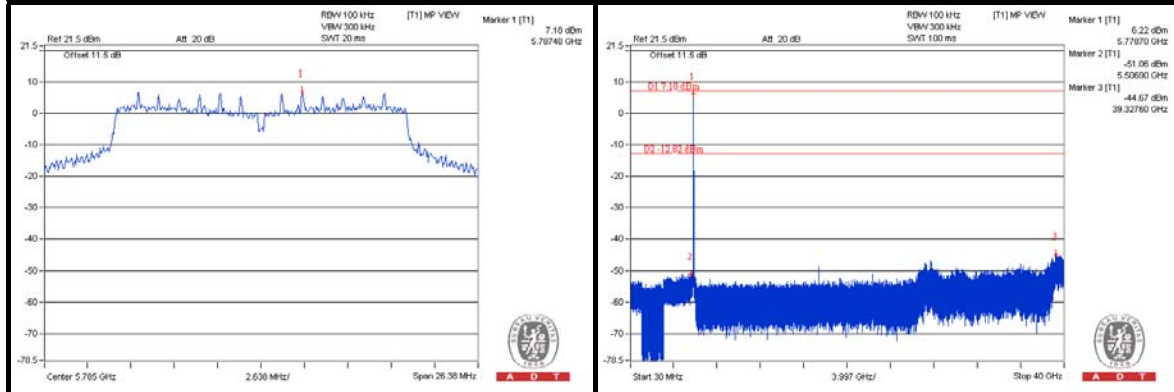

CH 165

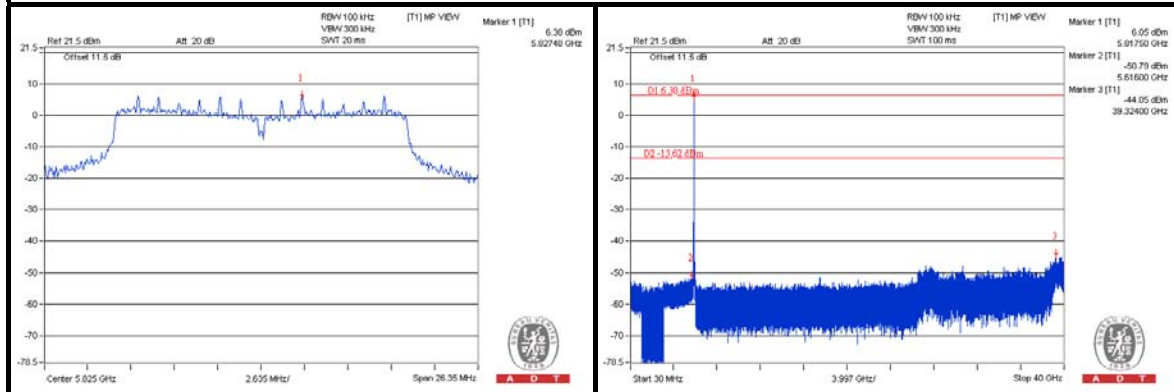

CH 149 Band edge

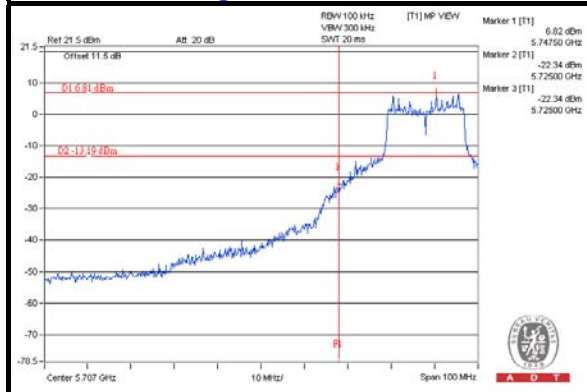

CH 165 Band edge

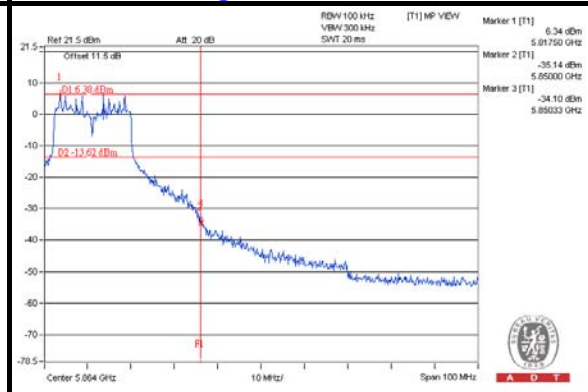



A D T

CHAIN 1

CH 149

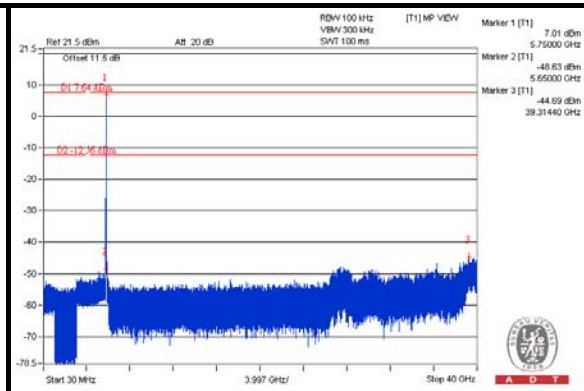
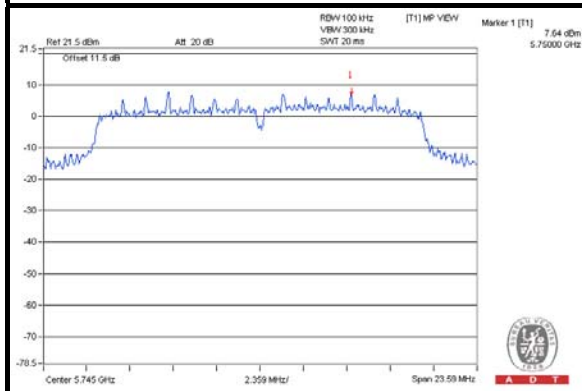

CH 157

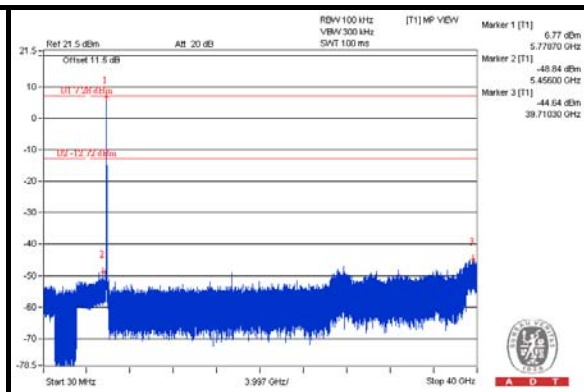
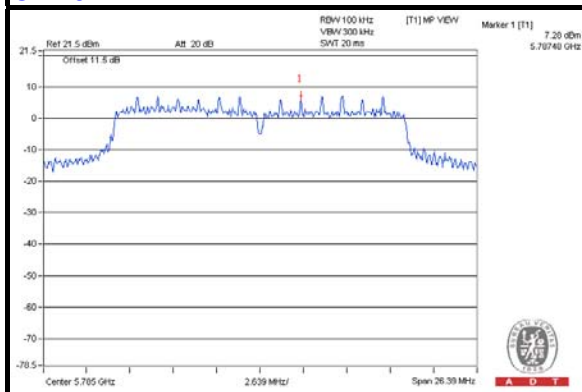

CH 165

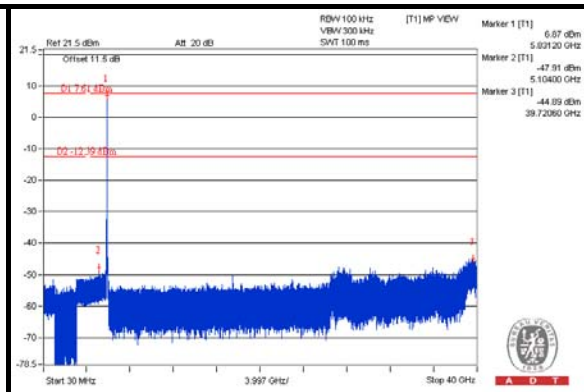
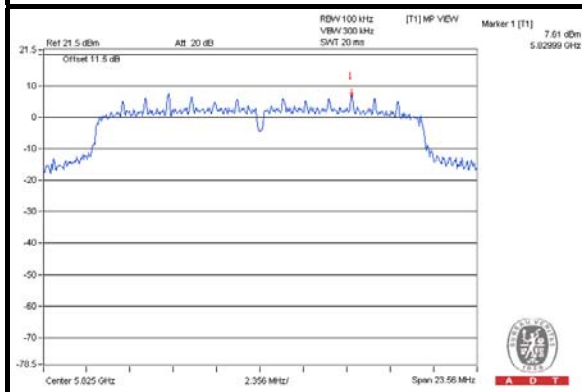

CH 149 Band edge

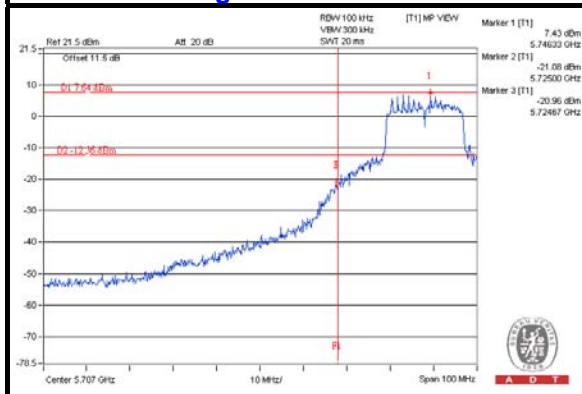

CH 165 Band edge

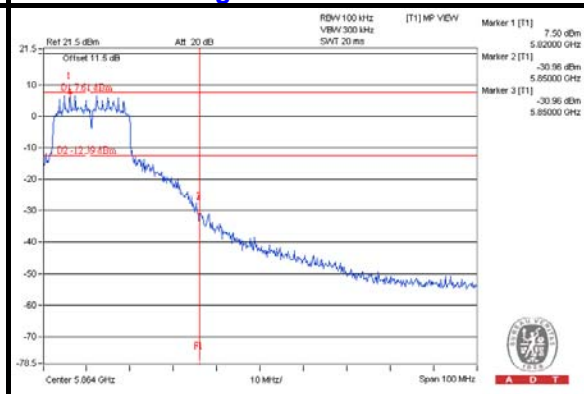



A D T

802.11n (40MHz) CHAIN 0

CH 151

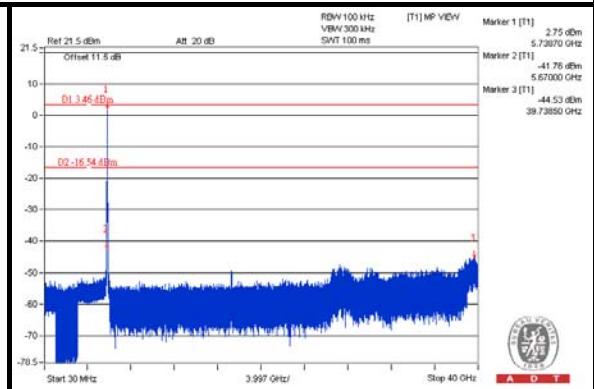
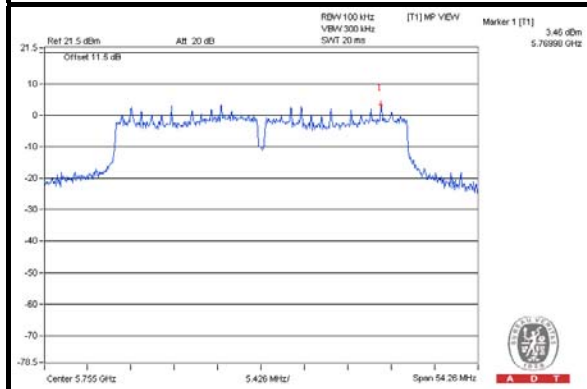

CH 159

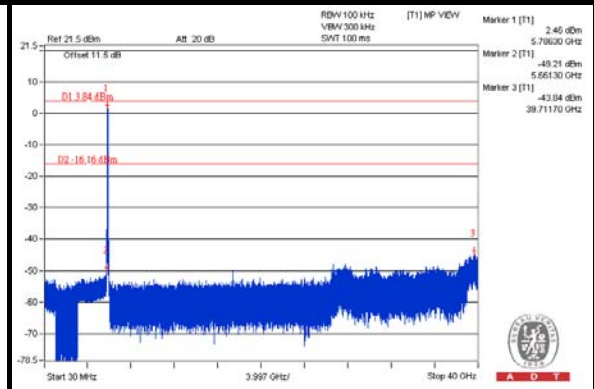
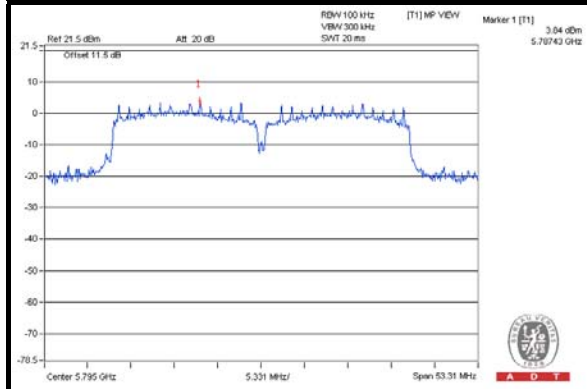

CH 151 Band edge

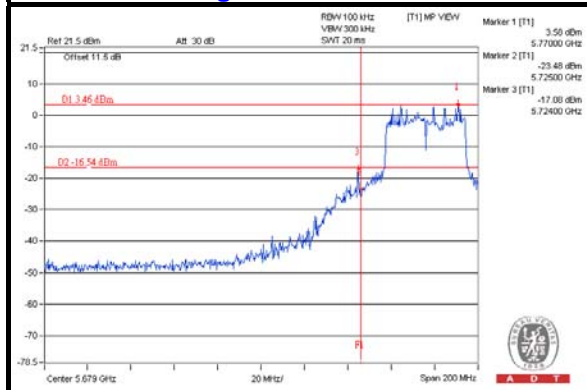

CH 159 Band edge

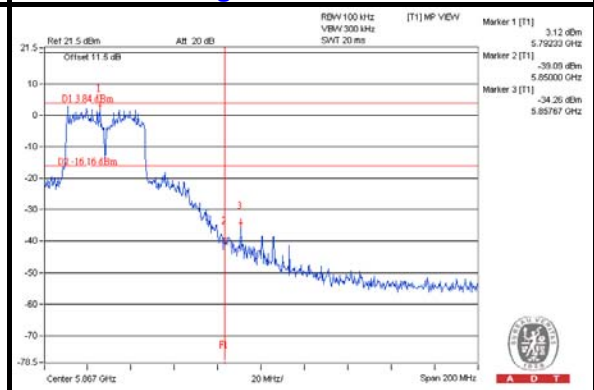



A D T

CHAIN 1 CH 151

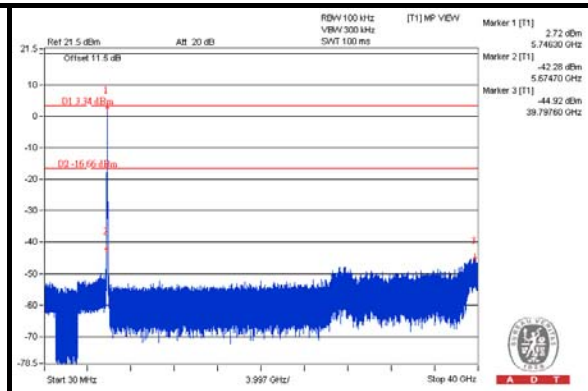
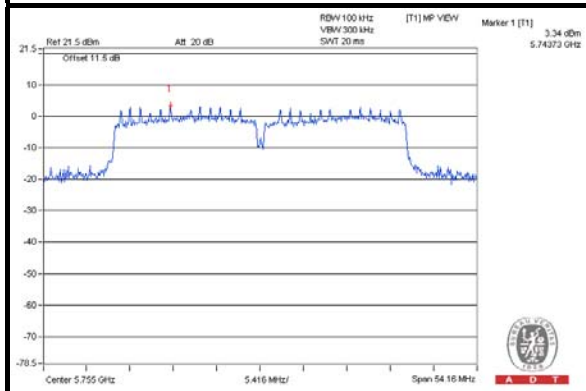

CH 159

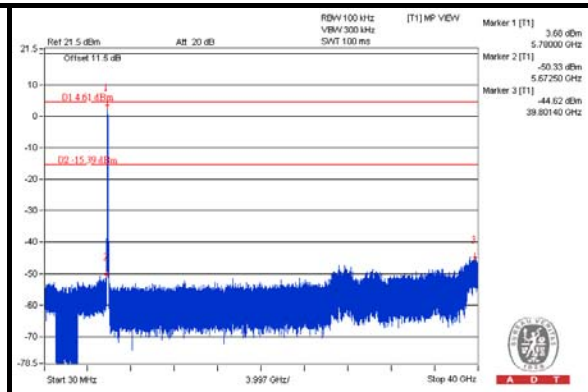
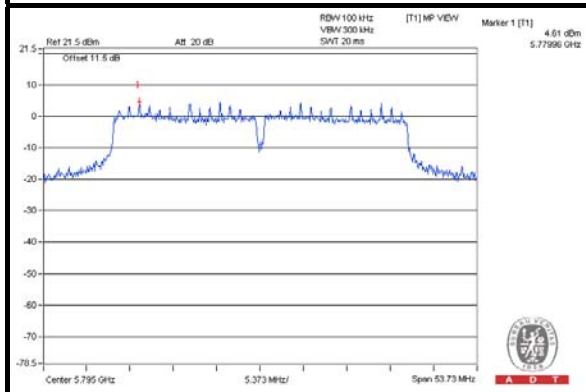

CH 151 Band edge

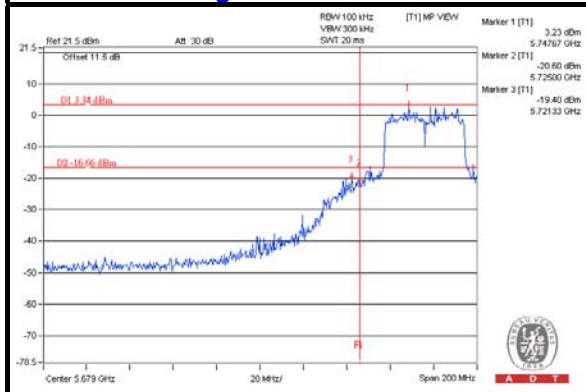

CH 159 Band edge

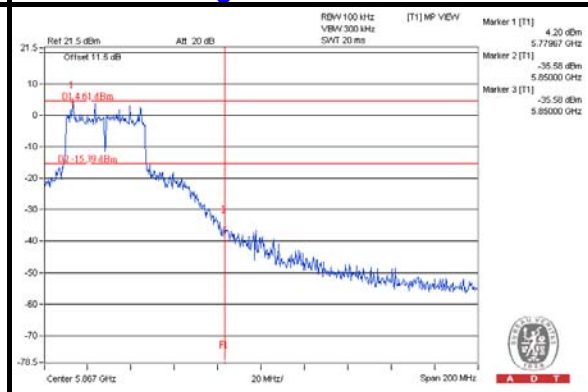



A D T

6. PHOTOGRAPHS OF THE TEST CONFIGURATION

Please refer to the attached file (Test Setup Photo).



A D T

7. INFORMATION ON THE TESTING LABORATORIES

We, Bureau Veritas Consumer Products Services (H.K.) Ltd., Taoyuan Branch, were founded in 1988 to provide our best service in EMC, Radio, Telecom and Safety consultation. Our laboratories are accredited and approved according to ISO/IEC 17025.

If you have any comments, please feel free to contact us at the following:

Linko EMC/RF Lab

Tel: 886-2-26052180

Fax: 886-2-26051924

Hsin Chu EMC/RF Lab

Tel: 886-3-5935343

Fax: 886-3-5935342

Hwa Ya EMC/RF/Safety/Telecom Lab

Tel: 886-3-3183232

Fax: 886-3-3270892

Email: service.adt@tw.bureauveritas.com

Web Site: www.bureauveritas-adt.com

The address and road map of all our labs can be found in our web site also.



A D T

8. APPENDIX A – MODIFICATIONS RECORDERS FOR ENGINEERING CHANGES TO THE EUT BY THE LAB

No modifications were made to the EUT by the lab during the test.

---END---