

FCC Test Report

Report No.: RF120531C10Q

FCC ID: U2M-AN300APIN

Test Model: AN-300-AP-I-N

Received Date: Jul. 04, 2016

Test Date: Jul. 23 ~ Sep. 29, 2016

Issued Date: Oct. 14, 2016

Applicant: Senao Networks, Inc.

Address: 3F, No. 529, Chung Cheng Rd., Hsintien, New Taipei City, R.O.C

Issued By: Bureau Veritas Consumer Products Services (H.K.) Ltd., Taoyuan Branch

Lab Address: No. 47-2, 14th Ling, Chia Pau Vil., Lin Kou Dist., New Taipei City, Taiwan (R.O.C.)

Test Location: No.19, Hwa Ya 2nd Rd., Wen Hwa Vil., Kwei Shan Dist., Taoyuan City 33383, TAIWAN (R.O.C.)



This report is for your exclusive use. Any copying or replication of this report to or for any other person or entity, or use of our name or trademark, is permitted only with our prior written permission. This report sets forth our findings solely with respect to the test samples identified herein. The results set forth in this report are not indicative or representative of the quality or characteristics of the lot from which a test sample was taken or any similar or identical product specifically and expressly noted. Our report includes all of the tests requested by you and the results thereof based upon the information that you provided to us. You have 60 days from date of issuance of this report to notify us of any material error or omission caused by our negligence, provided, however, that such notice shall be in writing and shall specifically address the issue you wish to raise. A failure to raise such issue within the prescribed time shall constitute your unqualified acceptance of the completeness of this report, the tests conducted and the correctness of the report contents. Unless specific mention, the uncertainty of measurement has been explicitly taken into account to declare the compliance or non-compliance to the specification. The report must not be used by the client to claim product certification, approval, or endorsement by TAF or any government agencies.



Table of Contents

Release Control Record	4
1 Certificate of Conformity	5
2 Summary of Test Results	6
2.1 Measurement Uncertainty.....	6
2.2 Modification Record.....	6
3 General Information	7
3.1 General Description of EUT.....	7
3.2 Description of Test Modes.....	8
3.2.1 Test Mode Applicability and Tested Channel Detail.....	9
3.3 Duty Cycle of Test Signal.....	11
3.4 Description of Support Units.....	12
3.4.1 Configuration of System under Test.....	12
3.5 General Description of Applied Standard.....	13
4 Test Types and Results	14
4.1 Radiated Emission and Bandedge Measurement.....	14
4.1.1 Limits of Radiated Emission and Bandedge Measurement.....	14
4.1.2 Test Instruments.....	15
4.1.3 Test Procedure.....	16
4.1.4 Deviation from Test Standard.....	16
4.1.5 Test Setup.....	17
4.1.6 EUT Operating Conditions.....	18
4.1.7 Test Results.....	19
4.2 Conducted Emission Measurement.....	37
4.2.1 Limits of Conducted Emission Measurement.....	37
4.2.2 Test Instruments.....	37
4.2.3 Test Procedure.....	38
4.2.4 Deviation from Test Standard.....	38
4.2.5 Test Setup.....	38
4.2.6 EUT Operating Conditions.....	38
4.2.7 Test Results.....	39
4.3 Transmit Power Measurement.....	43
4.3.1 Limits of Transmit Power Measurement.....	43
4.3.2 Test Setup.....	43
4.3.3 Test Instruments.....	43
4.3.4 Test Procedure.....	44
4.3.5 Deviation from Test Standard.....	44
4.3.6 EUT Operating Conditions.....	44
4.3.7 Test Result.....	45
4.4 Occupied Bandwidth Measurement.....	48
4.4.1 Test Setup.....	48
4.4.2 Test Instruments.....	48
4.4.3 Test Procedure.....	48
4.4.4 Test Results.....	49
4.5 Peak Power Spectral Density Measurement.....	51
4.5.1 Limits of Peak Power Spectral Density Measurement.....	51
4.5.2 Test Setup.....	51
4.5.3 Test Instruments.....	51
4.5.4 Test Procedure.....	51
4.5.5 Deviation from Test Standard.....	52
4.5.6 EUT Operating Condition.....	52
4.5.7 Test Results.....	53
4.6 Frequency Stability.....	57
4.6.1 Limits of Frequency Stability Measurement.....	57

4.6.2	Test Setup.....	57
4.6.3	Test Instruments	57
4.6.4	Test Procedure	57
4.6.5	Deviation from Test Standard	57
4.6.6	EUT Operating Condition	57
4.6.7	Test Results	58
4.7	6dB Bandwidth Measurement.....	59
4.7.1	Limits of 6dB Bandwidth Measurement.....	59
4.7.2	Test Setup.....	59
4.7.3	Test Instruments	59
4.7.4	Test Procedure	59
4.7.5	Deviation from Test Standard	59
4.7.6	EUT Operating Condition	59
4.7.7	Test Results	60
5	Pictures of Test Arrangements.....	62
	Annex A- Radiated Out of Band Emission (OOBE) Measurement (For U-NII-3 band).....	63
	Appendix – Information on the Testing Laboratories	66

Release Control Record

Issue No.	Description	Date Issued
RF120531C10Q	Original release.	Oct. 14, 2016

1 Certificate of Conformity

Product: Araknis Networks 300-series Dual-Band Concurrent Wireless-N Indoor Access Point
Brand: Araknis Networks
Test Model: AN-300-AP-I-N
Sample Status: Engineering Sample
Applicant: Senao Networks, Inc.
Test Date: Jul. 23 ~ Sep. 29, 2016
Standard: 47 CFR FCC Part 15, Subpart E (Section 15.407)
ANSI C63.10:2013

The above equipment has been tested by **Bureau Veritas Consumer Products Services (H.K.) Ltd., Taoyuan Branch**, and found compliance with the requirement of the above standards. The test record, data evaluation & Equipment Under Test (EUT) configurations represented herein are true and accurate accounts of the measurements of the sample's EMC characteristics under the Conditions specified in this report.

Prepared by :  , **Date:** Oct. 14, 2016
Pettie Chen / Senior Specialist

Approved by :  , **Date:** Oct. 14, 2016
Ken Liu / Senior Manager

2 Summary of Test Results

47 CFR FCC Part 15, Subpart E (Section 15.407)			
FCC Clause	Test Item	Result	Remarks
15.407(b)(6)	AC Power Conducted Emissions	Pass	Meet the requirement of limit. Minimum passing margin is -9.61dB at 3.75502MHz.
15.407(b) (1/2/3/4(i/ii)/6)	Radiated Emissions & Band Edge Measurement*	Pass	Meet the requirement of limit. Minimum passing margin is -1.0dB at 874.99, 5100.00, 5104.00, 5400.00, 10400.00, 10480.00, 11490.00, 11510.00, 11570.00, 11590.00, 11650.00MHz.
15.407(a) (1/2/3)	Max Average Transmit Power	Pass	Meet the requirement of limit.
15.407(a) (1/2/3)	Peak Power Spectral Density	Pass	Meet the requirement of limit.
15.407(e)	6dB bandwidth	Pass	Meet the requirement of limit. (U-NII-3 Band only)
15.407(g)	Frequency Stability	Pass	Meet the requirement of limit.
15.203	Antenna Requirement	Pass	Antenna connector is IPEX not a standard connector.

*For U-NII-3 band compliance with rule part 15.407(b)(i), the OOB test plots were recorded in Annex A.

2.1 Measurement Uncertainty

Where relevant, the following measurement uncertainty levels have been estimated for tests performed on the EUT as specified in CISPR 16-4-2:

Measurement	Frequency	Expanded Uncertainty (k=2) (±)
Conducted Emissions at mains ports	150kHz ~ 30MHz	2.44 dB
Radiated Emissions up to 1 GHz	30MHz ~ 200MHz	3.86 dB
	200MHz ~ 1000MHz	3.87 dB
Radiated Emissions above 1 GHz	1GHz ~ 18GHz	2.29 dB
	18GHz ~ 40GHz	2.29 dB

2.2 Modification Record

There were no modifications required for compliance.

3 General Information

3.1 General Description of EUT

Product	Araknis Networks 300-series Dual-Band Concurrent Wireless-N Indoor Access Point
Brand	Araknis Networks
Test Model	AN-300-AP-I-N
Status of EUT	Engineering sample
Power Supply Rating	12Vdc from adapter 48Vdc from PoE
Modulation Type	64QAM, 16QAM, QPSK, BPSK
Modulation Technology	OFDM
Transfer Rate	802.11a: 54.0/ 48.0/ 36.0/ 24.0/ 18.0/ 12.0/ 9.0/ 6.0Mbps 802.11n: up to 300.0Mbps
Operating Frequency	5180 ~ 5240MHz & 5745 ~ 5825MHz
Number of Channel	5180 ~ 5240MHz: 4 for 802.11a, 802.11n (HT20) 2 for 802.11n (HT40) 5745 ~ 5825MHz: 5 for 802.11a, 802.11n (HT20) 2 for 802.11n (HT40)
Output Power	5180 ~ 5240MHz: 62.885mW 5745 ~ 5825MHz: 128.139mW
Antenna Type	PIFA antenna with 2dBi gain
Antenna Connector	IPEX
Accessory Device	Adapter
Data Cable Supplied	NA

Note:

1. This report is issued as a supplementary report to the original report no. RF120531C10H-1. The differences compared with the original design are updating standard to new rule version for U-NII-1 & U-NII-3 band. All tests had been re-tested.
2. The EUT incorporates a MIMO function. Physically, the EUT provides 2 completed transmitters and 2 receivers.

Modulation Mode	TX Function
802.11a	2TX
802.11n (HT20)	2TX
802.11n (HT40)	2TX

3. The EUT consumes power from the following adapter and PoE.

Adapter	
Brand	Powertron Electronics Corp.
Model	PA1024-2HUB PA1024-2HU PA1024-120HUB200
Input Power	100-240Vac, 50-60Hz, 0.6A
Output Power	12Vdc, 2.0A, 24.0W Max
Power Line	1.5m cable with one core attached on adapter

PoE (Support unit only)	
Model	PD-6083G300
Input Power	100-250Vac, 50/60Hz, 0.5A
Output Power	48Vdc, 0.35A

4. Spurious emission of the simultaneous operation (2.4GHz and 5GHz) has been evaluated and no non-compliance was found.
5. The above EUT information is declared by manufacturer and for more detailed features description, please refer to the manufacturer's specifications or user's manual.

3.2 Description of Test Modes

FOR 5180 ~ 5240MHz

4 channels are provided for 802.11a, 802.11n (HT20):

Channel	Frequency	Channel	Frequency
36	5180 MHz	44	5220 MHz
40	5200 MHz	48	5240 MHz

2 channels are provided for 802.11n (HT40):

Channel	Frequency	Channel	Frequency
38	5190 MHz	46	5230 MHz

FOR 5745 ~ 5825MHz:

5 channels are provided for 802.11a, 802.11n (HT20):

Channel	Frequency	Channel	Frequency
149	5745MHz	161	5805MHz
153	5765MHz	165	5825MHz
157	5785MHz		

2 channels are provided for 802.11n (HT40):

Channel	Frequency	Channel	Frequency
151	5755MHz	159	5795MHz

3.2.1 Test Mode Applicability and Tested Channel Detail

EUT CONFIGURE MODE	APPLICABLE TO				DESCRIPTION
	RE \geq 1G	RE $<$ 1G	PLC	APCM	
A	√	√	√	√	Powered by adapter
B	-	√	√	-	Powered by POE

Where **RE \geq 1G**: Radiated Emission above 1GHz **RE $<$ 1G**: Radiated Emission below 1GHz
PLC: Power Line Conducted Emission **APCM**: Antenna Port Conducted Measurement

NOTE:

1. The EUT had been pre-tested on the positioned of each 3 axis. The worst case was found when positioned on **Z-plane**.
2. "-" means no effect.

Radiated Emission Test (Above 1GHz):

- Pre-Scan has been conducted to determine the worst-case mode from all possible combinations between available modulations, data rates and antenna ports (if EUT with antenna diversity architecture).
- Following channel(s) was (were) selected for the final test as listed below.

EUT CONFIGURE MODE	MODE	FREQ. BAND (MHz)	AVAILABLE CHANNEL	TESTED CHANNEL	MODULATION TECHNOLOGY	MODULATION TYPE	DATA RATE (Mbps)
A	802.11a	5180-5240	36 to 48	36, 40, 48	OFDM	BPSK	6.0
A	802.11n (HT20)		36 to 48	36, 40, 48	OFDM	BPSK	6.5
A	802.11n (HT40)		38 to 46	38, 46	OFDM	BPSK	13.5
A	802.11a	5745-5825	149 to 165	149, 157, 165	OFDM	BPSK	6.0
A	802.11n (HT20)		149 to 165	149, 157, 165	OFDM	BPSK	6.5
A	802.11n (HT40)		151 to 159	151, 159	OFDM	BPSK	13.5

Radiated Emission Test (Below 1GHz):

- Pre-Scan has been conducted to determine the worst-case mode from all possible combinations between available modulations, data rates and antenna ports (if EUT with antenna diversity architecture).
- Following channel(s) was (were) selected for the final test as listed below.

EUT CONFIGURE MODE	MODE	FREQ. BAND (MHz)	AVAILABLE CHANNEL	TESTED CHANNEL	MODULATION TECHNOLOGY	MODULATION TYPE	DATA RATE (Mbps)
A, B	802.11a	5180-5240	36 to 48	36	OFDM	BPSK	6.0
	802.11a	5745-5825	149 to 165		OFDM	BPSK	6.0

Power Line Conducted Emission Test:

- Pre-Scan has been conducted to determine the worst-case mode from all possible combinations between available modulations, data rates and antenna ports (if EUT with antenna diversity architecture).
- Following channel(s) was (were) selected for the final test as listed below.

EUT CONFIGURE MODE	MODE	FREQ. BAND (MHz)	AVAILABLE CHANNEL	TESTED CHANNEL	MODULATION TECHNOLOGY	MODULATION TYPE	DATA RATE (Mbps)
A, B	802.11a	5180-5240	36 to 48	36	OFDM	BPSK	6.0
	802.11a	5745-5825	149 to 165		OFDM	BPSK	6.0

Antenna Port Conducted Measurement:

- This item includes all test value of each mode, but only includes spectrum plot of worst value of each mode.
- Pre-Scan has been conducted to determine the worst-case mode from all possible combinations between available modulations, data rates and antenna ports (if EUT with antenna diversity architecture).
- Following channel(s) was (were) selected for the final test as listed below.

EUT CONFIGURE MODE	MODE	FREQ. BAND (MHz)	AVAILABLE CHANNEL	TESTED CHANNEL	MODULATION TECHNOLOGY	MODULATION TYPE	DATA RATE (Mbps)
A	802.11a	5180-5240	36 to 48	36, 40, 48	OFDM	BPSK	6.0
A	802.11n (HT20)		36 to 48	36, 40, 48	OFDM	BPSK	6.5
A	802.11n (HT40)		38 to 46	38, 46	OFDM	BPSK	13.5
A	802.11a	5745-5825	149 to 165	149, 157, 165	OFDM	BPSK	6.0
A	802.11n (HT20)		149 to 165	149, 157, 165	OFDM	BPSK	6.5
A	802.11n (HT40)		151 to 159	151, 159	OFDM	BPSK	13.5

Test Condition:

APPLICABLE TO	ENVIRONMENTAL CONDITIONS	INPUT POWER	TESTED BY
RE \geq 1G	16deg. C, 70%RH 19deg. C, 70%RH	120Vac, 60Hz	Jones Chang
RE<1G	16deg. C, 70%RH	120Vac, 60Hz 48Vdc	James Yang
PLC	20deg. C, 70%RH	120Vac, 60Hz 48Vdc	Jones Chang
APCM	20deg. C, 70%RH	120Vac, 60Hz	Antony Lee

3.3 Duty Cycle of Test Signal

Duty cycle of test signal is < 98 %, duty factor is required

802.11a: Duty cycle = $2.023/2.080 = 0.973$, Duty factor = $10 * \log(1/0.973) = 0.12$

802.11n (HT20): Duty cycle = $1.874/1.934 = 0.969$, Duty factor = $10 * \log(1/0.969) = 0.14$

802.11n (HT40): Duty cycle = $0.488/0.540 = 0.904$, Duty factor = $10 * \log(1/0.904) = 0.44$



3.4 Description of Support Units

The EUT has been tested as an independent unit together with other necessary accessories or support units. The following support units or accessories were used to form a representative test configuration during the tests.

ID	Product	Brand	Model No.	Serial No.	FCC ID	Remarks
A.	Notebook	DELL	D531	CN-0XM006-48643-81 U-2973	QDS-BRCM1020	-
B.	POE	NA	PD-6083G300	N/A	N/A	Provided by client

Note:

1. All power cords of the above support units are non-shielded (1.8m).
2. Item A acted as communication partner to transfer data.

ID	Descriptions	Qty.	Length (m)	Shielding (Yes/No)	Cores (Qty.)	Remarks
1.	RJ45, Cat5e	1	10	N	0	-
2.	RJ45, Cat5e	1	1.8	N	0	-

3.4.1 Configuration of System under Test

Test Mode A

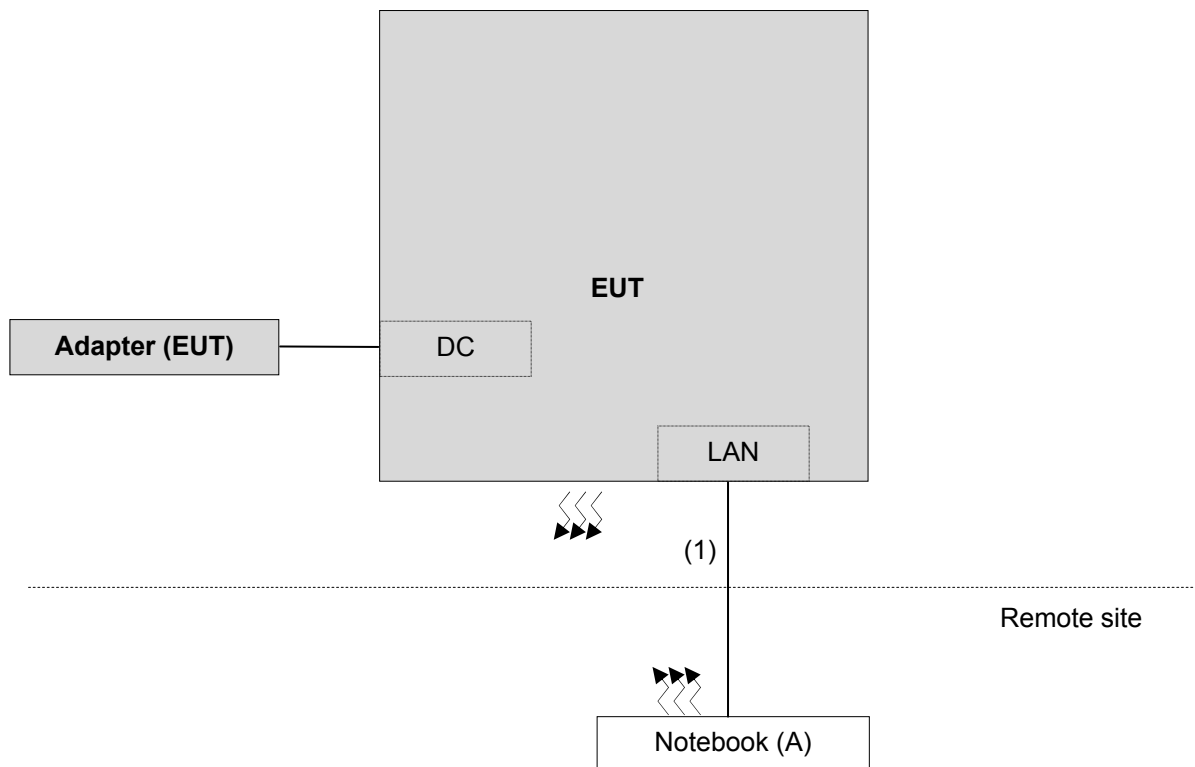

Test Mode B

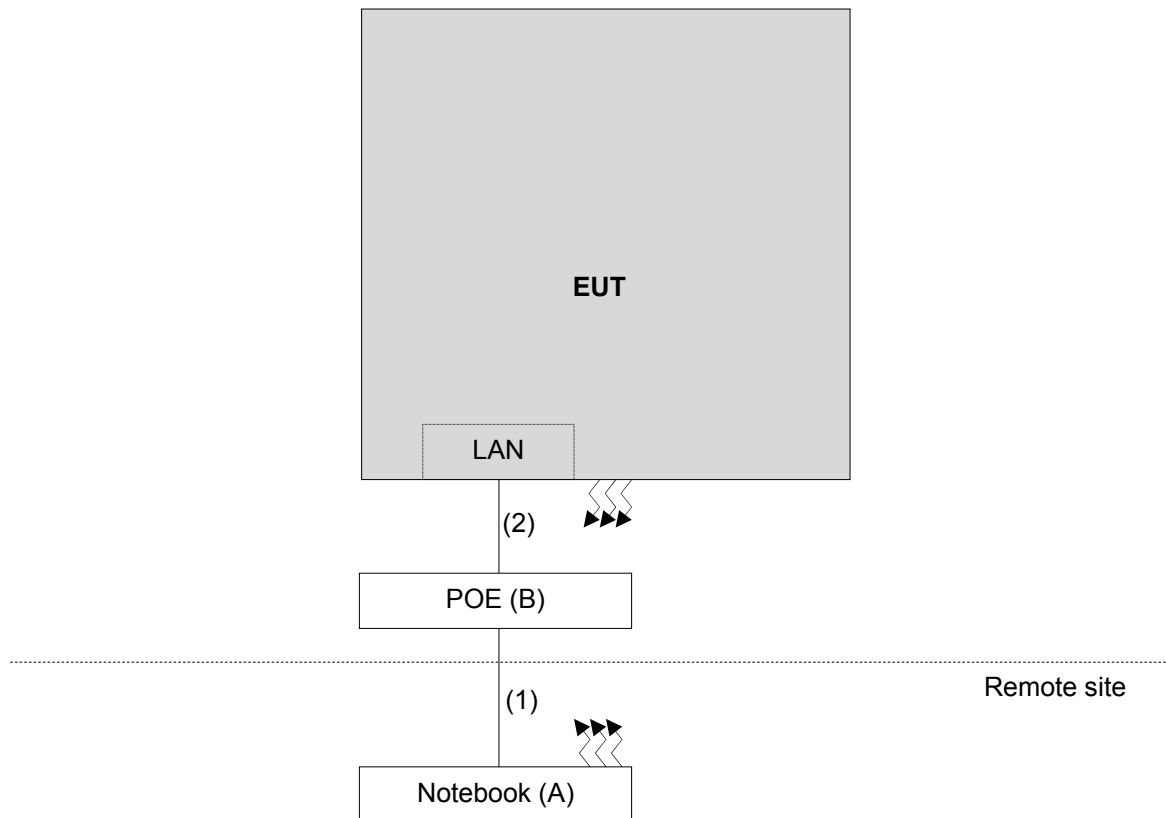

3.5 General Description of Applied Standard

The EUT is a RF Product. According to the specifications of the manufacturer, it must comply with the requirements of the following standards:

FCC Part 15, Subpart E (15.407)
789033 D02 General UNII Test Procedure New Rules v01r03
662911 D01 Multiple Transmitter Output v02r01
 ANSI C63.10-2013

All test items have been performed and recorded as per the above standards.

NOTE: The EUT is also considered as a kind of computer peripheral, because the connection to computer is necessary for typical use. It has been verified to comply with the requirements of FCC Part 15, Subpart B, Class B (DoC). The test report has been issued separately.

4 Test Types and Results

4.1 Radiated Emission and Bandedge Measurement

4.1.1 Limits of Radiated Emission and Bandedge Measurement

Radiated emissions which fall in the restricted bands must comply with the radiated emission limits specified as below table.

Frequencies (MHz)	Field Strength (microvolts/meter)	Measurement Distance (meters)
0.009 ~ 0.490	2400/F(kHz)	300
0.490 ~ 1.705	24000/F(kHz)	30
1.705 ~ 30.0	30	30
30 ~ 88	100	3
88 ~ 216	150	3
216 ~ 960	200	3
Above 960	500	3

NOTE:

1. The lower limit shall apply at the transition frequencies.
2. Emission level (dBuV/m) = 20 log Emission level (uV/m).
3. For frequencies above 1000MHz, the field strength limits are based on average detector, however, the peak field strength of any emission shall not exceed the maximum permitted average limits, specified above by more than 20dB under any Condition of modulation.

Limits of Unwanted Emission Out of the Restricted Bands

Applicable To		Limit	
789033 D02 General UNII Test Procedure New Rules v01r03		Field Strength at 3m	
		PK:74 (dBuV/m)	AV:54 (dBuV/m)
Frequency Band	Applicable To	EIRP Limit	Equivalent Field Strength at 3m
5150~5250 MHz	15.407(b)(1)	PK:-27 (dBm/MHz)	PK:68.2(dBuV/m)
5250~5350 MHz	15.407(b)(2)		
5470~5725 MHz	15.407(b)(3)		
5725~5850 MHz	<input checked="" type="checkbox"/> 15.407(b)(4)(i)	PK:-27 (dBm/MHz) ^{*1} PK:10 (dBm/MHz) ^{*2} PK:15.6 (dBm/MHz) ^{*3} PK:27 (dBm/MHz) ^{*4}	PK: 68.2 (dBuV/m) ^{*1} PK:105.2 (dBuV/m) ^{*2} PK: 110.8 (dBuV/m) ^{*3} PK:122.2 (dBuV/m) ^{*4}
	<input type="checkbox"/> 15.407(b)(4)(ii)	Emission limits in section 15.247(d)	
^{*1} beyond 75 MHz or more above of the band edge.		^{*2} below the band edge increasing linearly to 10 dBm/MHz at 25 MHz above.	
^{*3} below the band edge increasing linearly to a level of 15.6 dBm/MHz at 5 MHz above.		^{*4} from 5 MHz above or below the band edge increasing linearly to a level of 27 dBm/MHz at the band edge.	

NOTE: The following formula is used to convert the equipment isotropic radiated power (eirp) to field strength:

$$E = \frac{1000000 \sqrt{30P}}{3} \mu\text{V/m, where P is the eirp (Watts).}$$

4.1.2 Test Instruments

Description & Manufacturer	Model No.	Serial No.	Cal. Date	Cal. Due
Test Receiver ROHDE & SCHWARZ	ESIB7	100187	Apr. 18, 2016	Apr. 17, 2017
Spectrum Analyzer ROHDE & SCHWARZ	E4446A	MY51100039	Aug. 25, 2015	Aug. 24, 2016
			Aug. 30, 2016	Aug. 29, 2017
BILOG Antenna SCHWARZBECK	VULB9168	9168-171	Jan. 07, 2016	Jan. 06, 2017
HORN Antenna SCHWARZBECK	9120D	209	Jan. 20, 2016	Jan. 19, 2017
HORN Antenna SCHWARZBECK	BBHA 9170	BBHA9170241	Jan. 18, 2016	Jan. 17, 2017
Preamplifier Agilent	8447D	2944A10738	Oct. 18, 2015	Oct. 17, 2016
			Aug. 22, 2016	Aug. 21, 2017
Preamplifier Agilent	8449B	3008A01964	Aug. 22, 2015	Aug. 21, 2016
			Aug. 22, 2016	Aug. 21, 2017
RF signal cable HUBER+SUHNER	SUCOFLEX 104	Cable-CH3-03 (214378)	Aug. 22, 2015	Aug. 21, 2016
			Aug. 22, 2016	Aug. 21, 2017
RF signal cable HUBER+SUHNER	SUCOFLEX 106	Cable-CH3-03 (309224+12738)	Aug. 22, 2015	Aug. 21, 2016
			Aug. 22, 2016	Aug. 21, 2017
Software BV ADT	ADT_Radiated_ V7.6.15.9.4	NA	NA	NA
Antenna Tower inn-co GmbH	MA 4000	013303	NA	NA
Antenna Tower Controller BV ADT	AT100	AT93021702	NA	NA
Turn Table BV ADT	TT100	TT93021702	NA	NA
Turn Table Controller BV ADT	SC100	SC93021702	NA	NA
26GHz ~ 40GHz Amplifier	EM26400	815221	Oct. 18, 2015	Oct. 17, 2016
High Speed Peak Power Meter	ML2495A	0842014	Apr. 28, 2016	Apr. 27, 2017
Power Sensor	MA2411B	0738404	Apr. 28, 2016	Apr. 27, 2017

- Note: 1. The calibration interval of the above test instruments is 12 months and the calibrations are traceable to NML/ROC and NIST/USA.
2. The test was performed in HwaYa Chamber 3.
3. The horn antenna and preamplifier (model: 8449B) are used only for the measurement of emission frequency above 1GHz if tested.
4. The FCC Site Registration No. is 988962.
5. The IC Site Registration No. is IC 7450F-3.

4.1.3 Test Procedure

For Radiated emission below 30MHz

- a. The EUT was placed on the top of a rotating table 0.8 meters above the ground at a 3 meter chamber room. The table was rotated 360 degrees to determine the position of the highest radiation.
- b. The EUT was set 3 meters away from the interference-receiving antenna, which was mounted on the top of a variable-height antenna tower.
- c. Both X and Y axes of the antenna are set to make the measurement.
- d. For each suspected emission, the EUT was arranged to its worst case and the rotatable table was turned from 0 degrees to 360 degrees to find the maximum reading.
- e. The test-receiver system was set to Quasi-Peak Detect Function and Specified Bandwidth with Maximum Hold Mode.

NOTE:

1. The resolution bandwidth and video bandwidth of test receiver/spectrum analyzer is 9kHz at frequency below 30MHz.

For Radiated emission above 30MHz

- a. The EUT was placed on the top of a rotating table 0.8 meters (for 30MHz ~ 1GHz) / 1.5 meters (for above 1GHz) above the ground at 3 meter chamber room for test. The table was rotated 360 degrees to determine the position of the highest radiation.
- b. The EUT was set 3 meters away from the interference-receiving antenna, which was mounted on the top of a variable-height antenna tower.
- c. The height of antenna is varied from one meter to four meters above the ground to determine the maximum value of the field strength. Both horizontal and vertical polarizations of the antenna are set to make the measurement.
- d. For each suspected emission, the EUT was arranged to its worst case and then the antenna was tuned to heights from 1 meter to 4 meters and the rotatable table was turned from 0 degrees to 360 degrees to find the maximum reading.
- e. The test-receiver system was set to quasi-peak detect function and specified bandwidth with maximum hold mode when the test frequency is below 1 GHz.
- f. The test-receiver system was set to peak and average detect function and specified bandwidth with maximum hold mode when the test frequency is above 1 GHz. If the peak reading value also meets average limit, measurement with the average detector is unnecessary.

Note:

1. The resolution bandwidth and video bandwidth of test receiver/spectrum analyzer is 120kHz for Quasi-peak detection (QP) at frequency below 1GHz.
2. The resolution bandwidth of test receiver/spectrum analyzer is 1 MHz and the video bandwidth is 3 MHz for Peak detection (PK) at frequency above 1GHz.
3. The resolution bandwidth of test receiver/spectrum analyzer is 1MHz and the video bandwidth is $\geq 1/T$ (Duty cycle < 98%) or 10Hz (Duty cycle $\geq 98\%$) for Average detection (AV) at frequency above 1GHz.
4. All modes of operation were investigated and the worst-case emissions are reported.

4.1.4 Deviation from Test Standard

No deviation.

4.1.5 Test Setup

For Radiated emission below 30MHz

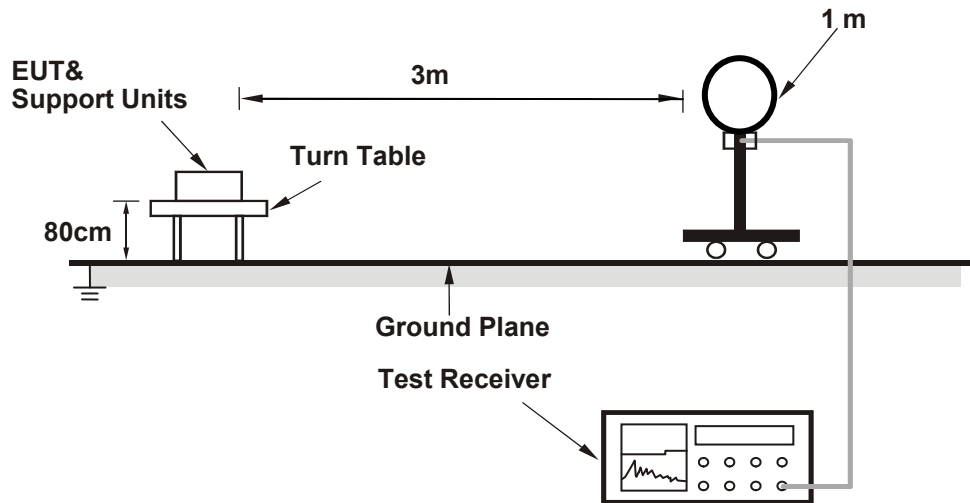

For Radiated emission 30MHz to 1GHz

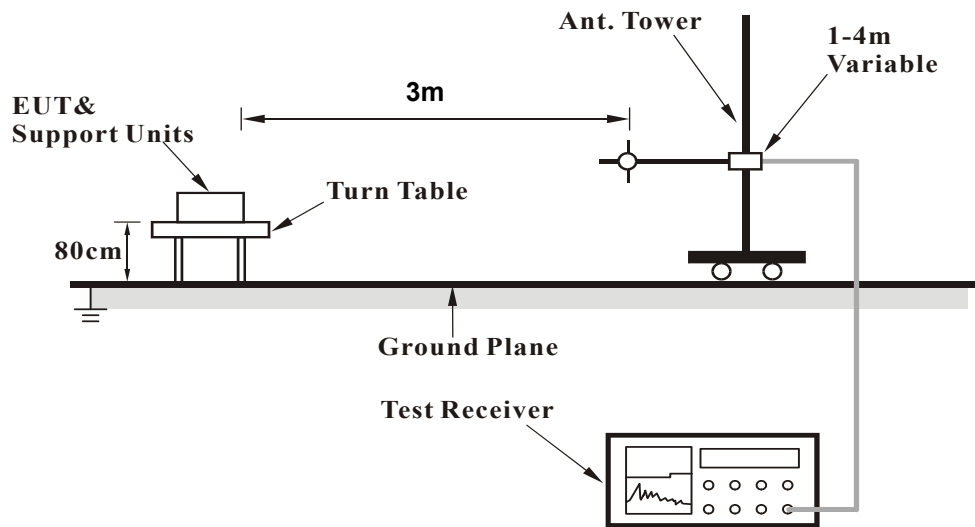

For Radiated emission above 1GHz

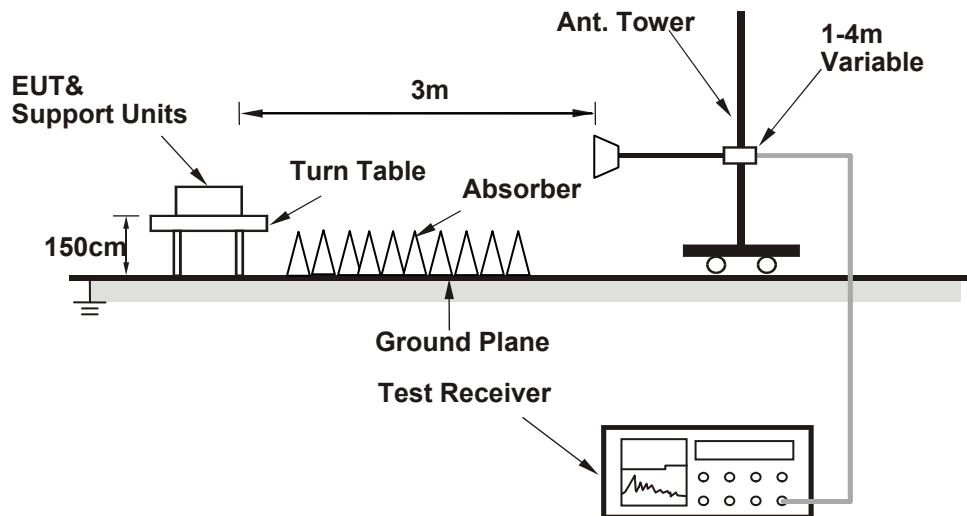

For the actual test configuration, please refer to the attached file (Test Setup Photo).

4.1.6 EUT Operating Conditions

- Placed the EUT on the testing table.
- Prepared notebook to act as a communication partner and placed it outside of testing area.
- The communication partner connected with EUT via a RJ45 cable and ran a test program (provided by manufacturer) to enable EUT under transmission condition continuously at specific channel frequency.
- The communication partner sent data to EUT by command "PING".
- The necessary accessories enable the system in full functions.

4.1.7 Test Results

ABOVE 1GHz WORST-CASE DATA :

802.11a

CHANNEL	TX Channel 36	DETECTOR FUNCTION	Peak (PK)
FREQUENCY RANGE	1GHz ~ 40GHz		Average (AV)

ANTENNA POLARITY & TEST DISTANCE: HORIZONTAL AT 3 M

NO.	FREQ. (MHz)	EMISSION LEVEL (dBuV/m)	LIMIT (dBuV/m)	MARGIN (dB)	ANTENNA HEIGHT (m)	TABLE ANGLE (Degree)	RAW VALUE (dBuV)	CORRECTION FACTOR (dB/m)
1	5100.00	62.9 PK	74.0	-11.1	1.01 H	291	58.3	4.6
2	5100.00	53.0 AV	54.0	-1.0	1.01 H	291	48.4	4.6
3	*5180.00	109.9 PK			1.01 H	286	71.2	38.7
4	*5180.00	100.6 AV			1.01 H	286	61.9	38.7
5	5400.00	62.6 PK	74.0	-11.4	1.01 H	294	57.1	5.5
6	5400.00	52.8 AV	54.0	-1.2	1.01 H	294	47.3	5.5
7	#10360.00	66.4 PK	74.0	-7.6	1.80 H	262	48.8	17.6
8	#10360.00	50.9 AV	54.0	-3.1	1.80 H	262	33.3	17.6

ANTENNA POLARITY & TEST DISTANCE: VERTICAL AT 3 M

NO.	FREQ. (MHz)	EMISSION LEVEL (dBuV/m)	LIMIT (dBuV/m)	MARGIN (dB)	ANTENNA HEIGHT (m)	TABLE ANGLE (Degree)	RAW VALUE (dBuV)	CORRECTION FACTOR (dB/m)
1	5100.00	56.8 PK	74.0	-17.2	1.63 V	19	52.2	4.6
2	5100.00	46.8 AV	54.0	-7.2	1.63 V	19	42.2	4.6
3	*5180.00	106.3 PK			3.07 V	343	67.6	38.7
4	*5180.00	96.9 AV			3.07 V	343	58.2	38.7
5	5400.00	59.0 PK	74.0	-15.0	1.77 V	25	53.5	5.5
6	5400.00	48.6 AV	54.0	-5.4	1.77 V	25	43.1	5.5
7	#10360.00	60.4 PK	74.0	-13.6	2.89 V	260	42.8	17.6
8	#10360.00	47.5 AV	54.0	-6.5	2.89 V	260	29.9	17.6

REMARKS:

1. Emission Level(dBuV/m) = Raw Value(dBuV) + Correction Factor(dB/m)
2. Correction Factor(dB/m) = Antenna Factor(dB/m) + Cable Factor(dB)
3. The other emission levels were very low against the limit.
4. Margin value = Emission Level – Limit value
5. " * ": Fundamental frequency.
6. " # ": The radiated frequency is out of the restricted band.



CHANNEL	TX Channel 40	DETECTOR FUNCTION	Peak (PK)
FREQUENCY RANGE	1GHz ~ 40GHz		Average (AV)

ANTENNA POLARITY & TEST DISTANCE: HORIZONTAL AT 3 M

NO.	FREQ. (MHz)	EMISSION LEVEL (dBuV/m)	LIMIT (dBuV/m)	MARGIN (dB)	ANTENNA HEIGHT (m)	TABLE ANGLE (Degree)	RAW VALUE (dBuV)	CORRECTION FACTOR (dB/m)
1	5104.00	61.6 PK	74.0	-12.4	1.00 H	290	56.9	4.7
2	5104.00	52.9 AV	54.0	-1.1	1.00 H	290	48.2	4.7
3	*5200.00	111.5 PK			1.01 H	288	72.8	38.7
4	*5200.00	101.2 AV			1.01 H	288	62.5	38.7
5	5400.00	61.1 PK	74.0	-12.9	1.09 H	295	55.6	5.5
6	5400.00	52.2 AV	54.0	-1.8	1.09 H	295	46.7	5.5
7	#10400.00	70.1 PK	74.0	-3.9	1.78 H	258	52.5	17.6
8	#10400.00	53.0 AV	54.0	-1.0	1.78 H	258	35.4	17.6

ANTENNA POLARITY & TEST DISTANCE: VERTICAL AT 3 M

NO.	FREQ. (MHz)	EMISSION LEVEL (dBuV/m)	LIMIT (dBuV/m)	MARGIN (dB)	ANTENNA HEIGHT (m)	TABLE ANGLE (Degree)	RAW VALUE (dBuV)	CORRECTION FACTOR (dB/m)
1	5104.00	58.6 PK	74.0	-15.4	1.61 V	19	53.9	4.7
2	5104.00	47.8 AV	54.0	-6.2	1.61 V	19	43.1	4.7
3	*5200.00	106.1 PK			1.63 V	17	67.4	38.7
4	*5200.00	96.7 AV			1.63 V	17	58.0	38.7
5	5400.00	60.3 PK	74.0	-13.7	1.73 V	21	54.8	5.5
6	5400.00	50.4 AV	54.0	-3.6	1.73 V	21	44.9	5.5
7	#10400.00	60.7 PK	74.0	-13.3	2.07 V	245	43.1	17.6
8	#10400.00	47.9 AV	54.0	-6.1	2.07 V	245	30.3	17.6

REMARKS:

1. Emission Level(dBuV/m) = Raw Value(dBuV) + Correction Factor(dB/m)
2. Correction Factor(dB/m) = Antenna Factor(dB/m) + Cable Factor(dB)
3. The other emission levels were very low against the limit.
4. Margin value = Emission Level – Limit value
5. " * ": Fundamental frequency.
6. " # ": The radiated frequency is out of the restricted band.



CHANNEL	TX Channel 48	DETECTOR FUNCTION	Peak (PK)
FREQUENCY RANGE	1GHz ~ 40GHz		Average (AV)

ANTENNA POLARITY & TEST DISTANCE: HORIZONTAL AT 3 M

NO.	FREQ. (MHz)	EMISSION LEVEL (dBuV/m)	LIMIT (dBuV/m)	MARGIN (dB)	ANTENNA HEIGHT (m)	TABLE ANGLE (Degree)	RAW VALUE (dBuV)	CORRECTION FACTOR (dB/m)
1	5120.00	62.3 PK	74.0	-11.7	1.01 H	288	57.5	4.8
2	5120.00	52.5 AV	54.0	-1.5	1.01 H	288	47.7	4.8
3	*5240.00	110.7 PK			1.04 H	289	71.8	38.9
4	*5240.00	101.6 AV			1.04 H	289	62.7	38.9
5	5440.00	62.1 PK	74.0	-11.9	1.03 H	288	56.4	5.7
6	5440.00	52.6 AV	54.0	-1.4	1.03 H	288	46.9	5.7
7	#10480.00	70.7 PK	74.0	-3.3	1.80 H	258	52.3	18.4
8	#10480.00	52.4 AV	54.0	-1.6	1.80 H	258	34.0	18.4

ANTENNA POLARITY & TEST DISTANCE: VERTICAL AT 3 M

NO.	FREQ. (MHz)	EMISSION LEVEL (dBuV/m)	LIMIT (dBuV/m)	MARGIN (dB)	ANTENNA HEIGHT (m)	TABLE ANGLE (Degree)	RAW VALUE (dBuV)	CORRECTION FACTOR (dB/m)
1	5104.00	57.3 PK	74.0	-16.7	1.62 V	20	52.6	4.7
2	5104.00	47.6 AV	54.0	-6.4	1.62 V	20	42.9	4.7
3	*5240.00	106.3 PK			2.99 V	306	67.4	38.9
4	*5240.00	97.0 AV			2.99 V	306	58.1	38.9
5	5400.00	57.7 PK	74.0	-16.3	1.65 V	346	52.2	5.5
6	5400.00	47.6 AV	54.0	-6.4	1.65 V	346	42.1	5.5
7	#10480.00	62.0 PK	74.0	-12.0	3.12 V	320	43.6	18.4
8	#10480.00	48.9 AV	54.0	-5.1	3.12 V	320	30.5	18.4

REMARKS:

1. Emission Level(dBuV/m) = Raw Value(dBuV) + Correction Factor(dB/m)
2. Correction Factor(dB/m) = Antenna Factor(dB/m) + Cable Factor(dB)
3. The other emission levels were very low against the limit.
4. Margin value = Emission Level – Limit value
5. " * ": Fundamental frequency.
6. " # ": The radiated frequency is out of the restricted band.

CHANNEL	TX Channel 149	DETECTOR FUNCTION	Peak (PK)
FREQUENCY RANGE	1GHz ~ 40GHz		Average (AV)

ANTENNA POLARITY & TEST DISTANCE: HORIZONTAL AT 3 M

NO.	FREQ. (MHz)	EMISSION LEVEL (dBuV/m)	LIMIT (dBuV/m)	MARGIN (dB)	ANTENNA HEIGHT (m)	TABLE ANGLE (Degree)	RAW VALUE (dBuV)	CORRECTION FACTOR (dB/m)
1	#5640.00	57.3 PK	68.2	-10.9	1.01 H	278	51.2	6.1
2	*5745.00	112.7 PK			1.01 H	278	72.7	40.0
3	*5745.00	102.6 AV			1.01 H	278	62.6	40.0
4	#5933.60	57.0 PK	68.2	-11.2	1.01 H	278	50.4	6.6
5	11490.00	69.8 PK	74.0	-4.2	1.92 H	31	50.5	19.3
6	11490.00	53.0 AV	54.0	-1.0	1.92 H	31	33.7	19.3

ANTENNA POLARITY & TEST DISTANCE: VERTICAL AT 3 M

NO.	FREQ. (MHz)	EMISSION LEVEL (dBuV/m)	LIMIT (dBuV/m)	MARGIN (dB)	ANTENNA HEIGHT (m)	TABLE ANGLE (Degree)	RAW VALUE (dBuV)	CORRECTION FACTOR (dB/m)
1	#5631.20	56.6 PK	68.2	-11.6	2.99 V	312	50.5	6.1
2	*5745.00	109.3 PK			2.99 V	312	69.3	40.0
3	*5745.00	100.0 AV			2.99 V	312	60.0	40.0
4	#5945.60	57.0 PK	68.2	-11.2	2.99 V	312	50.4	6.6
5	11490.00	62.2 PK	74.0	-11.8	2.77 V	1	42.9	19.3
6	11490.00	49.4 AV	54.0	-4.6	2.77 V	1	30.1	19.3

REMARKS:

1. Emission Level(dBuV/m) = Raw Value(dBuV) + Correction Factor(dB/m)
2. Correction Factor(dB/m) = Antenna Factor(dB/m) + Cable Factor(dB)
3. The other emission levels were very low against the limit.
4. Margin value = Emission Level – Limit value
5. " * ": Fundamental frequency.
6. " # ": The radiated frequency is out of the restricted band.

CHANNEL	TX Channel 157	DETECTOR FUNCTION	Peak (PK)
FREQUENCY RANGE	1GHz ~ 40GHz		Average (AV)

ANTENNA POLARITY & TEST DISTANCE: HORIZONTAL AT 3 M

NO.	FREQ. (MHz)	EMISSION LEVEL (dBuV/m)	LIMIT (dBuV/m)	MARGIN (dB)	ANTENNA HEIGHT (m)	TABLE ANGLE (Degree)	RAW VALUE (dBuV)	CORRECTION FACTOR (dB/m)
1	#5608.00	58.2 PK	68.2	-10.0	1.02 H	278	52.1	6.1
2	*5785.00	112.3 PK			1.02 H	278	72.2	40.1
3	*5785.00	102.4 AV			1.02 H	278	62.3	40.1
4	#5942.40	57.9 PK	68.2	-10.3	1.02 H	278	51.3	6.6
5	11570.00	68.4 PK	74.0	-5.6	1.66 H	45	49.2	19.2
6	11570.00	53.0 AV	54.0	-1.0	1.66 H	45	33.8	19.2

ANTENNA POLARITY & TEST DISTANCE: VERTICAL AT 3 M

NO.	FREQ. (MHz)	EMISSION LEVEL (dBuV/m)	LIMIT (dBuV/m)	MARGIN (dB)	ANTENNA HEIGHT (m)	TABLE ANGLE (Degree)	RAW VALUE (dBuV)	CORRECTION FACTOR (dB/m)
1	#5614.40	57.3 PK	68.2	-10.9	3.05 V	310	51.2	6.1
2	*5785.00	110.2 PK			3.05 V	310	70.1	40.1
3	*5785.00	100.8 AV			3.05 V	310	60.7	40.1
4	#5962.40	58.2 PK	68.2	-10.0	3.05 V	310	51.5	6.7
5	11570.00	62.2 PK	74.0	-11.8	2.80 V	0	43.0	19.2
6	11570.00	49.1 AV	54.0	-4.9	2.80 V	0	29.9	19.2

REMARKS:

1. Emission Level(dBuV/m) = Raw Value(dBuV) + Correction Factor(dB/m)
2. Correction Factor(dB/m) = Antenna Factor(dB/m) + Cable Factor(dB)
3. The other emission levels were very low against the limit.
4. Margin value = Emission Level – Limit value
5. " * ": Fundamental frequency.
6. " # ": The radiated frequency is out of the restricted band.

CHANNEL	TX Channel 165	DETECTOR FUNCTION	Peak (PK)
FREQUENCY RANGE	1GHz ~ 40GHz		Average (AV)

ANTENNA POLARITY & TEST DISTANCE: HORIZONTAL AT 3 M

NO.	FREQ. (MHz)	EMISSION LEVEL (dBuV/m)	LIMIT (dBuV/m)	MARGIN (dB)	ANTENNA HEIGHT (m)	TABLE ANGLE (Degree)	RAW VALUE (dBuV)	CORRECTION FACTOR (dB/m)
1	#5616.00	57.0 PK	68.2	-11.2	1.03 H	284	50.9	6.1
2	*5825.00	111.6 PK			1.03 H	284	71.5	40.1
3	*5825.00	101.8 AV			1.03 H	284	61.7	40.1
4	#5987.20	57.2 PK	68.2	-11.0	1.03 H	284	50.5	6.7
5	11650.00	66.0 PK	74.0	-8.0	1.83 H	34	46.7	19.3
6	11650.00	52.9 AV	54.0	-1.1	1.83 H	34	33.6	19.3

ANTENNA POLARITY & TEST DISTANCE: VERTICAL AT 3 M

NO.	FREQ. (MHz)	EMISSION LEVEL (dBuV/m)	LIMIT (dBuV/m)	MARGIN (dB)	ANTENNA HEIGHT (m)	TABLE ANGLE (Degree)	RAW VALUE (dBuV)	CORRECTION FACTOR (dB/m)
1	#5642.40	57.9 PK	68.2	-10.3	3.02 V	308	51.8	6.1
2	*5825.00	109.6 PK			3.02 V	308	69.5	40.1
3	*5825.00	100.1 AV			3.02 V	308	60.0	40.1
4	#5977.60	58.8 PK	68.2	-9.4	3.02 V	308	52.1	6.7
5	11650.00	62.2 PK	74.0	-11.8	2.83 V	4	42.9	19.3
6	11650.00	49.1 AV	54.0	-4.9	2.83 V	4	29.8	19.3

REMARKS:

1. Emission Level(dBuV/m) = Raw Value(dBuV) + Correction Factor(dB/m)
2. Correction Factor(dB/m) = Antenna Factor(dB/m) + Cable Factor(dB)
3. The other emission levels were very low against the limit.
4. Margin value = Emission Level – Limit value
5. " * ": Fundamental frequency.
6. " # ": The radiated frequency is out of the restricted band.

802.11n (HT20)

CHANNEL	TX Channel 36	DETECTOR FUNCTION	Peak (PK)
FREQUENCY RANGE	1GHz ~ 40GHz		Average (AV)

ANTENNA POLARITY & TEST DISTANCE: HORIZONTAL AT 3 M								
NO.	FREQ. (MHz)	EMISSION LEVEL (dBuV/m)	LIMIT (dBuV/m)	MARGIN (dB)	ANTENNA HEIGHT (m)	TABLE ANGLE (Degree)	RAW VALUE (dBuV)	CORRECTION FACTOR (dB/m)
1	5100.00	61.7 PK	74.0	-12.3	1.03 H	290	57.1	4.6
2	5100.00	52.1 AV	54.0	-1.9	1.03 H	290	47.5	4.6
3	*5180.00	111.0 PK			1.00 H	287	72.3	38.7
4	*5180.00	100.6 AV			1.00 H	287	61.9	38.7
5	5400.00	61.9 PK	74.0	-12.1	1.14 H	289	56.4	5.5
6	5400.00	53.0 AV	54.0	-1.0	1.14 H	289	47.5	5.5
7	#10360.00	62.6 PK	74.0	-11.4	1.79 H	256	45.0	17.6
8	#10360.00	49.9 AV	54.0	-4.1	1.79 H	256	32.3	17.6

ANTENNA POLARITY & TEST DISTANCE: VERTICAL AT 3 M								
NO.	FREQ. (MHz)	EMISSION LEVEL (dBuV/m)	LIMIT (dBuV/m)	MARGIN (dB)	ANTENNA HEIGHT (m)	TABLE ANGLE (Degree)	RAW VALUE (dBuV)	CORRECTION FACTOR (dB/m)
1	5100.00	56.5 PK	74.0	-17.5	1.68 V	12	51.9	4.6
2	5100.00	46.0 AV	54.0	-8.0	1.68 V	12	41.4	4.6
3	*5180.00	105.2 PK			2.92 V	308	66.5	38.7
4	*5180.00	95.0 AV			2.92 V	308	56.3	38.7
5	5400.00	59.8 PK	74.0	-14.2	1.60 V	36	54.3	5.5
6	5400.00	49.0 AV	54.0	-5.0	1.60 V	36	43.5	5.5
7	#10360.00	60.5 PK	74.0	-13.5	2.80 V	264	42.9	17.6
8	#10360.00	47.3 AV	54.0	-6.7	2.80 V	264	29.7	17.6

REMARKS:

1. Emission Level(dBuV/m) = Raw Value(dBuV) + Correction Factor(dB/m)
2. Correction Factor(dB/m) = Antenna Factor(dB/m) + Cable Factor(dB)
3. The other emission levels were very low against the limit.
4. Margin value = Emission Level – Limit value
5. " * ": Fundamental frequency.
6. " # ": The radiated frequency is out of the restricted band.



CHANNEL	TX Channel 40	DETECTOR FUNCTION	Peak (PK)
FREQUENCY RANGE	1GHz ~ 40GHz		Average (AV)

ANTENNA POLARITY & TEST DISTANCE: HORIZONTAL AT 3 M

NO.	FREQ. (MHz)	EMISSION LEVEL (dBuV/m)	LIMIT (dBuV/m)	MARGIN (dB)	ANTENNA HEIGHT (m)	TABLE ANGLE (Degree)	RAW VALUE (dBuV)	CORRECTION FACTOR (dB/m)
1	5104.00	62.5 PK	74.0	-11.5	1.03 H	288	57.8	4.7
2	5104.00	52.2 AV	54.0	-1.8	1.03 H	288	47.5	4.7
3	*5200.00	111.4 PK			1.07 H	284	72.7	38.7
4	*5200.00	101.4 AV			1.07 H	284	62.7	38.7
5	5400.00	62.3 PK	74.0	-11.7	1.01 H	291	56.8	5.5
6	5400.00	52.5 AV	54.0	-1.5	1.01 H	291	47.0	5.5
7	#10400.00	65.9 PK	74.0	-8.1	1.83 H	264	48.3	17.6
8	#10400.00	49.5 AV	54.0	-4.5	1.83 H	264	31.9	17.6

ANTENNA POLARITY & TEST DISTANCE: VERTICAL AT 3 M

NO.	FREQ. (MHz)	EMISSION LEVEL (dBuV/m)	LIMIT (dBuV/m)	MARGIN (dB)	ANTENNA HEIGHT (m)	TABLE ANGLE (Degree)	RAW VALUE (dBuV)	CORRECTION FACTOR (dB/m)
1	5104.00	57.1 PK	74.0	-16.9	1.70 V	30	52.4	4.7
2	5104.00	46.2 AV	54.0	-7.8	1.70 V	30	41.5	4.7
3	*5200.00	104.6 PK			2.81 V	322	65.9	38.7
4	*5200.00	94.9 AV			2.81 V	322	56.2	38.7
5	5400.00	58.6 PK	74.0	-15.4	1.66 V	22	53.1	5.5
6	5400.00	47.7 AV	54.0	-6.3	1.66 V	22	42.2	5.5
7	#10400.00	61.3 PK	74.0	-12.7	3.01 V	345	43.7	17.6
8	#10400.00	48.1 AV	54.0	-5.9	3.01 V	345	30.5	17.6

REMARKS:

1. Emission Level(dBuV/m) = Raw Value(dBuV) + Correction Factor(dB/m)
2. Correction Factor(dB/m) = Antenna Factor(dB/m) + Cable Factor(dB)
3. The other emission levels were very low against the limit.
4. Margin value = Emission Level – Limit value
5. " * ": Fundamental frequency.
6. " # ": The radiated frequency is out of the restricted band.

CHANNEL	TX Channel 48	DETECTOR FUNCTION	Peak (PK)
FREQUENCY RANGE	1GHz ~ 40GHz		Average (AV)

ANTENNA POLARITY & TEST DISTANCE: HORIZONTAL AT 3 M

NO.	FREQ. (MHz)	EMISSION LEVEL (dBuV/m)	LIMIT (dBuV/m)	MARGIN (dB)	ANTENNA HEIGHT (m)	TABLE ANGLE (Degree)	RAW VALUE (dBuV)	CORRECTION FACTOR (dB/m)
1	5104.00	62.0 PK	74.0	-12.0	1.01 H	291	57.3	4.7
2	5104.00	52.3 AV	54.0	-1.7	1.01 H	291	47.6	4.7
3	*5240.00	110.2 PK			1.11 H	289	71.3	38.9
4	*5240.00	100.8 AV			1.11 H	289	61.9	38.9
5	5440.00	62.7 PK	74.0	-11.3	1.01 H	295	57.0	5.7
6	5440.00	52.6 AV	54.0	-1.4	1.01 H	295	46.9	5.7
7	#10480.00	66.9 PK	74.0	-7.1	1.88 H	324	48.5	18.4
8	#10480.00	53.0 AV	54.0	-1.0	1.88 H	324	34.6	18.4

ANTENNA POLARITY & TEST DISTANCE: VERTICAL AT 3 M

NO.	FREQ. (MHz)	EMISSION LEVEL (dBuV/m)	LIMIT (dBuV/m)	MARGIN (dB)	ANTENNA HEIGHT (m)	TABLE ANGLE (Degree)	RAW VALUE (dBuV)	CORRECTION FACTOR (dB/m)
1	5104.00	58.3 PK	74.0	-15.7	1.78 V	19	53.6	4.7
2	5104.00	46.8 AV	54.0	-7.2	1.78 V	19	42.1	4.7
3	*5240.00	105.4 PK			2.99 V	312	66.5	38.9
4	*5240.00	95.4 AV			2.99 V	312	56.5	38.9
5	5440.00	59.2 PK	74.0	-14.8	1.50 V	19	53.5	5.7
6	5440.00	47.9 AV	54.0	-6.1	1.50 V	19	42.2	5.7
7	#10480.00	61.5 PK	74.0	-12.5	2.99 V	0	43.1	18.4
8	#10480.00	48.7 AV	54.0	-5.3	2.99 V	0	30.3	18.4

REMARKS:

1. Emission Level(dBuV/m) = Raw Value(dBuV) + Correction Factor(dB/m)
2. Correction Factor(dB/m) = Antenna Factor(dB/m) + Cable Factor(dB)
3. The other emission levels were very low against the limit.
4. Margin value = Emission Level – Limit value
5. " * ": Fundamental frequency.
6. " # ": The radiated frequency is out of the restricted band.

CHANNEL	TX Channel 149	DETECTOR FUNCTION	Peak (PK)
FREQUENCY RANGE	1GHz ~ 40GHz		Average (AV)

ANTENNA POLARITY & TEST DISTANCE: HORIZONTAL AT 3 M

NO.	FREQ. (MHz)	EMISSION LEVEL (dBuV/m)	LIMIT (dBuV/m)	MARGIN (dB)	ANTENNA HEIGHT (m)	TABLE ANGLE (Degree)	RAW VALUE (dBuV)	CORRECTION FACTOR (dB/m)
1	#5612.00	57.6 PK	68.2	-10.6	1.05 H	279	51.5	6.1
2	*5745.00	111.7 PK			1.05 H	279	71.7	40.0
3	*5745.00	101.8 AV			1.05 H	279	61.8	40.0
4	#5957.60	58.8 PK	68.2	-9.4	1.05 H	279	52.2	6.6
5	11490.00	69.1 PK	74.0	-4.9	1.91 H	33	49.8	19.3
6	11490.00	53.0 AV	54.0	-1.0	1.91 H	33	33.7	19.3

ANTENNA POLARITY & TEST DISTANCE: VERTICAL AT 3 M

NO.	FREQ. (MHz)	EMISSION LEVEL (dBuV/m)	LIMIT (dBuV/m)	MARGIN (dB)	ANTENNA HEIGHT (m)	TABLE ANGLE (Degree)	RAW VALUE (dBuV)	CORRECTION FACTOR (dB/m)
1	#5600.00	57.8 PK	68.2	-10.4	3.07 V	351	51.7	6.1
2	*5745.00	109.9 PK			3.07 V	351	69.9	40.0
3	*5745.00	100.0 AV			3.07 V	351	60.0	40.0
4	#5949.60	58.0 PK	68.2	-10.2	3.07 V	351	51.4	6.6
5	11490.00	62.2 PK	74.0	-11.8	2.50 V	0	42.9	19.3
6	11490.00	49.3 AV	54.0	-4.7	2.50 V	0	30.0	19.3

REMARKS:

1. Emission Level(dBuV/m) = Raw Value(dBuV) + Correction Factor(dB/m)
2. Correction Factor(dB/m) = Antenna Factor(dB/m) + Cable Factor(dB)
3. The other emission levels were very low against the limit.
4. Margin value = Emission Level – Limit value
5. " * ": Fundamental frequency.
6. " # ": The radiated frequency is out of the restricted band.

CHANNEL	TX Channel 157	DETECTOR FUNCTION	Peak (PK)
FREQUENCY RANGE	1GHz ~ 40GHz		Average (AV)

ANTENNA POLARITY & TEST DISTANCE: HORIZONTAL AT 3 M

NO.	FREQ. (MHz)	EMISSION LEVEL (dBuV/m)	LIMIT (dBuV/m)	MARGIN (dB)	ANTENNA HEIGHT (m)	TABLE ANGLE (Degree)	RAW VALUE (dBuV)	CORRECTION FACTOR (dB/m)
1	#5633.60	57.2 PK	68.2	-11.0	1.04 H	283	51.1	6.1
2	*5785.00	111.9 PK			1.04 H	283	71.8	40.1
3	*5785.00	101.4 AV			1.04 H	283	61.3	40.1
4	#5952.00	58.2 PK	68.2	-10.0	1.04 H	283	51.6	6.6
5	11570.00	67.8 PK	74.0	-6.2	1.92 H	34	48.6	19.2
6	11570.00	53.0 AV	54.0	-1.0	1.92 H	34	33.8	19.2

ANTENNA POLARITY & TEST DISTANCE: VERTICAL AT 3 M

NO.	FREQ. (MHz)	EMISSION LEVEL (dBuV/m)	LIMIT (dBuV/m)	MARGIN (dB)	ANTENNA HEIGHT (m)	TABLE ANGLE (Degree)	RAW VALUE (dBuV)	CORRECTION FACTOR (dB/m)
1	#5627.20	57.0 PK	68.2	-11.2	2.99 V	347	50.9	6.1
2	*5785.00	108.5 PK			2.99 V	347	68.4	40.1
3	*5785.00	99.1 AV			2.99 V	347	59.0	40.1
4	#5945.60	57.7 PK	68.2	-10.5	2.99 V	347	51.1	6.6
5	11570.00	62.2 PK	74.0	-11.8	2.60 V	47	43.0	19.2
6	11570.00	49.4 AV	54.0	-4.6	2.60 V	47	30.2	19.2

REMARKS:

1. Emission Level(dBuV/m) = Raw Value(dBuV) + Correction Factor(dB/m)
2. Correction Factor(dB/m) = Antenna Factor(dB/m) + Cable Factor(dB)
3. The other emission levels were very low against the limit.
4. Margin value = Emission Level – Limit value
5. " * ": Fundamental frequency.
6. " # ": The radiated frequency is out of the restricted band.

CHANNEL	TX Channel 165	DETECTOR FUNCTION	Peak (PK)
FREQUENCY RANGE	1GHz ~ 40GHz		Average (AV)

ANTENNA POLARITY & TEST DISTANCE: HORIZONTAL AT 3 M

NO.	FREQ. (MHz)	EMISSION LEVEL (dBuV/m)	LIMIT (dBuV/m)	MARGIN (dB)	ANTENNA HEIGHT (m)	TABLE ANGLE (Degree)	RAW VALUE (dBuV)	CORRECTION FACTOR (dB/m)
1	#5640.00	57.4 PK	68.2	-10.8	1.01 H	285	51.3	6.1
2	*5825.00	110.7 PK			1.01 H	285	70.6	40.1
3	*5825.00	101.1 AV			1.01 H	285	61.0	40.1
4	#5940.00	58.2 PK	68.2	-10.0	1.01 H	285	51.6	6.6
5	11650.00	66.8 PK	74.0	-7.2	1.80 H	36	47.5	19.3
6	11650.00	53.0 AV	54.0	-1.0	1.80 H	36	33.7	19.3

ANTENNA POLARITY & TEST DISTANCE: VERTICAL AT 3 M

NO.	FREQ. (MHz)	EMISSION LEVEL (dBuV/m)	LIMIT (dBuV/m)	MARGIN (dB)	ANTENNA HEIGHT (m)	TABLE ANGLE (Degree)	RAW VALUE (dBuV)	CORRECTION FACTOR (dB/m)
1	#5628.00	57.5 PK	68.2	-10.7	3.10 V	308	51.4	6.1
2	*5825.00	110.0 PK			3.10 V	305	69.9	40.1
3	*5825.00	100.1 AV			3.10 V	305	60.0	40.1
4	#5969.60	57.5 PK	68.2	-10.7	3.10 V	308	50.8	6.7
5	11650.00	62.4 PK	74.0	-11.6	2.44 V	8	43.1	19.3
6	11650.00	49.6 AV	54.0	-4.4	2.44 V	8	30.3	19.3

REMARKS:

1. Emission Level(dBuV/m) = Raw Value(dBuV) + Correction Factor(dB/m)
2. Correction Factor(dB/m) = Antenna Factor(dB/m) + Cable Factor(dB)
3. The other emission levels were very low against the limit.
4. Margin value = Emission Level – Limit value
5. " * ": Fundamental frequency.
6. " # ": The radiated frequency is out of the restricted band.

802.11n (HT40)

CHANNEL	TX Channel 38	DETECTOR FUNCTION	Peak (PK)
FREQUENCY RANGE	1GHz ~ 40GHz		Average (AV)

ANTENNA POLARITY & TEST DISTANCE: HORIZONTAL AT 3 M

NO.	FREQ. (MHz)	EMISSION LEVEL (dBuV/m)	LIMIT (dBuV/m)	MARGIN (dB)	ANTENNA HEIGHT (m)	TABLE ANGLE (Degree)	RAW VALUE (dBuV)	CORRECTION FACTOR (dB/m)
1	5104.00	62.6 PK	74.0	-11.4	1.02 H	288	57.9	4.7
2	5104.00	52.7 AV	54.0	-1.3	1.02 H	288	48.0	4.7
3	*5190.00	106.5 PK			1.04 H	285	67.8	38.7
4	*5190.00	97.6 AV			1.04 H	285	58.9	38.7
5	5400.00	61.0 PK	74.0	-13.0	1.03 H	291	55.5	5.5
6	5400.00	53.0 AV	54.0	-1.0	1.03 H	291	47.5	5.5
7	#10380.00	60.1 PK	74.0	-13.9	1.83 H	337	42.5	17.6
8	#10380.00	47.1 AV	54.0	-6.9	1.83 H	337	29.5	17.6

ANTENNA POLARITY & TEST DISTANCE: VERTICAL AT 3 M

NO.	FREQ. (MHz)	EMISSION LEVEL (dBuV/m)	LIMIT (dBuV/m)	MARGIN (dB)	ANTENNA HEIGHT (m)	TABLE ANGLE (Degree)	RAW VALUE (dBuV)	CORRECTION FACTOR (dB/m)
1	5104.00	57.6 PK	74.0	-16.4	1.66 V	20	52.9	4.7
2	5104.00	47.7 AV	54.0	-6.3	1.66 V	20	43.0	4.7
3	*5190.00	102.5 PK			3.03 V	343	63.8	38.7
4	*5190.00	92.5 AV			3.03 V	343	53.8	38.7
5	5400.00	59.0 PK	74.0	-15.0	1.63 V	310	53.5	5.5
6	5400.00	48.9 AV	54.0	-5.1	1.63 V	310	43.4	5.5
7	#10380.00	59.6 PK	74.0	-14.4	2.89 V	303	42.0	17.6
8	#10380.00	46.7 AV	54.0	-7.3	2.89 V	303	29.1	17.6

REMARKS:

1. Emission Level(dBuV/m) = Raw Value(dBuV) + Correction Factor(dB/m)
2. Correction Factor(dB/m) = Antenna Factor(dB/m) + Cable Factor(dB)
3. The other emission levels were very low against the limit.
4. Margin value = Emission Level – Limit value
5. " * ": Fundamental frequency.
6. " # ": The radiated frequency is out of the restricted band.

CHANNEL	TX Channel 46	DETECTOR FUNCTION	Peak (PK)
FREQUENCY RANGE	1GHz ~ 40GHz		Average (AV)

ANTENNA POLARITY & TEST DISTANCE: HORIZONTAL AT 3 M

NO.	FREQ. (MHz)	EMISSION LEVEL (dBuV/m)	LIMIT (dBuV/m)	MARGIN (dB)	ANTENNA HEIGHT (m)	TABLE ANGLE (Degree)	RAW VALUE (dBuV)	CORRECTION FACTOR (dB/m)
1	5104.00	62.4 PK	74.0	-11.6	1.01 H	289	57.7	4.7
2	5104.00	53.0 AV	54.0	-1.0	1.01 H	289	48.3	4.7
3	*5230.00	107.8 PK			1.10 H	293	68.9	38.9
4	*5230.00	97.5 AV			1.10 H	293	58.6	38.9
5	5440.00	62.5 PK	74.0	-11.5	1.00 H	293	56.8	5.7
6	5440.00	52.8 AV	54.0	-1.2	1.00 H	293	47.1	5.7
7	#10460.00	61.7 PK	74.0	-12.3	1.99 H	323	43.5	18.2
8	#10460.00	48.6 AV	54.0	-5.4	1.99 H	323	30.4	18.2

ANTENNA POLARITY & TEST DISTANCE: VERTICAL AT 3 M

NO.	FREQ. (MHz)	EMISSION LEVEL (dBuV/m)	LIMIT (dBuV/m)	MARGIN (dB)	ANTENNA HEIGHT (m)	TABLE ANGLE (Degree)	RAW VALUE (dBuV)	CORRECTION FACTOR (dB/m)
1	5104.00	56.7 PK	74.0	-17.3	1.50 V	30	52.0	4.7
2	5104.00	47.0 AV	54.0	-7.0	1.50 V	30	42.3	4.7
3	*5230.00	101.5 PK			3.02 V	315	62.6	38.9
4	*5230.00	92.7 AV			3.02 V	315	53.8	38.9
5	5440.00	59.0 PK	74.0	-15.0	1.60 V	310	53.3	5.7
6	5440.00	49.3 AV	54.0	-4.7	1.60 V	310	43.6	5.7
7	#10460.00	59.7 PK	74.0	-14.3	2.54 V	264	41.5	18.2
8	#10460.00	47.0 AV	54.0	-7.0	2.54 V	264	28.8	18.2

REMARKS:

1. Emission Level(dBuV/m) = Raw Value(dBuV) + Correction Factor(dB/m)
2. Correction Factor(dB/m) = Antenna Factor(dB/m) + Cable Factor(dB)
3. The other emission levels were very low against the limit.
4. Margin value = Emission Level – Limit value
5. " * ": Fundamental frequency.
6. " # ": The radiated frequency is out of the restricted band.

CHANNEL	TX Channel 151	DETECTOR FUNCTION	Peak (PK)
FREQUENCY RANGE	1GHz ~ 40GHz		Average (AV)

ANTENNA POLARITY & TEST DISTANCE: HORIZONTAL AT 3 M

NO.	FREQ. (MHz)	EMISSION LEVEL (dBuV/m)	LIMIT (dBuV/m)	MARGIN (dB)	ANTENNA HEIGHT (m)	TABLE ANGLE (Degree)	RAW VALUE (dBuV)	CORRECTION FACTOR (dB/m)
1	#5631.20	58.0 PK	68.2	-10.2	1.00 H	281	51.9	6.1
2	*5755.00	109.3 PK			1.00 H	281	69.3	40.0
3	*5755.00	99.9 AV			1.00 H	281	59.9	40.0
4	#5977.60	58.7 PK	68.2	-9.5	1.00 H	281	52.0	6.7
5	11510.00	66.0 PK	74.0	-8.0	1.73 H	30	46.7	19.3
6	11510.00	53.0 AV	54.0	-1.0	1.73 H	30	33.7	19.3

ANTENNA POLARITY & TEST DISTANCE: VERTICAL AT 3 M

NO.	FREQ. (MHz)	EMISSION LEVEL (dBuV/m)	LIMIT (dBuV/m)	MARGIN (dB)	ANTENNA HEIGHT (m)	TABLE ANGLE (Degree)	RAW VALUE (dBuV)	CORRECTION FACTOR (dB/m)
1	#5604.80	57.9 PK	68.2	-10.3	3.05 V	352	51.8	6.1
2	*5755.00	106.9 PK			3.05 V	352	66.9	40.0
3	*5755.00	98.1 AV			3.05 V	352	58.1	40.0
4	#5983.20	57.5 PK	68.2	-10.7	3.05 V	352	50.8	6.7
5	11510.00	61.9 PK	74.0	-12.1	2.63 V	12	42.6	19.3
6	11510.00	48.8 AV	54.0	-5.2	2.63 V	12	29.5	19.3

REMARKS:

1. Emission Level(dBuV/m) = Raw Value(dBuV) + Correction Factor(dB/m)
2. Correction Factor(dB/m) = Antenna Factor(dB/m) + Cable Factor(dB)
3. The other emission levels were very low against the limit.
4. Margin value = Emission Level – Limit value
5. " * ": Fundamental frequency.
6. " # ": The radiated frequency is out of the restricted band.

CHANNEL	TX Channel 159	DETECTOR FUNCTION	Peak (PK)
FREQUENCY RANGE	1GHz ~ 40GHz		Average (AV)

ANTENNA POLARITY & TEST DISTANCE: HORIZONTAL AT 3 M

NO.	FREQ. (MHz)	EMISSION LEVEL (dBuV/m)	LIMIT (dBuV/m)	MARGIN (dB)	ANTENNA HEIGHT (m)	TABLE ANGLE (Degree)	RAW VALUE (dBuV)	CORRECTION FACTOR (dB/m)
1	#5606.40	57.2 PK	68.2	-11.0	1.04 H	279	51.1	6.1
2	*5795.00	108.6 PK			1.04 H	279	68.5	40.1
3	*5795.00	99.2 AV			1.04 H	279	59.1	40.1
4	#5968.00	57.9 PK	68.2	-10.3	1.04 H	279	51.2	6.7
5	11590.00	65.4 PK	74.0	-8.6	1.81 H	32	46.2	19.2
6	11590.00	53.0 AV	54.0	-1.0	1.81 H	32	33.8	19.2

ANTENNA POLARITY & TEST DISTANCE: VERTICAL AT 3 M

NO.	FREQ. (MHz)	EMISSION LEVEL (dBuV/m)	LIMIT (dBuV/m)	MARGIN (dB)	ANTENNA HEIGHT (m)	TABLE ANGLE (Degree)	RAW VALUE (dBuV)	CORRECTION FACTOR (dB/m)
1	#5612.80	57.2 PK	68.2	-11.0	3.05 V	315	51.1	6.1
2	*5795.00	107.4 PK			3.05 V	315	67.3	40.1
3	*5795.00	98.0 AV			3.05 V	315	57.9	40.1
4	#5956.00	58.3 PK	68.2	-9.9	3.05 V	315	51.7	6.6
5	11590.00	61.6 PK	74.0	-12.4	2.70 V	3	42.4	19.2
6	11590.00	48.5 AV	54.0	-5.5	2.70 V	3	29.3	19.2

REMARKS:

1. Emission Level(dBuV/m) = Raw Value(dBuV) + Correction Factor(dB/m)
2. Correction Factor(dB/m) = Antenna Factor(dB/m) + Cable Factor(dB)
3. The other emission levels were very low against the limit.
4. Margin value = Emission Level – Limit value
5. " * ": Fundamental frequency.
6. " # ": The radiated frequency is out of the restricted band.

Below 1GHz Worst-Case Data:

802.11a

CHANNEL	TX Channel 36	DETECTOR FUNCTION	Quasi-Peak (QP)
FREQUENCY RANGE	9kHz ~ 1GHz	TEST MODE	A

ANTENNA POLARITY & TEST DISTANCE: HORIZONTAL AT 3 M

NO.	FREQ. (MHz)	EMISSION LEVEL (dBuV/m)	LIMIT (dBuV/m)	MARGIN (dB)	ANTENNA HEIGHT (m)	TABLE ANGLE (Degree)	RAW VALUE (dBuV)	CORRECTION FACTOR (dB/m)
1	57.12	30.7 QP	40.0	-9.3	1.99 H	79	45.3	-14.6
2	94.06	32.8 QP	43.5	-10.7	1.99 H	240	52.4	-19.6
3	199.05	41.0 QP	43.5	-2.5	1.00 H	270	57.5	-16.5
4	374.04	38.6 QP	46.0	-7.4	1.00 H	312	49.2	-10.6
5	500.42	30.3 QP	46.0	-15.7	1.99 H	292	38.5	-8.2
6	624.85	42.4 QP	46.0	-3.6	1.00 H	220	47.6	-5.2
7	751.23	35.6 QP	46.0	-10.4	1.00 H	159	38.4	-2.8
8	875.67	38.9 QP	46.0	-7.1	1.00 H	171	39.7	-0.8

ANTENNA POLARITY & TEST DISTANCE: VERTICAL AT 3 M

NO.	FREQ. (MHz)	EMISSION LEVEL (dBuV/m)	LIMIT (dBuV/m)	MARGIN (dB)	ANTENNA HEIGHT (m)	TABLE ANGLE (Degree)	RAW VALUE (dBuV)	CORRECTION FACTOR (dB/m)
1	34.04	30.1 QP	40.0	-9.9	1.00 V	186	45.7	-15.6
2	197.11	36.3 QP	43.5	-7.2	1.00 V	21	52.8	-16.5
3	374.04	38.5 QP	46.0	-7.5	1.49 V	349	49.1	-10.6
4	500.42	30.8 QP	46.0	-15.2	2.00 V	306	39.0	-8.2
5	624.85	40.7 QP	46.0	-5.3	1.00 V	347	45.9	-5.2
6	716.23	41.2 QP	46.0	-4.8	1.00 V	56	45.0	-3.8
7	751.23	34.2 QP	46.0	-11.8	1.49 V	10	37.0	-2.8
8	875.67	32.4 QP	46.0	-13.6	2.00 V	47	33.2	-0.8

REMARKS:

1. Emission Level(dBuV/m) = Raw Value(dBuV) + Correction Factor(dB/m)
2. Correction Factor(dB/m) = Antenna Factor(dB/m) + Cable Factor(dB)
3. The other emission levels were very low against the limit.
4. Margin value = Emission Level – Limit value

CHANNEL	TX Channel 36	DETECTOR FUNCTION	Quasi-Peak (QP)
FREQUENCY RANGE	9kHz ~ 1GHz	TEST MODE	B

ANTENNA POLARITY & TEST DISTANCE: HORIZONTAL AT 3 M

NO.	FREQ. (MHz)	EMISSION LEVEL (dBuV/m)	LIMIT (dBuV/m)	MARGIN (dB)	ANTENNA HEIGHT (m)	TABLE ANGLE (Degree)	RAW VALUE (dBuV)	CORRECTION FACTOR (dB/m)
1	57.12	29.8 QP	40.0	-10.2	1.49 H	52	44.4	-14.6
2	160.17	32.0 QP	43.5	-11.5	1.49 H	264	45.8	-13.8
3	249.60	34.8 QP	46.0	-11.2	1.00 H	270	48.8	-14.0
4	374.04	42.0 QP	46.0	-4.0	1.00 H	130	52.5	-10.5
5	624.85	44.2 QP	46.0	-1.8	1.00 H	133	48.9	-4.7
6	875.00	44.9 QP	46.0	-1.1	1.50 H	136	45.0	-0.1

ANTENNA POLARITY & TEST DISTANCE: VERTICAL AT 3 M

NO.	FREQ. (MHz)	EMISSION LEVEL (dBuV/m)	LIMIT (dBuV/m)	MARGIN (dB)	ANTENNA HEIGHT (m)	TABLE ANGLE (Degree)	RAW VALUE (dBuV)	CORRECTION FACTOR (dB/m)
1	39.50	36.3 QP	40.0	-3.7	1.00 V	21	51.5	-15.2
2	111.56	27.1 QP	43.5	-16.4	1.49 V	95	44.2	-17.1
3	249.60	32.0 QP	46.0	-14.0	1.00 V	299	46.0	-14.0
4	374.04	41.9 QP	46.0	-4.1	1.00 V	176	52.4	-10.5
5	624.85	42.1 QP	46.0	-3.9	1.49 V	195	46.8	-4.7
6	874.99	45.0 QP	46.0	-1.0	1.00 V	168	45.1	-0.1

REMARKS:

1. Emission Level(dBuV/m) = Raw Value(dBuV) + Correction Factor(dB/m)
2. Correction Factor(dB/m) = Antenna Factor(dB/m) + Cable Factor(dB)
3. The other emission levels were very low against the limit.
4. Margin value = Emission Level – Limit value

4.2 Conducted Emission Measurement

4.2.1 Limits of Conducted Emission Measurement

Frequency (MHz)	Conducted Limit (dBuV)	
	Quasi-peak	Average
0.15 - 0.5	66 - 56	56 - 46
0.50 - 5.0	56	46
5.0 - 30.0	60	50

- Note: 1. The lower limit shall apply at the transition frequencies.
 2. The limit decreases in line with the logarithm of the frequency in the range of 0.15 to 0.50MHz.

4.2.2 Test Instruments

Description & Manufacturer	Model No.	Serial No.	Cal. Date	Cal. Due
Test Receiver ROHDE & SCHWARZ	ESCS30	100289	Dec. 23, 2015	Dec. 22, 2016
RF signal cable (with 10dB PAD) Woken	5D-FB	Cable-cond2-01	Dec. 26, 2015	Dec. 25, 2016
LISN ROHDE & SCHWARZ (EUT)	ESH2-Z5	100100	Jan. 11, 2016	Jan. 10, 2017
LISN ROHDE & SCHWARZ (Peripheral)	ESH3-Z5	100312	Jul. 26, 2016	Jul. 25, 2017
Software ADT	BV ADT_Cond_ V7.3.7.3	NA	NA	NA

- Note: 1. The calibration interval of the above test instruments is 12 months and the calibrations are traceable to NML/ROC and NIST/USA.
 2. The test was performed in HwaYa Shielded Room 2.
 3. The VCCI Site Registration No. is C-2047.

4.2.3 Test Procedure

- The EUT was placed 0.4 meters from the conducting wall of the shielded room with EUT being connected to the power mains through a line impedance stabilization network (LISN). Other support units were connected to the power mains through another LISN. The two LISNs provide 50 ohm/ 50uH of coupling impedance for the measuring instrument.
- Both lines of the power mains connected to the EUT were checked for maximum conducted interference.
- The frequency range from 150kHz to 30MHz was searched. Emission levels under (Limit - 20dB) was not recorded.

NOTE: The resolution bandwidth and video bandwidth of test receiver is 9kHz for quasi-peak detection (QP) and average detection (AV) at frequency 0.15MHz-30MHz.

4.2.4 Deviation from Test Standard

No deviation.

4.2.5 Test Setup

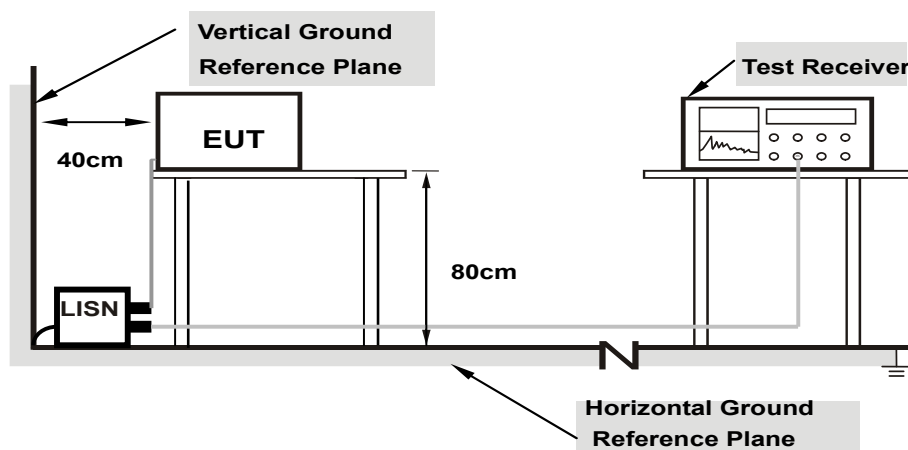

- Note:**
- Support units were connected to second LISN.
 - Both of LISNs (AMN) are 80 cm from EUT and at least 80 from other units and other metal planes

For the actual test configuration, please refer to the attached file (Test Setup Photo).

4.2.6 EUT Operating Conditions

Same as 4.1.6.

4.2.7 Test Results

Phase	Line (L)	Detector Function	Quasi-Peak (QP) / Average (AV)
Test Mode	A		

No	Freq. [MHz]	Corr. Factor (dB)	Reading Value		Emission Level		Limit		Margin	
			[dB (uV)]		[dB (uV)]		[dB (uV)]		(dB)	
			Q.P.	AV.	Q.P.	AV.	Q.P.	AV.	Q.P.	AV.
1	0.15802	10.08	42.52	26.61	52.60	36.69	65.57	55.57	-12.97	-18.88
2	0.20084	10.08	37.15	22.47	47.23	32.55	63.58	53.58	-16.35	-21.03
3	0.54491	10.20	31.82	24.87	42.02	35.07	56.00	46.00	-13.98	-10.93
4	1.80803	10.35	24.61	18.60	34.96	28.95	56.00	46.00	-21.04	-17.05
5	11.97384	10.89	30.56	25.60	41.45	36.49	60.00	50.00	-18.55	-13.51
6	26.62461	11.84	21.83	17.03	33.67	28.87	60.00	50.00	-26.33	-21.13

REMARKS:

1. Q.P. and AV. are abbreviations of quasi-peak and average individually.
2. The emission levels of other frequencies were very low against the limit.
3. Margin value = Emission level - Limit value
4. Correction factor = Insertion loss + Cable loss
5. Emission Level = Correction Factor + Reading Value.

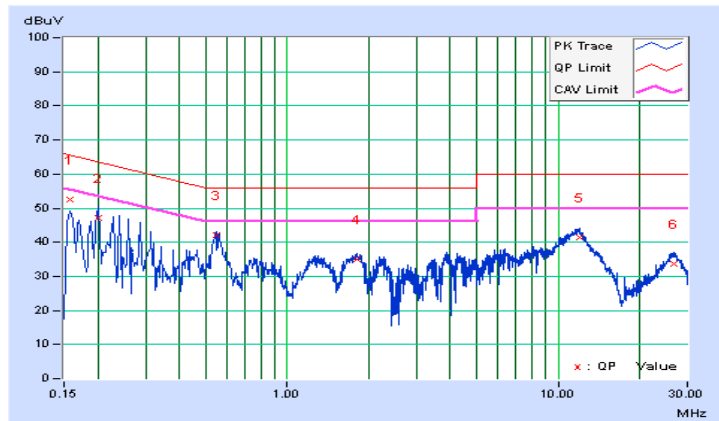

Phase	Neutral (N)	Detector Function	Quasi-Peak (QP) / Average (AV)
Test Mode	A		

No	Freq. [MHz]	Corr. Factor (dB)	Reading Value [dB (uV)]		Emission Level [dB (uV)]		Limit [dB (uV)]		Margin (dB)	
			Q.P.	AV.	Q.P.	AV.	Q.P.	AV.	Q.P.	AV.
	1	0.16569	10.08	40.89	23.69	50.97	33.77	65.17	55.17	-14.20
2	0.29858	10.16	26.87	15.29	37.03	25.45	60.28	50.28	-23.25	-24.83
3	0.55241	10.25	30.65	23.75	40.90	34.00	56.00	46.00	-15.10	-12.00
4	1.89386	10.38	22.98	15.92	33.36	26.30	56.00	46.00	-22.64	-19.70
5	11.68450	10.96	23.40	17.97	34.36	28.93	60.00	50.00	-25.64	-21.07
6	26.60897	12.04	20.28	15.58	32.32	27.62	60.00	50.00	-27.68	-22.38

REMARKS:

1. Q.P. and AV. are abbreviations of quasi-peak and average individually.
2. The emission levels of other frequencies were very low against the limit.
3. Margin value = Emission level - Limit value
4. Correction factor = Insertion loss + Cable loss
5. Emission Level = Correction Factor + Reading Value.

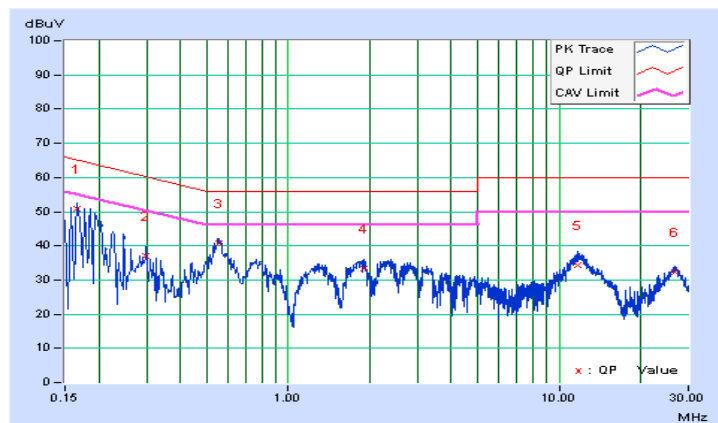

Phase	Line (L)	Detector Function	Quasi-Peak (QP) / Average (AV)
Test Mode	B		

No	Freq. [MHz]	Corr. Factor (dB)	Reading Value [dB (uV)]		Emission Level [dB (uV)]		Limit [dB (uV)]		Margin (dB)	
			Q.P.	AV.	Q.P.	AV.	Q.P.	AV.	Q.P.	AV.
	1	0.18903	10.08	35.06	29.12	45.14	39.20	64.08	54.08	-18.94
2	0.28685	10.12	27.94	22.75	38.06	32.87	60.62	50.62	-22.56	-17.75
3	0.38069	10.16	27.50	27.36	37.66	37.52	58.26	48.26	-20.60	-10.74
4	3.75502	10.46	25.94	25.93	36.40	36.39	56.00	46.00	-19.60	-9.61
5	15.88699	11.13	31.30	28.67	42.43	39.80	60.00	50.00	-17.57	-10.20
6	19.02356	11.35	27.15	24.71	38.50	36.06	60.00	50.00	-21.50	-13.94

REMARKS:

1. Q.P. and AV. are abbreviations of quasi-peak and average individually.
2. The emission levels of other frequencies were very low against the limit.
3. Margin value = Emission level - Limit value
4. Correction factor = Insertion loss + Cable loss
5. Emission Level = Correction Factor + Reading Value.

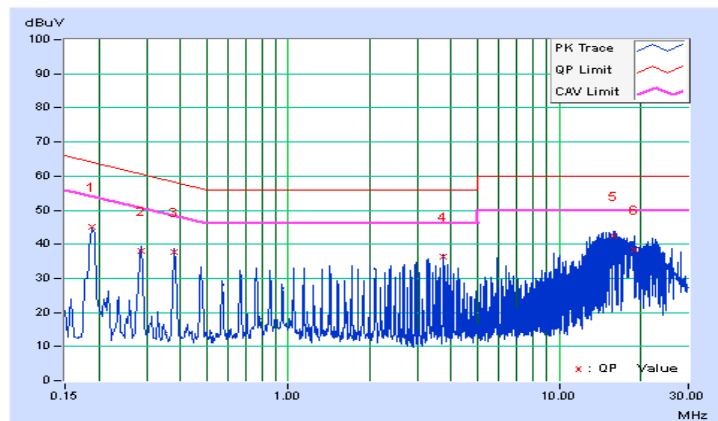

Phase	Neutral (N)	Detector Function	Quasi-Peak (QP) / Average (AV)
Test Mode	B		

No	Freq. [MHz]	Corr. Factor (dB)	Reading Value [dB (uV)]		Emission Level [dB (uV)]		Limit [dB (uV)]		Margin (dB)	
			Q.P.	AV.	Q.P.	AV.	Q.P.	AV.	Q.P.	AV.
			1	0.19305	10.08	35.29	25.96	45.37	36.04	63.90
2	0.38099	10.22	25.78	25.06	36.00	35.28	58.26	48.26	-22.26	-12.98
3	1.04930	10.29	21.41	21.11	31.70	31.40	56.00	46.00	-24.30	-14.60
4	3.75502	10.57	25.80	25.77	36.37	36.34	56.00	46.00	-19.63	-9.66
5	14.78513	11.17	23.04	16.09	34.21	27.26	60.00	50.00	-25.79	-22.74
6	17.81913	11.41	28.72	25.75	40.13	37.16	60.00	50.00	-19.87	-12.84

REMARKS:

1. Q.P. and AV. are abbreviations of quasi-peak and average individually.
2. The emission levels of other frequencies were very low against the limit.
3. Margin value = Emission level - Limit value
4. Correction factor = Insertion loss + Cable loss
5. Emission Level = Correction Factor + Reading Value.

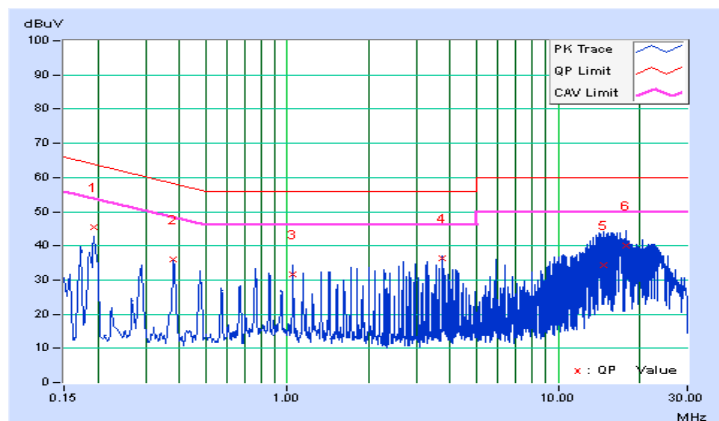

4.3 Transmit Power Measurement

4.3.1 Limits of Transmit Power Measurement

Operation Band	EUT Category		LIMIT
U-NII-1		Outdoor Access Point	1 Watt (30 dBm) (Max. e.i.r.p \leq 125mW(21 dBm) at any elevation angle above 30 degrees as measured from the horizon)
		Fixed point-to-point Access Point	1 Watt (30 dBm)
	√	Indoor Access Point	1 Watt (30 dBm)
		Mobile and Portable client device	250mW (24 dBm)
U-NII-2A	---		250mW (24 dBm) or 11 dBm+10 log B*
U-NII-2C	---		250mW (24 dBm) or 11 dBm+10 log B*
U-NII-3	√		1 Watt (30 dBm)

*B is the 26 dB emission bandwidth in megahertz

Per KDB 662911 Method of conducted output power measurement on IEEE 802.11 devices,

Array Gain = 0 dB (i.e., no array gain) for $N_{ANT} \leq 4$;

Array Gain = 0 dB (i.e., no array gain) for channel widths ≥ 40 MHz for any N_{ANT} ;

Array Gain = $5 \log(N_{ANT}/N_{SS})$ dB or 3 dB, whichever is less for 20-MHz channel widths with $N_{ANT} \geq 5$.

For power measurements on all other devices: Array Gain = $10 \log(N_{ANT}/N_{SS})$ dB.

4.3.2 Test Setup

For Power Output Measurement

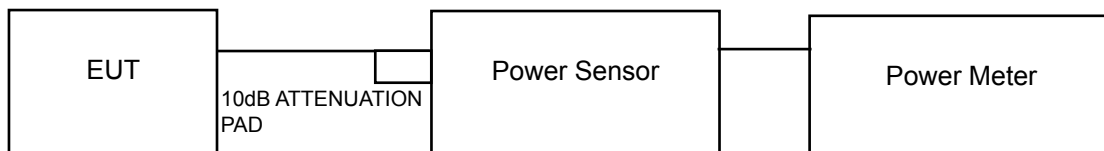

For 26dB Bandwidth

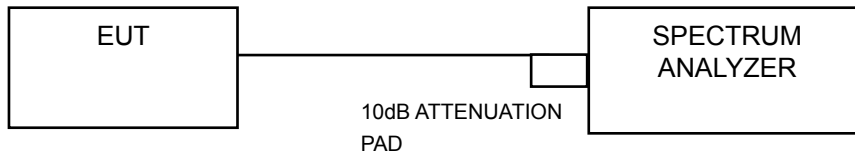

4.3.3 Test Instruments

Refer to section 4.1.2 to get information of above instrument.

4.3.4 Test Procedure

For Average Power Measurement

Method PM is used to perform output power measurement, trigger and gating function of wide band power meter is enabled to measure max output power of TX on burst. Duty factor is not added to measured value.

For 26dB Bandwidth

- 1) Set RBW = approximately 1% of the emission bandwidth.
- 2) Set the VBW > RBW.
- 3) Detector = Peak.
- 4) Trace mode = max hold.
- 5) Measure the maximum width of the emission that is 26 dB down from the peak of the emission. Compare this with the RBW setting of the analyzer. Readjust RBW and repeat measurement as needed until the RBW/EBW ratio is approximately 1%.

4.3.5 Deviation from Test Standard

No deviation.

4.3.6 EUT Operating Conditions

The software provided by client to enable the EUT under transmission Condition continuously at lowest, middle and highest channel frequencies individually.

4.3.7 Test Result

POWER OUTPUT:

802.11a

Chan.	Freq. (MHz)	Maximum Conducted Power (dBm)		Total Power (mW)	Total Power (dBm)	Power Limit (dBm)	Pass / Fail
		Chain 0	Chain 1				
36	5180	14.17	13.59	48.978	16.90	30	Pass
40	5200	14.68	15.02	61.145	17.86	30	Pass
48	5240	14.86	14.33	57.722	17.61	30	Pass
149	5745	18.18	17.95	128.139	21.08	30	Pass
157	5785	17.95	17.91	124.175	20.94	30	Pass
165	5825	17.71	17.75	118.586	20.74	30	Pass

802.11n (HT20)

Chan.	Freq. (MHz)	Maximum Conducted Power (dBm)		Total Power (mW)	Total Power (dBm)	Power Limit (dBm)	Pass / Fail
		Chain 0	Chain 1				
36	5180	14.13	13.72	49.432	16.94	30	Pass
40	5200	14.94	15.01	62.885	17.99	30	Pass
48	5240	14.65	14.49	57.293	17.58	30	Pass
149	5745	17.49	16.99	106.108	20.26	30	Pass
157	5785	16.74	16.92	96.410	19.84	30	Pass
165	5825	16.66	16.82	94.429	19.75	30	Pass

802.11n (HT40)

Chan.	Freq. (MHz)	Maximum Conducted Power (dBm)		Total Power (mW)	Total Power (dBm)	Power Limit (dBm)	Pass / Fail
		Chain 0	Chain 1				
38	5190	13.34	13.35	43.204	16.36	30	Pass
46	5230	13.42	13.12	42.491	16.28	30	Pass
151	5755	17.23	17.96	115.362	20.62	30	Pass
159	5795	16.72	17.64	105.065	20.21	30	Pass

26dB Bandwidth:

802.11a

Channel	Frequency (MHz)	26dBc Bandwidth (MHz)	
		Chain 0	Chain 1
36	5180	23.11	22.64
40	5200	23.14	21.91
48	5240	23.30	22.05

802.11n (HT20)

Channel	Frequency (MHz)	26dBc Bandwidth (MHz)	
		Chain 0	Chain 1
36	5180	24.50	23.24
40	5200	23.52	23.16
48	5240	23.49	23.49

802.11n (HT40)

Channel	Frequency (MHz)	26dBc Bandwidth (MHz)	
		Chain 0	Chain 1
38	5190	48.37	47.61
46	5230	48.11	47.92



SPECTRUM PLOT OF WORST VALUE

802.11a

802.11n (HT20)

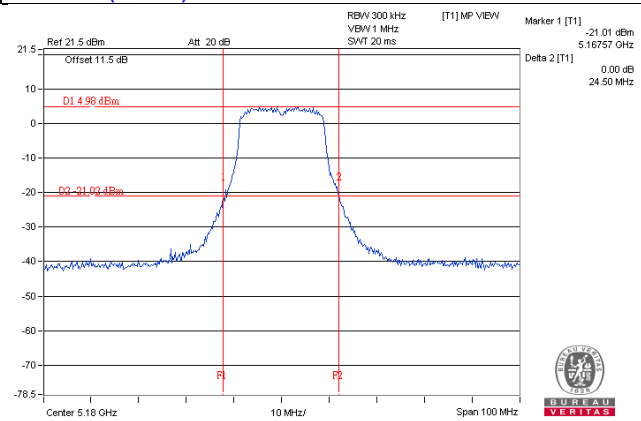
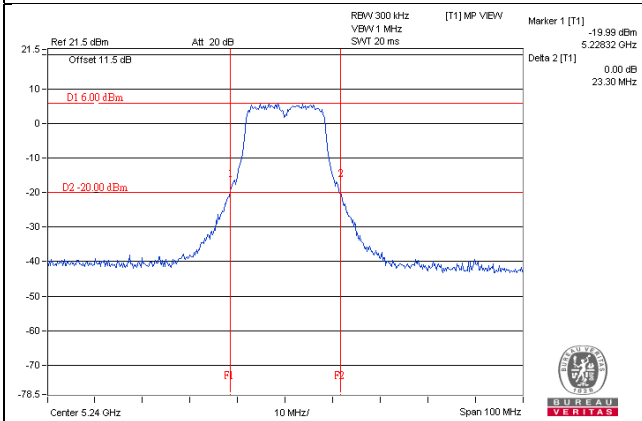

802.11n (HT40)

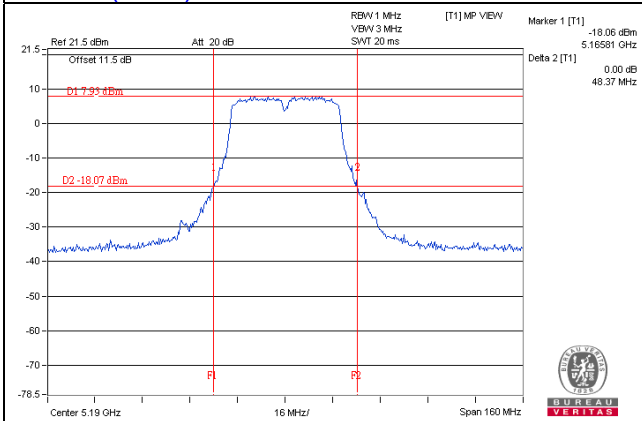

4.4 Occupied Bandwidth Measurement

4.4.1 Test Setup

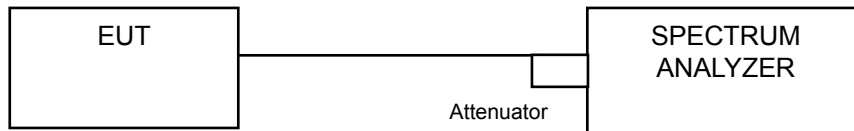

4.4.2 Test Instruments

Refer to section 4.1.2 to get information of above instrument.

4.4.3 Test Procedure

The transmitter output was connected to the spectrum analyzer through an attenuator. The bandwidth of the fundamental frequency was measured by spectrum analyzer with resolution bandwidth in the range of 1% to 5% of the anticipated emission bandwidth, and a video bandwidth at least 3x the resolution bandwidth and set the detector to SAMPLE. The width of a frequency band such that, below the lower and above the upper frequency limits, the mean powers emitted are each equal to a specified percentage 0.5 %of the total mean power of a given emission.

4.4.4 Test Results

802.11a

Channel	Channel Frequency (MHz)	Occupied Bandwidth (MHz)	
		Chain 0	Chain 1
36	5180	16.80	16.80
40	5200	16.92	16.68
48	5240	16.92	16.68
149	5745	17.04	16.69
157	5785	16.92	16.80
165	5825	16.80	16.80

802.11n (HT20)

Channel	Channel Frequency (MHz)	Occupied Bandwidth (MHz)	
		Chain 0	Chain 1
36	5180	17.88	17.88
40	5200	18.00	17.88
48	5240	17.88	17.88
149	5745	17.76	18.00
157	5785	17.76	17.76
165	5825	18.00	18.00

802.11n (HT40)

Channel	Channel Frequency (MHz)	Occupied Bandwidth (MHz)	
		Chain 0	Chain 1
38	5190	36.84	36.72
46	5230	37.08	36.84
151	5755	37.08	36.96
159	5795	37.08	36.84

SPECTRUM PLOT OF WORST VALUE

802.11a

802.11n (HT20)

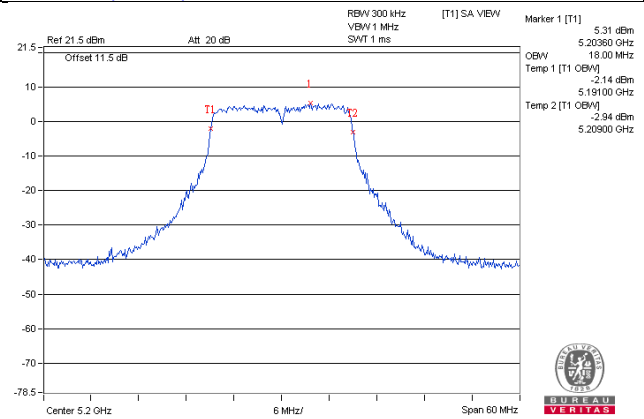
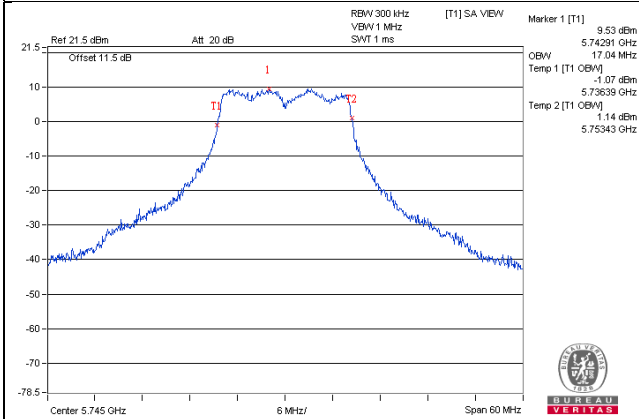

802.11n (HT40)

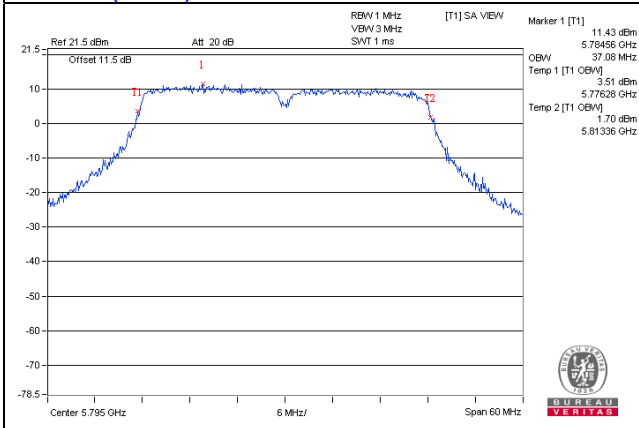

4.5 Peak Power Spectral Density Measurement

4.5.1 Limits of Peak Power Spectral Density Measurement

Operation Band	EUT Category		LIMIT
U-NII-1		Outdoor Access Point	17dBm/ MHz
		Fixed point-to-point Access Point	
	√	Indoor Access Point	
		Mobile and Portable client device	11dBm/ MHz
U-NII-2A	---		11dBm/ MHz
U-NII-2C	---		11dBm/ MHz
U-NII-3	√		30dBm/ 500kHz

4.5.2 Test Setup

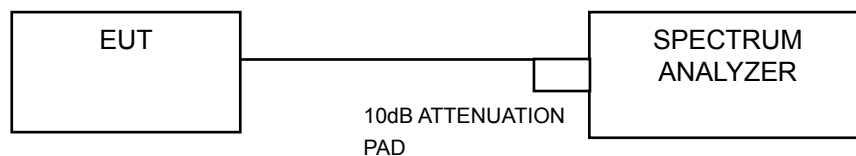

4.5.3 Test Instruments

Refer to section 4.1.2 to get information of above instrument.

4.5.4 Test Procedure

For U-NII-1 band:

Using method SA-2 alternative

- 1) Set span to encompass the entire emission bandwidth (EBW) of the signal.
- 2) Set RBW = 1MHz, Set VBW ≥ 3 MHz, Detector = RMS
- 3) Set Channel power measure = 1MHz
- 4) Sweep time =20ms.
- 5) Perform a single sweep.
- 6) Record the max value and add 10 log (1/duty cycle)

For U-NII-3 band:

- 1) Set span to encompass the entire emission bandwidth (EBW) of the signal.
- 2) Set RBW = 300 kHz, Set VBW ≥ 1 MHz, Detector = RMS
- 3) Use the peak marker function to determine the maximum power level in any 300 kHz band segment within the fundamental EBW.
- 4) Scale the observed power level to an equivalent value in 500 kHz by adjusting (reducing) the measured power by a bandwidth correction factor (BWCF) where $BWCF = 10\log(500 \text{ kHz}/300\text{kHz})$
- 5) Sweep time = auto, trigger set to "free run".
- 6) Trace average at least 100 traces in power averaging mode.
- 7) Record the max value and add 10 log (1/duty cycle)

4.5.5 Deviation from Test Standard

No deviation.

4.5.6 EUT Operating Condition

Same as Item 4.3.6.

4.5.7 Test Results

For U-NII-1 Band

802.11a

Chan.	Freq. (MHz)	PSD (dBm)		Total PSD w/o duty factor (dBm)	Duty factor	Total PSD with duty factor (dBm)	Max. Limit (dBm)	Pass / Fail
		Chain 0	Chain 1					
36	5180	0.74	1.63	4.22	0.12	4.34	17.00	Pass
40	5200	1.76	2.55	5.18	0.12	5.30	17.00	Pass
48	5240	1.42	1.64	4.54	0.12	4.66	17.00	Pass

NOTE:

1. Method 1 of power density measurement of KDB 662911 is using for calculating total power density. Total power density is summing entire spectra across corresponding frequency bins on the various outputs by computer.
2. Directional gain = $2\text{dBi} + 10\log(2) = 5.01\text{dBi} < 6\text{dBi}$, therefore the limit no need to reduced.
3. Refer to section 3.3 for duty cycle spectrum plot.

802.11n (HT20)

Chan.	Freq. (MHz)	PSD (dBm)		Total PSD w/o duty factor (dBm)	Duty factor	Total PSD with duty factor (dBm)	Max. Limit (dBm)	Pass / Fail
		Chain 0	Chain 1					
36	5180	0.38	1.60	4.04	0.14	4.18	17.00	Pass
40	5200	1.67	2.33	5.02	0.14	5.16	17.00	Pass
48	5240	1.26	1.31	4.29	0.14	4.43	17.00	Pass

NOTE:

1. Method 1 of power density measurement of KDB 662911 is using for calculating total power density. Total power density is summing entire spectra across corresponding frequency bins on the various outputs by computer.
2. Directional gain = $2\text{dBi} + 10\log(2) = 5.01\text{dBi} < 6\text{dBi}$, therefore the limit no need to reduced.
3. Refer to section 3.3 for duty cycle spectrum plot.

802.11n (HT40)

Chan.	Freq. (MHz)	PSD (dBm)		Total PSD w/o duty factor (dBm)	Duty factor	Total PSD with duty factor (dBm)	Max. Limit (dBm)	Pass / Fail
		Chain 0	Chain 1					
38	5190	-3.32	-2.24	0.26	0.44	0.70	17.00	Pass
46	5230	-3.31	-3.36	-0.33	0.44	0.11	17.00	Pass

NOTE:

- Method 1 of power density measurement of KDB 662911 is using for calculating total power density. Total power density is summing entire spectra across corresponding frequency bins on the various outputs by computer.
- Directional gain = $2\text{dBi} + 10\log(2) = 5.01\text{dBi} < 6\text{dBi}$, therefore the limit no need to reduced.
- Refer to section 3.3 for duty cycle spectrum plot.

SPECTRUM PLOT OF WORST VALUE

802.11a / CH 40 / Chain 1

802.11n (HT20) / CH 40 / Chain 1

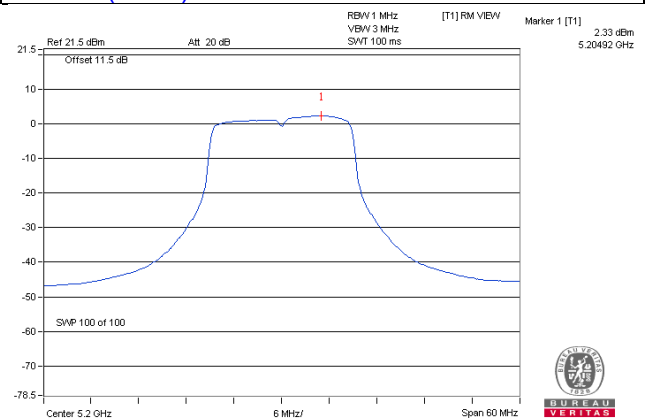
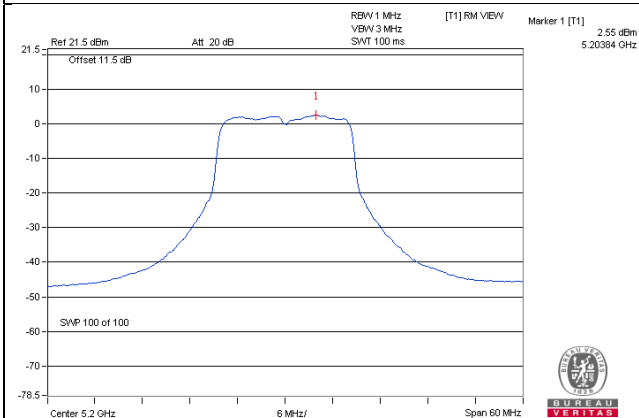

802.11n (HT40) / CH 38 / Chain 1

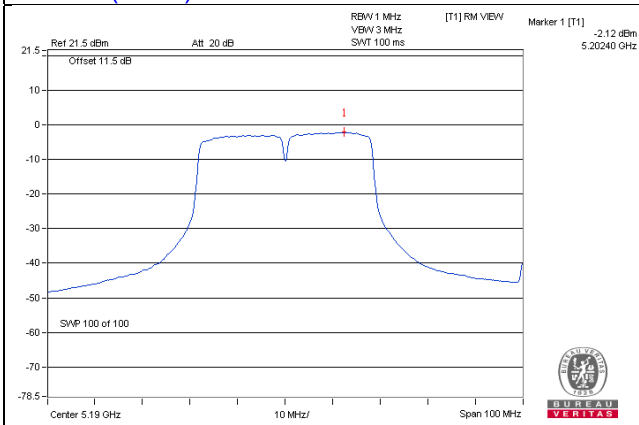

For U-NII-3 Band

802.11a

TX chain	Channel	Freq. (MHz)	PSD (dBm/300kHz)	PSD (dBm/500kHz)	10 log (N=2) dB	Duty factor	Total PSD (dBm/500kHz)	Limit (dBm/500kHz)	Pass /Fail
0	149	5745	-2.84	-0.62	3.01	0.12	2.51	30.00	Pass
	157	5785	-3.19	-0.97	3.01	0.12	2.16	30.00	Pass
	165	5825	-3.02	-0.80	3.01	0.12	2.33	30.00	Pass
1	149	5745	-3.37	-1.15	3.01	0.12	1.98	30.00	Pass
	157	5785	-3.39	-1.17	3.01	0.12	1.96	30.00	Pass
	165	5825	-3.34	-1.12	3.01	0.12	2.01	30.00	Pass

NOTE:

- Method 1 of power density measurement of KDB 662911 is using for calculating total power density. Total power density is summing entire spectra across corresponding frequency bins on the various outputs by computer.
- Directional gain = $2\text{dBi} + 10\log(2) = 5.01\text{dBi} < 6\text{dBi}$, therefore the limit no need to reduced.
- Refer to section 3.3 for duty cycle spectrum plot.

802.11n (HT20)

TX chain	Channel	Freq. (MHz)	PSD (dBm/300kHz)	PSD (dBm/500kHz)	10 log (N=2) dB	Duty factor	Total PSD (dBm/500kHz)	Limit (dBm/500kHz)	Pass /Fail
0	149	5745	-4.20	-1.98	3.01	0.14	1.17	30.00	Pass
	157	5785	-4.73	-2.51	3.01	0.14	0.64	30.00	Pass
	165	5825	-4.47	-2.25	3.01	0.14	0.90	30.00	Pass
1	149	5745	-4.87	-2.65	3.01	0.14	0.50	30.00	Pass
	157	5785	-4.90	-2.68	3.01	0.14	0.47	30.00	Pass
	165	5825	-4.76	-2.54	3.01	0.14	0.61	30.00	Pass

NOTE:

- Method 1 of power density measurement of KDB 662911 is using for calculating total power density. Total power density is summing entire spectra across corresponding frequency bins on the various outputs by computer.
- Directional gain = $2\text{dBi} + 10\log(2) = 5.01\text{dBi} < 6\text{dBi}$, therefore the limit no need to reduced.
- Refer to section 3.3 for duty cycle spectrum plot.

802.11n (HT40)

TX chain	Channel	Freq. (MHz)	PSD (dBm/300kHz)	PSD (dBm/500kHz)	10 log (N=2) dB	Duty factor	Total PSD (dBm/500kHz)	Limit (dBm/500kHz)	Pass /Fail
0	151	5755	-7.99	-5.77	3.01	0.44	-2.32	30.00	Pass
	159	5795	-8.47	-6.25	3.01	0.44	-2.80	30.00	Pass
1	151	5755	-7.48	-5.26	3.01	0.44	-1.81	30.00	Pass
	159	5795	-7.89	-5.67	3.01	0.44	-2.22	30.00	Pass

NOTE:

- Method 1 of power density measurement of KDB 662911 is using for calculating total power density. Total power density is summing entire spectra across corresponding frequency bins on the various outputs by computer.
- Directional gain = $2\text{dBi} + 10\log(2) = 5.01\text{dBi} < 6\text{dBi}$, therefore the limit no need to reduced.
- Refer to section 3.3 for duty cycle spectrum plot.

SPECTRUM PLOT OF WORST VALUE

802.11a

802.11n (HT20)

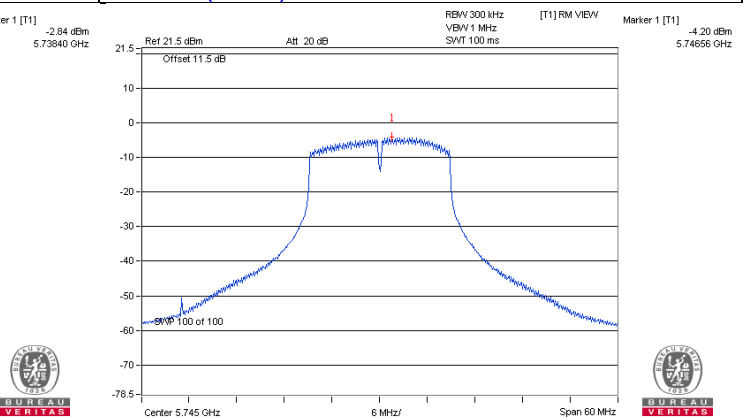
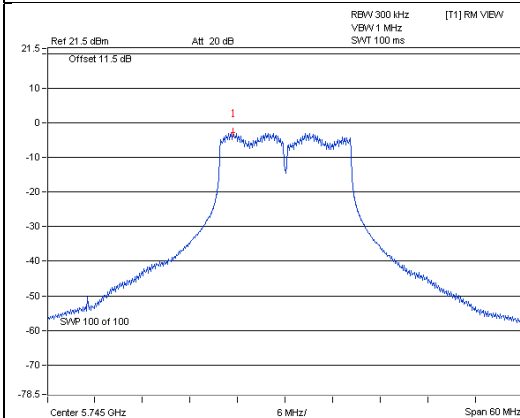

802.11n (HT40)

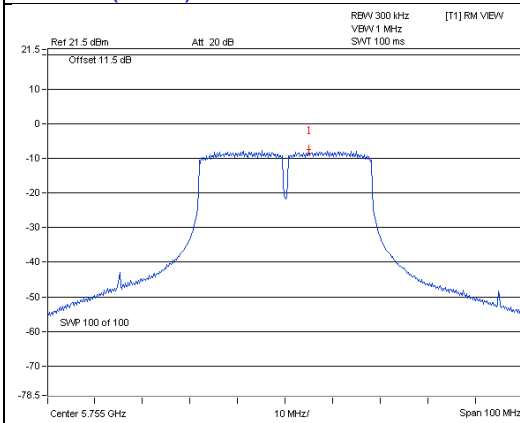

4.6 Frequency Stability

4.6.1 Limits of Frequency Stability Measurement

The frequency of the carrier signal shall be maintained within band of operation

4.6.2 Test Setup

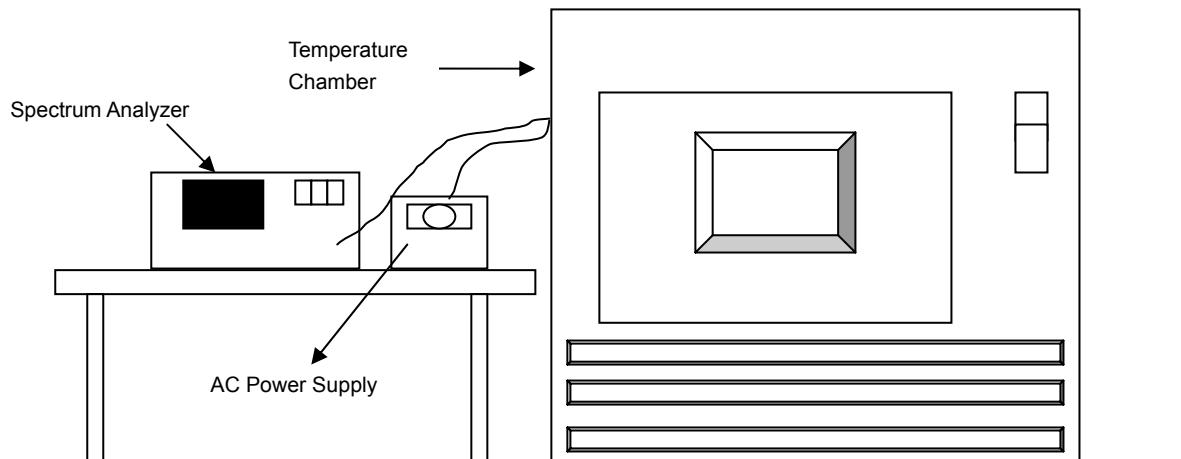

4.6.3 Test Instruments

Refer to section 4.1.2 to get information of above instrument.

4.6.4 Test Procedure

- The EUT was placed inside the environmental test chamber and powered by nominal AC voltage.
- Turn the EUT on and couple its output to a spectrum analyzer.
- Turn the EUT off and set the chamber to the highest temperature specified.
- Allow sufficient time (approximately 30 min) for the temperature of the chamber to stabilize, turn the EUT on and measure the operating frequency after 2, 5, and 10 minutes.
- Repeat step 2 and 3 with the temperature chamber set to the lowest temperature.
- The test chamber was allowed to stabilize at +20 degree C for a minimum of 30 minutes. The supply voltage was then adjusted on the EUT from 85% to 115% and the frequency record.

4.6.5 Deviation from Test Standard

No deviation.

4.6.6 EUT Operating Condition

Set the EUT transmit at un-modulation mode to test frequency stability.

4.6.7 Test Results

802.11a

FREQUENCY STABILITY VERSUS TEMP.									
OPERATING FREQUENCY: 5180MHz									
TEMP. (°C)	POWER SUPPLY (Vac)	0 MINUTE		2 MINUTE		5 MINUTE		10 MINUTE	
		Measured Frequency (MHz)	Frequency Drift (%)	Measured Frequency (MHz)	Frequency Drift (%)	Measured Frequency (MHz)	Frequency Drift (%)	Measured Frequency (MHz)	Frequency Drift (%)
50	120	5179.9982	-0.00003	5179.9986	-0.00003	5179.9968	-0.00006	5179.9967	-0.00006
40	120	5179.9901	-0.00019	5179.9915	-0.00016	5179.9879	-0.00023	5179.9914	-0.00017
30	120	5179.9894	-0.00020	5179.9883	-0.00023	5179.9856	-0.00028	5179.9868	-0.00025
20	120	5179.9737	-0.00051	5179.9761	-0.00046	5179.9728	-0.00053	5179.9732	-0.00052
10	120	5179.9854	-0.00028	5179.9852	-0.00029	5179.9831	-0.00033	5179.9858	-0.00027
0	120	5179.9801	-0.00038	5179.9828	-0.00033	5179.9823	-0.00034	5179.9808	-0.00037
-10	120	5180.0224	0.00043	5180.0260	0.00050	5180.0215	0.00042	5180.0218	0.00042
-20	120	5179.9790	-0.00041	5179.9803	-0.00038	5179.9786	-0.00041	5179.9792	-0.00040
-30	120	5179.9949	-0.00010	5179.9948	-0.00010	5179.9920	-0.00015	5179.9923	-0.00015

FREQUENCY STABILITY VERSUS VOLTAGE									
OPERATING FREQUENCY: 5180MHz									
TEMP. (°C)	POWER SUPPLY (Vac)	0 MINUTE		2 MINUTE		5 MINUTE		10 MINUTE	
		Measured Frequency (MHz)	Frequency Drift (%)	Measured Frequency (MHz)	Frequency Drift (%)	Measured Frequency (MHz)	Frequency Drift (%)	Measured Frequency (MHz)	Frequency Drift (%)
20	138	5179.9727	-0.00053	5179.9761	-0.00046	5179.9736	-0.00051	5179.9725	-0.00053
	120	5179.9737	-0.00051	5179.9761	-0.00046	5179.9728	-0.00053	5179.9732	-0.00052
	102	5179.9729	-0.00052	5179.9766	-0.00045	5179.9722	-0.00054	5179.9728	-0.00053

4.7 6dB Bandwidth Measurement

4.7.1 Limits of 6dB Bandwidth Measurement

The minimum of 6dB Bandwidth Measurement is 0.5MHz.

4.7.2 Test Setup

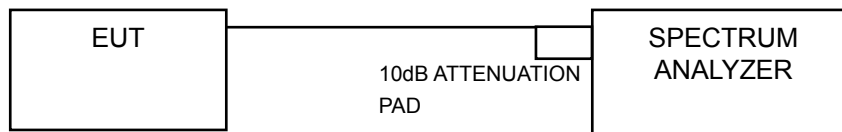

4.7.3 Test Instruments

Refer to section 4.1.2 to get information of above instrument.

4.7.4 Test Procedure

- a. Set resolution bandwidth (RBW) = 100kHz
- b. Set the video bandwidth (VBW) $\geq 3 \times$ RBW, Detector = Peak.
- c. Trace mode = max hold.
- d. Sweep = auto couple.
- e. Measure the maximum width of the emission that is constrained by the frequencies associated with the two amplitude points (upper and lower) that are attenuated by 6 dB relative to the maximum level measured in the fundamental emission

4.7.5 Deviation from Test Standard

No deviation.

4.7.6 EUT Operating Condition

The software provided by client to enable the EUT under transmission Condition continuously at lowest, middle and highest channel frequencies individually.



4.7.7 Test Results

802.11a

Channel	Frequency (MHz)	6dB Bandwidth (MHz)		Minimum Limit (MHz)	Pass / Fail
		Chain 0	Chain 1		
149	5745	16.40	16.40	0.5	Pass
157	5785	16.37	16.38	0.5	Pass
165	5825	16.38	16.43	0.5	Pass

802.11n (HT20)

Channel	Frequency (MHz)	6dB Bandwidth (MHz)		Minimum Limit (MHz)	Pass / Fail
		Chain 0	Chain 1		
149	5745	15.50	17.63	0.5	Pass
157	5785	16.41	17.34	0.5	Pass
165	5825	16.97	17.66	0.5	Pass

802.11n (HT40)

Channel	Frequency (MHz)	6dB Bandwidth (MHz)		Minimum Limit (MHz)	Pass / Fail
		Chain 0	Chain 1		
151	5755	35.65	36.19	0.5	Pass
159	5795	35.58	36.03	0.5	Pass



SPECTRUM PLOT OF WORST VALUE

802.11a

802.11n (HT20)

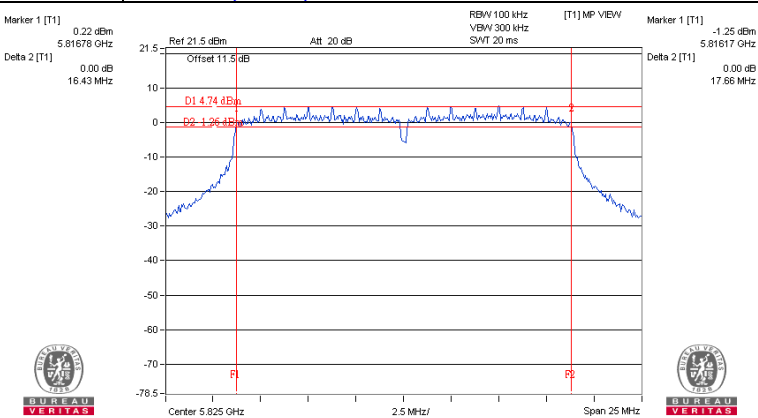
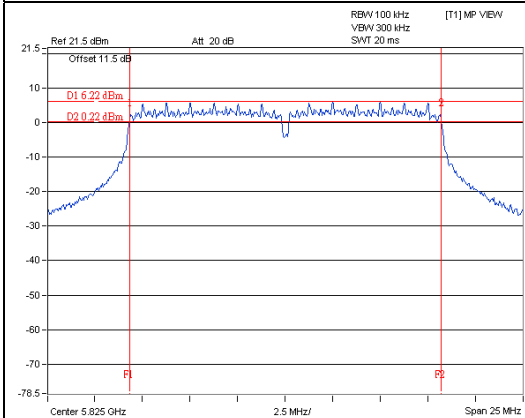

802.11n (HT40)

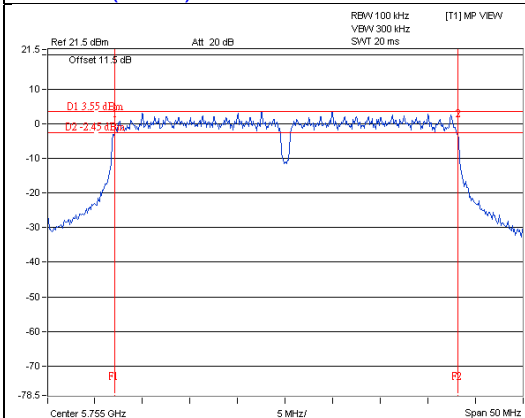

5 Pictures of Test Arrangements

Please refer to the attached file (Test Setup Photo).

Annex A- Radiated Out of Band Emission (OOBE) Measurement (For U-NII-3 band)

802.11a

CH149

Horizontal

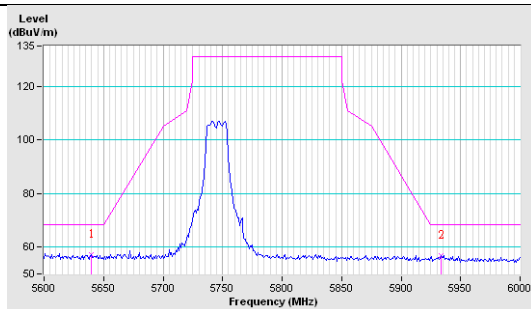

Vertical

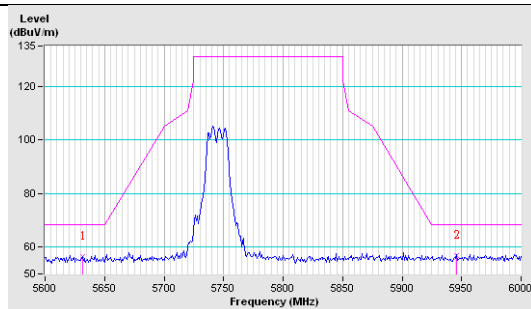

CH157

Horizontal

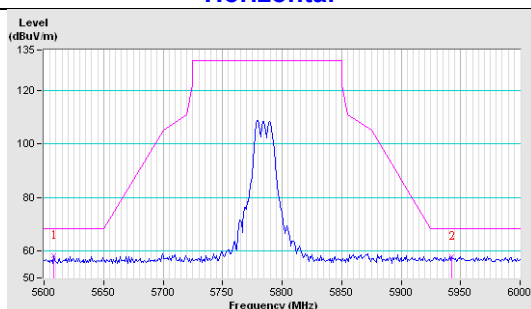

Vertical

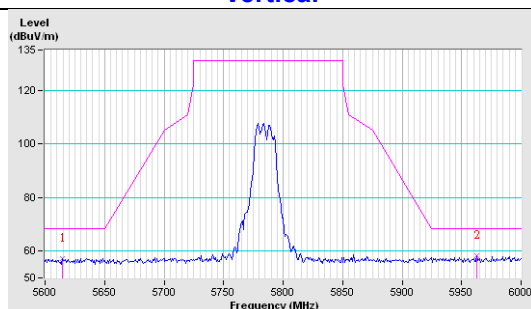

CH165

Horizontal

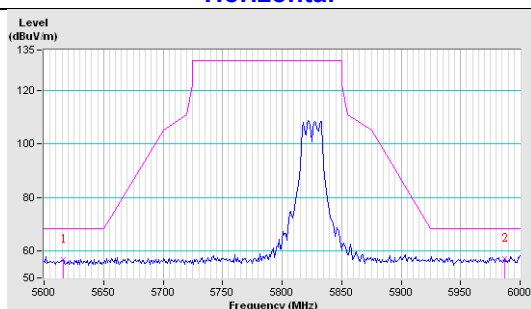

Vertical

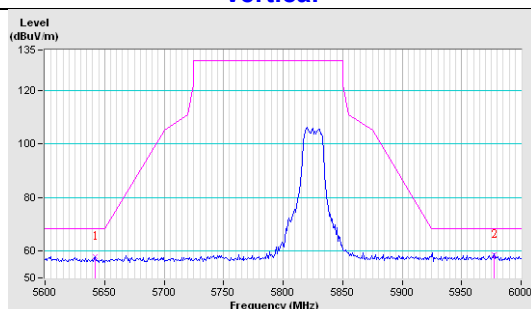

802.11n (HT20)

CH149

Horizontal

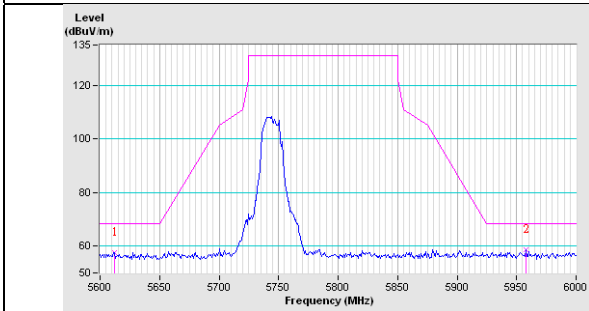

Vertical

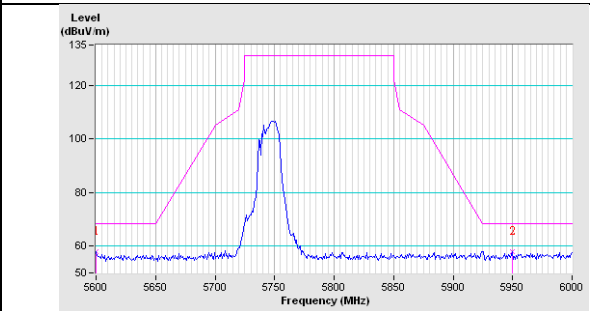

CH157

Horizontal

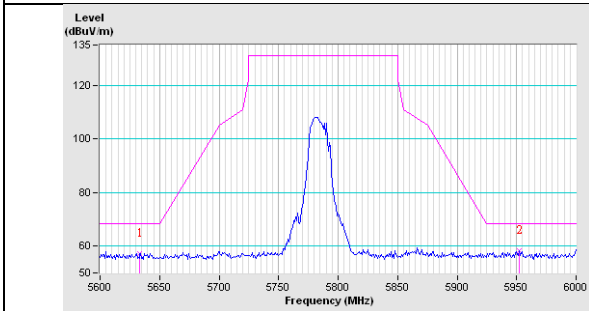

Vertical

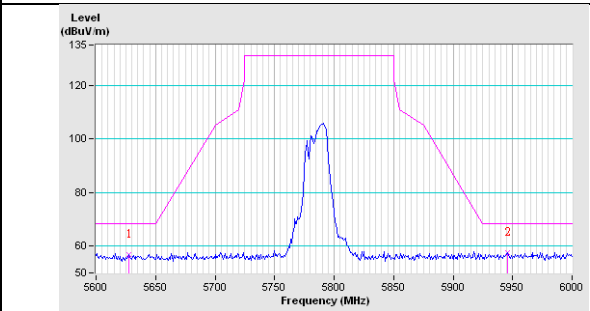

CH165

Horizontal

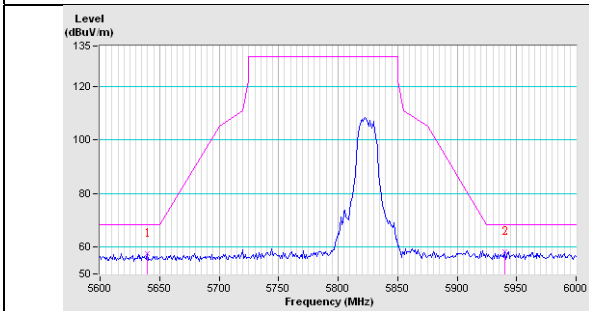

Vertical

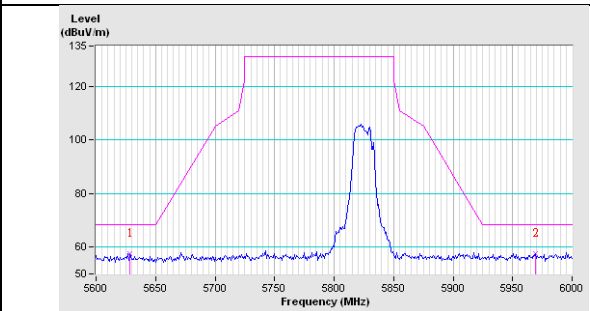

802.11n (HT40)

CH151

Horizontal

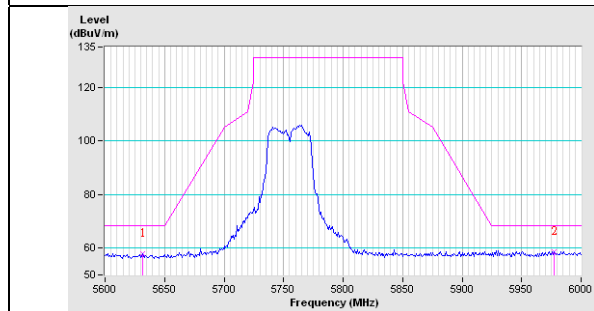

Vertical

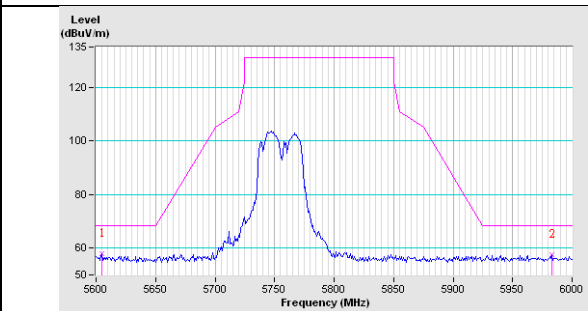

CH159

Horizontal

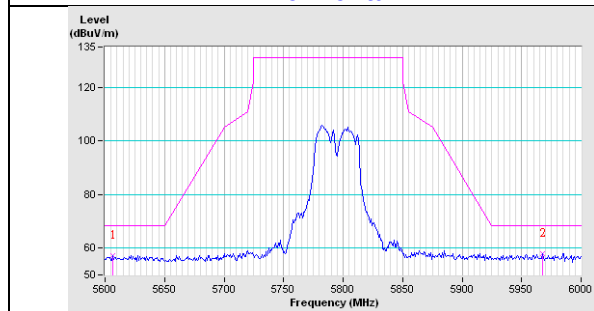

Vertical

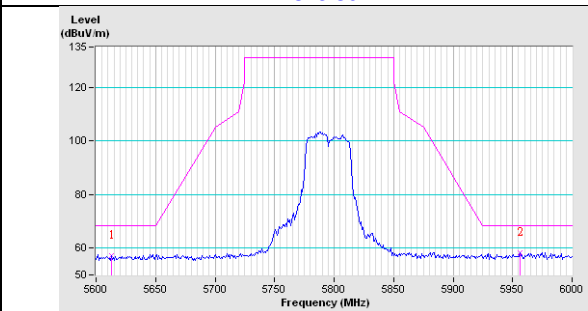

Appendix – Information on the Testing Laboratories

We, Bureau Veritas Consumer Products Services (H.K.) Ltd., Taoyuan Branch, were founded in 1988 to provide our best service in EMC, Radio, Telecom and Safety consultation. Our laboratories are accredited and approved according to ISO/IEC 17025.

If you have any comments, please feel free to contact us at the following:

Linko EMC/RF Lab

Tel: 886-2-26052180

Fax: 886-2-26051924

Hsin Chu EMC/RF/Telecom Lab

Tel: 886-3-6668565

Fax: 886-3-6668323

Hwa Ya EMC/RF/Safety Lab

Tel: 886-3-3183232

Fax: 886-3-3270892

Email: service.adt@tw.bureauveritas.com

Web Site: www.bureauveritas-adt.com

The address and road map of all our labs can be found in our web site also.

--- END ---