



FCC TEST REPORT (15.407)

REPORT NO.: RF120531C10H-1
MODEL NO.: AN-300-AP-I-N
FCC ID: U2M-AN300APIN
RECEIVED: Aug. 12, 2014
TESTED: Sep. 09 ~ Sep. 10, 2014
ISSUED: Sep. 10, 2014

APPLICANT: Senao Networks, Inc.

ADDRESS: 3F, No. 529, Chung Cheng Rd., Hsintien, New Taipei City, R.O.C

ISSUED BY: Bureau Veritas Consumer Products Services (H.K.) Ltd., Taoyuan Branch

LAB ADDRESS: No. 47-2, 14th Ling, Chia Pau Vil., Lin Kou Dist., New Taipei City, Taiwan, R.O.C.

TEST LOCATION: No. 19, Hwa Ya 2nd Rd, Wen Hwa Tsuen, Kwei Shan Hsiang, Taoyuan Hsien 333, Taiwan, R.O.C.

This report should not be used by the client to claim product certification, approval, or endorsement by TAF or any government agencies.



This report is for your exclusive use. Any copying or replication of this report to or for any other person or entity, or use of our name or trademark, is permitted only with our prior written permission. This report sets forth our findings solely with respect to the test samples identified herein. The results set forth in this report are not indicative or representative of the quality or characteristics of the lot from which a test sample was taken or any similar or identical product unless specifically and expressly noted. Our report includes all of the tests requested by you and the results thereof based upon the information that you provided to us. You have 60 days from date of issuance of this report to notify us of any material error or omission caused by our negligence, provided, however, that such notice shall be in writing and shall specifically address the issue you wish to raise. A failure to raise such issue within the prescribed time shall constitute your unqualified acceptance of the completeness of this report, the tests conducted and the correctness of the report contents. Unless specific mention, the uncertainty of measurement has been explicitly taken into account to declare the compliance or non-compliance to the specification.

TABLE OF CONTENTS

RELEASE CONTROL RECORD	4
1. CERTIFICATION	5
2. SUMMARY OF TEST RESULTS	6
2.1 MEASUREMENT UNCERTAINTY	6
3. GENERAL INFORMATION	7
3.1 GENERAL DESCRIPTION OF EUT	7
3.2 DESCRIPTION OF TEST MODES	8
3.2.1 TEST MODE APPLICABILITY AND TESTED CHANNEL DETAIL	9
3.3 DUTY CYCLE OF TEST SIGNAL	11
3.4 DESCRIPTION OF SUPPORT UNITS	15
3.4.1 CONFIGURATION OF SYSTEM UNDER TEST	16
3.5 GENERAL DESCRIPTION OF APPLIED STANDARDS	17
4. TEST TYPES AND RESULTS	18
4.1 RADIATED EMISSION AND BANDEDGE MEASUREMENT	18
4.1.1 LIMITS OF RADIATED EMISSION AND BANDEDGE MEASUREMENT	18
4.1.2 LIMITS OF UNWANTED EMISSION OUT OF THE RESTRICTED BANDS	18
4.1.3 TEST INSTRUMENTS	19
4.1.4 TEST PROCEDURES	20
4.1.5 DEVIATION FROM TEST STANDARD	20
4.1.6 TEST SETUP	21
4.1.7 EUT OPERATING CONDITION	22
4.1.8 TEST RESULTS	23
4.2 CONDUCTED EMISSION MEASUREMENT	33
4.2.1 LIMITS OF CONDUCTED EMISSION MEASUREMENT	33
4.2.2 TEST INSTRUMENTS	33
4.2.3 TEST PROCEDURES	34
4.2.4 DEVIATION FROM TEST STANDARD	34
4.2.5 TEST SETUP	34
4.2.6 EUT OPERATING CONDITIONS	34
4.2.7 TEST RESULTS	35
4.3 PEAK TRANSMIT POWER MEASUREMENT	39
4.3.1 LIMITS OF PEAK TRANSMIT POWER MEASUREMENT	39
4.3.2 TEST SETUP	39
4.3.3 TEST INSTRUMENTS	39
4.3.4 TEST PROCEDURE	40
4.3.5 DEVIATION FROM TEST STANDARD	40
4.3.6 EUT OPERATING CONDITIONS	40
4.3.7 TEST RESULTS	41
4.4 PEAK POWER SPECTRAL DENSITY MEASUREMENT	45
4.4.1 LIMITS OF PEAK POWER SPECTRAL DENSITY MEASUREMENT	45
4.4.2 TEST SETUP	45
4.4.3 TEST INSTRUMENTS	45
4.4.4 TEST PROCEDURES	45
4.4.5 DEVIATION FROM TEST STANDARD	45
4.4.6 EUT OPERATING CONDITIONS	45
4.4.7 TEST RESULTS	46
4.5 PEAK POWER EXCURSION MEASUREMENT	48
4.5.1 LIMITS OF PEAK POWER EXCURSION MEASUREMENT	48
4.5.2 TEST SETUP	48



A D T

4.5.3	TEST INSTRUMENTS	48
4.5.4	TEST PROCEDURE	48
4.5.5	DEVIATION FROM TEST STANDARD	48
4.5.6	EUT OPERATING CONDITIONS.....	48
4.5.7	TEST RESULTS.....	49
4.6	FREQUENCY STABILITY	50
4.6.1	LIMITS OF FREQUENCY STABILITY MEASUREMENT	50
4.6.2	TEST SETUP	50
4.6.3	TEST INSTRUMENTS	50
4.6.4	TEST PROCEDURE	51
4.6.5	DEVIATION FROM TEST STANDARD	51
4.6.6	EUT OPERATING CONDITION	51
4.6.7	TEST RESULTS.....	52
5.	PHOTOGRAPHS OF THE TEST CONFIGURATION	53
6.	INFORMATION ON THE TESTING LABORATORIES.....	54
7.	APPENDIX A - MODIFICATIONS RECORDERS FOR ENGINEERING CHANGES TO THE EUT BY THE LAB	55



A D T

RELEASE CONTROL RECORD

ISSUE NO.	REASON FOR CHANGE	DATE ISSUED
RF120531C10H-1	Original release	Sep. 10, 2014



1. CERTIFICATION

PRODUCT: Araknis Networks 300-series Dual-Band Concurrent
Wireless-N Indoor Access Point

MODEL: AN-300-AP-I-N

BRAND: Araknis Networks

APPLICANT: Senao Networks, Inc.

TESTED: Sep. 09 ~ Sep. 10, 2014

TEST SAMPLE: ENGINEERING SAMPLE

STANDARDS: FCC Part 15, Subpart E (Section 15.407)

ANSI C63.10-2009

The above equipment (model: AN-300-AP-I-N) has been tested by **Bureau Veritas Consumer Products Services (H.K.) Ltd., Taoyuan Branch**, and found compliance with the requirement of the above standards. The test record, data evaluation & Equipment Under Test (EUT) configurations represented herein are true and accurate accounts of the measurements of the sample's EMC characteristics under the conditions specified in this report.

PREPARED BY : Polly Chien , **DATE** : Sep. 10, 2014
Polly Chien / Specialist

APPROVED BY : Ken Liu , **DATE** : Sep. 10, 2014
Ken Liu / Senior Manager

2. SUMMARY OF TEST RESULTS

The EUT has been tested according to the following specifications:

APPLIED STANDARD: FCC PART 15, SUBPART E (SECTION 15.407)			
STANDARD SECTION	TEST TYPE	RESULT	REMARK
15.407(b)(6)	AC Power Conducted Emission	PASS	Meet the requirement of limit. Minimum passing margin is -9.66dB at 3.46094MHz.
15.407(b/1/2/3)(b)(6)	Radiated Emissions	PASS	Meet the requirement of limit. Minimum passing margin is -1.1dB at 5150.00MHz.
15.407(a/1/2)	Max Average Transmit Power	PASS	Meet the requirement of limit.
15.407(a)(6)	Peak Power Excursion	PASS	Meet the requirement of limit.
15.407(a/1/2)	Peak Power Spectral Density	PASS	Meet the requirement of limit.
15.407(g)	Frequency Stability	PASS	Meet the requirement of limit.
15.203	Antenna Requirement	PASS	Antenna connector is IPEX not a standard connector.

2.1 MEASUREMENT UNCERTAINTY

Where relevant, the following measurement uncertainty levels have been estimated for tests performed on the EUT as specified in CISPR 16-4-2:

MEASUREMENT	FREQUENCY	UNCERTAINTY
Conducted emissions	9kHz~30MHz	2.44 dB
Radiated emissions	30MHz ~ 200MHz	3.34 dB
	200MHz ~1000MHz	3.35 dB
	1GHz ~ 18GHz	2.26 dB
	18GHz ~ 40GHz	1.94 dB

This uncertainty represents an expanded uncertainty expressed at approximately the 95% confidence level using a coverage factor of $k = 2$.

3. GENERAL INFORMATION

3.1 GENERAL DESCRIPTION OF EUT

EUT	Araknis Networks 300-series Dual-Band Concurrent Wireless-N Indoor Access Point
MODEL NO.	AN-300-AP-I-N
POWER SUPPLY	12Vdc (Adapter) 48Vdc (PoE)
MODULATION TYPE	64QAM, 16QAM, QPSK, BPSK
MODULATION TECHNOLOGY	OFDM
TRANSFER RATE	802.11a: 54.0/ 48.0/ 36.0/ 24.0/ 18.0/ 12.0/ 9.0/ 6.0Mbps 802.11n: up to 300.0Mbps
OPERATING FREQUENCY	5180.0 ~ 5240.0MHz
NUMBER OF CHANNEL	4 for 802.11a, 802.11n (20MHz) 2 for 802.11n (40MHz)
OUTPUT POWER	43.64mW
ANTENNA TYPE	PIFA antenna with 2dBi gain
ANTENNA CONNECTOR	IPEX
DATA CABLE	NA
I/O PORTS	Refer to user's manual
ACCESSORY DEVICES	Adapter

NOTE:

1. The EUT incorporates a MIMO function. Physically, the EUT provides two completed transmitters and two receivers.

MODULATION MODE	TX FUNCTION
802.11b	2TX
802.11g	2TX
802.11a	2TX
802.11n (20MHz)	2TX
802.11n (40MHz)	2TX

2. The EUT uses following adapter and POE.

ADAPTER	
BRAND:	Powertron Electronics Corp.
MODEL:	PA1024-2HUB PA1024-2HU PA1024-120HUB200
INPUT:	100-240Vac, 50-60Hz, 0.6A
OUTPUT:	12Vdc, 2.0A, 24.0W Max
POWER LINE:	1.5m cable with one core attached on adapter

POE	
MODEL:	PD-6083G300
INPUT:	100-250Vac, 50/60Hz, 0.5A
OUTPUT:	48Vdc, 0.35A

*POE as above is provided as support unit only.

3. The above EUT information is declared by manufacturer and for more detailed features description, please refer to the manufacturer's specifications or user's manual.

3.2 DESCRIPTION OF TEST MODES

4 channels are provided for 802.11a, 802.11n (20MHz):

CHANNEL	FREQUENCY	CHANNEL	FREQUENCY
36	5180MHz	44	5220MHz
40	5200MHz	48	5240MHz

2 channels are provided for 802.11n (40MHz):

CHANNEL	FREQUENCY	CHANNEL	FREQUENCY
38	5190MHz	46	5230MHz

3.2.1 TEST MODE APPLICABILITY AND TESTED CHANNEL DETAIL

EUT CONFIGURE MODE	APPLICABLE TO				DESCRIPTION
	RE \geq 1G	RE<1G	PLC	APCM	
A	√	√	√	√	Power from adapter
B	-	√	√	-	Power from PoE

Where **RE \geq 1G**: Radiated Emission above 1GHz **RE<1G**: Radiated Emission below 1GHz
PLC: Power Line Conducted Emission **APCM**: Antenna Port Conducted Measurement

NOTE 1:
The EUT had been pre-tested on the positioned of each 3 axis. The worst case was found when positioned on **X-plane**.
NOTE 2: “-” means no effect.

RADIATED EMISSION TEST (ABOVE 1GHz):

- Pre-Scan has been conducted to determine the worst-case mode from all possible combinations between available modulations, data rates and antenna ports (if EUT with antenna diversity architecture).
- Following channel(s) was (were) selected for the final test as listed below.

EUT CONFIGURE MODE	MODE	AVAILABLE CHANNEL	TESTED CHANNEL	MODULATION TECHNOLOGY	MODULATION TYPE	DATA RATE (Mbps)
A	802.11a	36 to 48	36, 40, 48	OFDM	BPSK	6.0
A	802.11n (20MHz)	36 to 48	36, 40, 48	OFDM	BPSK	7.2
A	802.11n (40MHz)	38 to 46	38, 46	OFDM	BPSK	15.0

RADIATED EMISSION TEST (BELOW 1GHz):

- Pre-Scan has been conducted to determine the worst-case mode from all possible combinations between available modulations, data rates and antenna ports (if EUT with antenna diversity architecture).
- Following channel(s) was (were) selected for the final test as listed below.

EUT CONFIGURE MODE	MODE	AVAILABLE CHANNEL	TESTED CHANNEL	MODULATION TECHNOLOGY	MODULATION TYPE	DATA RATE (Mbps)
A, B	802.11n (20MHz)	36 to 48	40	OFDM	BPSK	7.2

POWER LINE CONDUCTED EMISSION TEST:

- Pre-Scan has been conducted to determine the worst-case mode from all possible combinations between available modulations, data rates and antenna ports (if EUT with antenna diversity architecture).
- Following channel(s) was (were) selected for the final test as listed below.

EUT CONFIGURE MODE	MODE	AVAILABLE CHANNEL	TESTED CHANNEL	MODULATION TECHNOLOGY	MODULATION TYPE	DATA RATE (Mbps)
A, B	802.11n (20MHz)	36 to 48	40	OFDM	BPSK	7.2

ANTENNA PORT CONDUCTED MEASUREMENT:

- This item includes all test value of each mode, but only includes spectrum plot of worst value of each mode.
- Pre-Scan has been conducted to determine the worst-case mode from all possible combinations between available modulations, data rates and antenna ports (if EUT with antenna diversity architecture).
- Following channel(s) was (were) selected for the final test as listed below.

EUT CONFIGURE MODE	MODE	AVAILABLE CHANNEL	TESTED CHANNEL	MODULATION TECHNOLOGY	MODULATION TYPE	DATA RATE (Mbps)
A	802.11a	36 to 48	36, 40, 48	OFDM	BPSK	6.0
A	802.11n (20MHz)	36 to 48	36, 40, 48	OFDM	BPSK	7.2
A	802.11n (40MHz)	38 to 46	38, 46	OFDM	BPSK	15.0

TEST CONDITION:

APPLICABLE TO	ENVIRONMENTAL CONDITIONS	INPUT POWER	TESTED BY
RE≥1G	25deg. C, 65%RH	120Vac, 60Hz	Chris Lin
RE<1G	25deg. C, 68%RH	120Vac, 60Hz, 48Vdc	Chris Lin
PLC	24deg. C, 64%RH	120Vac, 60Hz, 48Vdc	Match Tsui
APCM	24deg. C, 64%RH	120Vac, 60Hz	Match Tsui

3.3 DUTY CYCLE OF TEST SIGNAL

If duty cycle is < 98%, duty factor shall be considered.

MODULATION TYPE: BPSK

802.11a: Duty cycle = $2.017/2.070 = 0.974$, Duty factor = $10 * \log(1/0.974) = 0.11$

802.11n (20MHz): Duty cycle = $1.887/1.940 = 0.973$, Duty factor = $10 * \log(1/0.973) = 0.12$

802.11n (40MHz): Duty cycle = $0.478/0.522 = 0.916$, Duty factor = $10 * \log(1/0.916) = 0.38$

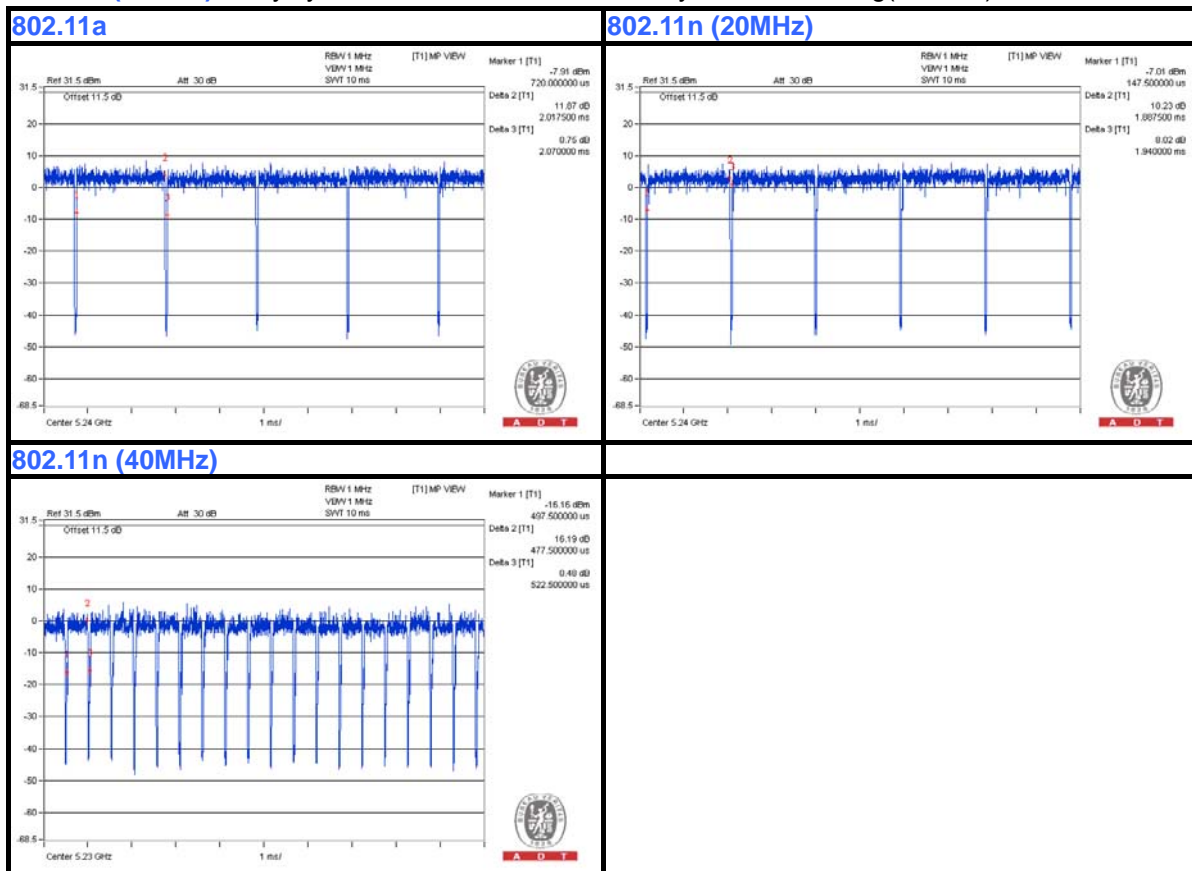



A D T

MODULATION TYPE: QPSK

802.11a: Duty cycle = $1.023/1.083 = 0.945$, Duty factor = $10 * \log(1/0.945) = 0.25$

802.11n (20MHz): Duty cycle = $0.960/1.008 = 0.952$, Duty factor = $10 * \log(1/0.952) = 0.21$

802.11n (40MHz): Duty cycle = $0.263/0.298 = 0.883$, Duty factor = $10 * \log(1/0.883) = 0.54$

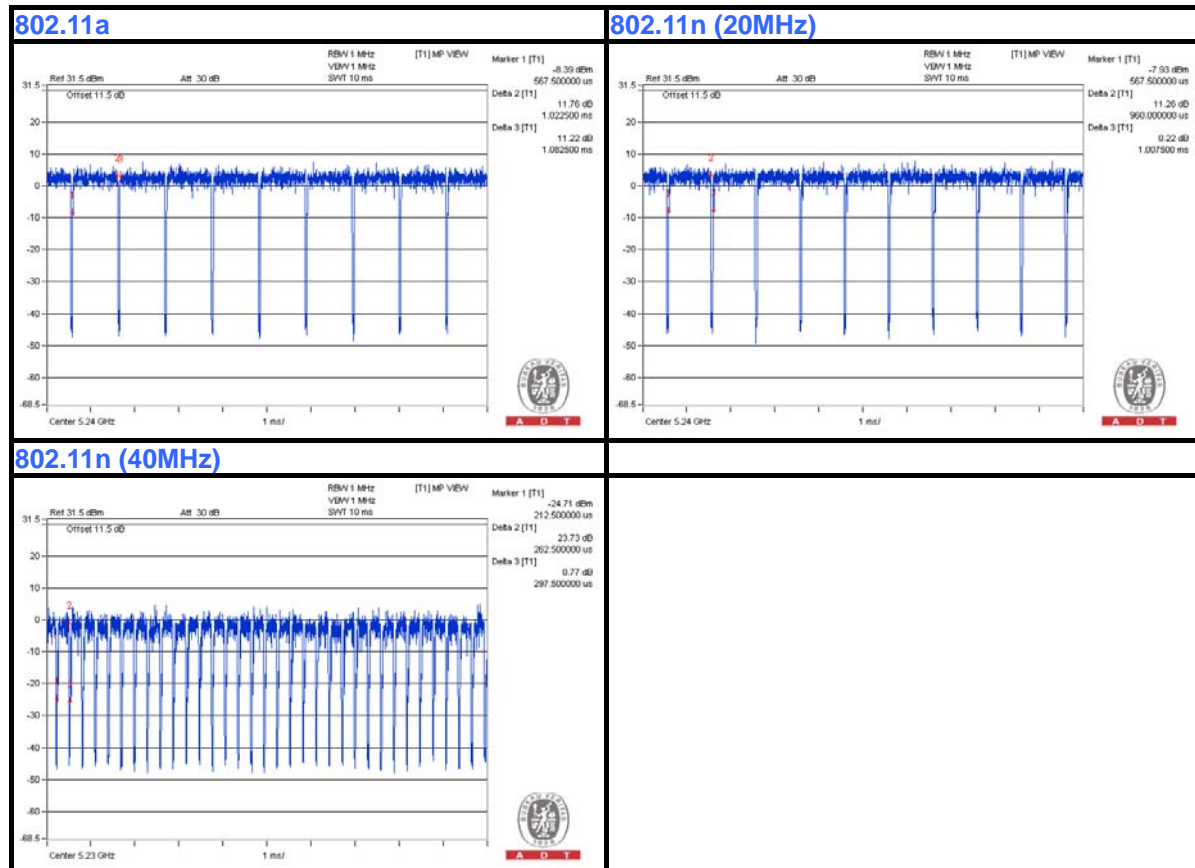



A D T

MODULATION TYPE: 16QAM

802.11a: Duty cycle = $0.520/0.568 = 0.915$, Duty factor = $10 * \log(1/0.915) = 0.39$

802.11n (20MHz): Duty cycle = $0.495/0.545 = 0.908$, Duty factor = $10 * \log(1/0.908) = 0.42$

802.11n (40MHz): Duty cycle = $0.140/0.183 = 0.765$, Duty factor = $10 * \log(1/0.765) = 1.16$

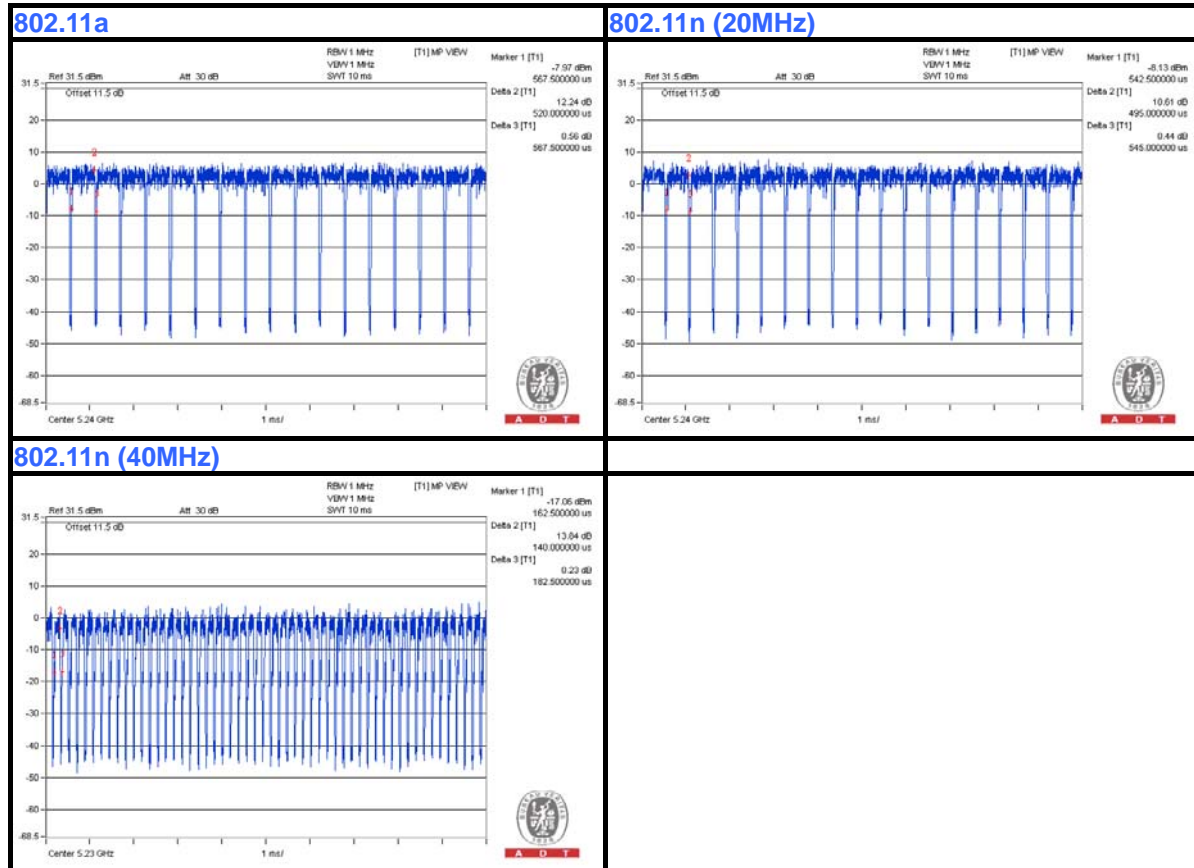



A D T

MODULATION TYPE: 64QAM

802.11a: Duty cycle = $0.265/0.315 = 0.841$, Duty factor = $10 * \log(1/0.841) = 0.75$

802.11n (20MHz): Duty cycle = $0.265/0.310 = 0.855$, Duty factor = $10 * \log(1/0.855) = 0.68$

802.11n (40MHz): Duty cycle = $0.088/0.128 = 0.688$, Duty factor = $10 * \log(1/0.688) = 1.62$

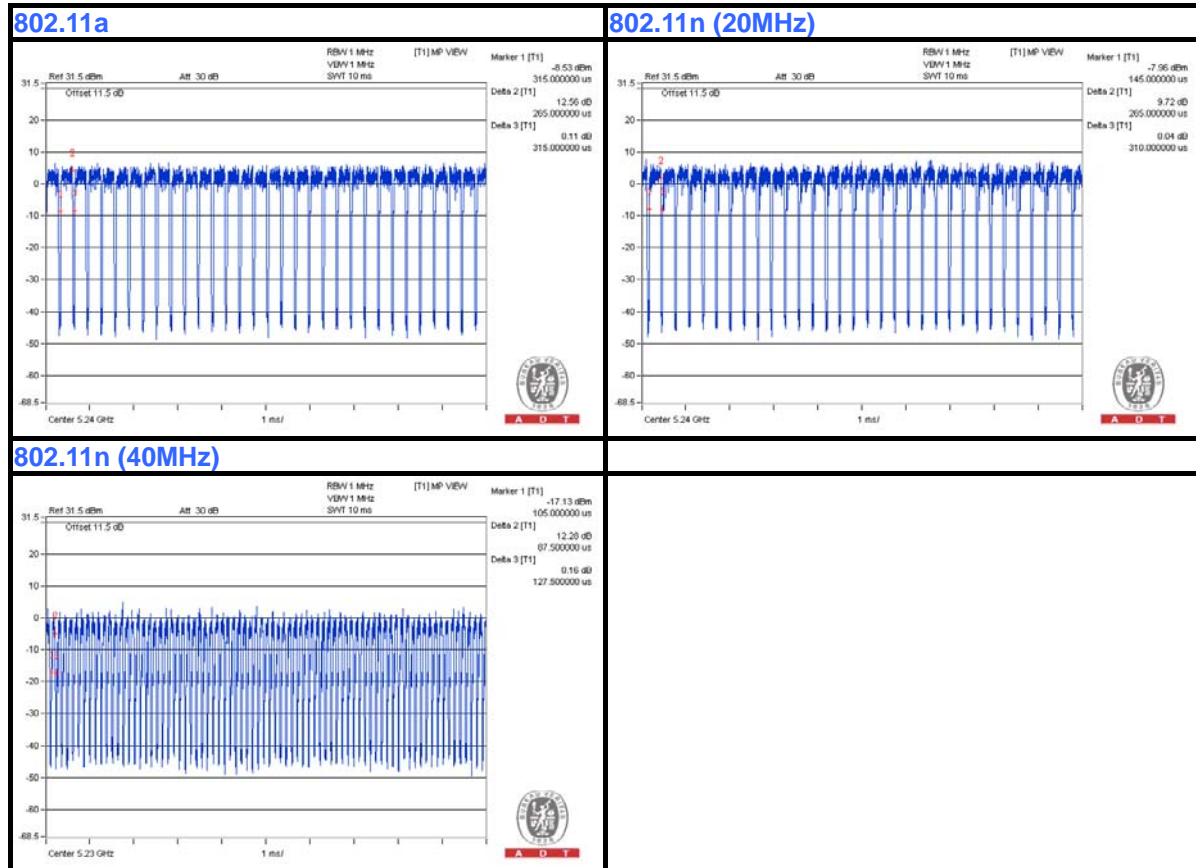



3.4 DESCRIPTION OF SUPPORT UNITS

The EUT has been tested as an independent unit together with other necessary accessories or support units. The following support units or accessories were used to form a representative test configuration during the tests.

NO.	PRODUCT	BRAND	MODEL NO.	SERIAL NO.	FCC ID
1	Notebook	DELL	E5410	1HC2XM1	FCC DoC Approved

NO.	SIGNAL CABLE DESCRIPTION OF THE ABOVE SUPPORT UNITS
1	10m RJ45 UTP cable

NOTE:

1. All power cords of the above support units are non shielded (1.8m).
2. Item 1 acted as communication partner to transfer data.

3.4.1 CONFIGURATION OF SYSTEM UNDER TEST

Test Mode A

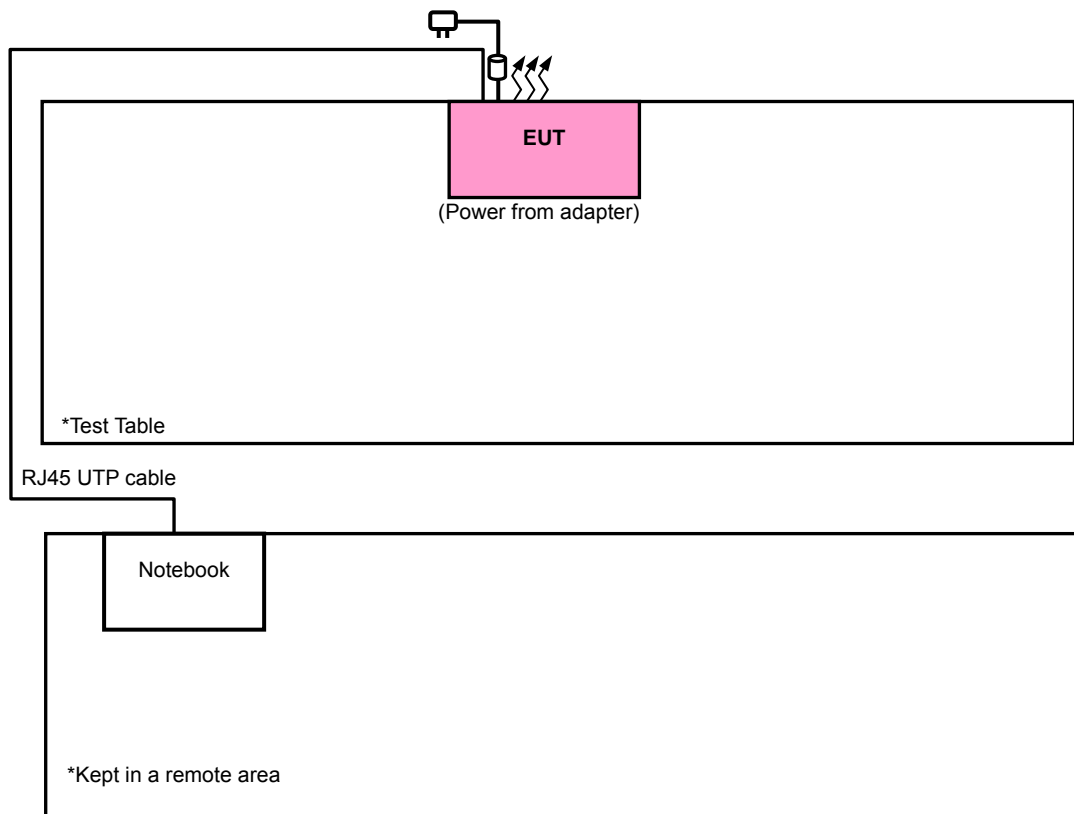

Test Mode B

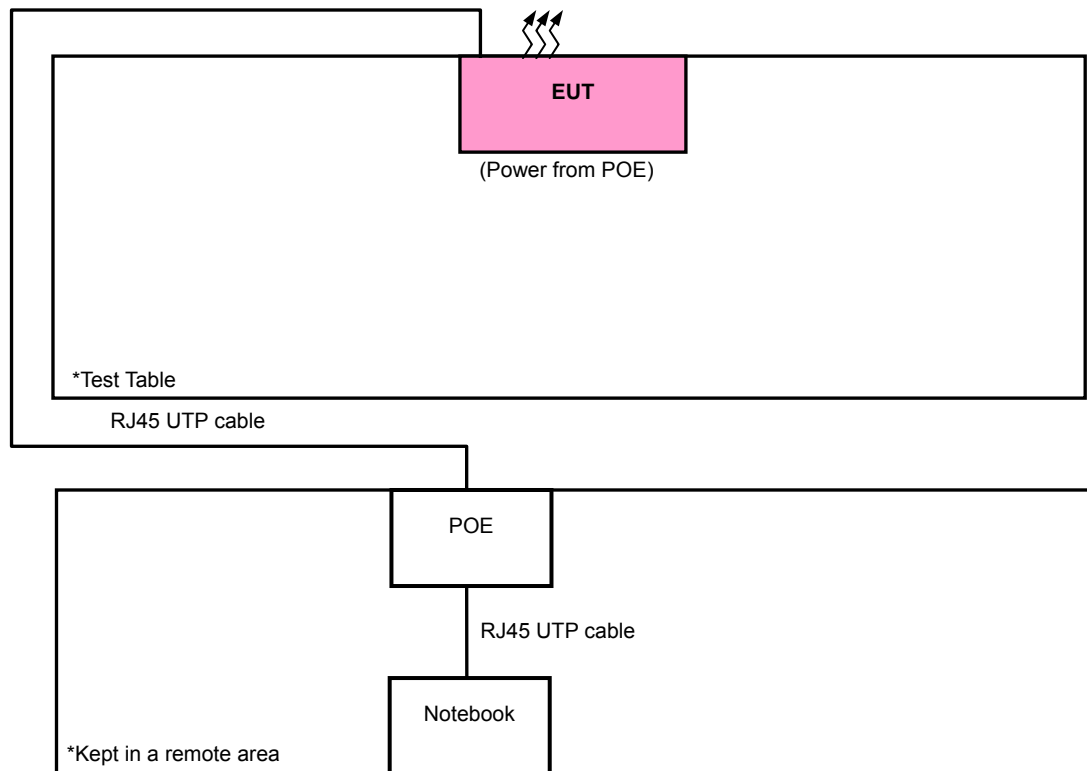

3.5 GENERAL DESCRIPTION OF APPLIED STANDARDS

The EUT is a RF Product. According to the specifications of the manufacturer, it must comply with the requirements of the following standards:

FCC Part 15, Subpart E (15.407)

789033 D01 General UNII Test Procedures Old Rules v01r04

662911 D01 Multiple Transmitter Output v02

ANSI C63.10-2009

All test items have been performed and recorded as per the above standards.

NOTE: The EUT is also considered as a kind of computer peripheral, because the connection to computer is necessary for typical use. It has been verified to comply with the requirements of FCC Part 15, Subpart B, Class B (DoC). The test report has been issued separately.

4. TEST TYPES AND RESULTS

4.1 RADIATED EMISSION AND BANDEDGE MEASUREMENT

4.1.1 LIMITS OF RADIATED EMISSION AND BANDEDGE MEASUREMENT

Radiated emissions which fall in the restricted bands must comply with the radiated emission limits specified as below table:

FREQUENCIES (MHz)	FIELD STRENGTH (microvolts/meter)	MEASUREMENT DISTANCE (meters)
0.009 ~ 0.490	2400/F(kHz)	300
0.490 ~ 1.705	24000/F(kHz)	30
1.705 ~ 30.0	30	30
30 ~ 88	100	3
88 ~ 216	150	3
216 ~ 960	200	3
Above 960	500	3

NOTE:

1. The lower limit shall apply at the transition frequencies.
2. Emission level (dBuV/m) = 20 log Emission level (uV/m).
3. For frequencies above 1000MHz, the field strength limits are based on average detector, however, the peak field strength of any emission shall not exceed the maximum permitted average limits, specified above by more than 20dB under any condition of modulation.

4.1.2 LIMITS OF UNWANTED EMISSION OUT OF THE RESTRICTED BANDS

APPLICABLE TO	LIMIT	
	FIELD STRENGTH AT 3m (dBμV/m)	
	PK	AV
	74	54
	EIRP LIMIT (dBm)	EQUIVALENT FIELD STRENGTH AT 3m (dBμV/m)
√	PK	PK
	-27	68.3

NOTE: The following formula is used to convert the equipment isotropic radiated power (eirp) to field strength:

$$E = \frac{1000000\sqrt{30P}}{3} \mu\text{V/m, where P is the eirp (Watts).}$$

4.1.3 TEST INSTRUMENTS

DESCRIPTION & MANUFACTURER	MODEL NO.	SERIAL NO.	DATE OF CALIBRATION	DUE DATE OF CALIBRATION
Test Receiver ROHDE & SCHWARZ	ESIB7	100187	Jan. 02, 2014	Jan. 01, 2015
Spectrum Analyzer ROHDE & SCHWARZ	FSP40	100039	Mar. 03, 2014	Mar. 02, 2015
BILOG Antenna SCHWARZBECK	VULB9168	9168-160	Feb. 26, 2014	Feb. 25, 2015
HORN Antenna SCHWARZBECK	9120D	209	Sep. 12, 2013	Sep. 11, 2014
HORN Antenna SCHWARZBECK	BBHA 9170	BBHA9170241	Feb. 17, 2014	Feb. 16, 2015
Loop Antenna	HFH2-Z2	100070	Mar. 06, 2014	Mar. 05, 2016
Preamplifier Agilent	8447D	2944A10633	Oct. 07, 2013	Oct. 06, 2014
Preamplifier Agilent	8449B	3008A01964	Aug. 22, 2014	Aug. 21, 2015
RF signal cable HUBER+SUHNNER	SUCOFLEX 104	214378/4	Aug. 25, 2014	Aug. 24, 2015
RF signal cable HUBER+SUHNNER	SUCOFLEX 106	12738/6 +309224/4	Aug. 25, 2014	Aug. 24, 2015
Software BV ADT	ADT_Radiated_ V7.6.15.9.4	NA	NA	NA
Antenna Tower inn-co GmbH	MA 4000	013303	NA	NA
Antenna Tower Controller inn-co GmbH	CO2000	017303	NA	NA
Turn Table BV ADT	TT100	TT93021703	NA	NA
Turn Table Controller BV ADT	SC100	SC93021703	NA	NA
26GHz ~ 40GHz Amplifier	EM26400	815221	Oct. 18, 2013	Oct. 17, 2014
High Speed Peak Power Meter	ML2495A	0824011	Jul. 26, 2014	Jul. 25, 2015
Power Sensor	MA2411B	0738171	Jul. 26, 2014	Jul. 25, 2015
WIT Standard Temperature And Humidity Chamber	TH-4S-C	W981030	Jun. 9, 2014	Jun. 08, 2015

- NOTE:**
1. The calibration interval of the above test instruments is 12 months and the calibrations are traceable to NML/ROC and NIST/USA.
 2. The calibration interval of the loop antenna is 24 months and the calibrations are traceable to NML/ROC and NIST/USA.
 3. The test was performed in HwaYa Chamber 3.
 4. The horn antenna and HP preamplifier (model: 8449B) are used only for the measurement of emission frequency above 1GHz if tested.
 5. The FCC Site Registration No. is 988962.
 6. The IC Site Registration No. is IC 7450F-3.

4.1.4 TEST PROCEDURES

- a. The EUT was placed on the top of a rotating table 0.8 meters above the ground at a 3 meter semi-anechoic chamber. The table was rotated 360 degrees to determine the position of the highest radiation.
- b. The EUT was set 3 meters away from the interference-receiving antenna, which was mounted on the top of a variable-height antenna tower.
- c. The antenna is a broadband antenna, and its height is varied from one meter to four meters above the ground to determine the maximum value of the field strength. Both horizontal and vertical polarizations of the antenna are set to make the measurement.
- d. For each suspected emission, the EUT was arranged to its worst case and then the antenna was tuned to heights from 1 meter to 4 meters and the rotatable table was turned from 0 degrees to 360 degrees to find the maximum reading.
- e. The test-receiver system was set to Peak Detect Function and Specified Bandwidth with Maximum Hold Mode.
- f. If the emission level of the EUT in peak mode was 10dB lower than the limit specified, then testing could be stopped and the peak values of the EUT would be reported. Otherwise the emissions that did not have 10dB margin would be re-tested one by one using peak, quasi-peak or average method as specified and then reported in a data sheet.

NOTE:

1. The resolution bandwidth and video bandwidth of test receiver/spectrum analyzer is 120kHz for Peak detection (PK) and Quasi-peak detection (QP) at frequency below 1GHz.
2. The resolution bandwidth of test receiver/spectrum analyzer is 1MHz and video bandwidth is 3MHz for Peak detection at frequency above 1GHz.
3. The resolution bandwidth of test receiver/spectrum analyzer is 1MHz and the video bandwidth is $\geq 1/T$ (Duty cycle < 98%) or 10Hz(Duty cycle > 98%) for Average detection (AV) at frequency above 1GHz.
4. All modes of operation were investigated and the worst-case emissions are reported.

4.1.5 DEVIATION FROM TEST STANDARD

No deviation.

4.1.6 TEST SETUP

Frequency range 30MHz~1GHz

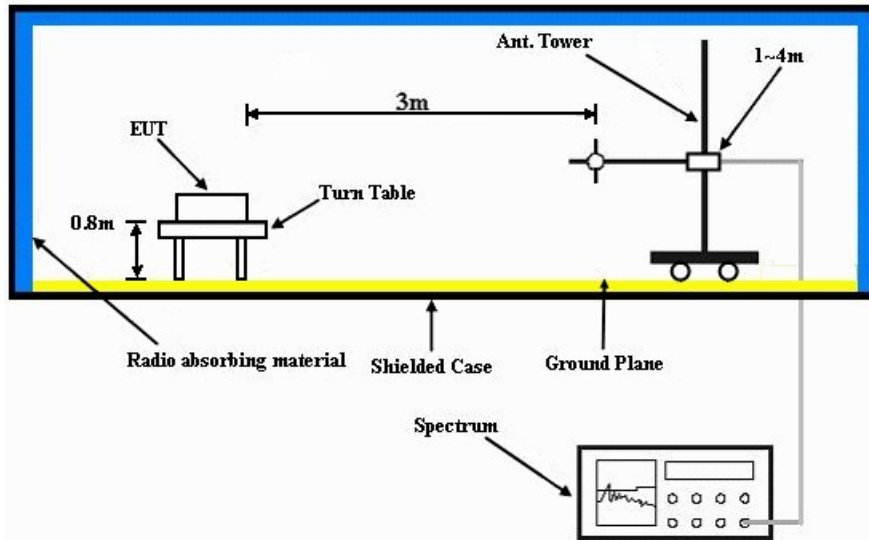

Frequency range above 1GHz

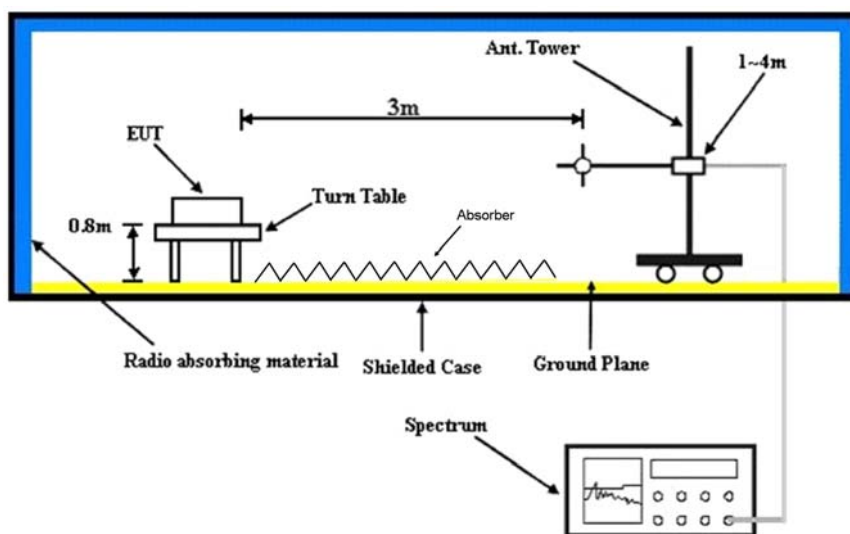

For the actual test configuration, please refer to the attached file (Test Setup Photo).

4.1.7 EUT OPERATING CONDITION

- a. Placed the EUT on the testing table.
- b. Prepared notebook to act as communication partner and placed it outside of testing area.
- c. The communication partner connected with EUT via a RJ45 cable and run a test program (provided by manufacturer) to enable EUT under transmission condition continuously at specific channel frequency.
- d. The communication partner sent data to EUT by command "PING".

4.1.8 TEST RESULTS

ABOVE 1GHz DATA :

802.11a

EUT TEST CONDITION		MEASUREMENT DETAIL	
CHANNEL	Channel 36	FREQUENCY RANGE	1 ~ 40GHz
INPUT POWER	120Vac, 60 Hz	DETECTOR FUNCTION	Peak (PK) Average (AV)
ENVIRONMENTAL CONDITIONS	25deg. C, 65%RH	TESTED BY	Chris Lin

ANTENNA POLARITY & TEST DISTANCE: HORIZONTAL AT 3 M								
NO.	FREQ. (MHz)	EMISSION LEVEL (dBuV/m)	LIMIT (dBuV/m)	MARGIN (dB)	ANTENNA HEIGHT (m)	TABLE ANGLE (Degree)	RAW VALUE (dBuV)	CORRECTION FACTOR (dB/m)
1	5150.00	55.4 PK	74.0	-18.6	1.01 H	112	49.00	6.40
2	5150.00	43.6 AV	54.0	-10.4	1.01 H	112	37.20	6.40
3	*5180.00	103.4 PK			1.04 H	28	63.50	39.90
4	*5180.00	91.8 AV			1.04 H	28	51.90	39.90
5	#10360.00	55.8 PK	68.3	-12.4	1.12 H	140	37.10	18.70
ANTENNA POLARITY & TEST DISTANCE: VERTICAL AT 3 M								
NO.	FREQ. (MHz)	EMISSION LEVEL (dBuV/m)	LIMIT (dBuV/m)	MARGIN (dB)	ANTENNA HEIGHT (m)	TABLE ANGLE (Degree)	RAW VALUE (dBuV)	CORRECTION FACTOR (dB/m)
1	5150.00	55.4 PK	74.0	-18.6	1.16 V	112	49.00	6.40
2	5150.00	43.5 AV	54.0	-10.5	1.16 V	112	37.10	6.40
3	*5180.00	108.2 PK			1.00 V	175	68.30	39.90
4	*5180.00	96.0 AV			1.00 V	175	56.10	39.90
5	#10360.00	55.7 PK	68.3	-12.5	4.00 V	120	37.00	18.70

REMARKS:

1. Emission Level(dBuV/m) = Raw Value(dBuV) + Correction Factor(dB/m)
2. Correction Factor(dB/m) = Antenna Factor(dB/m) + Cable Factor(dB)
– Pre-Amplifier Factor(dB)
3. The other emission levels were very low against the limit.
4. Margin value = Emission Level – Limit value
5. “ * “: Fundamental frequency.
6. “#”:The radiated frequency is out the restricted band.



A D T

EUT TEST CONDITION		MEASUREMENT DETAIL	
CHANNEL	Channel 40	FREQUENCY RANGE	1 ~ 40GHz
INPUT POWER	120Vac, 60 Hz	DETECTOR FUNCTION	Peak (PK) Average (AV)
ENVIRONMENTAL CONDITIONS	25deg. C, 65%RH	TESTED BY	Chris Lin

ANTENNA POLARITY & TEST DISTANCE: HORIZONTAL AT 3 M								
NO.	FREQ. (MHz)	EMISSION LEVEL (dBuV/m)	LIMIT (dBuV/m)	MARGIN (dB)	ANTENNA HEIGHT (m)	TABLE ANGLE (Degree)	RAW VALUE (dBuV)	CORRECTION FACTOR (dB/m)
1	*5200.00	103.4 PK			1.00 H	4	63.40	40.00
2	*5200.00	91.8 AV			1.00 H	4	51.80	40.00
3	#10400.00	57.2 PK	68.3	-11.0	1.12 H	270	38.20	19.00
4	15600.00	59.7 PK	74.0	-14.3	1.05 H	207	40.50	19.20
5	15600.00	46.4 AV	54.0	-7.6	1.05 H	207	27.20	19.20
ANTENNA POLARITY & TEST DISTANCE: VERTICAL AT 3 M								
NO.	FREQ. (MHz)	EMISSION LEVEL (dBuV/m)	LIMIT (dBuV/m)	MARGIN (dB)	ANTENNA HEIGHT (m)	TABLE ANGLE (Degree)	RAW VALUE (dBuV)	CORRECTION FACTOR (dB/m)
1	*5200.00	108.4 PK			1.02 V	326	68.40	40.00
2	*5200.00	96.8 AV			1.02 V	326	56.80	40.00
3	#10400.00	57.8 PK	68.3	-10.4	1.04 V	129	38.80	19.00
4	15600.00	60.7 PK	74.0	-13.3	1.00 V	139	41.50	19.20
5	15600.00	46.9 AV	54.0	-7.1	1.00 V	139	27.70	19.20

REMARKS:

1. Emission Level(dBuV/m) = Raw Value(dBuV) + Correction Factor(dB/m)
2. Correction Factor(dB/m) = Antenna Factor(dB/m) + Cable Factor(dB)
– Pre-Amplifier Factor(dB)
3. The other emission levels were very low against the limit.
4. Margin value = Emission Level – Limit value
5. “ * “: Fundamental frequency.
6. “#”:The radiated frequency is out the restricted band.



A D T

EUT TEST CONDITION		MEASUREMENT DETAIL	
CHANNEL	Channel 48	FREQUENCY RANGE	1 ~ 40GHz
INPUT POWER	120Vac, 60 Hz	DETECTOR FUNCTION	Peak (PK) Average (AV)
ENVIRONMENTAL CONDITIONS	25deg. C, 65%RH	TESTED BY	Chris Lin

ANTENNA POLARITY & TEST DISTANCE: HORIZONTAL AT 3 M								
NO.	FREQ. (MHz)	EMISSION LEVEL (dBuV/m)	LIMIT (dBuV/m)	MARGIN (dB)	ANTENNA HEIGHT (m)	TABLE ANGLE (Degree)	RAW VALUE (dBuV)	CORRECTION FACTOR (dB/m)
1	*5240.00	103.0 PK			1.03 H	360	63.00	40.00
2	*5240.00	93.5 AV			1.03 H	360	53.50	40.00
3	5350.00	55.6 PK	74.0	-18.4	1.03 H	222	49.20	6.40
4	5350.00	43.0 AV	54.0	-11.0	1.03 H	222	36.60	6.40
5	#10400.00	56.9 PK	68.3	-11.3	1.11 H	330	37.90	19.00

ANTENNA POLARITY & TEST DISTANCE: VERTICAL AT 3 M								
NO.	FREQ. (MHz)	EMISSION LEVEL (dBuV/m)	LIMIT (dBuV/m)	MARGIN (dB)	ANTENNA HEIGHT (m)	TABLE ANGLE (Degree)	RAW VALUE (dBuV)	CORRECTION FACTOR (dB/m)
1	*5240.00	108.0 PK			1.14 V	187	68.00	40.00
2	*5240.00	98.5 AV			1.14 V	187	58.50	40.00
3	5350.00	57.3 PK	74.0	-16.7	1.20 V	165	50.90	6.40
4	5350.00	43.7 AV	54.0	-10.3	1.20 V	165	37.30	6.40
5	#10480.00	57.1 PK	68.3	-11.1	1.00 V	20	37.90	19.20

REMARKS:

1. Emission Level(dBuV/m) = Raw Value(dBuV) + Correction Factor(dB/m)
2. Correction Factor(dB/m) = Antenna Factor(dB/m) + Cable Factor(dB)
– Pre-Amplifier Factor(dB)
3. The other emission levels were very low against the limit.
4. Margin value = Emission Level – Limit value
5. “ * “: Fundamental frequency.
6. “#”:The radiated frequency is out the restricted band.

802.11n (20MHz)

EUT TEST CONDITION		MEASUREMENT DETAIL	
CHANNEL	Channel 36	FREQUENCY RANGE	1 ~ 40GHz
INPUT POWER	120Vac, 60 Hz	DETECTOR FUNCTION	Peak (PK) Average (AV)
ENVIRONMENTAL CONDITIONS	25deg. C, 65%RH	TESTED BY	Chris Lin

ANTENNA POLARITY & TEST DISTANCE: HORIZONTAL AT 3 M								
NO.	FREQ. (MHz)	EMISSION LEVEL (dBuV/m)	LIMIT (dBuV/m)	MARGIN (dB)	ANTENNA HEIGHT (m)	TABLE ANGLE (Degree)	RAW VALUE (dBuV)	CORRECTION FACTOR (dB/m)
1	5150.00	55.1 PK	74.0	-18.9	1.35 H	52	48.70	6.40
2	5150.00	42.6 AV	54.0	-11.4	1.35 H	52	36.20	6.40
3	*5180.00	103.3 PK			1.41 H	33	63.40	39.90
4	*5180.00	93.4 AV			1.41 H	33	53.50	39.90
5	#10360.00	57.2 PK	68.3	-11.0	1.16 H	83	38.50	18.70

ANTENNA POLARITY & TEST DISTANCE: VERTICAL AT 3 M								
NO.	FREQ. (MHz)	EMISSION LEVEL (dBuV/m)	LIMIT (dBuV/m)	MARGIN (dB)	ANTENNA HEIGHT (m)	TABLE ANGLE (Degree)	RAW VALUE (dBuV)	CORRECTION FACTOR (dB/m)
1	5150.00	54.6 PK	74.0	-19.4	1.16 V	109	48.20	6.40
2	5150.00	42.6 AV	54.0	-11.4	1.16 V	109	36.20	6.40
3	*5180.00	108.0 PK			1.12 V	185	68.10	39.90
4	*5180.00	98.1 AV			1.12 V	185	58.20	39.90
5	#10360.00	55.9 PK	68.3	-12.3	1.06 V	40	37.20	18.70

REMARKS:

1. Emission Level(dBuV/m) = Raw Value(dBuV) + Correction Factor(dB/m)
2. Correction Factor(dB/m) = Antenna Factor(dB/m) + Cable Factor(dB)
– Pre-Amplifier Factor(dB)
3. The other emission levels were very low against the limit.
4. Margin value = Emission Level – Limit value
5. “ * “: Fundamental frequency.
6. “#”:The radiated frequency is out the restricted band.



A D T

EUT TEST CONDITION		MEASUREMENT DETAIL	
CHANNEL	Channel 40	FREQUENCY RANGE	1 ~ 40GHz
INPUT POWER	120Vac, 60 Hz	DETECTOR FUNCTION	Peak (PK) Average (AV)
ENVIRONMENTAL CONDITIONS	25deg. C, 65%RH	TESTED BY	Chris Lin

ANTENNA POLARITY & TEST DISTANCE: HORIZONTAL AT 3 M								
NO.	FREQ. (MHz)	EMISSION LEVEL (dBuV/m)	LIMIT (dBuV/m)	MARGIN (dB)	ANTENNA HEIGHT (m)	TABLE ANGLE (Degree)	RAW VALUE (dBuV)	CORRECTION FACTOR (dB/m)
1	*5200.00	101.3 PK			1.00 H	12	61.30	40.00
2	*5200.00	92.1 AV			1.00 H	12	52.10	40.00
3	#10400.00	57.8 PK	68.3	-10.4	1.08 H	111	38.80	19.00
4	15600.00	59.8 PK	74.0	-14.2	1.02 H	127	40.60	19.20
5	15600.00	47.3 AV	54.0	-6.7	1.02 H	127	28.10	19.20
ANTENNA POLARITY & TEST DISTANCE: VERTICAL AT 3 M								
NO.	FREQ. (MHz)	EMISSION LEVEL (dBuV/m)	LIMIT (dBuV/m)	MARGIN (dB)	ANTENNA HEIGHT (m)	TABLE ANGLE (Degree)	RAW VALUE (dBuV)	CORRECTION FACTOR (dB/m)
1	*5200.00	108.9 PK			1.00 V	185	68.90	40.00
2	*5200.00	98.8 AV			1.00 V	185	58.80	40.00
3	#10400.00	57.3 PK	68.3	-10.9	1.06 V	164	38.30	19.00
4	15600.00	61.0 PK	74.0	-13.0	1.14 V	147	41.80	19.20
5	15600.00	47.4 AV	54.0	-6.6	1.14 V	147	28.20	19.20

REMARKS:

1. Emission Level(dBuV/m) = Raw Value(dBuV) + Correction Factor(dB/m)
2. Correction Factor(dB/m) = Antenna Factor(dB/m) + Cable Factor(dB) – Pre-Amplifier Factor(dB)
3. The other emission levels were very low against the limit.
4. Margin value = Emission Level – Limit value
5. “ * “: Fundamental frequency.
6. “#”:The radiated frequency is out the restricted band.



A D T

EUT TEST CONDITION		MEASUREMENT DETAIL	
CHANNEL	Channel 48	FREQUENCY RANGE	1 ~ 40GHz
INPUT POWER	120Vac, 60 Hz	DETECTOR FUNCTION	Peak (PK) Average (AV)
ENVIRONMENTAL CONDITIONS	25deg. C, 65%RH	TESTED BY	Chris Lin

ANTENNA POLARITY & TEST DISTANCE: HORIZONTAL AT 3 M								
NO.	FREQ. (MHz)	EMISSION LEVEL (dBuV/m)	LIMIT (dBuV/m)	MARGIN (dB)	ANTENNA HEIGHT (m)	TABLE ANGLE (Degree)	RAW VALUE (dBuV)	CORRECTION FACTOR (dB/m)
1	*5240.00	103.1 PK			1.37 H	203	63.10	40.00
2	*5240.00	92.8 AV			1.37 H	203	52.80	40.00
3	5350.00	55.7 PK	74.0	-18.3	1.19 H	157	49.30	6.40
4	5350.00	43.2 AV	54.0	-10.8	1.19 H	157	36.80	6.40
5	#10480.00	57.3 PK	68.3	-10.9	1.25 H	143	38.10	19.20
ANTENNA POLARITY & TEST DISTANCE: VERTICAL AT 3 M								
NO.	FREQ. (MHz)	EMISSION LEVEL (dBuV/m)	LIMIT (dBuV/m)	MARGIN (dB)	ANTENNA HEIGHT (m)	TABLE ANGLE (Degree)	RAW VALUE (dBuV)	CORRECTION FACTOR (dB/m)
1	*5240.00	106.9 PK			1.00 V	351	66.90	40.00
2	*5240.00	97.2 AV			1.00 V	351	57.20	40.00
3	5350.00	55.1 PK	74.0	-18.9	1.11 V	158	48.70	6.40
4	5350.00	43.5 AV	54.0	-10.5	1.11 V	158	37.10	6.40
5	#10480.00	58.6 PK	68.3	-9.6	1.13 V	193	39.40	19.20

REMARKS:

1. Emission Level(dBuV/m) = Raw Value(dBuV) + Correction Factor(dB/m)
2. Correction Factor(dB/m) = Antenna Factor(dB/m) + Cable Factor(dB)
– Pre-Amplifier Factor(dB)
3. The other emission levels were very low against the limit.
4. Margin value = Emission Level – Limit value
5. “ * “: Fundamental frequency.
6. “#”:The radiated frequency is out the restricted band.



A D T

802.11n (40MHz)

EUT TEST CONDITION		MEASUREMENT DETAIL	
CHANNEL	Channel 38	FREQUENCY RANGE	1 ~ 40GHz
INPUT POWER	120Vac, 60 Hz	DETECTOR FUNCTION	Peak (PK) Average (AV)
ENVIRONMENTAL CONDITIONS	25deg. C, 65%RH	TESTED BY	Chris Lin

ANTENNA POLARITY & TEST DISTANCE: HORIZONTAL AT 3 M								
NO.	FREQ. (MHz)	EMISSION LEVEL (dBuV/m)	LIMIT (dBuV/m)	MARGIN (dB)	ANTENNA HEIGHT (m)	TABLE ANGLE (Degree)	RAW VALUE (dBuV)	CORRECTION FACTOR (dB/m)
1	5150.00	58.8 PK	74.0	-15.2	1.00 H	352	52.40	6.40
2	5150.00	47.5 AV	54.0	-6.5	1.00 H	352	41.10	6.40
3	*5190.00	101.4 PK			1.06 H	355	61.50	39.90
4	*5190.00	91.9 AV			1.06 H	355	52.00	39.90
5	#10380.00	56.3 PK	68.3	-11.9	1.31 H	190	37.50	18.80

ANTENNA POLARITY & TEST DISTANCE: VERTICAL AT 3 M								
NO.	FREQ. (MHz)	EMISSION LEVEL (dBuV/m)	LIMIT (dBuV/m)	MARGIN (dB)	ANTENNA HEIGHT (m)	TABLE ANGLE (Degree)	RAW VALUE (dBuV)	CORRECTION FACTOR (dB/m)
1	5150.00	65.0 PK	74.0	-9.0	1.00 V	220	60.60	4.40
2	5150.00	52.9 AV	54.0	-1.1	1.00 V	220	48.50	4.40
3	*5190.00	108.7 PK			1.00 V	188	70.80	37.90
4	*5190.00	97.9 AV			1.00 V	188	60.00	37.90
5	#10380.00	57.4 PK	68.3	-10.8	1.13 V	149	42.00	15.40

REMARKS:

1. Emission Level(dBuV/m) = Raw Value(dBuV) + Correction Factor(dB/m)
2. Correction Factor(dB/m) = Antenna Factor(dB/m) + Cable Factor(dB)
– Pre-Amplifier Factor(dB)
3. The other emission levels were very low against the limit.
4. Margin value = Emission Level – Limit value
5. “ * “: Fundamental frequency.
6. “#”:The radiated frequency is out the restricted band.



A D T

EUT TEST CONDITION		MEASUREMENT DETAIL	
CHANNEL	Channel 46	FREQUENCY RANGE	1 ~ 40GHz
INPUT POWER	120Vac, 60 Hz	DETECTOR FUNCTION	Peak (PK) Average (AV)
ENVIRONMENTAL CONDITIONS	25deg. C, 65%RH	TESTED BY	Chris Lin

ANTENNA POLARITY & TEST DISTANCE: HORIZONTAL AT 3 M								
NO.	FREQ. (MHz)	EMISSION LEVEL (dBuV/m)	LIMIT (dBuV/m)	MARGIN (dB)	ANTENNA HEIGHT (m)	TABLE ANGLE (Degree)	RAW VALUE (dBuV)	CORRECTION FACTOR (dB/m)
1	*5230.00	103.7 PK			1.43 H	35	63.70	40.00
2	*5230.00	93.7 AV			1.43 H	35	53.70	40.00
3	5350.00	52.5 PK	74.0	-21.5	1.12 H	147	46.10	6.40
4	5350.00	41.7 AV	54.0	-12.3	1.12 H	147	35.30	6.40
5	#10460.00	57.0 PK	68.3	-11.2	1.07 H	158	37.90	19.10
ANTENNA POLARITY & TEST DISTANCE: VERTICAL AT 3 M								
NO.	FREQ. (MHz)	EMISSION LEVEL (dBuV/m)	LIMIT (dBuV/m)	MARGIN (dB)	ANTENNA HEIGHT (m)	TABLE ANGLE (Degree)	RAW VALUE (dBuV)	CORRECTION FACTOR (dB/m)
1	*5230.00	108.7 PK			1.12 V	178	68.70	40.00
2	*5230.00	98.6 AV			1.12 V	178	58.60	40.00
3	5350.00	54.8 PK	74.0	-19.2	1.11 V	200	48.40	6.40
4	5350.00	43.2 AV	54.0	-10.8	1.11 V	200	36.80	6.40
5	#10460.00	57.3 PK	68.3	-16.7	1.11 V	200	38.20	19.10

REMARKS:

1. Emission Level(dBuV/m) = Raw Value(dBuV) + Correction Factor(dB/m)
2. Correction Factor(dB/m) = Antenna Factor(dB/m) + Cable Factor(dB)
– Pre-Amplifier Factor(dB)
3. The other emission levels were very low against the limit.
4. Margin value = Emission Level – Limit value
5. “ * “: Fundamental frequency.
6. “#”:The radiated frequency is out the restricted band.



A D T

BELOW 1GHz WORST-CASE DATA : 802.11n (20MHz)

EUT TEST CONDITION		MEASUREMENT DETAIL	
CHANNEL	Channel 40	FREQUENCY RANGE	Below 1000MHz
INPUT POWER	120Vac, 60 Hz	DETECTOR FUNCTION	Quasi-Peak
ENVIRONMENTAL CONDITIONS	25deg. C, 68%RH	TESTED BY	Chris Lin
TEST MODE	A		

ANTENNA POLARITY & TEST DISTANCE: HORIZONTAL AT 3 M								
NO.	FREQ. (MHz)	EMISSION LEVEL (dBuV/m)	LIMIT (dBuV/m)	MARGIN (dB)	ANTENNA HEIGHT (m)	TABLE ANGLE (Degree)	RAW VALUE (dBuV)	CORRECTION FACTOR (dB/m)
1	86.28	34.2 QP	40.0	-5.8	1.99 H	88	53.60	-19.40
2	150.45	33.3 QP	43.5	-10.2	1.99 H	263	47.20	-13.90
3	224.33	34.6 QP	46.0	-11.4	1.24 H	134	50.20	-15.60
4	253.49	32.6 QP	46.0	-13.4	1.00 H	254	47.00	-14.40
5	500.42	28.3 QP	46.0	-17.7	1.50 H	224	37.20	-8.90
6	624.85	30.2 QP	46.0	-15.8	1.24 H	142	36.80	-6.60
ANTENNA POLARITY & TEST DISTANCE: VERTICAL AT 3 M								
NO.	FREQ. (MHz)	EMISSION LEVEL (dBuV/m)	LIMIT (dBuV/m)	MARGIN (dB)	ANTENNA HEIGHT (m)	TABLE ANGLE (Degree)	RAW VALUE (dBuV)	CORRECTION FACTOR (dB/m)
1	62.95	32.7 QP	40.0	-7.3	1.00 V	330	47.70	-15.00
2	86.28	36.1 QP	40.0	-3.9	1.00 V	119	55.50	-19.40
3	146.56	32.7 QP	43.5	-10.8	1.00 V	258	46.70	-14.00
4	374.04	31.7 QP	46.0	-14.3	1.00 V	195	43.00	-11.30
5	500.42	26.3 QP	46.0	-19.7	1.00 V	187	35.20	-8.90
6	624.85	26.7 QP	46.0	-19.3	1.00 V	14	33.30	-6.60

REMARKS:

1. Emission Level(dBuV/m) = Raw Value(dBuV) + Correction Factor(dB/m)
2. Correction Factor(dB/m) = Antenna Factor(dB/m) + Cable Factor(dB) – Pre-Amplifier Factor (dB)
3. The other emission levels were very low against the limit.
4. Margin value = Emission Level – Limit value



A D T

EUT TEST CONDITION		MEASUREMENT DETAIL	
CHANNEL	Channel 40	FREQUENCY RANGE	Below 1000MHz
INPUT POWER	48Vdc (POE)	DETECTOR FUNCTION	Quasi-Peak
ENVIRONMENTAL CONDITIONS	25deg. C, 68%RH	TESTED BY	Chris Lin
TEST MODE	B		

ANTENNA POLARITY & TEST DISTANCE: HORIZONTAL AT 3 M								
NO.	FREQ. (MHz)	EMISSION LEVEL (dBuV/m)	LIMIT (dBuV/m)	MARGIN (dB)	ANTENNA HEIGHT (m)	TABLE ANGLE (Degree)	RAW VALUE (dBuV)	CORRECTION FACTOR (dB/m)
1	226.27	34.6 QP	46.0	-11.4	1.50 H	219	50.20	-15.60
2	255.44	33.0 QP	46.0	-13.0	1.24 H	101	47.20	-14.20
3	374.04	38.3 QP	46.0	-7.7	1.00 H	223	49.60	-11.30
4	500.42	36.1 QP	46.0	-9.9	1.99 H	203	45.00	-8.90
5	624.85	35.6 QP	46.0	-10.4	1.24 H	191	42.20	-6.60
6	875.67	32.4 QP	46.0	-13.6	1.99 H	15	33.90	-1.50
ANTENNA POLARITY & TEST DISTANCE: VERTICAL AT 3 M								
NO.	FREQ. (MHz)	EMISSION LEVEL (dBuV/m)	LIMIT (dBuV/m)	MARGIN (dB)	ANTENNA HEIGHT (m)	TABLE ANGLE (Degree)	RAW VALUE (dBuV)	CORRECTION FACTOR (dB/m)
1	64.90	32.8 QP	40.0	-7.2	1.00 V	4	48.10	-15.30
2	255.44	34.0 QP	46.0	-12.0	1.00 V	263	48.20	-14.20
3	374.04	35.7 QP	46.0	-10.3	1.24 V	193	47.00	-11.30
4	500.42	36.1 QP	46.0	-9.9	1.00 V	211	45.00	-8.90
5	675.40	29.0 QP	46.0	-17.0	1.50 V	164	35.10	-6.10
6	899.00	28.5 QP	46.0	-17.5	1.50 V	109	29.70	-1.20

REMARKS:

1. Emission Level(dBuV/m) = Raw Value(dBuV) + Correction Factor(dB/m)
2. Correction Factor(dB/m) = Antenna Factor(dB/m) + Cable Factor(dB) – Pre-Amplifier Factor (dB)
3. The other emission levels were very low against the limit.
4. Margin value = Emission Level – Limit value

4.2 CONDUCTED EMISSION MEASUREMENT

4.2.1 LIMITS OF CONDUCTED EMISSION MEASUREMENT

FREQUENCY OF EMISSION (MHz)	CONDUCTED LIMIT (dB μ V)	
	Quasi-peak	Average
0.15 ~ 0.5	66 to 56	56 to 46
0.5 ~ 5	56	46
5 ~ 30	60	50

- NOTE:** 1. The lower limit shall apply at the transition frequencies.
 2. The limit decreases in line with the logarithm of the frequency in the range of 0.15 to 0.50MHz.
 3. All emanations from a class A/B digital device or system, including any network of conductors and apparatus connected thereto, shall not exceed the level of field strengths specified above.

4.2.2 TEST INSTRUMENTS

DESCRIPTION & MANUFACTURER	MODEL NO.	SERIAL NO.	DATE OF CALIBRATION	DUE DATE OF CALIBRATION
Test Receiver ROHDE & SCHWARZ	ESCS30	100289	Nov. 29, 2013	Nov. 28, 2014
RF signal cable Woken	5D-FB	Cable-HYC01-01	Dec. 27, 2013	Dec. 26, 2014
LISN ROHDE & SCHWARZ (EUT)	ESH3-Z5	835239/001	Feb. 13, 2014	Feb. 12, 2015
LISN ROHDE & SCHWARZ (Peripheral)	ESH3-Z5	100311	Jul. 21, 2014	Jul. 20, 2015
Software ADT	BV ADT_Cond_ V7.3.7.3	NA	NA	NA

- NOTE:** 1. The calibration interval of the above test instruments is 12 months and the calibrations are traceable to NML/ROC and NIST/USA.
 2. The test was performed in HwaYa Shielded Room 1.
 3. The VCCI Site Registration No. is C-2040.

4.2.3 TEST PROCEDURES

- The EUT was placed 0.4 meters from the conducting wall of the shielded room with EUT being connected to the power mains through a line impedance stabilization network (LISN). Other support units were connected to the power mains through another LISN. The two LISNs provide 50 ohm/ 50uH of coupling impedance for the measuring instrument.
- Both lines of the power mains connected to the EUT were checked for maximum conducted interference.
- The frequency range from 150kHz to 30MHz was searched. Emission levels under (Limit - 20dB) was not recorded.

NOTE: All modes of operation were investigated and the worst-case emissions are reported.

4.2.4 DEVIATION FROM TEST STANDARD

No deviation.

4.2.5 TEST SETUP

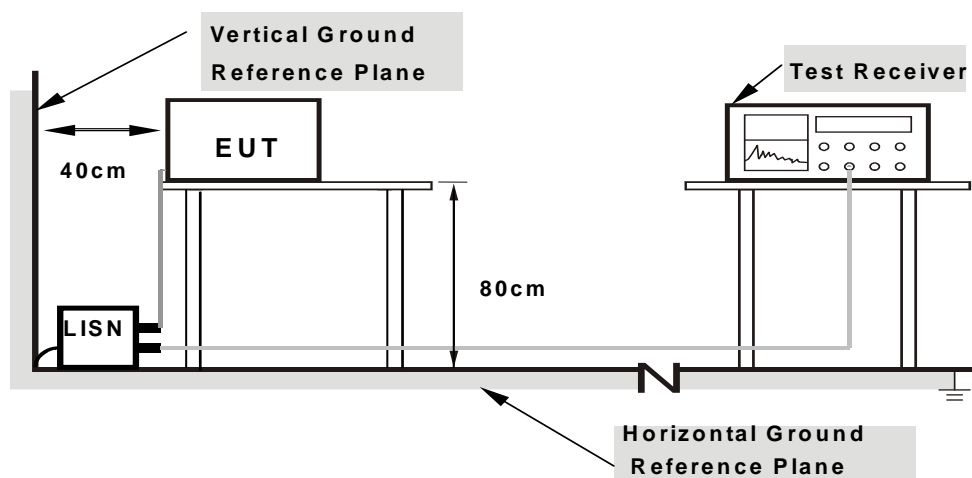

- Note:**
- Support units were connected to second LISN.
 - Both of LISNs (AMN) are 80 cm from EUT and at least 80 cm from other units and other metal planes

For the actual test configuration, please refer to the attached file (Test Setup Photo).

4.2.6 EUT OPERATING CONDITIONS

Same as 4.1.6.

4.2.7 TEST RESULTS

CONDUCTED WORST-CASE DATA : 802.11n (20MHz)

PHASE	Line 1	6dB BANDWIDTH	9kHz
TEST MODE	A		

No	Freq. [MHz]	Corr. Factor (dB)	Reading Value		Emission Level		Limit		Margin	
			[dB (uV)]		[dB (uV)]		[dB (uV)]		(dB)	
			Q.P.	AV.	Q.P.	AV.	Q.P.	AV.	Q.P.	AV.
1	0.15000	0.11	50.07	33.88	50.18	33.99	66.00	56.00	-15.82	-22.01
2	0.26719	0.10	39.47	27.54	39.57	27.64	61.20	51.20	-21.64	-23.57
3	0.54844	0.13	39.84	34.00	39.97	34.13	56.00	46.00	-16.03	-11.87
4	2.05078	0.25	35.07	28.71	35.32	28.96	56.00	46.00	-20.68	-17.04
5	3.44922	0.26	36.78	29.92	37.04	30.18	56.00	46.00	-18.96	-15.82
6	5.26563	0.32	34.03	26.27	34.35	26.59	60.00	50.00	-25.65	-23.41

REMARKS:

1. Q.P. and AV. are abbreviations of quasi-peak and average individually.
2. The emission levels of other frequencies were very low against the limit.
3. Margin value = Emission level - Limit value
4. Correction factor = Insertion loss + Cable loss
5. Emission Level = Correction Factor + Reading Value.

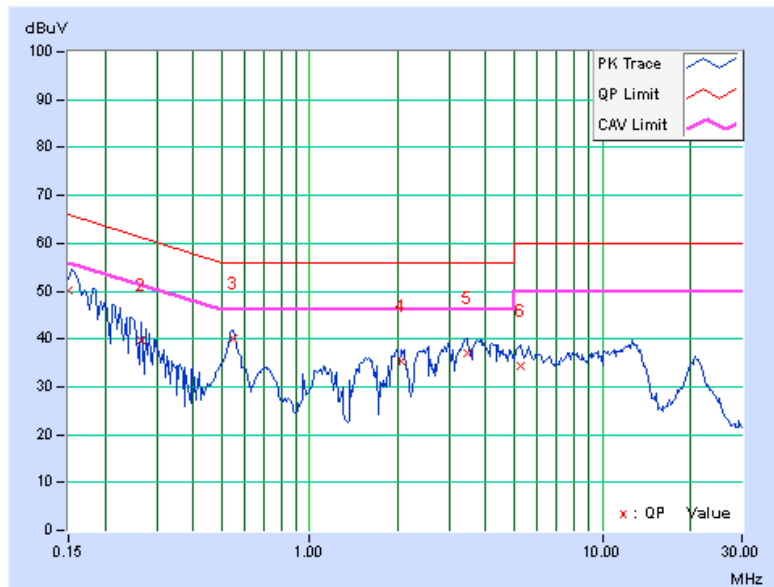

PHASE	Line 2	6dB BANDWIDTH	9kHz
TEST MODE	A		

No	Freq. [MHz]	Corr. Factor (dB)	Reading Value		Emission Level		Limit		Margin	
			[dB (uV)]		[dB (uV)]		[dB (uV)]		(dB)	
			Q.P.	AV.	Q.P.	AV.	Q.P.	AV.	Q.P.	AV.
1	0.15781	0.06	50.26	34.72	50.32	34.78	65.58	55.58	-15.26	-20.80
2	0.20859	0.09	43.69	27.73	43.78	27.82	63.26	53.26	-19.48	-25.44
3	0.54453	0.18	40.14	34.38	40.32	34.56	56.00	46.00	-15.68	-11.44
4	2.06641	0.22	34.94	28.43	35.16	28.65	56.00	46.00	-20.84	-17.35
5	3.40625	0.25	36.88	31.25	37.13	31.50	56.00	46.00	-18.87	-14.50
6	12.21484	0.65	34.11	28.53	34.76	29.18	60.00	50.00	-25.24	-20.82

REMARKS:

1. Q.P. and AV. are abbreviations of quasi-peak and average individually.
2. The emission levels of other frequencies were very low against the limit.
3. Margin value = Emission level - Limit value
4. Correction factor = Insertion loss + Cable loss
5. Emission Level = Correction Factor + Reading Value.

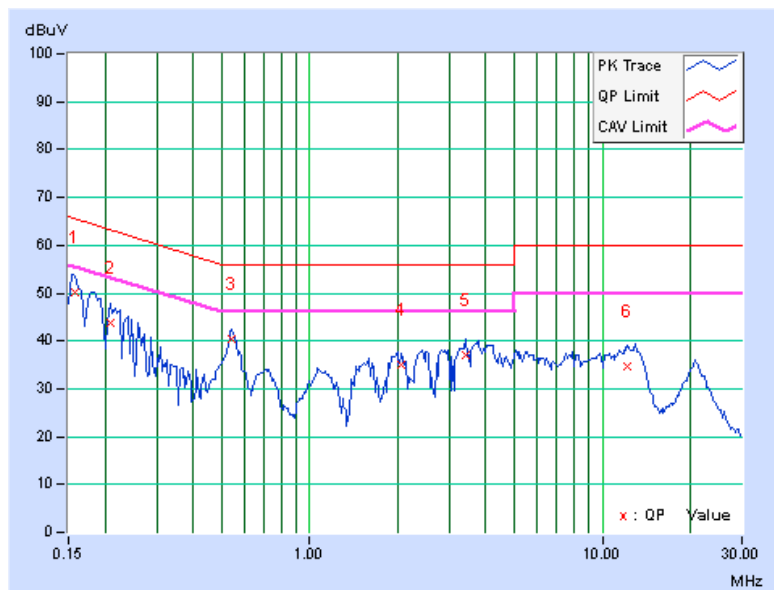



A D T

PHASE	Line 1	6dB BANDWIDTH	9kHz
TEST MODE	B		

No	Freq. [MHz]	Corr. Factor (dB)	Reading Value		Emission Level		Limit		Margin	
			[dB (uV)]		[dB (uV)]		[dB (uV)]		(dB)	
			Q.P.	AV.	Q.P.	AV.	Q.P.	AV.	Q.P.	AV.
1	0.18516	0.10	41.87	34.74	41.97	34.84	64.25	54.25	-22.28	-19.41
2	0.37266	0.11	35.90	34.91	36.01	35.02	58.44	48.44	-22.43	-13.42
3	0.65391	0.15	36.75	34.28	36.90	34.43	56.00	46.00	-19.10	-11.57
4	3.46094	0.26	37.64	36.08	37.90	36.34	56.00	46.00	-18.10	-9.66
5	9.73281	0.54	32.26	27.91	32.80	28.45	60.00	50.00	-27.20	-21.55
6	16.08203	0.89	31.32	29.06	32.21	29.95	60.00	50.00	-27.79	-20.05

REMARKS:

1. Q.P. and AV. are abbreviations of quasi-peak and average individually.
2. The emission levels of other frequencies were very low against the limit.
3. Margin value = Emission level - Limit value
4. Correction factor = Insertion loss + Cable loss
5. Emission Level = Correction Factor + Reading Value.

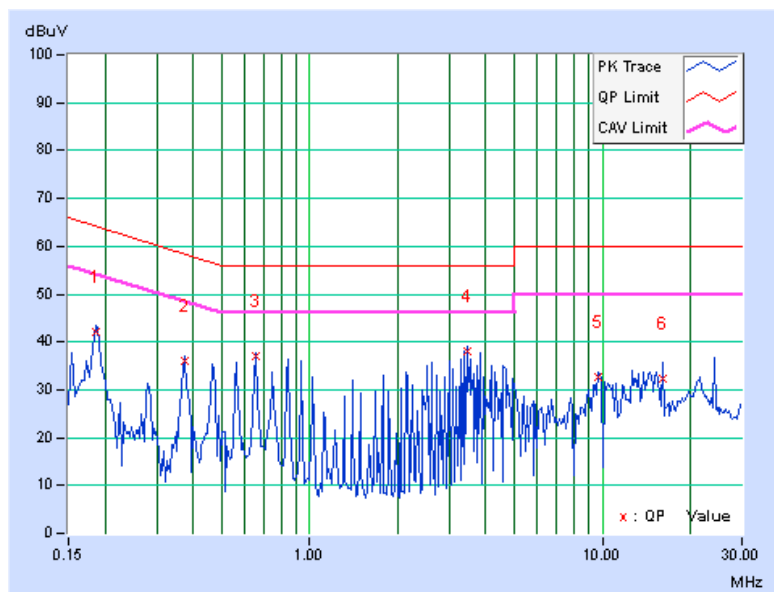



A D T

PHASE	Line 2	6dB BANDWIDTH	9kHz
TEST MODE	B		

No	Freq. [MHz]	Corr. Factor (dB)	Reading Value		Emission Level		Limit		Margin	
			[dB (uV)]		[dB (uV)]		[dB (uV)]		(dB)	
			Q.P.	AV.	Q.P.	AV.	Q.P.	AV.	Q.P.	AV.
1	0.18516	0.08	42.29	35.15	42.37	35.23	64.25	54.25	-21.88	-19.02
2	0.37266	0.16	36.06	35.08	36.22	35.24	58.44	48.44	-22.22	-13.20
3	0.65391	0.19	36.77	34.34	36.96	34.53	56.00	46.00	-19.04	-11.47
4	2.14844	0.22	33.13	32.66	33.35	32.88	56.00	46.00	-22.65	-13.12
5	3.82813	0.26	36.49	34.61	36.75	34.87	56.00	46.00	-19.25	-11.13
6	14.84375	0.77	30.56	30.26	31.33	31.03	60.00	50.00	-28.67	-18.97

REMARKS:

1. Q.P. and AV. are abbreviations of quasi-peak and average individually.
2. The emission levels of other frequencies were very low against the limit.
3. Margin value = Emission level - Limit value
4. Correction factor = Insertion loss + Cable loss
5. Emission Level = Correction Factor + Reading Value.

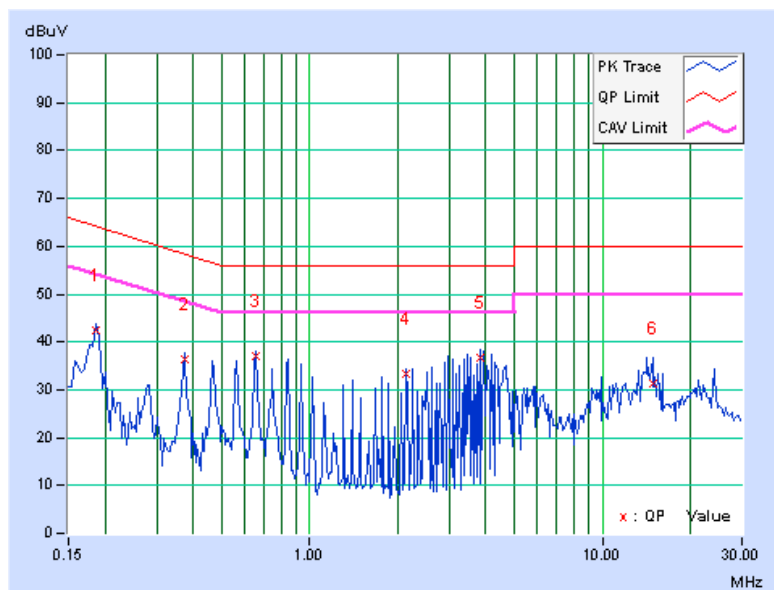

4.3 PEAK TRANSMIT POWER MEASUREMENT

4.3.1 LIMITS OF PEAK TRANSMIT POWER MEASUREMENT

FREQUENCY BAND	LIMIT
5.15 ~ 5.25GHz	The lesser of 50mW (17dBm) or 4dBm + 10logB

NOTE: Where B is the 26dB emission bandwidth in MHz.

Per KDB 662911 D01 Multiple Transmitter Output v02 Method of conducted output power measurement on IEEE 802.11 devices,

Array Gain = 0 dB (i.e., no array gain) for NANT ≤ 4;

Array Gain = 0 dB (i.e., no array gain) for channel widths ≥ 40 MHz for any NANT;

Array Gain = 5 log(NANT/NSS) dB or 3 dB, whichever is less for 20-MHz channel widths with NANT ≥ 5.

For power measurements on all other devices: Array Gain = 10 log(NANT/NSS) dB.

4.3.2 TEST SETUP

FOR POWER OUTPUT MEASUREMENT

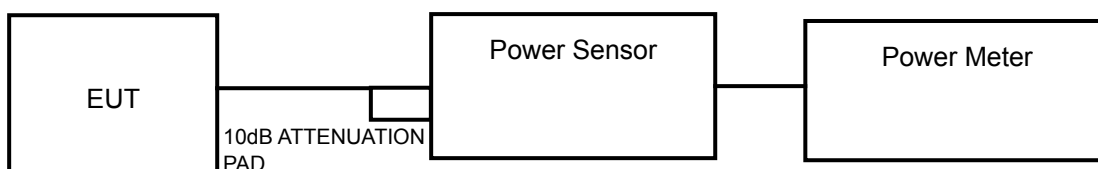

FOR 26dB BANDWIDTH

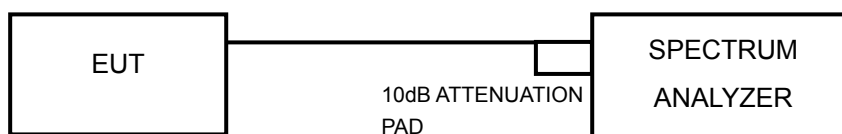

4.3.3 TEST INSTRUMENTS

Refer to section 4.1.3 to get information of above instrument.

4.3.4 TEST PROCEDURE

FOR AVERAGE POWER MEASUREMENT

Method PM is used to perform output power measurement, trigger and gating function of wide band power meter is enabled to measure max output power of TX on burst. Duty factor is not added to measured value.

FOR 26dB BANDWIDTH

- 1) Set RBW = approximately 1% of the emission bandwidth.
- 2) Set the VBW > RBW.
- 3) Detector = Peak.
- 4) Trace mode = max hold.
- 5) Measure the maximum width of the emission that is 26 dB down from the peak of the emission. Compare this with the RBW setting of the analyzer. Readjust RBW and repeat measurement as needed until the RBW/EBW ratio is approximately 1%.

4.3.5 DEVIATION FROM TEST STANDARD

No deviation.

4.3.6 EUT OPERATING CONDITIONS

The software provided by client to enable the EUT under transmission condition continuously at specific channel frequencies individually.

4.3.7 TEST RESULTS

POWER OUTPUT:

802.11a

CHAN.	CHAN. FREQ. (MHz)	AVERAGE POWER (dBm)		TOTAL POWER (mW)	TOTAL POWER (dBm)	POWER LIMIT (dBm)	PASS / FAIL
		CHAIN 0	CHAIN 1				
36	5180	10.80	11.40	25.83	14.12	16.94	PASS
40	5200	10.90	11.50	26.43	14.22	16.95	PASS
48	5240	10.90	11.50	26.43	14.22	16.96	PASS

NOTE:

CHAIN 0

1. $4\text{dBm} + 10\log(19.96) = 17.002\text{dBm} > 17\text{dBm}$.
2. $4\text{dBm} + 10\log(19.71) = 16.95\text{dBm} < 17\text{dBm}$.
3. $4\text{dBm} + 10\log(19.78) = 16.96\text{dBm} < 17\text{dBm}$.

CHAIN 1

1. $4\text{dBm} + 10\log(19.68) = 16.94\text{dBm} < 17\text{dBm}$.
2. $4\text{dBm} + 10\log(19.90) = 16.99\text{dBm} < 17\text{dBm}$.
3. $4\text{dBm} + 10\log(19.78) = 16.96\text{dBm} < 17\text{dBm}$.

802.11n (20MHz)

CHAN.	CHAN. FREQ. (MHz)	AVERAGE POWER (dBm)		TOTAL POWER (mW)	TOTAL POWER (dBm)	POWER LIMIT (dBm)	PASS / FAIL
		CHAIN 0	CHAIN 1				
36	5180	10.85	11.24	25.47	14.06	17.00	PASS
40	5200	11.57	11.65	28.98	14.62	16.95	PASS
48	5240	11.01	11.02	25.27	14.03	17.00	PASS

NOTE:

CHAIN 0

1. $4\text{dBm} + 10\log(20.59) = 17.14\text{dBm} > 17\text{dBm}$.
2. $4\text{dBm} + 10\log(19.74) = 16.95\text{dBm} < 17\text{dBm}$.
3. $4\text{dBm} + 10\log(20.42) = 17.10\text{dBm} > 17\text{dBm}$.

CHAIN 1

1. $4\text{dBm} + 10\log(20.40) = 17.10\text{dBm} > 17\text{dBm}$.
2. $4\text{dBm} + 10\log(20.49) = 17.12\text{dBm} > 17\text{dBm}$.
3. $4\text{dBm} + 10\log(20.14) = 17.04\text{dBm} > 17\text{dBm}$.



802.11n (40MHz)

CHAN.	CHAN. FREQ. (MHz)	AVERAGE POWER (dBm)		TOTAL POWER (mW)	TOTAL POWER (dBm)	POWER LIMIT (dBm)	PASS / FAIL
		CHAIN 0	CHAIN 1				
38	5190	12.62	13.98	43.28	16.36	17.00	PASS
46	5230	13.10	13.66	43.64	16.40	17.00	PASS

NOTE:

CHAIN 0

- 1. $4\text{dBm} + 10\log(45.53) = 20.58\text{dBm} > 17\text{dBm}$.
- 2. $4\text{dBm} + 10\log(44.94) = 20.48\text{dBm} > 17\text{dBm}$.

CHAIN 1

- 1. $4\text{dBm} + 10\log(44.80) = 20.51\text{dBm} > 17\text{dBm}$.
- 2. $4\text{dBm} + 10\log(45.05) = 20.54\text{dBm} > 17\text{dBm}$.



26dB BANDWIDTH:

802.11a

CHANNEL	CHANNEL FREQUENCY (MHz)	26dBc BANDWIDTH (MHz)		PASS / FAIL
		CHAIN 0	CHAIN 1	
36	5180	19.96	19.68	PASS
40	5200	19.71	19.90	PASS
48	5240	19.78	19.78	PASS

802.11n (20MHz)

CHANNEL	CHANNEL FREQUENCY (MHz)	26dBc BANDWIDTH (MHz)		PASS / FAIL
		CHAIN 0	CHAIN 1	
36	5180	20.59	20.40	PASS
40	5200	19.74	20.49	PASS
48	5240	20.42	20.14	PASS

802.11n (40MHz)

CHANNEL	CHANNEL FREQUENCY (MHz)	26dBc BANDWIDTH (MHz)		PASS / FAIL
		CHAIN 0	CHAIN 1	
38	5190	45.53	44.80	PASS
46	5230	44.94	45.05	PASS



A D T

SPECTRUM PLOT OF WORST VALUE

802.11a

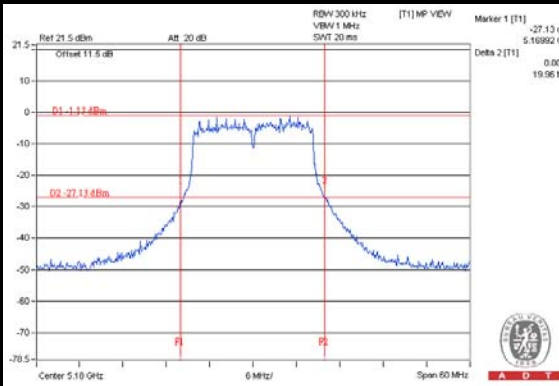

802.11n (20MHz)

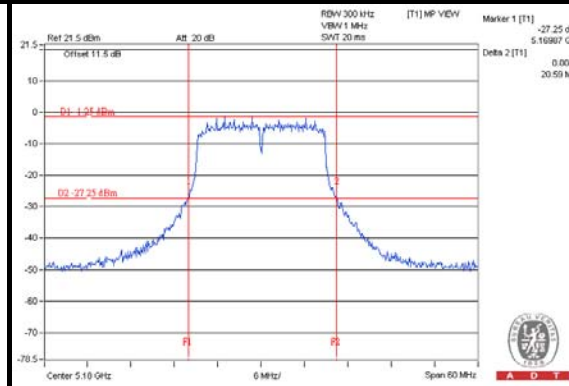

802.11n (40MHz)

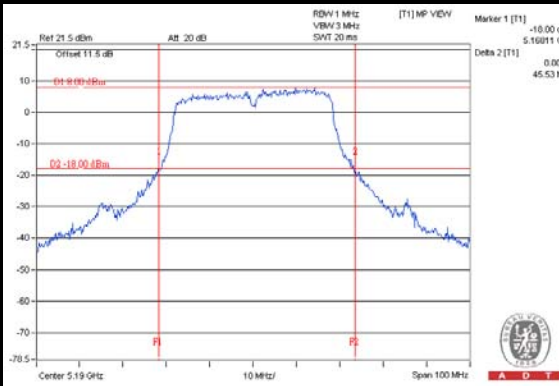

4.4 PEAK POWER SPECTRAL DENSITY MEASUREMENT

4.4.1 LIMITS OF PEAK POWER SPECTRAL DENSITY MEASUREMENT

FREQUENCY BAND	LIMIT
5.15 ~ 5.25GHz	4dBm

4.4.2 TEST SETUP



4.4.3 TEST INSTRUMENTS

Refer to section 4.1.3 to get information of above instrument.

4.4.4 TEST PROCEDURES

Using method SA-1

- 1) Set span to encompass the entire emission bandwidth (EBW) of the signal.
- 2) Set RBW = 30kHz, Set VBW \geq 1MHz, Detector = RMS
- 3) Sweep time = auto, trigger set to "free run".
- 4) Trace average at least 100 traces in power averaging mode.
- 5) Record the max value

4.4.5 DEVIATION FROM TEST STANDARD

No deviation.

4.4.6 EUT OPERATING CONDITIONS

Same as 4.3.6.

4.4.7 TEST RESULTS

802.11a

CHAN.	CHAN. FREQ. (MHz)	PSD (dBm)		TOTAL PSD W/O DUTY FACTOR (dBm)	DUTY FACTOR	TOTAL PSD WITH DUTY FACTOR (dBm)	MAX. LIMIT (dBm)	PASS / FAIL
		CHAIN 0	CHAIN 1					
36	5180	-1.69	-1.70	1.32	0.11	1.43	4	PASS
40	5200	-0.99	-0.64	2.20	0.11	2.31	4	PASS
48	5240	-0.65	-0.77	2.30	0.11	2.41	4	PASS

NOTE:

1. Method 1 of power density measurement of KDB 662911 is using for calculating total power density. Total power density is summing entire spectra across corresponding frequency bins on the various outputs by computer.
2. Directional gain = $2\text{dBi} + 10\log(2) = 5.01\text{dBi} < 6\text{dBi}$, therefore the limit no need to reduced.
3. Refer to section 3.3 for duty cycle spectrum plot.

802.11n (20MHz)

CHAN.	CHAN. FREQ. (MHz)	PSD (dBm)		TOTAL PSD W/O DUTY FACTOR (dBm)	DUTY FACTOR	TOTAL PSD WITH DUTY FACTOR (dBm)	MAX. LIMIT (dBm)	PASS / FAIL
		CHAIN 0	CHAIN 1					
36	5180	-2.03	-2.42	0.79	0.12	0.91	4	PASS
40	5200	-1.61	-1.70	1.36	0.12	1.48	4	PASS
48	5240	-0.58	-0.21	2.62	0.12	2.74	4	PASS

NOTE:

1. Method 1 of power density measurement of KDB 662911 is using for calculating total power density. Total power density is summing entire spectra across corresponding frequency bins on the various outputs by computer.
2. Directional gain = $2\text{dBi} + 10\log(2) = 5.01\text{dBi} < 6\text{dBi}$, therefore the limit no need to reduced.
3. Refer to section 3.3 for duty cycle spectrum plot.

802.11n (40MHz)

CHAN.	CHAN. FREQ. (MHz)	PSD (dBm)		TOTAL PSD W/O DUTY FACTOR (dBm)	DUTY FACTOR	TOTAL PSD WITH DUTY FACTOR (dBm)	MAX. LIMIT (dBm)	PASS / FAIL
		CHAIN 0	CHAIN 1					
38	5190	-2.43	-2.22	0.69	0.38	1.07	4	PASS
46	5230	-1.56	-1.74	1.36	0.38	1.74	4	PASS

NOTE:

1. Method 1 of power density measurement of KDB 662911 is using for calculating total power density. Total power density is summing entire spectra across corresponding frequency bins on the various outputs by computer.
2. Directional gain = $2\text{dBi} + 10\log(2) = 5.01\text{dBi} < 6\text{dBi}$, therefore the limit no need to reduced.
3. Refer to section 3.3 for duty cycle spectrum plot.



A D T

SPECTRUM PLOT OF WORST VALUE

802.11a

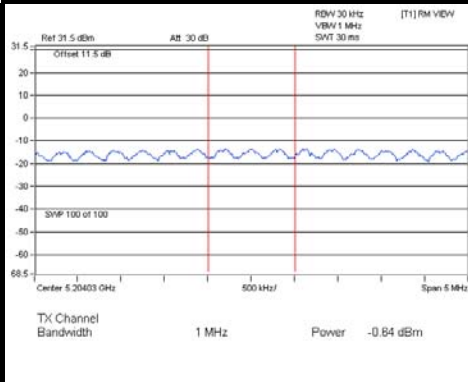

802.11n (20MHz)

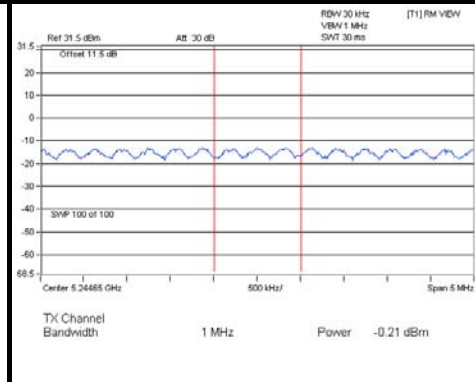

802.11n (40MHz)

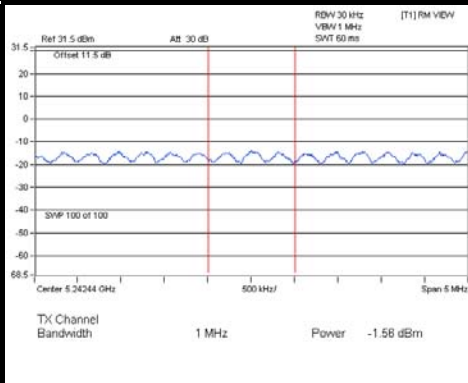

4.5 PEAK POWER EXCURSION MEASUREMENT

4.5.1 LIMITS OF PEAK POWER EXCURSION MEASUREMENT

Shall not exceed 13 dB

4.5.2 TEST SETUP

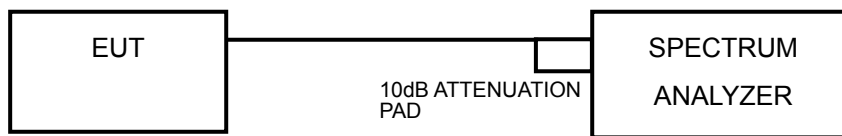

4.5.3 TEST INSTRUMENTS

Refer to section 4.1.3 to get information of above instrument.

4.5.4 TEST PROCEDURE

- 1) Set RBW = 1 MHz, VBW \geq 3 MHz, Detector = peak.
- 2) Trace mode = max-hold. Allow the sweeps to continue until the trace stabilizes.
- 3) Use the peak search function to find the peak of the spectrum.
- 4) Measure the PPSD.
- 5) Compute the ratio of the maximum of the peak-max-hold spectrum to the PPSD. Find the worst channel and modulation mode as above test procedure, and follow KDB 789033 D01 General UNII Test Procedures v01r03 and repeat step 1 to 5 for final testing of each modulation mode on a single channel (all modulation types) in a single operating band to compliance with the peak excursion requirement.

4.5.5 DEVIATION FROM TEST STANDARD

No deviation.

4.5.6 EUT OPERATING CONDITIONS

Same as 4.2.6

4.5.7 TEST RESULTS

MODULATION MODE	MODULATION TYPE	CHAN. FREQ. (MHz)	PEAK VALUE (dBm)	PPSD WITHOUT DUTY FACTOR (dBm)	PPSD WITH DUTY FACTOR (dBm)	PEAK EXCURSION (dB)	LIMIT (dB)	PASS /FAIL
802.11a	BPSK	5240	8.89	-0.77	-0.66	9.55	13	PASS
	QPSK		9.20	-0.66	-0.41	9.61	13	PASS
	16QAM		8.74	-1.31	-0.92	9.67	13	PASS
	64QAM		8.38	-2.39	-1.64	10.02	13	PASS
802.11n (20MHz)	BPSK	5240	8.11	-0.21	-0.09	8.20	13	PASS
	QPSK		8.82	-0.78	-0.57	9.39	13	PASS
	16QAM		9.08	-1.32	-0.90	9.98	13	PASS
	64QAM		8.76	-2.04	-1.36	10.12	13	PASS
802.11n (40MHz)	BPSK	5230	9.25	-1.74	-1.36	10.61	13	PASS
	QPSK		8.26	-2.31	-1.77	10.03	13	PASS
	16QAM		9.02	-2.53	-1.37	10.39	13	PASS
	64QAM		8.91	-2.73	-1.11	10.01	13	PASS

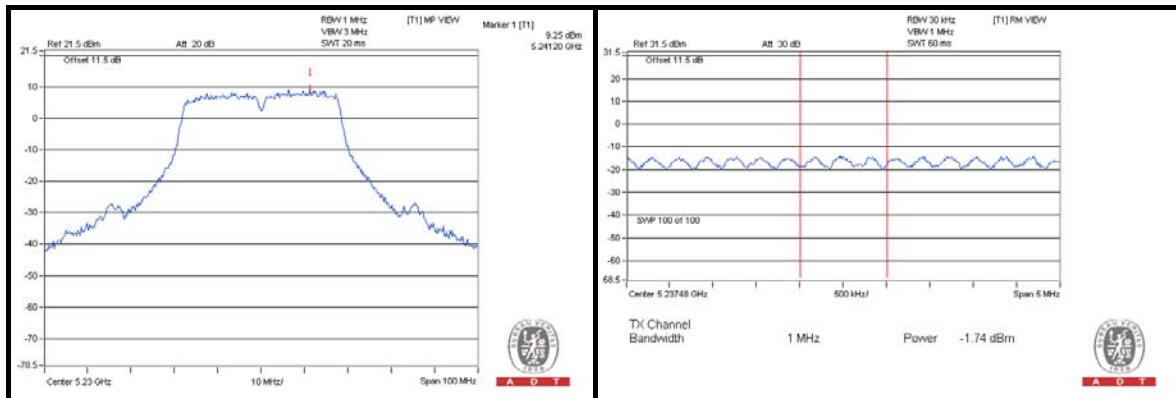

4.6 FREQUENCY STABILITY

4.6.1 LIMITS OF FREQUENCY STABILITY MEASUREMENT

The frequency of the carrier signal shall be maintained within band of operation

4.6.2 TEST SETUP

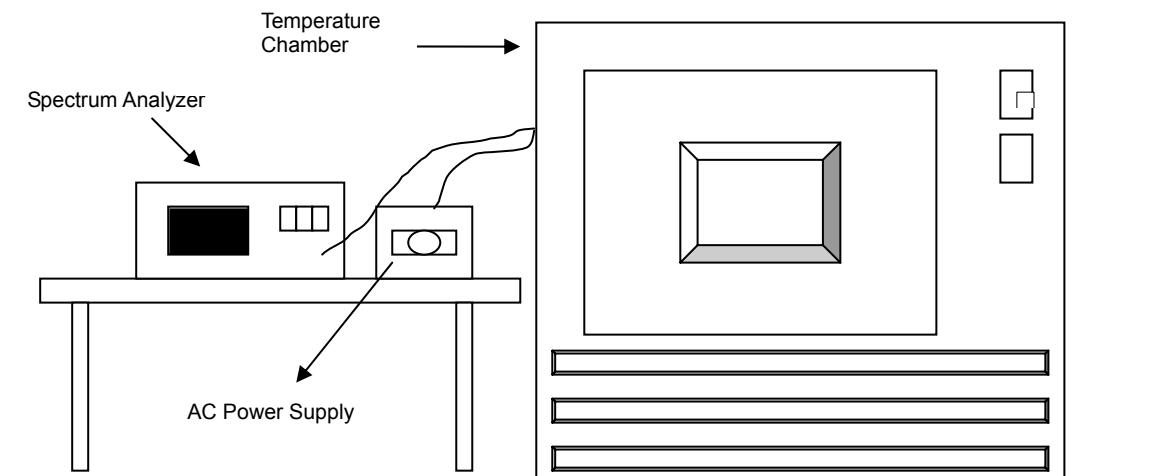

4.6.3 TEST INSTRUMENTS

Refer to section 4.1.3 to get information of above instrument.

4.6.4 TEST PROCEDURE

- a. The EUT was placed inside the environmental test chamber and powered by nominal AC voltage.
- b. Turn the EUT on and couple its output to a spectrum analyzer.
- c. Turn the EUT off and set the chamber to the highest temperature specified.
- d. Allow sufficient time (approximately 30 min) for the temperature of the chamber to stabilize, turn the EUT on and measure the operating frequency after 2, 5, and 10 minutes.
- e. Repeat step 2 and 3 with the temperature chamber set to the lowest temperature.
- f. The test chamber was allowed to stabilize at +20 degree C for a minimum of 30 minutes. The supply voltage was then adjusted on the EUT from 85% to 115% and the frequency record.

4.6.5 DEVIATION FROM TEST STANDARD

No deviation.

4.6.6 EUT OPERATING CONDITION

Set the EUT transmit at un-modulation mode to test frequency stability.

4.6.7 TEST RESULTS

FREQUENCY STABILITY VERSUS TEMP.									
OPERATING FREQUENCY: 5240MHz									
TEMP. (°C)	POWER SUPPLY (Vac)	0 MINUTE		2 MINUTE		5 MINUTE		10 MINUTE	
		Measured Frequency (MHz)	Frequency Drift (%)	Measured Frequency (MHz)	Frequency Drift (%)	Measured Frequency (MHz)	Frequency Drift (%)	Measured Frequency (MHz)	Frequency Drift (%)
50	120	5239.9782	-0.00042	5239.9709	-0.00056	5239.9723	-0.00053	5239.9747	-0.00048
40	120	5239.9858	-0.00027	5239.9854	-0.00028	5239.9818	-0.00035	5239.9876	-0.00024
30	120	5240.0086	0.00016	5240.0101	0.00019	5240.0116	0.00022	5240.0049	0.00009
20	120	5240.0147	0.00028	5240.0157	0.00030	5240.0082	0.00016	5240.0129	0.00025
10	120	5240.0247	0.00047	5240.028	0.00053	5240.0236	0.00045	5240.0249	0.00048
0	120	5239.9774	-0.00043	5239.9749	-0.00048	5239.9762	-0.00045	5239.9745	-0.00049
-10	120	5240.0292	0.00056	5240.0284	0.00054	5240.0292	0.00056	5240.0266	0.00051
-20	120	5240.0259	0.00049	5240.0264	0.00050	5240.0188	0.00036	5240.0206	0.00039
-30	120	5239.9751	-0.00048	5239.9766	-0.00045	5239.9853	-0.00028	5239.9795	-0.00039

FREQUENCY STABILITY VERSUS VOLTAGE									
OPERATING FREQUENCY: 5240MHz									
TEMP. (°C)	POWER SUPPLY (Vac)	0 MINUTE		2 MINUTE		5 MINUTE		10 MINUTE	
		Measured Frequency (MHz)	Frequency Drift (%)	Measured Frequency (MHz)	Frequency Drift (%)	Measured Frequency (MHz)	Frequency Drift (%)	Measured Frequency (MHz)	Frequency Drift (%)
20	138	5240.0152	0.00029	5240.0165	0.00031	5240.0085	0.00016	5240.0126	0.00024
	120	5240.0147	0.00028	5240.0157	0.00030	5240.0082	0.00016	5240.0129	0.00025
	102	5240.0143	0.00027	5240.0149	0.00028	5240.0081	0.00015	5240.0127	0.00024

5. PHOTOGRAPHS OF THE TEST CONFIGURATION

Please refer to the attached file (Test Setup Photo).



6. INFORMATION ON THE TESTING LABORATORIES

We, Bureau Veritas Consumer Products Services (H.K.) Ltd., Taoyuan Branch, were founded in 1988 to provide our best service in EMC, Radio, Telecom and Safety consultation. Our laboratories are accredited and approved according to ISO/IEC 17025.

If you have any comments, please feel free to contact us at the following:

Linko EMC/RF Lab:
Tel: 886-2-26052180
Fax: 886-2-26051924

Hsin Chu EMC/RF/Telecom Lab:
Tel: 886-3-5935343
Fax: 886-3-5935342

Hwa Ya EMC/RF/Safety Lab:
Tel: 886-3-3183232
Fax: 886-3-3270892

Email: service.adt@tw.bureauveritas.com
Web Site: www.bureauveritas-adt.com

The address and road map of all our labs can be found in our web site also.

7. APPENDIX A - MODIFICATIONS RECORDERS FOR ENGINEERING CHANGES TO THE EUT BY THE LAB

No modifications were made to the EUT by the lab during the test.

---END---