



A D T

FCC TEST REPORT (15.247)

REPORT NO.: RF120531C10H
MODEL NO.: AN-300-AP-I-N
FCC ID: U2M-AN300APIN
RECEIVED: Aug. 12, 2014
TESTED: Sep. 09 ~ Sep. 10, 2014
ISSUED: Sep. 10, 2014

APPLICANT: Senao Networks, Inc.

ADDRESS: 3F, No. 529, Chung Cheng Rd., Hsintien, New Taipei City, R.O.C

ISSUED BY: Bureau Veritas Consumer Products Services (H.K.) Ltd., Taoyuan Branch

LAB ADDRESS: No. 47-2, 14th Ling, Chia Pau Vil., Lin Kou Dist., New Taipei City, Taiwan, R.O.C.

TEST LOCATION: No. 19, Hwa Ya 2nd Rd, Wen Hwa Tsuen, Kwei Shan Hsiang, Taoyuan Hsien 333, Taiwan, R.O.C.

This report should not be used by the client to claim product certification, approval, or endorsement by TAF or any government agencies.



This report is for your exclusive use. Any copying or replication of this report to or for any other person or entity, or use of our name or trademark, is permitted only with our prior written permission. This report sets forth our findings solely with respect to the test samples identified herein. The results set forth in this report are not indicative or representative of the quality or characteristics of the lot from which a test sample was taken or any similar or identical product unless specifically and expressly noted. Our report includes all of the tests requested by you and the results thereof based upon the information that you provided to us. You have 60 days from date of issuance of this report to notify us of any material error or omission caused by our negligence, provided, however, that such notice shall be in writing and shall specifically address the issue you wish to raise. A failure to raise such issue within the prescribed time shall constitute your unqualified acceptance of the completeness of this report, the tests conducted and the correctness of the report contents. Unless specific mention, the uncertainty of measurement has been explicitly taken into account to declare the compliance or non-compliance to the specification.



TABLE OF CONTENTS

RELEASE CONTROL RECORD.....	5
1. CERTIFICATION.....	6
2. SUMMARY OF TEST RESULTS.....	7
2.1 MEASUREMENT UNCERTAINTY.....	7
3. GENERAL INFORMATION.....	8
3.1 GENERAL DESCRIPTION OF EUT.....	8
3.2 DESCRIPTION OF TEST MODES.....	10
3.2.1 TEST MODE APPLICABILITY AND TESTED CHANNEL DETAIL.....	11
3.3 DUTY CYCLE OF TEST SIGNAL.....	16
3.4 DESCRIPTION OF SUPPORT UNITS.....	18
3.4.1 CONFIGURATION OF SYSTEM UNDER TEST.....	19
3.5 GENERAL DESCRIPTION OF APPLIED STANDARDS.....	20
4. TEST TYPES AND RESULTS (FOR 2.4GHz BAND).....	21
4.1 RADIATED EMISSION AND BANDEDGE MEASUREMENT.....	21
4.1.1 LIMITS OF RADIATED EMISSION AND BANDEDGE MEASUREMENT.....	21
4.1.2 TEST INSTRUMENTS.....	22
4.1.3 TEST PROCEDURES.....	23
4.1.4 DEVIATION FROM TEST STANDARD.....	24
4.1.5 TEST SETUP.....	24
4.1.6 EUT OPERATING CONDITIONS.....	25
4.1.7 TEST RESULTS.....	26
4.2 CONDUCTED EMISSION MEASUREMENT.....	40
4.2.1 LIMITS OF CONDUCTED EMISSION MEASUREMENT.....	40
4.2.2 TEST INSTRUMENTS.....	40
4.2.3 TEST PROCEDURES.....	41
4.2.4 DEVIATION FROM TEST STANDARD.....	41
4.2.5 TEST SETUP.....	41
4.2.6 EUT OPERATING CONDITIONS.....	41
4.2.7 TEST RESULTS.....	42
4.3 6dB BANDWIDTH MEASUREMENT.....	46
4.3.1 LIMITS OF 6dB BANDWIDTH MEASUREMENT.....	46
4.3.2 TEST SETUP.....	46
4.3.3 TEST INSTRUMENTS.....	46
4.3.4 TEST PROCEDURE.....	46
4.3.5 DEVIATION FROM TEST STANDARD.....	46
4.3.6 EUT OPERATING CONDITIONS.....	46
4.3.7 TEST RESULTS.....	47
4.4 CONDUCTED OUTPUT POWER.....	49
4.4.1 LIMITS OF CONDUCTED OUTPUT POWER MEASUREMENT.....	49



A D T

4.4.2	TEST SETUP	49
4.4.3	TEST INSTRUMENTS	49
4.4.4	TEST PROCEDURES	49
4.4.5	DEVIATION FROM TEST STANDARD	49
4.4.6	EUT OPERATING CONDITIONS	49
4.4.7	TEST RESULTS	50
4.5	POWER SPECTRAL DENSITY MEASUREMENT	51
4.5.1	LIMITS OF POWER SPECTRAL DENSITY MEASUREMENT	51
4.5.2	TEST SETUP	51
4.5.3	TEST INSTRUMENTS	51
4.5.4	TEST PROCEDURE	51
4.5.5	DEVIATION FROM TEST STANDARD	51
4.5.6	EUT OPERATING CONDITION	51
4.5.7	TEST RESULTS	52
4.6	CONDUCTED OUT OF BAND EMISSION MEASUREMENT	54
4.6.1	LIMITS OF CONDUCTED OUT OF BAND EMISSION MEASUREMENT	54
4.6.2	TEST SETUP	54
4.6.3	TEST INSTRUMENTS	54
4.6.4	TEST PROCEDURE	54
4.6.5	DEVIATION FROM TEST STANDARD	55
4.6.6	EUT OPERATING CONDITION	55
4.6.7	TEST RESULTS	55
5.	TEST TYPES AND RESULTS (FOR 5.0GHz BAND)	64
5.1	RADIATED EMISSION MEASUREMENT	64
5.1.1	LIMITS OF RADIATED EMISSION MEASUREMENT	64
5.1.2	TEST INSTRUMENTS	65
5.1.3	TEST PROCEDURES	65
5.1.4	DEVIATION FROM TEST STANDARD	65
5.1.5	TEST SETUP	65
5.1.6	EUT OPERATING CONDITIONS	65
5.1.7	TEST RESULTS	66
5.2	CONDUCTED EMISSION MEASUREMENT	76
5.2.1	LIMITS OF CONDUCTED EMISSION MEASUREMENT	76
5.2.2	TEST INSTRUMENTS	76
5.2.3	TEST PROCEDURES	76
5.2.4	DEVIATION FROM TEST STANDARD	76
5.2.5	TEST SETUP	76
5.2.6	EUT OPERATING CONDITIONS	76
5.2.7	TEST RESULTS	77
5.3	6dB BANDWIDTH MEASUREMENT	81
5.3.1	LIMITS OF 6dB BANDWIDTH MEASUREMENT	81



A D T

5.3.2	TEST SETUP	81
5.3.3	TEST INSTRUMENTS	81
5.3.4	TEST PROCEDURE	81
5.3.5	DEVIATION FROM TEST STANDARD	81
5.3.6	EUT OPERATING CONDITIONS	81
5.3.7	TEST RESULTS	82
5.4	CONDUCTED OUTPUT POWER	84
5.4.1	LIMITS OF CONDUCTED OUTPUT POWER MEASUREMENT	84
5.4.2	TEST SETUP	84
5.4.3	INSTRUMENTS	84
5.4.4	TEST PROCEDURES	84
5.4.5	DEVIATION FROM TEST STANDARD	84
5.4.6	EUT OPERATING CONDITIONS	84
5.4.7	TEST RESULTS	85
5.5	POWER SPECTRAL DENSITY MEASUREMENT	86
5.5.1	LIMITS OF POWER SPECTRAL DENSITY MEASUREMENT	86
5.5.2	TEST SETUP	86
5.5.3	TEST INSTRUMENTS	86
5.5.4	TEST PROCEDURE	86
5.5.5	DEVIATION FROM TEST STANDARD	86
5.5.6	EUT OPERATING CONDITION	86
5.5.7	TEST RESULTS	87
5.6	CONDUCTED OUT OF BAND EMISSION MEASUREMENT	89
5.6.1	LIMITS OF CONDUCTED OUT OF BAND EMISSION MEASUREMENT	89
5.6.2	TEST SETUP	89
5.6.3	TEST INSTRUMENTS	89
5.6.4	TEST PROCEDURE	89
5.6.5	DEVIATION FROM TEST STANDARD	89
5.6.6	EUT OPERATING CONDITION	89
5.6.7	TEST RESULTS	89
6.	PHOTOGRAPHS OF THE TEST CONFIGURATION	96
7.	INFORMATION ON THE TESTING LABORATORIES	97
8.	APPENDIX A - MODIFICATIONS RECORDERS FOR ENGINEERING CHANGES TO THE EUT BY THE LAB	98



A D T

RELEASE CONTROL RECORD

ISSUE NO.	REASON FOR CHANGE	DATE ISSUED
RF120531C10H	Original release	Sep. 10, 2014



A D T

1. CERTIFICATION

PRODUCT: Araknis Networks 300-series Dual-Band Concurrent
Wireless-N Indoor Access Point

MODEL NO.: AN-300-AP-I-N

BRAND: Araknis Networks

APPLICANT: Senao Networks, Inc.

TESTED: Sep. 09 ~ Sep. 10, 2014

TEST SAMPLE: ENGINEERING SAMPLE

STANDARDS: **FCC Part 15, Subpart C (Section 15.247)**

ANSI C63.10-2009

The above equipment (model: AN-300-AP-I-N) has been tested by **Bureau Veritas Consumer Products Services (H.K.) Ltd., Taoyuan Branch**, and found compliance with the requirement of the above standards. The test record, data evaluation & Equipment Under Test (EUT) configurations represented herein are true and accurate accounts of the measurements of the sample's EMC characteristics under the conditions specified in this report.

PREPARED BY : Polly Chien , **DATE** : Sep. 10, 2014
Polly Chien / Specialist

APPROVED BY : Ken Liu , **DATE** : Sep. 10, 2014
Ken Liu / Senior Manager



2. SUMMARY OF TEST RESULTS

The EUT has been tested according to the following specifications:

APPLIED STANDARD: FCC PART 15, SUBPART C (SECTION 15.247)			
STANDARD SECTION	TEST TYPE	RESULT	REMARK
15.207	AC Power Conducted Emission	PASS	Meet the requirement of limit. Minimum passing margin is -11.20dB at 3.00781MHz.
15.247(d) 15.209	Radiated Emissions	PASS	Meet the requirement of limit. Minimum passing margin is -1.0dB at 2483.50MHz & 5725.00MHz.
15.247(d)	Band Edge Measurement	PASS	Meet the requirement of limit. Minimum passing margin is -1.0dB at 2483.50MHz & 5725.00MHz.
15.247(a)(2)	6dB bandwidth	PASS	Meet the requirement of limit.
15.247(b)	Conducted power	PASS	Meet the requirement of limit.
15.247(e)	Power Spectral Density	PASS	Meet the requirement of limit.
15.203	Antenna Requirement	PASS	Antenna connector is IPEX not a standard connector.

2.1 MEASUREMENT UNCERTAINTY

Where relevant, the following measurement uncertainty levels have been estimated for tests performed on the EUT as specified in CISPR 16-4-2:

MEASUREMENT	FREQUENCY	UNCERTAINTY
Conducted emissions	9kHz~30MHz	2.44 dB
Radiated emissions	30MHz ~ 200MHz	3.34 dB
	200MHz ~1000MHz	3.35 dB
	1GHz ~ 18GHz	2.26 dB
	18GHz ~ 40GHz	1.94 dB

This uncertainty represents an expanded uncertainty expressed at approximately the 95% confidence level using a coverage factor of $k = 2$.



3. GENERAL INFORMATION

3.1 GENERAL DESCRIPTION OF EUT

EUT	Araknis Networks 300-series Dual-Band Concurrent Wireless-N Indoor Access Point
MODEL NO.	AN-300-AP-I-N
POWER SUPPLY	12Vdc (Adapter) 48Vdc (PoE)
MODULATION TYPE	CCK, DQPSK, DBPSK for DSSS 64QAM, 16QAM, QPSK, BPSK for OFDM
MODULATION TECHNOLOGY	DSSS, OFDM
TRANSFER RATE	802.11b: 11.0/ 5.5/ 2.0/ 1.0Mbps 802.11g: 54.0/ 48.0/ 36.0/ 24.0/ 18.0/ 12.0/ 9.0/ 6.0Mbps 802.11a: 54.0/ 48.0/ 36.0/ 24.0/ 18.0/ 12.0/ 9.0/ 6.0Mbps 802.11n: up to 300.0Mbps
OPERATING FREQUENCY	2.4GHz: 2412 ~ 2462MHz 5.0GHz: 5745 ~ 5825MHz
NUMBER OF CHANNEL	2.4GHz: 11 for 802.11b, 802.11g, 802.11n (20MHz) 7 for 802.11n (40MHz) 5.0GHz: 5 for 802.11a, 802.11n (20MHz) 2 for 802.11n (40MHz)
OUTPUT POWER	980.30mW for 2412 ~ 2462MHz 737.35mW for 5745 ~ 5825MHz
ANTENNA TYPE	PIFA antenna with 2dBi gain
ANTENNA CONNECTOR	IPEX
DATA CABLE	NA
I/O PORTS	Refer to user's manual
ACCESSORY DEVICES	Adapter

NOTE:

1. The EUT incorporates a MIMO function. Physically, the EUT provides two completed transmitters and two receivers.

MODULATION MODE	TX FUNCTION
802.11b	2TX
802.11g	2TX
802.11a	2TX
802.11n (20MHz)	2TX
802.11n (40MHz)	2TX



A D T

2. The EUT uses following adapter and POE.

ADAPTER	
BRAND:	Powertron Electronics Corp.
MODEL:	PA1024-2HUB PA1024-2HU PA1024-120HUB200
INPUT:	100-240Vac, 50-60Hz, 0.6A
OUTPUT:	12Vdc, 2.0A, 24.0W Max
POWER LINE:	1.5m cable with one core attached on adapter

POE	
MODEL:	PD-6083G300
INPUT:	100-250Vac, 50/60Hz, 0.5A
OUTPUT:	48Vdc, 0.35A

*POE as above is provided as support unit only.

3. The above EUT information is declared by manufacturer and for more detailed features description, please refer to the manufacturer's specifications or user's manual.



3.2 DESCRIPTION OF TEST MODES

FOR 2.4GHz:

11 channels are provided for 802.11b, 802.11g and 802.11n (20MHz):

CHANNEL	FREQUENCY	CHANNEL	FREQUENCY
1	2412MHz	7	2442MHz
2	2417MHz	8	2447MHz
3	2422MHz	9	2452MHz
4	2427MHz	10	2457MHz
5	2432MHz	11	2462MHz
6	2437MHz		

7 channels are provided for 802.11n (40MHz):

CHANNEL	FREQUENCY	CHANNEL	FREQUENCY
3	2422MHz	7	2442MHz
4	2427MHz	8	2447MHz
5	2432MHz	9	2452MHz
6	2437MHz		

FOR 5.0GHz (5745 ~ 5825MHz):

5 channels are provided for 802.11a, 802.11n (20MHz):

CHANNEL	FREQUENCY	CHANNEL	FREQUENCY
149	5745MHz	161	5805MHz
153	5765MHz	165	5825MHz
157	5785MHz		

2 channels are provided for 802.11n (40MHz):

CHANNEL	FREQUENCY	CHANNEL	FREQUENCY
151	5755MHz	159	5795MHz

3.2.1 TEST MODE APPLICABILITY AND TESTED CHANNEL DETAIL

FOR 2.4GHz:

EUT CONFIGURE MODE	APPLICABLE TO				DESCRIPTION
	RE \geq 1G	RE<1G	PLC	APCM	
A	√	√	√	√	Power from adapter
B	-	√	√	-	Power from PoE

Where **RE \geq 1G**: Radiated Emission above 1GHz **RE<1G**: Radiated Emission below 1GHz
PLC: Power Line Conducted Emission **APCM**: Antenna Port Conducted Measurement

NOTE 1:

The EUT had been pre-tested on the positioned of each 3 axis. The worst case was found when positioned on **X-plane**.

NOTE 2: “-” means no effect.

RADIATED EMISSION TEST (ABOVE 1GHz):

- Pre-Scan has been conducted to determine the worst-case mode from all possible combinations between available modulations, data rates and antenna ports (if EUT with antenna diversity architecture).
- Following channel(s) was (were) selected for the final test as listed below.

EUT CONFIGURE MODE	MODE	AVAILABLE CHANNEL	TESTED CHANNEL	MODULATION TECHNOLOGY	MODULATION TYPE	DATA RATE (Mbps)
A	802.11b	1 to 11	1, 6, 11	DSSS	DBPSK	1.0
A	802.11g	1 to 11	1, 6, 11	OFDM	BPSK	6.0
A	802.11n (20MHz)	1 to 11	1, 6, 11	OFDM	BPSK	7.2
A	802.11n (40MHz)	3 to 9	3, 6, 9	OFDM	BPSK	15.0

RADIATED EMISSION TEST (BELOW 1GHz):

- Pre-Scan has been conducted to determine the worst-case mode from all possible combinations between available modulations, data rates and antenna ports (if EUT with antenna diversity architecture).
- Following channel(s) was (were) selected for the final test as listed below.

EUT CONFIGURE MODE	MODE	AVAILABLE CHANNEL	TESTED CHANNEL	MODULATION TECHNOLOGY	MODULATION TYPE	DATA RATE (Mbps)
A, B	802.11g	1 to 11	6	OFDM	BPSK	6.0



A D T

POWER LINE CONDUCTED EMISSION TEST:

- Pre-Scan has been conducted to determine the worst-case mode from all possible combinations between available modulations, data rates and antenna ports (if EUT with antenna diversity architecture).
- Following channel(s) was (were) selected for the final test as listed below.

EUT CONFIGURE MODE	MODE	AVAILABLE CHANNEL	TESTED CHANNEL	MODULATION TECHNOLOGY	MODULATION TYPE	DATA RATE (Mbps)
A, B	802.11g	1 to 11	6	OFDM	BPSK	6.0

BANDEDGE MEASUREMENT:

- Pre-Scan has been conducted to determine the worst-case mode from all possible combinations between available modulations, data rates and antenna ports (if EUT with antenna diversity architecture).
- Following channel(s) was (were) selected for the final test as listed below.

EUT CONFIGURE MODE	MODE	AVAILABLE CHANNEL	TESTED CHANNEL	MODULATION TECHNOLOGY	MODULATION TYPE	DATA RATE (Mbps)
A	802.11b	1 to 11	1, 11	DSSS	DBPSK	1.0
A	802.11g	1 to 11	1, 11	OFDM	BPSK	6.0
A	802.11n (20MHz)	1 to 11	1, 11	OFDM	BPSK	7.2
A	802.11n (40MHz)	3 to 9	3, 9	OFDM	BPSK	15.0

ANTENNA PORT CONDUCTED MEASUREMENT:

- This item includes all test value of each mode, but only includes spectrum plot of worst value of each mode.
- Pre-Scan has been conducted to determine the worst-case mode from all possible combinations between available modulations, data rates and antenna ports (if EUT with antenna diversity architecture).
- Following channel(s) was (were) selected for the final test as listed below.

EUT CONFIGURE MODE	MODE	AVAILABLE CHANNEL	TESTED CHANNEL	MODULATION TECHNOLOGY	MODULATION TYPE	DATA RATE (Mbps)
A	802.11b	1 to 11	1, 6, 11	DSSS	DBPSK	1.0
A	802.11g	1 to 11	1, 6, 11	OFDM	BPSK	6.0
A	802.11n (20MHz)	1 to 11	1, 6, 11	OFDM	BPSK	7.2
A	802.11n (40MHz)	3 to 9	3, 6, 9	OFDM	BPSK	15.0



A D T

TEST CONDITION:

APPLICABLE TO	ENVIRONMENTAL CONDITIONS	INPUT POWER	TESTED BY
RE \geq 1G	25deg. C, 65%RH	120Vac, 60Hz	Chris Lin
RE<1G	25deg. C, 68%RH	120Vac, 60Hz, 48Vdc	Chris Lin
PLC	24deg. C, 64%RH	120Vac, 60Hz, 48Vdc	Match Tsui
APCM	24deg. C, 64%RH	120Vac, 60Hz	Match Tsui



FOR 5.0GHz (5745 ~ 5825MHz):

EUT CONFIGURE MODE	APPLICABLE TO				DESCRIPTION
	RE≥1G	RE<1G	PLC	APCM	
A	√	√	√	√	Power from adapter
B	-	√	√	-	Power from PoE

Where **RE≥1G**: Radiated Emission above 1GHz **RE<1G**: Radiated Emission below 1GHz
PLC: Power Line Conducted Emission **APCM**: Antenna Port Conducted Measurement

NOTE 1:
The EUT had been pre-tested on the positioned of each 3 axis. The worst case was found when positioned on **X-plane**.
NOTE 2: “-” means no effect.

RADIATED EMISSION TEST (ABOVE 1GHz):

- Pre-Scan has been conducted to determine the worst-case mode from all possible combinations between available modulations, data rates and antenna ports (if EUT with antenna diversity architecture).
- Following channel(s) was (were) selected for the final test as listed below.

EUT CONFIGURE MODE	MODE	AVAILABLE CHANNEL	TESTED CHANNEL	MODULATION TECHNOLOGY	MODULATION TYPE	DATA RATE (Mbps)
A	802.11a	149 to 165	149, 157, 165	OFDM	BPSK	6.0
A	802.11n (20MHz)	149 to 165	149, 157, 165	OFDM	BPSK	7.2
A	802.11n (40MHz)	151 to 159	151, 159	OFDM	BPSK	15.0

RADIATED EMISSION TEST (BELOW 1GHz):

- Pre-Scan has been conducted to determine the worst-case mode from all possible combinations between available modulations, data rates and antenna ports (if EUT with antenna diversity architecture).
- Following channel(s) was (were) selected for the final test as listed below.

EUT CONFIGURE MODE	MODE	AVAILABLE CHANNEL	TESTED CHANNEL	MODULATION TECHNOLOGY	MODULATION TYPE	DATA RATE (Mbps)
A, B	802.11n (20MHz)	149 to 165	165	OFDM	BPSK	7.2

POWER LINE CONDUCTED EMISSION TEST:

- Pre-Scan has been conducted to determine the worst-case mode from all possible combinations between available modulations, data rates and antenna ports (if EUT with antenna diversity architecture).
- Following channel(s) was (were) selected for the final test as listed below.

EUT CONFIGURE MODE	MODE	AVAILABLE CHANNEL	TESTED CHANNEL	MODULATION TECHNOLOGY	MODULATION TYPE	DATA RATE (Mbps)
A, B	802.11n (20MHz)	149 to 165	165	OFDM	BPSK	7.2



BANDEDGE MEASUREMENT:

- Pre-Scan has been conducted to determine the worst-case mode from all possible combinations between available modulations, data rates and antenna ports (if EUT with antenna diversity architecture).
- Following channel(s) was (were) selected for the final test as listed below.

EUT CONFIGURE MODE	MODE	AVAILABLE CHANNEL	TESTED CHANNEL	MODULATION TECHNOLOGY	MODULATION TYPE	DATA RATE (Mbps)
A	802.11a	149 to 165	149, 165	OFDM	BPSK	6.0
A	802.11n (20MHz)	149 to 165	149, 165	OFDM	BPSK	7.2
A	802.11n (40MHz)	151 to 159	151, 159	OFDM	BPSK	15.0

ANTENNA PORT CONDUCTED MEASUREMENT:

- This item includes all test value of each mode, but only includes spectrum plot of worst value of each mode.
- Pre-Scan has been conducted to determine the worst-case mode from all possible combinations between available modulations, data rates and antenna ports (if EUT with antenna diversity architecture).
- Following channel(s) was (were) selected for the final test as listed below.

EUT CONFIGURE MODE	MODE	AVAILABLE CHANNEL	TESTED CHANNEL	MODULATION TECHNOLOGY	MODULATION TYPE	DATA RATE (Mbps)
A	802.11a	149 to 165	149, 157, 165	OFDM	BPSK	6.0
A	802.11n (20MHz)	149 to 165	149, 157, 165	OFDM	BPSK	7.2
A	802.11n (40MHz)	151 to 159	151, 159	OFDM	BPSK	15.0

TEST CONDITION:

APPLICABLE TO	ENVIRONMENTAL CONDITIONS	INPUT POWER	TESTED BY
RE≥1G	25deg. C, 65%RH	120Vac, 60Hz	Chris Lin
RE<1G	25deg. C, 68%RH	120Vac, 60Hz, 48Vdc	Chris Lin
PLC	24deg. C, 64%RH	120Vac, 60Hz, 48Vdc	Match Tsui
APCM	24deg. C, 64%RH	120Vac, 60Hz	Match Tsui

3.3 DUTY CYCLE OF TEST SIGNAL

2.4GHz Band:

802.11b: Duty cycle of test signal is = 100 %

802.11g, 802.11n (20MHz), 802.11n (40MHz): Duty cycle of test signal is < 98%

802.11g: Duty cycle = $2.02/2.095 = 0.964$, Duty factor = $10 * \log(1/0.964) = 0.16$

802.11n (20MHz): Duty cycle = $1.865/1.935 = 0.964$, Duty factor = $10 * \log(1/0.964) = 0.16$

802.11n (40MHz): Duty cycle = $480.0/530.0 = 0.906$, Duty factor = $10 * \log(1/0.906) = 0.43$

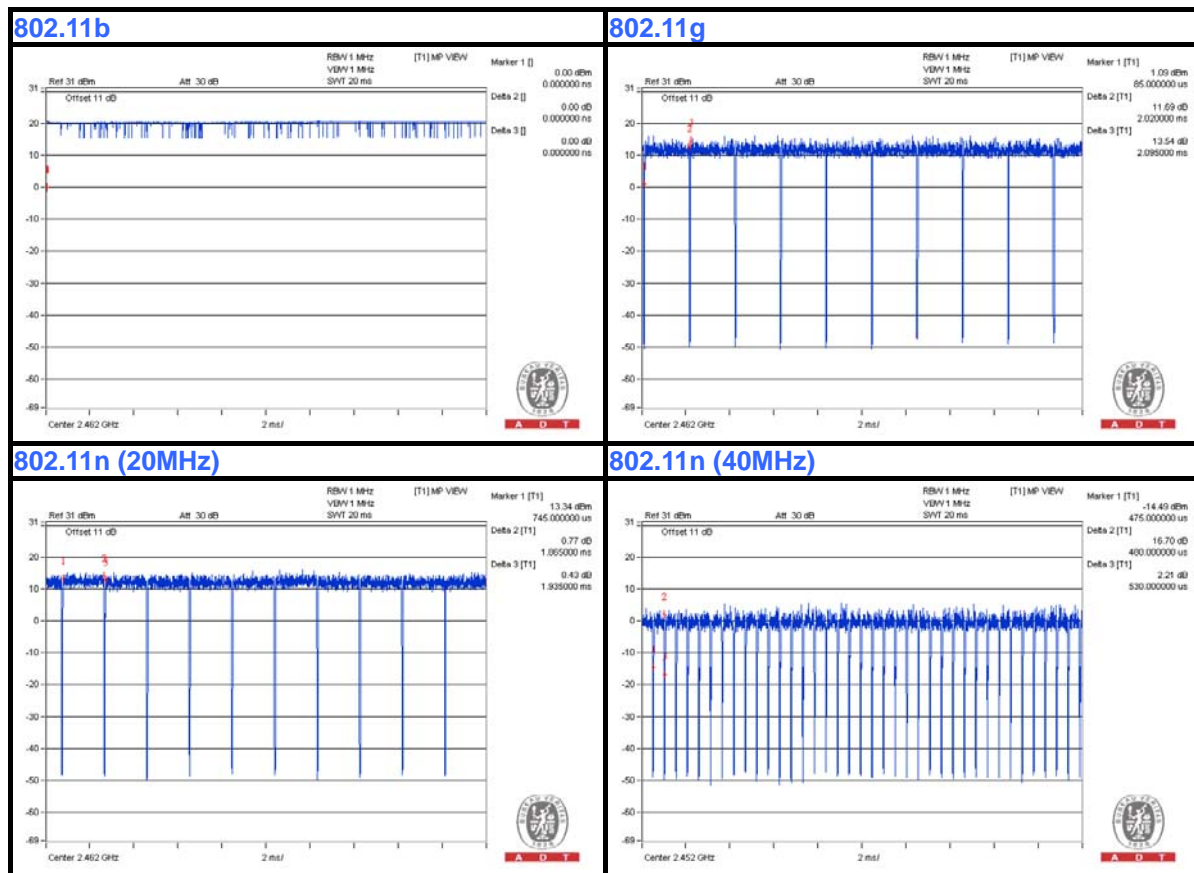



A D T

5.0GHz Band:

Duty cycle of test signal is < 98%

802.11a: Duty cycle = $2.005/2.075 = 0.966$, Duty factor = $10 * \log(1/0.966) = 0.15$

802.11n (20MHz): Duty cycle = $1.995/2.065 = 0.966$, Duty factor = $10 * \log(1/0.966) = 0.15$

802.11n (40MHz): Duty cycle = $460/510 = 0.902$, Duty factor = $10 * \log(1/0.902) = 0.43$

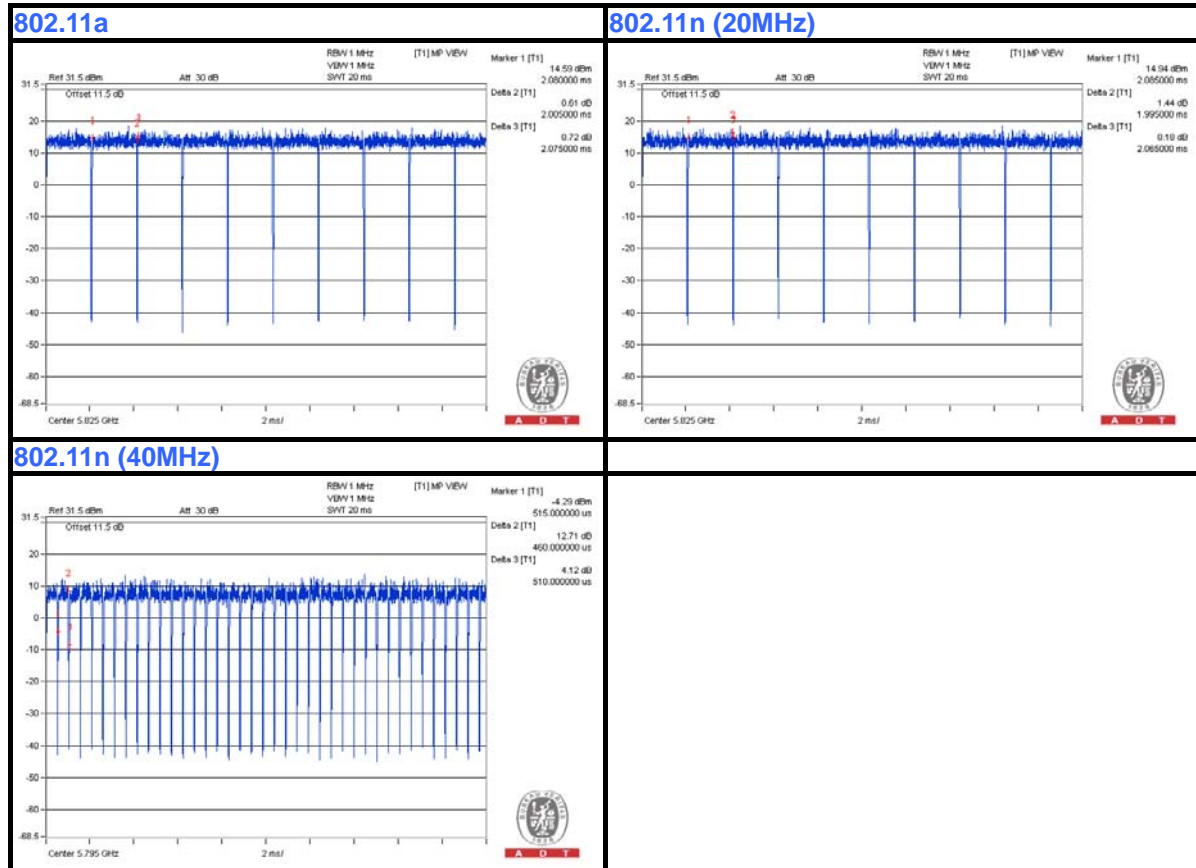



A D T

3.4 DESCRIPTION OF SUPPORT UNITS

The EUT has been tested as an independent unit together with other necessary accessories or support units. The following support units or accessories were used to form a representative test configuration during the tests.

NO.	PRODUCT	BRAND	MODEL NO.	SERIAL NO.	FCC ID
1	Notebook	DELL	E5410	1HC2XM1	FCC DoC Approved

NO.	SIGNAL CABLE DESCRIPTION OF THE ABOVE SUPPORT UNITS
1	10m RJ45 UTP cable

NOTE:

1. All power cords of the above support units are non shielded (1.8m).
2. Item 1 acted as communication partner to transfer data.

3.4.1 CONFIGURATION OF SYSTEM UNDER TEST

Test Mode A

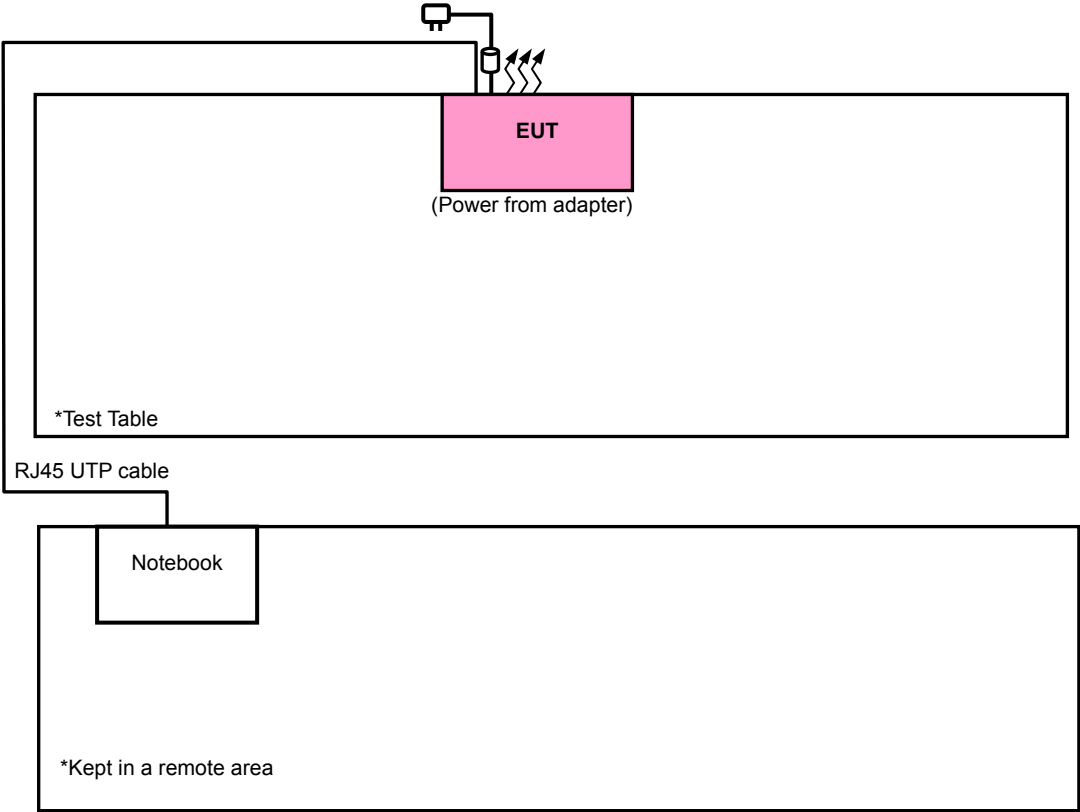

Test Mode B

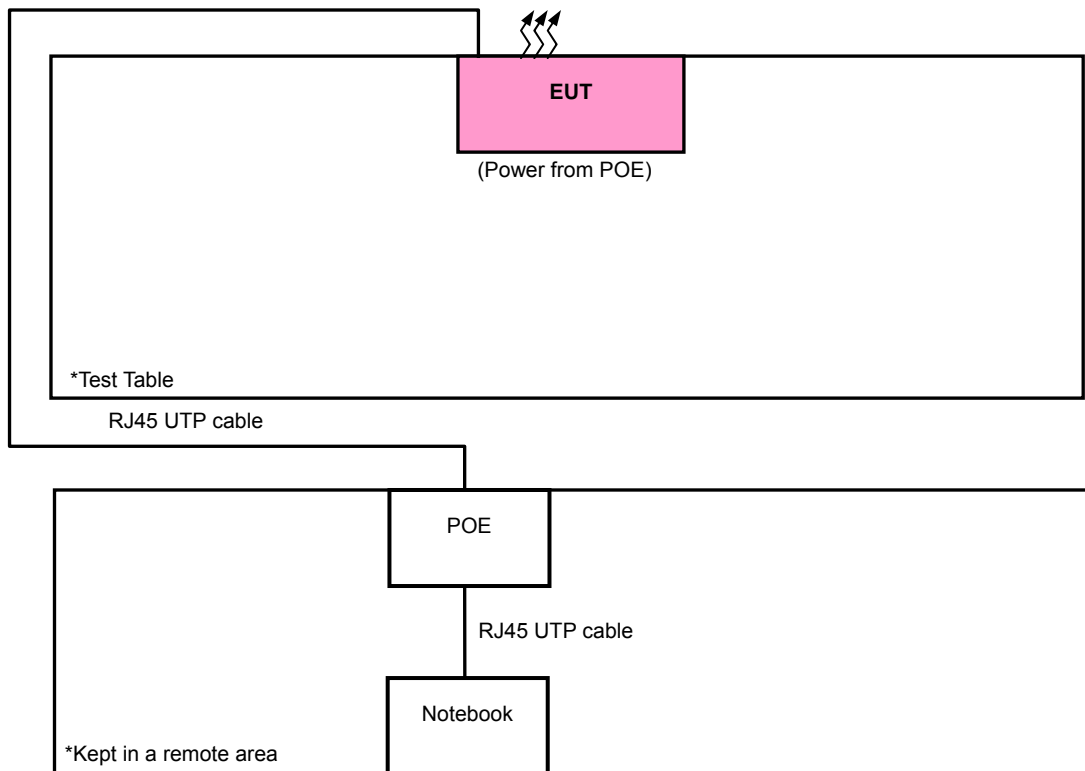

3.5 GENERAL DESCRIPTION OF APPLIED STANDARDS

The EUT is a RF Product. According to the specifications of the manufacturer, it must comply with the requirements of the following standards:

FCC Part 15, Subpart C (15.247)

558074 D01 DTS Meas Guidance v03r02

662911 D01 Multiple Transmitter Output v02r01

ANSI C63.10-2009

All test items have been performed and recorded as per the above standards.

NOTE: The EUT is also considered as a kind of computer peripheral, because the connection to computer is necessary for typical use. It has been verified to comply with the requirements of FCC Part 15, Subpart B, Class B (DoC). The test report has been issued separately.



4. TEST TYPES AND RESULTS (FOR 2.4GHZ BAND)

4.1 RADIATED EMISSION AND BANDEDGE MEASUREMENT

4.1.1 LIMITS OF RADIATED EMISSION AND BANDEDGE MEASUREMENT

Radiated emissions which fall in the restricted bands must comply with the radiated emission limits specified as below table. Other emissions shall be at least 30dB below the highest level of the desired power:

FREQUENCIES (MHz)	FIELD STRENGTH (microvolts/meter)	MEASUREMENT DISTANCE (meters)
0.009 ~ 0.490	2400/F(kHz)	300
0.490 ~ 1.705	24000/F(kHz)	30
1.705 ~ 30.0	30	30
30 ~ 88	100	3
88 ~ 216	150	3
216 ~ 960	200	3
Above 960	500	3

NOTE:

1. The lower limit shall apply at the transition frequencies.
2. Emission level (dBuV/m) = 20 log Emission level (uV/m).
3. For frequencies above 1000MHz, the field strength limits are based on average detector, however, the peak field strength of any emission shall not exceed the maximum permitted average limits, specified above by more than 30dB under any condition of modulation.



A D T

4.1.2 TEST INSTRUMENTS

DESCRIPTION & MANUFACTURER	MODEL NO.	SERIAL NO.	DATE OF CALIBRATION	DUE DATE OF CALIBRATION
Test Receiver ROHDE & SCHWARZ	ESIB7	100187	Jan. 02, 2014	Jan. 01, 2015
Spectrum Analyzer ROHDE & SCHWARZ	FSP40	100039	Mar. 03, 2014	Mar. 02, 2015
BILOG Antenna SCHWARZBECK	VULB9168	9168-160	Feb. 26, 2014	Feb. 25, 2015
HORN Antenna SCHWARZBECK	9120D	209	Sep. 12, 2013	Sep. 11, 2014
HORN Antenna SCHWARZBECK	BBHA 9170	BBHA9170241	Feb. 17, 2014	Feb. 16, 2015
Loop Antenna	HFH2-Z2	100070	Mar. 06, 2014	Mar. 05, 2016
Preamplifier Agilent	8447D	2944A10633	Oct. 07, 2013	Oct. 06, 2014
Preamplifier Agilent	8449B	3008A01964	Aug. 22, 2014	Aug. 21, 2015
RF signal cable HUBER+SUHNNER	SUCOFLEX 104	214378/4	Aug. 25, 2014	Aug. 24, 2015
RF signal cable HUBER+SUHNNER	SUCOFLEX 106	12738/6 +309224/4	Aug. 25, 2014	Aug. 24, 2015
Software BV ADT	ADT_Radiated_ V7.6.15.9.4	NA	NA	NA
Antenna Tower inn-co GmbH	MA 4000	013303	NA	NA
Antenna Tower Controller inn-co GmbH	CO2000	017303	NA	NA
Turn Table BV ADT	TT100	TT93021703	NA	NA
Turn Table Controller BV ADT	SC100	SC93021703	NA	NA
26GHz ~ 40GHz Amplifier	EM26400	815221	Oct. 18, 2013	Oct. 17, 2014
High Speed Peak Power Meter	ML2495A	0824011	Jul. 26, 2014	Jul. 25, 2015
Power Sensor	MA2411B	0738171	Jul. 26, 2014	Jul. 25, 2015

- NOTE:**
1. The calibration interval of the above test instruments is 12 months and the calibrations are traceable to NML/ROC and NIST/USA.
 2. The calibration interval of the loop antenna is 24 months and the calibrations are traceable to NML/ROC and NIST/USA.
 3. The test was performed in HwaYa Chamber 3.
 4. The horn antenna and HP preamplifier (model: 8449B) are used only for the measurement of emission frequency above 1GHz if tested.
 5. The FCC Site Registration No. is 988962.
 6. The IC Site Registration No. is IC 7450F-3.



A D T

4.1.3 TEST PROCEDURES

- a. The EUT was placed on the top of a rotating table 0.8 meters above the ground at a 3 meters semi-anechoic chamber. The table was rotated 360 degrees to determine the position of the highest radiation.
- b. The EUT was set 3 meters away from the interference-receiving antenna, which was mounted on the top of a variable-height antenna tower.
- c. The antenna is a broadband antenna, and its height is varied from one meter to four meters above the ground to determine the maximum value of the field strength. Both horizontal and vertical polarizations of the antenna are set to make the measurement.
- d. For each suspected emission, the EUT was arranged to its worst case and then the antenna was tuned to heights from 1 meter to 4 meters and the rotatable table was turned from 0 degrees to 360 degrees to find the maximum reading.
- e. The test-receiver system was set to Peak Detect Function and Specified Bandwidth with Maximum Hold Mode.
- f. If the emission level of the EUT in peak mode was lower than the limit specified, then testing could be stopped and the peak values of the EUT would be reported. Otherwise the emissions would be re-tested one by one using peak, quasi-peak or average method as specified and then reported in a data sheet.

NOTE:

1. The resolution bandwidth and video bandwidth of test receiver/spectrum analyzer is 120kHz for Quasi-peak detection at frequency below 1GHz.
2. The resolution bandwidth of test receiver/spectrum analyzer is 100kHz and video bandwidth is 300kHz for Peak detection at frequency above 1GHz.
3. The resolution bandwidth of test receiver/spectrum analyzer is 1MHz and the video bandwidth is $\geq 1/T$ (Duty cycle < 98%) or 10Hz (Duty cycle > 98%) for Average detection (AV) at frequency above 1GHz.
4. All modes of operation were investigated and the worst-case emissions are reported.

4.1.4 DEVIATION FROM TEST STANDARD

No deviation.

4.1.5 TEST SETUP

Frequency range 30MHz~1GHz

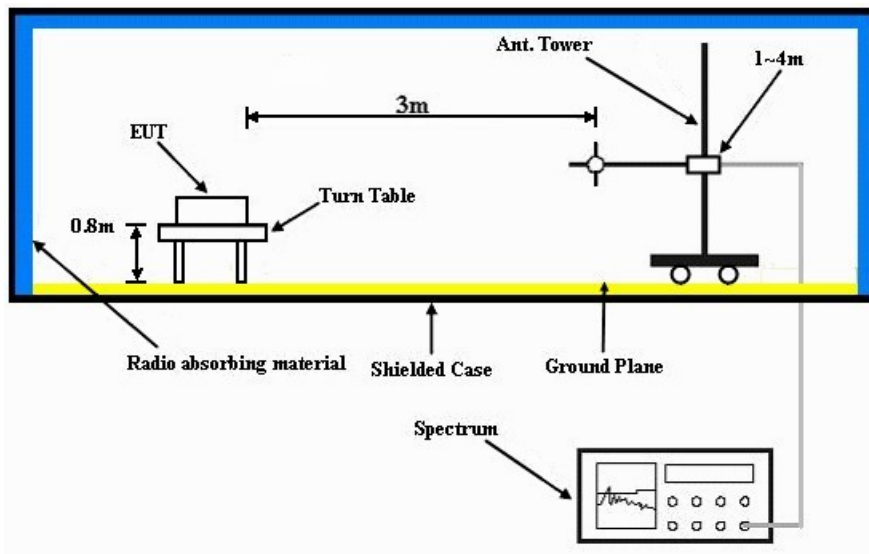

Frequency range above 1GHz

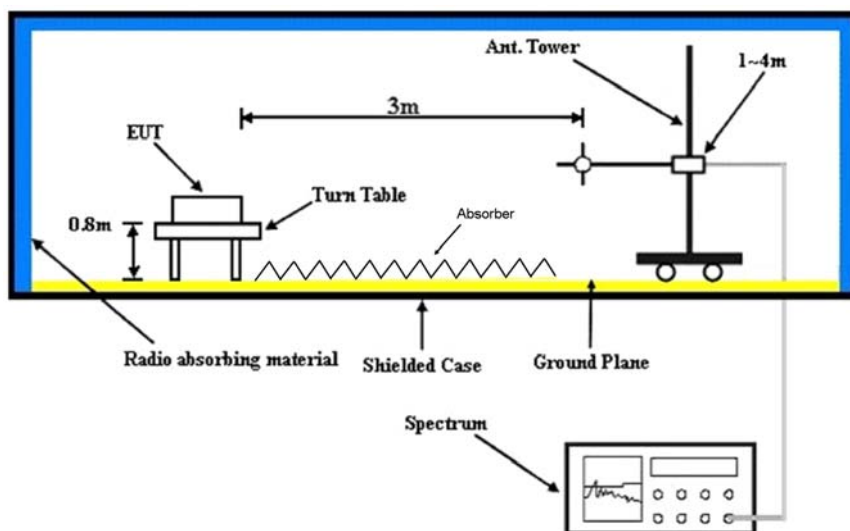

For the actual test configuration, please refer to the attached file (Test Setup Photo).



A D T

4.1.6 EUT OPERATING CONDITIONS

- a. Placed the EUT on the testing table.
- b. Prepared notebook to act as communication partner and placed it outside of testing area.
- c. The communication partner connected with EUT via a RJ45 cable and run a test program (provided by manufacturer) to enable EUT under transmission condition continuously at specific channel frequency.
- d. The communication partner sent data to EUT by command "PING".



A D T

4.1.7 TEST RESULTS

ABOVE 1GHz DATA :

802.11b

EUT TEST CONDITION		MEASUREMENT DETAIL	
CHANNEL	Channel 1	FREQUENCY RANGE	1 ~ 25GHz
INPUT POWER	120Vac, 60 Hz	DETECTOR FUNCTION	Peak (PK) Average (AV)
ENVIRONMENTAL CONDITIONS	25deg. C, 65%RH	TESTED BY	Chris Lin

ANTENNA POLARITY & TEST DISTANCE: HORIZONTAL AT 3 M								
NO.	FREQ. (MHz)	EMISSION LEVEL (dBuV/m)	LIMIT (dBuV/m)	MARGIN (dB)	ANTENNA HEIGHT (m)	TABLE ANGLE (Degree)	RAW VALUE (dBuV)	CORRECTION FACTOR (dB/m)
1	2288.00	60.9 PK	74.0	-13.1	2.21 H	2	59.70	1.20
2	2288.00	52.7 AV	54.0	-1.3	2.21 H	2	51.50	1.20
3	2390.00	61.9 PK	74.0	-12.1	1.34 H	234	28.70	33.20
4	2390.00	46.2 AV	54.0	-7.8	1.34 H	234	13.00	33.20
5	*2412.00	112.7 PK			1.07 H	6	79.40	33.30
6	*2412.00	108.7 AV			1.07 H	6	75.40	33.30
7	4824.00	47.1 PK	74.0	-26.9	1.45 H	183	41.00	6.10
8	4824.00	33.9 AV	54.0	-20.1	1.45 H	183	27.80	6.10

ANTENNA POLARITY & TEST DISTANCE: VERTICAL AT 3 M								
NO.	FREQ. (MHz)	EMISSION LEVEL (dBuV/m)	LIMIT (dBuV/m)	MARGIN (dB)	ANTENNA HEIGHT (m)	TABLE ANGLE (Degree)	RAW VALUE (dBuV)	CORRECTION FACTOR (dB/m)
1	2288.00	59.7 PK	74.0	-14.3	1.24 V	80	58.50	1.20
2	2288.00	51.0 AV	54.0	-3.0	1.24 V	80	49.80	1.20
3	2390.00	70.1 PK	74.0	-3.9	1.14 V	81	36.90	33.20
4	2390.00	46.2 AV	54.0	-7.8	1.14 V	81	13.00	33.20
5	*2412.00	109.2 PK			1.14 V	81	75.90	33.30
6	*2412.00	105.1 AV			1.14 V	81	71.80	33.30
7	4824.00	47.5 PK	74.0	-26.5	1.39 V	41	41.40	6.10
8	4824.00	38.0 AV	54.0	-16.0	1.39 V	41	31.90	6.10

REMARKS:

1. Emission Level(dBuV/m) = Raw Value(dBuV) + Correction Factor(dB/m)
2. Correction Factor(dB/m) = Antenna Factor(dB/m) + Cable Factor(dB)
– Pre-Amplifier Factor(dB)
3. The other emission levels were very low against the limit.
4. Margin value = Emission Level – Limit value
5. “ * “: Fundamental frequency.



A D T

EUT TEST CONDITION		MEASUREMENT DETAIL	
CHANNEL	Channel 6	FREQUENCY RANGE	1 ~ 25GHz
INPUT POWER	120Vac, 60 Hz	DETECTOR FUNCTION	Peak (PK) Average (AV)
ENVIRONMENTAL CONDITIONS	22deg. C, 69%RH	TESTED BY	Chris Lin

ANTENNA POLARITY & TEST DISTANCE: HORIZONTAL AT 3 M								
NO.	FREQ. (MHz)	EMISSION LEVEL (dBuV/m)	LIMIT (dBuV/m)	MARGIN (dB)	ANTENNA HEIGHT (m)	TABLE ANGLE (Degree)	RAW VALUE (dBuV)	CORRECTION FACTOR (dB/m)
1	2288.00	59.9 PK	74.0	-14.1	2.16 H	2	58.70	1.20
2	2288.00	51.7 AV	54.0	-2.3	2.16 H	2	50.50	1.20
3	*2437.00	113.2 PK			1.06 H	3	79.80	33.40
4	*2437.00	109.2 AV			1.06 H	3	75.80	33.40
5	4874.00	46.0 PK	74.0	-28.0	1.44 H	193	39.80	6.20
6	4874.00	34.5 AV	54.0	-19.5	1.44 H	193	28.30	6.20
7	7311.00	52.3 PK	74.0	-21.7	1.00 H	142	40.10	12.20
8	7311.00	38.4 AV	54.0	-15.6	1.00 H	142	26.20	12.20

ANTENNA POLARITY & TEST DISTANCE: VERTICAL AT 3 M								
NO.	FREQ. (MHz)	EMISSION LEVEL (dBuV/m)	LIMIT (dBuV/m)	MARGIN (dB)	ANTENNA HEIGHT (m)	TABLE ANGLE (Degree)	RAW VALUE (dBuV)	CORRECTION FACTOR (dB/m)
1	2288.00	59.0 PK	74.0	-15.0	1.23 V	78	57.80	1.20
2	2288.00	50.9 AV	54.0	-3.1	1.23 V	78	49.70	1.20
3	*2437.00	111.1 PK			1.14 V	69	77.70	33.40
4	*2437.00	106.5 AV			1.14 V	69	73.10	33.40
5	4874.00	46.9 PK	74.0	-27.1	1.27 V	65	40.70	6.20
6	4874.00	38.2 AV	54.0	-15.8	1.27 V	65	32.00	6.20
7	7311.00	52.7 PK	74.0	-21.3	1.00 V	217	40.50	12.20
8	7311.00	38.7 AV	54.0	-15.3	1.00 V	217	26.50	12.20

REMARKS:

1. Emission Level(dBuV/m) = Raw Value(dBuV) + Correction Factor(dB/m)
2. Correction Factor(dB/m) = Antenna Factor(dB/m) + Cable Factor(dB) – Pre-Amplifier Factor(dB)
3. The other emission levels were very low against the limit.
4. Margin value = Emission Level – Limit value
5. “ * “: Fundamental frequency.



A D T

EUT TEST CONDITION		MEASUREMENT DETAIL	
CHANNEL	Channel 11	FREQUENCY RANGE	1 ~ 25GHz
INPUT POWER	120Vac, 60 Hz	DETECTOR FUNCTION	Peak (PK) Average (AV)
ENVIRONMENTAL CONDITIONS	25deg. C, 65%RH	TESTED BY	Chris Lin

ANTENNA POLARITY & TEST DISTANCE: HORIZONTAL AT 3 M								
NO.	FREQ. (MHz)	EMISSION LEVEL (dBuV/m)	LIMIT (dBuV/m)	MARGIN (dB)	ANTENNA HEIGHT (m)	TABLE ANGLE (Degree)	RAW VALUE (dBuV)	CORRECTION FACTOR (dB/m)
1	2288.00	60.3 PK	74.0	-13.7	2.16 H	2	59.10	1.20
2	2288.00	52.3 AV	54.0	-1.7	2.16 H	2	51.10	1.20
3	*2462.00	113.1 PK			1.07 H	4	79.80	33.30
4	*2462.00	109.2 AV			1.07 H	4	75.90	33.30
5	2483.50	70.5 PK	74.0	-3.5	1.07 H	8	37.10	33.40
6	2483.50	49.9 AV	54.0	-4.1	1.07 H	8	16.50	33.40
7	4924.00	45.9 PK	74.0	-28.1	1.41 H	191	39.60	6.30
8	4924.00	33.9 AV	54.0	-20.1	1.41 H	191	27.60	6.30

ANTENNA POLARITY & TEST DISTANCE: VERTICAL AT 3 M								
NO.	FREQ. (MHz)	EMISSION LEVEL (dBuV/m)	LIMIT (dBuV/m)	MARGIN (dB)	ANTENNA HEIGHT (m)	TABLE ANGLE (Degree)	RAW VALUE (dBuV)	CORRECTION FACTOR (dB/m)
1	2288.00	58.8 PK	74.0	-15.2	1.24 V	79	57.60	1.20
2	2288.00	51.0 AV	54.0	-3.0	1.24 V	79	49.80	1.20
3	*2462.00	111.1 PK			1.14 V	104	77.80	33.30
4	*2462.00	107.1 AV			1.14 V	104	73.80	33.30
5	2483.50	69.8 PK	74.0	-4.2	1.14 V	104	36.40	33.40
6	2483.50	48.2 AV	54.0	-5.8	1.14 V	104	14.80	33.40
7	4924.00	46.0 PK	74.0	-28.0	1.25 V	64	39.70	6.30
8	4924.00	35.4 AV	54.0	-18.6	1.25 V	64	29.10	6.30

REMARKS:

1. Emission Level(dBuV/m) = Raw Value(dBuV) + Correction Factor(dB/m)
2. Correction Factor(dB/m) = Antenna Factor(dB/m) + Cable Factor(dB)
– Pre-Amplifier Factor(dB)
3. The other emission levels were very low against the limit.
4. Margin value = Emission Level – Limit value
5. “ * “: Fundamental frequency.



A D T

802.11g

EUT TEST CONDITION		MEASUREMENT DETAIL	
CHANNEL	Channel 1	FREQUENCY RANGE	1 ~ 25GHz
INPUT POWER	120Vac, 60 Hz	DETECTOR FUNCTION	Peak (PK) Average (AV)
ENVIRONMENTAL CONDITIONS	25deg. C, 65%RH	TESTED BY	Chris Lin

ANTENNA POLARITY & TEST DISTANCE: HORIZONTAL AT 3 M								
NO.	FREQ. (MHz)	EMISSION LEVEL (dBuV/m)	LIMIT (dBuV/m)	MARGIN (dB)	ANTENNA HEIGHT (m)	TABLE ANGLE (Degree)	RAW VALUE (dBuV)	CORRECTION FACTOR (dB/m)
1	2288.00	61.4 PK	74.0	-12.6	2.17 H	359	60.20	1.20
2	2288.00	51.8 AV	54.0	-2.2	2.17 H	359	50.60	1.20
3	2390.00	71.4 PK	74.0	-2.6	1.10 H	7	38.20	33.20
4	2390.00	51.9 AV	54.0	-2.1	1.10 H	7	18.70	33.20
5	*2412.00	108.7 PK			1.09 H	6	75.40	33.30
6	*2412.00	97.4 AV			1.09 H	6	64.10	33.30
7	4824.00	47.1 PK	74.0	-26.9	1.43 H	233	41.00	6.10
8	4824.00	32.6 AV	54.0	-21.4	1.43 H	233	26.50	6.10

ANTENNA POLARITY & TEST DISTANCE: VERTICAL AT 3 M								
NO.	FREQ. (MHz)	EMISSION LEVEL (dBuV/m)	LIMIT (dBuV/m)	MARGIN (dB)	ANTENNA HEIGHT (m)	TABLE ANGLE (Degree)	RAW VALUE (dBuV)	CORRECTION FACTOR (dB/m)
1	2288.00	58.7 PK	74.0	-15.3	1.25 V	81	57.50	1.20
2	2288.00	49.9 AV	54.0	-4.1	1.25 V	81	48.70	1.20
3	2390.00	68.4 PK	74.0	-5.6	1.19 V	81	35.20	33.20
4	2390.00	50.4 AV	54.0	-3.6	1.19 V	81	17.20	33.20
5	*2412.00	107.0 PK			1.19 V	81	73.70	33.30
6	*2412.00	95.6 AV			1.19 V	81	62.30	33.30
7	4824.00	47.4 PK	74.0	-26.6	1.06 V	79	41.30	6.10
8	4824.00	32.8 AV	54.0	-21.2	1.06 V	79	26.70	6.10

REMARKS:

- Emission Level(dBuV/m) = Raw Value(dBuV) + Correction Factor(dB/m)
- Correction Factor(dB/m) = Antenna Factor(dB/m) + Cable Factor(dB) – Pre-Amplifier Factor(dB)
- The other emission levels were very low against the limit.
- Margin value = Emission Level – Limit value
- “ * “: Fundamental frequency.



A D T

EUT TEST CONDITION		MEASUREMENT DETAIL	
CHANNEL	Channel 6	FREQUENCY RANGE	1 ~ 25GHz
INPUT POWER	120Vac, 60 Hz	DETECTOR FUNCTION	Peak (PK) Average (AV)
ENVIRONMENTAL CONDITIONS	25deg. C, 65%RH	TESTED BY	Chris Lin

ANTENNA POLARITY & TEST DISTANCE: HORIZONTAL AT 3 M								
NO.	FREQ. (MHz)	EMISSION LEVEL (dBuV/m)	LIMIT (dBuV/m)	MARGIN (dB)	ANTENNA HEIGHT (m)	TABLE ANGLE (Degree)	RAW VALUE (dBuV)	CORRECTION FACTOR (dB/m)
1	2288.00	59.5 PK	74.0	-14.5	2.19 H	1	58.30	1.20
2	2288.00	51.1 AV	54.0	-2.9	2.19 H	1	49.90	1.20
3	*2437.00	109.2 PK			1.07 H	1	75.80	33.40
4	*2437.00	97.4 AV			1.07 H	1	64.00	33.40
5	4874.00	47.0 PK	74.0	-27.0	1.44 H	251	40.80	6.20
6	4874.00	32.4 AV	54.0	-21.6	1.44 H	251	26.20	6.20
7	7311.00	52.0 PK	74.0	-22.0	1.00 H	155	39.80	12.20
8	7311.00	38.2 AV	54.0	-15.8	1.00 H	155	26.00	12.20

ANTENNA POLARITY & TEST DISTANCE: VERTICAL AT 3 M								
NO.	FREQ. (MHz)	EMISSION LEVEL (dBuV/m)	LIMIT (dBuV/m)	MARGIN (dB)	ANTENNA HEIGHT (m)	TABLE ANGLE (Degree)	RAW VALUE (dBuV)	CORRECTION FACTOR (dB/m)
1	2288.00	57.4 PK	74.0	-16.6	1.26 V	80	56.20	1.20
2	2288.00	49.0 AV	54.0	-5.0	1.26 V	80	47.80	1.20
3	*2437.00	107.7 PK			1.20 V	155	74.30	33.40
4	*2437.00	96.3 AV			1.20 V	155	62.90	33.40
5	4874.00	47.6 PK	74.0	-26.4	1.07 V	82	41.40	6.20
6	4874.00	32.6 AV	54.0	-21.4	1.07 V	82	26.40	6.20
7	7311.00	52.9 PK	74.0	-21.1	1.00 V	224	40.70	12.20
8	7311.00	38.8 AV	54.0	-15.2	1.00 V	224	26.60	12.20

REMARKS:

1. Emission Level(dBuV/m) = Raw Value(dBuV) + Correction Factor(dB/m)
2. Correction Factor(dB/m) = Antenna Factor(dB/m) + Cable Factor(dB)
– Pre-Amplifier Factor(dB)
3. The other emission levels were very low against the limit.
4. Margin value = Emission Level – Limit value
5. “ * “: Fundamental frequency.



A D T

EUT TEST CONDITION		MEASUREMENT DETAIL	
CHANNEL	Channel 11	FREQUENCY RANGE	1 ~ 25GHz
INPUT POWER	120Vac, 60 Hz	DETECTOR FUNCTION	Peak (PK) Average (AV)
ENVIRONMENTAL CONDITIONS	25deg. C, 65%RH	TESTED BY	Chris Lin

ANTENNA POLARITY & TEST DISTANCE: HORIZONTAL AT 3 M								
NO.	FREQ. (MHz)	EMISSION LEVEL (dBuV/m)	LIMIT (dBuV/m)	MARGIN (dB)	ANTENNA HEIGHT (m)	TABLE ANGLE (Degree)	RAW VALUE (dBuV)	CORRECTION FACTOR (dB/m)
1	2288.00	59.4 PK	74.0	-14.6	2.21 H	1	58.20	1.20
2	2288.00	50.9 AV	54.0	-3.1	2.21 H	1	49.70	1.20
3	*2462.00	109.2 PK			1.05 H	4	75.90	33.30
4	*2462.00	97.4 AV			1.05 H	4	64.10	33.30
5	2483.50	69.2 PK	74.0	-4.8	1.06 H	6	35.80	33.40
6	2483.50	49.7 AV	54.0	-4.3	1.06 H	6	16.30	33.40
7	4924.00	46.8 PK	74.0	-27.2	1.39 H	217	40.50	6.30
8	4924.00	32.1 AV	54.0	-21.9	1.39 H	217	25.80	6.30

ANTENNA POLARITY & TEST DISTANCE: VERTICAL AT 3 M								
NO.	FREQ. (MHz)	EMISSION LEVEL (dBuV/m)	LIMIT (dBuV/m)	MARGIN (dB)	ANTENNA HEIGHT (m)	TABLE ANGLE (Degree)	RAW VALUE (dBuV)	CORRECTION FACTOR (dB/m)
1	2288.00	58.5 PK	74.0	-15.5	1.26 V	81	57.30	1.20
2	2288.00	48.8 AV	54.0	-5.2	1.26 V	81	47.60	1.20
3	*2462.00	107.3 PK			1.22 V	145	74.00	33.30
4	*2462.00	95.9 AV			1.22 V	145	62.60	33.30
5	2483.50	66.6 PK	74.0	-7.4	1.22 V	145	33.20	33.40
6	2483.50	48.2 AV	54.0	-5.8	1.22 V	145	14.80	33.40
7	4924.00	46.9 PK	74.0	-27.1	1.07 V	92	40.60	6.30
8	4924.00	32.5 AV	54.0	-21.5	1.07 V	92	26.20	6.30

REMARKS:

1. Emission Level(dBuV/m) = Raw Value(dBuV) + Correction Factor(dB/m)
2. Correction Factor(dB/m) = Antenna Factor(dB/m) + Cable Factor(dB)
– Pre-Amplifier Factor(dB)
3. The other emission levels were very low against the limit.
4. Margin value = Emission Level – Limit value
5. “ * “: Fundamental frequency.



A D T

802.11n (20MHz)

EUT TEST CONDITION		MEASUREMENT DETAIL	
CHANNEL	Channel 1	FREQUENCY RANGE	1 ~ 25GHz
INPUT POWER	120Vac, 60 Hz	DETECTOR FUNCTION	Peak (PK) Average (AV)
ENVIRONMENTAL CONDITIONS	25deg. C, 65%RH	TESTED BY	Chris Lin

ANTENNA POLARITY & TEST DISTANCE: HORIZONTAL AT 3 M

NO.	FREQ. (MHz)	EMISSION LEVEL (dBuV/m)	LIMIT (dBuV/m)	MARGIN (dB)	ANTENNA HEIGHT (m)	TABLE ANGLE (Degree)	RAW VALUE (dBuV)	CORRECTION FACTOR (dB/m)
1	2288.00	59.8 PK	74.0	-14.2	2.19 H	3	62.80	-3.00
2	2288.00	52.0 AV	54.0	-2.0	2.19 H	3	55.00	-3.00
3	2390.00	70.5 PK	74.0	-3.5	1.09 H	353	39.20	31.30
4	2390.00	50.7 AV	54.0	-3.3	1.09 H	353	19.40	31.30
5	*2412.00	108.8 PK			1.09 H	1	77.40	31.40
6	*2412.00	96.5 AV			1.09 H	1	65.10	31.40
7	4824.00	46.6 PK	74.0	-27.4	1.44 H	165	42.80	3.80
8	4824.00	32.7 AV	54.0	-21.3	1.44 H	165	28.90	3.80

ANTENNA POLARITY & TEST DISTANCE: VERTICAL AT 3 M

NO.	FREQ. (MHz)	EMISSION LEVEL (dBuV/m)	LIMIT (dBuV/m)	MARGIN (dB)	ANTENNA HEIGHT (m)	TABLE ANGLE (Degree)	RAW VALUE (dBuV)	CORRECTION FACTOR (dB/m)
1	2288.00	58.8 PK	74.0	-15.2	1.25 V	83	57.60	1.20
2	2288.00	50.5 AV	54.0	-3.5	1.25 V	83	49.30	1.20
3	2390.00	66.4 PK	74.0	-7.6	1.15 V	102	33.20	33.20
4	2390.00	50.5 AV	54.0	-3.5	1.15 V	102	17.30	33.20
5	*2412.00	106.5 PK			1.15 V	102	73.20	33.30
6	*2412.00	94.7 AV			1.15 V	102	61.40	33.30
7	4824.00	47.1 PK	74.0	-26.9	1.05 V	58	41.00	6.10
8	4824.00	32.4 AV	54.0	-21.6	1.05 V	58	26.30	6.10

REMARKS:

1. Emission Level(dBuV/m) = Raw Value(dBuV) + Correction Factor(dB/m)
2. Correction Factor(dB/m) = Antenna Factor(dB/m) + Cable Factor(dB) – Pre-Amplifier Factor(dB)
3. The other emission levels were very low against the limit.
4. Margin value = Emission Level – Limit value
5. “ * “: Fundamental frequency.



A D T

EUT TEST CONDITION		MEASUREMENT DETAIL	
CHANNEL	Channel 6	FREQUENCY RANGE	1 ~ 25GHz
INPUT POWER	120Vac, 60 Hz	DETECTOR FUNCTION	Peak (PK) Average (AV)
ENVIRONMENTAL CONDITIONS	25deg. C, 65%RH	TESTED BY	Chris Lin

ANTENNA POLARITY & TEST DISTANCE: HORIZONTAL AT 3 M								
NO.	FREQ. (MHz)	EMISSION LEVEL (dBuV/m)	LIMIT (dBuV/m)	MARGIN (dB)	ANTENNA HEIGHT (m)	TABLE ANGLE (Degree)	RAW VALUE (dBuV)	CORRECTION FACTOR (dB/m)
1	2288.00	60.1 PK	74.0	-13.9	2.21 H	0	58.90	1.20
2	2288.00	51.4 AV	54.0	-2.6	2.21 H	0	50.20	1.20
3	*2437.00	108.8 PK			1.08 H	1	75.40	33.40
4	*2437.00	97.0 AV			1.08 H	1	63.60	33.40
5	4874.00	46.9 PK	74.0	-27.1	1.40 H	172	40.70	6.20
6	4874.00	32.8 AV	54.0	-21.2	1.40 H	172	26.60	6.20
7	7311.00	52.3 PK	74.0	-21.7	1.00 H	148	40.10	12.20
8	7311.00	38.0 AV	54.0	-16.0	1.00 H	148	25.80	12.20

ANTENNA POLARITY & TEST DISTANCE: VERTICAL AT 3 M								
NO.	FREQ. (MHz)	EMISSION LEVEL (dBuV/m)	LIMIT (dBuV/m)	MARGIN (dB)	ANTENNA HEIGHT (m)	TABLE ANGLE (Degree)	RAW VALUE (dBuV)	CORRECTION FACTOR (dB/m)
1	2288.00	59.3 PK	74.0	-14.7	1.23 V	84	58.10	1.20
2	2288.00	49.4 AV	54.0	-4.6	1.23 V	84	48.20	1.20
3	*2437.00	107.8 PK			1.18 V	114	74.40	33.40
4	*2437.00	95.7 AV			1.18 V	114	62.30	33.40
5	4874.00	47.5 PK	74.0	-26.5	1.04 V	61	41.30	6.20
6	4874.00	32.6 AV	54.0	-21.4	1.04 V	61	26.40	6.20
7	7311.00	52.7 PK	74.0	-21.3	1.00 V	247	40.50	12.20
8	7311.00	38.5 AV	54.0	-15.5	1.00 V	247	26.30	12.20

REMARKS:

1. Emission Level(dBuV/m) = Raw Value(dBuV) + Correction Factor(dB/m)
2. Correction Factor(dB/m) = Antenna Factor(dB/m) + Cable Factor(dB) – Pre-Amplifier Factor(dB)
3. The other emission levels were very low against the limit.
4. Margin value = Emission Level – Limit value
5. “ * “: Fundamental frequency.



A D T

EUT TEST CONDITION		MEASUREMENT DETAIL	
CHANNEL	Channel 11	FREQUENCY RANGE	1 ~ 25GHz
INPUT POWER	120Vac, 60 Hz	DETECTOR FUNCTION	Peak (PK) Average (AV)
ENVIRONMENTAL CONDITIONS	25deg. C, 65%RH	TESTED BY	Chris Lin

ANTENNA POLARITY & TEST DISTANCE: HORIZONTAL AT 3 M								
NO.	FREQ. (MHz)	EMISSION LEVEL (dBuV/m)	LIMIT (dBuV/m)	MARGIN (dB)	ANTENNA HEIGHT (m)	TABLE ANGLE (Degree)	RAW VALUE (dBuV)	CORRECTION FACTOR (dB/m)
1	2288.00	59.4 PK	74.0	-14.6	2.18 H	2	58.20	1.20
2	2288.00	51.1 AV	54.0	-2.9	2.18 H	2	49.90	1.20
3	*2462.00	109.7 PK			1.05 H	3	76.40	33.30
4	*2462.00	97.4 AV			1.05 H	3	64.10	33.30
5	2483.50	66.8 PK	74.0	-7.2	1.07 H	5	33.40	33.40
6	2483.50	51.1 AV	54.0	-2.9	1.07 H	5	17.70	33.40
7	4924.00	47.1 PK	74.0	-26.9	1.42 H	179	40.80	6.30
8	4924.00	32.7 AV	54.0	-21.3	1.42 H	179	26.40	6.30

ANTENNA POLARITY & TEST DISTANCE: VERTICAL AT 3 M								
NO.	FREQ. (MHz)	EMISSION LEVEL (dBuV/m)	LIMIT (dBuV/m)	MARGIN (dB)	ANTENNA HEIGHT (m)	TABLE ANGLE (Degree)	RAW VALUE (dBuV)	CORRECTION FACTOR (dB/m)
1	2288.00	57.6 PK	74.0	-16.4	1.23 V	82	56.40	1.20
2	2288.00	49.0 AV	54.0	-5.0	1.23 V	82	47.80	1.20
3	*2462.00	107.4 PK			1.18 V	156	74.10	33.30
4	*2462.00	95.9 AV			1.18 V	156	62.60	33.30
5	2483.50	67.0 PK	74.0	-7.0	1.18 V	156	33.60	33.40
6	2483.50	48.8 AV	54.0	-5.2	1.18 V	156	15.40	33.40
7	4924.00	47.9 PK	74.0	-26.1	1.06 V	77	41.60	6.30
8	4924.00	32.9 AV	54.0	-21.1	1.06 V	77	26.60	6.30

REMARKS:

1. Emission Level(dBuV/m) = Raw Value(dBuV) + Correction Factor(dB/m)
2. Correction Factor(dB/m) = Antenna Factor(dB/m) + Cable Factor(dB)
– Pre-Amplifier Factor(dB)
3. The other emission levels were very low against the limit.
4. Margin value = Emission Level – Limit value
5. “ * “: Fundamental frequency.



A D T

802.11n (40MHz)

EUT TEST CONDITION		MEASUREMENT DETAIL	
CHANNEL	Channel 3	FREQUENCY RANGE	1 ~ 25GHz
INPUT POWER	120Vac, 60 Hz	DETECTOR FUNCTION	Peak (PK) Average (AV)
ENVIRONMENTAL CONDITIONS	25deg. C, 65%RH	TESTED BY	Chris Lin

ANTENNA POLARITY & TEST DISTANCE: HORIZONTAL AT 3 M								
NO.	FREQ. (MHz)	EMISSION LEVEL (dBuV/m)	LIMIT (dBuV/m)	MARGIN (dB)	ANTENNA HEIGHT (m)	TABLE ANGLE (Degree)	RAW VALUE (dBuV)	CORRECTION FACTOR (dB/m)
1	2288.00	58.2 PK	74.0	-15.8	2.22 H	359	57.00	1.20
2	2288.00	49.2 AV	54.0	-4.8	2.22 H	359	48.00	1.20
3	2390.00	68.8 PK	74.0	-5.2	1.12 H	7	35.60	33.20
4	2390.00	52.7 AV	54.0	-1.3	1.12 H	7	19.50	33.20
5	*2422.00	103.9 PK			1.07 H	4	70.60	33.30
6	*2422.00	92.7 AV			1.07 H	4	59.40	33.30
7	4844.00	46.3 PK	74.0	-27.7	1.47 H	210	40.20	6.10
8	4844.00	33.1 AV	54.0	-20.9	1.47 H	210	27.00	6.10

ANTENNA POLARITY & TEST DISTANCE: VERTICAL AT 3 M								
NO.	FREQ. (MHz)	EMISSION LEVEL (dBuV/m)	LIMIT (dBuV/m)	MARGIN (dB)	ANTENNA HEIGHT (m)	TABLE ANGLE (Degree)	RAW VALUE (dBuV)	CORRECTION FACTOR (dB/m)
1	2288.00	57.7 PK	74.0	-16.3	1.50 V	97	56.50	1.20
2	2288.00	48.3 AV	54.0	-5.7	1.50 V	97	47.10	1.20
3	2390.00	67.2 PK	74.0	-6.8	1.22 V	131	34.00	33.20
4	2390.00	51.4 AV	54.0	-2.6	1.22 V	131	18.20	33.20
5	*2422.00	101.7 PK			1.22 V	131	68.40	33.30
6	*2422.00	91.6 AV			1.22 V	131	58.30	33.30
7	4844.00	47.0 PK	74.0	-27.0	1.04 V	47	40.90	6.10
8	4844.00	33.5 AV	54.0	-20.5	1.04 V	47	27.40	6.10

REMARKS:

1. Emission Level(dBuV/m) = Raw Value(dBuV) + Correction Factor(dB/m)
2. Correction Factor(dB/m) = Antenna Factor(dB/m) + Cable Factor(dB) – Pre-Amplifier Factor(dB)
3. The other emission levels were very low against the limit.
4. Margin value = Emission Level – Limit value
5. “ * “: Fundamental frequency.



A D T

EUT TEST CONDITION		MEASUREMENT DETAIL	
CHANNEL	Channel 6	FREQUENCY RANGE	1 ~ 25GHz
INPUT POWER	120Vac, 60 Hz	DETECTOR FUNCTION	Peak (PK) Average (AV)
ENVIRONMENTAL CONDITIONS	25deg. C, 65%RH	TESTED BY	Chris Lin

ANTENNA POLARITY & TEST DISTANCE: HORIZONTAL AT 3 M								
NO.	FREQ. (MHz)	EMISSION LEVEL (dBuV/m)	LIMIT (dBuV/m)	MARGIN (dB)	ANTENNA HEIGHT (m)	TABLE ANGLE (Degree)	RAW VALUE (dBuV)	CORRECTION FACTOR (dB/m)
1	2288.00	58.5 PK	74.0	-15.5	2.21 H	0	57.30	1.20
2	2288.00	49.9 AV	54.0	-4.1	2.21 H	0	48.70	1.20
3	2390.00	69.1 PK	74.0	-4.9	1.11 H	7	35.90	33.20
4	2390.00	52.3 AV	54.0	-1.7	1.11 H	7	19.10	33.20
5	*2437.00	104.4 PK			1.08 H	0	71.00	33.40
6	*2437.00	93.8 AV			1.08 H	0	60.40	33.40
7	4874.00	46.6 PK	74.0	-27.4	1.45 H	207	40.40	6.20
8	4874.00	33.2 AV	54.0	-20.8	1.45 H	207	27.00	6.20

ANTENNA POLARITY & TEST DISTANCE: VERTICAL AT 3 M								
NO.	FREQ. (MHz)	EMISSION LEVEL (dBuV/m)	LIMIT (dBuV/m)	MARGIN (dB)	ANTENNA HEIGHT (m)	TABLE ANGLE (Degree)	RAW VALUE (dBuV)	CORRECTION FACTOR (dB/m)
1	2288.00	58.1 PK	74.0	-15.9	1.43 V	91	56.90	1.20
2	2288.00	49.5 AV	54.0	-4.5	1.43 V	91	48.30	1.20
3	2390.00	65.9 PK	74.0	-8.1	1.21 V	144	32.70	33.20
4	2390.00	49.0 AV	54.0	-5.0	1.21 V	144	15.80	33.20
5	*2437.00	104.1 PK			1.21 V	144	70.70	33.40
6	*2437.00	93.2 AV			1.21 V	144	59.80	33.40
7	4874.00	47.5 PK	74.0	-26.5	1.08 V	52	41.30	6.20
8	4874.00	33.8 AV	54.0	-20.2	1.08 V	52	27.60	6.20

REMARKS:

1. Emission Level(dBuV/m) = Raw Value(dBuV) + Correction Factor(dB/m)
2. Correction Factor(dB/m) = Antenna Factor(dB/m) + Cable Factor(dB)
– Pre-Amplifier Factor(dB)
3. The other emission levels were very low against the limit.
4. Margin value = Emission Level – Limit value
5. “ * “: Fundamental frequency.



A D T

EUT TEST CONDITION		MEASUREMENT DETAIL	
CHANNEL	Channel 9	FREQUENCY RANGE	1 ~ 25GHz
INPUT POWER	120Vac, 60 Hz	DETECTOR FUNCTION	Peak (PK) Average (AV)
ENVIRONMENTAL CONDITIONS	25deg. C, 65%RH	TESTED BY	Chris Lin

ANTENNA POLARITY & TEST DISTANCE: HORIZONTAL AT 3 M								
NO.	FREQ. (MHz)	EMISSION LEVEL (dBuV/m)	LIMIT (dBuV/m)	MARGIN (dB)	ANTENNA HEIGHT (m)	TABLE ANGLE (Degree)	RAW VALUE (dBuV)	CORRECTION FACTOR (dB/m)
1	2288.00	57.9 PK	74.0	-16.1	2.21 H	2	56.70	1.20
2	2288.00	48.8 AV	54.0	-5.2	2.21 H	2	47.60	1.20
3	*2452.00	104.8 PK			1.07 H	2	71.40	33.40
4	*2452.00	94.0 AV			1.07 H	2	60.60	33.40
5	2483.50	69.7 PK	74.0	-4.3	1.06 H	1	36.30	33.40
6	2483.50	53.0 AV	54.0	-1.0	1.06 H	1	19.60	33.40
7	4904.00	47.3 PK	74.0	-26.7	1.07 H	49	41.20	6.10
8	4904.00	33.2 AV	54.0	-20.8	1.07 H	49	27.10	6.10

ANTENNA POLARITY & TEST DISTANCE: VERTICAL AT 3 M								
NO.	FREQ. (MHz)	EMISSION LEVEL (dBuV/m)	LIMIT (dBuV/m)	MARGIN (dB)	ANTENNA HEIGHT (m)	TABLE ANGLE (Degree)	RAW VALUE (dBuV)	CORRECTION FACTOR (dB/m)
1	2288.00	57.8 PK	74.0	-16.2	1.42 V	95	56.60	1.20
2	2288.00	48.5 AV	54.0	-5.5	1.42 V	95	47.30	1.20
3	*2452.00	103.7 PK			1.20 V	132	70.30	33.40
4	*2452.00	93.5 AV			1.20 V	132	60.10	33.40
5	2483.50	70.4 PK	74.0	-3.6	1.20 V	132	37.00	33.40
6	2483.50	52.9 AV	54.0	-1.1	1.20 V	132	19.50	33.40
7	4904.00	47.1 PK	74.0	-26.9	1.10 V	64	41.00	6.10
8	4904.00	33.3 AV	54.0	-20.7	1.10 V	64	27.20	6.10

REMARKS:

1. Emission Level(dBuV/m) = Raw Value(dBuV) + Correction Factor(dB/m)
2. Correction Factor(dB/m) = Antenna Factor(dB/m) + Cable Factor(dB)
– Pre-Amplifier Factor(dB)
3. The other emission levels were very low against the limit.
4. Margin value = Emission Level – Limit value
5. “ * “: Fundamental frequency.



A D T

BELOW 1GHz WORST-CASE DATA : 802.11g

EUT TEST CONDITION		MEASUREMENT DETAIL	
CHANNEL	Channel 6	FREQUENCY RANGE	Below 1000MHz
INPUT POWER	120Vac, 60 Hz	DETECTOR FUNCTION	Quasi-Peak
ENVIRONMENTAL CONDITIONS	25deg. C, 68%RH	TESTED BY	Chris Lin
TEST MODE	A		

ANTENNA POLARITY & TEST DISTANCE: HORIZONTAL AT 3 M								
NO.	FREQ. (MHz)	EMISSION LEVEL (dBuV/m)	LIMIT (dBuV/m)	MARGIN (dB)	ANTENNA HEIGHT (m)	TABLE ANGLE (Degree)	RAW VALUE (dBuV)	CORRECTION FACTOR (dB/m)
1	90.17	36.5 QP	43.5	-7.0	1.99 H	130	56.50	-20.00
2	179.61	34.4 QP	43.5	-9.1	1.50 H	250	49.70	-15.30
3	255.44	35.3 QP	46.0	-10.7	1.00 H	90	49.50	-14.20
4	374.04	31.9 QP	46.0	-14.1	1.99 H	250	43.20	-11.30
5	675.40	33.2 QP	46.0	-12.8	1.24 H	128	39.30	-6.10
6	902.89	35.8 QP	46.0	-10.2	1.00 H	266	37.00	-1.20
ANTENNA POLARITY & TEST DISTANCE: VERTICAL AT 3 M								
NO.	FREQ. (MHz)	EMISSION LEVEL (dBuV/m)	LIMIT (dBuV/m)	MARGIN (dB)	ANTENNA HEIGHT (m)	TABLE ANGLE (Degree)	RAW VALUE (dBuV)	CORRECTION FACTOR (dB/m)
1	57.12	32.5 QP	40.0	-7.5	1.00 V	9	47.10	-14.60
2	78.51	36.8 QP	40.0	-3.2	1.00 V	132	54.70	-17.90
3	181.55	30.7 QP	43.5	-12.8	1.00 V	35	46.20	-15.50
4	249.60	30.9 QP	46.0	-15.1	1.49 V	219	45.40	-14.50
5	500.42	27.6 QP	46.0	-18.4	1.99 V	159	36.50	-8.90
6	902.89	34.9 QP	46.0	-11.1	1.99 V	198	36.10	-1.20

REMARKS:

1. Emission Level(dBuV/m) = Raw Value(dBuV) + Correction Factor(dB/m)
2. Correction Factor(dB/m) = Antenna Factor(dB/m) + Cable Factor(dB) – Pre-Amplifier Factor (dB)
3. The other emission levels were very low against the limit.
4. Margin value = Emission Level – Limit value



A D T

EUT TEST CONDITION		MEASUREMENT DETAIL	
CHANNEL	Channel 6	FREQUENCY RANGE	Below 1000MHz
INPUT POWER	48Vdc (POE)	DETECTOR FUNCTION	Quasi-Peak
ENVIRONMENTAL CONDITIONS	25deg. C, 68%RH	TESTED BY	Chris Lin
TEST MODE	B		

ANTENNA POLARITY & TEST DISTANCE: HORIZONTAL AT 3 M								
NO.	FREQ. (MHz)	EMISSION LEVEL (dBuV/m)	LIMIT (dBuV/m)	MARGIN (dB)	ANTENNA HEIGHT (m)	TABLE ANGLE (Degree)	RAW VALUE (dBuV)	CORRECTION FACTOR (dB/m)
1	107.67	28.1 QP	43.5	-15.4	1.25 H	267	45.80	-17.70
2	230.16	33.5 QP	46.0	-12.5	1.50 H	215	48.90	-15.40
3	374.04	38.0 QP	46.0	-8.0	1.00 H	220	49.30	-11.30
4	500.42	35.8 QP	46.0	-10.2	2.00 H	202	44.70	-8.90
5	751.23	28.7 QP	46.0	-17.3	1.00 H	156	33.10	-4.40
6	850.39	28.8 QP	46.0	-17.2	1.00 H	125	30.90	-2.10
ANTENNA POLARITY & TEST DISTANCE: VERTICAL AT 3 M								
NO.	FREQ. (MHz)	EMISSION LEVEL (dBuV/m)	LIMIT (dBuV/m)	MARGIN (dB)	ANTENNA HEIGHT (m)	TABLE ANGLE (Degree)	RAW VALUE (dBuV)	CORRECTION FACTOR (dB/m)
1	39.62	32.1 QP	40.0	-7.9	1.00 V	252	46.60	-14.50
2	187.39	30.2 QP	43.5	-13.3	1.00 V	180	46.00	-15.80
3	500.42	36.3 QP	46.0	-9.7	1.00 V	207	45.20	-8.90
4	675.40	28.8 QP	46.0	-17.2	1.50 V	151	34.90	-6.10
5	751.23	27.4 QP	46.0	-18.6	1.50 V	131	31.80	-4.40
6	850.39	27.5 QP	46.0	-18.5	1.00 V	135	29.60	-2.10

REMARKS:

1. Emission Level(dBuV/m) = Raw Value(dBuV) + Correction Factor(dB/m)
2. Correction Factor(dB/m) = Antenna Factor(dB/m) + Cable Factor(dB) – Pre-Amplifier Factor (dB)
3. The other emission levels were very low against the limit.
4. Margin value = Emission Level – Limit value



A D T

4.2 CONDUCTED EMISSION MEASUREMENT

4.2.1 LIMITS OF CONDUCTED EMISSION MEASUREMENT

FREQUENCY OF EMISSION (MHz)	CONDUCTED LIMIT (dB μ V)	
	Quasi-peak	Average
0.15 ~ 0.5	66 to 56	56 to 46
0.5 ~ 5	56	46
5 ~ 30	60	50

- NOTE:** 1. The lower limit shall apply at the transition frequencies.
2. The limit decreases in line with the logarithm of the frequency in the range of 0.15 to 0.50MHz.
3. All emanations from a class A/B digital device or system, including any network of conductors and apparatus connected thereto, shall not exceed the level of field strengths specified above.

4.2.2 TEST INSTRUMENTS

DESCRIPTION & MANUFACTURER	MODEL NO.	SERIAL NO.	DATE OF CALIBRATION	DUE DATE OF CALIBRATION
Test Receiver ROHDE & SCHWARZ	ESCS30	100289	Nov. 29, 2013	Nov. 28, 2014
RF signal cable Woken	5D-FB	Cable-HYC01-01	Dec. 27, 2013	Dec. 26, 2014
LISN ROHDE & SCHWARZ (EUT)	ESH3-Z5	835239/001	Feb. 13, 2014	Feb. 12, 2015
LISN ROHDE & SCHWARZ (Peripheral)	ESH3-Z5	100311	Jul. 21, 2014	Jul. 20, 2015
Software ADT	BV ADT_Cond_ V7.3.7.3	NA	NA	NA

- NOTE:** 1. The calibration interval of the above test instruments is 12 months and the calibrations are traceable to NML/ROC and NIST/USA.
2. The test was performed in HwaYa Shielded Room 1.
3. The VCCI Site Registration No. is C-2040.

4.2.3 TEST PROCEDURES

- a. The EUT was placed 0.4 meters from the conducting wall of the shielded room with EUT being connected to the power mains through a line impedance stabilization network (LISN). Other support units were connected to the power mains through another LISN. The two LISNs provide 50 ohm/ 50uH of coupling impedance for the measuring instrument.
- b. Both lines of the power mains connected to the EUT were checked for maximum conducted interference.
- c. The frequency range from 150kHz to 30MHz was searched. Emission levels under (Limit - 20dB) was not recorded.

NOTE: All modes of operation were investigated and the worst-case emissions are reported.

4.2.4 DEVIATION FROM TEST STANDARD

No deviation.

4.2.5 TEST SETUP

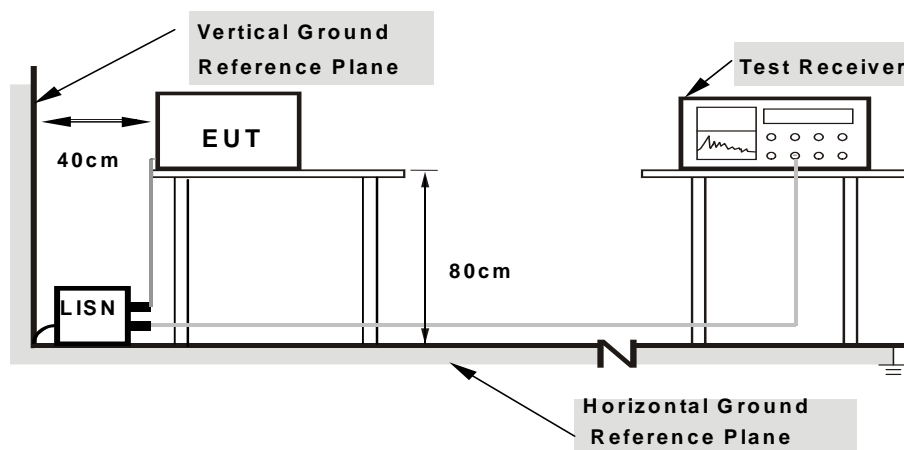

- Note:**
- 1.Support units were connected to second LISN.
 - 2.Both of LISNs (AMN) are 80 cm from EUT and at least 80 from other units and other metal planes

For the actual test configuration, please refer to the attached file (Test Setup Photo).

4.2.6 EUT OPERATING CONDITIONS

Same as 4.1.6.

4.2.7 TEST RESULTS

CONDUCTED WORST-CASE DATA : 802.11g

PHASE	Line 1	6dB BANDWIDTH	9kHz
TEST MODE	A		

No	Freq. [MHz]	Corr. Factor (dB)	Reading Value		Emission Level		Limit		Margin	
			[dB (uV)]		[dB (uV)]		[dB (uV)]		(dB)	
			Q.P.	AV.	Q.P.	AV.	Q.P.	AV.	Q.P.	AV.
1	0.15781	0.11	50.49	34.92	50.60	35.03	65.58	55.58	-14.98	-20.55
2	0.23203	0.09	41.74	27.21	41.83	27.30	62.38	52.38	-20.54	-25.07
3	0.54453	0.13	40.08	34.30	40.21	34.43	56.00	46.00	-15.79	-11.57
4	1.97656	0.25	35.29	29.55	35.54	29.80	56.00	46.00	-20.46	-16.20
5	3.88672	0.26	36.83	29.79	37.09	30.05	56.00	46.00	-18.91	-15.95
6	12.94141	0.71	34.44	29.37	35.15	30.08	60.00	50.00	-24.85	-19.92

REMARKS:

1. Q.P. and AV. are abbreviations of quasi-peak and average individually.
2. The emission levels of other frequencies were very low against the limit.
3. Margin value = Emission level - Limit value
4. Correction factor = Insertion loss + Cable loss
5. Emission Level = Correction Factor + Reading Value.

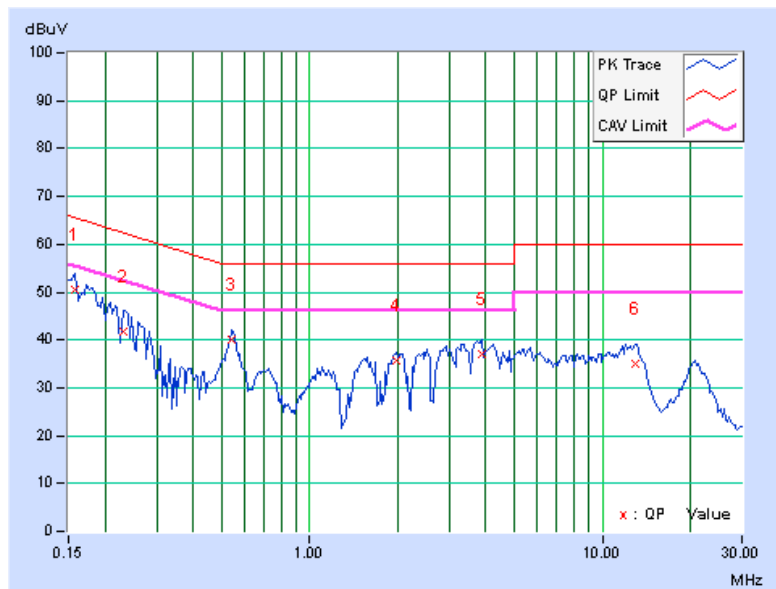



A D T

PHASE	Line 2	6dB BANDWIDTH	9kHz
TEST MODE	A		

No	Freq. [MHz]	Corr. Factor (dB)	Reading Value		Emission Level		Limit		Margin	
			[dB (uV)]		[dB (uV)]		[dB (uV)]		(dB)	
			Q.P.	AV.	Q.P.	AV.	Q.P.	AV.	Q.P.	AV.
1	0.15000	0.05	50.27	34.02	50.32	34.07	66.00	56.00	-15.68	-21.93
2	0.21641	0.10	44.27	29.88	44.37	29.98	62.96	52.96	-18.59	-22.98
3	0.54453	0.18	40.02	34.28	40.20	34.46	56.00	46.00	-15.80	-11.54
4	1.95313	0.22	34.89	29.42	35.11	29.64	56.00	46.00	-20.89	-16.36
5	3.67578	0.25	35.86	28.77	36.11	29.02	56.00	46.00	-19.89	-16.98
6	13.00781	0.68	34.41	29.39	35.09	30.07	60.00	50.00	-24.91	-19.93

REMARKS:

1. Q.P. and AV. are abbreviations of quasi-peak and average individually.
2. The emission levels of other frequencies were very low against the limit.
3. Margin value = Emission level - Limit value
4. Correction factor = Insertion loss + Cable loss
5. Emission Level = Correction Factor + Reading Value.

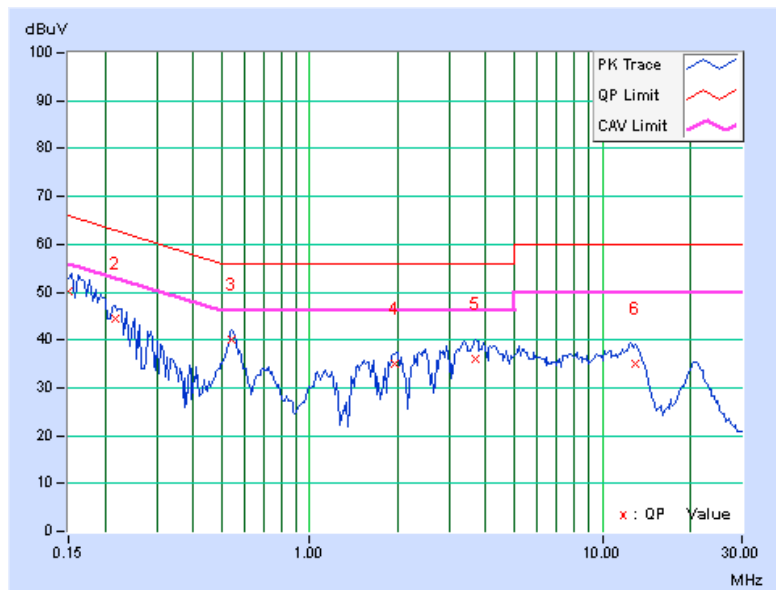



A D T

PHASE	Line 1	6dB BANDWIDTH	9kHz
TEST MODE	B		

No	Freq. [MHz]	Corr. Factor (dB)	Reading Value		Emission Level		Limit		Margin	
			[dB (uV)]		[dB (uV)]		[dB (uV)]		(dB)	
			Q.P.	AV.	Q.P.	AV.	Q.P.	AV.	Q.P.	AV.
1	0.18516	0.10	39.42	32.91	39.52	33.01	64.25	54.25	-24.73	-21.24
2	0.37656	0.11	36.49	35.52	36.60	35.63	58.35	48.35	-21.76	-12.73
3	0.65781	0.15	37.02	34.51	37.17	34.66	56.00	46.00	-18.83	-11.34
4	0.84531	0.18	32.66	27.70	32.84	27.88	56.00	46.00	-23.16	-18.12
5	3.85547	0.26	34.22	32.20	34.48	32.46	56.00	46.00	-21.52	-13.54
6	13.35938	0.74	31.99	31.89	32.73	32.63	60.00	50.00	-27.27	-17.37

REMARKS:

1. Q.P. and AV. are abbreviations of quasi-peak and average individually.
2. The emission levels of other frequencies were very low against the limit.
3. Margin value = Emission level - Limit value
4. Correction factor = Insertion loss + Cable loss
5. Emission Level = Correction Factor + Reading Value.

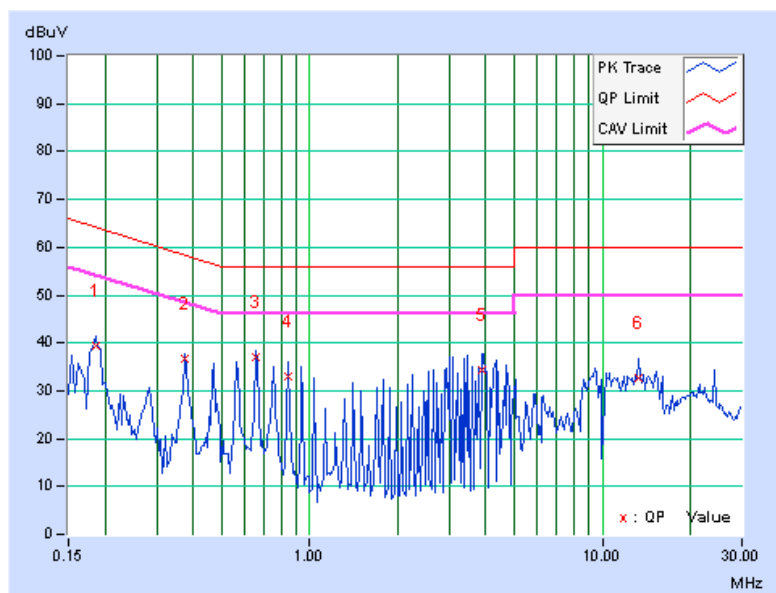



A D T

PHASE	Line 2	6dB BANDWIDTH	9kHz
TEST MODE	B		

No	Freq. [MHz]	Corr. Factor (dB)	Reading Value		Emission Level		Limit		Margin	
			[dB (uV)]		[dB (uV)]		[dB (uV)]		(dB)	
			Q.P.	AV.	Q.P.	AV.	Q.P.	AV.	Q.P.	AV.
1	0.18516	0.08	40.15	33.50	40.23	33.58	64.25	54.25	-24.02	-20.67
2	0.65781	0.19	37.04	34.57	37.23	34.76	56.00	46.00	-18.77	-11.24
3	0.84531	0.21	33.71	28.80	33.92	29.01	56.00	46.00	-22.08	-16.99
4	3.00781	0.24	35.66	34.56	35.90	34.80	56.00	46.00	-20.10	-11.20
5	3.85156	0.26	35.66	33.68	35.92	33.94	56.00	46.00	-20.08	-12.06
6	14.84375	0.77	30.24	30.02	31.01	30.79	60.00	50.00	-28.99	-19.21

REMARKS:

1. Q.P. and AV. are abbreviations of quasi-peak and average individually.
2. The emission levels of other frequencies were very low against the limit.
3. Margin value = Emission level - Limit value
4. Correction factor = Insertion loss + Cable loss
5. Emission Level = Correction Factor + Reading Value.

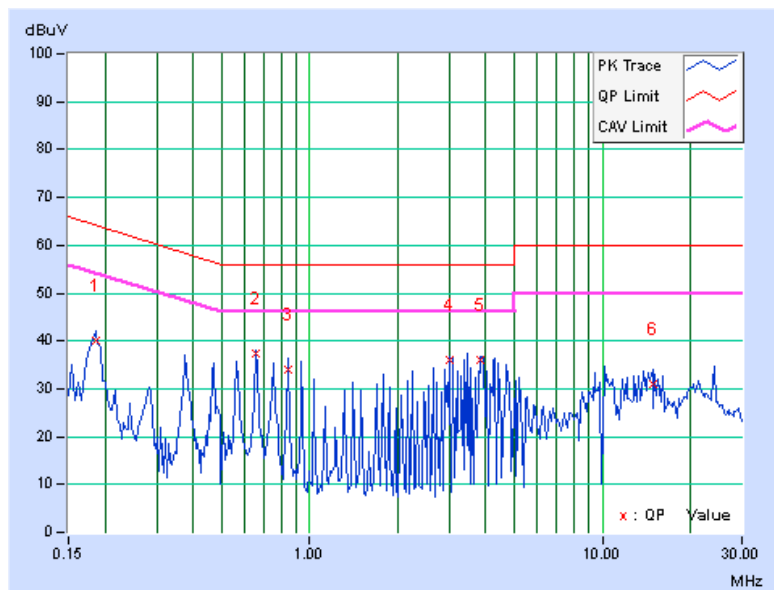

4.3 6dB BANDWIDTH MEASUREMENT

4.3.1 LIMITS OF 6dB BANDWIDTH MEASUREMENT

The minimum of 6dB Bandwidth Measurement is 0.5 MHz.

4.3.2 TEST SETUP

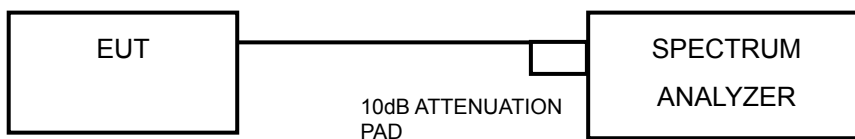

4.3.3 TEST INSTRUMENTS

Refer to section 4.1.2 to get information of above instrument.

4.3.4 TEST PROCEDURE

- a. Set resolution bandwidth (RBW) = 100kHz
- b. Set the video bandwidth (VBW) $\geq 3 \times$ RBW, Detector = Peak.
- c. Trace mode = max hold.
- d. Sweep = auto couple.
- e. Measure the maximum width of the emission that is constrained by the frequencies associated with the two amplitude points (upper and lower) that are attenuated by 6 dB relative to the maximum level measured in the fundamental emission

4.3.5 DEVIATION FROM TEST STANDARD

No deviation.

4.3.6 EUT OPERATING CONDITIONS

The software provided by client to enable the EUT under transmission condition continuously at lowest, middle and highest channel frequencies individually.



4.3.7 TEST RESULTS

802.11b

CHANNEL	FREQUENCY (MHz)	6dB BANDWIDTH (MHz)		MINIMUM LIMIT (MHz)	PASS / FAIL
		CHAIN 0	CHAIN 1		
1	2412	10.11	10.12	0.5	PASS
6	2437	10.13	10.11	0.5	PASS
11	2462	10.12	10.13	0.5	PASS

802.11g

CHANNEL	FREQUENCY (MHz)	6dB BANDWIDTH (MHz)		MINIMUM LIMIT (MHz)	PASS / FAIL
		CHAIN 0	CHAIN 1		
1	2412	16.39	16.43	0.5	PASS
6	2437	16.35	16.38	0.5	PASS
11	2462	16.39	16.43	0.5	PASS

802.11n (20MHz)

CHANNEL	FREQUENCY (MHz)	6dB BANDWIDTH (MHz)		MINIMUM LIMIT (MHz)	PASS / FAIL
		CHAIN 0	CHAIN 1		
1	2412	17.61	17.61	0.5	PASS
6	2437	16.96	17.59	0.5	PASS
11	2462	17.61	17.61	0.5	PASS



A D T

802.11n (40MHz)

CHANNEL	FREQUENCY (MHz)	6dB BANDWIDTH (MHz)		MINIMUM LIMIT (MHz)	PASS / FAIL
		CHAIN 0	CHAIN 1		
3	2422	36.25	36.32	0.5	PASS
6	2437	36.41	36.44	0.5	PASS
9	2452	36.25	36.32	0.5	PASS

SPECTRUM PLOT OF WORST VALUE

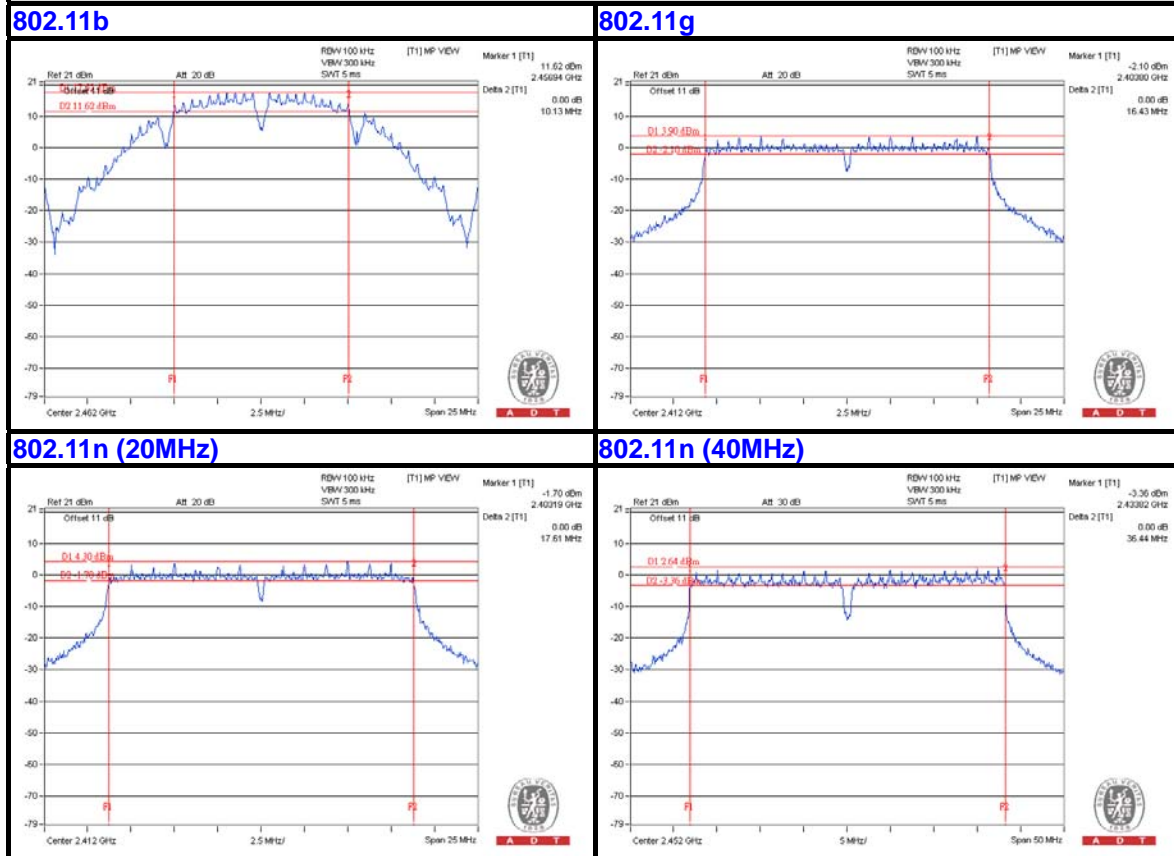

4.4 CONDUCTED OUTPUT POWER

4.4.1 LIMITS OF CONDUCTED OUTPUT POWER MEASUREMENT

For systems using digital modulation in the 2400–2483.5 MHz bands: 1 Watt (30dBm)

Per KDB 662911 D01 Multiple Transmitter Output v02r01 Method of conducted output power measurement on IEEE 802.11 devices,

Array Gain = 0 dB (i.e., no array gain) for $NANT \leq 4$;

Array Gain = 0 dB (i.e., no array gain) for channel widths ≥ 40 MHz for any NANT;

Array Gain = $5 \log(NANT/NSS)$ dB or 3 dB, whichever is less for 20-MHz channel widths with $NANT \geq 5$.

For power measurements on all other devices: Array Gain = $10 \log(NANT/NSS)$ dB.

4.4.2 TEST SETUP

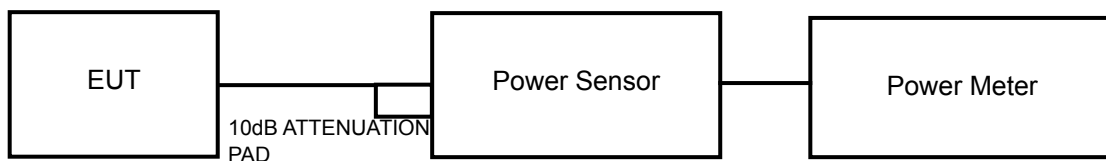

4.4.3 TEST INSTRUMENTS

Refer to section 4.1.2 to get information of above instrument.

4.4.4 TEST PROCEDURES

An average power sensor was used on the output port of the EUT. A power meter is used to perform output power measurement, trigger and gating function of wide band power meter is enabled to measure max output power of TX on burst. Duty factor is not added to measured value.

4.4.5 DEVIATION FROM TEST STANDARD

No deviation.

4.4.6 EUT OPERATING CONDITIONS

Same as Item 4.3.6.



A D T

4.4.7 TEST RESULTS

802.11b

CHAN.	FREQUENCY (MHz)	AVG. POWER (dBm)		TOTAL POWER (mW)	TOTAL POWER (dBm)	LIMIT (dBm)	PASS / FAIL
		CHAIN 0	CHAIN 1				
1	2412	23.40	23.50	442.65	26.46	30	PASS
6	2437	26.54	26.93	943.99	29.75	30	PASS
11	2462	26.60	26.70	924.82	29.66	30	PASS

802.11g

CHAN.	FREQUENCY (MHz)	AVG. POWER (dBm)		TOTAL POWER (mW)	TOTAL POWER (dBm)	LIMIT (dBm)	PASS / FAIL
		CHAIN 0	CHAIN 1				
1	2412	15.27	15.42	68.48	18.36	30	PASS
6	2437	26.55	27.23	980.30	29.91	30	PASS
11	2462	19.41	20.22	192.49	22.84	30	PASS

802.11n (20MHz)

CHAN.	FREQUENCY (MHz)	AVG. POWER (dBm)		TOTAL POWER (mW)	TOTAL POWER (dBm)	LIMIT (dBm)	PASS / FAIL
		CHAIN 0	CHAIN 1				
1	2412	15.47	15.54	71.05	18.52	30	PASS
6	2437	26.58	27.12	970.22	29.87	30	PASS
11	2462	18.46	19.02	149.94	21.76	30	PASS

802.11n (40MHz)

CHAN.	FREQUENCY (MHz)	AVG. POWER (dBm)		TOTAL POWER (mW)	TOTAL POWER (dBm)	LIMIT (dBm)	PASS / FAIL
		CHAIN 0	CHAIN 1				
3	2422	15.00	15.40	66.30	18.21	30	PASS
6	2437	15.53	15.96	75.17	18.76	30	PASS
9	2452	14.01	14.36	52.47	17.20	30	PASS

4.5 POWER SPECTRAL DENSITY MEASUREMENT

4.5.1 LIMITS OF POWER SPECTRAL DENSITY MEASUREMENT

The Maximum of Power Spectral Density Measurement is 8dBm.

4.5.2 TEST SETUP

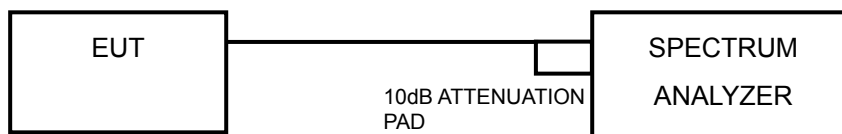

4.5.3 TEST INSTRUMENTS

Refer to section 4.1.2 to get information of above instrument.

4.5.4 TEST PROCEDURE

- a) Set instrument center frequency to DTS channel center frequency.
- b) Set span to at least 1.5 times the OBW.
- c) Set RBW to: $3 \text{ kHz} \leq \text{RBW} \leq 100 \text{ kHz}$.
- d) Set VBW $\geq 3 \times \text{RBW}$.
- e) Detector = power averaging (RMS) or sample detector (when RMS not available).
- f) Ensure that the number of measurement points in the sweep $\geq 2 \times \text{span}/\text{RBW}$.
- g) Sweep time = auto couple.
- h) Employ trace averaging (RMS) mode over a minimum of 100 traces.
- i) Use the peak marker function to determine the maximum amplitude level.

4.5.5 DEVIATION FROM TEST STANDARD

No deviation.

4.5.6 EUT OPERATING CONDITION

Same as Item 4.3.6



A D T

4.5.7 TEST RESULTS

802.11b

TX chain	Channel	Freq. (MHz)	PSD (dBm/3kHz)	10 log (N=2) dB	Total PSD (dBm/3kHz)	Limit (dBm/3kHz)	PASS /FAIL
0	1	2412	-7.43	3.01	-4.42	8	PASS
	6	2437	-4.16	3.01	-1.15	8	PASS
	11	2462	-3.57	3.01	-0.56	8	PASS
1	1	2412	-7.29	3.01	-4.28	8	PASS
	6	2437	-4.88	3.01	-1.87	8	PASS
	11	2462	-3.05	3.01	-0.04	8	PASS

NOTE: Directional gain = $2\text{dBi} + 10\log(2) = 5.01\text{dBi} < 6\text{dBi}$, therefore the limit no need to reduced.

802.11g

TX chain	Chan.	Freq. (MHz)	PSD (dBm/3kHz)	10 log (N=2) dB	Total PSD W/O DUTY FACTOR (dBm/3kHz)	DUTY FACTOR	Total PSD WITH DUTY FACTOR (dBm/3kHz)	Limit (dBm/3kHz)	PASS /FAIL
0	1	2412	-17.34	3.01	-14.33	0.16	-14.17	8	PASS
	6	2437	-5.57	3.01	-2.56	0.16	-2.40	8	PASS
	11	2462	-17.34	3.01	-9.32	0.16	-14.17	8	PASS
1	1	2412	-17.21	3.01	-14.20	0.16	-14.04	8	PASS
	6	2437	-6.02	3.01	-3.01	0.16	-2.85	8	PASS
	11	2462	-17.21	3.01	-14.20	0.16	-14.04	8	PASS

NOTE:

1. Directional gain = $2\text{dBi} + 10\log(2) = 5.01\text{dBi} < 6\text{dBi}$, therefore the limit no need to reduced.
2. Refer to section 3.3 for duty cycle spectrum plot.

802.11n (20MHz)

TX chain	Chan.	Freq. (MHz)	PSD (dBm/3kHz)	10 log (N=2) dB	Total PSD W/O DUTY FACTOR (dBm/3kHz)	DUTY FACTOR	Total PSD WITH DUTY FACTOR (dBm/3kHz)	Limit (dBm/3kHz)	PASS /FAIL
0	1	2412	-18.30	3.01	-15.29	0.16	-15.13	8	PASS
	6	2437	-6.01	3.01	-3.00	0.16	-2.84	8	PASS
	11	2462	-18.30	3.01	-8.57	0.16	-15.13	8	PASS
1	1	2412	-17.12	3.01	-14.11	0.16	-13.95	8	PASS
	6	2437	-6.02	3.01	-3.01	0.16	-2.85	8	PASS
	11	2462	-17.12	3.01	-4.11	0.16	-13.95	8	PASS

NOTE:

1. Directional gain = $2\text{dBi} + 10\log(2) = 5.01\text{dBi} < 6\text{dBi}$, therefore the limit no need to reduced.
2. Refer to section 3.3 for duty cycle spectrum plot.



A D T

802.11n (40MHz)

TX chain	Chan.	Freq. (MHz)	PSD (dBm/3kHz)	10 log (N=2) dB	Total PSD W/O DUTY FACTOR (dBm/3kHz)	DUTY FACTOR	Total PSD WITH DUTY FACTOR (dBm/3kHz)	Limit (dBm/3kHz)	PASS /FAIL
0	3	2422	-17.83	3.01	-14.82	0.43	-14.39	8	PASS
	6	2437	-17.60	3.01	-14.59	0.43	-14.16	8	PASS
	9	2452	-17.83	3.01	-14.82	0.43	-14.39	8	PASS
1	3	2422	-18.52	3.01	-15.51	0.43	-15.08	8	PASS
	6	2437	-18.09	3.01	-15.08	0.43	-14.65	8	PASS
	9	2452	-18.52	3.01	-15.51	0.43	-15.08	8	PASS

NOTE:

1. Directional gain = 2dBi + 10log(2) = 5.01dBi < 6dBi , therefore the limit no need to reduced.
2. Refer to section 3.3 for duty cycle spectrum plot.

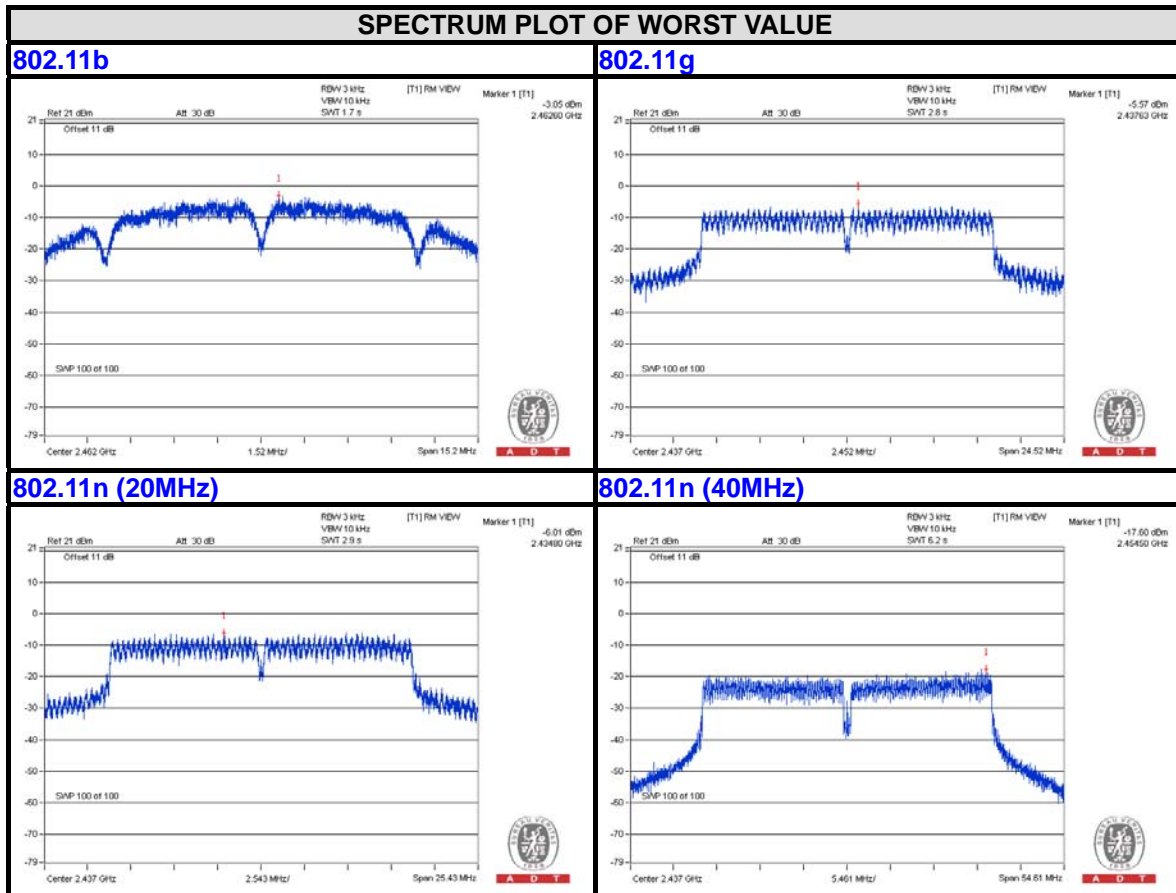

4.6 CONDUCTED OUT OF BAND EMISSION MEASUREMENT

4.6.1 LIMITS OF CONDUCTED OUT OF BAND EMISSION MEASUREMENT

Below -30dB of the highest emission level of operating band (in 100kHz Resolution Bandwidth).

4.6.2 TEST SETUP

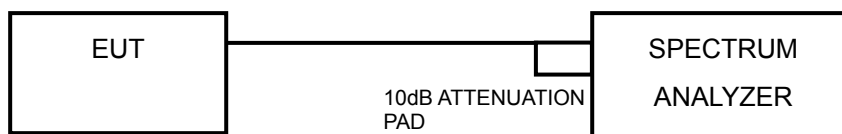

4.6.3 TEST INSTRUMENTS

Refer to section 4.1.2 to get information of above instrument.

4.6.4 TEST PROCEDURE

MEASUREMENT PROCEDURE REF

1. Set the RBW = 100 kHz.
2. Set the VBW \geq 300 kHz.
3. Detector = peak.
4. Sweep time = auto couple.
5. Trace mode = max hold.
6. Allow trace to fully stabilize.
7. Use the peak marker function to determine the maximum power level in any 100 kHz band segment within the fundamental EBW.



A D T

MEASUREMENT PROCEDURE OOB

1. Set RBW = 100 kHz.
2. Set VBW \geq 300 kHz.
3. Detector = peak.
4. Sweep = auto couple.
5. Trace Mode = max hold.
6. Allow trace to fully stabilize.
7. Use the peak marker function to determine the maximum amplitude level.

4.6.5 DEVIATION FROM TEST STANDARD

No deviation.

4.6.6 EUT OPERATING CONDITION

Same as Item 4.3.6

4.6.7 TEST RESULTS

The conducted emission test is performed on each TX port of operating mode without summing or adding $10\log(N)$ since the limit is relative emission limit. Only worst data of each operating mode is presented.

The spectrum plots are attached on the following pages. D1 line indicates the highest level, and D2 line indicates the 30dB offset below D1. It shows compliance with the requirement.



A D T

802.11b CHAIN 0

CH 1

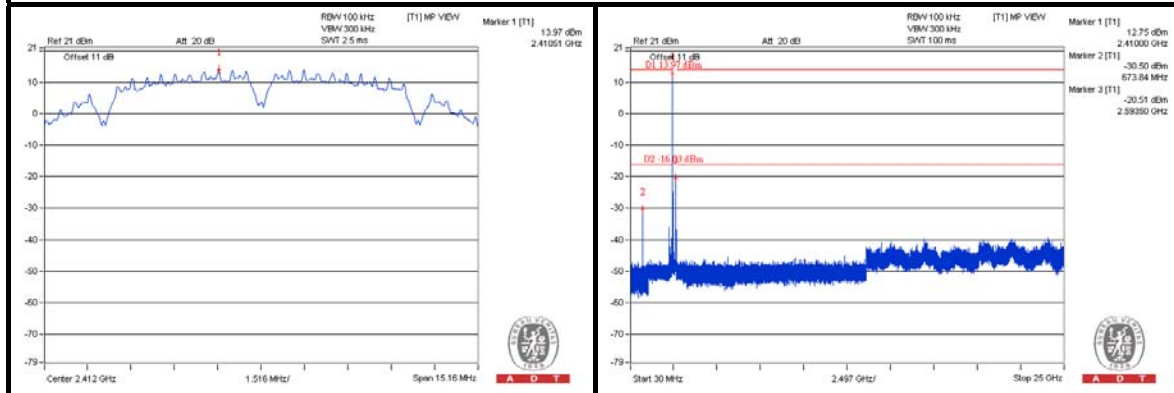

CH 6

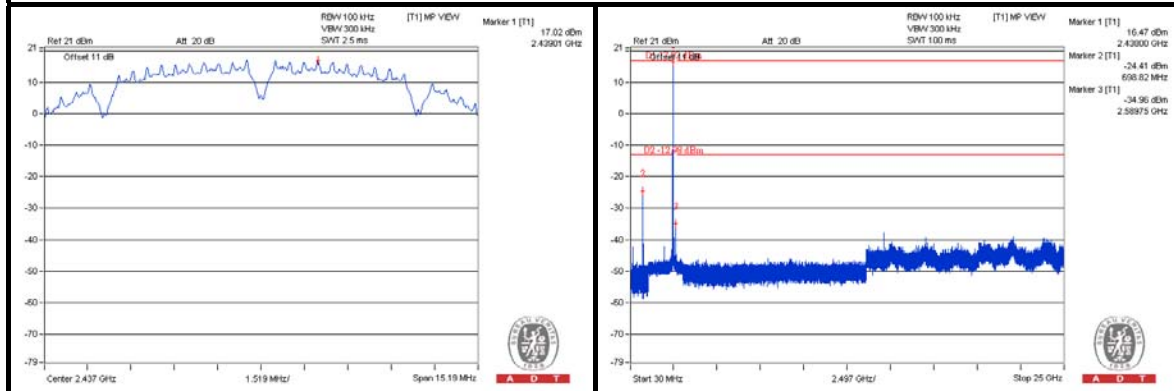

CH 11

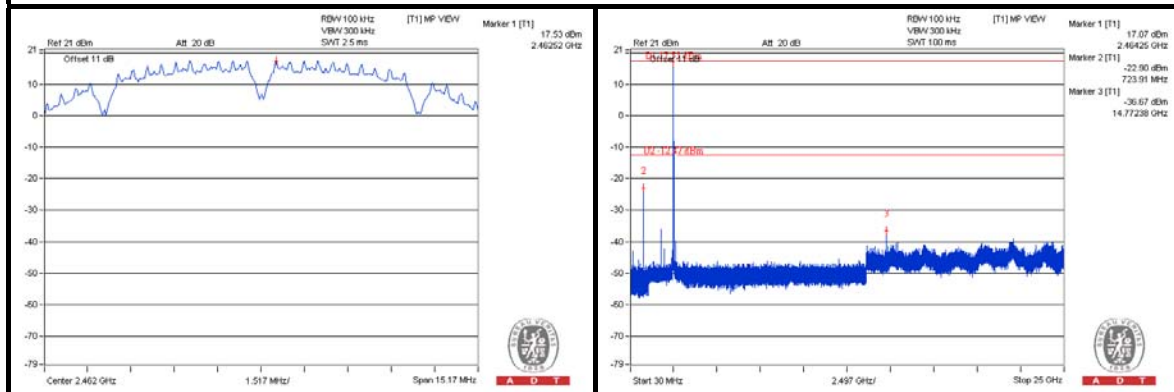

CH 1 Band edge

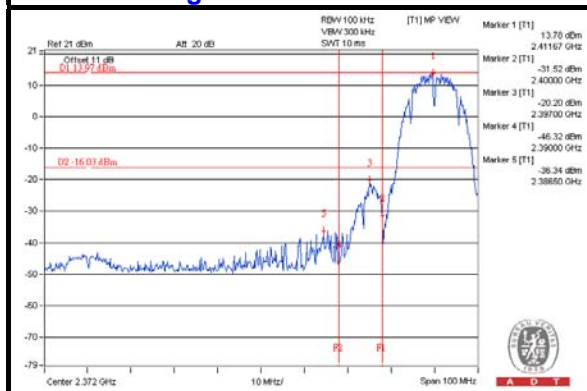

CH 11 Band edge

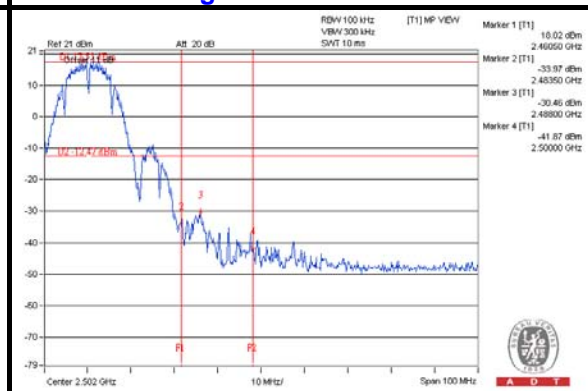



A D T

CHAIN 1

CH 1

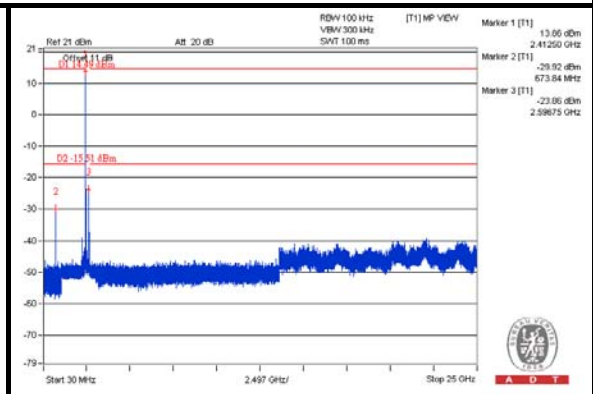
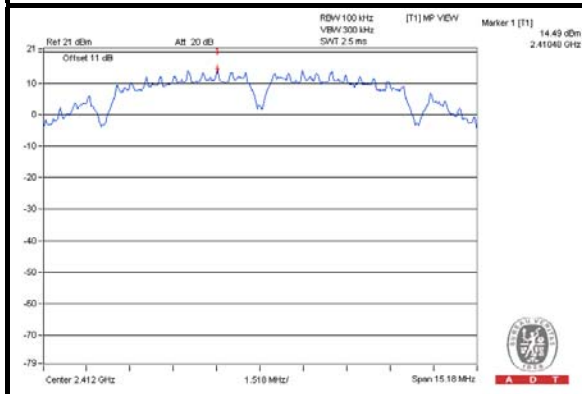

CH 6

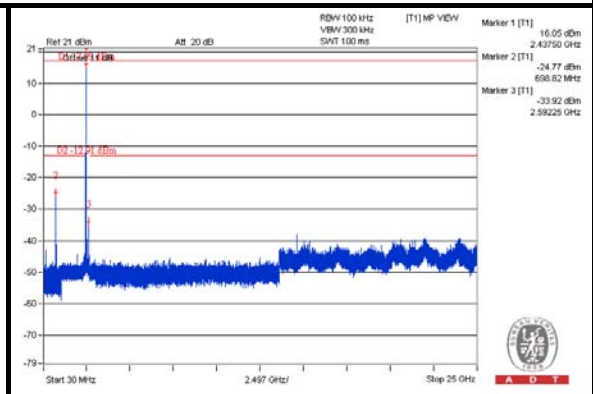
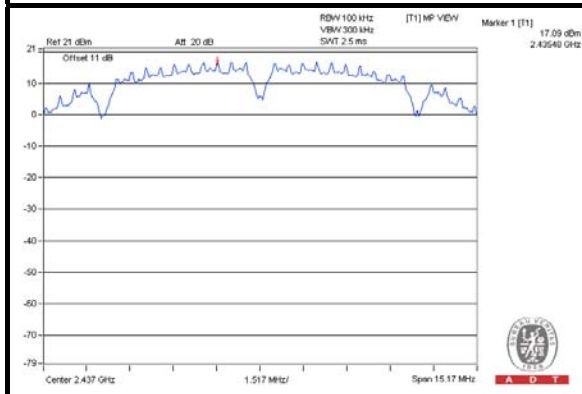

CH 11

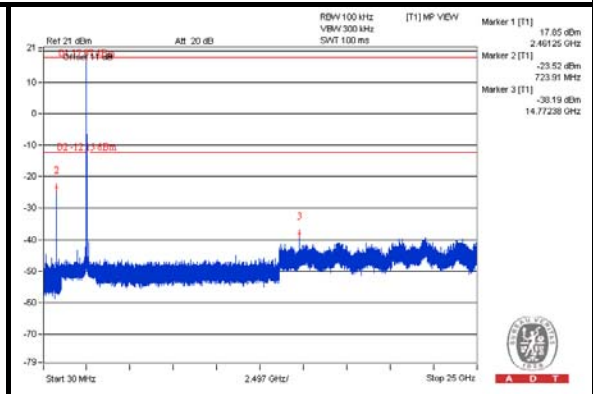
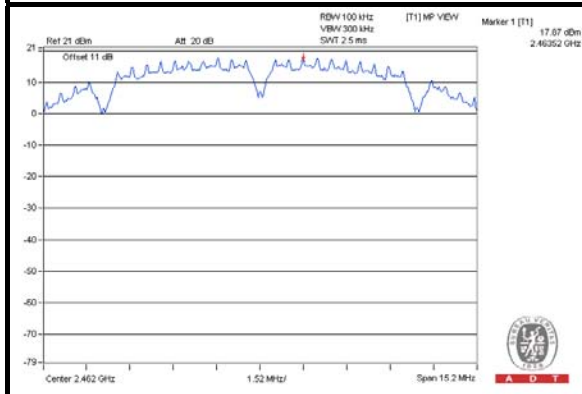

CH 1 Band edge

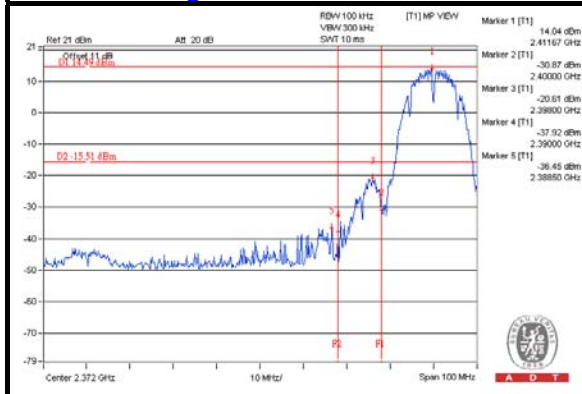

CH 11 Band edge

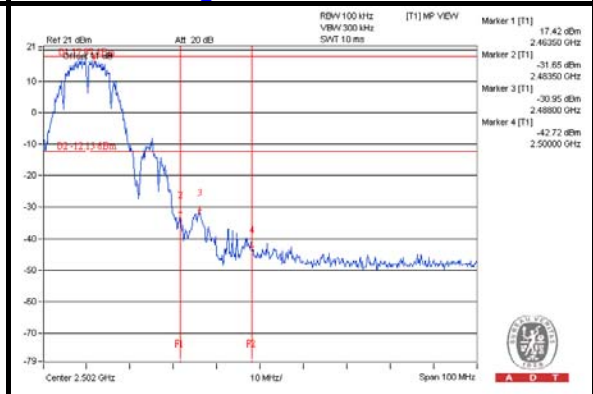



A D T

802.11g CHAIN 0

CH 1

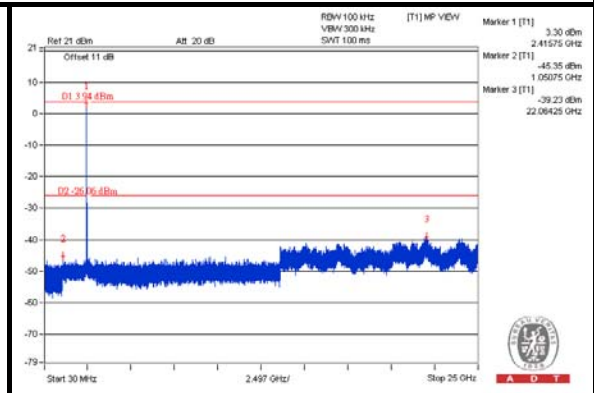
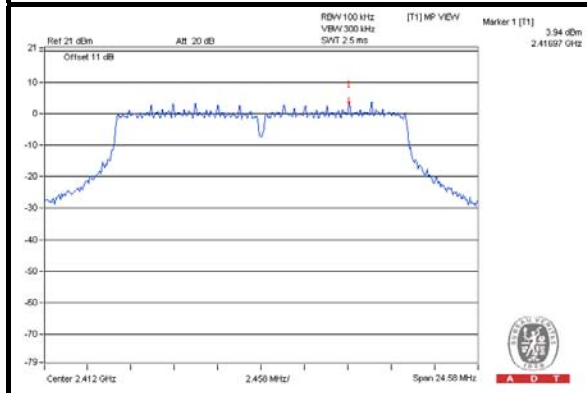

CH 6

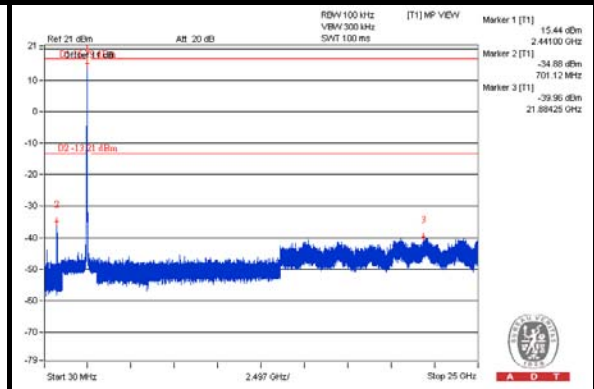
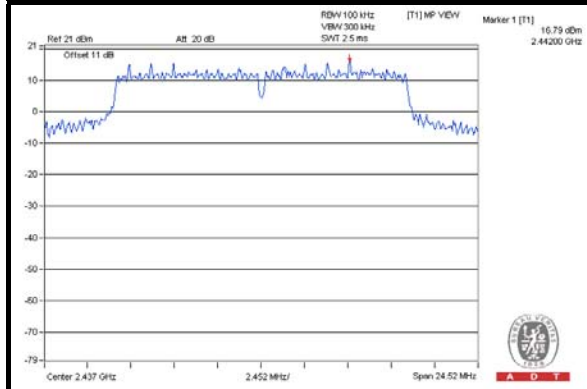

CH 11

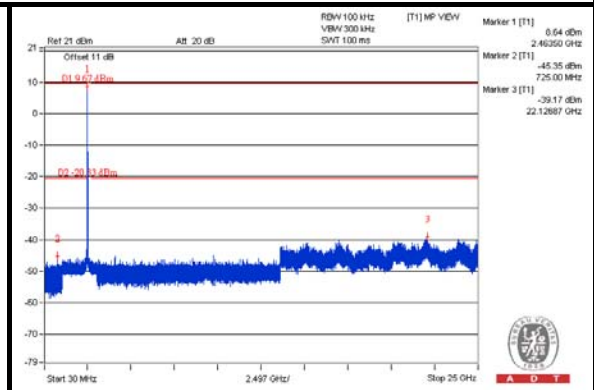
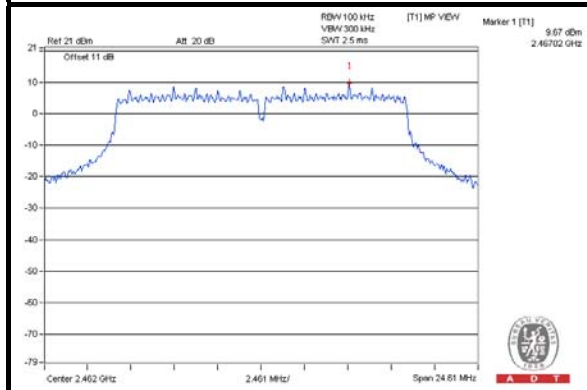

CH 1 Band edge

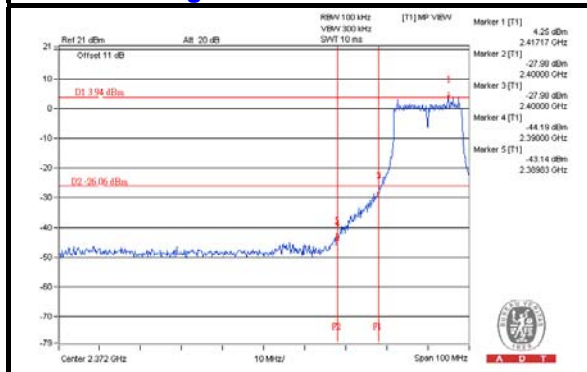

CH 11 Band edge

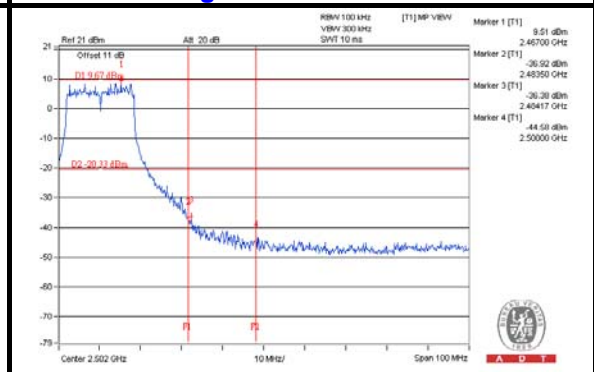



A D T

CHAIN 1

CH 1

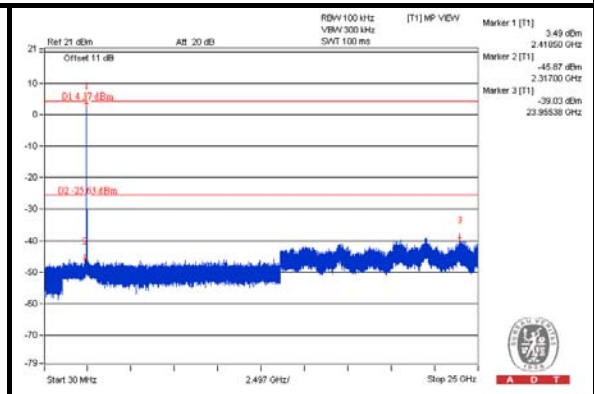
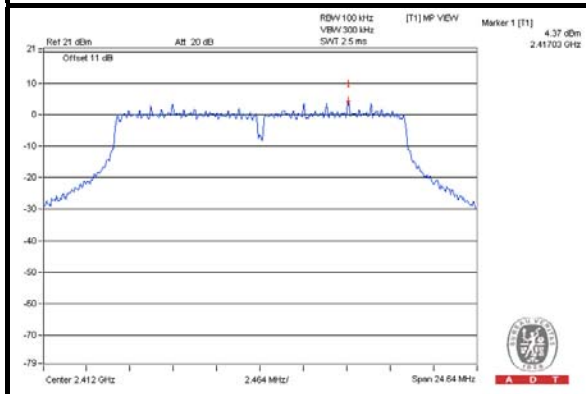

CH 6

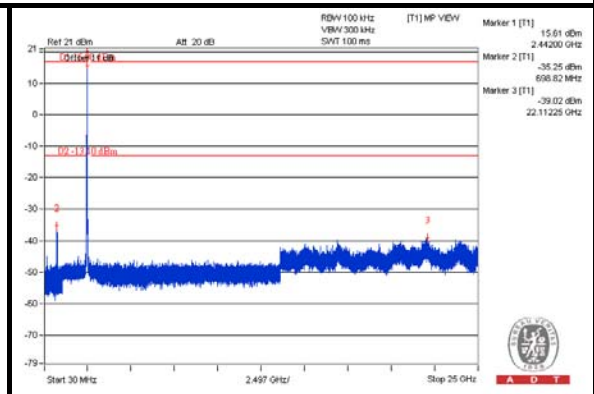
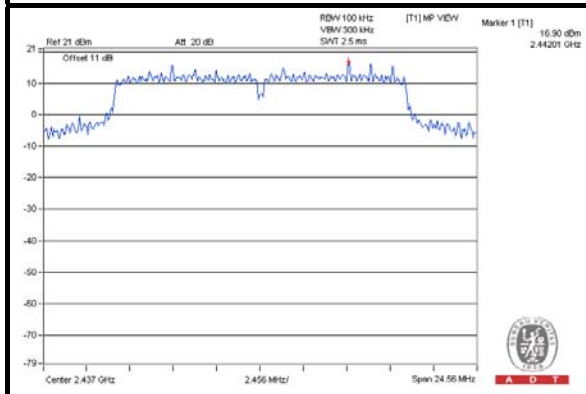

CH 11

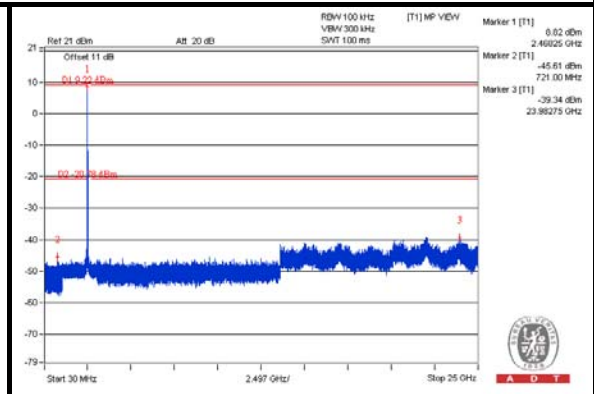
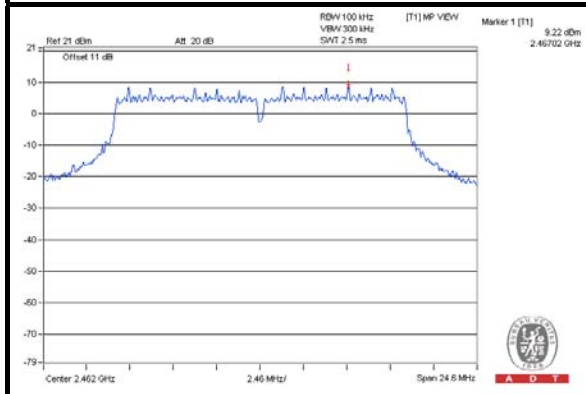

CH 1 Band edge

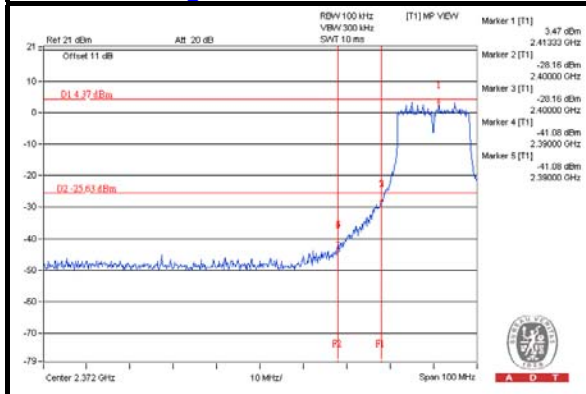

CH 11 Band edge

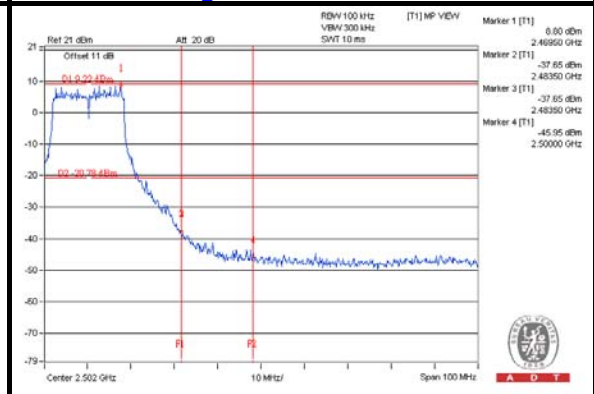



A D T

802.11n(20MHz) CHAIN 0

CH 1

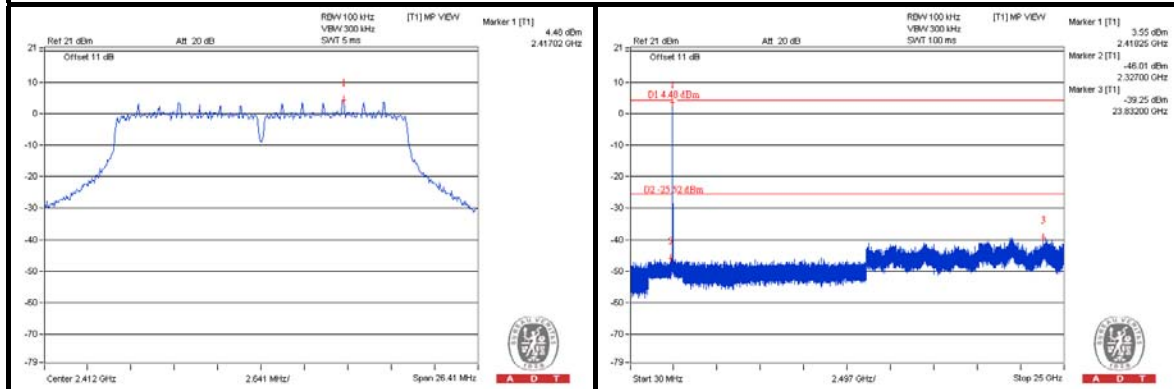

CH 6

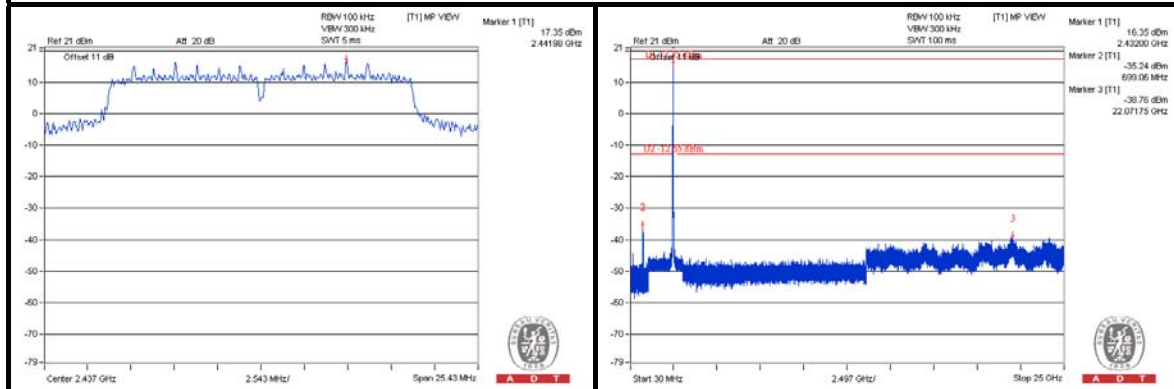

CH 11

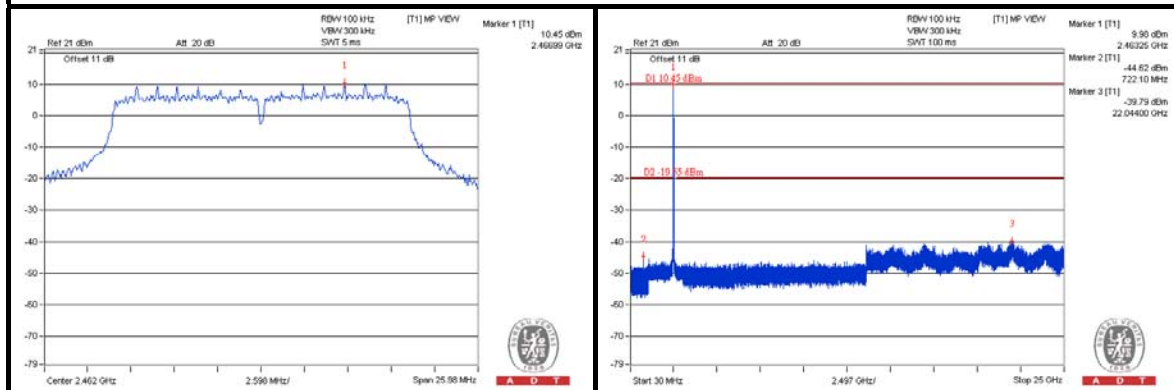

CH 1 Band edge

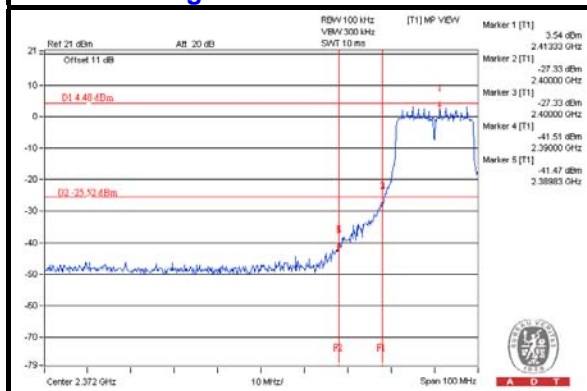

CH 11 Band edge

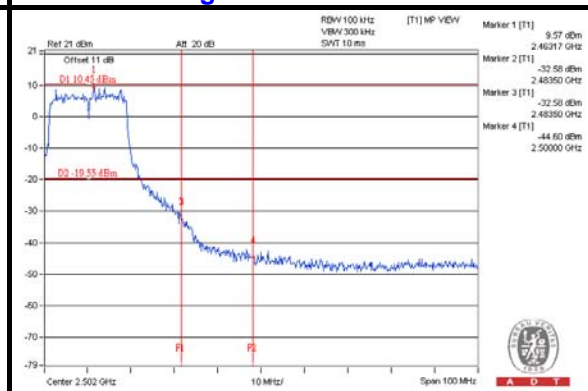



A D T

CHAIN 1

CH 1

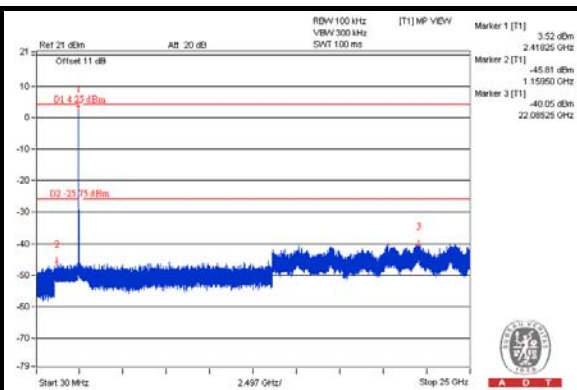
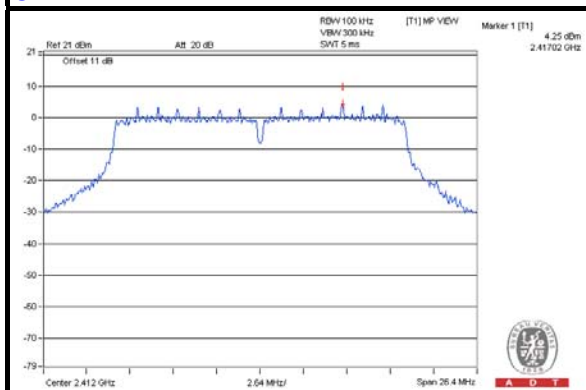

CH 6

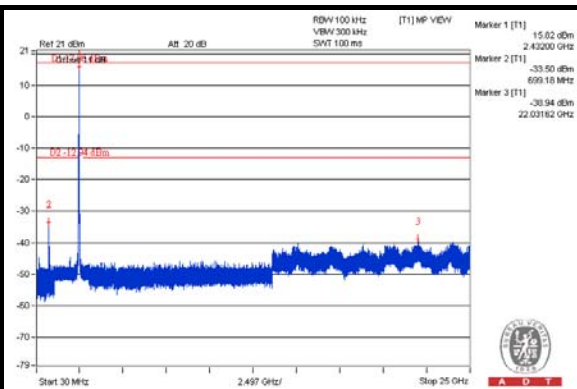
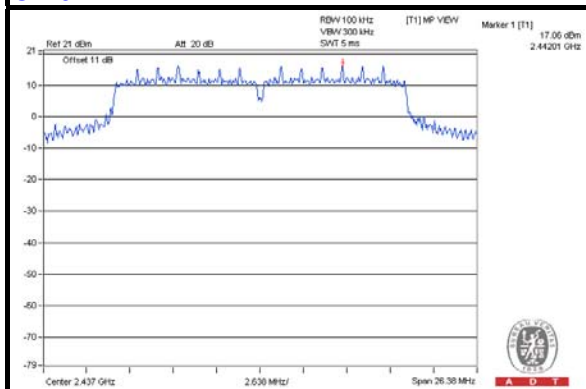

CH 11

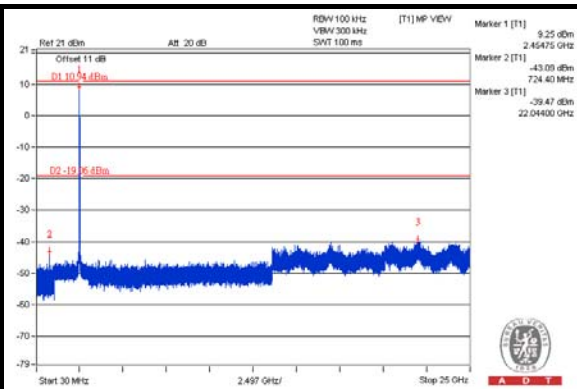
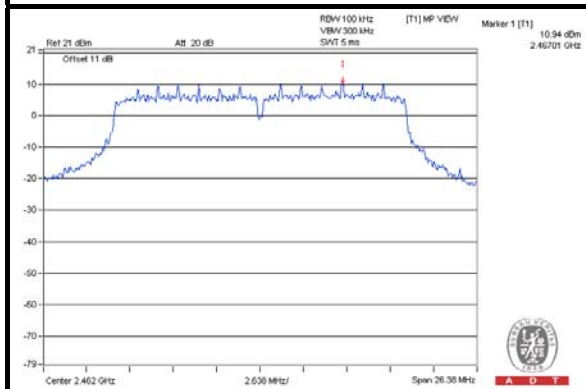

CH 1 Band edge

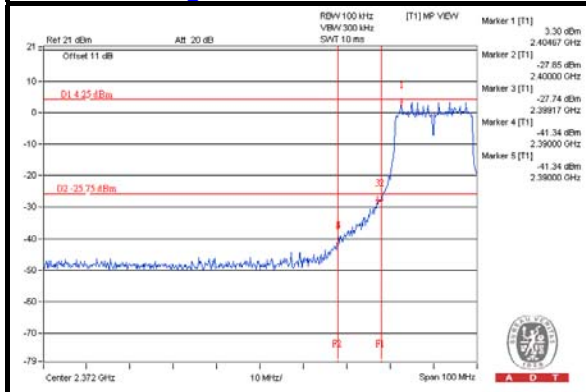

CH 11 Band edge

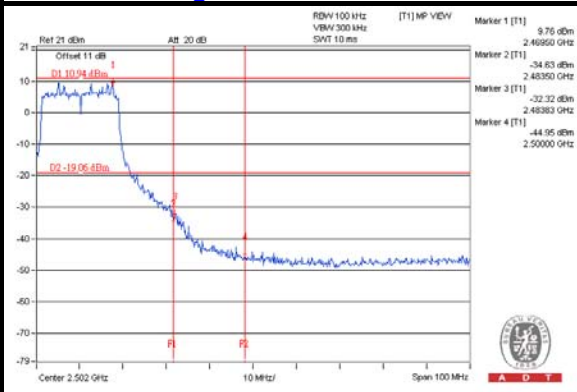



A D T

802.11n (40MHz) CHAIN 0

CH 3

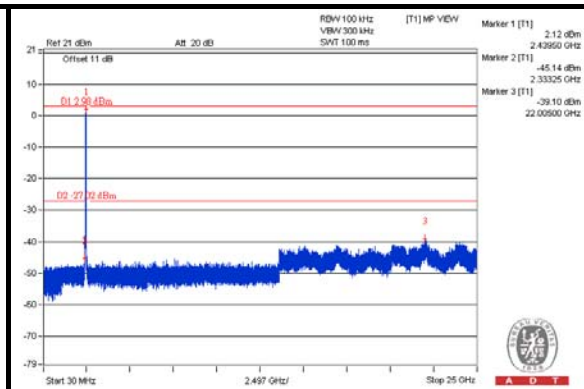
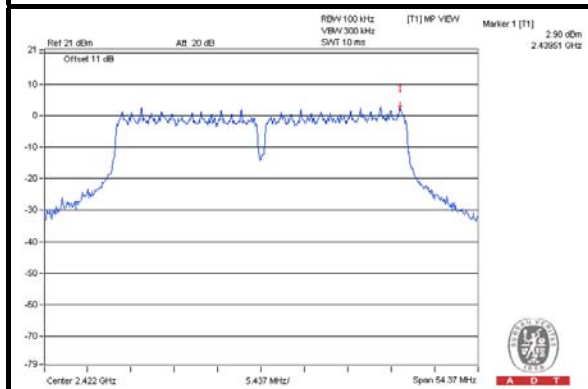

CH 6

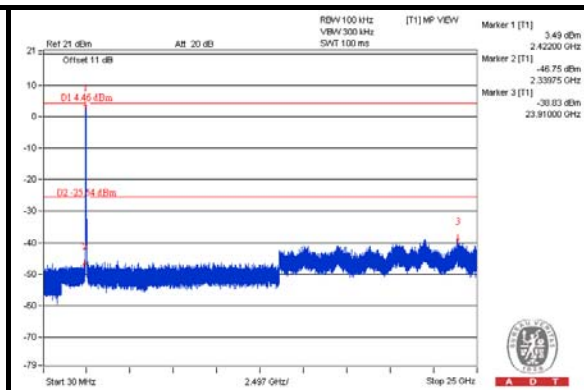
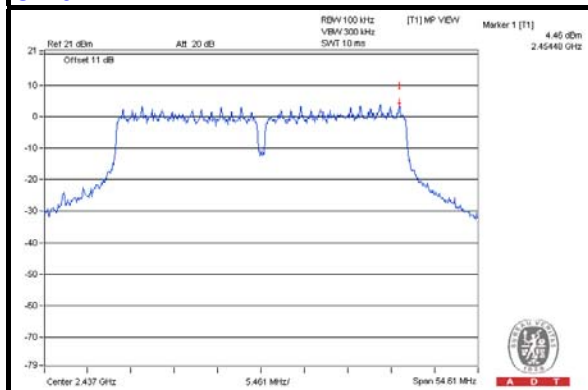

CH 9

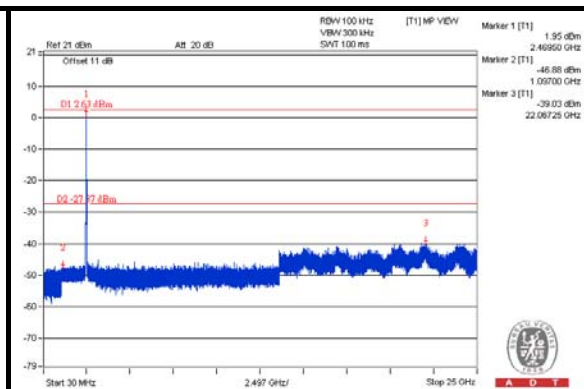
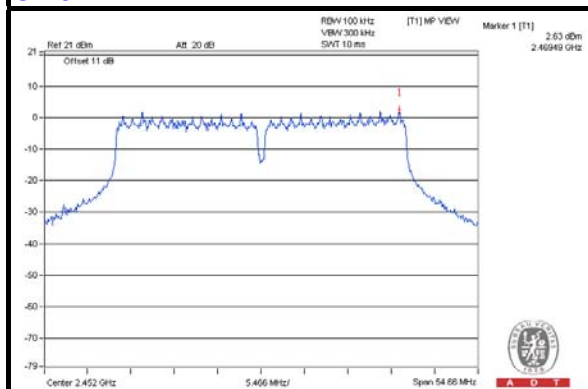

CH 3 Band edge

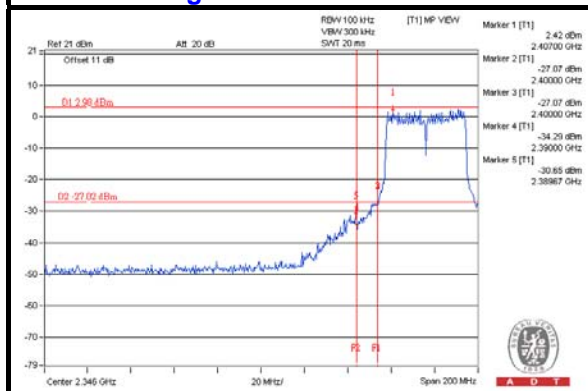

CH 9 Band edge

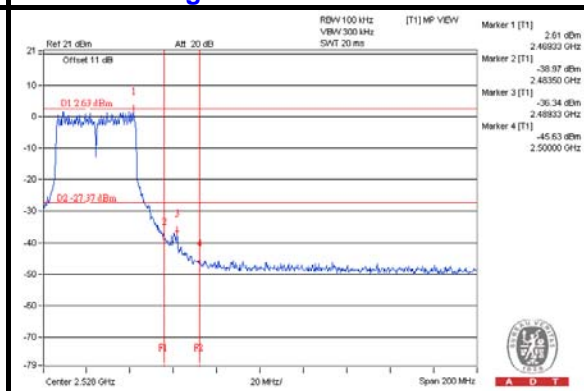



A D T

CHAIN 1

CH 3

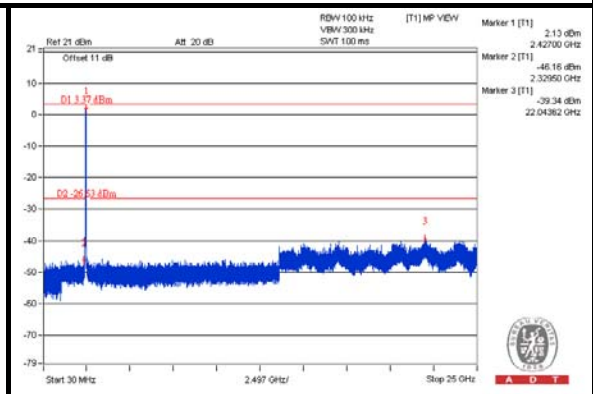
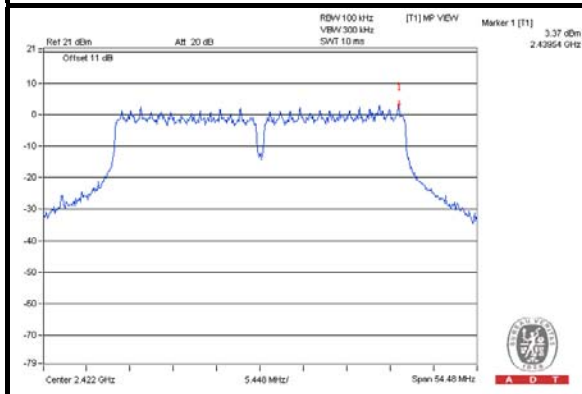

CH 6

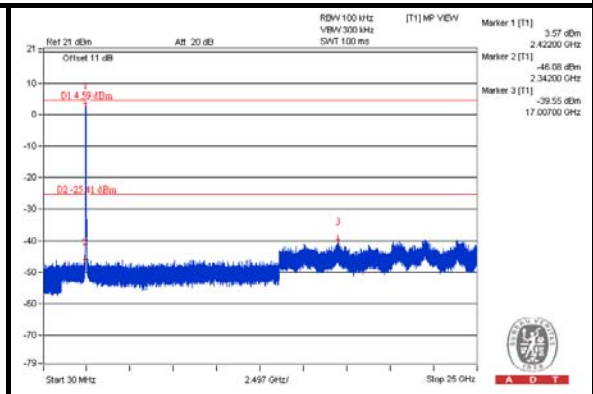
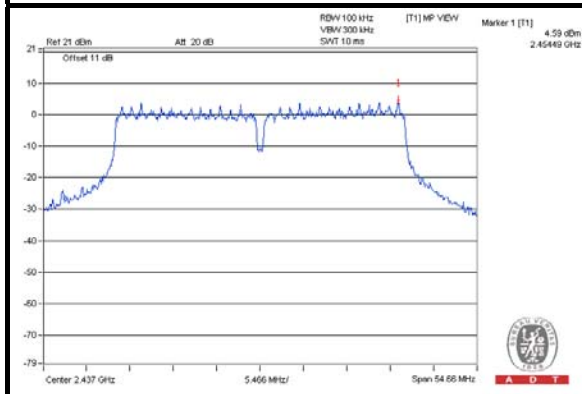

CH 9

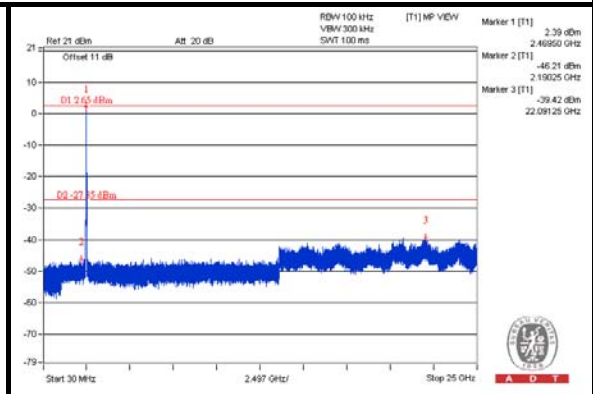
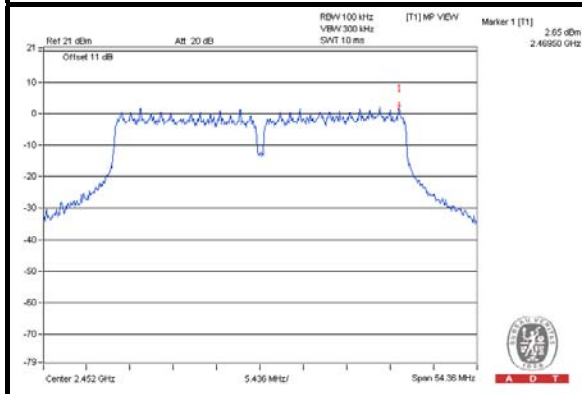

CH 3 Band edge

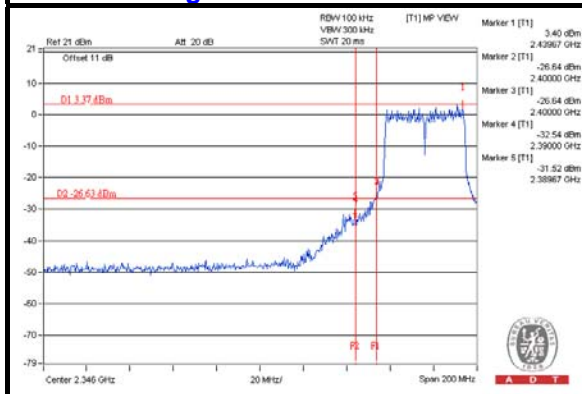

CH 9 Band edge

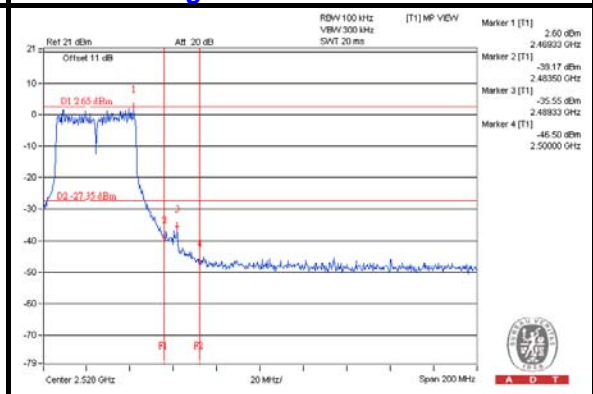



5. TEST TYPES AND RESULTS (FOR 5.0GHz BAND)

5.1 RADIATED EMISSION MEASUREMENT

5.1.1 LIMITS OF RADIATED EMISSION MEASUREMENT

Radiated emissions which fall in the restricted bands must comply with the radiated emission limits specified as below table. Other emissions shall be at least 30dB below the highest level of the desired power:

FREQUENCIES (MHz)	FIELD STRENGTH (microvolts/meter)	MEASUREMENT DISTANCE (meters)
0.009 ~ 0.490	2400/F(kHz)	300
0.490 ~ 1.705	24000/F(kHz)	30
1.705 ~ 30.0	30	30
30 ~ 88	100	3
88 ~ 216	150	3
216 ~ 960	200	3
Above 960	500	3

NOTE:

1. The lower limit shall apply at the transition frequencies.
2. Emission level (dBuV/m) = 20 log Emission level (uV/m).
3. For frequencies above 1000MHz, the field strength limits are based on average detector, however, the peak field strength of any emission shall not exceed the maximum permitted average limits, specified above by more than 30dB under any condition of modulation.



A D T

5.1.2 TEST INSTRUMENTS

Same as item 4.1.2.

5.1.3 TEST PROCEDURES

Same as item 4.1.3.

5.1.4 DEVIATION FROM TEST STANDARD

No deviation.

5.1.5 TEST SETUP

Same as item 4.1.5.

5.1.6 EUT OPERATING CONDITIONS

Same as item 4.1.6.



A D T

5.1.7 TEST RESULTS

ABOVE 1GHz DATA :

802.11a

EUT TEST CONDITION		MEASUREMENT DETAIL	
CHANNEL	Channel 149	FREQUENCY RANGE	1 ~ 40GHz
INPUT POWER	120Vac, 60 Hz	DETECTOR FUNCTION	Peak (PK) Average (AV)
ENVIRONMENTAL CONDITIONS	25deg. C, 65%RH	TESTED BY	Chris Lin

ANTENNA POLARITY & TEST DISTANCE: HORIZONTAL AT 3 M								
NO.	FREQ. (MHz)	EMISSION LEVEL (dBuV/m)	LIMIT (dBuV/m)	MARGIN (dB)	ANTENNA HEIGHT (m)	TABLE ANGLE (Degree)	RAW VALUE (dBuV)	CORRECTION FACTOR (dB/m)
1	#5725.00	80.5 PK	83.5	-3.0	1.64 H	56	73.40	7.10
2	#5725.00	71.2 AV	74.2	-3.0	1.64 H	56	64.10	7.10
3	*5745.00	113.5 PK			1.64 H	56	72.90	40.60
4	*5745.00	104.2 AV			1.64 H	56	63.60	40.60
5	11490.00	57.9 PK	74.0	-16.1	1.15 H	193	39.20	18.70
6	11490.00	45.1 AV	54.0	-8.9	1.15 H	193	26.40	18.70
ANTENNA POLARITY & TEST DISTANCE: VERTICAL AT 3 M								
NO.	FREQ. (MHz)	EMISSION LEVEL (dBuV/m)	LIMIT (dBuV/m)	MARGIN (dB)	ANTENNA HEIGHT (m)	TABLE ANGLE (Degree)	RAW VALUE (dBuV)	CORRECTION FACTOR (dB/m)
1	#5725.00	84.3 PK	87.4	-3.1	1.15 V	213	77.20	7.10
2	#5725.00	75.9 AV	78.9	-3.0	1.15 V	213	68.80	7.10
3	*5745.00	117.4 PK			1.21 V	203	76.80	40.60
4	*5745.00	108.9 AV			1.21 V	203	68.30	40.60
5	11490.00	66.2 PK	74.0	-7.8	1.48 V	349	47.50	18.70
6	11490.00	52.9 AV	54.0	-1.1	1.48 V	349	34.20	18.70

REMARKS:

1. Emission Level(dBuV/m) = Raw Value(dBuV) + Correction Factor(dB/m)
2. Correction Factor(dB/m) = Antenna Factor(dB/m) + Cable Factor(dB)
– Pre-Amplifier Factor(dB)
3. The other emission levels were very low against the limit.
4. Margin value = Emission Level – Limit value
5. “ * “: Fundamental frequency.
6. The limit value is defined as per 15.247.
7. "#":The radiated frequency is out the restricted band.



A D T

EUT TEST CONDITION		MEASUREMENT DETAIL	
CHANNEL	Channel 157	FREQUENCY RANGE	1 ~ 40GHz
INPUT POWER	120Vac, 60 Hz	DETECTOR FUNCTION	Peak (PK) Average (AV)
ENVIRONMENTAL CONDITIONS	25deg. C, 65%RH	TESTED BY	Chris Lin

ANTENNA POLARITY & TEST DISTANCE: HORIZONTAL AT 3 M								
NO.	FREQ. (MHz)	EMISSION LEVEL (dBuV/m)	LIMIT (dBuV/m)	MARGIN (dB)	ANTENNA HEIGHT (m)	TABLE ANGLE (Degree)	RAW VALUE (dBuV)	CORRECTION FACTOR (dB/m)
1	*5785.00	111.5 PK			1.00 H	335	70.80	40.70
2	*5785.00	102.1 AV			1.00 H	335	61.40	40.70
3	11570.00	60.7 PK	74.0	-13.3	1.30 H	220	41.90	18.80
4	11570.00	47.3 AV	54.0	-6.7	1.30 H	220	28.50	18.80
5	#17355.00	65.0 PK	81.5	-16.5	1.25 H	185	39.20	25.80
6	#17355.00	52.1 AV	72.1	-20.0	1.25 H	185	26.30	25.80
ANTENNA POLARITY & TEST DISTANCE: VERTICAL AT 3 M								
NO.	FREQ. (MHz)	EMISSION LEVEL (dBuV/m)	LIMIT (dBuV/m)	MARGIN (dB)	ANTENNA HEIGHT (m)	TABLE ANGLE (Degree)	RAW VALUE (dBuV)	CORRECTION FACTOR (dB/m)
1	*5785.00	118.5 PK			1.12 V	186	77.80	40.70
2	*5785.00	108.6 AV			1.12 V	186	67.90	40.70
3	11570.00	66.5 PK	74.0	-7.5	1.73 V	360	47.70	18.80
4	11570.00	52.6 AV	54.0	-1.4	1.73 V	360	33.80	18.80
5	#17355.00	64.9 PK	88.5	-23.6	1.03 V	23	39.10	25.80
6	#17355.00	52.5 AV	78.6	-26.1	1.03 V	23	26.70	25.80

REMARKS:

1. Emission Level(dBuV/m) = Raw Value(dBuV) + Correction Factor(dB/m)
2. Correction Factor(dB/m) = Antenna Factor(dB/m) + Cable Factor(dB) – Pre-Amplifier Factor(dB)
3. The other emission levels were very low against the limit.
4. Margin value = Emission Level – Limit value
5. “ * “: Fundamental frequency.
6. The limit value is defined as per 15.247.
7. “#“:The radiated frequency is out the restricted band.



A D T

EUT TEST CONDITION		MEASUREMENT DETAIL	
CHANNEL	Channel 165	FREQUENCY RANGE	1 ~ 40GHz
INPUT POWER	120Vac, 60 Hz	DETECTOR FUNCTION	Peak (PK) Average (AV)
ENVIRONMENTAL CONDITIONS	25deg. C, 65%RH	TESTED BY	Chris Lin

ANTENNA POLARITY & TEST DISTANCE: HORIZONTAL AT 3 M								
NO.	FREQ. (MHz)	EMISSION LEVEL (dBuV/m)	LIMIT (dBuV/m)	MARGIN (dB)	ANTENNA HEIGHT (m)	TABLE ANGLE (Degree)	RAW VALUE (dBuV)	CORRECTION FACTOR (dB/m)
1	*5825.00	111.3 PK			1.61 H	360	70.60	40.70
2	*5825.00	102.3 AV			1.61 H	360	61.60	40.70
3	#5850.00	77.3 PK	81.3	-4.0	1.55 H	13	70.30	7.00
4	#5850.00	68.3 AV	72.3	-4.0	1.55 H	13	61.30	7.00
5	11650.00	57.7 PK	74.0	-16.3	1.16 H	158	38.50	19.20
6	11650.00	44.9 AV	54.0	-9.1	1.16 H	158	25.70	19.20
ANTENNA POLARITY & TEST DISTANCE: VERTICAL AT 3 M								
NO.	FREQ. (MHz)	EMISSION LEVEL (dBuV/m)	LIMIT (dBuV/m)	MARGIN (dB)	ANTENNA HEIGHT (m)	TABLE ANGLE (Degree)	RAW VALUE (dBuV)	CORRECTION FACTOR (dB/m)
1	*5825.00	118.1 PK			1.10 V	185	77.40	40.70
2	*5825.00	108.8 AV			1.10 V	185	68.10	40.70
3	#5850.00	84.1 PK	88.1	-4.0	1.05 V	175	77.10	7.00
4	#5850.00	74.8 AV	78.8	-4.0	1.05 V	175	67.80	7.00
5	11650.00	63.1 PK	74.0	-10.9	1.30 V	13	43.90	19.20
6	11650.00	51.2 AV	54.0	-2.8	1.30 V	13	32.00	19.20

REMARKS:

1. Emission Level(dBuV/m) = Raw Value(dBuV) + Correction Factor(dB/m)
2. Correction Factor(dB/m) = Antenna Factor(dB/m) + Cable Factor(dB) – Pre-Amplifier Factor(dB)
3. The other emission levels were very low against the limit.
4. Margin value = Emission Level – Limit value
5. “ * “: Fundamental frequency.
6. The limit value is defined as per 15.247.
7. “#“:The radiated frequency is out the restricted band.



A D T

802.11n (20MHz)

EUT TEST CONDITION		MEASUREMENT DETAIL	
CHANNEL	Channel 149	FREQUENCY RANGE	1 ~ 40GHz
INPUT POWER	120Vac, 60 Hz	DETECTOR FUNCTION	Peak (PK) Average (AV)
ENVIRONMENTAL CONDITIONS	25deg. C, 65%RH	TESTED BY	Chris Lin

ANTENNA POLARITY & TEST DISTANCE: HORIZONTAL AT 3 M								
NO.	FREQ. (MHz)	EMISSION LEVEL (dBuV/m)	LIMIT (dBuV/m)	MARGIN (dB)	ANTENNA HEIGHT (m)	TABLE ANGLE (Degree)	RAW VALUE (dBuV)	CORRECTION FACTOR (dB/m)
1	#5725.00	78.0 PK	80.6	-2.6	1.25 H	326	70.90	7.10
2	#5725.00	69.4 AV	71.4	-2.0	1.25 H	326	62.30	7.10
3	*5745.00	110.6 PK			1.35 H	336	70.00	40.60
4	*5745.00	101.4 AV			1.35 H	336	60.80	40.60
5	11490.00	57.6 PK	74.0	-16.4	1.00 H	168	38.90	18.70
6	11490.00	45.5 AV	54.0	-8.5	1.00 H	168	26.80	18.70
ANTENNA POLARITY & TEST DISTANCE: VERTICAL AT 3 M								
NO.	FREQ. (MHz)	EMISSION LEVEL (dBuV/m)	LIMIT (dBuV/m)	MARGIN (dB)	ANTENNA HEIGHT (m)	TABLE ANGLE (Degree)	RAW VALUE (dBuV)	CORRECTION FACTOR (dB/m)
1	#5725.00	87.0 PK	89.1	-2.1	1.10 V	171	79.90	7.10
2	#5725.00	77.5 AV	79.5	-2.0	1.10 V	171	70.40	7.10
3	*5745.00	119.1 PK			1.12 V	181	78.50	40.60
4	*5745.00	109.5 AV			1.12 V	181	68.90	40.60
5	11490.00	66.6 PK	74.0	-7.4	1.61 V	353	47.90	18.70
6	11490.00	52.4 AV	54.0	-1.6	1.61 V	353	33.70	18.70

REMARKS:

1. Emission Level(dBuV/m) = Raw Value(dBuV) + Correction Factor(dB/m)
2. Correction Factor(dB/m) = Antenna Factor(dB/m) + Cable Factor(dB)
– Pre-Amplifier Factor(dB)
3. The other emission levels were very low against the limit.
4. Margin value = Emission Level – Limit value
5. " * ": Fundamental frequency.
6. The limit value is defined as per 15.247.
7. "#":The radiated frequency is out the restricted band.



A D T

EUT TEST CONDITION		MEASUREMENT DETAIL	
CHANNEL	Channel 157	FREQUENCY RANGE	1 ~ 40GHz
INPUT POWER	120Vac, 60 Hz	DETECTOR FUNCTION	Peak (PK) Average (AV)
ENVIRONMENTAL CONDITIONS	25deg. C, 65%RH	TESTED BY	Chris Lin

ANTENNA POLARITY & TEST DISTANCE: HORIZONTAL AT 3 M								
NO.	FREQ. (MHz)	EMISSION LEVEL (dBuV/m)	LIMIT (dBuV/m)	MARGIN (dB)	ANTENNA HEIGHT (m)	TABLE ANGLE (Degree)	RAW VALUE (dBuV)	CORRECTION FACTOR (dB/m)
1	*5785.00	110.6 PK			1.55 H	334	69.90	40.70
2	*5785.00	101.1 AV			1.55 H	334	60.40	40.70
3	11570.00	57.8 PK	74.0	-16.2	1.24 H	145	39.00	18.80
4	11570.00	45.3 AV	54.0	-8.7	1.24 H	145	26.50	18.80
5	#17355.00	65.5 PK	80.6	-15.1	1.12 H	80	39.70	25.80
6	#17355.00	51.9 AV	71.1	-19.2	1.12 H	80	26.10	25.80
ANTENNA POLARITY & TEST DISTANCE: VERTICAL AT 3 M								
NO.	FREQ. (MHz)	EMISSION LEVEL (dBuV/m)	LIMIT (dBuV/m)	MARGIN (dB)	ANTENNA HEIGHT (m)	TABLE ANGLE (Degree)	RAW VALUE (dBuV)	CORRECTION FACTOR (dB/m)
1	*5785.00	117.2 PK			1.11 V	202	76.50	40.70
2	*5785.00	108.1 AV			1.11 V	202	67.40	40.70
3	11570.00	66.0 PK	74.0	-8.0	1.84 V	348	47.20	18.80
4	11570.00	52.7 AV	54.0	-1.3	1.84 V	348	33.90	18.80
5	#17355.00	65.3 PK	87.2	-21.9	1.47 V	314	39.50	25.80
6	#17355.00	52.4 AV	78.1	-25.7	1.47 V	314	26.60	25.80

REMARKS:

1. Emission Level(dBuV/m) = Raw Value(dBuV) + Correction Factor(dB/m)
2. Correction Factor(dB/m) = Antenna Factor(dB/m) + Cable Factor(dB) – Pre-Amplifier Factor(dB)
3. The other emission levels were very low against the limit.
4. Margin value = Emission Level – Limit value
5. “ * “: Fundamental frequency.
6. The limit value is defined as per 15.247.
7. “#”:The radiated frequency is out the restricted band.



A D T

EUT TEST CONDITION		MEASUREMENT DETAIL	
CHANNEL	Channel 165	FREQUENCY RANGE	1 ~ 40GHz
INPUT POWER	120Vac, 60 Hz	DETECTOR FUNCTION	Peak (PK) Average (AV)
ENVIRONMENTAL CONDITIONS	25deg. C, 65%RH	TESTED BY	Chris Lin

ANTENNA POLARITY & TEST DISTANCE: HORIZONTAL AT 3 M								
NO.	FREQ. (MHz)	EMISSION LEVEL (dBuV/m)	LIMIT (dBuV/m)	MARGIN (dB)	ANTENNA HEIGHT (m)	TABLE ANGLE (Degree)	RAW VALUE (dBuV)	CORRECTION FACTOR (dB/m)
1	*5825.00	111.8 PK			1.36 H	10	71.10	40.70
2	*5825.00	101.9 AV			1.36 H	10	61.20	40.70
3	#5850.00	79.8 PK	81.8	-2.0	1.26 H	355	72.80	7.00
4	#5850.00	67.9 AV	71.9	-4.0	1.26 H	355	60.90	7.00
5	11650.00	57.2 PK	74.0	-16.8	1.22 H	214	38.00	19.20
6	11650.00	44.5 AV	54.0	-9.5	1.22 H	214	25.30	19.20
ANTENNA POLARITY & TEST DISTANCE: VERTICAL AT 3 M								
NO.	FREQ. (MHz)	EMISSION LEVEL (dBuV/m)	LIMIT (dBuV/m)	MARGIN (dB)	ANTENNA HEIGHT (m)	TABLE ANGLE (Degree)	RAW VALUE (dBuV)	CORRECTION FACTOR (dB/m)
1	*5825.00	117.8 PK			1.68 V	201	77.10	40.70
2	*5825.00	108.3 AV			1.68 V	201	67.60	40.70
3	#5850.00	83.8 PK	87.8	-4.0	1.58 V	188	76.80	7.00
4	#5850.00	74.3 AV	78.3	-4.0	1.58 V	188	67.30	7.00
5	11650.00	62.9 PK	74.0	-11.1	1.00 V	12	43.70	19.20
6	11650.00	50.7 AV	54.0	-3.3	1.00 V	12	31.50	19.20

REMARKS:

1. Emission Level(dBuV/m) = Raw Value(dBuV) + Correction Factor(dB/m)
2. Correction Factor(dB/m) = Antenna Factor(dB/m) + Cable Factor(dB) – Pre-Amplifier Factor(dB)
3. The other emission levels were very low against the limit.
4. Margin value = Emission Level – Limit value
5. “ * “: Fundamental frequency.
6. The limit value is defined as per 15.247.
7. “#“:The radiated frequency is out the restricted band.



A D T

802.11n (40MHz)

EUT TEST CONDITION		MEASUREMENT DETAIL	
CHANNEL	Channel 151	FREQUENCY RANGE	1 ~ 40GHz
INPUT POWER	120Vac, 60 Hz	DETECTOR FUNCTION	Peak (PK) Average (AV)
ENVIRONMENTAL CONDITIONS	25deg. C, 65%RH	TESTED BY	Chris Lin

ANTENNA POLARITY & TEST DISTANCE: HORIZONTAL AT 3 M								
NO.	FREQ. (MHz)	EMISSION LEVEL (dBuV/m)	LIMIT (dBuV/m)	MARGIN (dB)	ANTENNA HEIGHT (m)	TABLE ANGLE (Degree)	RAW VALUE (dBuV)	CORRECTION FACTOR (dB/m)
1	#5725.00	76.6 PK	77.6	-1.0	1.10 H	328	69.50	7.10
2	#5725.00	66.8 AV	67.8	-1.0	1.10 H	328	59.70	7.10
3	*5755.00	107.6 PK			1.19 H	338	66.90	40.70
4	*5755.00	97.8 AV			1.19 H	338	57.10	40.70
5	11510.00	57.1 PK	74.0	-16.9	1.07 H	276	38.40	18.70
6	11510.00	44.5 AV	54.0	-9.5	1.07 H	276	25.80	18.70
ANTENNA POLARITY & TEST DISTANCE: VERTICAL AT 3 M								
NO.	FREQ. (MHz)	EMISSION LEVEL (dBuV/m)	LIMIT (dBuV/m)	MARGIN (dB)	ANTENNA HEIGHT (m)	TABLE ANGLE (Degree)	RAW VALUE (dBuV)	CORRECTION FACTOR (dB/m)
1	#5725.00	82.3 PK	83.3	-1.0	1.10 V	157	75.20	7.10
2	#5725.00	72.8 AV	73.8	-1.0	1.10 V	157	65.70	7.10
3	*5755.00	113.3 PK			1.15 V	177	72.60	40.70
4	*5755.00	103.8 AV			1.15 V	177	63.10	40.70
5	11510.00	58.6 PK	74.0	-15.4	1.09 V	347	39.90	18.70
6	11510.00	45.6 AV	54.0	-8.4	1.09 V	347	26.90	18.70

REMARKS:

1. Emission Level(dBuV/m) = Raw Value(dBuV) + Correction Factor(dB/m)
2. Correction Factor(dB/m) = Antenna Factor(dB/m) + Cable Factor(dB) – Pre-Amplifier Factor(dB)
3. The other emission levels were very low against the limit.
4. Margin value = Emission Level – Limit value
5. “ * “: Fundamental frequency.
6. The limit value is defined as per 15.247.
7. “#”:The radiated frequency is out the restricted band.



A D T

EUT TEST CONDITION		MEASUREMENT DETAIL	
CHANNEL	Channel 159	FREQUENCY RANGE	1 ~ 40GHz
INPUT POWER	120Vac, 60 Hz	DETECTOR FUNCTION	Peak (PK) Average (AV)
ENVIRONMENTAL CONDITIONS	25deg. C, 65%RH	TESTED BY	Chris Lin

ANTENNA POLARITY & TEST DISTANCE: HORIZONTAL AT 3 M								
NO.	FREQ. (MHz)	EMISSION LEVEL (dBuV/m)	LIMIT (dBuV/m)	MARGIN (dB)	ANTENNA HEIGHT (m)	TABLE ANGLE (Degree)	RAW VALUE (dBuV)	CORRECTION FACTOR (dB/m)
1	*5795.00	108.2 PK			1.06 H	174	67.50	40.70
2	*5795.00	99.6 AV			1.06 H	174	58.90	40.70
3	#5850.00	70.2 PK	78.2	-8.0	1.00 H	154	63.20	7.00
4	#5850.00	61.6 AV	69.6	-8.0	1.00 H	154	54.60	7.00
5	11590.00	57.0 PK	74.0	-17.0	1.12 H	184	38.10	18.90
6	11590.00	44.4 AV	54.0	-9.6	1.12 H	184	25.50	18.90
ANTENNA POLARITY & TEST DISTANCE: VERTICAL AT 3 M								
NO.	FREQ. (MHz)	EMISSION LEVEL (dBuV/m)	LIMIT (dBuV/m)	MARGIN (dB)	ANTENNA HEIGHT (m)	TABLE ANGLE (Degree)	RAW VALUE (dBuV)	CORRECTION FACTOR (dB/m)
1	*5795.00	115.8 PK			1.00 V	200	75.10	40.70
2	*5795.00	106.0 AV			1.00 V	200	65.30	40.70
3	#5850.00	77.8 PK	85.8	-8.0	1.05 V	168	70.80	7.00
4	#5850.00	68.0 AV	76.0	-8.0	1.05 V	168	61.00	7.00
5	11590.00	65.6 PK	74.0	-8.4	1.49 V	303	46.70	18.90
6	11590.00	52.9 AV	54.0	-1.1	1.49 V	303	34.00	18.90

REMARKS:

1. Emission Level(dBuV/m) = Raw Value(dBuV) + Correction Factor(dB/m)
2. Correction Factor(dB/m) = Antenna Factor(dB/m) + Cable Factor(dB) – Pre-Amplifier Factor(dB)
3. The other emission levels were very low against the limit.
4. Margin value = Emission Level – Limit value
5. “ * “: Fundamental frequency.
6. The limit value is defined as per 15.247.
7. “#“:The radiated frequency is out the restricted band.



A D T

BELOW 1GHz WORST-CASE DATA : 802.11n (20MHz)

EUT TEST CONDITION		MEASUREMENT DETAIL	
CHANNEL	Channel 165	FREQUENCY RANGE	Below 1000MHz
INPUT POWER	120Vac, 60 Hz	DETECTOR FUNCTION	Quasi-Peak
ENVIRONMENTAL CONDITIONS	25deg. C, 68%RH	TESTED BY	Chris Lin
TEST MODE	A		

ANTENNA POLARITY & TEST DISTANCE: HORIZONTAL AT 3 M								
NO.	FREQ. (MHz)	EMISSION LEVEL (dBuV/m)	LIMIT (dBuV/m)	MARGIN (dB)	ANTENNA HEIGHT (m)	TABLE ANGLE (Degree)	RAW VALUE (dBuV)	CORRECTION FACTOR (dB/m)
1	88.23	34.4 QP	43.5	-9.1	1.99 H	96	54.10	-19.70
2	148.50	33.6 QP	43.5	-9.9	1.99 H	246	47.50	-13.90
3	177.67	33.6 QP	43.5	-9.9	1.24 H	255	48.70	-15.10
4	224.33	34.3 QP	46.0	-11.7	1.00 H	120	49.90	-15.60
5	475.14	30.5 QP	46.0	-15.5	1.99 H	140	39.80	-9.30
6	624.85	30.1 QP	46.0	-15.9	1.24 H	148	36.70	-6.60
ANTENNA POLARITY & TEST DISTANCE: VERTICAL AT 3 M								
NO.	FREQ. (MHz)	EMISSION LEVEL (dBuV/m)	LIMIT (dBuV/m)	MARGIN (dB)	ANTENNA HEIGHT (m)	TABLE ANGLE (Degree)	RAW VALUE (dBuV)	CORRECTION FACTOR (dB/m)
1	57.12	33.7 QP	40.0	-6.3	1.25 V	292	48.30	-14.60
2	74.62	36.6 QP	40.0	-3.4	1.25 V	112	53.60	-17.00
3	179.61	28.8 QP	43.5	-14.7	1.00 V	27	44.10	-15.30
4	249.60	29.0 QP	46.0	-17.0	1.99 V	206	43.50	-14.50
5	374.04	29.9 QP	46.0	-16.1	1.00 V	193	41.20	-11.30
6	500.42	27.0 QP	46.0	-19.0	1.00 V	203	35.90	-8.90

REMARKS:

1. Emission Level(dBuV/m) = Raw Value(dBuV) + Correction Factor(dB/m)
2. Correction Factor(dB/m) = Antenna Factor(dB/m) + Cable Factor(dB) – Pre-Amplifier Factor (dB)
3. The other emission levels were very low against the limit.
4. Margin value = Emission Level – Limit value



A D T

EUT TEST CONDITION		MEASUREMENT DETAIL	
CHANNEL	Channel 165	FREQUENCY RANGE	Below 1000MHz
INPUT POWER	48Vdc (POE)	DETECTOR FUNCTION	Quasi-Peak
ENVIRONMENTAL CONDITIONS	25deg. C, 68%RH	TESTED BY	Chris Lin
TEST MODE	B		

ANTENNA POLARITY & TEST DISTANCE: HORIZONTAL AT 3 M								
NO.	FREQ. (MHz)	EMISSION LEVEL (dBuV/m)	LIMIT (dBuV/m)	MARGIN (dB)	ANTENNA HEIGHT (m)	TABLE ANGLE (Degree)	RAW VALUE (dBuV)	CORRECTION FACTOR (dB/m)
1	228.22	33.6 QP	46.0	-12.4	1.50 H	219	49.10	-15.50
2	255.44	34.1 QP	46.0	-11.9	1.00 H	101	48.30	-14.20
3	374.04	37.9 QP	46.0	-8.1	1.00 H	207	49.20	-11.30
4	500.42	36.0 QP	46.0	-10.0	1.99 H	203	44.90	-8.90
5	624.85	36.0 QP	46.0	-10.0	1.24 H	207	42.60	-6.60
6	875.67	33.1 QP	46.0	-12.9	1.00 H	247	34.60	-1.50

ANTENNA POLARITY & TEST DISTANCE: VERTICAL AT 3 M								
NO.	FREQ. (MHz)	EMISSION LEVEL (dBuV/m)	LIMIT (dBuV/m)	MARGIN (dB)	ANTENNA HEIGHT (m)	TABLE ANGLE (Degree)	RAW VALUE (dBuV)	CORRECTION FACTOR (dB/m)
1	39.62	32.9 QP	40.0	-7.1	1.00 V	281	47.40	-14.50
2	185.44	28.1 QP	43.5	-15.4	1.00 V	212	43.70	-15.60
3	253.49	34.4 QP	46.0	-11.6	1.00 V	266	48.80	-14.40
4	374.04	35.1 QP	46.0	-10.9	1.25 V	173	46.40	-11.30
5	500.42	35.9 QP	46.0	-10.1	1.00 V	204	44.80	-8.90
6	675.40	28.9 QP	46.0	-17.1	1.50 V	153	35.00	-6.10

REMARKS:

1. Emission Level(dBuV/m) = Raw Value(dBuV) + Correction Factor(dB/m)
2. Correction Factor(dB/m) = Antenna Factor(dB/m) + Cable Factor(dB)
 - Pre-Amplifier Factor (dB)
3. The other emission levels were very low against the limit.
4. Margin value = Emission Level – Limit value



5.2 CONDUCTED EMISSION MEASUREMENT

5.2.1 LIMITS OF CONDUCTED EMISSION MEASUREMENT

FREQUENCY OF EMISSION (MHz)	CONDUCTED LIMIT (dBµV)	
	Quasi-peak	Average
0.15 ~ 0.5	66 to 56	56 to 46
0.5 ~ 5	56	46
5 ~ 30	60	50

- NOTE:** 1. The lower limit shall apply at the transition frequencies.
2. The limit decreases in line with the logarithm of the frequency in the range of 0.15 to 0.50MHz.
3. All emanations from a class A/B digital device or system, including any network of conductors and apparatus connected thereto, shall not exceed the level of field strengths specified above.

5.2.2 TEST INSTRUMENTS

Same as item 4.2.2.

5.2.3 TEST PROCEDURES

Same as item 4.2.3.

5.2.4 DEVIATION FROM TEST STANDARD

No deviation.

5.2.5 TEST SETUP

Same as item 4.2.5.

5.2.6 EUT OPERATING CONDITIONS

Same as item 4.1.6.



A D T

5.2.7 TEST RESULTS

CONDUCTED WORST-CASE DATA : 802.11n (20MHz)

PHASE	Line 1	6dB BANDWIDTH	9kHz
TEST MODE	A		

No	Freq. [MHz]	Corr. Factor (dB)	Reading Value		Emission Level		Limit		Margin	
			[dB (uV)]		[dB (uV)]		[dB (uV)]		(dB)	
			Q.P.	AV.	Q.P.	AV.	Q.P.	AV.	Q.P.	AV.
1	0.15000	0.11	49.26	30.97	49.37	31.08	66.00	56.00	-16.63	-24.92
2	0.25547	0.10	38.22	25.35	38.32	25.45	61.58	51.58	-23.26	-26.13
3	0.54453	0.13	40.26	34.53	40.39	34.66	56.00	46.00	-15.61	-11.34
4	1.98047	0.25	35.45	30.21	35.70	30.46	56.00	46.00	-20.30	-15.54
5	3.89063	0.26	36.28	29.61	36.54	29.87	56.00	46.00	-19.46	-16.13
6	12.95313	0.72	33.42	27.49	34.14	28.21	60.00	50.00	-25.86	-21.79

REMARKS:

1. Q.P. and AV. are abbreviations of quasi-peak and average individually.
2. The emission levels of other frequencies were very low against the limit.
3. Margin value = Emission level - Limit value
4. Correction factor = Insertion loss + Cable loss
5. Emission Level = Correction Factor + Reading Value.

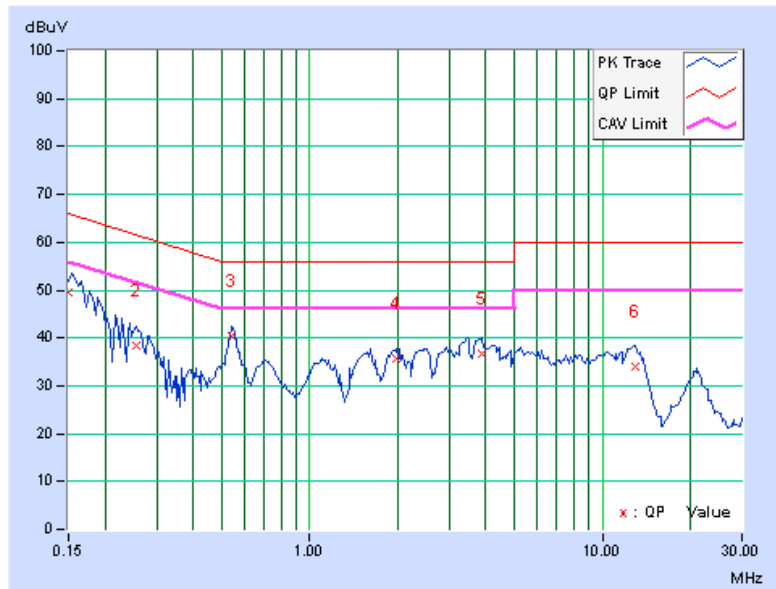



A D T

PHASE	Line 2	6dB BANDWIDTH	9kHz
TEST MODE	A		

No	Freq. [MHz]	Corr. Factor (dB)	Reading Value		Emission Level		Limit		Margin	
			[dB (uV)]		[dB (uV)]		[dB (uV)]		(dB)	
			Q.P.	AV.	Q.P.	AV.	Q.P.	AV.	Q.P.	AV.
1	0.15000	0.05	49.66	33.69	49.71	33.74	66.00	56.00	-16.29	-22.26
2	0.23203	0.10	41.38	27.11	41.48	27.21	62.38	52.38	-20.89	-25.16
3	0.54063	0.18	40.22	34.12	40.40	34.30	56.00	46.00	-15.60	-11.70
4	2.44922	0.23	35.59	30.23	35.82	30.46	56.00	46.00	-20.18	-15.54
5	3.73047	0.25	36.65	31.21	36.90	31.46	56.00	46.00	-19.10	-14.54
6	12.71094	0.67	34.29	29.05	34.96	29.72	60.00	50.00	-25.04	-20.28

REMARKS:

1. Q.P. and AV. are abbreviations of quasi-peak and average individually.
2. The emission levels of other frequencies were very low against the limit.
3. Margin value = Emission level - Limit value
4. Correction factor = Insertion loss + Cable loss
5. Emission Level = Correction Factor + Reading Value.

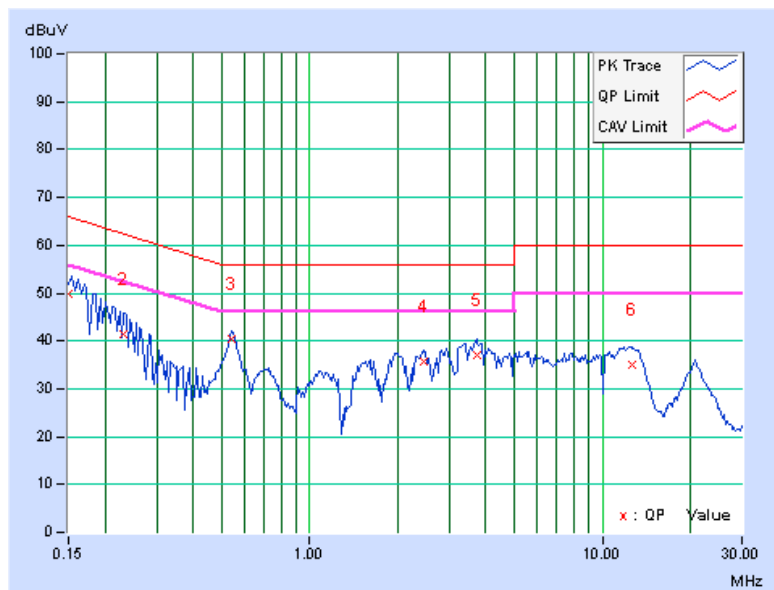



A D T

PHASE	Line 1	6dB BANDWIDTH	9kHz
TEST MODE	B		

No	Freq. [MHz]	Corr. Factor (dB)	Reading Value		Emission Level		Limit		Margin	
			[dB (uV)]		[dB (uV)]		[dB (uV)]		(dB)	
			Q.P.	AV.	Q.P.	AV.	Q.P.	AV.	Q.P.	AV.
1	0.18516	0.10	46.80	41.21	46.90	41.31	64.25	54.25	-17.35	-12.94
2	0.36875	0.11	37.01	35.49	37.12	35.60	58.53	48.53	-21.41	-12.93
3	0.92344	0.20	34.82	33.12	35.02	33.32	56.00	46.00	-20.98	-12.68
4	3.32031	0.26	34.61	32.97	34.87	33.23	56.00	46.00	-21.13	-12.77
5	9.42277	0.52	32.73	30.78	33.25	31.30	60.00	50.00	-26.75	-18.70
6	14.84375	0.82	30.88	30.58	31.70	31.40	60.00	50.00	-28.30	-18.60

REMARKS:

1. Q.P. and AV. are abbreviations of quasi-peak and average individually.
2. The emission levels of other frequencies were very low against the limit.
3. Margin value = Emission level - Limit value
4. Correction factor = Insertion loss + Cable loss
5. Emission Level = Correction Factor + Reading Value.

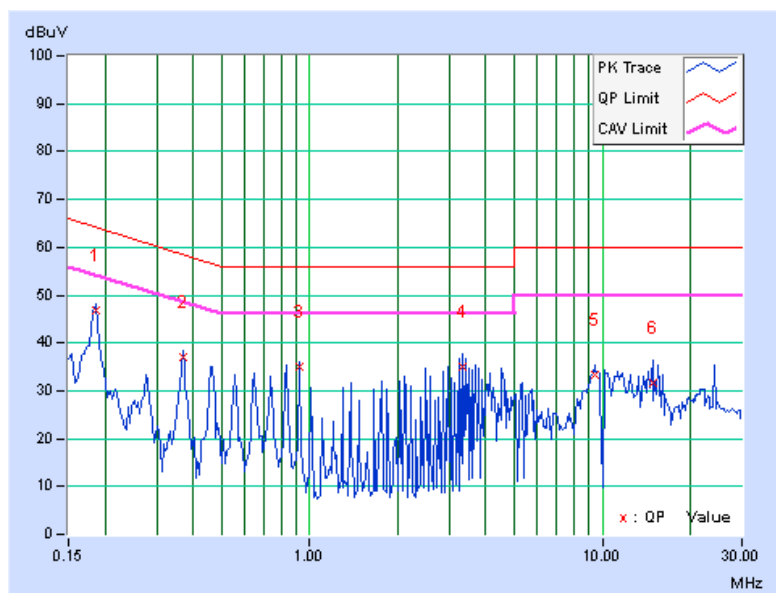



A D T

PHASE	Line 2	6dB BANDWIDTH	9kHz
TEST MODE	B		

No	Freq. [MHz]	Corr. Factor (dB)	Reading Value		Emission Level		Limit		Margin	
			[dB (uV)]		[dB (uV)]		[dB (uV)]		(dB)	
			Q.P.	AV.	Q.P.	AV.	Q.P.	AV.	Q.P.	AV.
1	0.18516	0.08	44.87	36.75	44.95	36.83	64.25	54.25	-19.30	-17.42
2	0.64609	0.19	35.63	33.19	35.82	33.38	56.00	46.00	-20.18	-12.62
3	0.92344	0.21	34.07	31.78	34.28	31.99	56.00	46.00	-21.72	-14.01
4	2.12500	0.22	25.12	24.16	25.34	24.38	56.00	46.00	-30.66	-21.62
5	3.78906	0.26	33.01	30.69	33.27	30.95	56.00	46.00	-22.73	-15.05
6	9.91486	0.54	31.78	27.53	32.32	28.07	60.00	50.00	-27.68	-21.93

REMARKS:

1. Q.P. and AV. are abbreviations of quasi-peak and average individually.
2. The emission levels of other frequencies were very low against the limit.
3. Margin value = Emission level - Limit value
4. Correction factor = Insertion loss + Cable loss
5. Emission Level = Correction Factor + Reading Value.

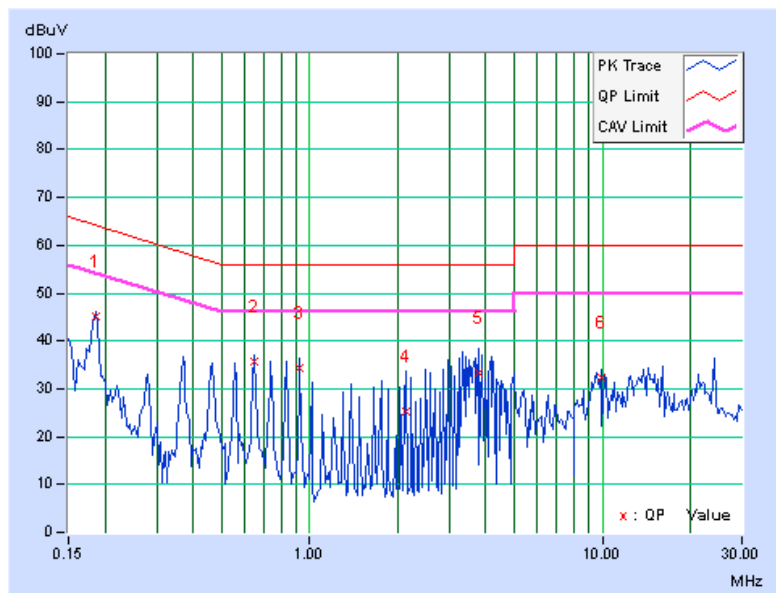



A D T

5.3 6dB BANDWIDTH MEASUREMENT

5.3.1 LIMITS OF 6dB BANDWIDTH MEASUREMENT

The minimum of 6dB Bandwidth Measurement is 0.5MHz.

5.3.2 TEST SETUP

Same as item 4.3.2.

5.3.3 TEST INSTRUMENTS

Refer to section 4.1.2 to get information of above instrument.

5.3.4 TEST PROCEDURE

Same as item 4.3.4.

5.3.5 DEVIATION FROM TEST STANDARD

No deviation.

5.3.6 EUT OPERATING CONDITIONS

Same as item 4.3.6.



5.3.7 TEST RESULTS

802.11a

CHANNEL	FREQUENCY (MHz)	6dB BANDWIDTH (MHz)		MINIMUM LIMIT (MHz)	PASS / FAIL
		CHAIN 0	CHAIN 1		
149	5745	16.38	16.38	0.5	PASS
157	5785	16.38	16.36	0.5	PASS
165	5825	16.35	16.38	0.5	PASS

802.11n (20MHz)

CHANNEL	FREQUENCY (MHz)	6dB BANDWIDTH (MHz)		MINIMUM LIMIT (MHz)	PASS / FAIL
		CHAIN 0	CHAIN 1		
149	5745	17.57	17.58	0.5	PASS
157	5785	16.38	17.35	0.5	PASS
165	5825	16.36	16.94	0.5	PASS

802.11n (40MHz)

CHANNEL	FREQUENCY (MHz)	6dB BANDWIDTH (MHz)		MINIMUM LIMIT (MHz)	PASS / FAIL
		CHAIN 0	CHAIN 1		
151	5755	36.05	36.28	0.5	PASS
159	5795	36.21	36.36	0.5	PASS



A D T

SPECTRUM PLOT OF WORST VALUE

802.11a

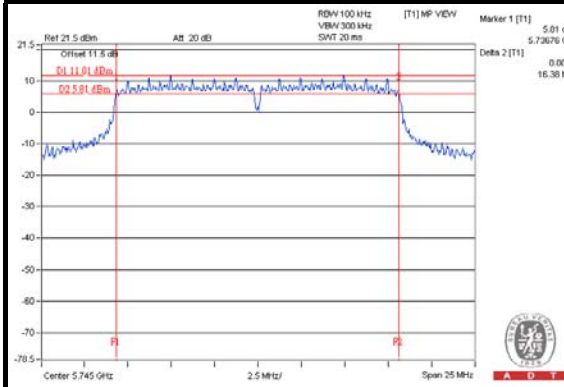

802.11n (20MHz)

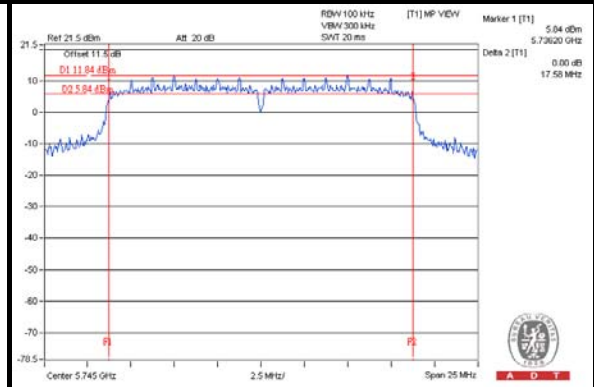

802.11n (40MHz)

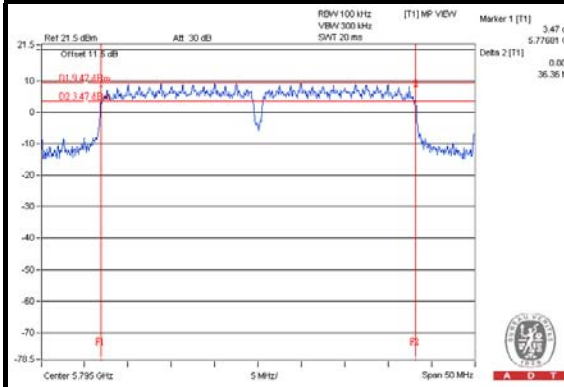



A D T

5.4 CONDUCTED OUTPUT POWER

5.4.1 LIMITS OF CONDUCTED OUTPUT POWER MEASUREMENT

For systems using digital modulation in the 5725 –5850 MHz bands: 1 Watt (30dBm)

Per KDB 662911 D01 Multiple Transmitter Output v02r01 Method of conducted output power measurement on IEEE 802.11 devices,

Array Gain = 0 dB (i.e., no array gain) for $NANT \leq 4$;

Array Gain = 0 dB (i.e., no array gain) for channel widths ≥ 40 MHz for any NANT;

Array Gain = $5 \log(NANT/NSS)$ dB or 3 dB, whichever is less for 20-MHz channel widths with $NANT \geq 5$.

For power measurements on all other devices: Array Gain = $10 \log(NANT/NSS)$ dB.

5.4.2 TEST SETUP

Same as Item 4.4.2.

5.4.3 INSTRUMENTS

Refer to section 4.1.2 to get information of above instrument.

5.4.4 TEST PROCEDURES

Same as Item 4.4.4.

5.4.5 DEVIATION FROM TEST STANDARD

No deviation.

5.4.6 EUT OPERATING CONDITIONS

Same as Item 4.3.6.



A D T

5.4.7 TEST RESULTS

802.11a

CHAN.	FREQUENCY (MHz)	AVG. POWER (dBm)		TOTAL POWER (mW)	TOTAL POWER (dBm)	LIMIT (dBm)	PASS / FAIL
		CHAIN 0	CHAIN 1				
149	5745	22.92	21.46	335.84	25.26	30	PASS
157	5785	23.43	21.48	360.90	25.57	30	PASS
165	5825	25.58	25.54	719.51	28.57	30	PASS

802.11n (20MHz)

CHAN.	FREQUENCY (MHz)	AVG. POWER (dBm)		TOTAL POWER (mW)	TOTAL POWER (dBm)	LIMIT (dBm)	PASS / FAIL
		CHAIN 0	CHAIN 1				
149	5745	23.09	21.39	341.43	25.33	30	PASS
157	5785	23.10	20.39	313.57	24.96	30	PASS
165	5825	25.73	25.56	733.86	28.66	30	PASS

802.11n (40MHz)

CHAN.	FREQUENCY (MHz)	AVG. POWER (dBm)		TOTAL POWER (mW)	TOTAL POWER (dBm)	LIMIT (dBm)	PASS / FAIL
		CHAIN 0	CHAIN 1				
151	5755	21.11	20.55	242.62	23.85	30	PASS
159	5795	25.34	25.97	737.35	28.68	30	PASS



A D T

5.5 POWER SPECTRAL DENSITY MEASUREMENT

5.5.1 LIMITS OF POWER SPECTRAL DENSITY MEASUREMENT

The Maximum of Power Spectral Density Measurement is 8dBm.

5.5.2 TEST SETUP

Same as item 4.5.2.

5.5.3 TEST INSTRUMENTS

Refer to section 4.1.2 to get information of above instrument.

5.5.4 TEST PROCEDURE.

Same as item 4.5.4.

5.5.5 DEVIATION FROM TEST STANDARD

No deviation.

5.5.6 EUT OPERATING CONDITION

Same as item 4.3.6.



5.5.7 TEST RESULTS

802.11a

TX chain	Chan.	Freq. (MHz)	PSD (dBm/3kHz)	10 log (N=2) dB	Total PSD W/O DUTY FACTOR (dBm/3kHz)	DUTY FACTOR	Total PSD WITH DUTY FACTOR (dBm/3kHz)	Limit (dBm/3kHz)	PASS /FAIL
0	149	5745	-10.06	3.01	-7.05	0.15	-6.90	8	PASS
	157	5785	-9.77	3.01	-6.76	0.15	-6.61	8	PASS
	165	5825	-10.70	3.01	-7.69	0.15	-7.54	8	PASS
1	149	5745	-10.25	3.01	-7.24	0.15	-7.09	8	PASS
	157	5785	-10.54	3.01	-7.53	0.15	-7.38	8	PASS
	165	5825	-10.57	3.01	-7.56	0.15	-7.41	8	PASS

NOTE: Directional gain = 2dBi + 10log(2) = 5.01dBi < 6dBi , therefore the limit no need to reduced.

802.11n (20MHz)

TX chain	Chan.	Freq. (MHz)	PSD (dBm/3kHz)	10 log (N=2) dB	Total PSD W/O DUTY FACTOR (dBm/3kHz)	DUTY FACTOR	Total PSD WITH DUTY FACTOR (dBm/3kHz)	Limit (dBm/3kHz)	PASS /FAIL
0	149	5745	-9.86	3.01	-6.85	0.15	-6.70	8	PASS
	157	5785	-10.61	3.01	-7.60	0.15	-7.45	8	PASS
	165	5825	-10.65	3.01	-7.64	0.15	-7.49	8	PASS
1	149	5745	-10.54	3.01	-7.53	0.15	-7.38	8	PASS
	157	5785	-11.18	3.01	-8.17	0.15	-8.02	8	PASS
	165	5825	-10.09	3.01	-7.08	0.15	-6.93	8	PASS

NOTE: Directional gain = 2dBi + 10log(2) = 5.01dBi < 6dBi , therefore the limit no need to reduced.

802.11n (40MHz)

TX chain	Chan.	Freq. (MHz)	PSD (dBm/3kHz)	10 log (N=2) dB	Total PSD W/O DUTY FACTOR (dBm/3kHz)	DUTY FACTOR	Total PSD WITH DUTY FACTOR (dBm/3kHz)	Limit (dBm/3kHz)	PASS /FAIL
0	151	5755	-13.70	3.01	-10.69	0.45	-10.24	8	PASS
	159	5795	-13.05	3.01	-10.04	0.45	-9.59	8	PASS
1	151	5755	-14.65	3.01	-11.64	0.45	-11.19	8	PASS
	159	5795	-12.41	3.01	-9.40	0.45	-8.95	8	PASS

NOTE: Directional gain = 2dBi + 10log(2) = 5.01dBi < 6dBi , therefore the limit no need to reduced.



A D T

SPECTRUM PLOT OF WORST VALUE

802.11a

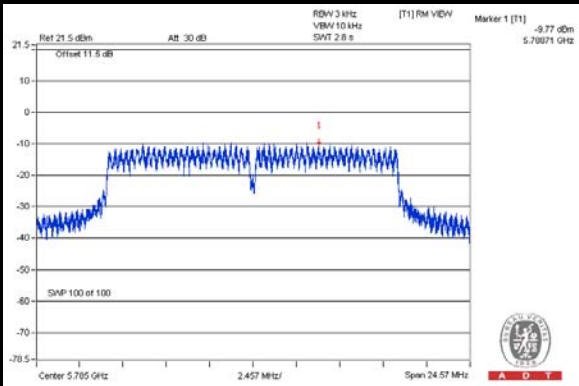

802.11n (20MHz)

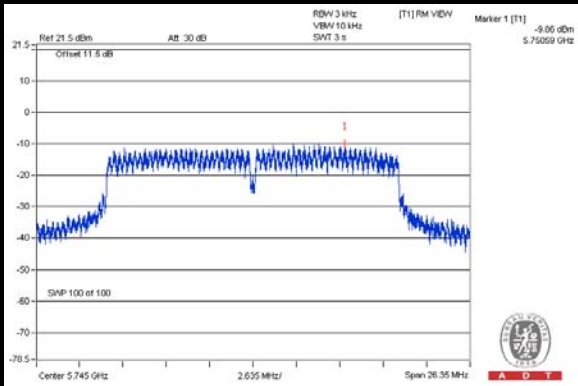

802.11n (40MHz)

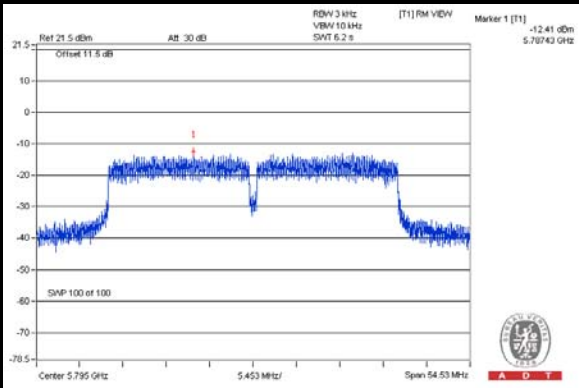



A D T

5.6 CONDUCTED OUT OF BAND EMISSION MEASUREMENT

5.6.1 LIMITS OF CONDUCTED OUT OF BAND EMISSION MEASUREMENT

Below -30dB of the highest emission level of operating band (in 100kHz Resolution Bandwidth).

5.6.2 TEST SETUP

Same as Item 4.6.2

5.6.3 TEST INSTRUMENTS

Refer to section 4.1.2 to get information of above instrument.

5.6.4 TEST PROCEDURE

Same as Item 4.6.4

5.6.5 DEVIATION FROM TEST STANDARD

No deviation.

5.6.6 EUT OPERATING CONDITION

Same as Item 4.3.6

5.6.7 TEST RESULTS

The conducted emission test is performed on each TX port of operating mode without summing or adding $10\log(N)$ since the limit is relative emission limit. Only worst data of each operating mode is presented.

The spectrum plots are attached on the following pages. D1 line indicates the highest level, and D2 line indicates the 30dB offset below D1. It shows compliance with the requirement.



A D T

802.11a CHAIN 0

CH 149

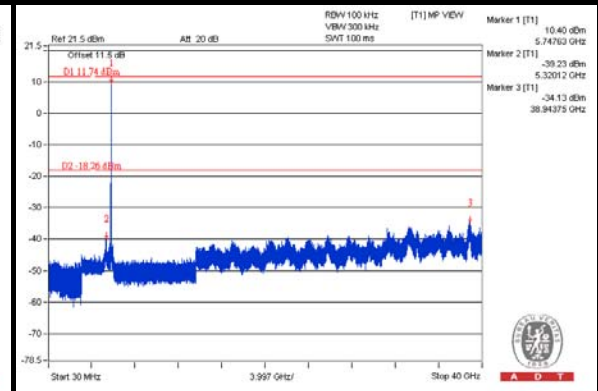
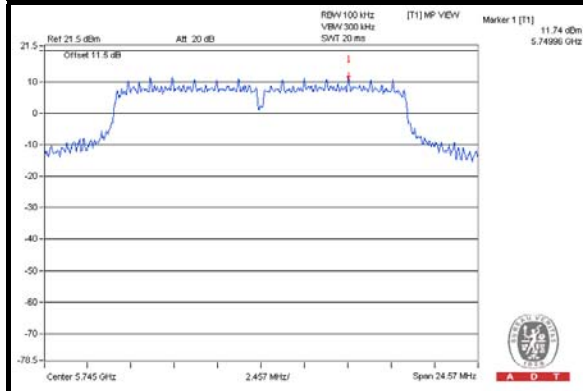

CH 157

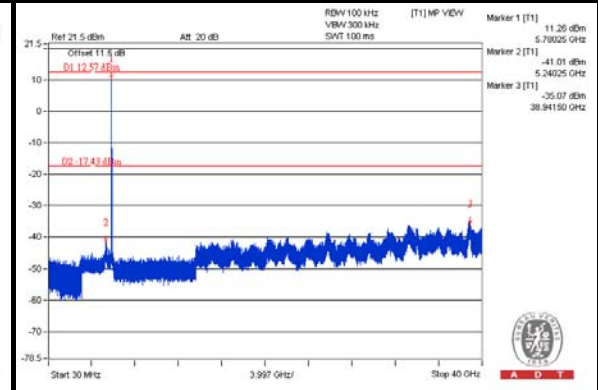
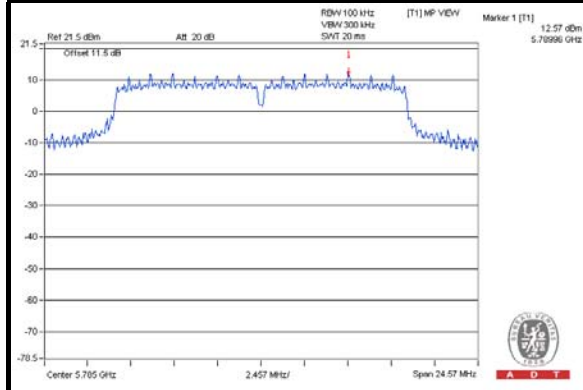

CH 165

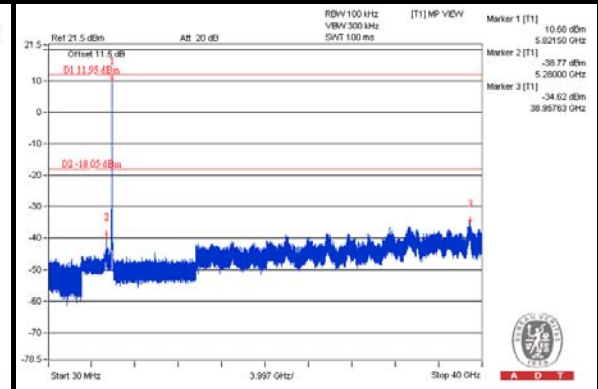
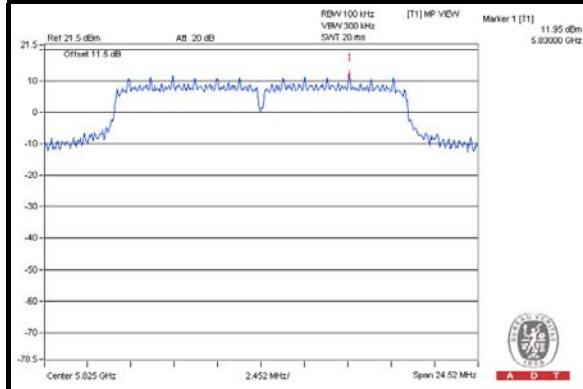

CH 149 Band edge

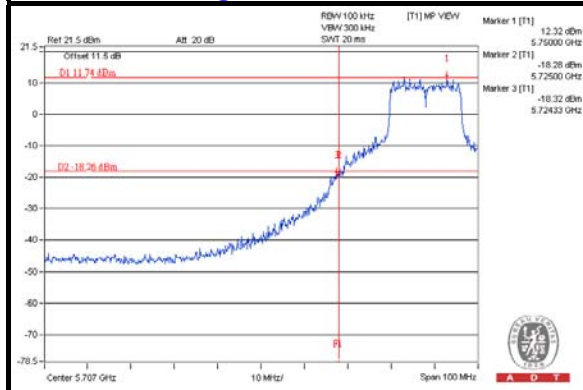

CH 165 Band edge

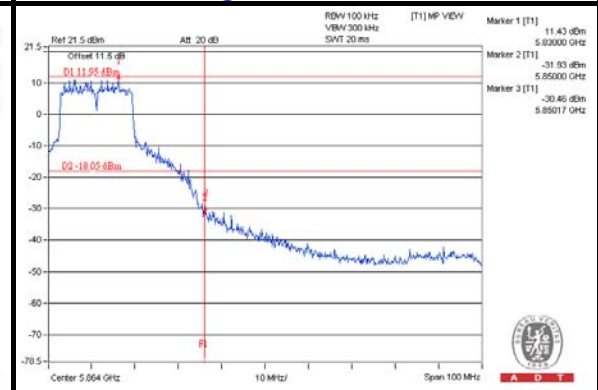



A D T

CHAIN 1

CH 149

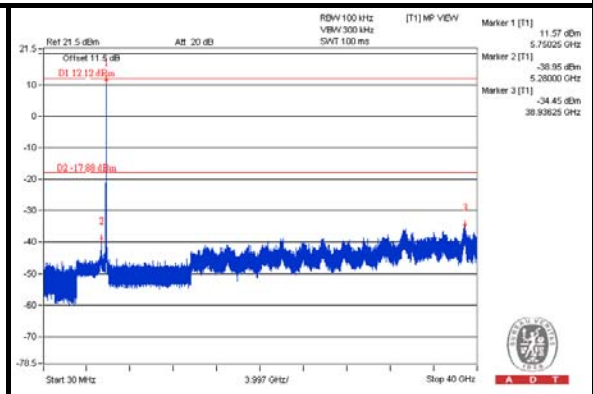
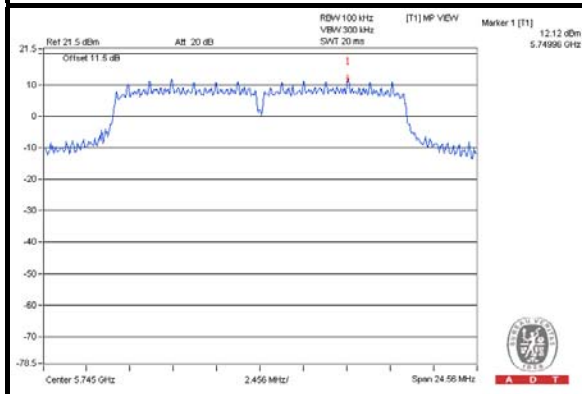

CH 157

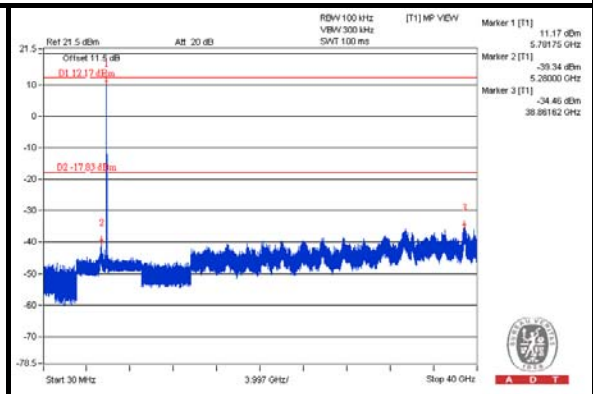
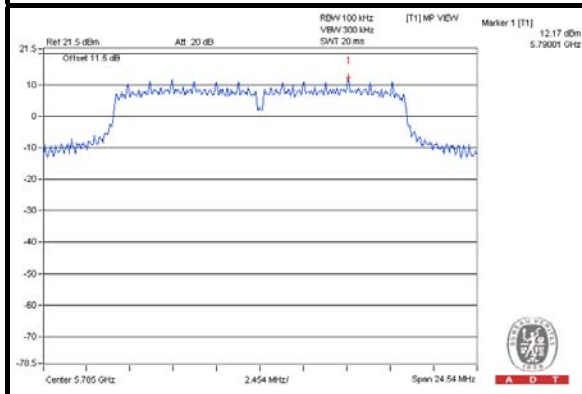

CH 165

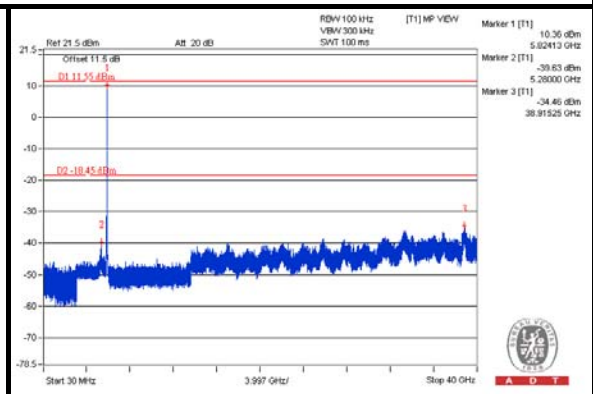
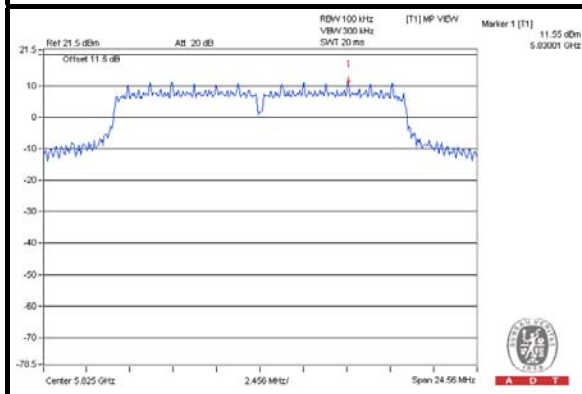

CH 149 Band edge

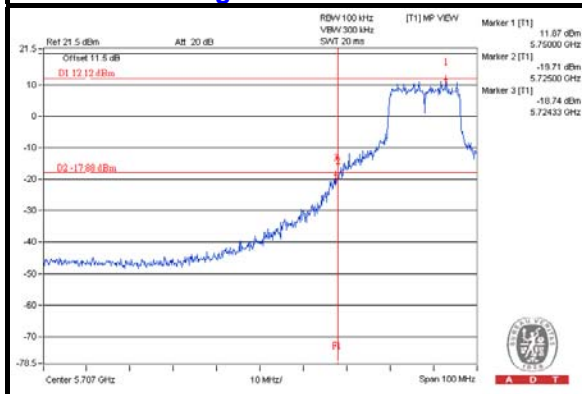

CH 165 Band edge

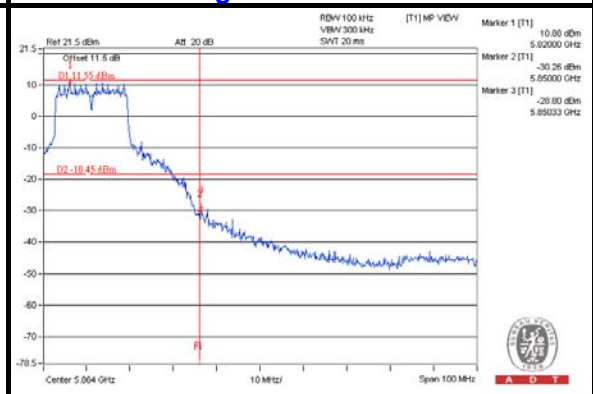



A D T

802.11n(20MHz) CHAIN 0

CH 149

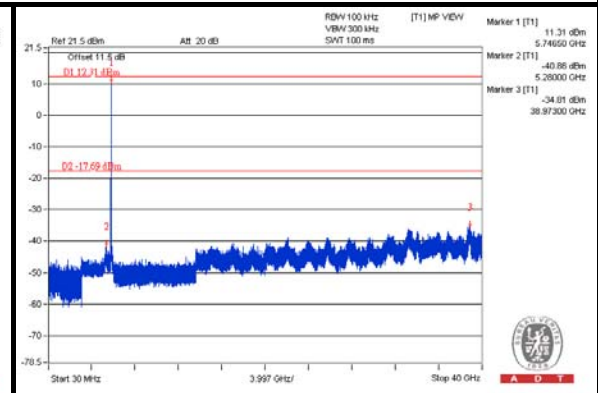
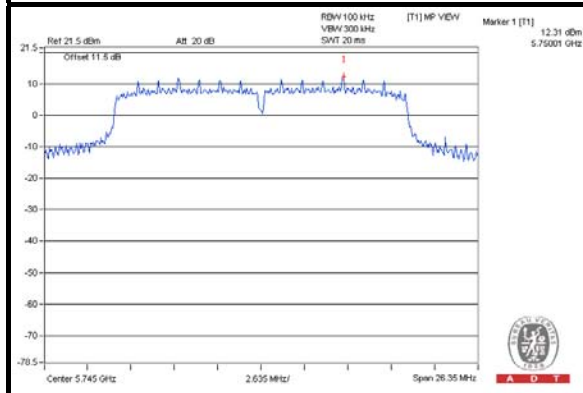

CH 157

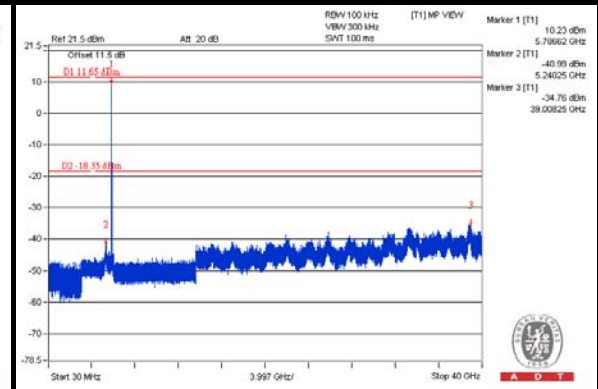
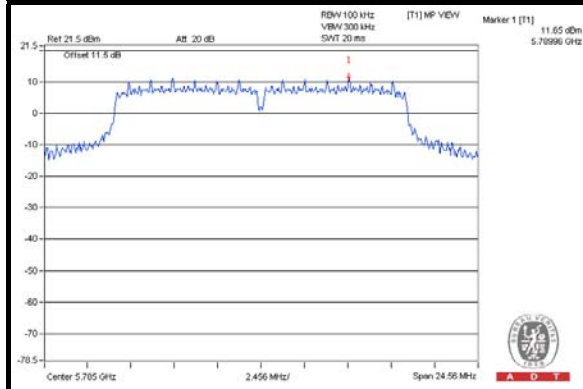

CH 165

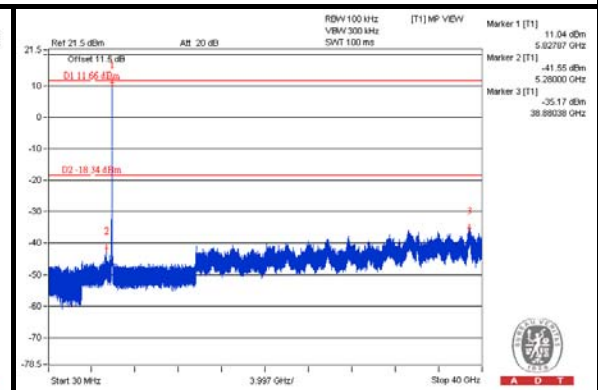
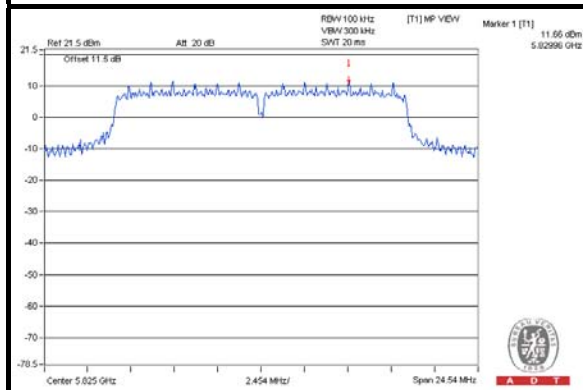

CH 149 Band edge

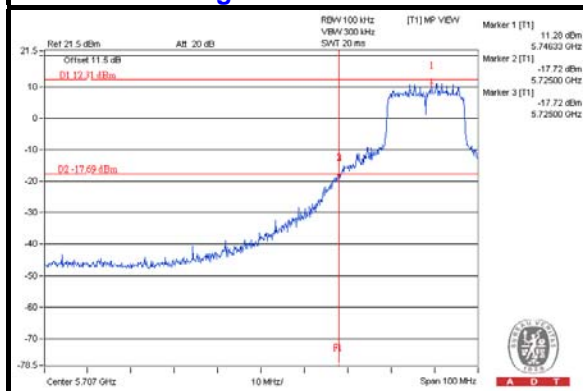

CH 165 Band edge

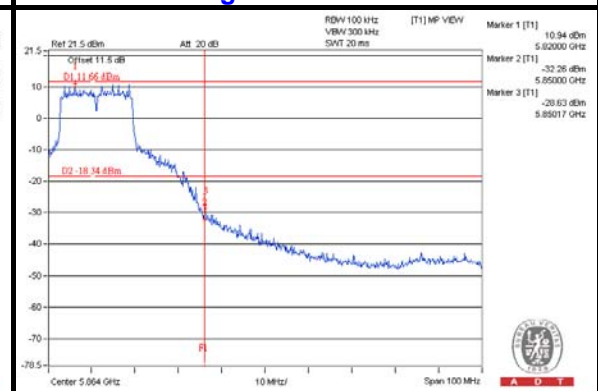



A D T

CHAIN 1

CH 149

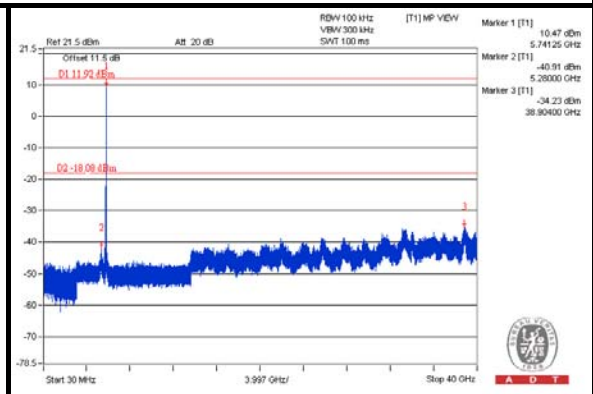
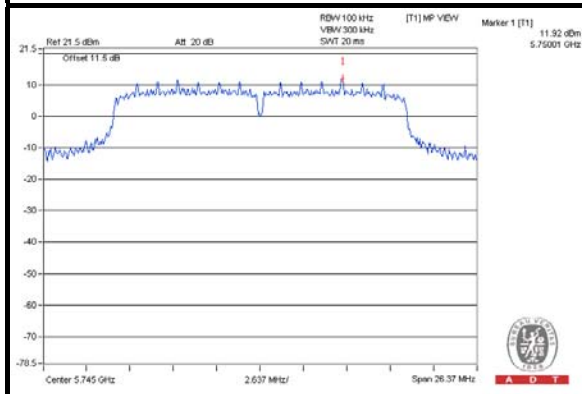

CH 157

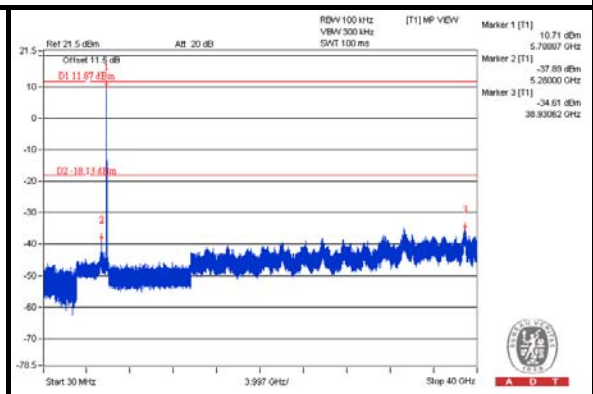
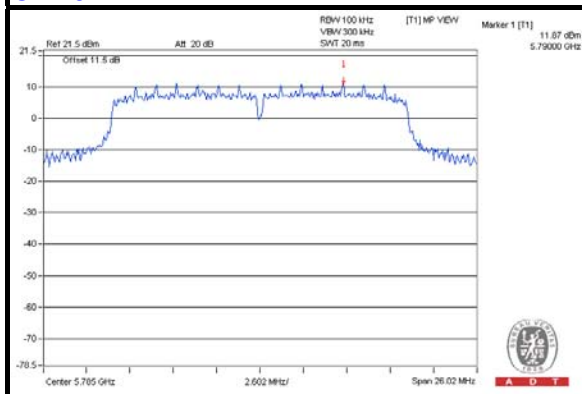

CH 165

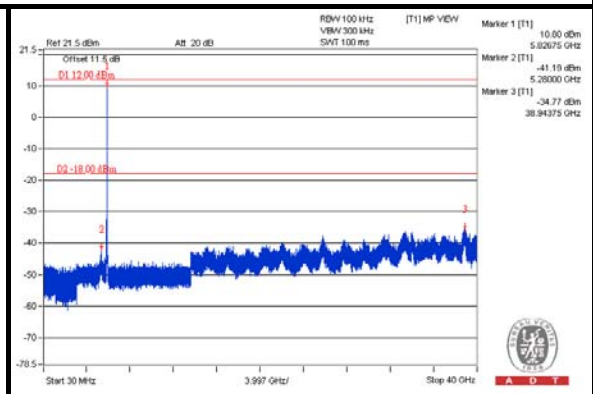
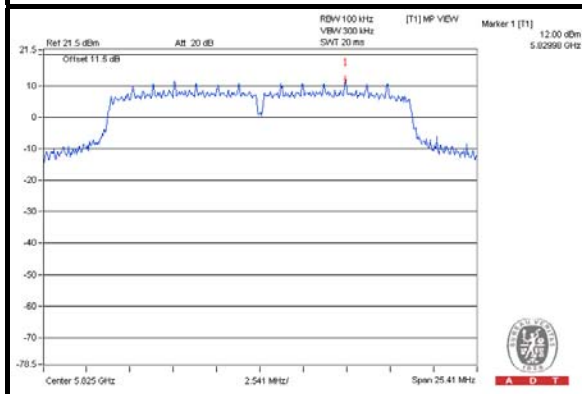

CH 149 Band edge

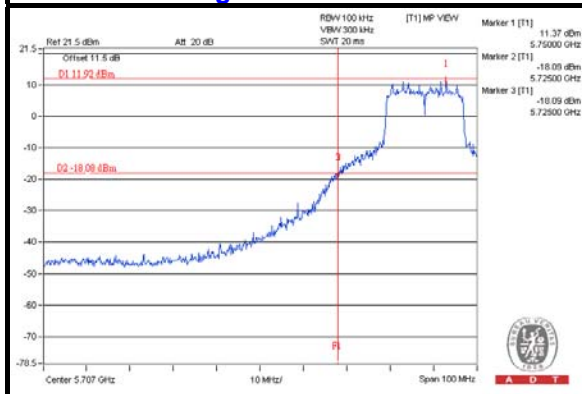

CH 165 Band edge

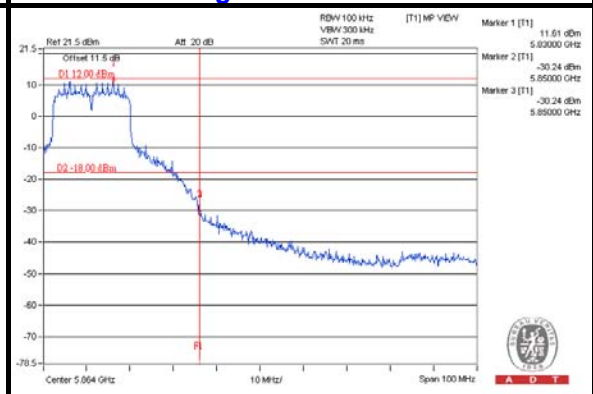



A D T

802.11n (40MHz)

CHAIN 0

CH 151

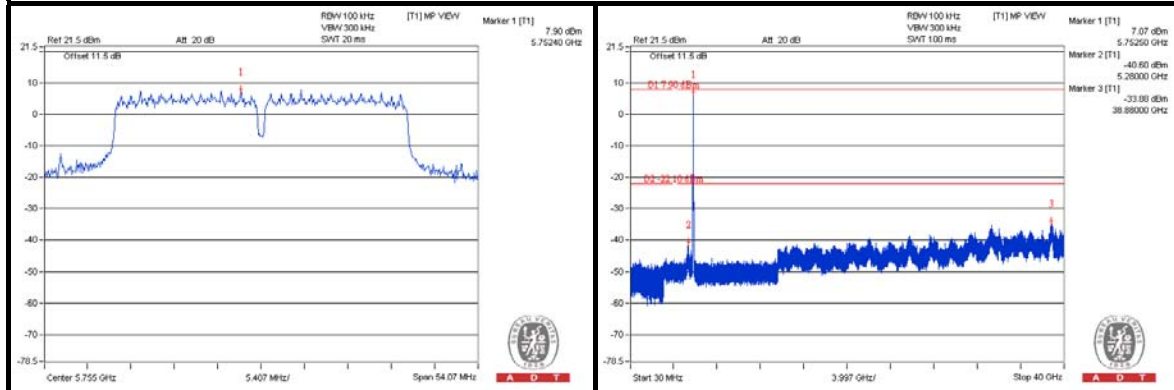

CH 159

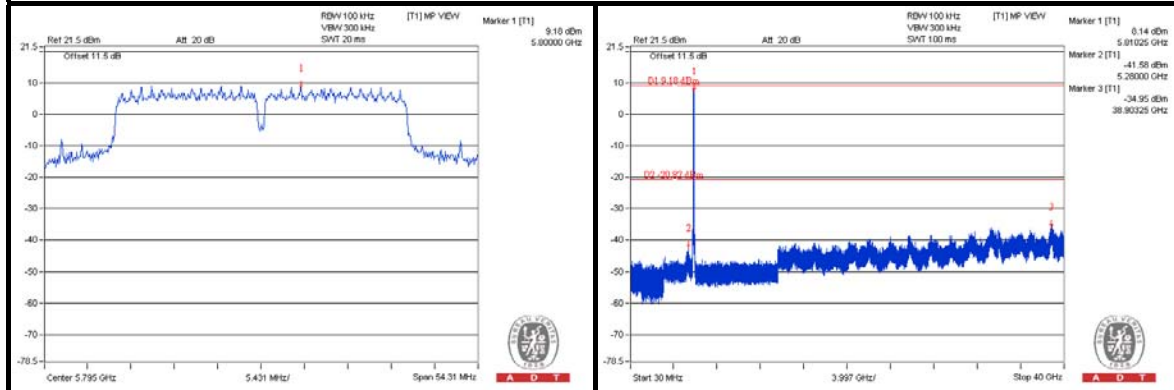

CH 151 Band edge

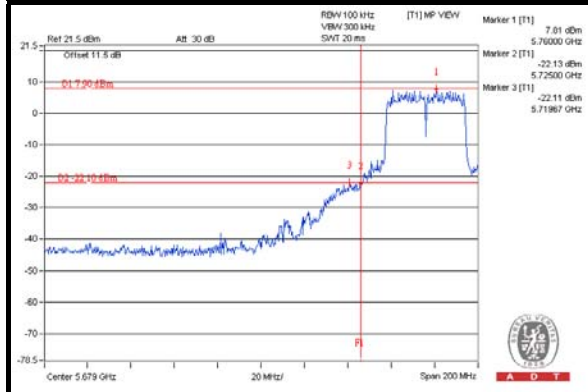

CH 159 Band edge

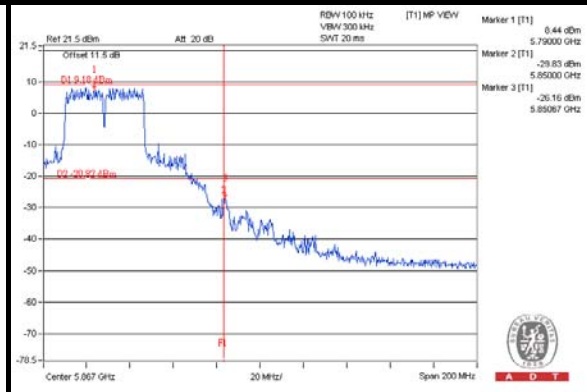



A D T

CHAIN 1

CH 151

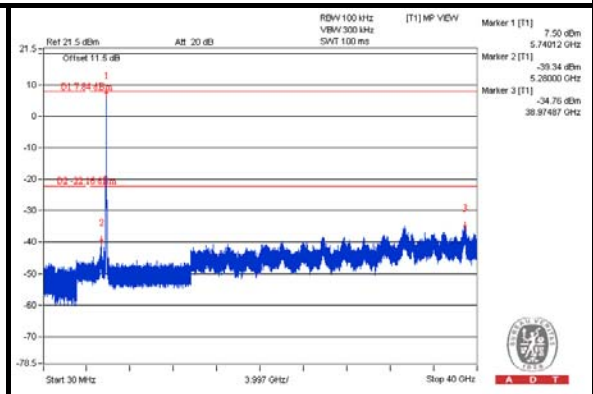
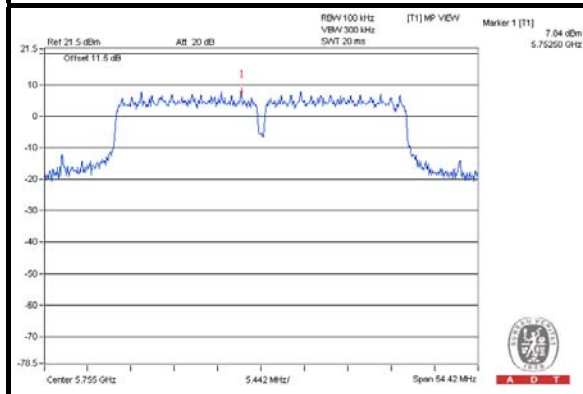

CH 159

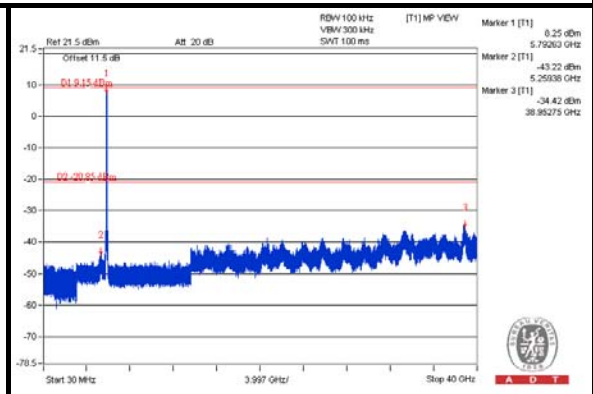
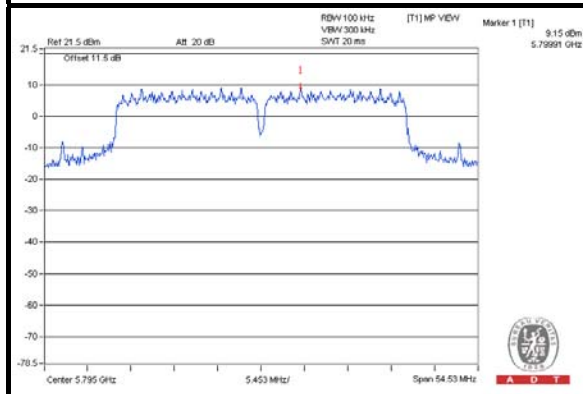

CH 151 Band edge

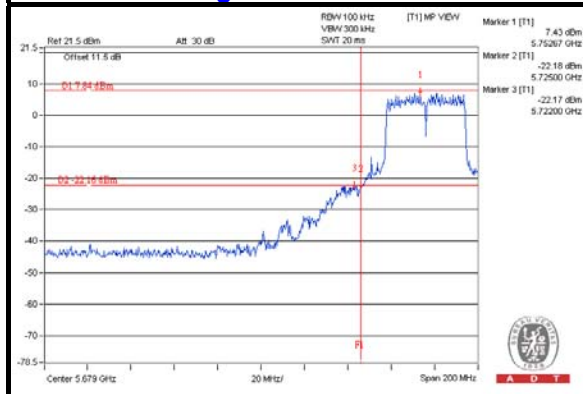

CH 159 Band edge

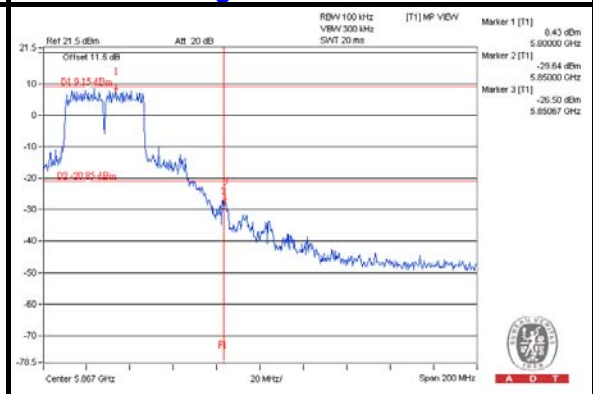



A D T

6. PHOTOGRAPHS OF THE TEST CONFIGURATION

Please refer to the attached file (Test Setup Photo).



A D T

7. INFORMATION ON THE TESTING LABORATORIES

We, Bureau Veritas Consumer Products Services (H.K.) Ltd., Taoyuan Branch, were founded in 1988 to provide our best service in EMC, Radio, Telecom and Safety consultation. Our laboratories are accredited and approved according to ISO/IEC 17025.

If you have any comments, please feel free to contact us at the following:

Linko EMC/RF Lab

Tel: 886-2-26052180

Fax: 886-2-26051924

Hsin Chu EMC/RF/Telecom Lab

Tel: 886-3-5935343

Fax: 886-3-5935342

Hwa Ya EMC/RF/Safety Lab

Tel: 886-3-3183232

Fax: 886-3-3270892

Email: service.adt@tw.bureauveritas.com

Web Site: www.bureauveritas-adt.com

The address and road map of all our labs can be found in our web site also.



A D T

8. APPENDIX A - MODIFICATIONS RECORDERS FOR ENGINEERING CHANGES TO THE EUT BY THE LAB

No modifications were made to the EUT by the lab during the test.

---END---