

FCC Test Report

FCC ID : U28OMSTREAMER
Equipment : Audio Streaming Module XM
Model No. : Audio Streaming Module XM
Applicant : Oticon A/S
Address : Kongebakken 9 DK-2765 Smørum, Denmark
Standard : 47 CFR FCC Part 15.247
Received Date : Nov. 13, 2018
Tested Date : Nov. 13, 2018 ~ Mar. 13, 2019

We, International Certification Corp., would like to declare that the tested sample has been evaluated and in compliance with the requirement of the above standards. The test results contained in this report refer exclusively to the product. It may be duplicated completely for legal use with the approval of the applicant. It shall not be reproduced except in full without the written approval of our laboratory.

Reviewed by:

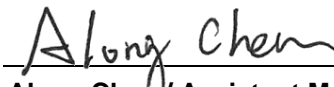

Along Chen / Assistant Manager

Approved by:



Gary Chang / Manager



Table of Contents

1	GENERAL DESCRIPTION	5
1.1	Information.....	5
1.2	Test Setup Chart	8
1.3	The Equipment List	9
1.4	Test Standards	11
1.5	Deviation from Test Standard and Measurement Procedure.....	11
1.6	Measurement Uncertainty	11
2	TEST CONFIGURATION.....	12
2.1	Testing Condition	12
2.2	The Worst Test Modes and Channel Details	12
3	TRANSMITTER TEST RESULTS	13
3.1	Conducted Emissions.....	13
3.2	Unwanted Emissions into Restricted Frequency Bands	16
3.3	Unwanted Emissions into Non-Restricted Frequency Bands	34
3.4	Conducted Output Power	39
3.5	Number of Hopping Frequency	42
3.6	20dB and Occupied Bandwidth.....	45
3.7	Channel Separation.....	50
3.8	Number of Dwell Time.....	55
4	TEST LABORATORY INFORMATION	60

Release Record

Report No.	Version	Description	Issued Date
FR8N1301AD	Rev. 01	Initial issue	Feb. 11, 2019
FR8N1301AD	Rev. 02	1. Update to the data from radiated emissions 2. Added Conducted Emissions data	Mar. 14, 2019

Summary of Test Results

FCC Rules	Test Items	Measured	Result
15.207	Conducted Emissions	[dBuV]: 0.481MHz 29.29 (Margin -17.03dB) - AV	Pass
15.247(d) 15.209	Radiated Emissions	[dBuV/m at 3m]: 4804.00MHz 67.28 (Margin -6.72dB) - PK	Pass
15.247(d)	Band Edge	Meet the requirement of limit	Pass
15.247(b)(1)	Conducted Output Power	Power [dBm]: 7.80	Pass
15.247(a)(1)(iii)	Number of Hopping Channels	Meet the requirement of limit	Pass
15.247(a)(1)	Hopping Channel Separation	Meet the requirement of limit	Pass
15.247(a)(1)(iii)	Dwell Time	Meet the requirement of limit	Pass
15.203	Antenna Requirement	Meet the requirement of limit	Pass

Declaration of Conformity:

The test results with all measurement uncertainty excluded are presented in accordance with the regulation limits or requirements declared by manufacturers.

Comments and Explanations:

The declared values of gain for EUT presented in the report are provided by the manufacturer, and the manufacturer takes all the responsibilities for the accuracy of the gain.

1 General Description

1.1 Information

1.1.1 Specification of the Equipment under Test (EUT)

RF General Information				
Frequency Range (MHz)	Bluetooth Mode	Ch. Frequency (MHz)	Channel Number	Data Rate
2400-2483.5	BR V4.0	2402-2480	0-78 [79]	1 Mbps
2400-2483.5	EDR V4.0	2402-2480	0-78 [79]	2 Mbps
2400-2483.5	EDR V4.0	2402-2480	0-78 [79]	3 Mbps

Note 1: RF output power specifies that Maximum Peak Conducted Output Power.
 Note 2: Bluetooth BR uses a GFSK.
 Note 3: Bluetooth EDR uses a combination of $\pi/4$ -DQPSK and 8DPSK.

1.1.2 Antenna Details

Ant. No.	Type	Connector	Gain (dBi)	Remarks
1	Inverted F	N/A	3	---

1.1.3 Power Supply Type of Equipment under Test (EUT)

Power Supply Type	3.7Vdc from battery
--------------------------	---------------------

1.1.4 Accessories

Accessories		
No.	Equipment	Description
1	AC Adapter	Brand: PHIHONG Model: AM05E-050A Power Rating: I/P: 100-240Vac, 50/60Hz, 0.2A O/P: 5Vdc, 1A Power Line: 1.8m non-shielded cable without core
2	Battery	Brand: ZHUHAI COSLIGHT BATTERY CO., LTD Model: CA422258 Power Rating: I/P: 3.7Vdc, 520mAh
3	USB charger cable	1.2m shielded without core
4	3.5mm mini jack stereo cable	1m non-shielded without core
5	3.5mm headset splitter cable	0.14m non-shielded without core
6	Neck loop-long	0.81m non-shielded without core
7	Neck loop-medium	0.66m non-shielded without core

1.1.5 Channel List

Frequency band (MHz)				2400~2483.5			
Channel	Frequency (MHz)	Channel	Frequency (MHz)	Channel	Frequency (MHz)	Channel	Frequency (MHz)
0	2402	20	2422	40	2442	60	2462
1	2403	21	2423	41	2443	61	2463
2	2404	22	2424	42	2444	62	2464
3	2405	23	2425	43	2445	63	2465
4	2406	24	2426	44	2446	64	2466
5	2407	25	2427	45	2447	65	2467
6	2408	26	2428	46	2448	66	2468
7	2409	27	2429	47	2449	67	2469
8	2410	28	2430	48	2450	68	2470
9	2411	29	2431	49	2451	69	2471
10	2412	30	2432	50	2452	70	2472
11	2413	31	2433	51	2453	71	2473
12	2414	32	2434	52	2454	72	2474
13	2415	33	2435	53	2455	73	2475
14	2416	34	2436	54	2456	74	2476
15	2417	35	2437	55	2457	75	2477
16	2418	36	2438	56	2458	76	2478
17	2419	37	2439	57	2459	77	2479
18	2420	38	2440	58	2460	78	2480
19	2421	39	2441	59	2461	---	---

1.1.6 Test Tool and Duty Cycle

Test Tool	control by CBT Test	
Modulation Mode	Duty Cycle Of Test Signal (%)	Duty Factor (dB)
DH5	81.36%	0.90
2DH5	81.78%	0.87
3DH5	81.70%	0.88

1.1.7 Power Setting

Modulation Mode	Test Frequency (MHz)		
	2402	2441	2480
GFSK/1Mbps	default	default	default
$\pi/4$ -DQPSK /2Mbps	default	default	default
8DPSK/3Mbps	default	default	default

1.2 Test Setup Chart

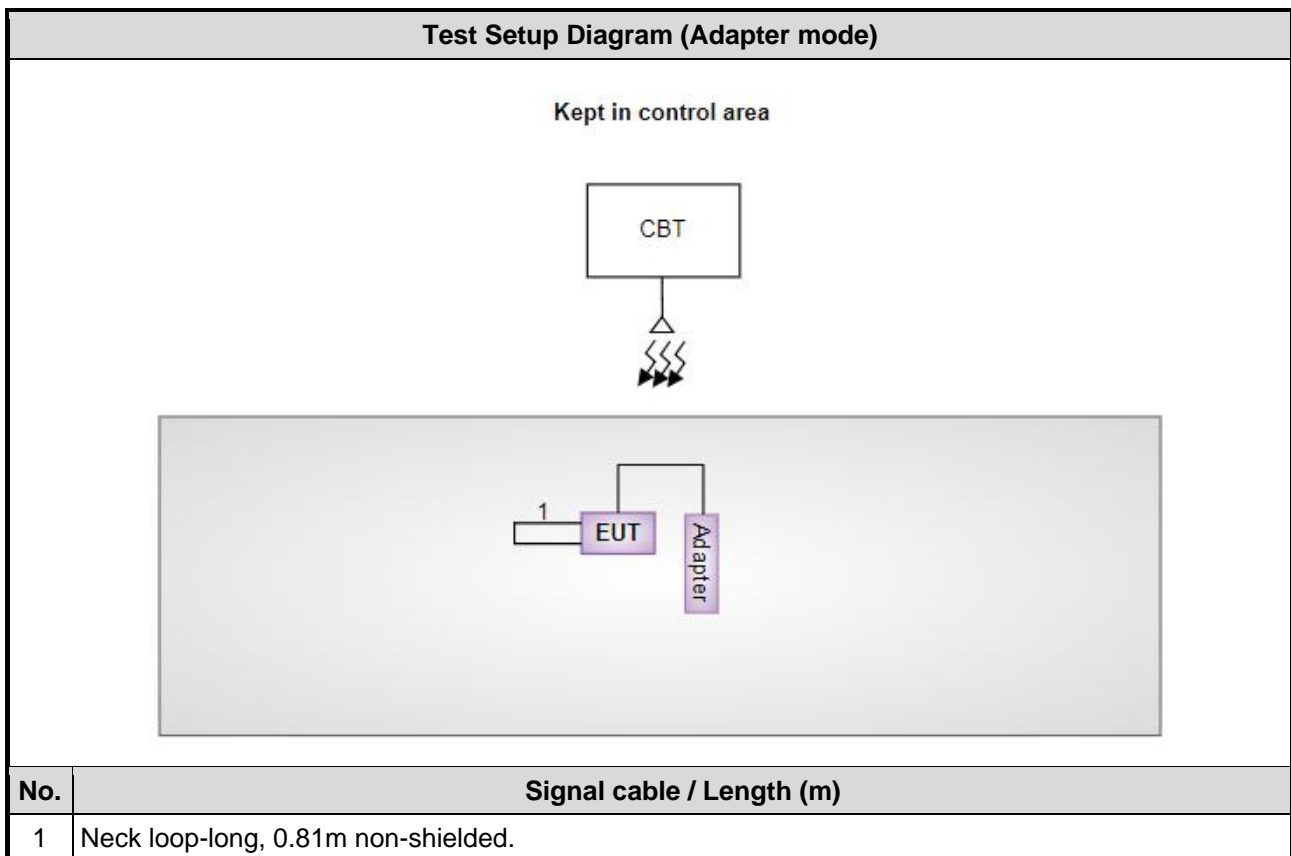
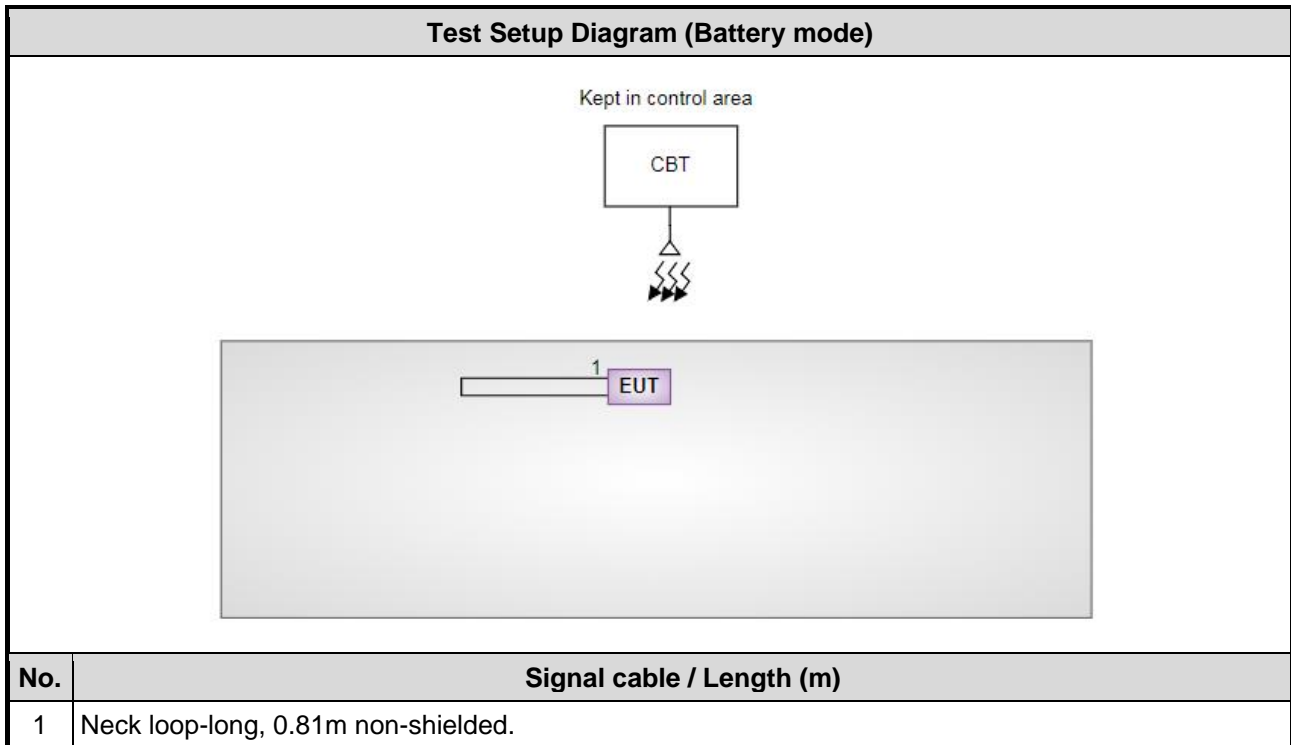

1.3 The Equipment List

Test Item	Conducted Emission				
Test Site	Conduction room 1 / (CO01-WS)				
Tested Date	Mar. 11, 2019				
Instrument	Manufacturer	Model No.	Serial No.	Calibration Date	Calibration Until
Receiver	R&S	ESR3	101657	Jan. 08, 2019	Jan. 07, 2020
LISN	SCHWARZBECK	Schwarzbeck 8127	8127-667	Nov. 05, 2018	Nov. 04, 2019
RF Cable-CON	Woken	CFD200-NL	CFD200-NL-001	Oct. 23, 2018	Oct. 23, 2019
Measurement Software	AUDIX	e3	6.120210k	NA	NA
Note: Calibration Interval of instruments listed above is one year.					

Test Item	Radiated Emission				
Test Site	966 chamber 3 / (03CH03-WS)				
Tested Date	Mar. 05, 2019				
Instrument	Manufacturer	Model No.	Serial No.	Calibration Date	Calibration Until
Spectrum Analyzer	R&S	FSV40	101499	Jan. 07, 2019	Jan. 06, 2020
Receiver	R&S	ESR3	101658	Dec. 11, 2018	Dec. 10, 2019
Bilog Antenna	SCHWARZBECK	VULB9168	VULB9168-685	Apr. 19, 2018	Apr. 18, 2019
Horn Antenna 1G-18G	SCHWARZBECK	BBHA 9120 D	BBHA 9120 D 1206	Jan. 07, 2019	Jan. 06, 2020
Loop Antenna	R&S	HFH2-Z2	100330	Nov. 09, 2018	Nov. 08, 2019
Loop Antenna Cable	KOAX KABEL	101354-BW	101354-BW	Oct. 08, 2018	Oct. 07, 2019
Preamplifier	EMC	EMC02325	980187	Aug. 24, 2018	Aug. 23, 2019
Preamplifier	Agilent	83017A	MY53270014	Aug. 09, 2018	Aug. 08, 2019
Preamplifier	EMC	EMC184045B	980192	Aug. 09, 2018	Aug. 08, 2019
RF cable-3M	HUBER+SUHNER	SUCOFLEX104	MY22620/4	Oct. 01, 2018	Sep. 30, 2019
RF cable-8M	EMC	EMC104-SM-SM-8000	181107	Oct. 01, 2018	Sep. 30, 2019
RF cable-1M	HUBER+SUHNER	SUCOFLEX104	MY22624/4	Oct. 01, 2018	Sep. 30, 2019
LF cable-0.8M	EMC	EMC8D-NM-NM-8000	EMC8D-NM-NM-800-001	Oct. 01, 2018	Sep. 30, 2019
LF cable-3M	EMC	EMC8D-NM-NM-3000	131103	Oct. 01, 2018	Sep. 30, 2019
LF cable-13M	EMC	EMC8D-NM-NM-13000	131104	Oct. 01, 2018	Sep. 30, 2019
Measurement Software	AUDIX	e3	6.120210g	NA	NA
Note: Calibration Interval of instruments listed above is one year.					

Test Item	Radiated Emission				
Test Site	966 chamber 3 / (03CH03-WS)				
Tested Date	Nov. 13, 2018				
Instrument	Manufacturer	Model No.	Serial No.	Calibration Date	Calibration Until
Spectrum Analyzer	R&S	FSV40	101499	Jan. 03, 2018	Jan. 02, 2019
Receiver	R&S	ESR3	101658	Nov. 20, 2017	Nov. 19, 2018
Bilog Antenna	SCHWARZBECK	VULB9168	VULB9168-685	Apr. 19, 2018	Apr. 18, 2019
Horn Antenna 1G-18G	SCHWARZBECK	BBHA 9120 D	BBHA 9120 D 1206	Jan. 18, 2018	Jan. 17, 2019
Horn Antenna 18G-40G	SCHWARZBECK	BBHA 9170	BBHA 9170517	Nov. 23, 2017	Nov. 22, 2018
Loop Antenna	R&S	HFH2-Z2	100330	Nov. 09, 2018	Nov. 08, 2019
Loop Antenna Cable	KOAX KABEL	101354-BW	101354-BW	Dec. 07, 2017	Dec. 06, 2018
Preamplifier	EMC	EMC02325	980187	Aug. 24, 2018	Aug. 23, 2019
Preamplifier	Agilent	83017A	MY53270014	Aug. 09, 2018	Aug. 08, 2019
Preamplifier	EMC	EMC184045B	980192	Aug. 09, 2018	Aug. 08, 2019
RF cable-3M	EMC	EMC104-SM-SM-80 00	181107	Oct. 30, 2018	Oct. 29, 2019
RF cable-8M	HUBER+SUHNER	SUCOFLEX104	MY32487/4	Oct. 30, 2018	Oct. 29, 2019
RF cable-1M	HUBER+SUHNER	SUCOFLEX104	MY22624/4	Oct. 30, 2018	Oct. 29, 2019
LF cable-0.8M	EMC	EMC8D-NM-NM-800	EMC8D-NM-NM-800 -001	Oct. 30, 2018	Oct. 29, 2019
LF cable-3M	EMC	EMC8D-NM-NM-300 0	131103	Oct. 30, 2018	Oct. 29, 2019
LF cable-13M	EMC	EMC8D-NM-NM-130 00	131104	Oct. 30, 2018	Oct. 29, 2019
Measurement Software	AUDIX	e3	6.120210g	NA	NA
Bluetooth Tester	R&S	CBT	100959	Sep. 24, 2018	Sep. 23, 2019
Note: Calibration Interval of instruments listed above is one year.					

Test Item	RF Conducted				
Test Site	(TH01-WS)				
Tested Date	Nov. 20, 2018				
Instrument	Manufacturer	Model No.	Serial No.	Calibration Date	Calibration Until
Spectrum Analyzer	R&S	FSV40	101063	Apr. 16, 2018	Apr. 15, 2019
Power Meter	Anritsu	ML2495A	1241002	Oct. 09, 2018	Oct. 08, 2019
Power Sensor	Anritsu	MA2411B	1207366	Oct. 09, 2018	Oct. 08, 2019
Bluetooth Tester	R&S	CBT	100959	Sep. 24, 2018	Sep. 23, 2019
DC POWER SOURCE	GW INSTEK	GPC-6030D	EM892433	Oct. 25, 2018	Oct. 24, 2019
Measurement Software	Sporton	Sporton_1	1.3.30	NA	NA
Note: Calibration Interval of instruments listed above is one year.					

1.4 Test Standards

According to the specification of EUT, the EUT must comply with following standards and KDB documents.

47 CFR FCC Part 15.247

ANSI C63.10-2013

FCC KDB 558074 D01 15.247 Meas Guidance v05r01

1.5 Deviation from Test Standard and Measurement Procedure

None

1.6 Measurement Uncertainty

ISO/IEC 17025 requires that an estimate of the measurement uncertainties associated with the emissions test results be included in the report. The measurement uncertainties given below are based on a 95% confidence level (based on a coverage factor (k=2))

Measurement Uncertainty	
Parameters	Uncertainty
Bandwidth	±34.134 Hz
Conducted power	±0.808 dB
Power density	±0.463 dB
Conducted emission	±2.670 dB
AC conducted emission	±2.92 dB
Radiated emission ≤ 1GHz	±3.66 dB
Radiated emission > 1GHz	±5.37 dB

2 Test Configuration

2.1 Testing Condition

Test Item	Test Site	Ambient Condition	Tested By
AC Conduction	CO01-WS	24°C / 64%	Alex Tsai
Radiated Emissions	03CH03-WS	24°C / 63%	Akun Chung Roger Lu
RF Conducted	TH01-WS	24°C / 63%	Felix Sung

- FCC Designation No.: TW0009
- FCC site registration No.: 207696
- IC site registration No.: 10807C-1

2.2 The Worst Test Modes and Channel Details

Test item	Mode	Test Frequency (MHz)	Data Rate (Mbps)	Test Configuration
Conducted Emissions	GFSK	2402	1Mbps	2
Radiated Emissions ≤ 1GHz	GFSK	2402	1Mbps	1, 2
Radiated Emissions > 1GHz	GFSK	2402, 2441, 2480	1Mbps	1
	8DPSK	2402, 2441, 2480	3Mbps	
Conducted Output Power	GFSK	2402, 2441, 2480	1Mbps	1
	π/4 DQPSK	2402, 2441, 2480	2Mbps	
	8DPSK	2402, 2441, 2480	3Mbps	
Number of Hopping Channels	GFSK	2402~2480	1Mbps	1
	π/4 DQPSK	2402~2480	2Mbps	
	8DPSK	2402~2480	3Mbps	
Hopping Channel Separation 20dB and Occupied bandwidth	GFSK	2402, 2441, 2480	1Mbps	1
	π/4 DQPSK	2402, 2441, 2480	2Mbps	
	8DPSK	2402, 2441, 2480	3Mbps	
Dwell Time	GFSK	2441	1Mbps	1
	π/4 DQPSK	2441	2Mbps	
	8DPSK	2441	3Mbps	

- 1) The EUT was pretested with 3 orientations placed on the table for the radiated emission measurement – X, Y, and Z-plane. The **Z-plane** results were found as the worst case and were shown in this report.
- 2) Test configurations are listed as below:
 Configuration 1 : Battery mode
 Configuration 2 : Adapter mode

3 Transmitter Test Results

3.1 Conducted Emissions

3.1.1 Limit of Conducted Emissions

Conducted Emissions Limit		
Frequency Emission (MHz)	Quasi-Peak	Average
0.15-0.5	66 - 56 *	56 - 46 *
0.5-5	56	46
5-30	60	50

Note 1: * Decreases with the logarithm of the frequency.

3.1.2 Test Procedures

1. The device is placed on a test table, raised 80 cm above the reference ground plane. The vertical conducting plane is located 40 cm to the rear of the device.
2. The device is connected to line impedance stabilization network (LISN) and other accessories are connected to other LISN. Measured levels of AC power line conducted emission are across the 50 Ω LISN port.
3. AC conducted emission measurements is made over frequency range from 150 kHz to 30 MHz.
4. This measurement was performed with AC 120V/60Hz

3.1.3 Test Setup

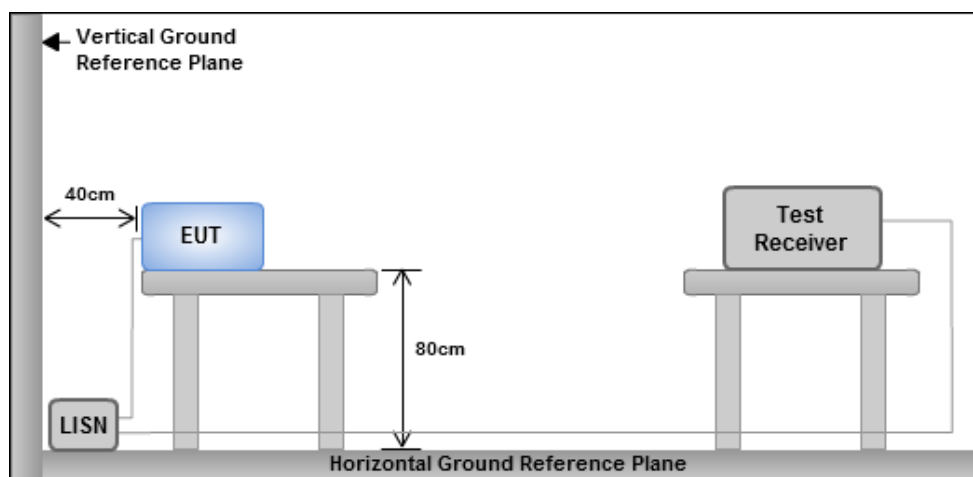

Note: 1. Support units were connected to second LISN.

2. Both of LISNs (AMN) are 80 cm from EUT and at least 80 cm from other units and other metal planes

3.1.4 Test Result of Conducted Emissions

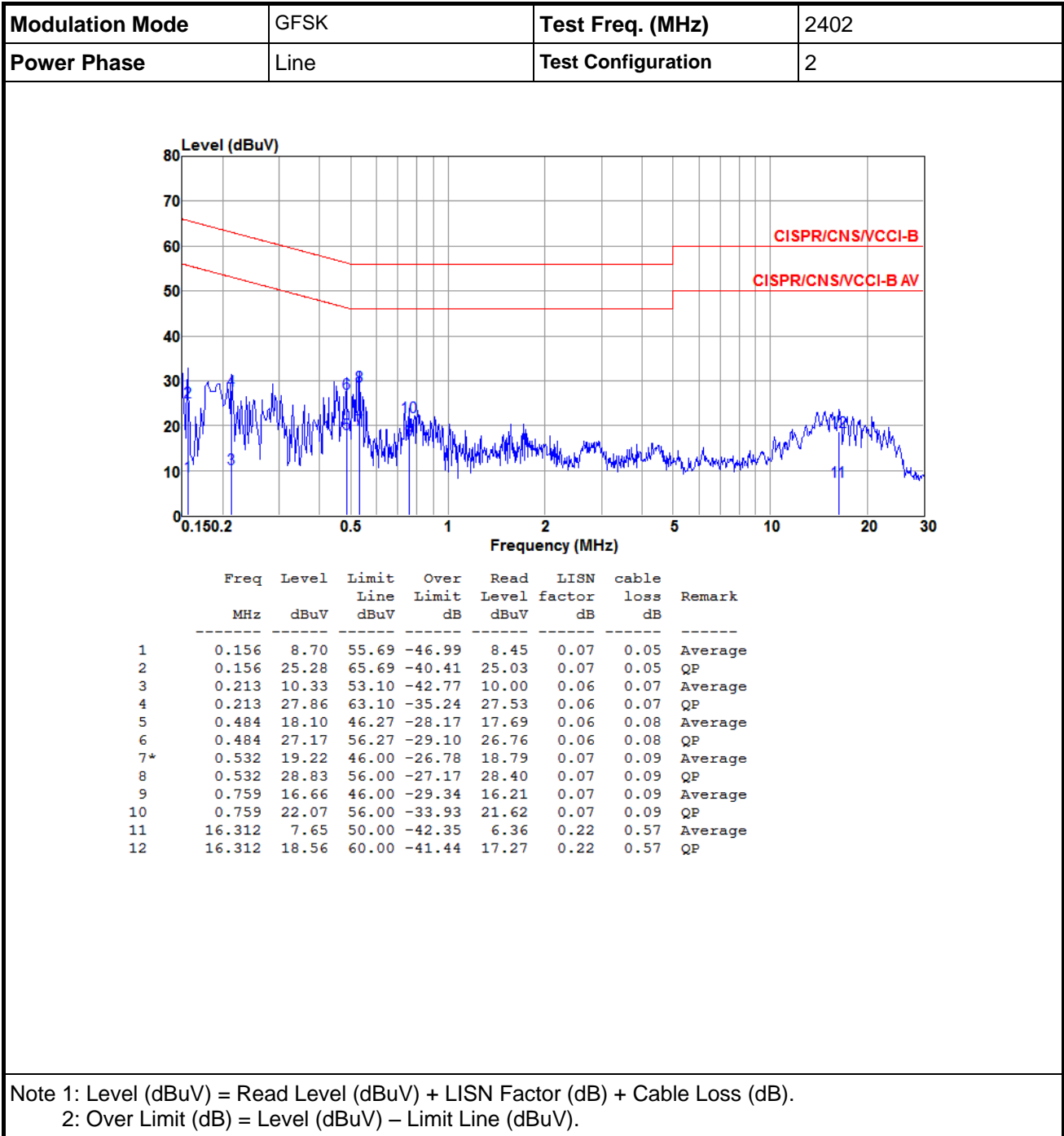

Modulation Mode	GFSK	Test Freq. (MHz)	2402
Power Phase	Neutral	Test Configuration	2

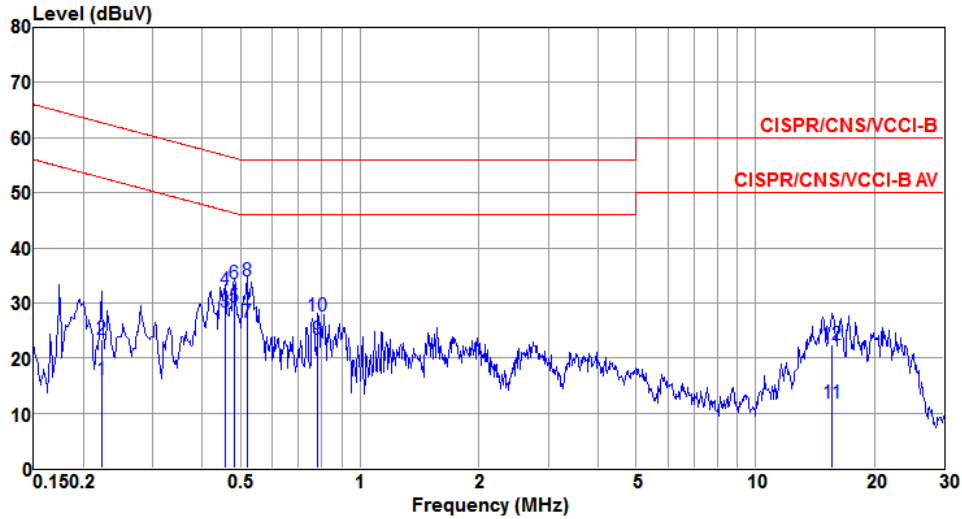

	Freq MHz	Level dBUV	Limit Line dBUV	Over Limit dB	Read Level dBUV	LISN factor dB	cable loss dB	Remark
1	0.222	15.94	52.74	-36.80	15.69	0.04	0.07	Average
2	0.222	23.45	62.74	-39.29	23.20	0.04	0.07	QP
3	0.456	28.41	46.76	-18.35	28.14	0.05	0.08	Average
4	0.456	32.24	56.76	-24.52	31.97	0.05	0.08	QP
5*	0.481	29.29	46.32	-17.03	29.02	0.05	0.08	Average
6	0.481	33.60	56.32	-22.72	33.33	0.05	0.08	QP
7	0.518	26.51	46.00	-19.49	26.22	0.05	0.09	Average
8	0.518	33.89	56.00	-22.11	33.60	0.05	0.09	QP
9	0.783	23.37	46.00	-22.63	23.02	0.06	0.09	Average
10	0.783	27.64	56.00	-28.36	27.29	0.06	0.09	QP
11	15.635	11.73	50.00	-38.27	10.58	0.23	0.57	Average
12	15.635	22.34	60.00	-37.66	21.19	0.23	0.57	QP

Note 1: Level (dBUV) = Read Level (dBUV) + LISN Factor (dB) + Cable Loss (dB).
 2: Over Limit (dB) = Level (dBUV) – Limit Line (dBUV).

3.2 Unwanted Emissions into Restricted Frequency Bands

3.2.1 Limit of Unwanted Emissions into Restricted Frequency Bands

Restricted Band Emissions Limit			
Frequency Range (MHz)	Field Strength (uV/m)	Field Strength (dBuV/m)	Measure Distance (m)
0.009~0.490	2400/F(kHz)	48.5 - 13.8	300
0.490~1.705	24000/F(kHz)	33.8 - 23	30
1.705~30.0	30	29	30
30~88	100	40	3
88~216	150	43.5	3
216~960	200	46	3
Above 960	500	54	3

Note 1:
Quasi-Peak value is measured for frequency below 1GHz except for 9–90 kHz, 110–490 kHz frequency band. Peak and average value are measured for frequency above 1GHz. The limit on average radio frequency emission is as above table. The limit on peak radio frequency emissions is 20 dB above the maximum permitted average emission limit

Note 2:
Measurements may be performed at a distance other than what is specified provided. When performing measurements at a distance other than that specified, the results shall be extrapolated to the specified distance using an extrapolation factor as below, Frequency at or above 30 MHz: 20 dB/decade Frequency below 30 MHz: 40 dB/decade.

3.2.2 Test Procedures

1. Measurement is made at a semi-anechoic chamber that incorporates a turntable allowing a EUT rotation of 360°. A continuously-rotating, remotely-controlled turntable is installed at the test site to support the EUT and facilitate determination of the direction of maximum radiation for each EUT emission frequency. The EUT is placed at test table. For emissions testing at or below 1 GHz, the table height is 80 cm above the reference ground plane. For emission measurements above 1 GHz, the table height is 1.5 m
2. Measurement is made with the antenna positioned in both the horizontal and vertical planes of polarization. The measurement antenna is varied in height (1m ~ 4m) above the reference ground plane to obtain the maximum signal strength. Distance between EUT and antenna is 3 m.
3. This investigation is performed with the EUT rotated 360°, the antenna height scanned between 1 m and 4 m, and the antenna rotated to repeat the measurements for both the horizontal and vertical antenna polarizations.

Note:

1. 120kHz measurement bandwidth of test receiver and Quasi-peak detector is for radiated emission below 1GHz.
2. Radiated emission above 1GHz / Peak value
RBW=1MHz, VBW=3MHz and Peak detector
3. Radiated emission above 1GHz / Average value
RBW=1MHz, VBW=1/T and Peak detector

3.2.3 Test Setup

Radiated Emissions below 1 GHz

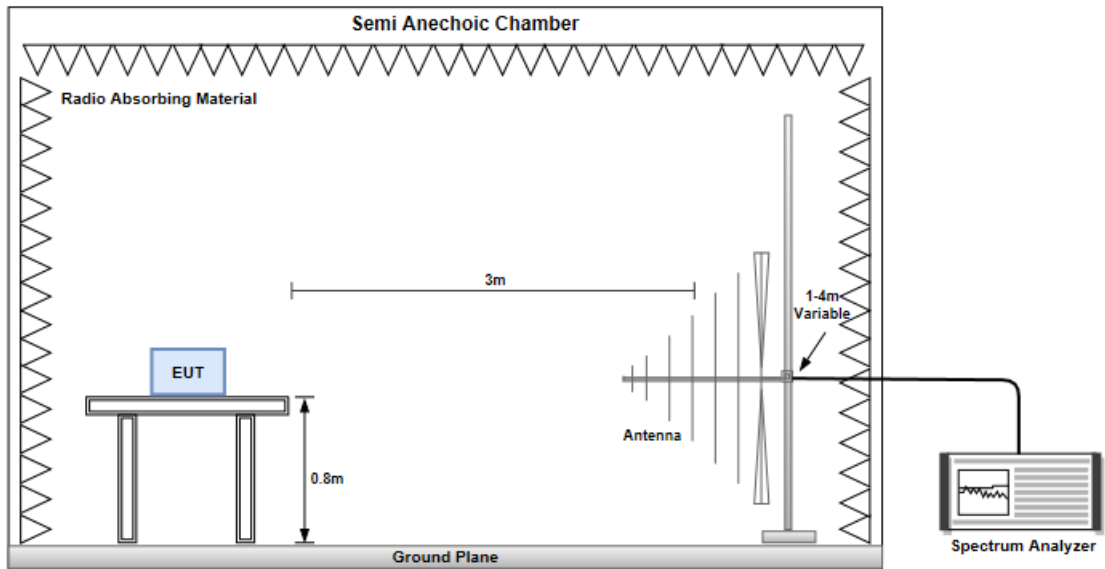

Radiated Emissions above 1 GHz

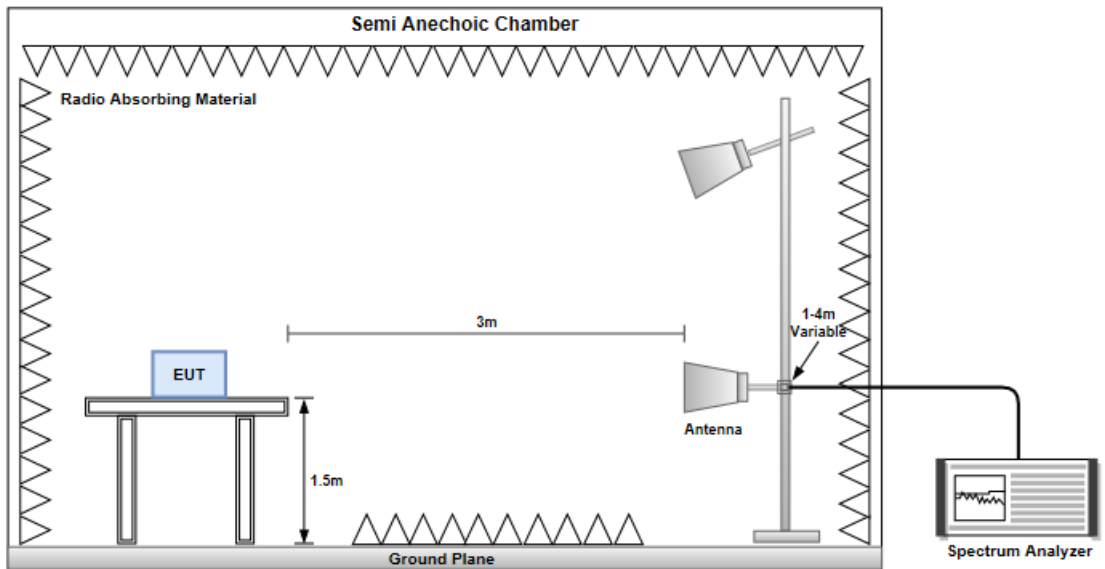

3.2.4 Transmitter Radiated Unwanted Emissions (Below 1GHz)

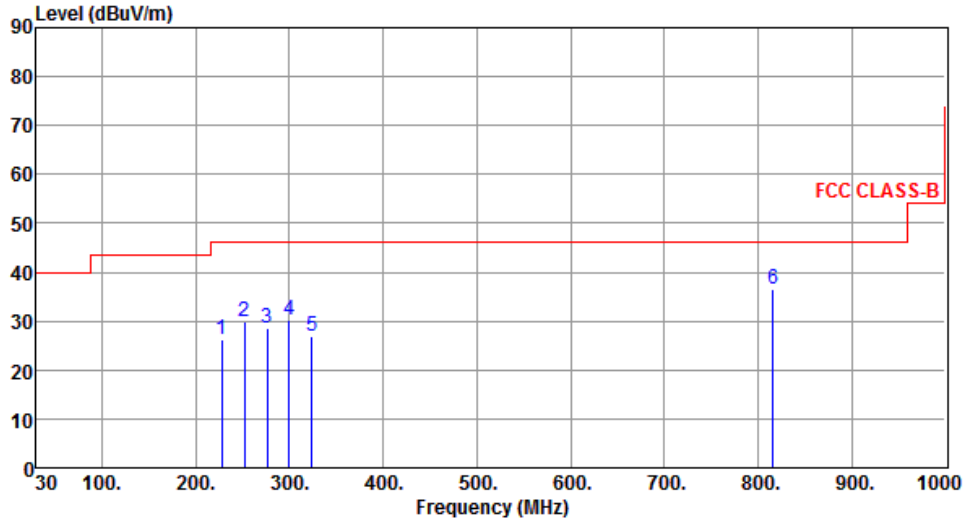
Modulation	GFSK	Test Freq. (MHz)	2402																																																																								
Polarization	Horizontal	Test Configuration	1																																																																								
 <p>The graph plots Level (dBuV/m) on the y-axis (0 to 90) against Frequency (MHz) on the x-axis (30 to 1000). A red line represents the FCC CLASS-B limit, which is 40 dBuV/m from 30 to 100 MHz, 45 dBuV/m from 100 to 300 MHz, 46 dBuV/m from 300 to 900 MHz, and 55 dBuV/m from 900 to 1000 MHz. Six blue vertical lines represent emission peaks at frequencies 227.88, 252.13, 276.38, 299.66, 323.91, and 815.70 MHz, with levels 26.31, 29.94, 28.42, 30.09, 26.98, and 36.38 dBuV/m respectively.</p>																																																																											
	<table border="1"> <thead> <tr> <th>Freq.</th> <th>Emission level</th> <th>Limit</th> <th>Margin</th> <th>SA reading</th> <th>Factor</th> <th>Remark</th> <th>ANT High</th> <th>Turn Table</th> </tr> <tr> <th>MHz</th> <th>dBuV/m</th> <th>dBuV/m</th> <th>dB</th> <th>dBuV</th> <th>dB</th> <th></th> <th>cm</th> <th>deg</th> </tr> </thead> <tbody> <tr> <td>1</td> <td>227.88</td> <td>26.31</td> <td>46.00</td> <td>-19.69</td> <td>36.70</td> <td>-10.39</td> <td>Peak</td> <td>---</td> </tr> <tr> <td>2</td> <td>252.13</td> <td>29.94</td> <td>46.00</td> <td>-16.06</td> <td>39.16</td> <td>-9.22</td> <td>Peak</td> <td>---</td> </tr> <tr> <td>3</td> <td>276.38</td> <td>28.42</td> <td>46.00</td> <td>-17.58</td> <td>36.74</td> <td>-8.32</td> <td>Peak</td> <td>---</td> </tr> <tr> <td>4</td> <td>299.66</td> <td>30.09</td> <td>46.00</td> <td>-15.91</td> <td>37.79</td> <td>-7.70</td> <td>Peak</td> <td>---</td> </tr> <tr> <td>5</td> <td>323.91</td> <td>26.98</td> <td>46.00</td> <td>-19.02</td> <td>34.04</td> <td>-7.06</td> <td>Peak</td> <td>---</td> </tr> <tr> <td>6</td> <td>815.70</td> <td>36.38</td> <td>46.00</td> <td>-9.62</td> <td>33.00</td> <td>3.38</td> <td>Peak</td> <td>---</td> </tr> </tbody> </table>	Freq.	Emission level	Limit	Margin	SA reading	Factor	Remark	ANT High	Turn Table	MHz	dBuV/m	dBuV/m	dB	dBuV	dB		cm	deg	1	227.88	26.31	46.00	-19.69	36.70	-10.39	Peak	---	2	252.13	29.94	46.00	-16.06	39.16	-9.22	Peak	---	3	276.38	28.42	46.00	-17.58	36.74	-8.32	Peak	---	4	299.66	30.09	46.00	-15.91	37.79	-7.70	Peak	---	5	323.91	26.98	46.00	-19.02	34.04	-7.06	Peak	---	6	815.70	36.38	46.00	-9.62	33.00	3.38	Peak	---		
Freq.	Emission level	Limit	Margin	SA reading	Factor	Remark	ANT High	Turn Table																																																																			
MHz	dBuV/m	dBuV/m	dB	dBuV	dB		cm	deg																																																																			
1	227.88	26.31	46.00	-19.69	36.70	-10.39	Peak	---																																																																			
2	252.13	29.94	46.00	-16.06	39.16	-9.22	Peak	---																																																																			
3	276.38	28.42	46.00	-17.58	36.74	-8.32	Peak	---																																																																			
4	299.66	30.09	46.00	-15.91	37.79	-7.70	Peak	---																																																																			
5	323.91	26.98	46.00	-19.02	34.04	-7.06	Peak	---																																																																			
6	815.70	36.38	46.00	-9.62	33.00	3.38	Peak	---																																																																			
<p>Note 1: Emission Level (dBuV/m) = SA Reading (dBuV/m) + Factor* (dB) *Factor includes antenna factor , cable loss and amplifier gain Note 2: Margin (dB) = Emission level (dBuV/m) – Limit (dBuV/m). Note 3: All spurious emissions below 30MHz are more than 20 dB below the limit.</p>																																																																											

Modulation	GFSK	Test Freq. (MHz)	2402
Polarization	Vertical	Test Configuration	1

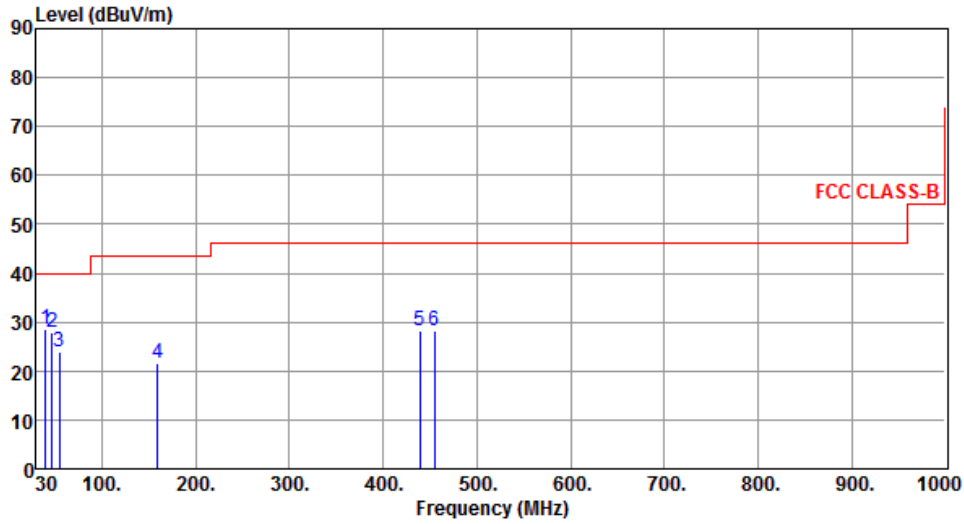

	Freq. MHz	Emission level dBuV/m	Limit dBuV/m	Margin dB	SA reading dBuV	Factor dB	Remark	ANT High cm	Turn Table deg
1	39.70	28.59	40.00	-11.41	37.07	-8.48	Peak	---	---
2	46.49	27.90	40.00	-12.10	35.94	-8.04	Peak	---	---
3	54.25	23.96	40.00	-16.04	32.17	-8.21	Peak	---	---
4	159.01	21.72	43.50	-21.78	29.94	-8.22	Peak	---	---
5	439.34	28.11	46.00	-17.89	32.08	-3.97	Peak	---	---
6	454.86	28.38	46.00	-17.62	32.01	-3.63	Peak	---	---

Note 1: Emission Level (dBuV/m) = SA Reading (dBuV/m) + Factor* (dB)

*Factor includes antenna factor , cable loss and amplifier gain

Note 2: Margin (dB) = Emission level (dBuV/m) – Limit (dBuV/m).

Note 3: All spurious emissions below 30MHz are more than 20 dB below the limit.

Modulation	GFSK	Test Freq. (MHz)	2402
Polarization	Horizontal	Test Configuration	2

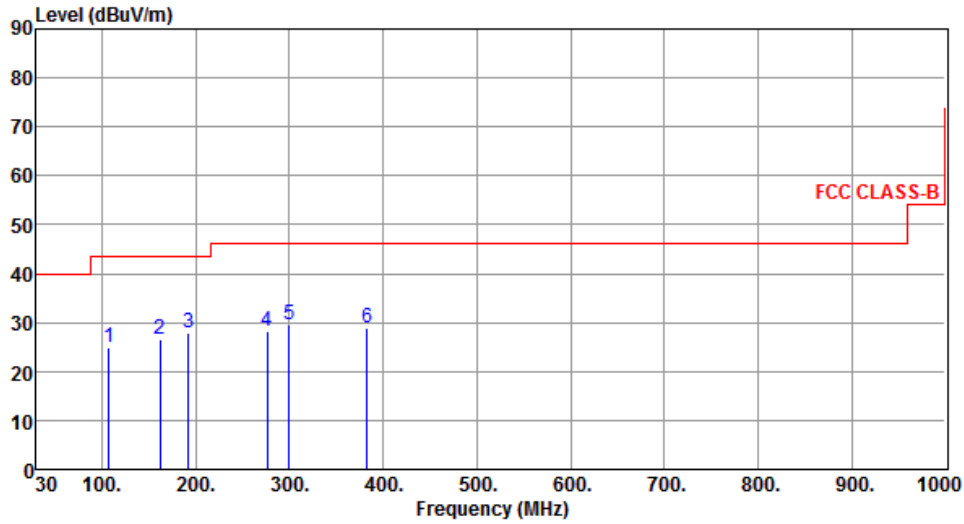

	Freq. MHz	Emission level dBuV/m	Limit dBuV/m	Margin dB	SA reading dBuV	Factor dB	Remark	ANT High cm	Turn Table deg
1	107.55	24.82	43.50	-18.68	37.10	-12.28	Peak	---	---
2	161.88	26.69	43.50	-16.81	35.05	-8.36	Peak	---	---
3	191.99	27.85	43.50	-15.65	38.67	-10.82	Peak	---	---
4	276.42	28.12	46.00	-17.88	36.43	-8.31	Peak	---	---
5	299.59	29.43	46.00	-16.57	37.11	-7.68	Peak	---	---
6	383.12	28.84	46.00	-17.16	34.24	-5.40	Peak	---	---

Note 1: Emission Level (dBuV/m) = SA Reading (dBuV/m) + Factor* (dB)

*Factor includes antenna factor , cable loss and amplifier gain

Note 2: Margin (dB) = Emission level (dBuV/m) – Limit (dBuV/m).

Note 3: All spurious emissions below 30MHz are more than 20 dB below the limit.

Modulation	GFSK	Test Freq. (MHz)	2402
Polarization	Vertical	Test Configuration	2

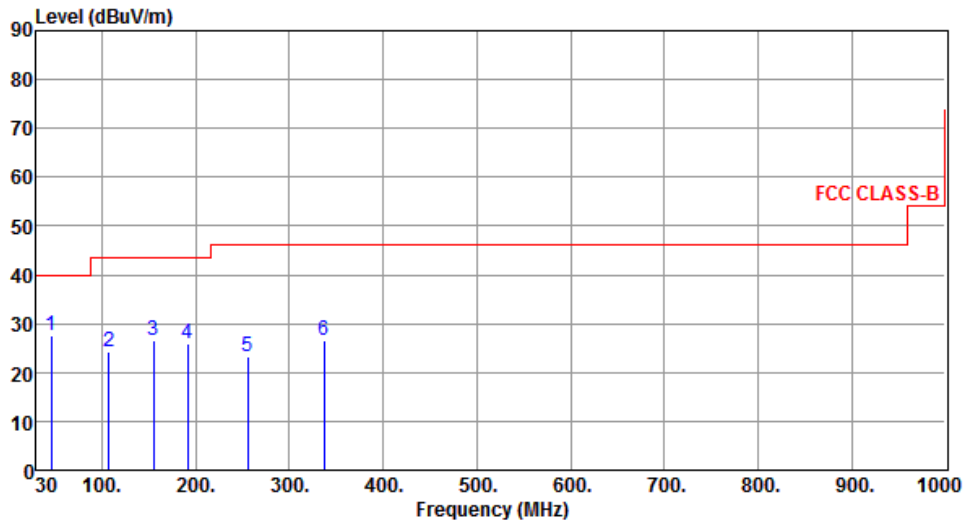

	Freq. MHz	Emission level dBuV/m	Limit dBuV/m	Margin dB	SA reading dBuV	Factor dB	Remark	ANT High cm	Turn Table deg
1	45.49	27.69	40.00	-12.31	35.78	-8.09	Peak	---	---
2	107.55	24.12	43.50	-19.38	36.40	-12.28	Peak	---	---
3	155.13	26.59	43.50	-16.91	34.91	-8.32	Peak	---	---
4	191.85	25.75	43.50	-17.75	36.57	-10.82	Peak	---	---
5	255.21	23.15	46.00	-22.85	32.30	-9.15	Peak	---	---
6	337.41	26.45	46.00	-19.55	33.12	-6.67	Peak	---	---

Note 1: Emission Level (dBuV/m) = SA Reading (dBuV/m) + Factor* (dB)

*Factor includes antenna factor , cable loss and amplifier gain

Note 2: Margin (dB) = Emission level (dBuV/m) – Limit (dBuV/m).

Note 3: All spurious emissions below 30MHz are more than 20 dB below the limit.

3.2.5 Transmitter Radiated Unwanted Emissions (Above 1GHz) for GFSK

Modulation	GFSK	Test Freq. (MHz)	2402
Polarization	Horizontal	Test Configuration	1

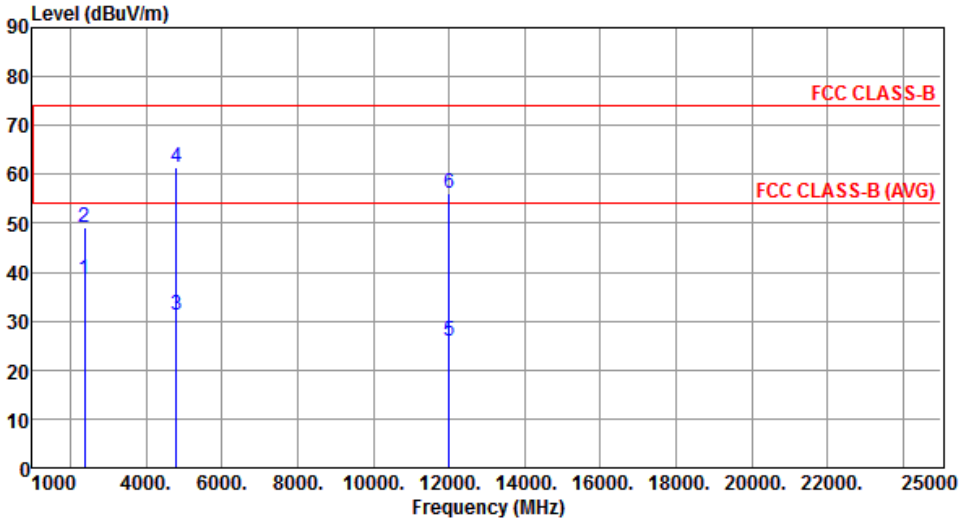

The graph plots Level (dBuV/m) on the y-axis (0 to 90) against Frequency (MHz) on the x-axis (1000 to 25000). Two horizontal red lines represent the FCC CLASS-B limit at approximately 74 dBuV/m and the FCC CLASS-B (AVG) limit at approximately 54 dBuV/m. Six data points are shown as vertical blue lines with labels 1 through 6. Points 1 and 2 are at 2390 MHz, point 3 is at 4804 MHz, and points 4, 5, and 6 are at 12010 MHz. Points 4 and 6 exceed the FCC CLASS-B (AVG) limit, while points 1, 2, 3, and 5 are below it.

	Freq. MHz	Emission level dBuV/m	Limit dBuV/m	Margin dB	SA reading dBuV	Factor dB	Remark	ANT High cm	Turn Table deg
1	2390.00	38.47	54.00	-15.53	39.71	-1.24	Average	100	110
2	2390.00	49.19	74.00	-24.81	50.43	-1.24	Peak	100	110
3	4804.00	31.37	54.00	-22.63	25.87	5.50	Average	279	167
4	4804.00	61.47	74.00	-12.53	55.97	5.50	Peak	279	167
5	12010.00	25.97	54.00	-28.03	10.23	15.74	Average	100	184
6	12010.00	56.07	74.00	-17.93	40.33	15.74	Peak	100	184

Note 1: Emission Level (dBuV/m) = SA Reading (dBuV/m) + Factor* (dB)
*Factor includes antenna factor , cable loss and amplifier gain
Note 2: Margin (dB) = Emission level (dBuV/m) – Limit (dBuV/m).

Modulation	GFSK	Test Freq. (MHz)	2402
Polarization	Vertical	Test Configuration	1

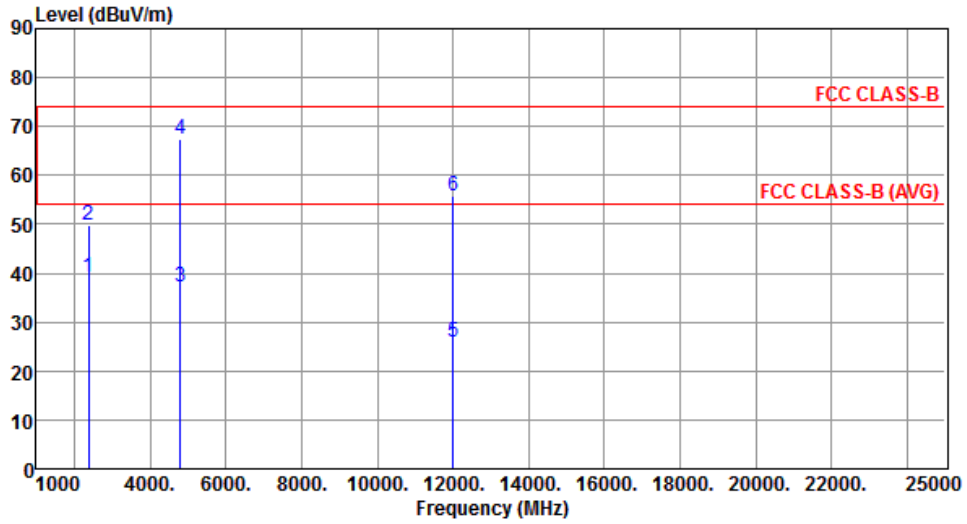

	Freq. MHz	Emission level dBUV/m	Limit dBUV/m	Margin dB	SA reading dBUV	Factor dB	Remark	ANT High cm	Turn Table deg
1	2390.00	39.12	54.00	-14.88	40.36	-1.24	Average	100	90
2	2390.00	49.82	74.00	-24.18	51.06	-1.24	Peak	100	90
3	4804.00	37.18	54.00	-16.82	31.68	5.50	Average	246	200
4	4804.00	67.28	74.00	-6.72	61.78	5.50	Peak	246	200
5	12010.00	25.86	54.00	-28.14	10.12	15.74	Average	100	171
6	12010.00	55.96	74.00	-18.04	40.22	15.74	Peak	100	171

Note 1: Emission Level (dBUV/m) = SA Reading (dBUV/m) + Factor* (dB)

*Factor includes antenna factor , cable loss and amplifier gain

Note 2: Margin (dB) = Emission level (dBUV/m) – Limit (dBUV/m).

Modulation	GFSK	Test Freq. (MHz)	2441
Polarization	Horizontal	Test Configuration	1

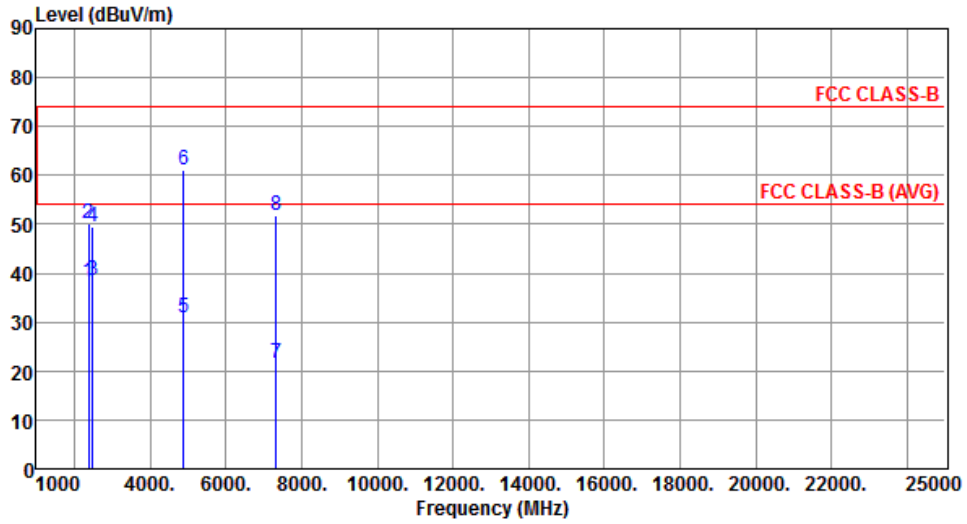

	Freq. MHz	Emission level dBuV/m	Limit dBuV/m	Margin dB	SA reading dBuV	Factor dB	Remark	ANT High cm	Turn Table deg
1	2390.00	38.28	54.00	-15.72	39.52	-1.24	Average	100	108
2	2390.00	50.17	74.00	-23.83	51.41	-1.24	Peak	100	108
3	2483.50	38.62	54.00	-15.38	39.50	-0.88	Average	100	108
4	2483.50	49.45	74.00	-24.55	50.33	-0.88	Peak	100	108
5	4882.00	31.02	54.00	-22.98	25.30	5.72	Average	301	164
6	4882.00	61.12	74.00	-12.88	55.40	5.72	Peak	301	164
7	7323.00	21.55	54.00	-32.45	10.62	10.93	Average	100	184
8	7323.00	51.65	74.00	-22.35	40.72	10.93	Peak	100	184

Note 1: Emission Level (dBuV/m) = SA Reading (dBuV/m) + Factor* (dB)

*Factor includes antenna factor , cable loss and amplifier gain

Note 2: Margin (dB) = Emission level (dBuV/m) – Limit (dBuV/m).

Modulation	GFSK	Test Freq. (MHz)	2441
Polarization	Vertical	Test Configuration	1

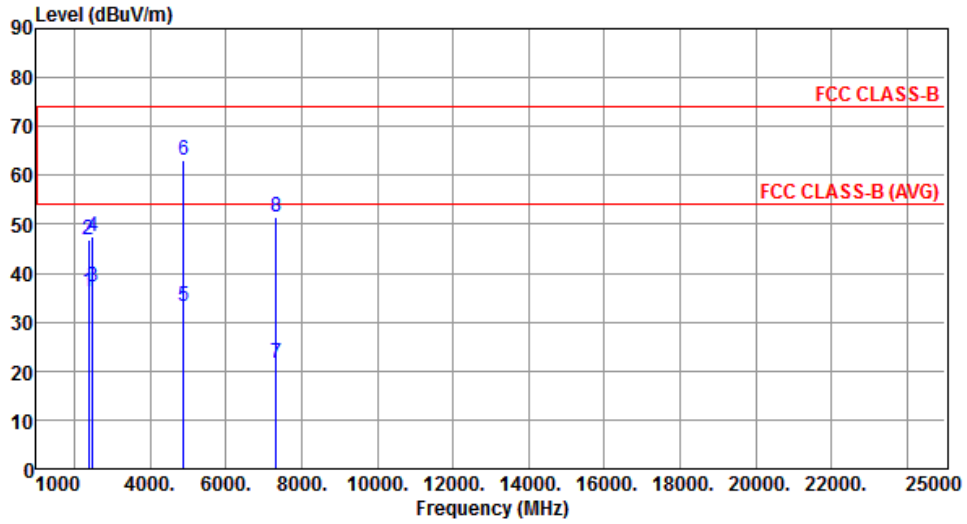

	Freq. MHz	Emission level dBuV/m	Limit dBuV/m	Margin dB	SA reading dBuV	Factor dB	Remark	ANT High cm	Turn Table deg
1	2390.00	36.21	54.00	-17.79	37.45	-1.24	Average	100	114
2	2390.00	46.98	74.00	-27.02	48.22	-1.24	Peak	100	114
3	2483.50	37.16	54.00	-16.84	38.04	-0.88	Average	100	114
4	2483.50	47.64	74.00	-26.36	48.52	-0.88	Peak	100	114
5	4882.00	33.07	54.00	-20.93	27.35	5.72	Average	223	191
6	4882.00	63.17	74.00	-10.83	57.45	5.72	Peak	223	191
7	7323.00	21.50	54.00	-32.50	10.57	10.93	Average	100	188
8	7323.00	51.60	74.00	-22.40	40.67	10.93	Peak	100	188

Note 1: Emission Level (dBuV/m) = SA Reading (dBuV/m) + Factor* (dB)

*Factor includes antenna factor , cable loss and amplifier gain

Note 2: Margin (dB) = Emission level (dBuV/m) – Limit (dBuV/m).

Modulation	GFSK	Test Freq. (MHz)	2480
Polarization	Horizontal	Test Configuration	1

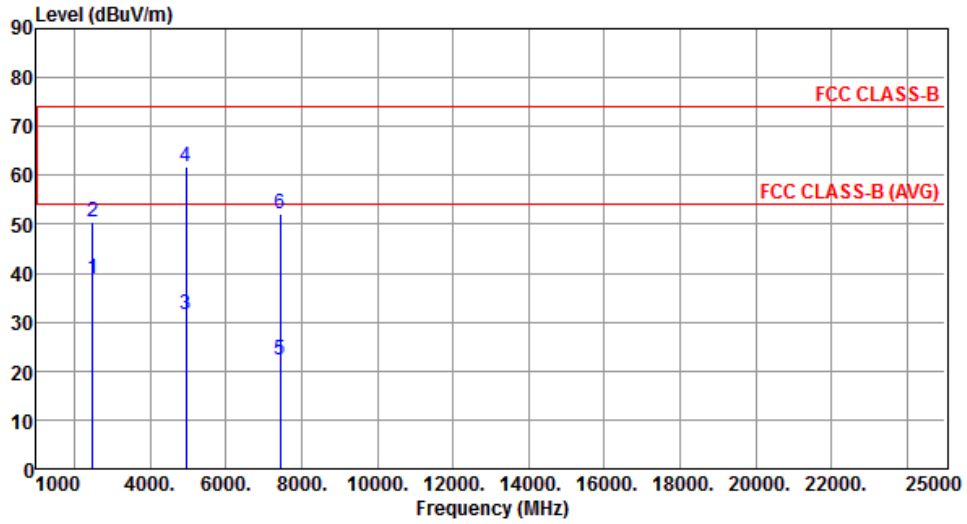

	Freq. MHz	Emission level dBuV/m	Limit dBuV/m	Margin dB	SA reading dBuV	Factor dB	Remark	ANT High cm	Turn Table deg
1	2483.50	39.02	54.00	-14.98	39.90	-0.88	Average	100	109
2	2483.50	50.60	74.00	-23.40	51.48	-0.88	Peak	100	109
3	4960.00	31.56	54.00	-22.44	25.63	5.93	Average	292	166
4	4960.00	61.66	74.00	-12.34	55.73	5.93	Peak	292	166
5	7440.00	22.19	54.00	-31.81	10.89	11.30	Average	100	183
6	7440.00	52.29	74.00	-21.71	40.99	11.30	Peak	100	183

Note 1: Emission Level (dBuV/m) = SA Reading (dBuV/m) + Factor* (dB)

*Factor includes antenna factor , cable loss and amplifier gain

Note 2: Margin (dB) = Emission level (dBuV/m) – Limit (dBuV/m).

Modulation	GFSK	Test Freq. (MHz)	2480
Polarization	Vertical	Test Configuration	1

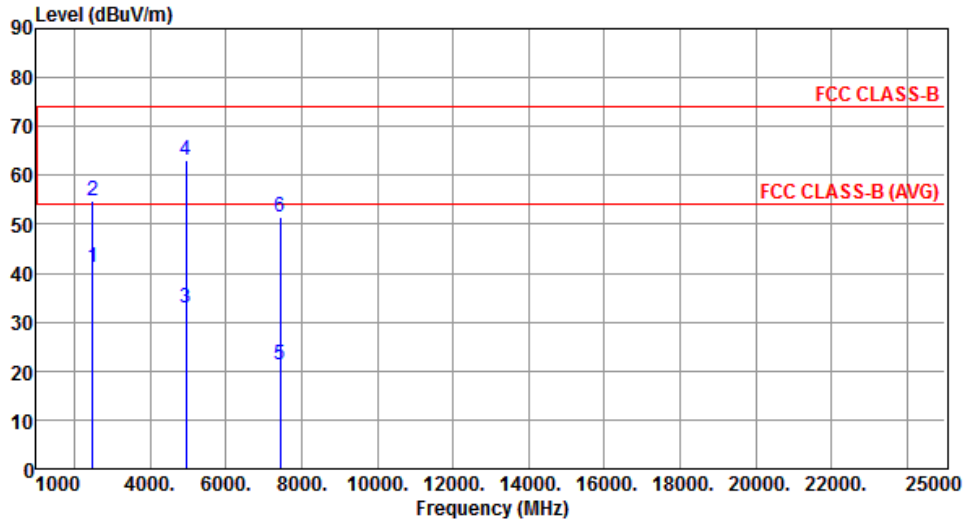

	Freq. MHz	Emission level dBuV/m	Limit dBuV/m	Margin dB	SA reading dBuV	Factor dB	Remark	ANT High cm	Turn Table deg
1	2483.50	41.32	54.00	-12.68	42.20	-0.88	Average	100	116
2	2483.50	54.66	74.00	-19.34	55.54	-0.88	Peak	100	116
3	4960.00	33.01	54.00	-20.99	27.08	5.93	Average	234	189
4	4960.00	63.11	74.00	-10.89	57.18	5.93	Peak	234	189
5	7440.00	21.41	54.00	-32.59	10.11	11.30	Average	100	183
6	7440.00	51.51	74.00	-22.49	40.21	11.30	Peak	100	183

Note 1: Emission Level (dBuV/m) = SA Reading (dBuV/m) + Factor* (dB)

*Factor includes antenna factor , cable loss and amplifier gain

Note 2: Margin (dB) = Emission level (dBuV/m) – Limit (dBuV/m).

3.2.6 Transmitter Radiated Unwanted Emissions (Above 1GHz) for 8DPSK

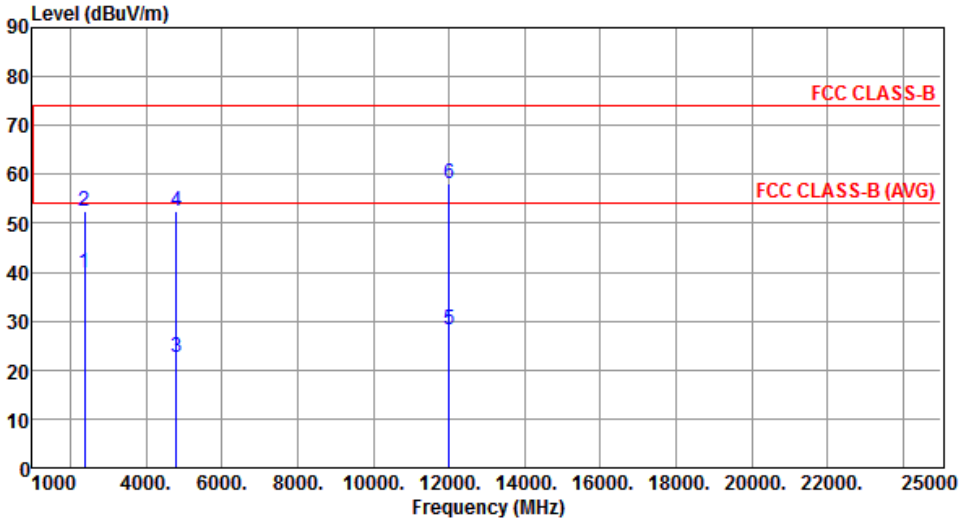
Modulation	8DPSK	Test Freq. (MHz)	2402						
Polarization	Horizontal	Test Configuration	1						
									
	Freq.	Emission level	Limit	Margin	SA reading	Factor	Remark	ANT High	Turn Table
	MHz	dBuV/m	dBuV/m	dB	dBuV	dB		cm	deg
1	2390.00	39.78	54.00	-14.22	41.02	-1.24	Average	104	182
2	2390.00	52.50	74.00	-21.50	53.74	-1.24	Peak	104	182
3	4804.00	22.44	54.00	-31.56	16.94	5.50	Average	100	51
4	4804.00	52.54	74.00	-21.46	47.04	5.50	Peak	100	51
5	12010.00	28.18	54.00	-25.82	12.44	15.74	Average	100	90
6	12010.00	58.28	74.00	-15.72	42.54	15.74	Peak	100	90
<p>Note 1: Emission Level (dBuV/m) = SA Reading (dBuV/m) + Factor* (dB) *Factor includes antenna factor , cable loss and amplifier gain Note 2: Margin (dB) = Emission level (dBuV/m) – Limit (dBuV/m).</p>									

Modulation	8DPSK	Test Freq. (MHz)	2402
Polarization	Vertical	Test Configuration	1

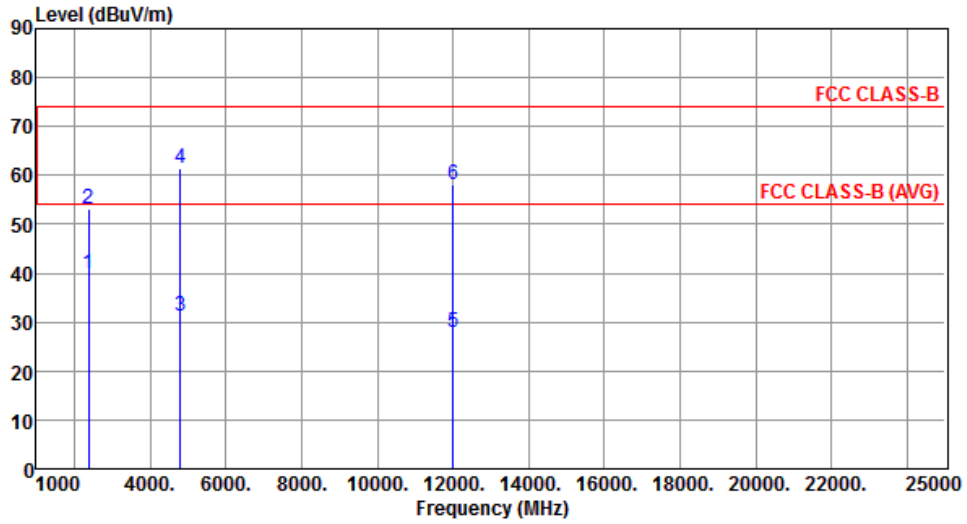

	Freq. MHz	Emission level dBuV/m	Limit dBuV/m	Margin dB	SA reading dBuV	Factor dB	Remark	ANT High cm	Turn Table deg
1	2390.00	39.79	54.00	-14.21	41.03	-1.24	Average	100	222
2	2390.00	53.08	74.00	-20.92	54.32	-1.24	Peak	100	222
3	4804.00	31.21	54.00	-22.79	25.71	5.50	Average	209	354
4	4804.00	61.31	74.00	-12.69	55.81	5.50	Peak	209	354
5	12010.00	28.05	54.00	-25.95	12.31	15.74	Average	100	30
6	12010.00	58.15	74.00	-15.85	42.41	15.74	Peak	100	30

Note 1: Emission Level (dBuV/m) = SA Reading (dBuV/m) + Factor* (dB)

*Factor includes antenna factor , cable loss and amplifier gain

Note 2: Margin (dB) = Emission level (dBuV/m) – Limit (dBuV/m).

Modulation	8DPSK	Test Freq. (MHz)	2441
Polarization	Horizontal	Test Configuration	1

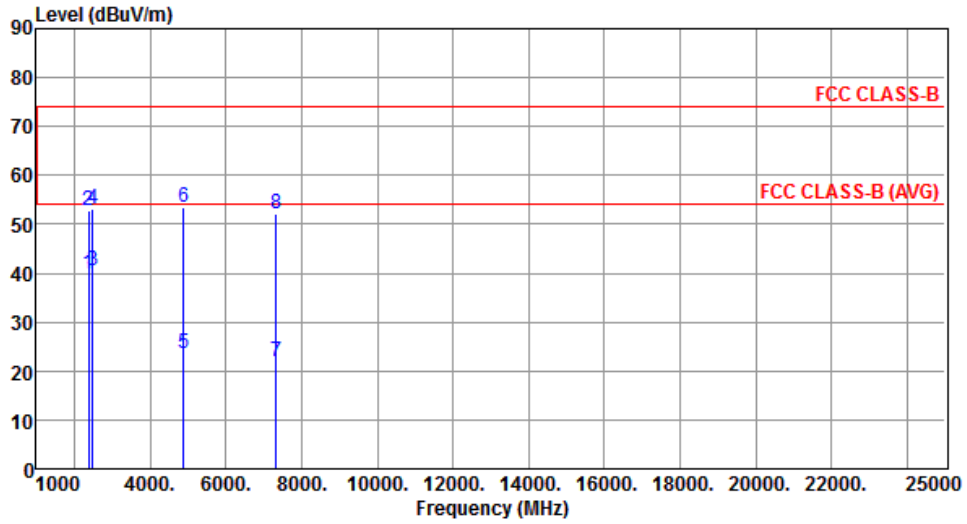

	Freq. MHz	Emission level dBuV/m	Limit dBuV/m	Margin dB	SA reading dBuV	Factor dB	Remark	ANT High cm	Turn Table deg
1	2390.00	39.99	54.00	-14.01	41.23	-1.24	Average	100	182
2	2390.00	52.85	74.00	-21.15	54.09	-1.24	Peak	100	182
3	2483.50	40.67	54.00	-13.33	41.55	-0.88	Average	100	182
4	2483.50	53.24	74.00	-20.76	54.12	-0.88	Peak	100	182
5	4882.00	23.46	54.00	-30.54	17.74	5.72	Average	100	47
6	4882.00	53.56	74.00	-20.44	47.84	5.72	Peak	100	47
7	7323.00	22.08	54.00	-31.92	11.15	10.93	Average	100	20
8	7323.00	52.18	74.00	-21.82	41.25	10.93	Peak	100	20

Note 1: Emission Level (dBuV/m) = SA Reading (dBuV/m) + Factor* (dB)

*Factor includes antenna factor , cable loss and amplifier gain

Note 2: Margin (dB) = Emission level (dBuV/m) – Limit (dBuV/m).

Modulation	8DPSK	Test Freq. (MHz)	2441
Polarization	Vertical	Test Configuration	1

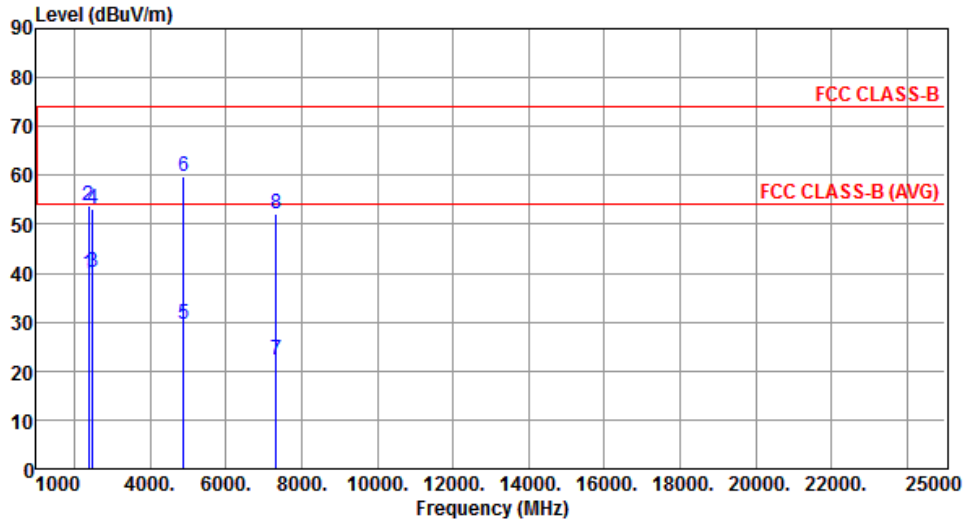

	Freq. MHz	Emission level dBUV/m	Limit dBUV/m	Margin dB	SA reading dBUV	Factor dB	Remark	ANT High cm	Turn Table deg
1	2390.00	39.92	54.00	-14.08	41.16	-1.24	Average	100	311
2	2390.00	53.71	74.00	-20.29	54.95	-1.24	Peak	100	311
3	2483.50	40.12	54.00	-13.88	41.00	-0.88	Average	100	311
4	2483.50	53.14	74.00	-20.86	54.02	-0.88	Peak	100	311
5	4882.00	29.70	54.00	-24.30	23.98	5.72	Average	209	344
6	4882.00	59.80	74.00	-14.20	54.08	5.72	Peak	209	344
7	7323.00	22.15	54.00	-31.85	11.22	10.93	Average	100	30
8	7323.00	52.25	74.00	-21.75	41.32	10.93	Peak	100	30

Note 1: Emission Level (dBUV/m) = SA Reading (dBUV/m) + Factor* (dB)

*Factor includes antenna factor , cable loss and amplifier gain

Note 2: Margin (dB) = Emission level (dBUV/m) – Limit (dBUV/m).

Modulation	8DPSK	Test Freq. (MHz)	2480
Polarization	Horizontal	Test Configuration	1

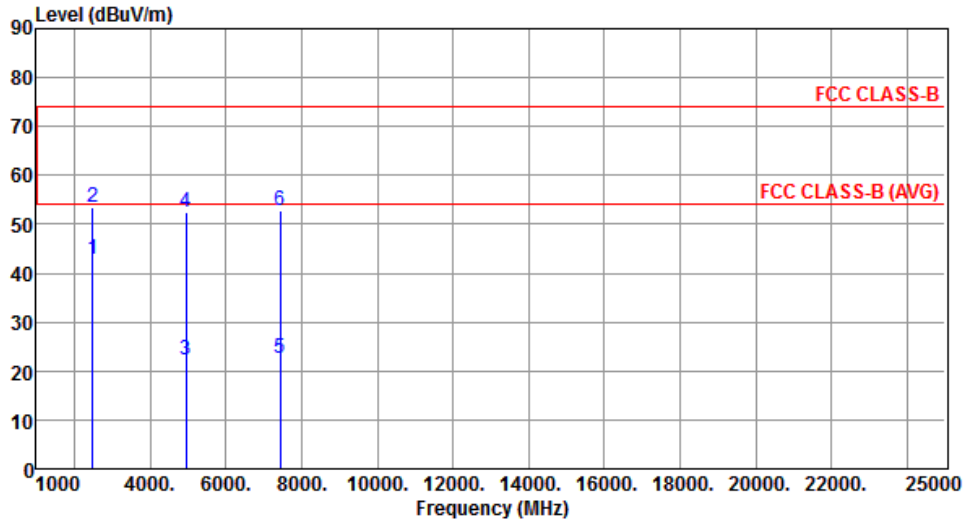

	Freq. MHz	Emission level dBuV/m	Limit dBuV/m	Margin dB	SA reading dBuV	Factor dB	Remark	ANT High cm	Turn Table deg
1	2483.50	42.70	54.00	-11.30	43.58	-0.88	Average	104	179
2	2483.50	53.47	74.00	-20.53	54.35	-0.88	Peak	104	179
3	4960.00	22.24	54.00	-31.76	16.31	5.93	Average	100	43
4	4960.00	52.34	74.00	-21.66	46.41	5.93	Peak	100	43
5	7440.00	22.66	54.00	-31.34	11.36	11.30	Average	100	30
6	7440.00	52.76	74.00	-21.24	41.46	11.30	Peak	100	30

Note 1: Emission Level (dBuV/m) = SA Reading (dBuV/m) + Factor* (dB)

*Factor includes antenna factor , cable loss and amplifier gain

Note 2: Margin (dB) = Emission level (dBuV/m) – Limit (dBuV/m).

Modulation	8DPSK	Test Freq. (MHz)	2480
Polarization	Vertical	Test Configuration	1

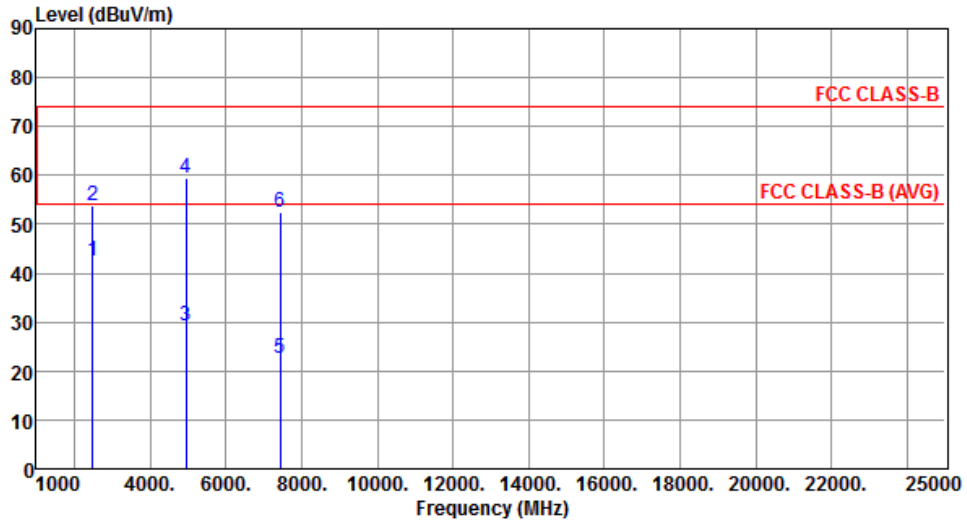

	Freq. MHz	Emission level dBuV/m	Limit dBuV/m	Margin dB	SA reading dBuV	Factor dB	Remark	ANT High cm	Turn Table deg
1	2483.50	42.50	54.00	-11.50	43.38	-0.88	Average	100	312
2	2483.50	53.81	74.00	-20.19	54.69	-0.88	Peak	100	312
3	4960.00	29.29	54.00	-24.71	23.36	5.93	Average	200	352
4	4960.00	59.39	74.00	-14.61	53.46	5.93	Peak	200	352
5	7440.00	22.48	54.00	-31.52	11.18	11.30	Average	100	50
6	7440.00	52.58	74.00	-21.42	41.28	11.30	Peak	100	50

Note 1: Emission Level (dBuV/m) = SA Reading (dBuV/m) + Factor* (dB)

*Factor includes antenna factor , cable loss and amplifier gain

Note 2: Margin (dB) = Emission level (dBuV/m) – Limit (dBuV/m).

3.3 Unwanted Emissions into Non-Restricted Frequency Bands

3.3.1 Limit of Unwanted Emissions into Non-Restricted Frequency Bands

Peak power in any 100 kHz bandwidth outside of the authorized frequency band shall be attenuated by at least 20 dB relative to the maximum in-band peak PSD level in 100 kHz.

3.3.2 Test Procedures

Reference level measurement

1. Set RBW=100kHz, VBW = 300kHz , Detector = Peak, Sweep time = Auto
2. Trace = max hold , Allow Trace to fully stabilize
3. Use the peak marker function to determine the maximum PSD level

Emission level measurement

1. Set RBW=100kHz, VBW = 300kHz , Detector = Peak, Sweep time = Auto
2. Trace = max hold , Allow Trace to fully stabilize
3. Scan Frequency range is up to 25GHz
4. Use the peak marker function to determine the maximum amplitude level

3.3.3 Test Setup

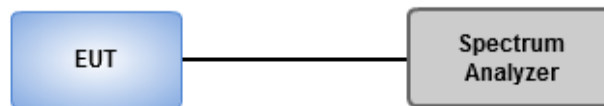

3.3.4 Unwanted Emissions into Non-Restricted Frequency Bands

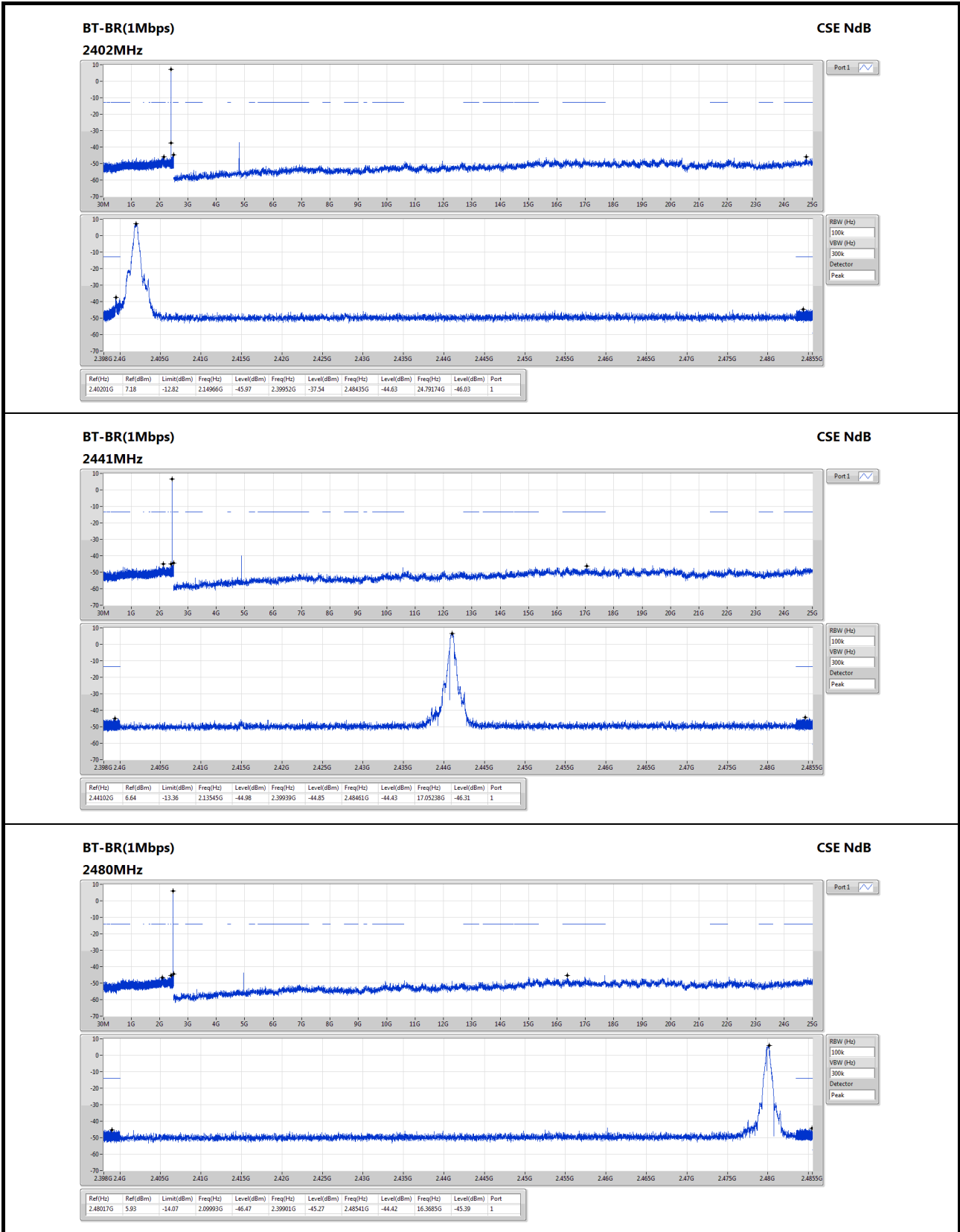

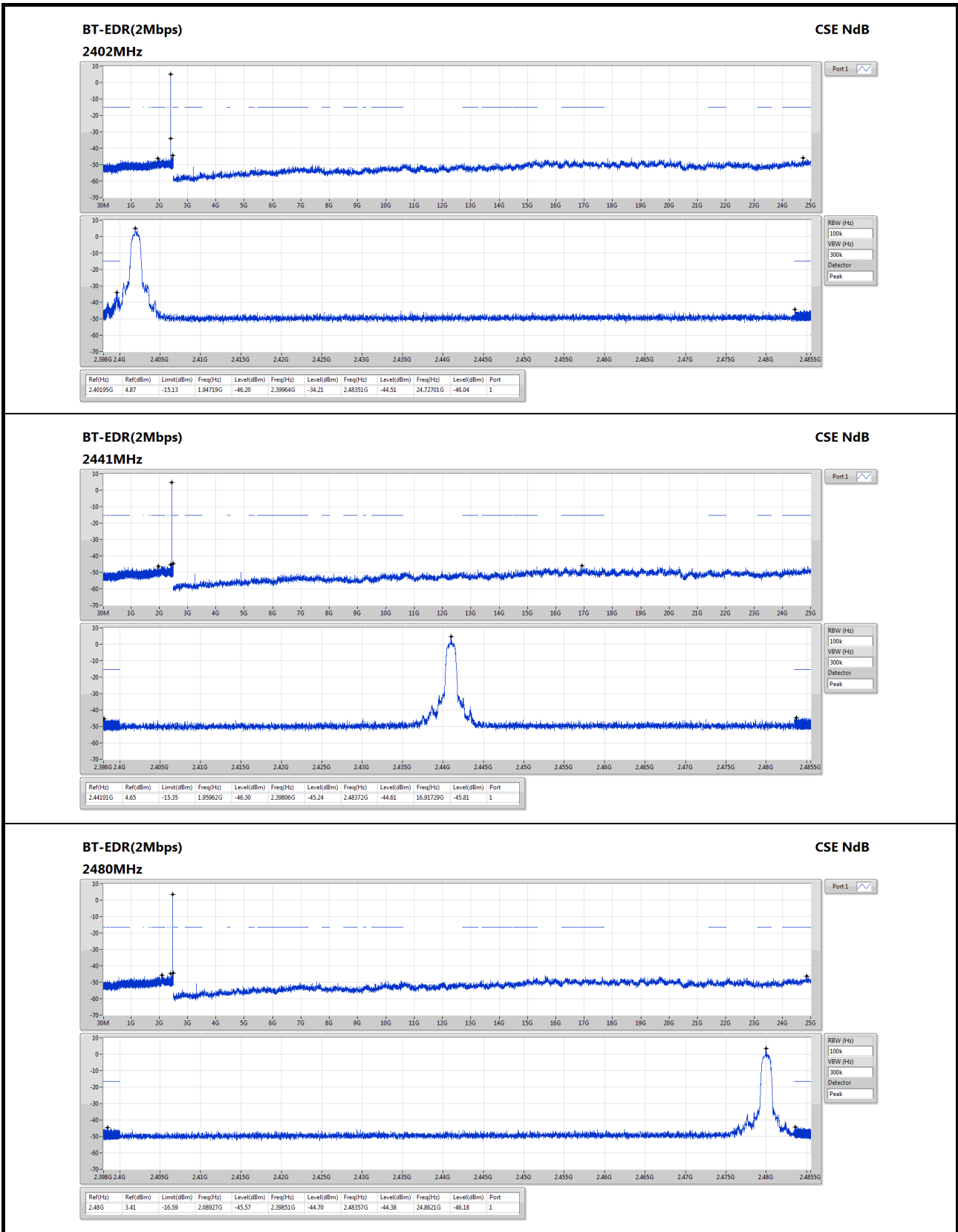

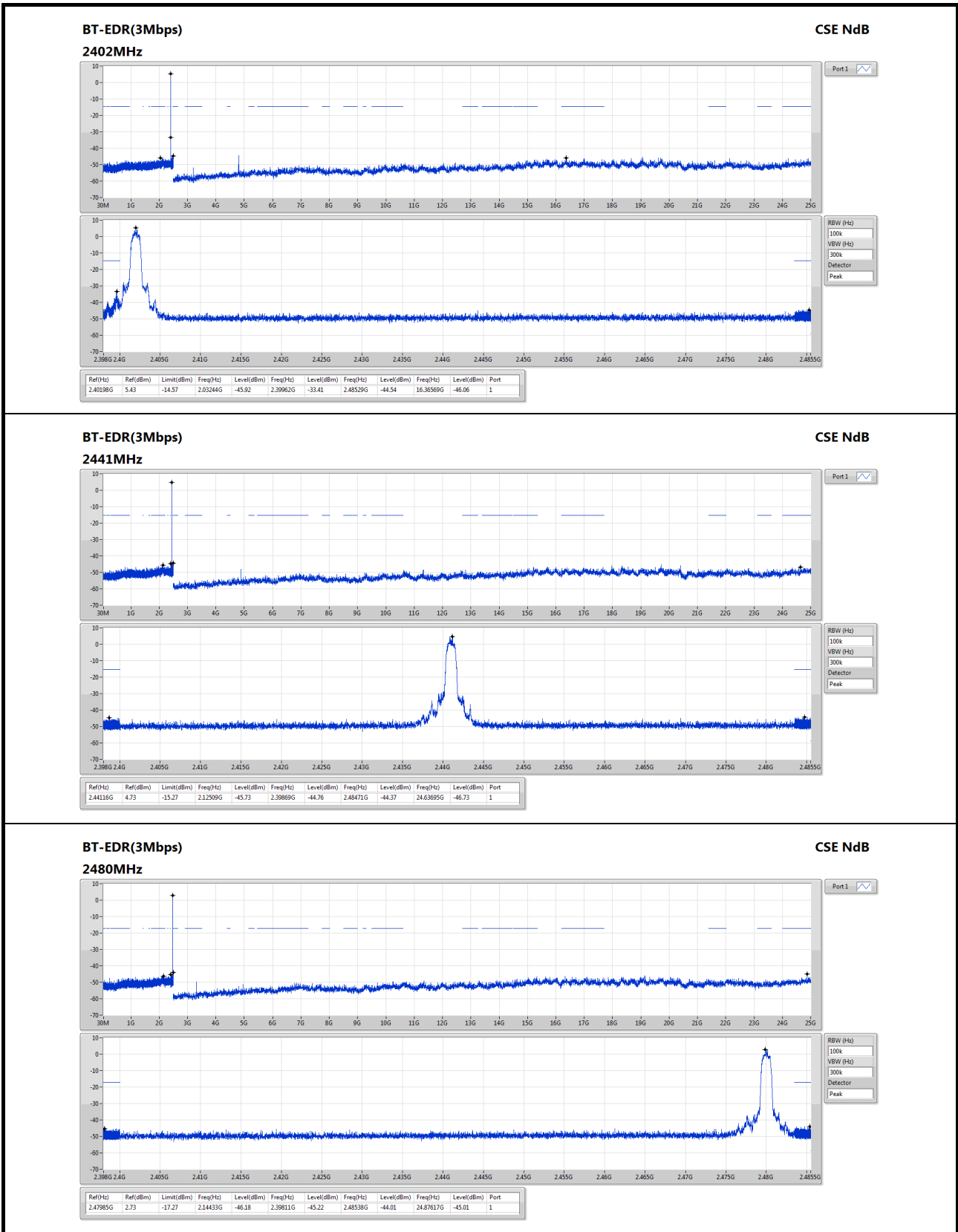

BT-BR(1Mbps)

2441MHz

Hopping Ch Bandedge (Non-restricted Band)

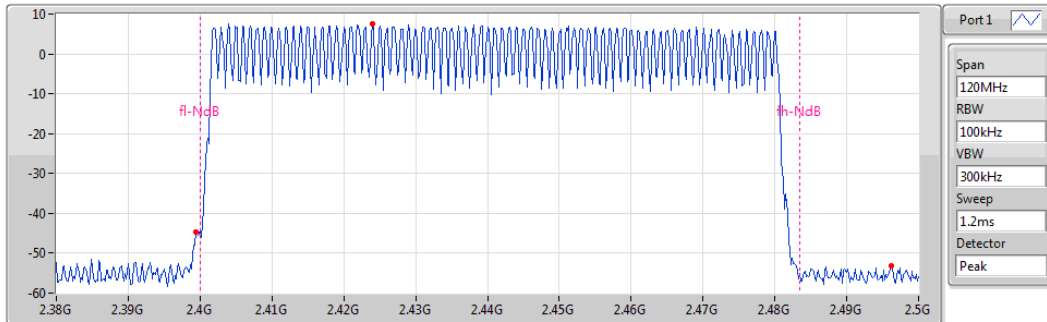

Limit(dBm)	Ref(Hz)	Ref(dBm)	BE-l(Hz)	BE-l(dBm)	BE-h(Hz)	BE-h(dBm)
-12.57	2.424G	7.43	2.399478G	-44.6	2.496174G	-53.22

BT-EDR(2Mbps)

2441MHz

Hopping Ch Bandedge (Non-restricted Band)

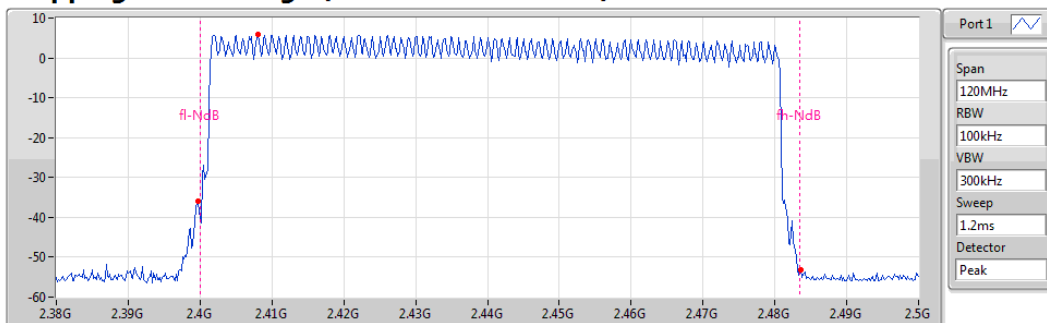

Limit(dBm)	Ref(Hz)	Ref(dBm)	BE-l(Hz)	BE-l(dBm)	BE-h(Hz)	BE-h(dBm)
-14.18	2.408G	5.82	2.399652G	-35.92	2.483652G	-53.21

BT-EDR(3Mbps)

2441MHz

Hopping Ch Bandedge (Non-restricted Band)

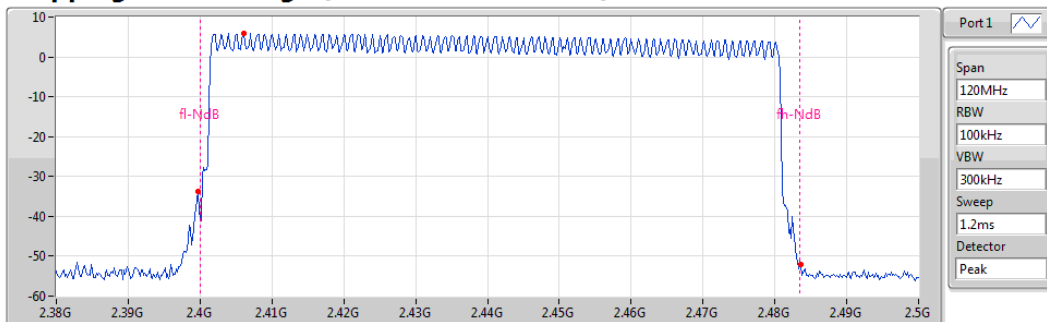

Limit(dBm)	Ref(Hz)	Ref(dBm)	BE-l(Hz)	BE-l(dBm)	BE-h(Hz)	BE-h(dBm)
-14.18	2.406087G	5.82	2.399652G	-33.88	2.483652G	-52

3.4 Conducted Output Power

3.4.1 Limit of Conducted Output Power

- 1 Watt
For frequency hopping systems operating in the 2400–2483.5 MHz band employing at least 75 non overlapping hopping channels, and all frequency hopping systems in the 5725–5850 MHz band.
- 0.125 Watt
For all other frequency hopping systems in the 2400–2483.5 MHz band.
- 0.125 Watt
For Frequency hopping systems operating in the 2400–2483.5 MHz band have hopping channel carrier frequencies that are separated by two-thirds of the 20 dB bandwidth of the hopping channel.

3.4.2 Test Procedures

1. A wideband power meter is used for power measurement. Bandwidth of power sensor and meter is 50MHz
2. If duty cycle of test signal is not 100 %, trigger and gating function of power meter will be enabled to capture transmission burst for measuring output power

3.4.3 Test Setup

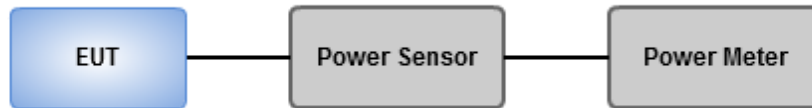

3.4.4 Test Result of Conducted Output Power

Peak Power Summary

Mode	Power (dBm)	Power (W)
2.4-2.4835GHz	-	-
BT-BR(1Mbps)	7.80	0.00603
BT-EDR(2Mbps)	6.79	0.00478
BT-EDR(3Mbps)	6.95	0.00495

Result

Mode	Result	Gain (dBi)	Power (dBm)	Power Limit (dBm)
BT-BR(1Mbps)	-	-	-	-
2402MHz	Pass	3.00	7.80	21.00
2441MHz	Pass	3.00	7.38	21.00
2480MHz	Pass	3.00	6.61	21.00
BT-EDR(2Mbps)	-	-	-	-
2402MHz	Pass	3.00	6.79	21.00
2441MHz	Pass	3.00	6.16	21.00
2480MHz	Pass	3.00	5.20	21.00
BT-EDR(3Mbps)	-	-	-	-
2402MHz	Pass	3.00	6.95	21.00
2441MHz	Pass	3.00	6.36	21.00
2480MHz	Pass	3.00	5.42	21.00

Average Power Summary

Mode	Power (dBm)	Power (W)
2.4-2.4835GHz	-	-
BT-BR(1Mbps)	7.65	0.00582
BT-EDR(2Mbps)	4.70	0.00295
BT-EDR(3Mbps)	4.71	0.00296

Result

Mode	Result	Gain (dBi)	Power (dBm)	Power Limit (dBm)
BT-BR(1Mbps)	-	-	-	-
2402MHz	Pass	3.00	7.65	
2441MHz	Pass	3.00	7.22	
2480MHz	Pass	3.00	6.44	
BT-EDR(2Mbps)	-	-	-	
2402MHz	Pass	3.00	4.70	
2441MHz	Pass	3.00	3.92	
2480MHz	Pass	3.00	2.73	
BT-EDR(3Mbps)	-	-	-	
2402MHz	Pass	3.00	4.71	
2441MHz	Pass	3.00	3.94	
2480MHz	Pass	3.00	2.75	

Note: Average power is for reference only.

3.5 Number of Hopping Frequency

3.5.1 Limit of Number of Hopping Frequency

Frequency hopping systems in the 2400–2483.5 MHz band shall use at least 15 channels.

3.5.2 Test Procedures

1. Set RBW = 100kHz, VBW = 300kHz, Sweep time = Auto, Detector = Peak Trace max hold.
2. Allow trace to stabilize.

3.5.3 Test Setup

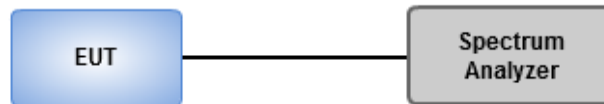

3.5.4 Test Result of Number of Hopping Frequency

Summary

Mode	Max-Hop No
2.4-2.4835GHz	-
BT-BR(1Mbps)	79
BT-EDR(2Mbps)	79
BT-EDR(3Mbps)	79

Result

Mode	Result	Hopping No	Limit
BT-BR(1Mbps)	-	-	-
2441MHz	Pass	79	15
BT-EDR(2Mbps)	-	-	-
2441MHz	Pass	79	15
BT-EDR(3Mbps)	-	-	-
2441MHz	Pass	79	15

BT-BR(1Mbps)
2441MHz

Hopping Ch

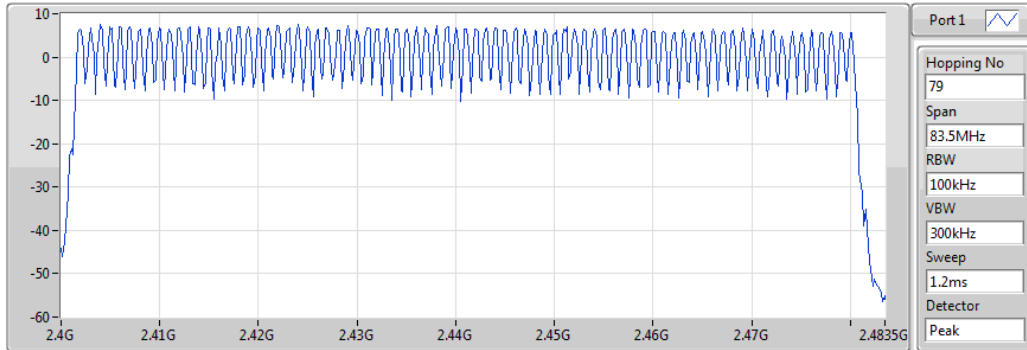

Hopping No	Limit
79	15

BT-EDR(2Mbps)
2441MHz

Hopping Ch

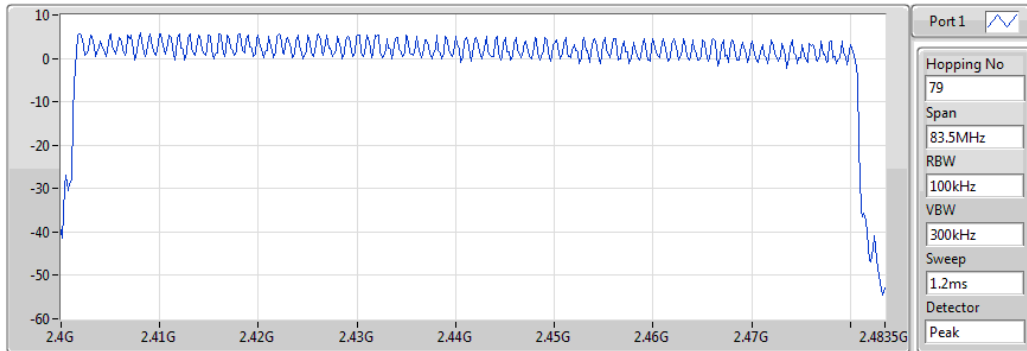

Hopping No	Limit
79	15

BT-EDR(3Mbps)
2441MHz

Hopping Ch

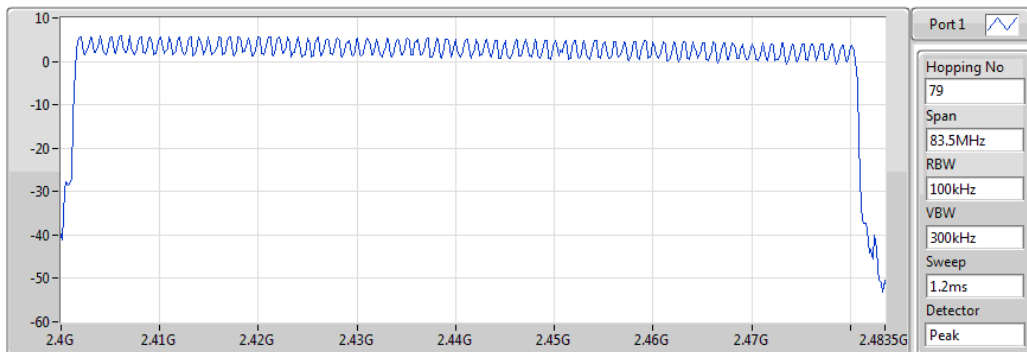

Hopping No	Limit
79	15

3.6 20dB and Occupied Bandwidth

3.6.1 Test Procedures

20dB Bandwidth

1. Set RBW=10kHz VBW= 30kHz for BT BR mode, RBW=20kHz, VBW=100kHz for other modes, Sweep time = Auto, Detector=Peak , Trace max hold
2. Allow trace to stabilize
3. Measure the maximum width of the emission that is constrained by the frequencies associated with the two outermost amplitude points (upper and lower) that are attenuated by 20 dB relative to the maximum level measured in the fundamental emission.

Occupied Bandwidth

1. Set RBW=10kHz VBW= 30kHz for BT BR mode, RBW=20kHz, VBW=100kHz for other modes, Sweep time = Auto, Detector=Sample , Trace max hold
2. Allow trace to stabilize
3. Use Occupied bandwidth function of spectrum analyzer to measuring 99% occupied bandwidth

3.6.2 Test Setup

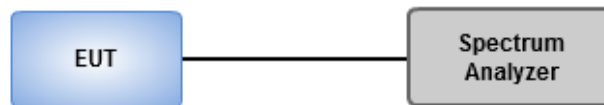

3.6.3 Test result of 20dB and Occupied Bandwidth

Summary

Mode	Max-N dB (Hz)	Max-OBW (Hz)	ITU-Code	Min-N dB (Hz)	Min-OBW (Hz)
2.4-2.4835GHz	-	-	-	-	-
BT-BR(1Mbps)	923.913k	900.868k	901KF1D	920.29k	879.161k
BT-EDR(2Mbps)	1.322M	1.198M	1M20G1D	1.228M	1.187M
BT-EDR(3Mbps)	1.315M	1.208M	1M21G1D	1.243M	1.183M

Max-N dB = Maximum 20dB down bandwidth; **Max-OBW** = Maximum 99% occupied bandwidth;

Min-N dB = Minimum 20dB down bandwidth; **Min-OBW** = Minimum 99% occupied bandwidth;

Result

Mode	Result	Limit (Hz)	Port 1-N dB (Hz)	Port 1-OBW (Hz)
BT-BR(1Mbps)	-	-	-	-
2402MHz	Pass	Inf	923.913k	900.868k
2441MHz	Pass	Inf	923.913k	900.868k
2480MHz	Pass	Inf	920.29k	879.161k
BT-EDR(2Mbps)	-	-	-	-
2402MHz	Pass	Inf	1.315M	1.187M
2441MHz	Pass	Inf	1.322M	1.187M
2480MHz	Pass	Inf	1.228M	1.198M
BT-EDR(3Mbps)	-	-	-	-
2402MHz	Pass	Inf	1.315M	1.208M
2441MHz	Pass	Inf	1.286M	1.198M
2480MHz	Pass	Inf	1.243M	1.183M

Port X-N dB = Port X 20dB down bandwidth; **Port X-OBW** = Port X 99% occupied bandwidth;

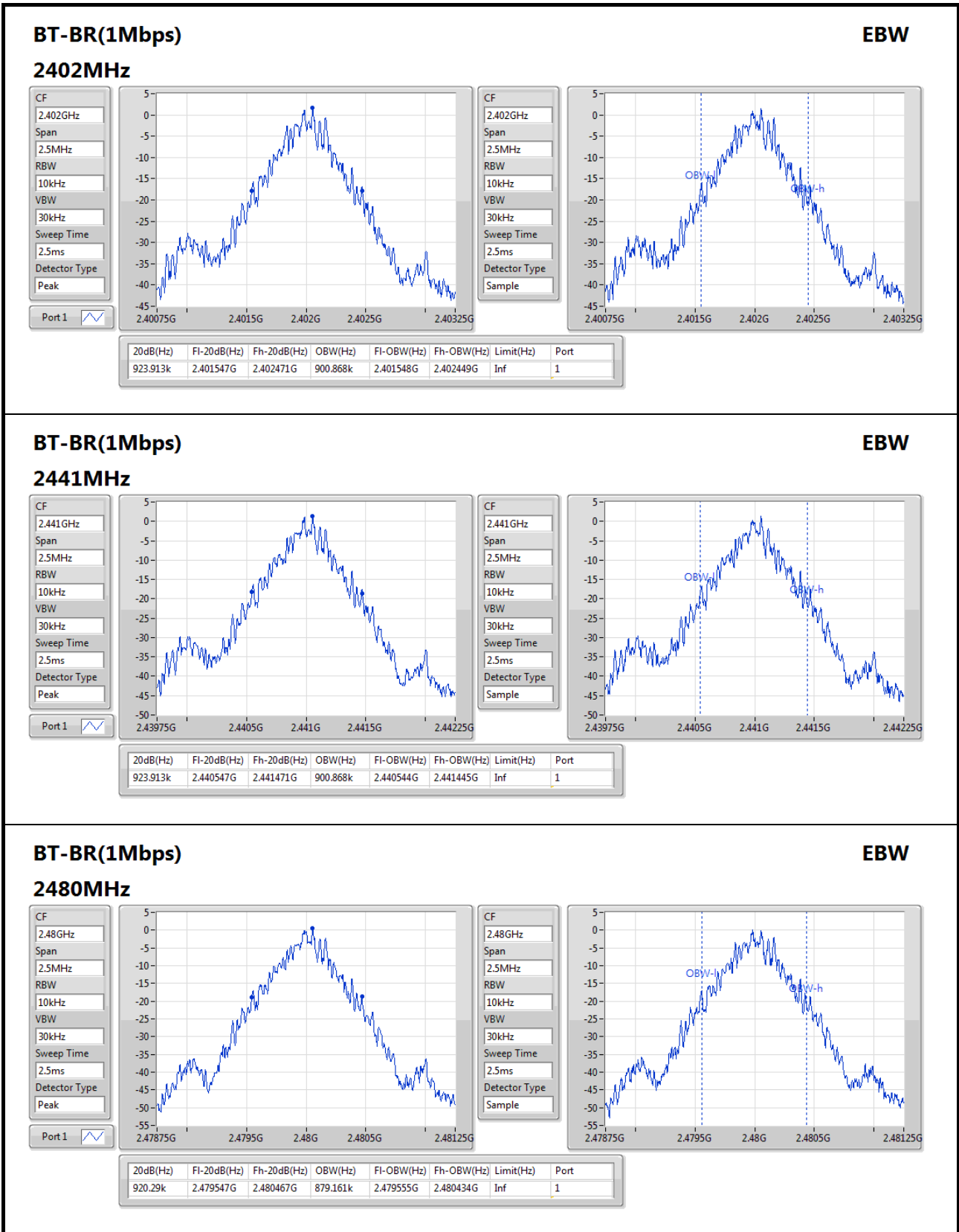

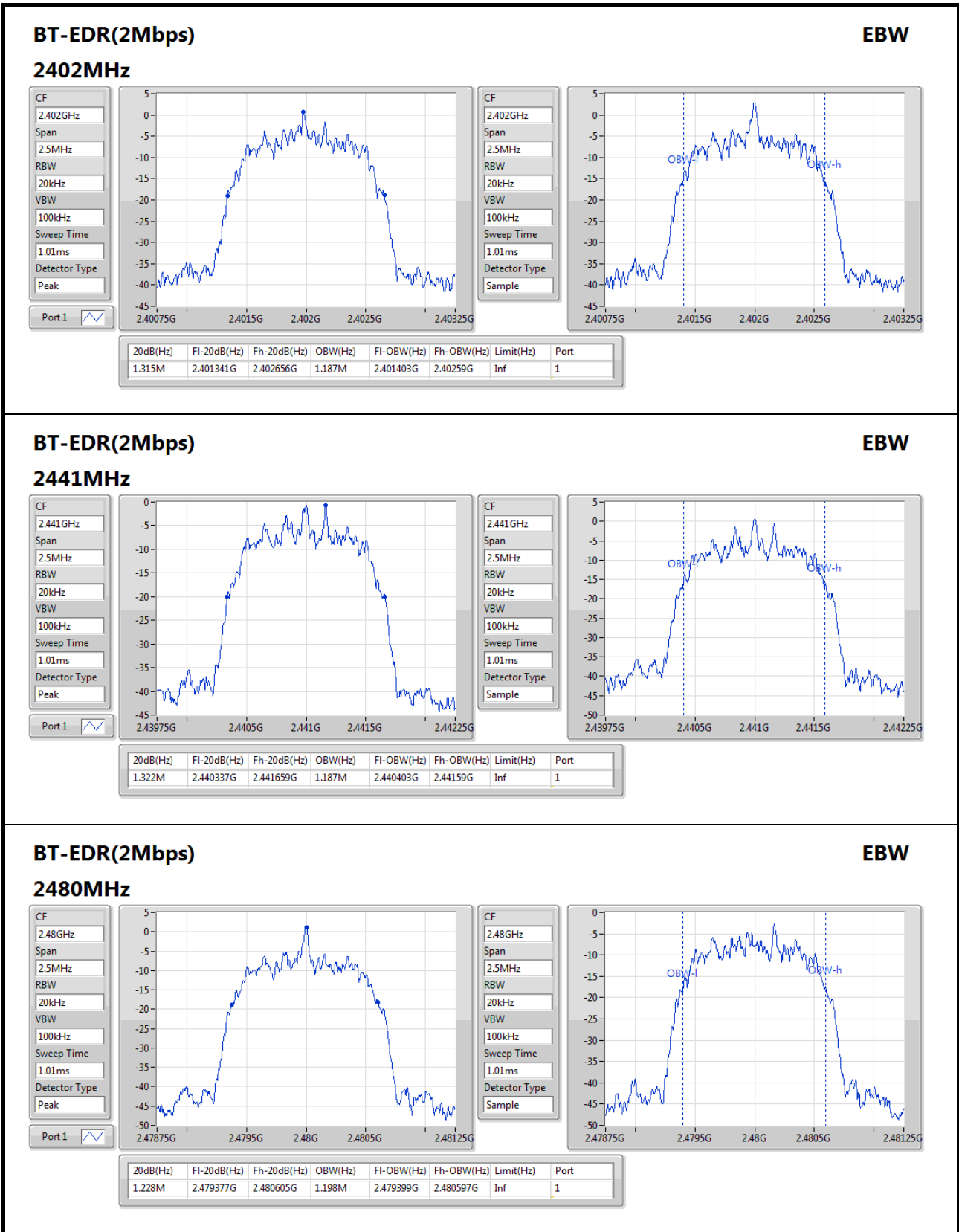

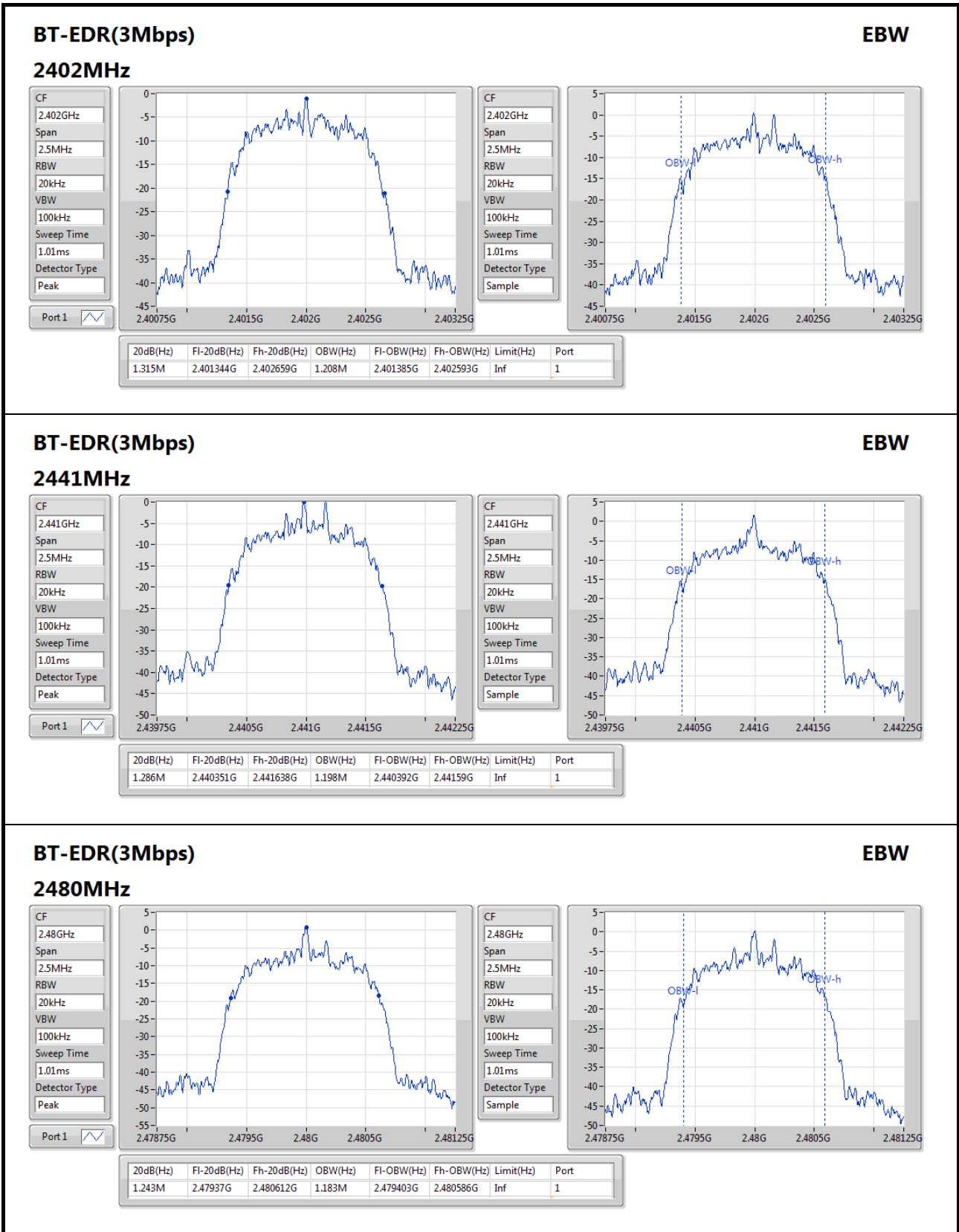

3.7 Channel Separation

3.7.1 Limit of Channel Separation

- Frequency hopping systems shall have hopping channel carrier frequencies separated by a minimum of 25 kHz or the 20 dB bandwidth of the hopping channel, whichever is greater.
- Frequency hopping systems operating in the 2400–2483.5 MHz band may have hopping channel carrier frequencies that are separated by 25 kHz or two-thirds of the 20 dB bandwidth of the hopping channel, whichever is greater.

3.7.2 Test Procedures

1. Set RBW=30kHz, VBW=100kHz, Sweep time = Auto, Detector=Peak Trace max hold
2. Allow trace to stabilize
3. Use the marker-delta function to determine the separation between the peaks of the adjacent channels. The EUT shall show compliance with the appropriate regulatory limit

3.7.3 Test Setup

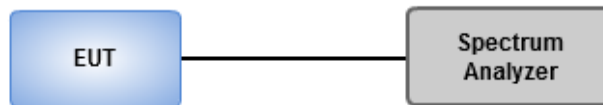

3.7.4 Test result of Channel Separation

Summary

Mode	Max-Space (Hz)	Min-Space (Hz)
2.4-2.4835GHz	-	-
BT-BR(1Mbps)	1.004348M	1M
BT-EDR(2Mbps)	1M	1M
BT-EDR(3Mbps)	1.004348M	1M

Result

Mode	Result	Fl (Hz)	Fh (Hz)	Ch.Space (Hz)	Limit (Hz)
BT-BR(1Mbps)	-	-	-	-	-
2402MHz	Pass	2.402G	2.403004G	1.004348M	680.652k
2441MHz	Pass	2.441G	2.442G	1M	615.326058k
2480MHz	Pass	2.479G	2.48G	1M	612.91314k
BT-EDR(2Mbps)	-	-	-	-	-
2402MHz	Pass	2.402G	2.403G	1M	875.79k
2441MHz	Pass	2.441G	2.442G	1M	880.452k
2480MHz	Pass	2.479G	2.48G	1M	817.848k
BT-EDR(3Mbps)	-	-	-	-	-
2402MHz	Pass	2.402G	2.403004G	1.004348M	875.79k
2441MHz	Pass	2.441G	2.442G	1M	856.476k
2480MHz	Pass	2.479G	2.48G	1M	827.838k

BT-BR(1Mbps)

Channel Separation

2.402G/2.403GHz



Ff(Hz)	Fh(Hz)	Ch.Space(Hz)	Limit(Hz)
2.402G	2.403004G	1.004348M	680.652k

BT-BR(1Mbps)

Channel Separation

2.441G/2.442GHz

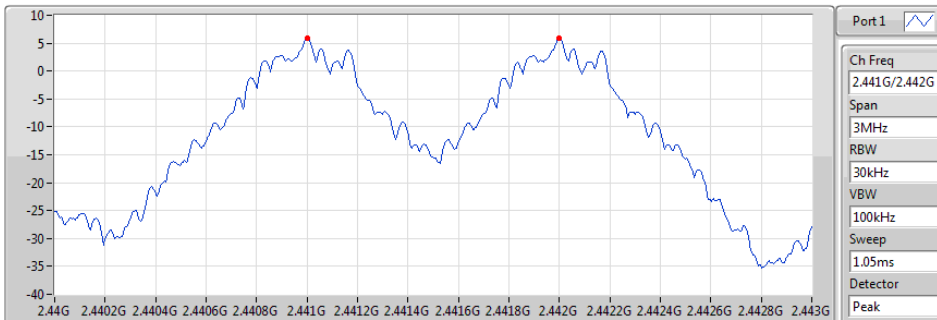

Ff(Hz)	Fh(Hz)	Ch.Space(Hz)	Limit(Hz)
2.441G	2.442G	1M	615.326058k

BT-BR(1Mbps)

Channel Separation

2.48G/2.479GHz



Ff(Hz)	Fh(Hz)	Ch.Space(Hz)	Limit(Hz)
2.479G	2.48G	1M	612.91314k

BT-EDR(2Mbps)

Channel Separation

2.402G/2.403GHz

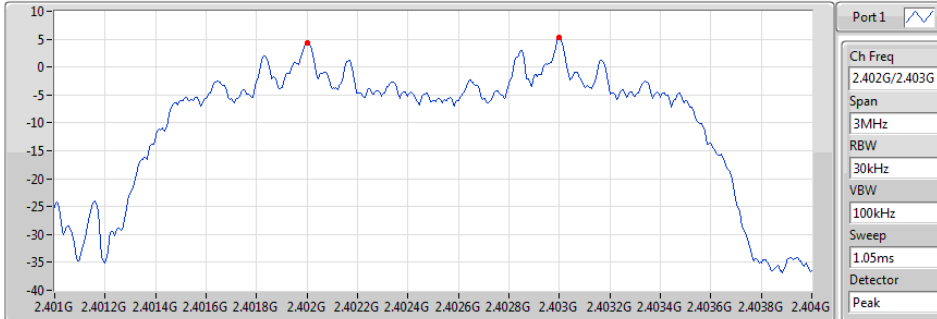

F1(Hz)	Fh(Hz)	Ch.Space(Hz)	Limit(Hz)
2.402G	2.403G	1M	875.79k

BT-EDR(2Mbps)

Channel Separation

2.441G/2.442GHz

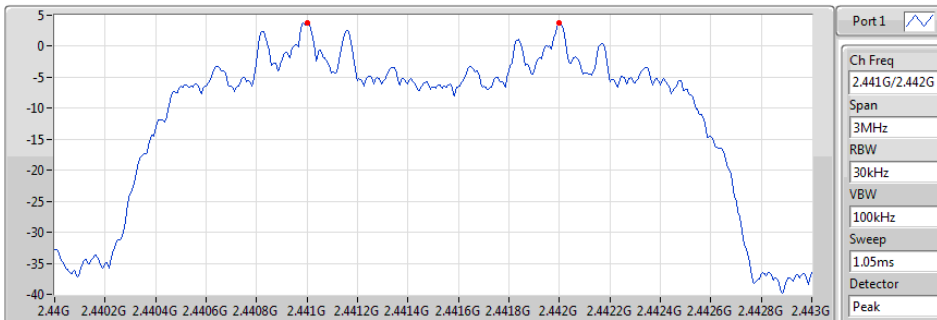

F1(Hz)	Fh(Hz)	Ch.Space(Hz)	Limit(Hz)
2.441G	2.442G	1M	880.452k

BT-EDR(2Mbps)

Channel Separation

2.48G/2.479GHz

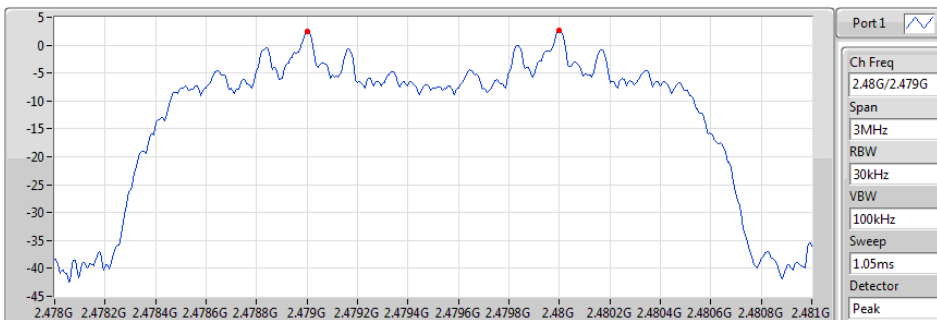

F1(Hz)	Fh(Hz)	Ch.Space(Hz)	Limit(Hz)
2.479G	2.48G	1M	817.848k

BT-EDR(3Mbps)

Channel Separation

2.402G/2.403GHz



F1(Hz)	Fh(Hz)	Ch.Space(Hz)	Limit(Hz)
2.402G	2.403004G	1.004348M	875.79k

BT-EDR(3Mbps)

Channel Separation

2.441G/2.442GHz

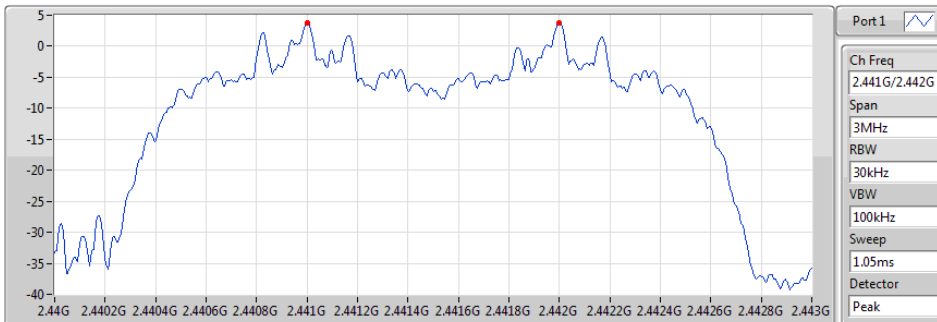

F1(Hz)	Fh(Hz)	Ch.Space(Hz)	Limit(Hz)
2.441G	2.442G	1M	856.476k

BT-EDR(3Mbps)

Channel Separation

2.48G/2.479GHz

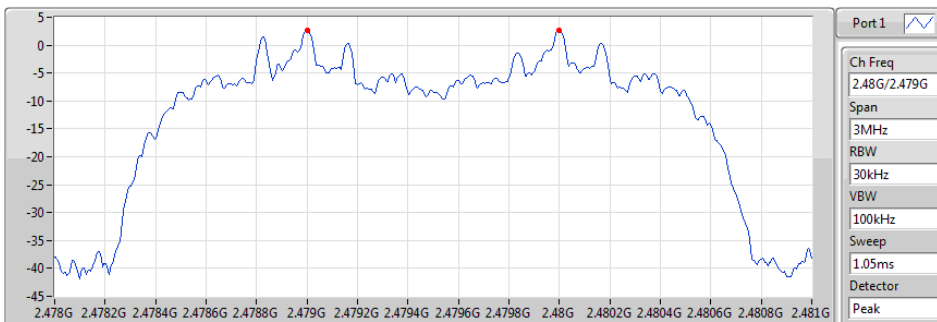

F1(Hz)	Fh(Hz)	Ch.Space(Hz)	Limit(Hz)
2.479G	2.48G	1M	827.838k

3.8 Number of Dwell Time

3.8.1 Limit of Dwell time

The average time of occupancy on any channel shall not be greater than 0.4 seconds within a period of 0.4 seconds multiplied by the number of hopping channels employed.

3.8.2 Test Procedures

1. Set RBW=300kHz,VBW=1MHz,Sweep time = 10 ms, Detector=Peak, Span=0Hz,Trace max hold
2. Enable gating and trigger function of spectrum analyzer to measure burst on time.
3. The DH1 packet can cover a single time slot. A maximum length packet has duration of 1 time slots.
Non AFH mode
The hopping rate is 1600 hops/second so the maximum dwell time is 1/1600 seconds. DH1 Packet permit maximum $1600 / 79 / 2 = 10.12$ hops per second in each channel (1 time slot TX, 1 time slot RX). So, the dwell time is the time duration of the pulse times $10.12 \times 31.6 = 320$ within 31.6 seconds.
AFH mode
The hopping rate is 800 hops/second so the maximum dwell time is 1/800 seconds. DH1 Packet permit maximum $800 / 20 / 2 = 20$ hops per second in each channel (1 time slot TX, 1 time slot RX). So, the dwell time is the time duration of the pulse times $20 \times 8 = 160$ within 8 seconds.
4. The DH3 packet can cover up to 3 time slots. A maximum length packet has duration of 3 time slots.
Non AFH mode
The hopping rate is 1600 hops/second so the maximum dwell time is 3/1600 seconds. DH3 Packet permit maximum $1600 / 79 / 4 = 5.06$ hops per second in each channel (3 time slots TX, 1 time slot RX). So, the dwell time is the time duration of the pulse times $5.06 \times 31.6 = 160$ within 31.6 seconds.
AFH mode
The hopping rate is 800hops/second so the maximum dwell time is 3/800 seconds. DH3 Packet permit maximum $800 / 20 / 4 = 10$ hops per second in each channel (3 time slots TX, 1 time slot RX). So, the dwell time is the time duration of the pulse times $10 \times 8 = 80$ within 8 seconds.
5. The DH5 packet can cover up to 5 time slots. Operate DH5 at maximum dwell time and maximum duty cycle. A maximum length packet has duration of 5 time slots.
Non AFH mode
The hopping rate is 1600 hops/second so the maximum dwell time is 5/1600 seconds, or 3.125ms. DH5 Packet permit maximum $1600 / 79 / 6 = 3.37$ hops per second in each channel (5 time slots TX, 1 time slot RX). So, the dwell time is the time duration of the pulse times $3.37 \times 31.6 = 106.6$ within 31.6 seconds
AFH mode
The hopping rate is 800 hops/second so the maximum dwell time is 5/800 seconds. DH5 Packet permit maximum $800 / 20 / 6 = 6.667$ hops per second in each channel (5 time slots TX, 1 time slot RX). So, the dwell time is the time duration of the pulse times $6.667 \times 8 = 53.33$ within 8 seconds

3.8.3 Test Setup

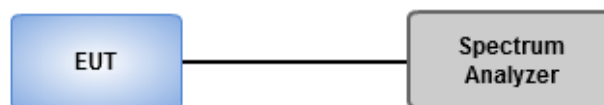

3.8.4 Test Result of Dwell Time

Summary

Mode	Max-Dwell (s)
2.4-2.4835GHz	-
BT-BR(1Mbps)	315.165217m_DH5
BT-EDR(2Mbps)	313.62029m_DH5
BT-EDR(3Mbps)	315.165217m_DH5

Result/ Non AFH mode

Mode	Result	Period (s)	Dwell (s)	Limit (s)	Tx On (s)
BT-BR(1Mbps)	-	-	-	-	-
2441MHz	Pass	31.6	315.165217m_DH5	400m	2.956522m
2441MHz	Pass	31.6	271.304348m_DH3	400m	1.695652m
2441MHz	Pass	31.6	139.130435m_DH1	400m	434.782609u
BT-EDR(2Mbps)	-	-	-	-	-
2441MHz	Pass	31.6	313.62029m_DH5	400m	2.942029m
2441MHz	Pass	31.6	273.623188m_DH3	400m	1.710145m
2441MHz	Pass	31.6	143.768116m_DH1	400m	449.275362u
BT-EDR(3Mbps)	-	-	-	-	-
2441MHz	Pass	31.6	315.165217m_DH5	400m	2.956522m
2441MHz	Pass	31.6	271.304348m_DH3	400m	1.695652m
2441MHz	Pass	31.6	143.768116m_DH1	400m	449.275362u

Result/ AFH mode

Mode	Result	Period (s)	Dwell (s)	Limit (s)	Tx On (s)
BT-BR(1Mbps)	-	-	-	-	-
2441MHz	Pass	8	157.6713m_DH5	400m	2.956522m
2441MHz	Pass	8	135.6522m_DH3	400m	1.695652m
2441MHz	Pass	8	69.56522m_DH1	400m	434.782609u
BT-EDR(2Mbps)	-	-	-	-	-
2441MHz	Pass	8	156.8984m_DH5	400m	2.942029m
2441MHz	Pass	8	136.8116m_DH3	400m	1.710145m
2441MHz	Pass	8	71.88406m_DH1	400m	449.275362u
BT-EDR(3Mbps)	-	-	-	-	-
2441MHz	Pass	8	157.6713m_DH5	400m	2.956522m
2441MHz	Pass	8	135.6522m_DH3	400m	1.695652m
2441MHz	Pass	8	71.88406m_DH1	400m	449.275362u

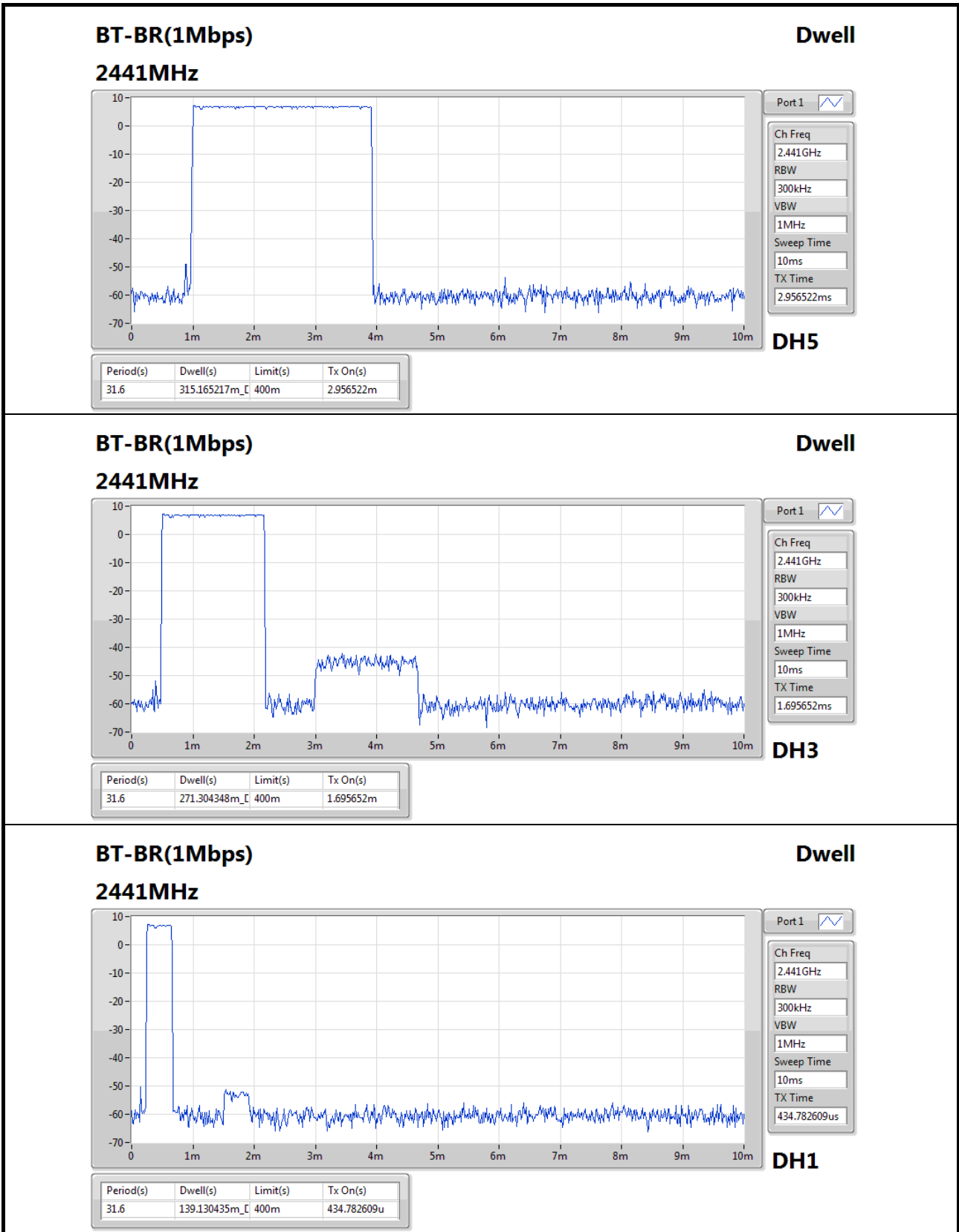

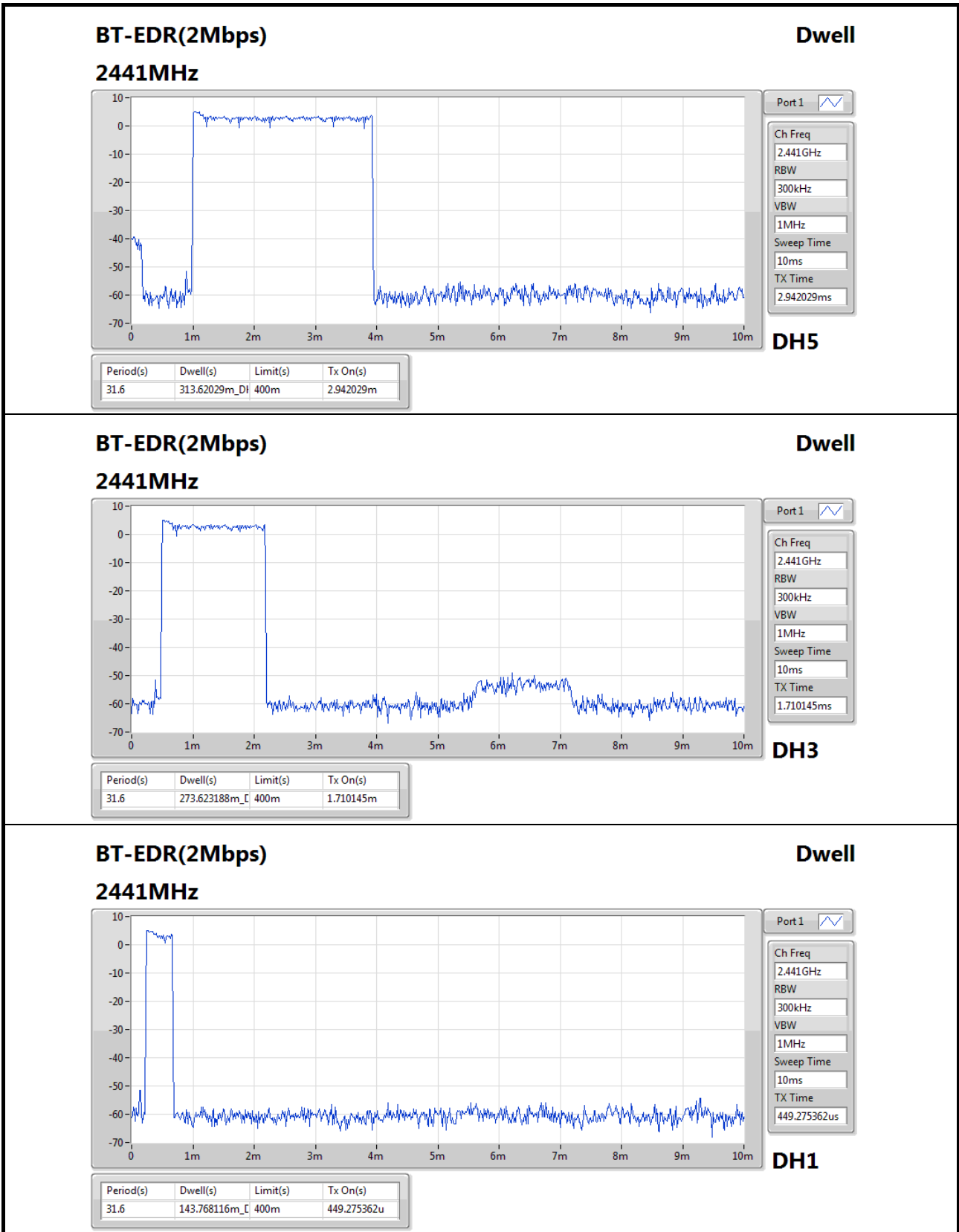

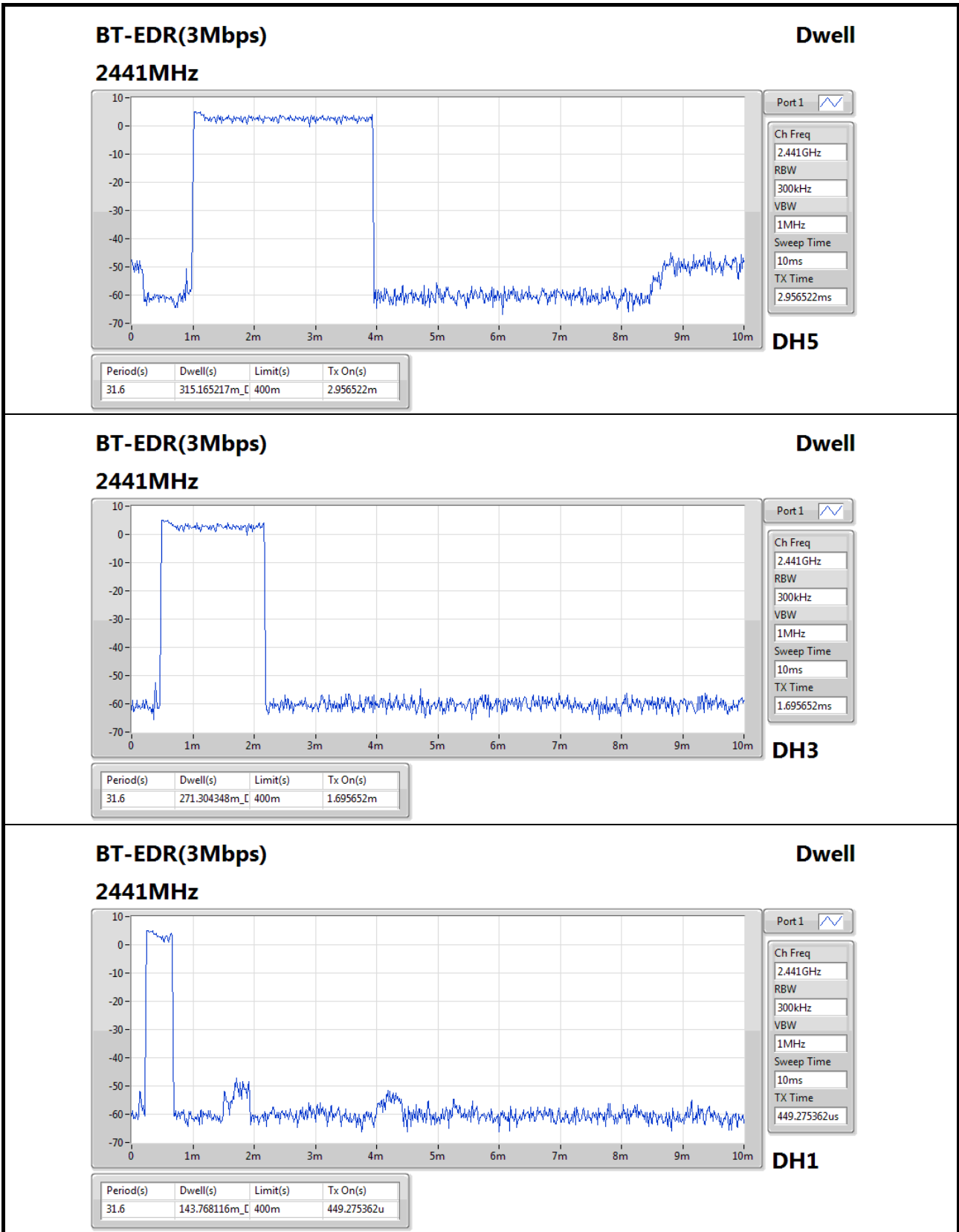

4 Test laboratory information

Established in 2012, ICC provides foremost EMC & RF Testing and advisory consultation services by our skilled engineers and technicians. Our services employ a wide variety of advanced edge test equipment and one of the widest certification extents in the business.

International Certification Corp (EMC and Wireless Communication Laboratory), it is our definitive objective is to institute long term, trust-based associations with our clients. The expectation we set up with our clients is based on outstanding service, practical expertise and devotion to a certified value structure. Our passion is to grant our clients with best EMC / RF services by oriented knowledgeable and accommodating staff.

Our Test sites are located at Linkou District and Kwei Shan District. Location map can be found on our website <http://www.icertifi.com.tw>.

Linkou

Tel: 886-2-2601-1640

No. 30-2, Ding Fwu Tsuen, Lin
Kou District, New Taipei City,
Taiwan, R.O.C.

Kwei Shan

Tel: 886-3-271-8666

No. 3-1, Lane 6, Wen San 3rd St.,
Kwei Shan District, Tao Yuan City
333, Taiwan, R.O.C.

Kwei Shan Site II

Tel: 886-3-271-8640

No. 14-1, Lane 19, Wen San 3rd
St., Kwei Shan District, Tao Yuan
City 333, Taiwan, R.O.C.

If you have any suggestion, please feel free to contact us as below information.

Tel: 886-3-271-8666

Fax: 886-3-318-0155

Email: ICC_Service@icertifi.com.tw

==END==