

Recognized by the
Federal Communications Commission
Anechoic chamber registration no.: 90462 (FCC)
Anechoic chamber registration no.: IC 3463A-1
TCB ID: DE 0001



Accredited by the
German Accreditation Council
DAR-Registration Number
DAT-P-176/94-D1



Accredited Bluetooth® Test Facility (BQTF)

Test report no. : 1-0789-01-05/08
Applicant : Oticon A/S
Type : Amigo eZync
Test Standard : FCC Part 15.223
RSS-210 Issue 7
FCC ID : U28EZYNC01
Certification No. IC : 1350B-EZYNC01

*The Bluetooth word mark and logos are owned by the Bluetooth SIG,
Inc. and any use of such marks by Cetecom ICT is under license*

Table of contents

1	ADMINISTRATIVE DATA	3
1.1	ADMINISTRATIVE DATA OF THE TEST FACILITY	3
1.1.1	Identification of the testing laboratory	3
1.1.2	Organizational items.....	3
1.1.3	Applicant´s details	4
1.1.4	Application Details	4
1.2	ADMINISTRATIVE DATA OF MANUFACTURER / MEMBER	4
1.3	DESCRIPTION OF THE EQUIPMENT UNDER TEST (EUT)	5
1.3.1	EUT: Type, S/N etc.	5
1.4	TEST SETUP	6
1.5	TEST SPECIFICATIONS.....	6
1.6	DESCRIPTION OF THE TEST SAMPLE:	6
2	STATEMENT OF COMPLIANCE	7
2.1	SUMMARY OF MEASUREMENT RESULTS.....	7
2.1.1	CFR 47 Part 15 Radio frequency devices	7
3	MEASUREMENTS AND RESULTS	8
4	FCC PART 15 SUBPART C.....	9
4.1	Timing of the transmitter	9
4.2	Field strength of the fundamental.....	11
4.3	Field strength of the harmonics and the spurious.....	12
4.4	Plots of measurements	13
4.5	Receiver spurious emission (radiated).....	17
4.6	Conducted Limits.....	18
5	USED TESTEQUIPMENT.....	20
6	PHOTOGRAPHS OF TEST SITE	23
7	EXTERNAL PHOTOGRAPHS OF THE EQUIPMENT.....	25
8	INTERNAL PHOTOGRAPHS OF THE EQUIPMENT.....	32

1 Administrative data

1.1 Administrative data of the test facility

1.1.1 Identification of the testing laboratory

Company name:	Cetecom ICT Services GmbH
Address:	Untertürkheimerstr. 6-10 D-66117 Saarbruecken Germany
Laboratory accreditation:	DAR-Registration No. DAT-P-176/94-D1 Bluetooth Qualification Test Facility (BQTF)
Responsible for testing laboratory:	Michael Berg, Stefan Bös Phone: +49 681 598 0 Fax: +49 681 598 9075 email: info@ict.cetecom.de



.....
Responsible for testing
(Stefan Bös)

1.1.2 Organizational items

Reference No.:	1-0789-01-05/08
Order No.:	-/-
Receipt of EUT:	2008-10-20
Date(s) of test:	2008-10-20 to 2008-11-03
Date of report:	2008-11-03
Number of report pages:	38
Number of diagram pages (annex):	0

Version of template:	1.8



.....
Responsible for laboratory
(Michael Berg)

Note:

The test results of this test report relate exclusively to the item tested as specified in this report. The CETECOM ICT Services GmbH does not assume responsibility for any conclusions and generalizations drawn from the test results with regard to other specimens or samples of the type of the equipment represented by the test item.

The test report may only be reproduced or published in full. Reproduction or publication of extracts from the report requires the prior written approval of the CETECOM ICT Services GmbH.

During the test no hardware and software changes are allowed to be performed at the EUT.

1.1.3 Applicant's details

Name	:	Oticon A/S
Street	:	Kongebakken 9
Town	:	2765 Smørum
Country	:	Denmark
Telephone	:	+45 39 17 71 00
Telefax	:	+45 39 27 79 00
Contact	:	Alice Haubjerg Olesen
Telephone	:	+45 39 13 82 38
Telefax	:	+45 39 27 79 00

1.1.4 Application Details

Date of receipt of application	:	2008-10-20
Date of receipt of test item	:	2008-10-20
Date(s) of test	:	2008-10-20 to 2008-11-03
Person(s) who have been present during the test	:	-/-

1.2 Administrative data of manufacturer / member

Name	:	Oticon A/S
Street	:	Kongebakken 9
Town	:	2765 Smørum
Country	:	Denmark

1.3 Description of the Equipment under test (EUT)

1.3.1 EUT: Type, S/N etc.

Type of equipment	:	Wireless FM channel change device
Model name	:	Amigo eZync
Manufacturer	:	Oticon A/S
Address	:	Kongebakken 9
City	:	2765 Smørum
Country	:	Denmark
Tested to Radio Standards Specification(RSS) No.	:	210 Issue 7
Open Area Test Site Industry Canada Number	:	IC 3463A-1
Frequency Range (or fixed frequency)	:	Tx / RX: 3.715 MHz
R F: Power in Watts	:	-/-
Field Strength (at what distance)	:	41.2 dB μ V/m in 10m, 21.2 dB μ V/m calculated at 30m
Occupied Bandwidth (99% BW)	:	442.9 kHz (measured very close to the EUT)
Type of Modulation	:	A1D
Antenna Information	:	Integrated PCB-Coil-Antenna
Emission Designator	:	442k9A1D
Transmitter Spurious (worst case)	:	49.5 dB μ V/m
Receiver Spurious (worst case)	:	Not applicable
IC no.	:	1350B-EZYNC01
FCC ID	:	U28EZYNC01

ATTESTATION:

DECLARATION OF COMPLIANCE:

I declare that the testing was performed or supervised by me; that the test measurements were made in accordance with the above-mentioned Industry Canada standard(s); and that the equipment identified in this application has been subjected to all the applicable test conditions specified in the Industry Canada standards and all of the requirements of the standard have been met.

Laboratory Manager:

2008-11-03

Stefan Bös

Date

Name

Signature



1.4 Test Setup

Hardware : -
Software : -

1.5 Test Specifications

FCC:	CFR Part 15.223
IC:	RSS 210, Issue 7

1.6 Description of the test sample:

The sample is a Wireless FM channel change device for hearing aids with a 3.715 MHz transmitter without receiving or idle function.

2 Statement of Compliance

No deviations from the technical specification(s) were ascertained in the course of the tests performed.

2.1 Summary of Measurement Results

2.1.1 CFR 47 Part 15 Radio frequency devices

Section in this Report	Test Name / Section FCC Part 15	Test Name / Section RSS 210 Issue 7	applicable	Verdict
4.1	§ 15.35 (c) Timing of the transmitter (Duty cycle correction factor)		YES	pass
4.2	§ 15.223 (a) FIELDSTRENGTH OF FUNDAMENTAL	2.6	YES	pass
4.3	§ 15.209 (a) FIELDSTRENGTH OF HARMONICS and SPURIOUS	2.6	YES	pass
4.4	§ 15.109 Receiver spurious emissions (radiated)	2.6	YES	pass
4.5	§ 15.107 / 15.207 Conducted Limits		YES	pass

3 Measurements and results

The radiated measurements are performed in vertical and horizontal plane in the frequency range from 9 kHz to 20 GHz in semi-anechoic chambers. The EUT is positioned on a non-conductive support with a height of 0.80 m above a conductive ground plane that covers the whole chamber.

The receiving antennas conform with specifications ANSI C63.2-1996 clause 15 and ANSI C63.4-2003 clause 4.1.5. These antennas can be moved over the height range between 1.0 m and 4.0 m in order to search for maximum field strength emitted from EUT. The measurement distances between EUT and receiving antennas are indicated in the test set-ups for the various frequency ranges. For each measurement, the EUT is rotated in all three axes until the maximum field strength is received.

The wanted and unwanted emissions are received by spectrum analysers where the detector modes and resolution bandwidths over various frequency ranges are set according to requirement ANSI C63.4-2003 clause 4.2. Antennas conform with ANSI C63.2-1996 item 15.

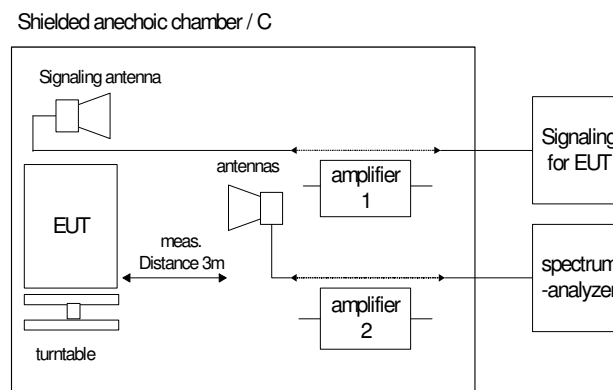

9 kHz – 150 kHz: Quasi Peak measurement, 200 Hz Bandwidth, magnetic shielded loop antenna.

150 kHz - 30 MHz: Quasi Peak measurement, 9kHz Bandwidth, magnetic shielded loop antenna.

30 MHz - 200 MHz: Quasi Peak measurement, 120KHz Bandwidth, biconical antenna

200MHz - 1GHz: Quasi Peak measurement, 120KHz Bandwidth, log periodic antenna

>1GHz: Average, RBW 1MHz, VBW 10 Hz, wave guide horn

All measurement settings are according to FCC 15.209 and 15.223

4 FCC Part 15 Subpart C

4.1 Timing of the transmitter

Plot 1:

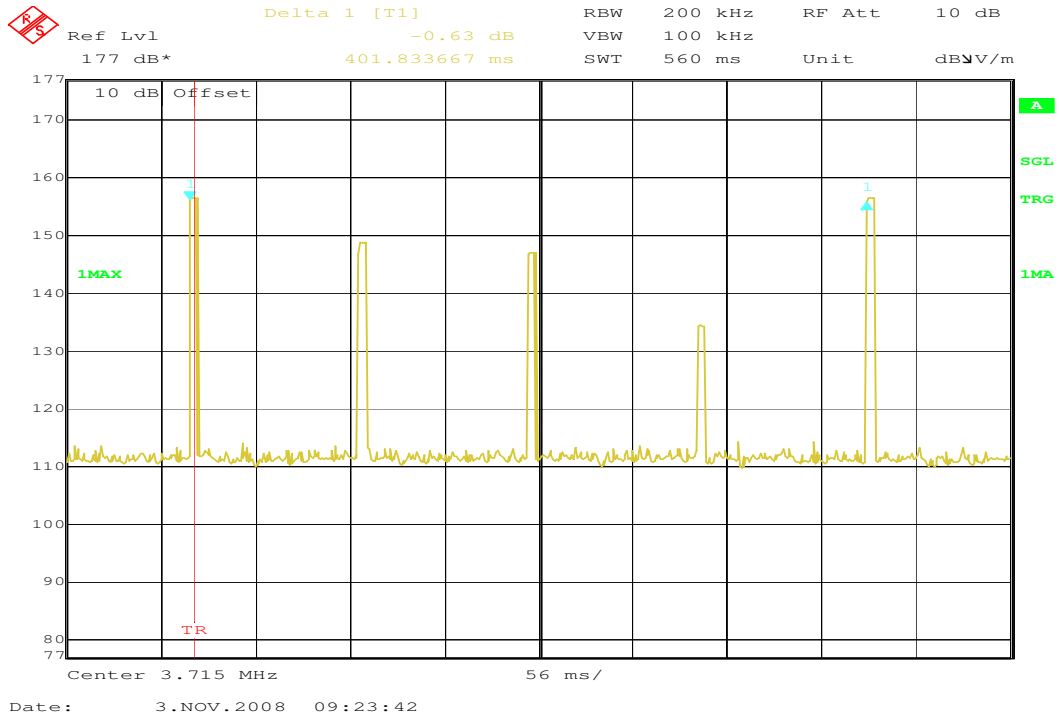

Plot 2:

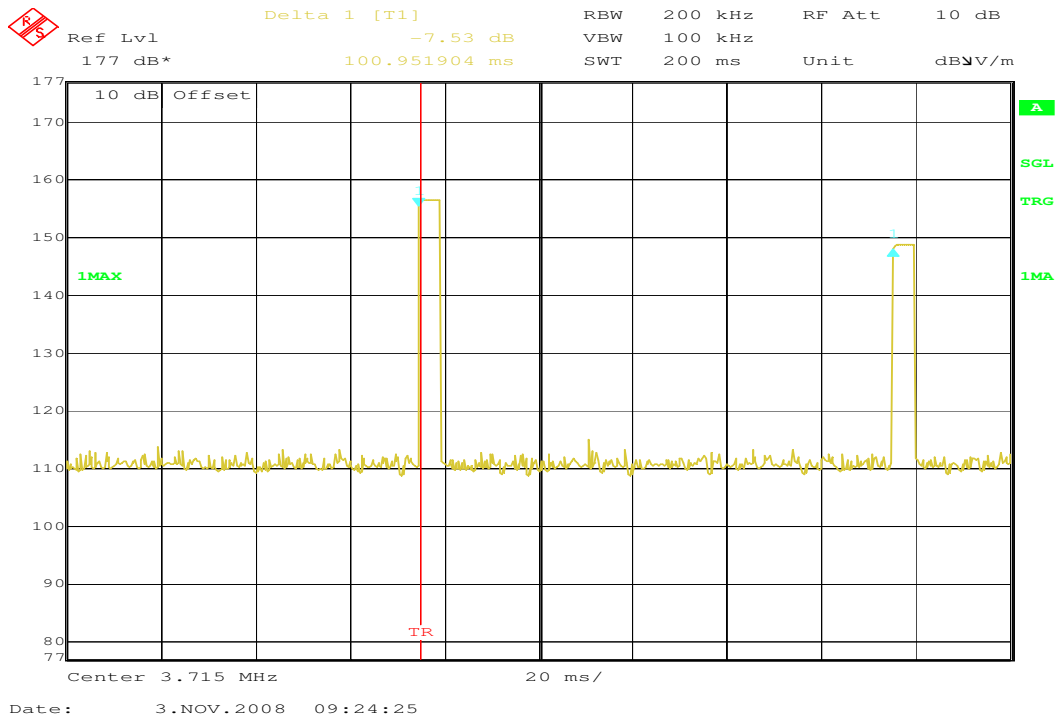

Plot 3:

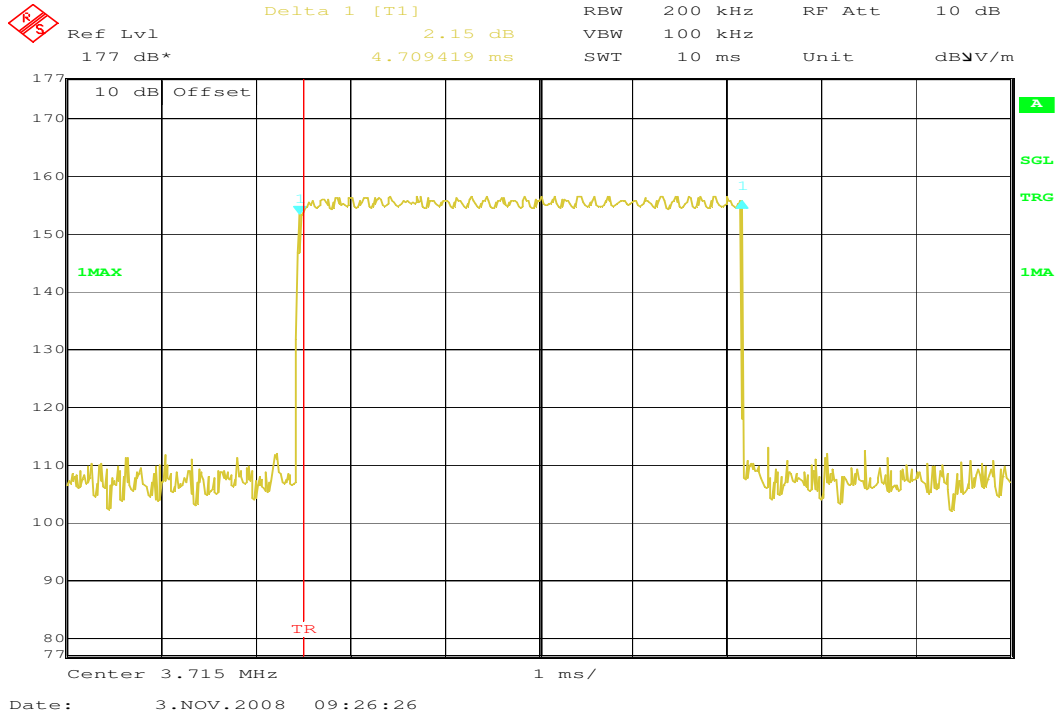

Reference

FCC:	CFR Part SUBCLAUSE § 15.35 (c)
IC:	-/-

Measurement not applicable, transmitter is continuous modulated

Limits: § 15.35 (c)

(c) Unless otherwise specified, e.g. Section 15.255(b), when the radiated emission limits are expressed in terms of the average value of the emission, and pulsed operation is employed, the measurement field strength shall be determined by averaging over one complete pulse train, including blanking intervals, as long as the pulse train does not exceed 0.1 seconds. As an alternative (provided the transmitter operates for longer than 0.1 seconds) or in cases where the pulse train exceeds 0.1 seconds, the measured field strength shall be determined from the average absolute voltage during a 0.1 second interval during which the field strength is at its maximum value. The exact method of calculating the average field strength shall be submitted with any application for certification or shall be retained in the measurement data file for equipment subject to notification or verification.

Result: The duty cycle is 5%.

4.2 Field strength of the fundamental

Reference

FCC:	CFR Part SUBCLAUSE § 15.223 (a)
IC:	RSS 210, Issue 7, 2.6

Maximum output power - (radiated)

TEST CONDITIONS		MAXIMUM POWER (dB μ V/m) QP		
		3.715 MHz at 3 m	3.715 MHz calculated at 10 m	3.715 MHz calculated at 30 m
T _{nom} +21 °C	V _{nom} 5.0V DC	61.2 dB μ V/m	41.2 dB μ V/m	21.2 dB μ V/m
Maximum deviation from output power under extreme test conditions (dBc)		not applicable		
Measurement uncertainty		±3dB		

RBW/VBW : 500 kHz up to 1 GHz

Limits

SUBCLAUSE § 15.223 (a)

Frequency (MHz)	Field strength (μ V/m)	Measurement distance (m)
1.705 - 10	29*	30

* Limit calculated with :

$$\text{Max Field Strength} = 6\text{dB-BW(kHz)} / \text{Center Frequency (MHz)}$$

4.3 Field strength of the harmonics and the spurious

Reference

FCC:	CFR Part SUBCLAUSE § 15.223 (a)
IC:	RSS 210, Issue 7, 2.6

EMISSION LIMITATIONS					
f (MHz)		amplitude of emission (dBµ V/m) Average/QP	limit max. allowed emmission power	actual attenuation below frequency of operation (dB)	results
		See pages 13 and 14			Pass
Measurement uncertainty			± 3dB		

RBW/VBW : 200 Hz up to 150 kHz, 9 kHz up to 30 MHz, 120 kHz up to 1 GHz

Limits

SUBCLAUSE § 15.209

Frequency (MHz)	Field strength (µ V/m)	Measurement distance (m)
0.0009 – 0.490	2400/F(kHz)	300
0.490 – 1.705	24000/F(kHz)	30
1.705 - 30	30	30
30 - 88	100	3
88 - 216	150	3
216 - 960	200	3
above 960	500	3

4.4 Plots of measurements

Part 15.209 Magnetics TX

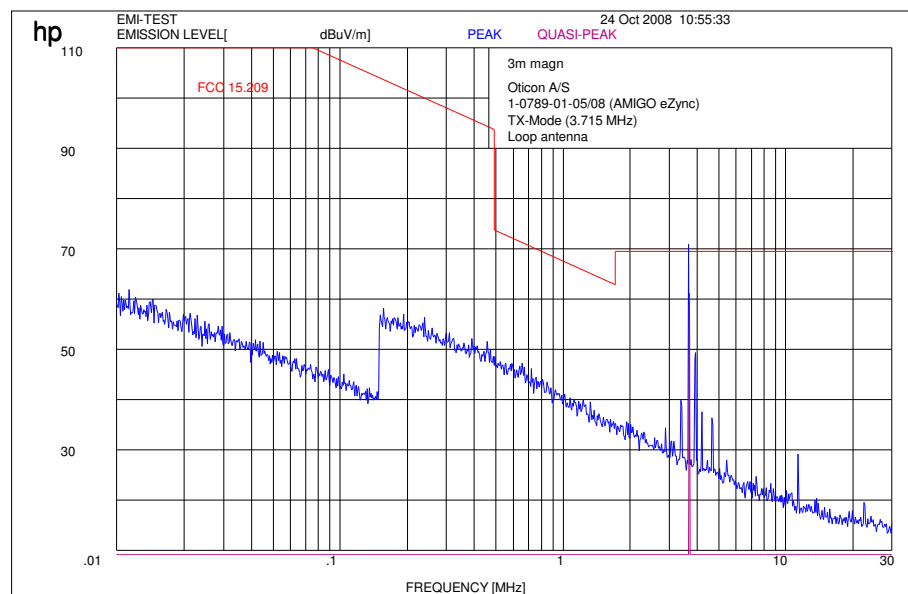

RBW/VBW : 200 Hz up to 150 kHz, 9 kHz up to 30 MHz

(to convert the measuring distance from 3 to 30m a correction factor from 40 dB/decade was used. Here we use 40 dB to recalculate from 3 m to 30m)

This measurement was done in 3 planes, the plot shows the worst case.

Limits

SUBCLAUSE § 15.209

Frequency (MHz)	Field strength ($\mu\text{V/m}$)	Measurement distance (m)
0.0009 – 0.490	$2400/F(\text{kHz})$	300
0.490 – 1.705	$24000/F(\text{kHz})$	30
1.705 - 30	30	30
30 - 88	100	3
88 - 216	150	3
216 - 960	200	3
above 960	500	3

TX (30 MHz to 1GHz)

Common Information

EUT: Amigo eZync + UEW-050020SPC
 Serial Number: TE0001686 +MDF:070501
 Test Description: FCC @ 10 m
 Operating Conditions: Transmit continuously
 Operator Name: Folz
 Comment: Powered with AC 115V/ 60 Hz; Ferrite at AC/DC Adapter on side of DC plug; 150pF low pass cap

Scan Setup: FCC_Fin [EMI radiated]

Hardware Setup: Electric Field (NOS)
 Level Unit: dB μ V/m

Subrange	Detectors	IF Bandwidth	Meas. Time	Receiver
30 MHz - 1 GHz	QuasiPeak	120 kHz	15 s	Receiver

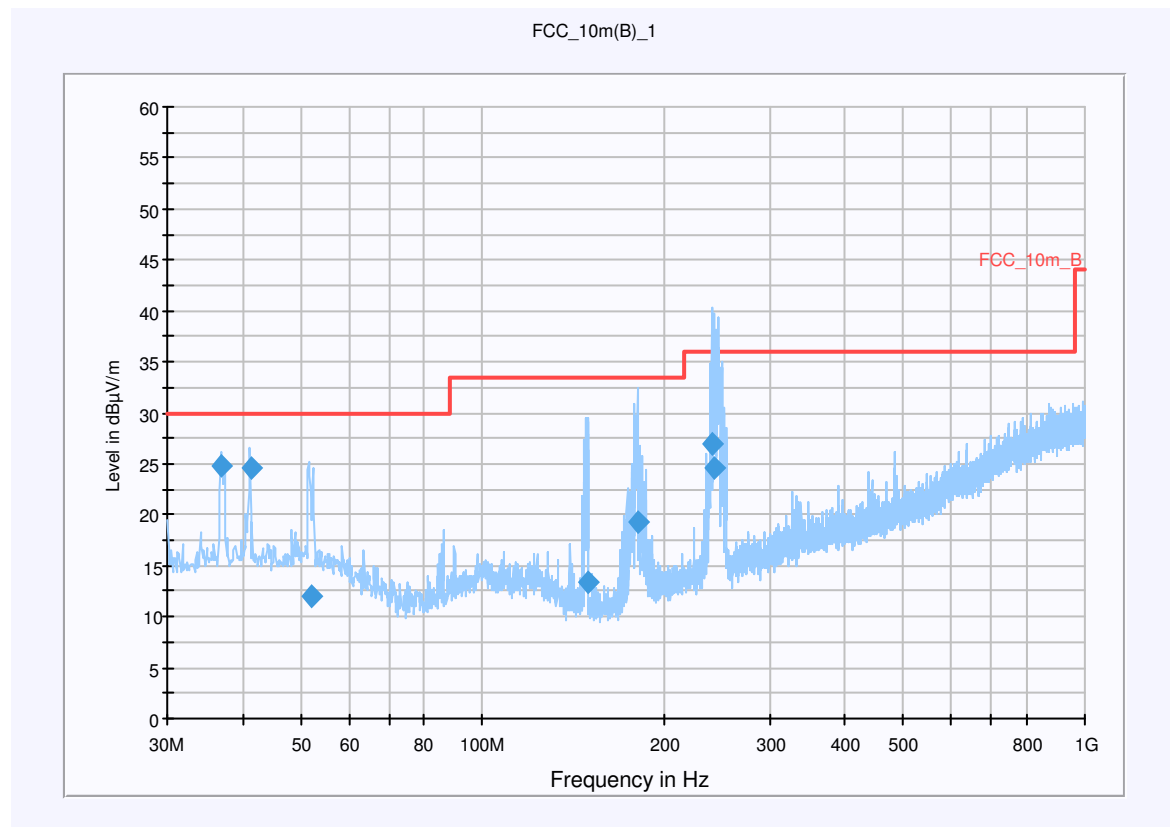

Final Result 1

Frequency (MHz)	QuasiPeak (dB μ V/m)	Meas. Time (ms)	Bandwidth (kHz)	Antenna height (cm)	Polarity	Turntable position (deg)	Corr. (dB)	Margin (dB)	Limit (dB μ V/m)	Comment
36.909700	24.8	15000.000	120.000	100.0	V	50.0	13.3	5.2	30.0	
41.234650	24.5	15000.000	120.000	206.0	V	229.0	13.5	5.5	30.0	
52.118300	12.1	15000.000	120.000	100.0	V	240.0	13.3	17.9	30.0	
149.900450	13.4	15000.000	120.000	200.0	V	245.0	9.1	20.1	33.5	
181.298900	19.2	15000.000	120.000	150.0	V	130.0	10.6	14.3	33.5	
239.871900	27.0	15000.000	120.000	100.0	V	42.0	13.2	9.0	36.0	
243.162850	24.6	15000.000	120.000	200.0	V	63.0	13.3	11.4	36.0	

Hardware Setup: EMI radiated\Electric Field (NOS) - [EMI radiated]

Subrange 1	
Frequency Range:	30 MHz - 2 GHz
Receiver:	Receiver [ESCI 3] @ GPIB0 (ADR 20), SN 100083/003, FW 3.32, CAL 07.01.2009
Signal Path:	without Notch FW 1.0
Antenna:	VULB 9163 SN 9163-295, FW ---, CAL 08.04.2010 Correction Table (vertical): VULP6113 Correction Table (horizontal): VULP6113 Correction Table: Cabel with switch (0908)
Antenna Tower:	Tower [EMCO 2090 Antenna Tower] @ GPIB0 (ADR 8), FW REV 3.12
Turntable:	Turntable [EMCO Turntable] @ GPIB0 (ADR 9), FW REV 3.12

Occupied bandwidth

Measured with field probe in short distance – without correction of the amplitude values

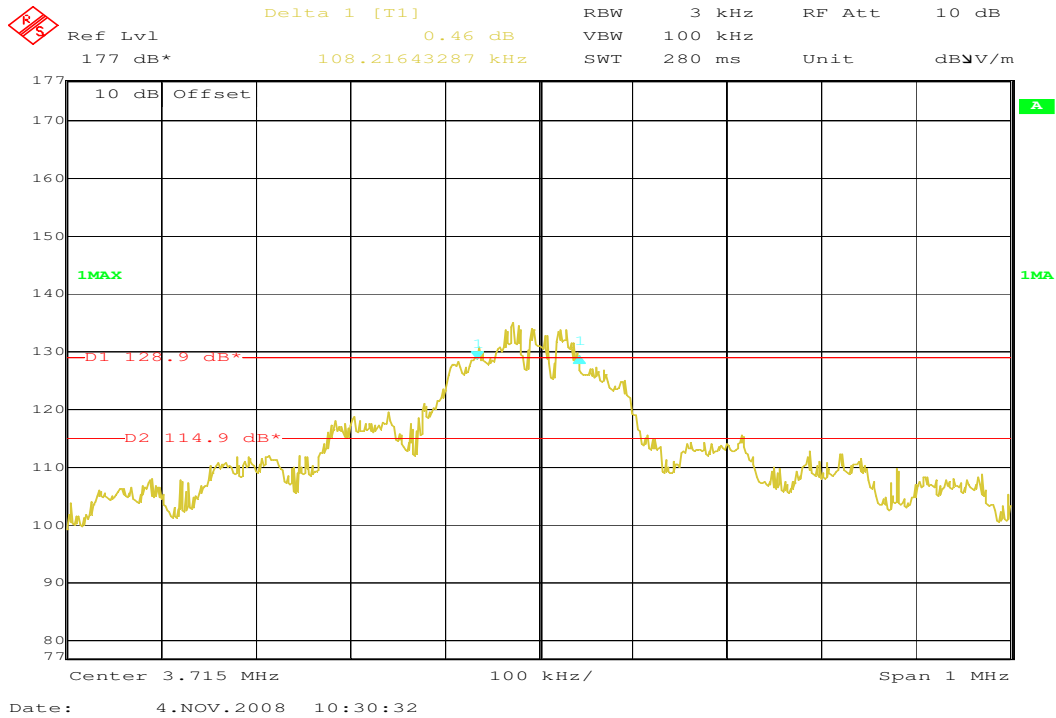

The 6dB-bandwidth is 108.2 kHz.

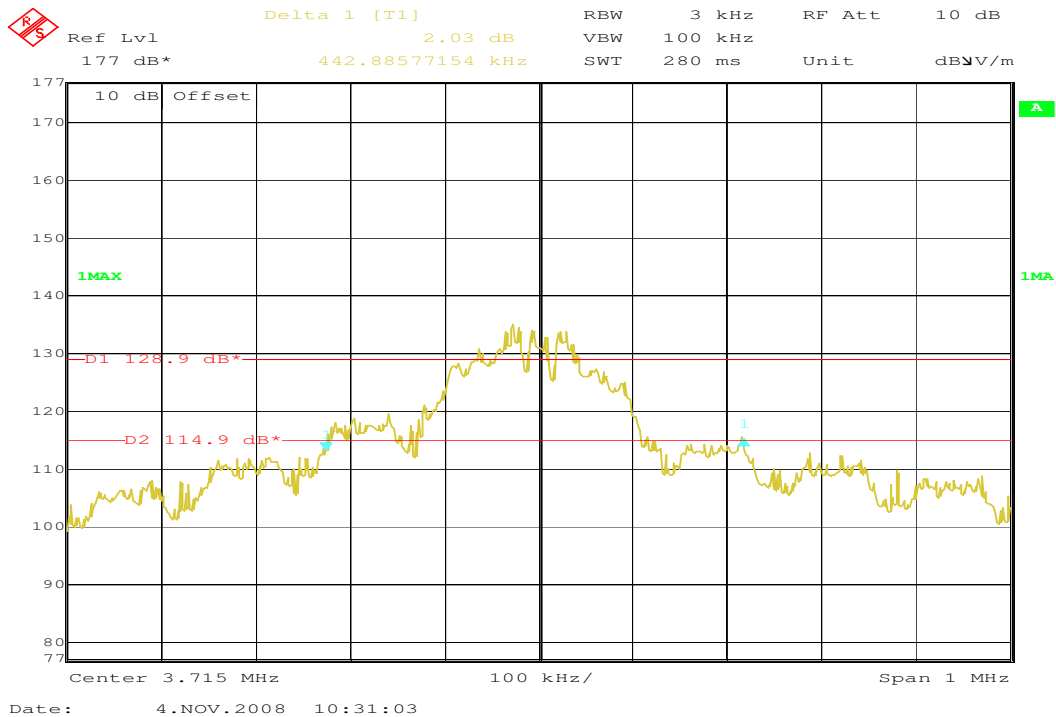

The 20dB-bandwidth is 442.9 kHz.

4.5 Receiver spurious emission (radiated)

Not applicable

Reference

FCC:	CFR Part SUBCLAUSE § 15.109/209
IC:	RSS 210, Issue 7, Section 2.6

SPURIOUS EMISSIONS LEVEL ($\mu\text{V/m}$)								
Low Channel			Middle Channel			High Channel		
--			--			--		
F [MHz]	Detector	Level [$\mu\text{V/m}$]	F [MHz]	Detector	Level [$\mu\text{V/m}$]	F [MHz]	Detector	Level [$\mu\text{V/m}$]
Measurement uncertainty			$\pm 3\text{ dB}$					

$f < 1\text{ GHz}$: RBW/VBW: 100 kHz

$f \geq 1\text{ GHz}$: RBW/VBW: 1 MHz

Limits

SUBCLAUSE § 15.109

Frequency (MHz)	Field strength ($\mu\text{V/m}$)	Measurement distance (m)
30 - 88	100	3
88 - 216	150	3
216 - 960	200	3
above 960	500	3

4.6 Conducted Limits

Manufacturer: Oticon A/S
 Operating Condition: TX-Mode
 Test site: CETECOM ICT Services
 Operator: Boes
 Power Supply: AC 115 V
 Comment: ---

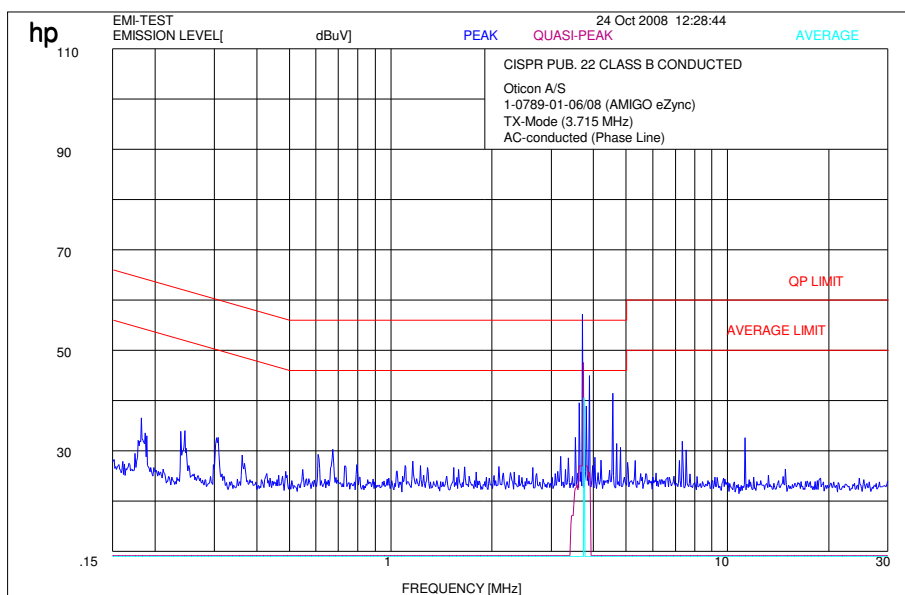
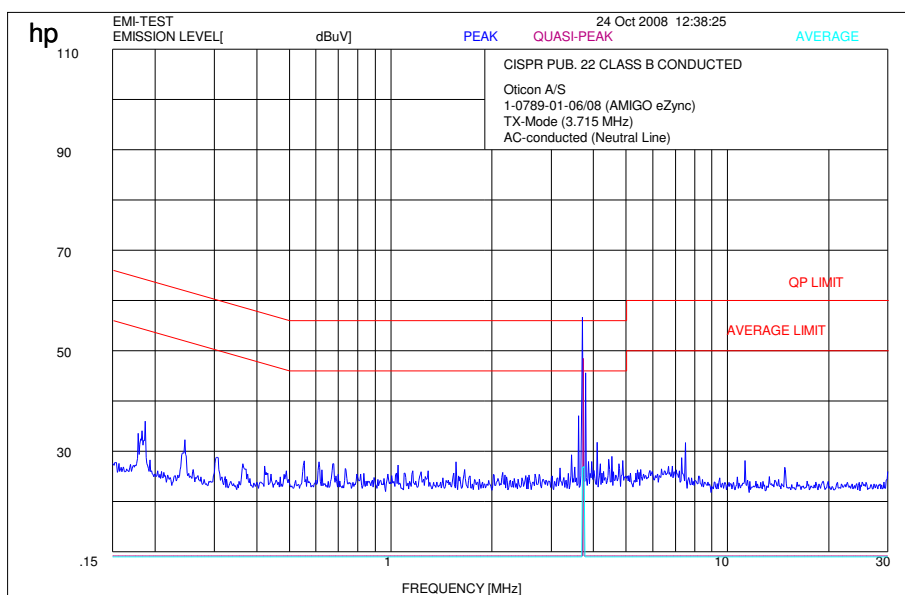

MEASUREMENT RESULT:

Frequency	Line	Results		
		Peak	Quasi-Peak	Average
3.715 MHz	Neutral	56.7 dB μ V	48.3 dB μ V	39.8 dB μ V
3.715 MHz	Neutral	57.1 dB μ V	47.9 dB μ V	40.4 dB μ V
Measurement uncertainty		±3 dB		

Limits: § 15.107 / 15.207

Frequency of Emission (MHz)	Conducted Limit (dB μ V)	
	Quasi-peak	Average
0.15 – 0.5	66 to 56 *	56 to 46 *
0.5 – 5	56	46
5 - 30	60	50

* Decreases with the logarithm of the frequency

5 Used Testequipment

To simplify the identification on each page of the test equipment used, on each page of the test report, each item of test equipment and ancillaries such as cables are identified (numbered) by the Test Laboratory, below.

All reported calibration intervals are calibrations according to the EN/ISO/IEC 17025 standard. These calibrations were performed from an accredited external calibration laboratory.

Additional to these calibrations the laboratory performed comparison measurements with other calibrated systems and performed a weekly chamber inspection.

All used devices are connected with a 10 MHz external reference.

According to the manufacturers' instruction is it possible to establish a calibration interval for the FSP unit of 24 month, if the device has an external 10 MHz reference.

Anechoic chamber C:

No	Equipment/Type	Manuf.	Serial Nr.	Inv. No. Cetecom	Last Calibration	Frequency (months)	Next Calibration
1	Anechoic chamber	MWB	87400/02	300000996	Monthly verification		
2	System-Rack 85900	HP I.V.	*	300000222	n.a.		
3	Measurement System 1						
4	Spektrum Analyzer 8566B	HP	3138A07614	300001207	13.12.2007	24	13.12.2009
5	Spektrum Analyzer Display 85662A	HP	3144A28627	300001208	13.12.2007	24	13.12.2009
6	Quasi-Peak-Adapter 85650A	HP	2811A01204	300002308	13.12.2007	24	13.12.2009
7	RF-Preselector 85685A	HP	2837A00778	300002448	13.12.2007	24	13.12.2009
8	PC Vectra VL	HP		300001688	n.a.		
9	Software EMI	HP		300000983	n.a.		
10	Measurement System 2						
11	FSP 30	R&S	100886	300003575	25.08.2008	24	25.08.2010
12	PC	F+W			n.a.		
13	TILE	TILE			n.a.		
14	Biconical antenna	EMCO	S/N: 860 942/003		Monthly verification (System cal.)		
15	Log. Period. Antenna 3146	EMCO	2130	300001603	Monthly verification (System cal.)		
16	Double Ridged Antenna HP 3115P	EMCO	3088	300001032	Monthly verification (System cal.)		
17	Active Loop Antenna 6502	EMCO	2210	300001015	Monthly verification (System cal.)		
18	Power Supply 6032A	HP	2818A03450	300001040	12.05.2007	36	12.05.2010
19	Busisolator	Kontron		300001056	n.a.		
20	Leitungsteiler 11850C	HP		300000997	Monthly verification (System cal.)		
21	Power attenuator 8325	Byrd	1530	300001595	Monthly verification (System cal.)		
22	Band reject filter WRCG1855/1910	Wainwright	7	300003350	Monthly verification (System cal.)		
23	Band reject filter WRCG2400/2483	Wainwright	11	300003351	Monthly verification (System cal.)		

System Rack Room 005 :

No	Equipment/Type	Manuf.	Serial Nr.	Inv. No. Cetecom	Last Calibration	Frequency (months)	Next Calibration
1	FSP 30	R&S	100886	300003575	25.08.2008	24	25.08.2010
2	CBT	R&S	100313	300003516	03.09.2008	24	03.09.2010
3	Switch Matrix	HP		300000929	n.a.		
4	Power Supply	HP	3041A00544	300002270	13.05.2007	36	13.05.2010
5	Signal Generator	R&S	836206/0092	300002680	30.05.2007	36	30.05.2010

Signalling Units:

No	Equipment/Type	Manuf.	Serial Nr.	Inv. No. Cetecom	Last Calibration	Frequency (months)	Next Calibration
1	CBT	R&S	100313	300003516	03.09.2008	24	03.09.2010
2	CBT	R&S	100185	300003416	27.08.2008	24	27.08.2010
3	CMU-200	R&S	103992	300003231	04.06.2008	12	04.06.2009
4	CMU-200	R&S	106240	300003321	27.08.2008	24	27.08.2010
5	CMU-200	R&S	832221/0055	300002862	20.03.2008	24	20.03.2010

Climatic Box:

No	Equipment/Type	Manuf.	Serial Nr.	Inv. No. Cetecom	Last Calibration	Frequency (months)	Next Calibration
1	Climatic box VT 4002	Heraeus Vötsch	58566046820010	300003019	11.05.2007	24	11.05.2009
2	Climatic box CTS T-40/50	CTS	064023	300003540	03.01.2007	24	03.01.2009

SRD Laboratory Room 002:

No	Equipment/Type	Manuf.	Serial Nr.	Inv. No. Cetecom	Last Calibration	Frequency (months)	Next Calibration
1	System Controller PSM 12	R&S	835259/007	3000002681-00xx	n.a.		
2	Memory Extension PSM-K10	R&S	To 1	3000002681	n.a.		
3	Operating Software PSM-B2	R&S	To 1	3000002681	n.a.		
4	19" Monitor		22759020-ED	3000002681	n.a.		
5	Mouse		LZE 0095/6639	3000002681	n.a.		
6	Keyboard		G00013834L461	3000002681	n.a.		
7	Spectrum Analyser FSIQ 26	R&S	835540/018	3000002681-0005	10.01.2008	24	10.01.2010
8	Tracking Generator FSIQ-B10	R&S	835107/015	3000002681	s.No.7		
10	RF-Generator SMIQ03 (B1 Signal)	R&S	835541/056	3000002681-0002	26.08.2008	36	26.08.2011
11	Modulation Coder SMIQ-B20	R&S	To 10	3000002681	s.No.10		
12	Data Generator SMIQ-B11	R&S	To 10	3000002681	s.No.10		
13	RF Rear Connection SMIQ-B19	R&S	To 10	3000002681	s.No.10		
14	Fast CPU SM-B50	R&S	To 10	3000002681	s.No.10		
15	FM Modulator SM-B5	R&S	835676/033	3000002681	s.No.10		
16	RF-Generator SMIQ03 (B2 Signal)	R&S	835541/055	3000002681-0001	25.08.2008	36	25.08.2011
17	Modulation Coder SMIQ-B20	R&S	To 16	3000002681	s.No.16		
18	Data Generator SMIQ-B11	R&S	To 16	3000002681	s.No.16		
19	RF Rear Connection SMIQ-B19	R&S	To 16	3000002681	s.No.16		
20	Fast CPU SM-B50	R&S	To 16	3000002681	s.No.16		
21	FM Modulator SM-B5	R&S	836061/022	3000002681	s.No.16		
22	RF-Generator SMP03 (B3 Signal)	R&S	835133/011	3000002681-0003	26.08.2008	36	26.08.2011
23	Attenuator SMP-B15	R&S	835136/014	3000002681	S.No.22		
24	RF Rear Connection SMP-B19	R&S	834745/007	3000002681	S.No.22		
25	Power Meter NRVD	R&S	835430/044	3000002681-0004	26.08.2008	24	26.08.2010
26	Power Sensor NRVD-Z1	R&S	833894/012	3000002681-0013	26.08.2008	24	26.08.2010
27	Power Sensor NRVD-Z1	R&S	833894/011	3000002681-0010	26.08.2008	24	26.08.2010
28	Rubidium Standard RUB	R&S		3000002681-0009	27.08.2008	24	27.08.2010

29	Switching and Signal Conditioning Unit SSCU	R&S	338864/003	3000002681-0006	01.08.2006	24	01.08.2008
30	Laser Printer HP Deskjet 2100	HP	N/A	3000002681-0011	n.a.		
31	19" Rack	R&S	11138363000004	3000002681	n.a.		
32	RF-cable set	R&S	N/A	3000002681	n.a.		
33	IEEE-cables	R&S	N/A	3000002681	n.a.		
34	Sampling System FSIQ-B70	R&S	835355/009	3000002681	s.No.7		
35	RSP programmable attenuator	R&S	834500/010	3000002681-0007	26.08.2008	24	26.08.2010
36	Signalling Unit	R&S	838312/011	3000002681	n.a.		
37	NGPE programmable Power Supply for EUT	R&S	192.033.41	3000002681			
39	Power Splitter 6005-3	Inmet Corp.	none	300002841	23.12.2006	24	23.12.2008
40	SMA Cables SPS-1151-985-SPS	Insulated Wire	different	different	n.a.		
41	CBT32 with EDR Signalling Unit	R&S					
42	Coupling unit	Narda	N/A	--	n.a.		
43	2xSwitch Matrix PSU	R&S	872584/021	300001329	n.a.		
44	RF-cable set	R&S	N/A	different	n.a.		
45	IEEE-cables	R&S	N/A	--	n.a.		

Note: 3000002681-00xx inventoried as a system

SRD Laboratory Room 005:

No	Equipment/Type	Manuf.	Serial Nr.	Inv. No. Cetecom	Last Calibration	Frequency (months)	Next Calibration
1	Spektrum Analyzer 8566B	HP	2747A05275	300000219	18.01.2008	24	18.01.2010
2	Spektrum Analyzer Display 85662A	HP	2816A16497	300001690	23.01.2008	24	23.01.2010
3	Quasi-Peak-Adapter 85650A	HP	2811A01135	300000216	23.01.2008	24	23.01.2010
4	Power Supply	Heiden	003202	300001187	12.05.2007	36	12.05.2010
5	Power Supply	Heiden	1701	300001392	12.05.2007	36	12.05.2010

SRD Laboratory Room 011:

No	Equipment/Type	Manuf.	Serial Nr.	Inv. No. Cetecom	Last Calibration	Frequency (months)	Next Calibration
1	NRP Power Meter	R&S	100212	300003780	27.02.2008	24	27.02.2010