

TEST REPORT

Test report no.: 1-4511/17-01-05_A



Deutsche
Akkreditierungsstelle
D-PL-12076-01-01

Testing laboratory

CTC advanced GmbH

Untertuerkheimer Strasse 6 – 10

66117 Saarbruecken / Germany

Phone: + 49 681 5 98 - 0

Fax: + 49 681 5 98 - 9075

Internet: <http://www.ctcadvanced.com>

e-mail: mail@ctcadvanced.com

Accredited Testing Laboratory:

The testing laboratory (area of testing) is accredited according to DIN EN ISO/IEC 17025 (2005) by the Deutsche Akkreditierungsstelle GmbH (DAkkS)

The accreditation is valid for the scope of testing procedures as stated in the accreditation certificate with the registration number: D-PL-12076-01-01

Applicant

Oticon A/S

Kongebakken 9

2765 Smørum / DENMARK

Phone: +45 39 17 71 00

Fax: -/-

Contact: Per Klaus Nielsen

e-mail: pkni@oticon.com

Phone: -/-

Manufacturer

Oticon A/S

Kongebakken 9

2765 Smørum / DENMARK

Test standard/s

47 CFR Part 15

Title 47 of the Code of Federal Regulations; Chapter I; Part 15 - Radio frequency devices

RSS - 247 Issue 2

Digital Transmission Systems (DTSs), Frequency Hopping Systems (FHSs) and Licence - Exempt Local Area Network (LE-LAN) Devices

RSS - Gen Issue 4

Spectrum Management and Telecommunications Radio Standards Specifications - General Requirements and Information for the Certification of Radio Apparatus

For further applied test standards please refer to section 3 of this test report.

Test Item

Kind of test item:

Hearing Aid, WL Hi platform

Model name:

Aurora BTE power module

FCC ID:

U28AUBTEP

IC:

1350B-AUBTEP

Frequency:

DTS band 2400 MHz to 2483.5 MHz

Technology tested:

Bluetooth® LE + proprietary RX mode 4Mbps

Antenna:

Internal PCB antenna

Power supply:

1.45 V DC by Zinc-Air-battery type p13

Temperature range:

0°C to +40°C

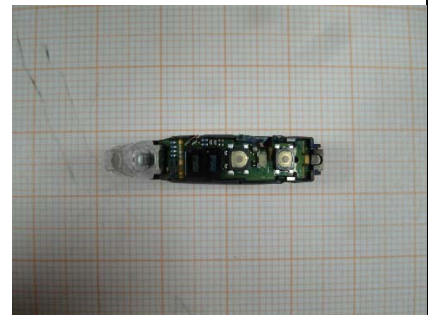

This test report is electronically signed and valid without handwritten signature. For verification of the electronic signatures, the public keys can be requested at the testing laboratory.

Test report authorized:

Mihail Dorongovskij
Lab Manager
Radio Communications & EMC

Test performed:

p.o.
Andreas Luckenbill
Lab Manager
Radio Communications & EMC

1 Table of contents

1	Table of contents	2
2	General information	3
2.1	Notes and disclaimer	3
2.2	Application details	3
2.3	Test laboratories sub-contracted	3
3	Test standard/s and references	4
4	Test environment	5
5	Test item	5
5.1	General description	5
6	Description of the test setup	6
6.1	Shielded semi anechoic chamber	7
6.2	Shielded fully anechoic chamber	8
6.3	Radiated measurements > 18 GHz	9
7	Sequence of testing	10
7.1	Sequence of testing radiated spurious 30 MHz to 1 GHz	10
7.2	Sequence of testing radiated spurious 1 GHz to 18 GHz	11
7.3	Sequence of testing radiated spurious above 18 GHz	12
8	Measurement uncertainty	13
9	Summary of measurement results	14
10	Additional comments	15
11	Measurement results	16
11.1	Spurious emissions radiated 30 MHz to 1 GHz	16
11.2	Spurious emissions radiated above 1 GHz	19
Annex A	Glossary	22
Annex B	Document history	23
Annex C	Accreditation Certificate	23

2 General information

2.1 Notes and disclaimer

The test results of this test report relate exclusively to the test item specified in this test report. CTC advanced GmbH does not assume responsibility for any conclusions and generalizations drawn from the test results with regard to other specimens or samples of the type of the equipment represented by the test item.

The test report may only be reproduced or published in full. Reproduction or publication of extracts from the report requires the prior written approval of CTC advanced GmbH.

The testing service provided by CTC advanced GmbH has been rendered under the current "General Terms and Conditions for CTC advanced GmbH".

CTC advanced GmbH will not be liable for any loss or damage resulting from false, inaccurate, inappropriate or incomplete product information provided by the customer.

Under no circumstances does the CTC advanced GmbH test report include any endorsement or warranty regarding the functionality, quality or performance of any other product or service provided.

Under no circumstances does the CTC advanced GmbH test report include or imply any product or service warranties from CTC advanced GmbH, including, without limitation, any implied warranties of merchantability, fitness for purpose, or non-infringement, all of which are expressly disclaimed by CTC advanced GmbH.

All rights and remedies regarding vendor's products and services for which CTC advanced GmbH has prepared this test report shall be provided by the party offering such products or services and not by CTC advanced GmbH. In no case this test report can be considered as a Letter of Approval.

This test report is electronically signed and valid without handwritten signature. For verification of the electronic signatures, the public keys can be requested at the testing laboratory.

This test report replaces the test report with the number 1-4511/17-01-05 and dated 2017-09-25.

2.2 Application details

Date of receipt of order:	2017-08-09
Date of receipt of test item:	2017-08-31
Start of test:	2017-09-05
End of test:	2017-09-11
Person(s) present during the test:	-/-

2.3 Test laboratories sub-contracted

None

3 Test standard/s and references

Test standard	Date	Description
47 CFR Part 15	-/-	Title 47 of the Code of Federal Regulations; Chapter I; Part 15 - Radio frequency devices
RSS - 247 Issue 2	February 2017	Digital Transmission Systems (DTSs), Frequency Hopping Systems (FHSs) and Licence - Exempt Local Area Network (LE-LAN) Devices
RSS - Gen Issue 4	November 2014	Spectrum Management and Telecommunications Radio Standards Specifications - General Requirements and Information for the Certification of Radio Apparatus

Guidance	Version	Description
DTS: KDB 558074 D01	V04	Guidance for Performing Compliance Measurements on Digital Transmission Systems (DTS) Operating Under §15.247
ANSI C63.4-2014	-/-	American national standard for methods of measurement of radio-noise emissions from low-voltage electrical and electronic equipment in the range of 9 kHz to 40 GHz
ANSI C63.10-2013	-/-	American national standard of procedures for compliance testing of unlicensed wireless devices

4 Test environment

Temperature	:	T_{nom} T_{max} T_{min}	+21 °C during room temperature tests No tests under extreme conditions required No tests under extreme conditions required
Relative humidity content	:		55 %
Barometric pressure	:		1021 hpa
Power supply	:	V_{nom} V_{max} V_{min}	1.45 V DC by Zinc-Air-battery type p13 No tests under extreme conditions required No tests under extreme conditions required

5 Test item

5.1 General description

Kind of test item	:	Hearing Aid, WL Hi platform
Type identification	:	Aurora BTE power module
HMN	:	-/-
PMN	:	Aurora BTE Power
HVIN	:	Aurora BTE Power
FVIN	:	-/-
S/N serial number	:	Rad. 48970114 RX on lowest channel 49251284 RX on highest channel
HW status	:	Rev. 6 (LAB 6)
FW status	:	SIV 3.3.A / FW eSW 7.3.1
Frequency band	:	DTS band 2400 MHz to 2483.5 MHz
Type of radio transmission	:	other digital transmission
Use of frequency spectrum	:	
Type of modulation	:	RX: 4Mbps proprietary: GFSK
Number of channels	:	4Mbps proprietary: 40
Antenna	:	Internal PCB antenna
Power supply	:	1.45 V DC by Zinc-Air-battery type p13
Temperature range	:	0°C to +40°C

6 Description of the test setup

Typically, the calibrations of the test apparatus are commissioned to and performed by an accredited calibration laboratory. The calibration intervals are determined in accordance with the DIN EN ISO/IEC 17025. In addition to the external calibrations, the laboratory executes comparison measurements with other calibrated test systems or effective verifications. Weekly chamber inspections and range calibrations are performed. Where possible, RF generating and signaling equipment as well as measuring receivers and analyzers are connected to an external high-precision 10 MHz reference (GPS-based or rubidium frequency standard).

In order to simplify the identification of the equipment used at some special tests, some items of test equipment and ancillaries can be provided with an identifier or number in the equipment list below (Lab/Item).

Agenda: Kind of Calibration

k	calibration / calibrated	EK	limited calibration
ne	not required (k, ev, izw, zw not required)	zw	cyclical maintenance (external cyclical maintenance)
ev	periodic self verification	izw	internal cyclical maintenance
Ve	long-term stability recognized	g	blocked for accredited testing
vlk!	Attention: extended calibration interval		
NK!	Attention: not calibrated	*)	next calibration ordered / currently in progress

6.1 Shielded semi anechoic chamber

The radiated measurements are performed in vertical and horizontal plane in the frequency range from 30 MHz to 1 GHz in semi-anechoic chambers. The EUT is positioned on a non-conductive support with a height of 0.80 m above a conductive ground plane that covers the whole chamber. The receiving antennas are conform to specifications ANSI C63. These antennas can be moved over the height range between 1.0 m and 4.0 m in order to search for maximum field strength emitted from EUT. The measurement distances between EUT and receiving antennas are indicated in the test setups for the various frequency ranges. For each measurement, the EUT is rotated in all three axes until the maximum field strength is received. The wanted and unwanted emissions are received by spectrum analyzers where the detector modes and resolution bandwidths over various frequency ranges are set according to requirement ANSI C63.

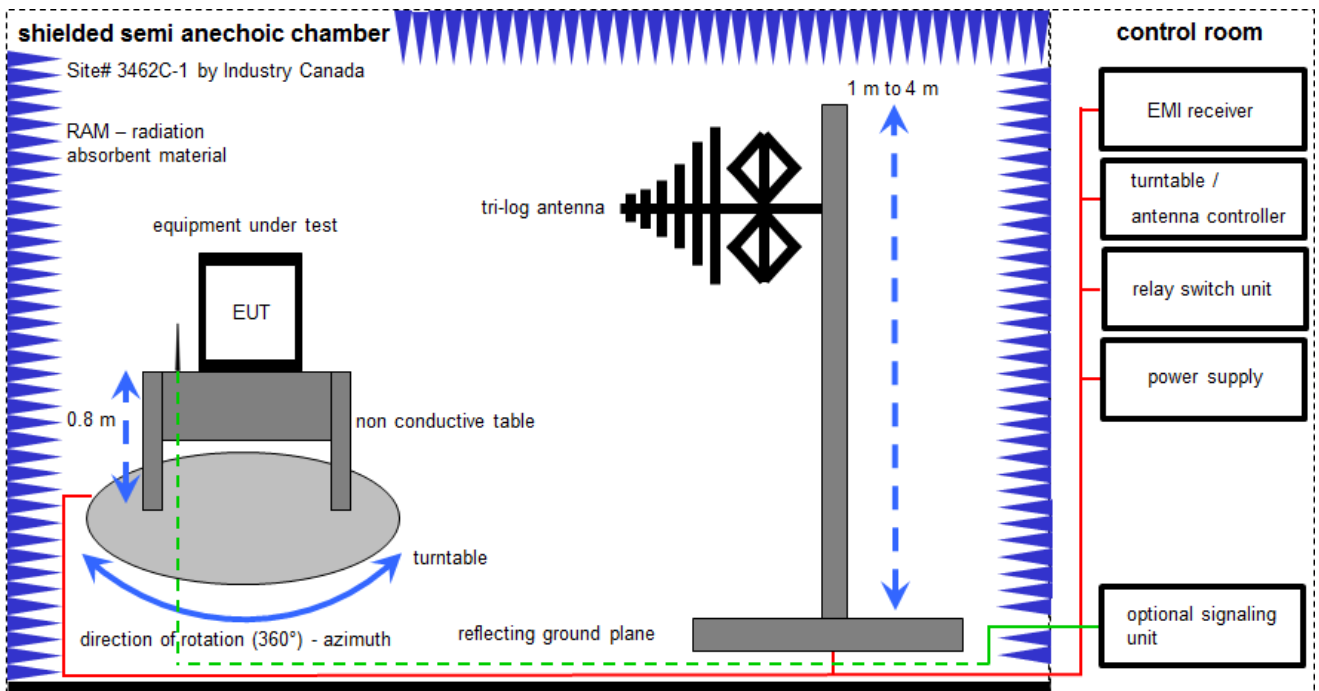

Measurement distance: tri-log antenna 10 meter

$$FS = UR + CL + AF$$

(FS-field strength; UR-voltage at the receiver; CL-loss of the cable; AF-antenna factor)

Example calculation:

$$FS [dB\mu V/m] = 12.35 [dB\mu V/m] + 1.90 [dB] + 16.80 [dB/m] = 31.05 [dB\mu V/m] (35.69 \mu V/m)$$

Equipment table:

No.	Lab / Item	Equipment	Type	Manufacturer	Serial No.	INV. No.	Kind of Calibration	Last Calibration	Next Calibration
1	A	Meßkabine 1	HF-Absorberhalle	MWB AG 300023		300000551	ne	-/-	-/-
2	A	EMI Test Receiver	ESCI 3	R&S	100083	300003312	k	01.02.2017	31.01.2018
3	A	Analyzer-Reference-System (Harmonics and Flicker)	ARS 16/1	SPS	A3509 07/0 0205	300003314	Ve	-/-	-/-
4	A	Antenna Tower	Model 2175	ETS-Lindgren	64762	300003745	izw	-/-	-/-
5	A	Positioning Controller	Model 2090	ETS-Lindgren	64672	300003746	izw	-/-	-/-
6	A	Turntable Interface-Box	Model 105637	ETS-Lindgren	44583	300003747	izw	-/-	-/-
7	A	TRILOG Broadband Test-Antenna 30 MHz - 3 GHz	VULB9163	Schwarzbeck	295	300003787	k	25.04.2016	25.04.2018

6.2 Shielded fully anechoic chamber

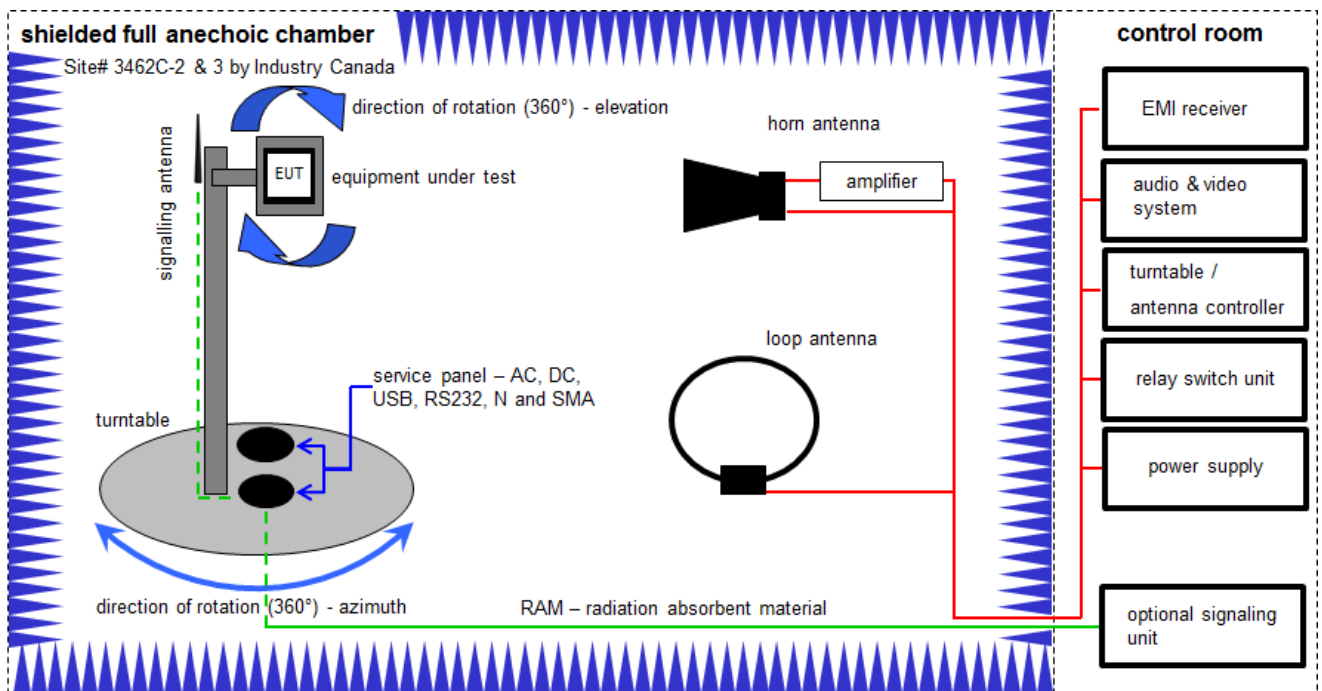

Measurement distance: horn antenna 3 meter; loop antenna 3 meter

$$FS = UR + CA + AF$$

(FS-field strength; UR-voltage at the receiver; CA-loss of the signal path; AF-antenna factor)

Example calculation:

$$FS \text{ [dB}\mu\text{V/m]} = 40.0 \text{ [dB}\mu\text{V/m]} + (-35.8) \text{ [dB]} + 32.9 \text{ [dB/m]} = 37.1 \text{ [dB}\mu\text{V/m]} \text{ (71.61 } \mu\text{V/m)}$$

Equipment table:

No.	Lab / Item	Equipment	Type	Manufacturer	Serial No.	INV. No.	Kind of Calibration	Last Calibration	Next Calibration
1	A	Anechoic chamber	FAC 3/5m	MWB / TDK	87400/02	300000996	ev	-/-	-/-
2	A	Switch / Control Unit	3488A	HP	*	300000199	ne	-/-	-/-
3	A	EMI Test Receiver 20Hz- 26,5GHz	ESU26	R&S	100037	300003555	k	31.01.2017	30.01.2018
4	A	Broadband Amplifier 0.5-18 GHz	CBLU5184540	CERNEX	22049	300004481	ev	-/-	-/-
5	A	4U RF Switch Platform	L4491A	Agilent Technologies	MY50000037	300004509	ne	-/-	-/-
6	A	NEXIO EMV-Software	BAT EMC V3.16.0.49	EMCO		300004682	ne	-/-	-/-
7	A	PC	ExOne	F+W		300004703	ne	-/-	-/-
8	A	RF-Amplifier	AMF-6F06001800-30-10P-R	NARDA-MITEQ Inc	2011572	300005241	ev	-/-	-/-
9	A	Double-Ridged Waveguide Horn Antenna 1-18.0GHz	3115	EMCO	9107-3697	300001605	vIKI!	14.02.2017	13.02.2019

6.3 Radiated measurements > 18 GHz

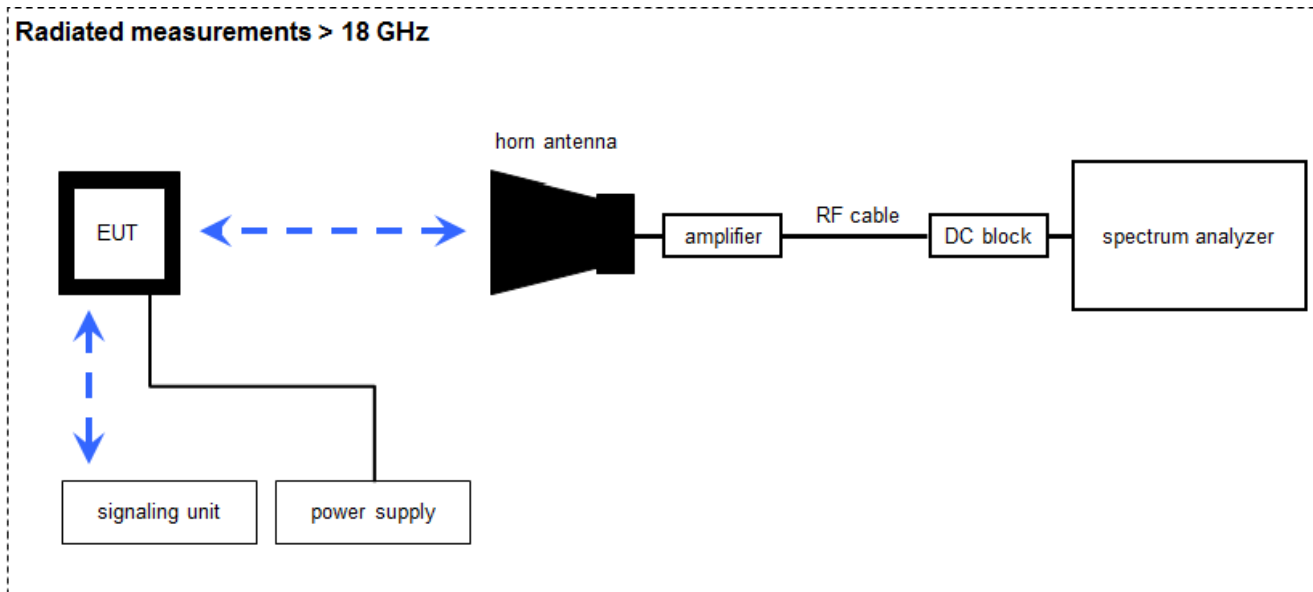

Measurement distance: horn antenna 50 cm

$$FS = UR + CA + AF$$

(FS-field strength; UR-voltage at the receiver; CA-loss signal path & distance correction; AF-antenna factor)

Example calculation:

$$FS [dB\mu V/m] = 40.0 [dB\mu V/m] + (-60.1) [dB] + 36.74 [dB/m] = 16.64 [dB\mu V/m] (6.79 \mu V/m)$$

Equipment table:

No.	Lab / Item	Equipment	Type	Manufacturer	Serial No.	INV. No.	Kind of Calibration	Last Calibration	Next Calibration
1	A	Horn Antenna 18,0-40,0 GHz	LHAF180	Microw.Devel	39180-103-022	300001748	k	22.05.2015	22.05.2018
2	A	Signal Analyzer 40 GHz	FSV40	R&S	101042	300004517	k	27.01.2017	26.01.2018
3	A	Microwave System Amplifier, 0.5-26.5 GHz	83017A	HP	00419	300002268	ev	-/-	-/-
4	A	RF-Cable	ST18/SMAm/SMAm/48	Huber & Suhner	Batch no. 600918	400001182	ev	-/-	-/-
5	A	RF-Cable	ST18/SMAm/SMAm/48	Huber & Suhner	Batch no. 127377	400001183	ev	-/-	-/-
6	A	DC-Blocker 0.1-40 GHz	8141A	Inmet	-/-	400001185	ev	-/-	-/-

7 Sequence of testing

7.1 Sequence of testing radiated spurious 30 MHz to 1 GHz

Setup

- The equipment is set up to simulate normal operation mode as described in the user manual or defined by the manufacturer.
- If the EUT is a tabletop system, a table with 0.8 m height is used, which is placed on the ground plane.
- If the EUT is a floor standing device, it is placed on the ground plane with insulation between both.
- Auxiliary equipment and cables are positioned to simulate normal operation conditions as described in ANSI C 63.4.
- The AC power port of the EUT (if available) is connected to a power outlet below the turntable.
- Measurement distance is 10 m or 3 m (see ANSI C 63.4) – see test details.
- EUT is set into operation.

Premeasurement

- The turntable rotates from 0° to 315° using 45° steps.
- The antenna is polarized vertical and horizontal.
- The antenna height changes from 1 m to 3 m.
- At each turntable position, antenna polarization and height the analyzer sweeps three times in peak to find the maximum of all emissions.

Final measurement

- The final measurement is performed for at least six highest peaks according to the requirements of the ANSI C63.4.
- Based on antenna and turntable positions at which the peak values are measured the software maximize the peaks by changing turntable position $\pm 45^\circ$ and antenna height between 1 and 4 m.
- The final measurement is done with quasi-peak detector (as described in ANSI C 63.4).
- Final levels, frequency, measuring time, bandwidth, antenna height, antenna polarization, turntable angle, correction factor, margin to the limit and limit are recorded. A plot with the graph of the premeasurement with marked maximum final results and the limit is stored.

7.2 Sequence of testing radiated spurious 1 GHz to 18 GHz

Setup

- The equipment is set up to simulate normal operation mode as described in the user manual or defined by the manufacturer.
- If the EUT is a tabletop system, a 2-axis positioner with 1.5 m height is used.
- If the EUT is a floor standing device, it is placed directly on the turn table.
- Auxiliary equipment and cables are positioned to simulate normal operation conditions as described in ANSI C 63.4.
- The AC power port of the EUT (if available) is connected to a power outlet below the turntable.
- Measurement distance is 3 m (see ANSI C 63.4) – see test details.
- EUT is set into operation.

Premeasurement

- The turntable rotates from 0° to 315° using 45° steps.
- The antenna is polarized vertical and horizontal.
- The antenna height is 1.5 m.
- At each turntable position and antenna polarization the analyzer sweeps with positive peak detector to find the maximum of all emissions.

Final measurement

- The final measurement is performed for at least six highest peaks according to the requirements of the ANSI C63.4.
- Based on antenna and turntable positions at which the peak values are measured the software maximizes the peaks by rotating the turntable from 0° to 360°. This measurement is repeated for different EUT-table positions (0° to 150° in 30°-steps) and for both antenna polarizations.
- The final measurement is done in the position (turntable, EUT-table and antenna polarization) causing the highest emissions with Peak and RMS detector (as described in ANSI C 63.4).
- Final levels, frequency, measuring time, bandwidth, turntable position, EUT-table position, antenna polarization, correction factor, margin to the limit and limit are recorded. A plot with the graph of the premeasurement with marked maximum final results and the limit is stored.

7.3 Sequence of testing radiated spurious above 18 GHz

Setup

- The equipment is set up to simulate normal operation mode as described in the user manual or defined by the manufacturer.
- Auxiliary equipment and cables are positioned to simulate normal operation conditions as described in ANSI C 63.4.
- The AC power port of the EUT (if available) is connected to a power outlet.
- The measurement distance is as appropriate (e.g. 0.5 m).
- The EUT is set into operation.

Premeasurement

- The test antenna is handheld and moved carefully over the EUT to cover the EUT's whole sphere and different polarizations of the antenna.

Final measurement

- The final measurement is performed at the position and antenna orientation causing the highest emissions with Peak and RMS detector (as described in ANSI C 63.4).
- Final levels, frequency, measuring time, bandwidth, correction factor, margin to the limit and limit are recorded. A plot with the graph of the premeasurement and the limit is stored.

8 Measurement uncertainty

Measurement uncertainty	
Test case	Uncertainty
Antenna gain	± 3 dB
Spectrum bandwidth	± 21.5 kHz absolute; ± 15.0 kHz relative
Maximum output power	± 1 dB
Detailed conducted spurious emissions @ the band edge	± 1 dB
Band edge compliance radiated	± 3 dB
Spurious emissions conducted	± 3 dB
Spurious emissions radiated below 30 MHz	± 3 dB
Spurious emissions radiated 30 MHz to 1 GHz	± 3 dB
Spurious emissions radiated 1 GHz to 12.75 GHz	± 3.7 dB
Spurious emissions radiated above 12.75 GHz	± 4.5 dB
Spurious emissions conducted below 30 MHz (AC conducted)	± 2.6 dB

9 Summary of measurement results

<input type="checkbox"/>	No deviations from the technical specifications were ascertained
<input type="checkbox"/>	There were deviations from the technical specifications ascertained
<input checked="" type="checkbox"/>	This test report is only a partial test report. The content and verdict of the performed test cases are listed below.

TC Identifier	Description	Verdict	Date	Remark
RF-Testing	CFR Part 15 RSS - 247, Issue 2	See table!	2017-11-29	only RX 4Mbps

Test specification clause	Test case	Guideline	Temperature conditions	Power source voltages	Mode	C	NC	NA	NP	Remark
§15.247(b)(4) RSS - 247 / 5.4 (4)	System gain	-/-	Nominal	Nominal	GFSK	<input type="checkbox"/>	<input type="checkbox"/>	<input type="checkbox"/>	<input checked="" type="checkbox"/>	only RX
§15.247(e) RSS - 247 / 5.2 (b)	Power spectral density	KDB 558074 DTS clause: 10.6	Nominal	Nominal	GFSK	<input type="checkbox"/>	<input type="checkbox"/>	<input type="checkbox"/>	<input checked="" type="checkbox"/>	only RX
§15.247(a)(2) RSS - 247 / 5.2 (a)	DTS bandwidth – 6 dB bandwidth	KDB 558074 DTS clause: 8.1	Nominal	Nominal	GFSK	<input type="checkbox"/>	<input type="checkbox"/>	<input type="checkbox"/>	<input checked="" type="checkbox"/>	only RX
RSS Gen clause 4.6.1	Occupied bandwidth	-/-	Nominal	Nominal	GFSK	<input type="checkbox"/>	<input type="checkbox"/>	<input type="checkbox"/>	<input checked="" type="checkbox"/>	only RX
§15.247(b)(3) RSS - 247 / 5.4 (4)	Maximum output power	KDB 558074 DTS clause: 9.1.1	Nominal	Nominal	GFSK	<input type="checkbox"/>	<input type="checkbox"/>	<input type="checkbox"/>	<input checked="" type="checkbox"/>	only RX
§15.247(d) RSS - 247 / 5.5	Detailed spurious emissions @ the band edge - conducted	-/-	Nominal	Nominal	GFSK	<input type="checkbox"/>	<input type="checkbox"/>	<input type="checkbox"/>	<input checked="" type="checkbox"/>	only RX
§15.205 RSS - 247 / 5.5 RSS - Gen	Band edge compliance radiated	KDB 558074 DTS clause: 13.3.2	Nominal	Nominal	GFSK	<input type="checkbox"/>	<input type="checkbox"/>	<input type="checkbox"/>	<input checked="" type="checkbox"/>	only RX
§15.247(d) RSS - 247 / 5.5	TX spurious emissions conducted	KDB 558074 DTS clause: 11.1 & 11.2 11.3	Nominal	Nominal	GFSK	<input type="checkbox"/>	<input type="checkbox"/>	<input type="checkbox"/>	<input checked="" type="checkbox"/>	only RX
§15.209(a) RSS - Gen	Spurious emissions radiated below 30 MHz	-/-	Nominal	Nominal	GFSK	<input type="checkbox"/>	<input type="checkbox"/>	<input type="checkbox"/>	<input checked="" type="checkbox"/>	only RX
15.247(d) RSS - 247 / 5.5 §15.109 RSS - Gen	Spurious emissions radiated 30 MHz to 1 GHz	-/-	Nominal	Nominal	RX	<input checked="" type="checkbox"/>	<input type="checkbox"/>	<input type="checkbox"/>	<input type="checkbox"/>	-/-
§15.247(d) RSS - 247 / 5.5 §15.109 RSS - Gen	Spurious emissions radiated above 1 GHz	-/-	Nominal	Nominal	RX	<input checked="" type="checkbox"/>	<input type="checkbox"/>	<input type="checkbox"/>	<input type="checkbox"/>	-/-
§15.107(a) §15.207	Conducted emissions below 30 MHz (AC conducted)	-/-	Nominal	Nominal	RX	<input type="checkbox"/>	<input type="checkbox"/>	<input checked="" type="checkbox"/>	<input type="checkbox"/>	battery powered device

Note: C = Compliant; NC = Not compliant; NA = Not applicable; NP = Not performed

10 Additional comments

The Bluetooth® word mark and logos are owned by the Bluetooth SIG Inc. and any use of such marks by CTC advanced GmbH is under license.

Purpose of the test report: PC II test report to cover additional RX mode 4 Mbit/s

Special test descriptions: None

Configuration descriptions: RX/Standby tests: BT enabled, TX Idle

- Test mode:
- Bluetooth LE Test mode enabled (EUT is controlled over CBT)
 - Special software is used.
EUT is transmitting pseudo random data by itself
- Antennas and transmit operating modes:
- Operating mode 1 (single antenna)
 - *Equipment with 1 antenna,*
 - *Equipment with 2 diversity antennas operating in switched diversity mode by which at any moment in time only 1 antenna is used,*
 - *Smart antenna system with 2 or more transmit/receive chains, but operating in a mode where only 1 transmit/receive chain is used)*
 - Operating mode 2 (multiple antennas, no beamforming)
 - *Equipment operating in this mode contains a smart antenna system using two or more transmit/receive chains simultaneously but without beamforming.*
 - Operating mode 3 (multiple antennas, with beamforming)
 - *Equipment operating in this mode contains a smart antenna system using two or more transmit/receive chains simultaneously with beamforming. In addition to the antenna assembly gain (G), the beamforming gain (Y) may have to be taken into account when performing the measurements.*

11 Measurement results

11.1 Spurious emissions radiated 30 MHz to 1 GHz

Description:

Measurement of the radiated spurious emissions in transmit mode. The EUT is set to single channel mode and the RX frequencies are 2402 MHz and 2480 MHz.

Measurement parameters	
Detector	Peak / Quasi Peak
Sweep time	Auto
Resolution bandwidth	120 kHz
Video bandwidth	3 x RBW
Span	30 MHz to 1 GHz
Trace mode	Max hold
Measured modulation	RX
Test setup	See sub clause 6.1 A
Measurement uncertainty	See sub clause 8

Limits:

FCC		IC
§15.209		
Frequency (MHz)	Field strength (dBµV/m)	Measurement distance
30 - 88	30.0	10
88 – 216	33.5	10
216 – 960	36.0	10
Above 960	54.0	3

Plots: RX mode

Plot 1: 30 MHz to 1 GHz, RX mode, lowest channel, vertical & horizontal polarization

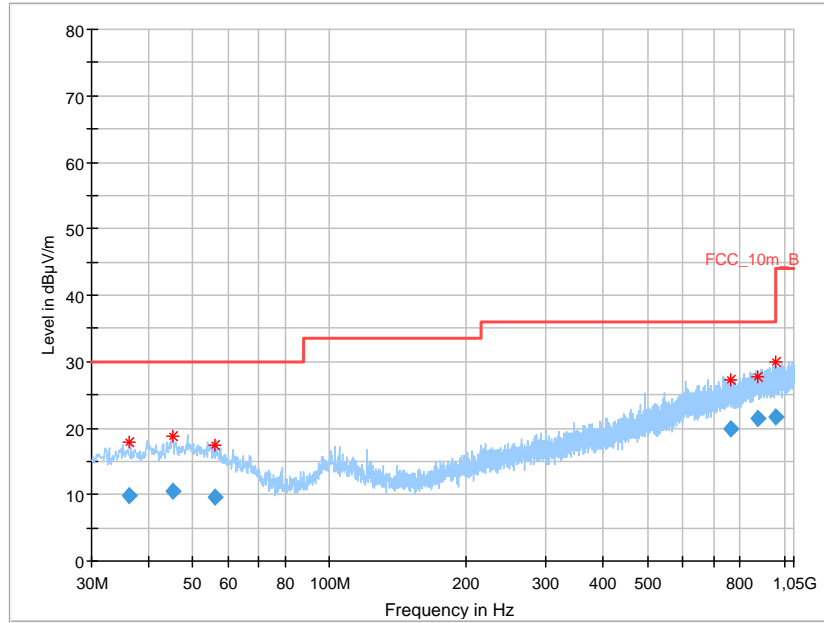

Final results:

Frequency (MHz)	QuasiPeak (dBµV/m)	Limit (dBµV/m)	Margin (dB)	Meas. Time (ms)	Bandwidth (kHz)	Height (cm)	Pol	Azimuth (deg)	Corr. (dB)
36.173	9.82	30.0	20.18	1000	120	170.0	V	10.0	12.8
45.285	10.58	30.0	19.42	1000	120	170.0	H	170.0	13.6
56.059	9.69	30.0	20.31	1000	120	101.0	H	10.0	12.8
765.360	19.99	36.0	16.01	1000	120	170.0	V	10.0	22.7
872.546	21.42	36.0	14.58	1000	120	170.0	V	261.0	23.8
957.812	21.64	36.0	14.36	1000	120	170.0	V	280.0	24.4

Plot 2: 30 MHz to 1 GHz, RX mode, highest channel, vertical & horizontal polarization

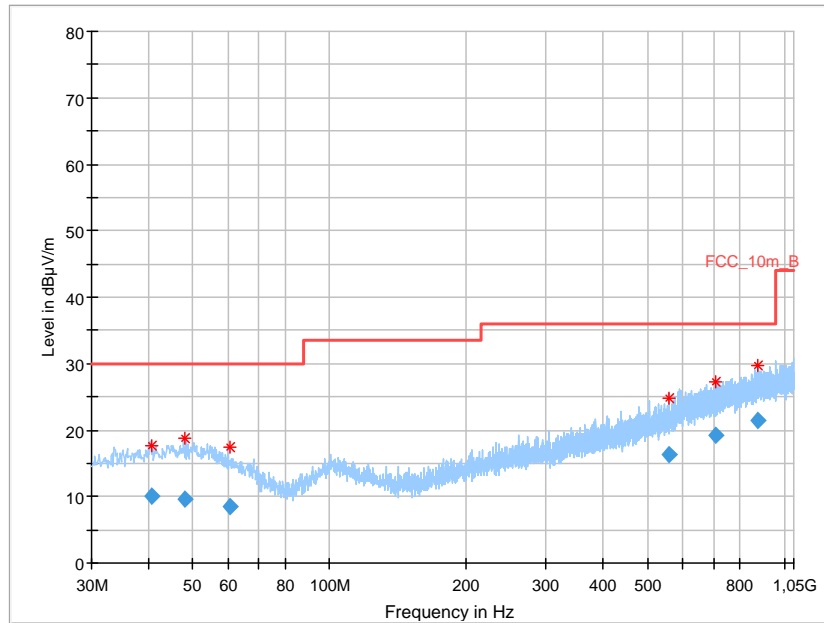

Final results:

Frequency (MHz)	QuasiPeak (dBµV/m)	Limit (dBµV/m)	Margin (dB)	Meas. Time (ms)	Bandwidth (kHz)	Height (cm)	Pol	Azimuth (deg)	Corr. (dB)
40.798	10.10	30.0	19.90	1000	120	98.0	V	280.0	13.3
48.143	9.65	30.0	20.35	1000	120	101.0	V	280.0	13.7
60.244	8.49	30.0	21.51	1000	120	170.0	H	190.0	11.8
558.972	16.24	36.0	19.76	1000	120	170.0	H	10.0	19.6
708.743	19.22	36.0	16.78	1000	120	98.0	H	-10.0	21.8
876.729	21.49	36.0	14.51	1000	120	98.0	H	10.0	23.9

11.2 Spurious emissions radiated above 1 GHz

Description:

Measurement of the radiated spurious emissions in transmit mode. The EUT is set to single channel mode and the RX frequencies are 2402 MHz and 2480 MHz.

Measurement parameters	
Detector	Peak / RMS
Sweep time	Auto
Resolution bandwidth	1 MHz
Video bandwidth	3 x RBW
Span	1 GHz to 26 GHz
Trace mode	Max hold
Measured modulation	GFSK
Test setup	See sub clause 6.2 A (1 GHz - 18 GHz) See sub clause 6.3 A (18 GHz - 26 GHz)
Measurement uncertainty	See sub clause 8

Limits:

FCC		IC	
§15.209			
Frequency (MHz)	Field strength (dBµV/m)	Measurement distance	
Above 960	54.0 (Average)	3	
Above 960	74.0 (Peak)	3	

Results: Receiver mode

RX spurious emissions radiated [dBµV/m]		
F [MHz]	Detector	Level [dBµV/m]
All detected emissions are more than 10 dB below the limit.		
	Peak	
	AVG	

Note: The limit was recalculated with 20 dB / decade (Part 15.31) for all radiated spurious emissions 30 MHz to 1 GHz from 3 meter limit to a 10 meter distance. (40dB/decade for emissions < 30MHz)

Plots: Receiver mode

Plot 1: 1 GHz to 18 GHz, RX / idle – mode, lowest channel, vertical & horizontal polarization

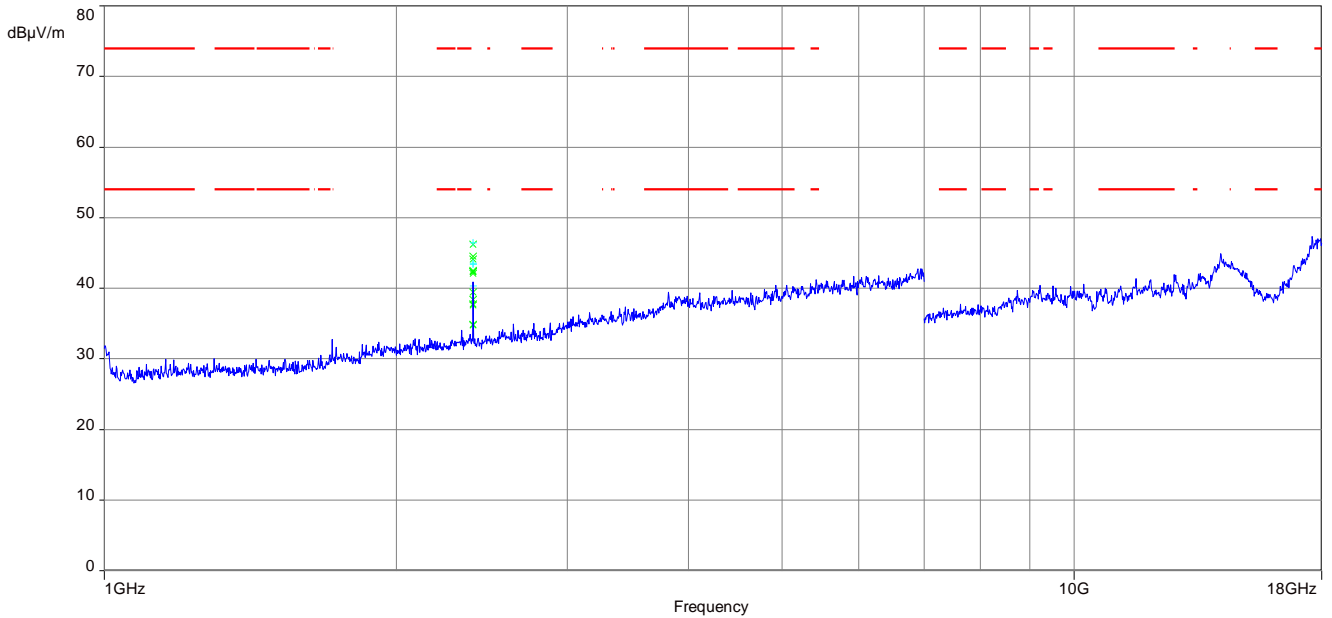

Plot 2: 18 GHz to 26 GHz, RX / idle – mode, lowest channel, vertical & horizontal polarization

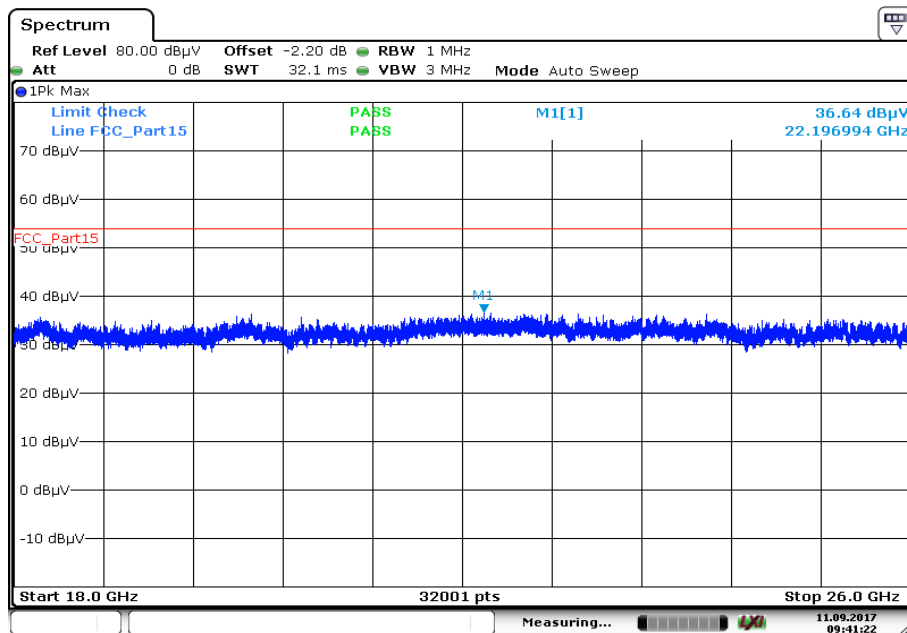

Date: 11.SEP.2017 09:41:22

Plot 3: 1 GHz to 18 GHz, RX / idle – mode, highest channel, vertical & horizontal polarization

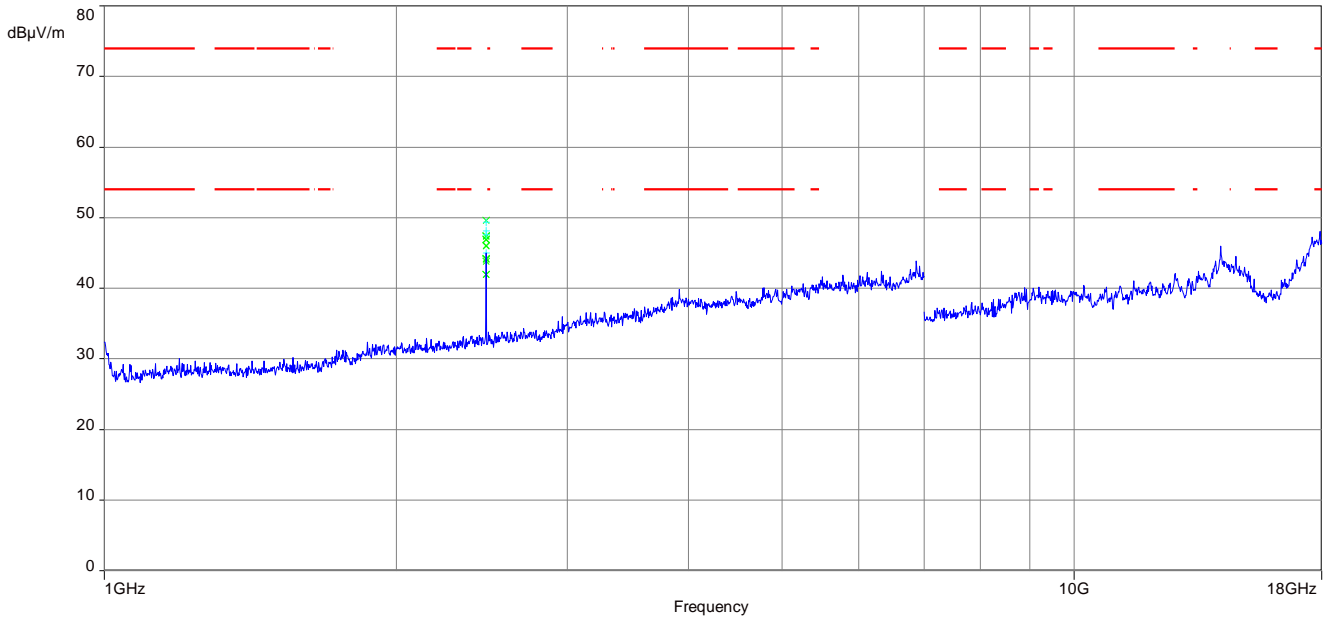

Plot 4: 18 GHz to 26 GHz, RX / idle – mode, highest channel, vertical & horizontal polarization

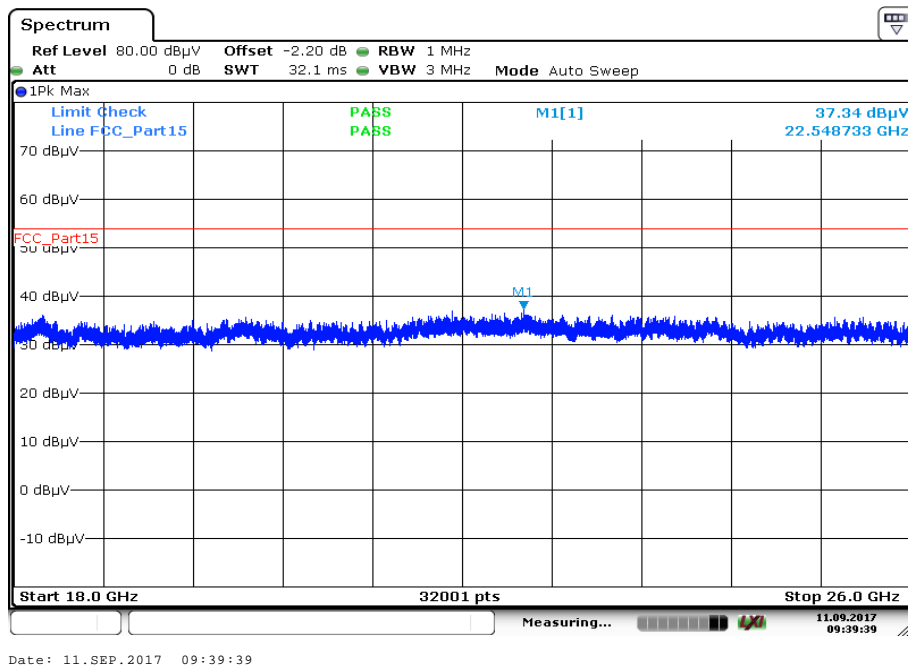

Annex A Glossary

EUT	Equipment under test
DUT	Device under test
UUT	Unit under test
GUE	GNSS User Equipment
ETSI	European Telecommunications Standards Institute
EN	European Standard
FCC	Federal Communications Commission
FCC ID	Company Identifier at FCC
IC	Industry Canada
PMN	Product marketing name
HMN	Host marketing name
HVIN	Hardware version identification number
FVIN	Firmware version identification number
EMC	Electromagnetic Compatibility
HW	Hardware
SW	Software
Inv. No.	Inventory number
S/N or SN	Serial number
C	Compliant
NC	Not compliant
NA	Not applicable
NP	Not performed
PP	Positive peak
QP	Quasi peak
AVG	Average
OC	Operating channel
OCW	Operating channel bandwidth
OBW	Occupied bandwidth
OOB	Out of band
DFS	Dynamic frequency selection
CAC	Channel availability check
OP	Occupancy period
NOP	Non occupancy period
DC	Duty cycle
PER	Packet error rate
CW	Clean wave
MC	Modulated carrier
WLAN	Wireless local area network
RLAN	Radio local area network
DSSS	Dynamic sequence spread spectrum
OFDM	Orthogonal frequency division multiplexing
FHSS	Frequency hopping spread spectrum
GNSS	Global Navigation Satellite System
C/N₀	Carrier to noise-density ratio, expressed in dB-Hz

Annex B Document history

Version	Applied changes	Date of release
-/-	Initial release	2017-09-25
A	Editorial changes	2017-11-29

Annex C Accreditation Certificate

first page	last page
 <p>Deutsche Akkreditierungsstelle GmbH</p> <p>Bellehene gemäß § 8 Absatz 1 AkkStelleG i.V.m. § 1 Absatz 1 AkkStelleGBV Unterzeichnerin der Multilateralen Abkommen von EA, ILAC und IAF zur gegenseitigen Anerkennung</p>  <p>Akkreditierung</p> <p>Die Deutsche Akkreditierungsstelle GmbH bestätigt hiermit, dass das Prüflaboratorium CTC advanced GmbH Untertürkheimer Straße 6-10, 66117 Saarbrücken</p> <p>die Kompetenz nach DIN EN ISO/IEC 17025:2005 besitzt, Prüfungen in folgenden Bereichen durchzuführen:</p> <ul style="list-style-type: none"> Funk Mobilfunk (GSM / DCS) + OTA Elektromagnetische Verträglichkeit (EMV) Produktsicherheit SAR / EMF Umwelt Smart Card Technology Bluetooth* Automotive Wi-Fi-Services Kanadische Anforderungen US-Anforderungen Akustik Near Field Communication (NFC) <p>Die Akkreditierungsurkunde gilt nur in Verbindung mit dem Bescheid vom 25.11.2016 mit der Akkreditierungsnummer D-PL-12076-01 und ist gültig bis 17.01.2018. Sie besteht aus diesem Deckblatt, der Rückseite des Deckblatts und der folgenden Anlage mit insgesamt 63 Seiten.</p> <p>Registrierungsnummer der Urkunde: D-PL-12076-01-01</p> <p>Frankfurt, 25.11.2016</p>  <p>Im Auftrag Dipl.-Ing. Ralf Egner Abteilungsleiter</p> <p><small>Seite Nummer 1 of der Rückseite</small></p>	<p>Deutsche Akkreditierungsstelle GmbH</p> <p>Standort Berlin Spittelmarkt 10 10117 Berlin</p> <p>Standort Frankfurt am Main Europa-Allee 52 60327 Frankfurt am Main</p> <p>Standort Braunschweig Bundesallee 100 38116 Braunschweig</p> <p>Die auszugsweise Veröffentlichung der Akkreditierungsurkunde bedarf der vorherigen schriftlichen Zustimmung der Deutsche Akkreditierungsstelle GmbH (DAKKS). Ausgenommen davon ist die separate Weiterverbreitung des Deckblattes durch die umseitig genannte Konformitätsbewertungsstelle in unveränderter Form.</p> <p>Es darf nicht der Anschein erweckt werden, dass sich die Akkreditierung auch auf Bereiche erstreckt, die über den durch die DAKKS bestätigten Akkreditierungsbereich hinausgehen.</p> <p>Die Akkreditierung erfolgte gemäß des Gesetzes über die Akkreditierungsstelle (AkkStelleG) vom 31. Juli 2009 (BGBl. I S. 2625) sowie der Verordnung (EG) Nr. 765/2008 des Europäischen Parlaments und des Rates vom 9. Juli 2008 über die Vorschriften für die Akkreditierung und Marktüberwachung im Zusammenhang mit der Vermarktung von Produkten (Abj. L 218 vom 9. Juli 2008, S. 30). Die DAKKS ist Unterzeichnerin der Multilateralen Abkommen zur gegenseitigen Anerkennung der European co-operation for Accreditation (EA), des International Accreditation Forum (IAF) und der International Laboratory Accreditation Cooperation (ILAC). Die Unterzeichner dieser Abkommen erkennen ihre Akkreditierungen gegenseitig an.</p> <p>Der aktuelle Stand der Mitgliedschaft kann folgenden Webseiten entnommen werden: EA: www.european-accreditation.org ILAC: www.ilac.org IAF: www.iaf.nu</p>

Note: The current certificate annex is published on the website (link see below) of the Accreditation Body DAkKS or may be received by CTC advanced GmbH on request

<http://www.dakks.de/as/ast/d/D-PL-12076-01-03.pdf>