

## TEST REPORT

Test report no.: 1-2071-01-02/10-B



### Testing laboratory

**CETECOM ICT Services GmbH**  
Untertuerkheimer Straße 6 – 10  
66117 Saarbruecken / Germany  
Phone: + 49 681 5 98 - 0  
Fax: + 49 681 5 98 - 9075  
Internet: <http://www.cetecom.com>  
e-mail: [ict@cetecom.com](mailto:ict@cetecom.com)

#### Accredited test laboratory:

The test laboratory (area of testing) is accredited according to DIN EN ISO/IEC 17025  
DAR registration number: DGA-PL-176/94-D1

Area of Testing: Radio/Satellite Communications

### Applicant

**Oticon A/S**  
Kongebakken 9  
2765 Smørum / Denmark  
Phone: +45 39 17 71 00  
Contact: Kristine Klitgaard Pedersen  
e-mail: [kkp@oticon.dk](mailto:kkp@oticon.dk)  
Phone: +45 39 13 85 83

### Manufacturer

**Oticon A/S**  
Kongebakken 9  
2765 Smørum / Denmark

### Test standard/s

47 CFR Part 2	Title 47 of the Code of Federal Regulations; Chapter I-Federal Communications Commission Frequency allocations and radio treaty matters; general rules and regulations
47 CFR Part 95	Title 47 of the Code of Federal Regulations; Chapter I-Federal Communications Commission subchapter D - safety and special radio services; Part 95-Personal radio services
RSS - Gen Issue 2	General Requirements and Information for the Certification of Radiocommunication Equipment

For further applied test standards please refer to section 3 of this test report.

### Test item

<b>Kind of test item:</b>	<b>FM Transmitter</b>
<b>Model name:</b>	<b>AMIGO T30/T31</b>
<b>FCC ID:</b>	<b>U28AT31</b>
<b>IC:</b>	<b>1350B-AT31</b>
<b>Frequency [MHz]:</b>	<b>216.0125MHz – 216.9875MHz</b>
<b>Power supply:</b>	<b>1.5V AA-battery / 1.2 V AA rechargeable battery</b>
<b>Temperature range:</b>	<b>-30 °C to 50 °C</b>

This test report is electronically signed and valid without handwriting signature. For verification of the electronic signatures, the public keys can be requested at the testing laboratory.

**Test performed:**

**Test report authorised:**

Andreas Keller

Stefan Bös

**1 Table of contents**

1 Table of contents .....2

2 General information .....3

    2.1 Notes.....3

    2.2 Application details.....3

3 Test standard/s .....3

4 Test environment.....4

5 Test item .....4

6 Test laboratories sub-contracted .....4

7 Summary of measurement results .....5

8 RF measurement testing.....6

    8.1 Description of test setup .....6

        8.1.1 Radiated measurements.....6

        8.1.2 Conducted measurements.....7

    8.2 Additional comments .....7

    8.3 RSP100 test report cover sheet / performance test data .....8

9 Measurement results.....9

    9.1 Radiated output power.....9

    9.2 Frequency stability .....10

    9.3 Modulation characteristics .....13

    9.4 Occupied bandwidth .....15

    9.5 Unwanted radiation (spectrum mask) .....18

    9.6 Field strength of spurious radiation.....21

    9.7 Receiver spurious emissions (radiated) .....31

10 Test equipment and ancillaries used for tests .....35

## 2 General information

### 2.1 Notes

The test results of this test report relate exclusively to the test item specified in this test report. CETECOM ICT Services GmbH does not assume responsibility for any conclusions and generalisations drawn from the test results with regard to other specimens or samples of the type of the equipment represented by the test item. The test report may only be reproduced or published in full. Reproduction or publication of extracts from the report requires the prior written approval of CETECOM ICT Services GmbH.

This test report is electronically signed and valid without handwriting signature. For verification of the electronic signatures, the public keys can be requested at the testing laboratory.

### 2.2 Application details

Date of receipt of order:	2010-06-28
Date of receipt of test item:	2010-08-31
Start of test:	2010-08-31
End of test:	2010-10-14
Person(s) present during the test:	Mr Arne Lindbjerg Pedersen, Mr Thorvaldur Oli Bodvarsson

## 3 Test standard/s

Test standard	Version	Test standard description
47 CFR Part 2	2009-10	Title 47 of the Code of Federal Regulations; Chapter I-Federal Communications Commission Frequency allocations and radio treaty matters; general rules and regulations
47 CFR Part 95	2009-10	Title 47 of the Code of Federal Regulations; Chapter I-Federal Communications Commission subchapter D - safety and special radio services; Part 95- Personal radio services
RSS - Gen Issue 2	2007-06	General Requirements and Information for the Certification of Radiocommunication Equipment
RSS - 210 Issue 7	2007-06	Spectrum Management and Telecommunications - Radio Standards Specification Low-power Licence-exempt Radiocommunication Devices (All Frequency Bands): Category I Equipment

#### 4 Test environment

Temperature:	$T_{nom}$	24 °C	during room temperature tests
	$T_{max}$	50 °C	during high temperature test
	$T_{min}$	-30 °C	during low temperature test
Relative humidity content:		55 %	
Air pressure:		not relevant for this kind of testing	
Power supply:	$V_{nom}$	1.5 V	AA-battery / 1.2 V AA rechargeable battery
	$V_{max}$	1.73 V	(1.15 x 1.5 V)
	$V_{min}$	1.00 V	(0.85 x 1.2 V)

#### 5 Test item

Kind of test item	:	FM Transmitter
Type identification	:	AMIGO T30/T31
S/N serial number	:	Radiated: Sample #4, Sample #43 Conducted: Sample #6, Sample #44
HW hardware status	:	Not available
SW software status	:	App: 9.5.2 Cdc: 2.13.c SnC: 11.0.b
Frequency band [MHz]	:	216.0125 MHz – 216.9875 MHz Country dependent: For Canada the sub-band 216.45MHz - 216.50MHz is not available according to RSS210 Issue7 A4.3.
Type of modulation	:	F3E ( $\Delta f=5\text{kHz}$ )
Number of channels	:	Country dependent
Antenna	:	Dedicated wire antenna (microphone LAPEL)
Power supply	:	1.5 V AA-battery / 1.2 V AA rechargeable battery
Temperature range	:	-30 °C to 50 °C

#### 6 Test laboratories sub-contracted

None

**7 Summary of measurement results**

- No deviations from the technical specifications were ascertained**
- There were deviations from the technical specifications ascertained

TC Identifier	Description	Verdict	Date	Remark
RF-Testing	47 CFR Part 2 47 CFR Part 95 G RSS Gen Issue 2 RSS 210 Issue 7 Annexe 4	Passed	2010-11-15	-/-

Test Specification Clause	Test Case	Temperature Conditions	Power Source Voltages	Pass	Fail	NA	NP	Results (max.)
FCC 47 CFR § 2.1046 § 95.639 (e) RSS 210 Issue 7 A4.3	Radiated output power	Nominal	Nominal	<input checked="" type="checkbox"/>	<input type="checkbox"/>	<input type="checkbox"/>	<input type="checkbox"/>	complies
FCC 47 CFR § 2.1055 § 95.629 (d) (2) RSS 210 Issue 7 A4.3	Frequency stability	Nominal	Extreme	<input checked="" type="checkbox"/>	<input type="checkbox"/>	<input type="checkbox"/>	<input type="checkbox"/>	complies
		Extreme	Nominal	<input checked="" type="checkbox"/>	<input type="checkbox"/>	<input type="checkbox"/>	<input type="checkbox"/>	
FCC 47 CFR § 2.1047 RSS Gen Issue 2	Modulation characteristics	Nominal	Nominal	<input checked="" type="checkbox"/>	<input type="checkbox"/>	<input type="checkbox"/>	<input type="checkbox"/>	complies
FCC 47 CFR § 2.1049 (1) RSS Gen Issue 2 Section 4	Occupied bandwidth	Nominal	Nominal	<input checked="" type="checkbox"/>	<input type="checkbox"/>	<input type="checkbox"/>	<input type="checkbox"/>	complies
FCC 47 CFR § 95.635 (c) (1) RSS 210 Issue 7 A4.3	Unwanted radiation (spectrum mask)	Nominal	Nominal	<input checked="" type="checkbox"/>	<input type="checkbox"/>	<input type="checkbox"/>	<input type="checkbox"/>	complies
FCC 47 CFR § 2.1053 § 95.635 (c) (1) RSS Gen Issue 2 Section 4	Field strength of spurious radiation	Nominal	Nominal	<input checked="" type="checkbox"/>	<input type="checkbox"/>	<input type="checkbox"/>	<input type="checkbox"/>	complies
	Transmitter unwanted emissions							
FCC 47 CFR § 15.209 RSS Gen Issue 2 Section 6	Receiver spurious emissions (radiated)	Nominal	Nominal	<input checked="" type="checkbox"/>	<input type="checkbox"/>	<input type="checkbox"/>	<input type="checkbox"/>	complies

**Note:** NA = Not Applicable; NP = Not Performed

## 8 RF measurement testing

### 8.1 Description of test setup

#### 8.1.1 Radiated measurements

The radiated measurements are performed in vertical and horizontal plane in the frequency range from 9 kHz to 25 GHz in semi-anechoic chambers. The EUT is positioned on a non-conductive support with a height of 0.80 m above a conductive ground plane that covers the whole chamber. The receiving antennas are confirmed with specifications ANSI C63.2-1996 clause 15 and ANSI C63.4-2009 clause 4.1.5. These antennas can be moved over the height range between 1.0 m and 4.0 m in order to search for maximum field strength emitted from EUT. The measurement distances between EUT and receiving antennas are indicated in the test setups for the various frequency ranges. For each measurement, the EUT is rotated in all three axes until the maximum field strength is received. The wanted and unwanted emissions are received by spectrum analysers where the detector modes and resolution bandwidths over various frequency ranges are set according to requirement ANSI C63-4-2009 clause 4.2.

Antennas are confirmed with ANSI C63.2-1996 item 15.

Semi anechoic chamber

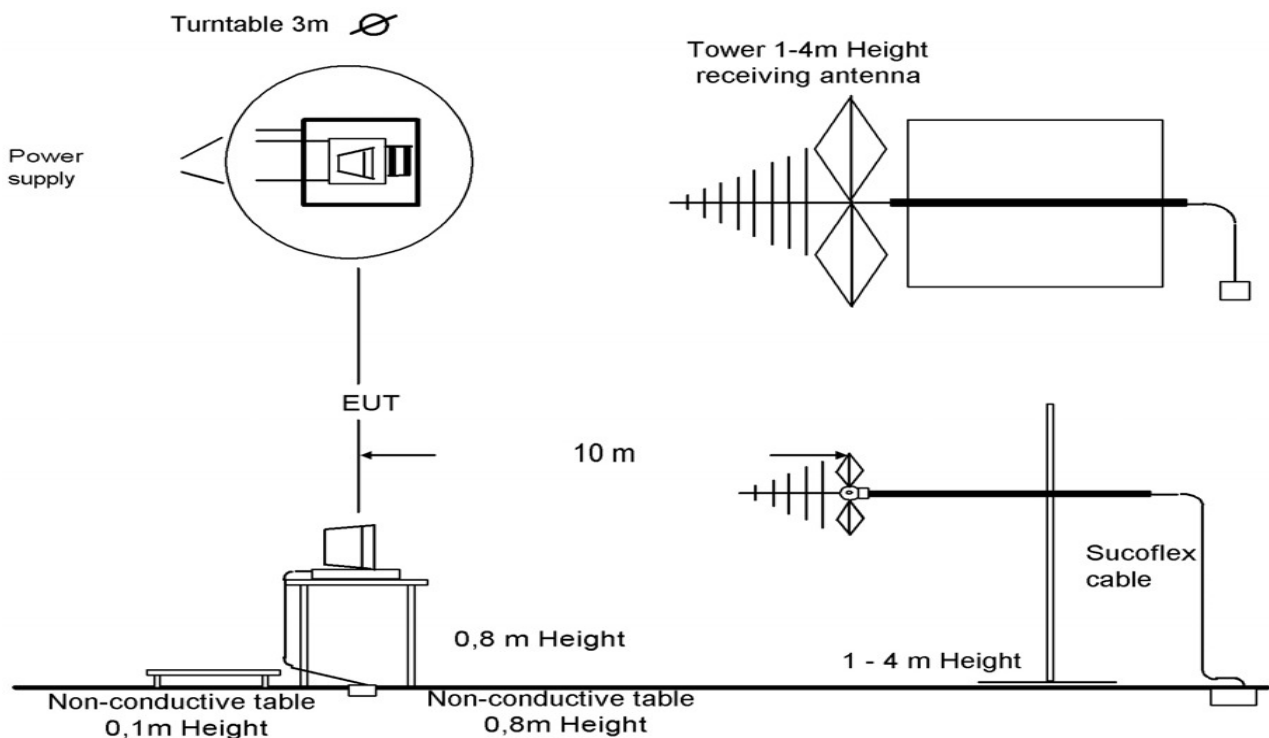

Picture 1: Diagram radiated measurements

9 kHz - 30 MHz:	active loop antenna
30 MHz – 1 GHz:	tri-log antenna
> 1 GHz:	horn antenna

The EUT is powered by an external power supply with nominal voltage. The signalling is performed from outside the chamber with a signalling unit (CMU200 or other) by air link using signalling antenna.

### 8.1.2 Conducted measurements

The EUT's RF signal is coupled out by the antenna connector which is supplied by the manufacturer. The signal is first 10dB attenuated before it is power divided (~6dB loss per branch). One of the signal paths is connected to the communication base Station (CMU200 or other), the other one is connected to the spectrum analyzer. The specific losses for both signal paths are first checked within a calibration. The measurement readings on the signalling unit/spectrum analyzer are corrected by the specific test set-up loss. The attenuator, power divider, signalling unit and the spectrum analyzer are impedance matched on 50 Ohm.

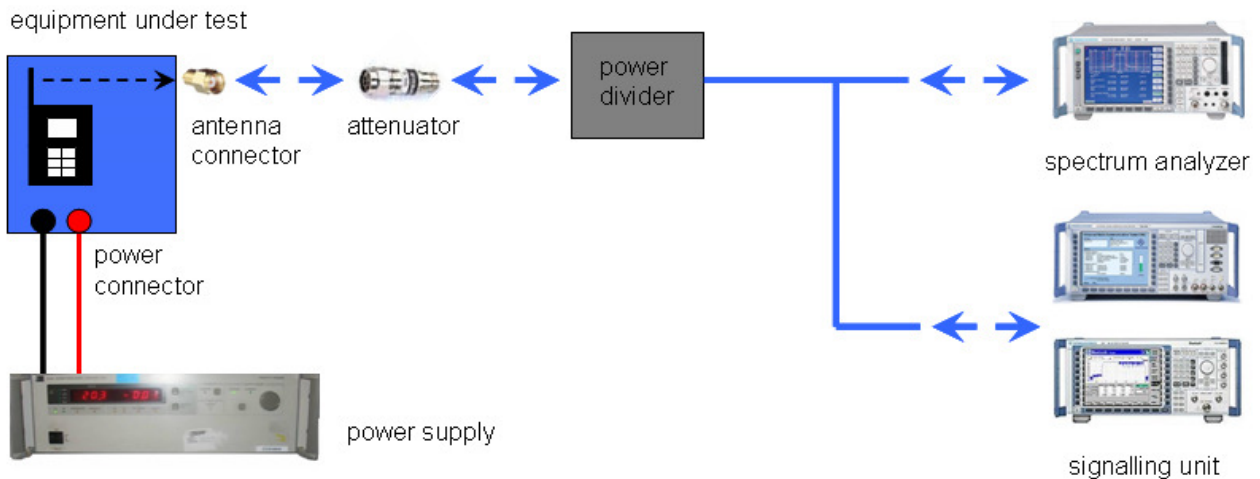

Picture 2: Diagram conducted measurements

### 8.2 Additional comments

- Reference documents: Product Information AMIGO T30/T31 108556UK /10.10
- Special test descriptions: None
- Configuration descriptions: In intended use mode, the device starts transmitting immediately when it is (battery) powered; no idle/stand-by mode exists.
- The charging mode is not an idle mode. The device has no functionality during the charging mode.
- An idle/TX stand-by mode was specially configured with a manufacturer software tool.

### 8.3 RSP100 test report cover sheet / performance test data

Test Report Number	:	1-2071-01-02/10-B
Equipment Model Number	:	AMIGO T30/T31
Certification Number	:	1350B-AT31
Manufacturer (complete Address)	:	Oticon A/S Kongebakken 9 2765 Smørum / Denmark
Tested to radio standards specification no.	:	RSS 210, Issue 7, Annex 8
Open Area Test Site IC No.	:	IC 3462C-1
Frequency Range or fixed frequency	:	216.0125MHz – 216.9875MHz The sub-band 216.45MHz - 216.50MHz is not available according to RSS210 Issue7 A4.3.
Output power	:	7.1mW E.R.P.@ 216.9875MHz
Occupied bandwidth (99%-BW)	:	15.3 kHz
Type of modulation	:	FM
Emission Designator (TRC-43)	:	15k3F3E
Antenna Information	:	Dedicated wire antenna (microphone LAPEL)
Transmitter Spurious (worst case)	:	30.8 dB $\mu$ V/m @ 10m at 129.99 MHz
Receiver Spurious (worst case)	:	45 dB $\mu$ V/m (noise floor)

#### ATTESTATION:

#### DECLARATION OF COMPLIANCE:

I attest that the testing was performed or supervised by me; that the test measurements were made in accordance with the above-mentioned Industry Canada standard(s); and that the equipment identified in this application has been subjected to all the applicable test conditions specified in the Industry Canada standards and all of the requirements of the standard have been met.

#### Laboratory Manager:

2010-11-15  
Date

Andreas Keller  
Name

  
Signature



## 9 Measurement results

### 9.1 Radiated output power

#### Measurement:

Measurement parameter	
Detector:	Peak
Sweep time:	Auto
Resolution bandwidth:	100 kHz
Video bandwidth:	100 kHz
Span:	50 kHz
Trace-Mode:	Max. hold

#### Limits:

FCC	IC
CFR § 2.1046 CFR § 95.639 (e)	RSS 210 Issue 7 A4.3
Maximum transmitter power	
100mW (20dBm)	

#### Result:

Frequency (channel)	Radiated output power
216.0125 MHz (US1)	8.3 dBm
216.5125 MHz (US21)	8.3 dBm
216.9875 MHz (US40)	8.5 dBm

**Result:** The result of the measurement is passed.

## 9.2 Frequency stability

### Measurement:

Measurement parameter	
Detector:	Peak
Sweep time:	Auto
Resolution bandwidth:	100 Hz
Video bandwidth:	100 Hz
Span:	1 kHz
Trace-Mode:	Max. hold

### Limits:

FCC	IC
CFR § 2.1055 CFR § 95.629 (b) (2)	RSS 210 Issue 7 A4.3
LPRS transmitters operating on standard band channels (channel bandwidth 25 kHz) must be maintained within a frequency stability of 50 ppm.	

**Results: low channel (216.0125MHz)**

Temperature	Frequency (MHz)	Deviation (kHz / ppm)
-30 °C	216.01164	-0.9/-4.0
-20 °C	216.01288	0.4/1.8
-10 °C	216.01355	1.1/4.9
0 °C	216.01357	1.1/5.0
10 °C	216.01324	0.7/3.4
20 °C ( $V_{nom}$ )	216.01302	0.5/2.4
30 °C	216.01255	0.1/0.2
40 °C	216.01221	-0.3/-1.3
50 °C	216.01211	-0.4/-1.8
<b>Voltage</b>		
$V_{min}$	216.01302	0.5/2.4
$V_{max}$	216.01302	0.5/2.4

**Results: middle channel (216.5125MHz)**

Temperature	Frequency (MHz)	Deviation (kHz / ppm)
-30 °C	216.51166	-0.8/-3.9
-20 °C	216.51281	0.3/1.4
-10 °C	216.51346	1.0/4.4
0 °C	216.51345	1.0/4.4
10 °C	216.51312	0.6/2.9
20 °C ( $V_{nom}$ )	216.51290	0.4/1.8
30 °C	216.51240	-0.1/-0.5
40 °C	216.51202	-0.5/-2.2
50 °C	216.51198	-0.5/-2.4
<b>Voltage</b>		
$V_{min}$	216.51290	0.4/1.8
$V_{max}$	216.51290	0.4/1.8

**Results: high channel (216.9875MHz)**

Temperature	Frequency (MHz)	Deviation (kHz / ppm)
-30 °C	216.98619	-1.3/-6.0
-20 °C	216.98794	0.4/2.0
-10 °C	216.98837	0.9/4.0
0 °C	216.98835	0.9/3.9
10 °C	216.98805	0.6/2.5
20 °C ( $V_{nom}$ )	216.98779	0.3/1.3
30 °C	216.98729	-0.2/-1.0
40 °C	216.98695	-0.6/-2.5
50 °C	216.98688	-0.6/-2.9
<b>Voltage</b>		
$V_{min}$	216.98779	0.3/1.3
$V_{max}$	216.98779	0.3/1.3

**Result:** The result of the measurement is passed.

### 9.3 Modulation characteristics

#### Measurement:

FCC	IC
47 CFR § 2.1047	-/-
Data showing the frequency response of the audio modulation circuit over a range of 100 to 5000 Hz shall be submitted.	
A curve showing the percentage of modulation versus the modulation input voltage shall be supplied. The information submitted shall be sufficient to show modulation limiting capability.	

#### Result: Frequency response of the audio modulation circuit

An audio signal at 1 kHz was adjusted for 100% rated FM deviation at 216.0125MHz with 4.5mV input. While maintaining this amplitude, the input frequency was varied and the measured FM deviation was recorded.

Frequency [kHz]	Deviation [kHz]
0.1	1.96
0.2	4.71
0.3	5.10
0.4	5.10
0.5	5.10
0.6	5.06
0.7	5.07
0.8	5.08
0.9	5.07
1.0	5.05
1.2	4.98
1.4	4.97
1.6	4.92
1.8	4.93
2.0	4.88
2.5	4.87
3.0	4.85
3.5	4.75
4.0	4.77
4.5	4.70
5.0	4.68
5.5	4.59
6.0	4.58
6.5	4.48
7.0	4.46
7.5	4.38
8.0	4.32
8.5	4.16
9.0	1.78
9.5	0.18
10.0	0.22

**Result: Modulation limiting capability**

Input audio signal with 1 kHz at 216.0125MHz.

Audio signal level [mV]	Deviation [kHz]
0.5	1.12
1.0	2.16
1.5	3.15
2.0	4.17
2.5	4.70
3.0	4.92
3.5	5.05
4.0	5.03
4.5	5.06
5.0	5.05

**Result: The result of the measurement is passed.**

## 9.4 Occupied bandwidth

### Measurement:

Measurement parameter	
Detector:	Peak
Sweep time:	Auto
Resolution bandwidth:	500 Hz
Video bandwidth:	500 Hz
Span:	50 kHz
Trace-Mode:	Max. hold

### Limits:

FCC	IC
47 CFR § 2.1049 (1)	RSS Gen Issue 2 Section 4
Occupied bandwidth 99%. Other than single sideband or independent sideband transmitters - when modulated by a 2500 Hz tone at an input level 16 dB greater than that necessary to produce 50 percent modulation. The input level shall be established at the frequency of maximum response of the audio modulating circuit.	
< 25kHz	

### Result:

Frequency (channel)	Bandwidth
216.0125 MHz (US1)	15.3 kHz
216.5125 MHz (US21)	15.3 kHz
216.9875 MHz (US40)	15.4 kHz

**Result:** The result of the measurement is passed.

Plots of the measurements

Plot 1: low channel

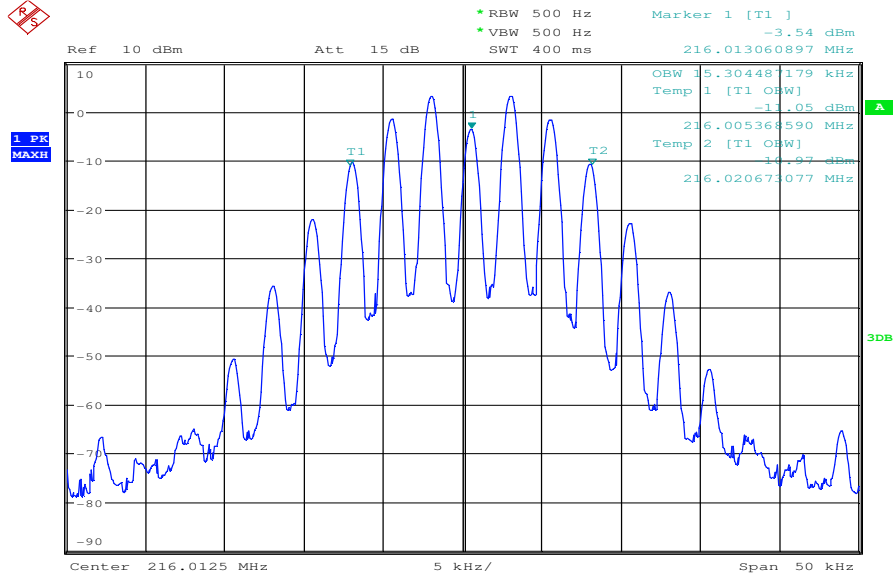

Date: 14.OCT.2010 07:57:59

Plot 2: middle channel

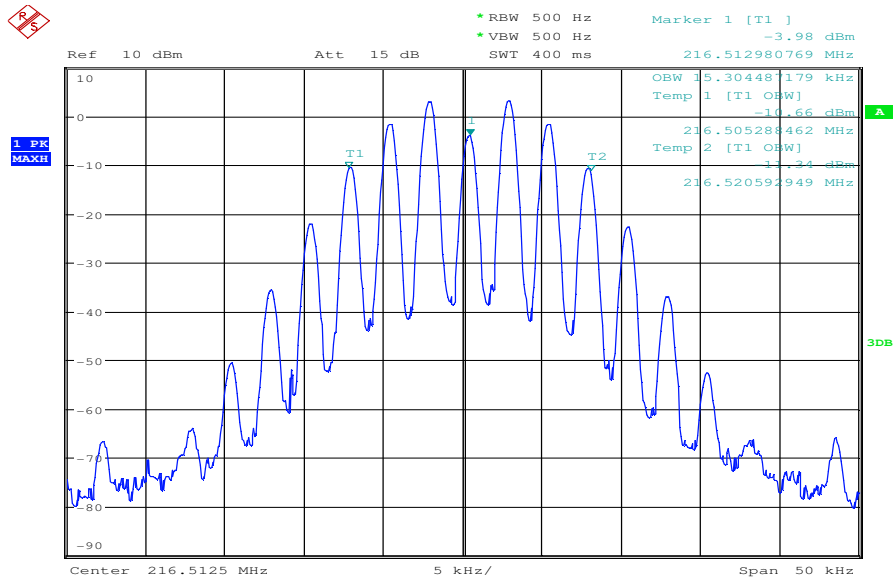

Date: 14.OCT.2010 07:58:50



Plot 3: high channel

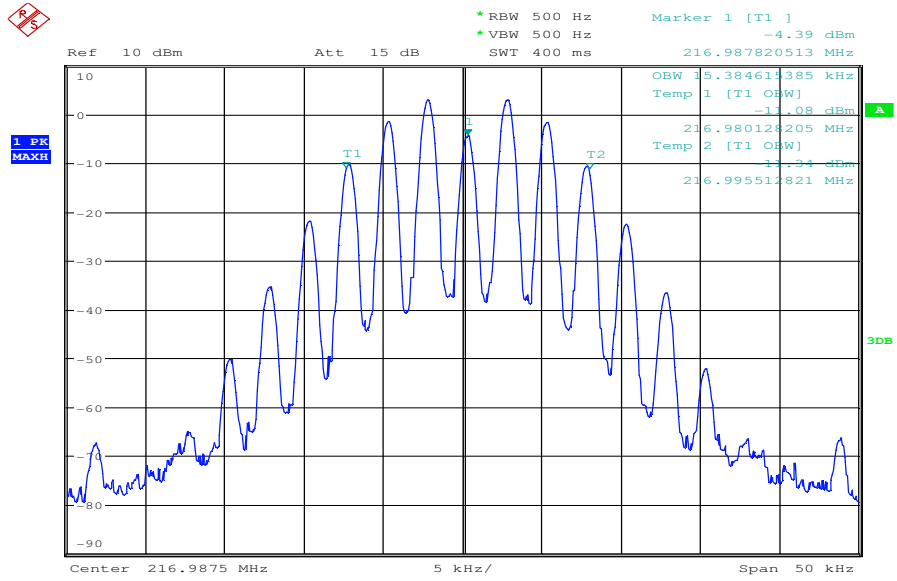

Date: 14.OCT.2010 07:59:39

**9.5 Unwanted radiation (spectrum mask)**

**Measurement:**

Measurement parameter	
Detector:	Peak
Sweep time:	Auto
Resolution bandwidth:	1 kHz
Video bandwidth:	1 kHz
Span:	50 kHz
Trace-Mode:	Max. hold

**Limits:**

FCC	IC
47 CFR § 95.635 (c) (1)	RSS 210 Issue 7 A4.3 (Mask C)
<p>Emissions for LPRS transmitters operating on standard band channels (25 kHz) shall be attenuated below the unmodulated carrier in accordance with the following:                      Emissions 12.5 kHz to 22.5 kHz away from the channel center frequency: at least 30 dB; and emissions more than 22.5 kHz away from the channel center frequency:  <b>FCC:</b> at least <math>43 + 10\log(\text{carrier power in watts})</math> dB  <b>IC:</b> at least <math>55 + 10\log(\text{carrier power in watts})</math> dB.</p>	

Audio input as described in 47 CFR § 2.1049 (1).

No violation of the spectrum mask detected.

**Result:** **The result of the measurement is passed.**

### Plots of the measurements

Plot 1: low channel

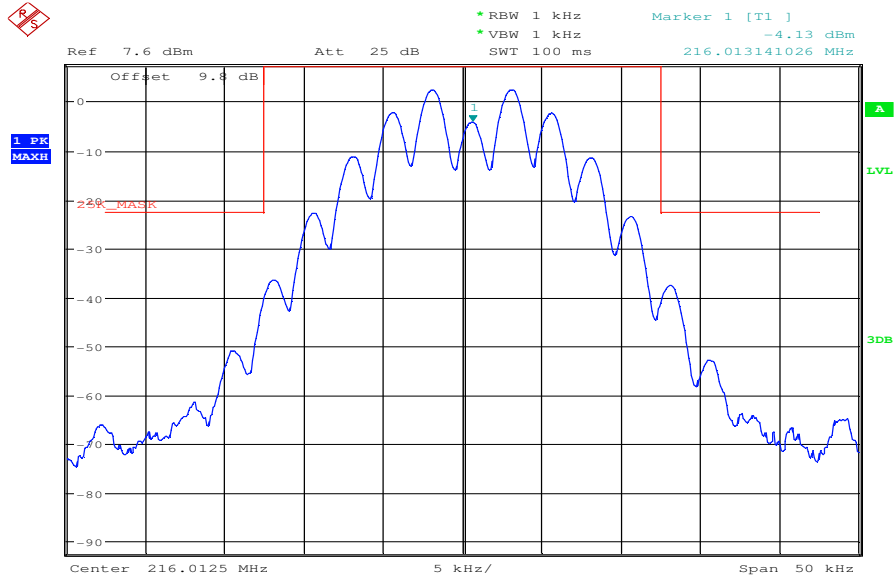

Date: 14.OCT.2010 11:58:51

Plot 2: middle channel

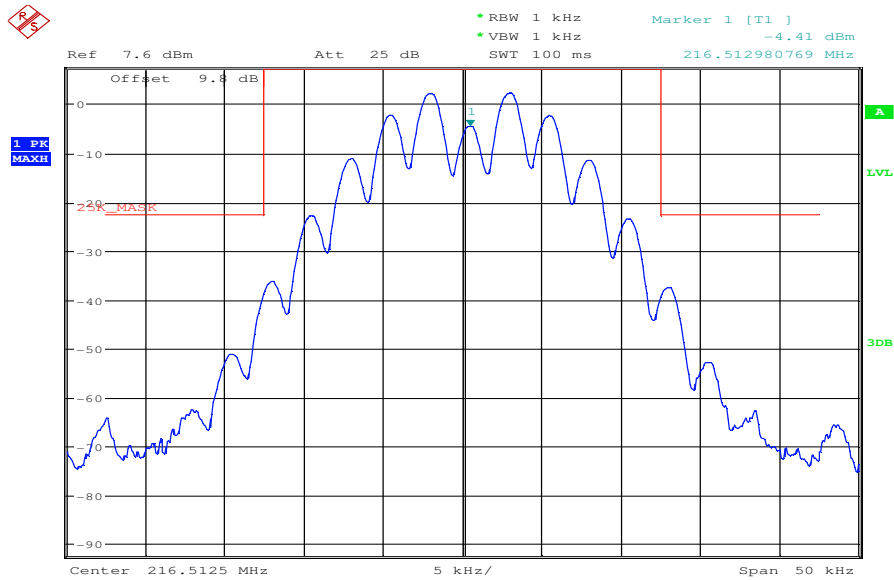

Date: 14.OCT.2010 12:00:52

Plot 3: high channel

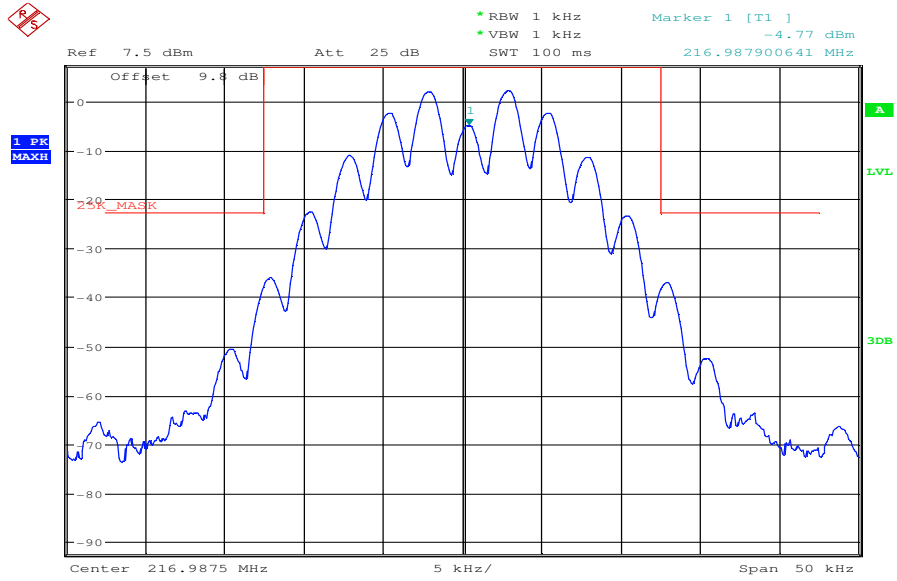

Date: 14.OCT.2010 12:02:03

**9.6 Field strength of spurious radiation.**

**Measurement:**

Measurement parameter	
Detector:	Peak
Sweep time:	Auto
Resolution bandwidth:	f < 1 GHz : 100 kHz f ≥ 1GHz : 1 MHz
Video bandwidth:	f < 1 GHz : 100 kHz f ≥ 1GHz : 1 MHz
Span:	-/-
Trace-Mode:	Max. hold

**Limits:**

FCC	IC
47 CFR § 2.1053 47 CFR § 95.635 (c) (1)	RSS Gen Issue 2 Section 4 RSS 210 Issue 7 A4.3 (Mask C)
Emissions for LPRS transmitters operating on standard band channels (25 kHz) shall be attenuated below the unmodulated carrier in accordance with the following: Emissions 12.5 kHz to 22.5 kHz away from the channel center frequency: at least 30 dB; and emissions more than 22.5 kHz away from the channel center frequency: <b>FCC:</b> at least 43 + 10log(carrier power in watts) dB <b>IC:</b> at least 55 + 10log(carrier power in watts) dB.	

SPURIOUS EMISSIONS LEVEL (dBm)								
Low channel			Middle channel			High channel		
Frequency	Detector	Level	Frequency	Detector	Level	Frequency	Detector	Level
All detected spurious emissions are more than 20 dB below the limit.			All detected spurious emissions are more than 20 dB below the limit.			All detected spurious emissions are more than 20 dB below the limit.		
Measurement uncertainty ± 3 dB								

**Result: The result of the measurement is passed.**

**Plots of the measurements**

Plot 1: 30 MHz – 1 GHz, low channel

EUT: AMIGO T30/T31  
 Serial Number: # 04  
 Test Description: FCC part 95  
 Operating Conditions: TX on low channel (216,0125 MHz)  
 Operator Name: LNG  
 Comment: Battery Powered

**Scan Setup: STAN\_Fin [EMI radiated]**

Hardware Setup: Electric Field (NOS)  
 Level Unit: dBµV/m  
**Subrange**                      **Detectors**                      **IF Bandwidth**                      **Meas. Time**                      **Receiver**  
 30 MHz - 1,05 GHz              QuasiPeak                      120 kHz                      15 s                      Receiver

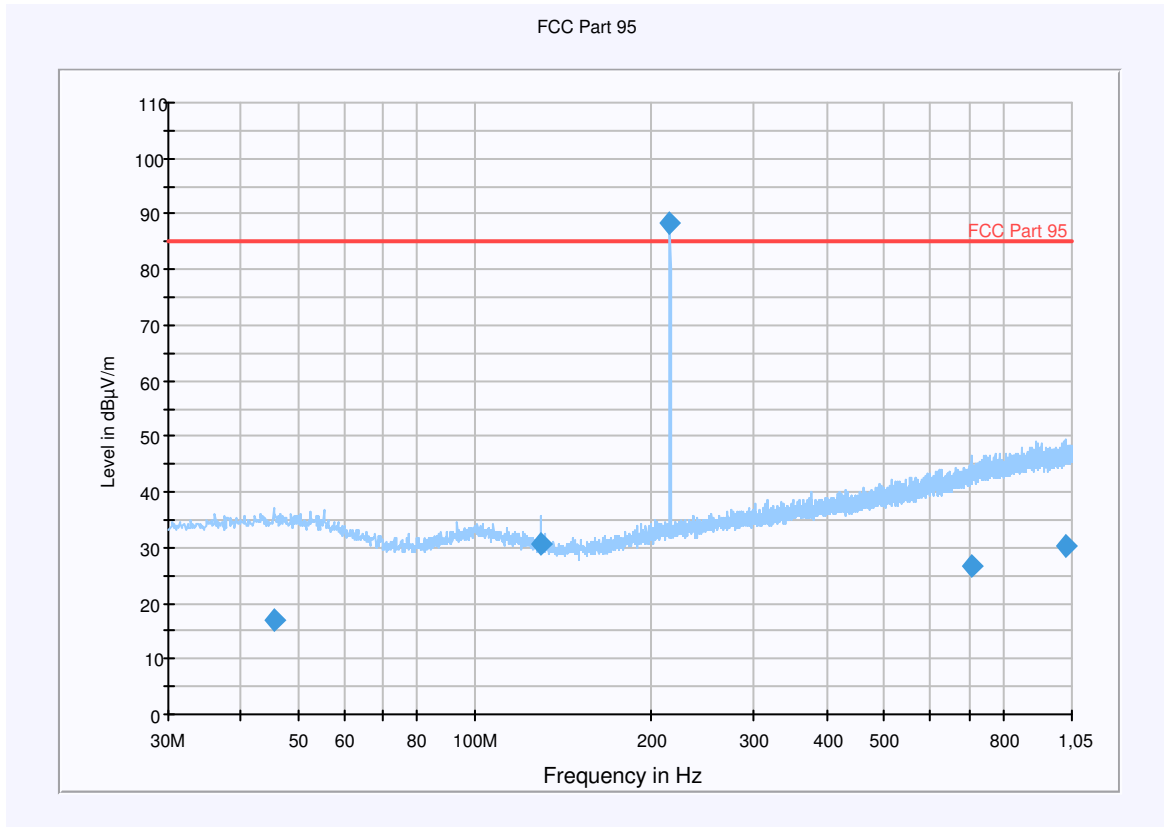

**Final Result 1**

Frequency (MHz)	QuasiPeak (dBµV/m)	Meas. Time (ms)	Bandwidth (kHz)	Antenna height (cm)	Polarity	Turntable position (deg)	Corr. (dB)	Margin (dB)	Limit (dBµV/m)	Comment
45.384750	16.9	15000.000	120.000	200.0	V	62.0	13.3	68.1	85.0	
129.985500	30.8	15000.000	120.000	100.0	V	261.0	9.4	54.2	85.0	
216.012000	88.5	15000.000	120.000	351.0	H	229.0	12.3	-3.5	85.0	
708.098850	26.8	15000.000	120.000	100.0	V	253.0	22.7	58.2	85.0	
1023.856950	30.2	15000.000	120.000	234.0	H	301.0	26.2	54.8	85.0	

**Hardware Setup: EMI radiated\Electric Field (NOS) - [EMI radiated]**

Subrange 1

Frequency Range: 30 MHz - 2 GHz

Receiver: Receiver [ESCI 3]  
@ GPIB0 (ADR 20), SN 100083/003, FW 4.32

Signal Path: without Notch  
FW 1.0

Antenna: VULB 9163  
SN 9163-295, FW ---  
Correction Table (vertical): VULP6113  
Correction Table (horizontal): VULP6113  
Correction Table: Cable\_EN\_1GHz (1005)

Antenna Tower: Tower [EMCO 2090 Antenna Tower]  
@ GPIB0 (ADR 8), FW REV 3.12

Turntable: Turntable [EMCO Turntable]  
@ GPIB0 (ADR 9), FW REV 3.12

EMC 32 Version 8.10.00

Plot 2: 1 GHz – 12.75 GHz, low channel (sample #43), antenna vertical

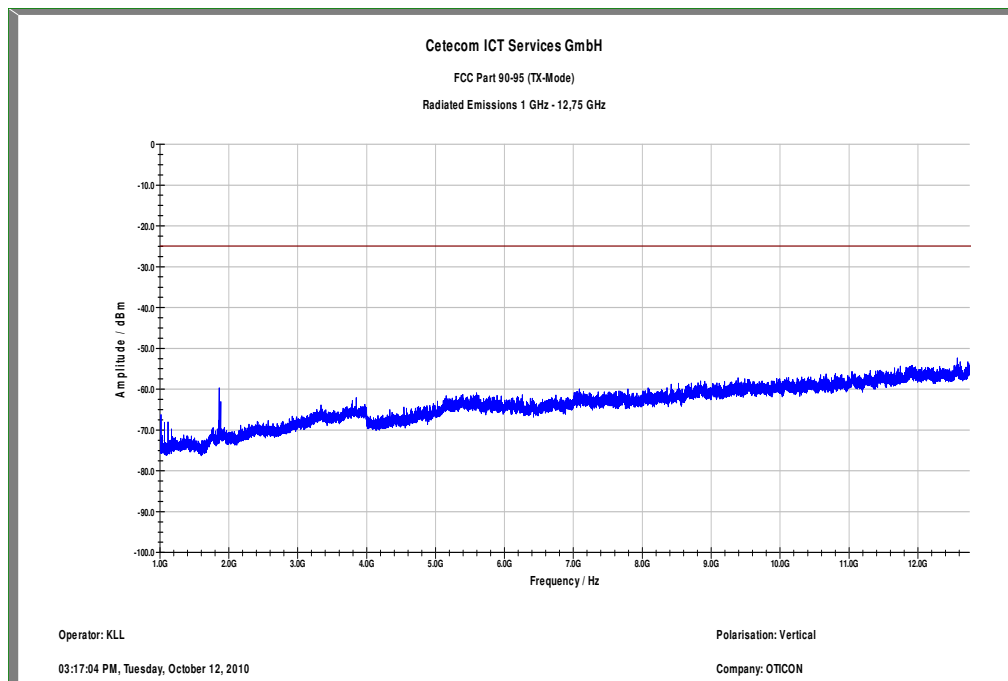

Plot 3: 1 GHz – 12.75 GHz, low channel (sample #43), antenna horizontal

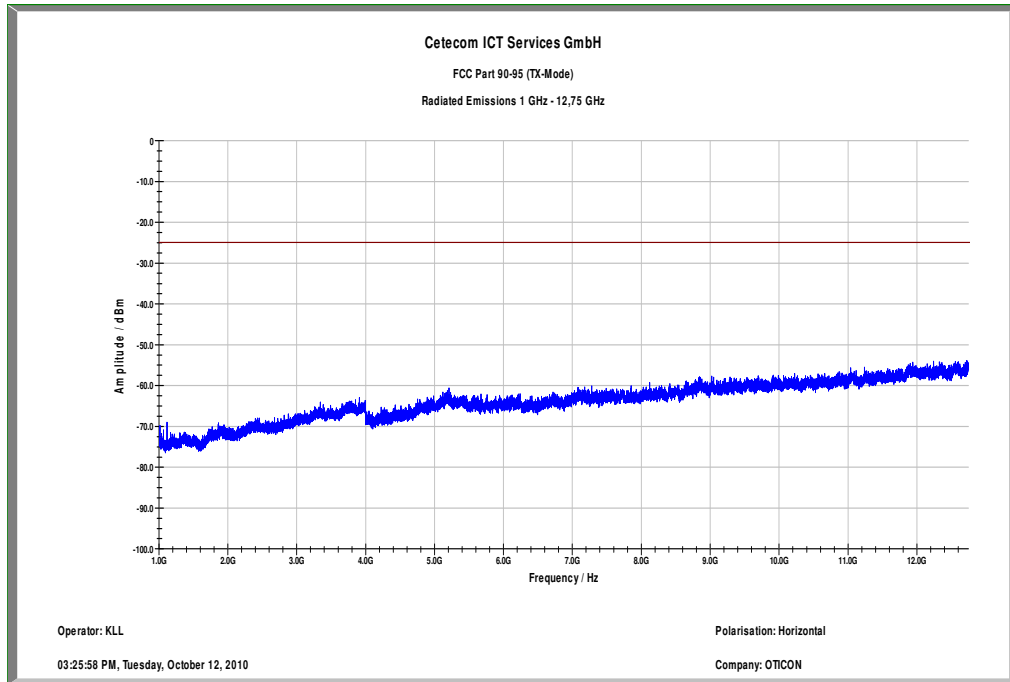



Plot 4: 30 MHz – 1 GHz, middle channel

EUT: AMIGO T30/T31  
 Serial Number: # 04  
 Test Description: FCC part 95  
 Operating Conditions: TX on middle channel (216,5125 MHz)  
 Operator Name: LNG  
 Comment: Battery Powered

**Scan Setup: STAN\_Fin [EMI radiated]**

Hardware Setup: Electric Field (NOS)  
 Level Unit: dBµV/m  
**Subrange**                      **Detectors**                      **IF Bandwidth**                      **Meas. Time**                      **Receiver**  
 30 MHz - 1,05 GHz              QuasiPeak                      120 kHz                      15 s                      Receiver

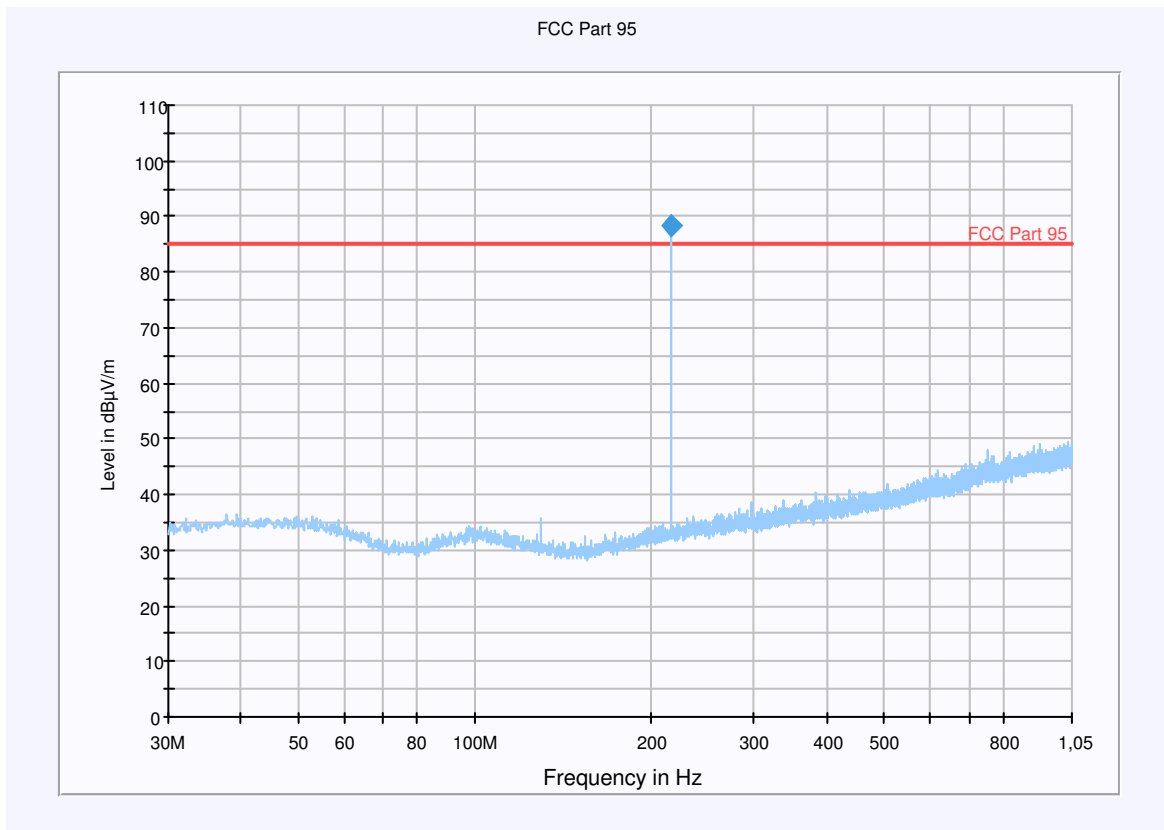

**Final Result 1**

Frequency (MHz)	QuasiPeak (dBµV/m)	Meas. Time (ms)	Bandwidth (kHz)	Antenna height (cm)	Polarity	Turntable position (deg)	Corr. (dB)	Margin (dB)	Limit (dBµV/m)	Comment
216.511950	88.4	15000.000	120.000	350.0	H	43.0	12.3	-3.4	85.0	

**Hardware Setup: EMI radiated\Electric Field (NOS) - [EMI radiated]**

Subrange 1

Frequency Range: 30 MHz - 2 GHz

Receiver: Receiver [ESCI 3]  
@ GPIB0 (ADR 20), SN 100083/003, FW 4.32

Signal Path: without Notch  
FW 1.0

Antenna: VULB 9163  
SN 9163-295, FW ---  
Correction Table (vertical): VULP6113  
Correction Table (horizontal): VULP6113  
Correction Table: Cable\_EN\_1GHz (1005)

Antenna Tower: Tower [EMCO 2090 Antenna Tower]  
@ GPIB0 (ADR 8), FW REV 3.12

Turntable: Turntable [EMCO Turntable]  
@ GPIB0 (ADR 9), FW REV 3.12

EMC 32 Version 8.10.00

Plot 5: 1 GHz – 12.75 GHz, middle channel (sample #43), antenna vertical

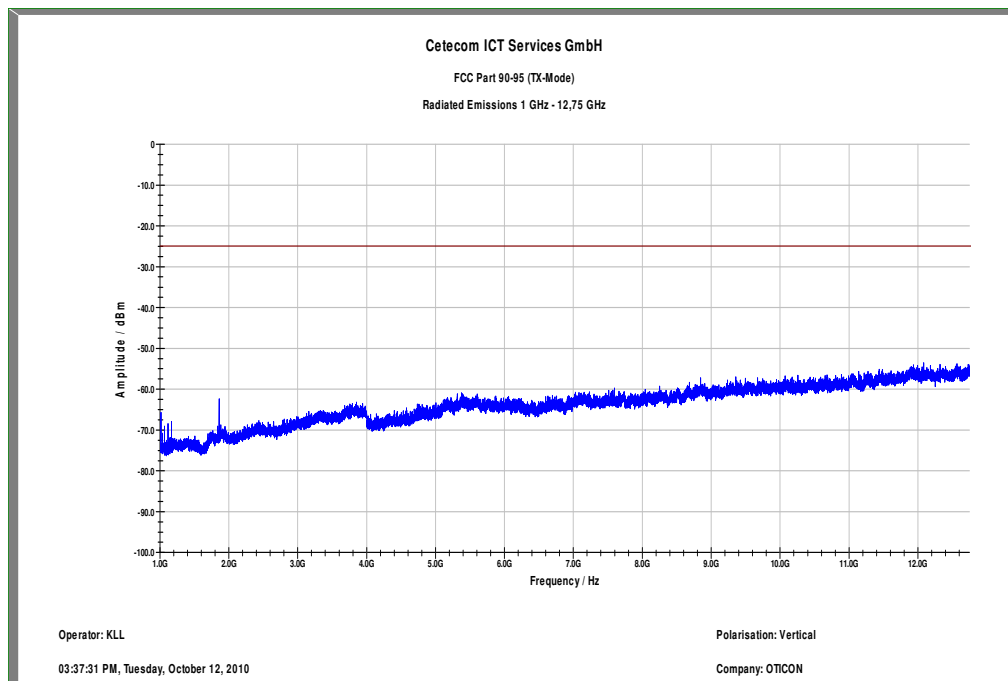

Plot 6: 1 GHz – 12.75 GHz, middle channel (sample #43), antenna horizontal

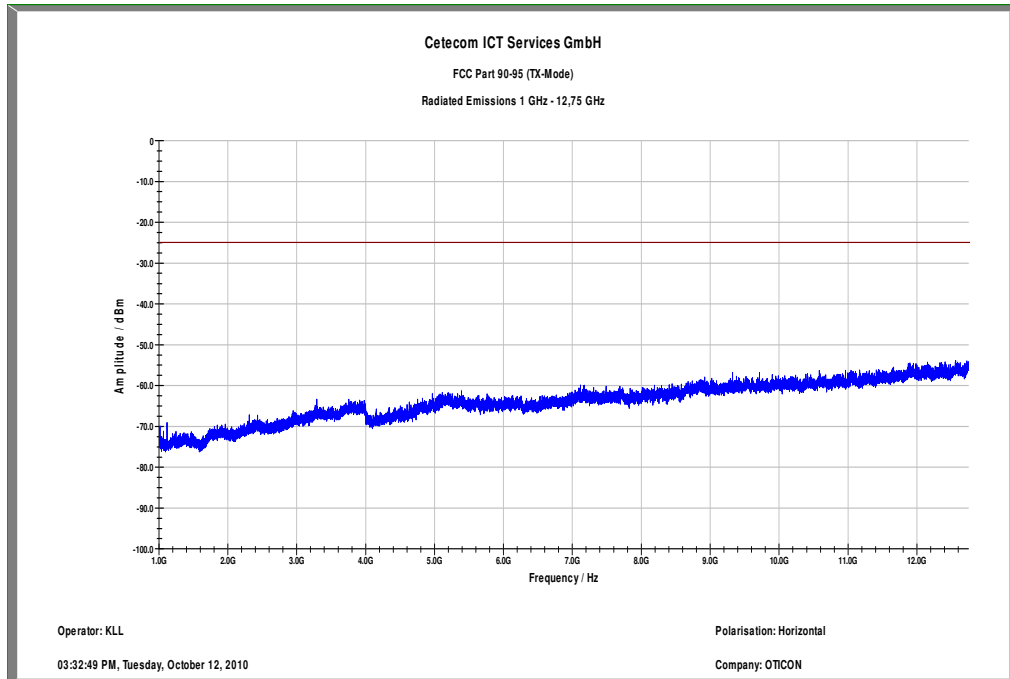

Plot 7: 30 MHz – 1 GHz, high channel

EUT: AMIGO T30/T31  
 Serial Number: # 04  
 Test Description: FCC part 95  
 Operating Conditions: TX on high channel (216,9875 MHz)  
 Operator Name: LNG  
 Comment: Battery Powered

**Scan Setup: STAN\_Fin [EMI radiated]**

Hardware Setup: Electric Field (NOS)  
 Level Unit: dBµV/m

Subrange	Detectors	IF Bandwidth	Meas. Time	Receiver
30 MHz - 1,05 GHz	QuasiPeak	120 kHz	15 s	Receiver

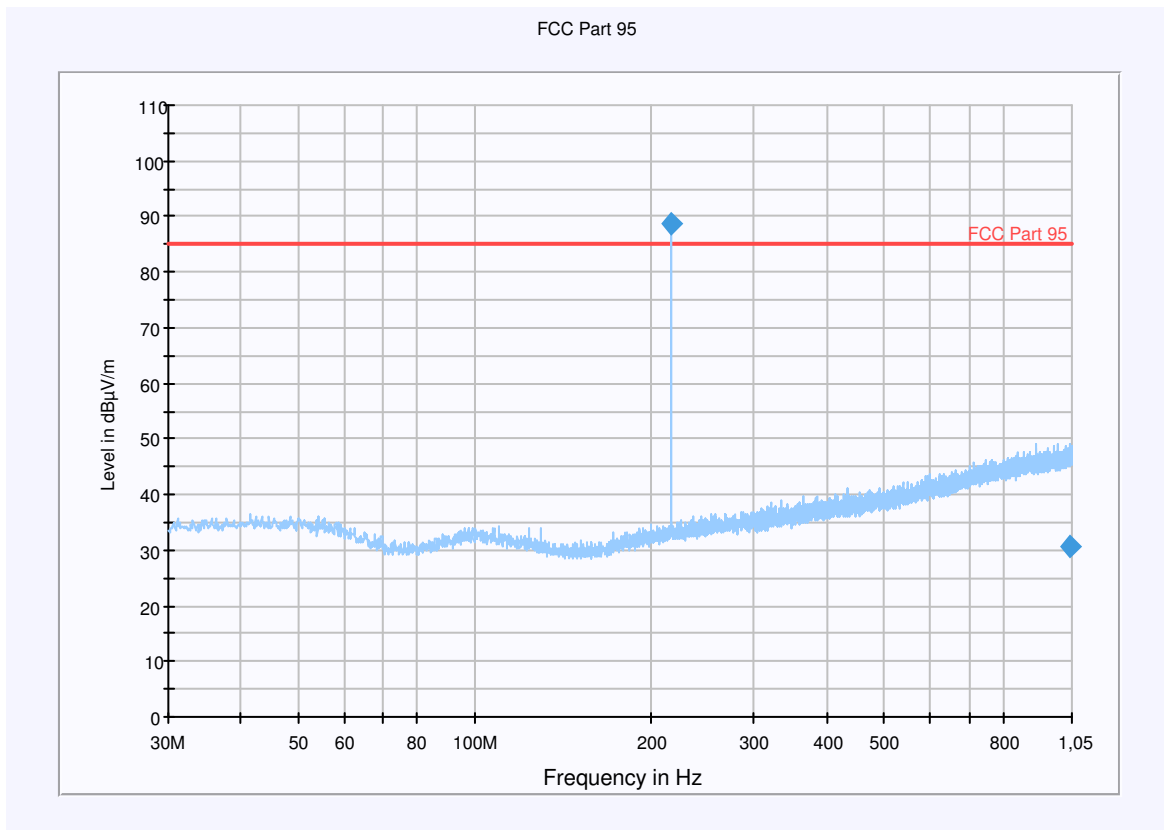

**Final Result 1**

Frequency (MHz)	QuasiPeak (dBµV/m)	Meas. Time (ms)	Bandwidth (kHz)	Antenna height (cm)	Polarity	Turntable position (deg)	Corr. (dB)	Margin (dB)	Limit (dBµV/m)	Comment
216.985650	88.7	15000.000	120.000	98.0	V	35.0	12.3	-3.7	85.0	
1043.500200	30.5	15000.000	120.000	198.0	H	342.0	26.6	54.5	85.0	

**Hardware Setup: EMI radiated\Electric Field (NOS) - [EMI radiated]**

Subrange 1

Frequency Range: 30 MHz - 2 GHz

Receiver: Receiver [ESCI 3]  
@ GPIB0 (ADR 20), SN 100083/003, FW 4.32

Signal Path: without Notch  
FW 1.0

Antenna: VULB 9163  
SN 9163-295, FW ---  
Correction Table (vertical): VULP6113  
Correction Table (horizontal): VULP6113  
Correction Table: Cable\_EN\_1GHz (1005)

Antenna Tower: Tower [EMCO 2090 Antenna Tower]  
@ GPIB0 (ADR 8), FW REV 3.12

Turntable: Turntable [EMCO Turntable]  
@ GPIB0 (ADR 9), FW REV 3.12

EMC 32 Version 8.10.00

Plot 8: 1 GHz – 12.75 GHz, high channel (sample #43), antenna vertical

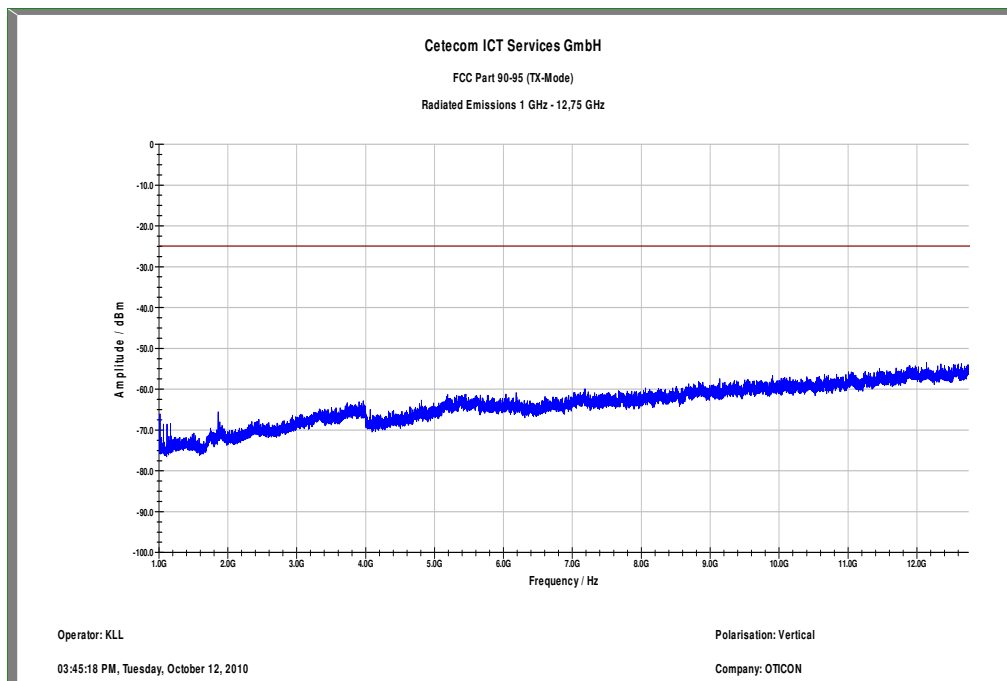

Plot 9: 1 GHz – 12.75 GHz, high channel (sample #43), antenna horizontal

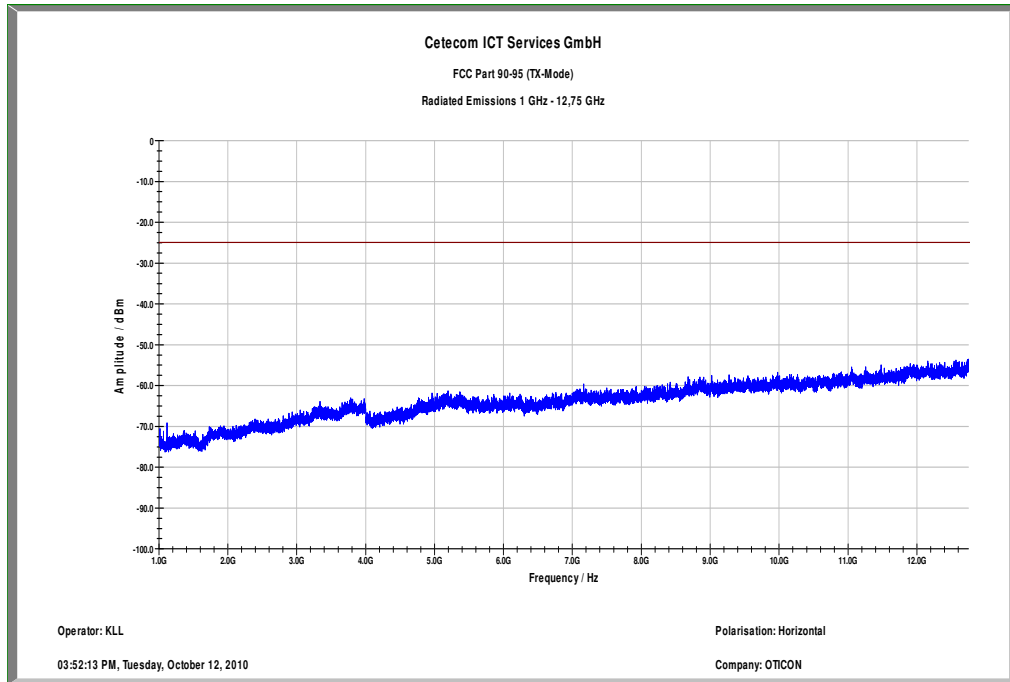

**9.7 Receiver spurious emissions (radiated)**

Limits:

FCC		IC	
SUBCLAUSE § 15.109		RSS-GEN Issue 2 Section 6	
Receiver Spurious Emission (radiated)			
Frequency (MHz)	Field strength (µV/m)	Measurement distance (m)	
30 - 88	100	3	
88 - 216	150	3	
216 - 960	200	3	
above 960	500	3	

**Plots of the measurements**

Plot 1: 30 MHz – 1 GHz

EUT: AMIGO T30/T31  
 Serial Number: # 04  
 Test Description: FCC part 95  
 Operating Conditions: idle  
 Operator Name: LNG  
 Comment: Battery Powered

**Scan Setup: STAN\_Fin [EMI radiated]**

Hardware Setup: Electric Field (NOS)  
 Level Unit: dBµV/m

Subrange	Detectors	IF Bandwidth	Meas. Time	Receiver
30 MHz - 1,05 GHz	QuasiPeak	120 kHz	15 s	Receiver

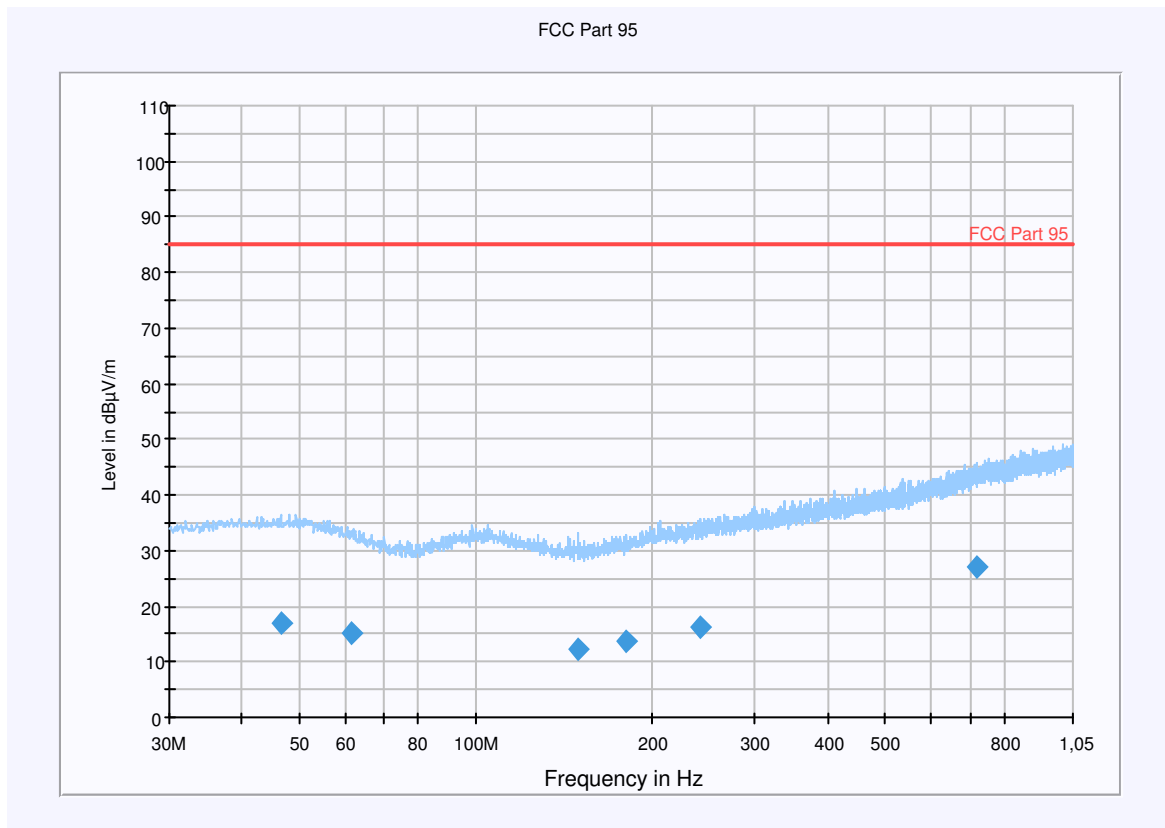

**Final Result 1**

Frequency (MHz)	QuasiPeak (dBµV/m)	Meas. Time (ms)	Bandwidth (kHz)	Antenna height (cm)	Polarity	Turntable position (deg)	Corr. (dB)	Margin (dB)	Limit (dBµV/m)	Comment
46.822500	17.1	15000.000	120.000	333.0	H	67.0	13.3	67.9	85.0	
61.290600	15.2	15000.000	120.000	381.0	V	112.0	11.3	69.8	85.0	
150.358650	12.4	15000.000	120.000	300.0	H	291.0	8.9	72.6	85.0	
181.029000	13.8	15000.000	120.000	365.0	V	-5.0	10.5	71.2	85.0	
241.456350	16.1	15000.000	120.000	181.0	V	305.0	13.1	68.9	85.0	
716.598750	27.0	15000.000	120.000	400.0	V	-5.0	22.9	58.0	85.0	



**Hardware Setup: EMI radiated\Electric Field (NOS) - [EMI radiated]**

Subrange 1

Frequency Range: 30 MHz - 2 GHz

Receiver: Receiver [ESCI 3]  
@ GPIB0 (ADR 20), SN 100083/003, FW 4.32

Signal Path: without Notch  
FW 1.0

Antenna: VULB 9163  
SN 9163-295, FW ---  
Correction Table (vertical): VULP6113  
Correction Table (horizontal): VULP6113  
Correction Table: Cable\_EN\_1GHz (1005)

Antenna Tower: Tower [EMCO 2090 Antenna Tower]  
@ GPIB0 (ADR 8), FW REV 3.12

Turntable: Turntable [EMCO Turntable]  
@ GPIB0 (ADR 9), FW REV 3.12

EMC 32 Version 8.10.00

Plot 3: 1 GHz – 12.75 GHz, antenna vertical (sample #43)

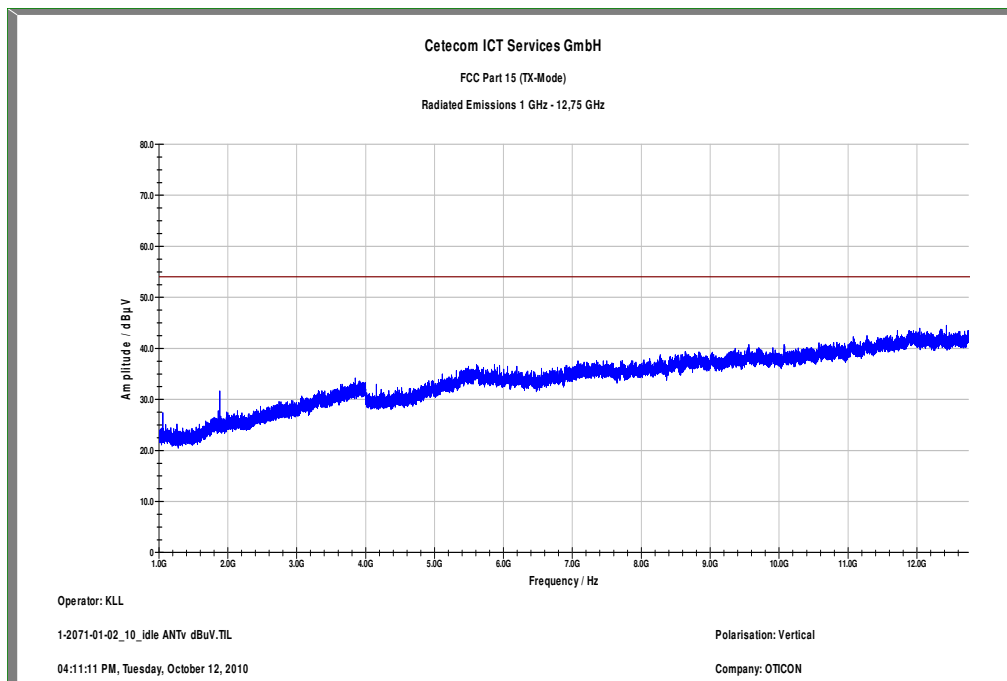

Plot 4: 1 GHz – 12.75 GHz, antenna horizontal (sample #43)

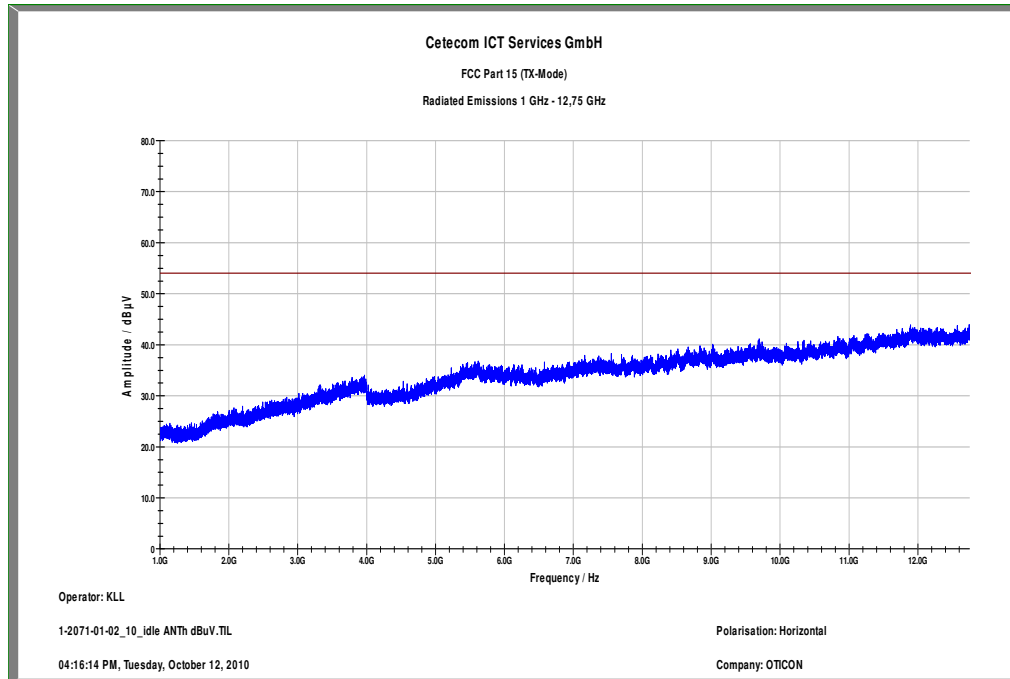

## 10 Test equipment and ancillaries used for tests

Typically, the calibrations of the test apparatus are commissioned to and performed by an accredited calibration laboratory. The calibration intervals are determined in accordance with the DIN EN ISO/IEC 17025. In addition to the external calibrations, the laboratory executes comparison measurements with other calibrated test systems or effective verifications. Weekly chamber inspections and range calibrations are performed. Where possible, rf-generating and signalling equipment as well as measuring receivers and analyzers are connected to an external high-precision 10 MHz reference (GPS-based or rubidium frequency standard).

In order to simplify the identification of the equipment used at some special tests, some items of test equipment and ancillaries can be provided with an identifier or number in the equipment list below (Labor/Item).

No.	Labor / Item	Equipment	Type	Manufact.	Serial No.	INV. No Cetecom	Kind of Calibration	Last Calibration	Next Calibration
1	45	Switch-Unit	3488A	HP Meßtechnik	2719A14505	300000368	g		
2	50	DC power supply, 60Vdc, 50A, 1200 W	6032A	HP Meßtechnik	2920A04466	300000580	k	06.01.2009	06.01.2011
3	n. a.	software	SPS_PHE 1.4f	Spitzberger & Spieß	B5981; 5D1081;B5979	300000210	ne		
4	n. a.	EMI Test Receiver	ESCI 1166.5950.03	R&S	100083	300003312	k	08.01.2010	08.01.2012
5	n. a.	Analyzer-Reference-System (Harmonics and Flicker)	ARS 16/1	SPS	A3509 07/0 0205	300003314	k	01.06.2009	01.06.2011
6	n. a.	Amplifier	JS42-00502650-28-5A	MITEQ	1084532	300003379	ev		
7	n. a.	Antenna Tower	Model 2175	ETS-LINDGREN	64762	300003745	izw		
8	n. a.	Positioning Controller	Model 2090	ETS-LINDGREN	64672	300003746	izw		
9	n. a.	Turntable Interface-Box	Model 105637	ETS-LINDGREN	44583	300003747	izw		
10	n. a.	TRILOG Broadband Test-Antenna 30 MHz - 3 GHz	VULB9163	Schwarzbeck	295	300003787	k	01.04.2010	01.04.2012
11	n. a.	Spectrum-Analyzer	FSU26	R&S	200809	300003874	k	08.01.2010	08.01.2012
12	n. a.	DC power supply, 60Vdc, 50A, 1200 W	6032A	HP Meßtechnik	2818A03450	300001040	Ve	08.01.2009	08.01.2012
13	n. a.	PowerAttenuator	8325	Byrd	1530	300001595			
14	n. a.	Double-Ridged Waveguide Horn Antenna 1-18.0GHz	3115	EMCO	8812-3088	300001032	vlKI!	05.03.2009	05.03.2011
15	n. a.	Active Loop Antenna	6502	EMCO	2210	300001015	ne		
16	n. a.	Anechoic chamber	FAC 3/5m	MWB / TDK	87400/02	300000996		23.03.2009	
17	Spec.A. 2_2e	System rack for EMI measurement solution	85900	HP I.V.	*	300000222	ne		
18	9	Artificial Mains 9 kHz to 30 MHz	ESH3-Z5	R&S	828576/020	300001210	Ve	06.01.2010	06.01.2012
19	n. a.	Relais Matrix	3488A	HP Meßtechnik	2719A15013	300001156	ne		
20	n. a.	Relais Matrix	PSU	R&S	890167/024	300001168	ne		
21	n. a.	Isolating Transformer	RT5A	Grundig	9242	300001263	ne		
22	n. a.	Three-Way Power Splitter, 50 Ohm	11850C	HP Meßtechnik		300000997	ne		
23	n. a.	Switch / Control Unit	3488A	HP	2605e08770	300001443	ne		
24	n. a.	Band Reject filter	WRCG1855/1910-1835/1925-40/8SS	Wainwright	7	300003350	ev		
25	n. a.	Band Reject filter	WRCG2400/2483-2375/2505-50/10SS	Wainwright	11	300003351	ev		
26	n. a.	TILE-Software	Quantum Change,	EMCO	none	300003451	ne		

		Emission	Modell TILE-ICS/FULL						
27	n. a.	Highpass Filter	WHKX2.9/18G-12SS	Wainwright	1	300003492	ev		
28	n. a.	Highpass Filter	WHK1.1/15G-10SS	Wainwright	3	300003255	ev		
29	n. a.	Highpass Filter	WHKX7.0/18G-8SS	Wainwright	18	300003789	ne		
30	n. a.	PSA Spectrum Analyzer 3 Hz - 26.5 GHz	E4440A	Agilent Technologies	MY48250080	300003812	k	08.09.2010	08.09.2012
31	n. a.	MXG Microwave Analog Signal Generator	N5183A	Agilent Technologies	MY47420220	300003813	k	13.09.2010	13.09.2012
32	n. a.	RF Filter Section 9kHz - 1GHz	N9039A	Agilent Technologies	MY48260003	300003825	vKI!	08.09.2010	08.09.2012
33	n. a.	TRIOLOG Broadband Test-Antenna 30 MHz - 3 GHz	VULB9163	Schwarzbeck	371	300003854	vKI!	17.12.2008	17.12.2010
34	SCT/Gelb	Climate Chamber	VC 4034	Voetsch Industrietechnik	58566088110010	300003390	k	19.03.2010	19.03.2011
35	n. a.	Signal Analyzer 20Hz-26,5GHz-150 to + 30 DBM	FSIQ26	R&S	835540/018	300002681-0005	k	07.01.2010	07.01.2012
36	n. a.	Spectrum Analyzer 20 Hz - 50 GHz	FSU50	R&S	200012	300003443	ve	01.07.2010	01.07.2012
37	2	Radiocom. Analyzer	CMTA 84	R&S	894199/012	300001176	vKI!	20.01.2010	20.01.2012
38	n. a.	Signal Analyzer 20Hz-26,5GHz-150 to + 30 DBM	FSIQ26	R&S	835111/0004	300002678	Ve	06.01.2009	06.01.2011
39	n. a.	DC Power Supply 0 – 32V	1108-32	Heiden	001802	300001383	Ve	23.06.2010	23.06.2013

Agenda: Kind of Calibration

k calibration / calibrated  
 ne not required (k, ev, izw, zw not required)  
 ev periodic self verification  
 Ve long-term stability recognized  
 vKI! Attention: extended calibration interval  
 NK! Attention: not calibrated

EK limited calibration  
 zw cyclical maintenance (external cyclical maintenance)  
 izw internal cyclical maintenance  
 g blocked for accredited testing  
 \*) next calibration ordered / currently in progress

## Annex A Document history

Version	Applied changes	Date of release
1.0	Initial release	2010-11-05
-A		
-B	Test equipment list / without photos	2010-11-15

## Annex B Further information

### Glossary

DUT	-	Device under Test
EMC	-	Electromagnetic Compatibility
EUT	-	Equipment under Test
FCC	-	Federal Communication Commission
FCC ID	-	Company Identifier at FCC
HW	-	Hardware
IC	-	Industry Canada
Inv. No.	-	Inventory number
N/A	-	not applicable
S/N	-	Serial Number
SW	-	Software