

# GAMETIME SCOREBOARD

## QUICK START GUIDE



### GAMETIME PORTABLE ELECTRONIC SCOREBOARD AND AUDIO PLAYER

MODEL: GTSB

Gametime Wi-Fi Password: 88888888

Get more info at:

[gametimescoreboard.com/support](http://gametimescoreboard.com/support)

If you are reading this document, it's probably because you have already purchased a Gametime Scoreboard unit. Before you go any further in this document, we would like to sincerely THANK YOU for your support.

You will now be able to bring the stadium at home, in your gym or at any activity you may participate in!



**Download our FREE app NOW!**

If you have an iOS device such as iPhone, iPod Touch, iPad mini or iPad, we highly recommend that you go on the App Store and download the FREE Gametime Scoreboard App.

By connecting your iOS device to the Gametime Scoreboard Wi-Fi network you will find an easy way to remotely control the unit, stream your favorite songs, create or add your own customized sound effects and even stream your voice as a real sports announcer.



**Disposal of your old product**

Your product is designed and manufactured with high quality materials and components, which can be recycled and reused.

When this crossed-out wheeled bin symbol is attached to a product it means the product is covered by the European Directive 2012/96/EC

Please inform yourself about the local separate collection system for electrical and electronic products.

Please act according to your local rules and do not dispose of your old products with your normal household waste. The correct disposal of your old product will help prevent potential negative consequences for the environment and human health.

## IMPORTANT SAFETY INSTRUCTIONS

1. Read these instructions carefully and keep them in a safe place.
2. DO NOT USE THE UNIT PLUGGED IN NEAR WATER OR IF RAINING ON THE UNIT.
3. Clean only with a soft dry cloth.
4. Only use attachments/accessories specified by the manufacturer.
5. Always unplug this unit during lightning storms or when not in use.
6. Refer all servicing to a qualified service personnel. Servicing is required when the appliance is damaged in any way.
7. No object filled with liquids shall be placed on the appliance.
8. Do not place naked flame sources such as candles on the appliance.
9. Make sure all electrical connections are properly made in accordance with the manufacturer's instructions. Switch off and unplug from the AC adapter before changing any connections.
10. Make sure the AC adapter is routed so that it is not likely to be walked on, or subjected to water and heat.
11. Do not obstruct the speakers which such things as newspapers, tablecloths, curtains and so on.
12. Do not operate the appliance if you are in doubt about it working normally, or if it is damaged in anyway.
13. Make sure there is adequate ventilation space around the appliance, at least 10 cm at the sides and on the top.
14. Lower the volume before using headphones with this unit, then gradually increase the volume to a comfortable level. Listening to music at a high volume and for a prolonged period of time can cause damage to hearing.

## Electrical Information



### Warning

Read these electrical safety instructions carefully before connecting the AC adaptor to the mains.

- This unit is supplied with an AC mains adaptor.
- This AC mains adaptor is designed to operate on AC 100-240V, 50/60Hz supply only.
- Connecting it to any other power sources may damage the unit.
- The AC mains adaptor is designed for indoor use only.
- The AC mains adaptor is a sealed unit. There are no user serviceable parts inside and it does not require any electrical adjustments.
- Do not attempt to open the AC mains adaptor.
- If the AC mains adaptor is not suitable for your socket, or becomes damaged, it must be replaced and disposed of in a safe and environmentally protective way.
- Always refer to qualified personnel.
- Periodically inspect the battery pack main adaptor for damage. Do not use if faults or damages are found. Refer to qualified personnel.
- Battery pack shall not be exposed to excessive heat such as sunshine, fire or the like.
- CAUTION: Danger of explosion if battery is incorrectly replaced. Never try to open the appliance casing and replace battery pack by yourself.
- Where the plug of the Direct Plug-in Adapter is used as the disconnect device, the disconnect device remain readily operable.

## **FCC**

Changes or modifications not expressly approved by the party responsible for compliance could void the user's authority to operate the equipment.

This equipment has been tested and found to comply with the limits for a Class B digital device, pursuant to Part 15 of the FCC Rules. These limits are designed to provide reasonable protection against harmful interference in a residential installation. This equipment generates, uses and can radiate radio frequency energy and, if not installed and used in accordance with the instructions, may cause harmful interference to radio communications. However, there is no guarantee that interference will not occur in a particular installation.

If this equipment does cause harmful interference to radio or television reception, which can be determined by turning the equipment off and on, the user is encouraged to try to correct the interference by one or more of the following measures:

- Reorient or relocate the receiving antenna.
- Increase the separation between the equipment and receiver.
- Connect the equipment into an outlet on a circuit different from that to which the receiver is connected.
- Consult the dealer or an experienced radio/TV technician for help.

This equipment complies with FCC radiation exposure limits set forth for an uncontrolled environment. This equipment should be installed and operated with minimum distance 20cm between the radiator and your body. This transmitter must not be co-located or operating in conjunction with any other antenna or transmitter.

## **IC**

This device complies with Industry Canada license-exempt RSS standard(s). Operation is subject to the following two conditions: (1) this device may not cause interference, and (2) this device must accept any interference, including interference that may cause undesired operation of the device.

---

# LOCATION OF UNIT CONTROLS

## FRONT VIEW

1. HOME FACEPLATE
2. HOME SCORE
3. HOME BONUS LED
4. HOME POSSESSION LED
5. PERIOD DISPLAY
6. TIMER
7. GUEST POSSESSION LED
8. GUEST BONUS LED
9. GUEST SCORE
10. GUEST FACEPLATE

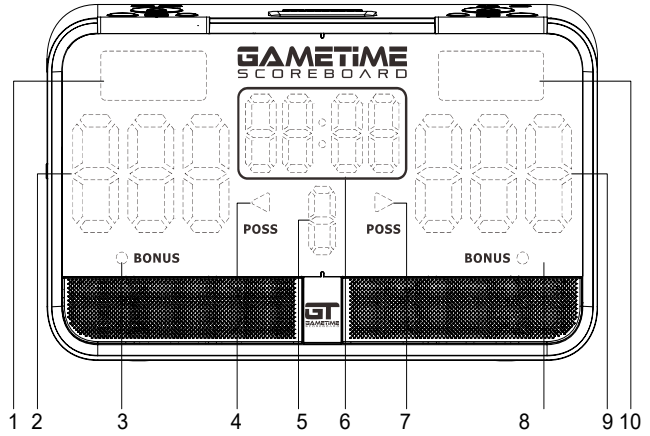

## LEFT VIEW

11. MUSIC SOURCE & 2<sup>nd</sup>F BUTTON
12. AUXILIARY IN FOR AUDIO
13. AUDIO LINE OUT
14. DC SOCKET
15. MCU/Wi-Fi RESET BUTTON
16. MIC SOCKET
17. USB PORT

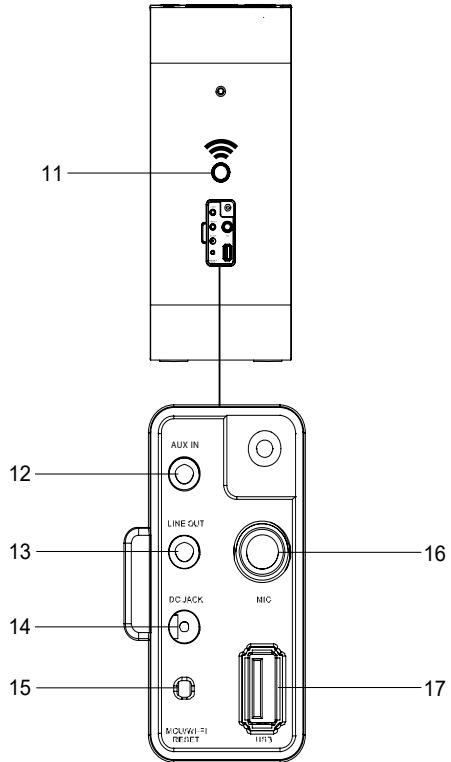

## LOCATION OF UNIT CONTROLS

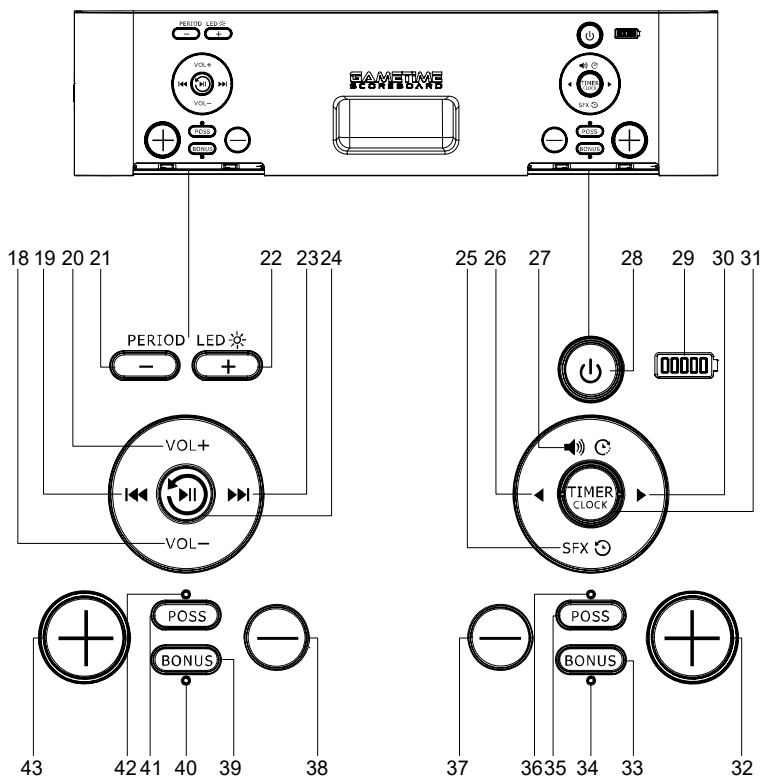

### TOP VIEW

- |   |                       |
|---|-----------------------|
| 18. VOLUME DOWN                                       | 32. GUEST SCORE UP    |
| 19. PREVIOUS TRACK                                    | 33. GUEST BONUS LIGHT |
| 20. VOLUME UP   | 34. GUEST BONUS LIGHT |
| 21. PERIOD DOWN & LED BRIGHTNESS DOWN                 | 35. GUEST POSS BUTTON |
| 22. PERIOD UP & LED BRIGHTNESS UP                     | 36. GUEST POSS LIGHT  |
| 23. NEXT TRACK  | 37. GUEST SCORE DOWN  |
| 24. PLAY/PAUSE & RESET FUNCTIONS                      | 38. HOME SCORE DOWN   |
| 25. SOUND EFFECTS ON/OFF & COUNT DOWN TIMER           | 39. HOME BONUS BUTTON |
| 26. TIMER DOWN ADJUSTMENT                             | 40. HOME BONUS LIGHT  |
| 27. BUZZER & STOPWATCH MODE                           | 41. HOME POSS BUTTON  |
| 28. POWER ON/OFF                                      | 42. HOME POSS LIGHT   |
| 29. BATTERY LEVEL INDICATOR                           | 43. HOME SCORE UP     |
| 30. TIMER UP ADJUSTMENT                               |                       |
| 31. TIMER START/STOP, TIMER SETTINGS & CLOCK SETTINGS |                       |

# GET STARTED

## Connect power

You can use the Gametime Scoreboard on AC power or battery power.

### OPTION 1: AC POWER

---

#### Caution

- Risk of product damage! Ensure that the power supply voltage corresponds to the voltage indicated on the label located on back of the product.
  - Risk of electric shock! When you unplug the AC adaptor, always pull the plug from the socket. Never pull the cord.
  - Use only the AC adaptor specified by the manufacturer or supplied with this unit.
1. Connect one end of the AC adaptor to the DC socket on the main unit [14](#).
  2. Connect the other end of the AC adaptor to the wall outlet.

### OPTION 2: BATTERY POWER

---

The Gametime Scoreboard can be operated using the built-in rechargeable battery.

#### Recharge battery

- Charge your Gametime Scoreboard overnight or at least 6 hours consecutively for the first charge. This will maximize the battery life.
- Subsequent charging time will take between 4 and 6 hours depending if unit is being recharged while OFF or charging while in use.
- The green charging light [29](#) will stop flashing when the battery becomes fully charged.
- The battery autonomy may vary from 3 to 5 hours depending on the functions being used.

#### Condition and attention:

- Do not short-circuit the terminals.
- Recharge the battery when you are ready to use it again.
- To get the longest service life of the rechargeable battery, charge at indoor temperature.
- Never dispose of the rechargeable battery in fire or water. Never heat up the rechargeable battery.

#### TIP

Once the battery level  [29](#) reaches 10%, the red light will start blinking. Charge the battery to ensure normal operation.

## SCOREBOARD OPERATION

### TIP:

Bilingual (English and French) Home **1** and Guest **10** faceplates are supplied with the scoreboard. You may visit our website to download the faceplate template that you may use to customize with your own team logo.

### Switching the unit ON

Press POWER  **28** .

→ The unit will display as following:

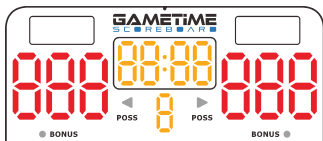

→ After 5 seconds, the unit will display as follow:





## BASIC CONTROLS

### Score Control

Press the SCORE + BUTTON **32 43** or SCORE - BUTTON **37 38** to increase or decrease the score.

The scores can be adjusted in the range of 0-999.

### Timer Control

1. Press and hold TIMER CLOCK BUTTON **31** for 3 seconds.
  - The timer digits for the minutes will blink.
  - The timer digits for the minutes will always blink if there is no operation.
2. Press BUTTON  **26** or BUTTON  **30** to set the minutes then press TIMER CLOCK BUTTON to confirm.
3. Repeat step 1 to set the other minutes and seconds digits.
4. Once timer is set, press and hold TIMER CLOCK **31** until the digits stop blinking to confirm.
  - The count down timer can be set in the range of 00:00 to 99:59 (99 minutes and 59 seconds)

Press TIMER CLOCK BUTTON **31** to start or stop the timer.

\*Timer can't be changed if the timer is running.

### Timing Units

If the clock is counting DOWN and there are fewer than 60 seconds on the game clock, the clock display shows seconds and hundredths of a second.

This is indicated by a period "." rather than a colon ":" in between the digits.



# SCOREBOARD OPERATION

## Period Control

1. Press PERIOD LED + BUTTON **22** or PERIOD LED - BUTTON **21** to increase or decrease the period.

→ The period can be adjusted in the range of 1-9.

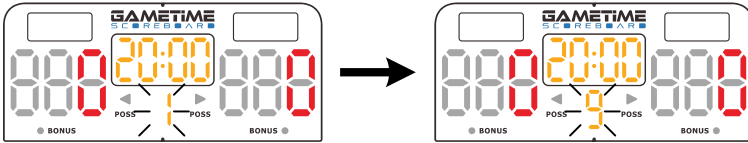

## Poss Control

1. Press POSS BUTTON **35** **41** to select the offensive team in possession of ball.
  - The Home POSS LED **4** will turn ON if you press Home POSS BUTTON **41**.
  - The Guest POSS LED **7** will turn ON if you press Guest POSS BUTTON **35**.
2. To turn POSS light OFF, just press on the button of the lit poss LED.

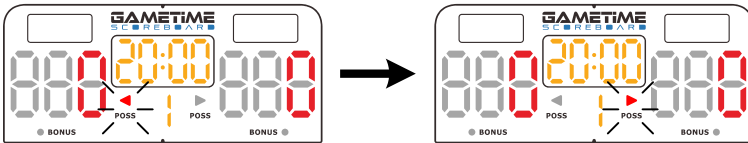

## Bonus Control

1. Press BONUS BUTTON **33** **39** to select the bonus team.
  - The Home BONUS LED **3** will turn ON if you press Home BONUS BUTTON **39**.
  - The Guest BONUS LED **8** will turn ON if you press Guest BONUS BUTTON **33**.
2. To turn BONUS light OFF, just press on the button of the lit bonus LED.

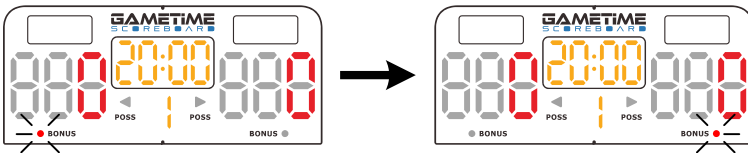

## Game Sound Effects (SFX)

The Gametime Scoreboard is designed to bring the feeling of a stadium right to your home! When certain events happen, they will be accompanied by an appropriate sound effect playing through the speakers.

1. Press SFX BUTTON **25**
2. Press SCORE + BUTTON of left **43** or right **32**.
  - A loud cheer rings out.
3. Press SCORE - BUTTON of left **38** or right **37**.
  - A crowd noise rings out.
4. Press TIMER CLOCK BUTTON **31**
5. To turn OFF all SFX (except the BUZZER) just press the SFX button **25** once. If SFX are OFF and you want to turn them on, simply press this same button and SFX will be activated.

## SCOREBOARD OPERATION

### Buzzer sound

Single press will produce the Buzzer **31** sound for 3sec.

\*The buzzer sound can not ring if the time is running in count up or count down mode.

## OTHER FEATURES

### USB OPERATION

Listening to audio files from your USB stick.

1. If unit is OFF, press POWER  **28** .
2. Connect a USB data medium to the USB PORT **17**.
3. Press MUSIC SOURCE BUTTON **11** to select USB mode.
  - The unit will say USB and begin to play automatically.
  - If no audio file is available, the unit will not play.

Press VOL + BUTTON **20** or VOL - BUTTON **18** to increase or decrease the volume.

4. Press BUTTON  **19** or BUTTON  **23** to select your desired track (with USB only)
5. Press BUTTON  **24** to start or pause the music

### Attention

The USB connection is only designed to be used for USB memory sticks. Other external storage media such as external hard disks can't be operated via the USB port. You may use this port to recharge your portable device but we recommend that you do this only if the unit is plugged in.

### AUDIO LINE IN & LINE OUT

The unit includes two inputs. AUX IN **12** allows to connect a portable device to play music while LINE OUT **13** allows to connect additional speakers to the unit.

1. Connect an audio input cable (not supplied) with a 3.5 mm connector on both ends to the AUX IN **12** port on the left of this unit and to the headphone port of your portable device.
2. Press the MUSIC SOURCE BUTTON **11** to select the AUX IN mode. A voice will say: Auxiliary In once this port is selected.
3. Play audio files from your portable device (refer to its user manual).

### MICROPHONE

A microphone (not included) can be used to make announcements, call the game or cheer. Your voice will be amplified and played through the speakers! The microphone can be plugged into the MIC port **16** located on the left hand side of the unit while facing it.

### Wi-Fi OPERATION

The built-in Wi-Fi module of the Gametime Scoreboard enables it to receive audio from various devices wirelessly (for example, a mobile phone, PDA etc.) within a range up to 50 meters (165 feet).

#### Connecting a mobile device with the unit

1. If unit is OFF, press POWER  **28** and.
2. connect to the GAMETIME SB APP
3. Place the portable device within 50 meters (165 feet) from the unit.
4. Set the portable device in search mode for Wi-Fi until it detects "Gametime"
5. Select "Gametime"
6. Enter "88888888" when prompted for a password.
7. Repeat the above steps if you want to connect more devices to the Wi-Fi.

#### Disconnecting from the Gametime Wi-Fi

Disconnect from the Gametime Wi-Fi or turn off the Wi-Fi on your mobile device.

## WARNING

**Never remove the casing of this unit.**

To keep the warranty valid, never try to repair the system yourself.

If you encounter problems when using this unit, check the following points before requesting service.

### NO POWER

---

- Make sure that the AC power plug of the unit is connected properly.
- Make sure that there is power at the AC outlet.

### NO SOUND OR POOR SOUND

---

- Adjust the volume.
- If using the AUX IN function with a portable media player ensure that the headphone volume is turned to full volume.
- If playing from a USB memory drive, check source MP3 file's recorded volume levels. If the source MP3 file is too quiet, adjust or acquire new content.
- If playing from a mobile phone, check source mobile phone's recorded volume levels. If the source mobile phone is too quiet, adjust or acquire new content.

### NO RESPONSE FROM THE UNIT

---

- Disconnect and reconnect the AC power plug, then turn on the unit again.
- Check if the unit is in battery power and the battery power is low. If yes, charge the rechargeable battery.

### LOW Wi-Fi SIGNAL STRENGTH

---

- Check the distance between your mobile device and the unit.
- Turn the unit off and turn it on again.
- Proceed to MCU/Wi-Fi module reset [15](#) as indicated in point 28 of the User Manual. Visit [gametimescoreboard.com/support](http://gametimescoreboard.com/support) to download full User Manual.

### NOT POSSIBLE TO CONNECT TO GAMETIME SCOREBOARD'S Wi-Fi

---

- Configure the Wi-Fi settings from your mobile device again.
- Turn the unit off and turn it on again.
- Proceed to MCU/Wi-Fi module reset [15](#) as indicated in point 28 of the User Manual. Visit [gametimescoreboard.com/support](http://gametimescoreboard.com/support) to download full User Manual.
- Unplug the unit and plug it again.

### THE UNIT DOES NOT WORK

---

- Unplug the unit and plug it again.
- Press & hold the  PLAY/PAUSE button [24](#) during 8 seconds to restore to factory settings.

# SPECIFICATIONS

## 1. GENERAL

---

Power requirements	INPUT: 100-240V ~ 50/60Hz 1.5A Max OUTPUT: 15V 3A
Dimensions of main unit	24" (W) x 14" (H) x 6" (D) 600 (W) x 350 (H) x 150 (D) mm
Weight of main unit	14 lbs / 6.43 Kg

## 2. AMPLIFIER SECTION

---

Power Output	45Watt
--------------	--------

## 3. Wi-Fi

---

Frequency Band / Output Power	2412-2472MHz (Europe) / ≤18dBm
Support Wireless Standards	802.11 b/g/n
Support Channels	2.4GHz 1 to 13 (Europe) or 1 to 11 (USA and Canada)

## 4. SPEAKER SYSTEM

---

Speaker	10W x 4 Speakers
Impedance	4 ohms

# JOIN THE GAMETIME SCOREBOARD COMMUNITY



facebook.com/GTScoreboard



twitter.com/GTScoreboard



instagram.com/GTScoreboard

# HELP AND SUPPORT

## DOWNLOAD THE USER MANUAL

---

To learn more about your Gametime scoreboard, download the User Manual at [gametimescoreboard.com/en/content/9-user-manual](http://gametimescoreboard.com/en/content/9-user-manual)

## TUTORIAL VIDEOS

---

Watch how-to tutorials showing your Gametime features at [gametimescoreboard.com/en/content/10-videos](http://gametimescoreboard.com/en/content/10-videos)

## DOWNLOAD OUR FREE APP AND GET FULL REMOTE CONTROL

---

To get access to all the features of your Gametime Scoreboard, download the free app now at [gametimescoreboard.com/en/content/12-download-the-free-mobile-app-and-remote](http://gametimescoreboard.com/en/content/12-download-the-free-mobile-app-and-remote)

## CUSTOMER SUPPORT

---

Need help? Find answers to your questions at [gametimescoreboard.com/en/content/category/3-support](http://gametimescoreboard.com/en/content/category/3-support)