



**FCC 47CFR part 15C
Test Report
For
DR1200 JN5168 Module
JN5168-001-M05**

Reference Standard: FCC 47CFR part 15C

Manufacturer: NXP Laboratories UK Ltd

For type of equipment and serial number, refer to section 3

Report Number: 11-6510-3-12 Issue 02

Supersedes report number 11-6510-3-12 Issue 01

Report Produced by: -

R.N. Electronics Ltd.

1 Arnolds Court
Arnolds Farm Lane
Mountnessing
Essex
CM13 1UT
U.K.

Copy No. pdf



Arnolds Court, Arnolds Farm Lane, Mountnessing, Brentwood Essex, CM13 1UT

Certificate of Test 6510/3

The unit noted below has been tested by **R.N. Electronics Limited** and, where appropriate, conforms to the relevant subpart of FCC 47CFR Part 15. This is a certificate of test only and should not be confused with an equipment authorisation. Other standards may also apply.

Equipment:	DR1200 JN5168 Module
Model Number:	JN5168-001-M05
Proposed FCC ID:	TYOJN5168M5
Unique Serial Number:	3
Manufacturer:	NXP Laboratories UK Ltd Furnival Street Sheffield S1 4QT
Customer Purchase Order Number:	GB628200059162
Full measurement results are detailed in Report Number:	11-6510-3-12 Issue 02
Test Standards:	FCC 47CFR Part 15.247 effective date October 1 st 2012, Class DTS Intentional Radiator

NOTE:

Certain tests were not performed based upon manufacturer's declarations. Certain other requirements are subject to manufacturer declaration only and have not been tested/verified. For details refer to section 3 of this report.

DEVIATIONS:

Deviations from the standards have been applied. For details refer to section 4.2 of this report.

This certificate relates only to the unit tested as identified by a unique serial number and in the condition at the time it was tested. It does not relate to any other similar equipment and performance of the product before or after the test cannot be guaranteed. Whilst every effort is made to assure quality of testing, type tests are not exhaustive and although no non-conformances may be found, this doesn't exclude the possibility of unit not meeting the intentions of the standard or the requirements of the Directive, particularly under different conditions to those during testing. Any compliance statements are made reliant on (a) the application of the product and use of the assigned band being acceptable to one or more national authorities within the EU and (b) the modes of operation as instructed to us by the Customer based on their specific knowledge of the application and functionality of the EUT. Statements of compliance, where measurements were made, do not include the measurement uncertainty. The measurement uncertainty, where stated, is the expanded uncertainty based on a standard uncertainty multiplied by a coverage factor of k=2, providing a level of confidence of approximately 95%.

Date of Test:	13th Nov 2012 - 16th Nov 2012
Test Engineer:	Lee Chandler
Approved By: Technical Director	
Customer Representative:	

File name NXP LABORATORIES UK LTD.6510-3 (FCC RADIO).DOCX

The contents of this report, apart from the referenced ANSI C63.4-2003, are beyond the scope of UKAS Testing Laboratory No. 2360 accreditation.

QMF21J - 3; 47CFR15.247, RNE ISSUE 01 SEP 2012

PAGE 2 OF 46

1 Contents

1	Contents	3
2	Summary of test results	4
3	Equipment Under Test (EUT)	5
3.1	EQUIPMENT SPECIFICATION	5
3.2	EUT CONFIGURATIONS FOR TESTING.....	5
3.3	FUNCTIONAL DESCRIPTION	6
3.4	EUT MODES.....	7
3.5	EMISSIONS CONFIGURATION	8
4	Specifications	9
4.1	RELEVANT STANDARDS	9
4.2	DEVIATIONS	9
4.3	TESTS AT EXTREMES OF TEMPERATURE & VOLTAGE	9
4.4	MEASUREMENT UNCERTAINTIES.....	9
5	Tests, Methods and Results	10
5.1	CONDUCTED EMISSIONS	10
5.2	PEAK CONDUCTED POWER.....	11
5.3	MAXIMUM POWER SPECTRAL DENSITY	12
5.4	DUTY CYCLE	13
5.5	RADIATED EMISSIONS	15
5.6	OCCUPIED BANDWIDTH	18
5.7	BAND EDGE COMPLIANCE.....	19
5.8	FHSS PARAMETERS	20
6	Plots and Results	21
6.1	CONDUCTED EMISSIONS	21
6.2	RADIATED EMISSIONS 30MHz – 1GHz.....	22
6.3	RADIATED EMISSIONS ABOVE 1GHz	24
6.4	6dB BANDWIDTH.....	30
6.5	BAND EDGE COMPLIANCE.....	32
6.6	DUTY CYCLE	35
7	Explanatory Notes	37
7.1	EXPLANATION OF TABLE OF SIGNALS MEASURED	37
7.2	EXPLANATION OF LIMIT LINE CALCULATIONS FOR RADIATED MEASUREMENTS	37
8	Photographs.....	38
9	Signal Leads	42
10	Test Equipment Calibration list	42
11	Auxiliary equipment.....	43
11.1	AUXILIARY EQUIPMENT SUPPLIED BY NXP	43
11.2	AUXILIARY EQUIPMENT SUPPLIED BY RN ELECTRONICS LIMITED	43
12	Modifications	44
12.1	MODIFICATIONS BEFORE TEST	44
12.2	MODIFICATIONS DURING TEST.....	44
13	Compliance information.....	45
14	Description of Test Sites.....	45
15	Abbreviations and Units.....	46

2 Summary of test results

The DR1200 JN5168 Module was tested to the following standards: -

FCC 47CFR Part 15.247 (effective date October 1st, 2012); Class DTS Intentional Radiator

Any compliance statements are made reliant on the modes of operation as instructed to us by the Manufacturer based on their specific knowledge of the application and functionality of the equipment tested. Whilst every effort is made to assure quality of testing, type tests are not exhaustive and although no non-conformances may be found, this doesn't exclude the possibility of equipment not meeting the intentions of the standard, particularly under different conditions to those during testing.

Title	Reference	Results
1. Conducted emissions	FCC Part 15C §15.207	Not Applicable ¹
2. Radiated emissions	FCC Part 15C §15.205, §15.209 and §15.247(d)	PASSED
3. Occupied bandwidth	FCC Part 15C §15.215(c), §15.247(a)(2)	PASSED
4. Peak conducted power	FCC Part 15C §15.247(b)	PASSED
5. Frequency tolerance	FCC Part 15C §15.215(c)	Not Applicable ²
6. Duty cycle	FCC Part 15C §15.35(c)	Not Applicable ³
7. Power Spectral Density	FCC Part 15C §15.247(e)	PASSED
8. Band edge compliance	FCC Part 15C §15.205, §15.209 and §15.247	PASSED
9. FHSS parameters	FCC Part 15C §15.247(a)(1)	Not Applicable ⁴

¹ EUT does not operate from the AC power lines nor contain provisions for operation while connected to AC power lines. N.b. although the EUT is intended to be powered from 3V dc supply (battery), it is also intended for modular approval. Any third party device it is incorporated into with a connection to the AC power line will require demonstration of compliance with the limits.

² No limits apply, however the requirement to contain the designated bandwidth of the emission within the specified frequency band includes the frequency stability of the transmitter over expected variations in temperature and supply voltage.

³ No limits apply, however duty cycle measurement performed to verify correction factors for average emissions.

⁴ EUT does not employ FHSS technology.

3 Equipment Under Test (EUT)

3.1 Equipment Specification

Applicant	NXP Laboratories UK Ltd Furnival Street Sheffield S1 4QT
Manufacturer of EUT	NXP Laboratories UK Ltd
Brand name of EUT	NXP
Model Number of EUT	JN5168-001-M05
Proposed FCC ID	TYOJN5168M5
Serial Number of EUT	3
Date when equipment was received by RN Electronics	12 th Nov 2012
Date of test:	13th Nov 2012 - 16th Nov 2012
Customer order number:	GB628200059162
Visual description of EUT:	The EUT is a small PCB module. Canned on top, with uFL antenna port for RF i/o and on the bottom are header sockets for mounting onto a mother board.
Main function of the EUT:	IEEE 802.15.4/Zigbee Wireless Microcontroller module.
Height	30 mm
Width	16 mm
Depth	3 mm
Weight	0.005 kg
Voltage	2-3.6V dc
Current required from above voltage source	0.04A

3.2 EUT Configurations for testing

Frequency range	2405 – 2480 MHz
Normal use position	Portable (module for OEM integration)
Normal test signals	Internally generated IEEE 802.15.4 compliant test packets
Declared power level	8dBm at antenna port
Declared channel bandwidth	1.73 MHz
Highest frequency generated / used	2480 MHz
Lowest frequency generated / used	32 MHz

3.3 Functional Description

The DR1200 JN5168 Module provides an easy way of interfacing to a wireless network based on the IEEE 802.15.4 protocol standard, where this network may additionally employ the ZigBee PRO or JenNet IP networking protocol. The module incorporates an NXP JN5168 wireless microcontroller.

Typical uses of the module include:

- A complete and stable hardware environment for the development of IEEE 802.15.4, ZigBee PRO and JenNet-IP applications.
- The basis of a packet sniffer for IEEE 802.15.4-based wireless communications

Radio

The figure below shows the single ended radio architecture and frequency generating scheme used in the JN5168 chip:

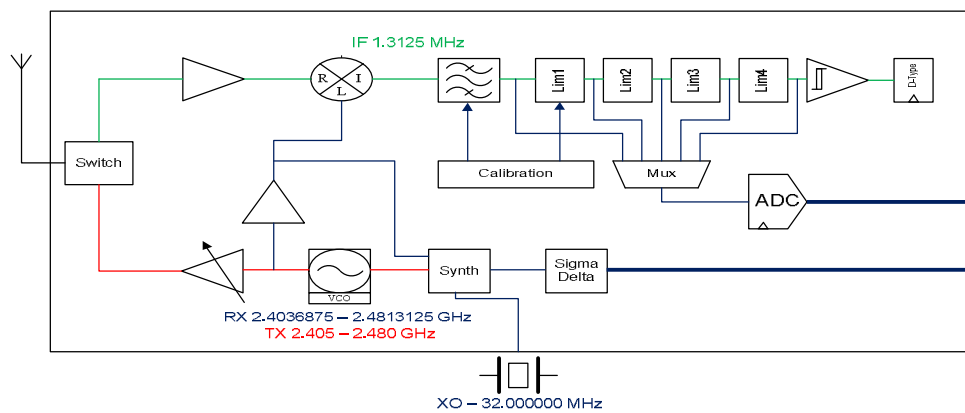

Figure 1: Radio Architecture

The radio comprises a low-IF receive path and a direct modulation transmit path, which converge at the TX/RX switch. The switch connects to the external single ended matching network, which consists of two inductors and a capacitor, this arrangement creates a 50Ω port and removes the need for a balun. A 50Ω single ended antenna can be connected directly to this port.

The 32MHz crystal oscillator feeds a divider, which provides the frequency synthesiser with a reference frequency. The synthesiser contains programmable feedback dividers, phase detector, charge pump and internal Voltage Controlled Oscillator (VCO). The VCO has no external components, and includes calibration circuitry to compensate for differences in internal component values due to process and temperature variations. The VCO is controlled by a Phase Locked Loop (PLL) that has an internal loop filter. A programmable charge pump is also used to tune the loop characteristic.

The receiver chain starts with the low noise amplifier/mixer combination whose outputs are passed to a low pass filter, which provides the channel definition. The signal is then passed to a series of amplifier blocks forming a limiting strip. The signal is converted to a digital signal before being passed to the Modem. The gain control for the RX path is derived in the automatic gain control (AGC) block within the Modem, which samples the signal level at various points down the RX chain. To improve the performance and reduce current consumption, automatic calibration is applied to various blocks in the RX path.

In the transmit direction, the digital stream from the Modem is passed to a digital sigma-delta modulator which controls the feedback dividers in the synthesiser, (dual point modulation). The VCO frequency now tracks the applied modulation. The 2.4 GHz signal from the VCO is then passed to the RF Power Amplifier (PA), whose power control can be selected from one of three settings. The output of the PA drives an external Skyworks Front End Module which houses an LNA, PA and necessary RF switching as shown in figure 2 the module block diagram.

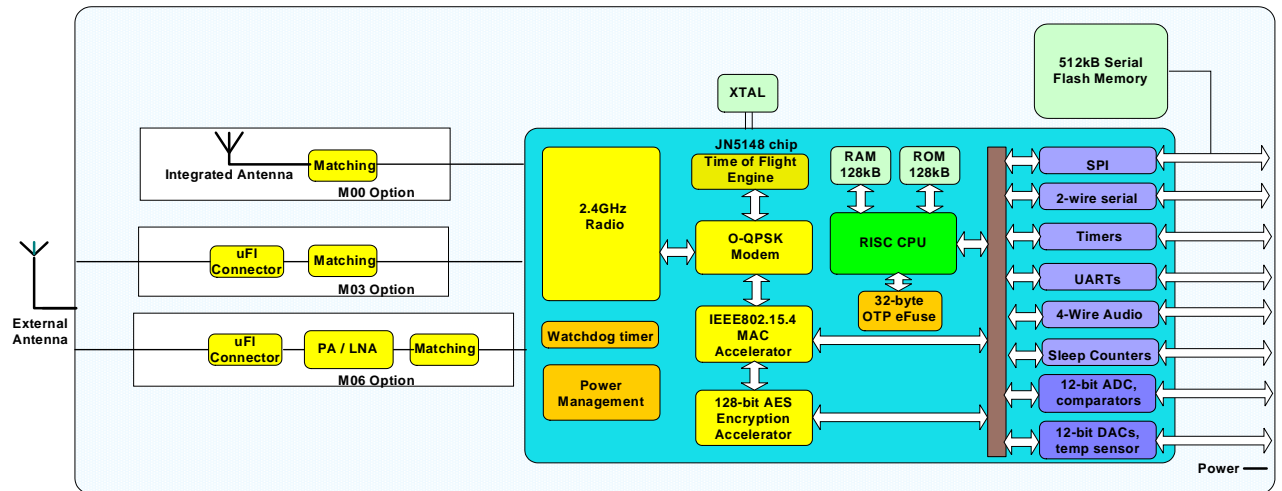

3.4 EUT Modes

Mode	Description of mode	Used for Testing
Transmit Low	Unit constantly transmitting packets on 2405MHz	YES
Transmit Mid	Unit constantly transmitting packets on 2440MHz	YES
Transmit High	Unit constantly transmitting packets on 2480MHz	YES
Transmit Other	Unit constantly transmitting on other available channels	NO
Receive	Unit receiving packets from networked RF device	NO
Transmit 1% duty cycle	Unit transmitting system modulation 1% duty cycle	YES

Description of ancillary equipment connected to the equipment under test, for the purpose of tests, can be found in Section 10.

Any modifications made to the EUT, whilst under test, can be found in Section 11.

This report was printed on: 16 January 2013

3.5 Emissions Configuration

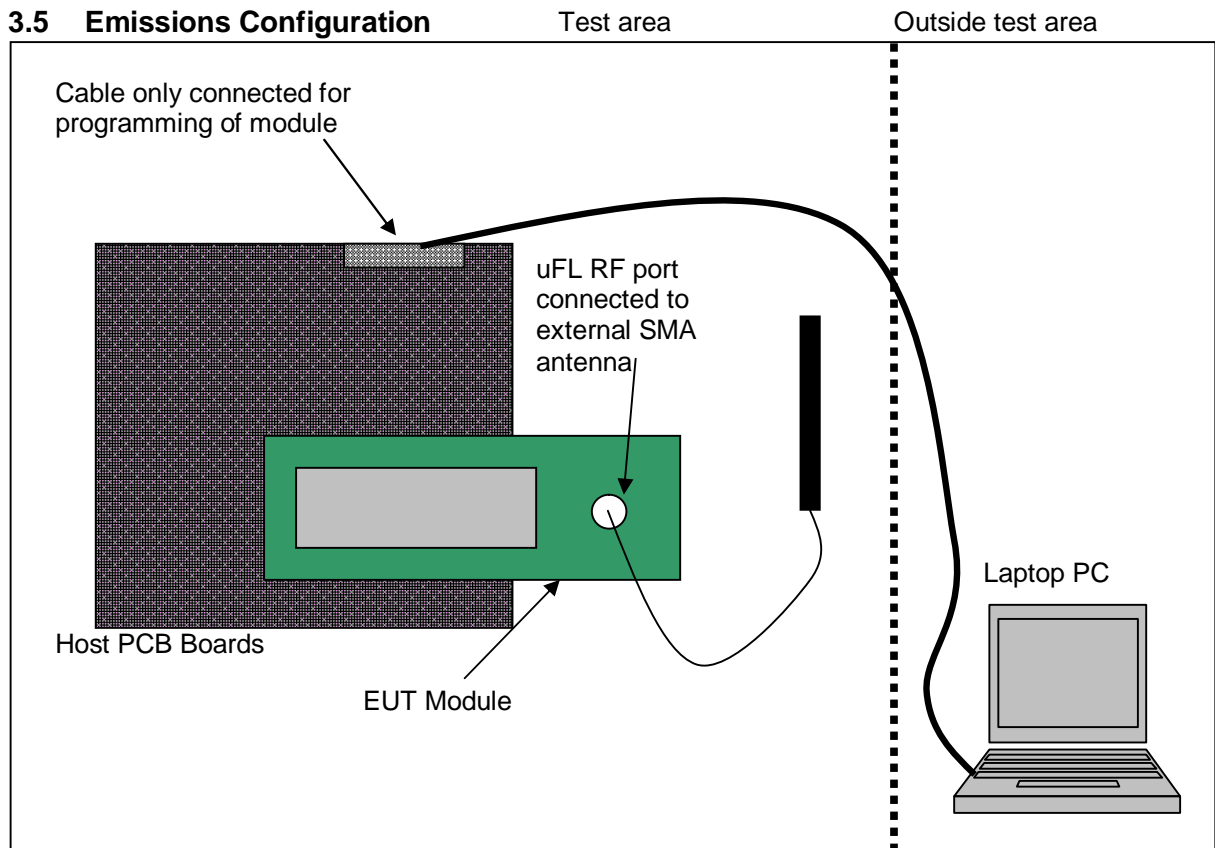

The equipment under test was supplied by 3V DC from new batteries situated on the provided host PCB boards. The battery levels were monitored throughout tests to ensure the levels did not drop below the +/- 10% required. To change channels and select the correct modes for test a programming lead was connected and the unit programmed. The programming lead was removed for tests. Application programming software and a laptop was provided by NXP Laboratories UK Ltd.

For radiated emissions the support equipment was situated outside the chamber and the programming lead removed after each channel/mode change.

Top, middle & bottom channels were tested in Transmit continuous modulated mode. All power levels were left at the default (level 3 of 3) setting, as set by the selection of the root menu mode named "**High Power module**".

Bottom channel = 2.405GHz
Middle channel = 2.440GHz
Top channel = 2.480GHz

The module had a uFL RF port which was attached to a dedicated antenna supplied by NXP Laboratories UK Ltd.

Separate antenna details: Manufacturer: Aveslink
 Model: E-2410-HA (2.2dBi vertical)

4 Specifications

4.1 Relevant Standards

The tests were performed by RN Electronics Engineer Lee Chandler who set up the tests, the test equipment, and operated it in accordance with the **R.N. Electronics Ltd** procedures manual, ANSI C63.10-2009, KDB 558074 v02 (Oct-2012), FCC Part 15 and those specifications incorporated by reference into 47CFR15 (e.g. ANSI C63.4-2003).

R.N. Electronics Ltd sites M and OATS are listed with the FCC. Registration Number 293246

4.2 Deviations

ANSI C63-10-2009 deviations:

The reference standard ANSI C63.4-2003 was used, not the latest ANSI C63.4-2009

FCC Part 15 deviations:

None.

4.3 Tests at Extremes of Temperature & Voltage

No tests at extremes of temperature and voltage were required.

4.4 Measurement Uncertainties

Parameter	Uncertainty
Transmitter Tests	
Conducted RF power	<± 1.0 dB
Occupied bandwidth	± 1.9 %
Radiated RF power	± 3.5 dB
Radiated spurious emissions	30MHz - 1000MHz ±5.1dB
	1000MHz - 2000MHz ±4.5dB
	1 – 18 GHz ±3.5dB
	18 – 26.5 GHz ±3.9dB

5 Tests, Methods and Results

5.1 Conducted emissions

Not applicable.

EUT does not operate from the AC power lines nor contain provisions for operation while connected to AC power lines. N.b. although the EUT is intended to be powered from 3V dc supply (battery), it is also intended for modular approval. Any third party device it is incorporated into with a connection to the AC power line will require demonstration of compliance with the limits.

5.2 Peak Conducted power

5.2.1 Test Methods

Test Requirements	FCC Part 15C, Reference (15.247)
Test Method:	FCC Part 15C, Reference (15.247) ANSI C63.10, Reference (6.10.2.1 a))

5.2.1.1 Configuration of EUT

The EUT was configured for maximum output power and measured at the antenna port. The EUT was set to each **Transmit** mode and test signal in turn (see section 3.4) and highest power levels recorded.

5.2.1.2 Test Procedure

Tests were made in accordance with FCC Part 15 using the measuring equipment noted below.

Peak stated reading is maximum power observed using a spectrum analyser RBW > 6dB BW of the EUT.

Measurements were made on a test bench in site **A**.

5.2.2 Test results

Test Environment: Temperature: 19°C Humidity: 42 %

Bottom channel results

Channel / scheme	Peak ANSI C63.10 (mW)	Result (mW)
Low	8.36	6.9
Mid	8.39	6.9
High	7.99	6.3

LIMITS:

15.247(b)(3)

For systems using digital modulation in the 902-928, 2400-2483.5 or 5725-5850 MHz bands 1 Watt.

These results show that the EUT has **PASSED** this test.

5.2.2.1 Test Equipment used

E492

See Section 10 for more details

5.3 Maximum Power Spectral Density

5.3.1 Test Methods

Test Requirements FCC Part 15C, Reference (15.247)

Test Method: FCC Part 15C, Reference (15.247)
KDB558074, PSD Option 1

5.3.1.1 Configuration of EUT

The EUT was configured for maximum output power and measured at the antenna port. The EUT was operated in **Transmit Low, Mid and High** modes.

5.3.1.2 Test Procedure

Tests were made in accordance with FCC Part 15 using the measuring equipment noted below. The emission from the EUT was maximised before taking any measurements. PEP was recorded in the required bandwidths.

5.3.2 Test results

Tests were performed using Test Site **A**.

Temperature of test Environment: 19°C

Table of results

Channel/ scheme	PEP (dBm/3kHz)
2.405GHz	-3.27
2.440GHz	-4.40
2.480GHz	-4.40

LIMITS:
15.247(e) +8dBm/3kHz.

These results show that the **EUT** has **PASSED** this test.

5.3.2.1 Test Equipment used

E492

See Section 10 for more details.

5.4 Duty cycle

5.4.1 Test Methods

Test Requirements FCC Part 15C, Reference (15.35)

Test Method: ANSI C63.10, Reference (7.5)

5.4.1.1 Configuration of EUT

The EUT was configured for maximum output power and measured at the antenna port. The EUT was operated in **Transmit Low and 1% duty cycle** modes.

5.4.1.2 Test Procedure

Tests were made in accordance with FCC Part 15 using the measuring equipment noted below. The centre frequency of the analyser was set to that of the transmitter, and the span set to zero. The sweep time was adjusted so that either the pulse width or the periodic operation could be observed.

5.4.2 Test results

Tests were performed using Test Site A.

Temperature of test Environment: 19°C

Analyser plots for the dwell time and duty cycle can be found in Section 6.6 of this report.

State	Result (ms)	Plot reference
TX on 100ms period (transmit low mode)	100	Plot9
TX on 100ms period (transmit 1% duty cycle mode)	0.162	Plot10
Repetition rate (transmit 1% duty cycle mode)	8.181	Plot11

Duty cycle measured in **Transmit Low** mode is 100%.

Duty cycle measured in **Transmit 1% duty cycle** mode is $11 \times 0.162 = 1.8\%$

LIMITS: Not applicable.

Measurements were only taken to demonstrate the validity of the constantly on and 1% duty cycle modes.

Note, the EUT is a module for OEM integration and as such the duty is dependent upon the final application.

The manufacturer has declared a duty cycle of 1% and quotes IEEE 802.15.4: "The specifications of IEEE Std 802.15.4-2003 are tailored for applications with low power and low data rates (a maximum of 250 kb/s and down to 20 kb/s). Typical applications for IEEE 802.15.4 devices are anticipated to run with low duty cycles (under 1%). This will make IEEE 802.15.4 devices less likely to cause interference to other standards".

IEEE 802.15.4 also quotes a nominal packet length of 0.01472ms (40 data bytes) and for <10% duty cycle restrictions up to 6 packets per 100ms.

For purposes of test the equipment was operated with the transmitter continuously on. For a 10% duty cycle, the power measured would be reduced by $20 \log (0.10) = -20\text{dB}$. According to the declared duty cycle, therefore, the emissions observed, in section 5.7, are below the limit after averaging for pulse rate.

5.4.2.1 Test Equipment used

E492

See Section 10 for more details.

5.5 Radiated emissions

5.5.1 Test Methods

Test Requirements	FCC Part 15C, Reference (15.209)
Test Method:	ANSI C63.10, Reference (6.4 – 6.6.)

5.5.1.1 Configuration of EUT

The EUT was placed on a non conductive support above a turntable. The dedicated antenna was supported vertically. The front edge of the EUT was initially positioned facing the antenna. The EUT was rotated in all three orthogonal planes. Radiated Emissions testing was performed with a new/fully charged battery. The EUT was operated in **Transmit Low, Mid and High** modes.

5.5.1.2 Test Procedure

Tests were made in accordance with FCC Part 15 using the measuring equipment noted below.

30MHz - 1GHz, measurements were made at 3m on a site listed with the FCC. The equipment was rotated 360° and the antenna scanned 1 – 4 metres in both horizontal and vertical polarisations to record the worst case emissions.

Above 1GHz, measurements were made in a semi-anechoic chamber with appropriate absorbing material for use in this range. Final measurements were made at 3m for 1-6.5GHz and 1.2m above 6.5GHz. Pre-scans were made at closer distances to observe any notable spurious emissions.

At least 6 signals within 20dB and all signals within 10dB of the limit were investigated.

5.5.2 Test results

Tests were performed using Test Site M.

Test Environment:

Temperature: 19°C

Humidity: 38-48%

Tables of signals for all 3 modes are shown below and analyser plots for one mode (Transmit Mid) peak/average, as applicable, can be found in Section 6.2 and 6.3 of this report.

Note: EUT tested in a continuous transmit mode for ease of test. Where average limits apply, duty cycle correction may then be calculated as per FCC 15.35. TX on time in 100ms period. See section 5.4 Duty cycle within this report.

Transmit Low Emissions - Horizontal

Signal No.	Freq (MHz)	Peak Amp (dBuV)	Peak- Lim1 (dB)	AV Amp (dBuV)	AV - Lim1 (dB)
1	2373	48.8	-25.2	42.9	-11.1
2	2437	46.7	-27.3	39.4	-14.6
3	4810	53.8	-20.2	45.4	-8.6
4	7215	49.1	-24.9	40.0	-14.0
5	9620	49.0	-25.0	38.9	-15.1
6	12025	49.9	-24.1	39.1	-14.9

Transmit Low Emissions - Vertical

Signal No.	Freq (MHz)	Peak Amp (dBuV)	Peak - Lim1 (dB)	AV Amp (dBuV)	AV - Lim1 (dB)
1	2373	48.4	-25.6	42.0	-12.0
2	2437	47.6	-26.4	41.3	-12.7
3	4810	48.1	-25.9	37.7	-16.3
4	7213.643	48.2	-25.8	38.9	-15.1
5	12022.568	51.8	-22.2	41.4	-12.6

Transmit Mid Emissions - Horizontal

Signal No.	Freq (MHz)	Peak Amp (dBuV)	Peak - Lim1 (dB)	AV Amp (dBuV)	AV - Lim1 (dB)
1	2408	44.5	-29.5	37.8	-16.2
2	2472	43.5	-30.5	35.5	-18.5
3	4880	50.4	-23.6	41.3	-12.7
4	7320	48.8	-25.2	39.8	-14.2
5	12200	51.1	-22.9	41.0	-13.0

Transmit Mid Emissions - Vertical

Signal No.	Freq (MHz)	Peak Amp (dBuV)	Peak - Lim1 (dB)	AV Amp (dBuV)	AV - Lim1 (dB)
1	2408	48.4	-25.6	41.9	-12.1
2	2472	47.1	-26.9	40.3	-13.7
3	4880	48.4	-25.6	38.5	-15.5
4	7320	47.6	-26.4	38.5	-15.5
5	12200	53.6	-20.4	44.4	-9.6

Transmit High Emissions – Horizontal

Signal No.	Freq (MHz)	Peak Amp (dBuV)	Peak - Lim1 (dB)	AV Amp (dBuV)	AV - Lim1 (dB)
1	2448	48.4	-25.6	40.6	-13.4
2	2512	49.7	-24.3	42.8	-11.2
3	4960	46.4	-27.6	36.0	-18.0
4	7440	49.3	-24.7	40.6	-13.4
5	12400	55.2	-18.8	46.0	-8.0

Transmit High Emissions – Vertical

Signal No.	Freq (MHz)	Peak Amp (dBuV)	Peak - Lim1 (dB)	AV Amp (dBuV)	AV - Lim1 (dB)
1	2448	47.8	-26.2	40.3	-13.7
2	2512	47.0	-27.0	41.1	-12.9
3	4960	48.0	-26.0	37.3	-16.7
4	7440	46.9	-27.1	37.7	-16.3
5	12400	56.4	-17.6	47.8	-6.2

File name NXP LABORATORIES UK LTD.6510-3 (FCC RADIO).DOCX

The contents of this report, apart from the referenced ANSI C63.4-2003, are beyond the scope of UKAS Testing Laboratory No. 2360 accreditation.

LIMITS:

15.209 limits are applicable in the restricted bands of 15.205 with the relevant detector.
15.247(d) other emissions, outside the intentional band, must be attenuated by at least 20dB from the level of the fundamental / meet the general limits of 15.209.

n.b. the worst case (general limits of 15.209) limits are as shown in the above tables and drawn on the respective plots.

These show that the **EUT** has **PASSED** this test.

5.5.2.1 Test Equipment used

E410, E411, E412, TMS933, E268, E342, TMS78, TMS79, TMS82, E429

See Section 10 for more details

5.6 Occupied bandwidth

5.6.1 Test Methods

Test Requirements FCC Part 15C, Reference (15.215)

Test Method: ANSI C63.10, Reference (6.9)

5.6.1.1 Configuration of EUT

The EUT was configured for maximum output power and measured at the antenna port. The EUT was operated in **Transmit Low, Mid and High** modes.

5.6.1.2 Test Procedure

Tests were made in accordance with FCC Part 15 using the measuring equipment noted below. A 10kHz RBW, 3x VBW, auto sweep time and max hold settings were used for the 6dB bandwidth.

5.6.2 Test results

Tests were performed using Test Site A.

Temperature of test Environment: 19°C

Analyser plots for the 6dB bandwidth can be found in Section 6.4 of this report.

Channel	Result	Plot reference
Bottom	1.39MHz	Plot6
Middle	1.55MHz	Plot7
Top	1.55MHz	Plot8

LIMITS:

15.247(a)(2) The minimum 6dB bandwidth shall be at least 500kHz.

These results show that the **EUT** has **PASSED** this test.

5.6.2.1 Test Equipment used

E492

See Section 10 for more details.

5.7 Band Edge Compliance

5.7.1 Test Methods

Test Requirements FCC Part 15C, Reference (15.215 and 15.247)

Test Method: FCC Part 15C, Reference (15.215)
ANSI C63.10, Reference clause 6.9.2

5.7.1.1 Configuration of EUT

The EUT was placed on a 0.8 metres high turntable. The front edge of the EUT was initially positioned facing the antenna. The EUT was measured at a distance of 3 metres. The EUT was operated in **Transmit Low and High** modes.

5.7.1.2 Test Procedure

Tests were made in accordance with FCC Part 15 using the measuring equipment noted below. The emission from the EUT was maximised before taking the plots. No account was taken of the influence of high in-band signals when using the specified resolution bandwidth, as the emissions were either below the specified limits, or would be below the specified limits once duty cycle correction taken into account.

5.7.2 Test results

Tests were performed using Test **Site M**, with appropriate absorber in the range measured.

Temperature of test Environment: 19°C

Analyser plots for the Band Edge Compliance can be found in Section 6.5 of this report. These show the 20dBc requirement of 15.247(d) are met at the band edges of 2400 and 2483.5 MHz. Restricted band edge plots are also shown in section 6.5.

The following tables list the field strengths observed in the adjacent restricted bands, which are required to meet the tighter 15.209 limits:

Channel	Band edge PK reading (dBuV/m)	Band edge AV reading (dBuV/m)	Plot reference
Bottom	48.52	-	Plot1 & Plot2
Top	69.48	58.84*	Plot3, Plot4 & Plot5

The band edge readings were performed with a peak detector (max held plot) and with the EUT set in a constant 100% transmit state.

*The limit is 54dBuV/m for Average emissions. According to 15.35(c): when the radiated emission limits are expressed in terms of the average value of the emission, and pulsed operation is employed, the measurement field strength shall be determined by averaging over one complete pulse train, including blanking intervals, as long as the pulse train does not exceed 0.1 seconds. For a 10% duty cycle, the power measured would be reduced by $20 \log(0.10) = 20\text{dB}$. According to the declared duty cycle, therefore, the emissions observed are below the limit after averaging for pulse rate.

Limits: AV = 54dBuV/m at band edges
PK = 74dBuV/m at band edges

The restricted band edges closest to the EUT frequency of 2400-2483.5MHz are 2390 & 2483.5MHz. /

Further wider span plots have been taken to show the fact that there are no spurious emissions above the restricted limits of 15.209.

These results show that the **EUT** has **PASSED** this test.

5.7.2.1 Test Equipment used

E268, E412, TMS82

5.8 FHSS Parameters

Test following tests were not applicable as the EUT does not employ FHSS Technology.

5.8.1 Frequency Separation

5.8.2 Number of hopping Channels

5.8.3 Dwell time

6 Plots and Results

6.1 Conducted Emissions

Not applicable. EUT does not operate from the AC power lines nor contain provisions for operation while connected to AC power lines. N.b. although the EUT is intended to be powered from 3V dc supply (battery), it is also intended for modular approval. Any third party device it is incorporated into with a connection to the AC power line will require demonstration of compliance with the limits.

6.2 Radiated Emissions 30MHz – 1GHz

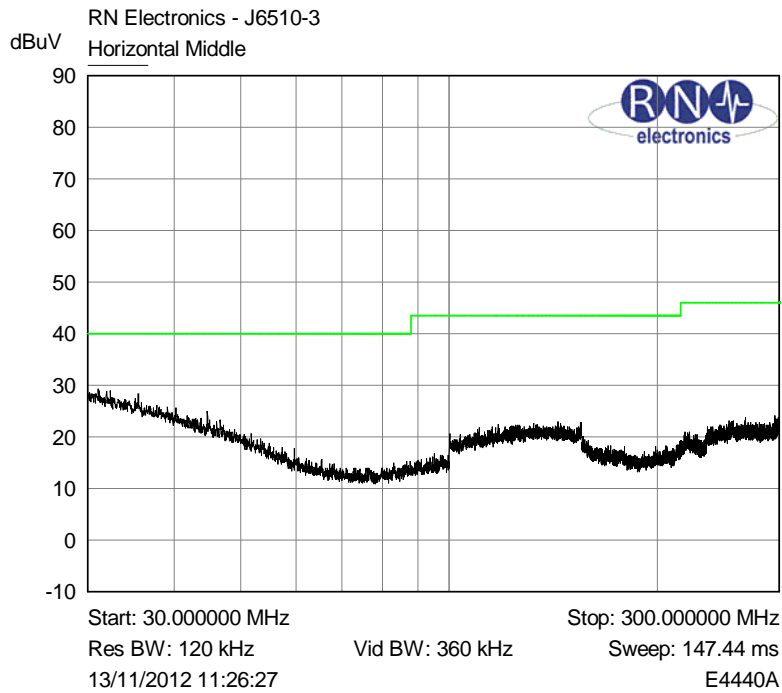

Plot of peak horizontal emissions 30MHz - 300MHz against the quasi-peak limit line.

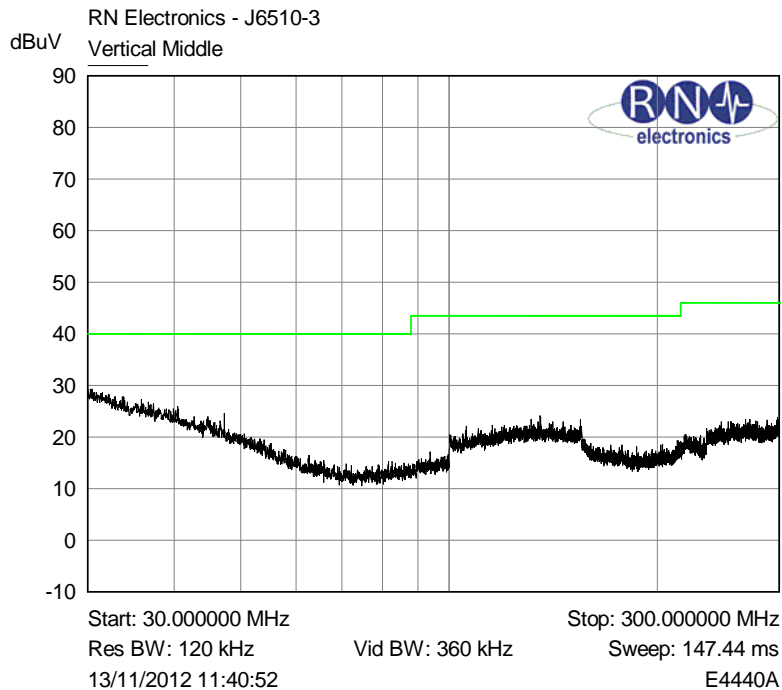

Plot of peak vertical emissions 30MHz - 300MHz against the quasi-peak limit line.

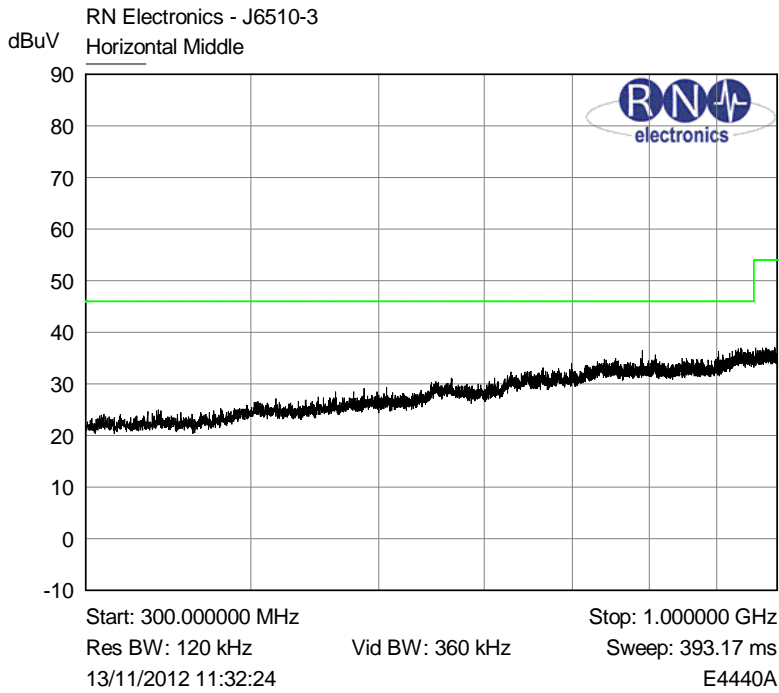

Plot of peak horizontal emissions 300MHz - 1GHz against the quasi-peak limit line.

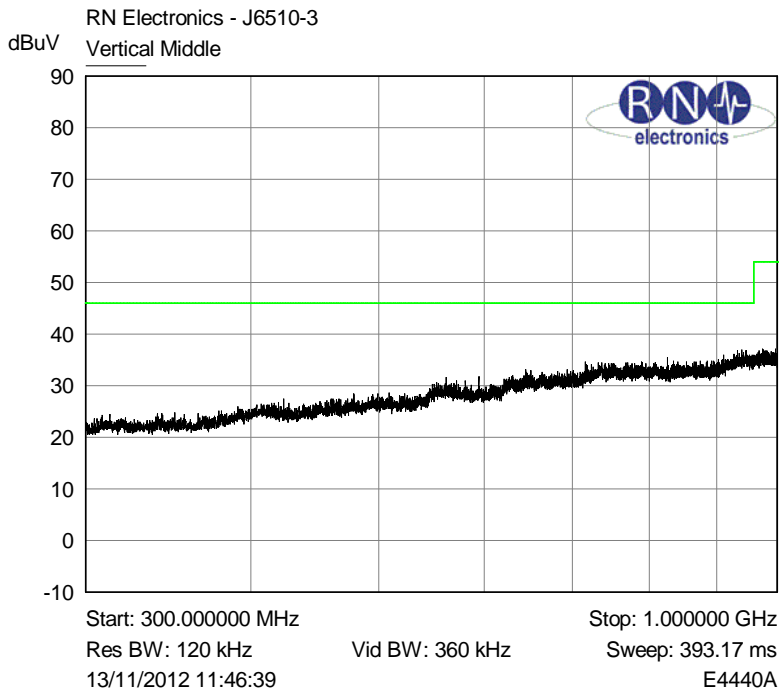

Plot of peak vertical emissions 300MHz - 1GHz against the quasi-peak limit line.

6.3 Radiated Emissions above 1GHz

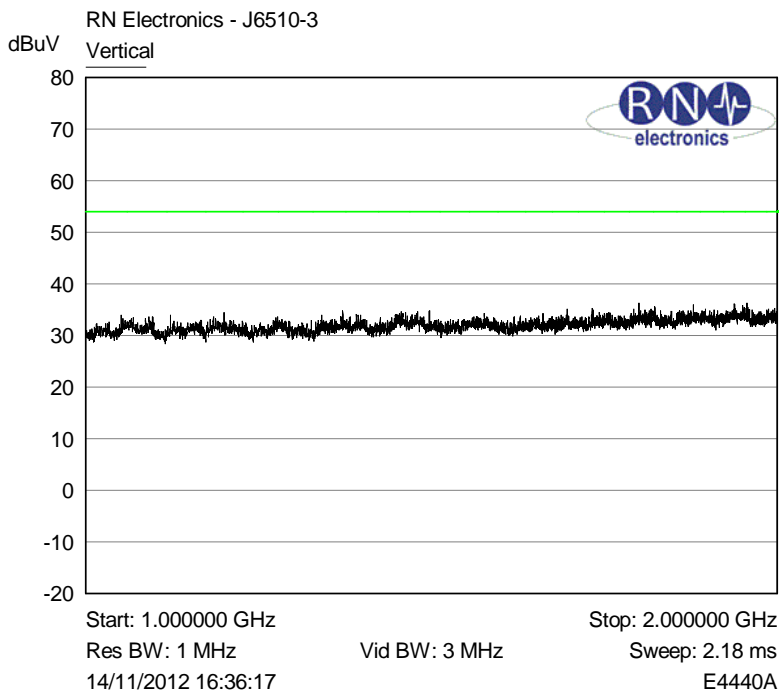
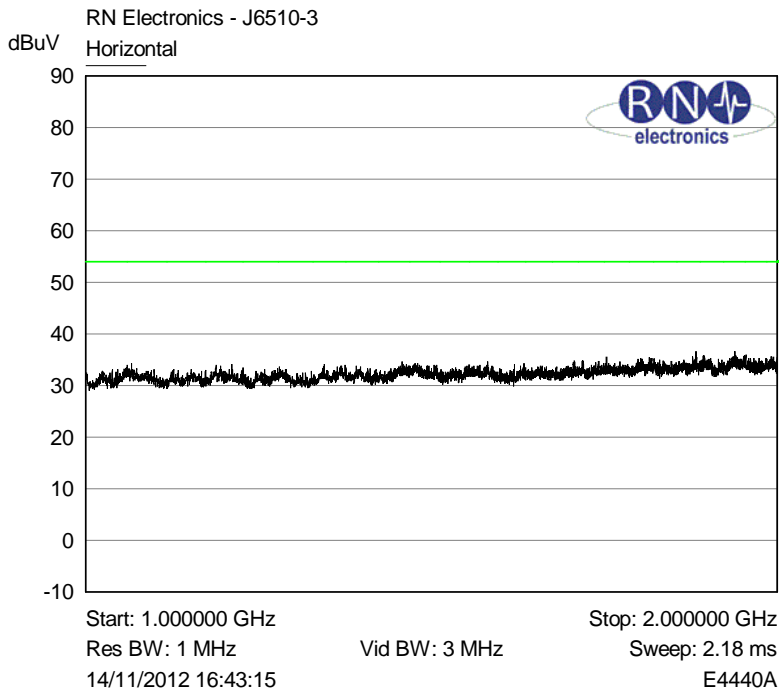

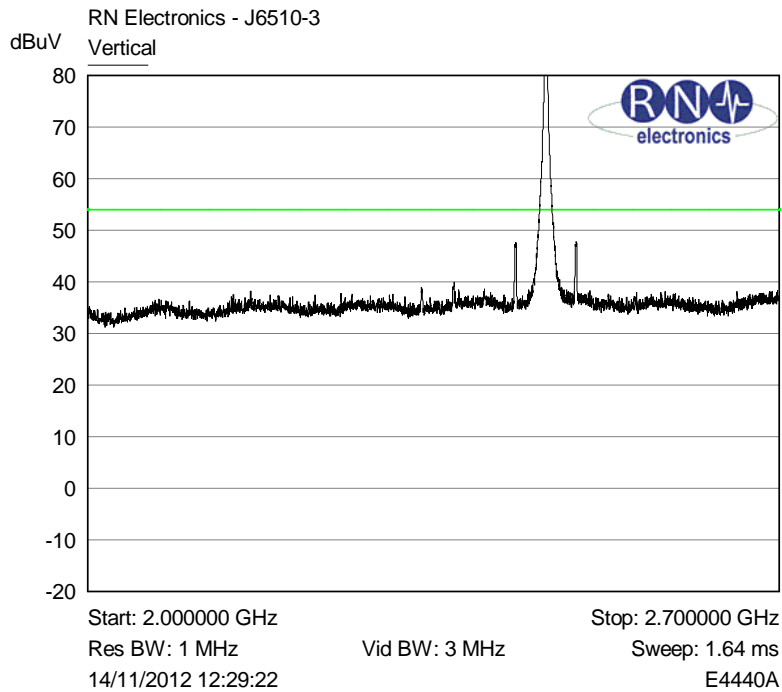
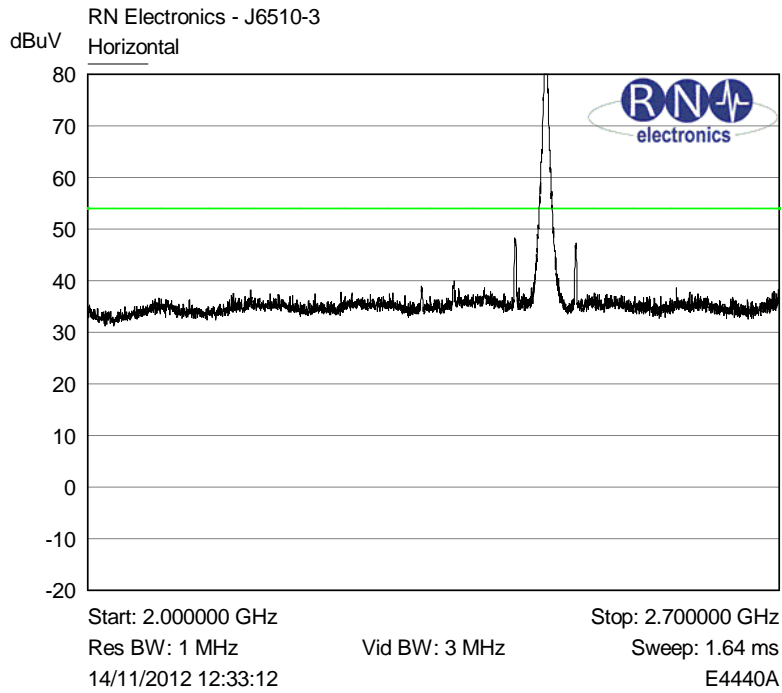

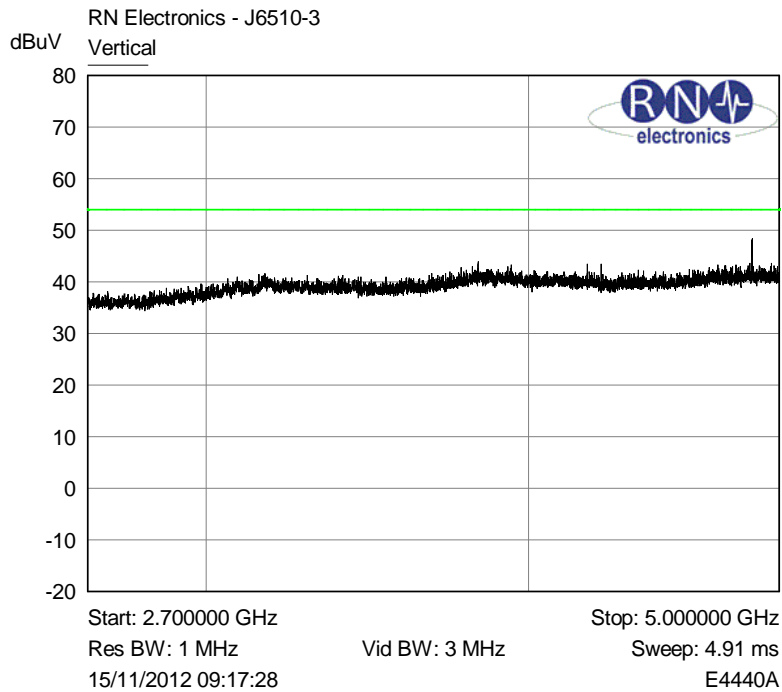
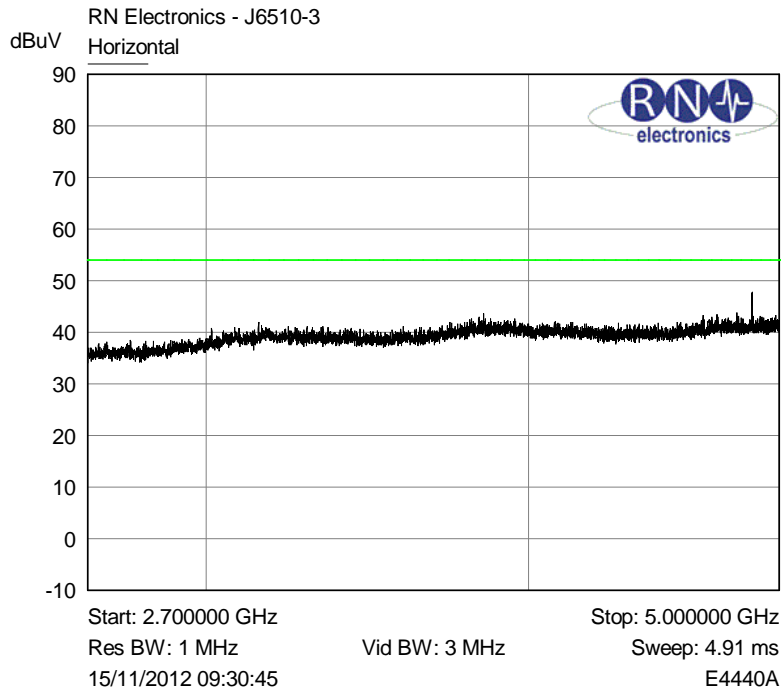

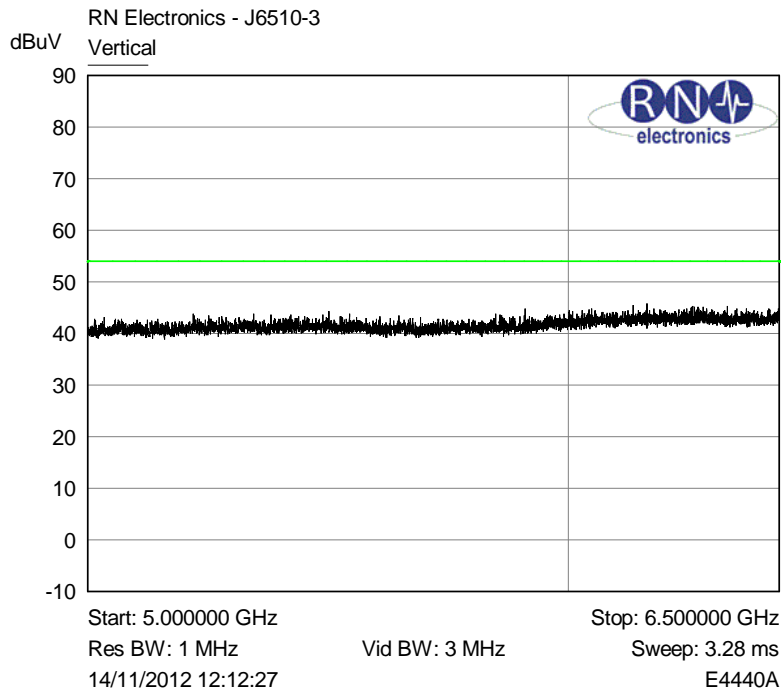
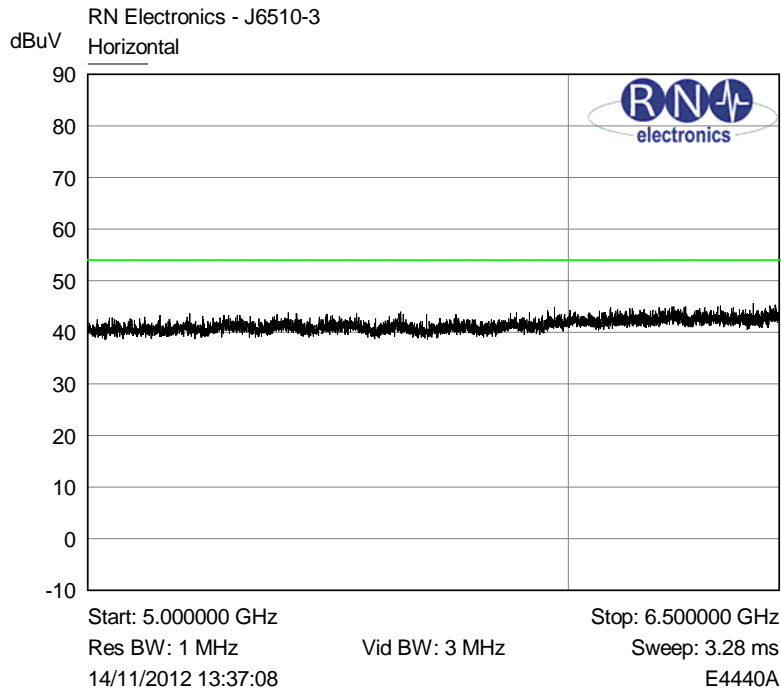

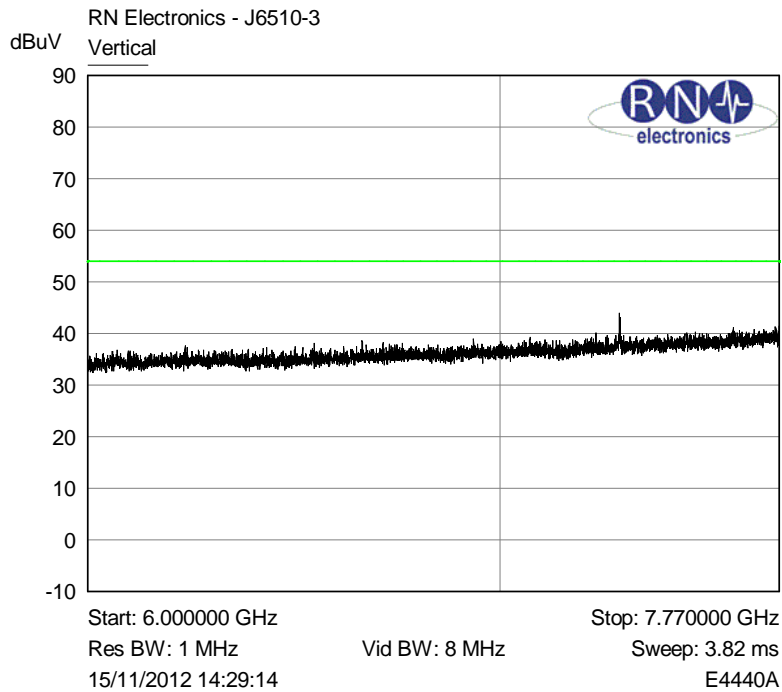
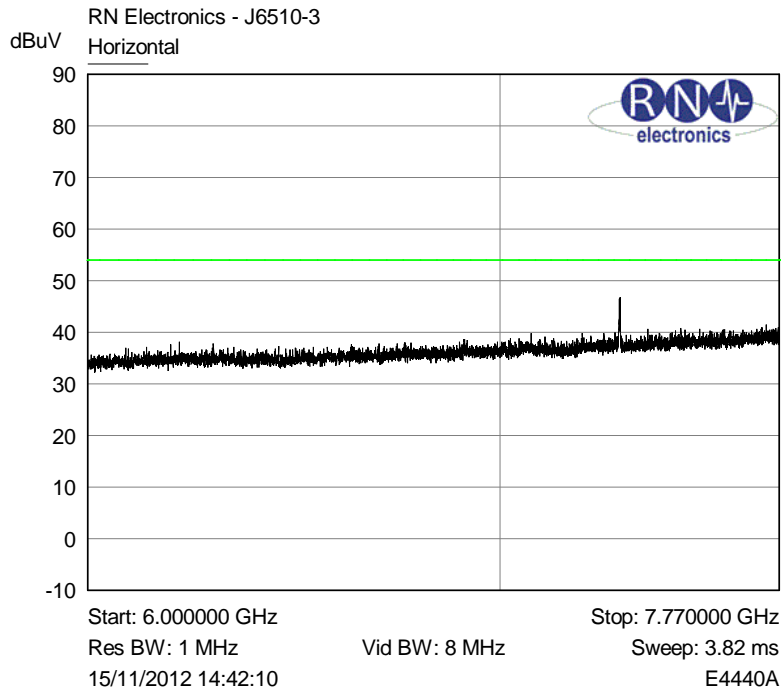

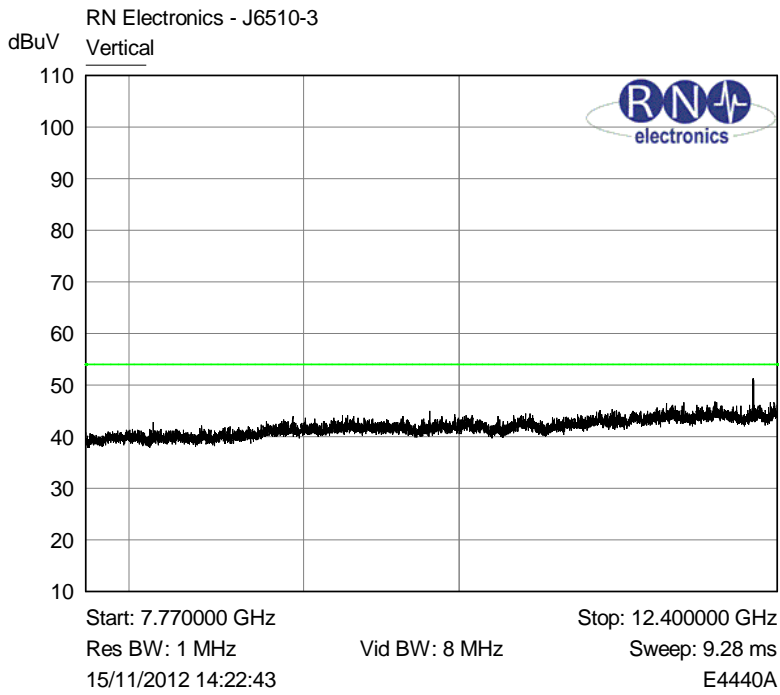
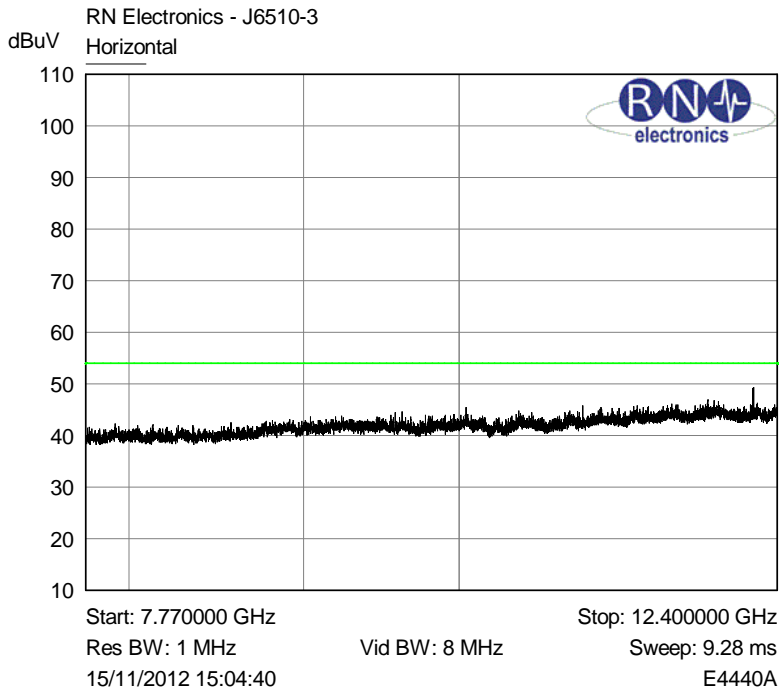

6.4 6dB Bandwidth

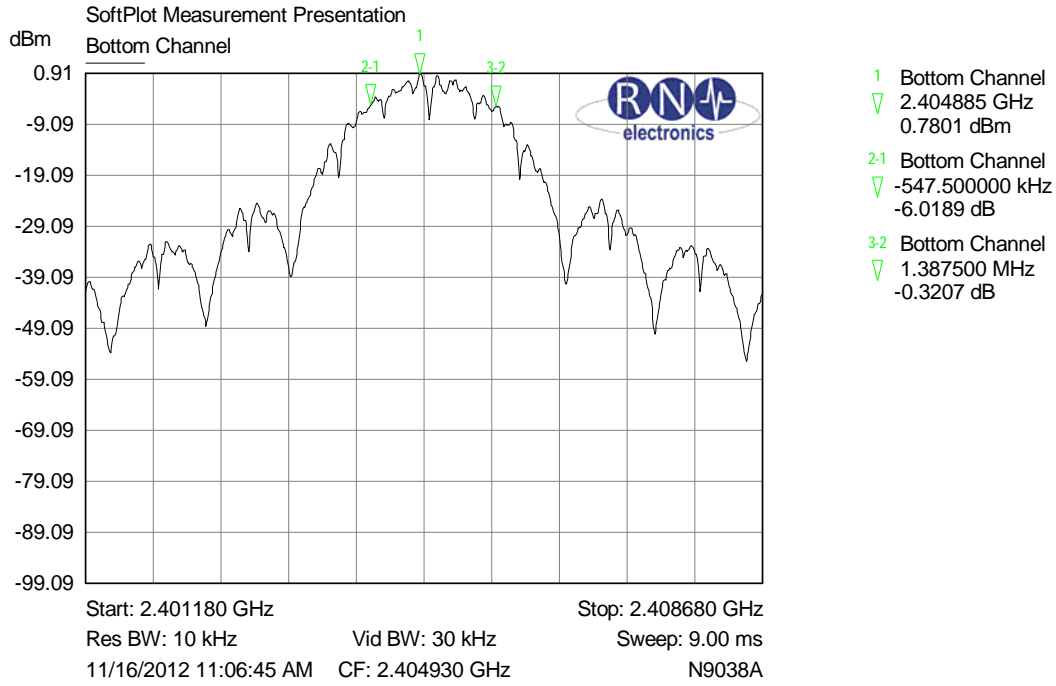

Plot6.

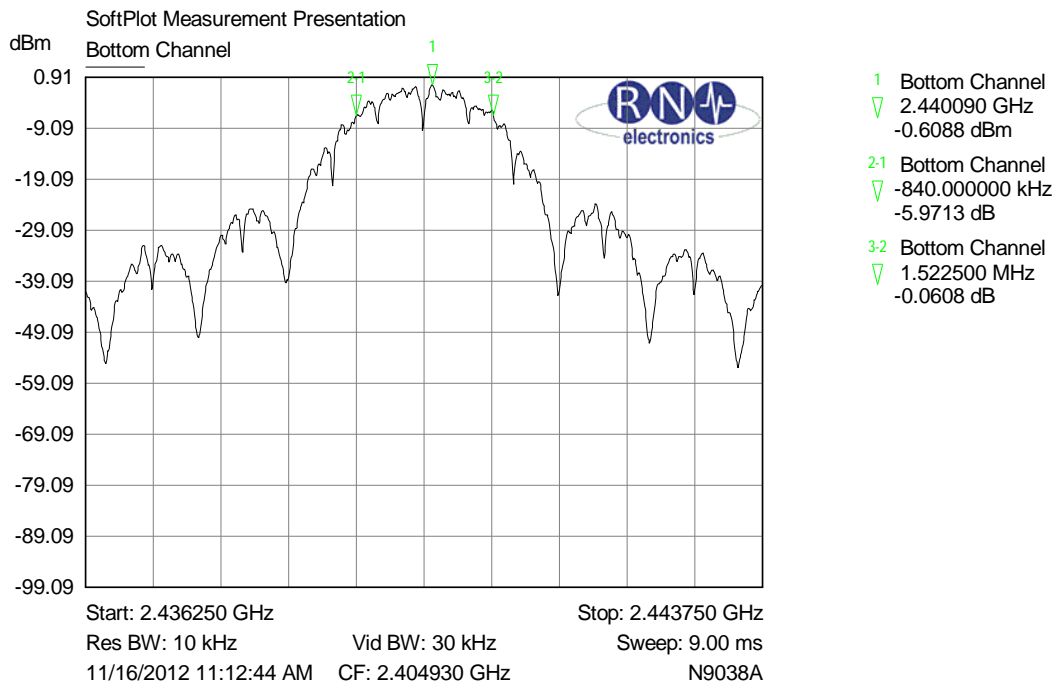

Plot7

File name NXP LABORATORIES UK LTD.6510-3 (FCC RADIO).DOCX
The contents of this report, apart from the referenced ANSI C63.4-2003, are beyond the scope of UKAS Testing Laboratory No. 2360 accreditation.

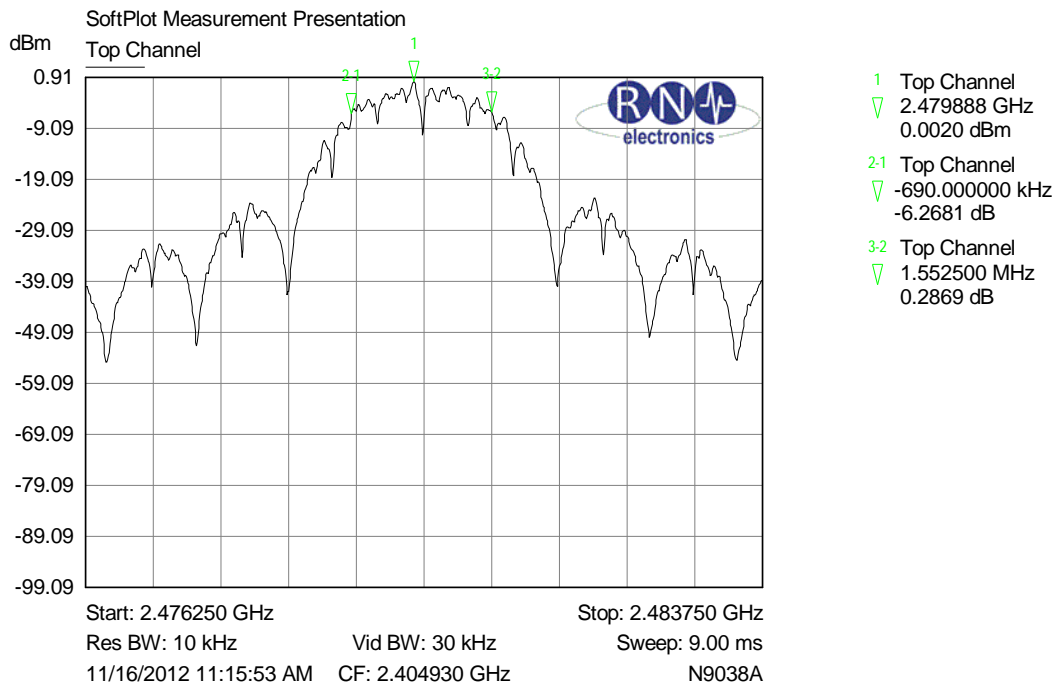

Plot8

6.5 Band Edge Compliance

Lower Band Edge

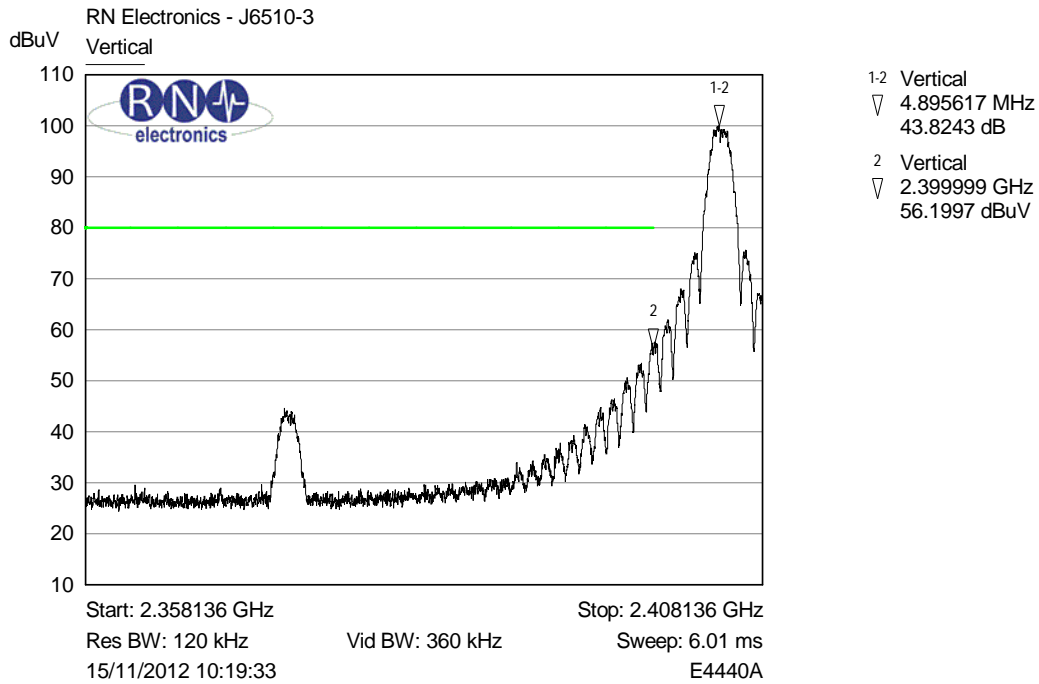

Plot1. The above plot shows compliance with the lower band edge 20dBc limit at 2400MHz.

Lower Restricted Band Edge.

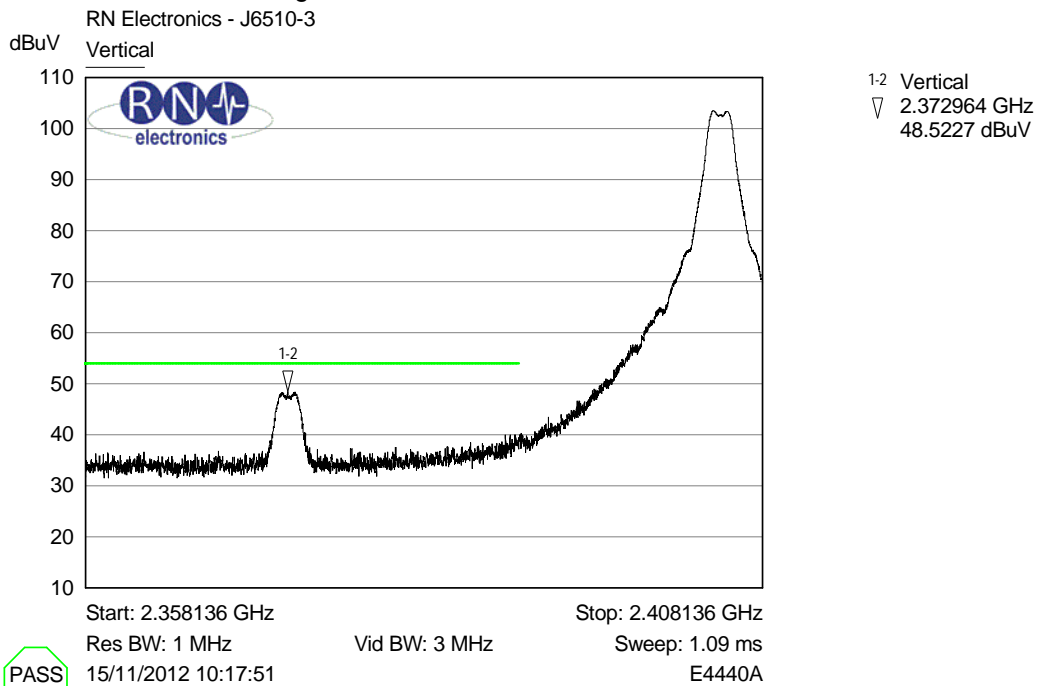

PASS

Plot2. The above peak plot shows compliance with the lower restricted band average limit.

Upper band edge.

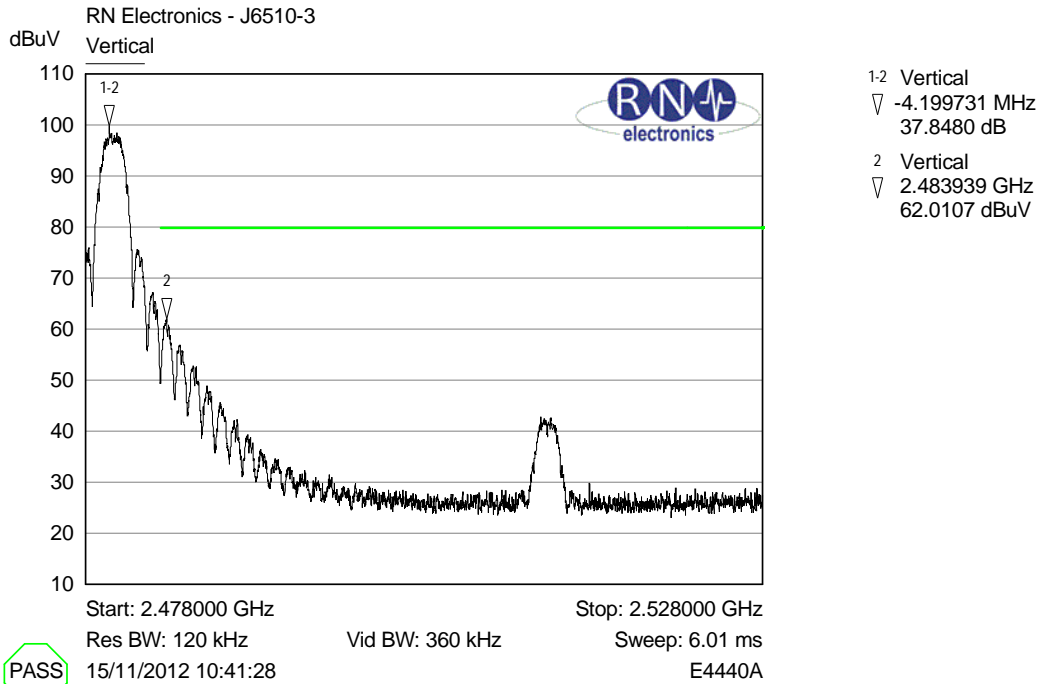

Plot3. The above plot shows compliance with the upper band edge 20dBc limit at 2463.5MHz.

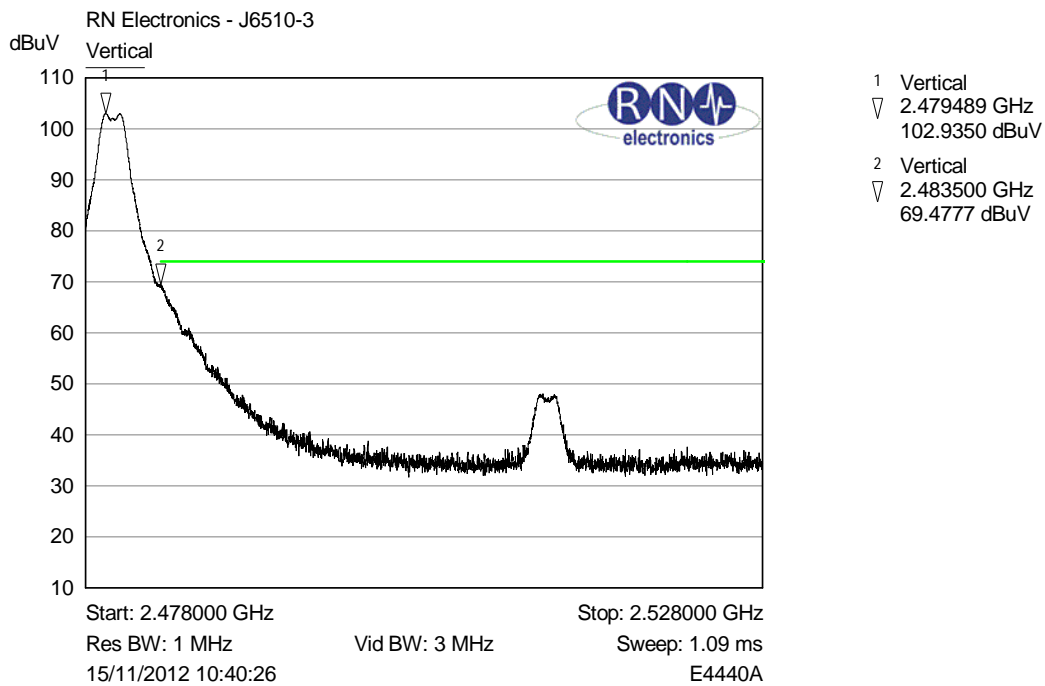

Plot4. The above peak plot shows compliance with the upper restricted band peak limit, 20dB above the 15.209 average limit.

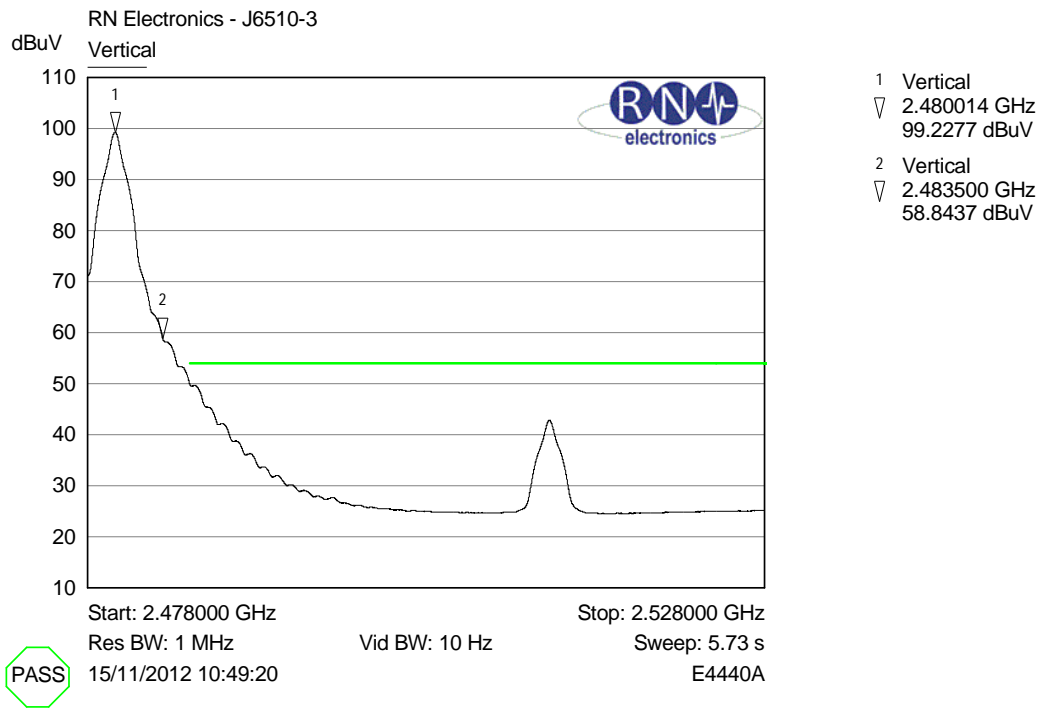

Plot5. The above average plot shows compliance with the upper restricted band limit of 15.209 from 2485.5MHz (band edge plus two standard bandwidths). N.b. the above plot does not account for pulsed behaviour of the transmitter as it is of a continuous transmission (100% duty).

6.6 Duty cycle

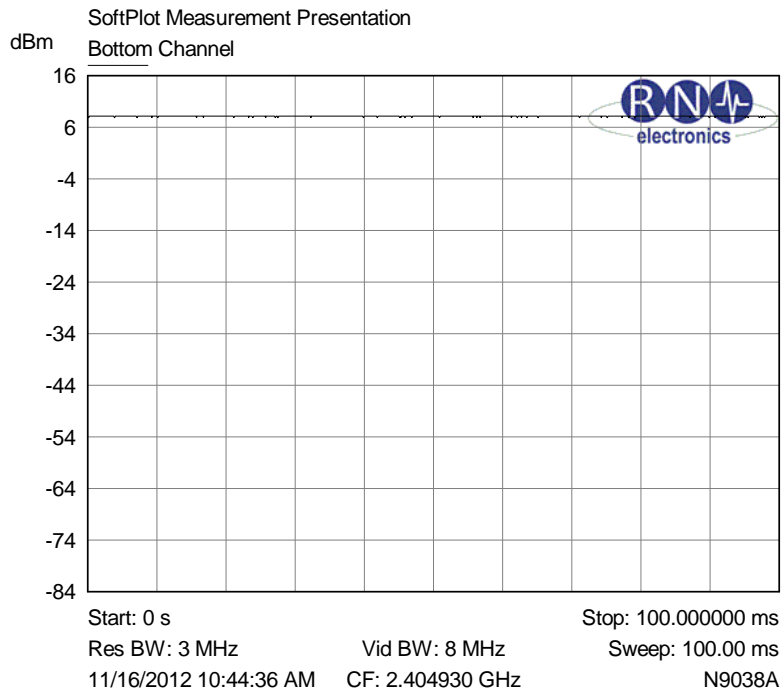

Plot9. 100% in 100ms duty plot.

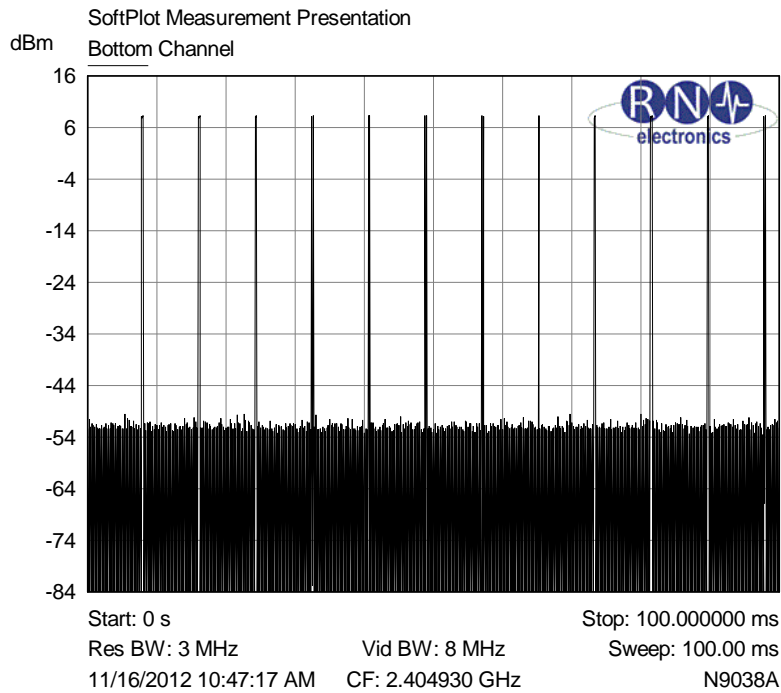

Plot10. 1% in 100ms duty plot.

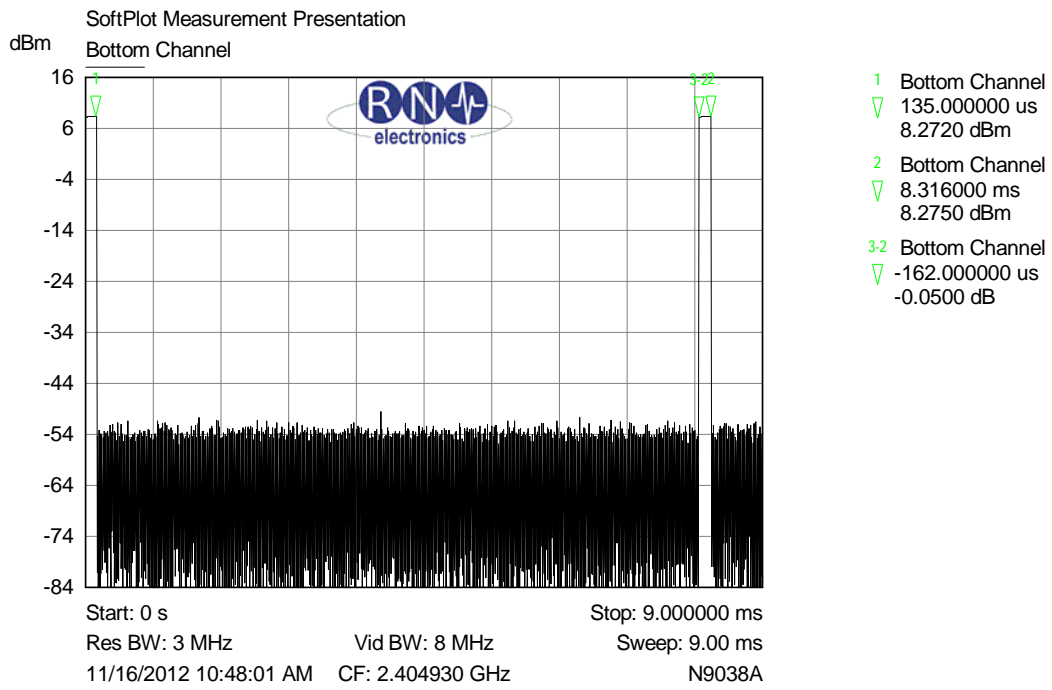

Plot11. 1% duty pulse width.

7 Explanatory Notes

7.1 Explanation of Table of Signals Measured

Measurements are made as required by the standard. These measurements are made and recorded using detectors, either peak, quasi peak or average dependant on the test. A table of results has been given following the relevant plots. This table looks similar to the one illustrated below dependant on the measurements required by the test: -

Signal No.	Freq (MHz)	Peak Amp (dB μ V)	Pk - Lim 1 (dB)	QP Amp (dB μ V)	QP - Lim1 (dB)	Av Amp (dB μ V)	Av - Lim1 (dB)
1	12345	54.9	-10.5	48.0	-12.6	37.6	-14.4

Column One - Labelled Signal No. is an incremental number that the receiver has given to each signal that has been measured.

Column Two - Labelled Freq (MHz) is the approximate frequency of the signal received.

Column Three - Labelled Peak Amp (dB μ V) is the level of received signal that was measured in dB above 1 μ V using the peak detector.

Column Four - Labelled Pk - Lim1 (dB) is the difference in level from the peak signal given to the active limit line. If this column appears in the table the peak detector measurement is required by the standard for this test. The results entered in this column indicate the signal level relative to the compliance limit required. Negative numbers indicate that the product is compliant.

Column Five - Labelled QP Amp (dB μ V) is the level of received signal that was measured in dB above 1 μ V using the quasi-peak detector.

Column Six - Labelled QP - Lim1 (dB) is the difference in level from the quasi-peak signal given to the active limit line. If this column appears in the table the quasi-peak detector measurement is required by the standard for this test. The results entered in this column indicate the signal level relative to the compliance limit required. Negative numbers indicate that the product is compliant.

Column Seven - Labelled Av Amp (dB μ V) is the level of received signal that was measured in dB above 1 μ V using the average detector.

Column Eight - Labelled Av - Lim1 (dB) is the difference in level from the average signal given to the active limit line. If this column appears in the table the average detector measurement is required by the standard for this test. The results entered in this column indicate the signal level relative to the compliance limit required. Negative numbers indicate that the product is compliant.

Only signals highlighted in red are deemed to exceed the limit of the detector required.

7.2 Explanation of limit line calculations for radiated measurements

The limits given in the test standard are normally expressed as absolute values (e.g. in μ V/m at a specified distance), whereas the measured values are expressed as peak, quasi peak or average values in dB μ V/m referenced to the measuring instrument inputs. RN Electronics calibrate the test set-up to account for any path losses, antenna gains, etc. so that the value read at the receiver relates directly to the absolute value required, except that it is expressed in dB relative to one microVolt and may need to take account of any alternative measuring distance used. Examples:

- (a) limit of 500 μ V/m equates to $20.\log(500) = 54$ dB μ V/m.
- (b) limit of 300 μ V/m at 10m equates to $20.\log(300 \cdot 10/3) = 60$ dB μ V/m at 3m

8 Photographs

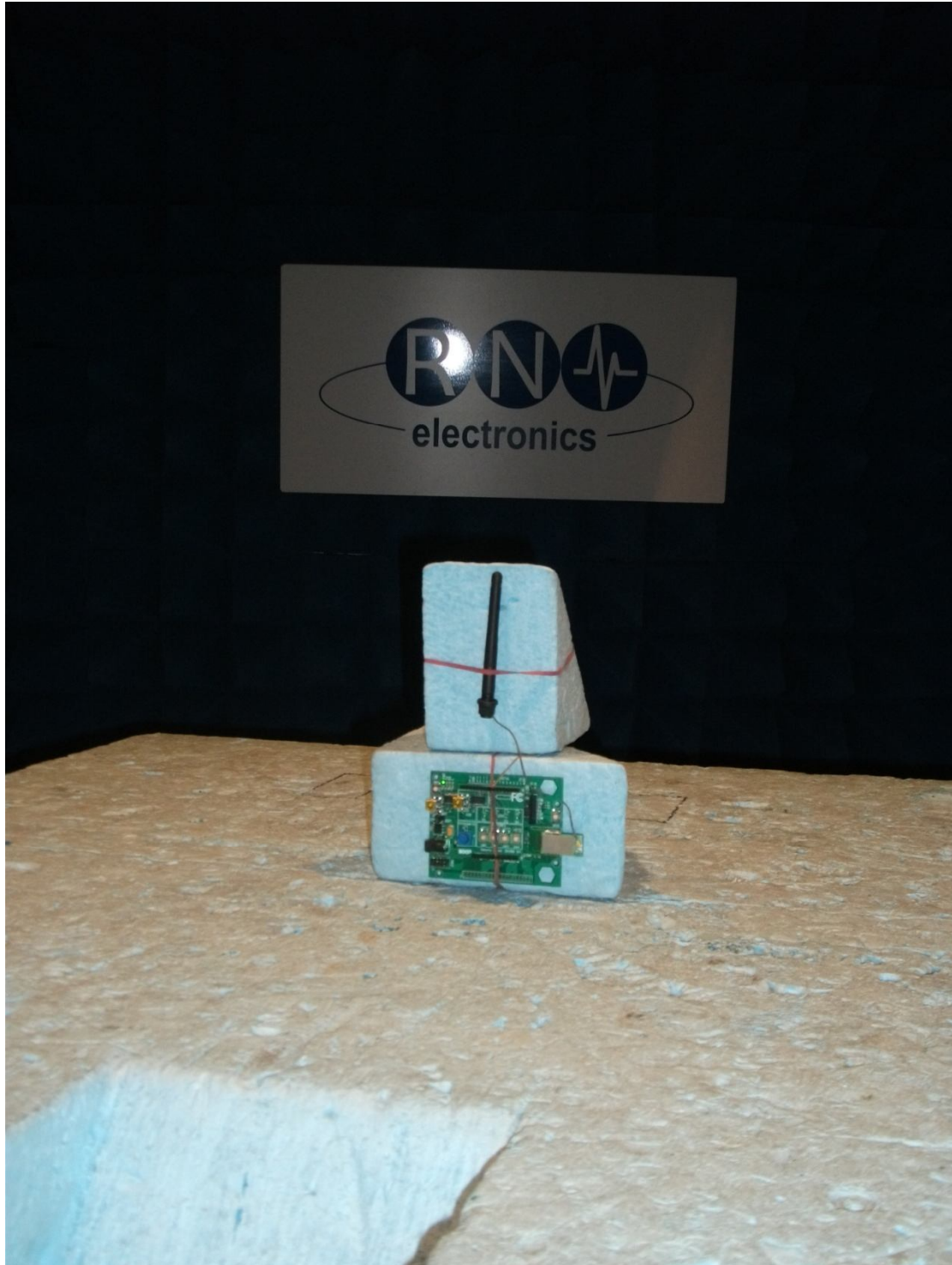

Photograph of the EUT as viewed from in front of the antenna, site M.

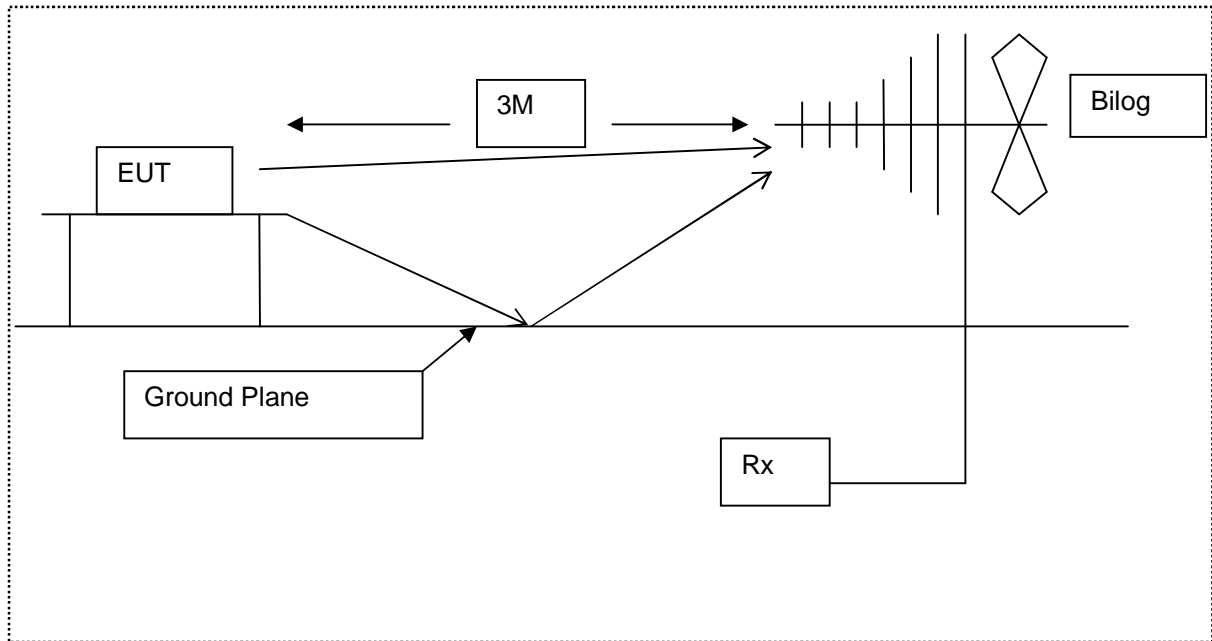
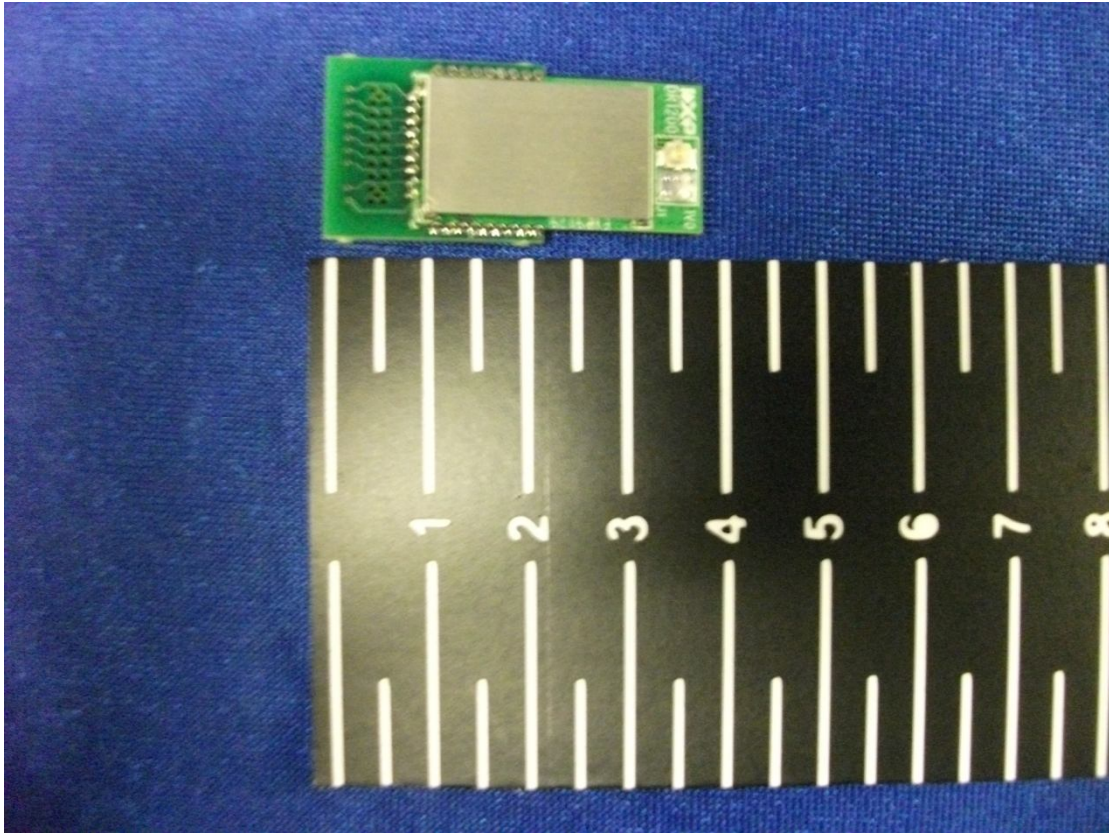
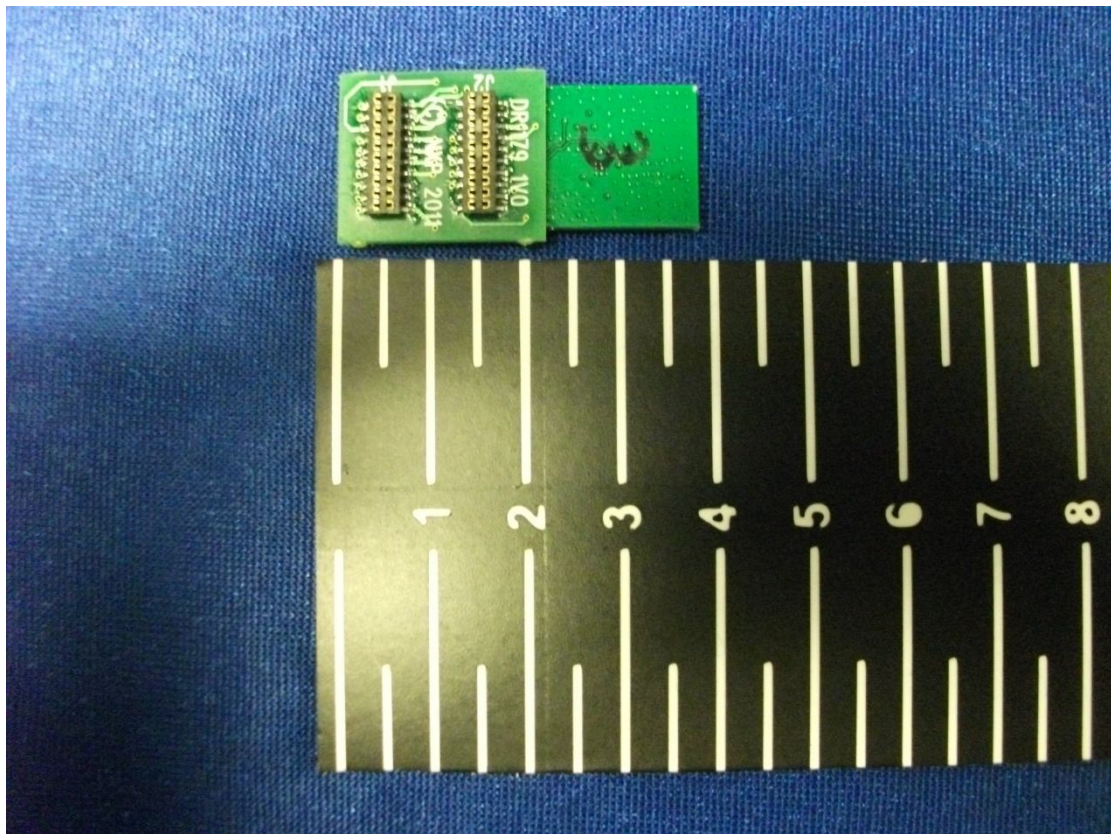

Diagram of the radiated emissions test setup, Site M
30MHz – 1GHz.

Identifying Photographs of the EUT





9 Signal Leads

Port Name	Cable Type	Connected
Header	N/A	Yes, mounted directly onto ancillary Carrier Board.

10 Test Equipment Calibration list

The following table lists the test equipment used, last calibration date and calibration interval. All test equipment used has been maintained within the calibration requirements of **R.N. Electronics Ltd.** test facility quality system. Calibration intervals are regularly reviewed dependent on equipment manufacturer's recommendations and actual usage of the equipment.

RN No.	Model	Description	Manufacturer	Period	Last Cal
E342	8563E	HP	Spectrum Analyser 26.5 GHz	24	29-Mar-11
E268	BHA 9118	Schaffner	1-18 GHz Horn Antenna	24	14-Apr-11
E410	N5181A	Agilent Technologies	3 GHz MXG Signal Generator	12	18-Oct-12
E411	N9039A	Agilent Technologies	9 kHz - 1 GHz RF Filter Section	12	18-Oct-12
E412	E4440A	Agilent Technologies	3 Hz - 26.5 GHz PSA	12	18-Oct-12
E429	-	RN Electronics	5 Switch Filter Box 0.91 GHz - 16.3 GHz	12	20-Nov-12 ¹
E492	N9038A	Agilent Technologies	20Hz - 8.4GHz MXE EMI Receiver	12	06-Feb-12
TMS78	3160-08	ETS Systems	Std Gain Horn Antenna 12.4-18 GHz	24	03-Nov-12
TMS79	3160-09	ETS Systems	Std Gain Horn Antenna 18-26.5 GHz	24	03-Nov-12
TMS82	8449B	Agilent	Pre Amplifier 1 - 26 GHz	12	19-Nov-12 ¹
TMS933	CBL6141A	York EMC	Bilog Antenna 30MHz - 2GHz	24	09-Sep-12

¹ Item was calibrated during the testing and 12 months prior.

11 Auxiliary equipment

11.1 Auxiliary equipment supplied by NXP

Auxiliary equipment used for the purpose of test supplied by the above has been listed below

Item No.	Model No.	Description	Manufacturer	Serial No.
1	DR1174	Carrier board	NXP	-
2	DR1199	Generic expansion board	NXP	-
3	PP21L	Laptop Inspiron 13000	Dell	00045-633-785-363

11.2 Auxiliary equipment supplied by RN Electronics Limited

Auxiliary equipment used for the purpose of test supplied by the above has been listed below

None.

12 Modifications

In order for the EUT to produce the results shown within this report the following modifications, if any, were implemented.

12.1 Modifications before test

There were no modifications made by R.N. Electronics Ltd before testing commenced.

12.2 Modifications during test

There were no modifications made by R.N. Electronics Ltd during testing.

13 Compliance information

Products subject to the Declaration of Conformity procedure are required to be supplied with a compliance information statement. A copy of this statement may be included here:

Not applicable. The EUT is subject to the Certification authorisation procedure.

14 Description of Test Sites

Site A	Radio / Calibration Laboratory and anechoic chamber
Site B	Semi-anechoic chamber
Site B1	Control Room for Site B
Site C	Transient Laboratory
Site D	Screened Room (Conducted Immunity)
Site E	Screened Room (Control Room for Site D)
Site F	Screened Room (Conducted Emissions) VCCI Registration No. C-2823
Site K	Screened Room (Control Room for Site M)
Site M	3m Semi-anechoic chamber (indoor OATS) FCC Registration No. 293246
Site Q	Fully-anechoic chamber
Site OATS	3m and 10m Open Area Test Site FCC Registration No. 293246 IC Registration No. 5612A-1 VCCI Registration No. R-2580
Site R	Screened Room (Conducted Immunity)
Site S	Safety Laboratory
Site T	Transient Laboratory

15 Abbreviations and Units

%	Percent	Hz	Hertz
µV	microVolts	IF	Intermediate Frequency
µW	microWatts	KHz	kiloHertz
AC	Alternating Current	LO	Local Oscillator
ALSE	Absorber Lined Screened Enclosure	mA	milliAmps
AM	Amplitude Modulation	max	maximum
Amb	Ambient	mbar	milliBars
ANSI	American National Standards Institute	MHz	MegaHertz
°C	Degrees Celsius	min	minimum
CFR	Code of Federal Regulations	mm	milliMetres
CS	Channel Spacing	ms	milliSeconds
CW	Continuous Wave	mW	milliWatts
dB	decibels	NA	Not Applicable
dBµV	decibels relative to 1µV	nom	Nominal
dBc	decibels relative to Carrier	nW	nanoWatt
dBm	decibels relative to 1mW	OATS	Open Area Test Site
DC	Direct Current	OFDM	Orthogonal Frequency Division Multiplexing
EIRP	Equivalent Isotropic Radiated Power	ppm	Parts per million
ERP	Effective Radiated Power	QAM	Quadrature Amplitude Modulation
EUT	Equipment Under Test	QPSK	Quadrature Phase Shift Keying
FCC	Federal Communications Commission	Ref	Reference
FM	Frequency Modulation	RF	Radio Frequency
FSK	Frequency Shift Keying	RTP	Room Temperature and Pressure
g	Grams	s	Seconds
GHz	GigaHertz	Tx	Transmitter
		V	Volts