

TEST REPORT
of
FCC PART 15 SUBPART E
AND CANADA RSS-247

New Application; Class I PC; Class II PC

Product : **J129 IP Deskphone**
Brand: **Avaya**
Model: **J129**
Model Difference: **N/A**
FCC ID: **TYM-J129**
IC: **3794C-J129**
FCC Rule Part: **§15.407, Cat:NII**
IC Rule Part: **RSS-247 issue 1: 2015**
 RSS-Gen issue 4: 2014
Applicant: **AVAYA**
Address: **250 Sidney Street, Belleville, Ontario k8P 3Z3,**
 Canada

Test Performed by:

International Standards Laboratory

<Lung-Tan LAB>

*Site Registration No.

BSMI: SL2-IN-E-0013; MRA TW1036; TAF: 0997; IC: IC4067B-3;

*Address:

No. 120, Lane 180, Hsin Ho Rd., Lung-Tan Dist., Tao Yuan City 325, Taiwan

*Tel : 886-3-407-1718; Fax: 886-3-407-1738

Report No.: ISL-16LR194FE

Issue Date : 2016/09/13

Test results given in this report apply only to the specific sample(s) tested and are traceable to national or international standard through calibration of the equipment and evaluating measurement uncertainty herein.

This report MUST not be used to claim product endorsement by TAF, NVLAP or any agency of the Government.

This test report shall not be reproduced except in full, without the written approval of International Standards Laboratory.

VERIFICATION OF COMPLIANCE

Applicant: AVAYA
Product Description: J129 IP Deskphone
Brand Name: Avaya
Model No.: J129
Model Difference: N/A
FCC ID: TYM-J129
IC: 3794C-J129
Date of test: 2016/07/22 ~ 2016/09/12
Date of EUT Received: 2016/07/22

We hereby certify that:

All the tests in this report have been performed and recorded in accordance with the standards described above and performed by an independent electromagnetic compatibility consultant, International Standards Laboratory.

The test results contained in this report accurately represent the measurements of the characteristics and the energy generated by sample equipment under test at the time of the test. The sample equipment tested as described in this report is in compliance with the limits of above standards.

Test By:



Date:

2016/09/13

Dino Chen / Engineer

Prepared By:



Date:

2016/09/13

Eva Kao / Technical Supervisor

Approved By:



Date:

2016/09/13

Vincent Su / Technical Manager

Version

Version No.	Date	Description
00	2016/09/13	Initial creation of document

Table of Contents

1. GENERAL INFORMATION	6
1.1. Product Description	6
1.2. Related Submittal(s) / Grant (s)	9
1.3. Test Methodology	9
1.4. Test Facility.....	9
1.5. Special Accessories	9
1.6. Equipment Modifications.....	9
2. SYSTEM TEST CONFIGURATION	10
2.1. EUT Configuration	10
2.2. EUT Exercise	10
2.3. Test Procedure.....	10
2.4. Configuration of Tested System.....	11
3. SUMMARY OF TEST RESULT	12
4. DESCRIPTION OF TEST MODES	13
5. AC POWER LINE CONDUCTED EMISSION TEST	14
5.1. Standard Applicable	14
5.2. Measurement Equipment Used:	14
5.3. EUT Setup:.....	14
5.4. Measurement Procedure:	15
5.5. Measurement Result:	15
6. OUTPUT POWER / EIRP /SPECTRAL DENSITY MEASUREMENT	18
6.1. Standard Applicable	18
6.2. Measurement Procedure.....	21
6.3. Measurement Equipment Used:	22
6.4. Measurement Equipment Used:	22
6.5. Measurement Result.....	23
7. 99% EMISSION BANDWIDTH MEASUREMENT	49
7.1. Standard Applicable	49
7.2. Measurement Procedure.....	49
7.3. Measurement Equipment Used:	49
7.4. Test Set-up:	49
7.5. Measurement Result.....	50

8.	6dB EMISSION BANDWIDTH MEASUREMENT	61
8.1.	Standard Applicable	61
8.2.	Measurement Procedure.....	61
8.3.	Measurement Equipment Used:	61
8.4.	Test Set-up:	61
8.5.	Measurement Result.....	62
9.	UNDESIRABLE EMISSION - RADIATED MEASUREMENT	68
9.1.	Standard Applicable	68
9.2.	EUT Setup.....	72
9.3.	Measurement Procedure.....	72
9.4.	Test SET-UP (Block Diagram of Configuration)	73
9.5.	Measurement Equipment Used:	74
9.6.	Field Strength Calculation	75
9.7.	Measurement Result.....	75
10.	TRANSMISSION IN THE ABSENCE OF DATA	87
10.1.	Standard Applicable	87
10.2.	Result:	87
11.	FREQUENCY STABILITY	88
11.1.	Standard Applicable	88
11.2.	Result	88
12.	ANTENNA REQUIREMENT	89
12.1.	Standard Applicable	89
12.2.	Antenna Connected Construction	90

1. GENERAL INFORMATION

1.1. Product Description

General:

Product Name:	J129 IP Deskphone
Brand Name:	Avaya
Model Name:	J129
Model Difference:	N/A
Operation Environment	Indoor used
TPC	No
DFS	No
Power Supply:	48Vdc from POE adapter

IC RSS-Gen:

Product SW version	FW_S_J129_R2_0_0_0_0b248
Product HW version	14124-1
Radio SW version	FW_S_J129_R2_0_0_0_0b248
Radio HW version	15329-1A

	FCC	IC
RF power setting in TEST SoftWare	<p>2.4G :</p> <p>b mode : low(17) mid(17) high(16) g mode : low(13) mid(13) high(13) n20 mode : low(13) mid(13) high(12) n40 mode : low(13) mid(13) high(12)</p> <p>5G :</p> <p>B1 a mode : low(17) mid(17) high(17) n20 mode : low(13) mid(13) high(13) n40 mode : low(13) high(13) ac mode : CH 42 5210MHz(12)</p> <p>B4 a mode : low(17) mid(17) high(17) n20 mode : low(13) mid(13) high(13) n40 mode : low(13) high(13) ac mode : CH 155 5775MHz(12)</p>	<p>2.4G :</p> <p>b mode : low(17) mid(17) high(16) g mode : low(13) mid(13) high(13) n20 mode : low(13) mid(13) high(12) n40 mode : low(13) mid(13) high(12)</p> <p>5G :</p> <p>B1 a mode : low(14) mid(14) high(14) n20 mode : low(11) mid(11) high(11) n40 mode : low(11) high(11) ac mode : CH 42 5210MHz(11)</p> <p>B4 a mode : low(17) mid(17) high(17) n20 mode : low(13) mid(13) high(13) n40 mode : low(13) high(13) ac mode : CH 155 5775MHz(12)</p>

Power Tolerance: +/- 1 dB

Measured Power Level for FCC

WLAN: 1TX/1RX

Wi-Fi	Frequency Range (MHz)	Channels	Peak / Average Rated Power	Modulation Technology
802.11b	2412 – 2462(DTS)	11	19.74dBm (PK)	DSSS
802.11g	2412 – 2462(DTS)	11	22.26dBm (PK)	OFDM
802.11n (2.4G)	HT20 2412 – 2462(DTS)	11	22.17dBm (PK)	
	HT40 2422 – 2452(DTS)	7	22.17dBm (PK)	
802.11a	5180 – 5240(NII)	4	17.45dBm (AV)	
	5745 – 5825(NII)	5	13.51dBm (AV)	
802.11n(5G)	HT20, 5180 – 5240(NII)	4	16.79dBm (AV)	
	HT20, 5745 – 5825(NII)	5	12.38dBm (AV)	
	HT40, 5190 – 5230(NII)	2	15.33dBm (AV)	
	HT40, 5755 – 5815(NII)	2	13.85dBm (AV)	
802.11ac	HT80, 5210(NII)	1	20.14dBm (AV)	
	HT80, 5775(NII)	1	19.87dBm (AV)	
Modulation type		CCK, DQPSK, DBPSK for DSSS 256QAM.64QAM. 16QAM, QPSK, BPSK for OFDM		
Antenna Designation		Fixed Chip Antenna WiFi 2.4G Antenna : 2.1 dBi WiFi 5G Antenna : 2.4 dBi		

The EUT is compliance with IEEE 802.11 a/b/g/n/ac Standard.

Measured Power Level for IC

WLAN: 1TX/1RX

Wi-Fi	Frequency Range (MHz)	Channels	Peak / Average Rated Power	Modulation Technology
802.11b	2412 – 2462(DTS)	11	19.74dBm (PK)	DSSS
802.11g	2412 – 2462(DTS)	11	22.26dBm (PK)	OFDM
802.11n (2.4G)	HT20 2412 – 2462(DTS)	11	22.17dBm (PK)	
	HT40 2422 – 2452(DTS)	7	22.17dBm (PK)	
802.11a	5180 – 5240(NII)	4	16.95dBm EIRP (AV)	
	5745 – 5825(NII)	5	13.51dBm (AV)	
802.11n(5G)	HT20, 5180 – 5240(NII)	4	17.17dBm EIRP (AV)	
	HT20, 5745 – 5825(NII)	5	12.38dBm (AV)	
	HT40, 5190 – 5230(NII)	2	16.27dBm EIRP (AV)	
	HT40, 5755 – 5815(NII)	2	13.85dBm (AV)	
802.11ac	HT80, 5210(NII)	1	22.54dBm EIRP (AV)	
	HT80, 5775(NII)	1	19.87dBm (AV)	
Modulation type		CCK, DQPSK, DBPSK for DSSS 256QAM.64QAM. 16QAM, QPSK, BPSK for OFDM		
Antenna Designation		Fixed Chip Antenna WiFi 2.4G Antenna : 2.1 dBi WiFi 5G Antenna : 2.4 dBi		

The EUT is compliance with IEEE 802.11 a/b/g/n/ac Standard.

This report applies for Wifi frequency band 5150 MHz– 5250 MHz, 5725 MHz– 5850 MHz

Remark: The above DUT's information was declared by manufacturer. Please refer to the specifications or user's manual for more detailed description.

1.2. Related Submittal(s) / Grant (s)

This submittal(s) (test report) is intended for FCC ID: TYM-J129 filing to comply with Section 15.407 of the FCC Part 15, Subpart E Rules. and IC: 3794C-J129 filing to comply with Industry Canada RSS-247 issue 1: 2015.

1.3. Test Methodology

Both conducted and radiated testing were performed according to the procedures in ANSI C63.10: 2013 and RSS-Gen issue 4: 2014. Radiated testing was performed at an antenna to EUT distance 3 meters.

KDB Document: 789033 D02 General UNII Test Procedures New Rules v01r03

FCC 14-30 Revision UNII

594280 D02 U-NII Device Security v01r03

1.4. Test Facility

The measurement facilities used to collect the 3m Radiated Emission and AC power line conducted data are located on the address of International Standards Laboratory <Lung-Tan LAB> No. 120, Lane 180, Hsin Ho Rd., Lung-Tan Dist., Tao Yuan City 325, Taiwan which are constructed and calibrated to meet the FCC requirements in documents ANSI C63.10: 2013. FCC Registration Number is: 872200; Designation Number is: TW1036, Canada Registration Number: 4067B-3.

1.5. Special Accessories

Not available for this EUT intended for grant.

1.6. Equipment Modifications

Not available for this EUT intended for grant.

2. SYSTEM TEST CONFIGURATION

2.1. EUT Configuration

The EUT configuration for testing is installed on RF field strength measurement to meet the Commissions requirement and operating in a manner which intends to maximize its emission characteristics in a continuous normal application.

2.2. EUT Exercise

The EUT (Transmitter) was operated in the engineering mode to fix the Tx frequency that was for the purpose of the measurements.

2.3. Test Procedure

2.3.1 Conducted Emissions

The EUT is a placed on as turn table which is 0.8 m above ground plane. According to the requirements in Section 6 of ANSI C63.10: 2013 and RSS-Gen issue 4: 2014. Con-ducted emissions from the EUT measured in the frequency range between 0.15 MHz and 30MHz using CISPR 16-1-1 Quasi-Peak and Average detector mode.

2.3.2 Radiated Emissions

The EUT is a placed on as turn table which is 0.8 m/1.5m(Frequency above 1GHz) above ground plane. The turn table shall rotate 360 degrees to determine the position of maximum emission level. EUT is set 3m away from the receiving antenna which varied from 1m to 4m to find out the highest emission. And also, each emission was to be maximized by changing the polarization of receiving antenna both horizontal and vertical. In order to find out the max. emission, the relative positions of this hand-held transmitter (EUT) was rotated through three orthogonal axes and measurement procedures for electric field radiated emissions above 1 GHz the EUT measurement is to be made “while keeping the antenna in the ‘cone of radiation’ from that area and pointed at the area both in azimuth and elevation, with polarization oriented for maximum response.” is still within the 3dB illumination BW of the measurement antenna. according to the requirements in Section 6 and 11 of ANSI C63.10: 2013

2.4. Configuration of Tested System

Fig. 2-1 Configuration of Tested System

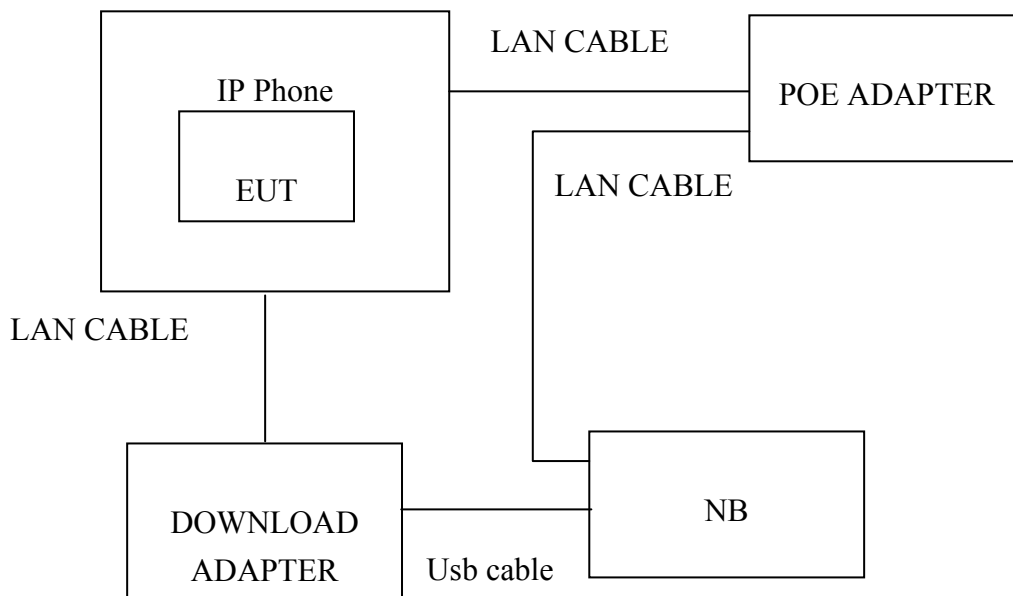

Table 1-1 Equipment Used in Tested System

Item	Equipment	Mfr/Brand	Model/ Type No.	Series No.	Data Cable	Power Cord
1	NB	Dell	LATITUDE 3340	481.06F01.0003	NA	Non-shielded
2	IP Phone	AVAYA	J129	16WZ2620003T	Non-shielded	Non-shielded
3	DOWNLOAD ADAPTER	AVAYA	FWADPT1A-003	09WZ30551803	Non-shielded	Non-shielded
4	POE adaptor	AVAYA	POE	C1531664000000 0210	Non-shielded	Non-shielded

3. SUMMARY OF TEST RESULT

FCC Rules	Description Of Test	Result
§15.207 RSS-Gen §7.2.4	AC Power Line Conducted Emission	Compliant
§15.407(a)(2) RSS-247, 6.2	Output Power/ EIRP/ Spectral Density Measurement	Compliant
§15.407(a) RSS-247, 6.2 RSS-Gen §4.6.3	26dB/99% Emission Bandwidth	Compliant
§15.407(e) RSS-247, 6.2.4 RSS-Gen §4.6.3	6dB Emission Bandwidth	Compliant
§15.407(b) RSS-247, 6.2	Undesirable Emission – Radiated Measurement	Compliant
§15.407(c) RSS-247, 6.4(2)	Transmission in case of Absence of Information	Compliant
§15.407(g)	Frequency Stability	Compliant
§15.407(a) RSS-GEN 7.1.2, RSS-247 issue 8,§A8.4	Antenna Requirement	Compliant
§15.407(d) RSS-247, 6.3	TPC and DFS Measurement	N/A
§15.407(i) RSS-247, 6.4(4)	Device Security	Compliant

4. DESCRIPTION OF TEST MODES

The EUT has been tested under operating condition.

Test program used to control the EUT for staying in continuous transmitting mode is programmed.

5150MHz-5250MHz:

a mode: Channel lowest (5180MHz) 、 Mid (5220MHz) and Highest (5240MHz) with 6Mbps data rate are chosen for full testing.

n HT 20 mode: Channel lowest (5180MHz) 、 Mid (5220MHz) and Highest (5240MHz) with 6.5Mbps data rate are chosen for full testing

n HT 40 mode: Channel lowest (5190MHz) and Highest (5230MHz) with 13.5Mbps data rate are chosen for full testing

802.11 AC HT80: Channel (5210MHz) with lowest data rate is chosen for full testing

The worst case Band 1, 802.11ac HT80 (5GHz) was reported for Radiated Emission.

5725-5850MHz:

802.11a mode: Channel low (5745MHz) 、 mid (5785MHz) and high (5825MHz) with 6Mbps lowest data rate are chosen for pre-test testing of radiated emissions.

802.11 n HT20: Channel low (5745MHz) 、 mid (5785MHz) and high (5825MHz) with 6.5Mbps lowest data rate are chosen for pre-test testing of radiated emissions.

802.11 n HT40: Channel low (5755MHz) and high (5795MHz) with 13.5Mbps lowest data rate are chosen for pre-test testing of radiated emissions.

802.11 AC HT80: Channel (5775MHz) with lowest data rate is chosen for full testing

The worst case Band 4, 802.11ac HT80 was reported for Radiated Emission.

5. AC POWER LINE CONDUCTED EMISSION TEST

5.1. Standard Applicable

According to §15.207 and RSS-Gen §8.8, frequency range within 150KHz to 30MHz shall not exceed the Limit table as below.

Frequency range MHz	Limits dB(uV)	
	Quasi-peak	Average
0.15 to 0.50	66 to 56	56 to 46
0.50 to 5	56	46
5 to 30	60	50

Note

- 1.The lower limit shall apply at the transition frequencies
- 2.The limit decreases linearly with the logarithm of the frequency in the range 0.15 MHz to 0.50 MHz.

5.2. Measurement Equipment Used:

Conducted Emission Test Site					
EQUIPMENT TYPE	MFR	MODEL NUMBER	SERIAL NUMBER	LAST CAL.	CAL DUE.
Conduction 04-3 Cable	WOKEN	CFD 300-NL	Conduction 04 -3	07/27/2016	07/26/2017
EMI Receiver 17	Rohde & Schwarz	ESCI 7	100887	09/08/2016	09/07/2017
LISN 18	ROHDE & SCHWARZ	ENV216	101424	02/11/2016	02/10/2017
LISN 19	ROHDE & SCHWARZ	ENV216	101425	03/12/2016	03/11/2017
Test Software	Farad	EZEMC Ver:ISL-03A2	N/A	N/A	N/A

5.3. EUT Setup:

1. The conducted emission tests were performed in the test site, using the setup in accordance with the ANSI C63.10: 2013
2. The AC/DC Power adaptor of EUT was plug-in LISN. The EUT was placed flushed with the rear of the table.
3. The LISN was connected with 120Vac/60Hz power source.

5.4. Measurement Procedure:

1. The EUT was placed on a table which is 0.8m above ground plane.
2. Maximum procedure was performed on the six highest emissions to ensure EUT compliance.
3. Repeat above procedures until all frequency measured were complete.

5.5. Measurement Result:

The initial step in collecting conducted data is a spectrum analyzer peak scan of the measurement range. Significant peaks are then marked as shown on the following data page, and these signals are then quasi-peaked.

Note: Refer to next page for measurement data and plots.

AC POWER LINE CONDUCTED EMISSION TEST DATA

Operation Mode:	Operation Mode	Test Date:	2016/08/15
Test By:	Lake		



Address: No. 120, Lane 180, Hsin Ho Rd., Lung-Tan Dist.,
Tao Yuan City 325, Taiwan.
Tel: 03-4071718

Conducted Emission Measurement

Date: 2016/8/15

operator: Jiin Lee
Temperature: 26 °C
Humidity: 54 %

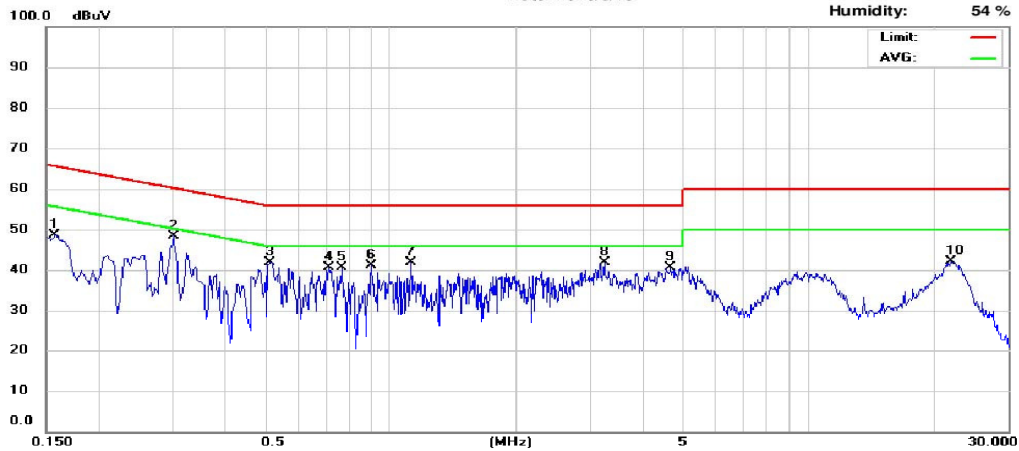

Site: Conduction 04

Phase: L7

Limit: CISPR22 Class B Conduction(QP)

No.	Frequency (MHz)	QP_R (dBuV)	AVG_R (dBuV)	Correct Factor (dB)	QP Emission (dBuV)	QP Limit (dBuV)	QP Margin (dB)	AVG Emission (dBuV)	AVG Limit (dBuV)	AVG Margin (dB)
1	0.158	34.34	18.14	9.69	44.03	65.57	-21.54	27.83	55.57	-27.74
2	0.302	39.62	37.84	9.69	49.31	60.19	-10.88	47.53	50.19	-2.66
3	0.518	28.37	22.50	9.70	38.07	56.00	-17.93	32.20	46.00	-13.80
4	0.714	25.97	21.53	9.71	35.68	56.00	-20.32	31.24	46.00	-14.76
5	0.766	22.05	6.75	9.72	31.77	56.00	-24.23	16.47	46.00	-29.53
6	0.902	24.24	17.49	9.72	33.96	56.00	-22.04	27.21	46.00	-18.79
7	1.122	26.83	24.50	9.72	36.55	56.00	-19.45	34.22	46.00	-11.78
8	3.254	28.97	23.56	9.79	38.76	56.00	-17.24	33.35	46.00	-12.65
9	4.690	28.20	24.48	9.83	38.03	56.00	-17.97	34.31	46.00	-11.69
10	21.990	29.54	25.47	10.08	39.62	60.00	-20.38	35.55	50.00	-14.45



Address: No. 120, Lane 180, Hsin Ho Rd., Lung-Tan Dist.,
Tao Yuan City 325, Taiwan.
Tel: 03-4071718

Conducted Emission Measurement

Date: 2016/8/15

operator: Jiin Lee
Temperature: 26 °C
Humidity: 54 %

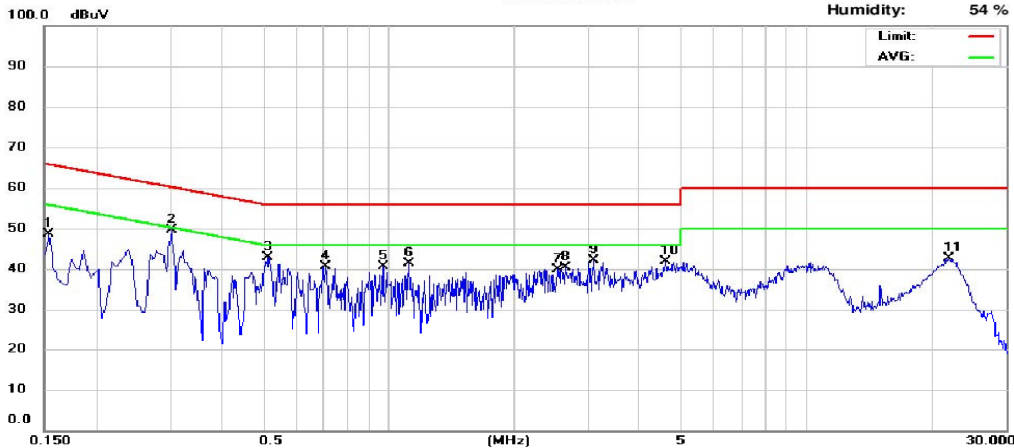

Site: Conduction 04

Phase: N

Limit: CISPR22 Class B Conduction(QP)

No.	Frequency (MHz)	QP_R (dBuV)	AVG_R (dBuV)	Correct Factor (dB)	QP Emission (dBuV)	QP Limit (dBuV)	QP Margin (dB)	AVG Emission (dBuV)	AVG Limit (dBuV)	AVG Margin (dB)
1	0.154	34.35	25.57	9.68	44.03	65.78	-21.75	35.25	55.78	-20.53
2	0.302	39.60	38.18	9.68	49.28	60.19	-10.91	47.86	50.19	-2.33
3	0.518	28.60	24.04	9.69	38.29	56.00	-17.71	33.73	46.00	-12.27
4	0.706	24.85	18.79	9.69	34.54	56.00	-21.46	28.48	46.00	-17.52
5	0.970	27.08	24.45	9.70	36.78	56.00	-19.22	34.15	46.00	-11.85
6	1.122	26.44	24.18	9.70	36.14	56.00	-19.86	33.88	46.00	-12.12
7	2.542	27.07	19.07	9.76	36.83	56.00	-19.17	28.83	46.00	-17.17
8	2.650	28.55	22.80	9.76	38.31	56.00	-17.69	32.56	46.00	-13.44
9	3.102	28.48	21.54	9.77	38.25	56.00	-17.75	31.31	46.00	-14.69
10	4.606	28.48	24.72	9.82	38.30	56.00	-17.70	34.54	46.00	-11.46
11	21.934	29.98	25.85	10.20	40.18	60.00	-19.82	36.05	50.00	-13.95

6. OUTPUT POWER / EIRP /SPECTRAL DENSITY MEASUREMENT

6.1. Standard Applicable

According to §15.407(a) Power limits:

(1) For the band 5.15-5.25 GHz.

(i) For an outdoor access point operating in the band 5.15 – 5.25 GHz, the maximum conducted output power over the frequency band of operation shall not exceed 1 W provided the maximum antenna gain does not exceed 6 dBi. In addition, the maximum power spectral density shall not exceed 17 dBm in any 1 megahertz band. If transmitting antennas of directional gain greater than 6 dBi are used, both the maximum conducted output power and the maximum power spectral density shall be reduced by the amount in dB that the directional gain of the antenna exceeds 6 dBi. The maximum e.i.r.p. at any elevation angle above 30 degrees as measured from the horizon must not exceed 125 mW (21 dBm).

(ii) For an indoor access point operating in the band 5.15 – 5.25 GHz, the maximum conducted output power over the frequency band of operation shall not exceed 1 W provided the maximum antenna gain does not exceed 6 dBi. In addition, the maximum power spectral density shall not exceed 17 dBm in any 1 megahertz band. If transmitting antennas of directional gain greater than 6 dBi are used, both the maximum conducted output power and the maximum power spectral density shall be reduced by the amount in dB that the directional gain of the antenna exceeds 6 dBi.

(iii) For fixed point-to-point access points operating in the band 5.15 – 5.25 GHz, the maximum conducted output power over the frequency band of operation shall not exceed 1 W. Fixed point-to-point U-NII devices may employ antennas with directional gain up to 23 dBi without any corresponding reduction in the maximum conducted output power or maximum power spectral density. For fixed point-to-point transmitters that employ a directional antenna gain greater than 23 dBi, a 1 dB reduction in maximum conducted output power and maximum power spectral density is required for each 1 dB of antenna gain in excess of 23 dBi. Fixed, point-to-point operations exclude the use of point-to-multipoint systems, omnidirectional applications, and multiple collocated transmitters transmitting the same information. The operator of the U-NII device, or if the equipment is professionally installed, the installer, is responsible for ensuring that systems employing high gain directional antennas are used exclusively for fixed, point-to-point operations.

(iv) For mobile and portable client devices in the 5.15 – 5.25 GHz band, the maximum conducted output power over the frequency band of operation shall not exceed 250 mW provided the maximum antenna gain does not exceed 6 dBi. In addition, the maximum power spectral density shall not exceed 11 dBm in any 1 megahertz band. If transmitting antennas of directional gain greater than 6 dBi are used, both the maximum conducted output power and the maximum power spectral density shall be reduced by the amount in dB that the directional gain of the antenna exceeds 6 dBi.

(2) For the 5.25-5.35 GHz and 5.47-5.725 GHz bands, the maximum conducted output power over the frequency bands of operation shall not exceed the lesser of 250 mW or $11 \text{ dBm} + 10 \log B$, where B is the 26 dB emission bandwidth in megahertz. In addition, the maximum power spectral density shall not exceed 11 dBm in any 1 megahertz band. If transmitting antennas of directional gain greater than 6 dBi are used, both the maximum conducted output power and the maximum power spectral density shall be reduced by the amount in dB that the directional gain of the antenna exceeds 6 dBi.

(3) For the band 5.725-5.85 GHz, the maximum conducted output power over the frequency band of operation shall not exceed 1 W. In addition, the maximum power spectral density shall not exceed 30 dBm in any 500 kHz band. If transmitting antennas of directional gain greater than 6 dBi are used, both the maximum conducted output power and the maximum power spectral density shall be reduced by the amount in dB that the directional gain of the antenna exceeds 6 dBi. However, fixed point-to-point U-NII devices operating in this band may employ transmitting antennas with directional gain greater than 6 dBi without any corresponding reduction in transmitter conducted power. Fixed, point-to-point operations exclude the use of point-to-multipoint systems, omnidirectional applications, and multiple collocated transmitters transmitting the same information. The operator of the U-NII device, or if the equipment is professionally installed, the installer, is responsible for ensuring that systems employing high gain directional antennas are used exclusively for fixed, point-to-point operations.

NOTE TO PARAGRAPH (a)(3): The Commission strongly recommends that parties employing U-NII devices to provide critical communications services should determine if there are any nearby Government radar systems that could affect their operation.

According to RSS-247

6.2.1 Frequency Band 5150-5250 MHz

The maximum e.i.r.p. shall not exceed 200 mW or $10 + 10 \log_{10} B$, dBm, whichever power is less. B is the 99% emission bandwidth in megahertz. The e.i.r.p. spectral density shall not exceed 10 dBm in any 1.0 MHz band.

6.2.2 Frequency Band 5250-5350 MHz

The maximum conducted output power shall not exceed 250 mW or $11 + 10 \log_{10} B$, dBm, whichever is less. The power spectral density shall not exceed 11 dBm in any 1.0 MHz band.

The maximum e.i.r.p. shall not exceed 1.0 W or $17 + 10 \log_{10} B$, dBm, whichever is less. B is the 99% emission bandwidth in megahertz. Note that devices with a maximum e.i.r.p. greater than 500 mW shall implement TPC in order to have the capability to operate at least 6 dB below the maximum permitted e.i.r.p. of 1 W.

6.2.3 Frequency Bands 5470-5600 MHz and 5650-5725 MHz

The maximum conducted output power shall not exceed 250 mW or $11 + 10 \log_{10} B$, dBm, whichever is less. The power spectral density shall not exceed 11 dBm in any 1.0 MHz band.

The maximum e.i.r.p. shall not exceed 1.0 W or $17 + 10 \log_{10} B$, dBm, whichever is less. B is the 99% emission bandwidth in megahertz. Note that devices with a maximum e.i.r.p. greater than 500 mW shall implement TPC in order to have the capability to operate at least 6 dB below the maximum permitted e.i.r.p. of 1 W.

6.2.4 Frequency Band 5725-5850 MHz

The maximum conducted output power shall not exceed 1 W.

The power spectral density shall not exceed 30 dBm in any 500 kHz band. If transmitting antennas of directional gain greater than 6 dBi are used, both the maximum conducted output power and the power spectral density shall be reduced by the amount in dB that the directional gain of the antenna exceeds 6 dBi. However, fixed point-to-point devices operating in this band may employ transmitting antennas with directional gain greater than 6 dBi without any corresponding reduction in transmitter conducted power. Fixed point-to-point operations exclude the use of point-to-multipoint systems, omnidirectional applications and multiple collocated transmitters transmitting the same information.

6.2. Measurement Procedure

For Output Power

1. Place the EUT on the table and set it in transmitting mode.
2. Remove the antenna from the EUT and then connect a low loss RF cable from the antenna port to the power meter
3. Record the max. reading.
4. Repeat above procedures until all frequency measured were complete.

For Power Spectral Density

1. Place the EUT on the table and set it in transmitting mode.
2. Remove the antenna from the EUT and then connect a low loss RF cable from the antenna port to Spectrum.
3. Set RBW=1MHz,VBW=3MHz, Span=50MHz (Base Mode), Sweep time = Auto, traces 100 sweeps of video averaging for 5150-5725MHz;
4. Set RBW=500KHz,VBW=1.5MHz, Span=60MHz (Base Mode), Sweep time = Auto, traces 100 sweeps of video averaging for 5725-5850MHz;
5. Record the max. reading.
6. Repeat above procedures until all frequency measured were complete.

Refer to section E3 of KDB Document: KDB 789033 D02 General UNII Test Procedures New Rules v01r03

6.3. Measurement Equipment Used:

Conducted Emission Test Site					
EQUIPMENT TYPE	MFR	MODEL NUMBER	SERIAL NUMBER	LAST CAL.	CAL DUE.
Power Meter 05	Anritsu	ML2495A	1116010	07/28/2016	07/27/2017
Power Sensor 05	Anritsu	MA2411B	34NKF50	07/28/2016	07/27/2017
Power Sensor 06	DARE	RPR3006W	13I00030SNO3 3	11/03/2015	11/02/2016
Power Sensor 07	DARE	RPR3006W	13I00030SNO3 4	11/03/2015	11/02/2016
Temperature Chamber	KSON	THS-B4H100	2287	06/28/2016	06/27/2017
DC Power supply	ABM	8185D	N/A	09/05/2016	09/04/2017
AC Power supply	EXTECH	CFC105W	NA	12/26/2015	12/25/2016
Attenuator	Woken	Watt-65m3502	11051601	NA	NA
Splitter	MCLI	PS4-199	12465	12/26/2015	12/25/2017
Spectrum analyzer	Agilent	N9030A	MY51360021	10/02/2015	10/01/2016
Test Software	DARE	Radimation Ver:2013.1.23	NA	NA	NA

6.4. Measurement Equipment Used:

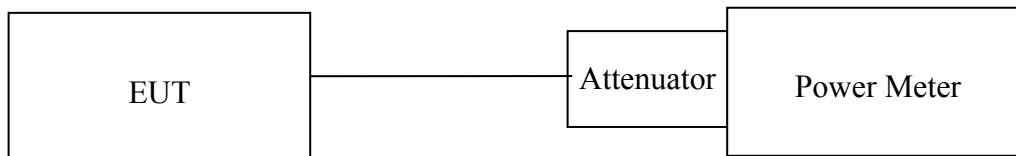

6.5. Measurement Result

FCC

Average Power Measurement:

802.11a

Channel	power (dBm)	limit(dBm)	result
5180	17.15	23.97	pass
5220	17.37	23.97	pass
5240	17.45	23.97	pass
5745	13.46	30	pass
5785	13.39	30	pass
5825	13.51	30	pass

802.11n HT20

Freq(MHz)	power (dBm)	limit(dBm)	result
5180	16.73	23.97	pass
5220	16.79	23.97	pass
5240	16.68	23.97	pass
5745	12.23	30	pass
5785	12.38	30	pass
5825	12.13	30	pass

802.11n HT40

Freq(MHz)	power (dBm)	limit(dBm)	result
5190	15.29	23.97	pass
5230	15.33	23.97	pass
5755	13.85	30	pass
5795	13.79	30	pass

802.11AC HT80

Freq(MHz)	power (dBm)	limit(dBm)	result
5210	20.14	23.97	pass
5775	19.87	30	pass

FCC

Power Spectral Density Measurement:

BAND 1

802.11a Mode

Frequency MHz	RF Power Density Reading (dBm/MHz)	Cable loss (dB)	Maximum Limit (dBm/MHz)
5180	10.294	0.00	11
5220	10.209	0.00	11
5240	10.053	0.00	11

802.11n HT20

Frequency MHz	RF Power Density Reading (dBm/MHz)	Cable loss (dB)	Maximum Limit (dBm/MHz)
5180	9.948	0.00	11
5220	10.198	0.00	11
5240	10.136	0.00	11

802.11n HT40 Mode

Frequency MHz	RF Power Density Reading (dBm/MHz)	Cable loss (dB)	Maximum Limit (dBm/MHz)
5190	9.743	0.00	11
5230	9.561	0.00	11

802.11AC HT80 Mode

Frequency MHz	RF Power Density Reading (dBm/MHz)	Cable loss (dB)	Maximum Limit (dBm/MHz)
5210	6.495	0.00	11

FCC

Power Spectral Density Measurement:

BAND 4

802.11a Mode

Frequency MHz	RF Power Density Reading (dBm/500KHz)	Cable loss (dB)	Maximum Limit (dBm/500KHz)
5745	5.052	0.00	30
5785	5.394	0.00	30
5825	5.505	0.00	30

802.11n HT20

Frequency MHz	RF Power Density Reading (dBm/500KHz)	Cable loss (dB)	Maximum Limit (dBm/500KHz)
5745	4.678	0.00	30
5785	4.483	0.00	30
5825	5.768	0.00	30

802.11n HT40 Mode

Frequency MHz	RF Power Density Reading (dBm/500KHz)	Cable loss (dB)	Maximum Limit (dBm/500KHz)
5755	1.708	0.00	30
5795	2.450	0.00	30

802.11AC HT80 Mode

Frequency MHz	RF Power Density Reading (dBm/500KHz)	Cable loss (dB)	Maximum Limit (dBm/500KHz)
5775	-0.481	0.00	30

IC

Average Power Measurement:

802.11a

Channel	conducted power (dBm)	conducted power limit(dBm)	EIRP(dBm)	EIRP limit(dBm)
5180	14.55	NA	16.95	23.01
5220	14.47	NA	16.87	23.01
5240	14.49	NA	16.89	23.01
5745	13.46	30	15.86	NA
5785	13.39	30	15.79	NA
5825	13.51	30	15.91	NA

802.11n HT20

Freq(MHz)	conducted power (dBm)	conducted power limit(dBm)	EIRP(dBm)	EIRP limit(dBm)
5180	14.32	NA	16.72	23.01
5220	14.54	NA	16.94	23.01
5240	14.77	NA	17.17	23.01
5745	12.23	30	14.63	NA
5785	12.38	30	14.78	NA
5825	12.13	30	14.53	NA

802.11n HT40

Freq(MHz)	conducted power (dBm)	conducted power limit(dBm)	EIRP(dBm)	EIRP limit(dBm)
5190	13.87	NA	16.27	23.01
5230	13.66	NA	16.06	23.01
5755	13.85	30	16.25	NA
5795	13.79	30	16.19	NA

802.11AC HT80

Freq(MHz)	conducted power (dBm)	conducted power limit(dBm)	EIRP(dBm)	EIRP limit(dBm)
5210	20.14	NA	22.54	23.01
5775	19.87	30	22.27	NA

EIRP Power = Conducted Power + Antenna Gain

IC

Power Spectral Density Measurement:

BAND 1

802.11a Mode

Frequency MHz	RF Power Density Reading (dBm/MHz)	Conducted Limit (dBm/MHz)	EIRP Density (dBm/MHz)	EIRP Density Limit (dBm/MHz)
5180	6.450	NA	8.85	10
5220	6.627	NA	9.03	10
5240	6.555	NA	8.96	10

802.11n HT20

Frequency MHz	RF Power Density Reading (dBm/MHz)	Conducted Limit (dBm/MHz)	EIRP Density (dBm/MHz)	EIRP Density Limit (dBm/MHz)
5180	6.170	NA	8.57	10
5220	6.474	NA	8.87	10
5240	6.439	NA	8.84	10

802.11n HT40 Mode

Frequency MHz	RF Power Density Reading (dBm/MHz)	Conducted Limit (dBm/MHz)	EIRP Density (dBm/MHz)	EIRP Density Limit (dBm/MHz)
5190	6.128	NA	8.53	10
5230	5.942	NA	8.34	10

802.11AC HT80 Mode

Frequency MHz	RF Power Density Reading (dBm/MHz)	Conducted Limit (dBm/MHz)	EIRP Density (dBm/MHz)	EIRP Density Limit (dBm/MHz)
5210	6.495	NA	8.90	10

IC

Power Spectral Density Measurement:

BAND 4

802.11a Mode

Frequency MHz	RF Power Density Reading (dBm/500KHz)	Conducted Limit (dBm/500KHz)	EIRP Density (dBm/500KHz)	EIRP Density Limit (dBm/500KHz)
5745	5.052	30	7.45	NA
5785	5.394	30	7.79	NA
5825	5.505	30	7.91	NA

802.11n HT20

Frequency MHz	RF Power Density Reading (dBm/500KHz)	Conducted Limit (dBm/500KHz)	EIRP Density (dBm/500KHz)	EIRP Density Limit (dBm/500KHz)
5745	4.678	30	7.08	NA
5785	4.483	30	6.88	NA
5825	5.768	30	8.17	NA

802.11n HT40 Mode

Frequency MHz	RF Power Density Reading (dBm/500KHz)	Conducted Limit (dBm/500KHz)	EIRP Density (dBm/500KHz)	EIRP Density Limit (dBm/500KHz)
5755	1.708	30	4.11	NA
5795	2.450	30	4.85	NA

802.11AC HT80 Mode

Frequency MHz	RF Power Density Reading (dBm/500KHz)	Conducted Limit (dBm/500KHz)	EIRP Density (dBm/500KHz)	EIRP Density Limit (dBm/500KHz)
5775	-0.481	30	1.92	NA

FCC: BAND 1

802.11a

Power Spectral Density Data Plot (CH Low)

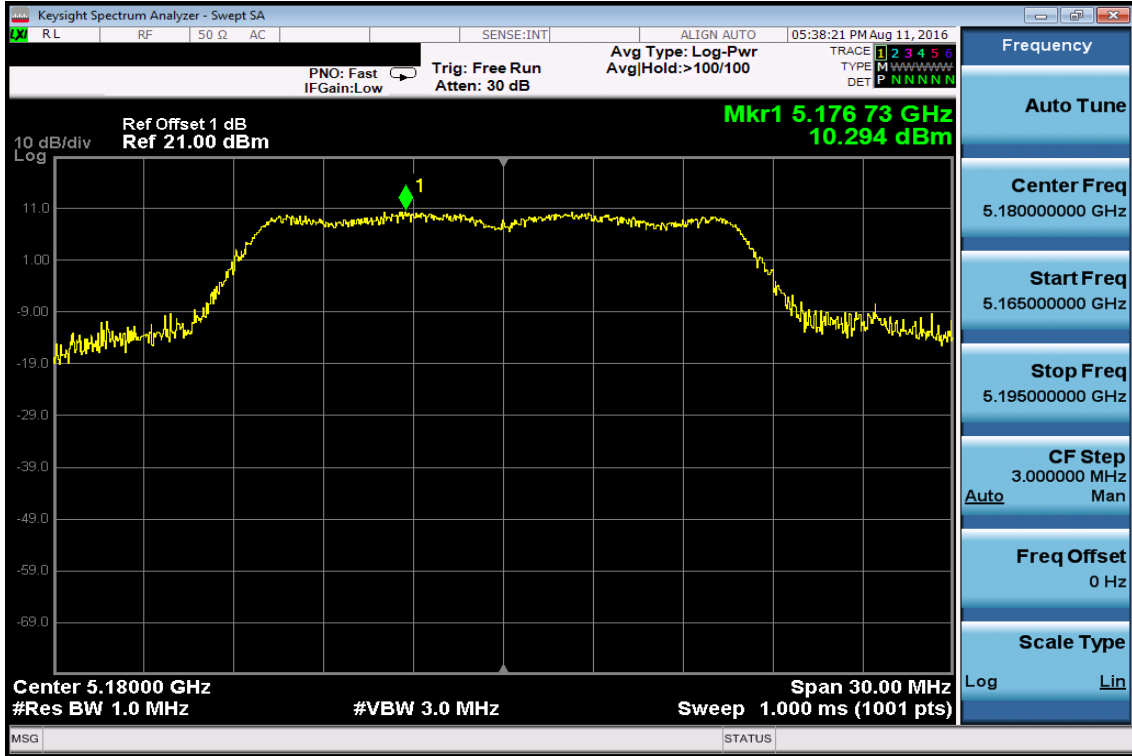

Power Spectral Density Data Plot (CH Mid)

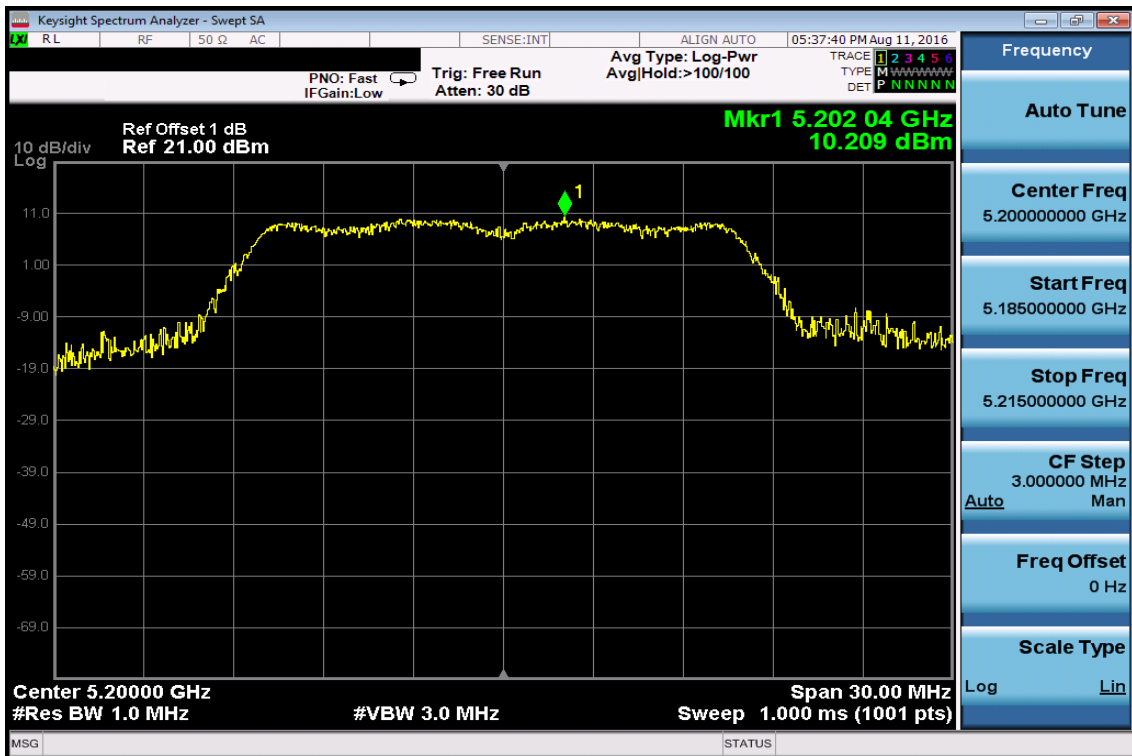

Power Spectral Density Data Plot (CH High)

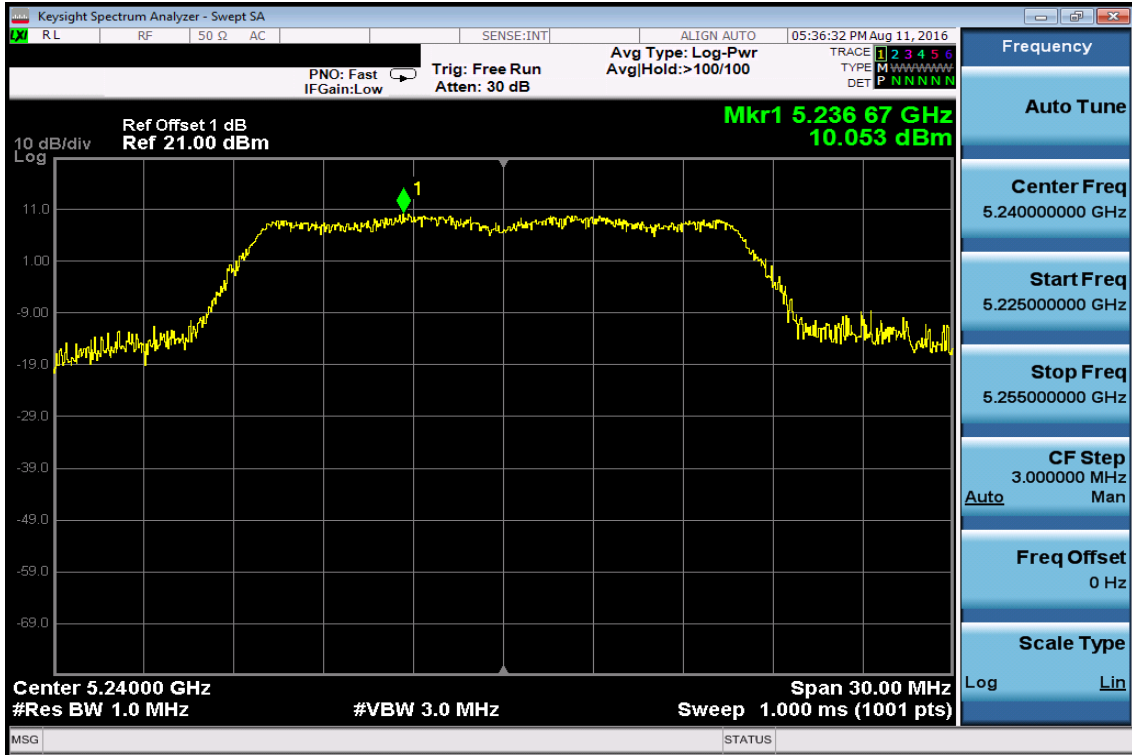

802.11n HT20

Power Spectral Density Test Plot (CH-Low)

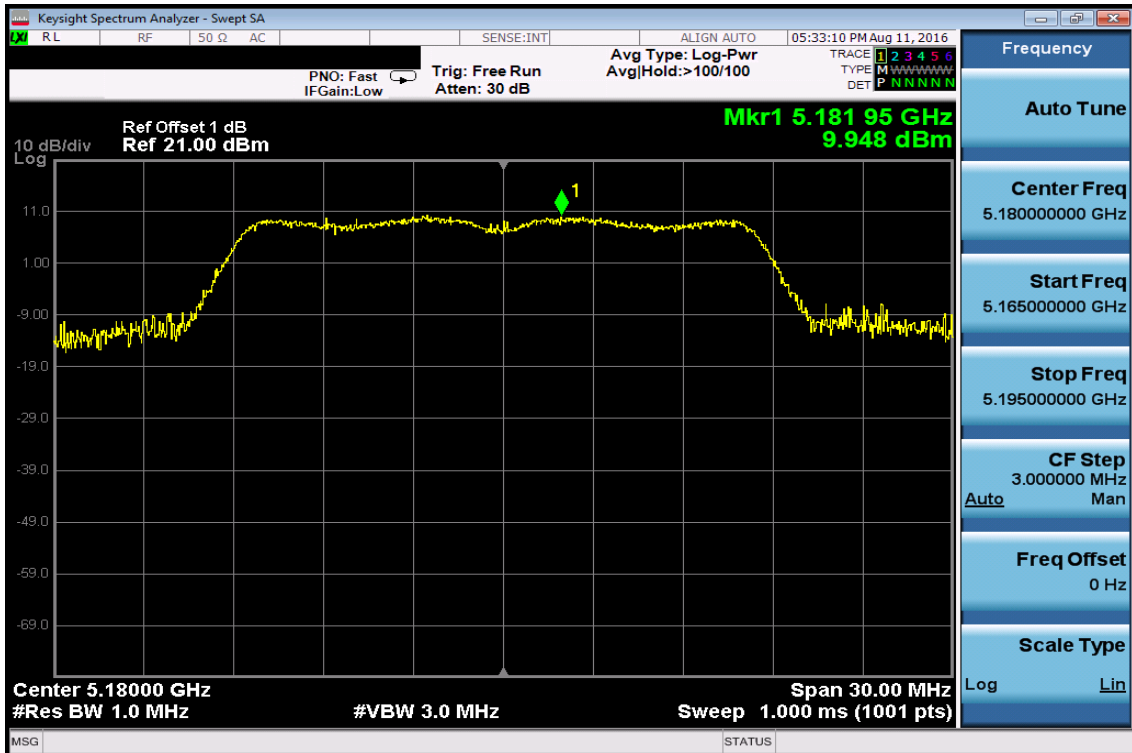

Power Spectral Density Test Plot (CH-Mid)

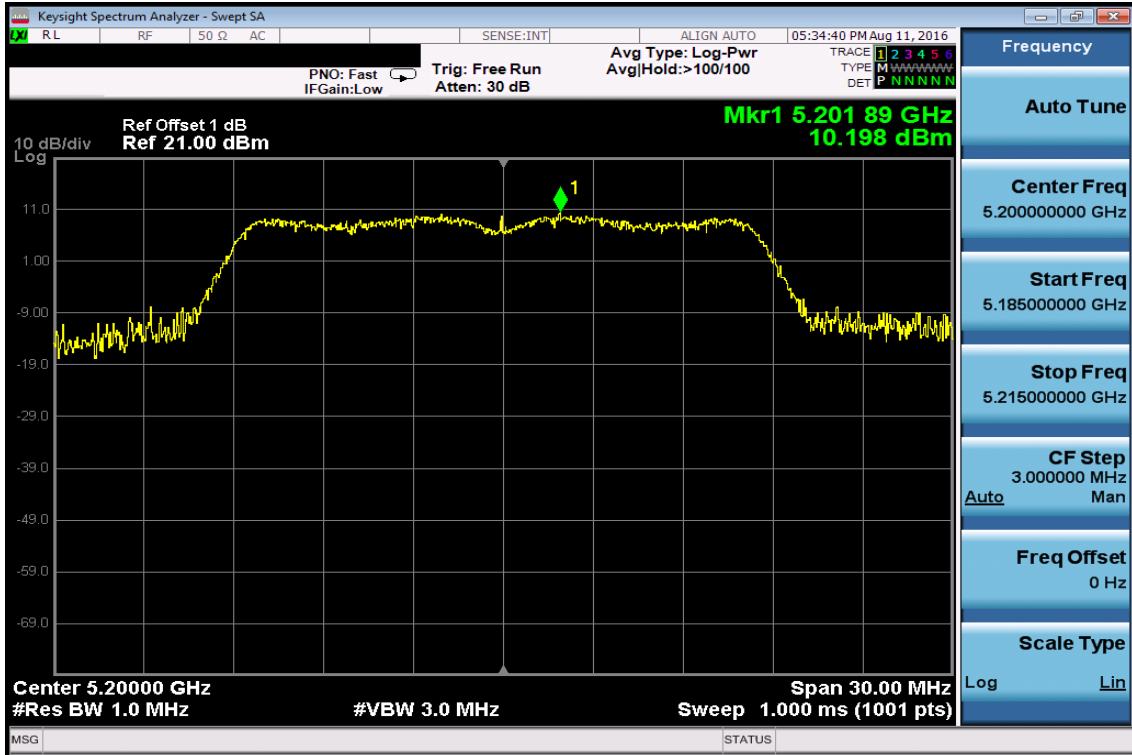

Power Spectral Density Test Plot (CH-High)

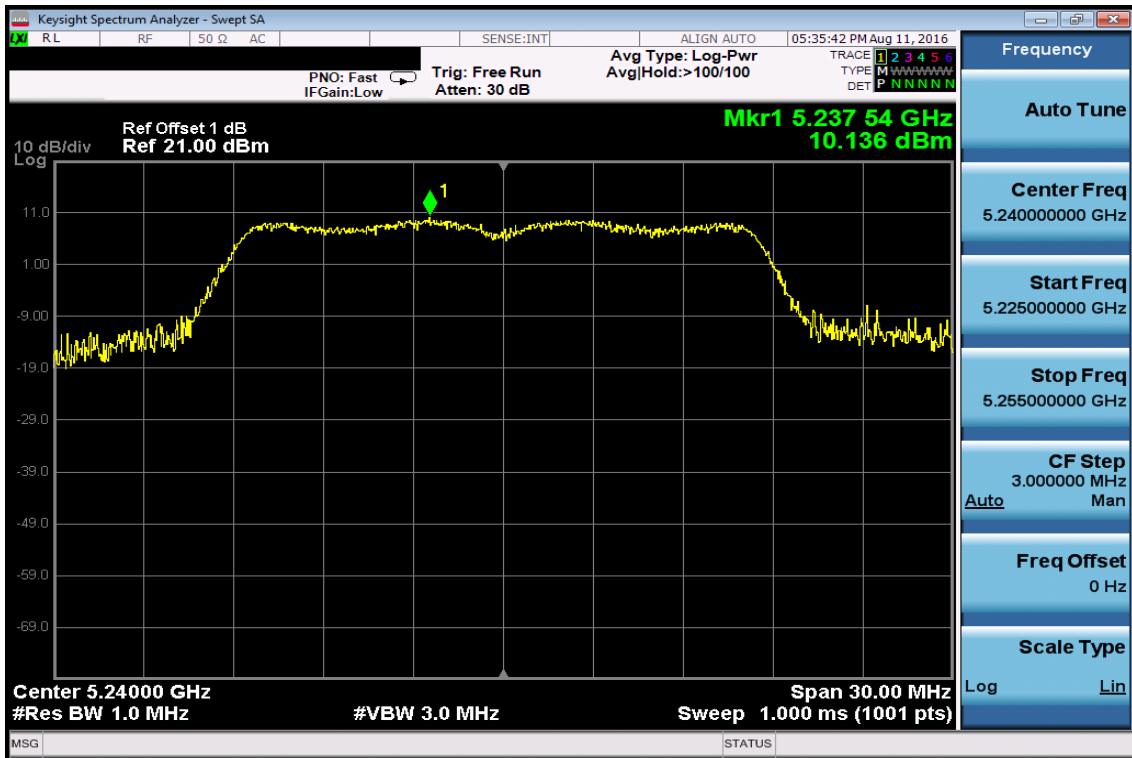

802.11AC HT80 Power Spectral Density Test Plot

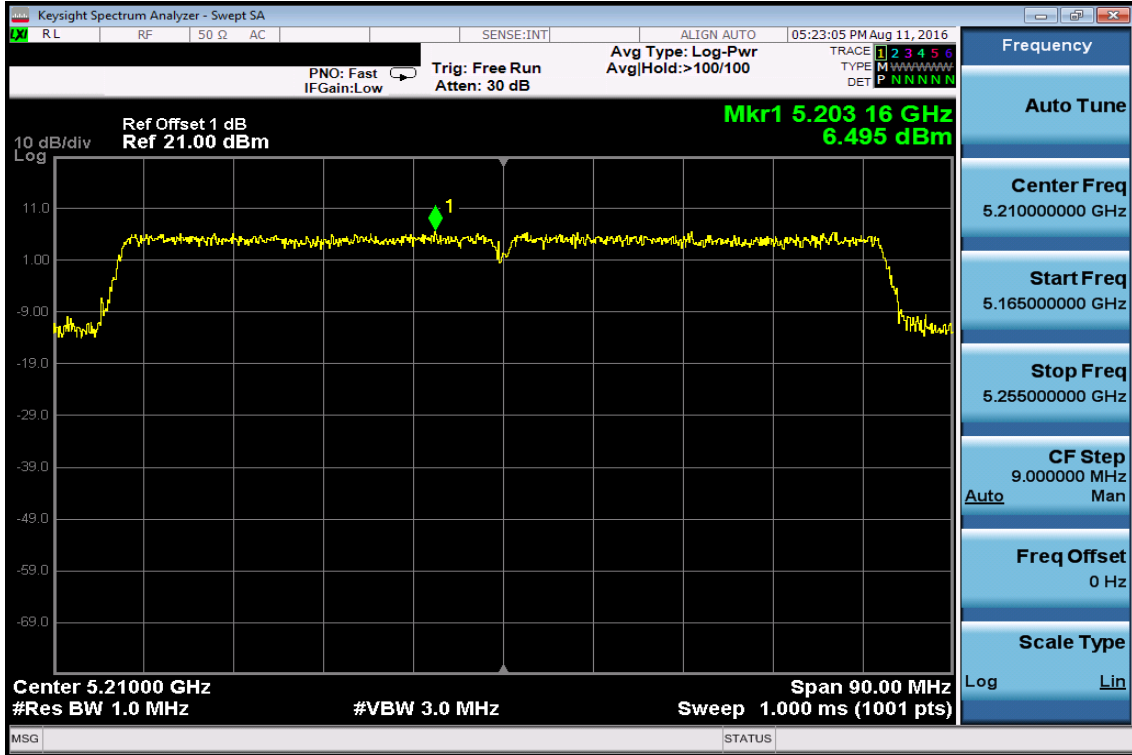

FCC: BAND 4

802.11a

Power Spectral Density Data Plot (CH Low)

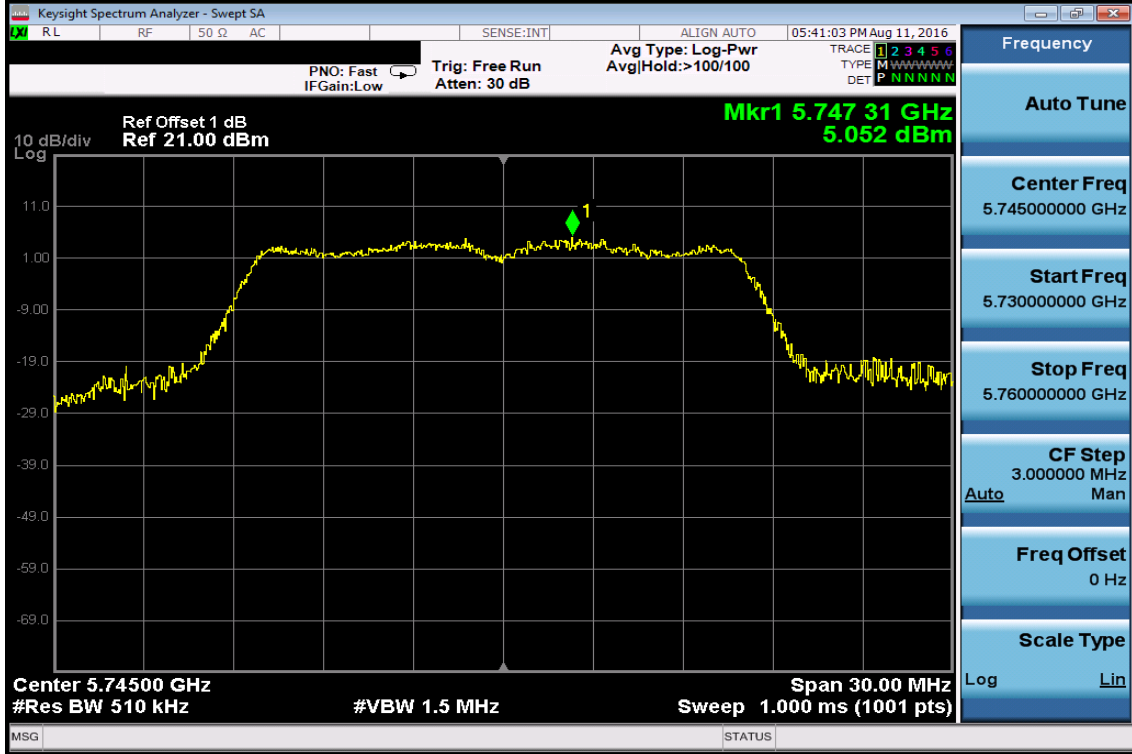

Power Spectral Density Data Plot (CH Mid)

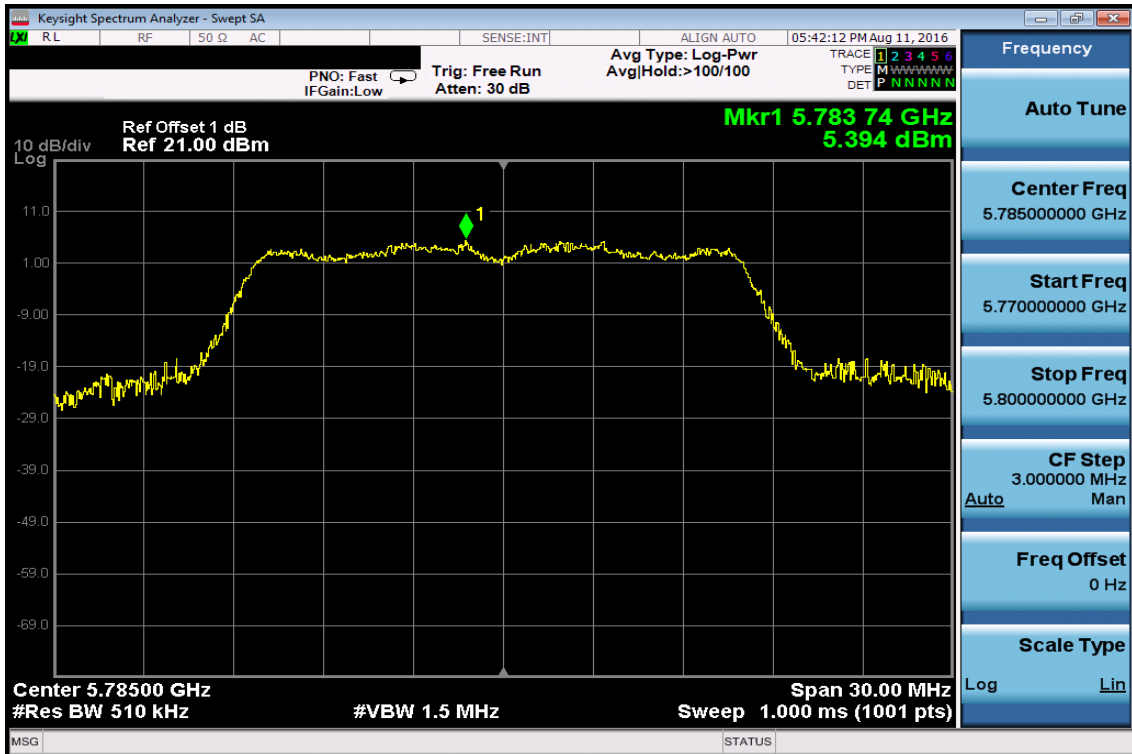

Power Spectral Density Data Plot (CH High)

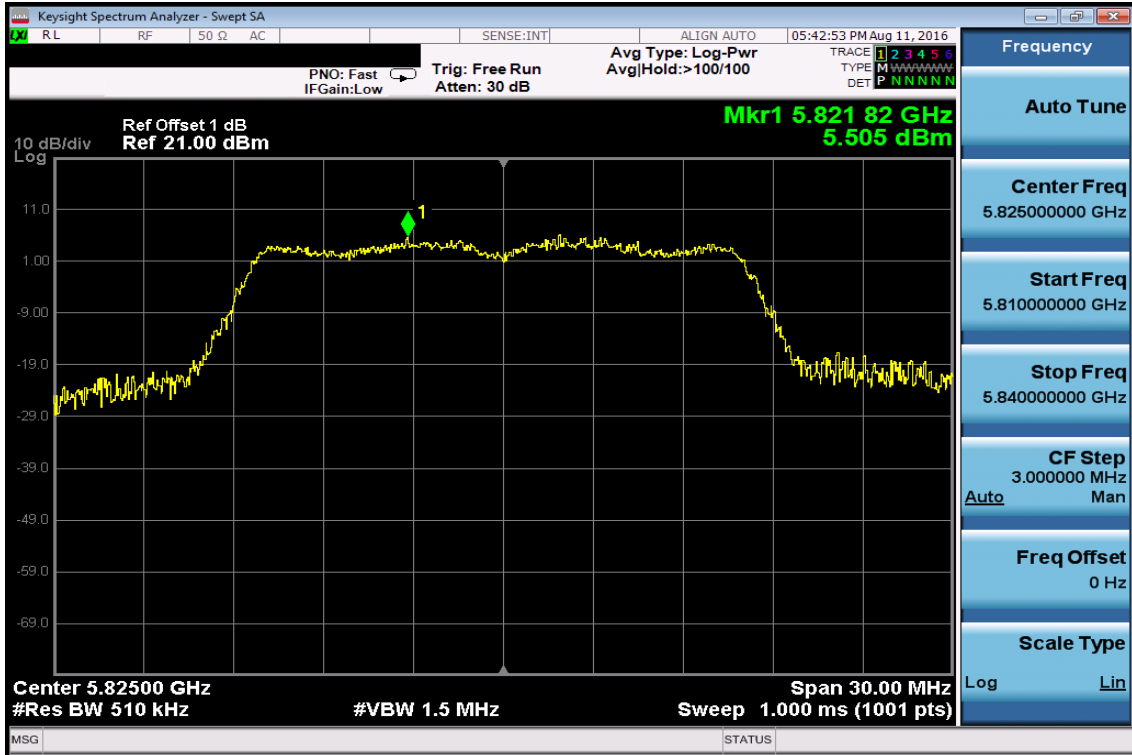

802.11n HT20

Power Spectral Density Test Plot (CH-Low)

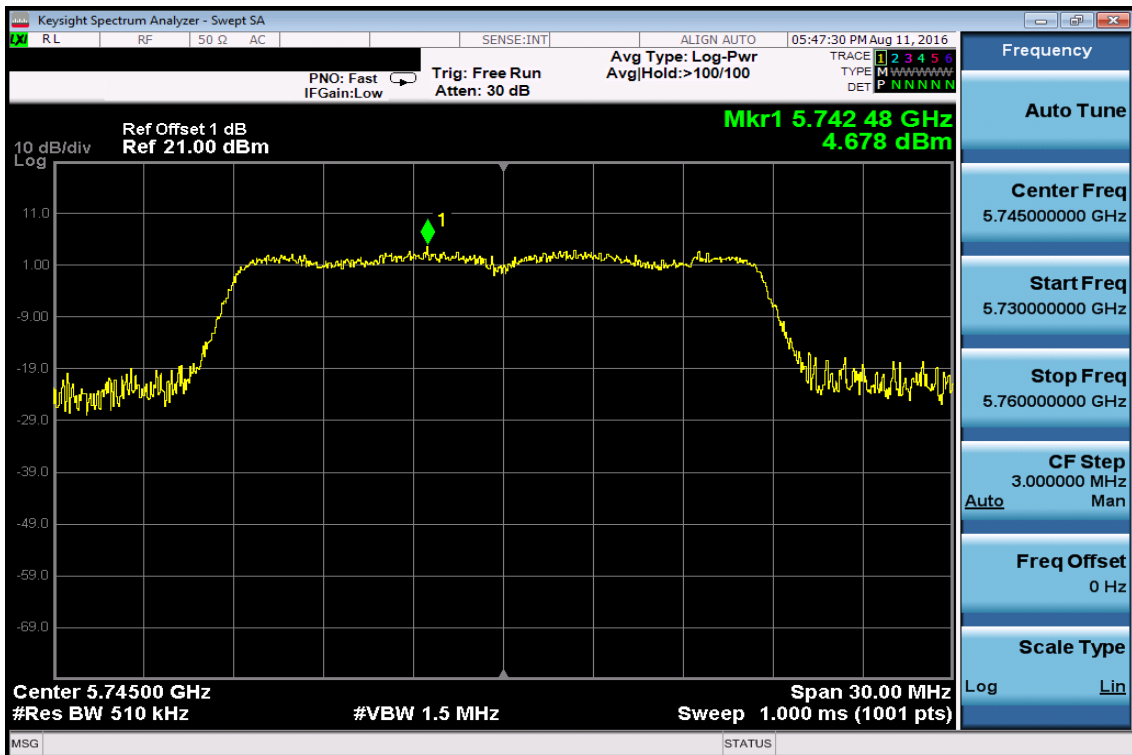

Power Spectral Density Test Plot (CH-Mid)

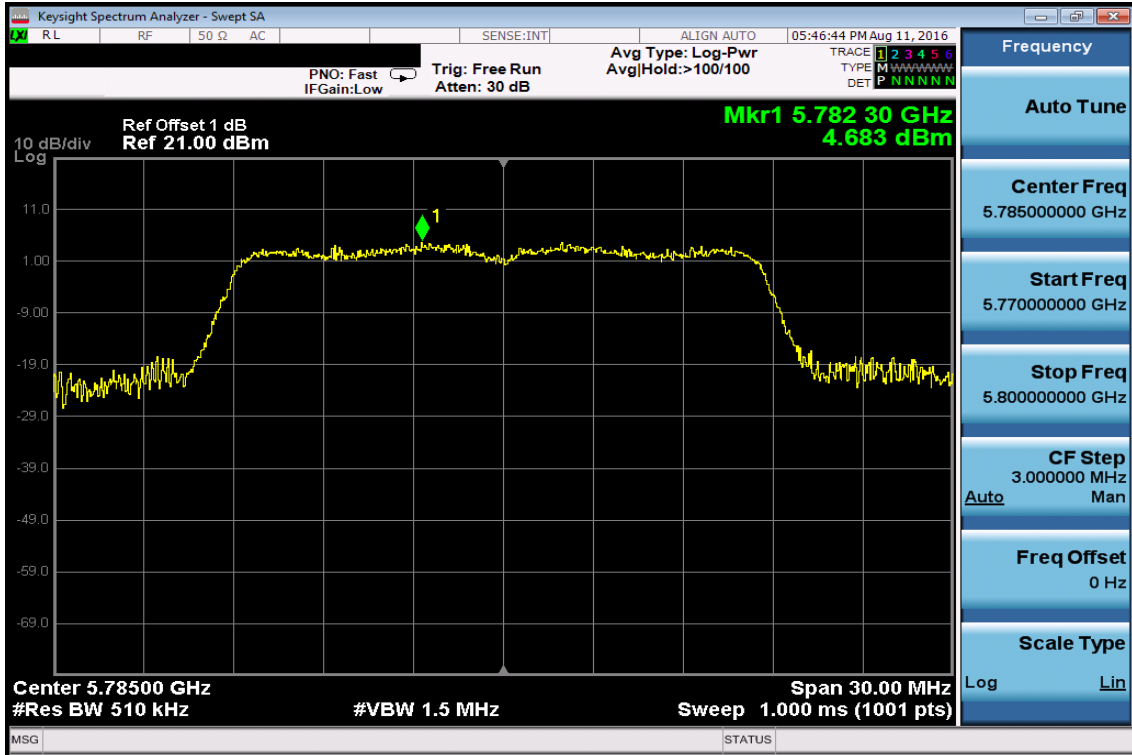

Power Spectral Density Test Plot (CH-High)

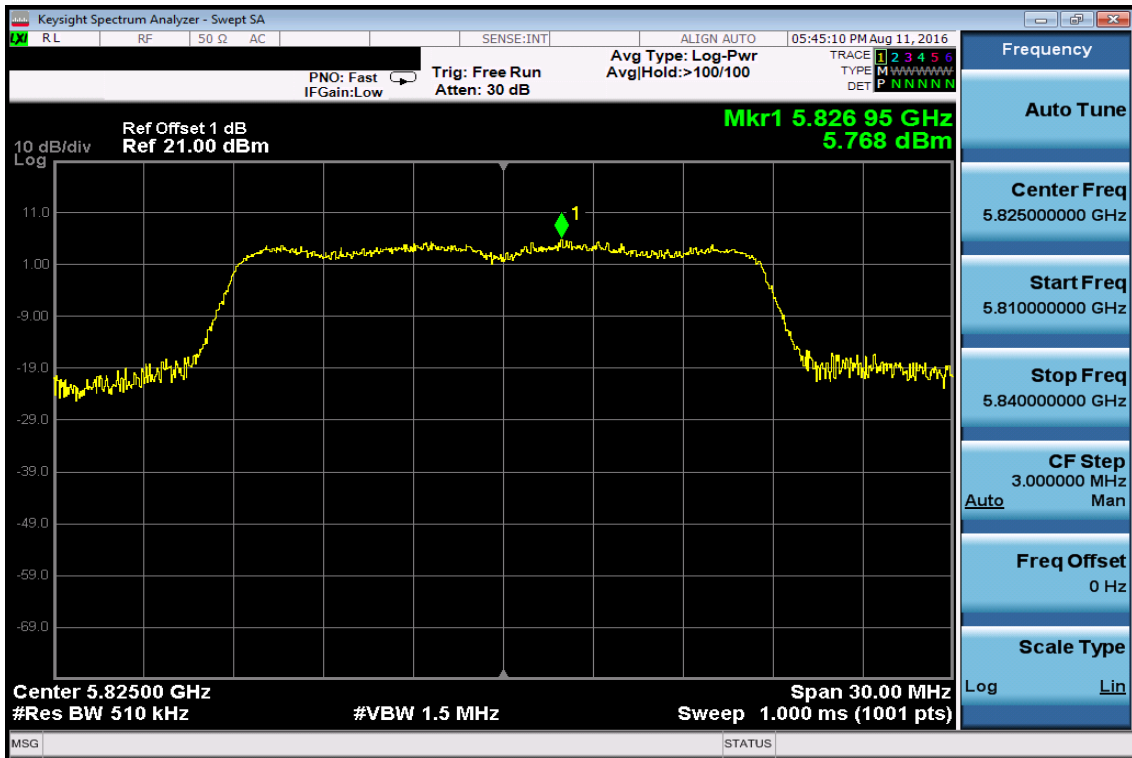

802.11n HT40

Power Spectral Density Test Plot (CH-Low)



Power Spectral Density Test Plot (CH-High)



802.11AC HT80 Power Spectral Density Test Plot

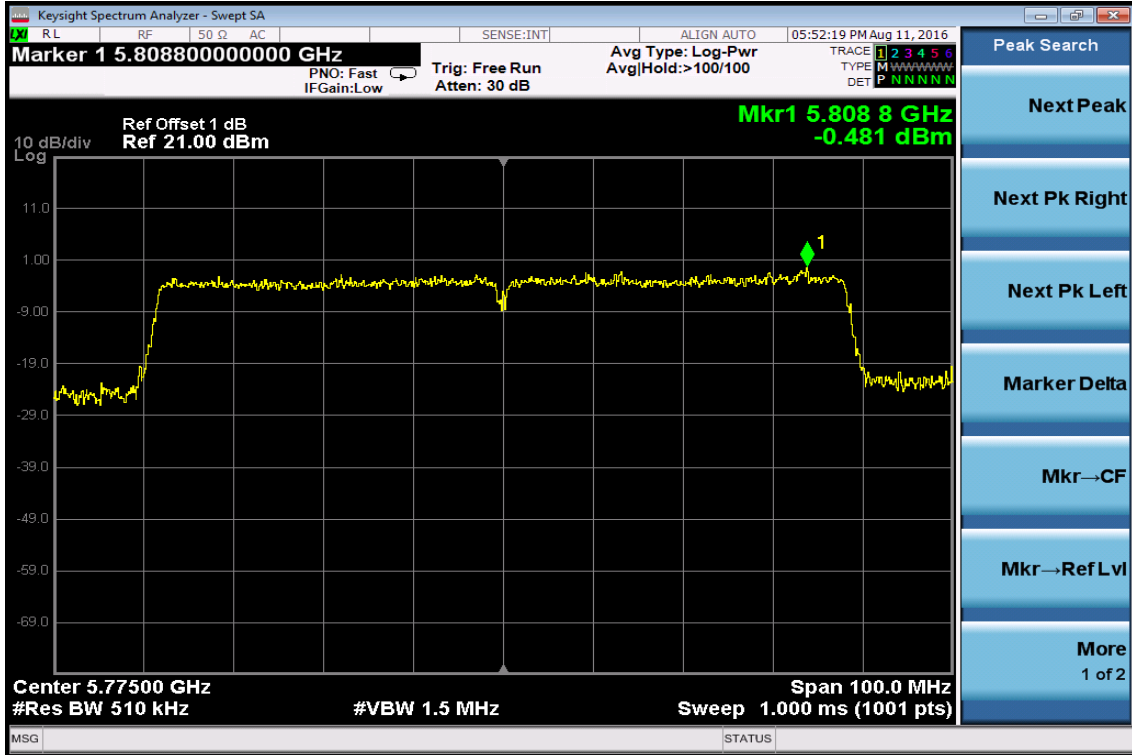

IC: BAND 1

802.11a

Power Spectral Density Data Plot (CH Low)

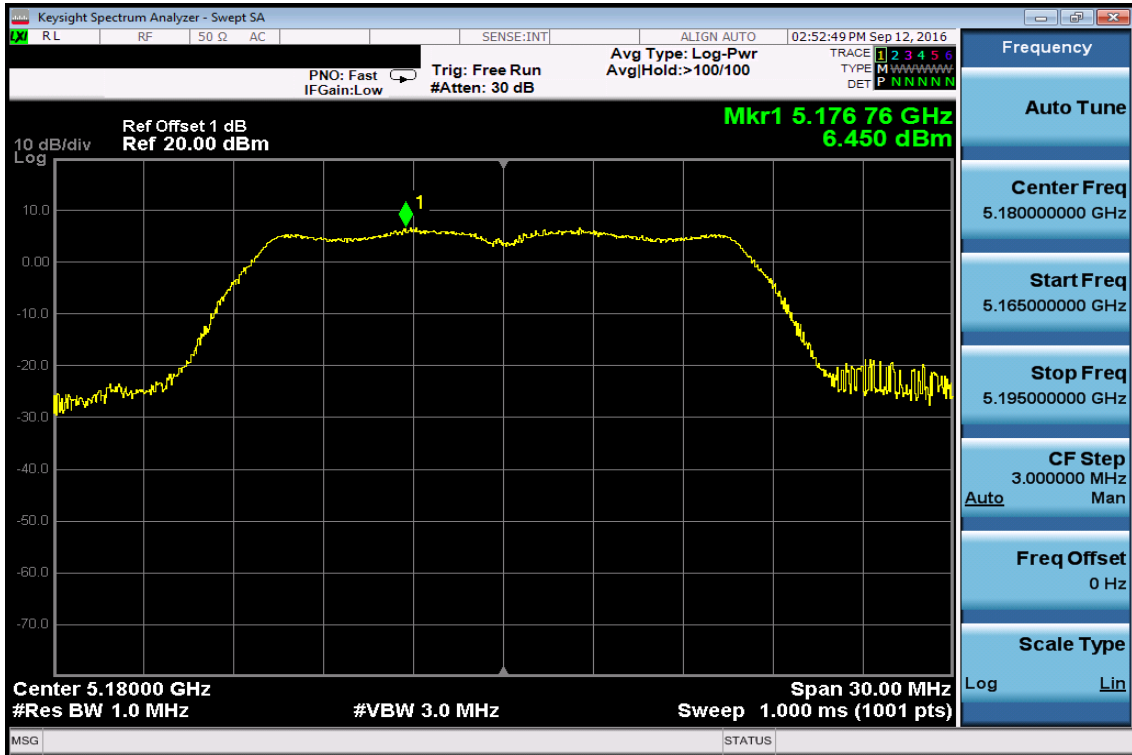

Power Spectral Density Data Plot (CH Mid)

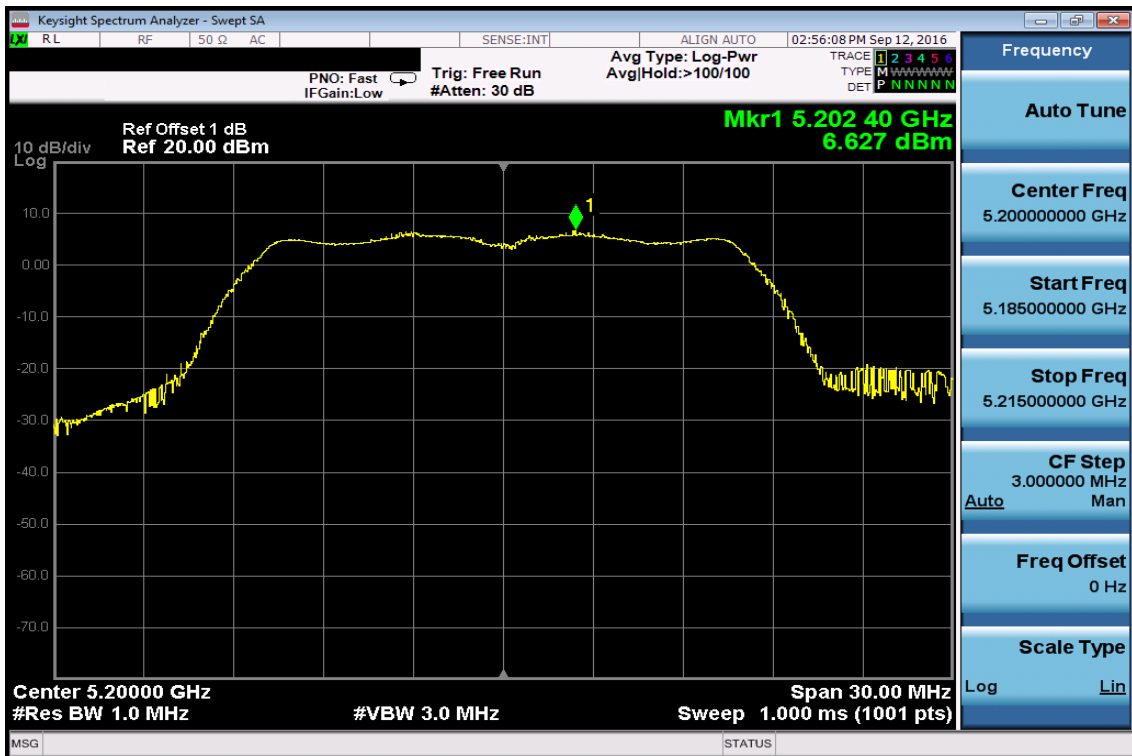

Power Spectral Density Data Plot (CH High)

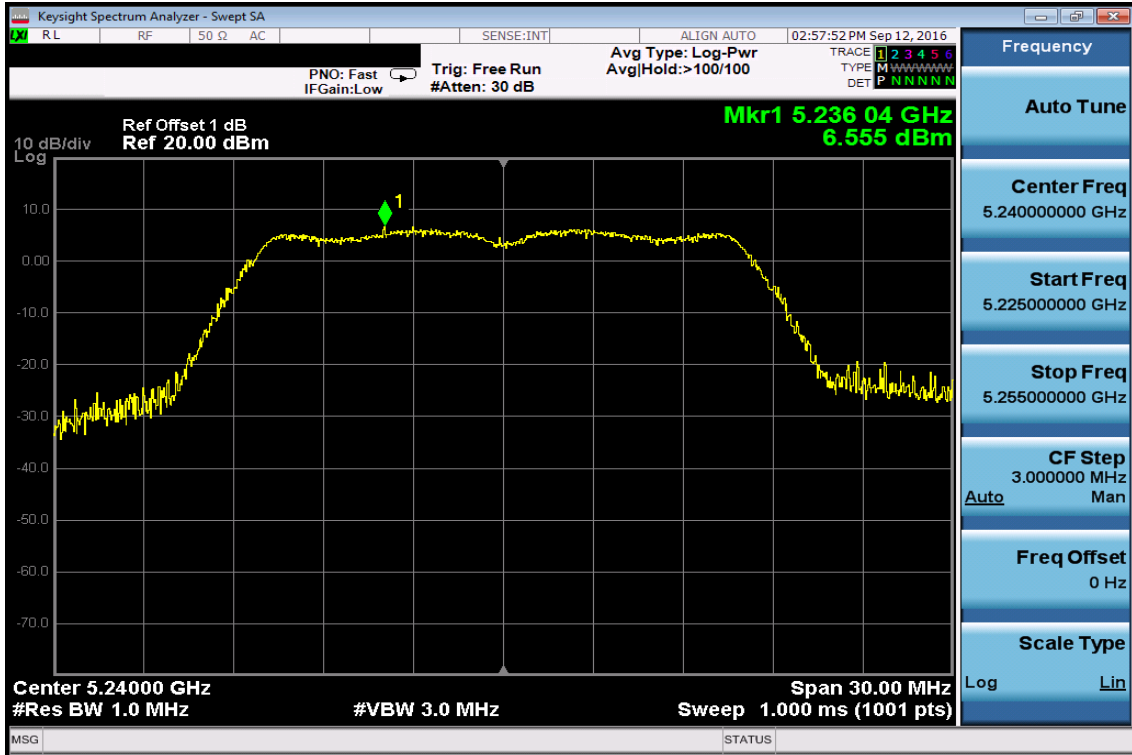

802.11n HT20

Power Spectral Density Test Plot (CH-Low)

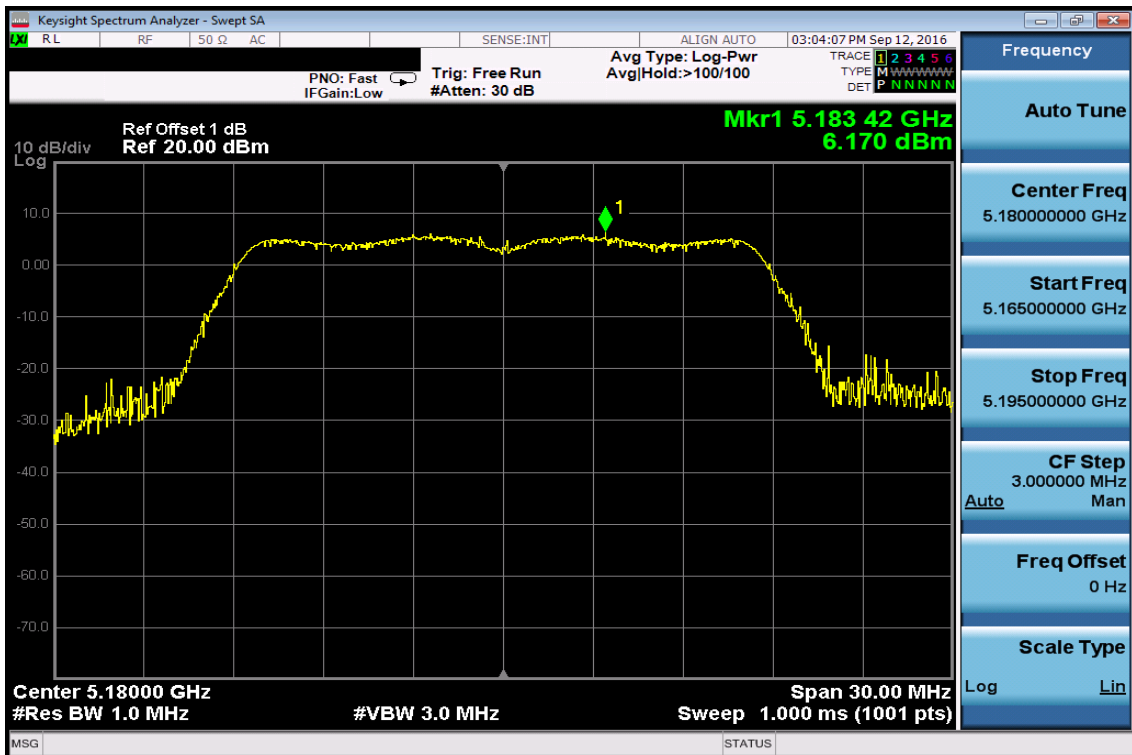

Power Spectral Density Test Plot (CH-Mid)

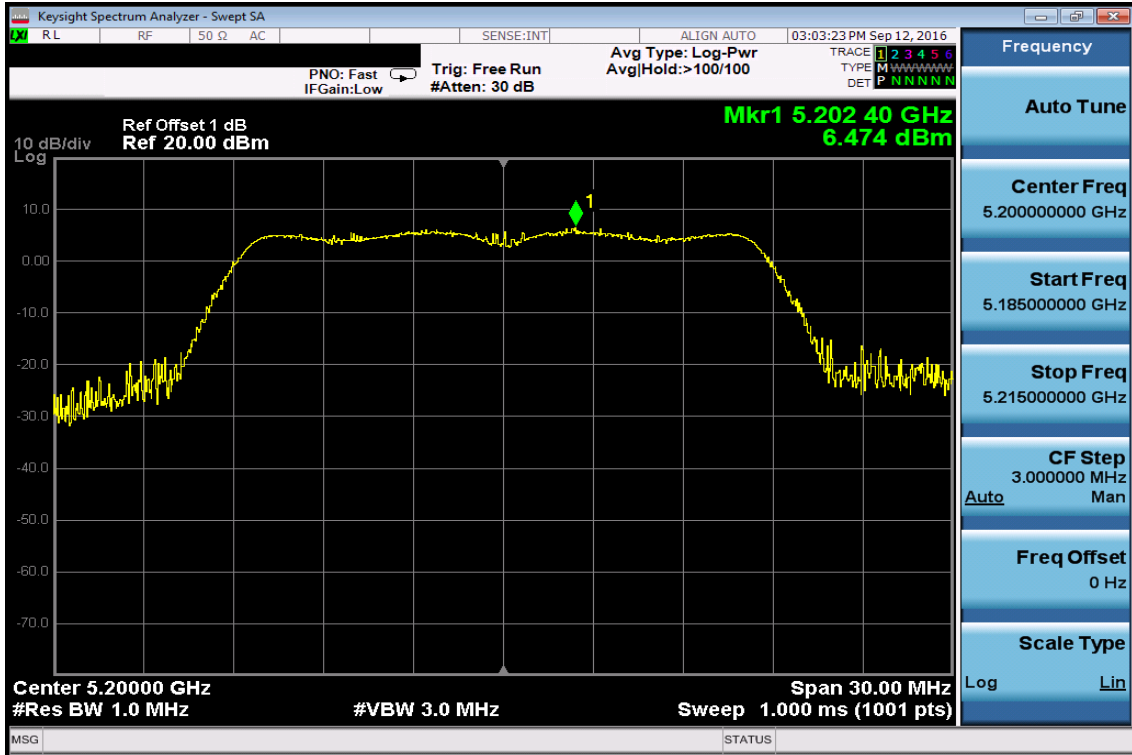

Power Spectral Density Test Plot (CH-High)

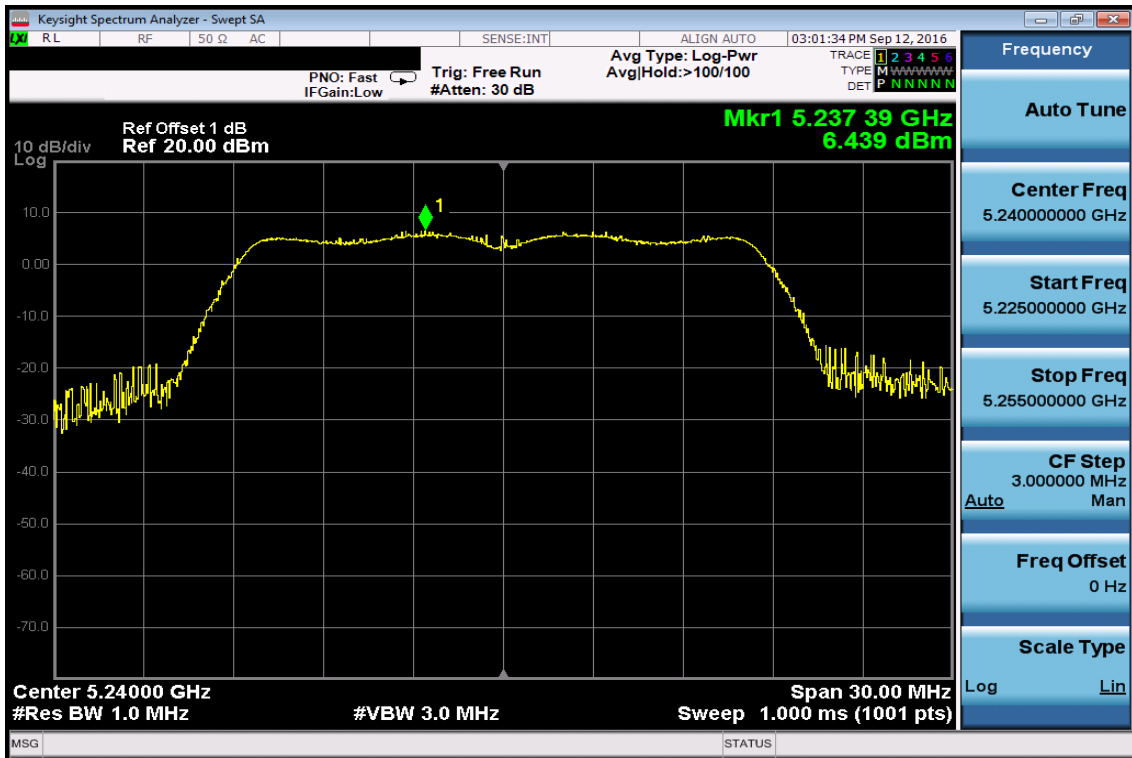

802.11n HT40

Power Spectral Density Test Plot (CH-Low)



Power Spectral Density Test Plot (CH-High)

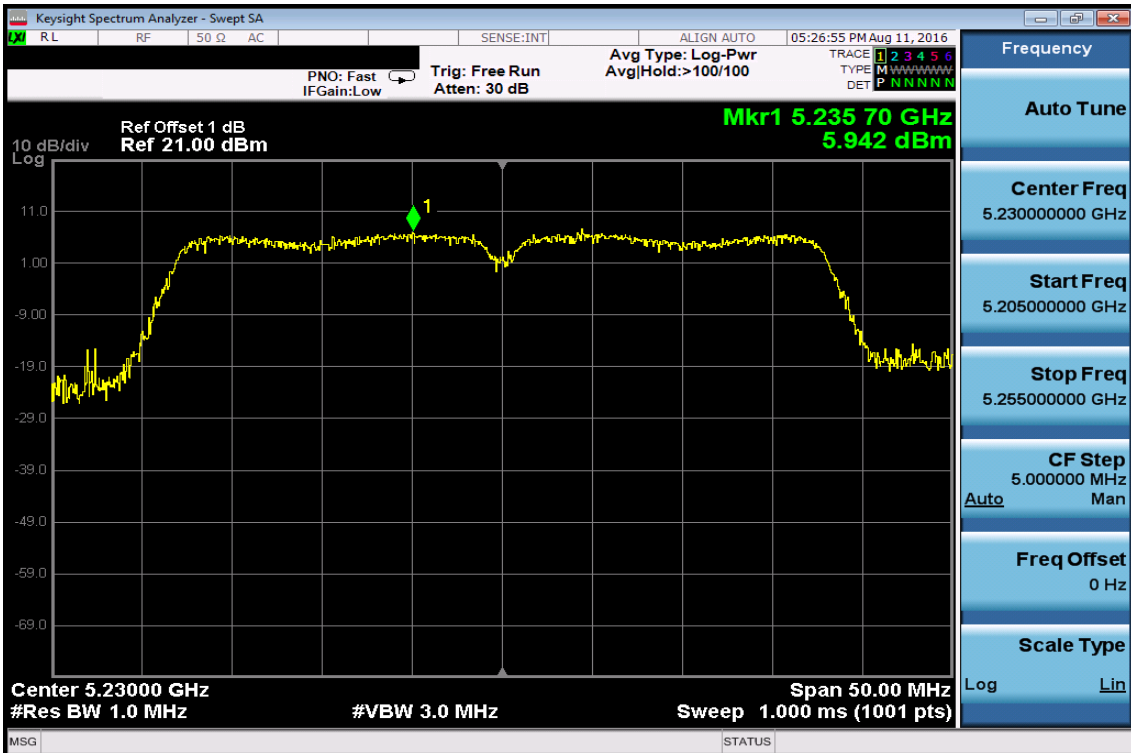

IC: BAND 4

802.11a

Power Spectral Density Data Plot (CH Low)

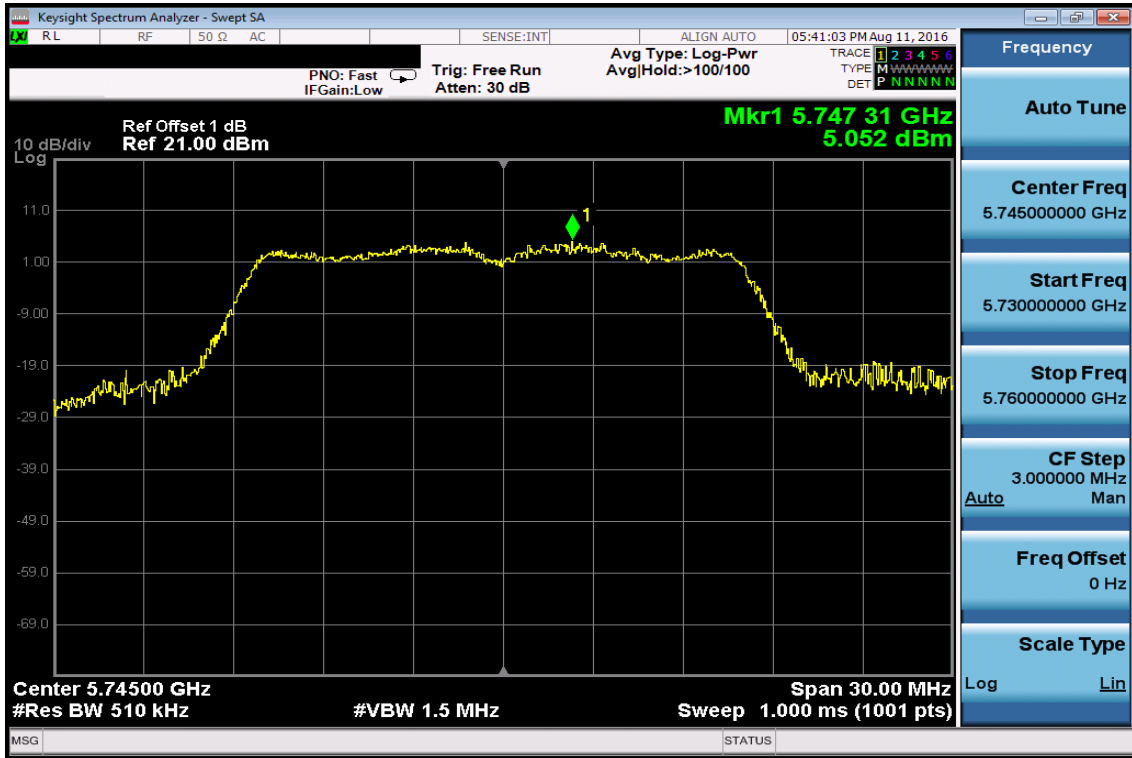

Peak Power Spectral Density Data Plot (CH Mid)

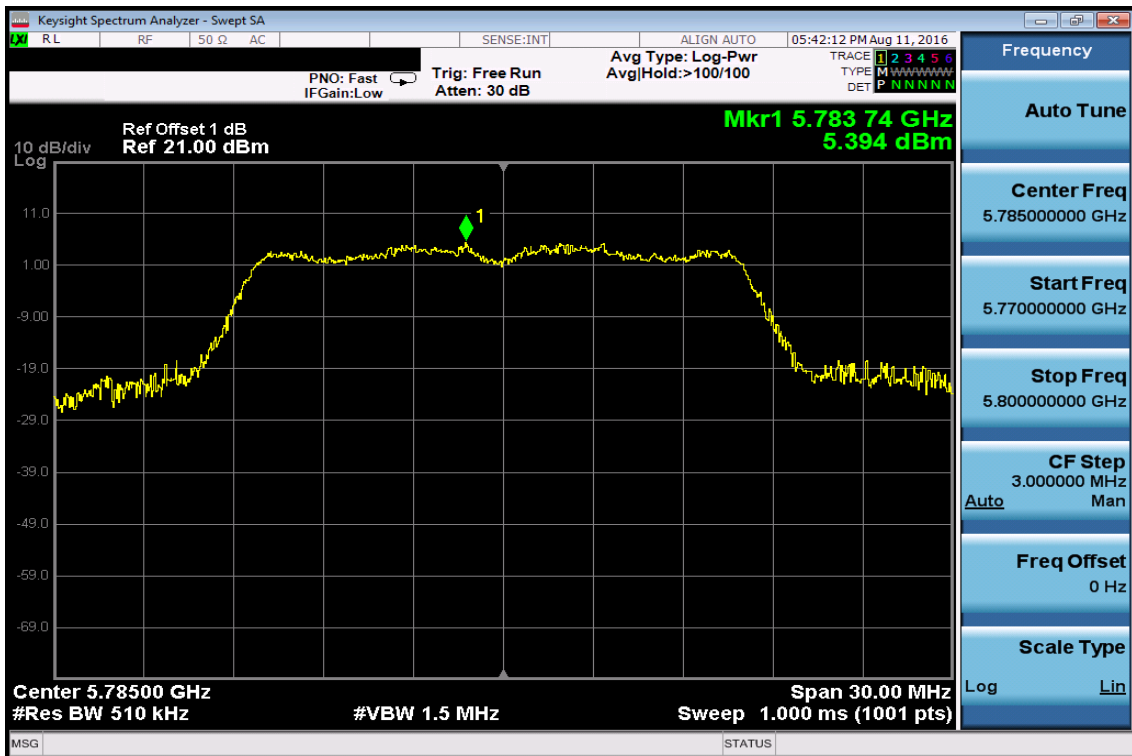

Power Spectral Density Data Plot (CH High)

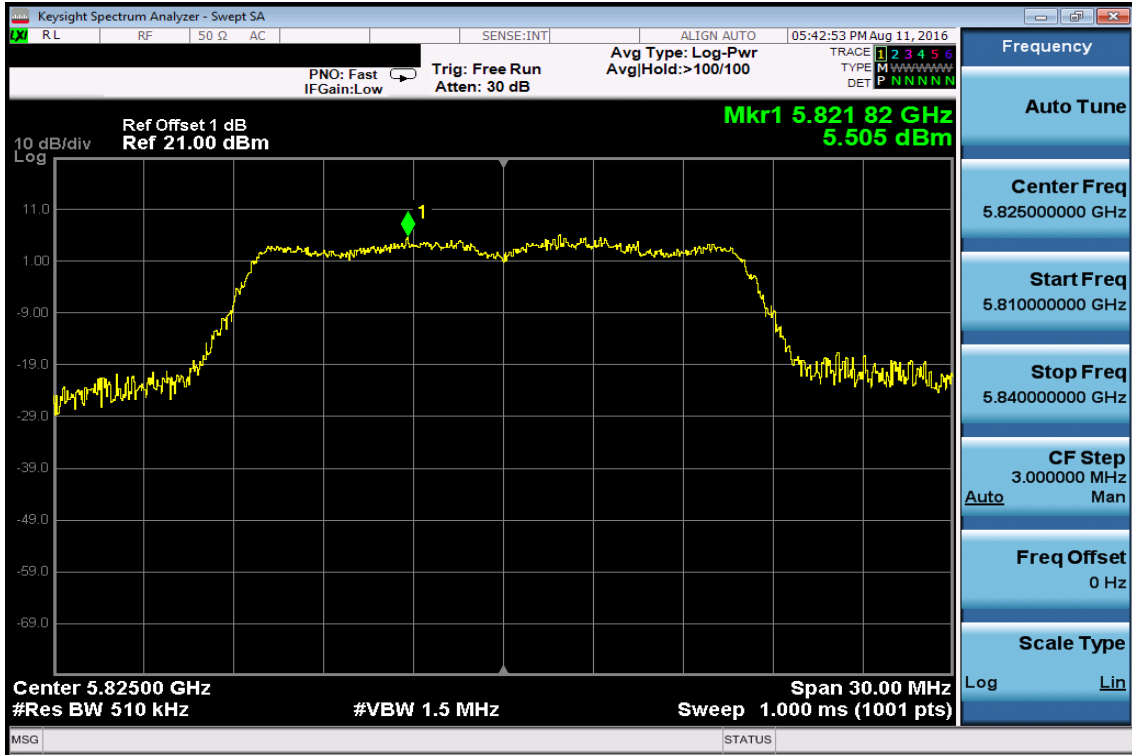

802.11n HT20

Power Spectral Density Test Plot (CH-Low)

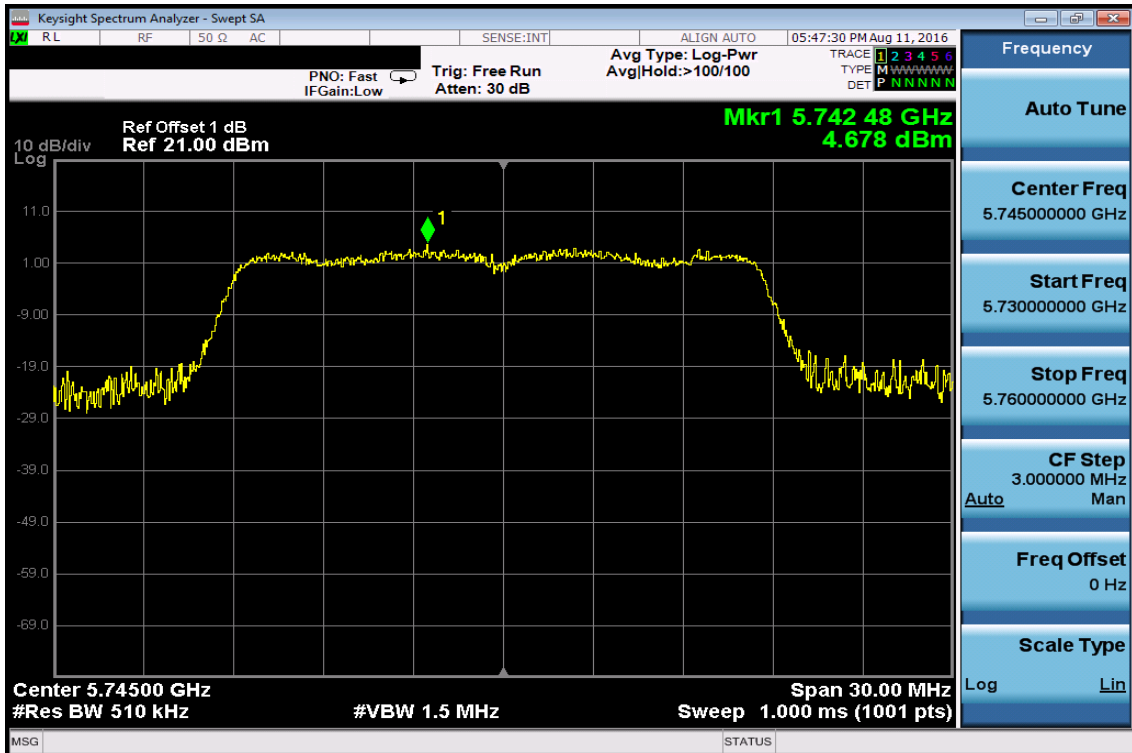

Power Spectral Density Test Plot (CH-Mid)



Power Spectral Density Test Plot (CH-High)

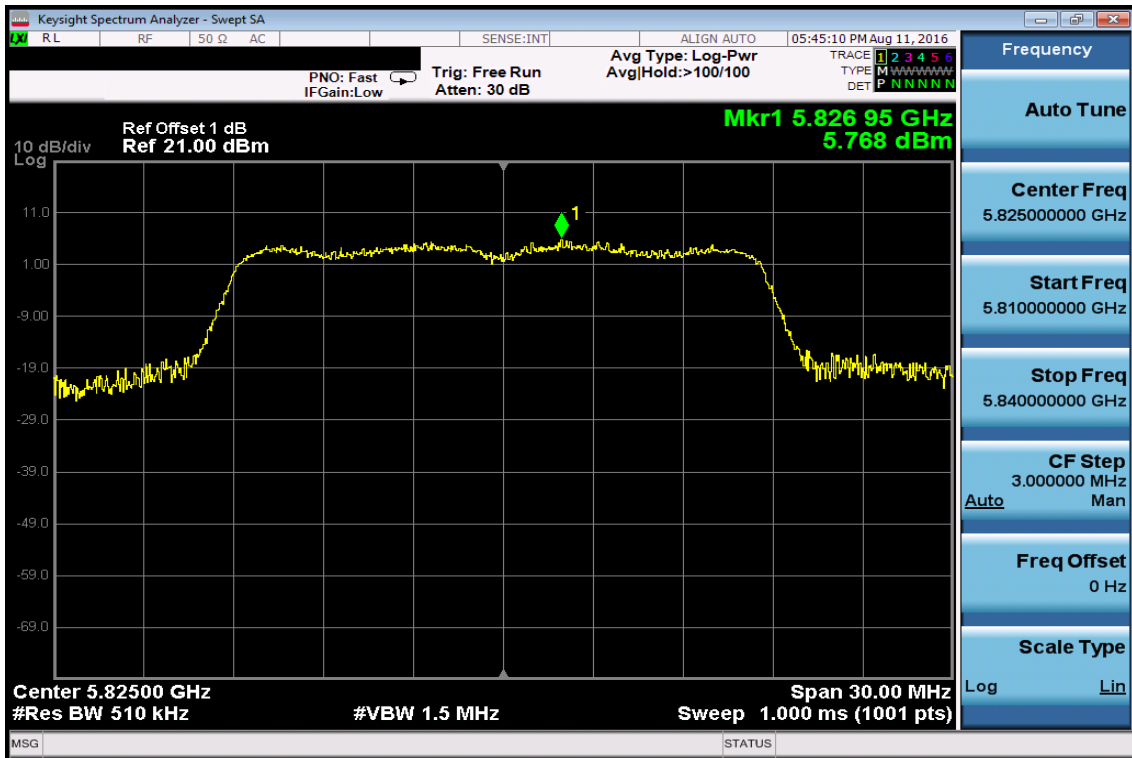

802.11n HT40

Power Spectral Density Test Plot (CH-Low)



Power Spectral Density Test Plot (CH-High)

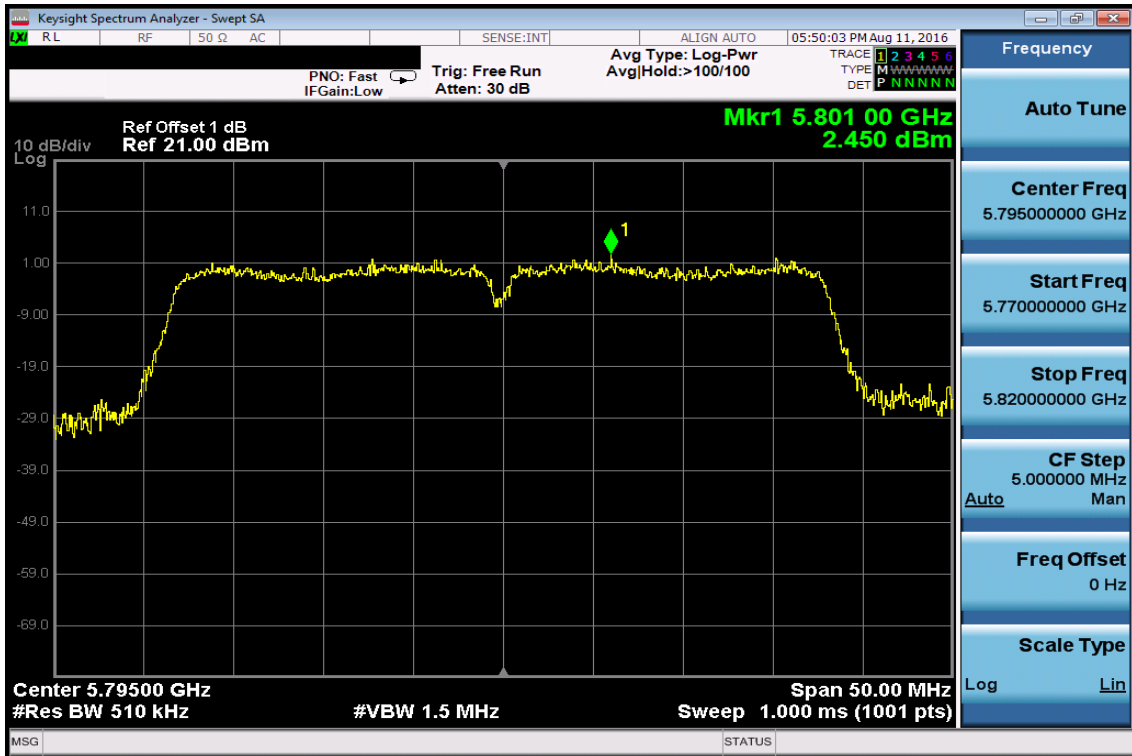

802.11AC HT80 Power Spectral Density Test Plot (CH-Low)

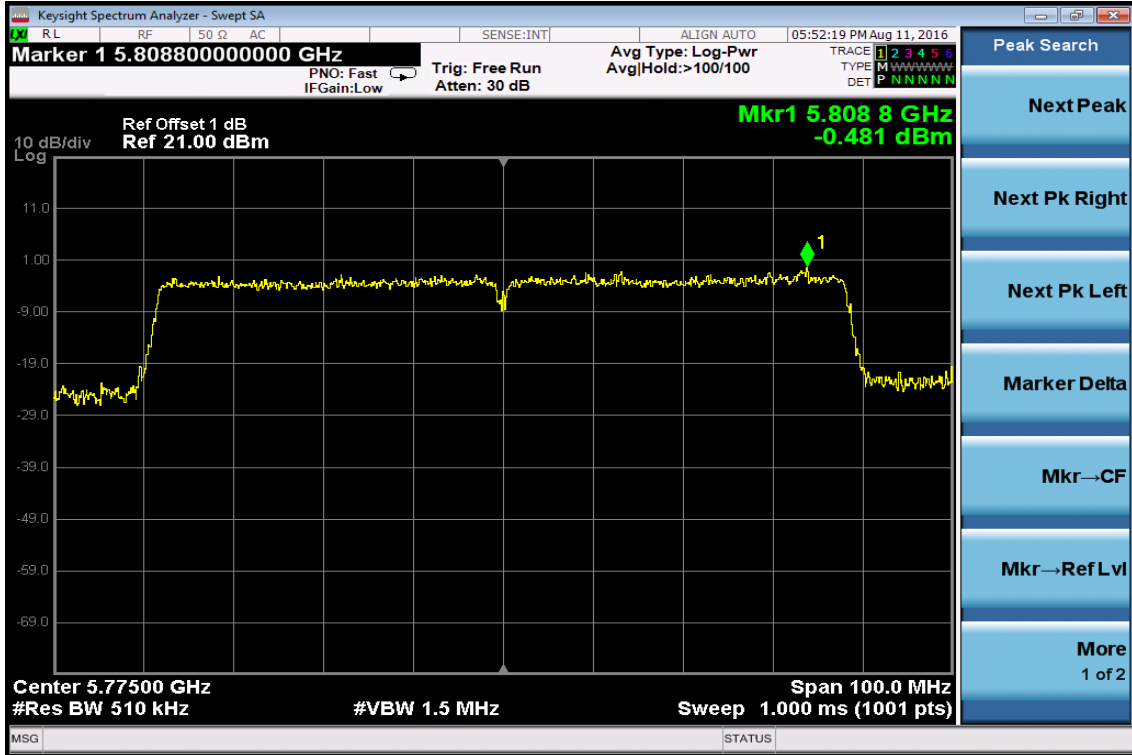

7. 99% EMISSION BANDWIDTH MEASUREMENT

7.1. Standard Applicable

According to §15.407(a). No Limit required.

According to RSS -247, 6.2, No Limit required.

RSS-Gen §4.4.1, the transmitter shall be operated at its maximum carrier power measured under normal test conditions. The span of the analyzer shall be set to capture all products of the modulation process, including the emission skirts. The resolution bandwidth shall be set to as close to 1% of the selected span as is possible without being below 1%. The video bandwidth shall be set to 3 times the resolution bandwidth. Video averaging is not permitted. Where practical, a sampling detector shall be used since a peak or, peak hold, may produce a wider bandwidth than actual.

The trace data points are recovered and are directly summed in linear terms. The recovered amplitude data points, beginning at the lowest frequency, are placed in a running sum until 0.5% of the total is reached and that frequency recorded. The process is repeated for the highest frequency data points. This frequency is recorded.

7.2. Measurement Procedure

1. Place the EUT on the table and set it in transmitting mode.
2. Remove the antenna from the EUT and then connect a low loss RF cable from the antenna port to the spectrum analyzer.
3. Set the spectrum analyzer as RBW=300KHz, VBW =1MHz, Span= 50MHz, Sweep=auto
4. Mark the peak frequency and -26dB (upper and lower) frequency.
5. Repeat above procedures until all frequency measured were complete.

Refer to section D of KDB Document: KDB 789033 D02 General UNII Test Procedures New Rules v01r03

7.3. Measurement Equipment Used:

Refer to section 6.3 for details.

7.4. Test Set-up:

Refer to section 6.4 for details.

7.5. Measurement Result

802.11a Mode

Frequency (MHz)	99% Bandwidth (MHz)
5180	25.282
5200	24.334
5240	23.057
5745	18.261
5785	18.918
5825	18.440

802.11n HT20 Mode

Frequency (MHz)	99% Bandwidth (MHz)
5180	23.693
5200	24.168
5240	21.378
5745	18.717
5785	18.679
5825	18.884

802.11n HT40 Mode

Frequency (MHz)	99% Bandwidth (MHz)
5190	37.868
5230	37.699
5755	38.092
5795	38.054

802.11a HT80 Mode

Frequency (MHz)	99% Bandwidth (MHz)
5210	76.398
5755	76.157

5150-5250MHz

802.11a

99% Band Width Test Data CH-Low

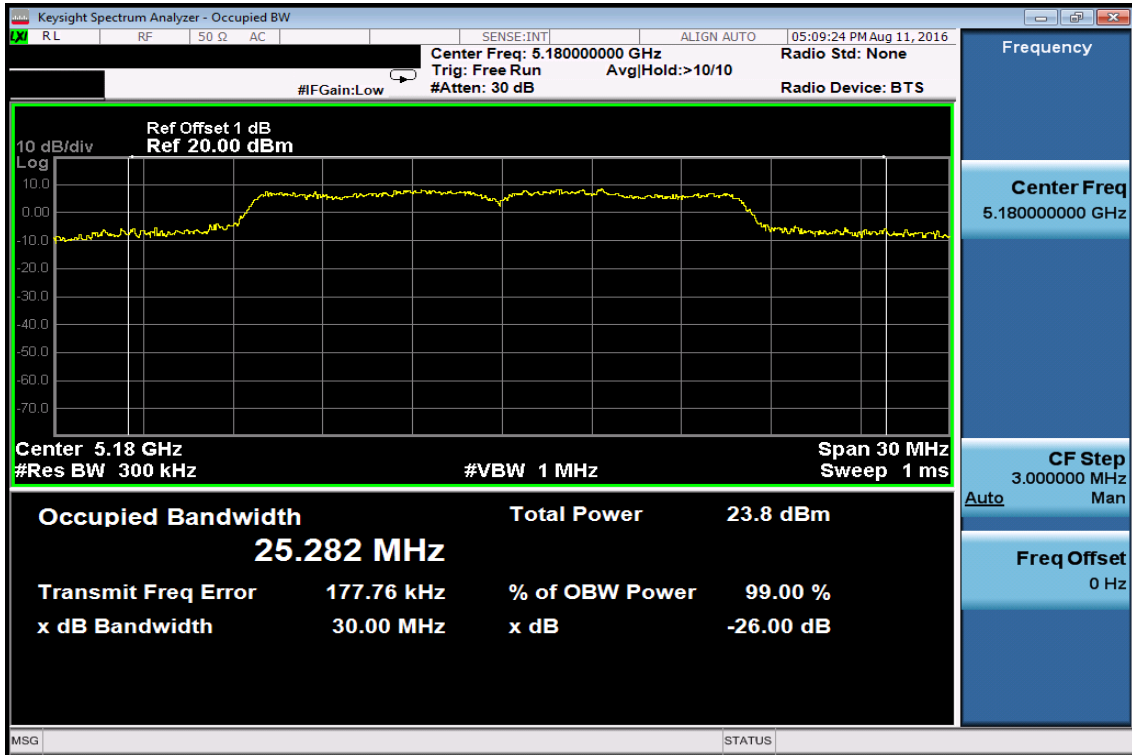

99% Band Width Test Data CH-Mid

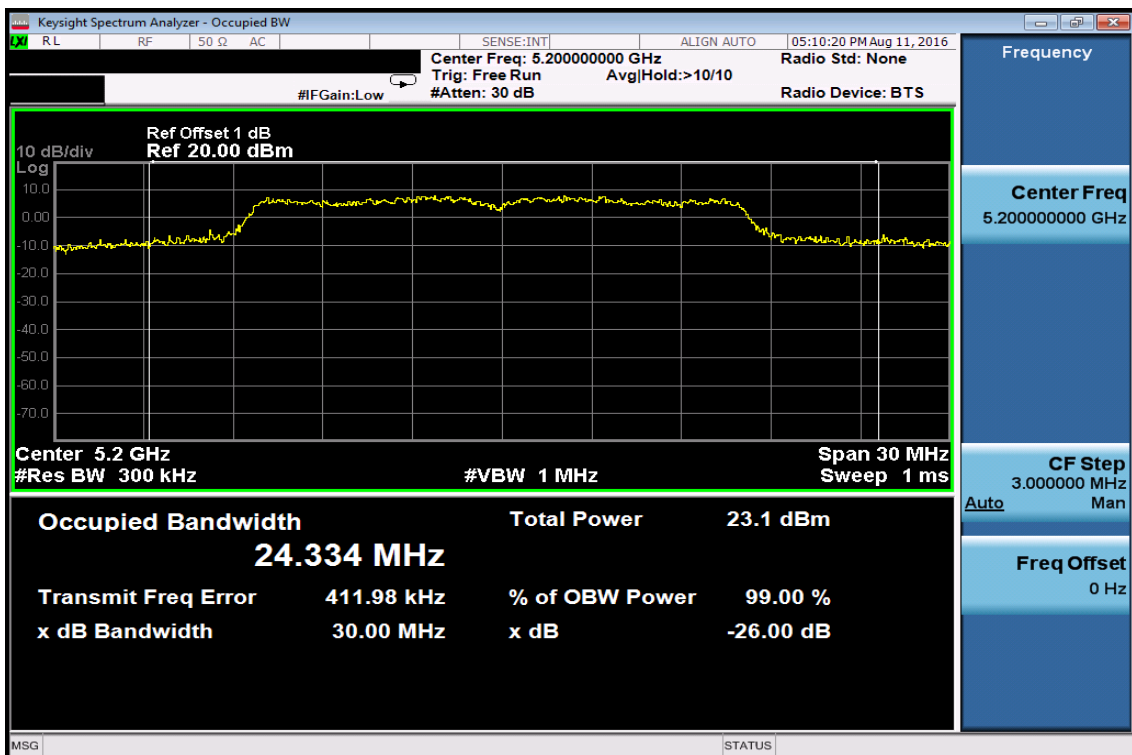

99% Band Width Test Data CH-High

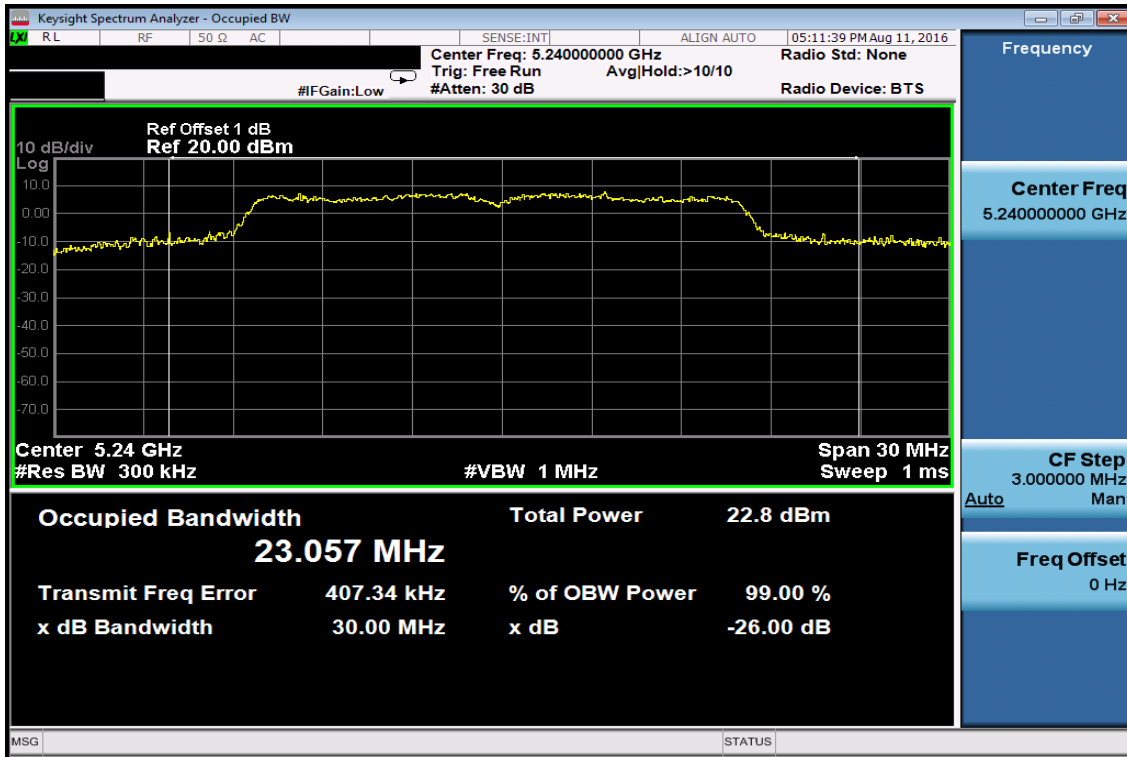

802.11n HT20

99% Band Width Test Data CH-Low

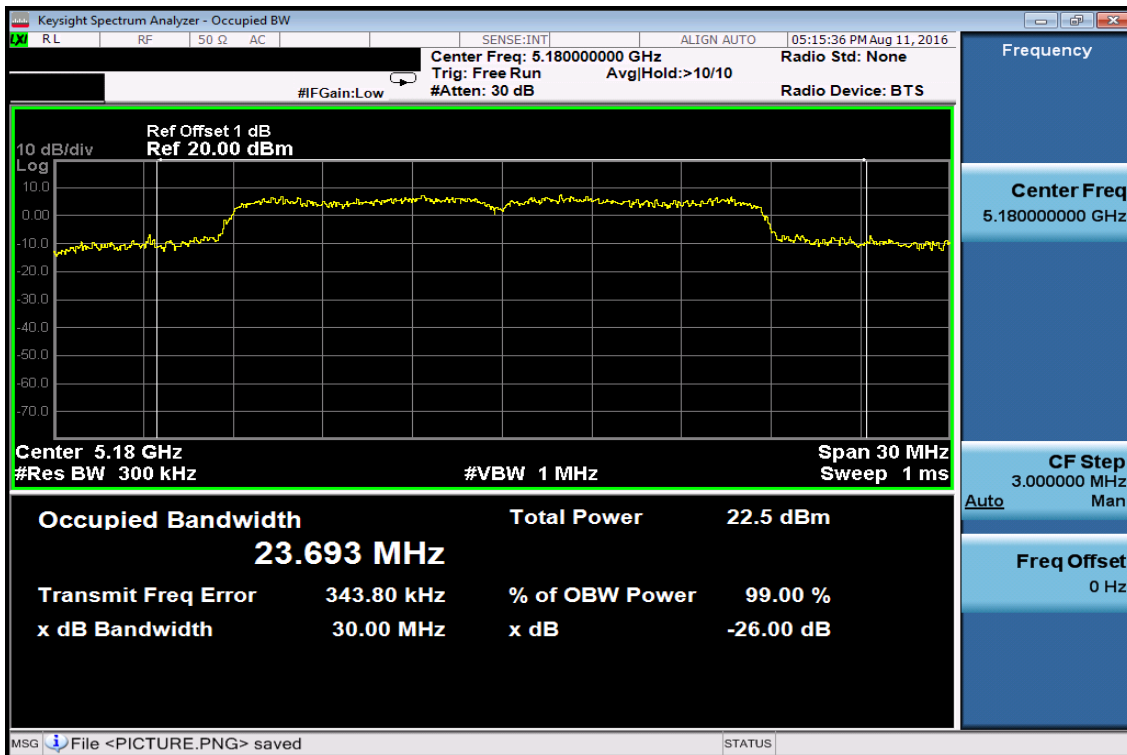

99% Band Width Test Data CH-Mid

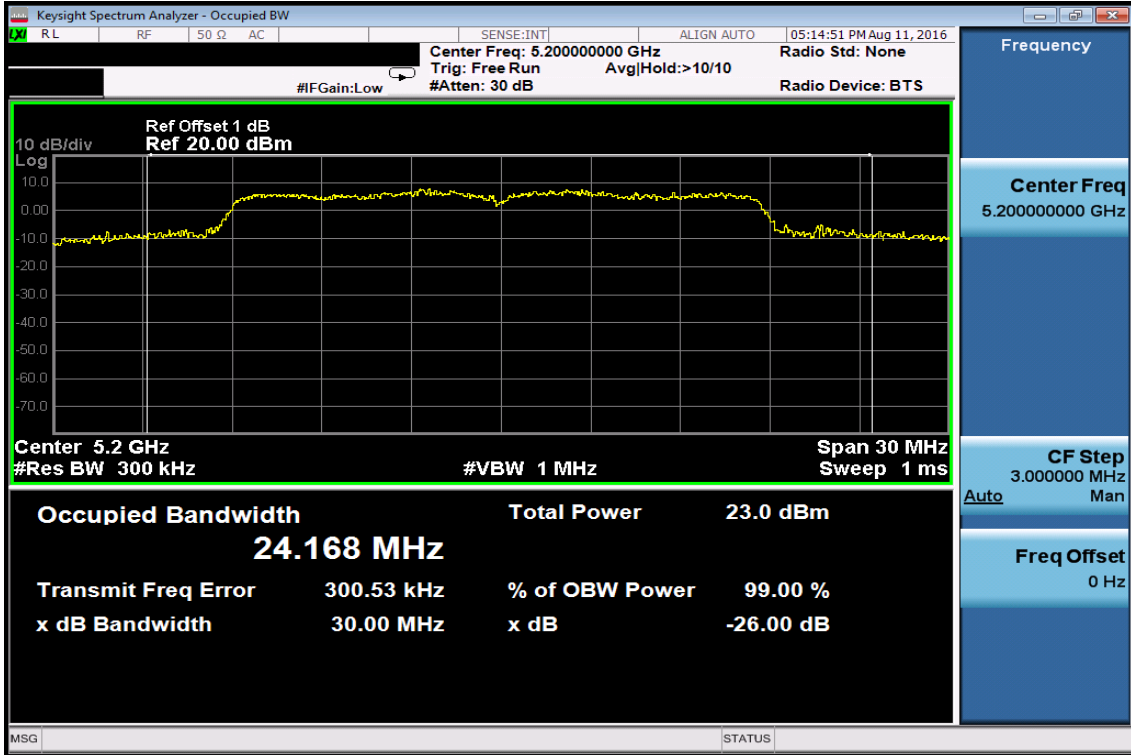

99% Band Width Test Data CH-High

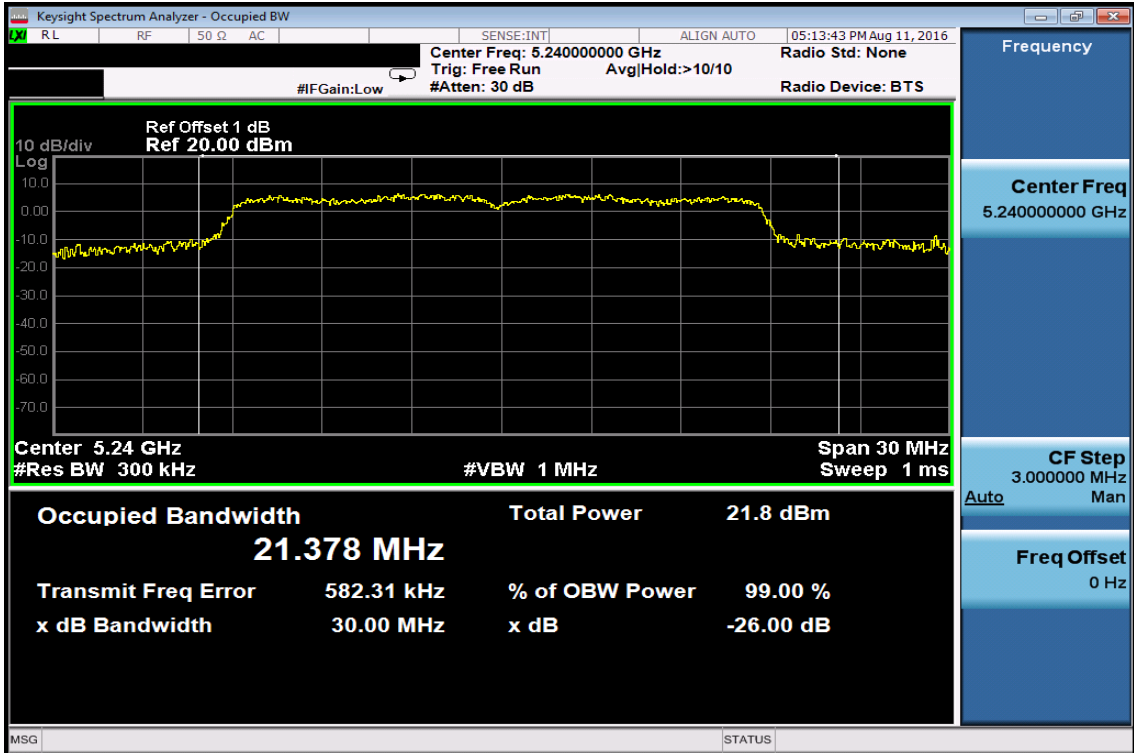

802.11n HT40

99% Band Width Test Data CH-Low

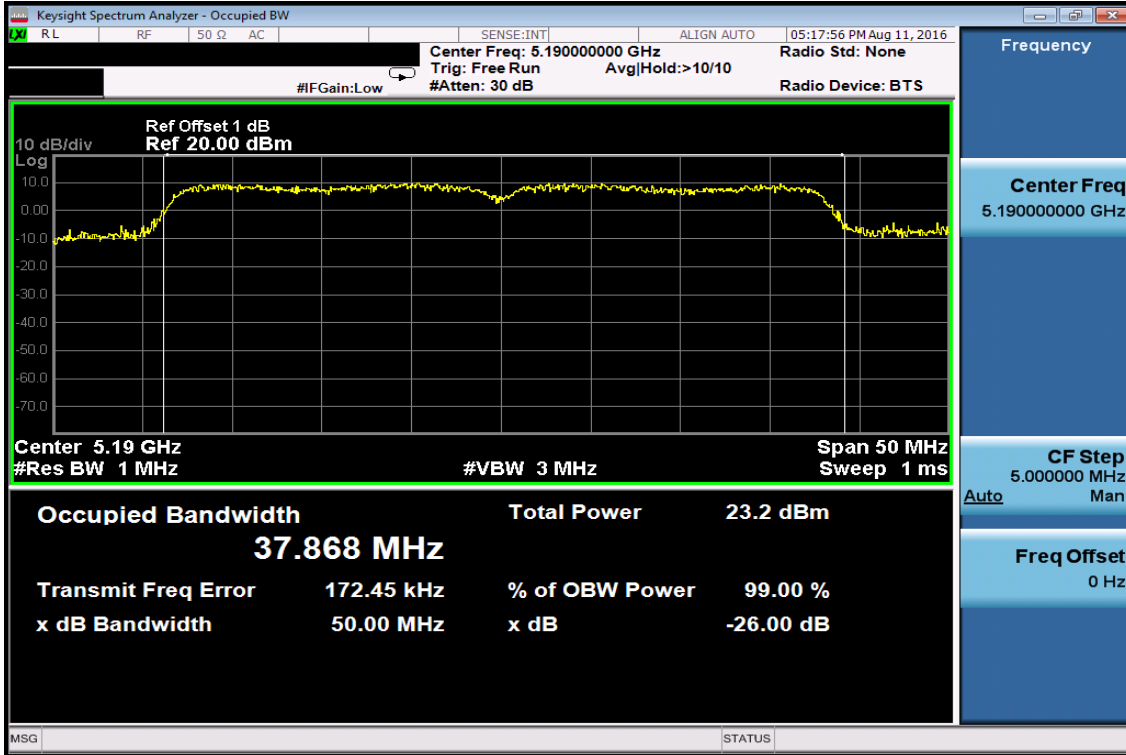

99% Band Width Test Data CH-High

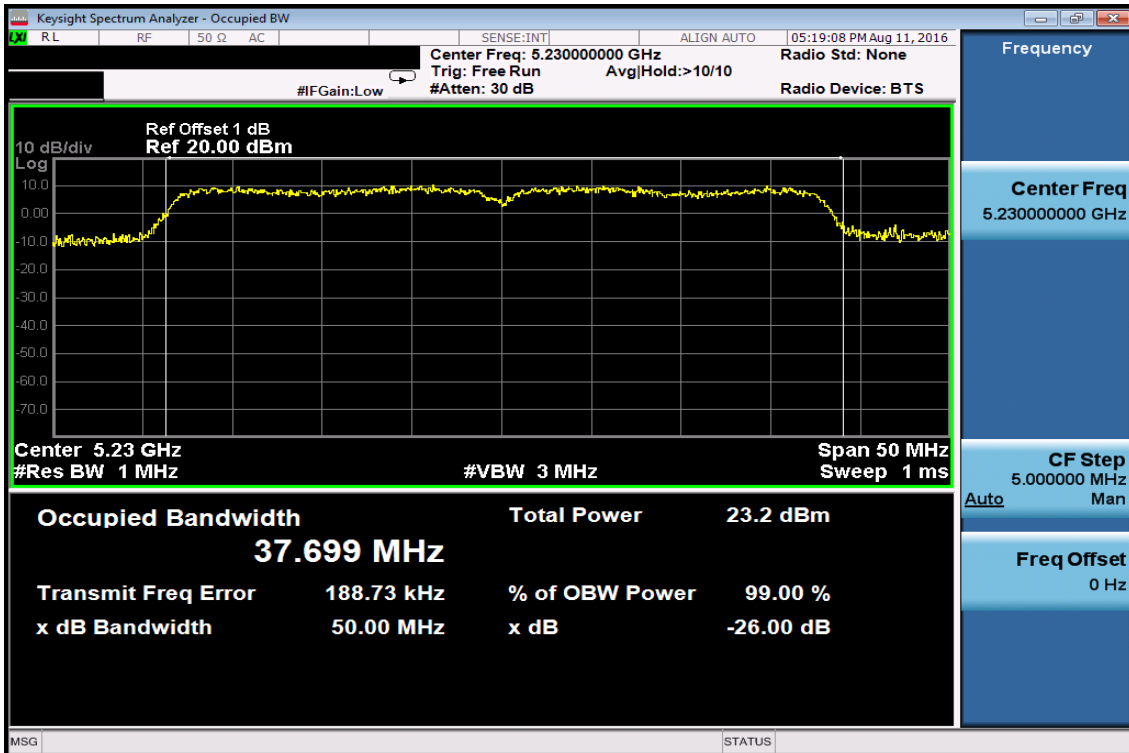

802.11AC HT80 99% Band Width Test Data

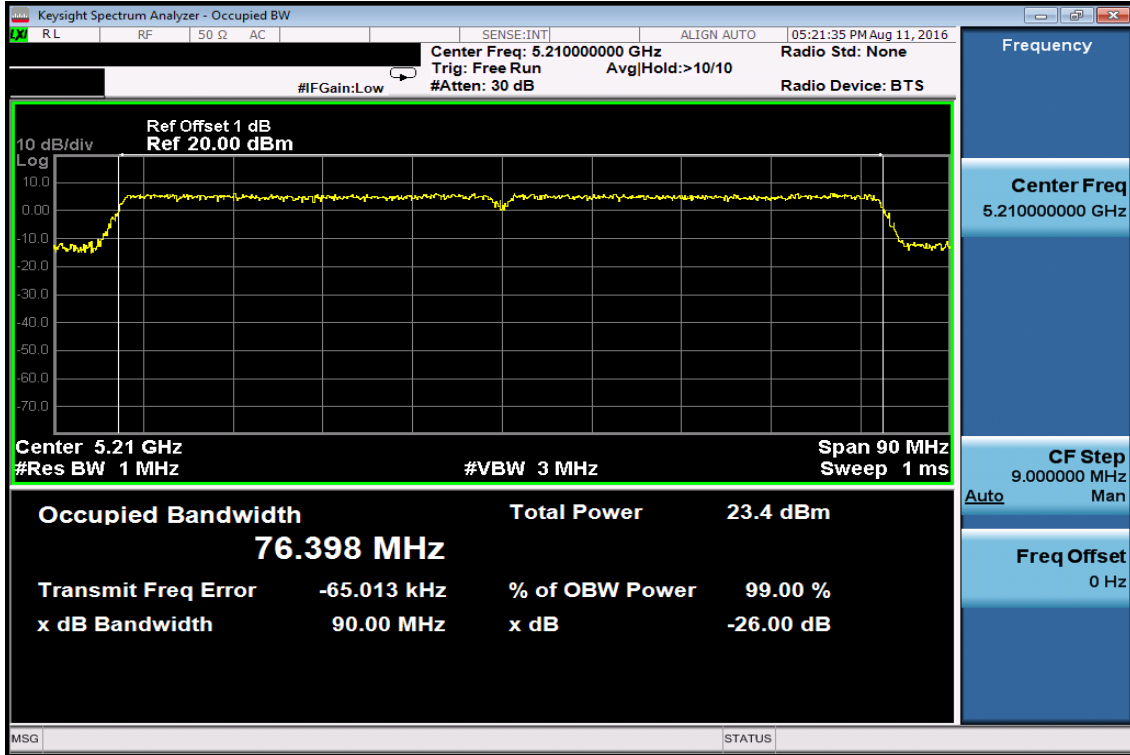

5725MHz -5850MHz

802.11a

99% Band Width Test Data CH-Low

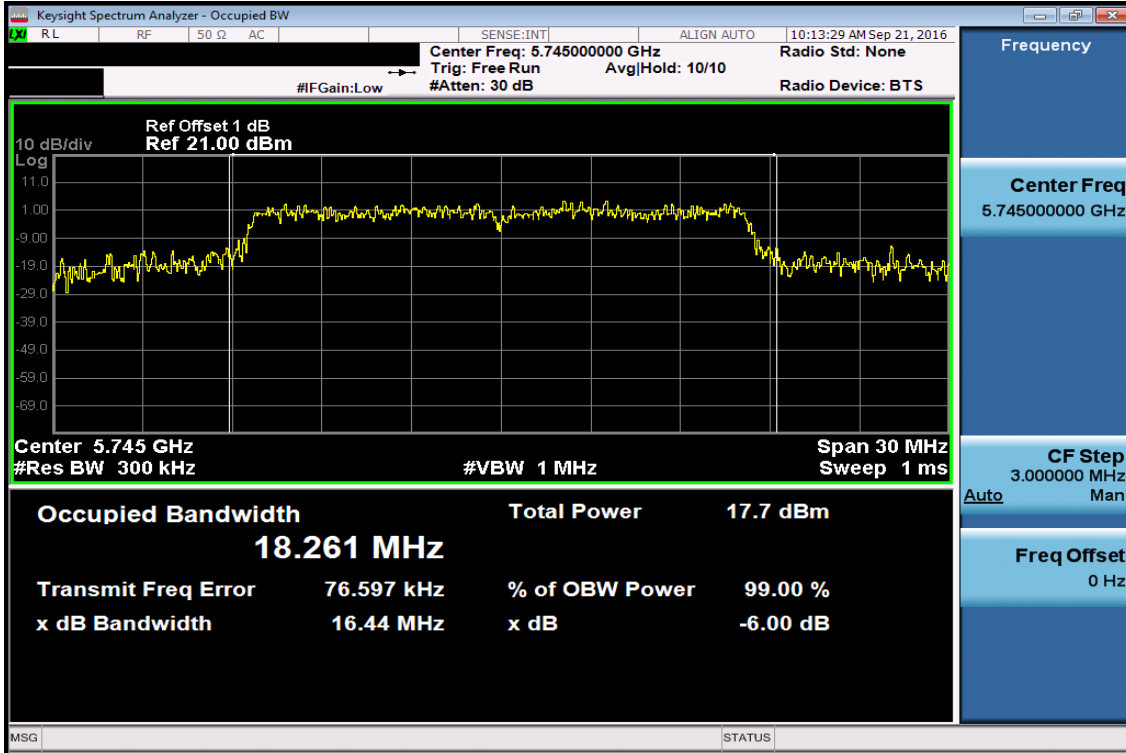

99% Band Width Test Data CH-Mid

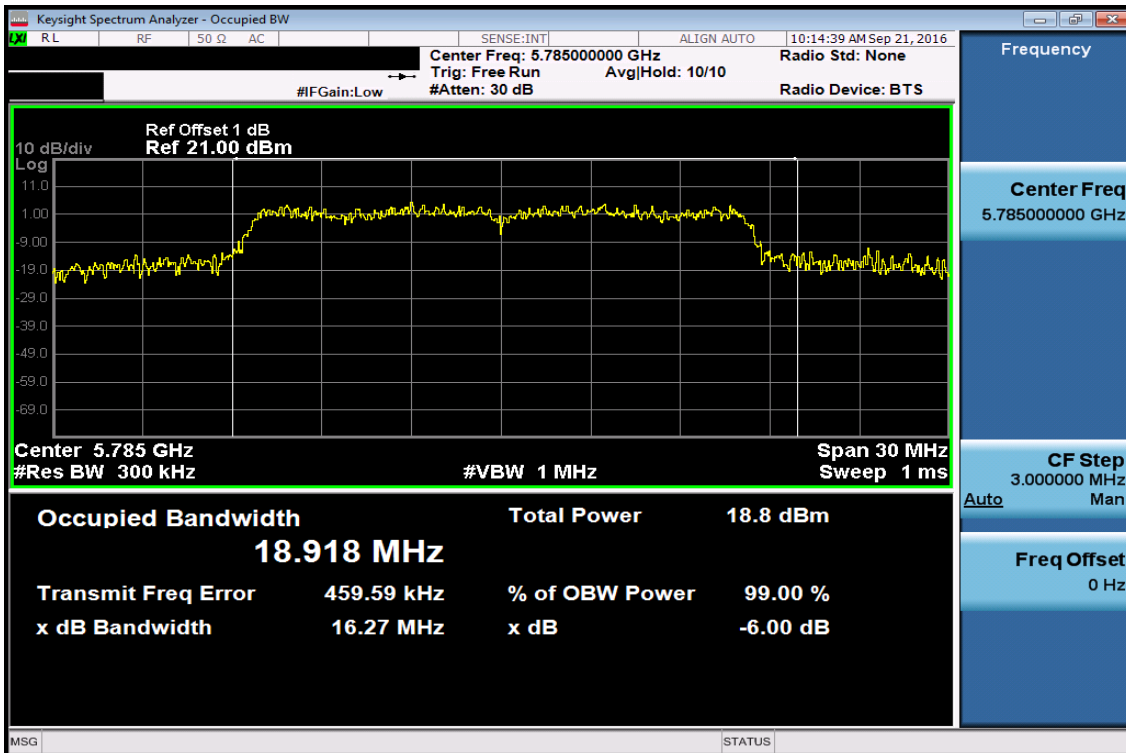

99% Band Width Test Data CH-High

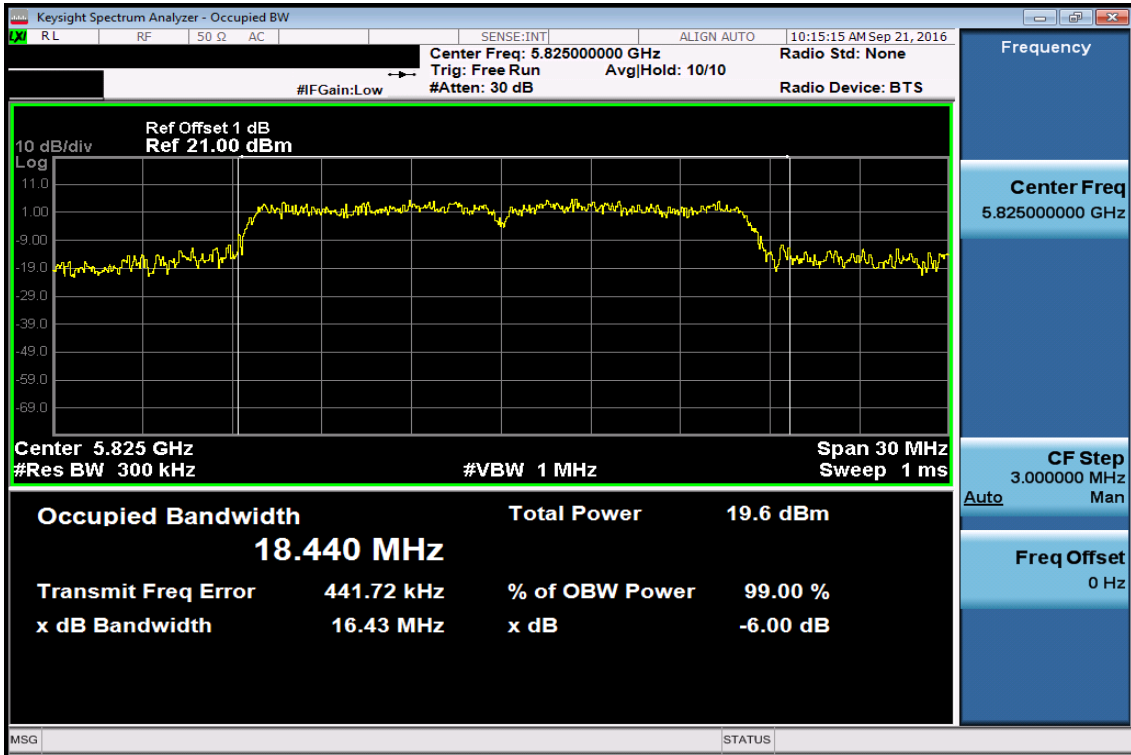

802.11n HT20

99% Band Width Test Data CH-Low

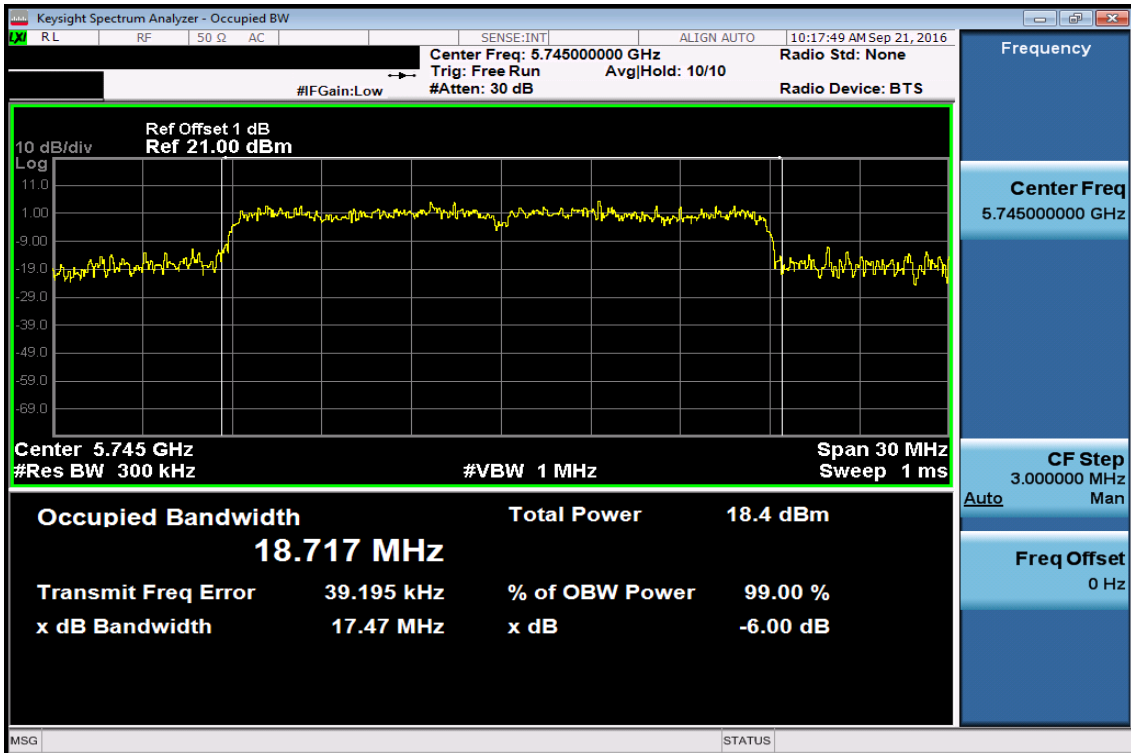

99% Band Width Test Data CH-Mid

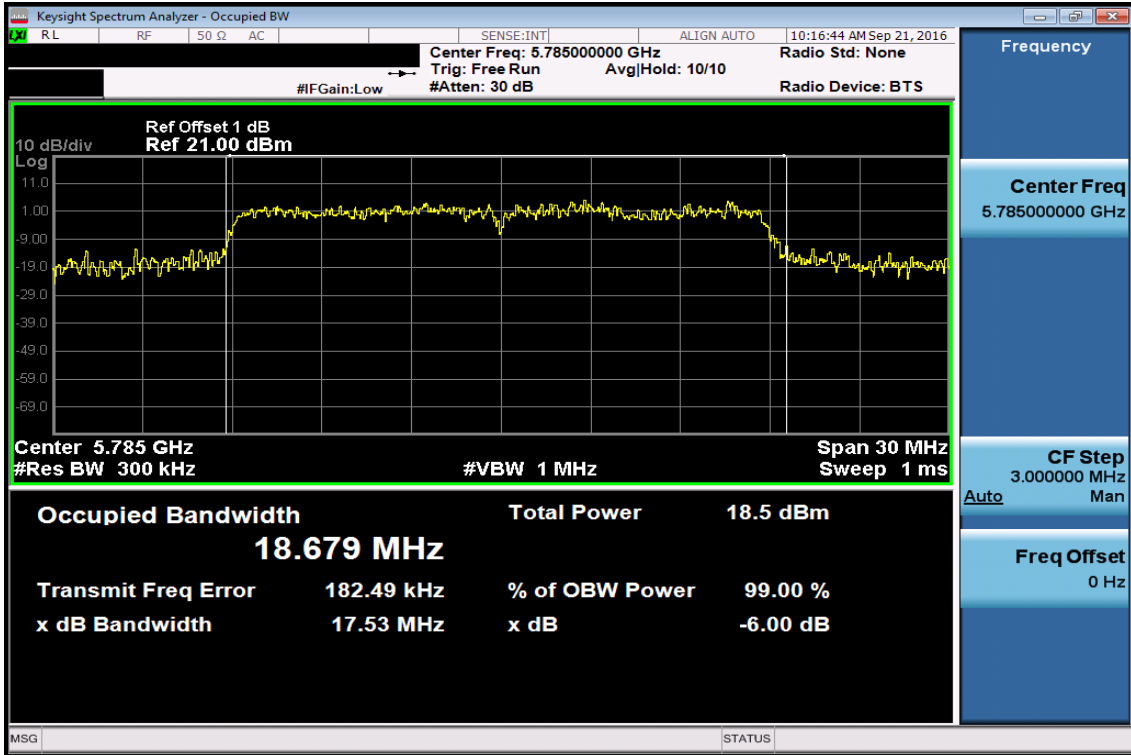

99% Band Width Test Data CH-High

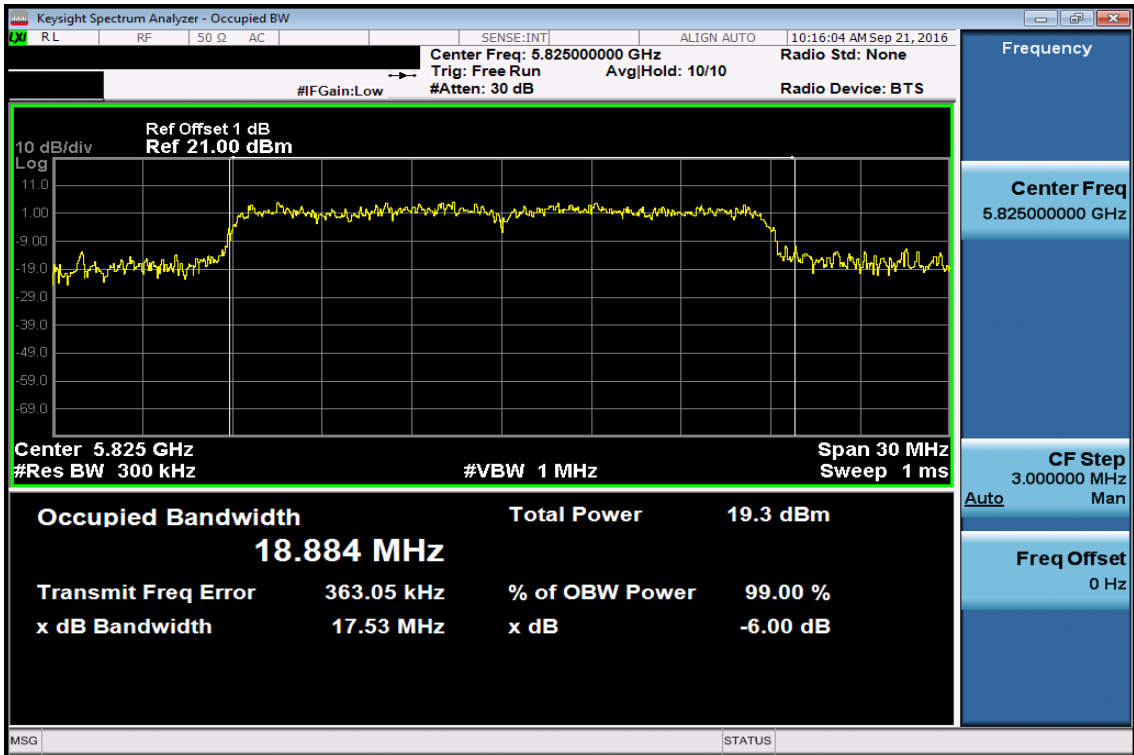

802.11n HT40

99% Band Width Test Data CH-Low

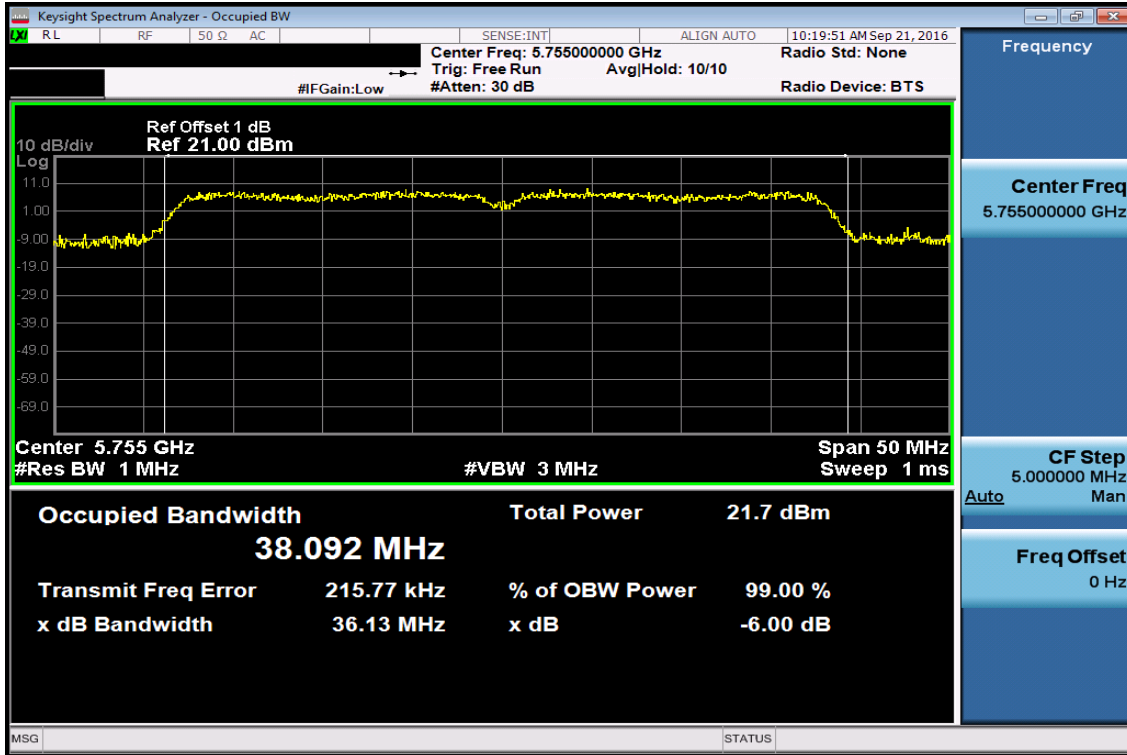

99% Band Width Test Data CH-High

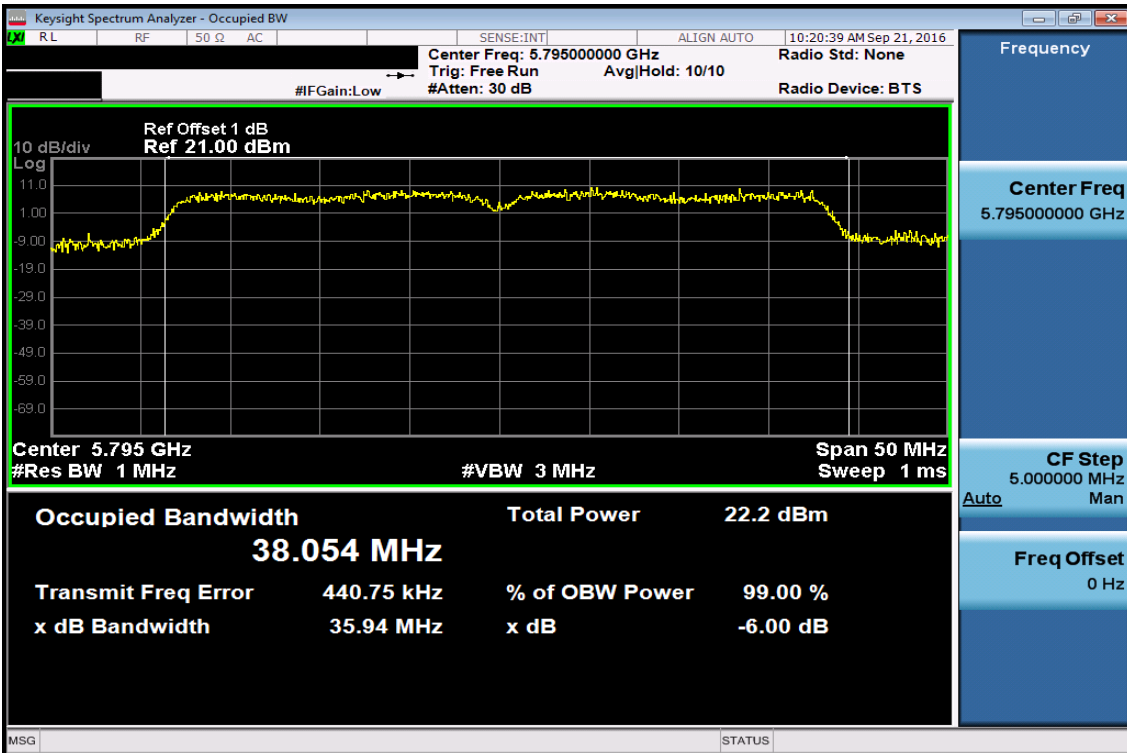

802.11AC HT80 99% Band Width Test Data

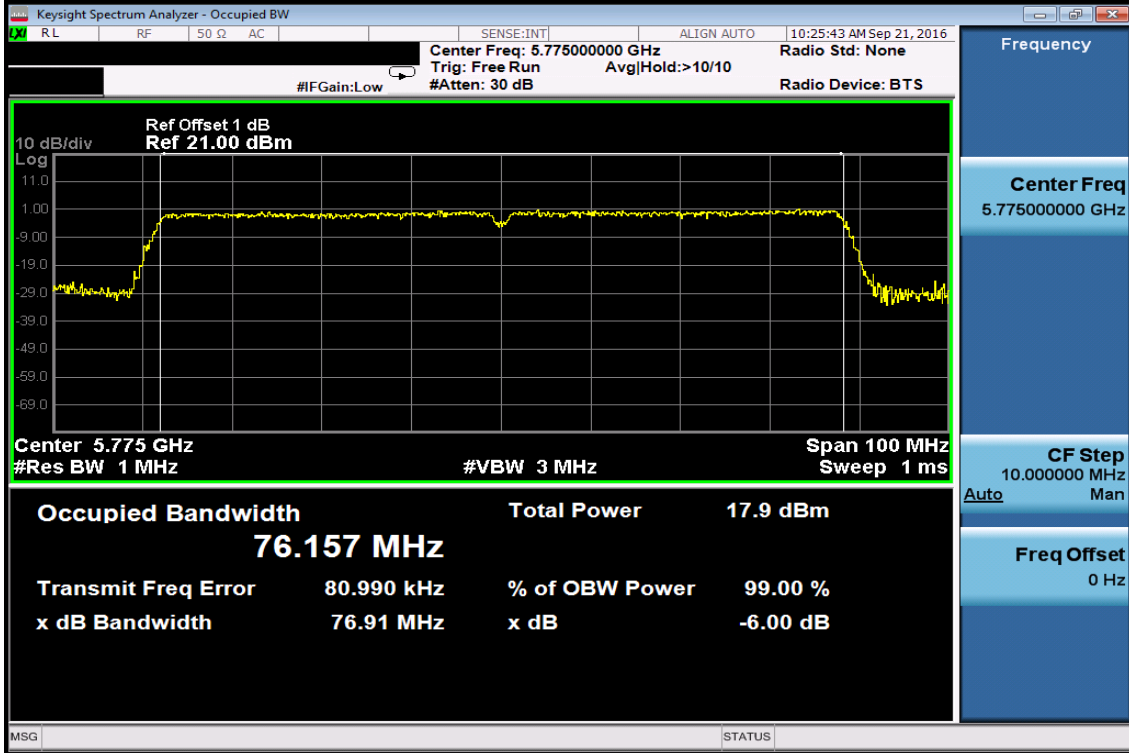

8. 6dB EMISSION BANDWIDTH MEASUREMENT

8.1. Standard Applicable

According to §15.407 (e) Within the 5.725-5.85 GHz band, the minimum 6 dB bandwidth of U-NII devices shall be at least 500 kHz.

According to RSS-247, 6.2.4

For equipment operating in the band 5725-5850 MHz, the minimum 6 dB bandwidth shall be at least 500 kHz.

8.2. Measurement Procedure

1. Place the EUT on the table and set it in transmitting mode.
2. Remove the antenna from the EUT and then connect a low loss RF cable from the antenna port to the spectrum analyzer.
3. Set the spectrum analyzer as RBW=100KHz, VBW =300MHz, Span= 50MHz, Sweep=auto
4. Mark the peak frequency and -6dB (upper and lower) frequency.
5. Repeat above procedures until all frequency measured were complete.

Refer to section D of KDB Document: KDB 789033 D02 General UNII Test Procedures New Rules v01r03

8.3. Measurement Equipment Used:

Refer to section 6.3 for details.

8.4. Test Set-up:

Refer to section 6.4 for details.

8.5. Measurement Result

802.11a Mode

Frequency (MHz)	6dB Bandwidth (MHz)	Limit (KHz)
5745	16.44	>500
5785	16.27	>500
5825	16.43	>500

802.11n HT20 Mode

Frequency (MHz)	6dB Bandwidth (MHz)	Limit (KHz)
5745	17.47	>500
5785	17.53	>500
5825	17.53	>500

802.11n HT40 Mode

Frequency (MHz)	6dB Bandwidth (MHz)	Limit (KHz)
5755	36.13	>500
5795	35.94	>500

802.11a HT80 Mode

Frequency (MHz)	6dB Bandwidth (MHz)	Limit (KHz)
5755	76.91	>500

5725-5850 MHz

802.11a

6dB Band Width Test Data CH-Low

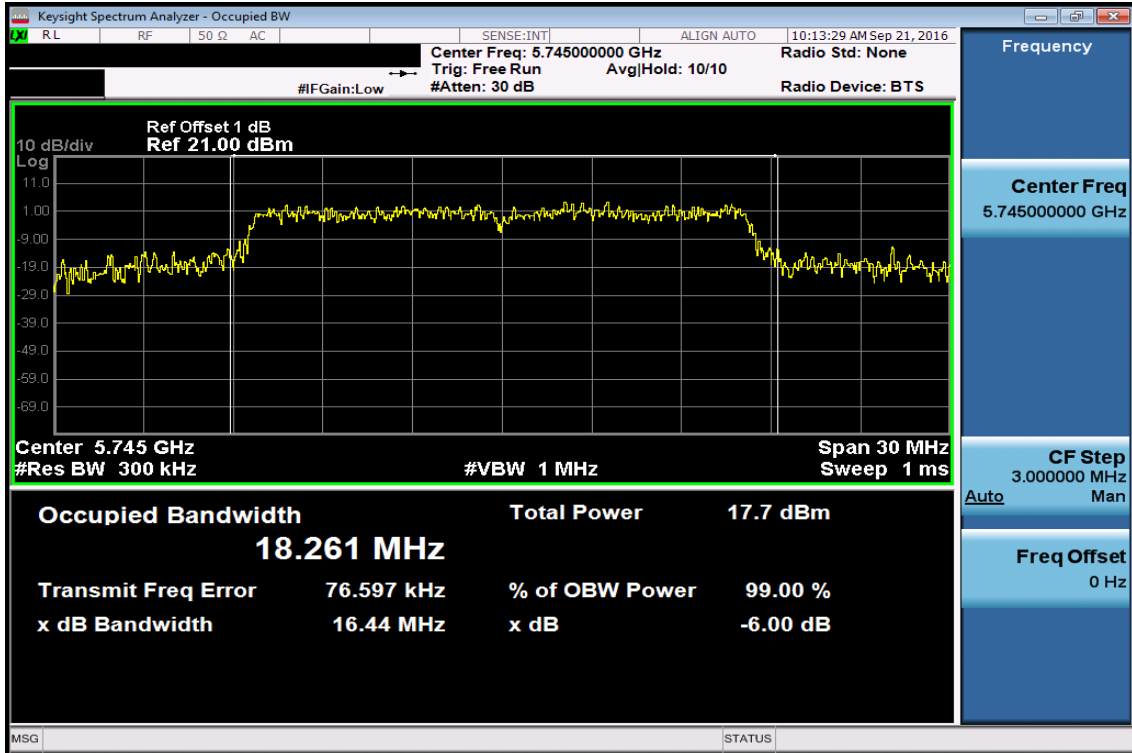

6dB Band Width Data CH-Mid

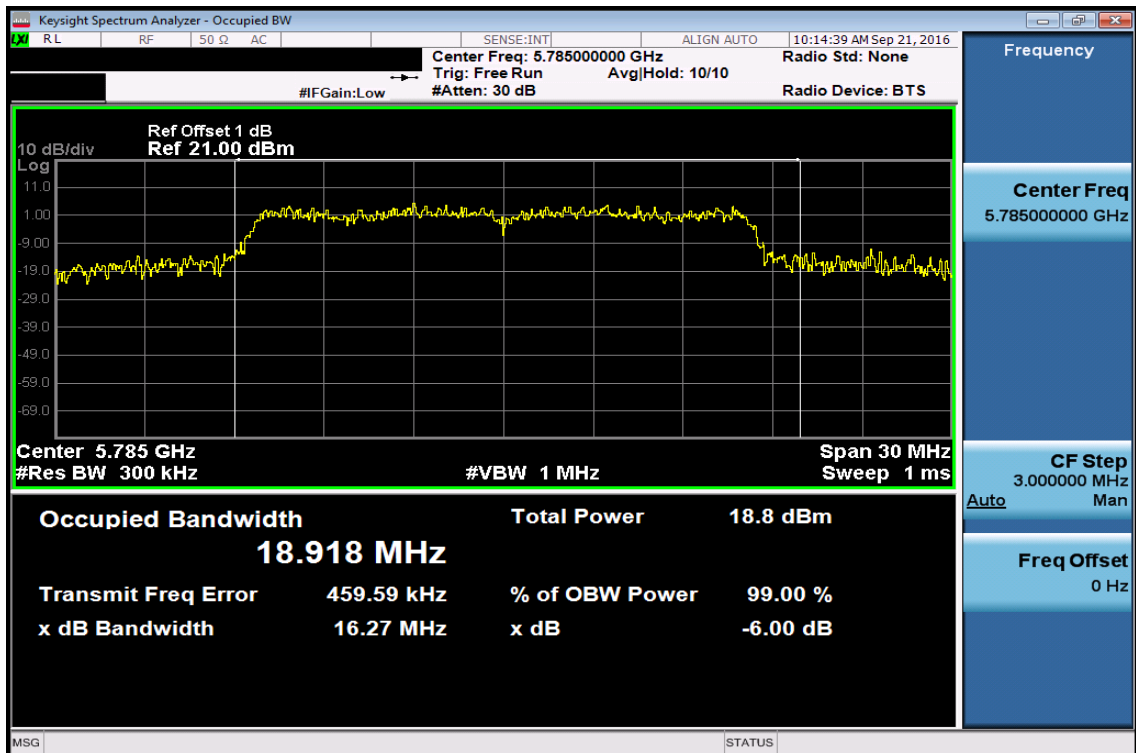

6dB Band Width Data CH-High

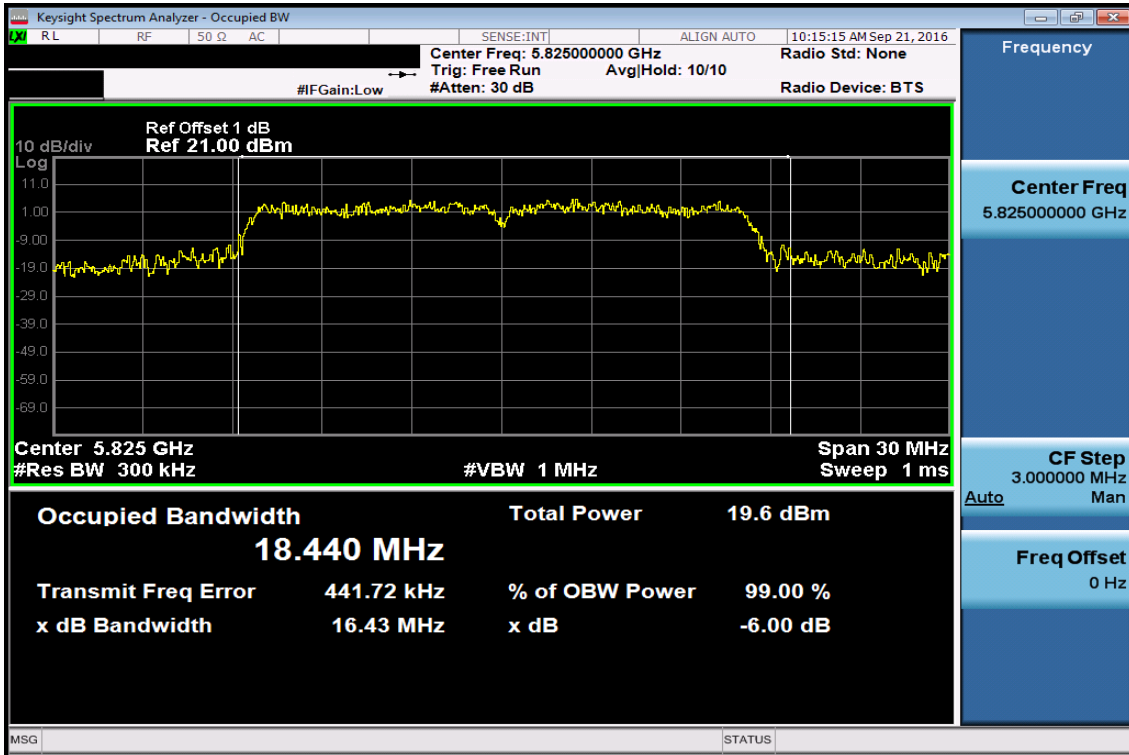

802.11n HT20

6dB Band Width Data CH-Low

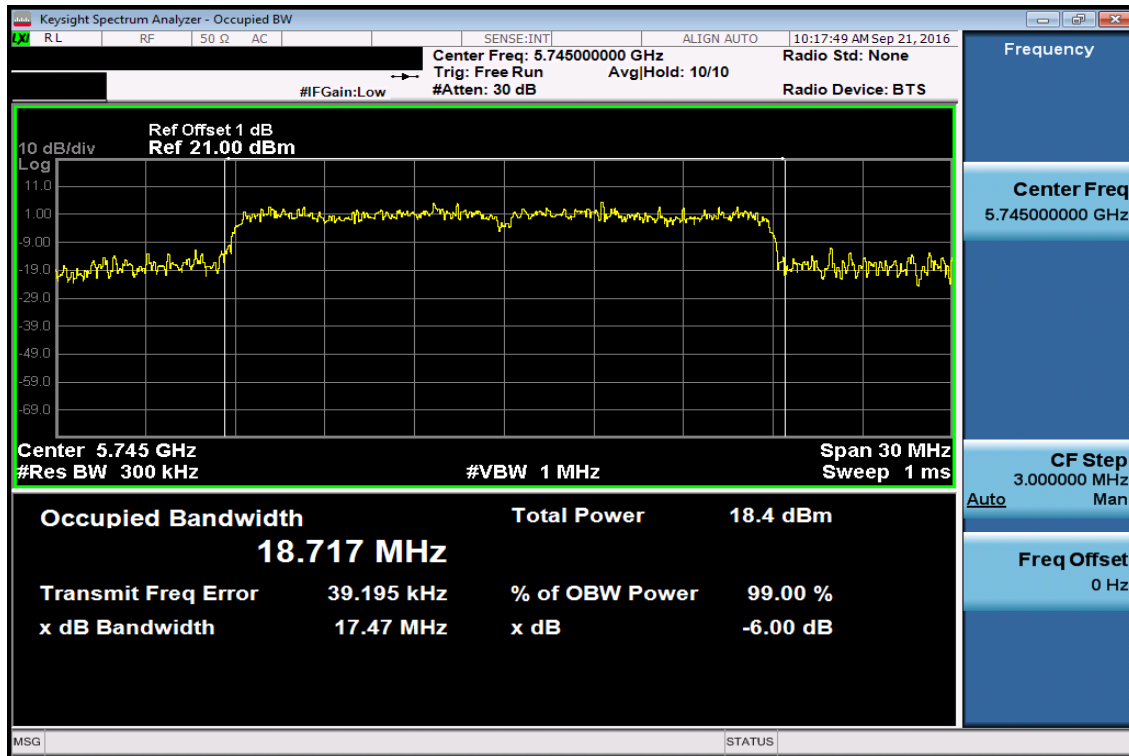

6dB Band Width Data CH-Mid

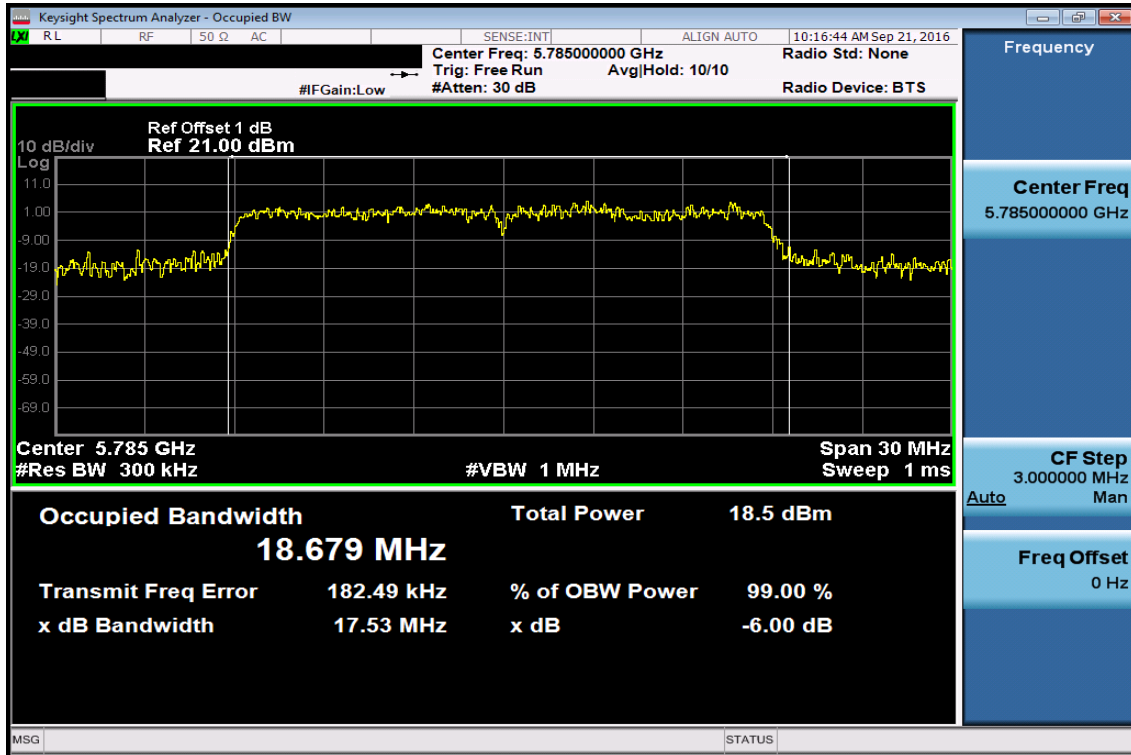

6dB Band Width Data CH-High

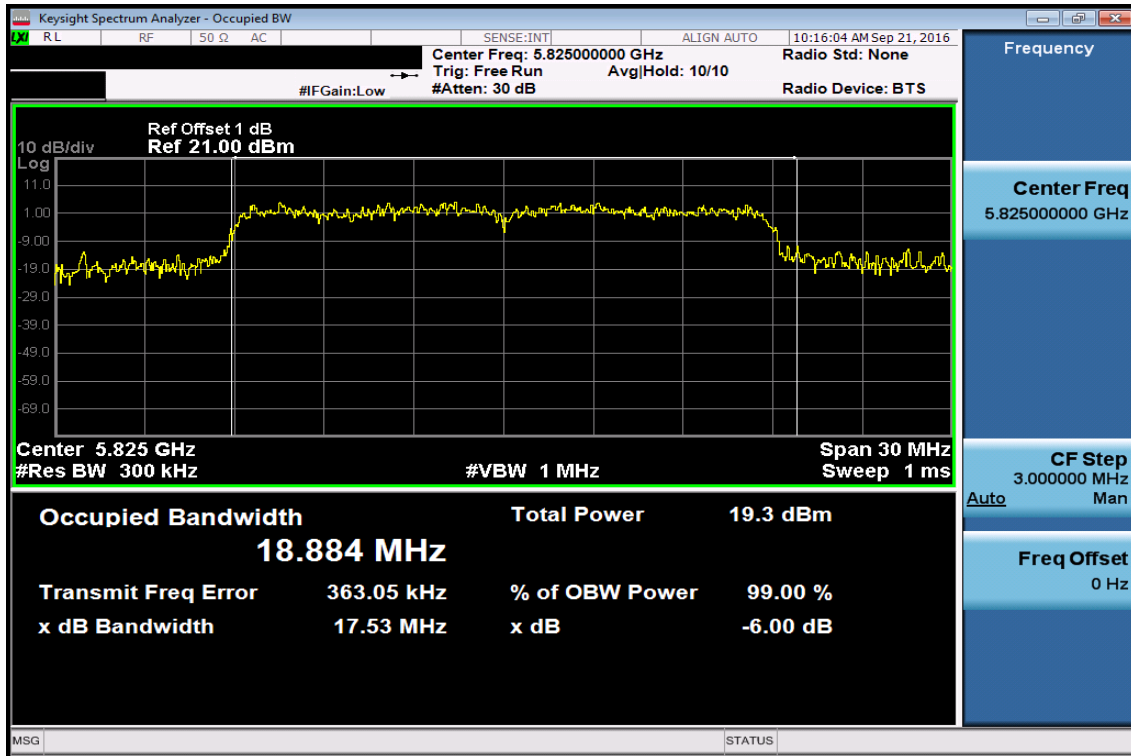

802.11n HT40

6dB Band Width Data CH-Low

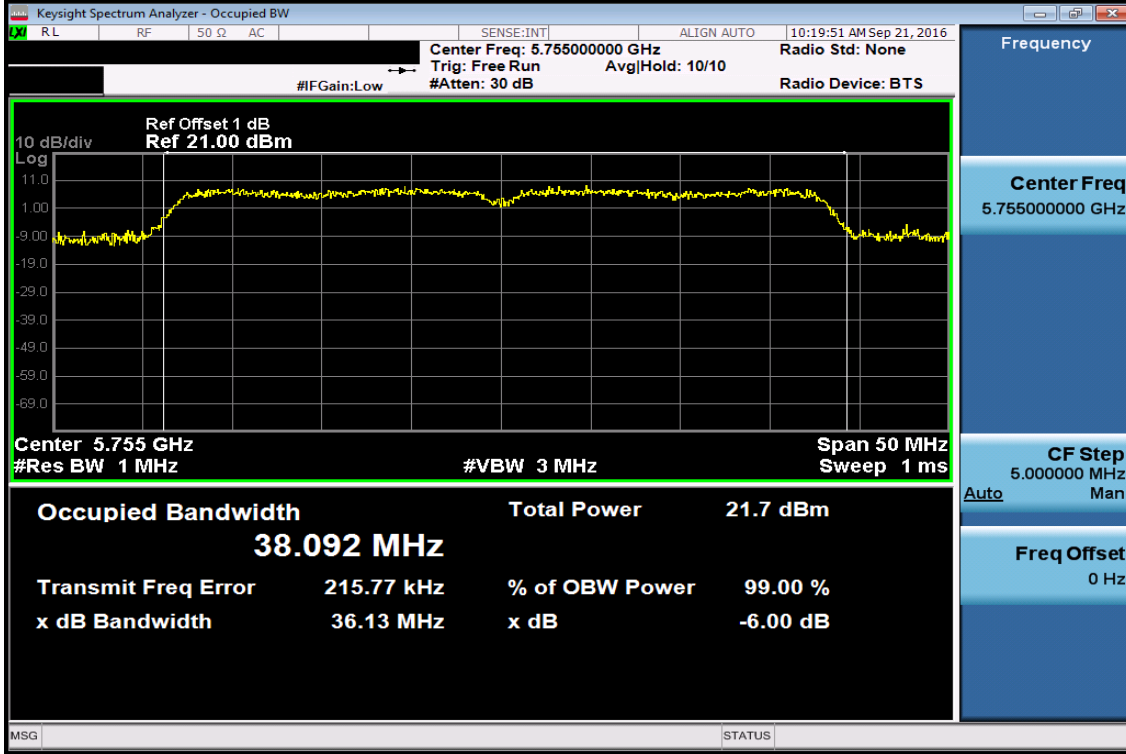

6dB Band Width Data CH-High

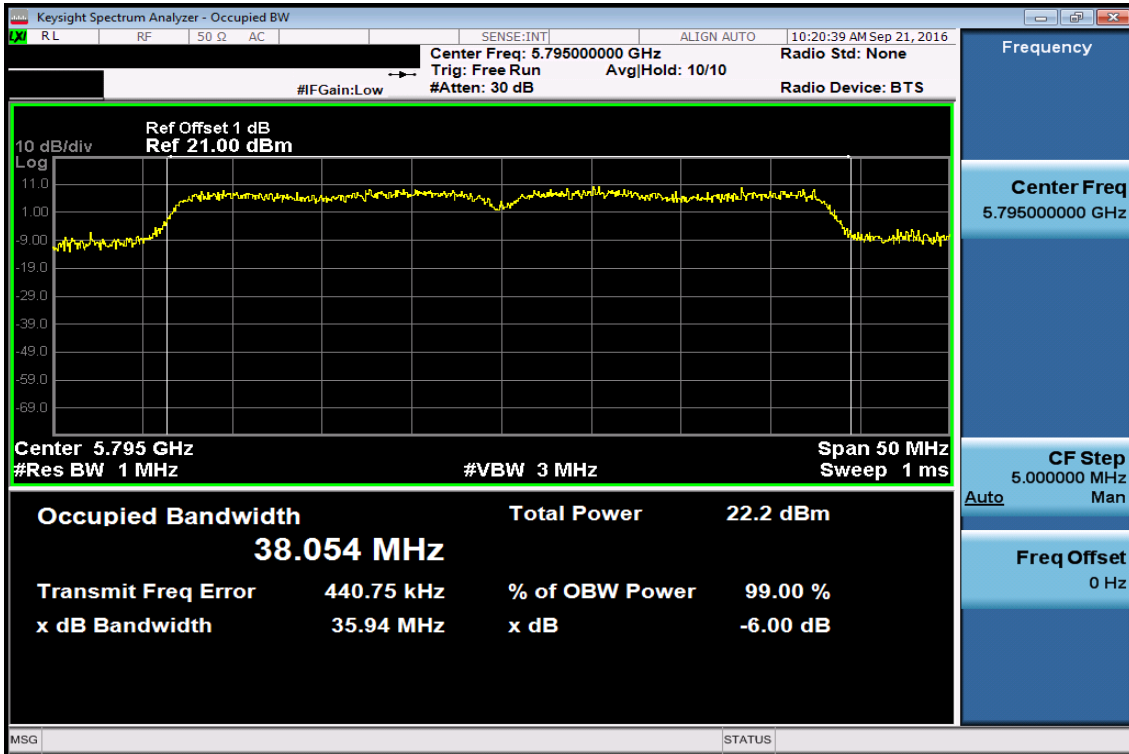

802.11AC HT80

6dB Band Width Data CH-Low

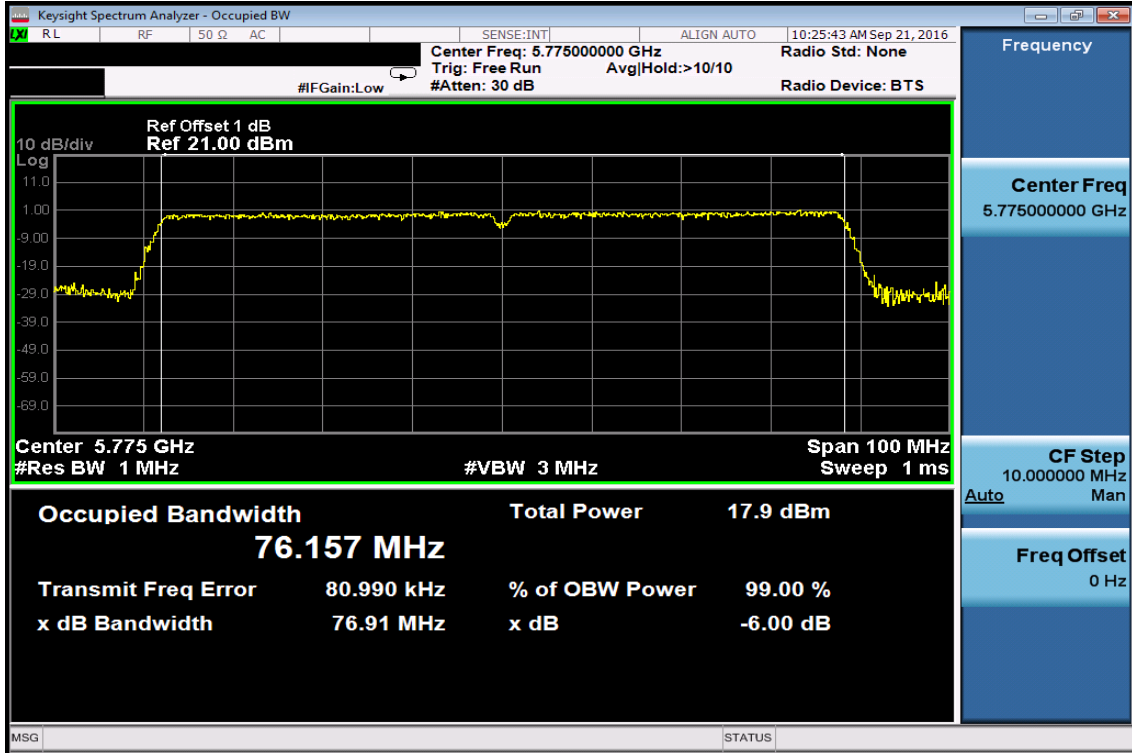

9. UNDESIRABLE EMISSION - RADIATED MEASUREMENT

9.1. Standard Applicable

According to §15.407(b), Undesirable Emission Limits: Except as shown in Paragraph (b)(7) of this section, the peak emissions outside of the frequency bands of operation shall be attenuated in accordance with the following limits:

- (1) For transmitters operating in the 5.15-5.25 GHz band: all emissions outside of the 5.15-5.35 GHz band shall not exceed an e.i.r.p. of -27 dBm/MHz.
- (2) For transmitters operating in the 5.25-5.35 GHz band: all emissions outside of the 5.15-5.35 GHz band shall not exceed an e.i.r.p. of -27 dBm/MHz.
- (3) For transmitters operating in the 5.47-5.725 GHz band: all emissions outside of the 5.47-5.725 GHz band shall not exceed an e.i.r.p. of -27 dBm/MHz.
- (4) For transmitters operating in the 5.725-5.85 GHz band: all emissions within the frequency range from the band edge to 10 MHz above or below the band edge shall not exceed an e.i.r.p. of -17dBm/MHz; for frequencies 10 MHz or greater above or below the band edge, emissions shall not exceed an e.i.r.p. of -27 dBm/MHz.
- (5) The above emission measurements shall be performed using a minimum resolution bandwidth of 1 MHz. A lower resolution bandwidth may be employed near the band edge, when necessary, provided the measured energy is integrated to show the total power over 1 MHz.
- (6) Unwanted emissions below 1 GHz must comply with the general field strength limits set forth in Section 15.209. Further, any U-NII devices using an AC power line are required to comply also with the conducted limits set forth in Section 15.207.
- (7) The provisions of Section 15.205 of this part apply to intentional radiators operating under this section.
- (8) When measuring the emission limits, the nominal carrier frequency shall be adjusted as close to the upper and lower frequency band edges as the design of the equipment permits.

According to RSS-247, 6.2

6.2.1 Frequency Band 5150-5250 MHz

For transmitters operating in the band 5150-5250 MHz, all emissions outside the band 5150-5350 MHz shall not exceed -27 dBm/MHz e.i.r.p. However, any unwanted emissions that fall into the band 5250-5350 MHz must be 26 dBc, when measured using a resolution bandwidth between 1 and 5% of the occupied bandwidth, above 5.25 GHz. Otherwise, the transmission is considered as intentional and the devices shall implement dynamic frequency selection (DFS) and transmitter power control (TPC) as per the requirements for the band 5250-5350 MHz.

6.2.2 Frequency Band 5250-5350 MHz

- i) For devices with both operating frequencies and channel bandwidths contained within the band 5250-5350 MHz, the device shall comply with the following:
 - a. All emissions outside the band 5250-5350 MHz shall not exceed -27 dBm/MHz e.i.r.p. if the equipment is intended for outdoor use; or
 - b. All emissions outside the band 5150-5350 MHz shall not exceed -27 dBm/MHz e.i.r.p. and any emissions within the band 5150-5250 MHz shall meet the power spectral density limits of Section 6.2.1. The device shall be labelled “for indoor use only.”
- ii) For devices with operating frequencies in the band 5250-5350 MHz but having a channel bandwidth that overlaps the band 5150-5250 MHz, the devices’ unwanted emission shall not exceed -27 dBm/MHz e.i.r.p. outside the band 5150-5350 MHz and its power shall comply with the spectral power density for operation within the band 5150-5250 MHz. The device shall be labelled “for indoor use only.”

(3) Additional requirements

In addition to the above requirements, devices operating in the band 5250-5350 MHz with a maximum e.i.r.p. greater than 200 mW shall comply with the following e.i.r.p. at different elevations, where θ is the angle above the local horizontal plane (of the Earth) as shown below:

- (i) -13 dBW/MHz for $0^\circ \leq \theta < 8^\circ$
- (ii) (ii) $-13 - 0.716 (\theta - 8)$ dBW/MHz for $8^\circ \leq \theta < 40^\circ$
- (iii) (iii) $-35.9 - 1.22 (\theta - 40)$ dBW/MHz for $40^\circ \leq \theta \leq 45^\circ$
- (iv) (iv) -42 dBW/MHz for $\theta > 45^\circ$

The measurement procedure defined in Annex A of this document shall be used to verify the compliance to the e.i.r.p. at different elevations.

6.2.3 Frequency Bands 5470-5600 MHz and 5650-5725 MHz

Emissions outside the band 5470-5725 MHz shall not exceed -27 dBm/MHz e.i.r.p.

6.2.4 Frequency Band 5725-5850 MHz

For the band 5725-5850 MHz, emissions at frequencies from the band edges to 10 MHz above or below the band edges shall not exceed -17 dBm/MHz e.i.r.p.

For emissions at frequencies more than 10 MHz above or below the band edges, the emissions power shall not exceed -27 dBm/MHz.

§15.205- RESTRICTED BANDS OF OPERATIONS

(a) Except as shown in paragraph (d) of this section, only spurious emissions are permitted in any of the frequency bands listed below:

MHz	MHz	MHz	GHz
0.090 - 0.110	16.42 - 16.423	399.9 - 410	4.5 - 5.15
¹ 0.495 - 0.505	16.69475 - 16.69525	608 - 614	5.35 - 5.46
2.1735 - 2.1905	16.80425 - 16.80475	960 - 1240	7.25 - 7.75
4.125 - 4.128	25.5 - 25.67	1300 - 1427	8.025 - 8.5
4.17725 - 4.17775	37.5 - 38.25	1435 - 1626.5	9.0 - 9.2
4.20725 - 4.20775	73 - 74.6	1645.5 - 1646.5	9.3 - 9.5
6.215 - 6.218	74.8 - 75.2	1660 - 1710	10.6 - 12.7
6.26775 - 6.26825	108 - 121.94	1718.8 - 1722.2	13.25 - 13.4
6.31175 - 6.31225	123 - 138	2200 - 2300	14.47 - 14.5
8.291 - 8.294	149.9 - 150.05	2310 - 2390	15.35 - 16.2
8.362 - 8.366	156.52475 -	2483.5 - 2500	17.7 - 21.4
8.37625 - 8.38675	156.52525	2655 - 2900	22.01 - 23.12
8.41425 - 8.41475	156.7 - 156.9	3260 - 3267	23.6 - 24.0
12.29 - 12.293	162.0125 - 167.17	3332 - 3339	31.2 - 31.8
12.51975 - 12.52025	167.72 - 173.2	3345.8 - 3358	36.43 - 36.5
12.57675 - 12.57725	240 - 285	3600 - 4400	⁽²⁾
13.36 - 13.41	322 - 335.4		

¹ Until February 1, 1999, this restricted band shall be 0.490-0.510 MHz.

² Above 38.6

(b) Except as provided in paragraphs (d) and (e), the field strength of emissions appearing within these frequency bands shall not exceed the limits shown in Section 15.209. At frequencies equal to or less than 1000 MHz, compliance with the limits in Section 15.209 shall be demonstrated using measurement instrumentation employing a CISPR quasi-peak detector. Above 1000 MHz, compliance with the emission limits in Section 15.209 shall be demonstrated based on the average value of the measured emissions. The provisions in Section 15.35 apply to these measurements.

§15.209- RADIATED EMISSION LIMITS: GENERAL REQUIREMENTS

FCC PART 15.209

MEASURING DISTANCE OF 3 METER		
FREQUENCY RANGE (MHz)	FIELD STRENGTH (Microvolts/m)	FIELD STRENGTH (dBuV/m)
30-88	100	40
88-216	150	43.5
216-960	200	46
Above 960	500	54

9.2. EUT Setup

1. The radiated emission tests were performed in the 3 meter open-test site, using the setup in accordance with the ANSI C63.10: 2013
2. The EUT was put in the front of the test table. The host PC system was placed on the center of the back edge on the test table. The peripherals like modem, monitor printer, K/B, and mouse were placed on the side of the host PC system. The rear of the EUT and peripherals were placed flushed with the rear of the tabletop.
3. The keyboard was placed directly in the front of the monitor, flushed with the front tabletop. The mouse was placed next to the Keyboard, flushed with the back of keyboard.
4. The spacing between the peripherals was 10 centimeters.
5. External I/O cables were draped along the edge of the test table and bundle when necessary.
6. The host PC system was connected with 120Vac/60Hz power source.

9.3. Measurement Procedure

1. The EUT was placed on a turn table which is 0.8m above ground plane.
2. The turn table shall rotate 360 degrees to determine the position of maximum emission level.
3. EUT is set 3m away from the receiving antenna which varied from 1m to 4m to find out the highest emissions.
4. Maximum procedure was performed on the six highest emissions to ensure EUT compliance.
5. And also, each emission was to be maximized by changing the polarization of receiving antenna both horizontal and vertical.
6. Repeat above procedures until all frequency measured were complete.

Refer to section F of KDB Document: KDB 789033 D02 General UNII Test Procedures New Rules v01r03

9.4. Test SET-UP (Block Diagram of Configuration)

(A) Radiated Emission Test Set-Up, Frequency Below 1000MHz

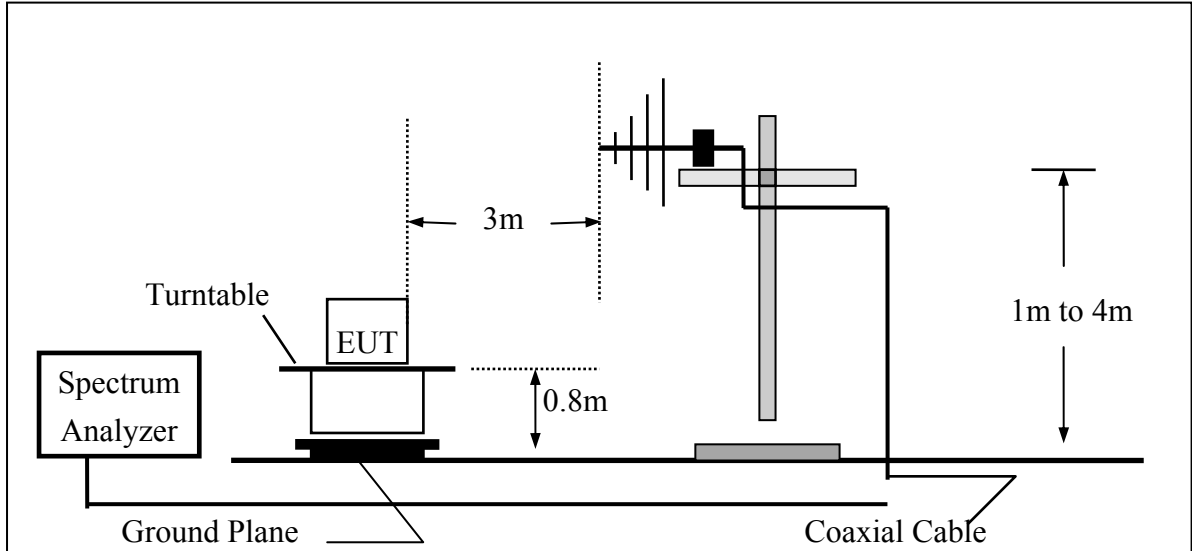

(B) Radiated Emission Test Set-Up Frequency Over 1 GHz

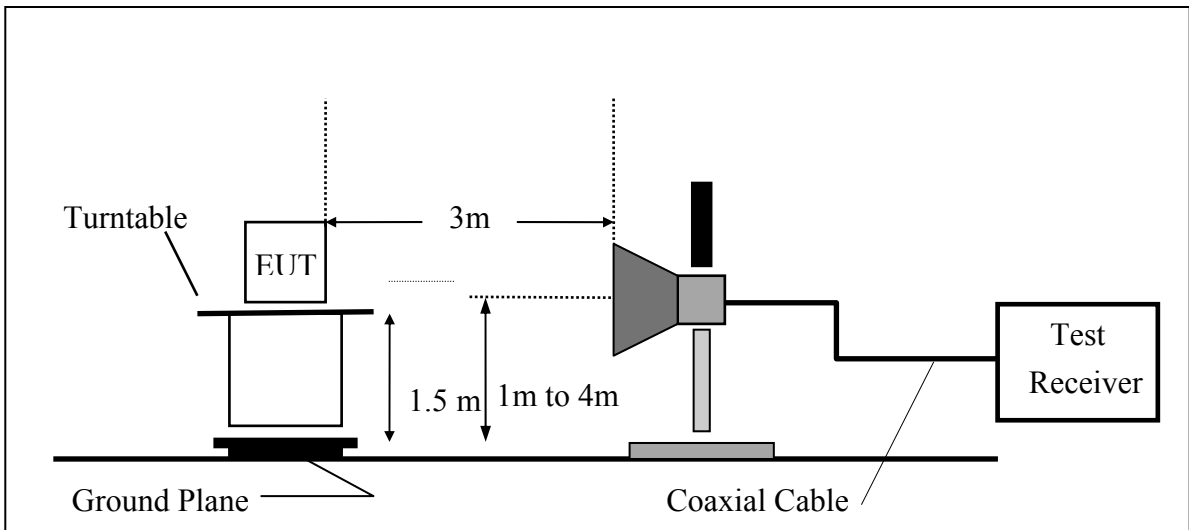

9.5. Measurement Equipment Used:

Chamber 14(966)					
EQUIPMENT TYPE	MFR	MODEL NUMBER	SERIAL NUMBER	LAST CAL.	CAL DUE.
Spectrum Analyzer 21(26.5GHz)	Agilent	N9010A	MY49060537	07/29/2016	07/28/2017
Spectrum Analyzer 20(6.5GHz)	Agilent	E4443A	MY48250315	05/20/2016	05/19/2017
Spectrum Analyzer 22(43GHz)	R&S	FSU43	100143	05/22/2016	05/21/2017
Loop Antenna9K-30M	A.H.SYSTEM	SAS-564	294	06/17/2015	06/16/2017
Bilog Antenna30-1G	SCHWARZBECK	VULB9168	644	03/02/2016	03/01/2017
Horn antenna1-18G	ETS	3117	00066665	11/30/2015	11/29/2016
Horn antenna26-40G(05)	Com-power	AH-640	100A	01/21/2015	01/20/2017
Horn antenna18-26G(04)	Com-power	AH-826	081001	07/24/2015	07/23/2017
Preamplifier9-1000M	HP	8447D	NA	03/11/2016	03/10/2017
Preamplifier1-18G	MITEQ	AFS44-001018 00-25-10P-44	1329256	07/27/2016	07/26/2017
Preamplifier1-26G	EM	EM01M26G	NA	03/10/2016	03/09/2017
Preamplifier26-40G	MITEQ	JS-26004000-2 7-5A	818471	07/23/2015	07/22/2017
Cable1-18G	HUBER SUHNER	Sucoflex 106	NA	11/25/2015	11/24/2016
Cable UP to 1G	HUBER SUHNER	RG 214/U	NA	10/02/2015	10/01/2016
SUCOFLEX 1GHz~40GHz cable	HUBER SUHNER	Sucoflex 102	27963/2&3742 1/2	11/03/2015	11/02/2017
2.4G Filter	Micro-Tronics	Brm50702	76	12/26/2015	12/25/2016
5G Filter	Micro-Tronics	Brm50716	005	12/26/2015	12/25/2016
Test Software	Audix	E3 Ver:6.12023	N/A	N/A	N/A

9.6. Field Strength Calculation

The field strength is calculated by adding the Antenna Factor and Cable Factor and subtracting the Amplifier Gain and Duty Cycle Correction Factor(if any) from the measured reading. The basic equation with a sample calculation is as follows:

$$FS = RA + AF + CL - AG$$

Where	FS = Field Strength	CL = Cable Attenuation Factor (Cable Loss)
	RA = Reading Amplitude	AG = Amplifier Gain
	AF = Antenna Factor	

9.7. Measurement Result

Refer to attach tabular data sheets.

NOTE:

The resolution bandwidth and video bandwidth of test receiver/spectrum analyzer is 100kHz for Peak detection (PK) and Quasi-peak detection (QP) at frequency below 1GHz. And RBW 1MHz for frequency above 1GHz.

Radiated Spurious Emission Measurement Result (below 1GHz)

(Worst case: Band 1, 802.11ac HT80)

Operation Mode	TX MODE	Test Date	2016/08/15
Channel Number	CH Low	Test By	Dino
Temperature	25 °C	Pol	Ver./Hor
Humidity	65 %		

No	Freq MHz	Reading dBuV	Factor dB	Level dBuV/m	Limit dBuV/m	Over Limit dB	Remark	Pol V/H
1	199.75	53.22	-14.80	38.42	43.50	-5.08	Peak	VERTICAL
2	250.19	52.13	-12.84	39.29	46.00	-6.71	Peak	VERTICAL
3	450.01	44.46	-7.91	36.55	46.00	-9.45	Peak	VERTICAL
4	518.88	41.05	-7.07	33.98	46.00	-12.02	Peak	VERTICAL
5	749.74	43.95	-2.83	41.12	46.00	-4.88	Peak	VERTICAL
6	849.65	38.84	-1.35	37.49	46.00	-8.51	Peak	VERTICAL
1	199.75	49.59	-14.80	34.79	43.50	-8.71	Peak	HORIZONTAL
2	250.19	52.37	-12.84	39.53	46.00	-6.47	Peak	HORIZONTAL
3	350.10	48.06	-10.06	38.00	46.00	-8.00	Peak	HORIZONTAL
4	518.88	44.80	-7.07	37.73	46.00	-8.27	Peak	HORIZONTAL
5	549.92	44.41	-6.53	37.88	46.00	-8.12	Peak	HORIZONTAL
6	700.27	37.77	-4.03	33.74	46.00	-12.26	Peak	HORIZONTAL

Remark:

- 1 No further spurious emissions detected from the lowest internal frequency and 30MHz.
- 2 Measuring frequencies from the lowest internal frequency to the 1GHz.
- 3 Radiated emissions measured in frequency range from 9MHz to 1000MHz were made with an instrument detector setting 9-90KHz/110-490KHz using PK/AV and other Frequency Band using PK/QP
- 4 Measurement result within this frequency range shown “ - ” in the table above means the reading of emissions are attenuated more than 20dB below the permissible limits or the field strength is too small to be measured.
- 5 The IF bandwidth of SPA between 9kHz to 30MHz was 10kHz, VBW= 30kHz; between 30MHz to 1GHz was 100KHz, VBW=300KHz.

Radiated Spurious Emission Measurement Result (below 1GHz)

Operation Mode	TX MODE	Test Date	2016/08/15
Channel Number	CH Mid	Test By	Dino
Temperature	25 °C	Pol	Ver./Hor
Humidity	65 %		

No	Freq MHz	Reading dBuV	Factor dB	Level dBuV/m	Limit dBuV/m	Over Limit dB	Remark	Pol V/H
1	199.75	53.36	-14.80	38.56	43.50	-4.94	Peak	VERTICAL
2	250.19	52.81	-12.84	39.97	46.00	-6.03	Peak	VERTICAL
3	450.01	44.34	-7.91	36.43	46.00	-9.57	Peak	VERTICAL
4	551.86	44.42	-6.49	37.93	46.00	-8.07	Peak	VERTICAL
5	749.74	43.27	-2.83	40.44	46.00	-5.56	Peak	VERTICAL
6	849.65	38.42	-1.35	37.07	46.00	-8.93	Peak	VERTICAL
1	199.75	49.22	-14.80	34.42	43.50	-9.08	Peak	HORIZONTAL
2	250.19	51.22	-12.84	38.38	46.00	-7.62	Peak	HORIZONTAL
3	350.10	48.00	-10.06	37.94	46.00	-8.06	Peak	HORIZONTAL
4	450.01	44.31	-7.91	36.40	46.00	-9.60	Peak	HORIZONTAL
5	549.92	44.19	-6.53	37.66	46.00	-8.34	Peak	HORIZONTAL
6	700.27	37.44	-4.03	33.41	46.00	-12.59	Peak	HORIZONTAL

Remark:

- 1 No further spurious emissions detected from the lowest internal frequency and 30MHz.
- 2 Measuring frequencies from the lowest internal frequency to the 1GHz.
- 3 Radiated emissions measured in frequency range from 9MHz to 1000MHz were made with an instrument detector setting 9-90KHz/110-490KHz using PK/AV and other Frequency Band using PK/QP
- 4 Measurement result within this frequency range shown “ - ” in the table above means the reading of emissions are attenuated more than 20dB below the permissible limits or the field strength is too small to be measured.
- 5 The IF bandwidth of SPA between 9kHz to 30MHz was 10kHz, VBW= 30kHz; between 30MHz to 1GHz was 100KHz, VBW=300KHz.

Radiated Spurious Emission Measurement Result (below 1GHz)

Operation Mode	TX MODE	Test Date	2016/08/15
Channel Number	CH High	Test By	Dino
Temperature	25 °C	Pol	Ver./Hor
Humidity	65 %		

No	Freq MHz	Reading dBuV	Factor dB	Level dBuV/m	Limit dBuV/m	Over Limit dB	Remark	Pol V/H
1	199.75	53.26	-14.80	38.46	43.50	-5.04	Peak	VERTICAL
2	250.19	52.63	-12.84	39.79	46.00	-6.21	Peak	VERTICAL
3	450.01	44.41	-7.91	36.50	46.00	-9.50	Peak	VERTICAL
4	518.88	43.50	-7.07	36.43	46.00	-9.57	Peak	VERTICAL
5	749.74	43.91	-2.83	41.08	46.00	-4.92	Peak	VERTICAL
6	849.65	38.81	-1.35	37.46	46.00	-8.54	Peak	VERTICAL
1	199.75	49.47	-14.80	34.67	43.50	-8.83	Peak	HORIZONTAL
2	250.19	51.23	-12.84	38.39	46.00	-7.61	Peak	HORIZONTAL
3	350.10	47.99	-10.06	37.93	46.00	-8.07	Peak	HORIZONTAL
4	450.01	44.44	-7.91	36.53	46.00	-9.47	Peak	HORIZONTAL
5	549.92	44.07	-6.53	37.54	46.00	-8.46	Peak	HORIZONTAL
6	700.27	37.28	-4.03	33.25	46.00	-12.75	Peak	HORIZONTAL

Remark:

- 1 No further spurious emissions detected from the lowest internal frequency and 30MHz.
- 2 Measuring frequencies from the lowest internal frequency to the 1GHz.
- 3 Radiated emissions measured in frequency range from 9MHz to 1000MHz were made with an instrument detector setting 9-90KHz/110-490KHz using PK/AV and other Frequency Band using PK/QP
- 4 Measurement result within this frequency range shown “ - ” in the table above means the reading of emissions are attenuated more than 20dB below the permissible limits or the field strength is too small to be measured.
- 5 The IF bandwidth of SPA between 9kHz to 30MHz was 10kHz, VBW= 30kHz; between 30MHz to 1GHz was 100KHz, VBW=300KHz.

Radiated Spurious Emission Measurement Result (above 1GHz)

(Worst case: Band 1, 802.11ac HT80)

Operation Mode	TX MODE	Test Date	2016/08/15
Channel Number	CH Low	Test By	Dino
Temperature	25 °C	Humidity	60 %

No	Freq MHz	Reading dBuV	Factor dB	Level dBuV/m	Limit dBuV/m	Over Limit dB	Remark	Pol V/H
1	3002.00	56.34	-9.25	47.09	74.00	-26.91	Peak	VERTICAL
2	10360.00	36.11	7.59	43.70	74.00	-30.30	Peak	VERTICAL
3	15540.00	30.08	9.84	39.92	54.00	-14.08	Average	VERTICAL
4	15540.00	45.43	9.84	55.27	74.00	-18.73	Peak	VERTICAL
1	2624.00	54.85	-10.08	44.77	74.00	-29.23	Peak	HORIZONTAL
2	10360.00	36.15	7.59	43.74	74.00	-30.26	Peak	HORIZONTAL
3	15540.00	42.46	9.84	52.30	74.00	-21.70	Peak	HORIZONTAL

Remark:

- 1 Field strength limits for frequency above 1000MHz are based on average limits. However, Peak mode field strength shall not exceed the average limits specified plus 20dB.
- 2 Measurement of data within this frequency range shown “ - ” in the table above means the reading of emissions are attenuated more than 20dB below the permissible limits or the field strength is too small to be measured.
- 3 Spectrum Peak mode IF bandwidth Setting : 1GHz- 26GHz, RBW= 1MHz, Sweep time= 200 ms., the VBW setting was 3 MHz.
- 4 Spectrum AV mode if bandwidth Setting : 1GHz- 26GHz, RBW= 1MHz, VBW= 10Hz, Sweep time= 200 ms.

Radiated Spurious Emission Measurement Result (above 1GHz)

Operation Mode	TX MODE	Test Date	2016/08/15
Channel Number	CH Mid	Test By	Dino
Temperature	25 °C	Humidity	60 %

No	Freq MHz	Reading dBuV	Factor dB	Level dBuV/m	Limit dBuV/m	Over Limit dB	Remark	Pol V/H
1	3002.00	54.91	-9.25	45.66	74.00	-28.34	Peak	VERTICAL
2	10400.00	37.33	7.66	44.99	74.00	-29.01	Peak	VERTICAL
3	15600.00	28.77	9.98	38.75	54.00	-15.25	Average	VERTICAL
4	15600.00	44.38	9.98	54.36	74.00	-19.64	Peak	VERTICAL
1	1504.00	61.58	-14.81	46.77	74.00	-27.23	Peak	HORIZONTAL
2	10400.00	36.84	7.66	44.50	74.00	-29.50	Peak	HORIZONTAL
3	15600.00	41.19	9.98	51.17	74.00	-22.83	Peak	HORIZONTAL

Remark:

- Field strength limits for frequency above 1000MHz are based on average limits. However, Peak mode field strength shall not exceed the average limits specified plus 20dB.
- Measurement of data within this frequency range shown “ - ” in the table above means the reading of emissions are attenuated more than 20dB below the permissible limits or the field strength is too small to be measured.
- Spectrum Peak mode IF bandwidth Setting : 1GHz- 26GHz, RBW= 1MHz, Sweep time= 200 ms., the VBW setting was 3 MHz.
- Spectrum AV mode if bandwidth Setting : 1GHz- 26GHz, RBW= 1MHz, VBW= 10Hz, Sweep time= 200 ms.

Radiated Spurious Emission Measurement Result (above 1GHz) (worst case)

Operation Mode	TX MODE	Test Date	2016/08/15
Channel Number	CH High	Test By	Dino
Temperature	25 °C	Humidity	60 %

No	Freq MHz	Reading dBuV	Factor dB	Level dBuV/m	Limit dBuV/m	Over Limit dB	Remark	Pol V/H
1	1602.00	62.97	-14.26	48.71	74.00	-25.29	Peak	VERTICAL
2	10480.00	35.94	7.80	43.74	74.00	-30.26	Peak	VERTICAL
3	15720.00	31.22	10.29	41.51	54.00	-12.49	Average	VERTICAL
4	15720.00	46.84	10.29	57.13	74.00	-16.87	Peak	VERTICAL
1	2624.00	54.74	-10.08	44.66	74.00	-29.34	Peak	HORIZONTAL
2	10480.00	36.06	7.80	43.86	74.00	-30.14	Peak	HORIZONTAL
3	15720.00	42.14	10.29	52.43	74.00	-21.57	Peak	HORIZONTAL

Remark:

- 1 Field strength limits for frequency above 1000MHz are based on average limits. However, Peak mode field strength shall not exceed the average limits specified plus 20dB.
- 2 Measurement of data within this frequency range shown “ - ” in the table above means the reading of emissions are attenuated more than 20dB below the permissible limits or the field strength is too small to be measured.
- 3 Spectrum Peak mode IF bandwidth Setting : 1GHz- 26GHz, RBW= 1MHz, Sweep time= 200 ms., the VBW setting was 3 MHz.
- 4 Spectrum AV mode if bandwidth Setting : 1GHz- 26GHz, RBW= 1MHz, VBW= 10Hz, Sweep time= 200 ms.

Band Edges test (worst case: Band 1, 802.11ac HT80) -Radiated

Operation Mode	TX CH Low	Test Date	2016/08/15
Channel Number	5170 MHz	Test By	Dino
Temperature	25 °C	Humidity	65 %

No	Freq MHz	Reading dBuV	Factor dB	Level dBuV/m	Limit dBuV/m	Over Limit dB	Remark	Pol V/H
1	5150.30	41.12	-2.50	38.62	54.00	-15.38	Average	VERTICAL
2	5150.30	66.35	-2.50	63.85	74.00	-10.15	Peak	VERTICAL
1	5150.30	43.02	-2.50	40.52	54.00	-13.48	Average	HORIZONTAL
2	5150.30	70.26	-2.50	67.76	74.00	-6.24	Peak	HORIZONTAL

Operation Mode	TX CH High	Test Date	2016/08/15
Channel Number	5240MHz	Test By	Dino
Temperature	25 °C	Humidity	65 %

No	Freq MHz	Reading dBuV	Factor dB	Level dBuV/m	Limit dBuV/m	Over Limit dB	Remark	Pol V/H
1	5350.08	42.93	-2.05	40.88	74.00	-33.12	Peak	VERTICAL
1	5350.08	43.59	-2.05	41.54	74.00	-32.46	Peak	HORIZONTAL

Remark:

- 1 Measuring frequencies from the lowest internal frequency to the 10th of fundamental frequency
- 2 Field strength limits for frequency above 1000MHz are based on average limits. However, Peak mode field strength shall not exceed the average limits specified plus 20dB.
- 3 Measurement of data within this frequency range shown “ - ” in the table above means the reading of emissions are attenuated more than 20dB below the permissible limits or the field strength is too small to be measured.
- 4 Spectrum Peak mode IF bandwidth Setting : 1GHz- 26GHz, RBW= 1MHz, Sweep time= 200 ms., the VBW setting was 3 MHz.
- 5 Spectrum AV mode if bandwidth Setting : 1GHz- 26GHz, RBW= 1MHz, VBW= 10Hz, Sweep time= 200 ms.

Band Edges test (worst case: Band 4, 802.11ac HT80) - Radiated

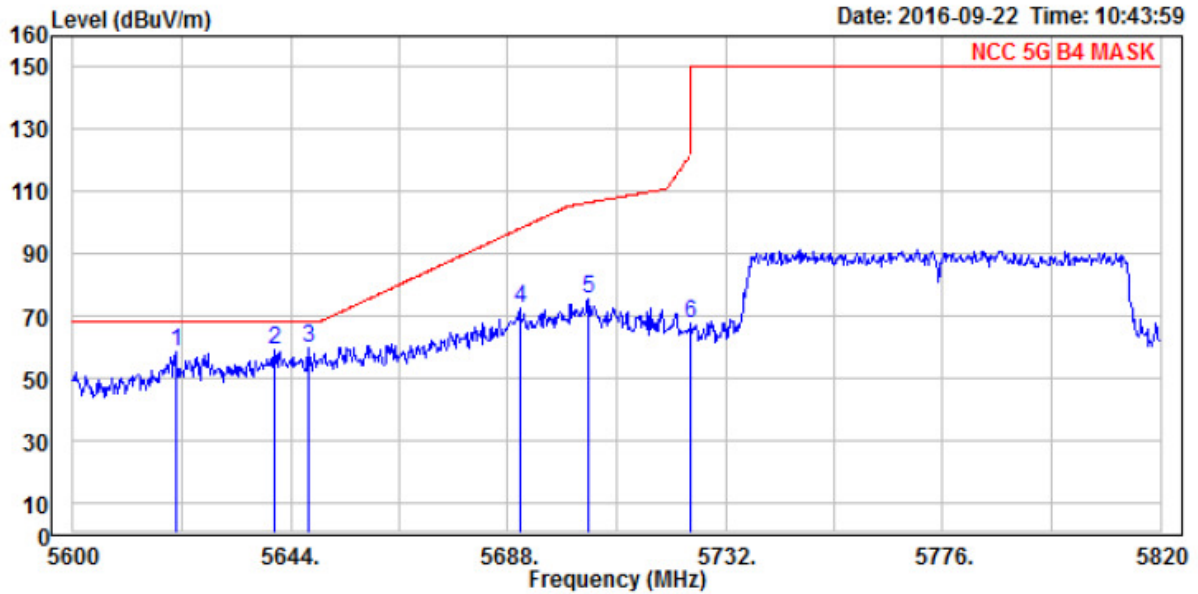

Condition: NCC 5G B4 MASK 3m 1166 EMAH10180 V 1-18G Vertical
 : RBW:1000kHz VBW:1000kHz SWT:Auto DET:Positive
 EUT : WYSBHVXG
 Mode : 5G Band4 n-HT80 mode TX ch 5775MHz Bandedge
 Note :

	Read		Limit	Over		
Freq	Level	Factor	Level	Line	Limit	Pol/Phase
MHz	dBuV	dB/m	dBuV/m	dBuV/m	dB	
1	5620.680	55.55	2.57	58.12	68.20	-10.08 Vertical
2	5640.920	56.19	2.63	58.82	68.20	-9.38 Vertical
3 PP	5647.520	57.08	2.65	59.73	68.20	-8.47 Vertical
4	5690.420	69.43	2.76	72.19	98.14	-25.95 Vertical
5	5704.280	72.76	2.80	75.56	106.40	-30.84 Vertical
6	5724.960	64.56	2.85	67.41	122.11	-54.70 Vertical

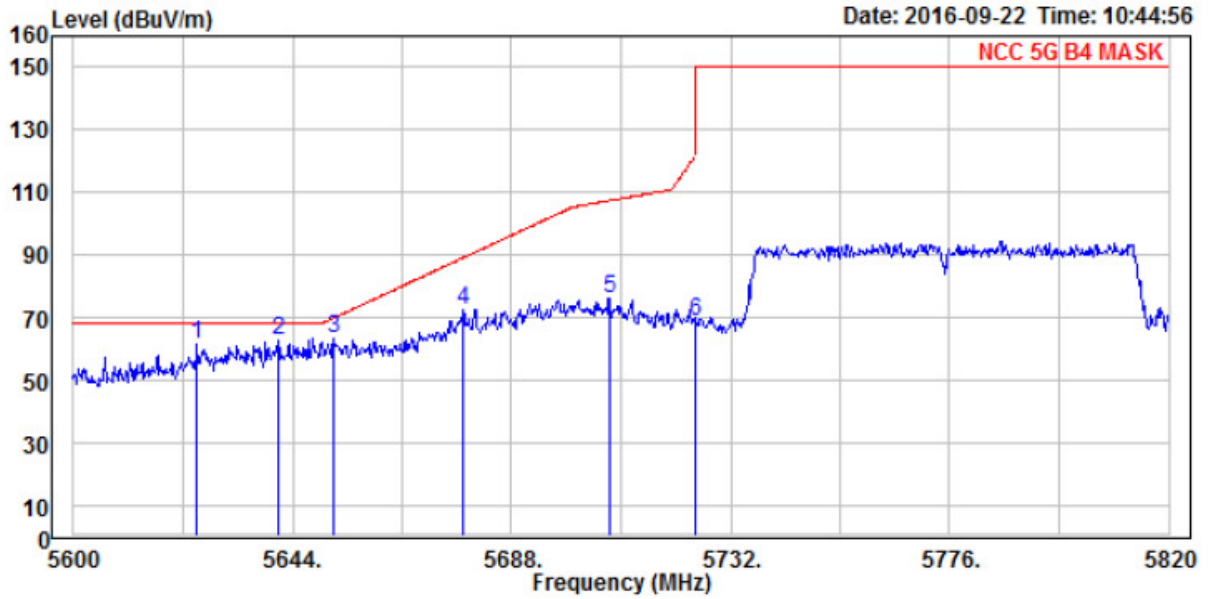

Condition: NCC 5G B4 MASK 3m 1166 EMAH10180 H 1-18G Horizontal
 : RBW:1000kHz VBW:1000kHz SWT:Auto DET:Positive
 EUT : WYSBHVXGXG
 Mode : 5G Band4 n-HT80 mode TX ch 5775MHz Bandedge
 Note :

	Read	Limit	Over				
Freq	Level	Factor	Level	Line	Limit	Pol/Phase	
MHz	dBuV	dB/m	dBuV/m	dBuV/m	dB		
1	5624.860	58.74	2.59	61.33	68.20	-6.87	Horizontal
2 PP	5641.140	59.81	2.63	62.44	68.20	-5.76	Horizontal
3	5652.140	60.68	2.65	63.33	69.79	-6.46	Horizontal
4	5678.320	69.76	2.73	72.49	89.20	-16.71	Horizontal
5	5707.580	73.26	2.81	76.07	107.32	-31.25	Horizontal
6	5724.960	66.04	2.85	68.89	122.11	-53.22	Horizontal

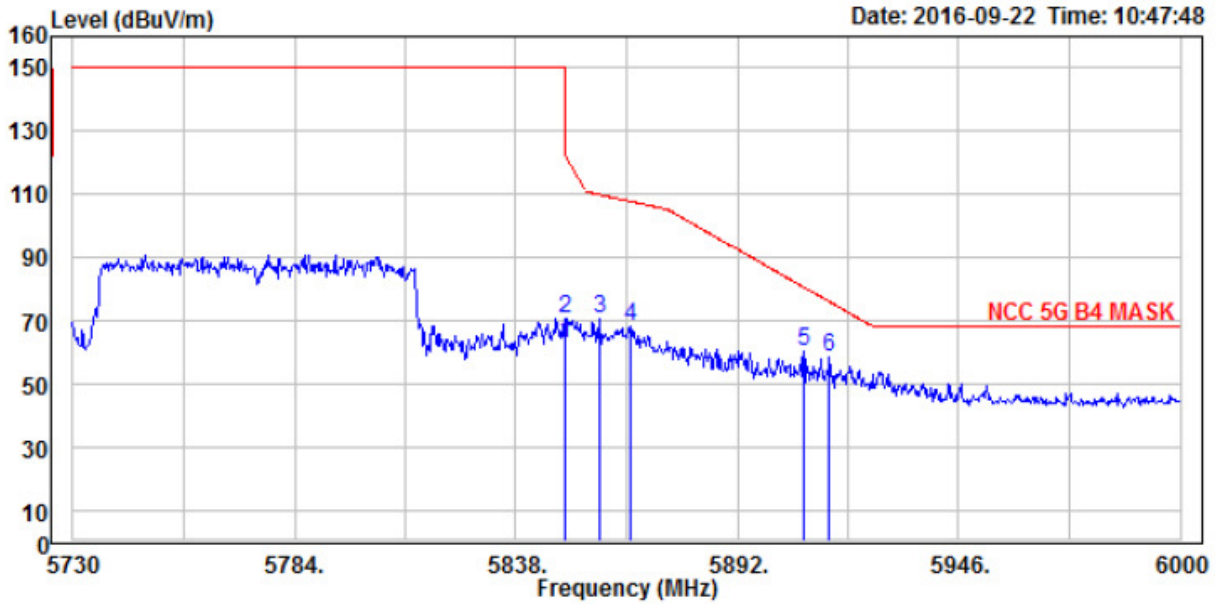

Condition: NCC 5G B4 MASK 3m 1166 EMAH10180 V 1-18G Vertical
 : RBW:1000kHz VBW:1000kHz SWT:Auto DET:Positive
 EUT : WYSBHVGXG
 Mode : 5G Band4 n-HT80 mode TX ch 5775MHz Bandedge
 Note :

	Read Freq	Read Level	Factor	Level	Limit	Over	Pol/Phase
	MHz	dBuV	dB/m	dBuV/m	dBuV/m	dB	
1	5849.880	59.75	3.18	62.93	150.00	-87.07	Vertical
2	5850.150	67.44	3.18	70.62	121.86	-51.24	Vertical
3	5858.250	67.11	3.20	70.31	109.89	-39.58	Vertical
4	5865.810	65.03	3.22	68.25	107.77	-39.52	Vertical
5	5908.200	56.87	3.33	60.20	80.60	-20.40	Vertical
6 PP	5914.410	55.27	3.35	58.62	76.01	-17.39	Vertical

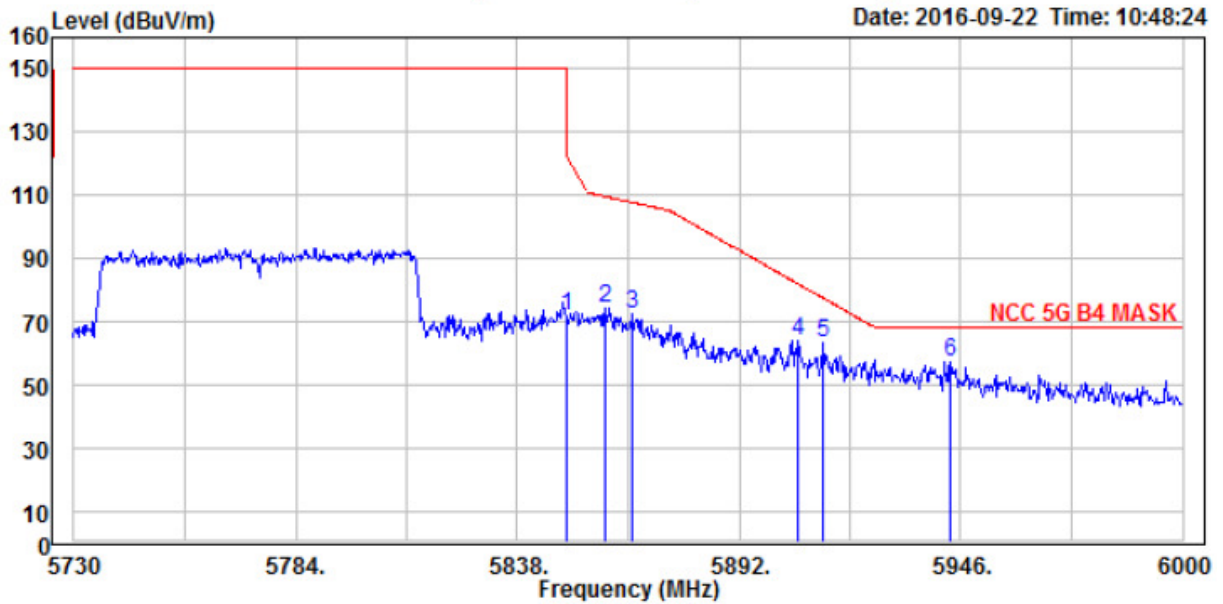

Condition: NCC 5G B4 MASK 3m 1166 EMAH10180 H 1-18G Horizontal
 : RBW:1000kHz VBW:1000kHz SWT:Auto DET:Positive
 EUT : WYSBHVXGX
 Mode : 5G Band4 n-HT80 mode TX ch 5775MHz Bandedge
 Note :

	Read		Limit	Over		
Freq	Level	Factor	Level	Line	Limit	Pol/Phase
MHz	dBuV	dB/m	dBuV/m	dBuV/m	dB	
1	5849.880	68.33	3.18	71.51	150.00	-78.49 Horizontal
2	5859.330	71.22	3.20	74.42	109.59	-35.17 Horizontal
3	5866.080	69.47	3.22	72.69	107.70	-35.01 Horizontal
4	5906.310	60.64	3.32	63.96	81.99	-18.03 Horizontal
5	5912.250	59.65	3.34	62.99	77.61	-14.62 Horizontal
6 PP	5943.300	53.69	3.42	57.11	68.20	-11.09 Horizontal

10. TRANSMISSION IN THE ABSENCE OF DATA

10.1. Standard Applicable

According to §15.407(c)

The device shall automatically discontinue transmission in case of either absence of information to transmit or operational failure. These provisions are not intended to preclude the transmission of control or signaling information or the use of repetitive codes used by certain digital technologies to complete frame or burst intervals. Applicants shall include in their application for equipment authorization a description of how this requirement is met.

According to RSS-247, 6.4(2)

The device shall automatically discontinue transmission in cases of absence of information to transmit, or operational failure. A description on how this is done shall accompany the application for equipment certification. Note that this is not intended to prohibit transmission of control or signaling information or the use of repetitive codes where required by the technology.

10.2. Result:

Pass, the device is compliance with 802.11 a/ b/g/n ac standard, the short control signal is appear during no transmission period.

11. FREQUENCY STABILITY

11.1. Standard Applicable

According to §15.407 (g) Manufacturers of U-NII devices are responsible for ensuring frequency stability such that an emission is maintained within the band of operation under all conditions of normal operation as specified in the user's manual.

According to A9.5

- (5) The applicant shall ensure frequency stability by showing that an emission is maintained within the band of operation under all normal operating conditions as specified in the user's manual.

11.2. Result

Test frequency : 5200 MHz

Temperature test				
Power Supply	Environment	Frequency	Delta (MHz)	frequency drift (PPM)
Vdc	Temperature (°C)	(MHz)		
48	-20	5199.991220	-0.008780	-1.69
	-10	5199.992840	-0.007160	-1.38
	0	5200.022320	0.022320	4.29
	10	5200.023180	0.023180	4.46
	20	5200.016460	0.016460	3.17
	30	5199.987520	-0.012480	-2.40
	40	5200.029270	0.029270	5.63
	50	5199.988130	-0.011870	-2.28

Voltage test				
Power Supply	Environment	Frequency	Delta (KHz)	frequency drift (PPM)
Vdc	Temperature (°C)	(MHz)		
48	20	5200.016460	0.01646	3.17
52.8	20	5199.987220	-0.01278	-2.46
43.2	20	5200.024560	0.02456	4.72

12. ANTENNA REQUIREMENT

12.1. Standard Applicable

According to §15.203, Antenna requirement.

An intentional radiator shall be designed to ensure that no antenna other than that furnished by the responsible party shall be used with the device. The use of a permanently attached antenna or of an antenna that uses a unique coupling to the intentional radiator shall be considered sufficient to comply with the provisions of this Section. The manufacturer may design the unit so that a broken antenna can be replaced by the user, but the use of a standard antenna jack or electrical connector is prohibited. This requirement does not apply to carrier current devices or to devices operated under the provisions of Sections 15.211, 15.213, 15.217, 15.219, or 15.221. Further, this requirement does not apply to intentional radiators that must be professionally installed, such as perimeter protection systems and some field disturbance sensors, or to other intentional radiators which, in accordance with Section 15.31(d), must be measured at the installation site. However, the installer shall be responsible for ensuring that the proper antenna is employed so that the limits in this Part are not exceeded.

According to RSS-GEN 7.1.2, a transmitter can only be sold or operated with antennas with which it was certified. A transmitter may be certified with multiple antenna types. An antenna type comprises antennas having similar in-band and out-of-band radiation patterns. Testing shall be performed using the highest-gain antenna of each combination of transmitter and antenna type for which certification is being sought, with the transmitter output power set at the maximum level. Any antenna of the same type and having equal or lesser gain as an antenna that had been successfully tested for certification with the transmitter, will also be considered certified with the transmitter, and may be used and marketed with the transmitter. The manufacturer shall include with the application for certification a list of acceptable antenna types to be used with the transmitter.

When a measurement at the antenna connector is used to determine RF output power, the effective gain of the device's antenna shall be stated, based on measurement or on data from the antenna manufacturer. Any antenna gain in excess of 6 dBi (6 dB above isotropic gain) shall be added to the measured RF output power before using the power limits specified in RSS-247 or RSS-310 for devices of RF output powers of 10 milliwatts or less. For devices of output powers greater than 10 milliwatts, except devices subject to RSS-247 Annex 8 (Frequency Hopping and Digital Modulation Systems Operating in the 902-928 MHz, 2400-2483.5 MHz, and 5745-5850 MHz Bands) or RSS-247 Annex 9 (Local Area Network Devices), the total antenna gain shall be added to the measured RF output power before using the specified power limits. For devices subject to RSS-247 Annex 8 or Annex 9, the antenna gain shall not be added.

12.2. Antenna Connected Construction

The directional gains of antenna used for transmitting is below table, and the antenna connector is designed with unique type RF connector and no consideration of replacement. Please see EUT photo and antenna spec. for details.

Antenna Designation:

	P/N	Type	Gain (2.4GHz)	Gain (5GHz)
Ant	AH 104N2450D1	Fixed Chip Antenna	2.1dBi	2.4dBi