

THIS DOCUMENT AND THE INFORMATION CONTAINED HEREIN MAY NOT BE COPIED, USED OR DISCLOSED IN WHOLE OR IN PART EXCEPT WITH PRIOR WRITTEN PERMISSION OF STANDARD COMMUNICATIONS PTY LTD OR IF THIS DOCUMENT HAS BEEN PRODUCED UNDER CONTRACT WITH ANOTHER PARTY, AS EXPRESSLY AUTHORISED UNDER THAT CONTRACT. IT IS SUPPLIED WITHOUT LIABILITY FOR ERRORS OR OMISSIONS.

REV	ECO No	DETAILS	BY	DATE
1	Create	Required to support product release	CJWD	1-07-2003

Specification		Performance
Modes of operation		
Normal (Activated)		121.5MHz modulated 406MHz modulated Strobe & Audible alert
End of Life (Activated)		121.5MHz modulated At >48hrs+, other functions as supported by remaining battery capacity
Self Test		121.5MHz, full power short burst 406MHz with inverted synchronisation, full power, one burst Strobe & Audible alert
Operational		
Duration		48hrs minimum continuous
Warm-up		None required, full specification performance at activation
User Data		Programmable via external interface
Protocol		All Short Protocols supported and programmable via external interface (refer to manufacturer for currently approved protocols)
406 Repetition Period		50s nominal, fully random variance up to ± 2.5s maximum
Strobe Rate		20 flashes nominal per minute
Transmission Frequencies		
VHF		121.5MHz
UHF		406.028 MHz (programmable 406.000MHz to 406.100MHz)
Transmission Output Power		
VHF		50mW ± 3dB (PERP)
UHF		5W ± 2dB
Modulation Format		
406MHz		Phase shift key (PSK)
121.5MHz		Swept tone amplitude modulation
COSPAS/SARSAT Compatibility		
406MHz		Yes, meets requirements of C/S T.001 (Class 2)
121.5MHz		Yes, is phase coherent
Activation		
Method		Manually activated by slider switch
Delay		Will not transmit until activated for 60s~70s
Battery		
Replacement period		Within 5 years after date of manufacture
Replacement method		Service centre, or factory only (non-user replaceable)
Chemistry		LiSO ₂
No./Size		2 D size cells
Physical		
Ruggedness & Durability		IEC 61097-2, AS/NZS 4280.1, ETSI EN 300 066
Environmental sealing		IEC 61097-2, AS/NZS 4280.1, ETSI EN 300 066

AUTHORED BY C.J.W.Duncan	STANDARD COMMUNICATIONS PTY LTD 6 Frank St. Gladesville (PO Box 296) NSW 2111 AUSTRALIA ABN: 93 000 346 814			
CHECKED BY L.May	TITLE MT400 EPIRB, Technical Data Sheet			
APPROVED BY C.J.W.Duncan	PART NO	DRAWING NO 41843	REVISION 1	SHEET 1 OF 2 FILE: 41843-1.DOC
				A4

THIS DOCUMENT AND THE INFORMATION CONTAINED HEREIN MAY NOT BE COPIED, USED OR DISCLOSED IN WHOLE OR IN PART EXCEPT WITH PRIOR WRITTEN PERMISSION OF STANDARD COMMUNICATIONS PTY LTD OR IF THIS DOCUMENT HAS BEEN PRODUCED UNDER CONTRACT WITH ANOTHER PARTY, AS EXPRESSLY AUTHORISED UNDER THAT CONTRACT. IT IS SUPPLIED WITHOUT LIABILITY FOR ERRORS OR OMISSIONS.

REV	ECO No	DETAILS	BY	DATE
1	Create	Required to support product release	CJWD	1-07-2003

Specification		Performance
Temperature	Operating	-20°C to +55°C
	Storage	-30°C to +70°C
Size	Height	Typical complete, unit in bracket with antenna stowed 260mm (max)
	Width	102mm (max)
	Depth	83mm (max)
Weight	Beacon	535g (typical, including battery cells)
	Bracket	98g (typical)
Other Features	Retention Lanyard	Buoyant type and approximately 5.5m in length.
	Retro-reflective tape	Large surface area, encircling unit above waterline
	Solid-state Strobe	Meets or exceeds IMO requirements
	Antenna	High durability stainless steel tape construction
	Bracket	Quick release mechanism (manual). Retained by 4 vessel fixing points

AUTHORED BY C.J.W.Duncan	STANDARD COMMUNICATIONS PTY LTD 6 Frank St. Gladesville (PO Box 296) NSW 2111 AUSTRALIA ABN: 93 000 346 814				
CHECKED BY L.May	TITLE MT400 EPIRB, Technical Data Sheet				
APPROVED BY C.J.W.Duncan	PART NO	DRAWING NO 41843	REVISION 1	SHEET 2 OF 2 FILE: 41843-1.DOC	A4

MT400 406MHz EPIRB

PHOTOGRAPHS OF TEST UNIT

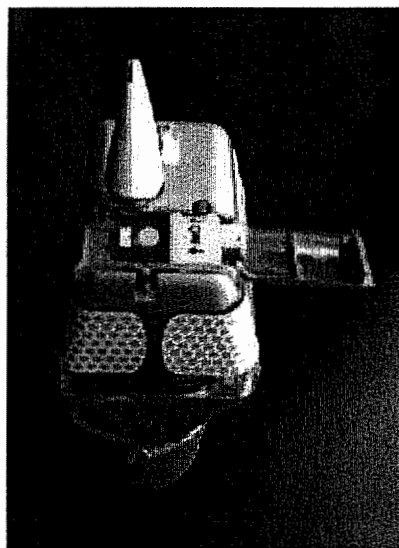
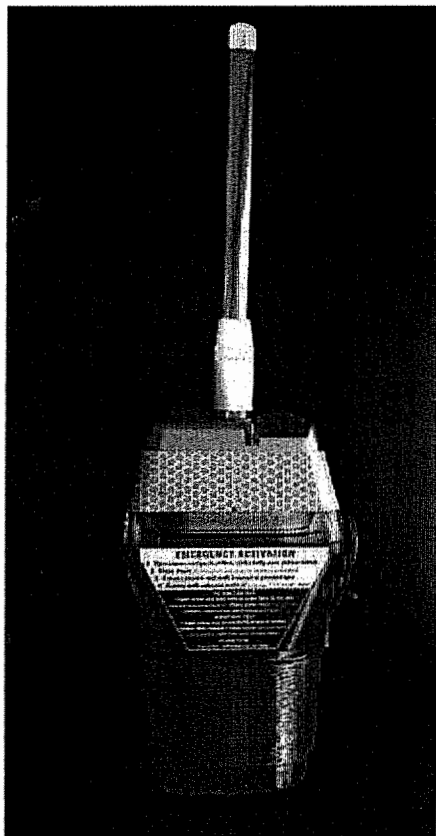

MT400 406MHz EPIRB **OPERATING INSTRUCTIONS**

1. INTRODUCTION

The following instructions apply to the operation of the MT400 EPIRB.

2. UNIT OPERATION

Activation & Deployment

De-Activation

- 2.2 2.1 a) Remove unit from mounting bracket by pushing down at the point marked '**→ RELEASE ←**' (located at bottom of unit)';
- b) Withdraw unit base first away from bracket to fully release;
- c) Open hinged orange cover next to antenna by lifting at the point marked '**LIFT**';
- d) Move yellow slider marked '**ON →**' forward and fully over yellow button (Security label is permanently torn with this action);
- e) Securely close orange cover over switch mechanism;
- f) Unit indicator with commence flashing and audible beep will occur every 3 seconds to indicated activation;
- g) Unwind orange cord by pulling loop firmly (braking clear tape) and secure free end to avoid unit drifting away;
- h) Deploy in water (if conditions allow) for best performance and clear of surrounding objects; and
- i) If deployed on a hard surface ensure that the antenna is vertical.
- a) Open hinged orange cover on unit top face by lifting at the point marked '**LIFT**';
- b) Move yellow slider fully rearward as shown '**OFF →**';
- c) Visual indicator and audible beep will cease operating, confirming de-activation;
- d) Securely close orange cover over switch mechanism;
- e) Unit may be activated again by following instructions for 'Activation & Deployment';
- f) After the unit has been activated it should, as soon as is practical, be returned to an authorised dealer or distributor to have the internal battery cells replaced; and

- g) NOTE: Only units which have full battery capacity (i.e. never previously activated and within expiry date marked on the units body) are guaranteed to meet the continuous operational duration requirements needed for rescue.

2.3 Permanent De-Activation (Unit Fault)

- a) Should the unit develop an internal fault and commence operation the following instructions should be followed to disable radio transmission:
- b) Remove four recessed screws retaining top cover;
- c) Withdraw cap and PCB from main housing;
- d) Unplug battery lead from circuit assembly;
- e) Contact National Authority to report activation; and
- f) Immediately return unit to authorised dealer or distributor for service.

2.4 Self-Test

- a) It is recommended that the Self-Test function should be carried exercised approximately once every month, or immediately prior to any extended voyage;
- b) Self-test may be carried with unit in or out of storage bracket;
- c) Open hinged orange cover on unit top face by lifting at the point marked 'LIFT';
- d) Inspect that security seal on slider has not been torn (indicating previous activation);
- e) Press and release yellow button marked 'TEST';
- f) Securely close orange cover over switch mechanism;
- g) Double beep and indicator flash confirms that unit has passed self-test;
- h) Replace unit back into stowage bracket, if removed, in a reverse action to which it was released; and
- i) Inspect battery change date on unit side. Out of date batteries require the unit's immediate return to an authorised dealer or distributor for service.

MT400 406MHz EPIRB

PROTECTION AGAINST CONTINUOUS TRANSMISSION

1. INTRODUCTION

The MT400 architecture and circuitry contains integral security features designed to eliminate the occurrence of an extended on channel emission.

2. PROTECTION FEATURES

The following features all act to ensure than an extended transmission event will not occur:

2.1 Microcontroller Watchdog Timer

This feature protects against a software execution failure which may have been either hardware or software induced.

A hardware based counter is provided which is clocked off the microcontroller's oscillator. The counters value must be reset by software intervention every 3 seconds; else associated circuitry will force a hard reset. The reset of the controller's circuitry and software is designed to clear the fault condition by resetting all registers and variables to their initial start-up values.

2.2 Low Voltage Detect and Reset

This feature protects against an execution failure which by induced by a failing battery supply.

Operating currents widely fluctuate during the normal EPIRB operating cycle as some functions, such as 406MHz transmission and strobe operation, are energy intensive. A reduced operating voltage or 'glitch' can affect proper software operation. For this reason the supply voltage is monitored. If it crosses an alarm threshold high current functions are immediately aborted so that the operating voltage is restored. A lower second alarm threshold is provided which signals that a critically low supply condition is being approached. Note, the alarm thresholds are monitored to avoid the occurrence of attempted, then aborted, 406MHz transmissions at end of battery life.

2.3 Circuit Enable Functions

This feature protects against the failure of the 406MHz circuitry to turn off when instructed to do so by the executable software.

Each major functional element, namely the reference oscillator, 406MHz generator and RF power amplifier, are enabled and disabled by their own independent control signal. All three functions must be simultaneously active for a 406MHz emission to occur. Normally between transmissions these functions are disabled.

2.4 System Lock-up

This feature protects against a stalled microprocessor clock during a 406MHz transmission.

If the microprocessor clock fails then no software will execute and the watchdog timer will be ineffective. All microprocessor outputs would remain static.

The 406 Mhz generator enable input is edge triggered. That is, a level transition will enable that circuit for approximately 1.5s duration, after which that function will automatically de-activate.

3. **CONCLUSION**

Current COSPAS-SARSAT specifications require that (C/S T.001, para 2.3.8):

'The distress beacon shall be designed to limit any inadvertent continuous transmission to a maximum of 45 seconds.'

The MT400 design provides robust protection against the occurrence of an extended transmission ever exceeding 1.5 seconds.

Fault Mode Analysis (FMA) has identified that 2 or more independent failures within a single EPIRB unit would be required for these features to be overcome.

MT400 406MHz EPIRB

LONG TERM FREQUENCY STABILITY

1. INTRODUCTION

Quartz crystals display a gradual shift in nominal frequency over time. This phenomenon is generally referred to as 'crystal aging'.

C/S T.001 (para 2.3.1) requires that newer beacons maintain their frequency within +2kHz /-5kHz of 406.028MHz over a 5 year period.

The effect of crystal aging must be considered to determine that the requirement of C/S T.001 is met.

2. ACCELERATED AGING

An accelerated aging technique may be applied to a crystal to determine its expected long term aging characteristics.

To gain a statistically significant sample it was decided that data from 40 units would be analysed. Further to address production consistency crystals were randomly selected from 4 separate production batches (10 from each).

The crystals were placed into a chamber and the temperature elevated to a constant 85°C for the test duration. It is accepted within the industry that each 7 days exposure to 85°C is equivalent to 1 year of aging at 25°C.

Each crystal's frequency was recorded within the chamber over the test duration (refer Figure 1).

Note that the frequency was not recorded between days 50 to 66 however the crystals remained within the chamber under accelerated aging conditions for that period.

Five years of aging corresponds to 35 days of accelerated aging at 85°C (ie 5 x 7days). The specifications and results are summarised within Table 1.

Limit Type	C/S T.001 Absolute shift at 5yrs	C/S T.001 Relative to operating freq (5yrs)	Worst Case Measurement within 5yr period	Specification MARGIN
Low	-5kHz	-12.31ppm	-0.78ppm	1,578 %
High	+2kHz	+4.93ppm	+0.1	4,930 %

Table 1 - Specifications & Results within 5yrs window

Furthermore, a fifteen year of aging corresponds to 105 days of accelerated aging at 85°C (ie 15 x 7days). The results for this comparison are summarised within Table 2.

Limit Type	C/S T.001 Absolute shift at 5yrs	Relative to operating freq	Worst Case Measurement within 15yr period	MARGIN 15yr performance wrt to 5yr Spec
Low	-5kHz	-12.31ppm	-1.3	947 %
High	+2kHz	+4.93ppm	+0.1	4,930 %

Table 2 - Fifteen Year Aging Results (not C/S requirement)

3. CONCLUSION

The expected long term performance of crystals used within the MT400 easily meet COSPAS-SARSAT specified requirements.

It is worth noting that the MT400's output frequency is fully programmable. Therefore the crystal's initial frequency is irrelevant. The ambient operating frequency of 406.028MHz is set during factory calibration where accuracy superior to the specified ± 1 kHz is easily achievable.

**Long Term Aging of MT400 Quartz Crystal
10 units from 4 batches**

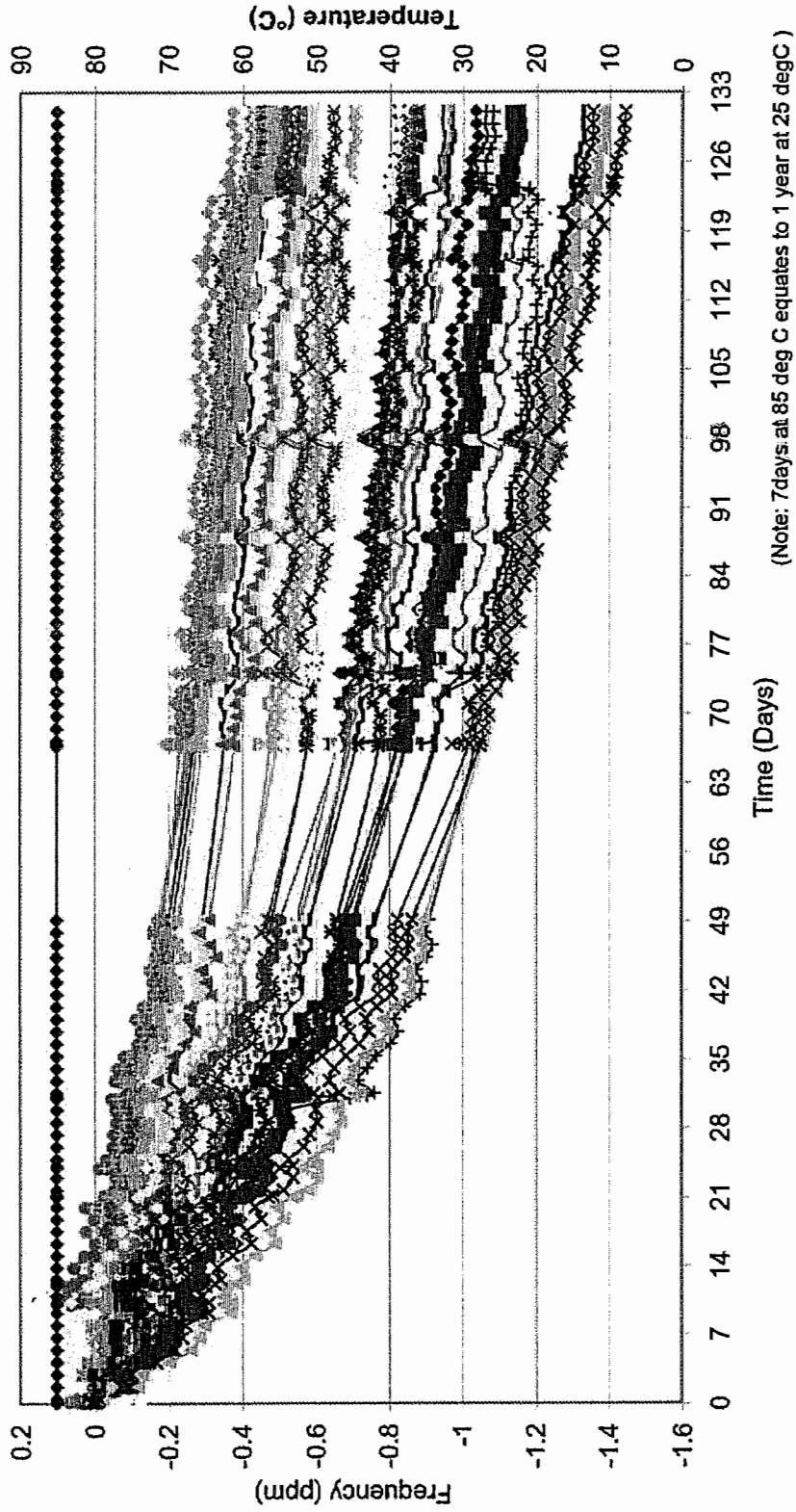

Figure 1 - Measurement Results

MT400 406MHz EPIRB

PRODUCTION RUN, REPETITION RATE RANDOMISATION

1. INTRODUCTION

The MT400 design uses a pseudo-random number generator to apply a variance of up to $\pm 2.5s$ to the base 50s repetition rate. This calculation is performed between each and every transmission burst.

The product serial number is used as an initialisation seed at power up to ensure a unique starting seed for the sequence, and therefore further enhance the randomisation performance.

2. CONCLUSION

Each MT400 displays a unique random repetition period to ensure that the transmission bursts of two or more active units will not become synchronised.

MT400 406MHz EPIRB

50 OHM INTERFACE ADAPTOR

1. INTRODUCTION

The MT400 is equipped with a permanently attached (integral) antenna. To obtain optimum power efficiency the 121.5MHz and 406MHz amplifier circuits are directly matched to the respective antenna impedance at those frequencies.

In order to support laboratory measurements it is convenient to have an adaptor which simulates the antenna and provides a 50 ohm interface port to which test equipment may be directly connected.

2. TECHNICAL DESCRIPTION

2.1 Antenna Measurements

With the MT400 in a standard deployment, the antenna has been measured as presenting the following impedances at the interface with the internal circuitry:

$$Z_{121} = 2.0 - j193 \quad (6.8\text{pF})$$

$$Z_{406} = 72 - j8.5 \quad (47\text{pF})$$

2.2 Circuit Configuration

The Circuit of Figure 1 was designed and optimised so as to present the above impedances when it is used to replace the MT400 antenna.

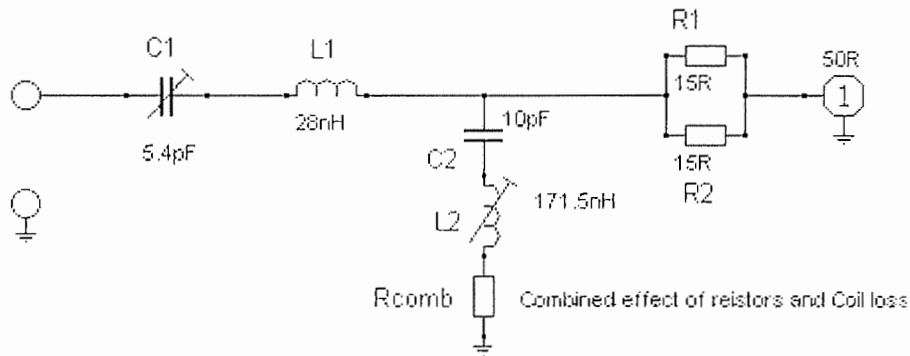

Figure 1 – 50 ohm Interface Adaptor

2.3 Circuit Description

C2 and L2 are series resonant at 121.5MHz providing a pure resistance consisting of Coil losses and Rcomb. This Resistance is in shunt with R1, R2 and the 50 Ohm load.

C1 is then adjusted such that C1 and L1 provide a net reactance of $-j193$ at 121MHz.

C2, L2 and Rcomb provide a large inductive reactance at 406 MHz ($+j400$) which is considerably larger than the combined resistance R1, R2 and the load.

The value of L1 was calculated such that when C1 is adjusted for correct impedance at 121.5 MHz, the combined reactance of C1 and L1 is appropriate at 406MHz.

A theoretical design was used as a starting point. Component values were adjusted on the physical unit, based on impedance measurements made using a Vector Network Analyser (this is why the nominal circuit values may not appear to be optimal in a theoretical analysis).

2.4 Loss Calibration

The unit was calibrated to determine circuit, cable and connector loss:

$$\text{Loss @ 121Mhz} = 14.38 \text{ dB}$$

$$\text{Loss @ 406MHz} = 1.32 \text{ dB}$$

2.5 Loss Correction (on Test Unit)

On return from testing at Intespace (Toulouse) it was found that the calibration correction for unit #204 at 121.5 MHz was incorrect. Investigation of the transfer characteristics showed that the coil L2 had been slightly detuned during installation at Intespace, resulting in a lesser attenuation at 121.5MHz.

When measured with a calibrated MT400 the attenuation was found to be 5.2dB less than indicated in the initial calibration data:

$$\text{Loss @ 121Mhz} = 9.18 \text{ dB (test unit)}$$

The loss calibration at 121.5MHz is extremely sensitive to the tuning of the notch due to the low impedances present. This appears to be the only effect though, as measurements confirmed that DC power consumption during 121.5MHz operation remained unchanged.

Both 406MHz calibration and operation are completely unaffected.

406 MHz BEACON SELF-TEST CHARACTERISTICS

406 MHz Beacon Model(s): MT400

	Answer (✓)	
	Yes	No
1. Does beacon have a self-test mode ?	... ✓
if yes :		
• does self-test have a separate switch position ?	... ✓
• does self-test switch automatically return to normal position when released ? if not, how long until the first "distress" message is emitted:_____	... ✓
• does self-test transmit a 406 MHz signal ?	... ✓
if yes:		
- unmodulated signal only ✓
- normal data, but with inverted frame synchronization pattern	... ✓
- 1 burst only	... ✓
• does self-test transmit a 121.5 MHz signal ?	... ✓
if yes:		
- for less than 1 second	... ✓
- continually while self-test switch is activated ✓
- other (please specify) : <u> Unmodulated at peak RF power </u>	... ✓
• does self-test transmit any other frequency (e.g. 243 MHz) ? ✓
2. Result of self-test is indicated by:		
• pass/fail display indicator light	... ✓
• strobe light flash	... ✓
• other (please specify) : <u> Audible annunciator </u>	... ✓
3. Can the self-test be performed without removing the beacon from its mounting bracket ?	... ✓
4. What parameters are internally tested by the self-test ?		
• battery voltage	... ✓
• RF power	... ✓
• approximate RF frequency ✓
• phase locked loop	... ✓
• other (please specify) : <u> System User data (eg UIN) memory parity check </u>	... ✓
5. Do the above characteristics apply to this beacon model:		
• for all countries where beacon is sold ?	... ✓
if no, please specify : _____		
• for all production serial numbers?	... ✓
if no, please specify : _____		
6. Comments: _____		

MT400 406MHz EPIRB

POWER SOURCE

1. INTRODUCTION

The MT400 contains an integral battery consisting of 2 series wired high energy long life cells. This battery is replaced approximately every five years to ensure that sufficient capacity exists to support the specified beacon performance and operational duration.

The battery is non-user replaceable, requiring that the MT400 be returned to an authorised service centre.

The battery contains protective features, as does the MT400 beacon circuitry

2. IMPLEMENTATION DETAILS

The cells used within the MT400 are the Saft Lo 26 SX type.

They are 3.0V Primary lithium-sulfur-dioxide (LiSO₂) high drain capability spiral D-size cells. Please refer to the manufacturer's data sheet, provided, for further details.

It is worth noting that these cells are hermetically sealed; but include a vent to improve cell safety should it be exposed to an abnormal operating condition.

The battery circuit diagram is shown in Figure 1. A fusible link is provided at the cell series connection. A short circuit or abnormally high current condition at the battery pack output causes the link to fuse.

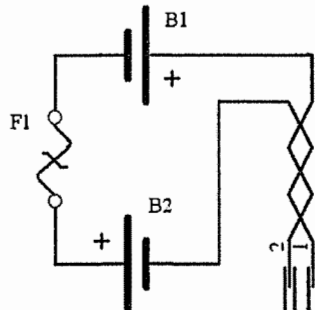

Figure 1- Battery Pack Circuit Diagram

The potential of cell reversal is not a problem with this 2 battery design. Should a cell reverse, the resultant battery output will be too low to drive the MT400 circuitry. This will cause the MT400 to shut down, as for a pack that has reached its end-of-life.

The cells are protected at each end; a plastic moulding over one end, a silicon insulator at the other (Figure 2). The implementation does not compromise each cell's integral safety vents (verified through destructive tests, and advice from Saft).

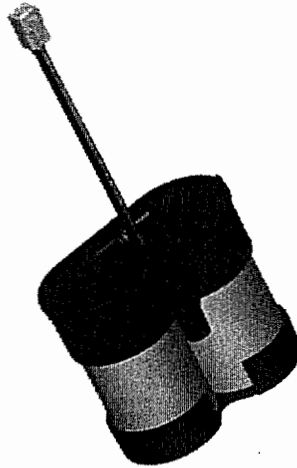
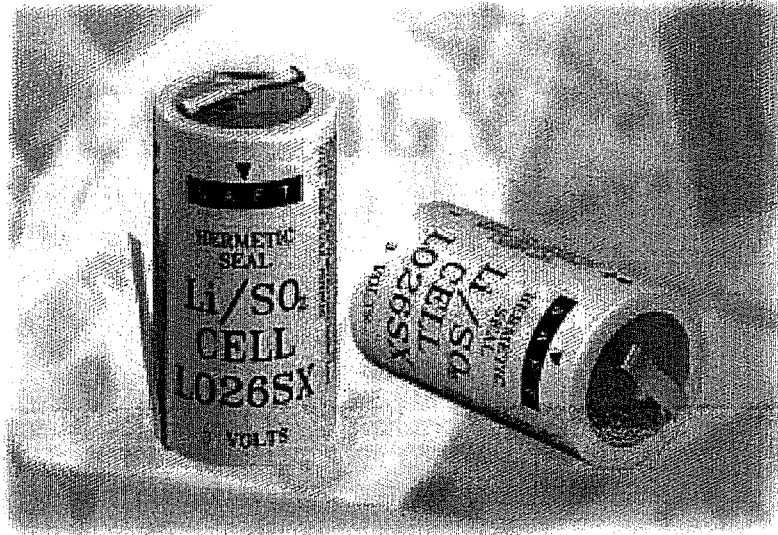

Figure 2 - Battery Pack Assembly

Additionally, a board mounted fuse has been provided in the negative lead at the power pack connector on the MT400 PCB. Choosing to fuse the negative lead offers improved protection as the electrically floating battery pack is surrounded by a conductive chassis at ground potential.

LO 26 SX

3.0 V Primary lithium - sulfur dioxide (Li-SO₂) High Drain capability Spiral D-size cell



For high drain applications up to 3 A continuous, 10 A pulse currents, possibly combined with exposure to extreme temperatures.

Key features

- High and stable discharge voltage
- Performance not affected by cell orientation
- Low self discharge rate
(less than 3% after 1 year of storage at +21°C/+70°F)
- Hermetic glass-to-metal sealing
- Built-in safety vent (at the negative end of the cell)
- 1 A-fused version not restricted for transport
- UL Component Recognition (File Number MH 15076)
- Meets shock, vibration and other environmental requirements of military specifications
- Made in the USA

Main applications

- Radiocommunications and other military applications
- Beacons and Emergency Location Transmitters
- Sonobuoys
- ... etc.

Cell size reference	R20 - D
Electrical characteristics <i>(typical values for cells stored for one year or less)</i>	
Nominal capacity	7.5 Ah
<i>(at 240 mA +21°C/+70°F 2.0 V cut off. The capacity restored by the cell varies according to current drain, temperature and cut off).</i>	
Open circuit voltage (at +21°C)	3.0 V
Nominal voltage (at 240 mA +21°C/+70°F)	2.8 V
Maximum recommended continuous current <i>(to avoid over-heating. Higher currents possible, consult Saft).</i>	3 A
Pulse capability : varies according to pulse characteristics (frequency, duration), temperature, cell history (storage conditions prior to usage) and the application's acceptable minimum voltage. Consult Saft.	
Storage (recommended) max	+30°C/+86°F
(possible without leakage)	-60°C (-76°F) / +85°C (+185°F)
Operating temperature range	-60°C (-76°F) / +71°C (+160°F)
<i>(Short excursions up to 85°C possible at currents below 1 A).</i>	
Physical characteristics	
Diameter (max)	33.8 mm (1.33")
Height (max; finish with radial tabs)	59.3 mm (2.33")
Typical weight	85 g (2.98 oz)
Weight of Li metal	2.4g
Standard cell comes with two radial 0.15 mm thick nickel tabs	
Finish with positive button on request	
Finish with 1 A fuse on request	

LO 26 SX

Voltage at mid-discharge versus Current and Temperature (2.0 V cut off)

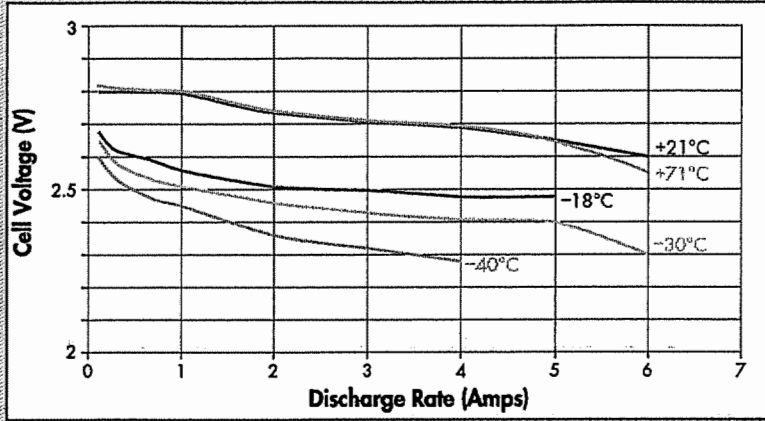

Typical discharge profiles at +21°C/+70°F

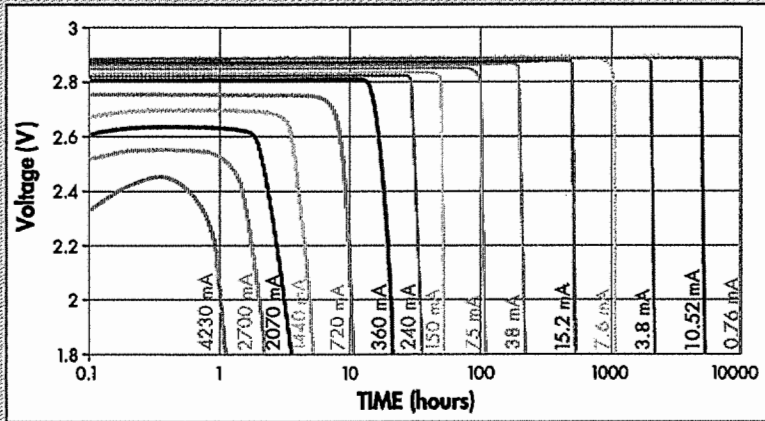

Capacity versus Current and Temperature (2.0 V cut off)

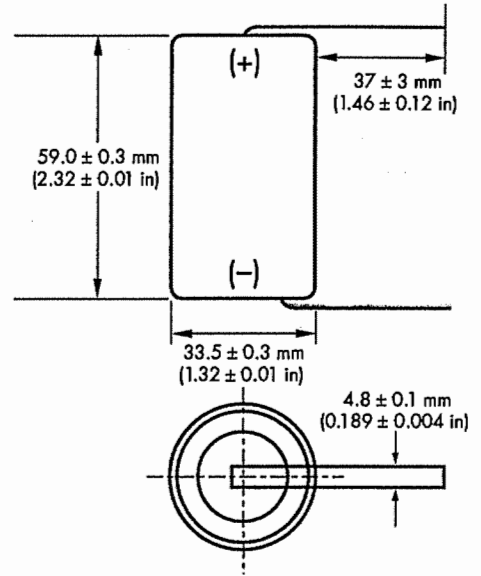
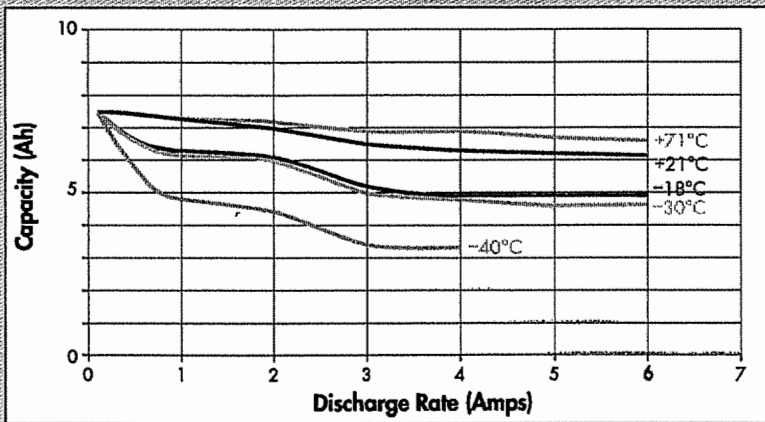

overall dimensions

Handling precautions

- Do not puncture, open or mutilate. Cell is pressurised.
- Do not obstruct the safety vent mechanism.
- Do not short circuit or charge
- Do not expose to fire or temperatures above 70°C (160°F).



12, rue Sadi Carnot
93170 Bagnole - France
Tel +33 (0)1 49 93 17 70
Fax +33 (0)1 49 93 19 69

313, Crescent Street
Valdese NC 28690 USA
Tel +1 (828) 874 41 11
Fax +1 (828) 879 39 81

Internet: <http://www.saftbatteries.com>

Doc. No. 12.00 - 31030.2
Published by the Communications Department

Information in this document is subject to change without notice and becomes contractual only after written confirmation by Saft.

INFORMATION ONLY

EMERGENCY ACTIVATION

1. Open cover and push yellow slider fully over yellow button
2. Close cover (flashing light and beeping confirms activation)
3. Always secure unit with cord to prevent loss
4. Deploy with antenna vertical (in water if conditions allow)

TO SWITCH OFF

- Open cover and push yellow slider fully to the rear (exposing yellow button) • Close cover (flashing light and beeping stops which confirms deactivation)

MONTHLY TEST

- Open cover and momentarily depress yellow button then release • Close cover (functionality confirmed by light flash and double beep)

ATTENTION
Important information on rear

MT400 Sample label- FRONT

NOTE: Content may change depending on target market
requirements.

STANDARD COMMUNICATIONS PTY LTD			
6 frank Street. Gladesville NSW Australia 2111			
DRAWN	DESCRIPTION		
MS	ARTWORK MT400 CHASSIS (FACE B)		
	DO NOT SCALE PRINT		
DATE	PART NO.	UNITS	SHEET OF
19/05/03			1:1
APP	SUPP DRG. NO.	SIZE	SCALE
CD		A4	1:1
	DEVELOPMENT NO.	DRAWING NO.	ISS.
		41576	- 1
DISK FILE: Marian's HD		FILE NAME: 41576-1 MT400 Face B	

INFORMATION ONLY

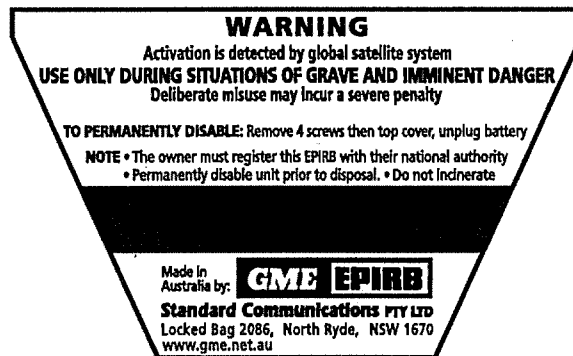

MT400 Sample label- REAR



NOTE: Content may change depending on target market
requirements.

STANDARD COMMUNICATIONS PTY LTD 6 frank Street. Gladesville NSW Australia 2111			
DRAWN	DESCRIPTION		
MS	ARTWORK MT400 CHASSIS (FACE D)		
	DO NOT SCALE PRINT		
DATE		UNITS	SHEET OF
19/05/03	PART NO.		1:1
APP	SUPP DRG. NO.	SIZE	SCALE
CD		A4	1:1
	DEVELOPMENT NO.	DRAWING NO.	ISS.
		41739	- 1
DISK FILE: Marian's HD		FILE NAME:41739-1 MT400 Face D	

INFORMATION ONLY

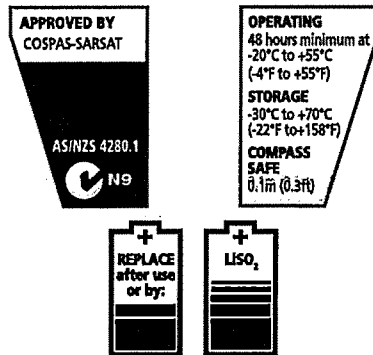

MT400 Sample label- SIDE

NOTE: Content may change depending on target market requirements.

STANDARD COMMUNICATIONS PTY LTD			
6 frank Street. Gladesville NSW Australia 2111			
DRAWN	DESCRIPTION		
MS	ARTWORK MT400 CHASSIS (FACE E)		
	DO NOT SCALE PRINT		
DATE	PART NO.	UNITS	SHEET OF
23/05/03			1:1
APP	SUPP DRG. NO.	SIZE	SCALE
CD		A4	1:1
	DEVELOPMENT NO.	DRAWING NO.	ISS.
		41785	- 1
DISK FILE: Marian's HD		FILE NAME: 41785-1 MT400 Face E	

INFORMATION ONLY

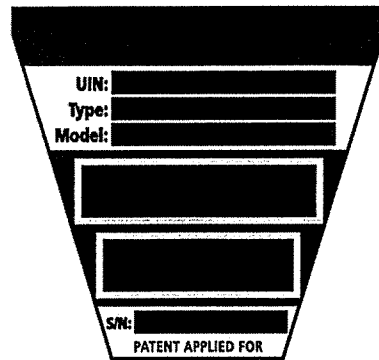

MT400 Sample label- SIDE

NOTE: Content may change depending on target market
 requirements.

STANDARD COMMUNICATIONS PTY LTD 6 frank Street. Gladesville NSW Australia 2111			
DRAWN	DESCRIPTION		
MS	ARTWORK MT400 CHASSIS (FACE C)		
DATE	DO NOT SCALE PRINT		
23/05/03	PART NO.	UNITS	SHEET OF
			1:3
APP	SUPP DRG. NO.	SIZE	SCALE
CD		A4	1:1
	DEVELOPMENT NO.	DRAWING NO.	ISS.
		41738	- 1
DISK FILE: Marian's HD		FILE NAME: 41738-1 MT400 Face C	

MT400 Qualification Testing

Low Temperature Operating Life – Battery Preconditioning

Table of Contents

1.	Introduction.....	2
2.	Associated Documents.....	2
3.	Definitions and Abbreviations	2
4.	Calculation	3
4.1	Determination of Equivalent Activation Period	3
4.1.1	Energy Consumption per 50s Activation Cycle.....	3
4.1.2	Self Discharge "(a1,a2,E)".....	3
4.1.3	Self Test "(b)"	4
4.1.4	Stand-by "(c)"	5
4.2	Battery Pre-Conditioning Prior to Low Temp Life Test.....	6
4.2.1	IEC/ETSI Specification Method "(a1,b,c)"	6
4.2.2	C/S T.007 Test Specification Method "(a2,b,c)"	6
4.2.3	Selected Method.....	7

Tables

Table 1 - Supporting Documentation.....	2
Table 2 - Definitions and Abbreviations.....	2
Table 3 - Energy per 50s activation cycle.....	3
Table 4 - Cell capacity loss over time.....	3
Table 5 - Calculation of "(a1)", "(a2)" and "(E)".....	4
Table 6 - Energy per self-test.....	5
Table 7 - Calculation of "(b)"	5
Table 8 - Calculation of "(c)"	5
Table 9 - IEC/ETSI Pre-conditioning Calculations	6
Table 10 - COSPAS-SARSAT Pre-conditioning Calculations	6

1. INTRODUCTION

Cospas-Sarsat C/S T.007, IEC61097-2 and ETSI EN 300 066 all specify a level of battery pre-conditioning prior to conducting an operational life test at the minimum operating temperature condition.

The pre-conditioning requirements of both IEC and ETSI are identical and will therefore be covered by a single analysis within this document. A separate analysis is provided per Cospas-Sarsat C/S T.007.

The more demanding of the two pre-conditioning periods will be adopted for the certification of the MT400, there-by demonstrating compliance to all three specifications.

2. ASSOCIATED DOCUMENTS

Information within the documents identified at Table 1 has been used as the basis for some of the calculations presented here-in. They are provided as attachments for reference purposes.

Description	Designation
Battery Manufacturer's Datasheet	Attachment 1
Battery Self Discharge, Manufacturer's correspondence.	Attachment 2
Interpretation of date code, Manufacturer's correspondence.	Attachment 3

Table 1 - Supporting Documentation

3. DEFINITIONS AND ABBREVIATIONS

Term	Definition/Description
Rated Life	≡ Extends from the date of battery cell manufacture to that date declared on the beacon as the latest date of replacement. The beacon is designed to operate fully within specifications when powered by batteries, which have not reached their replacement date.
Useful Life	≡ The useful life of the battery is defined as the period of time after the date of battery cell manufacture that the beacon will continue to meet the power input requirements f that unto
hrs	≡ Hours. Unless otherwise state are in decimal (i.e. 6.5 hrs is 6 & ½ hrs)
Ah	≡ Ampere-hour
s	≡ second
mA	≡ milli-ampere
ms	≡ milli-second
ETSI	≡ European Telecommunications Standards Institute
IEC	≡ International Electrotechnical Commission
wrt	≡ with respect to

Table 2 - Definitions and Abbreviations

4. CALCULATION

4.1 Determination of Equivalent Activation Period

4.1.1 Energy Consumption per 50s Activation Cycle

The current and duration requirements seen by the battery for each separate MT400 function are provided at Table 3.

This demand is then equated to an energy requirement, expressed in Ampere-hours, per unit of operational time. For the MT400, and the purposes of this analysis, a convenient unit of time is a single complete 'activation cycle' of nominally 50s duration.

Note: Knowledge of the rate of energy consumption is applied to determine the period of time that an MT400 needs to be activated so as to discharge the battery by a known amount, prior to conducting operational life testing.

Description	Duration (ms)	Current (mA)	Quantity	Energy (Ah)
406MHz, short message	440	2496	1	0.000305
121.5MHz carrier, modulated	48100	67	1	0.000895
Audible alert	100	61	17.5	0.000030
LED strobe	260	341	17.5	0.000431
Energy per 50s activation cycle				<u>0.001661</u>

Table 3 - Energy per 50s activation cycle

4.1.2 Self Discharge "(a1, a2, E)"

The battery rate of self-discharge (Table 4) has been obtained from the cell datasheet and for direct correspondence with the cell manufacturer. Each figure given is the total loss from date of manufacture (ie non-cumulative).

The 15 year figure is given for information purposes only and does not feature within the analysis of this document.

Elapsed Duration (yrs wrt new)		Comment on capacity loss	Capacity Loss (at 21°C)	
			(% wrt new)	Source
0	New cell		0	---
1	Estimated typ as ≈80% of rated maximum		2.5	Cell Datasheet
5	Typical value		5	Attachment 2
10	Typical value		8	Attachment 2
15	Typical value		10	Attachment 2

Table 4 - Cell capacity loss over time

Description	Operation		units
Cell capacity at new		7.00	Ah
Capacity loss at 1 year	x (Table 4)	<u>2.5</u>	%
Self-discharge energy loss at 1 year		0.18	Ah
Energy per 50s activation cycle	/	<u>0.001661</u>	Ah
No. 50s act cyc consuming equiv. energy to 1yr s'dist		105.36	
Hours per 50s activation cycle	x	<u>(50/60)/60</u>	
"(E)" Equivalent (1yr loss) activation time		<u>1.46</u>	hrs
Cell capacity at new		7.00	Ah
Capacity loss at 5 years	x (Table 4)	<u>5</u>	%
Self-discharge energy loss at 5 years		0.35	Ah
Energy per 50s activation cycle	/	<u>0.001661</u>	Ah
No. 50s act cyc consuming equiv. energy to 5yr s'dist		210.73	
Hours per 50s activation cycle	x	<u>(50/60)/60</u>	
"(a2)" Equivalent (5yr loss) activation time		<u>2.93</u>	hrs
Cell capacity at new		7.00	Ah
Capacity loss at 10 years	x (Table 4)	<u>8</u>	%
Self-discharge energy loss at 10 years		0.56	Ah
Energy per 50s activation cycle	/	<u>0.001661</u>	Ah
No. 50s act cyc consuming equiv energy to 10yr s'dist		337.17	
Hours per 50s activation cycle	x	<u>(50/60)/60</u>	
"(a1)" Equivalent (10yr loss) activation time		<u>4.68</u>	hrs

Table 5 - Calculation of "(a1)", "(a2)" and "(E)"

4.1.3 Self Test "(b)"

The current and duration requirements seen by the battery for each separate MT400 function during a routine 'Self-Test' operation are provided at Table 6.

This demand is then equated to an energy requirement, expressed in Ampere-hours for completion of a single self-test.

It is worthy to note that the 121.5MHz homer is un-modulated during self-test, which accounts for the current draw being significantly higher than in normal swept tone operation.

Description	Duration (ms)	Current (mA)	Quantity	Energy (Ah)
406MHz, short message	440	2496	1	0.000305
121.5MHz carrier, unmodulated	300	161	1	0.000013
Audible alert	100	61	2	0.000003
LED strobe	260	341	1	0.000025
				0.000347

Table 6 - Energy per self-test

The MT400 is specified for a routine monthly self-test over its 5 year rated battery life.

Description	Operation	units
Number of Years		5
Months per year	x	12
Number of self-test over battery life		60
Energy consumed per self-test cycle	x (Table 6)	0.000347 Ah
Total self-test energy consumed over battery life		0.020790 Ah
Energy per 50s activation cycle	/	0.001661 Ah
No. 50s act cyc consuming equiv. energy to tot s'test		12.52
Hours per 50s activation cycle	x	(50/60)/60
"(b)" Equivalent (Self-test) activation time		0.17 hrs

Table 7 - Calculation of "(b)"

4.1.4 Stand-by "(c)"

The MT400 does not draw current in the OFF state.

Description	Operation	units
"(c)" Equivalent (Stand-by) activation time		0.00 hrs

Table 8 - Calculation of "(c)"

4.2 Battery Pre-Conditioning Prior to Low Temp Life Test

4.2.1 IEC/ETSI Specification Method "(a1, b, c, E)"

Calculations according to the IEC/ETSI method are shown in Table 9.

Description	Formula	Equivalent Activation Period (hrs)
Self Discharge, Useful life (10yrs)	(a1)	4.68
Self Test (monthly over 5yrs)	(b)	0.17
Standby Load (5yrs)	(c)	0.00
Total pre-conditioning activation period for new cells	(p)=(a1+b+c)	4.86
Discharge due to existing test cell age	(E)	1.46
		- 1.46
Pre-conditioning activation period for actual test cells	(p)-(E)	<u>3.40</u>

Table 9 - IEC/ETSI Pre-conditioning Calculations

4.2.2 C/S T.007 Test Specification Method "(a2, b, c, E)"

Calculations according to the COSPAS SARSAT method are shown in Table 10.

Note, it is believed that the intention is that energy loss due to self-discharge should be included (although this is not explicitly stated in C/S T.007). For the purpose of this analysis self-discharge has been included as represents a more stringent requirement.

Description	Formula	Equivalent Activation Period (hrs)
Self Discharge, Rated life (5yrs)	(a2)	2.93
Self Test (monthly over 5yrs)	(b)	0.17
Standby Load (5yrs)	(c)	0.00
Total pre-conditioning activation period for new cells	(p)=(a2+b+c)	3.10
Correction Co-efficient	(f)	1.65
Corrected pre-conditioning activation period for new cells	(p)x(f)	5.12
Discharge due to existing test cell age	(E)	1.46
		- 1.46
Required pre-conditioning activation period (actual cells)	(p x f)-(E)	<u>3.66</u>

Table 10 - COSPAS-SARSAT Pre-conditioning Calculations

4.2.3 Selected Method and Pre-Test Discharge Duration

After accounting for the current age of the test cells (1 year as of April 2003) the IEC/ETSI methods require a minimum 3.40 hrs of pre-test activation, whereas the COSPAS/SARSAT method requires a minimum of 3.66 hrs.

For the purpose of the low temperature life test the later is the more demanding of the two pre-conditioning periods, and will therefore be adopted for the certification of the MT400 there-by demonstrating compliance to all three specifications.

PRE-TEST DISCHARGE DURATION > 3.66 hrs

PRIMARY LITHIUM BATTERY

LO 26 SX

**3.0 V Primary
lithium - sulfur
dioxide (Li-SO₂)
High Drain capability
Spiral D-size cell**

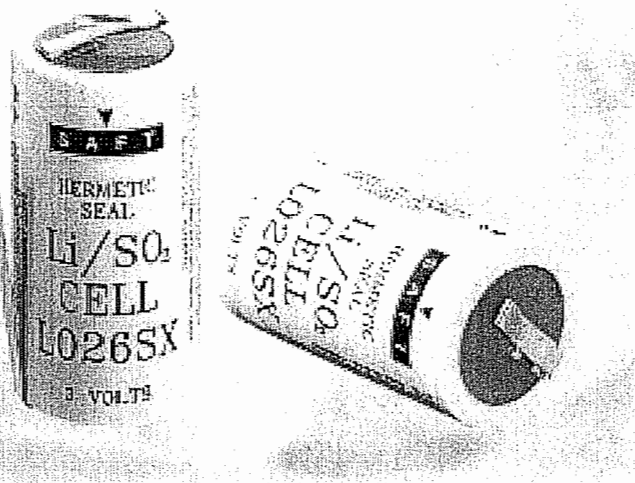

For high drain applications up to 3 A continuous, 10 A pulse currents, possibly combined with exposure to extreme temperatures.

Key features

- High and stable discharge voltage
- Performance not affected by cell orientation
- Low self discharge rate (less than 3% after 1 year of storage at +21°C/+70°F)
- Hermetic glass-to-metal sealing
- Built-in safety vent (at the negative end of the cell)
- 1 A-fused version not restricted for transport
- UL Component Recognition (File Number MH 15076)
- Meets shock, vibration and other environmental requirements of military specifications
- Made in the USA

Main applications

- Radiocommunications and other military applications
- Beacons and Emergency Location Transmitters
- Sonobuoys
- ... etc.

Cell size reference

R20 - D

Electrical characteristics

(typical values for cells stored for one year or less)

Nominal capacity	7.5 Ah
(at 240 mA +21°C/+70°F 2.0 V cut off. The capacity restored by the cell varies according to current drain, temperature and cut off).	
Open circuit voltage (at +21°C)	3.0 V
Nominal voltage (at 240 mA +21°C/+70°F)	2.8 V
Maximum recommended continuous current	3 A
(to avoid over-heating. Higher currents possible, consult Saft).	
Pulse capability : varies according to pulse characteristics (frequency, duration), temperature, cell history (storage conditions prior to usage) and the application's acceptable minimum voltage. Consult Saft.	
Storage (recommended)	+30°C/+86°F
max	-60°C (-76°F) / +85°C (+185°F)
(possible without leakage)	
Operating temperature range	-60°C (-76°F) / +71°C (+160°F)
(Short excursions up to 85°C possible at currents below 1 A).	
Physical characteristics	
Diameter (max)	33.8 mm (1.33")
Height (max; finish with radial tabs)	59.3 mm (2.33")
Typical weight	85 g (2.98 oz)
Weight of Li metal	2.4g
Standard cell comes with two radial 0.15 mm thick nickel tabs	
Finish with positive button on request	
Finish with 1 A fuse on request	

SAFT

LO 26 SX

Voltage at mid-discharge versus Current and Temperature (2.0 V cut off)

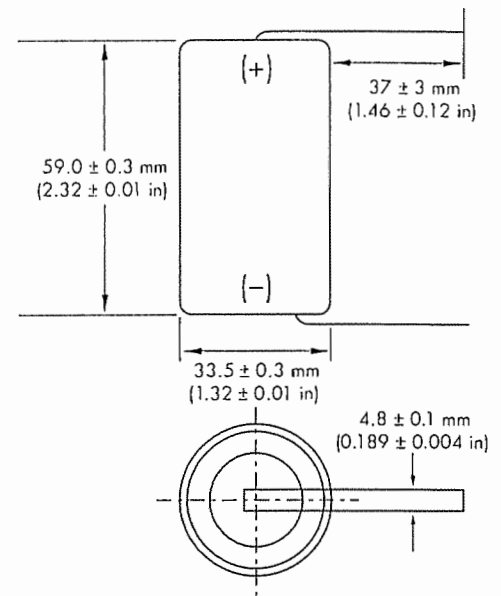
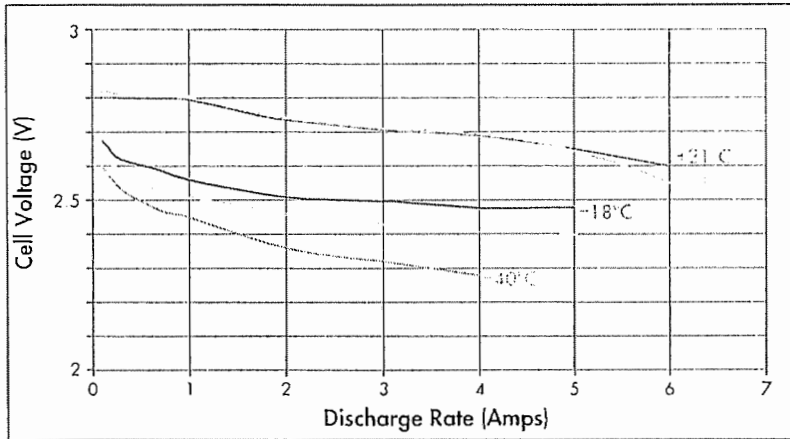

overall dimensions

Typical discharge profiles at +21°C/+70°F

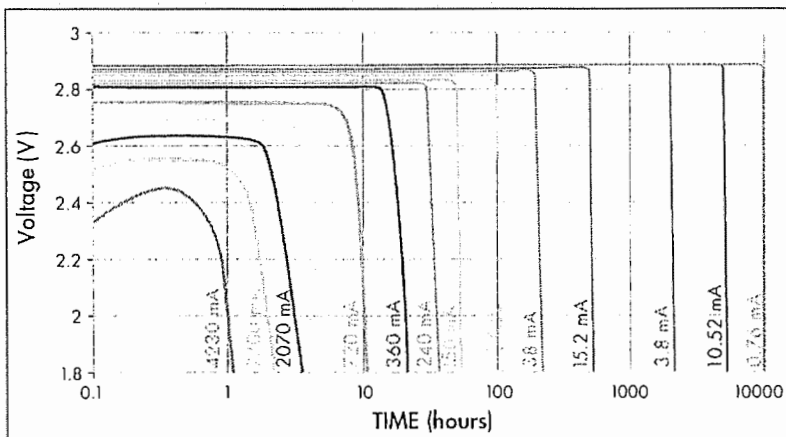

Handling precautions

- Do not puncture, open or mutilate. Cell is pressurised.
- Do not obstruct the safety vent mechanism.
- Do not short circuit or charge
- Do not expose to fire or temperatures above 70°C (160°F).

Capacity versus Current and Temperature (2.0 V cut off)

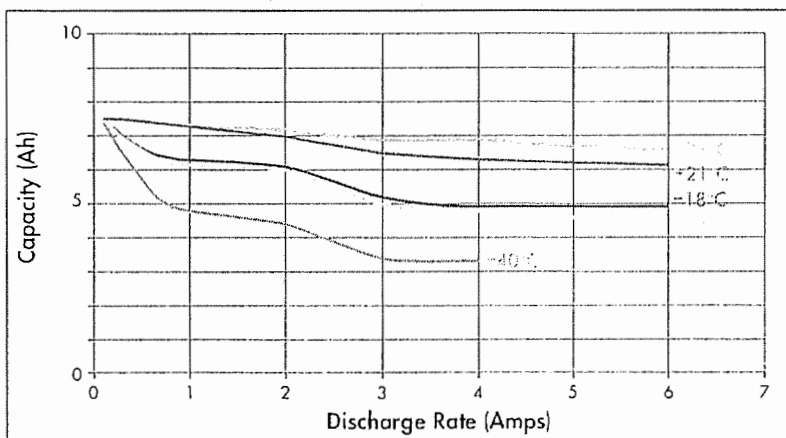

12, rue Sadi Carnot
93170 Bagnole - France
Tel +33 (0)1 49 93 17 70
Fax +33 (0)1 49 93 19 69

313, Crescent Street
Valdese NC 28690 USA
Tel +1 (828) 874 41 11
Fax +1 (828) 879 39 81

Internet: <http://www.softbatteries.com>

Doc. N° 12.00 - 31030.2
Published by the Communications Department



To: Craig Duncan

June 26, 2003

Subject: Capacity Retention of LO26SX(D size LiSO₂ primary lithium cell)

Saft has performed a number of tests on capacity retention of our LiSO₂ cells and batteries. LiSO₂ is the most prevalently used chemistry for military portable batteries, and the LO26SX cell is the most used cell type in military batteries. The excellent capacity retention after long periods of storage is one of the major strengths of LiSO₂ that has resulted in its popularity for use in military applications.

Saft LiSO₂ cells and batteries stored in warehouse conditions have been tested after up to 15 years storage. The average temperature during the storage period is in the range of 20 to 25°C with a maximum temperature of 40°C. Military batteries up to 5 years storage in military use (including deployment in the Middle East during Dessert Storm) have been capacity tested as well. From the results of testing of aged batteries Saft has developed typical capacity retention rates. The capacity loss is greatest in the first 1 to 2 years and gradually reduces to almost negligible loss with time after that. After 5 years aging typical LiSO₂ battery capacity is 95% of its initial capacity; after 10 years approximately 92%; and after 15 years the typical capacity is still greater than 90%.

Respectfully,

A handwritten signature in dark ink, appearing to read 'Michael S. Sink', written over a light-colored background.

Michael S. Sink
Mgr. New Business
Development

Direct Voice: 828-879-5031 Fax: 828-879-3981
email: mike.sink@saftamerica.com

From: Wayne.Pitt@saft.alcatel.com.au
To: 'Kevan Wilson-Elswood'
Sent: Friday, April 04, 2003 4:53 PM
Subject: RE: Lithium battery application information

Hi Kevan,

The cells will be market with a code, similar to the following; 991127Y. This is year month day, with the letter being a production identifier. If you do not find the identification code on the outside of the white sleeve, you may have to peel off the outside white heat shrink sleeve, and check the cell can underneath. If you have any problems at all, please do not hesitate in contacting me.

Regards
Wayne

IMPORTANT INFORMATION

This transmission is for the intended addressee/s only and is privileged information and is subject to the National Privacy Principles in the Privacy Amendment (Private Sector) Act 2000. If you have received this transmission in error, you are requested to delete it and notify the sender. Views expressed in this message are those of the individual sender, and are not necessarily the views of Saft Australia Pty Ltd.

-----Original Message-----

From: Kevan Wilson-Elswood [mailto:kelswood@gme.net.au]
Sent: Friday, 4 April 2003 15:14
To: Wayne.Pitt@saft.alcatel.com.au
Subject: Re: Lithium battery application information
Importance: High

Hello Wayne,
Sorry to bother you again but this is fairly important. To get an accurate idea of how to simulate self discharge on the LO26SX cells we need to know when they were manufactured. I note that the cell bodies are stamped with a code. Can we deduce the date of Manufacture from that code.

Thanks for any help you can provide

Kevan Wilson-Elswood
Senior Design Engineer
Standard Communications Pty Ltd
Gladesville, Australia

Toulouse, 17 October 2003

INTESPACE reference : M4586-Rev2

**COMPLEMENTARY C/S TEST REPORT OF
406 MHz DISTRESS BEACON**

MANUFACTURER : STANDARD COMMUNICATIONS PTY. LTD.
BEACON MODEL : MT400 Rev 2

Written : 17/10/2003

By : Gerard PEYROU

Visa : 

Approved : 20/10/2003

By : Didier NAWS

Visa : 

Quality Control : 22.10.03

By : André LOUIT

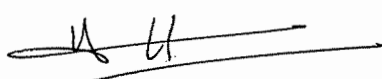
Visa : P. A. KOFFMAN 

Distribution :

- | | | | |
|-------------|--------------|--------------------|----------|
| - Mr | Craig DUNCAN | STANDARD COMMUNICA | (1 copy) |
| - Mr | S. MIKAILOV | COSPAS/SARSAT Sec | (1 copy) |
| - Mr | M. SARTHOU | CNES - DSO/RC/AS | (1 copy) |
| - INTESPACE | | ITS/AP/ET | (1 copy) |

This document may not be reproduced other than in full .
It includes 29 pages . A part of reproduction
must be submitted at the laboratory authorization .

1 - ADMINISTRATION

1.1. WORK ORDER

Manufacturer : STANDARD COMMUNICATIONS PTY. LTD.
Address : 6, Frank street - GLADESVILLE NSW 2111 - AUSTRALIA

Represented by : Mr Craig DUNCAN

1.2. INTESPACE TEST CENTER

The test operations have been conducted by : Mr G. PEYROU

1.3. SCHEDULE

Start of test: 14 October 2003
End of test : 17 October 2003

1.4. WORK REFERENCE : **M4586-Rev2**

1.5. EQUIPMENT UNDER TEST

The results from this test report concern only the equipment here after referenced :

- Commercial designation :
- Model : MT400 Rev 2
- Sérial number: MT0

2 - TEST FACILITIES

- ARGOS - COSPAS/SARSAT Certification Test Bench.
- Anechoic chamber for antenna test .
- Toulouse CNES MCC .

3 - OBJECTIVE OF TESTS

To check modulation signal at 3 beacon operating temperatures in normal configuration and with VSWR 3:1

4 - STANDARDS AND TEST PROCEDURES APPLICABLE

COSPAS-SARSAT standards :

- "C/S T. 001- Issue 3 - Revision 4 - October 2002 "
- "C/S T. 007- Issue 3 - Revision 9 - October 2002"

INTESPACE Radio Beacon Test Procédures :

- | | |
|-------------------------------------------|------------------------|
| - " COSPAS-SARSAT Certification Test" | Réf. ITS : 572 AP/QA |
| - " 406 MHz Characteristic Antenna Test " | Réf. ITS : 566 AP/QA |
| - " Radio Beacon Test Report " | Réf. ITS : 579 AP/QA-f |

5 - RESULTS

See following pages :

- application form for a COSPAS-SARSAT 406 MHz beacon Type Approval Certificate,
- summary of 406 MHz beacon test results
- test results : data and graphs

**APPLICATION FOR A COSPAS - SARSAT 406 MHz
BEACON TYPE APPROVAL CERTIFICATE**

Beacon Manufacturer : STANDARD COMMUNICATIONS PTY. LTD.

Beacon model : MT400 Rev 2

Beacon Number : MT0

Name and Location of Beacon Test Facility : INTESPACE / CNES Toulouse

Beacon Type : Aviation : Land : Maritime :

Antenna Model :

Specified Operating Temperature Range -20 °C to 55 °C

Specified Operating Lifetime : 24 hr 48 hr Other Specify :

Beacon Battery Type(s)

Chemistry : LiSO2
 Manufacturer & model n° : SAFT / LO 26SX
 Size & number of cells : D Size / 2 Cells

Extra Features in Beacon

	No	Yes	Details
a) Auxiliary Radio-Locating Device :	<input type="checkbox"/>	<input checked="" type="checkbox"/>	Frequency : 121.5 MHz Power : 17 dBm (50 Ω) Tx. Duty Cycle : Continuous (> 96 %)
b) Transmits Encoded Position Data	<input checked="" type="checkbox"/>	<input type="checkbox"/>	Nav. Device : Type : Manufacturer : Model :
c) Transmits Long Message (144 bits)	<input checked="" type="checkbox"/>	<input type="checkbox"/>	
c) Automatic Activation :	<input checked="" type="checkbox"/>	<input type="checkbox"/>	
d) Built-in Strobe light :	<input type="checkbox"/>	<input checked="" type="checkbox"/>	Intensity > 0,75 Cd Flash rate : 20/21 per mn
e) Self-test mode	<input type="checkbox"/>	<input checked="" type="checkbox"/>	
f) Other	<input type="checkbox"/>	<input checked="" type="checkbox"/>	Specify : Audible Annunciator

I hereby confirm that the 406 MHz beacon described above has been successfully tested in accordance with the COSPAS-SARSAT Type Approval Standard (C/S T.007) and complies with the COSPAS-SARSAT Specification (C/ST T.001) as demonstrated in the attached report.

Dated : 17 October 2003

Signed :



(for test facility)

Table C2 : SUMMARY OF 406 MHz BEACON TEST RESULTS

PARAMÈTRES TO BE MEASURED DURING TESTS	RANGE OF SPECIFICATION	UNITS	TEST RESULTS			COMMENTS
			T _{min.} -20°C (±3)	T _{amb.} 22°C (±3)	T _{max.} 55°C (±3)	
1 - POWER OUTPUT o transmitter power output o Power output rise time o power output 1 ms before burst	35 - 39	dBm	36,6	35,7	35,4	Not checked
	< 5	ms	1,06	1,34	1,53	
	must be < -10 dBm	√ *				
2 - DIGITAL MESSAGE o bit sync o frame sync o format flag o protocol flag o identification/position code o BCH code o emerg. code/nat. use/supplem. data o additional data/BCH (if applicable) o position error (if applicable)	Bits number					
	1-15	√	√	√		
	16-24	√	√	√		
	25	√	0	0		
	26	√	1	1		
	27-85	√	√	√		
	86-106	√	√	√		
	107-112	data bits	000000	000000	000000	
	113-144	√	N/A	N/A	N/A	Not applicable
	< 5	km	N/A	N/A	N/A	

Table C2 : SUMMARY OF 406 MHz BEACON TEST RESULTS

Ref : M4586-Rev2

PARAMÈTRES TO BE MEASURED DURING TESTS	RANGE OF SPECIFICATION	UNITS	TEST RESULTS			COMMENTS
			T _{min.} -20°C (±3)	T _{amb.} 22°C (±3)	T _{max.} 55°C (±3)	
3 - DIGITAL MESSAGE GENERATOR						
o repetition rate :						
minimum T _R =	47,5	seconds	48,0	48,0	48,0	
maximum T _R =	52,5	seconds	52,0	52,0	52,0	
o bit rate						
minimum f _b =	396	bits/sec.	399,67	399,68	399,67	
maximum f _b =	404	bits/sec.	399,75	399,75	399,76	
o total transmission time :						
short message =	435.6 - 444.4	ms	440,88	440,70	440,57	
long message (optional) =	514.8 - 525.2	ms				
o CW preamble						
minimum T ₁ =	158,4	ms	160,63	160,45	160,39	
maximum T ₁ =	161,6	ms	160,70	160,53	160,45	
o first burst delay	> 47,5	seconds	> 47,5	> 47,5	> 47,5	

 Data and graphs
pages 9 to 18

Table C2 : SUMMARY OF 406 MHz BEACON TEST RESULTS

PARAMÈTRES TO BE MEASURED DURING TESTS	RANGE OF SPECIFICATION	UNITS	TEST RESULTS			COMMENTS
			T _{min.} -20°C (±3)	T _{amb.} 22°C (±3)	T _{max.} 55°C (±3)	
4 - MODULATION o biphase-L o rise time o fall time o phase deviation : positive o phase deviation : negative o symmetry measurement	√		√	√	√	Data and graphs pages 9 to 18
	50 - 250	microsec.	150	140	150	
	50 - 250	microsec.	140	140	130	
	+ (1.0 to 1.2)	radians	+ 1,07	+ 1,06	+ 1,08	
	- (1.0 to 1.2)	radians	- 1,11	- 1,11	- 1,07	
	≤ 0.05		4,01E-06	+ 0,0160	+ 0,0160	
5 - 406 MHz TRANSMITTED FREQUENCY o nominal value o short term stability o medium term stability . slope . residual frequency variation	as specified in C/S T.001 and C/S T.012	MHz	406,0279406	406,0279152	406,0279386	Data pages 10, 13 and 16
	≤ 2 x 10 ⁻⁹	/100 ms	4,46E-10	2,18E-10	3,30E-10	
	(-1 to +1) x 10 ⁻⁹	/minute	-1,18E-10	-1,03E-11	2,18E-10	
	≤ 3 x 10 ⁻⁹		7,57E-10	1,25E-09	5,56E-10	
	see spurious emission mask in C/S T.001	√	√	√	√	See graphs pages 19 to 22
6 - SPURIOUS EMISSION ** (into 50 ohms) o in-band (406.0 - 406.1 MHz)						

Table C2 : SUMMARY OF 406 MHz BEACON TEST RESULTS

PARAMÈTRES TO BE MEASURED DURING TESTS	RANGE OF SPECIFICATION	UNITS	TEST RESULTS			COMMENTS
			T _{min.} -20°C (±3)	T _{amb.} 22°C (±3)	T _{max.} 55°C (±3)	
7 - 406 MHz VSWR CHECK after open circuit, short circuit, then while VSWR is 3:1, measure : nominal transmitted frequency Modulation : o rise time o fall time o phase deviation : positive o phase deviation : negative o symmetry measurement o digital message	as specified in C/S T.001 and C/S T.012	MHz	406,0279424	406,0279383	406,0279409	See data and graphs pages 23 to 29
	50 - 250	microsec.	149,7	149,7	149,7	
	50 - 250	microsec.	149,7	139,7	159,7	
	+ (1.0 to 1.2)	radians	1,05	1,07	1,07	
	- (1.0 to 1.2)	radians	-1,12	-1,07	-1,10	
	≤ 0.05	√	+ 0,0080	+ 0,0121	+ 0,0079	
	must be correct	√	√	√	√	
	9 bits (011010000)	√				
	1/0	bit				
	≤ 440 / 520 (+1%)	ms				
must be correct	√					
protection provided	√					
one burst	√					
must be correct	√					
8 - SELF-TEST MODE (if applicable) o frame sync o format flag o single radiated burst o default position data (if applicable) o description provided o design data provided on protection against repetitive self-test mode transmissions o single burst verification o provides for beacon 15 Hex ID						Not checked

CERTIFICATION TEST RESULTS ON
MT400 Rev 2 STANDARD COMMUNICATIONS PTY. LTD. EPIRB
N° MT0
at -20° C, 22° C and 55° C

Certification Test at -20°C

Date of test : 15-oct-03

Manufacturer : Standard Communications

Beacon Type : MT400 Rev2

Number : MT0

Message

Message received		FFFE2F5F7703C4800000086FFE80
Format Flag	25	0
Protocol flag	26	1
Ident./Position code	27-85	BEEE07890000001
Country Code/Country	27-36	503 / AUSTRALIA
Protocol Code : U/Std-Nat	37-39/37-40	11
Protocol Code Used	37-39/37-40	
Identification Data	40-85/41-64/41-58	1E
Identification Used		::::::
Calculated BCH1	25-85	01BFFA
Readed BCH1	86-106	01BFFA
Homing	84-85	01
Em.cod/nat.use/supp.data	107-112	000000
Emer cod / Encod pos data	107	0
Activation type	108	0 Manual
Calculated BCH2	107-132	
Readed BCH2	133-144	
Latitude position		
Longitude position		
Delta position		

Electrical and other parameters

CW preamble	ms	158,4 <	< 162,6	160,66
Total transmission time	ms	434,6 <	< 445,4	440,88
Modulation frequency	Hz	395,4 <	< 404,6	399,70
Phase deviation : total	rd		<= 2,40	2,17
Phase deviation : positive	rd	1,00 <	< 1,20	1,07
Phase deviation : negative	rd	-1,20 <	< -1,00	-1,11
Symmetry measurement	%		<= 5 %	4,01E-04
Nominal frequency : F2	Hz			406027940,61
Short term2				2,82E-10
Short term3				4,46E-10
Slope				-1,18E-10
Residual				7,57E-10
406 MHz power output	dBm			36,6
Homing frequency	MHz			Not checked
121,5 MHz power output	dBm			Not checked
Soak temperature	°C			-19,6
Extra feature				No

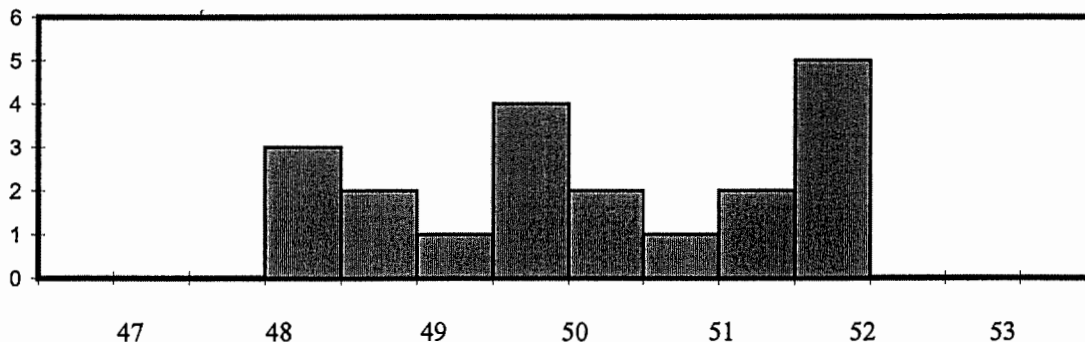

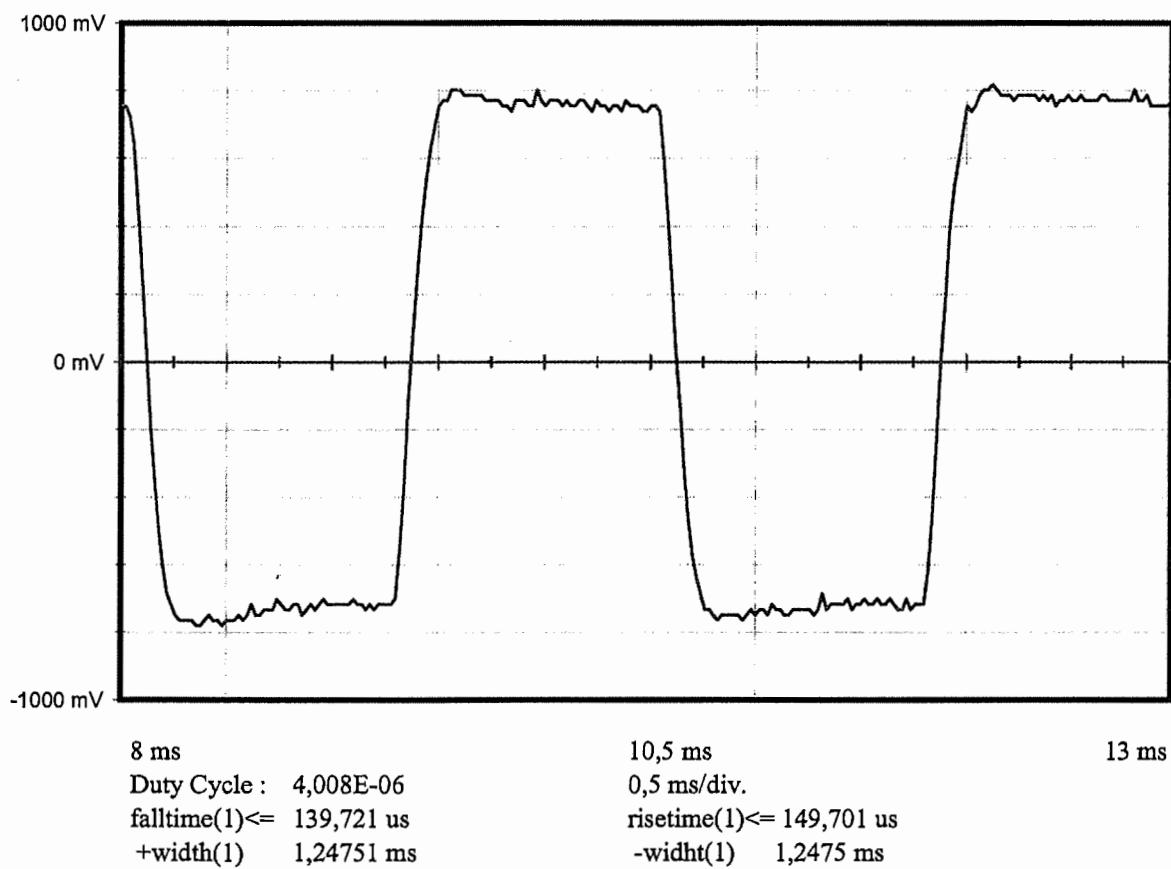
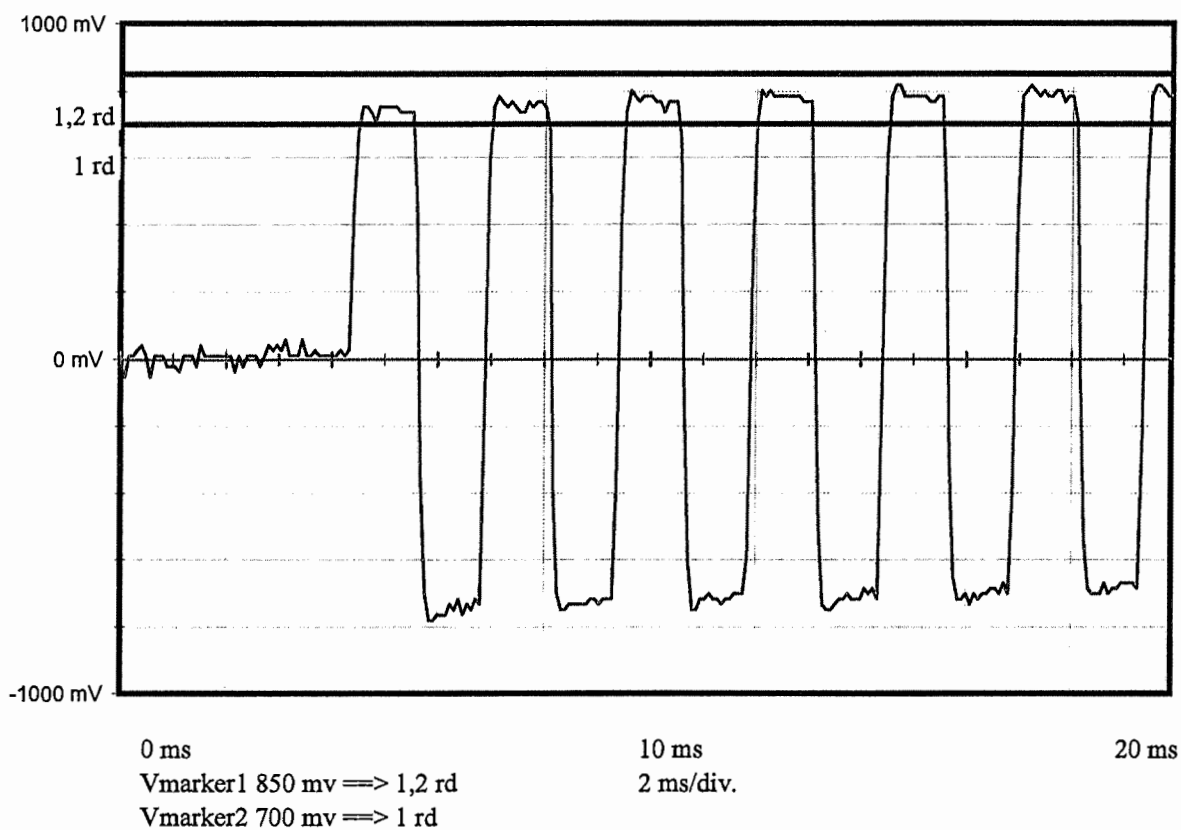

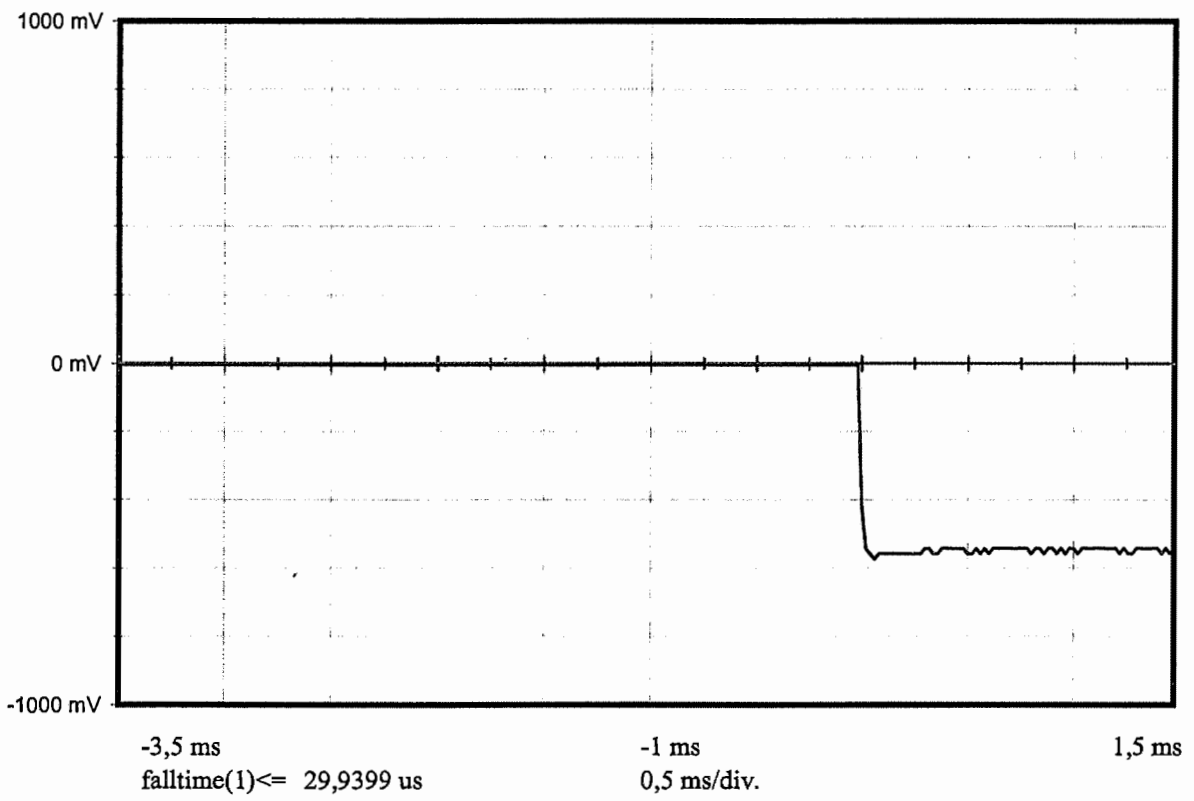
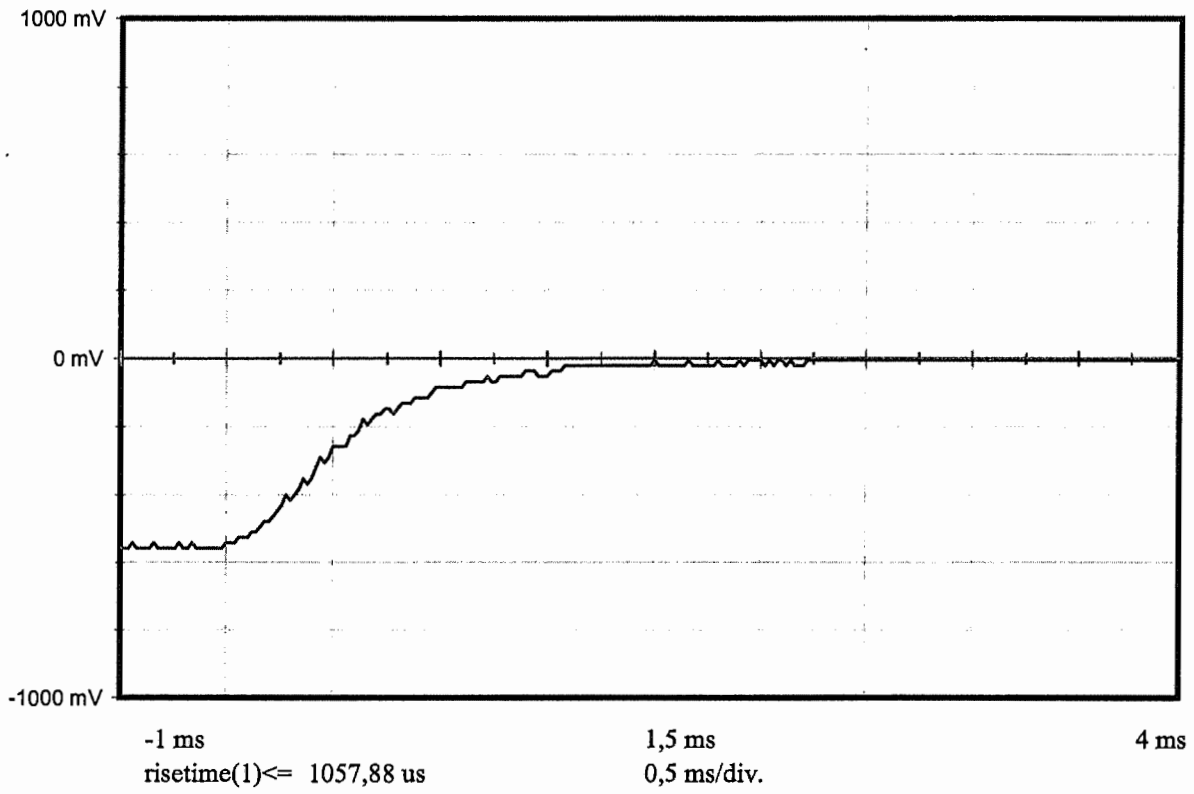

Certification Test at 22°C

Date of test : 14-oct-2003

Manufacturer : Standard Communications

Beacon Type : MT400 Rev2

Number : MT0

Message

Message received		FFFE2F5F7703C4800000086FFE80
Format Flag	25	0
Protocol flag	26	1
Ident./Position code	27-85	BEEE07890000001
Country Code/Country	27-36	503 / AUSTRALIA
Protocol Code : U/Std-Nat	37-39/37-40	11
Protocol Code Used	37-39/37-40	
Identification Data	40-85/41-64/41-58	1E
Identification Used	
Calculated BCH1	25-85	01BFFA
Readed BCH1	86-106	01BFFA
Homing	84-85	01
Em.cod/nat.use/supp.data	107-112	000000
Emer cod / Encod pos data	107	0
Activation type	108	0
Calculated BCH2	107-132	
Readed BCH2	133-144	
Latitude position		
Longitude position		
Delta position		

Electrical and other parameters

CW preamble	ms	158,4 <	< 162,6	160,48
Total transmission time	ms	434,6 <	< 445,4	440,70
Modulation frequency	Hz	395,4 <	< 404,6	399,71
Phase deviation : total	rd		<= 2,40	2,17
Phase deviation : positive	rd	1,00 <	< 1,20	1,06
Phase deviation : negative	rd	-1,20 <	< -1,00	-1,11
Symmetry measurement	%		<= 5 %	1,60
Nominal frequency : F2	Hz			406027915,22
Short term2				1,96E-10
Short term3				2,18E-10
Slope				-1,03E-11
Residual				1,25E-09
406 MHz power output	dBm			35,7
Homing frequency	MHz			Not checked
121,5 MHz power output	dBm			Not checked
Soak temperature	°C			19,6
Extra feature				No

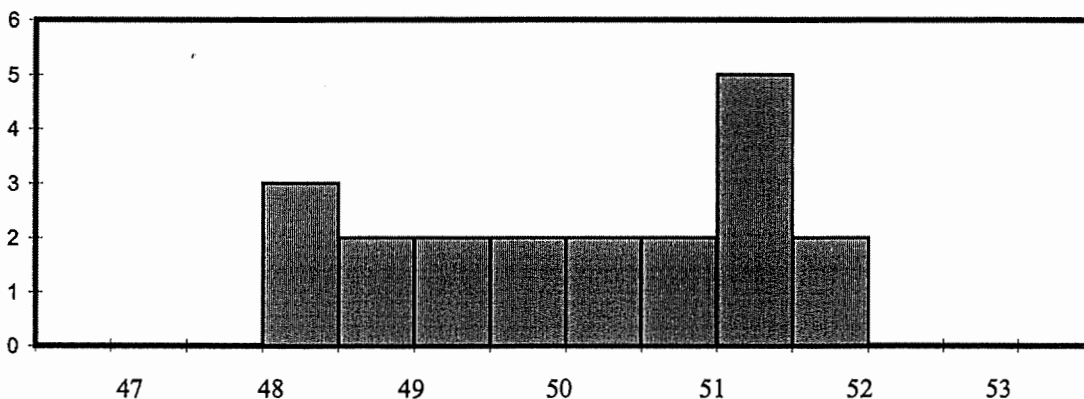

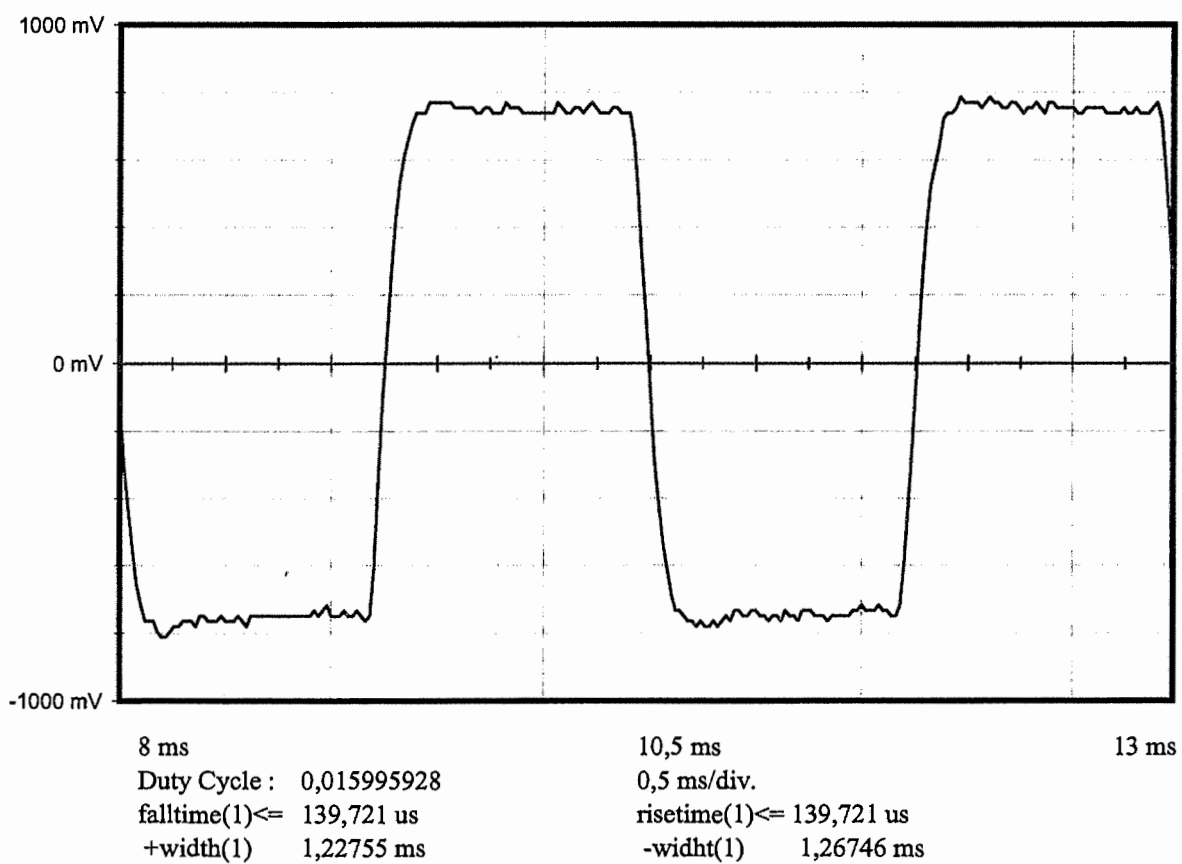
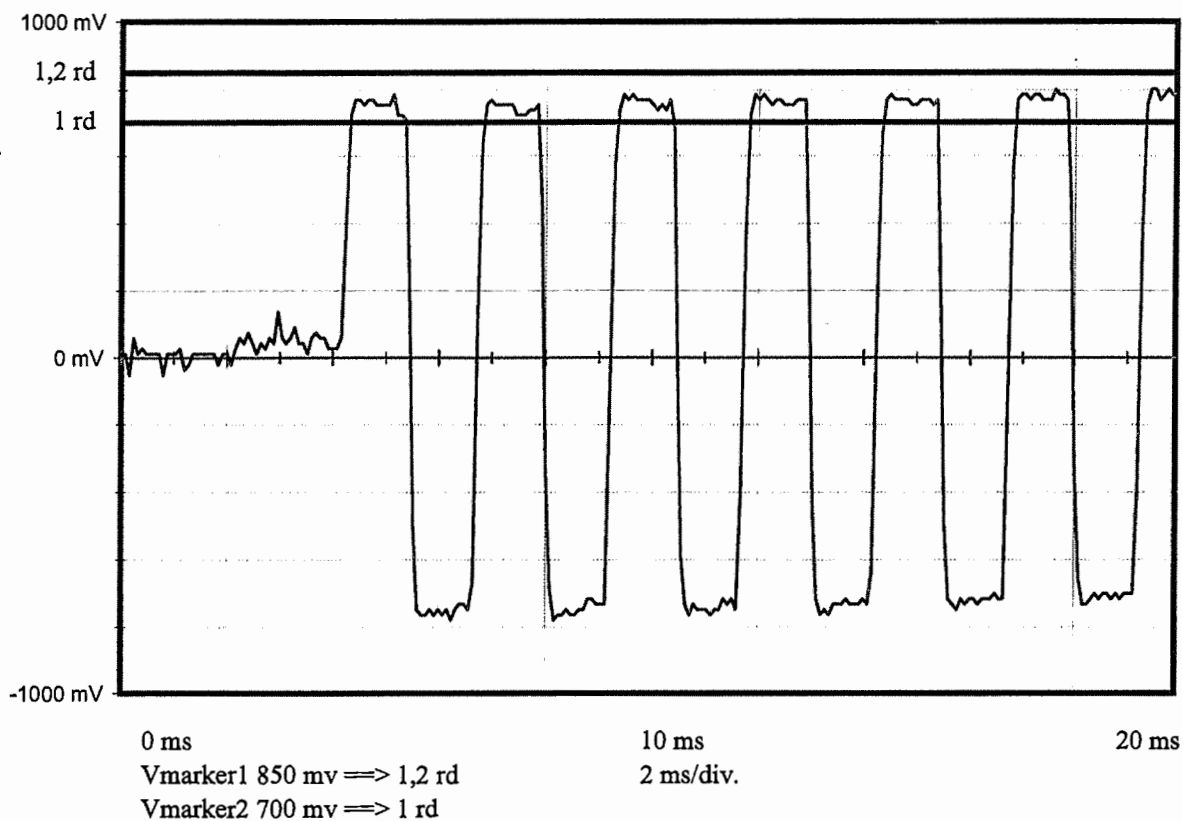

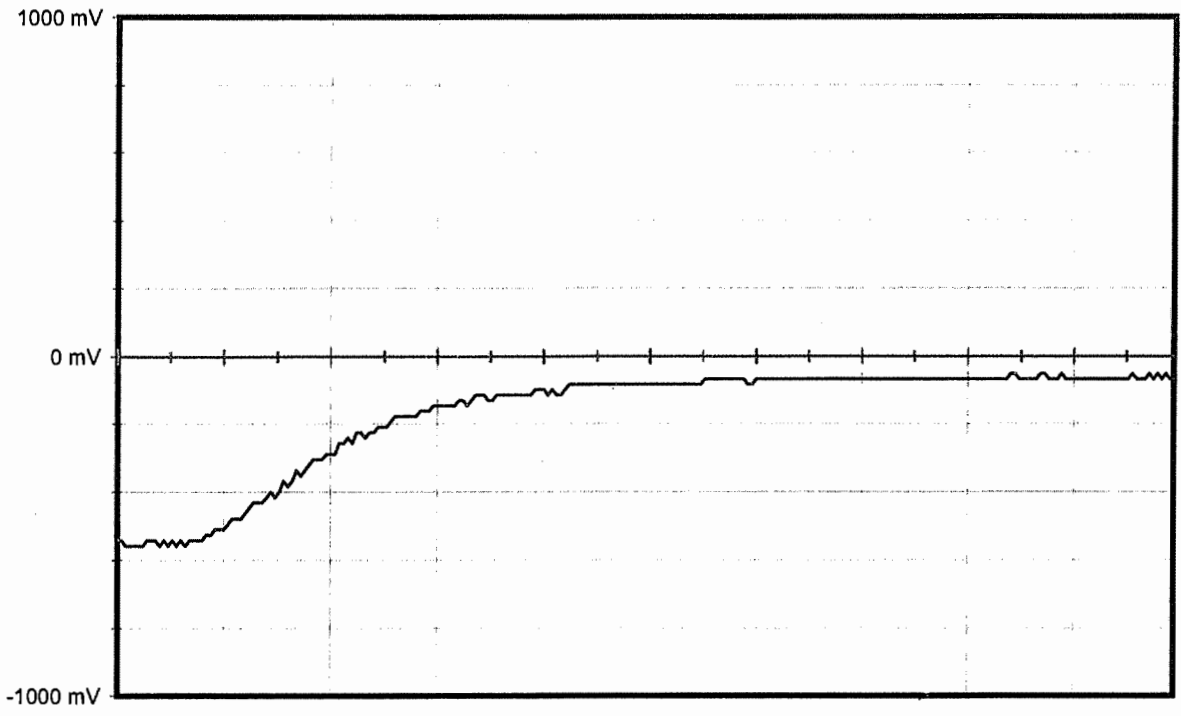

-1 ms
risetime(1) <= 1337,33 us

1,5 ms
0,5 ms/div.

4 ms

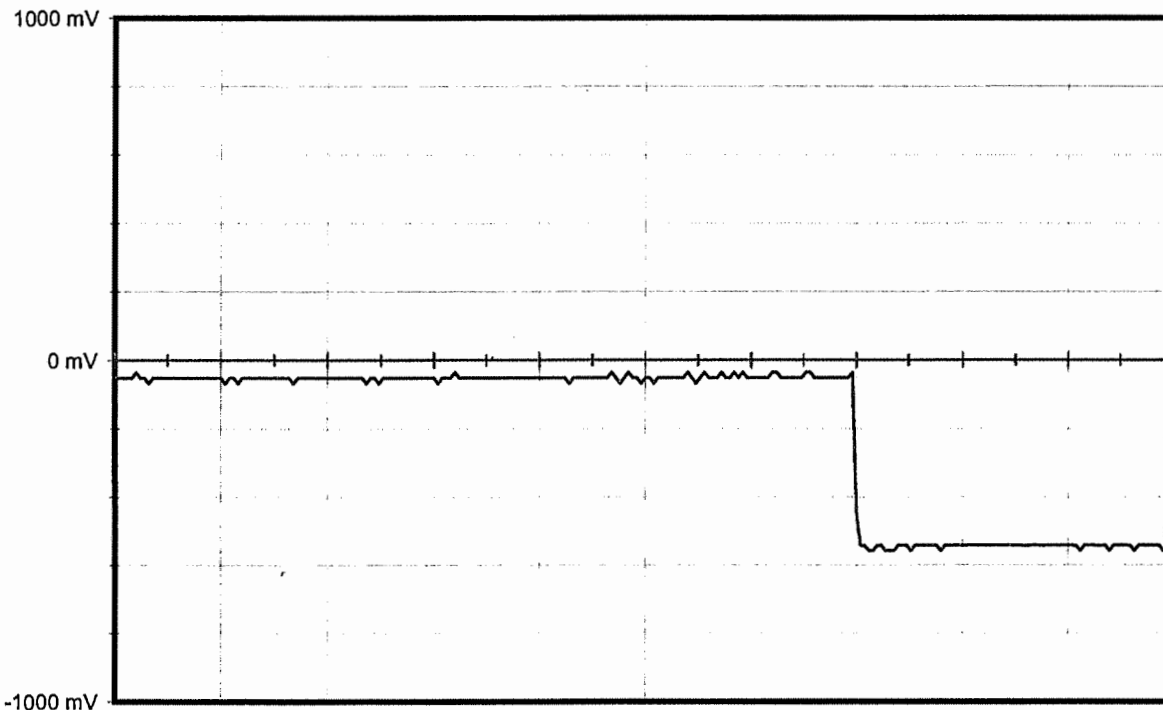

-3,5 ms
falltime(1) <= 29,9399 us

-1 ms
0,5 ms/div.

1,5 ms

Certification Test at 55°C

Date of test : 16-oct-2003

Manufacturer : Standard Communications

Beacon Type : MT400 Rev2

Number : MT0

Message

Message received		FFFE2F5F7703C4800000086FFE80
Format Flag	25	0
Protocol flag	26	1
Ident./Position code	27-85	BEEE07890000001
Country Code/Country	27-36	503 / AUSTRALIA
Protocol Code : U/Std-Nat	37-39/37-40	11
Protocol Code Used	37-39/37-40	
Identification Data	40-85/41-64/41-58	1E
Identification Used		::::::
Calculated BCH1	25-85	01BFFA
Readed BCH1	86-106	01BFFA
Homing	84-85	01
Em.cod/nat.use/supp.data	107-112	000000
Emer cod / Encod pos data	107	0
Activation type	108	0
Calculated BCH2	107-132	
Readed BCH2	133-144	
Latitude position		
Longitude position		
Delta position		

Electrical and other parameters

CW preamble	ms	158,4 <	< 162,6	160,41
Total transmission time	ms	434,6 <	< 445,4	440,57
Modulation frequency	Hz	395,4 <	< 404,6	399,70
Phase deviation : total	rd		<=2,40	2,15
Phase deviation : positive	rd	1,00 <	< 1,20	1,08
Phase deviation : negative	rd	-1,20 <	< -1,00	-1,07
Symmetry measurement	%		<=5 %	1,60
Nominal frequency : F2	Hz			406027938,65
Short term2				2,42E-10
Short term3				3,30E-10
Slope				2,18E-10
Residual				5,56E-10
406 MHz power output	dBm			35,4
Homing frequency	MHz			Not checked
121,5 MHz power output	dBm			Not checked
Soak temperature	°C			54,4
Extra feature				No

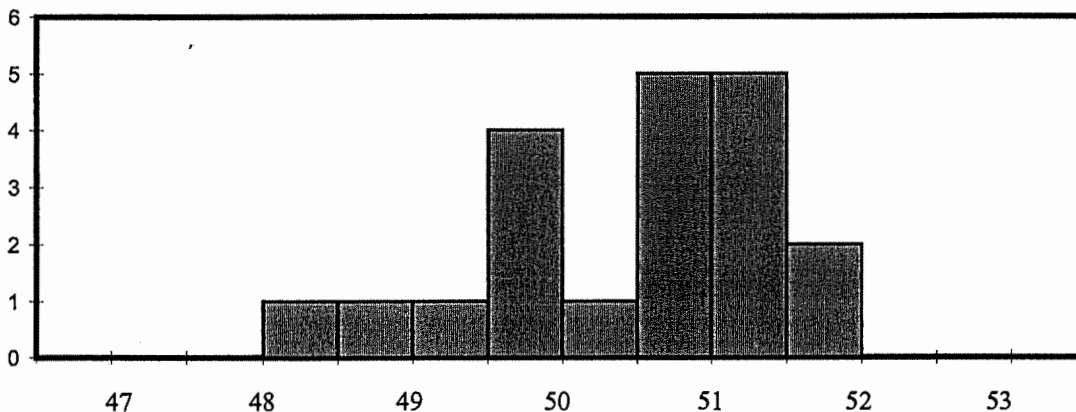

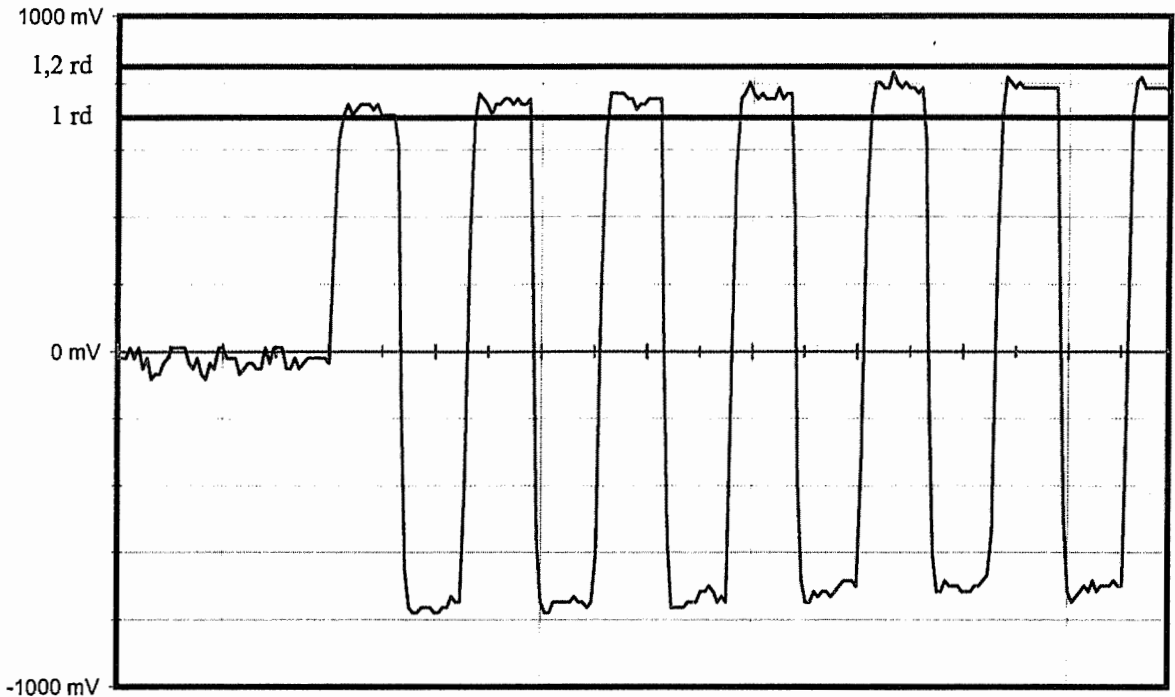

0 ms 10 ms 20 ms
 Vmarker1 850 mv ==> 1,2 rd 2 ms/div.
 Vmarker2 700 mv ==> 1 rd

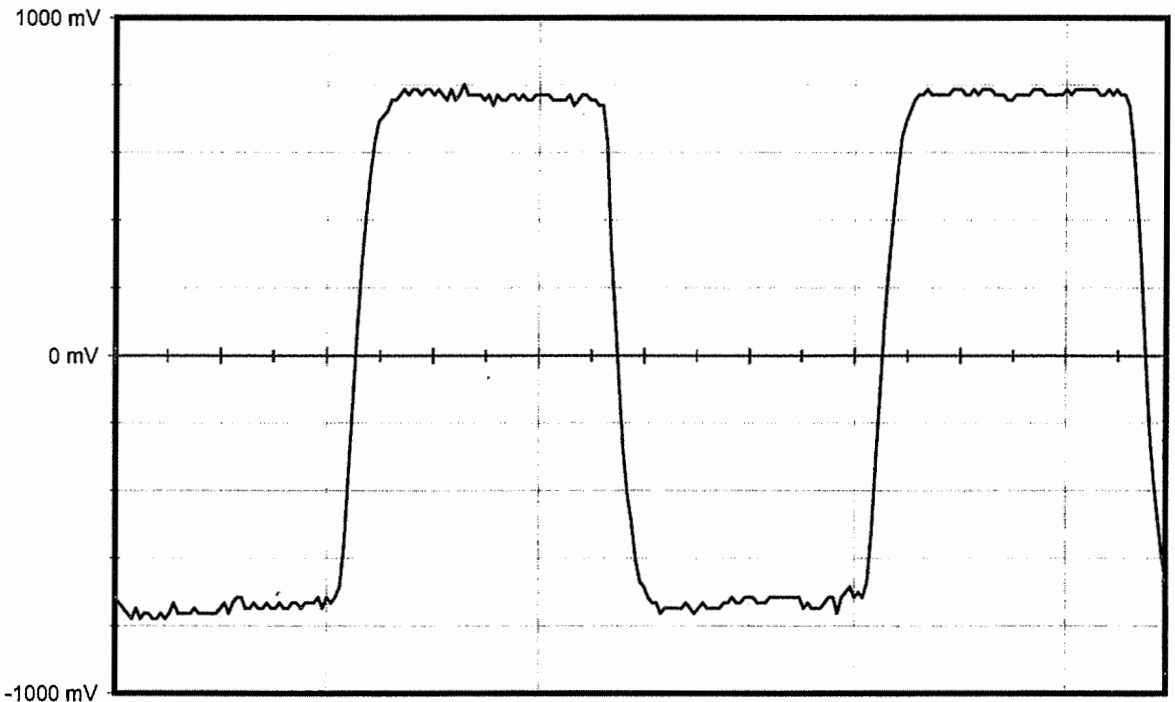

8 ms 10,5 ms 13 ms
 Duty Cycle : 0,016 0,5 ms/div.
 falltime(1) <= 129,741 us risetime(1) <= 149,7 us
 +width(1) 1,22754 ms -width(1) 1,26746 ms

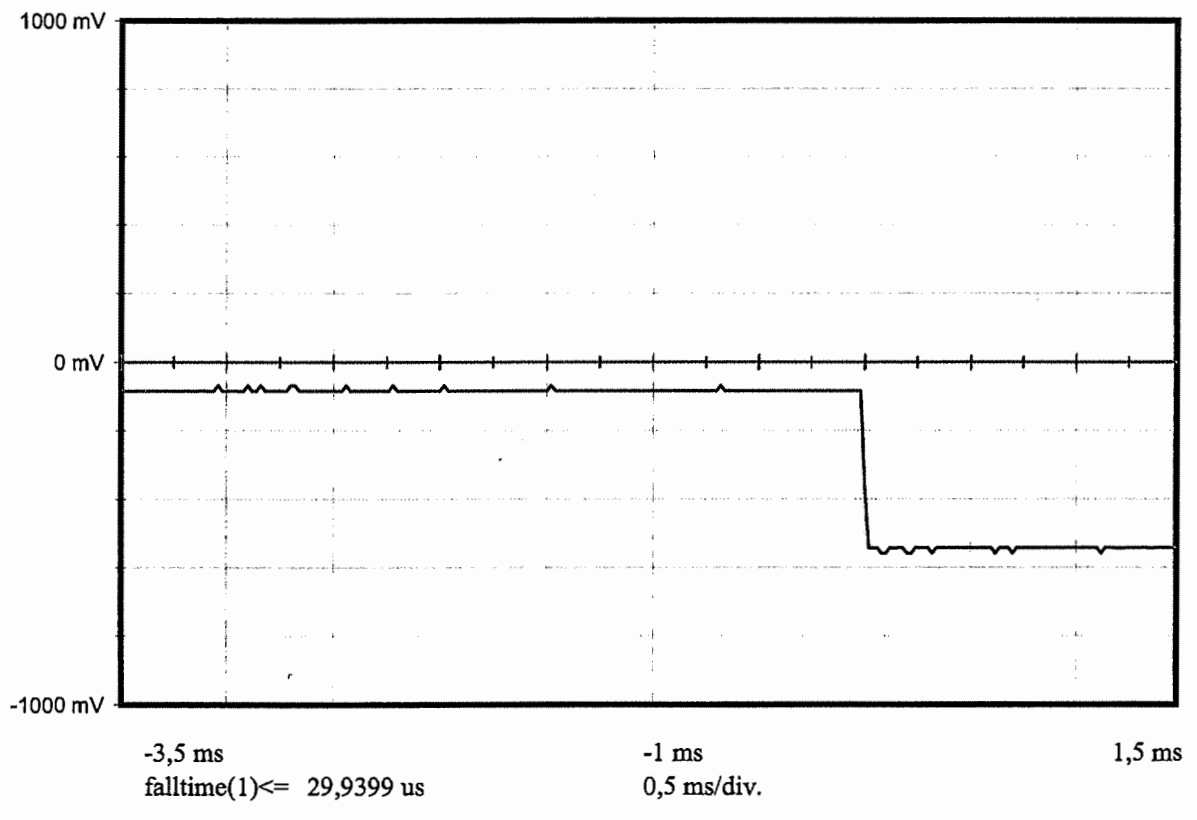
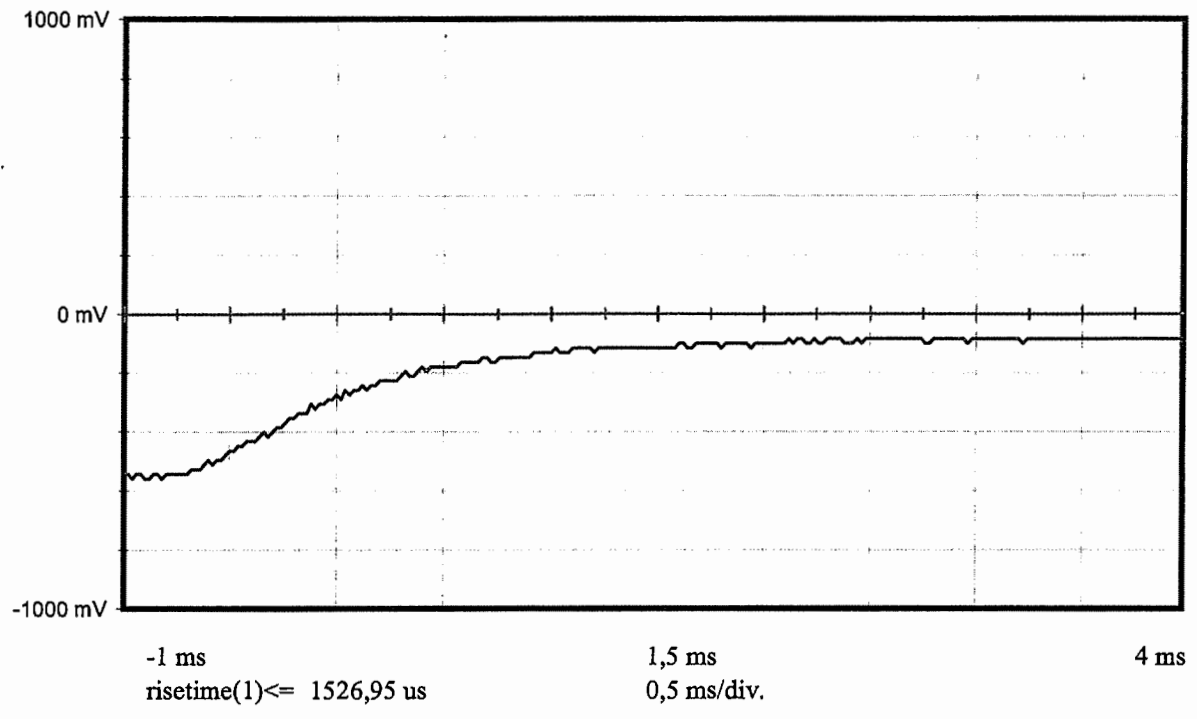

SPURIOUS EMISSIONS RESULTS
MT400 Rev 2 STANDARD COMMUNICATIONS PTY. LTD. EPIRB
N° MT0
at -20° C, 22° C and 55° C

Standard Communications
 MT400
 C204 Rev2
 Certification nominale
 406 MHz
 -20 °C

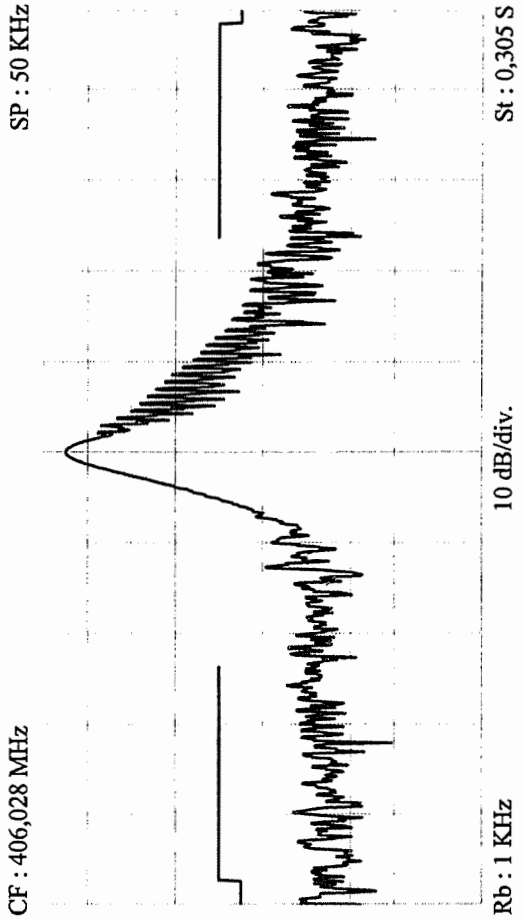
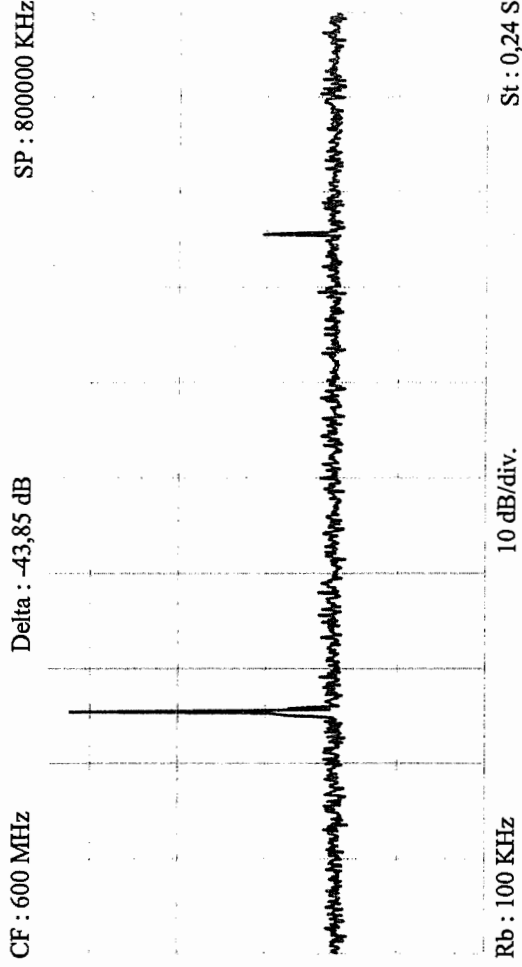
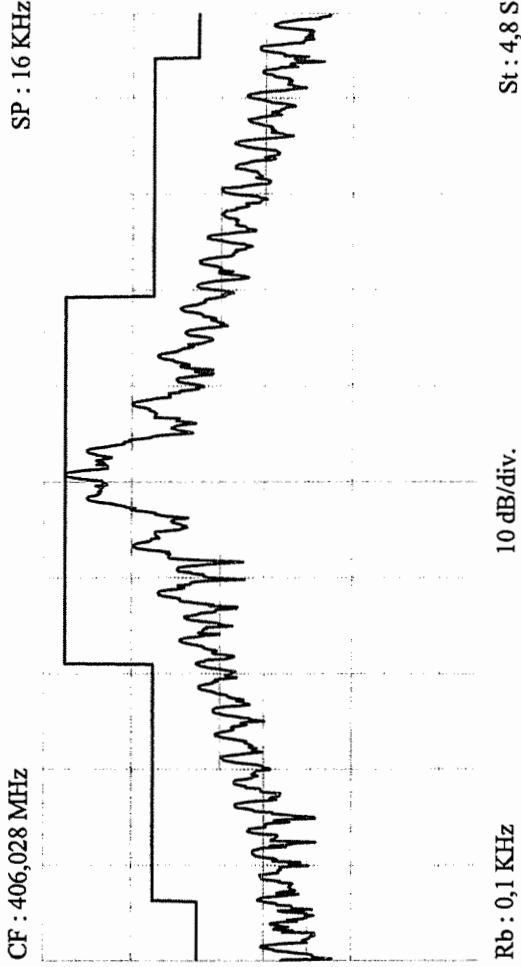

Standard Communications

MT400

C204 Rev2

Certification nominale

406 MHz

22 °C

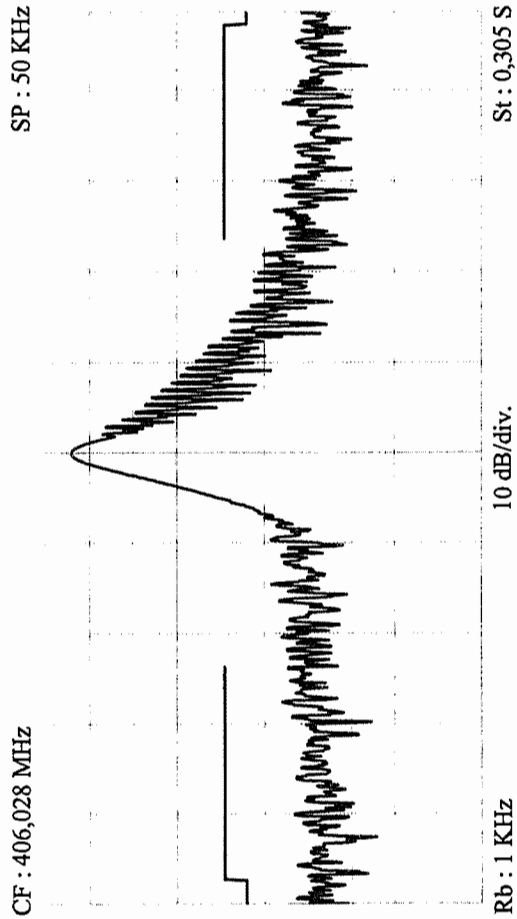
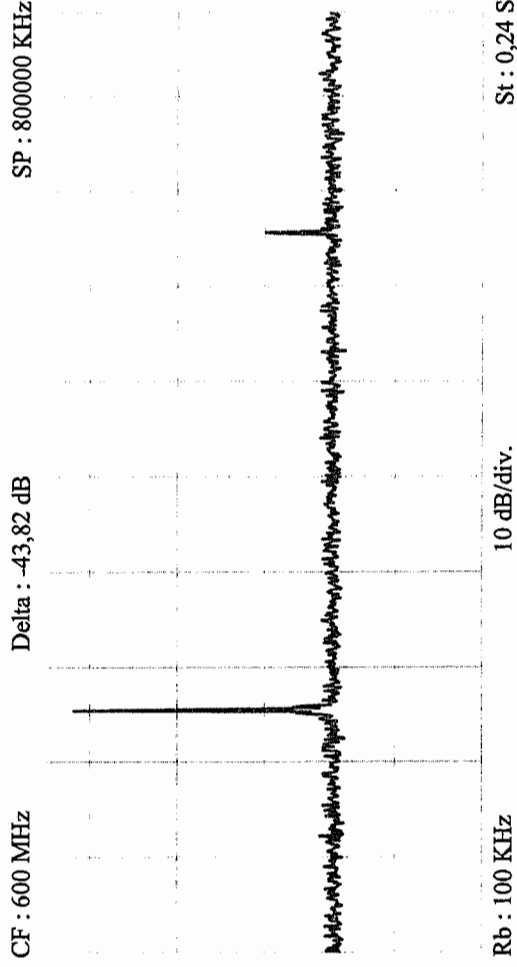
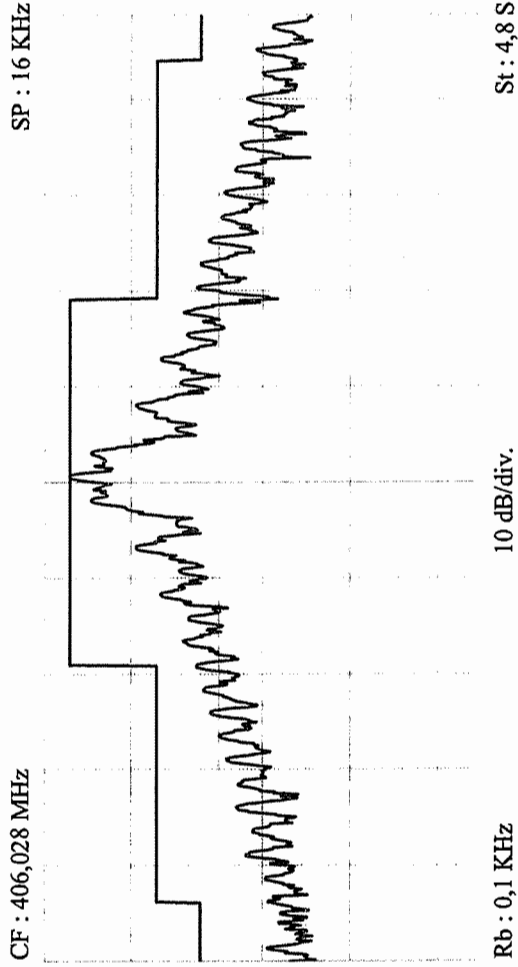

Standard Communications
 MT400
 C204 Rev2
 Certification nominale
 406 MHz
 55 °C

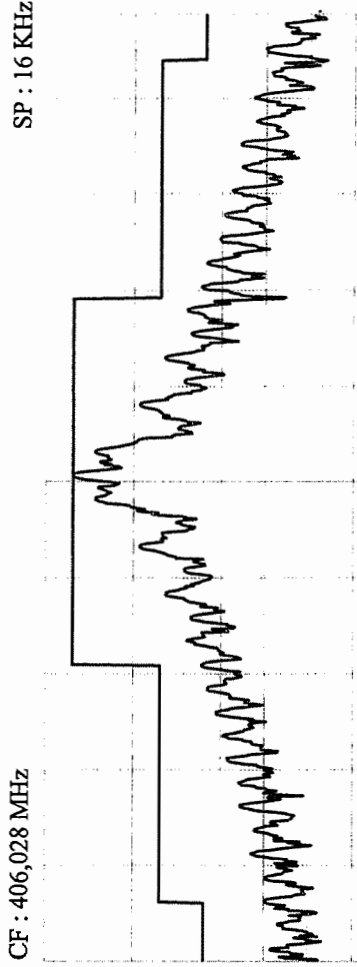

CF : 406,028 MHz

SP : 16 KHz

St : 4,8 S

10 dB/div.

Rb : 0,1 KHz

CF : 406,028 MHz

SP : 50 KHz

CF : 600 MHz

Delta : -43,7 dB

SP : 80000 KHz

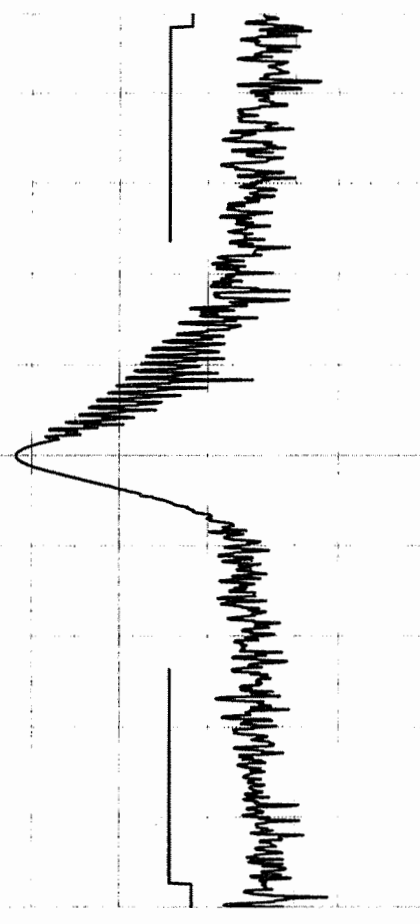

Rb : 1 KHz

10 dB/div.

St : 0,305 S

Rb : 100 KHz

10 dB/div.

St : 0,24 S

**406 MHz VSWR 3:1 TEST RESULTS ON
MT400 Rev 2 STANDARD COMMUNICATIONS PTY. LTD. EPIRB
N° MT0
at -20° C, 22° C and 55° C**

Certification Test VSWR at -20°C

Date of test : 16-oct-03

Manufacturer : Standard Communications

Beacon Type : MT400 Rev2

Number : MT0

Message

Message received		FFFE2F5F7703C4800000086FFE81
Format Flag	25	0
Protocol flag	26	1
Ident./Position code	27-85	BEEE07890000001
Country Code/Country	27-36	503 / AUSTRALIA
Protocol Code : U/Std-Nat	37-39/37-40	12
Protocol Code Used	37-39/37-40	
Identification Data	40-85/41-64/41-58	1E
Identification Used		::::::
Calculated BCH1	25-85	01BFFA
Readed BCH1	86-106	01BFFA
Homing	84-85	01
Em.cod/nat.use/supp.data	107-112	000000
Emer cod / Encod pos data	107	0
Activation type	108	0 Manual
Calculated BCH2	107-132	
Readed BCH2	147-144	
Latitude position		
Longitude position		
Delta position		

Electrical and other parameters

Rise time Modulation	ms		0,1497
Fall time Modulation	ms		0,1497
Phase deviation : positive	rd 1,00 <	< 1,20	1,05
Phase deviation : negative	rd -1,20 <	< -1,00	-1,12
Symmetry measurement	%	<=5 %	0,80
Nominal frequency : F2	Hz		406027942,43

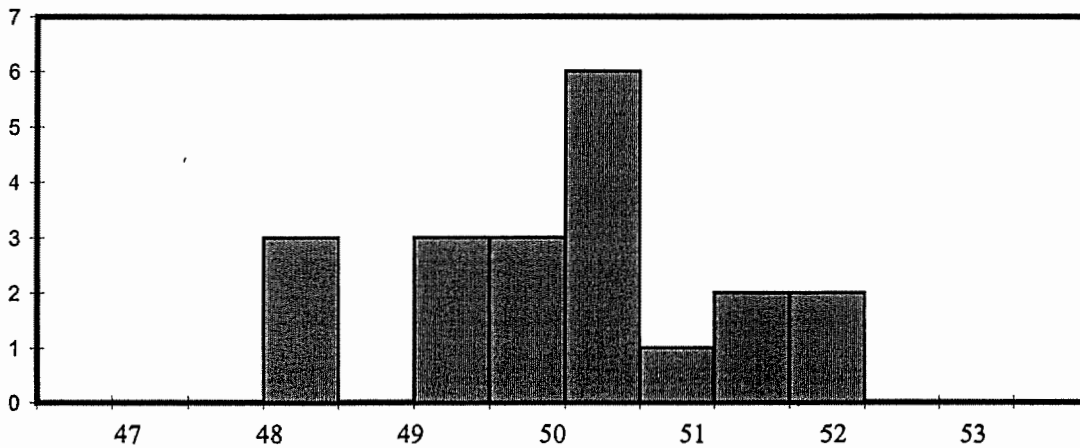

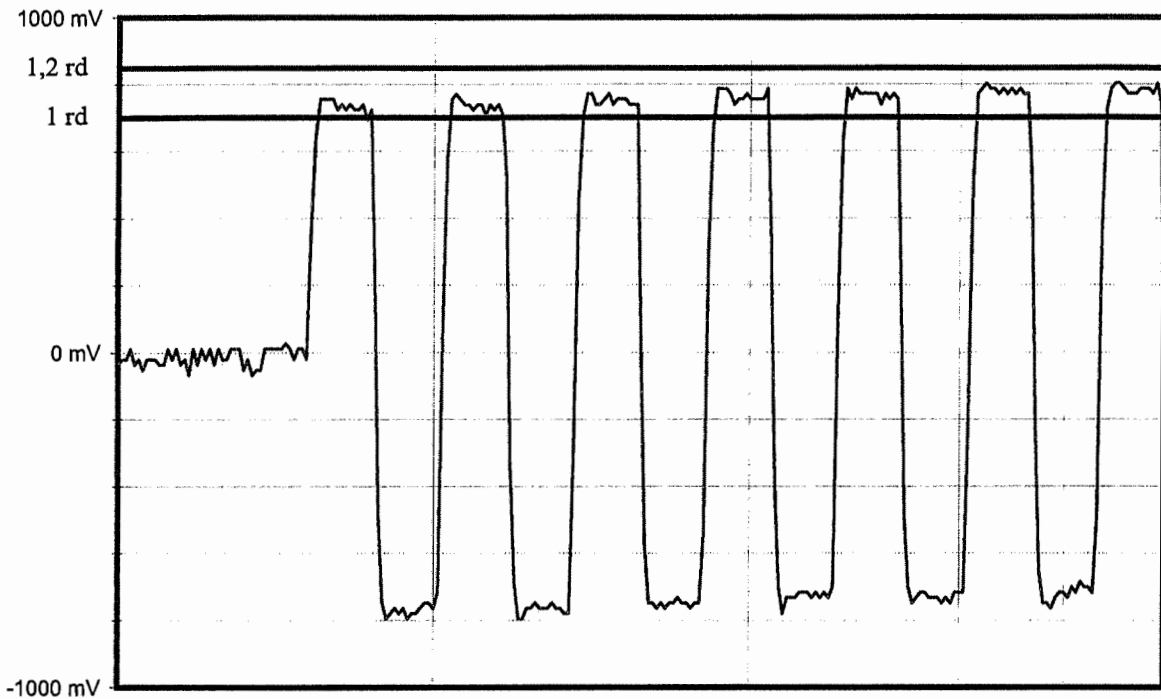

Vmarker1 850 mv ==> 1,2 rd
Vmarker2 700 mv ==> 1 rd

2 ms/div.

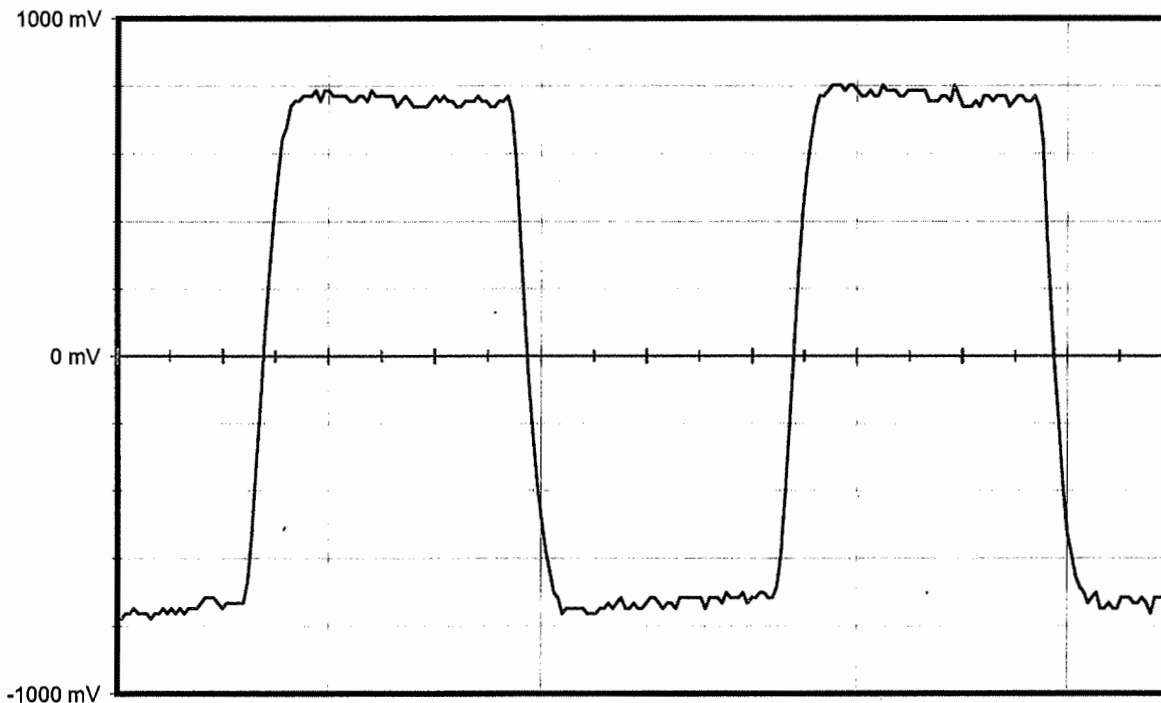

Duty Cycle : 0,008003976
falltime(1) <= 149,7 us
+width(1) 1,23752 ms

0,5 ms/div.
risetime(1) <= 149,701 us
-width(1) 1,25749 ms

Certification Test VSWR at 22°C

Date of test : 16 oct 2003

Manufacturer : Standard Communications

Beacon Type : MT400 Rev2

Number : MT0

Message

Message received		FFFE2F5F7703C480000086FFE82
Format Flag	25	0
Protocol flag	26	1
Ident./Position code	27-85	BEEE07890000001
Country Code/Country	27-36	503 / AUSTRALIA
Protocol Code : U/Std-Nat	37-39/37-40	13
Protocol Code Used	37-39/37-40	
Identification Data	40-85/41-64/41-58	1E
Identification Used		::::::
Calculated BCH1	25-85	01BFFA
Readed BCH1	86-106	01BFFA
Homing	84-85	01
Em.cod/nat.use/supp.data	107-112	000000
Emer cod / Encod pos data	107	0
Activation type	108	0 Manual
Calculated BCH2	107-132	
Readed BCH2	147-144	
Latitude position		
Longitude position		
Delta position		

Electrical and other parameters

Rise time Modulation	ms		0,1497
Fall time Modulation	ms		0,1397
Phase deviation : positive	rd 1,00 <	< 1,20	1,07
Phase deviation : negative	rd -1,20 <	< -1,00	-1,07
Symmetry measurement	%	<=5 %	1,21
Nominal frequency : F2	Hz		406027938,33

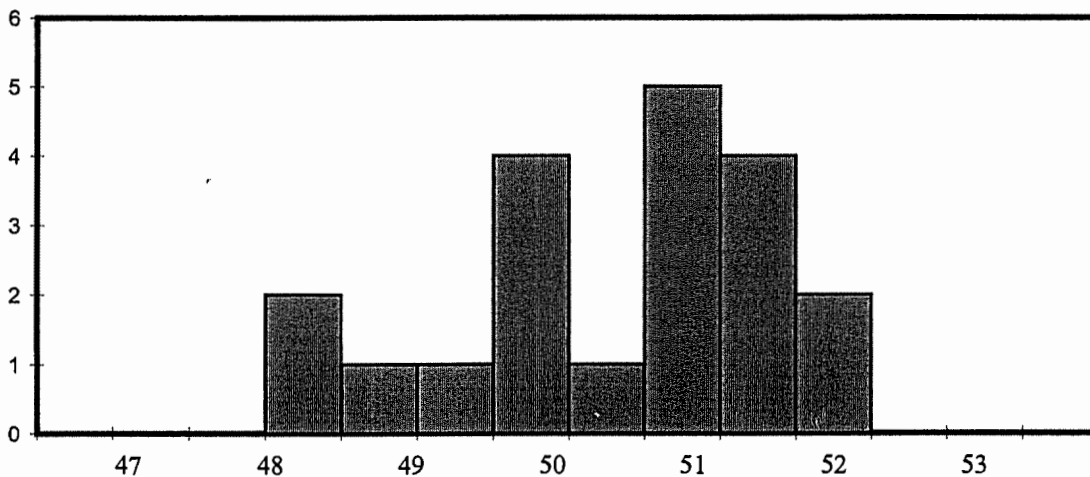

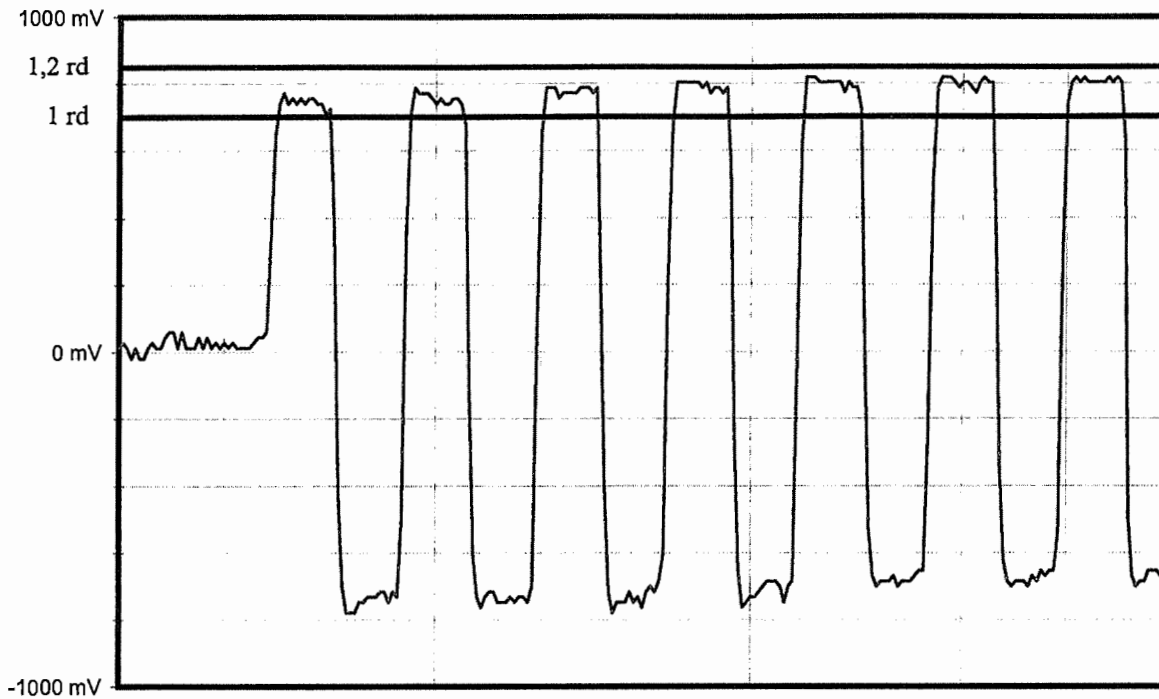

Vmarker1 850 mv ==> 1,2 rd 2 ms/div.
Vmarker2 700 mv ==> 1 rd

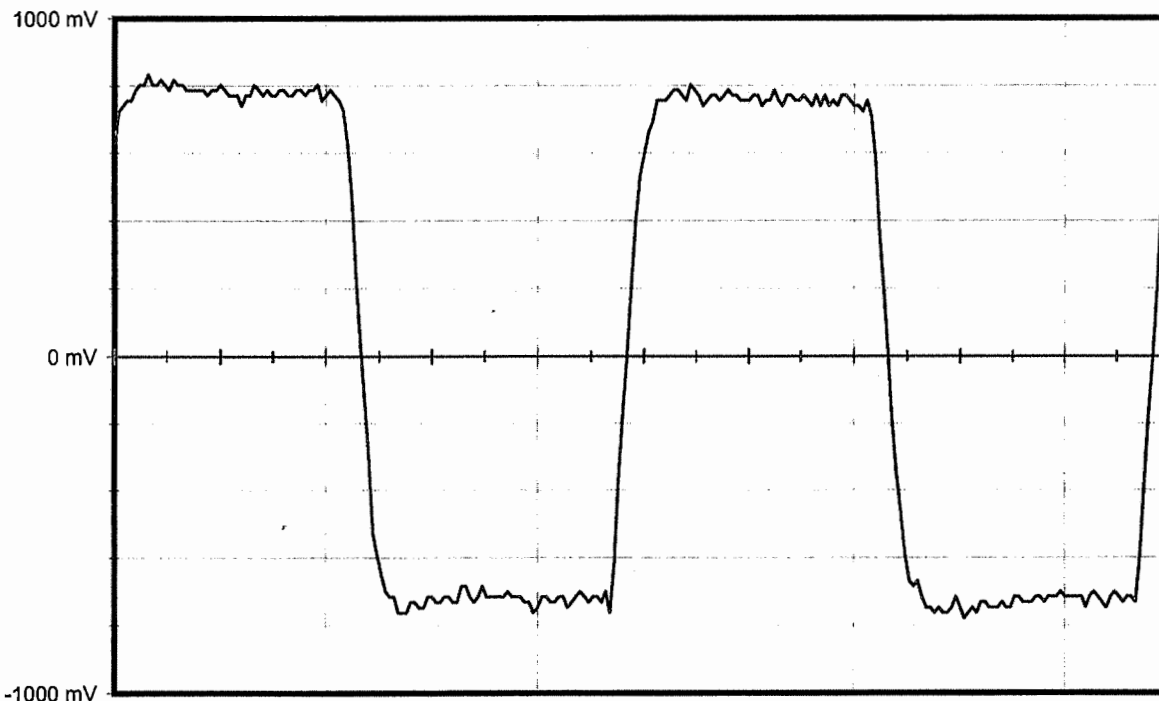

Duty Cycle : 0,012052168 0,5 ms/div.
falltime(1) <= 139,72 us risetime(1) <= 149,701 us
+width(1) 1,22754 ms -width(1) 1,25749 ms

Certification Test VSWR at 55°C

Date of test : 16 oct 2003

Manufacturer : Standard Communications

Beacon Type : MT400 Rev2

Number : MT0

Message

Message received		FFFE2F5F7703C4800000086FFE83
Format Flag	25	0
Protocol flag	26	1
Ident./Position code	27-85	BEEE07890000001
Country Code/Country	27-36	503 / AUSTRALIA
Protocol Code : U/Std-Nat	37-39/37-40	14
Protocol Code Used	37-39/37-40	
Identification Data	40-85/41-64/41-58	1E
Identification Used		::::::
Calculated BCH1	25-85	01BFFA
Readed BCH1	86-106	01BFFA
Homing	84-85	01
Em.cod/nat.use/supp.data	107-112	000000
Emer cod / Encod pos data	107	0
Activation type	108	0 Manual
Calculated BCH2	107-132	
Readed BCH2	147-144	
Latitude position		
Longitude position		
Delta position		

Electrical and other parameters

Rise time Modulation	ms		0,1597
Fall time Modulation	ms		0,1497
Phase deviation : positive	rd 1,00 <	< 1,20	1,07
Phase deviation : negative	rd -1,20 <	< -1,00	-1,10
Symmetry measurement	%	<=5 %	0,79
Nominal frequency : F2	Hz		406027940,88

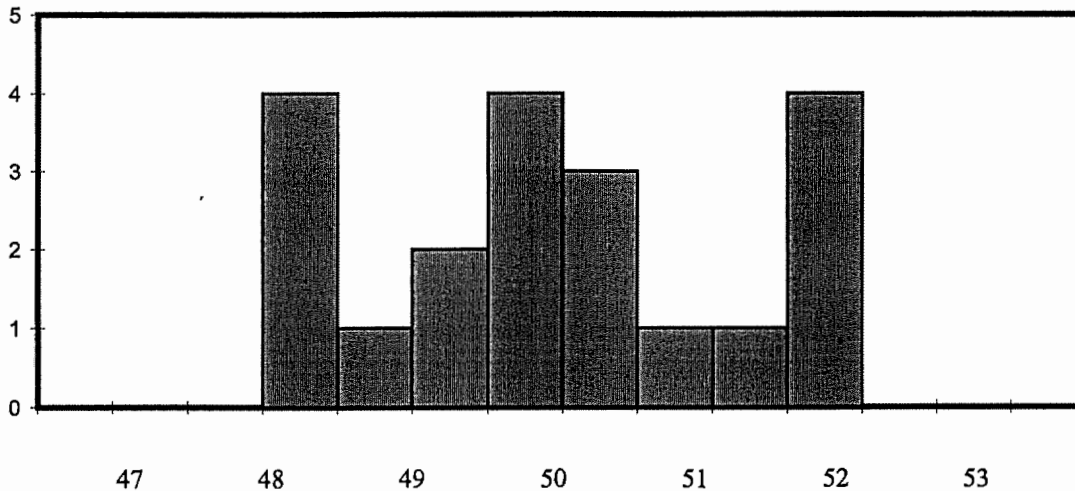

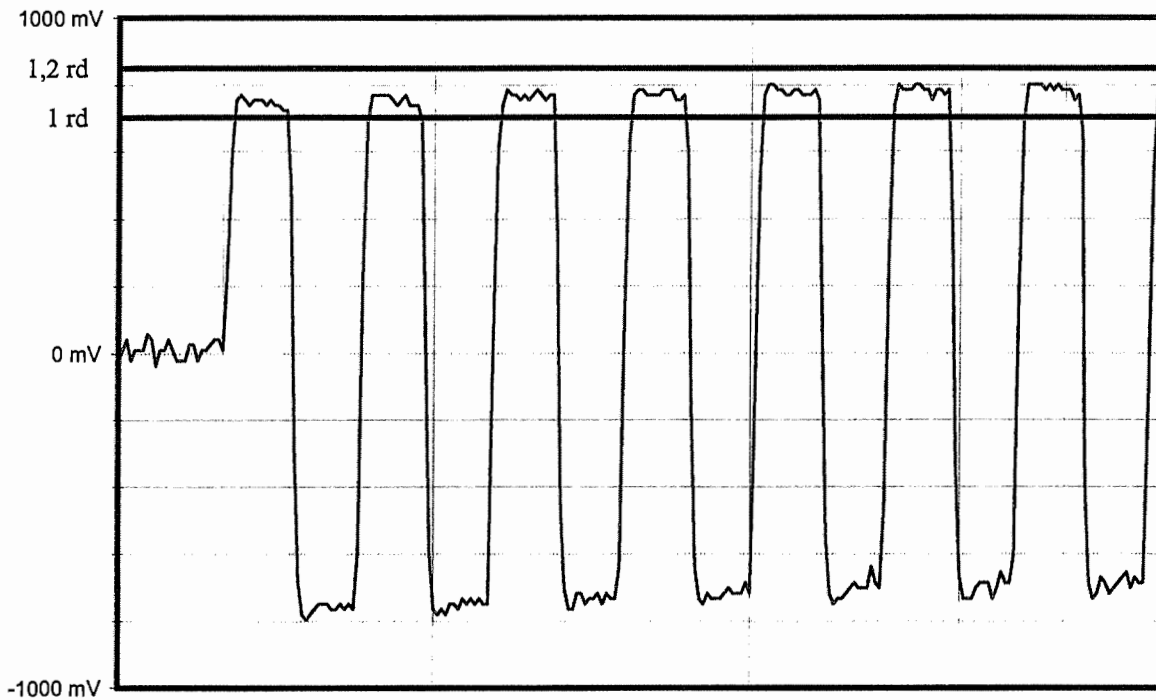

Vmarker1 850 mv ==> 1,2 rd
Vmarker2 700 mv ==> 1 rd

2 ms/div.

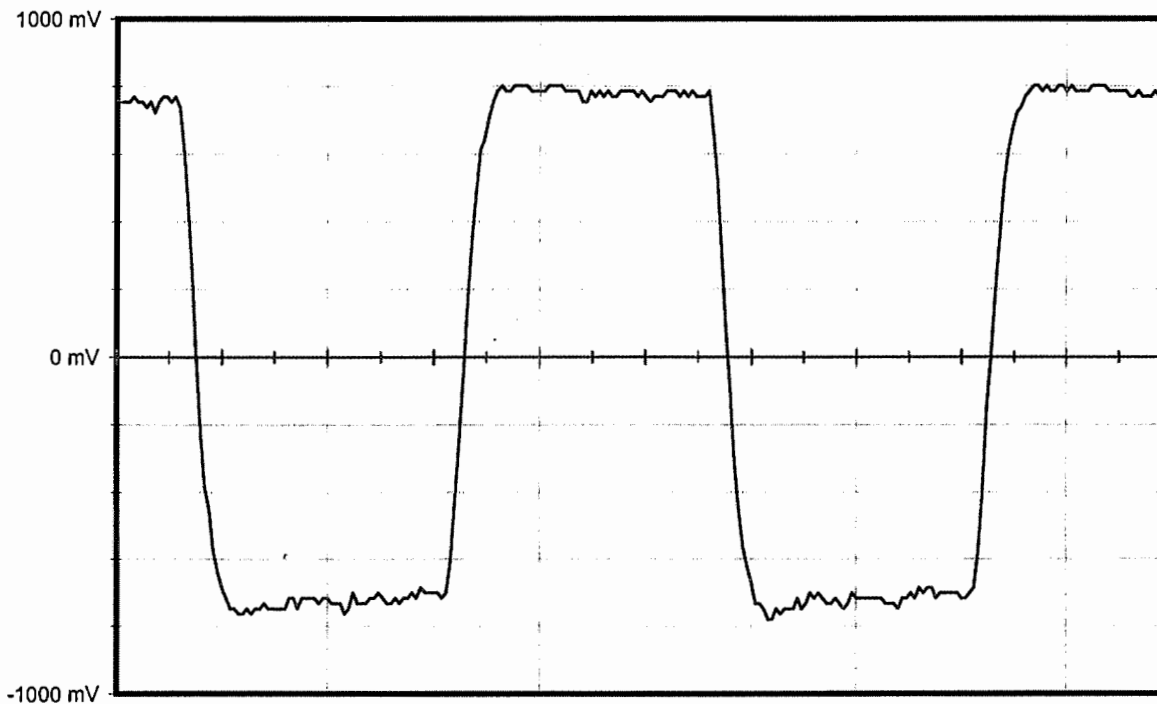

Duty Cycle : 0,007936508
falltime(1) <= 159,68 us
+width(1) 1,2475 ms

0,5 ms/div.
risetime(1) <= 149,701 us
-width(1) 1,26746 ms

CHAPTER 11

HOSE STREAM TEST

11.1. TEST SPECIFICATIONS AND PROGRAMME

Following :

- Section 6.9 of ETS 300-066;

- Install the unit consisting of satellite EPIRB (on ready position) and its release mechanism in the test bracket .
- Direct a stream from a hose at the EUT for a period of five minutes :
 - diameter of the nozzle = 63.5 mm,
 - water delivery rate \approx 2300 liters per minute,
 - the end of the nozzle is 3.5 m away from the EUT and 1.5 m above the base of antenna .
- During the test rotate the EPIRB unit so that water strikes the EUT from all directions over an arc of least 180°.
- Verify that the EUT don't release from its bracket, nor don't it automatically activate as a result of the water from the hose stream.

11.2. EQUIPMENT UNDER TEST

Beacon Unit : 2/3
Name : STANDARD COMMUNICATIONS
Type : MT400
Number : C203

Bracket : STANDARD COMMUNICATION MT400 Mounting Bracket

11.3. TEST SITE

INTESPACE Parking.

11.4. TEST EQUIPMENT

- Fire hydrant .
- Debitmeter .
- Mechanical support .
- Cospas/Sarsat Receiver : SERPE-IESM RMD01 S/N 004996
- Argos - Cospas/Sarsat Test Bench

11.5. TEST IMPLEMENTATION AND RESULTS

Date	Time	Operations	Comments
May 5 th , 2003	09:00	Test preparation	Water pressure = 630 kPa Nothing abnormal to note No automatic activation OK
	09:30	Start watering at about 2300 liters of water per minute. Rotation of satellite EPIRB (180°)	
	09:35	End watering .	
	09:45	Visual inspection :	
	09:45	Beacon with release mechanism cleaned and dried.	

See photos next pages

HOSE STREAM TEST



CHAPTER 12

CORROSION TEST

12.1. TEST SPECIFICATIONS AND SEQUENCE

Following :

- Section 6.5 of ETS 300-066 V1.3.1(2001-01) ;
- Section A1.6 of IEC 61097-2 (Second edition -09 2002) and
- Section 8.12 of EN 60945 (Fourth edition - 08 2002)

12.2. EQUIPMENT UNDER TEST

Beacon Unit : 3/3 (Case only)
Name : STANDARD COMMUNICATION
Type : MT400
Number : C223

Bracket : STANDARD COMMUNICATION MT400 Mounting Bracket

12.3. TEST SITE

Toulouse Space Center (C.S.T.) - INTESPACE Laboratory.

12.4. TEST EQUIPMENT

- Salt fog chamber SAPRATIN S /N : 229 (see photo next page),
- Salt solution : Mil-Std-810 D (July 19th, 1983), method 509.2,
- METLER TOLEDO Phmeter , Type : check mate 90 S/N : ITS 01 – Validity : October 2003,
- VAISALA thermo-hygrometer, Type : HM131 S/N : 133535 – Validity : Feb. 2004,
- KEITHLEY thermometer/multimeter ,Type : 2000, S/N 0678112 with CU-CT thermocoupler - Validity : June 2003,
- Argos - Cospas/Sarsat Test Bench.

CORROSION TEST



12.5. TEST RESULTS

12.5.1 Test implementation

Place : INTESPACE Laboratory

Date	Hour	Events - Observations
March 26 th , 2003	9h	Salt bath preparation ; warning up of the chamber
	11h	Beacon placed into the chamber
	12h	First salt fog injection 5% of NaCl) at 40 °C ± 2 °C for to 2 hours
	14h	Salt fog injection stoped and begining of first storage period at 40 °C ± 2 °C and 93 % ± 3 % of HR PH 7.0
	15h	Temp chamber : 38.1 °C - HR : 91.8 %
March 27 th , 2003	10h	Temp chamber : 38.5 °C - HR : 91.1 %
March 28 th , 2003	11h	Temp chamber : 38.8 °C - HR : 90.5 %
March 31 th , 2003	10h	Temp chamber : 38.3 °C - HR : 91.5 %
April 1 st , 2003	10h	Temp chamber : 38.9 °C - HR : 91 %
April 2 nd , 2003	12h 30	Second salt fog injection 5% of NaCl) at 40 °C ± 2 °C for 2 hours
	14h 30	Salt fog injection stopped and begining of the second storage period at 40 °C ± 2 °C and 93 % ± 3 % of HR PH 6.9
	15 h	Temp chamber : 38.5 °C - HR : 95 %
April 3 rd , 2003	11h	Temp chamber : 39.1 °C - HR : 92 %
April 4 th , 2003	16h	Temp chamber : 39.4 °C - HR : 91 %
April 7 th , 2003	9h	Temp chamber : 39.8 °C - HR : 90.1 %
April 8 th , 2003	14h	Temp chamber : 40.2 °C - HR : 91 %
April 9 th , 2003	11h 30	Third salt fog injection 5% of NaCl) at 40 °C ± 2 °C for 2 hours
	13h 30	Salt fog injection stopped and begining of the third storage period at 40 °C ± 2 °C and 93 % ± 3 % of HR PH 6.9
	14 h	Temp chamber : 39.8 °C - HR : 94 %
April 10 th , 2003	14h	Temp chamber : 39.9 °C - HR : 93 %
April 11 th , 2003	14h	Temp chamber : 40.1 °C - HR : 91 %

Date	Hour	Events - Observations
April 14 th , 2003	14h	Temp chamber : 40.2 °C - HR : 90.8 %
April 15 th , 2003	14h	Temp chamber : 40.2 °C - HR : 91 %
April 16 th , 2003	11h 30	Third salt fog injection 5% of NaCl) at 40 °C ± 2 °C for 2 hours
	13h 30	Salt fog injection stopped and beginning of the third storage period at 40 °C ± 2 °C and 93 % ± 3 % of HR PH 7.0
	15 h	Temp chamber : 40.1 °C - HR : 93 %
April 17 th , 2003	14h	Temp chamber : 40.2 °C - HR : 92.5 %
April 18 th , 2003	15h	Temp chamber : 40.0 °C - HR : 92 %
April 22 th , 2003	14h	Temp chamber : 40.2 °C - HR : 91.6 %
April 23 th , 2003	14h	Temp chamber : 40.3 °C - HR : 91 %
		End of corrosion test
		Visual Inspection at 22 °C : OK . Nothing abnormal to note

CHAPTER 13

<p>HOMING DEVICE TRANSMITTER TEST</p>

**13.1 - ELECTRICAL AND FUNCTIONAL TEST OF 121,5 MHZ
AT CONSTANT TEMPERATURE**

13.1.1 TEST SPECIFICATIONS AND PROGRAMME

Following Section 10.3 of ETS 300-066 :

- Perform following measurements.
- Carrier frequency
- Modulation frequency
- Transmitter duty cycle
- Sweep repetition rate
- Modulation duty cycle
- Modulation factor

Note : These tests are performed during the COSPAS-SARSAT Type Approval tests (chapter 10)

13.1.2 EQUIPMENT UNDER TEST

Beacon Unit : 2/3
Name : STANDARD COMMUNICATIONS
Type : MT400
Number : C203

13.1.3 TEST SITE

INTESPACE Laboratory.

13.1.4 TEST EQUIPMENT

- Climatic chamber : CLIMATS F.C.H. – Type: Austral 137H60/1,5E - S/N: S4880.
- Argos - Cospas/Sarsat Test Bench

13.1.5. RESULTS OF HOMING TRANSMITTER TESTS

Beacon Unit : 2/3
 Name : STANDARD COMMUNICATIONS
 Type : MT400
 Number : C203

		T min. - 20° C	T amb. 22° C	T max + 55° C
1 - OPERATING LIFETIME AT MINIMUM TEMPERATURE	48H	> 50 h		
2 - CARRIER FREQUENCY	* 121500 kHz± 5 kHz	121.50008	121.50112	121.50051
3 - PEAK ENVELOPE OUTPUT POWER (into 50 Ohms load)	** 14 dBm + 6/- 2 dBm	18.5 dBm	18.6 dBm	17.3 dBm
4 - TRANSMITTER DUTY CYCLE	continuous	Cont.	Cont.	Cont.
5 - MODULATION FREQUENCY	300 to 1 600 Hz	300 to 1360	300 to 1360	300 to 1360
6 - MODULATION DUTY CYCLE	33 % - 55 %	38 %	40 %	36 %
7 - MODULATION FACTOR	> 0.85	. > 0.85	> 0.85	> 0.85
8 - SWEEP REPETITION RATE	2 Hz - 4 Hz	2.7 Hz	2.7 Hz	2.7 Hz
9 - HOMING TRANSMISSION CODING	* Bits 84-85 = 01	01	01	01

* See data and graphs of results on chapter 10 " Cospas-Sarsat Type Approval Tests Report "

13.1.6. SPECTRUM MEASUREMENT RESULTS

STANDARD COMMUNICATIONS PTY. LTD.

MT400

C204

Certification nominale

121,5 MHz

-20 °C

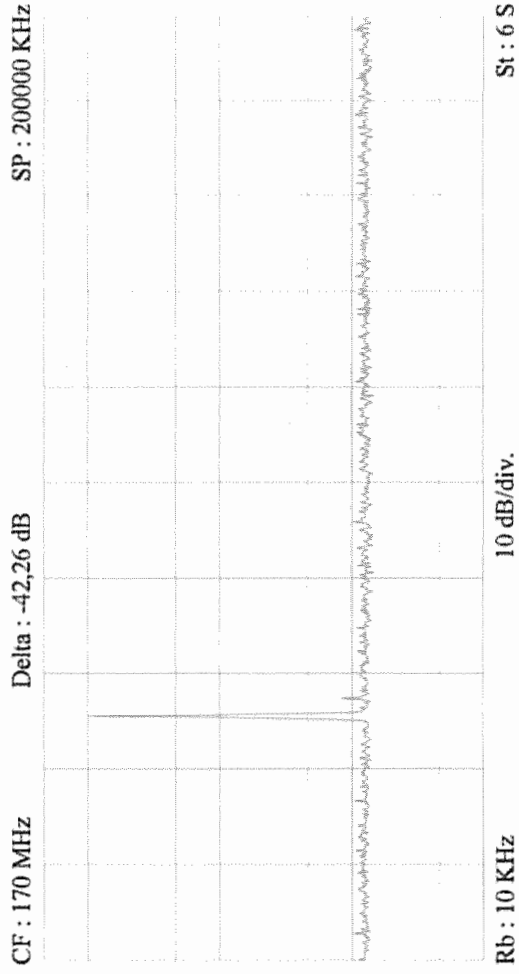
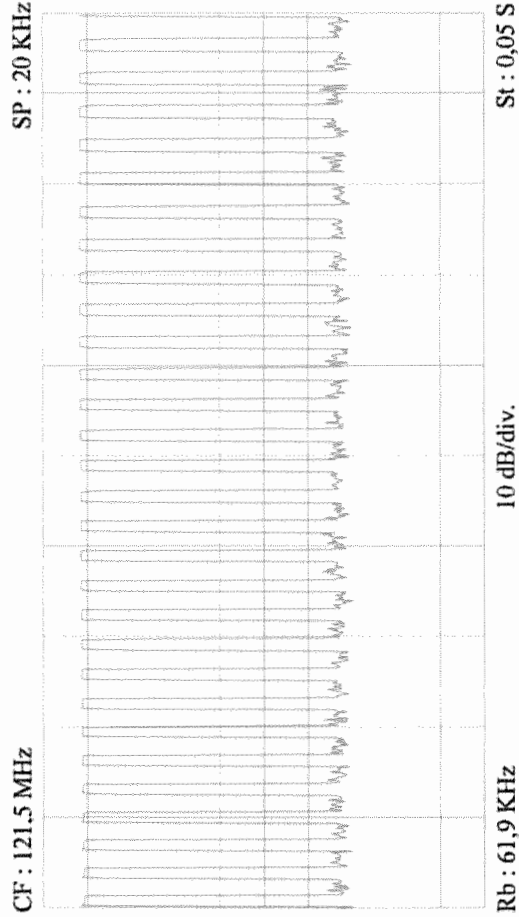
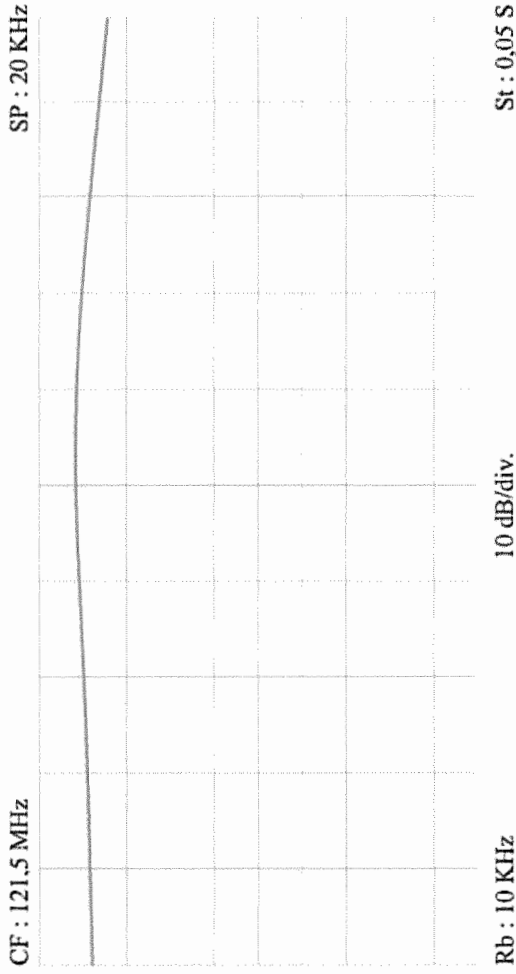

STANDARD COMMUNICATIONS PTY. LTD.

MT400

C204

Certification nominale

121,5 MHz

22 °C

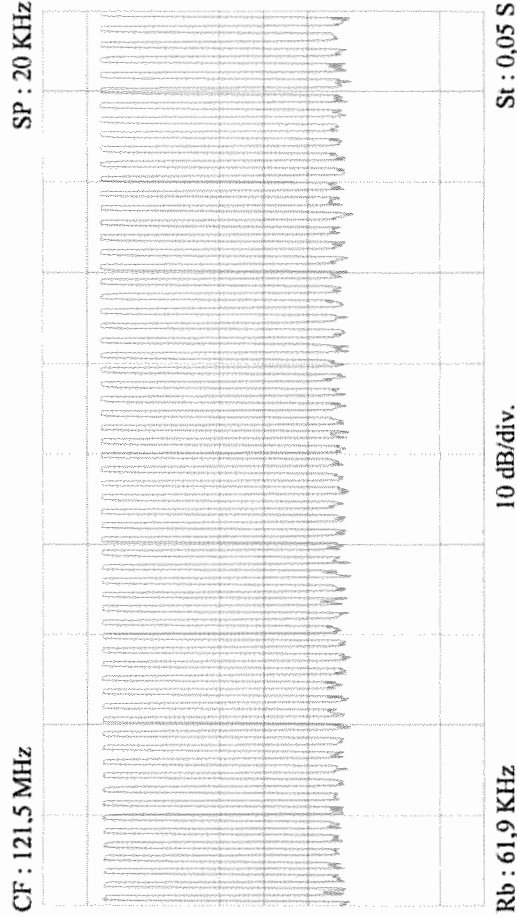
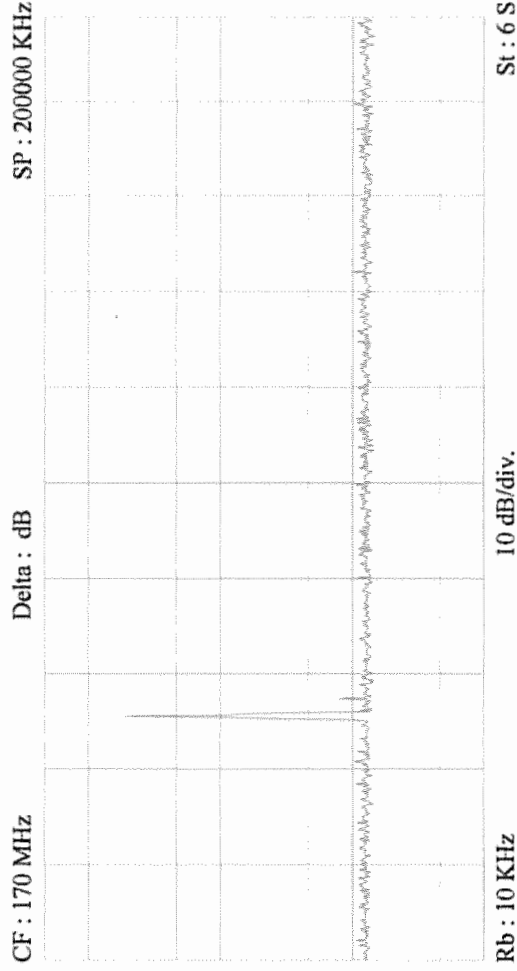
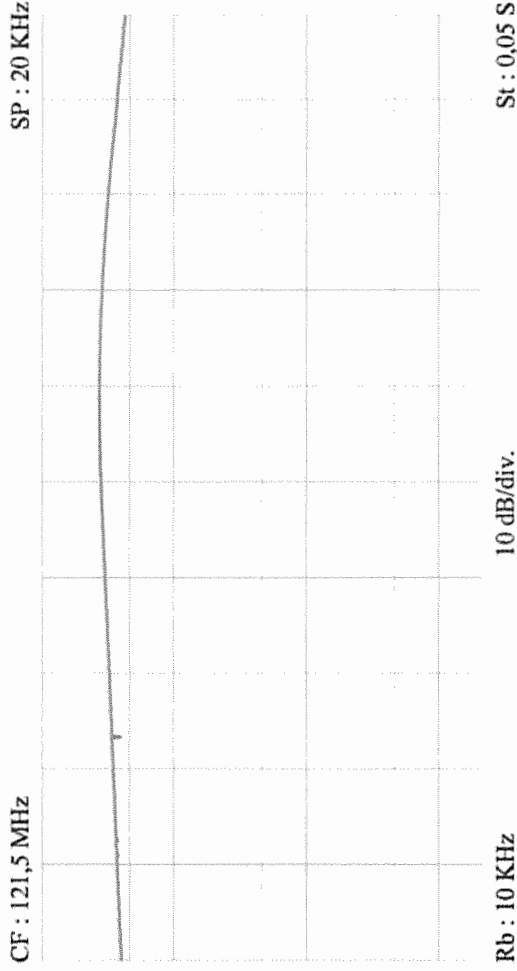

STANDARD COMMUNICATIONS PTY. LTD.

MT400

C204

Certification nominale

121,5 MHz

55 °C

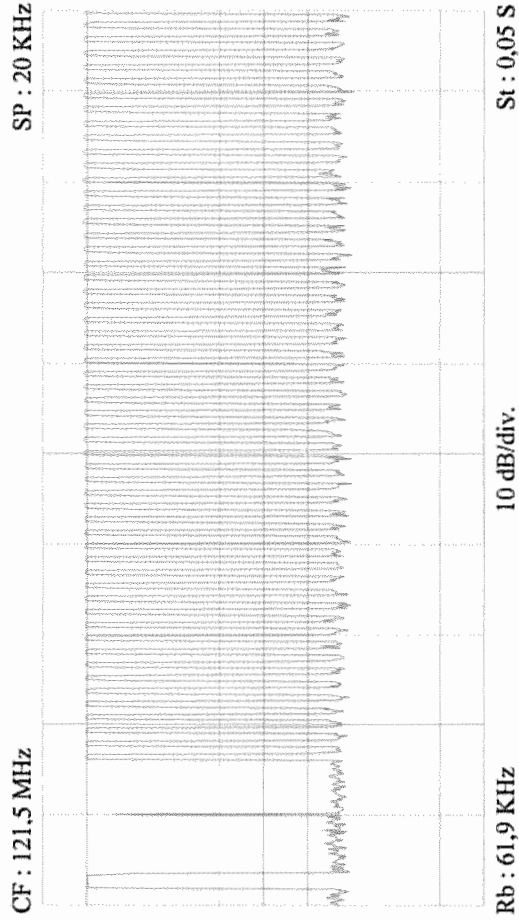
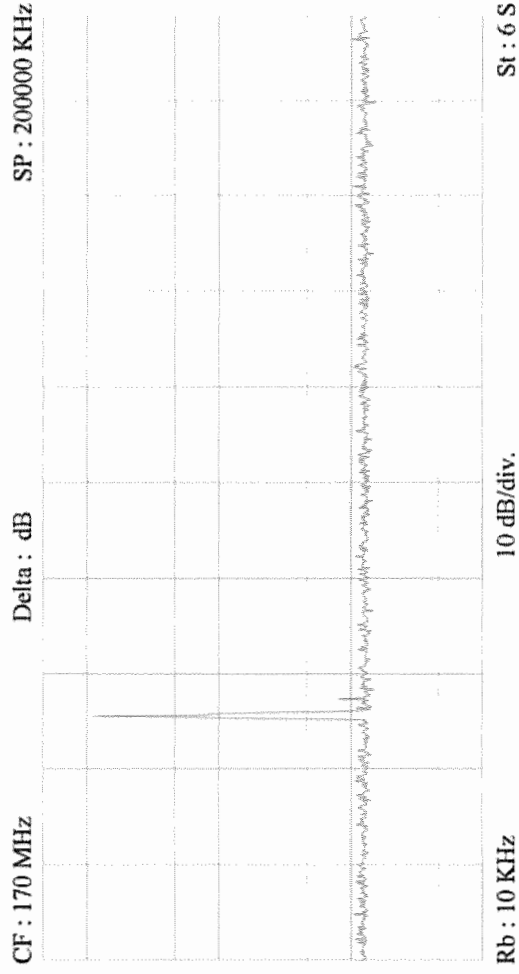
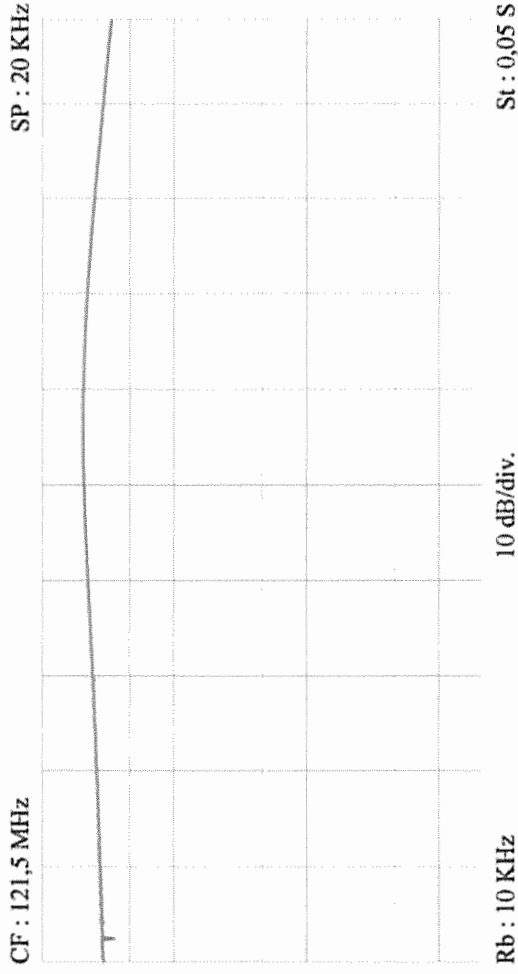

13.2- HOMING RADIATED OUTPUT POWER ON UUT 2/3

13.2.1 - ADMINISTRATION

13.2.1.1	WORK ORDER :	Reference: M4586-IEC & ETS
13.2.1.2	TEST TEAM :	A. COURTINADE (INTESPACE)
13.2.1.3	SCHEDULE :	March 27 th , 2003

13.2.2 - PURPOSE

The radiation tests of the dedicated radio beacon are performed in INTESPACE EMC Laboratory in compliance with the test methods described in Section 10.3.5 of ETS 300-066
Frequency tested : 121.5 MHz.

13.2.3 - RADIO BEACON IDENTIFICATIONS

- Manufacturer : Standard Communications
- Model N° : MT400
- Serial N° : C203
- Antenna : Standard Communications - P/N : 46A0427

13.2.4 - TEST SITE DESCRIPTION

Tests are performed in an anechoic chamber (size 16 m x 10 m x 11 m) .
Walls, ceiling and doors are lined with EMERSON CUMING foams VHP 36 and VHP 26 type.
The EPIRB is placed as shown on figures n° 1 and n° 2 next pages .

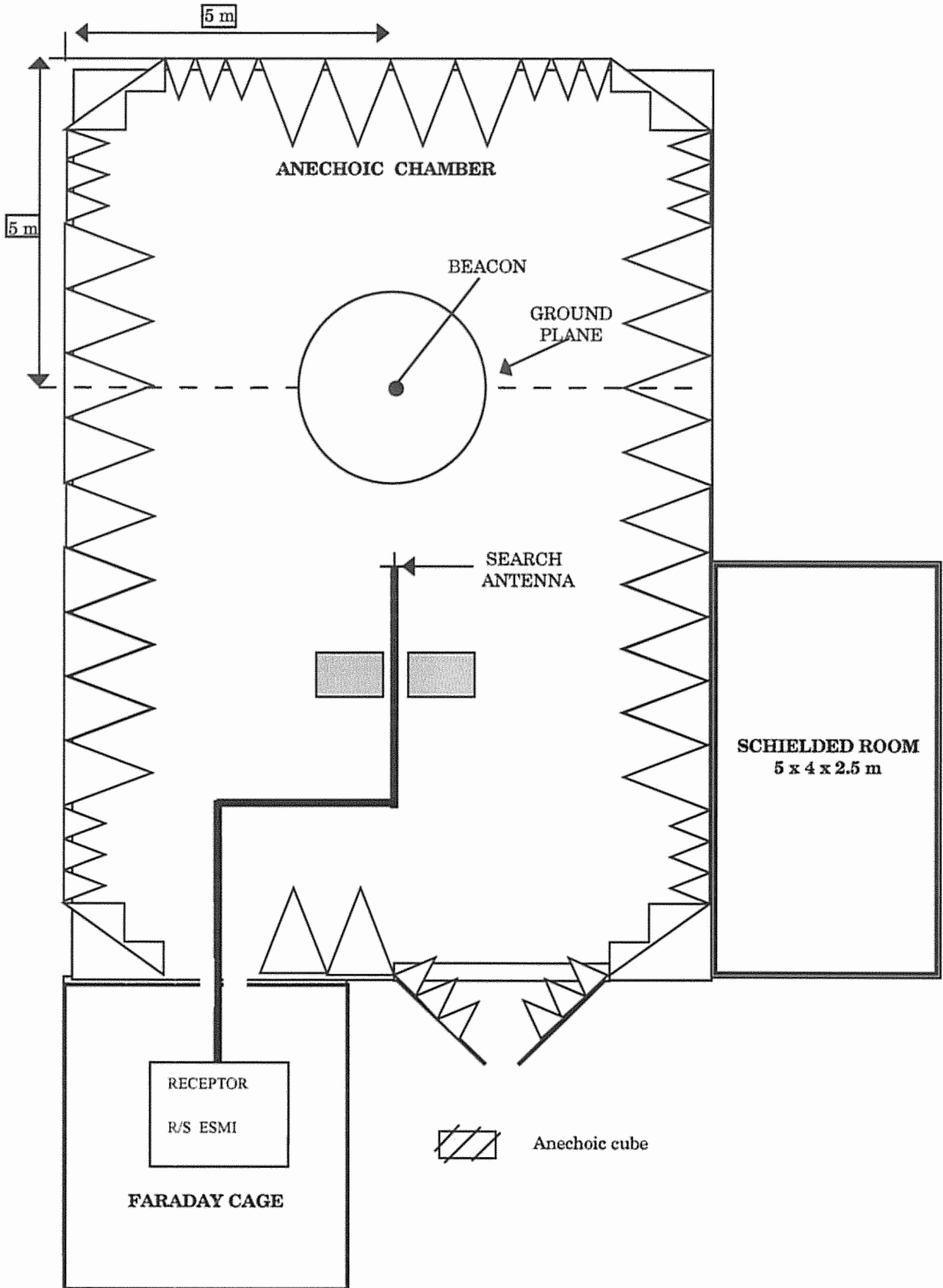

FIGURE 1

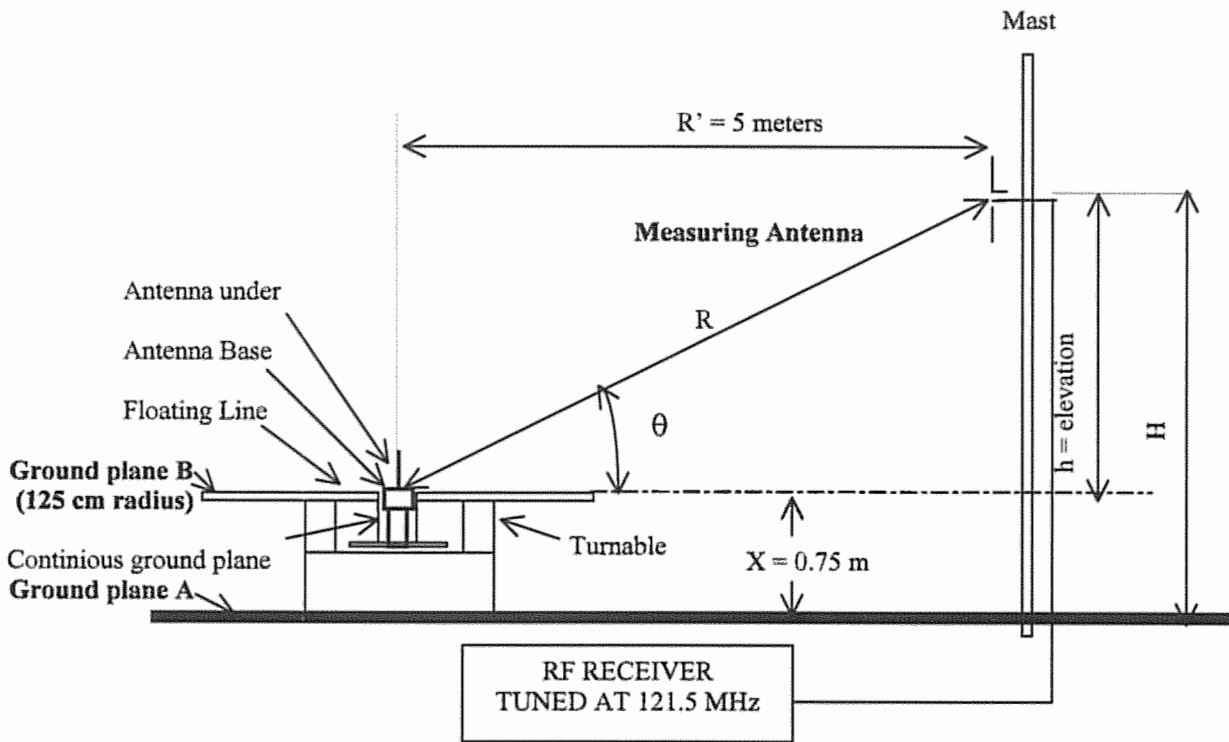

FIGURE 2 : Equipement Test Set Up For BEACON Antenna Test
(For BEACON designed for normal operation in water, ex: EPIRB)

13.2.5 - TEST METHOD

According Section 10.3.5 of ETS 300-066 following measurements are performed :

- 1/ The elevation angle between 5° and 20° which produces a maximum gain is determined with the EUT at an arbitrary azimuth .
- 2/ The PEP is measured and the elevation angle is noted (between 5° to 20°) and is remain fixed for the remainder of the test .
- 3/ The remaining 12 measurements of PERP is obtained by rotating the EUT in increments of 30° ± 3°. For each measurements the EUT PERP is computed using the following equation :

$$PERP = LOG^{-1} [(P_{REC} - G_{REC} + L_C + L_P)/10] \quad (\text{Equation A})$$

Where :

- P_{rec} = Measured Power level from spectrum analyzer (dBm)
- G_{rec} = Antenna gain of search antenna (dB)
- L_c = Receive system attenuator and cable loss (dB)
- L_p = Free space propagation loss (dB)

- 4/ The median value of PERP is compared to the specified PERP to be in the range 25 mW to 100 mW (14 dBm to 20 dBm)

13.2.6 - TEST MEASUREMENT EQUIPMENTS

Search Antenna

- 121.5 MHz test : EMCO Dipole - 3121 C – DB4 - S/N 763

SPECTRUM ANALYSER

- R/S ESMI

CABLES

- 20 m cable SUCOFLEX type 100 - cable loss at 121.5 MHz : 1.5 dB

13.2.7 - EPIRB MECHANICAL SET UP

EPIRB 0° axisq identified by the antenna position (see figure) is the rotation center of azimuth angle.

A conductive aluminium paper is used to assure a good conductivits between beacon float level and the ground plane.

BEACON

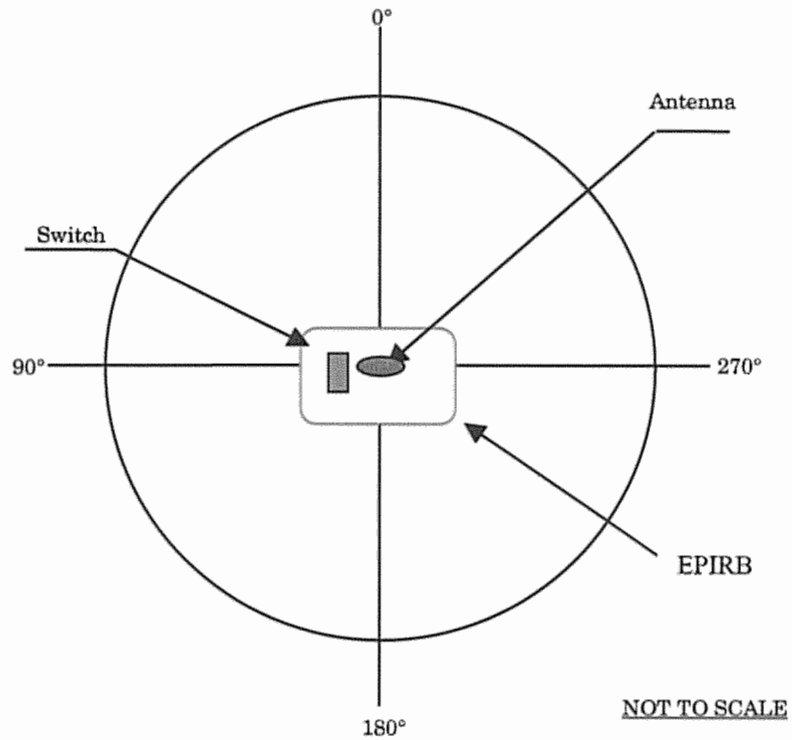

13.2.8- TESTS RESULTS

Following the Equation (A), 12 value of EUT PERP are computed at 15 ° (maximum level) of elevation angle

Azimut Angle	PERP (dBm)
0	16,16
30	15,50
60	16,50
90	16,16
120	16,16
150	16,00
130	15,50
210	15,00
240	16,16
270	16,00
300	16,16
330	16,16
Mean value	15,96 dBm

The PERP measured and computed are in conformance with specification required :

$$14 \text{ dBm} \leq \text{PERP} \leq 20 \text{ dBm}$$

and

$$\text{PERP Azimuth Variation} < 3 \text{ dB}$$



CHAPTER 14

BUOYANCY AND STABILITY TESTS

14.1. TEST SPECIFICATIONS AND SEQUENCE

Following :

- Section 6.10 of ETS 300-066 ;
- Section A2.3 of IEC 61097-2

The reserve buoyancy of the satellite EPIRB should be at least 5% when determined by one of the following methods of measurement :

1. The buoyant force shall be measured when the satellite EPIRB is totally submerged in fresh water .
The buoyant force shall be then divided by the measured gravity force .
- 2 . The buoyancy may be calculated by dividing the volume of the unit above the waterline by the total volume of the satellite EPIRB .

14.2. EQUIPMENT UNDER TEST

Beacon Unit : 2/3
Name : STANDARD COMMUNICATIONS
Type : MT400
Number : C203

14.3 TEST SITE

Toulouse, INTESPACE Metrology.Laboratory

14.4. TEST EQUIPMENT

- Fresh water container
- Balance : Sartorius type 3626 001
- Argos - Cospas/Sarsat Test Bench.

14.5 TEST IMPLEMENTATION AND RESULTS

Date: April 3rd, 2001

- Stability test :

When the EUT rotated to a horizontal position about any axis, is submerged just below the surface of calm fresh water, and is released, pass through an upright position within ~1 second .

The satellite EPIRB float upright in calm fresh water with the base of the antenna a minimum of 40 mm above the waterline

- Buoyancy test :

1 Buoyant Force method :

- Buoyant Force (Fb) = 150 gr ± 10
- Beacon Weight (W) = 535 gr ± 20
- Reserve of buoyancy (Fb/W) = 28 % ± 2

2 Volumetric method :

- Volume of EUT above waterline (Va) = 134 cm³ ± 10
- Total volume of EUT (Vt) = 568 cm³ ± 30
- Reserve of buoyancy (Va/Vt) = 24 % ± 2

CHAPTER 15

SOLAR RADIATION TEST

15.1 TEST SPECIFICATIONS AND PROGRAMME

Following :

- section 6.11 of ETS 300-066
- Section 8.10 of IEC 60945

- Expose the EUT in its bracket continuously to a simulated solar radiation source for 80 hours .

- Radiation intensity : $1120 \text{ W/m}^2 \pm 10 \%$

- At the conclusion of the test the self-test of the EPIRB is carried out

15.2. EQUIPMENT UNDER TEST

Beacon

Beacon Unit : 2/3
Name : STANDARD COMMUNICATIONS
Type : MT400
Number : C203
Class : II

Bracket : STANDARD COMMUNICATION MT400 Mounting Bracket

15.3. TEST SITE

Intespace Beacon Certification laboratory .

See photograph next page

15.4. TEST EQUIPMENT

- Solar simulator : Starlette (See spectral distribution at the end of its chapter).
- Thermopile : Medtherm AP/TH/01
- Thermo-hygrometer : COLE PARMER, Type : TriSense S/N : 37000-00
- Recorder : W+W Electronic Type 314 S/N 3582172
- Argos - Cospas/Sarsat Test Bench

15.5. RESULTS

15.5.1 Test implementation

Date	Hour	Operations	Results
April 7 th ,2003	08:05	The beacon, in the ready condition and in it bracket, is exposed to the solar radiation source at $1120 \text{ W/m}^2 \pm 10 \%$	
April 18 th ,2003	15 :20	End of solar radiation test	Total time irradiation = 80 hrs 45 mn
	16 :00	Aliveness test	OK

15.5.2 ALIVENESS TEST RESULTS AFTER SOLAR RADIATION TEST

Beacon Unit : 2/3
 Name : STANDARD COMMUNICATIONS
 Type : MT400
 Number : C203
 Date : April 18th,2003

1 - Environmental Temperature (° C)			+ 22° C
2 – POWER OUTPUT			
- Transmission power	dBm	37 ± 2	36.1
- Power risetime	ms	< 5	-
- Power falltime	ms	< 5	-
3 – SPURIOUS OUTPUT			
- In band	*		-
- Carrier harmonics			
4 –DIGITAL MESSAGE GENERATOR			
- Repetition rate			OK
- Bit rate	bits/S	400 ± 4	
- Transmission time	ms	$440 \pm 4.4 / 520 \pm 5.2$	OK
- CW preamble	ms	160 ± 1.6	
5 – DIGITAL MESSAGE			
- Bit and frame sync	bits	1-24	FFFE2F
- Format flag	bit	25	0
- Protocol flag	bit	26	1
- Country code	bits	27-36	0503
- Protocol	bits	37-39	111
- Homing	bits	84-85	01
- Activation type	bits	108	0
- BCH 1 code read / calculated	bits	86-106 / 25-85	070010 / 070010
- BCH 2 code read / calculated	bits	133-144 / 107-132	NA
6 – FREQUENCY			
- Nominal value	KHz	$406\,028 \pm 1$	OK
- Short term stability		$< 2 \times 10^{-9} / 100 \text{ ms}$	no measured

* See data next page

Date: 18 April 2005 . Message checked after Irradiation of Solar

OUT: 2/3

Standard Communications.

MT 400

S/N: 203.

Message balise

Message recu	(1-112):	FFED05F7F03C480000009C00400	Self test
Format flag	(25):	0	mode
Protocole flag	(26):	1	
Code pays	(27-36):	0503	
Pays	:		
Code protocole	(37-39):	111	
Protocole utilise	:	User - Test	
Identification code	(26-85):	BEFE07890000001	
Identification (Baudot)	(40-81):	:::::~	
Numero	:	1E	
BCH 1 lu/calculé	(86-106/25-85):	070010/070010	
Homing	(84-85):	01	
Activation type	(108):	Manual	
Position GPS de reference	:	N 43°33'34'' E 1°28'48	
Position GPS	:	No	

Message balise

Message recu	(1-112):	FFFE2F5F7F03C4800000009C00400	normal? protoca
Format flag	(25):	0	
Protocole flag	(26):	1	
Code pays	(27-36):	0503	
Pays	:		
Code protocole	(37-39):	111	
Protocole utilise	:	User - Test	
Identification code	(26-85):	BEFE07890000001	
Identification (Baudot)	(40-81):	:::::~	
Numero	:	1E	
BCH 1 lu/calculé	(86-106/25-85):	070010/070010	
Homing	(84-85):	01	
Activation type	(108):	Manual	
Position GPS de reference	:	N 43°33'34'' E 1°28'48	
Position GPS	:	No	

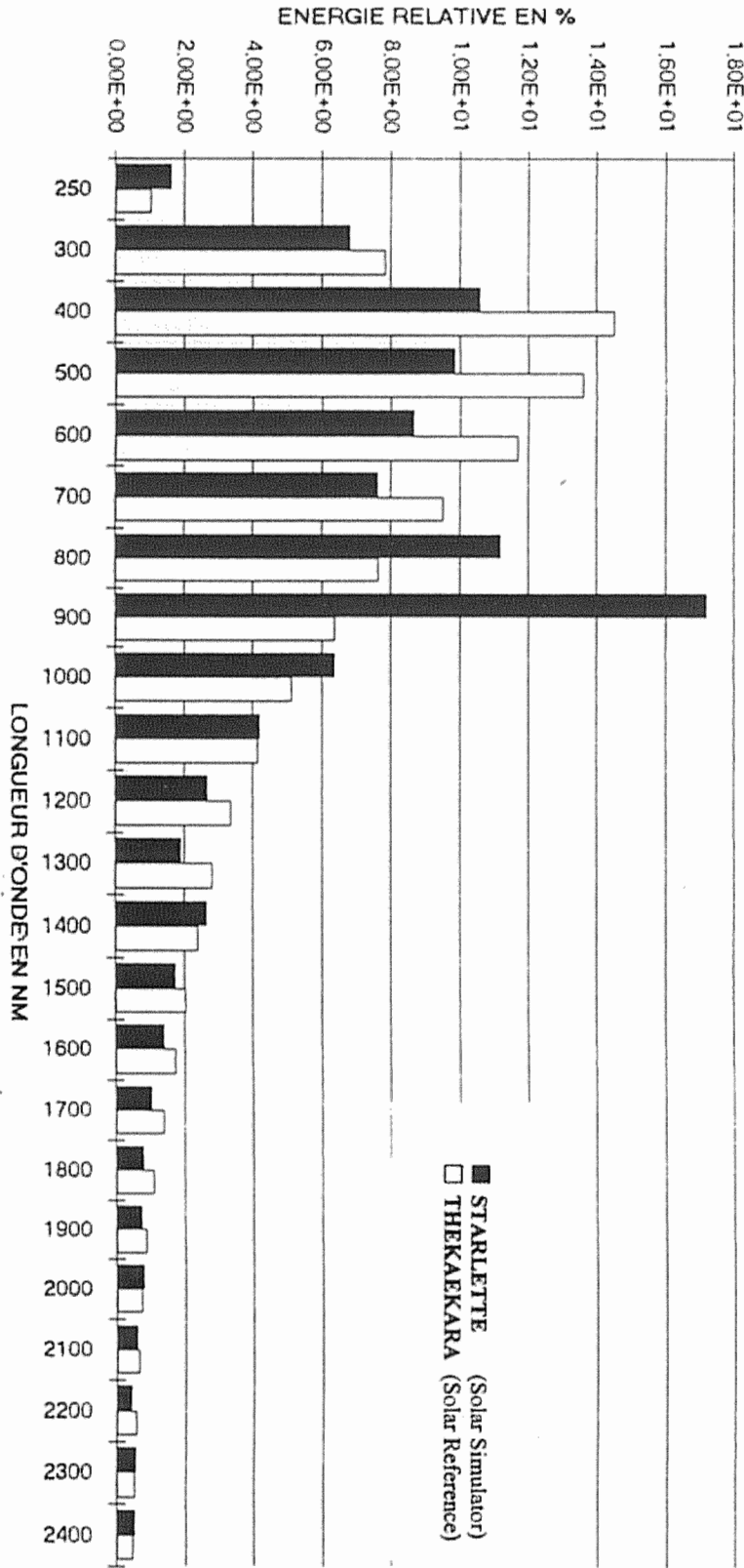

REPARTITION SPECTRALE D'ECLAIREMENT ENERGETIQUE

SOLAR RADIATION TEST



CHAPTER 16

OIL RESISTANCE TEST

16.1 TEST SPECIFICATIONS AND PROGRAMME

Following :

- Section 6.12 of ETS 300-066 and
- Section 8.11 of IEC 60945

- Immerse horizontally the EUT for a period of 24 hours under a 100 mm head of mineral oil as specified below at room temperature .
- Aniline point : 120 °C
- Flash point : 240 °C
- Viscosity: 10 - 25 cST at 99 °C

- At the conclusion of the test the self-test of the EPIRB is carried out . The EUT is cleaned in accordance with manufacturer's instructions .

16.2. EQUIPMENT UNDER TEST

Beacon

Beacon Unit : 3/3
Name : STANDARD COMMUNICATIONS
Type : MT400
Number : C223
Class : II

16.3. TEST SITE

Intespace Beacon Certification laboratory .

See photograph next page

16.4. TEST EQUIPMENT

- Mineral oil: Unil Opal Fluid M320 :
 - Aniline point: 116 °C
 - Flash point: 280 °C
 - Viscosity: 24 cST at 100 °C

- Argos - Cospas/Sarsat Test Bench

16.5. RESULTS

Date	Hour	Operations	Results
May 7 th ,2003	17:00	The beacon, in the ready condition and in it bracket, immersed in 20 liters of mineral oil	
May 16 th ,2003	8:00	End of oil resistance test .	≈ 89 hours of oil immersion
	9:15	Self-test operation on EPIRB	OK
	9:45	EUT cleaned and dried with RBS (soap) and water	Nothing abnormal to note

OIL RESISTANCE TEST



CHAPTER 17

COMPASS SAFE DISTANCE TEST

17.1 TEST SPECIFICATIONS AND PROGRAMME

Following :

- Section A2.6 of IEC 61097-2 (Second edition –09 2002) ;
 - Section 11.2 of EN 60945 (Fourth edition - 08 2002) and
 - PO 1013/AP/QA-f Intespace Procedure
- 1) Measure 'T' the magnetic earth field in the earth field compensation area
 - 2) Compute the maximum compass deviation : $D_{max} = 5,4 \text{ }^\circ / T (\mu\text{Tesla})$
 - 3) Put EUT on the wood bracket in the no compensated magnetic earth field area . Approach it slowly near to the reference compass . Note the distance 'Lnc' that occur the Dmax deviation, on the reference compass .
 - 4) Repeat 3) in the compensated magnetic eath field area and note the distance 'Lc' that occur the Dmax deviation, on the reference compass

17.2. EQUIPMENT UNDER TEST

Beacon

Beacon Unit : 2/3
Name : STANDARD COMMUNICATIONS
Type : MT400
Number : C203
Class : II

17.3. TEST SITE

CNES/Intespace amagnetic chamber
ITS Beacon Certification laboratory .

See photograph next page

17.4. TEST EQUIPMENT

- Compensated magnetic earth field area
- Magnetometer reference : Institut Dr FORSTER REUTLINGEN - Model : 1.107 – S/N : 81.11-824
- Reference Compass
- Argos - Cospas/Sarsat Test Bench

17.5. RESULTS

Date	Hour	Operations	Results
April 2 th ,2003	09:00	Magnetic earth field = 24 μ T \rightarrow Max compass deviation	Dmax = 0,22 °
	09 :30	Compass safe distance measured in none compensated earth field with (Dmax = 0,22 °) :	Lnc = 12 cm
	10 :00	Compass safe distance measured in compensated earth field with (Dmax = 1 °) :	Lc = 12 cm

COMPASS SAFE DISTANCE TEST



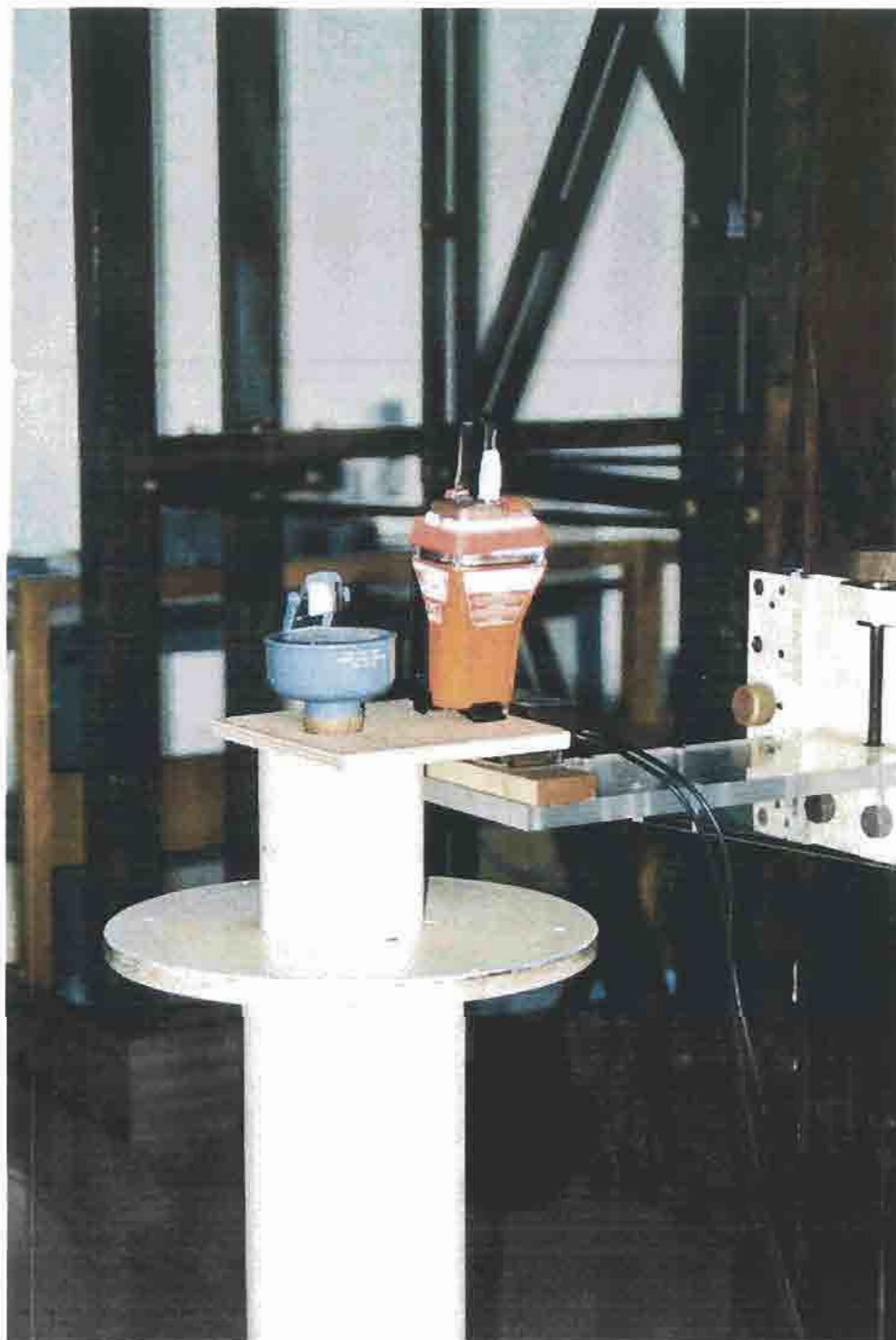

CHAPTER 18

RADIATED RF IMMUNITY TEST

18.1 TEST SPECIFICATIONS AND PROGRAMME

Following IEC 1000-4-3 (Clause 10.4 of IEC 60945):

Severity level : 3 (following IEC 1000-4-3) = 10 V/m.

Calibration at 6 V/m.

Calculation of the offset :

offset = $20 \log (10/6) = 4,44 \text{ dB}$.

Suceptibility criteria :

The test was run with EPIRB in Ready position without its bracket .

During the test the Epirb was tended with video camera if it was running (flash).

Only the accessible faces of Epirb was tested .

Note : This test is more restricting than the IEC specification because the EPIRB is normally protected by its bracket

18.2 EQUIPMENT UNDER TEST

Beacon Unit : b2

Name : Standard Communications Pty Ltd

Type : MT400

Number : 011

18.3. DATES :

RS Test start on : November 27th, 2003

RS End of test : November 27th, 2003

18.4 TEST SITE

INTESPACE Laboratory.
Hight Field Anechoic Chamber
(See photo next page)

18.5 TEST EQUIPMENT

Generator :

Name & SN	Frequency Range	Last calibration date
HP8340	1GHz-18GHz	2003
RS SMG	100kHz-1GHz	2003

Amplificator :

Name & SN	Frequency Range	Last calibration date
AR 2000L	10kHz-220MHz	2003
AR 1000HA	220MHz-400MHz	2003
KALMUS LA500UE	400MHz-500MHz	2003
KALMUS 722FC	500MHz-1GHz	2003

Field sensor :

Name & SN	Frequency Range	Last calibration date
HOLADAY 3004	30MHz-1GHz	2003
HOLADAY Hi 3113	30MHz-1GHz	2003

Power meter :

Name & SN	Frequency Range	Last calibration date
NAP+sonde 350W	25MHz-1GHz	2003
HP438+sonde8482A	100kHz-4,2GHz	2003

Coupleur :

Name & SN	Frequency Range	Last calibration date
AR DC2000 NS1715		2003

Antenna :

Name & SN	Frequency Range	Last calibration date
Biconique 3109 NS2068	30MHz-200MHz	2003
LOG PER R&S HUF-Z3	200MHz-1GHz	2003

18.6 RESULTS

Measurements curves are given in annex of this chapter

TEST NUMBER			
Frequency Range	Antenna	Front Face	
		PH	PV
80 MHz-200MHz	Biconic	490	489
200MHz-1000MHz	Log Périodique	491	492
1GHz-2GHz	Log Périodique	494	493

No susceptibility were detected on the equipment.

18.7 SELF TEST CONTROL

Nothing abnormal to note . See hereafter the beacon self test message checked after test

Logiciel ARGOS/SARSAT vers. 3.0 Octobre 2001 Ref. balise : M4586-2 (Sarsat)
Tests de contrôle (406.028 MHz) Lecture Message N°: 1

```

Message reçu          (1-112): FFFED05F7703C4800000086FFE00
Format flag          (25): 0
Protocole flag       (26): 1
Code pays            (27-36): 0503
Pays                 :
Code protocole       (37-39): 011
Protocole utilise    : User - Serialized user
Identification code   (26-85): BEEE07890000001
Identification (Baudot) (40-81): :::::
Numero              : 1E
BCH 1 lu/calculé    (86-106/25-85): 01BFFA/01BFFA
Homing              (84-85): 01
Activation type      (108): Manual
Position GPS de référence lab : N 43°33'34'' E 1°28'48
Position GPS         : No
    
```



ANNEX

IDENTIFICATION DE L'ESSAI :

Société : INTESPACE

Date de fin de l'essai : 27/11/03 15:40:17

Opérateur : R. BERGE

IDENTIFICATION DE L'EQUIPEMENT TESTE :

Nom commercial : Radio balise GME MT400

Nom du modèle et numéro de type : MT400 S/N 011

Numéro de série ou identification : 011

Mode(s) de fonctionnement :

Modifications apportées :

Description
complémentaire :**CONDITIONS D'ESSAIS :**

Température : 22 °

Hygrométrie : 45 %

Pression : 1005 hPa

REFERENCES :

Spécification Essai : Aucune

Commentaire :

Procédure Essai : NF EN 61000-4.3

Commentaire :

Consigne / perturbation

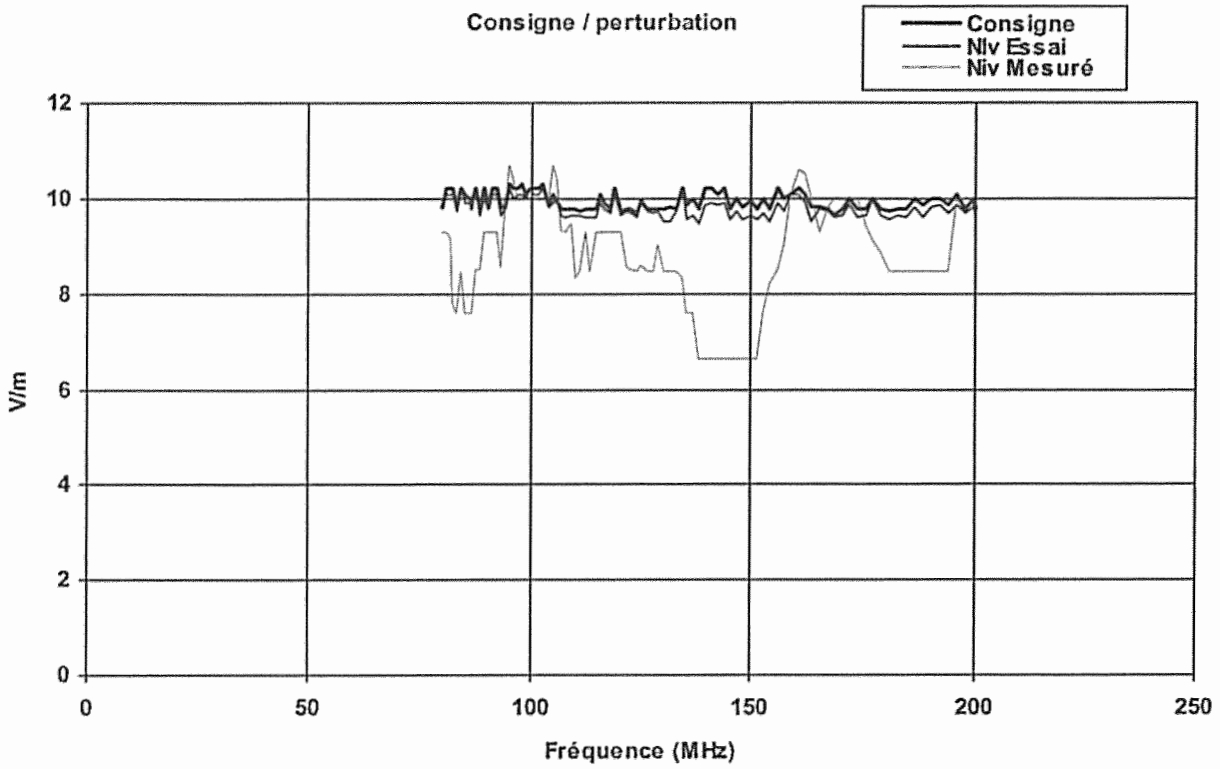

Défauts

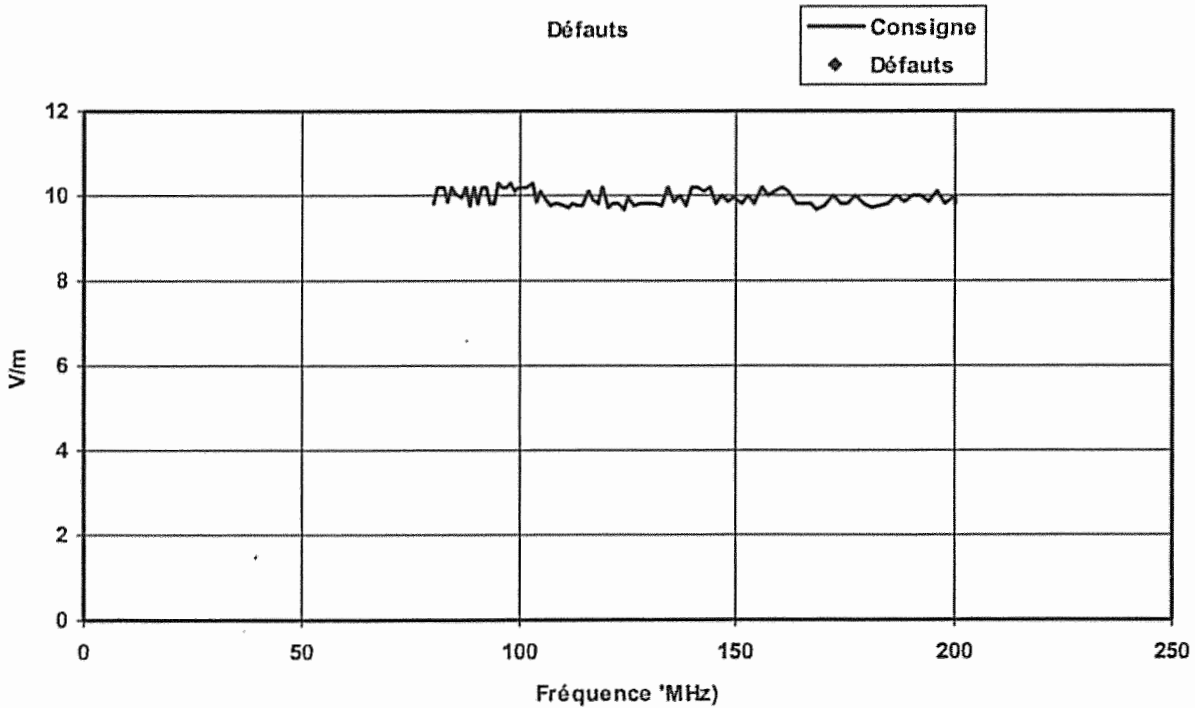

PH

Consigne / perturbation

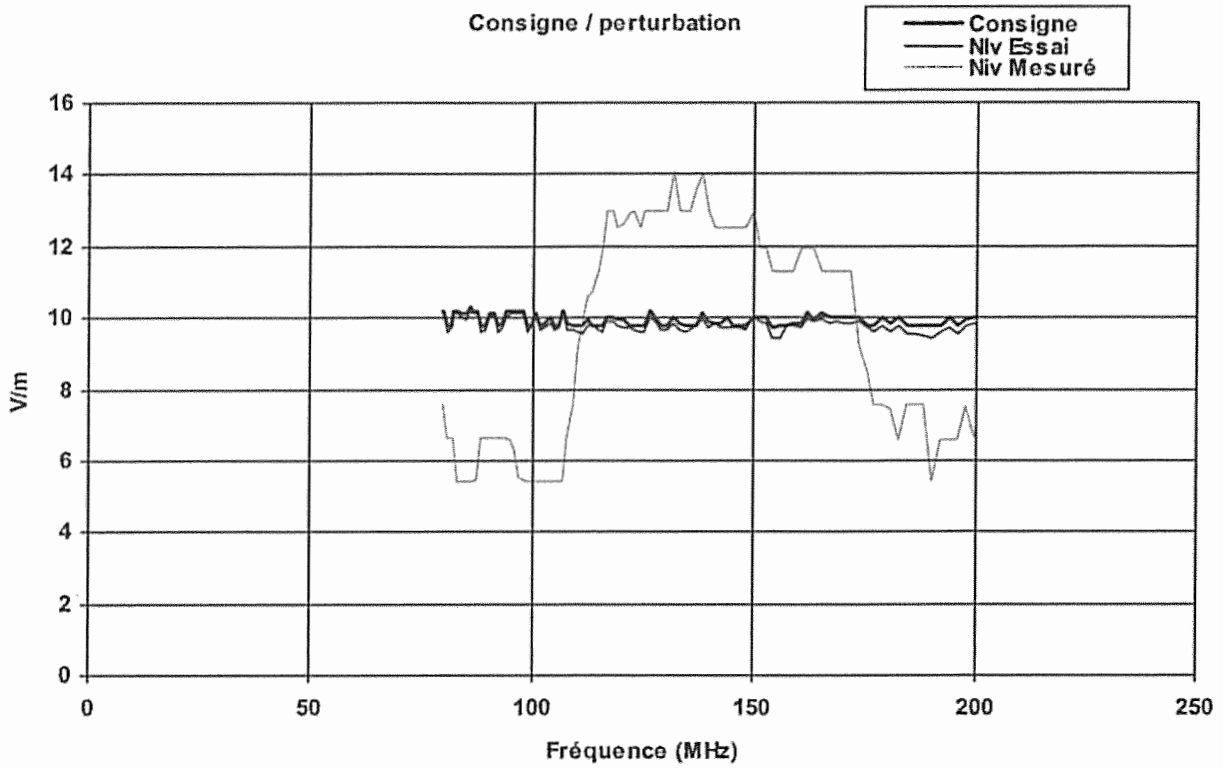

Défauts

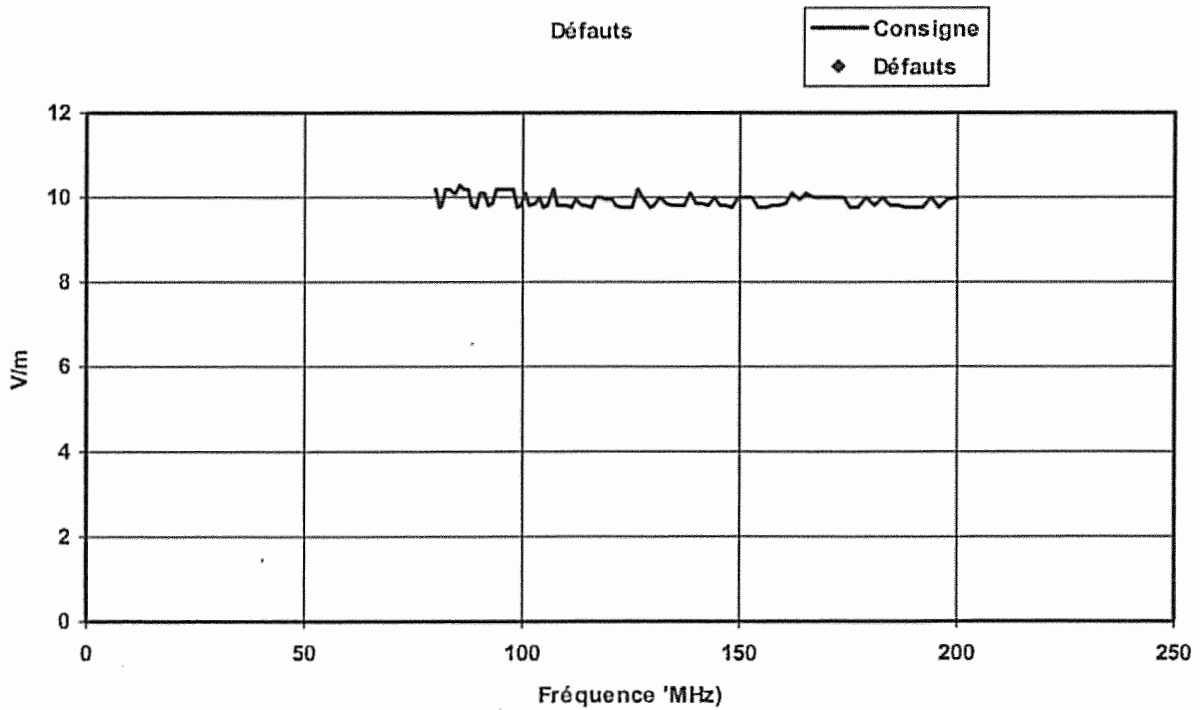

Consigne / perturbation

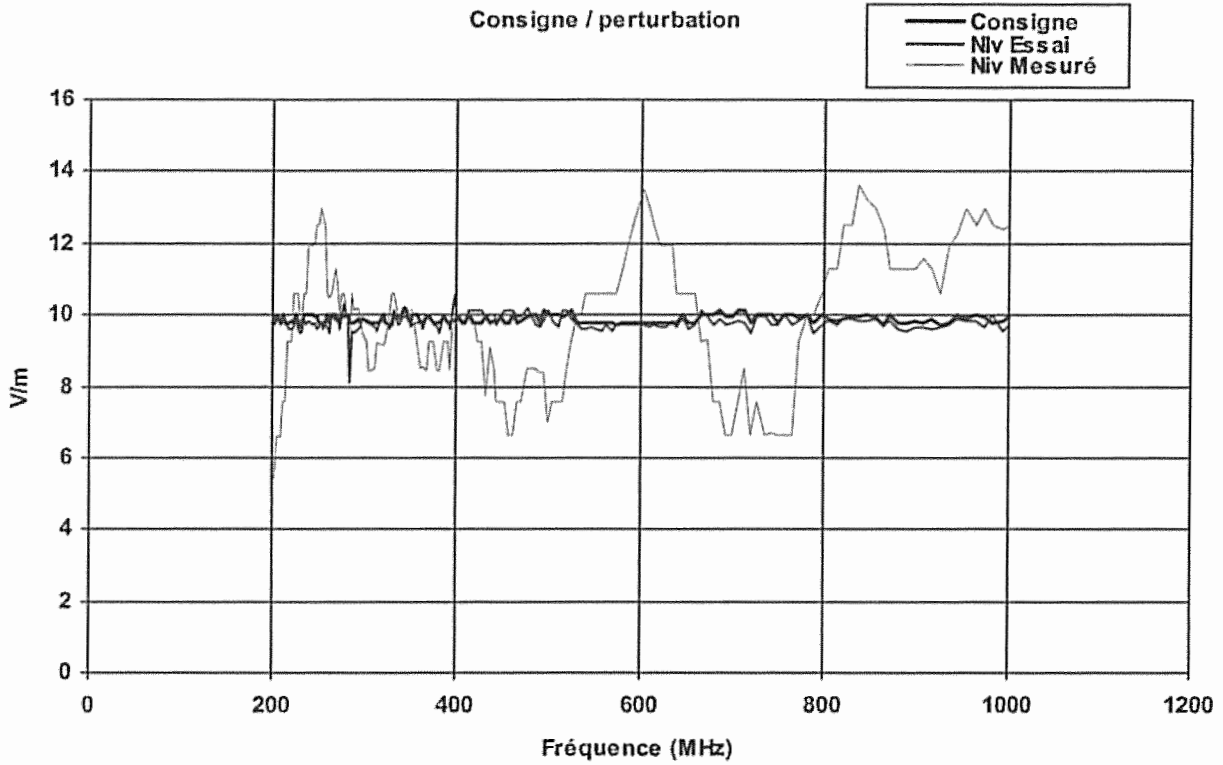

Défauts

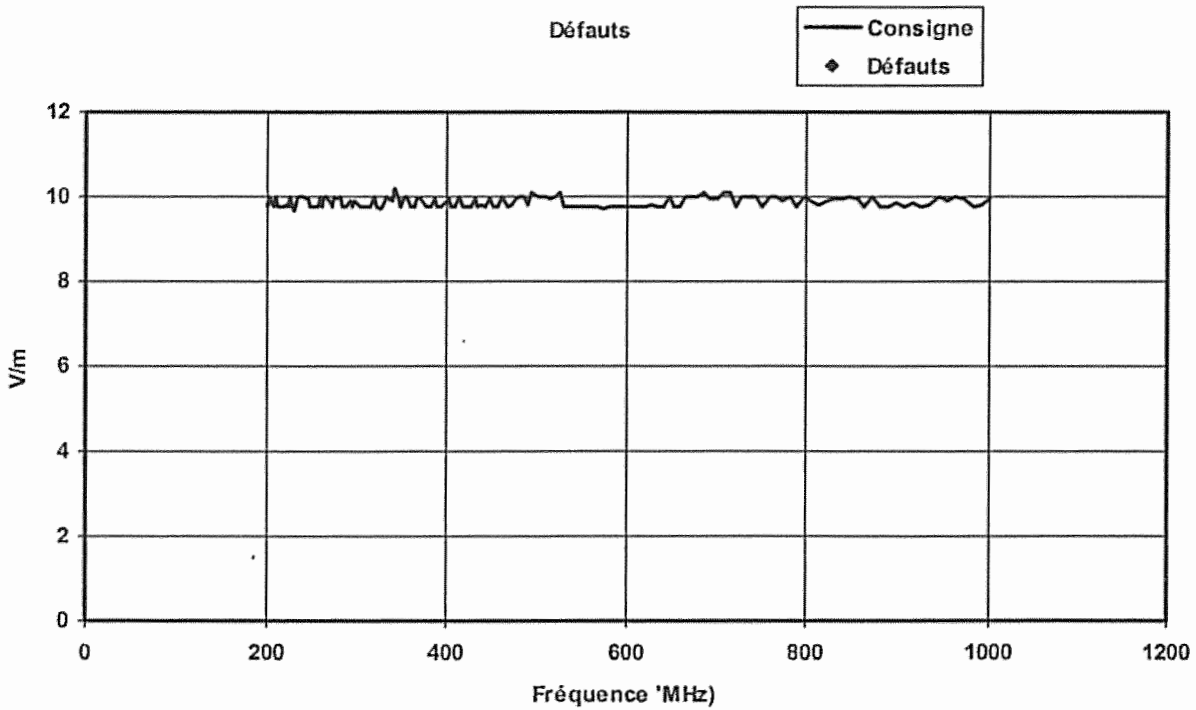

PV

Consigne / perturbation

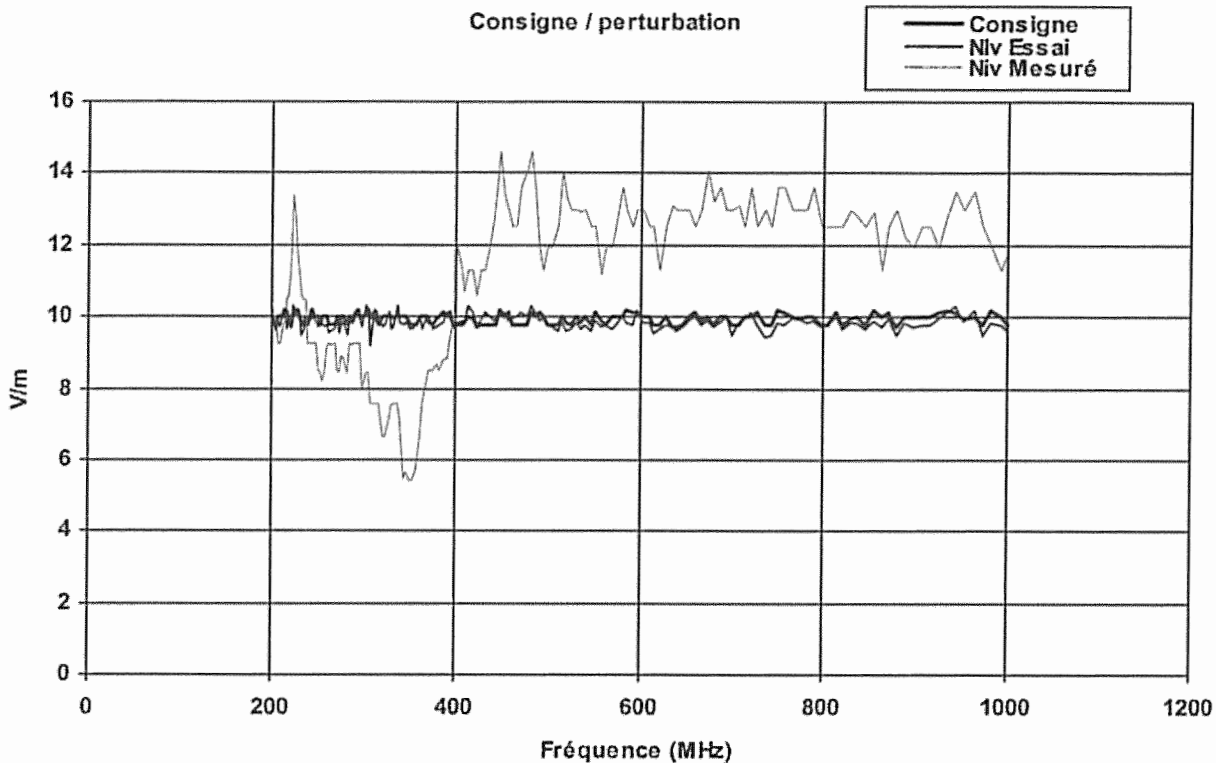

Défauts

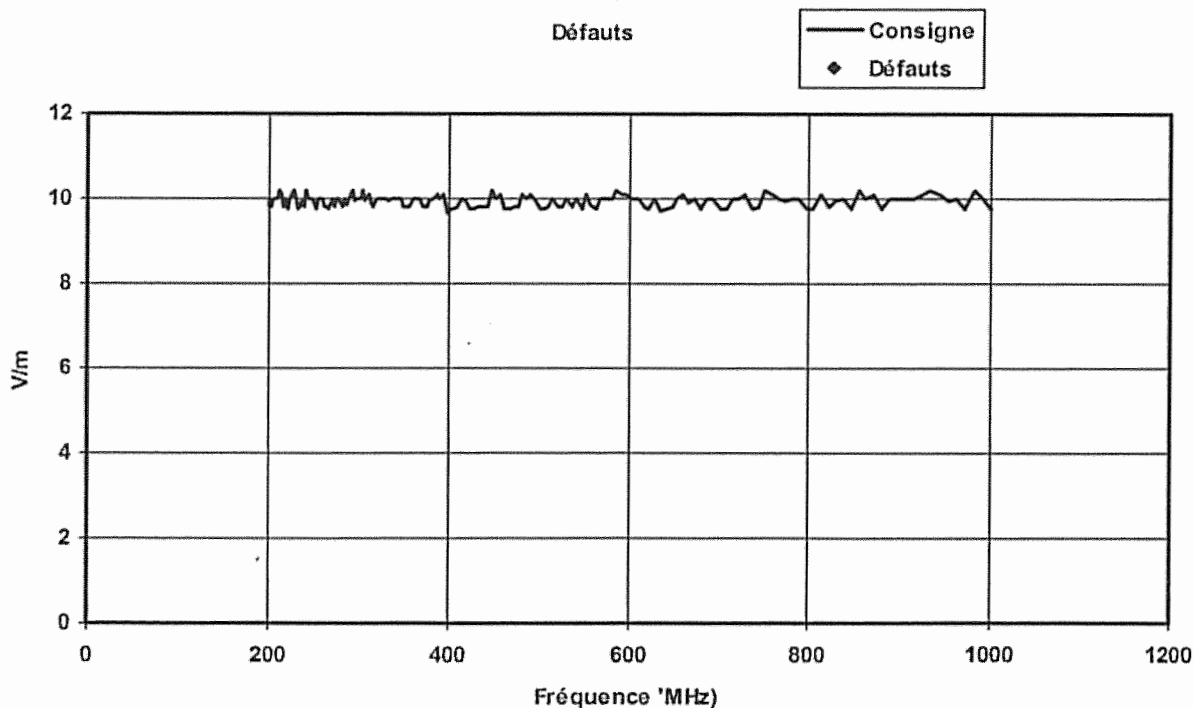

Consigne / perturbation

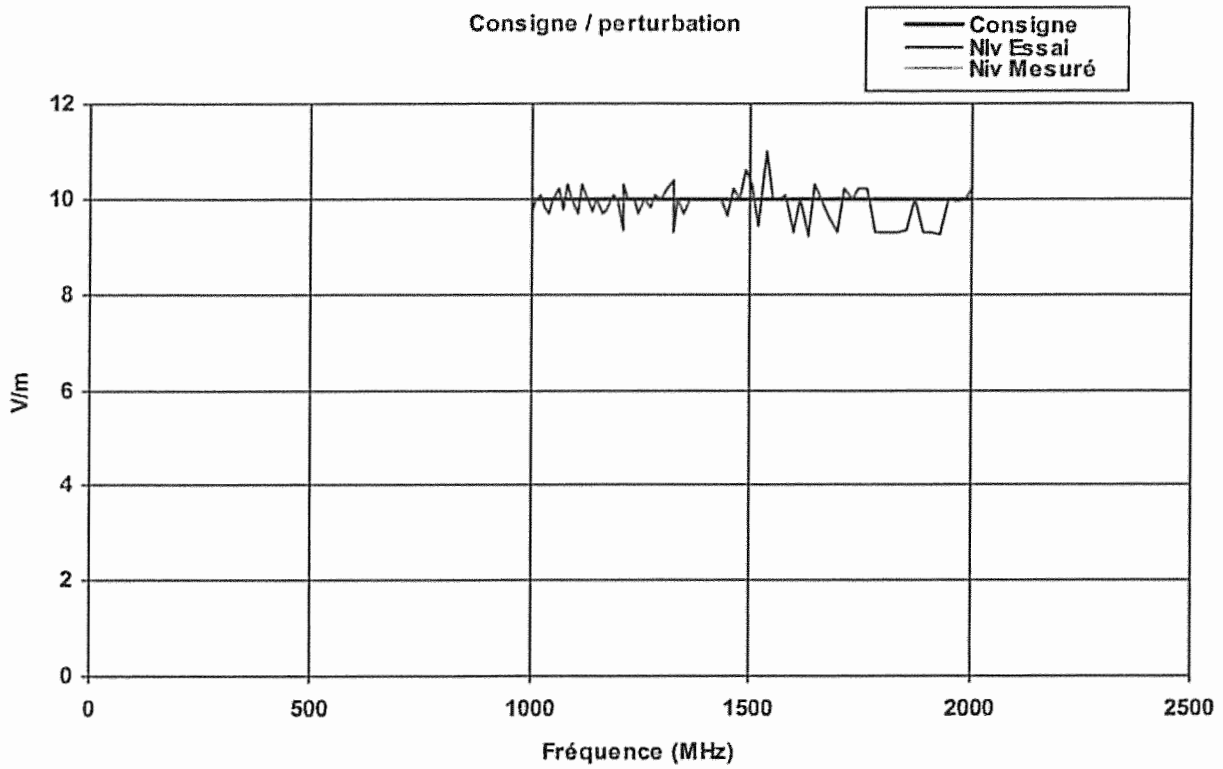

Défauts

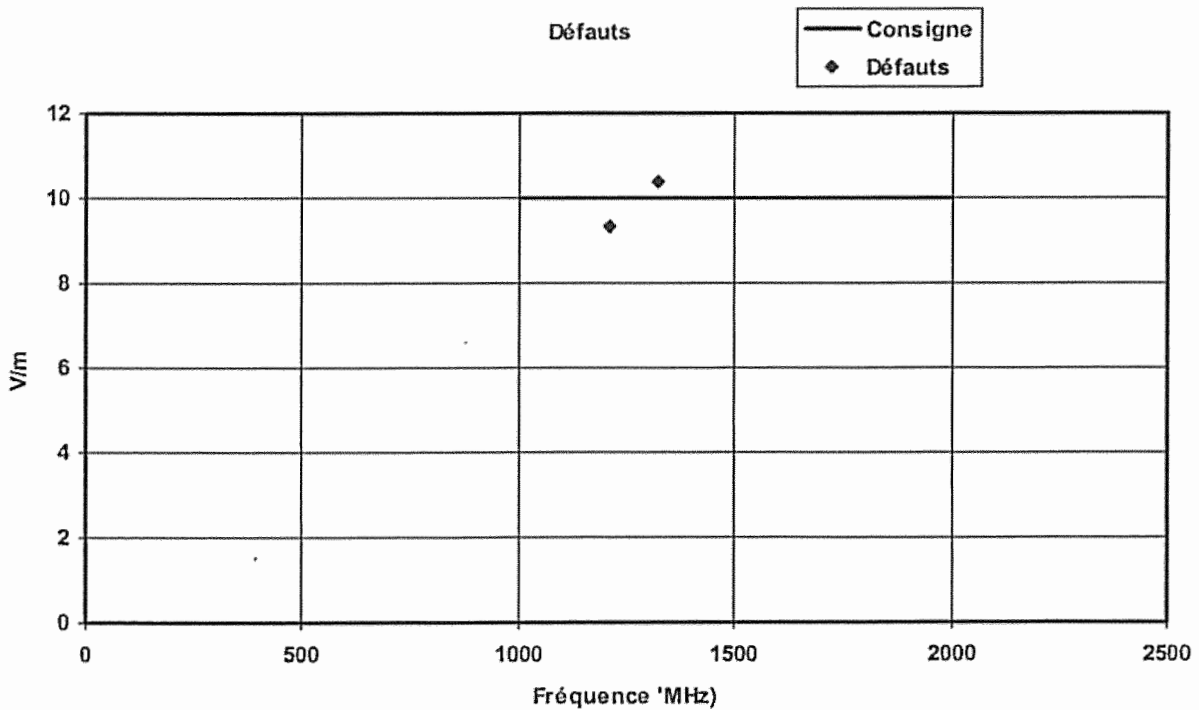

Consigne / perturbation

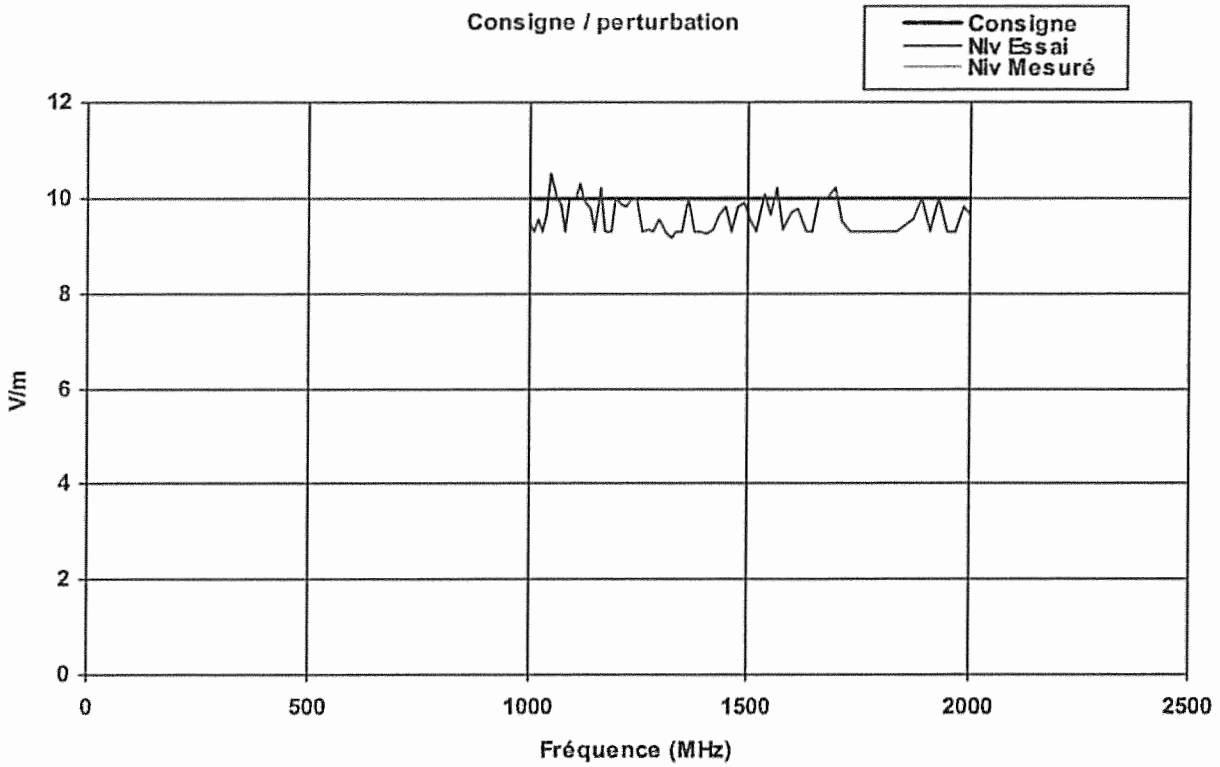

Défauts

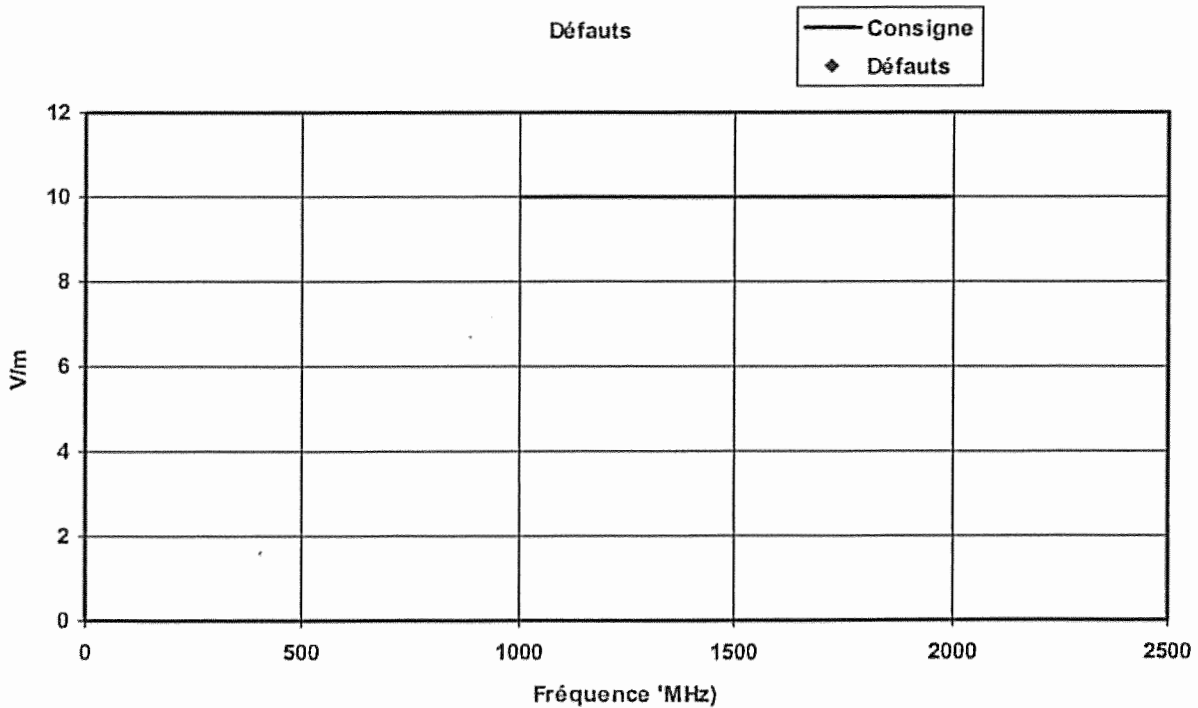

CHAPTER 19

ELECTROSTATIC DECHARGE IMMUNITY TEST

19.1 TEST SPECIFICATIONS AND PROGRAMME

Following IEC 1000-4-2 (Clause 10.9.2 of EN60945):

Severity level : 3 (According IEC 1000-4-2) = 6 kV by « contact »
= 8 kV on « Air »

Susceptibility criteria : The test has been performed in standby mode; susceptibility criteria is that the operate mode do not appear.

19.2 EQUIPMENT UNDER TEST

Beacon Unit :
Name : MT400
Type :
Number : 011

19.3. DATES :

ESD Test start on : November 28th, 2003

ESD End of test : November 28th, 2003

19.3 TEST SITE

INTESPACE Laboratory. EMI anechoic chamber

19.4 TEST EQUIPMENT

Name	SN	Validity date
ESD Tester	PSD 258	11/2004

19.5 INJECTION METHOD

Two kinds of injection were applied on the equipment :

- A series of positive and negative « Air » discharges at 8 kV were applied to all operator accessible fixtures.

- A series of positive and negative « Contact » discharges at 6 kV were applied to all operator accessible fixtures. (See picture next page



Air Discharge Test set-up

19.6. RESULTS

No susceptibility were detected on the equipment.

19.7 TEST CONTROL

Date: December 2nd, 2003

Beacon Unit : 2b

Name : Standard Communications Pty Ltd

Type : MT400

Number : 011

Result: The Test pass . See hereafter the decodage of message checked after ESD test

Logiciel ARGOS/SARSAT vers. 3.0 Octobre 2001 Ref. balise : M4586-2 (Sarsat)
Tests de contrôle (406.028 MHz) Lecture Message No: 1

Message reçu	(1-112):	FFFE2F5F7703C48000000086FFFE00
Format flag	(25):	0
Protocole flag	(26):	1
Code pays	(27-36):	0503
Pays	:	
Code protocole	(37-39):	011
Protocole utilise	:	User - Serialized user
Identification code	(26-85):	0EEE07090000001
Identification (Baudot)	(40-81):	:::~::~
Numero	:	1E
BCH 1 lu/calculé	(86-106/25-85):	01BFFA/01BFFA
Homing	(84-85):	01
Activation type	(108):	Manual
Position GPS de reference lab	:	N 43°33'34'' E 1028'48
Position GPS	:	No