



FCC CFR 47 Part 90 Test Report

APPLICANT	STANDARD COMMUNICATIONS PTY.LTD.
ADDRESS	PO BOX 96 WINSTON HILLS NSW 2153 AUSTRALIA
FCC ID	TXJCM60V25
MODEL NUMBER	CM60-V25B
PRODUCT DESCRIPTION	VHF TRANSCEIVER
DATE SAMPLE RECEIVED	4/9/2018
FINAL TEST DATE	4/16/2018
TESTED BY	Franklin Rose
APPROVED BY	Tim Royer
TEST RESULTS	<input checked="" type="checkbox"/> PASS <input type="checkbox"/> FAIL

Report Number	Report Version	Description	Issue Date
477AUT18 PT90_TestReport_	Rev1	Initial Issue	04/30/2018
477AUT18 PT90_TestReport_	Rev2	Clerical Update	05/29/2018

THE ATTACHED REPORT SHALL NOT BE REPRODUCED EXCEPT IN FULL WITHOUT THE WRITTEN APPROVAL OF TIMCO ENGINEERING, INC.



TABLE OF CONTENTS

GENERAL REMARKS.....	2
GENERAL INFORMATION	3
RESULTS SUMMARY.....	4
RF POWER OUTPUT	5
PART 2.1033 (c)(8) DC INPUT INTO FINAL AMPLIFIER.....	5
MODULATION CHARACTERISTICS	6
11K2F3E (NARROWBAND ANALOG FM VOICE) BANDWIDTH	6
8K57F1E/F1D (C4FM VOICE/DATA) BANDWIDTH	6
AUDIO FREQUENCY RESPONSE & LOW PASS FILTER	7
Test Data: 12.5 kHz FM Audio Frequency Response & Low Pass Filter.....	7
MODULATION LIMITING	8
Test Data: 12.5 kHz FM Modulation Limiting.....	8
OCCUPIED BANDWIDTH.....	9
TEST DATA: 11K2F3E (NARROWBAND ANALOG FM VOICE).....	10
TEST DATA: 8K57F1E/F1D (C4FM VOICE/DATA).....	11
EMISSION MASKS	12
EMISSION MASK D - NARROWBAND FM (12.5 kHz).....	13
Test Data: 150.8075 MHz	13
Test Data: 156.2225 MHz	16
Test Data: 157.4575 MHz	19
Test Data: 161.5525 MHz	22
Test Data: 161.7875 MHz	25
Test Data: 162.045 MHz.....	28
Test Data: 167.0000 MHz	31
Test Data: 173.3925 MHz	34
EMISSION MASK D – P25 PHASE I C4FM (12.5 kHz)	37
Test Data: 150.8075 MHz	37
Test Data: 156.2225 MHz	40
Test Data: 157.4575 MHz	43
Test Data: 161.5525 MHz	46
Test Data: 161.7875 MHz	49
Test Data: 162.045 MHz.....	52
Test Data: 167.0000 MHz	55
Test Data: 173.3925 MHz	58



SPURIOUS EMISSIONS AT ANTENNA TERMINALS (CONDUCTED).....	61
SPURIOUS EMISSIONS - NARROWBAND FM (12.5 kHz)	62
Test Data: 150.8075 MHz	62
Test Data: 156.2225 MHz	63
Test Data: 157.4575 MHz	64
Test Data: 161.5525 MHz	65
Test Data: 161.7825 MHz	66
Test Data: 162.0450 MHz	67
Test Data: 167.0000 MHz	68
Test Data: 173.3925 MHz	69
SPURIOUS EMISSIONS – P25 PHASE I C4FM (12.5 kHz)	70
Test Data: 150.8075 MHz	70
Test Data: 156.2225 MHz	71
Test Data: 157.4575 MHz	72
Test Data: 161.5525 MHz	73
Test Data: 161.7825 MHz	74
Test Data: 162.0450 MHz	75
Test Data: 167.0000 MHz	76
Test Data: 173.3925 MHz	77
FIELD STRENGTH OF SPURIOUS EMISSIONS	78
TEST DATA: 150.8075 MHz	79
TEST DATA: 156.2225 MHz	80
TEST DATA: 157.4575 MHz	81
TEST DATA: 161.5525 MHz	82
TEST DATA: 161.7875 MHz	83
TEST DATA: 162.0450 MHz	84
TEST DATA: 167.0000 MHz	85
TEST DATA: 173.3925 MHz	86
FREQUENCY STABILITY	87
TRANSIENT FREQUENCY BEHAVIOR	89
TEST DATA: TURN-ON PERIOD (T_1)	90
TEST DATA: TURN-OFF PERIOD (T_3)	91
STATEMENT OF MEASUREMENT UNCERTAINTY	92
EMC EQUIPMENT LIST	93

GENERAL REMARKS

Summary

The device under test does:

- Fulfill the general approval requirements as identified in this test report and was selected by the customer.
- Not fulfill the general approval requirements as identified in this test report

Attestations

This equipment has been tested in accordance with the standards identified in this test report. To the best of my knowledge and belief, these tests were performed using the measurement procedures described in this report.

All instrumentation and accessories used to test products for compliance to the indicated standards are calibrated regularly in accordance with ISO 17025 requirements.

I attest that the necessary measurements were made at:

Timco Engineering Inc.
849 NW State Road 45
Newberry, FL 32669
Designation #: US1070

Tested by:



Name and Title Franklin Rose, Project Manager / EMC Testing Technician

Date 04/26/2018

Reviewed and Approved by:



Name and Title Tim Royer, Project Manager / EMC Testing Engineer

Date 04/30/2018

GENERAL INFORMATION

EUT Description	VHF TRANSCEIVER
FCC ID	TXJCM60V25
Model Number	CM60-V25B
Operating Frequency	Band 1: 150.8 - 156.2475 Band 2: 157.1875 - 161.575 Band 3: 161.775 - 161.9625 Band 4: 162.0375 - 173.4 MHz
Test Frequencies	Band 1: 150.8075, 156.2225 MHz Band 2: 157.4575, 161.5525 MHz Band 3: 161.7825 MHz Band 4: 162.045, 167.0, 173.3925 MHz
Type of Emission	11K2F3E (Narrowband Analog FM Voice), 8K57F1E (P25 Phase I C4FM Voice), 8K57F1D (P25 Phase I C4FM Data)
Modulation	FM
EUT Power Source	<input type="checkbox"/> 110–120Vac/50– 60Hz
	<input checked="" type="checkbox"/> DC Power (13.8 V)
	<input type="checkbox"/> Battery Operated Exclusively
Test Item	<input type="checkbox"/> Prototype
	<input checked="" type="checkbox"/> Pre-Production
	<input type="checkbox"/> Production
Type of Equipment	<input type="checkbox"/> Fixed
	<input checked="" type="checkbox"/> Mobile
	<input type="checkbox"/> Portable
Antenna Connector	BNC
Test Conditions	The temperature was 26°C Relative humidity of 50%.
Modification to the EUT	No Modification to EUT.
Test Exercise	The EUT was placed in continuous transmit and was operated in "Test Mode" for digital emissions tests.
Applicable Standards	ANSI/TIA 603-E:2016, ANSI C63.26, FCC CFR 47 Part 2, Part 90
Test Facility	Timco Engineering Inc. at 849 NW State Road 45 Newberry, FL 32669 USA. Designation #: US1070

RESULTS SUMMARY

Rule Part No.	Test Item	Results
2.1046(a), 90.205(d)	RF Power Output	PASS
2.1033(c)(4), 90.209(b)(5)	Modulation Characteristics	PASS
2.1047(a)	Audio Frequency Response and Low Filter	PASS
2.1047(b)	Modulation Limiting	PASS
2.1049 (c)	Occupied Bandwidth	PASS
90.210(d)(1), (2)	Emission Masks	PASS
2.1051(a), 90.210(d)(3)	Spurious Emissions at Antenna Terminals	PASS
2.1053(a), 90.210(d)(3)	Field Strength of Spurious Emissions	PASS
2.1055(a)(2), 90.213	Frequency Stability < 5 ppm	PASS
90.214	Transient Frequency Behavior	PASS

RF POWER OUTPUT

FCC Rule Parts: FCC Part 2.1046(a), 90.205(d)

(d) 150-174 MHz. (1) The maximum allowable station ERP is dependent upon the station's antenna HAAT and required service area and will be authorized in accordance with table 1. Applicants requesting an ERP in excess of that listed in table 1 must submit an engineering analysis based upon generally accepted engineering practices and standards that includes coverage contours to demonstrate that the requested station parameters will not produce coverage in excess of that which the applicant requires.

TABLE 1—150-174MHz—MAXIMUM ERP/REFERENCE HAAT FOR A SPECIFIC SERVICE AREA RADIUS

	Service area radius (km)									
	3	8	13	16	24	32	40	48 ⁴	64 ⁴	80 ⁴
Maximum ERP (w) ¹	1	28	178	2500	2500	2500	500	2500	2500	2500
Up to reference HAAT (m) ³	15	15	15	15	33	65	110	160	380	670

¹Maximum ERP indicated provides for a 37 dBu signal strength at the edge of the service area per FCC Report R-6602, Fig. 19 (See §73.699, Fig. 10).

²Maximum ERP of 500 watts allowed. Signal strength at the service area contour may be less than 37 dBu.

³When the actual antenna HAAT is greater than the reference HAAT, the allowable ERP will be reduced in accordance with the following equation: $ERP_{allow} = ERP_{max} \times (HAAT_{ref} / HAAT_{actual})^2$.

⁴Applications for this service area radius may be granted upon specific request with justification and must include a technical demonstration that the signal strength at the edge of the service area does not exceed 37 dBu.

Method of Measurement: TIA-603-E, 2.2.1

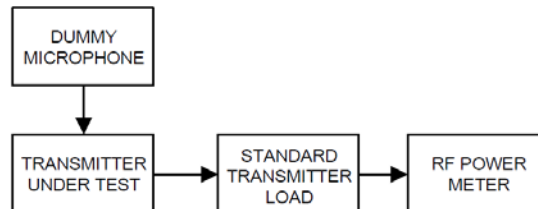

Test Data: Power Measurement Table

Peak Power Output					
dBm			Watts		
High	Med	Low	High	Med	Low
43.81	39.84	30.02	24.04	9.64	1.00

Part 2.1033 (c) (8) DC Input into Final Amplifier

INPUT POWER: (13.8 V) (3.0 A) = **41.4 Watts**

Result: Meets Requirements

Applicant: STANDARD COMMUNICATIONS PTY.LTD.
 FCC ID: TXJCM60V25
 Report: 477AUT18 PT90_TestReport_Rev2

[Table of Contents](#)

MODULATION CHARACTERISTICS

FCC Rule Parts: Part 2.1033(c)(4), 90.209(b)(5)

STANDARD CHANNEL SPACING/BANDWIDTH

Frequency band (MHz)	Channel spacing (kHz)	Authorized bandwidth (kHz)
150-174	17.5	¹ 320/11.25/6

¹For stations authorized on or after August 18, 1995.

³Operations using equipment designed to operate with a 25 kHz channel bandwidth will be authorized a 20 kHz bandwidth. Operations using equipment designed to operate with a 12.5 kHz channel bandwidth will be authorized a 11.25 kHz bandwidth. Operations using equipment designed to operate with a 6.25 kHz channel bandwidth will be authorized a 6 kHz bandwidth. All stations must operate on channels with a bandwidth of 12.5 kHz or less beginning January 1, 2013, unless the operations meet the efficiency standard of §90.203(j)(3).

11K2F3E (Narrowband Analog FM Voice) Bandwidth

$$B_n = 2M + 2Dk$$

$$B_n = (2 \times 3) + (2 \times 2.5) = 11.0 \text{ kHz}$$

Where:

f_m = modulating frequency, kHz

f_d = deviation, kHz

k = constant (= 1)

Necessary Bandwidth for 11K2F3E = **11.0 kHz**

90. 209(b)(5) Authorized Bandwidth for 11K2F3E = **11.25 kHz**

8K57F1E/F1D (C4FM Voice/Data) Bandwidth

Necessary Bandwidth for 8K57F1E/F1D (99% Occupied Bandwidth) = **8.57 kHz**

90. 209(b)(5) Authorized Bandwidth for 8K57F1E/F1D = **11.25 kHz**

Result: Meets Requirements

AUDIO FREQUENCY RESPONSE & LOW PASS FILTER

Rule Part No.: 2.1047(a)

Requirements:

(a) *Voice modulated communication equipment.* A curve or equivalent data showing the frequency response of the audio modulating circuit over a range of 100 to 5000 Hz shall be submitted. For equipment required to have an audio low-pass filter, a curve showing the frequency response of the filter, or of all circuitry installed between the modulation limiter and the modulated stage shall be submitted.

Test Procedure: TIA 603-E, 2.2.6.2.2, 2.2.15 (Using the Test Setup from section 2.2.6).

Note: The Low Pass Filter is digital, and has no "input" or "output" as found in the method of measurement, above. Testing has been altered accordingly to show the operation of the filter.

Note: Testing deviates from TIA 603-E 2.2.6.2.2 and 2.2.15. The Audio Frequency Response and Low Pass Filter Response plot data has been taken simultaneously using the Modulation Meter reading of Deviation (kHz), satisfying the requirements above.

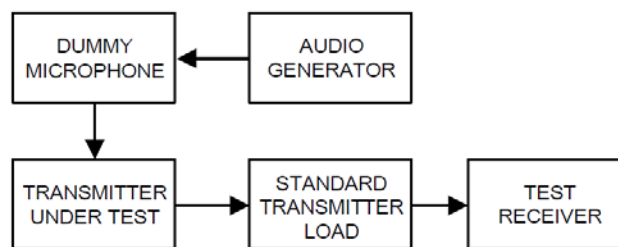

Test Data: 12.5 kHz FM Audio Frequency Response & Low Pass Filter

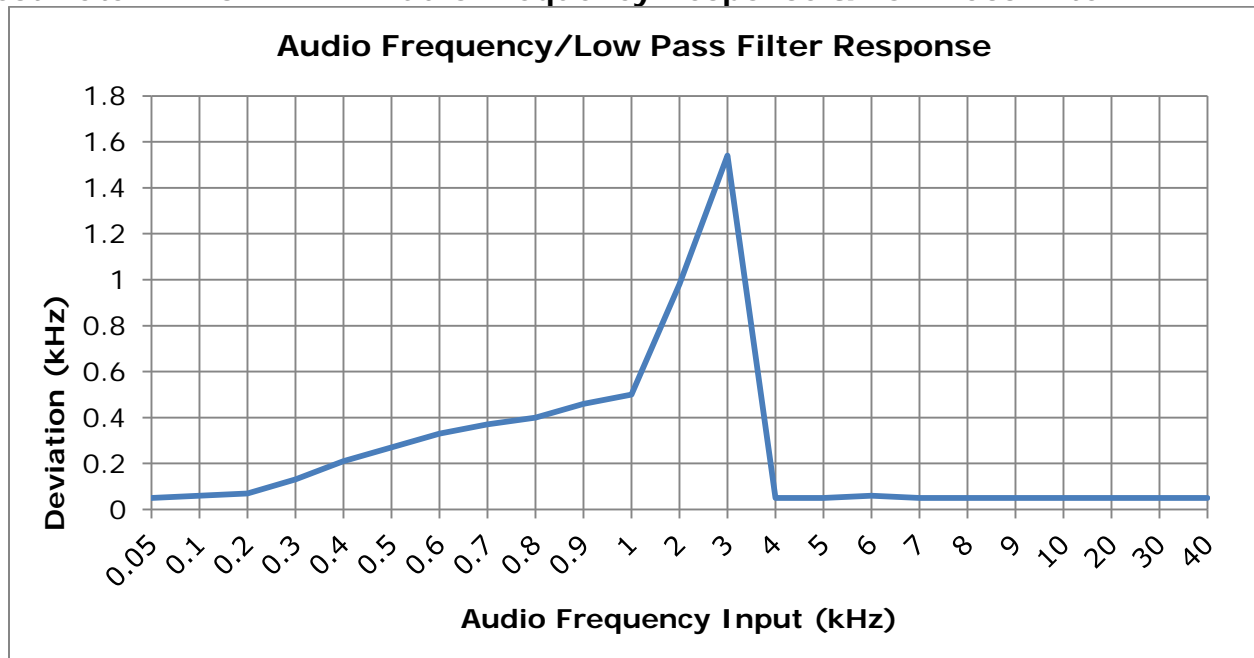

MODULATION LIMITING

Rule Part No.: 2.1047(b)

Requirements:

(b) *Equipment which employs modulation limiting.* A curve or family of curves showing the percentage of modulation versus the modulation input voltage shall be supplied. The information submitted shall be sufficient to show modulation limiting capability throughout the range of modulating frequencies and input modulating signal levels employed.

Test Procedure: TIA 603-E, 2.2.3

Note: The test method is not sufficient to meet the standard of FCC Pt. 2.1047 alone. Deviation (kHz), as recorded from test equipment, has been converted into percentage as required above.

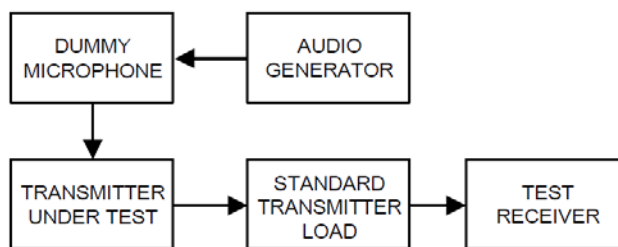

Test Data: 12.5 kHz FM Modulation Limiting

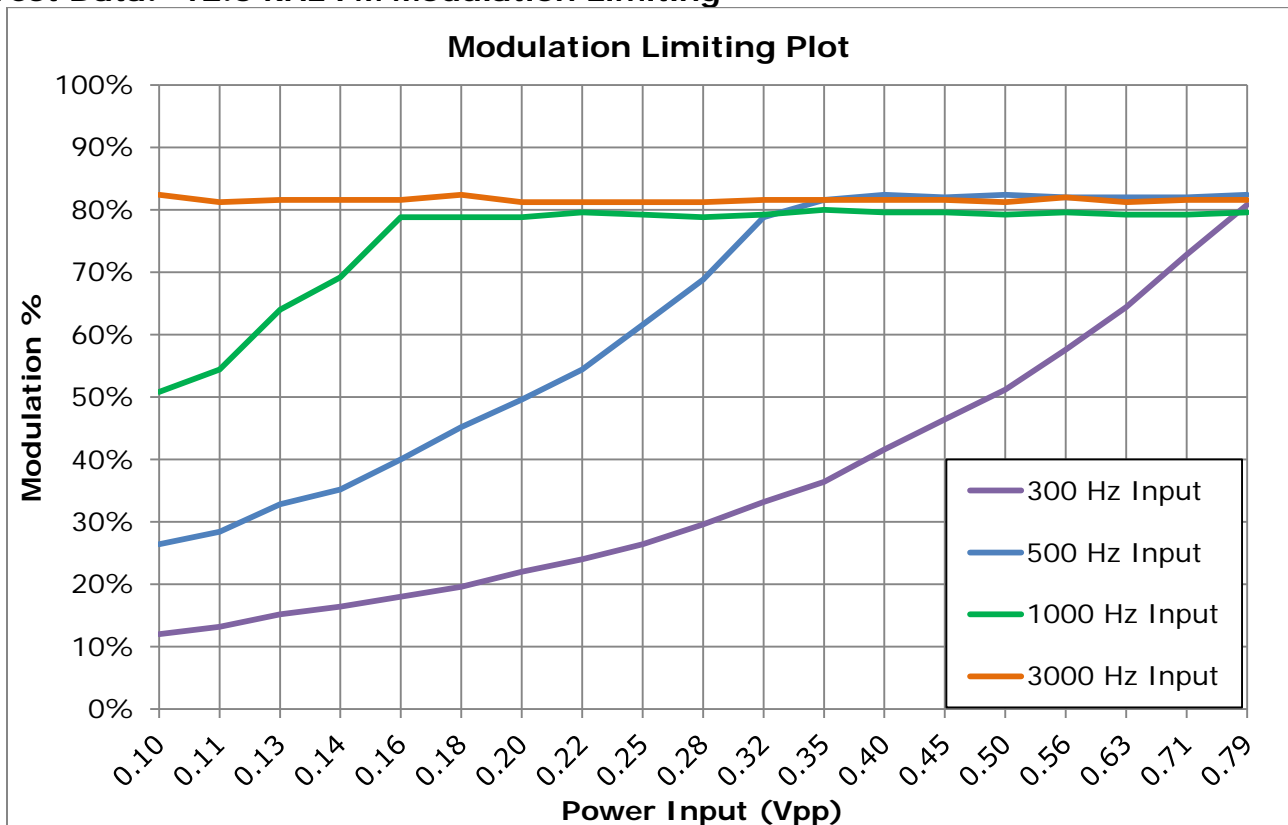

OCCUPIED BANDWIDTH

FCC Rule Parts: 2.1049 (c)

(c) Radiotelephone transmitters equipped with a device to limit modulation or peak envelope power shall be modulated as follows. For single sideband and independent sideband transmitters, the input level of the modulating signal shall be 10 dB greater than that necessary to produce rated peak envelope power.

(1) Other than single sideband or independent sideband transmitters—when modulated by a 2500 Hz tone at an input level 16 dB greater than that necessary to produce 50 percent modulation. The input level shall be established at the frequency of maximum response of the audio modulating circuit.

Method of Measurement: ANSI C63.26, 5.4.4 (using Test Setup from TIA 603-E 2.2.11, below)

Note: The receiver's automatic 99% Occupied Bandwidth function was used. The function is identical in operation to ANSI C63.26, 5.4.4, Step e).

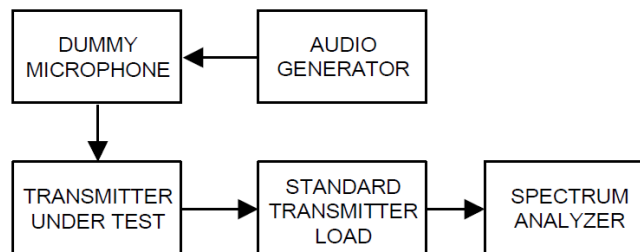

OCCUPIED BANDWIDTH 99%

Test Data: 11K2F3E (Narrowband Analog FM Voice)



Ref Lvl	44 dBm	Marker 1 [T1]	41.51 dBm	RBW	300 Hz	RF Att	20 dB
			150.80767535 MHz	VBW	3 kHz		
				SWT	1.4 s	Unit	dBm

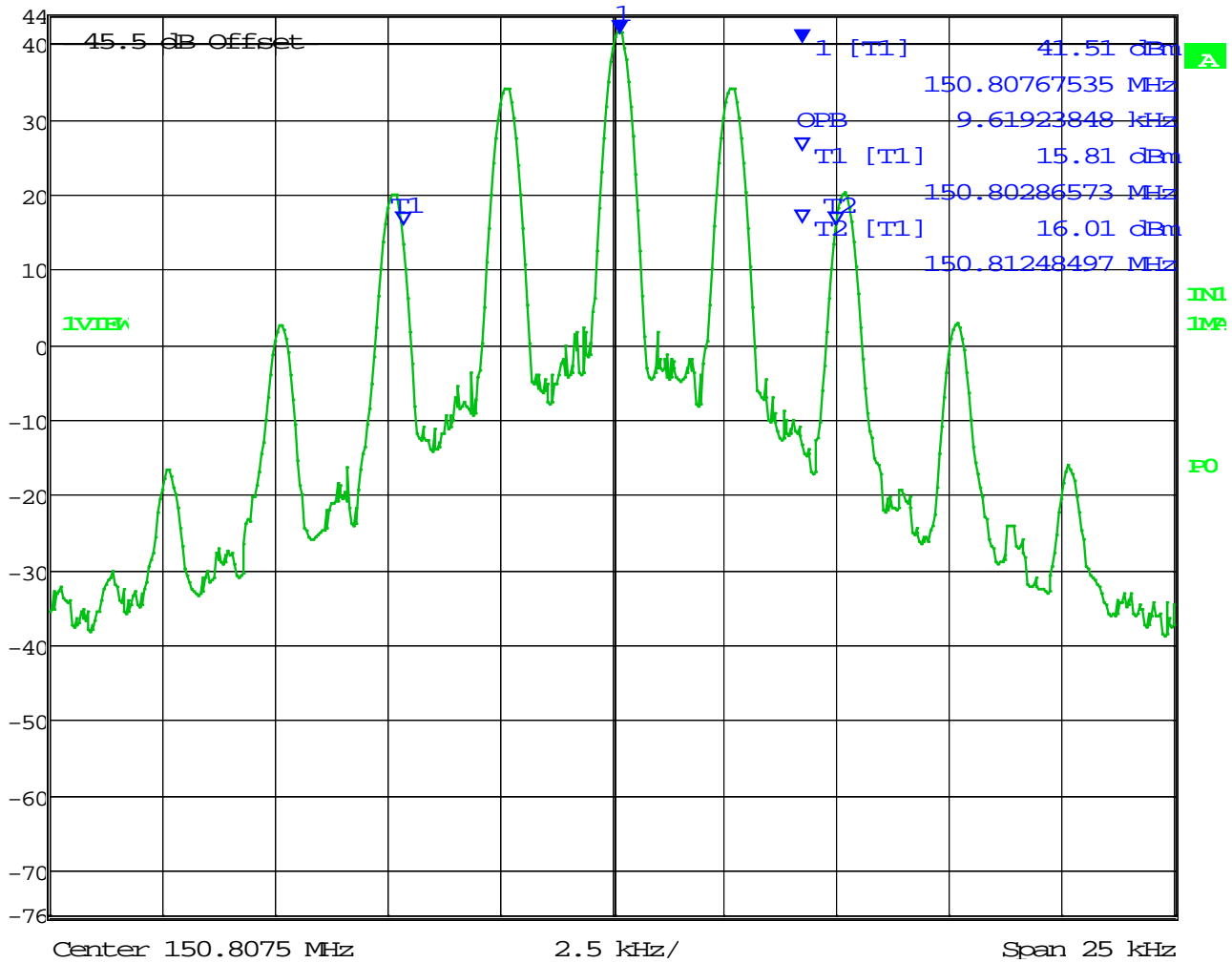

Date: 1.JAN.1997 05:13:13

99% OBW = 9.62 kHz

OCCUPIED BANDWIDTH 99%

Test Data: 8K57F1E/F1D (C4FM Voice/Data)



Ref Lvl	44 dBm	Marker 1 [T1]	42.28 dBm	RBW	300 Hz	RF Att	20 dB
			150.80822645 MHz	VBW	3 kHz		
				SWT	1.4 s	Unit	dBm

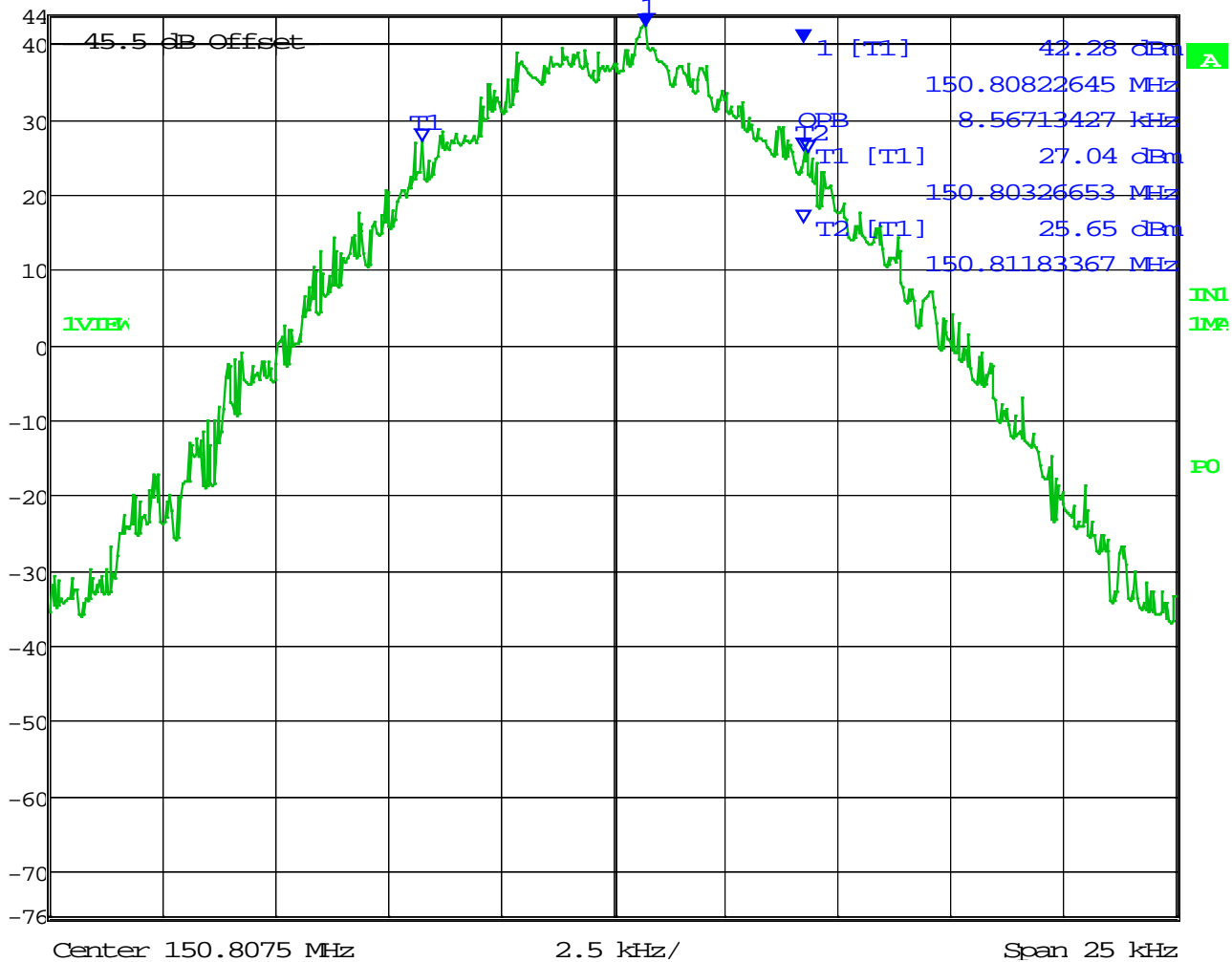

Date: 1.JAN.1997 05:16:20

99% OBW = 8.57 kHz

Result: Meets Requirements

EMISSION MASKS

FCC Rule Parts: 90.210(d)(1), (2)

APPLICABLE EMISSION MASKS

Frequency band (MHz)	Mask for equipment with audio low pass filter	Mask for equipment without audio low pass filter
150-174 ²	B, D, or E	C, D or E

²Equipment designed to operate with a 25 kHz channel bandwidth must meet the requirements of Emission Mask B or C, as applicable. Equipment designed to operate with a 12.5 kHz channel bandwidth must meet the requirements of Emission Mask D, and equipment designed to operate with a 6.25 kHz channel bandwidth must meet the requirements of Emission Mask E.

Requirements:

(d) *Emission Mask D—12.5 kHz channel bandwidth equipment.* For transmitters designed to operate with a 12.5 kHz channel bandwidth, any emission must be attenuated below the power (P) of the highest emission contained within the authorized bandwidth as follows:

(1) On any frequency from the center of the authorized bandwidth f_0 to 5.625 kHz removed from f_0 : Zero dB.

(2) On any frequency removed from the center of the authorized bandwidth by a displacement frequency (f_d in kHz) of more than 5.625 kHz but no more than 12.5 kHz: At least $7.27(f_d - 2.88 \text{ kHz})$ dB.

Method of Measurement: ANSI C63.26, 5.4.4 (using Test Setup from TIA 603-E 2.2.11, below)

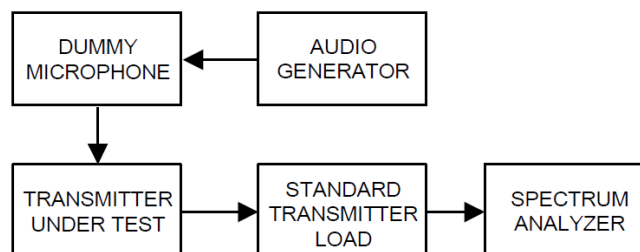

EMISSION MASK D - NARROWBAND FM (12.5 kHz)

Test Data: 150.8075 MHz

Low Power

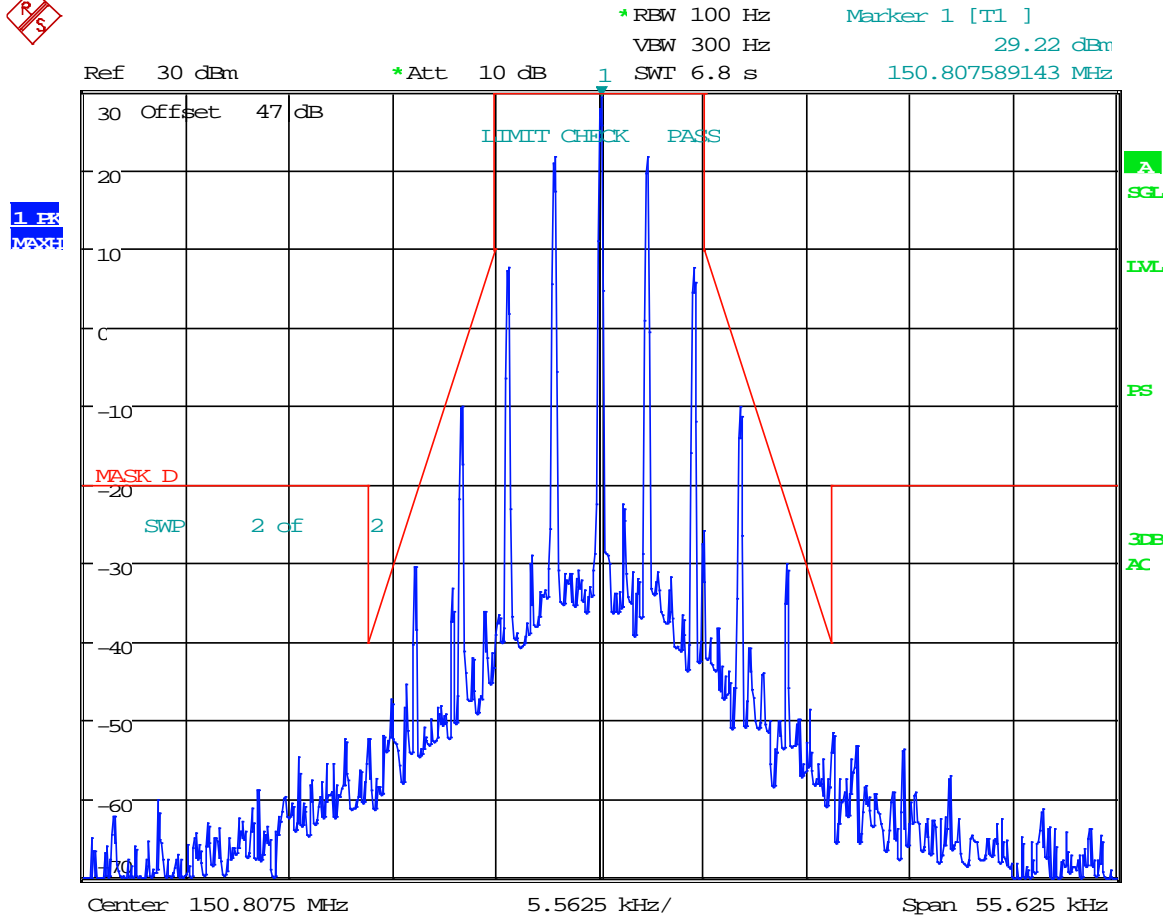

Date: 26.APR.2018 16:50:35

EMISSION MASK D

Medium Power

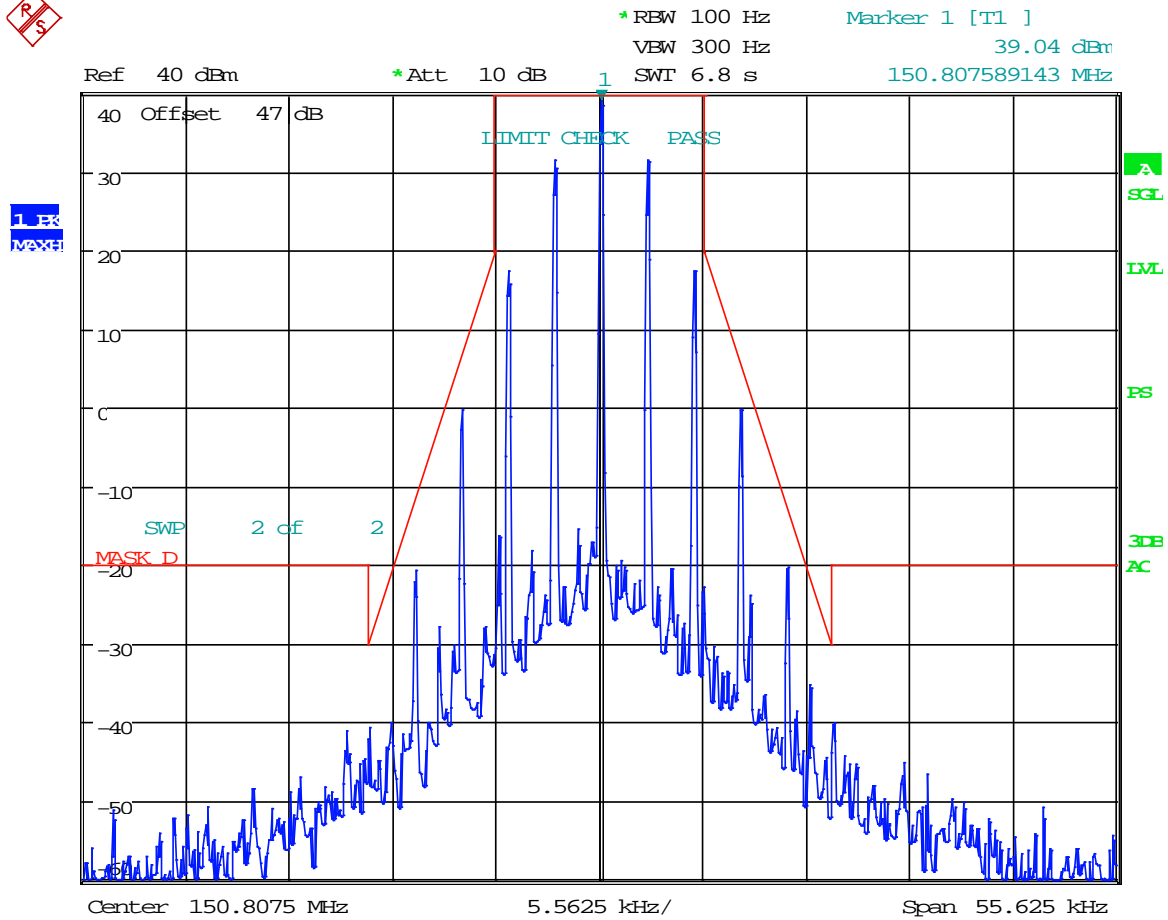

Date: 26.APR.2018 16:39:26

EMISSION MASK D

High Power

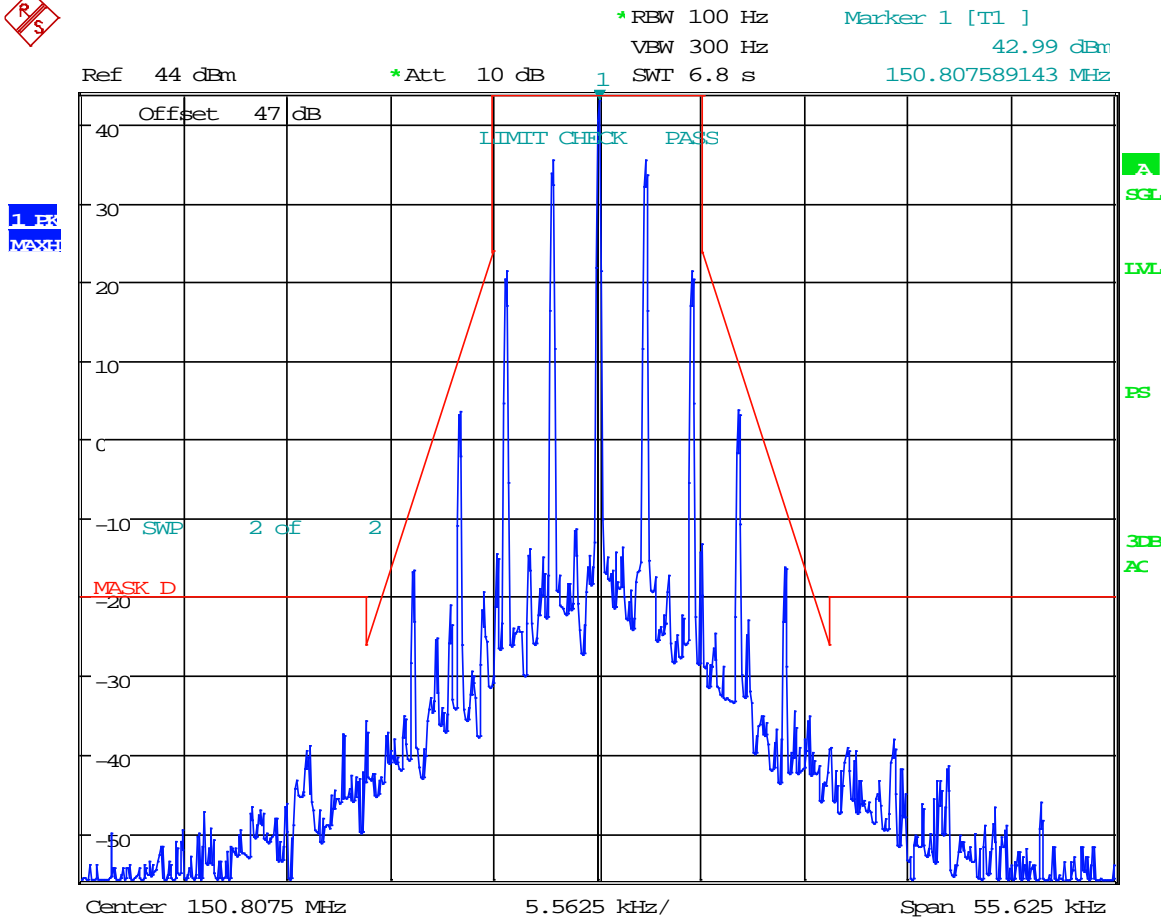

Date: 26.APR.2018 16:26:29

EMISSION MASK D

Test Data: 156.2225 MHz

Low Power



1.5K
MAX

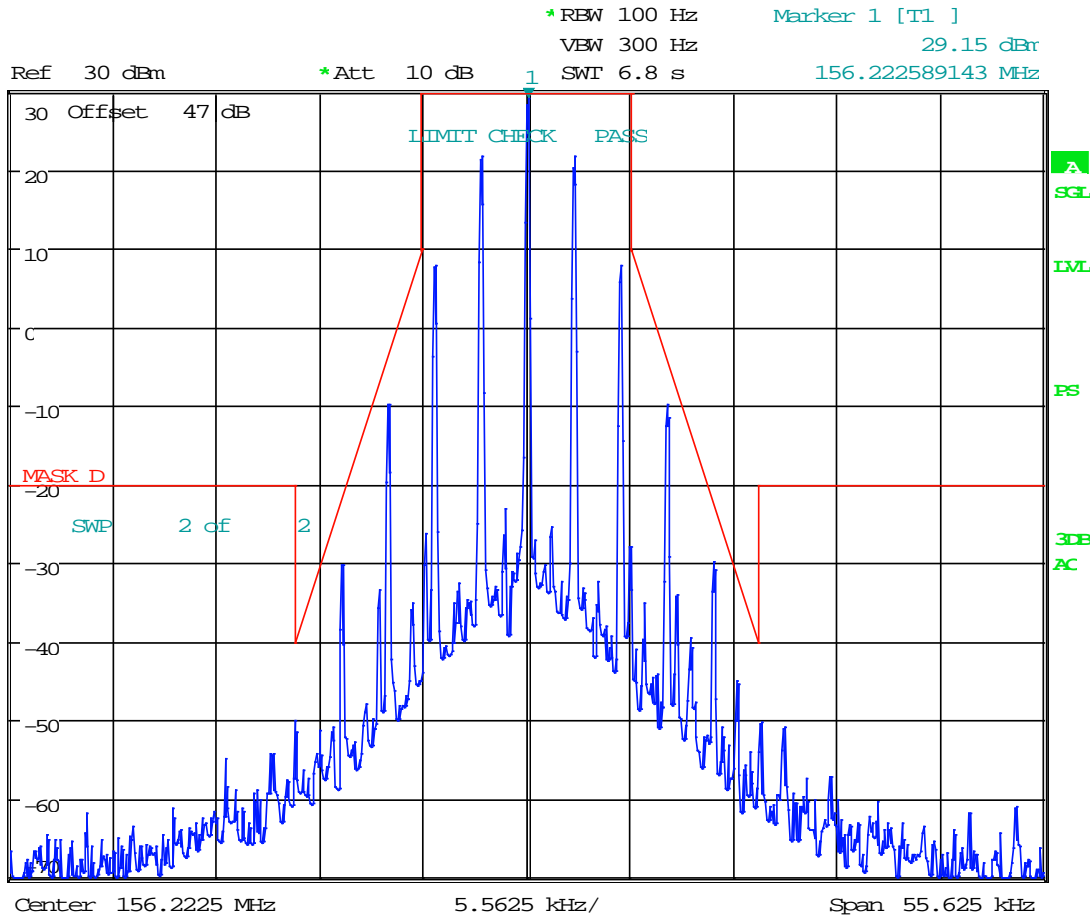

Date: 26.APR.2018 16:55:18

EMISSION MASK D

Medium Power

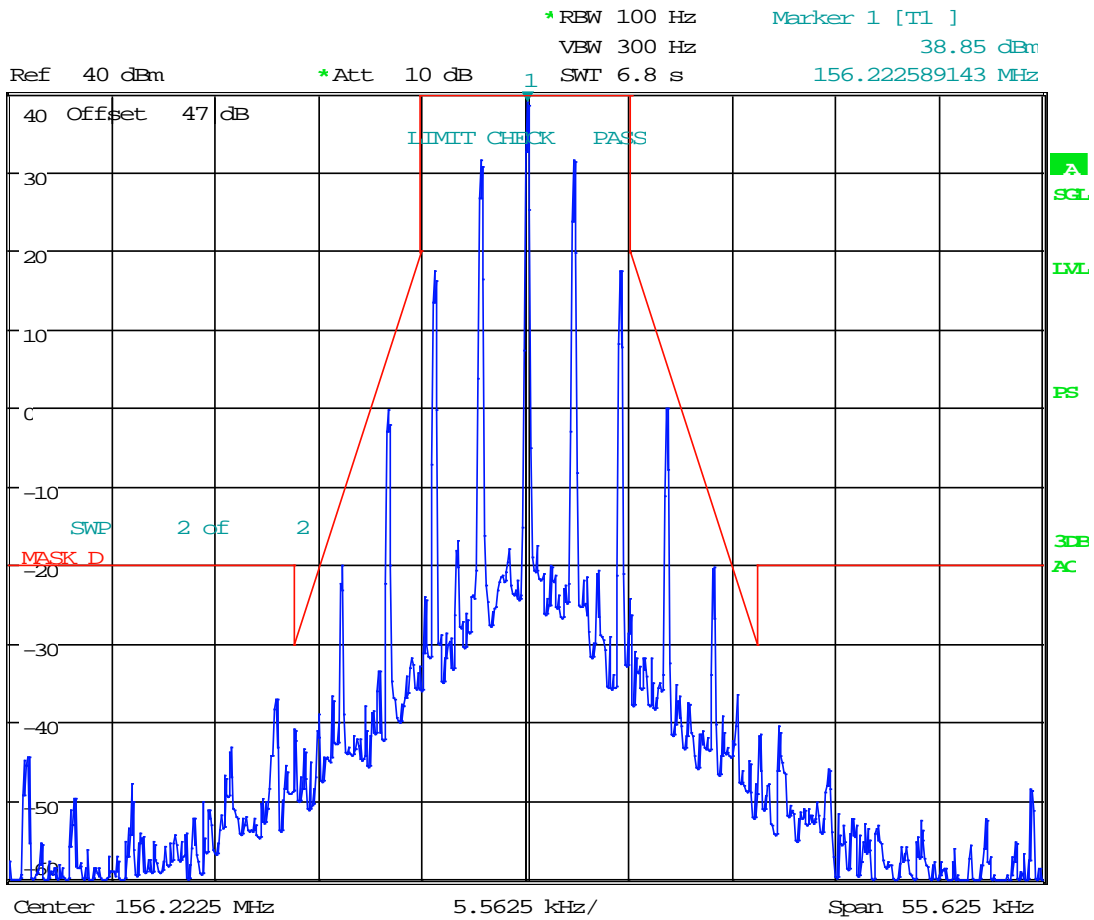

Date: 26.APR.2018 16:44:12

EMISSION MASK D

High Power

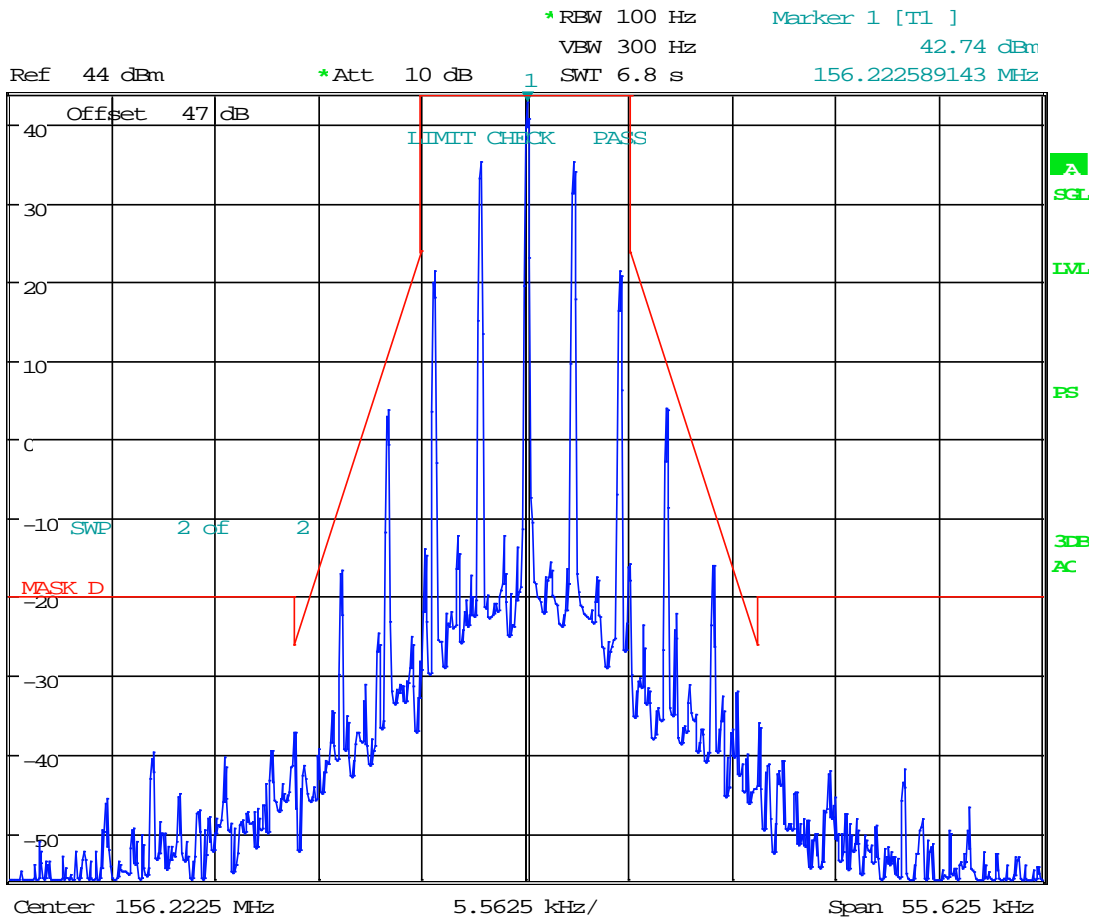

Date: 26.APR.2018 16:31:29

EMISSION MASK D

Test Data: 157.4575 MHz

Low Power



1.5K
MAX

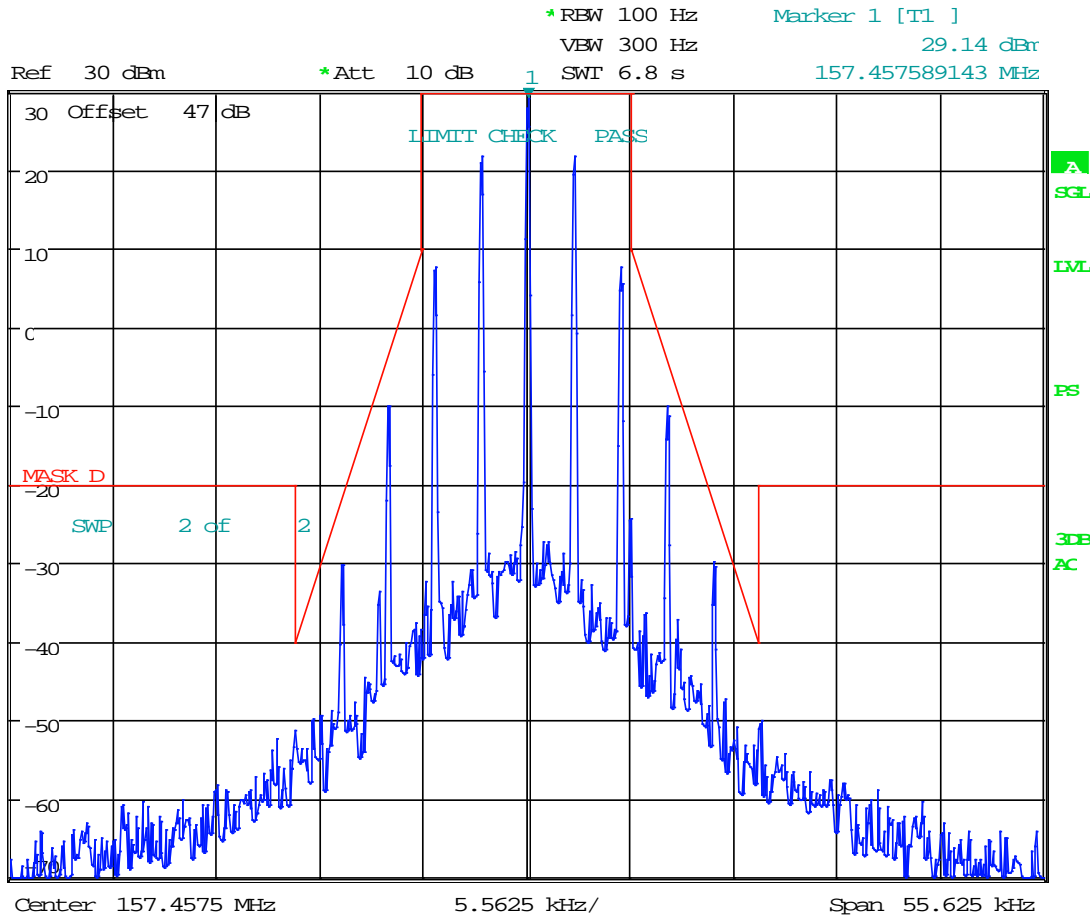

Date: 26.APR.2018 16:49:59

EMISSION MASK D

Medium Power



*RBW 100 Hz Marker 1 [T1]
 VBW 300 Hz 38.86 dBm
 SWI 6.8 s 157.457589143 MHz

Ref 40 dBm

*Att 10 dB 1

1 PK
 MAXH

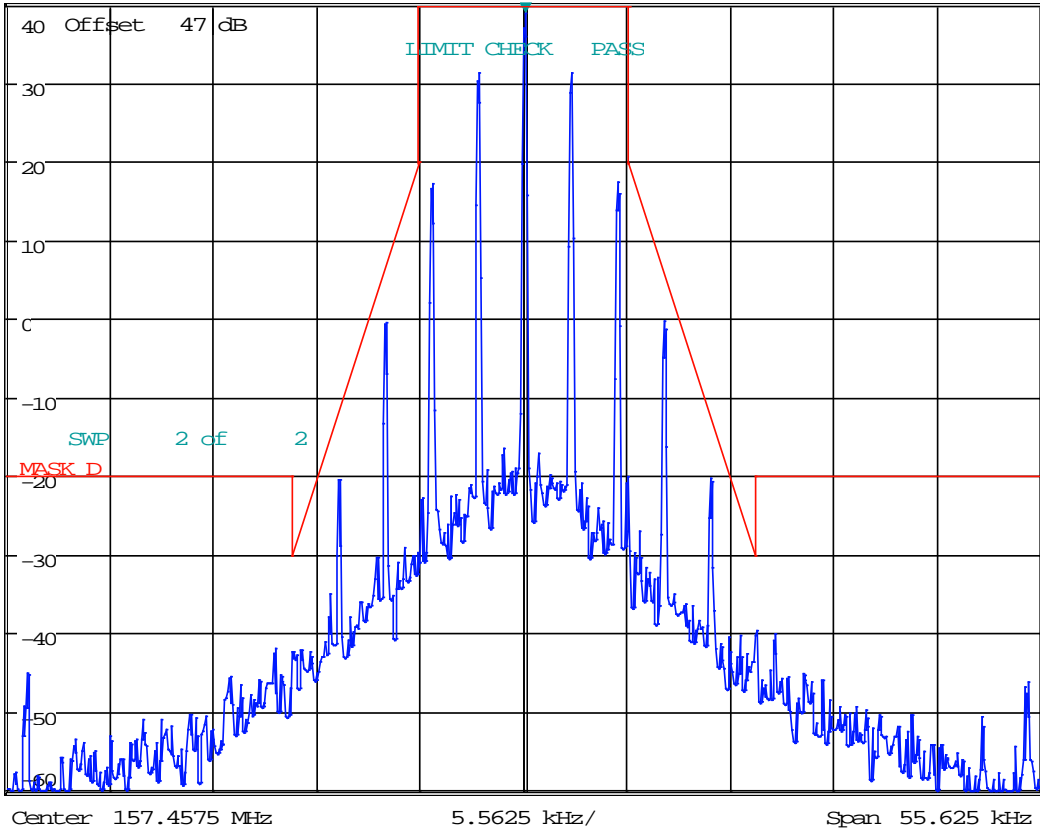

Date: 26.APR.2018 16:38:44

EMISSION MASK D

High Power

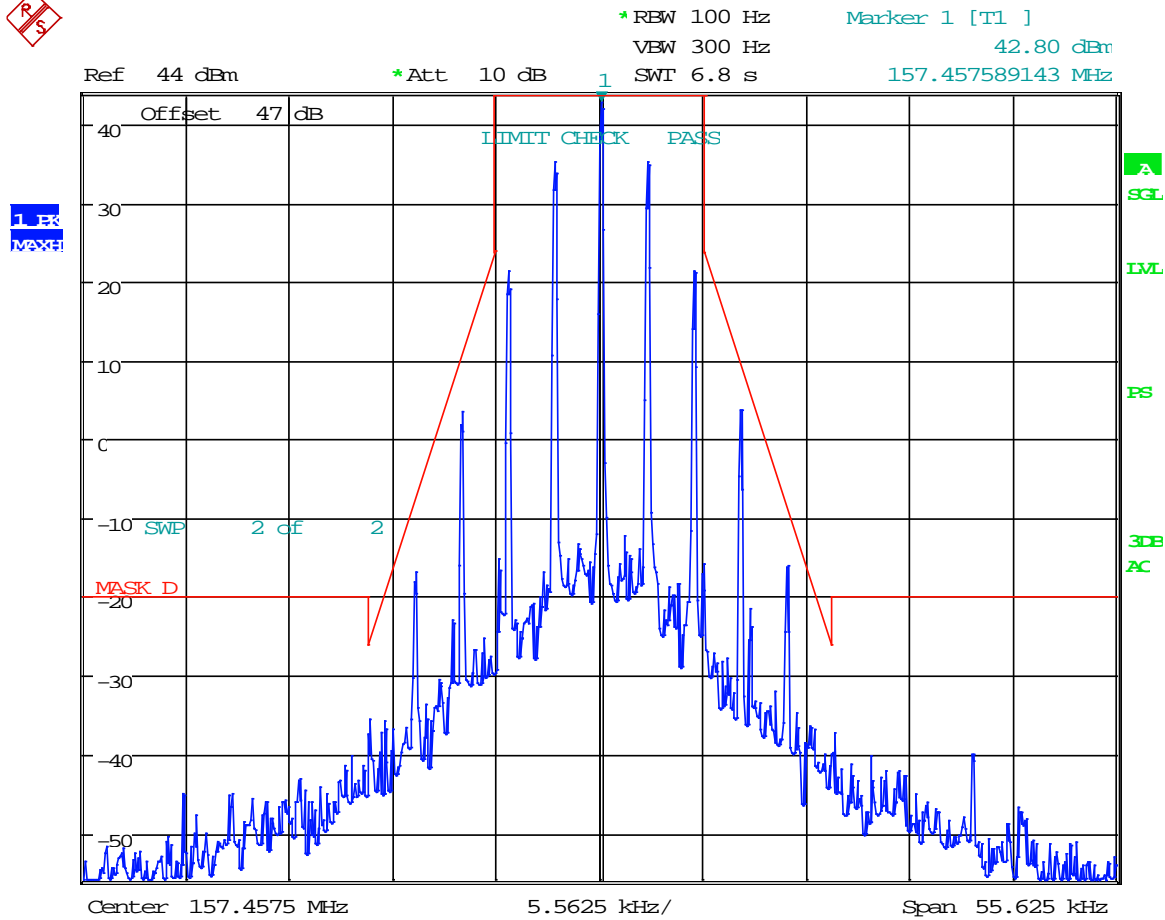

Date: 26.APR.2018 16:23:35

EMISSION MASK D

Test Data: 161.5525 MHz

Low Power

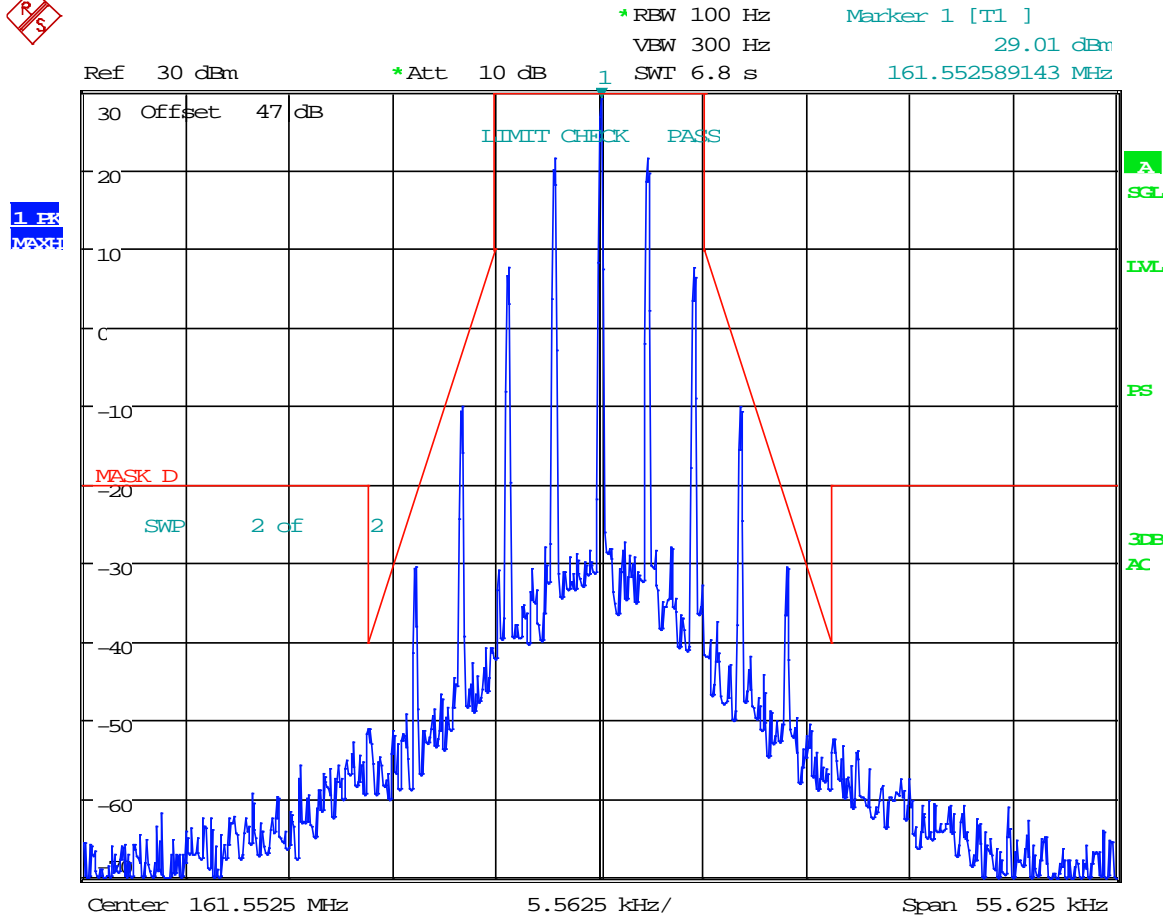

Date: 26.APR.2018 16:51:18

EMISSION MASK D

Medium Power



*RBW 100 Hz Marker 1 [T1]
 *Att 10 dB 38.86 dBm
 VBW 300 Hz
 SWI 6.8 s 161.552589143 MHz

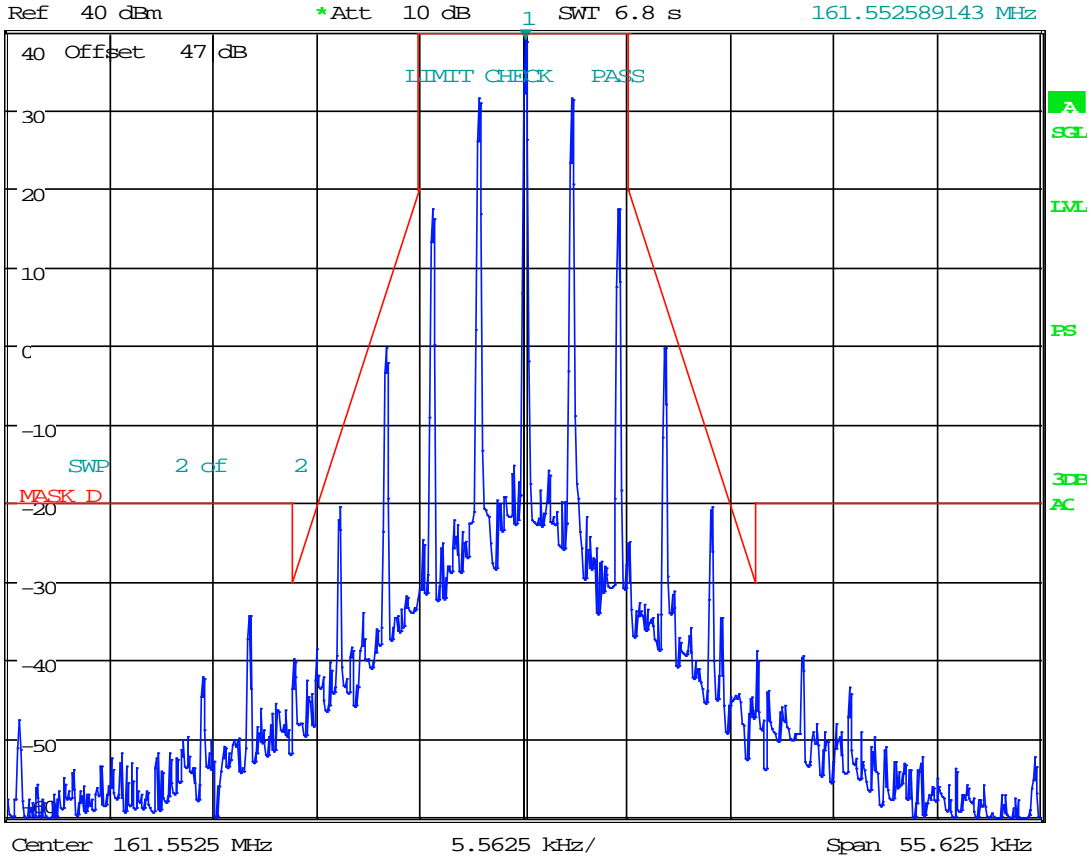

Date: 26.APR.2018 16:40:15

EMISSION MASK D

High Power

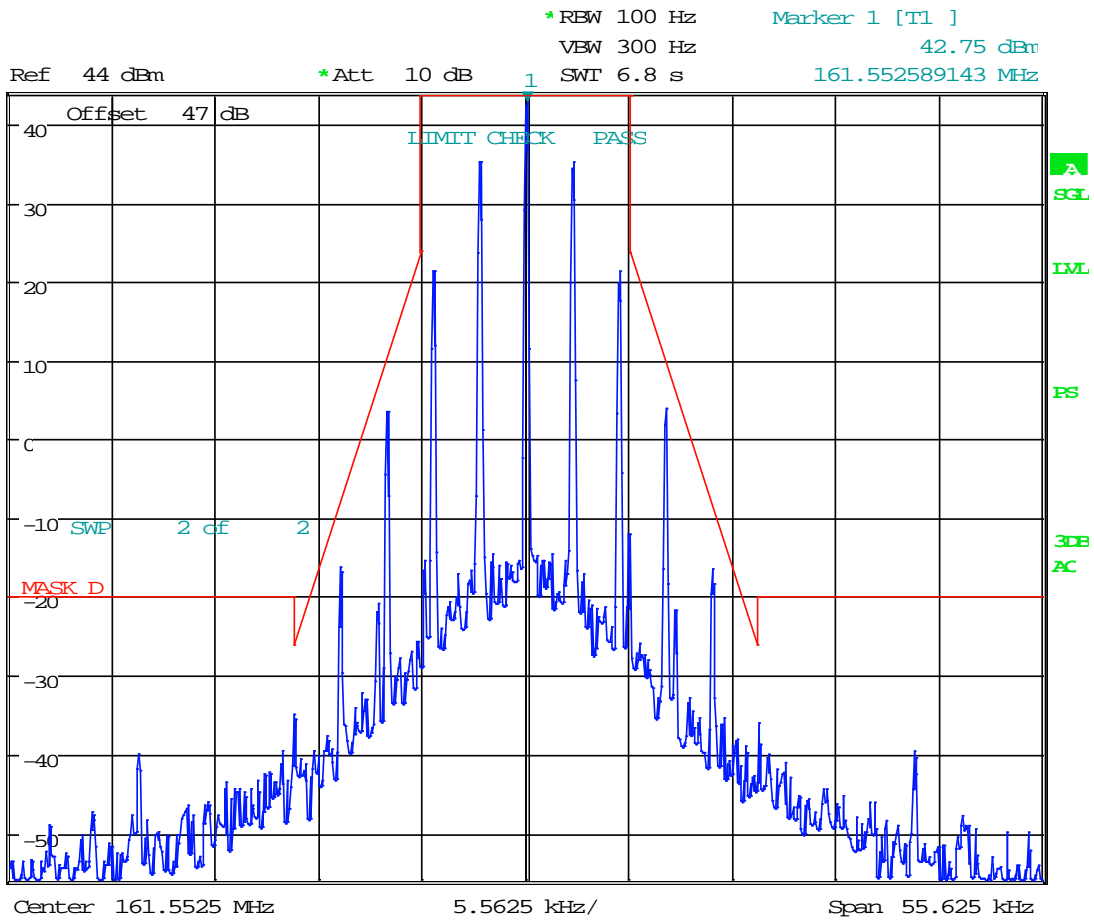

Date: 26.APR.2018 16:27:16

EMISSION MASK D

Test Data: 161.7875 MHz

Low Power

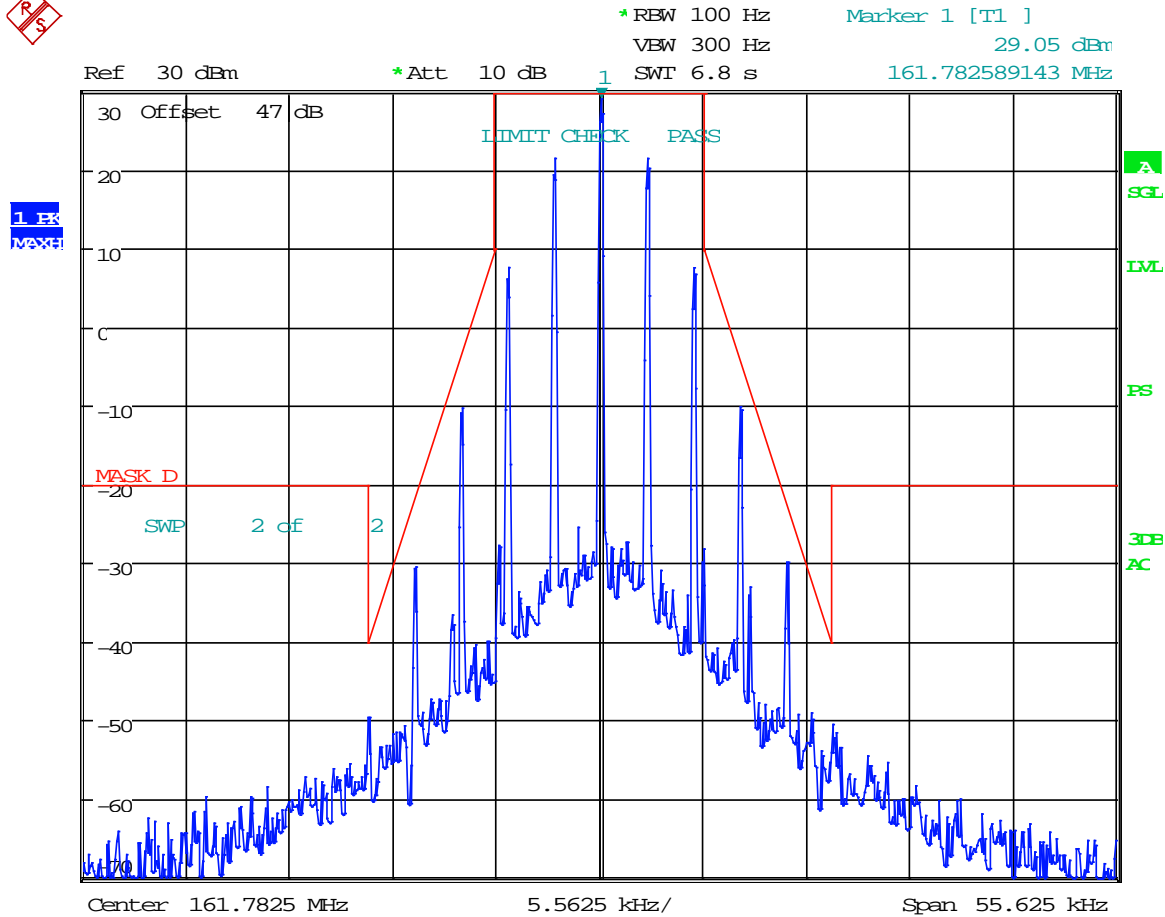

Date: 26.APR.2018 16:52:42

EMISSION MASK D

Medium Power

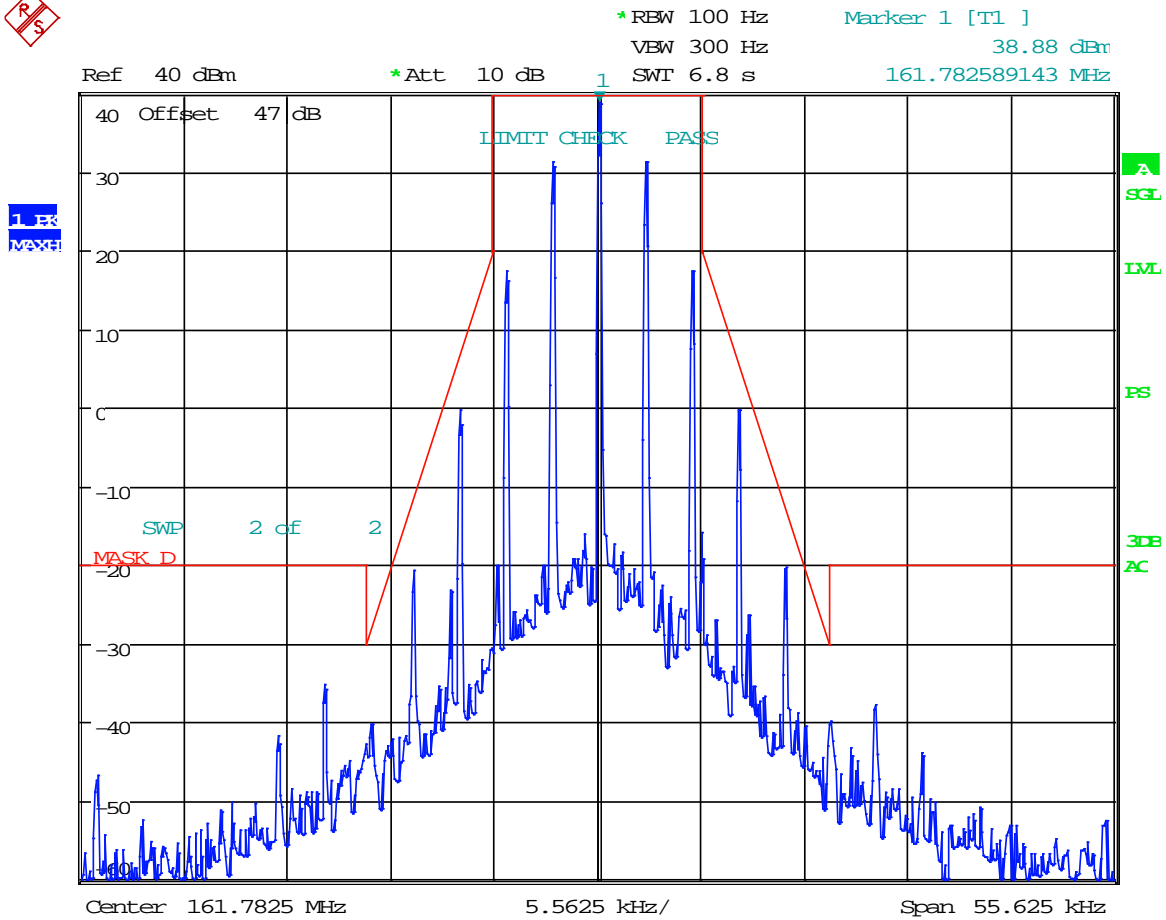

Date: 26.APR.2018 16:41:37

EMISSION MASK D

High Power

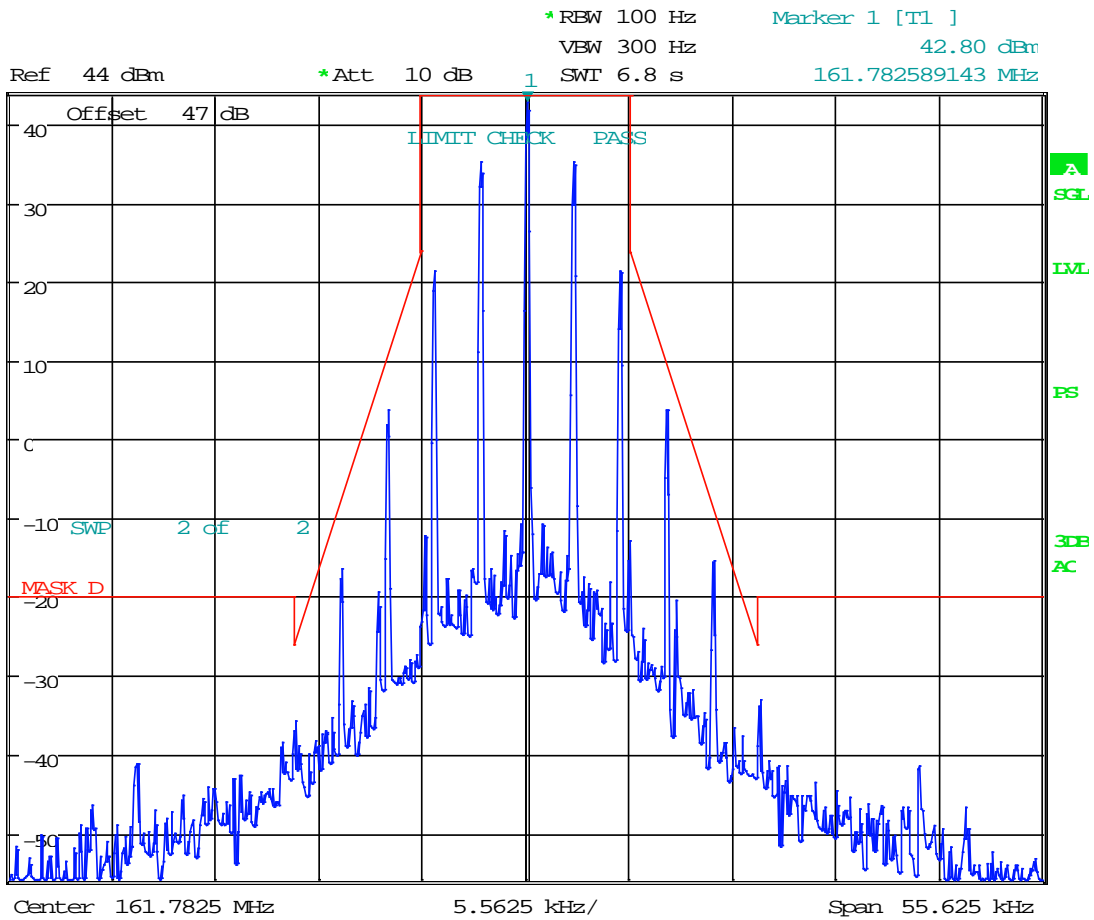

Date: 26.APR.2018 16:29:00

EMISSION MASK D

Test Data: 162.045 MHz

Low Power

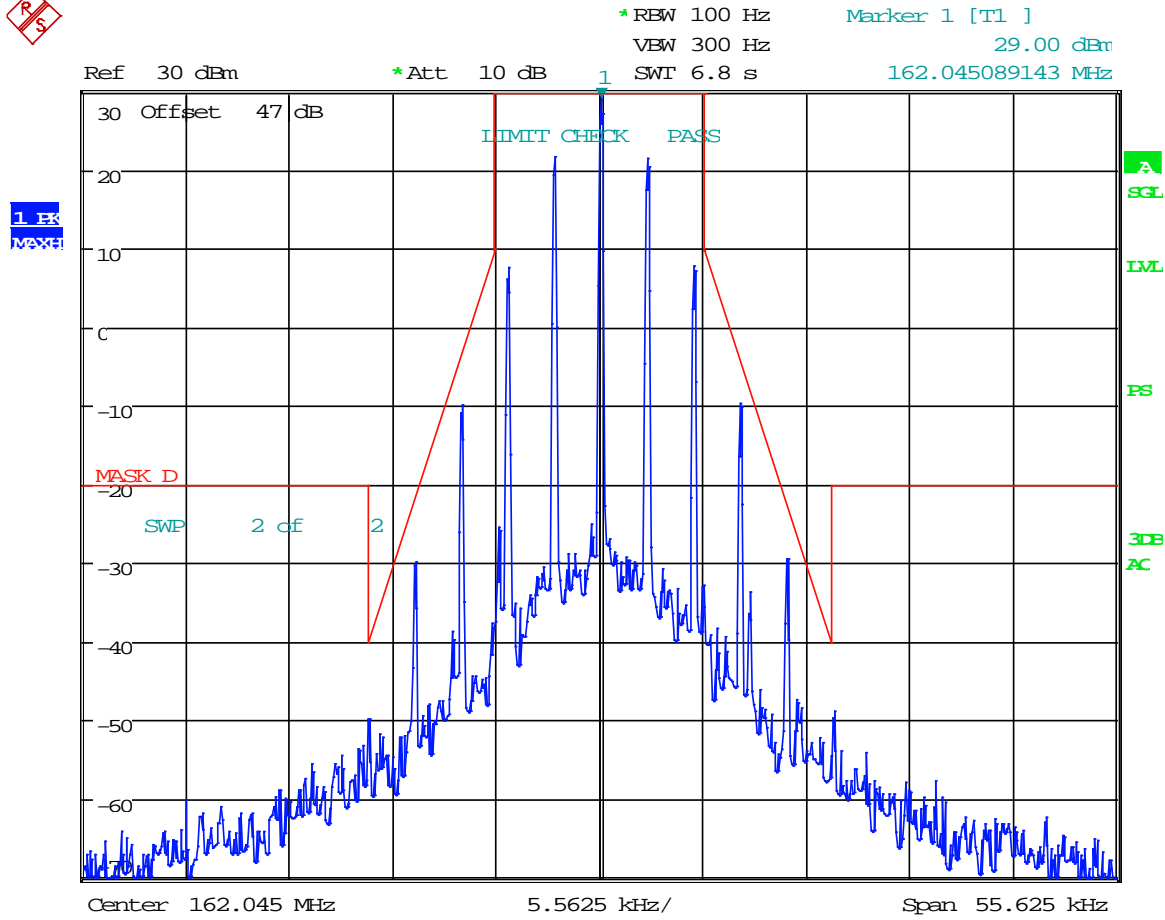

Date: 26.APR.2018 16:53:16

EMISSION MASK D

Medium Power



*RBW 100 Hz Marker 1 [T1]
 VBW 300 Hz 38.84 dBm
 *Att 10 dB 1 162.045089143 MHz
 SWT 6.8 s

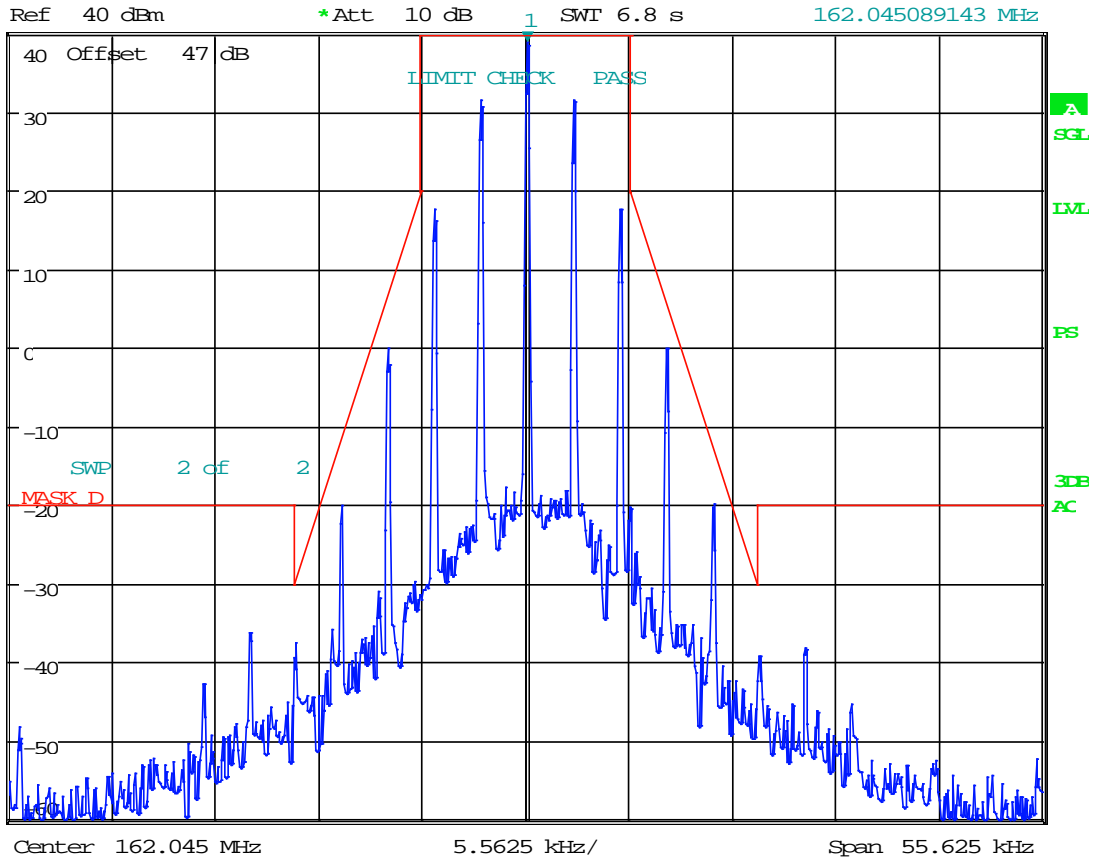

Date: 26.APR.2018 16:42:14

EMISSION MASK D

High Power

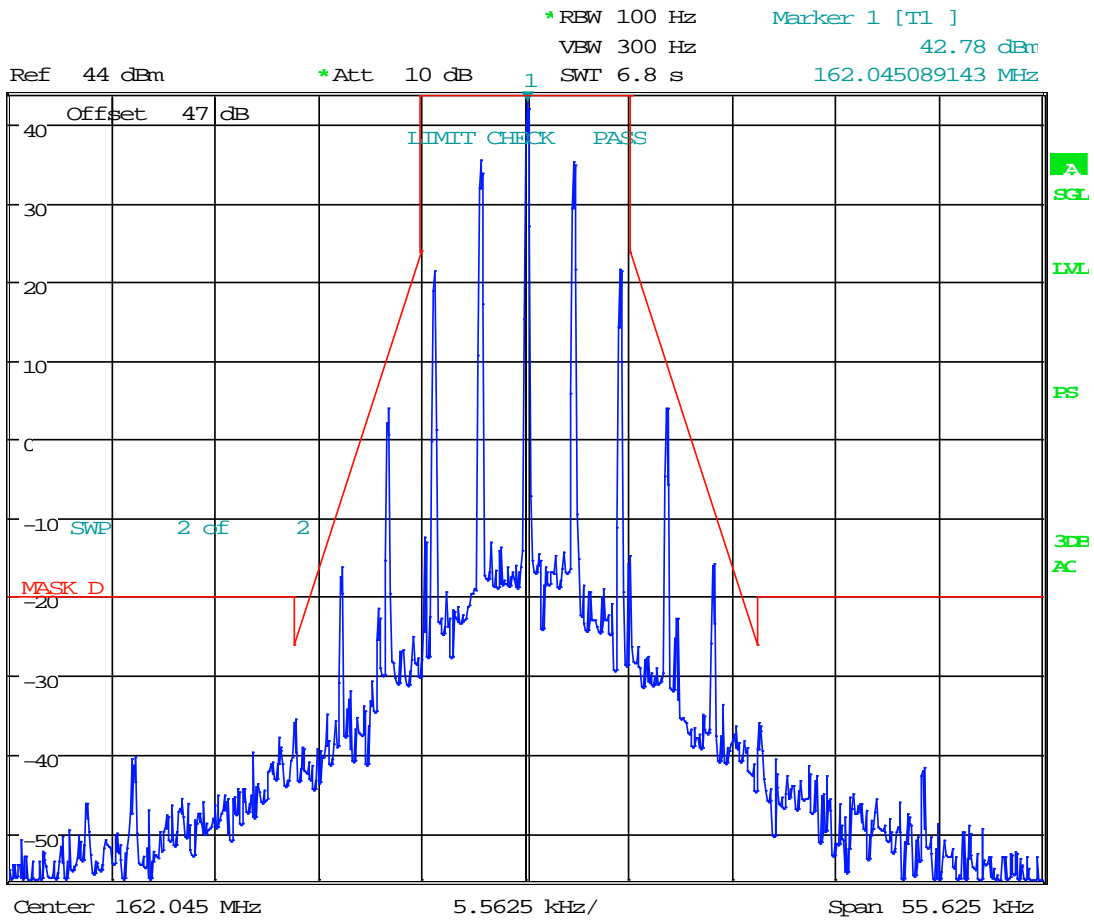

Date: 26.APR.2018 16:29:39

EMISSION MASK D

Test Data: 167.0000 MHz

Low Power

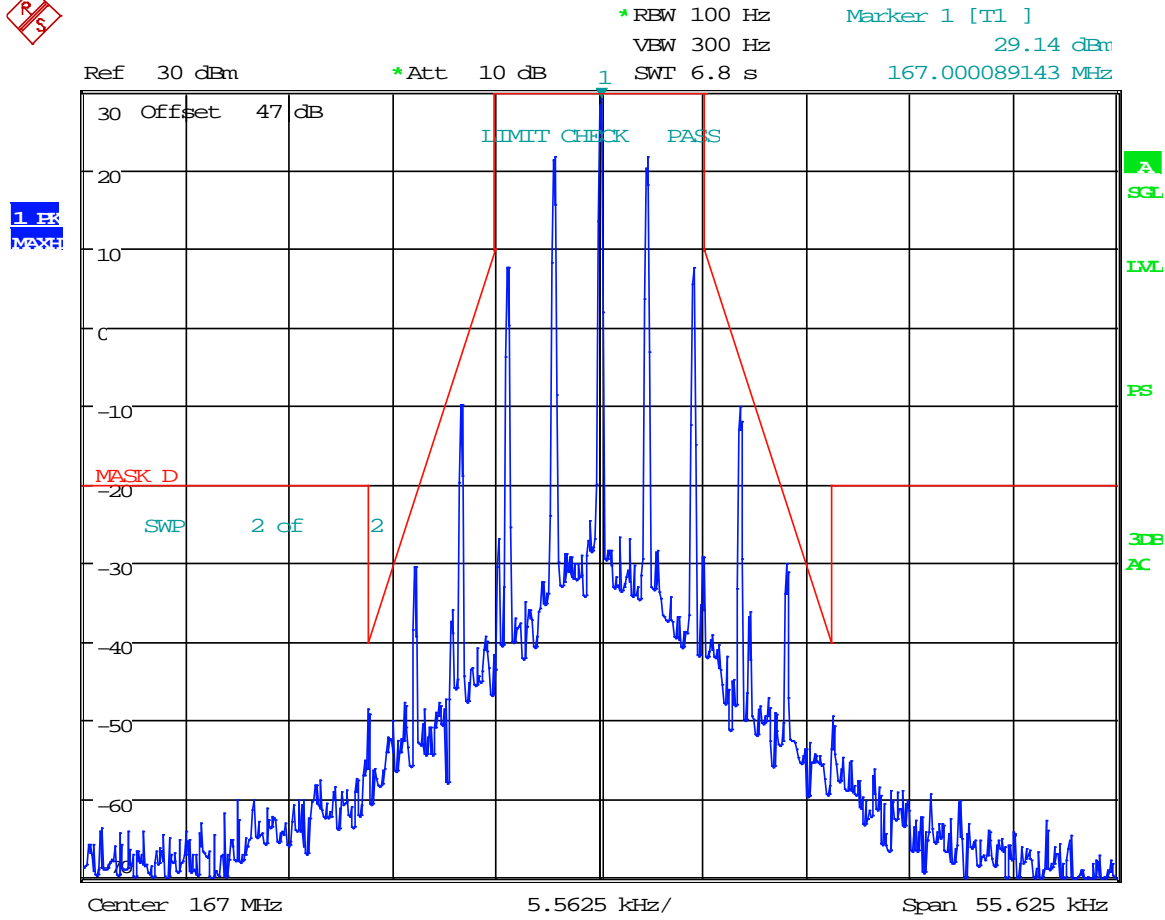

Date: 26.APR.2018 16:54:07

EMISSION MASK D

Medium Power

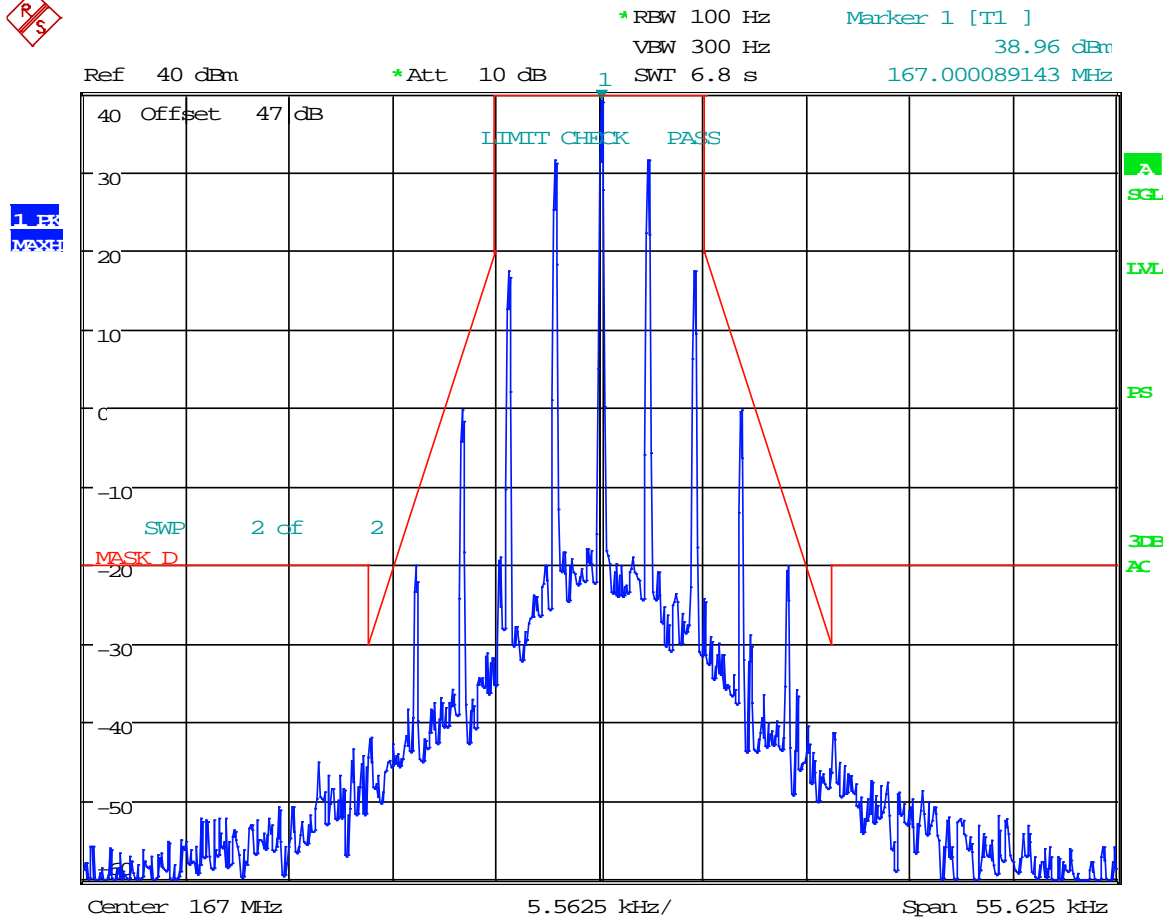

Date: 26.APR.2018 16:42:52

EMISSION MASK D

High Power

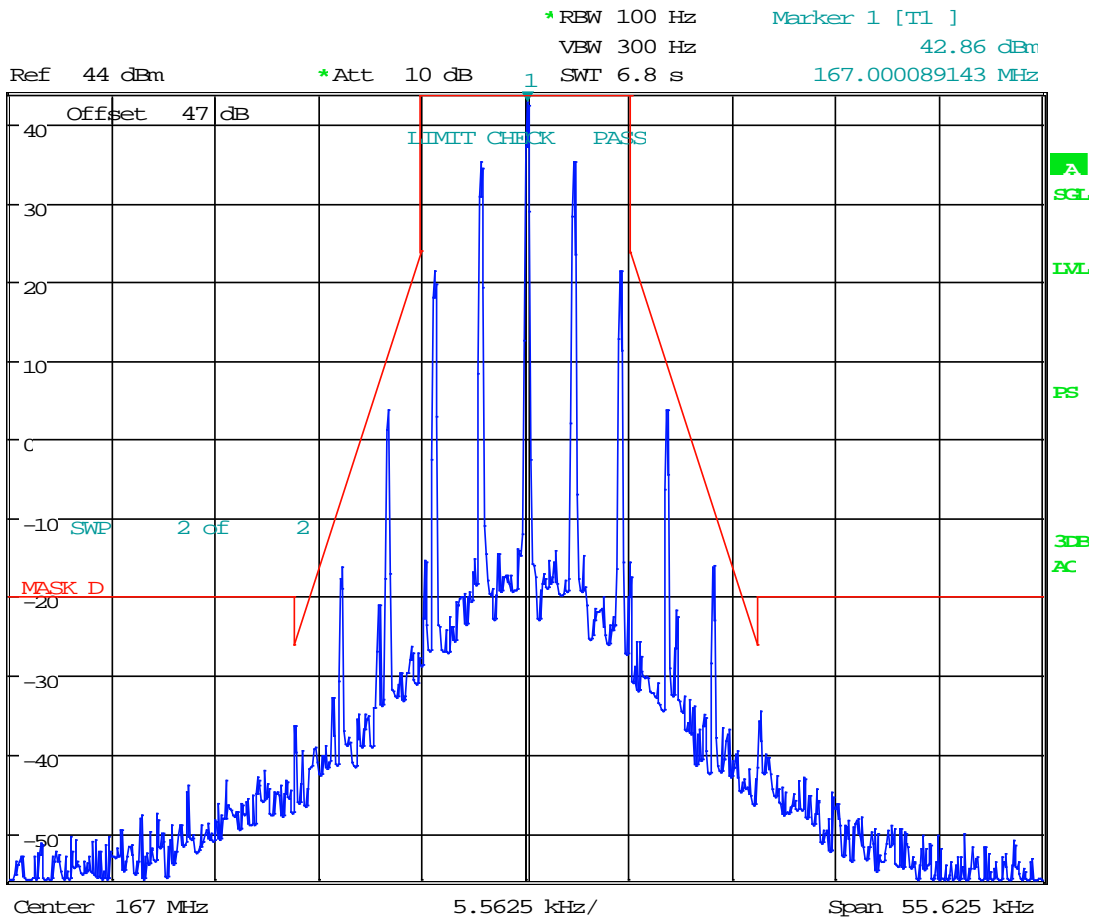

Date: 26.APR.2018 16:30:12

Result: Meets Requirements

EMISSION MASK D

Test Data: 173.3925 MHz

Low Power



*RBW 100 Hz
 *Att 10 dB
 Marker 1 [T1]
 29.01 dBm
 173.392589143 MHz

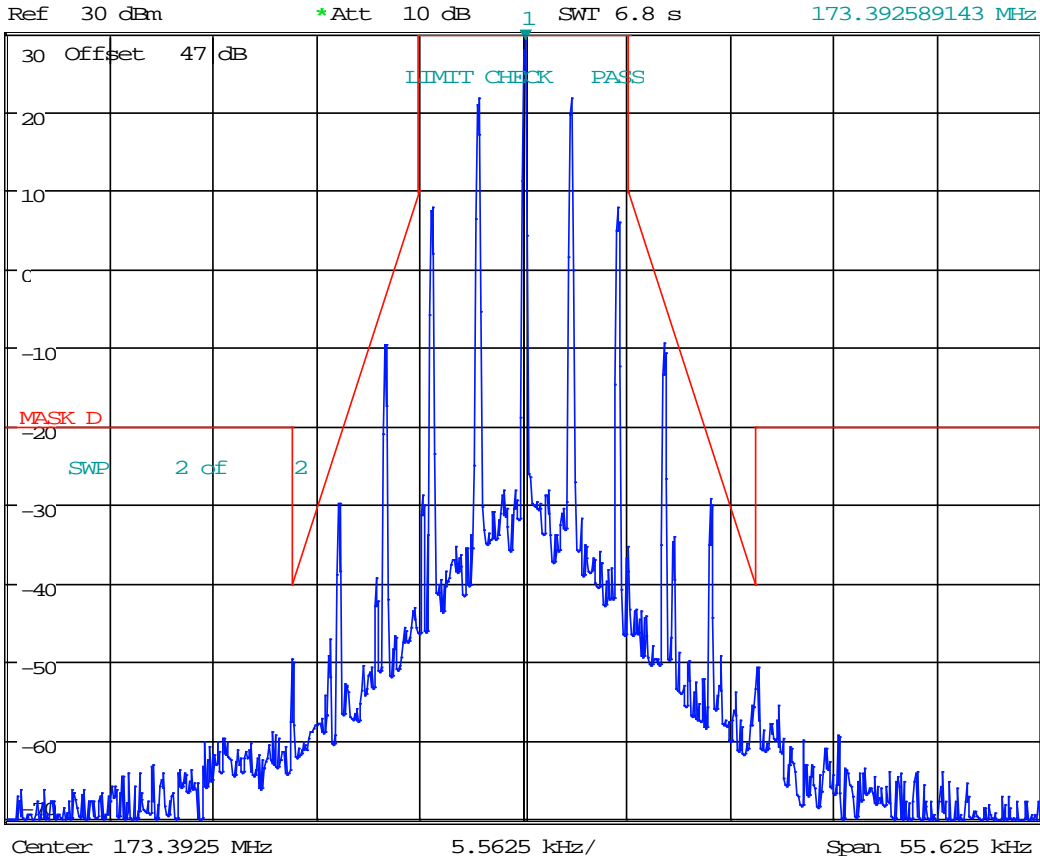

Date: 26.APR.2018 16:54:42

EMISSION MASK D

Medium Power

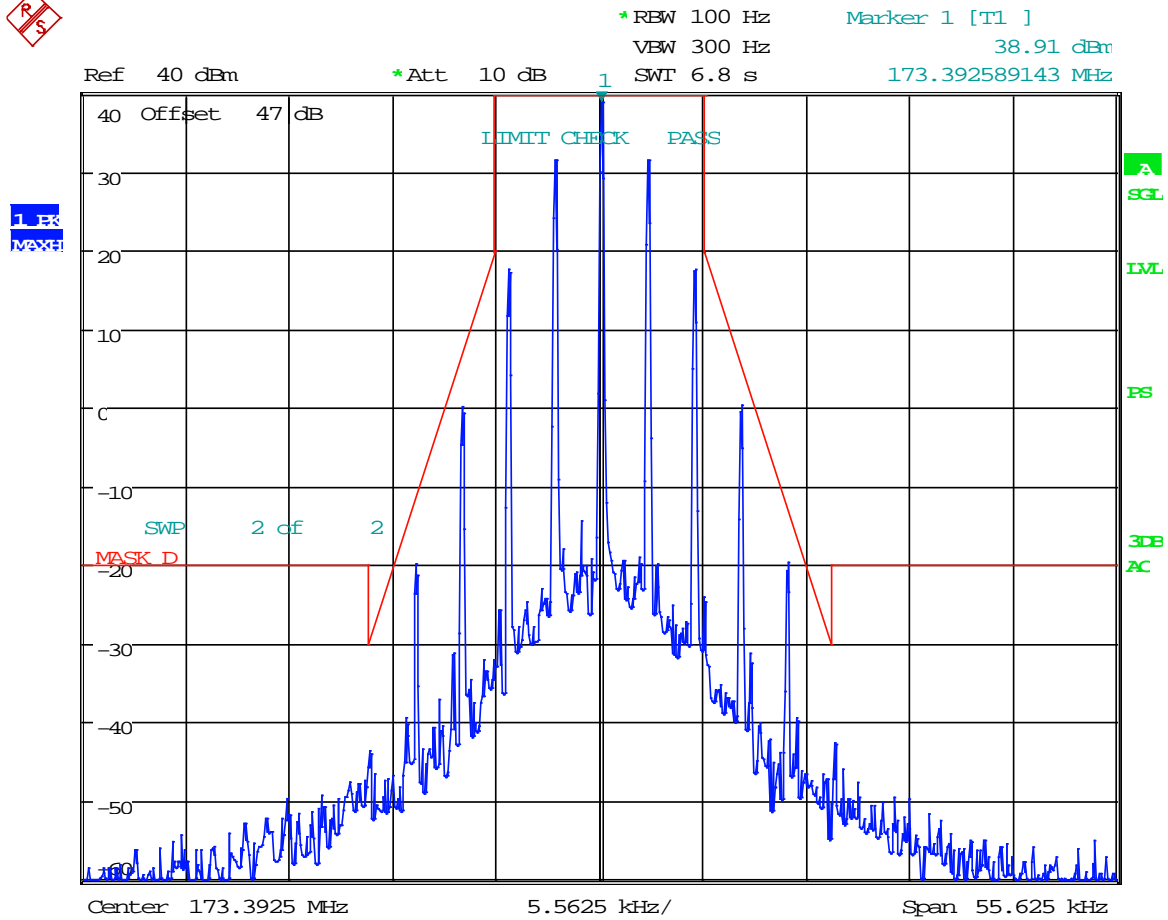

Date: 26.APR.2018 16:43:34

EMISSION MASK D

High Power

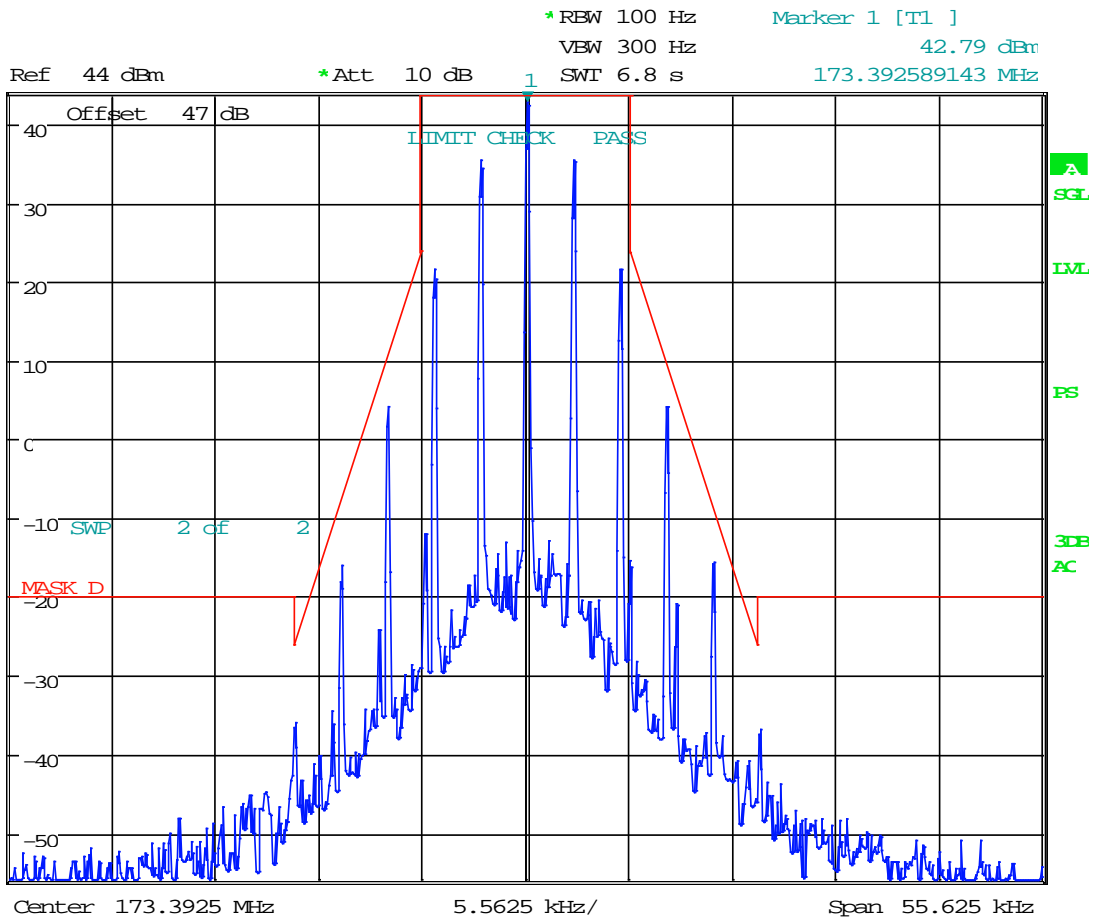

Date: 26.APR.2018 16:30:51

EMISSION MASK D – P25 Phase I C4FM (12.5 kHz)

Test Data: 150.8075 MHz

Low Power



Ref Lvl	Marker 1 [T1]	RBW	100 Hz	RF Att	20 dB
30 dBm	25.07 dBm	VBW	1 kHz		
	150.80811310 MHz	SWT	28 s	Unit	dBm

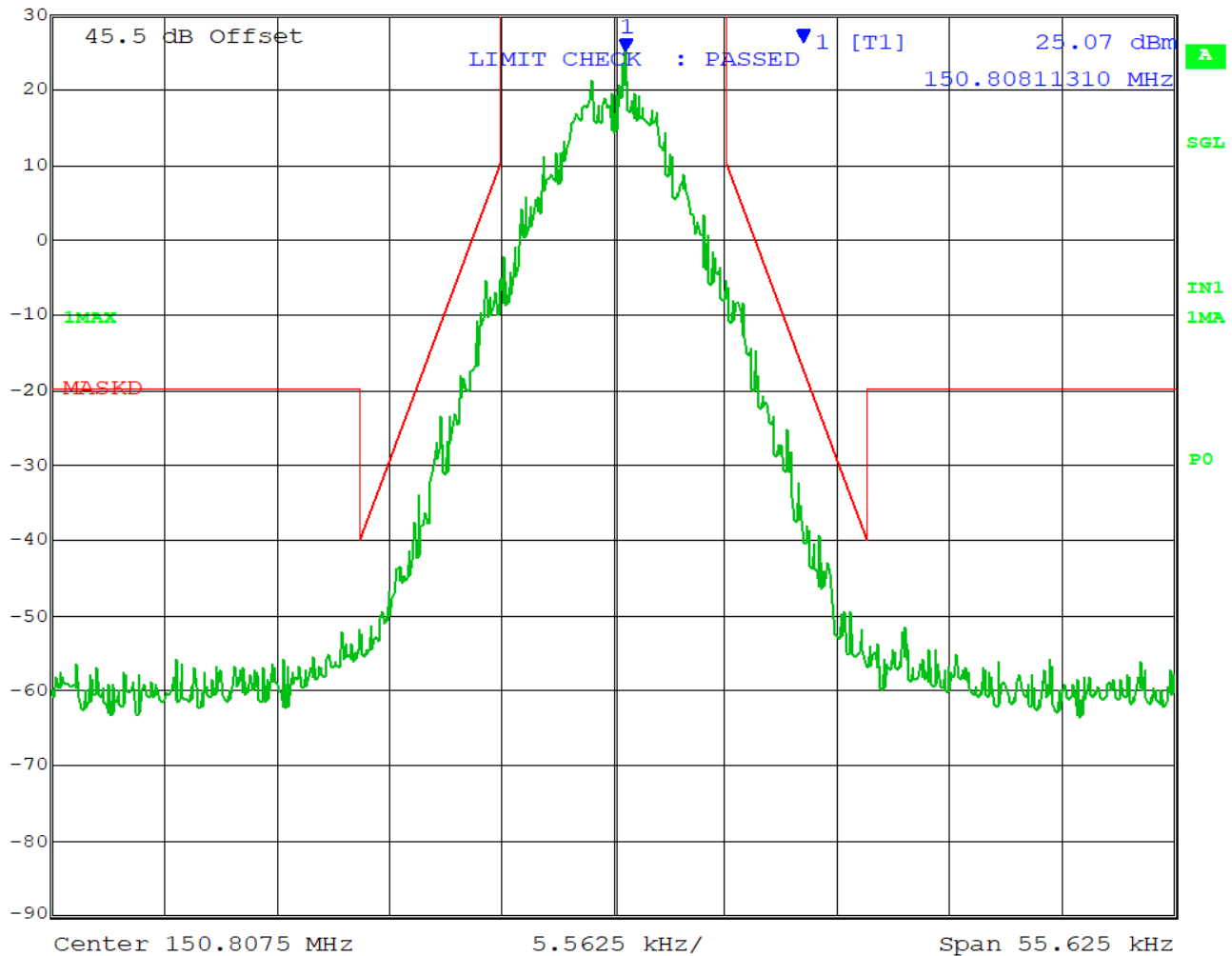

Date: 1.JAN.1997 06:45:10

EMISSION MASK D

Medium Power



Ref Lvl	Marker 1 [T1]	RBW	100 Hz	RF Att	20 dB
40 dBm	34.68 dBm	VBW	1 kHz		
	150.80822457 MHz	SWT	28 s	Unit	dBm

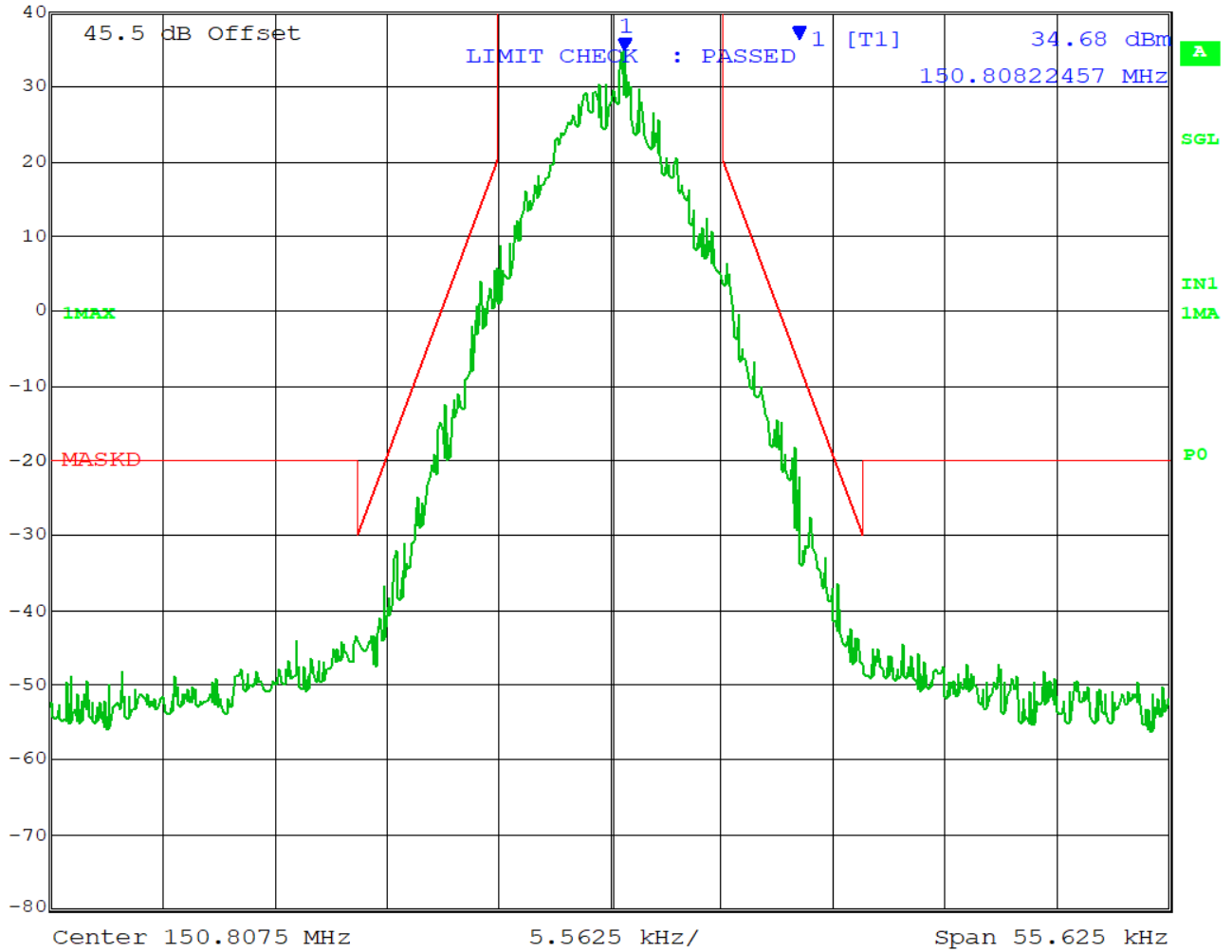

Date: 1.JAN.1997 06:02:31

EMISSION MASK D

High Power



Ref Lvl	Marker 1 [T1]	RBW	100 Hz	RF Att	20 dB
44 dBm	37.41 dBm	VBW	1 kHz		
	150.80811310 MHz	SWT	28 s	Unit	dBm

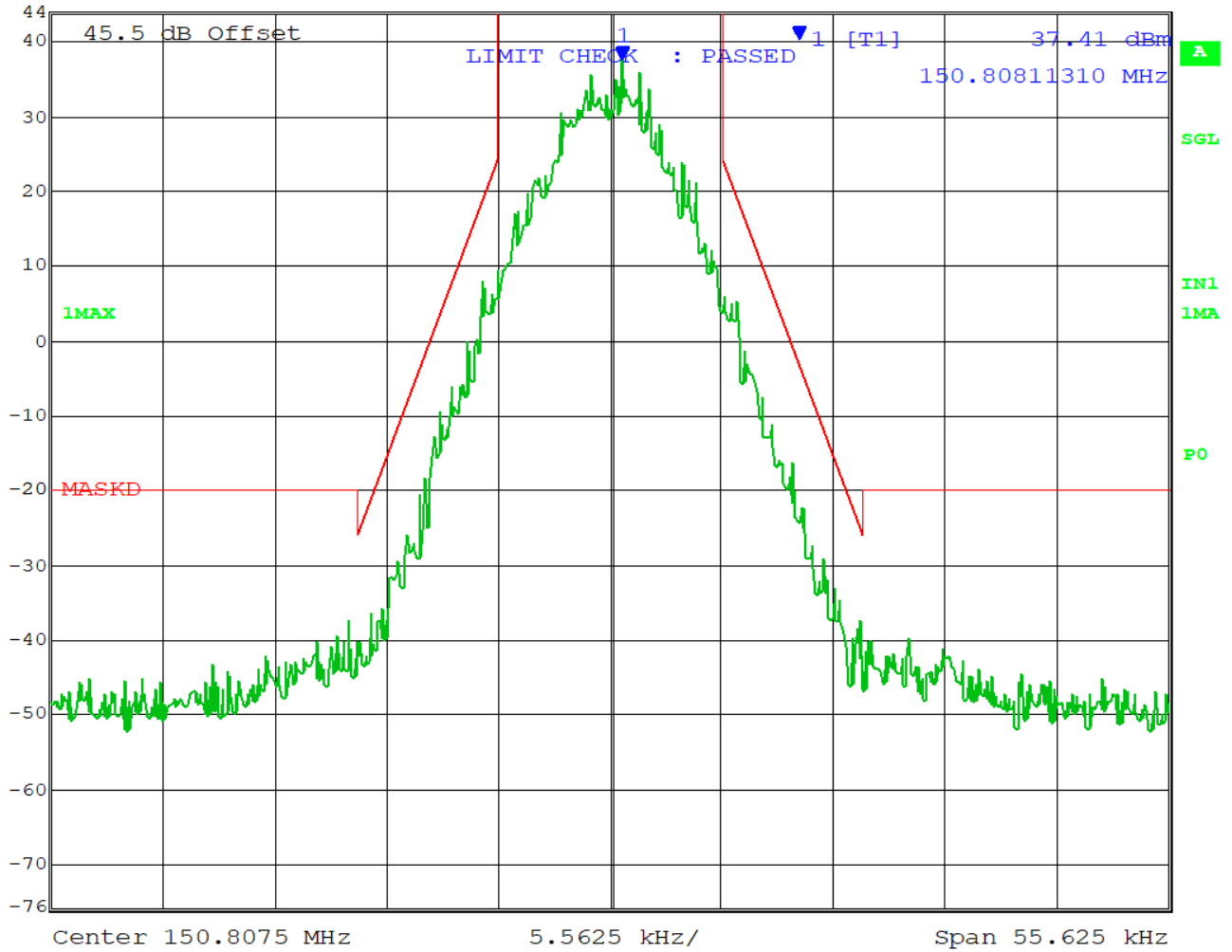

Date: 1.JAN.1997 05:17:31

EMISSION MASK D

Test Data: 156.2225 MHz

Low Power



Ref Lvl	Marker 1 [T1]	RBW	100 Hz	RF Att	20 dB
30 dBm	24.56 dBm	VBW	1 kHz		
	156.22311310 MHz	SWT	28 s	Unit	dBm

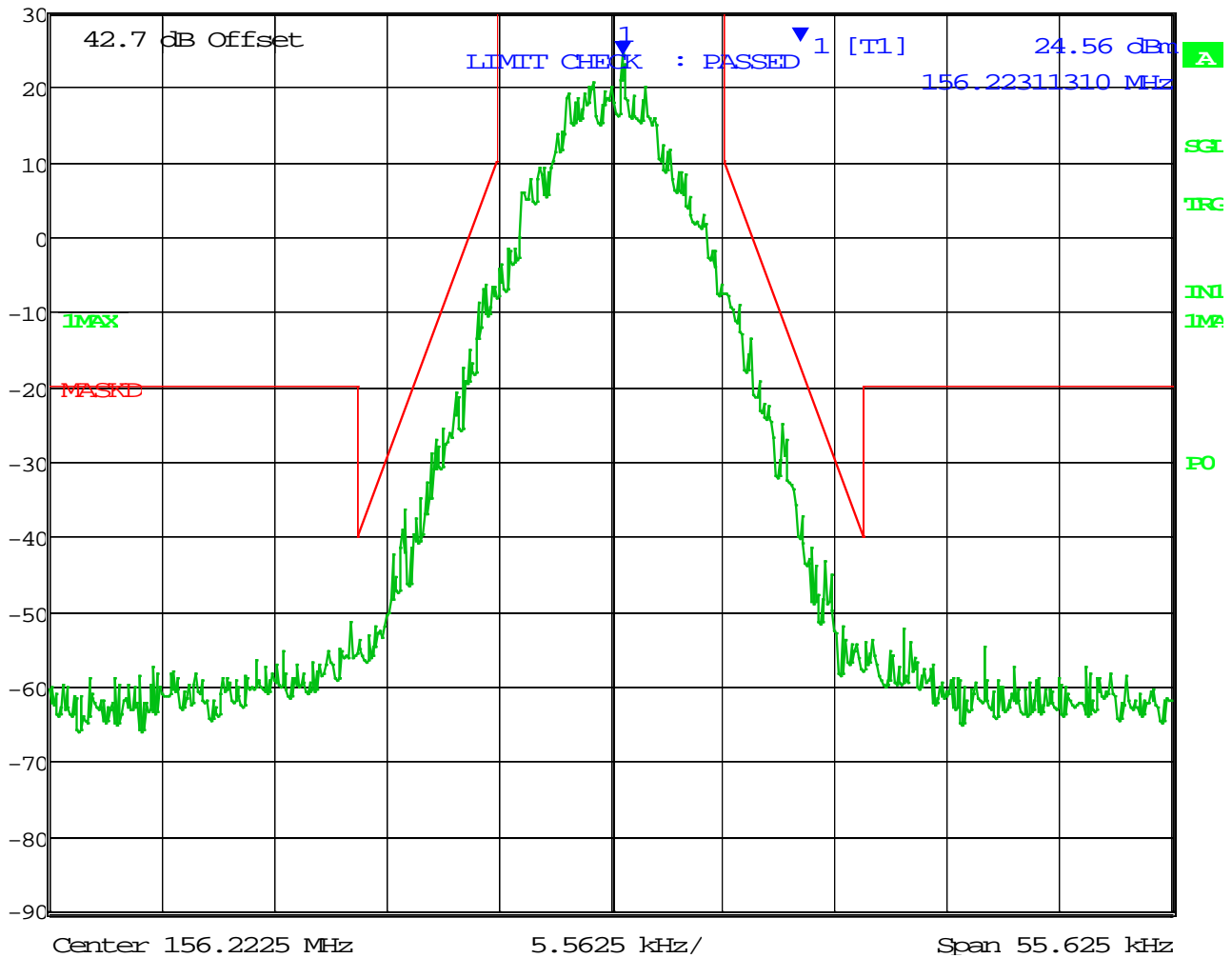

Date: 1.JAN.1997 02:25:53

EMISSION MASK D

Medium Power



Marker 1 [T1] RBW 100 Hz RF Att 20 dB
 Ref Lvl 34.46 dBm VBW 1 kHz
 40 dBm 156.22311310 MHz SWT 28 s Unit dBm

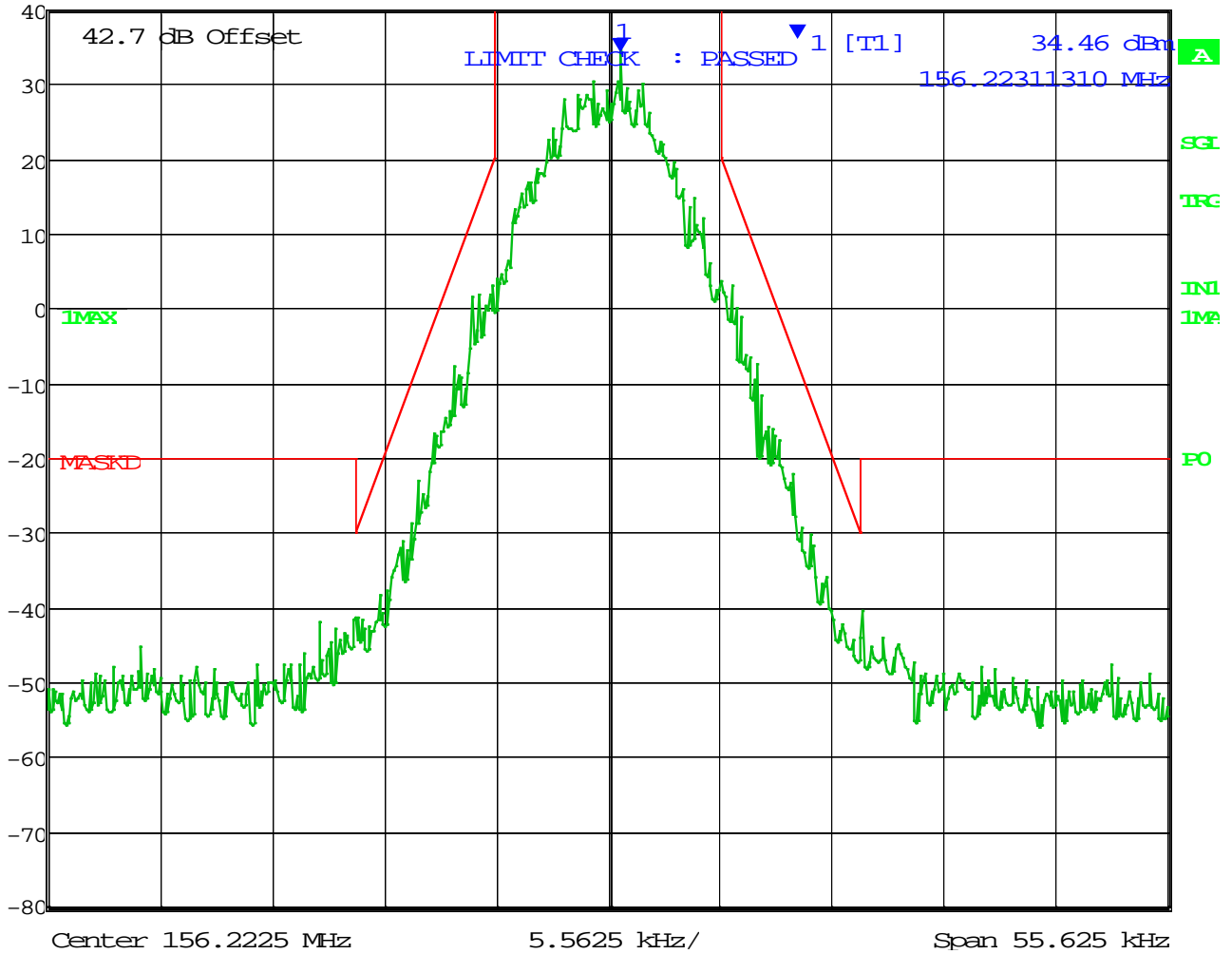

Date: 1.JAN.1997 02:30:26

EMISSION MASK D

High Power



Marker 1 [T1] RBW 100 Hz RF Att 20 dB
 Ref Lvl 36.96 dBm VBW 1 kHz
 44 dBm 156.22311310 MHz SWT 28 s Unit dBm

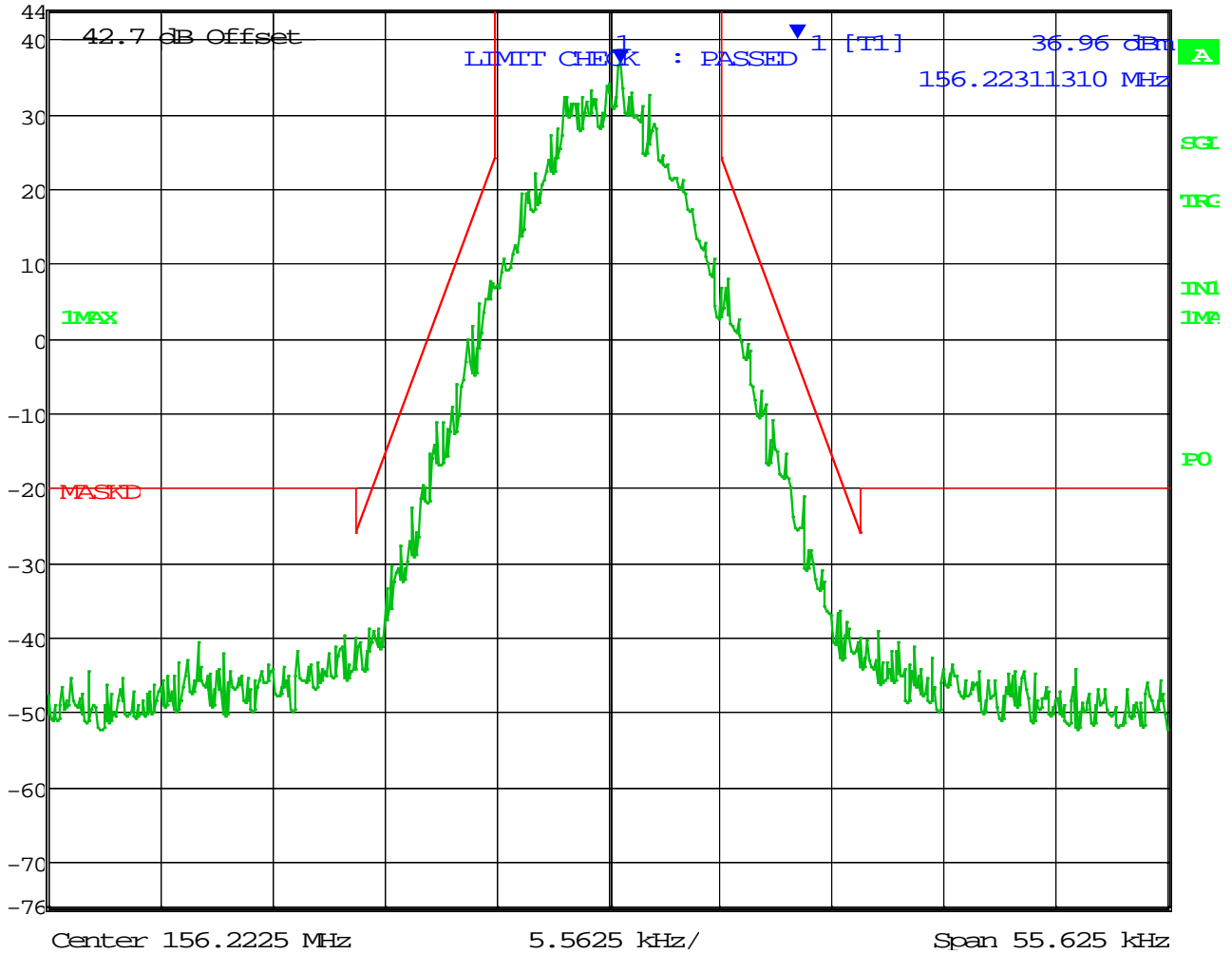

Date: 1.JAN.1997 02:34:34

EMISSION MASK D

Test Data: 157.4575 MHz

Low Power



Ref Lvl	30 dBm	Marker 1 [T1]	24.40 dBm	RBW	100 Hz	RF Att	20 dB
			157.45811310 MHz	VBW	1 kHz	Unit	dBm
				SWT	28 s		

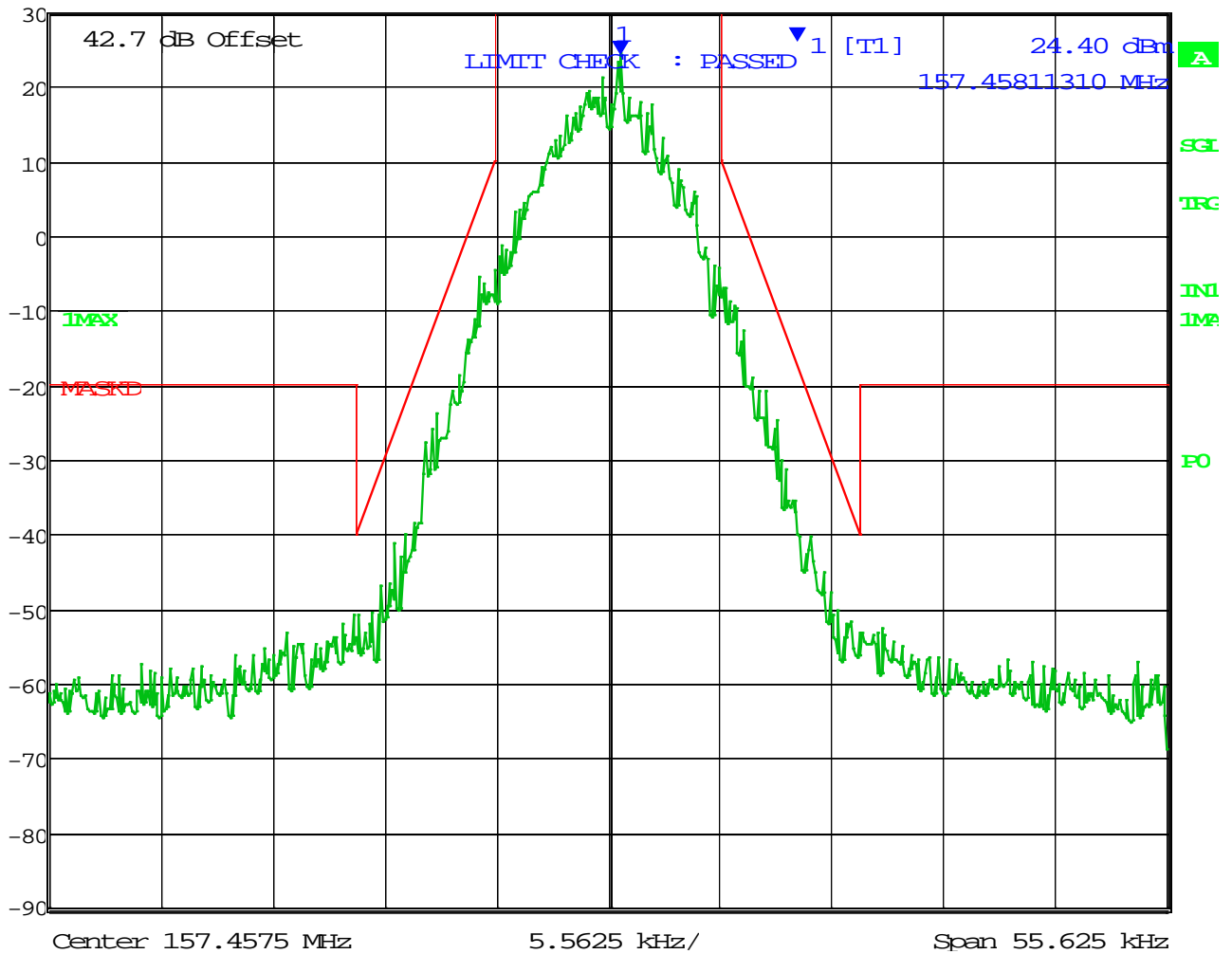

Date: 1.JAN.1997 02:26:55

EMISSION MASK D

Medium Power



Marker 1 [T1] RBW 100 Hz RF Att 20 dB
 Ref Lvl 34.50 dBm VBW 1 kHz
 40 dBm 157.45811310 MHz SWT 28 s Unit dBm

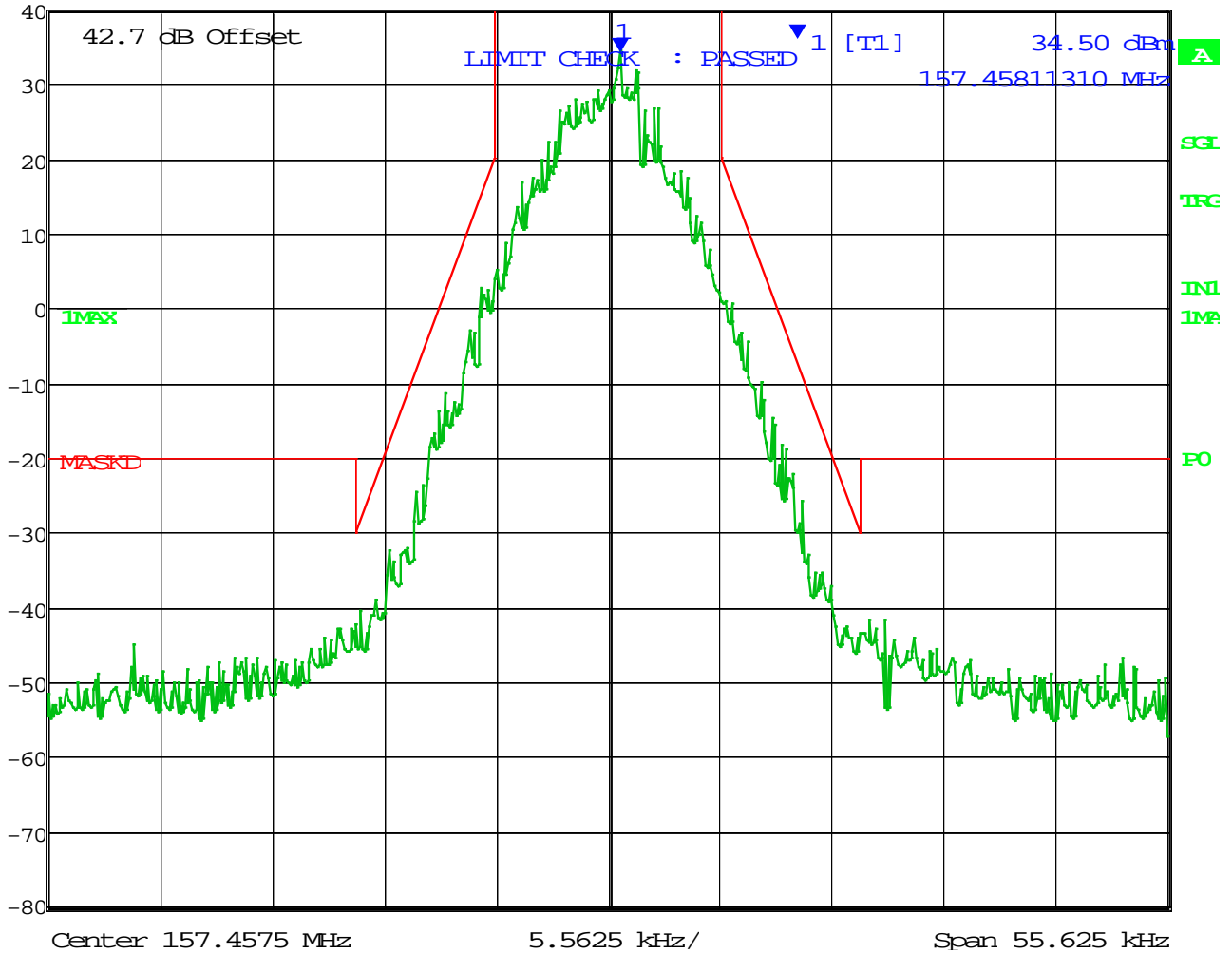

Date: 1.JAN.1997 02:31:26

EMISSION MASK D

High Power



Ref Lvl	Marker 1 [T1]	RBW	100 Hz	RF Att	20 dB
44 dBm	37.47 dBm	VBW	1 kHz		
	157.45811310 MHz	SWT	28 s	Unit	dBm

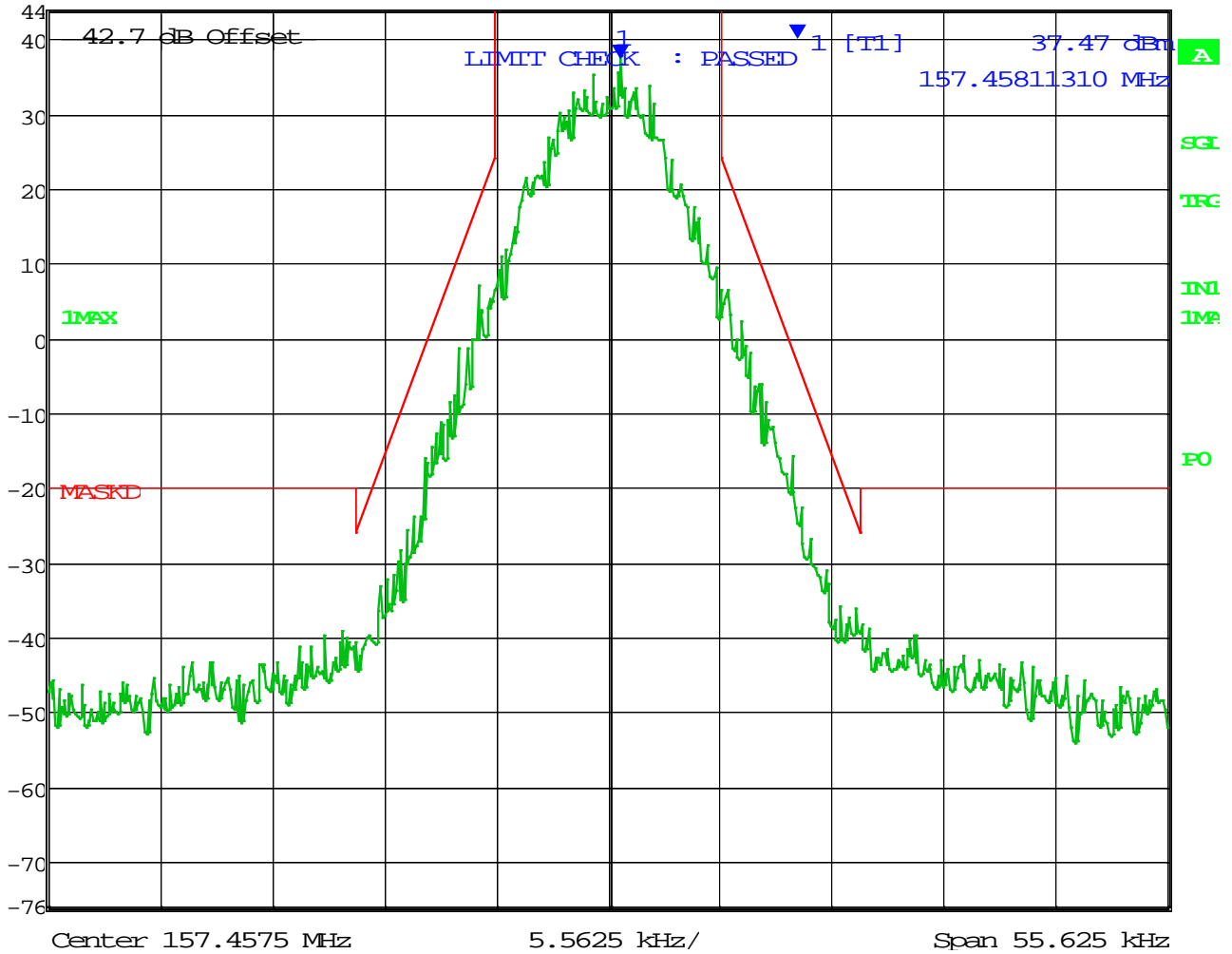

Date: 1.JAN.1997 02:35:45

EMISSION MASK D

Test Data: 161.5525 MHz

Low Power



Ref Lvl	Marker 1 [T1]	RBW	100 Hz	RF Att	20 dB
30 dBm	22.48 dBm	VBW	1 kHz		
	161.58322457 MHz	SWT	28 s	Unit	dBm

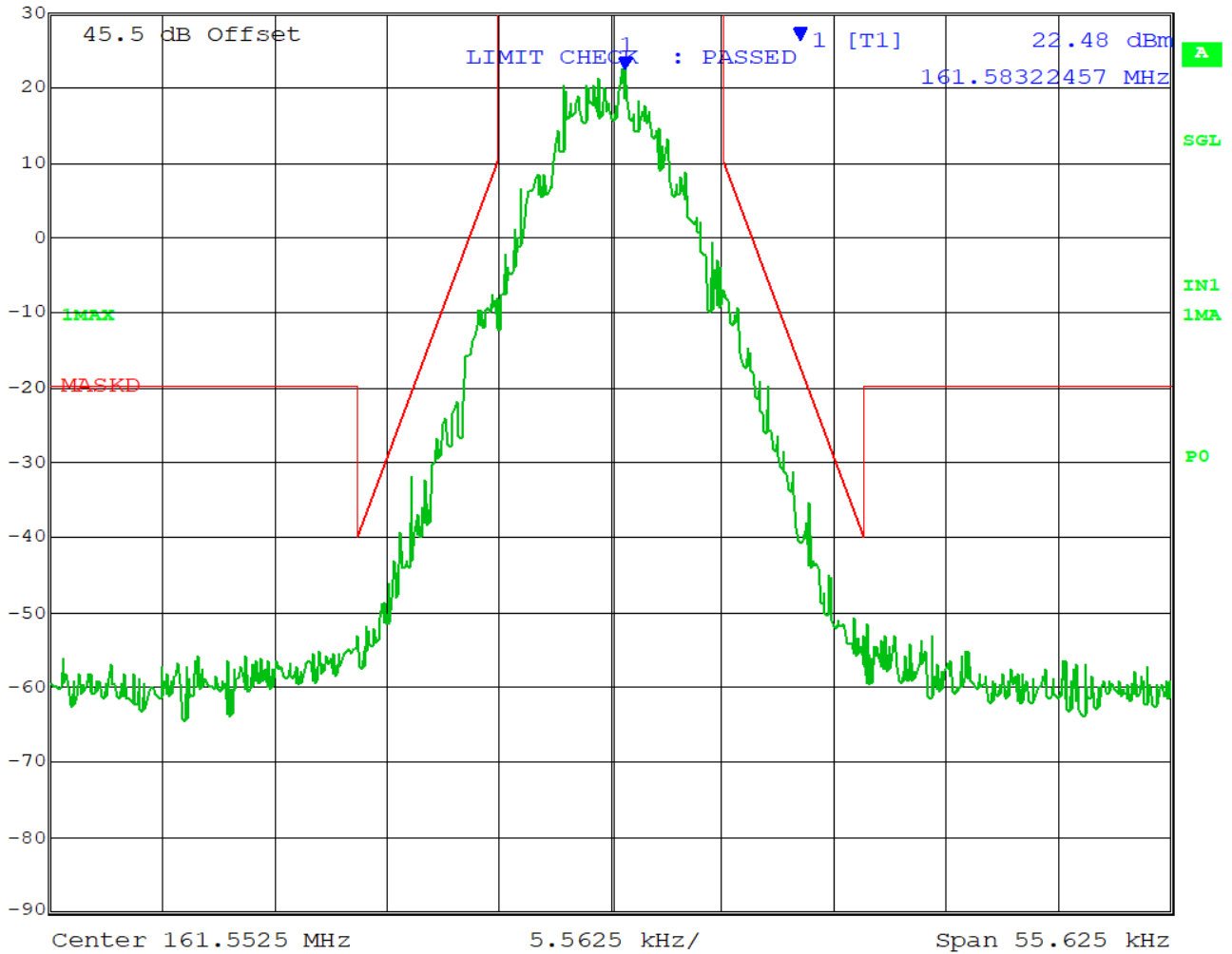

Date: 1.JAN.1997 06:48:21

EMISSION MASK D

Medium Power



Ref Lvl	Marker 1 [T1]	RBW	100 Hz	RF Att	20 dB
40 dBm	33.48 dBm	VBW	1 kHz		
	161.58322457 MHz	SWT	28 s	Unit	dBm

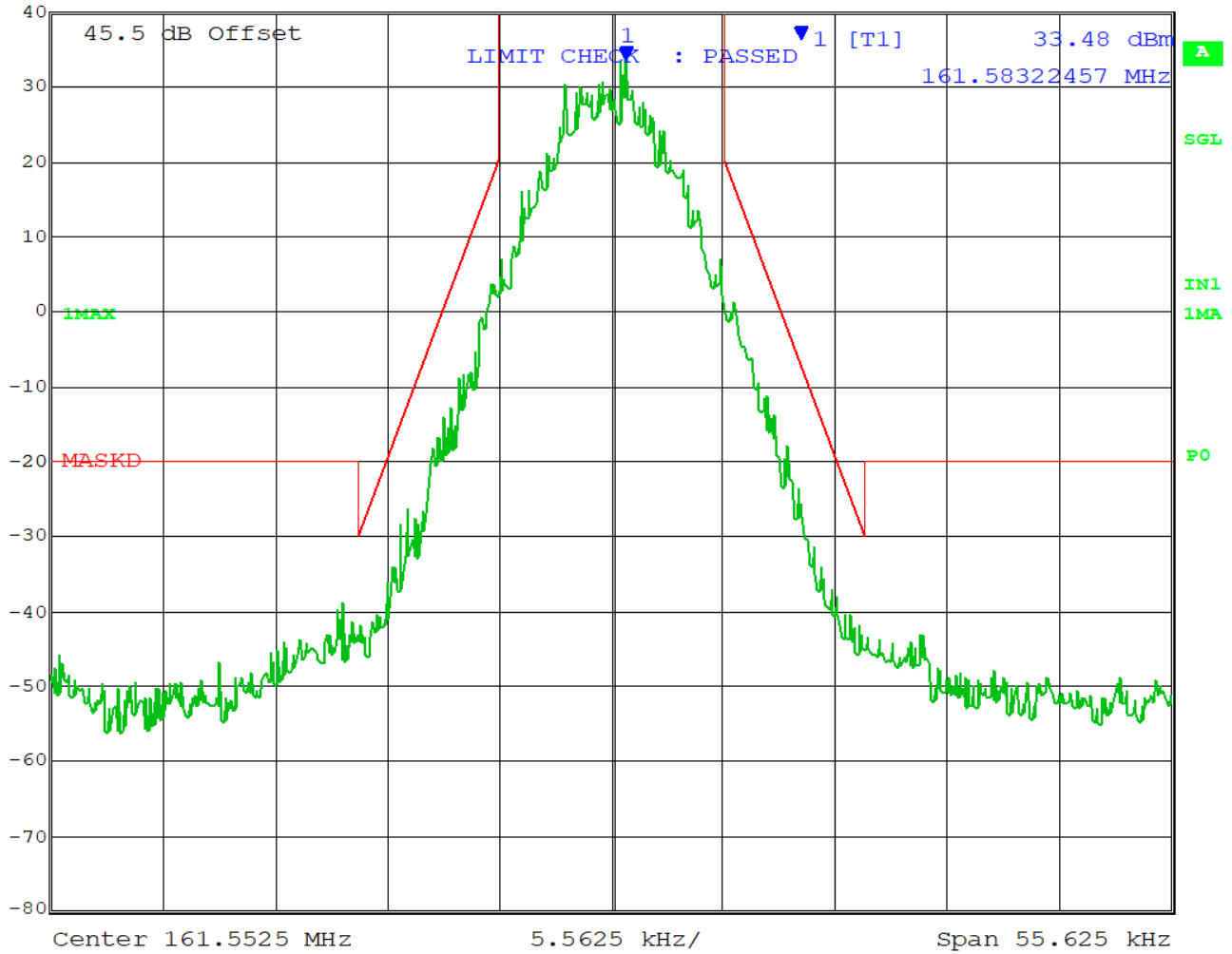

Date: 1.JAN.1997 06:04:41

EMISSION MASK D

High Power



Ref Lvl	Marker 1 [T1]	RBW	100 Hz	RF Att	20 dB
44 dBm	36.48 dBm	VBW	1 kHz		
	161.58311310 MHz	SWT	28 s	Unit	dBm

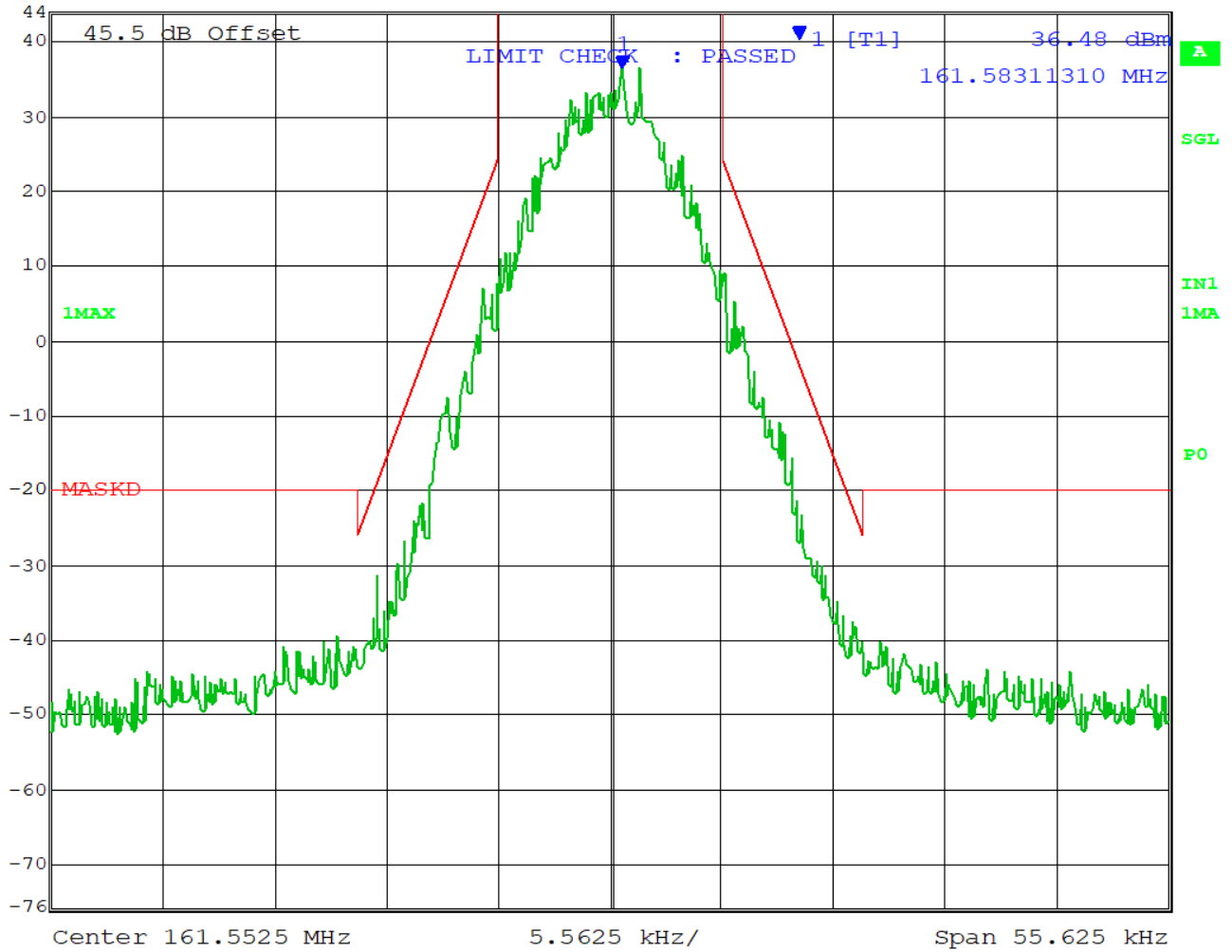

Date: 1.JAN.1997 05:19:38

EMISSION MASK D

Test Data: 161.7875 MHz

Low Power



Ref Lvl	Marker 1 [T1]	RBW	100 Hz	RF Att	20 dB
30 dBm	23.95 dBm	VBW	1 kHz		
	161.78311310 MHz	SWT	28 s	Unit	dBm

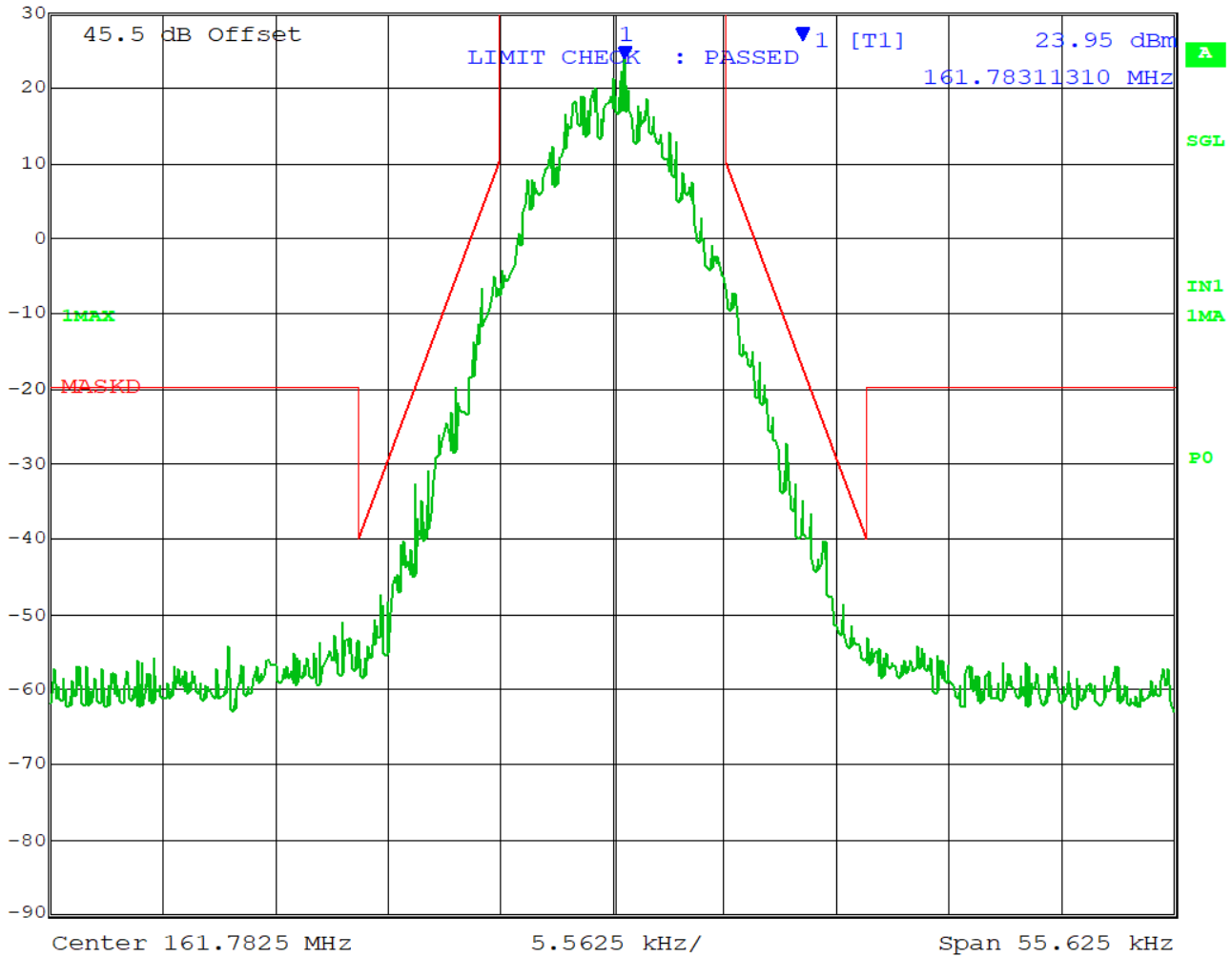

Date: 1.JAN.1997 07:19:57

EMISSION MASK D

Medium Power



Ref Lvl	Marker 1 [T1]	RBW	100 Hz	RF Att	20 dB
40 dBm	32.29 dBm	VBW	1 kHz		
	161.78300163 MHz	SWT	28 s	Unit	dBm

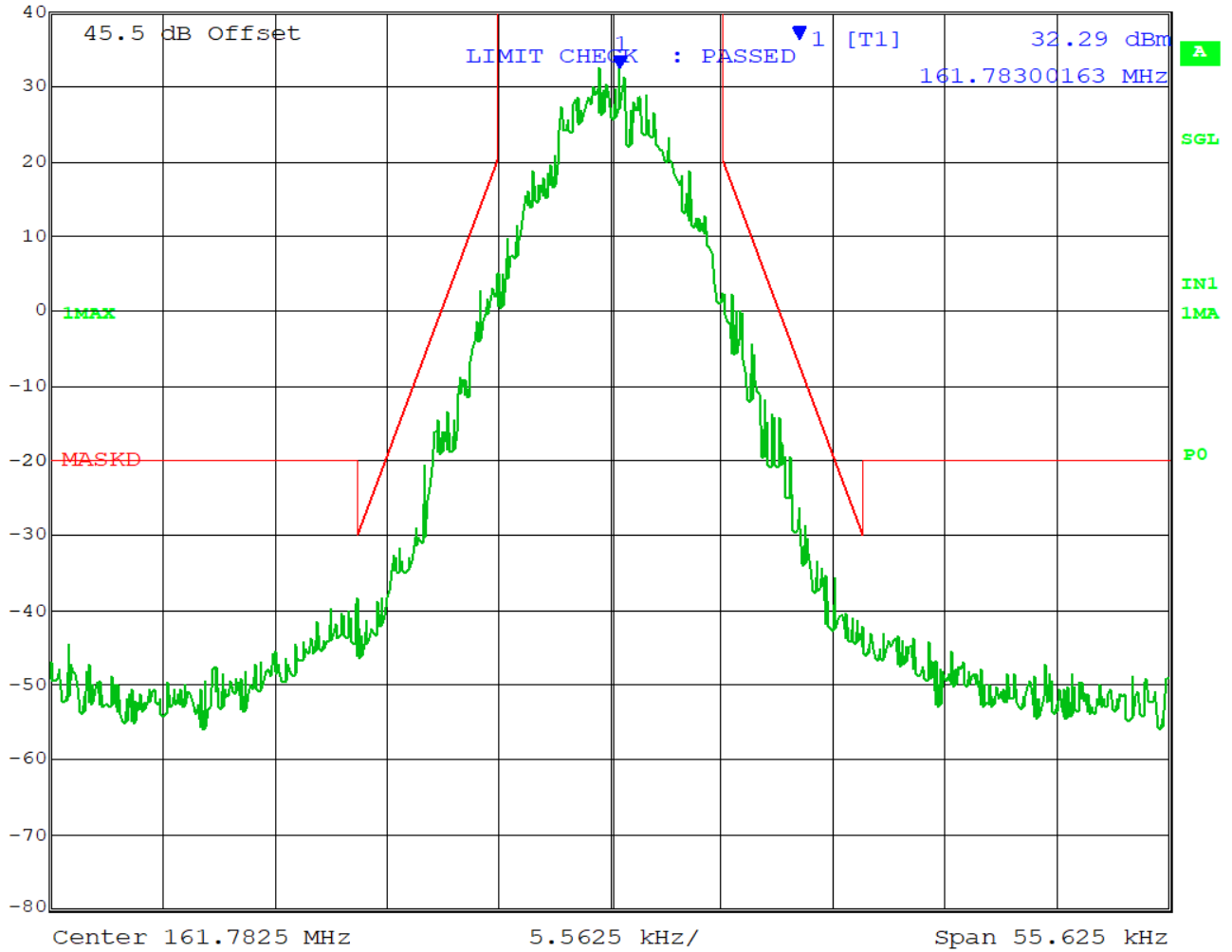

Date: 1.JAN.1997 06:08:54

EMISSION MASK D

High Power



Ref Lvl	Marker 1 [T1]	RBW	100 Hz	RF Att	20 dB
44 dBm	37.39 dBm	VBW	1 kHz		
	161.78322457 MHz	SWT	28 s	Unit	dBm

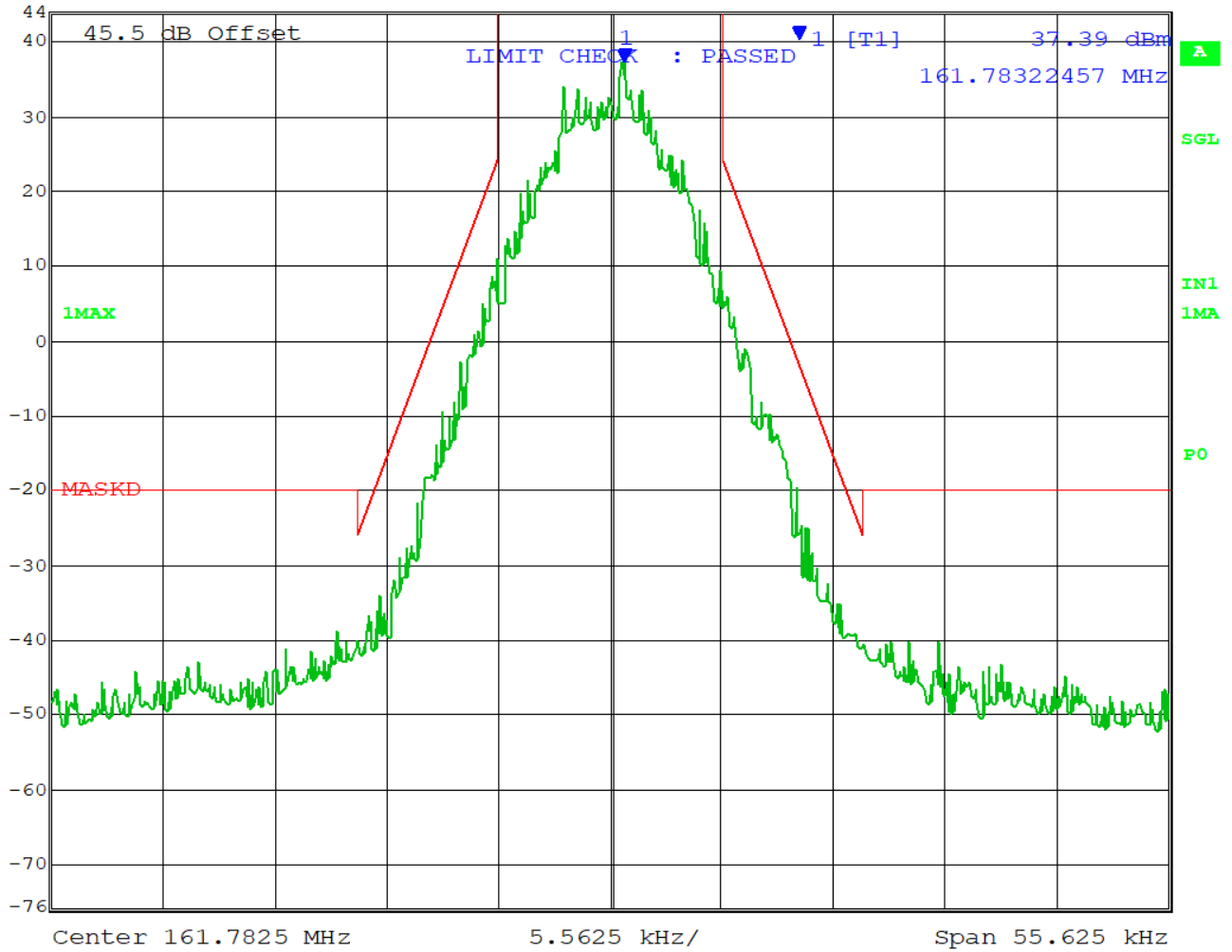

Date: 1.JAN.1997 05:21:38

EMISSION MASK D

Test Data: 162.045 MHz

Low Power



Ref Lvl	Marker 1 [T1]	RBW	100 Hz	RF Att	20 dB
30 dBm	25.31 dBm	VBW	1 kHz		
	162.04550163 MHz	SWT	28 s	Unit	dBm

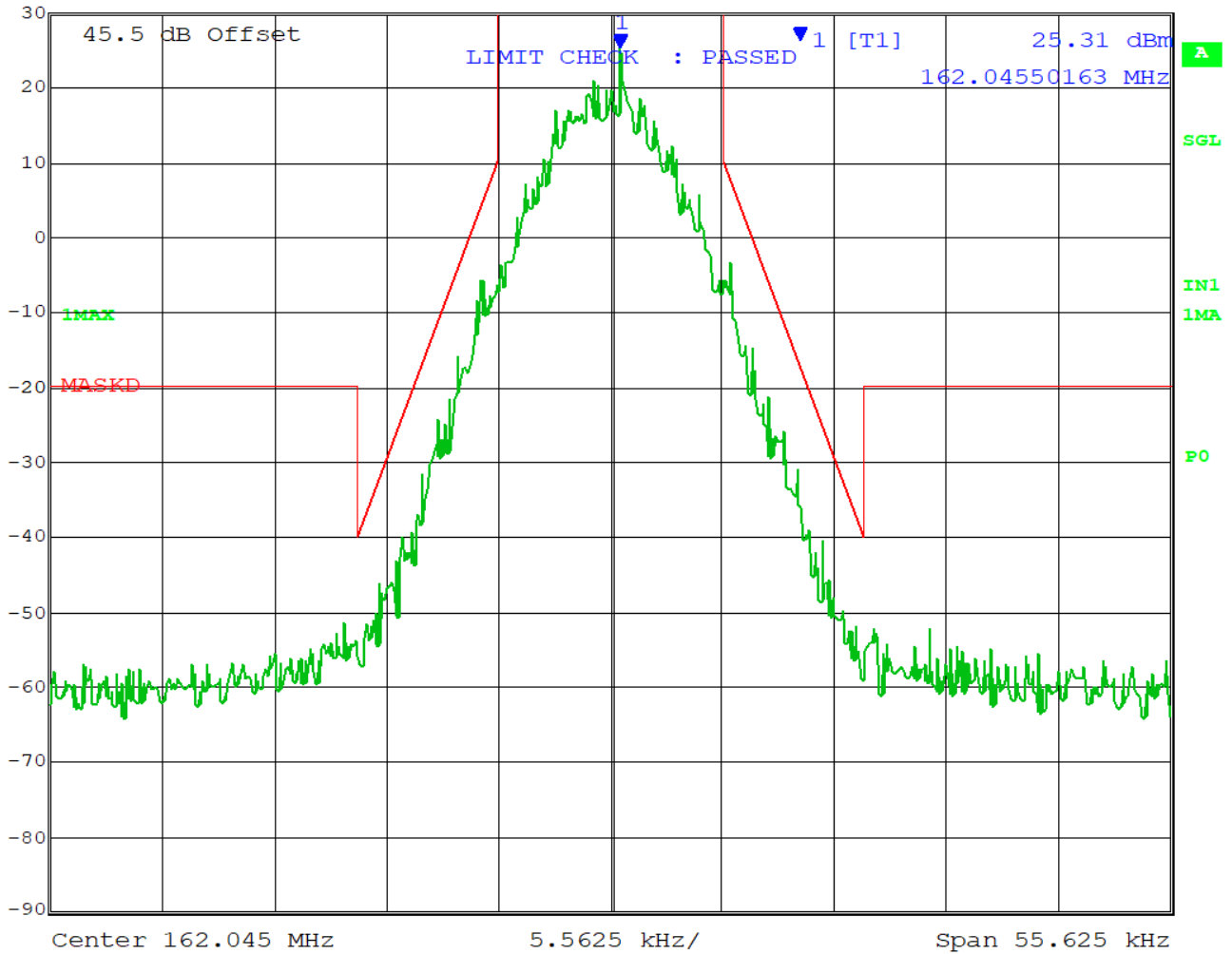

Date: 1.JAN.1997 07:20:58

EMISSION MASK D

Medium Power



Ref Lvl	Marker 1 [T1]	RBW	100 Hz	RF Att	20 dB
40 dBm	33.80 dBm	VBW	1 kHz		
	162.04561310 MHz	SWT	28 s	Unit	dBm

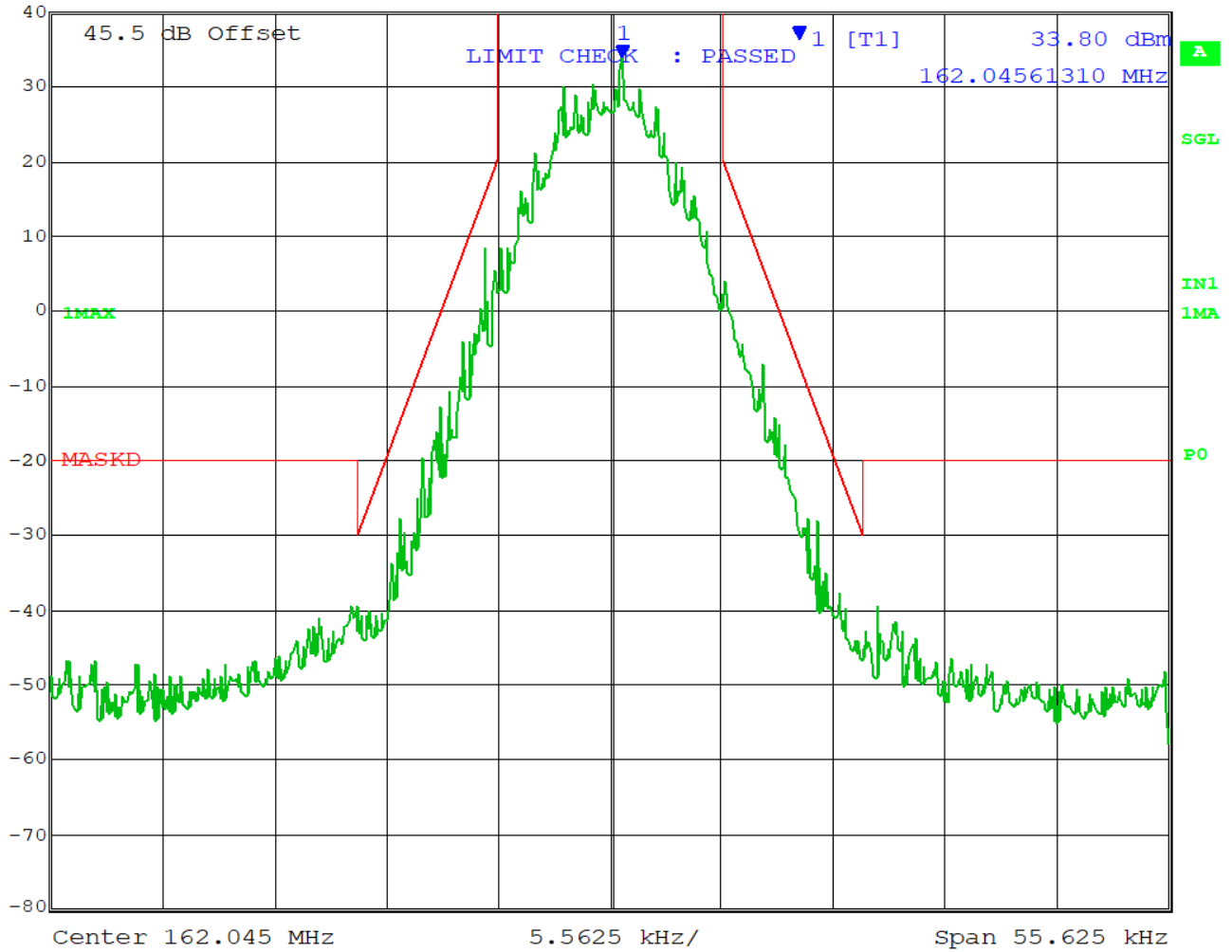

Date: 1.JAN.1997 06:23:27

EMISSION MASK D

High Power



Ref Lvl	Marker 1 [T1]	RBW	100 Hz	RF Att	20 dB
44 dBm	38.01 dBm	VBW	1 kHz		
	162.04561310 MHz	SWT	28 s	Unit	dBm

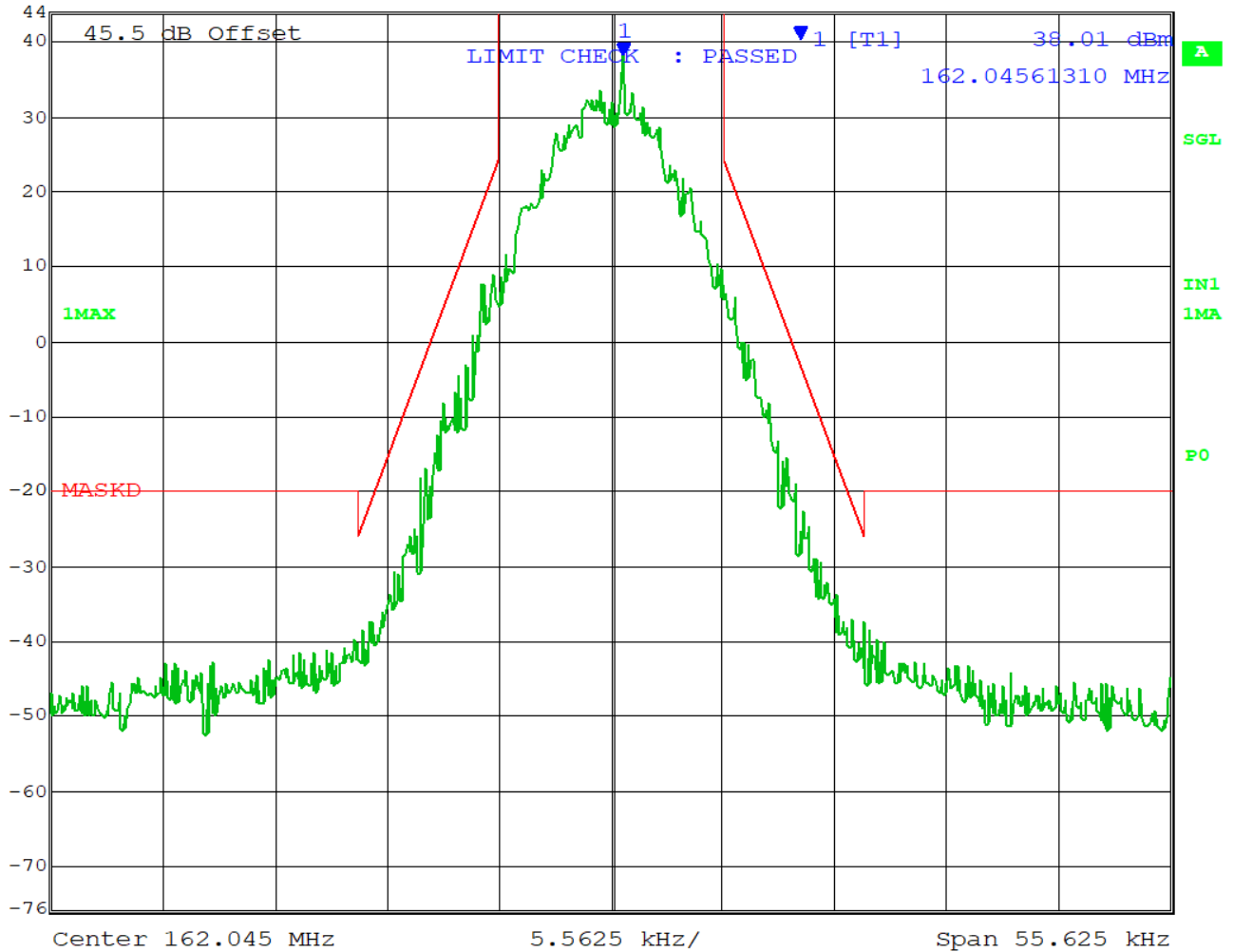

Date: 1.JAN.1997 05:22:35

EMISSION MASK D

Test Data: 167.0000 MHz

Low Power



Ref Lvl	Marker 1 [T1]	RBW	100 Hz	RF Att	20 dB
30 dBm	25.03 dBm	VBW	1 kHz		
	167.00061310 MHz	SWT	28 s	Unit	dBm

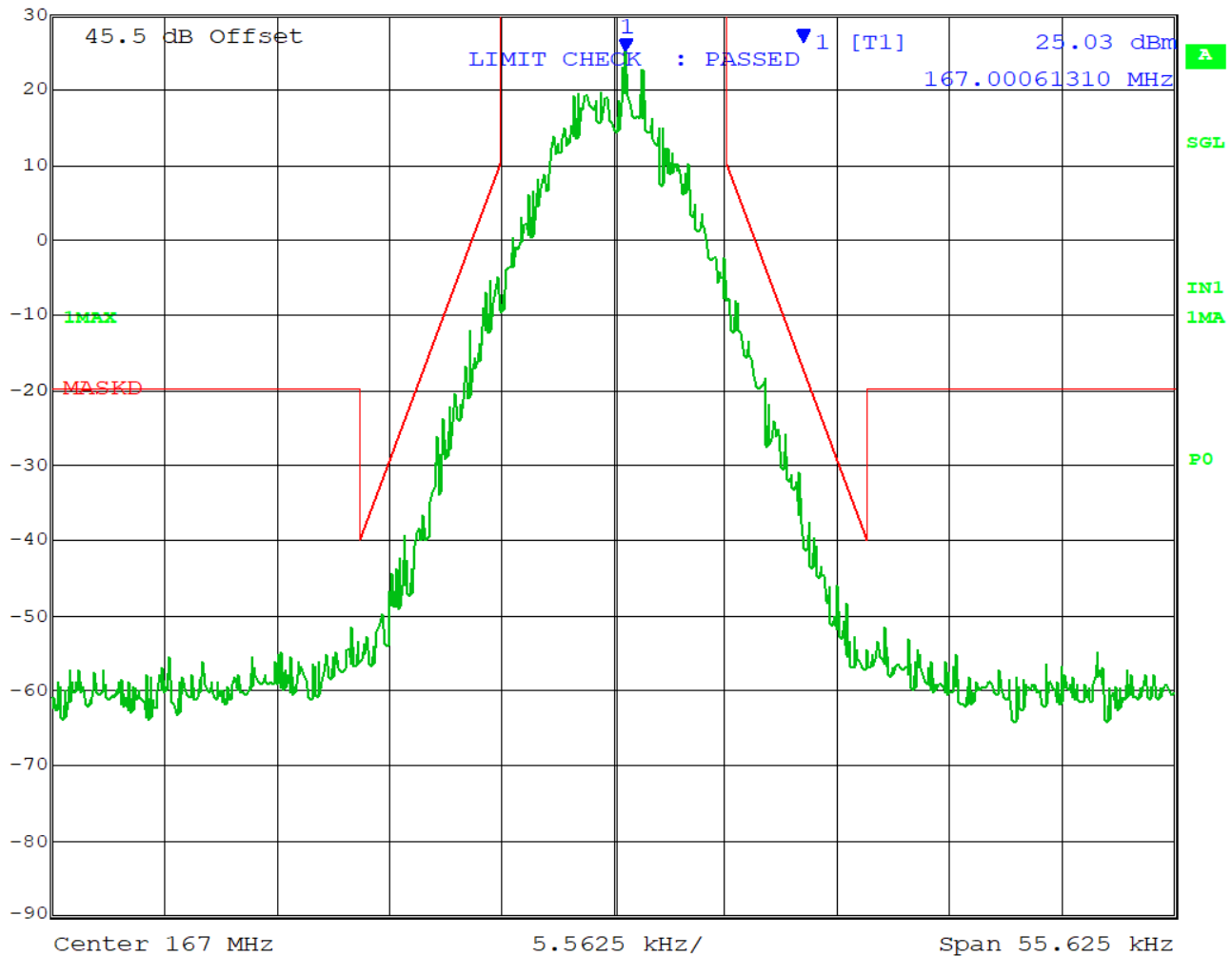

Date: 1.JAN.1997 07:21:58

EMISSION MASK D

Medium Power



Ref Lvl	Marker 1 [T1]	RBW	100 Hz	RF Att	20 dB
40 dBm	33.32 dBm	VBW	1 kHz		
	167.00061310 MHz	SWT	28 s	Unit	dBm

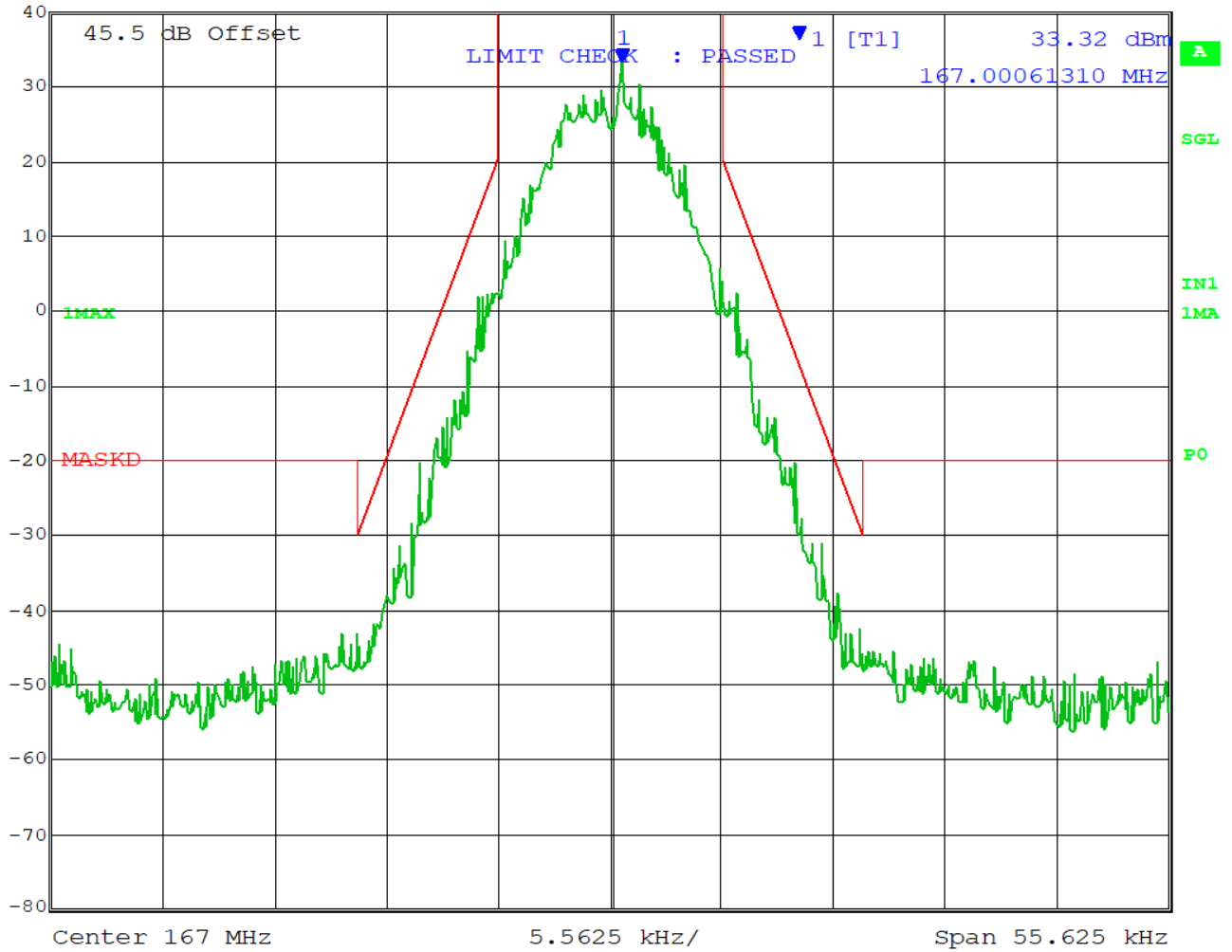

Date: 1.JAN.1997 06:24:21

EMISSION MASK D

High Power



Ref Lvl	Marker 1 [T1]	RBW	100 Hz	RF Att	20 dB
44 dBm	38.51 dBm	VBW	1 kHz		
	167.00061310 MHz	SWT	28 s	Unit	dBm

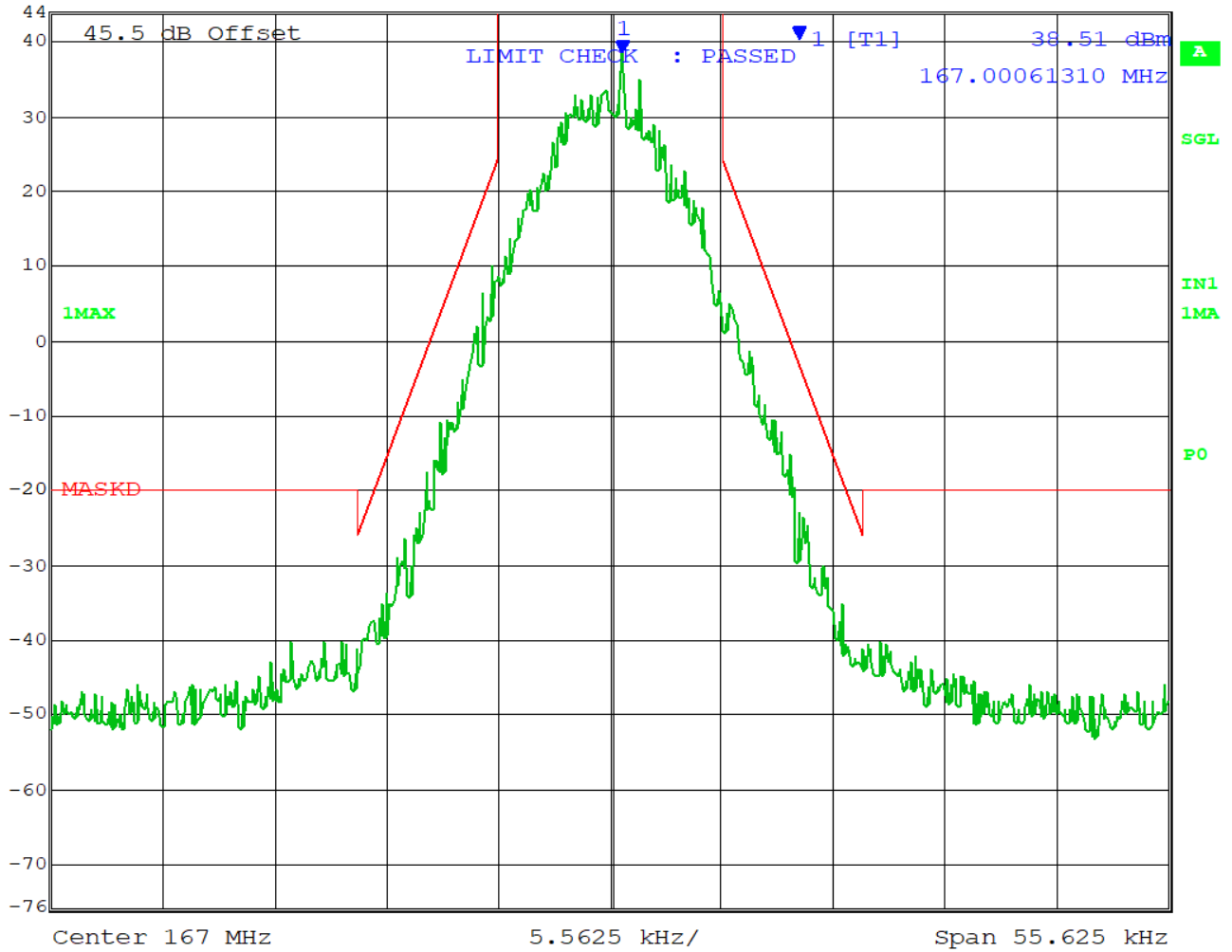

Date: 1.JAN.1997 05:25:45

Result: Meets Requirements

EMISSION MASK D

Test Data: 173.3925 MHz

Low Power



Ref Lvl	Marker 1 [T1]	RBW	100 Hz	RF Att	20 dB
30 dBm	26.07 dBm	VBW	1 kHz		
	173.39311310 MHz	SWT	28 s	Unit	dBm

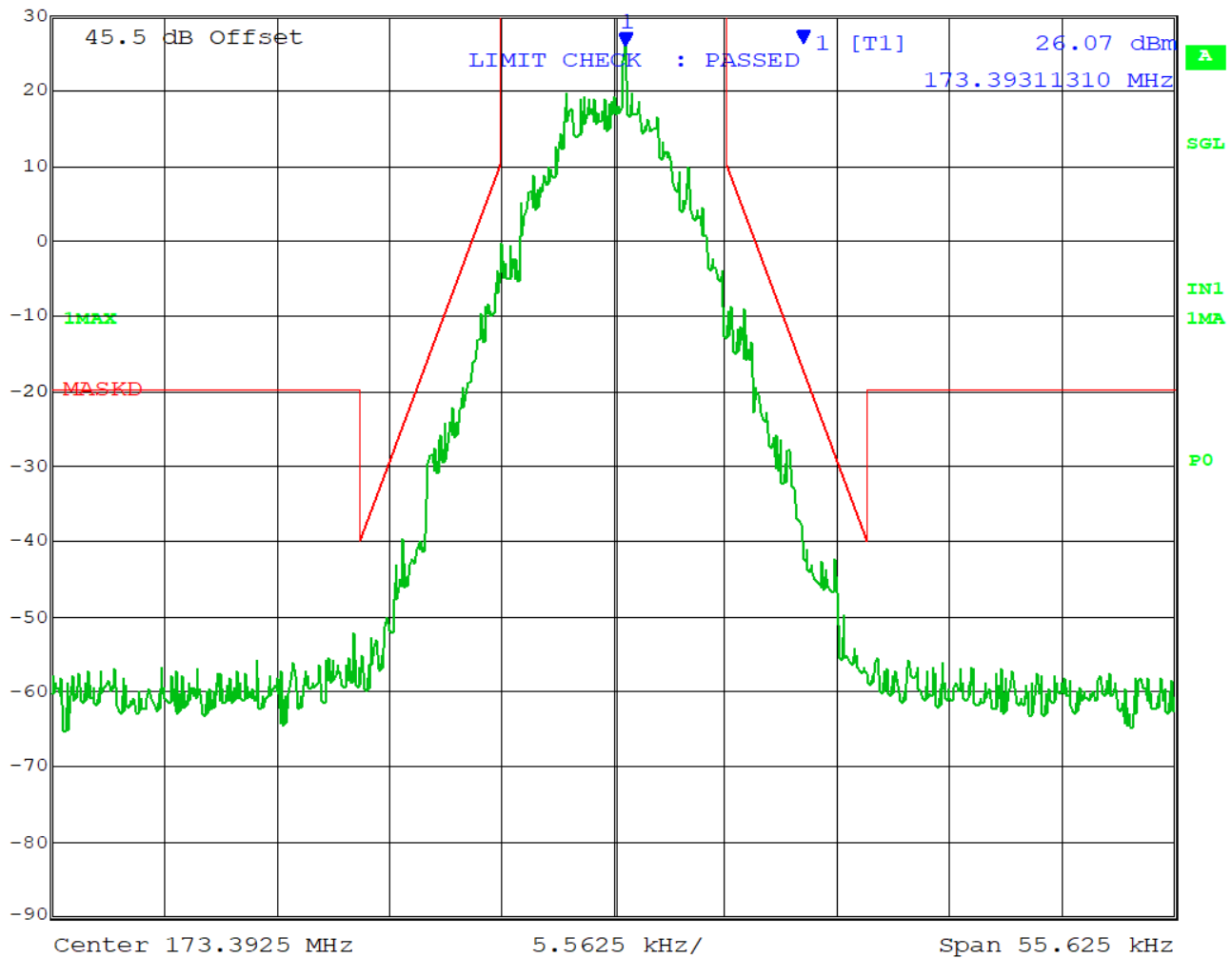

Date: 1.JAN.1997 07:23:13

EMISSION MASK D

Medium Power



Ref Lvl	Marker 1 [T1]	RBW	100 Hz	RF Att	20 dB
40 dBm	35.16 dBm	VBW	1 kHz		
	173.39322457 MHz	SWT	28 s	Unit	dBm

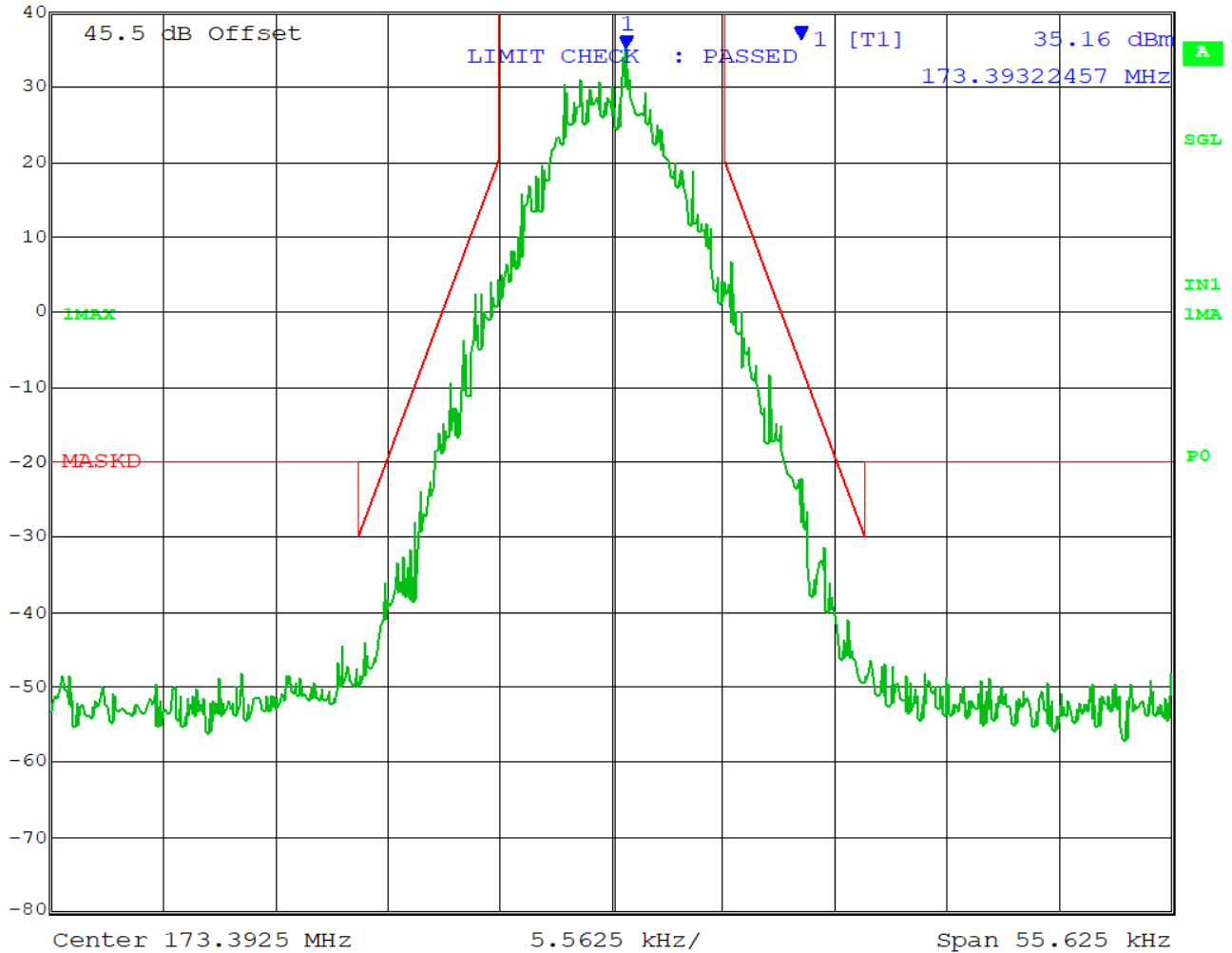

Date: 1.JAN.1997 06:25:20

EMISSION MASK D

High Power



Ref Lvl	Marker 1 [T1]	RBW	100 Hz	RF Att	20 dB
44 dBm	37.07 dBm	VBW	1 kHz		
	173.39322457 MHz	SWT	28 s	Unit	dBm

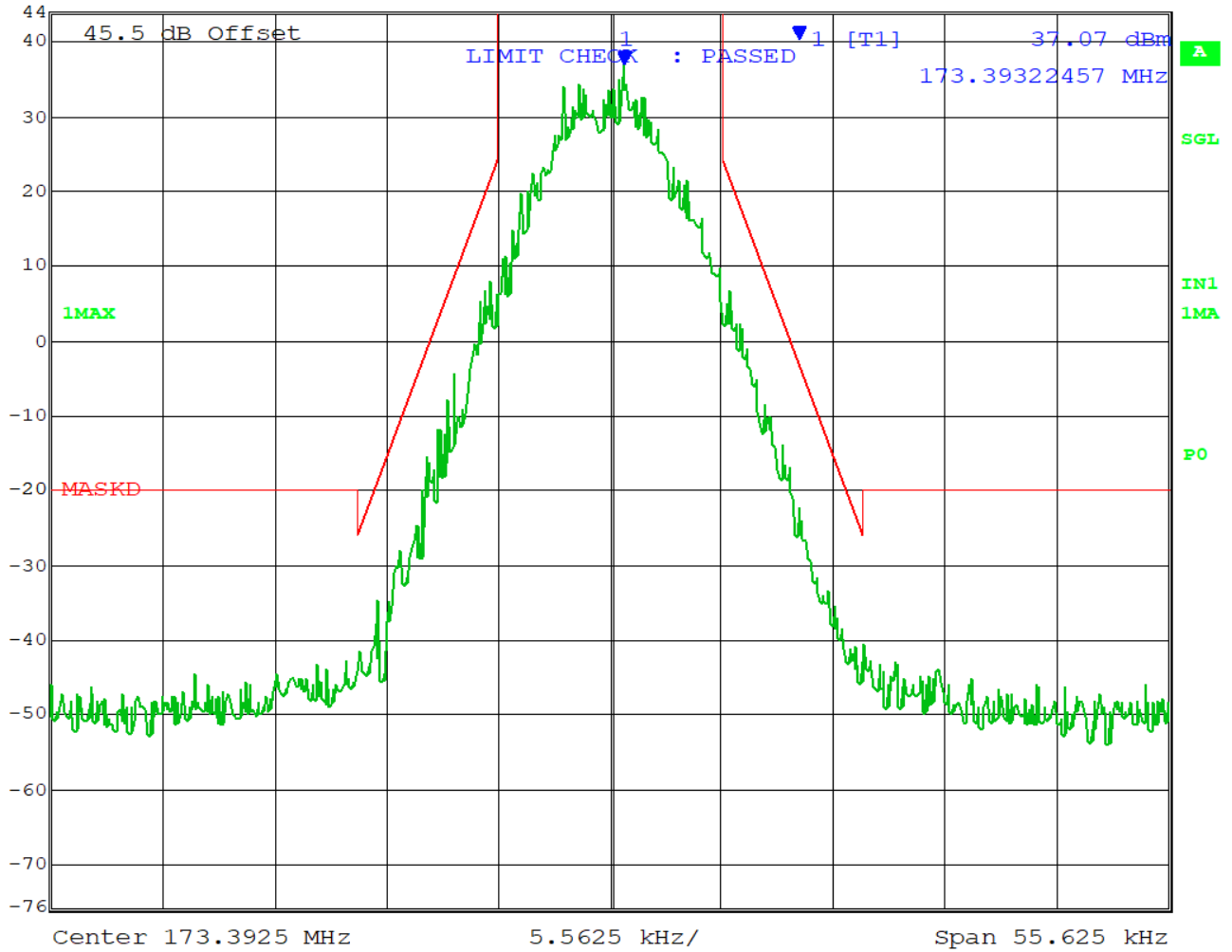

Date: 1.JAN.1997 05:26:54

SPURIOUS EMISSIONS AT ANTENNA TERMINALS (CONDUCTED)

FCC Rule Parts: FCC Part 2.1051(a), 90.210(d)(3)

Requirements:

(3) On any frequency removed from the center of the authorized bandwidth by a displacement frequency (f_d in kHz) of more than 12.5 kHz: At least $50 + 10 \log (P)$ dB or 70 dB, whichever is the lesser attenuation.

Method of Measurement: ANSI/TIA-603-E

Test Procedure: TIA 603-E, 2.2.13

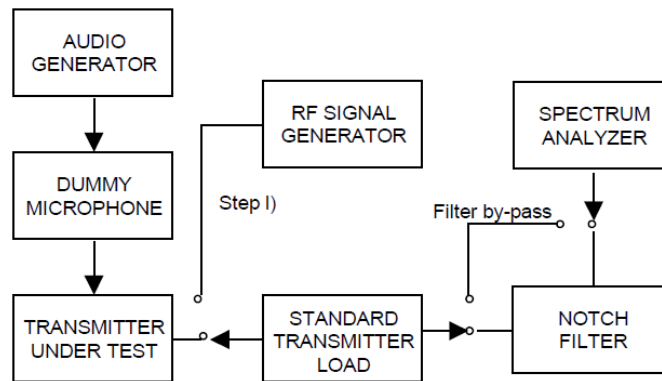

SPURIOUS EMISSIONS - NARROWBAND FM (12.5 kHz)

Test Data: 150.8075 MHz

Spurious Conducted Emissions, Narrowband FM (12.5 kHz), Mask D Limit (≥250% Authorized BW)	High Power		Med Power		Low Power	
	dBm	43.81	dBm	39.84	dBm	30.02
	Watts	24.04	Watts	9.64	Watts	1.00
	Limit (dBm)	-20	Limit (dBm)	-20	Limit (dBm)	-20
Frequency (MHz)	Peak (dBm)	Margin (dB)	Peak (dBm)	Margin (dB)	Peak (dBm)	Margin (dB)
Fundamental 150.8075	43.81	0.00	39.84	0.00	30.02	0.00
2nd Harmonic 301.6150	-40.53	20.53	-39.19	19.19	-43.36	23.36
3rd Harmonic 452.4225	-37.84	17.84	-43.06	23.06	-50.10	30.10
4th Harmonic 603.2300	-31.41	11.41	-36.63	16.63	-47.49	27.49
5th Harmonic 754.0375	-45.32	25.32	-44.78	24.78	-48.48	28.48
6th Harmonic 904.8450	-32.21	12.21	-42.93	22.93	-49.72	29.72
7th Harmonic 1055.6525	-58.96	38.96	-58.54	38.54	-55.03	35.03
8th Harmonic 1206.4600	-53.35	33.35	-55.31	35.31	-54.41	34.41
9th Harmonic 1357.2675	-57.88	37.88	-57.09	37.09	-56.64	36.64
10th Harmonic * 1508.0750	-60.21	40.21	-59.64	39.64	-60.00	40.00

* Indicates Noise Floor of Measurement

SPURIOUS EMISSIONS AT ANTENNA TERMINALS

Test Data: 156.2225 MHz

Spurious Conducted Emissions, Narrowband FM (12.5 kHz), Mask D Limit (≥250% Authorized BW)	High Power		Med Power		Low Power	
	dBm	43.81	dBm	39.84	dBm	30.02
	Watts	24.04	Watts	9.64	Watts	1.00
	Limit (dBm)	-20	Limit (dBm)	-20	Limit (dBm)	-20
Frequency (MHz)	Peak (dBm)	Margin (dB)	Peak (dBm)	Margin (dB)	Peak (dBm)	Margin (dB)
Fundamental 156.2225	43.81	0.00	39.84	0.00	30.02	0.00
2nd Harmonic 312.4450	-39.75	19.75	-38.41	18.41	-44.73	24.73
3rd Harmonic 468.6675	-34.88	14.88	-41.28	21.28	-48.70	28.70
4th Harmonic 624.8900	-30.68	10.68	-34.91	14.91	-44.21	24.21
5th Harmonic 781.1125	-37.63	17.63	-52.57	32.57	-50.38	30.38
6th Harmonic 937.3350	-28.40	8.40	-36.14	16.14	-52.26	32.26
7th Harmonic 1093.5575	-55.49	35.49	-57.03	37.03	-57.12	37.12
8th Harmonic 1249.7800	-54.91	34.91	-56.05	36.05	-56.07	36.07
9th Harmonic 1406.0025	-59.16	39.16	-59.53	39.53	-59.39	39.39
10th Harmonic * 1562.2250	-58.69	38.69	-59.26	39.26	-60.43	40.43

* Indicates Noise Floor of Measurement

SPURIOUS EMISSIONS AT ANTENNA TERMINALS

Test Data: 157.4575 MHz

Spurious Conducted Emissions, Narrowband FM (12.5 kHz), Mask D Limit (≥250% Authorized BW)	High Power		Med Power		Low Power	
	dBm	43.81	dBm	39.84	dBm	30.02
	Watts	24.04	Watts	9.64	Watts	1.00
	Limit (dBm)	-20	Limit (dBm)	-20	Limit (dBm)	-20
Frequency (MHz)	Peak (dBm)	Margin (dB)	Peak (dBm)	Margin (dB)	Peak (dBm)	Margin (dB)
Fundamental 157.4575	43.81	0.00	39.84	0.00	30.02	0.00
2nd Harmonic 314.9150	-43.72	23.72	-39.44	19.44	-45.41	25.41
3rd Harmonic 472.3725	-39.72	19.72	-38.80	18.80	-48.03	28.03
4th Harmonic 629.8300	-31.34	11.34	-32.66	12.66	-43.59	23.59
5th Harmonic 787.2875	-35.66	15.66	-44.23	24.23	-42.28	22.28
6th Harmonic 944.7450	-28.52	8.52	-35.56	15.56	-52.85	32.85
7th Harmonic 1102.2025	-53.33	33.33	-56.73	36.73	-55.99	35.99
8th Harmonic 1259.6600	-55.10	35.10	-57.43	37.43	-55.58	35.58
9th Harmonic 1417.1175	-57.49	37.49	-60.48	40.48	-60.54	40.54
10th Harmonic * 1574.5750	-59.05	39.05	-58.61	38.61	-59.74	39.74

* Indicates Noise Floor of Measurement

SPURIOUS EMISSIONS AT ANTENNA TERMINALS

Test Data: 161.5525 MHz

Spurious Conducted Emissions, Narrowband FM (12.5 kHz), Mask D Limit (≥250% Authorized BW)	High Power		Med Power		Low Power	
	dBm	43.81	dBm	39.84	dBm	30.02
	Watts	24.04	Watts	9.64	Watts	1.00
	Limit (dBm)	-20	Limit (dBm)	-20	Limit (dBm)	-20
Frequency (MHz)	Peak (dBm)	Margin (dB)	Peak (dBm)	Margin (dB)	Peak (dBm)	Margin (dB)
Fundamental 161.5525	43.81	0.00	39.84	0.00	30.02	0.00
2nd Harmonic 323.1050	-43.81	23.81	-42.77	22.77	-49.11	29.11
3rd Harmonic 484.6575	-40.79	20.79	-46.31	26.31	-45.96	25.96
4th Harmonic 646.2100	-41.88	21.88	-32.47	12.47	-41.39	21.39
5th Harmonic 807.7625	-33.91	13.91	-48.95	28.95	-60.73	40.73
6th Harmonic 969.3150	-36.81	16.81	-36.93	16.93	-60.17	40.17
7th Harmonic 1130.8675	-51.62	31.62	-55.82	35.82	-59.00	39.00
8th Harmonic 1292.4200	-59.31	39.31	-58.84	38.84	-59.02	39.02
9th Harmonic 1453.9725	-58.45	38.45	-59.57	39.57	-58.75	38.75
10th Harmonic * 1615.5250	-59.59	39.59	-58.61	38.61	-58.41	38.41

* Indicates Noise Floor of Measurement

SPURIOUS EMISSIONS AT ANTENNA TERMINALS

Test Data: 161.7825 MHz

Spurious Conducted Emissions, Narrowband FM (12.5 kHz), Mask D Limit (≥250% Authorized BW)	High Power		Med Power		Low Power	
	dBm	43.81	dBm	39.84	dBm	30.02
	Watts	24.04	Watts	9.64	Watts	1.00
	Limit (dBm)	-20	Limit (dBm)	-20	Limit (dBm)	-20
Frequency (MHz)	Peak (dBm)	Margin (dB)	Peak (dBm)	Margin (dB)	Peak (dBm)	Margin (dB)
Fundamental 161.7825	43.81	0.00	39.84	0.00	30.02	0.00
2nd Harmonic 323.5650	-43.27	23.27	-42.45	22.45	-48.74	28.74
3rd Harmonic 485.3475	-39.44	19.44	-45.31	25.31	-44.22	24.22
4th Harmonic 647.1300	-45.48	25.48	-32.69	12.69	-41.16	21.16
5th Harmonic 808.9125	-34.43	14.43	-48.75	28.75	-60.23	40.23
6th Harmonic 970.6950	-38.63	18.63	-37.25	17.25	-61.40	41.40
7th Harmonic 1132.4775	-51.69	31.69	-57.40	37.40	-57.37	37.37
8th Harmonic 1294.2600	-59.31	39.31	-59.65	39.65	-59.59	39.59
9th Harmonic 1456.0425	-57.11	37.11	-59.38	39.38	-59.32	39.32
10th Harmonic * 1617.8250	-58.95	38.95	-59.04	39.04	-58.98	38.98

* Indicates Noise Floor of Measurement

SPURIOUS EMISSIONS AT ANTENNA TERMINALS

Test Data: 162.0450 MHz

Spurious Conducted Emissions, Narrowband FM (12.5 kHz), Mask D Limit (≥250% Authorized BW)	High Power		Med Power		Low Power	
	dBm	43.81	dBm	39.84	dBm	30.02
	Watts	24.04	Watts	9.64	Watts	1.00
	Limit (dBm)	-20	Limit (dBm)	-20	Limit (dBm)	-20
Frequency (MHz)	Peak (dBm)	Margin (dB)	Peak (dBm)	Margin (dB)	Peak (dBm)	Margin (dB)
Fundamental 162.0450	43.81	0.00	39.84	0.00	30.02	0.00
2nd Harmonic 324.0900	-43.07	23.07	-42.25	22.25	-48.20	28.20
3rd Harmonic 486.1350	-38.21	18.21	-44.25	24.25	-44.56	24.56
4th Harmonic 648.1800	-45.18	25.18	-32.81	12.81	-41.02	21.02
5th Harmonic 810.2250	-34.32	14.32	-48.96	28.96	-62.08	42.08
6th Harmonic 972.2700	-38.73	18.73	-37.93	17.93	-59.38	39.38
7th Harmonic 1134.3150	-51.04	31.04	-55.93	35.93	-58.49	38.49
8th Harmonic 1296.3600	-59.78	39.78	-59.57	39.57	-58.51	38.51
9th Harmonic 1458.4050	-57.64	37.64	-59.30	39.30	-58.24	38.24
10th Harmonic * 1620.4500	-59.17	39.17	-58.96	38.96	-57.90	37.90

* Indicates Noise Floor of Measurement

SPURIOUS EMISSIONS AT ANTENNA TERMINALS

Test Data: 167.0000 MHz

Spurious Conducted Emissions, Narrowband FM (12.5 kHz), Mask D Limit (≥250% Authorized BW)	High Power		Med Power		Low Power	
	dBm	43.81	dBm	39.84	dBm	30.02
	Watts	24.04	Watts	9.64	Watts	1.00
	Limit (dBm)	-20	Limit (dBm)	-20	Limit (dBm)	-20
Frequency (MHz)	Peak (dBm)	Margin (dB)	Peak (dBm)	Margin (dB)	Peak (dBm)	Margin (dB)
Fundamental 167.0000	43.81	0.00	39.84	0.00	30.02	0.00
2nd Harmonic 334.0000	-45.00	25.00	-43.10	23.10	-48.96	28.96
3rd Harmonic 501.0000	-35.28	15.28	-42.41	22.41	-40.07	20.07
4th Harmonic 668.0000	-45.74	25.74	-34.16	14.16	-43.05	23.05
5th Harmonic 835.0000	-31.75	11.75	-44.60	24.60	-57.25	37.25
6th Harmonic 1002.0000	-45.72	25.72	-50.03	30.03	-56.37	36.37
7th Harmonic 1169.0000	-54.82	34.82	-57.22	37.22	-57.25	37.25
8th Harmonic 1336.0000	-55.09	35.09	-60.11	40.11	-59.14	39.14
9th Harmonic 1503.0000	-57.32	37.32	-59.84	39.84	-58.87	38.87
10th Harmonic * 1670.0000	-59.10	39.10	-59.50	39.50	-58.53	38.53

* Indicates Noise Floor of Measurement

SPURIOUS EMISSIONS AT ANTENNA TERMINALS

Test Data: 173.3925 MHz

Spurious Conducted Emissions, Narrowband FM (12.5 kHz), Mask D Limit ($\geq 250\%$ Authorized BW)	High Power		Med Power		Low Power	
	dBm	43.81	dBm	39.84	dBm	30.02
	Watts	24.04	Watts	9.64	Watts	1.00
	Limit (dBm)	-20	Limit (dBm)	-20	Limit (dBm)	-20
Frequency (MHz)	Peak (dBm)	Margin (dB)	Peak (dBm)	Margin (dB)	Peak (dBm)	Margin (dB)
Fundamental 173.3925	43.81	0.00	39.84	0.00	30.02	0.00
2nd Harmonic 346.7850	-50.20	30.20	-44.85	24.85	-50.81	30.81
3rd Harmonic 520.1775	-40.82	20.82	-49.23	29.23	-41.50	21.50
4th Harmonic 693.5700	-38.22	18.22	-34.82	14.82	-47.16	27.16
5th Harmonic 866.9625	-26.11	6.11	-40.18	20.18	-49.54	29.54
6th Harmonic 1040.3550	-45.49	25.49	-49.65	29.65	-52.06	32.06
7th Harmonic 1213.7475	-54.66	34.66	-55.20	35.20	-54.30	34.30
8th Harmonic 1387.1400	-58.09	38.09	-59.74	39.74	-58.89	38.89
9th Harmonic * 1560.5325	-58.91	38.91	-59.47	39.47	-59.43	39.43
10th Harmonic * 1733.9250	-58.57	38.57	-59.13	39.13	-59.09	39.09

* Indicates Noise Floor of Measurement

Narrowband FM - Worst-Case Spurious Emission: 173.3925 MHz, -26.11 dBm

Result: Meets Requirement

SPURIOUS EMISSIONS – P25 Phase I C4FM (12.5 kHz)

Test Data: 150.8075 MHz

Spurious Conducted Emissions, C4FM (12.5 kHz), Mask D Limit (≥250% Authorized BW)		High Power		Med Power		Low Power	
		dBm	43.81	dBm	39.84	dBm	30.02
		Watts	24.04	Watts	9.64	Watts	1.00
		Limit (dBm)	-20	Limit (dBm)	-20	Limit (dBm)	-20
Frequency (MHz)		Peak (dBm)	Margin (dB)	Peak (dBm)	Margin (dB)	Peak (dBm)	Margin (dB)
Fundamental	150.8075	43.81	0.00	39.84	0.00	30.02	0.00
2nd Harmonic	301.6150	-40.54	20.54	-39.48	19.48	-43.82	23.82
3rd Harmonic	452.4225	-36.70	16.70	-43.92	23.92	-52.32	32.32
4th Harmonic	603.2300	-30.73	10.73	-36.10	16.10	-47.09	27.09
5th Harmonic	754.0375	-44.30	24.30	-45.26	25.26	-50.86	30.86
6th Harmonic	904.8450	-32.05	12.05	-43.23	23.23	-49.28	29.28
7th Harmonic	1055.6525	-59.35	39.35	-58.23	38.23	-54.06	34.06
8th Harmonic	1206.4600	-52.31	32.31	-54.48	34.48	-54.34	34.34
9th Harmonic	1357.2675	-57.84	37.84	-57.29	37.29	-57.29	37.29
10th Harmonic	* 1508.0750	-59.50	39.50	-59.70	39.70	-58.88	38.88

* Indicates Noise Floor of Measurement

SPURIOUS EMISSIONS AT ANTENNA TERMINALS

Test Data: 156.2225 MHz

Spurious Conducted Emissions, C4FM (12.5 kHz), Mask D Limit ($\geq 250\%$ Authorized BW)	High Power		Med Power		Low Power	
	dBm	43.81	dBm	39.84	dBm	30.02
	Watts	24.04	Watts	9.64	Watts	1.00
	Limit (dBm)	-20	Limit (dBm)	-20	Limit (dBm)	-20
Frequency (MHz)	Peak (dBm)	Margin (dB)	Peak (dBm)	Margin (dB)	Peak (dBm)	Margin (dB)
Fundamental 156.2225	43.81	0.00	39.84	0.00	30.02	0.00
2nd Harmonic 312.4450	-40.17	20.17	-38.18	18.18	-44.58	24.58
3rd Harmonic 468.6675	-37.69	17.69	-38.99	18.99	-47.92	27.92
4th Harmonic 624.8900	-30.87	10.87	-33.13	13.13	-44.15	24.15
5th Harmonic 781.1125	-37.33	17.33	-43.11	23.11	-50.06	30.06
6th Harmonic 937.3350	-28.38	8.38	-35.88	15.88	-52.35	32.35
7th Harmonic 1093.5575	-56.06	36.06	-56.99	36.99	-56.92	36.92
8th Harmonic 1249.7800	-54.25	34.25	-57.16	37.16	-56.17	36.17
9th Harmonic 1406.0025	-57.27	37.27	-59.06	39.06	-60.12	40.12
10th Harmonic * 1562.2250	-59.01	39.01	-60.16	40.16	-59.88	39.88

* Indicates Noise Floor of Measurement

SPURIOUS EMISSIONS AT ANTENNA TERMINALS

Test Data: 157.4575 MHz

Spurious Conducted Emissions, C4FM (12.5 kHz), Mask D Limit ($\geq 250\%$ Authorized BW)	High Power		Med Power		Low Power	
	dBm	43.81	dBm	39.84	dBm	30.02
	Watts	24.04	Watts	9.64	Watts	1.00
	Limit (dBm)	-20	Limit (dBm)	-20	Limit (dBm)	-20
Frequency (MHz)	Peak (dBm)	Margin (dB)	Peak (dBm)	Margin (dB)	Peak (dBm)	Margin (dB)
Fundamental 157.4575	43.81	0.00	39.84	0.00	30.02	0.00
2nd Harmonic 314.9150	-43.17	23.17	-39.67	19.67	-45.99	25.99
3rd Harmonic 472.3725	-35.94	15.94	-42.03	22.03	-49.17	29.17
4th Harmonic 629.8300	-31.92	11.92	-33.99	13.99	-43.69	23.69
5th Harmonic 787.2875	-35.66	15.66	-54.79	34.79	-54.62	34.62
6th Harmonic 944.7450	-28.44	8.44	-35.55	15.55	-52.01	32.01
7th Harmonic 1102.2025	-52.80	32.80	-55.12	35.12	-56.99	36.99
8th Harmonic 1259.6600	-54.60	34.60	-56.53	36.53	-56.13	36.13
9th Harmonic 1417.1175	-57.39	37.39	-60.48	40.48	-59.83	39.83
10th Harmonic * 1574.5750	-59.51	39.51	-60.14	40.14	-59.49	39.49

* Indicates Noise Floor of Measurement

SPURIOUS EMISSIONS AT ANTENNA TERMINALS

Test Data: 161.5525 MHz

Spurious Conducted Emissions, C4FM (12.5 kHz), Mask D Limit ($\geq 250\%$ Authorized BW)	High Power		Med Power		Low Power	
	dBm	43.81	dBm	39.84	dBm	30.02
	Watts	24.04	Watts	9.64	Watts	1.00
	Limit (dBm)	-20	Limit (dBm)	-20	Limit (dBm)	-20
Frequency (MHz)	Peak (dBm)	Margin (dB)	Peak (dBm)	Margin (dB)	Peak (dBm)	Margin (dB)
Fundamental 161.5825	43.81	0.00	39.84	0.00	30.02	0.00
2nd Harmonic 323.1650	-42.21	22.21	-41.68	21.68	-47.45	27.45
3rd Harmonic 484.7475	-33.91	13.91	-41.78	21.78	-42.85	22.85
4th Harmonic 646.3300	-44.95	24.95	-33.17	13.17	-40.70	20.70
5th Harmonic 807.9125	-35.11	15.11	-49.19	29.19	-59.62	39.62
6th Harmonic 969.4950	-38.24	18.24	-36.90	16.90	-58.11	38.11
7th Harmonic 1131.0775	-50.73	30.73	-56.84	36.84	-58.76	38.76
8th Harmonic 1292.6600	-59.09	39.09	-59.88	39.88	-58.78	38.78
9th Harmonic 1454.2425	-56.60	36.60	-59.61	39.61	-58.51	38.51
10th Harmonic * 1615.8250	-59.41	39.41	-59.27	39.27	-58.17	38.17

* Indicates Noise Floor of Measurement

SPURIOUS EMISSIONS AT ANTENNA TERMINALS

Test Data: 161.7825 MHz

Spurious Conducted Emissions, C4FM (12.5 kHz), Mask D Limit ($\geq 250\%$ Authorized BW)	High Power		Med Power		Low Power	
	dBm	43.81	dBm	39.84	dBm	30.02
	Watts	24.04	Watts	9.64	Watts	1.00
	Limit (dBm)	-20	Limit (dBm)	-20	Limit (dBm)	-20
Frequency (MHz)	Peak (dBm)	Margin (dB)	Peak (dBm)	Margin (dB)	Peak (dBm)	Margin (dB)
Fundamental 161.7825	43.81	0.00	39.84	0.00	30.02	0.00
2nd Harmonic 323.5650	-42.06	22.06	-41.36	21.36	-47.62	27.62
3rd Harmonic 485.3475	-31.78	11.78	-41.51	21.51	-42.23	22.23
4th Harmonic 647.1300	-44.65	24.65	-33.13	13.13	-40.55	20.55
5th Harmonic 808.9125	-34.81	14.81	-49.84	29.84	-58.75	38.75
6th Harmonic 970.6950	-38.46	18.46	-37.24	17.24	-59.22	39.22
7th Harmonic 1132.4775	-50.98	30.98	-57.09	37.09	-58.76	38.76
8th Harmonic 1294.2600	-59.00	39.00	-59.52	39.52	-58.78	38.78
9th Harmonic 1456.0425	-56.07	36.07	-59.25	39.25	-58.51	38.51
10th Harmonic * 1617.8250	-58.74	38.74	-58.91	38.91	-58.17	38.17

* Indicates Noise Floor of Measurement

SPURIOUS EMISSIONS AT ANTENNA TERMINALS

Test Data: 162.0450 MHz

Spurious Conducted Emissions, C4FM (12.5 kHz), Mask D Limit ($\geq 250\%$ Authorized BW)	High Power		Med Power		Low Power	
	dBm	43.81	dBm	39.84	dBm	30.02
	Watts	24.04	Watts	9.64	Watts	1.00
	Limit (dBm)	-20	Limit (dBm)	-20	Limit (dBm)	-20
Frequency (MHz)	Peak (dBm)	Margin (dB)	Peak (dBm)	Margin (dB)	Peak (dBm)	Margin (dB)
Fundamental 162.0045	43.81	0.00	39.84	0.00	30.02	0.00
2nd Harmonic 324.0090	-42.65	22.65	-41.36	21.36	-47.63	27.63
3rd Harmonic 486.0135	-32.09	12.09	-40.97	20.97	-41.48	21.48
4th Harmonic 648.0180	-46.37	26.37	-33.08	13.08	-40.29	20.29
5th Harmonic 810.0225	-35.25	15.25	-49.07	29.07	-58.83	38.83
6th Harmonic 972.0270	-39.01	19.01	-37.94	17.94	-58.55	38.55
7th Harmonic 1134.0315	-50.11	30.11	-57.11	37.11	-58.98	38.98
8th Harmonic * 1296.0360	-60.11	40.11	-59.89	39.89	-59.00	39.00
9th Harmonic 1458.0405	-55.86	35.86	-59.62	39.62	-58.73	38.73
10th Harmonic * 1620.0450	-59.33	39.33	-59.28	39.28	-58.39	38.39

* Indicates Noise Floor of Measurement

SPURIOUS EMISSIONS AT ANTENNA TERMINALS

Test Data: 167.0000 MHz

Spurious Conducted Emissions, C4FM (12.5 kHz), Mask D Limit ($\geq 250\%$ Authorized BW)	High Power		Med Power		Low Power	
	dBm	43.81	dBm	39.84	dBm	30.02
	Watts	24.04	Watts	9.64	Watts	1.00
	Limit (dBm)	-20	Limit (dBm)	-20	Limit (dBm)	-20
Frequency (MHz)	Peak (dBm)	Margin (dB)	Peak (dBm)	Margin (dB)	Peak (dBm)	Margin (dB)
Fundamental 167.0000	43.81	0.00	39.84	0.00	30.02	0.00
2nd Harmonic 334.0000	-44.13	24.13	-42.37	22.37	-48.49	28.49
3rd Harmonic 501.0000	-31.29	11.29	-39.72	19.72	-38.74	18.74
4th Harmonic 668.0000	-45.75	25.75	-34.29	14.29	-42.38	22.38
5th Harmonic 835.0000	-32.03	12.03	-44.71	24.71	-57.33	37.33
6th Harmonic 1002.0000	-45.76	25.76	-49.43	29.43	-56.80	36.80
7th Harmonic 1169.0000	-54.60	34.60	-56.44	36.44	-56.33	36.33
8th Harmonic 1336.0000	-54.61	34.61	-58.89	38.89	-59.27	39.27
9th Harmonic 1503.0000	-57.87	37.87	-58.62	38.62	-59.00	39.00
10th Harmonic * 1670.0000	-58.69	38.69	-58.28	38.28	-58.66	38.66

* Indicates Noise Floor of Measurement

SPURIOUS EMISSIONS AT ANTENNA TERMINALS

Test Data: 173.3925 MHz

Spurious Conducted Emissions, C4FM (12.5 kHz), Mask D Limit ($\geq 250\%$ Authorized BW)	High Power		Med Power		Low Power	
	dBm	43.81	dBm	39.84	dBm	30.02
	Watts	24.04	Watts	9.64	Watts	1.00
	Limit (dBm)	-20	Limit (dBm)	-20	Limit (dBm)	-20
Frequency (MHz)	Peak (dBm)	Margin (dB)	Peak (dBm)	Margin (dB)	Peak (dBm)	Margin (dB)
Fundamental 173.3925	43.81	0.00	39.84	0.00	30.02	0.00
2nd Harmonic 346.7850	-48.71	28.71	-43.49	23.49	-48.82	28.82
3rd Harmonic 520.1775	-37.34	17.34	-47.91	27.91	-41.21	21.21
4th Harmonic 693.5700	-38.26	18.26	-34.74	14.74	-45.76	25.76
5th Harmonic 866.9625	-25.99	5.99	-39.83	19.83	-49.19	29.19
6th Harmonic 1040.3550	-44.69	24.69	-48.90	28.90	-52.71	32.71
7th Harmonic 1213.7475	-54.77	34.77	-53.97	33.97	-54.15	34.15
8th Harmonic 1387.1400	-59.12	39.12	-59.19	39.19	-58.77	38.77
9th Harmonic 1560.5325	-57.84	37.84	-58.92	38.92	-58.94	38.94
10th Harmonic * 1733.9250	-58.56	38.56	-58.58	38.58	-58.60	38.60

* Indicates Noise Floor of Measurement

Result: Meets Requirements

FIELD STRENGTH OF SPURIOUS EMISSIONS

FCC Rule Parts: FCC Part 2.1053(a), 90.210(d)(3)

Method of Measurement: ANSI C63.26, 5.5.4

Test Site Setup:

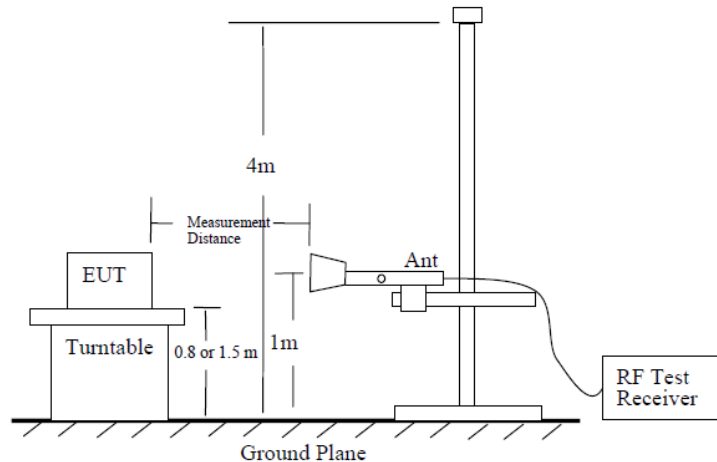

EUT Orientation(s):

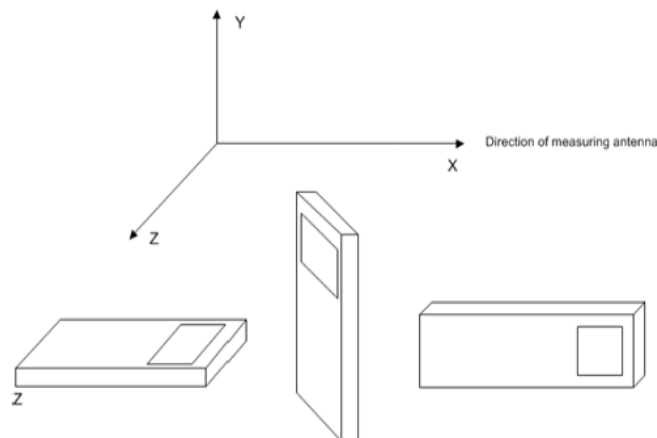

Note: The tabulated data shows the results of the radiated field strength emissions test. The spectrum was scanned from the lowest frequency generated internally to at least the tenth harmonic of the fundamental. This test was conducted in accordance with the standard listed above using the substitution method. Measurements were made at the test site of TIMCO ENGINEERING, INC. located at 849 NW State Road 45, Newberry, FL 32669. The measurements below represent the worst case of all the frequencies tested.

Note: The six (6) highest emissions or more of each worst-case operational modes of the EUT are represented below. Emissions 20 dB below the limit are not required to be reported.

FIELD STRENGTH OF SPURIOUS EMISSIONS

Test Data: 150.8075 MHz

Low Power

Power Output		Limit		
dBm	Watts	dBc	dBm	
30.02	1.00	50.02	-20.00	
Tuned Freq MHz	Emission Frequency MHz	Antenna Polarity	ERP (dBm)	Margin (dB)
150.81	603.23	V	-44.188	24.19
150.81	603.23	H	-43.218	23.22

Medium Power

Power Output		Limit		
dBm	Watts	dBc	dBm	
39.84	9.64	59.84	-20.00	
Tuned Freq MHz	Emission Frequency MHz	Antenna Polarity	ERP (dBm)	Margin (dB)
150.81	603.23	H	-33.278	13.28
150.81	603.23	V	-32.348	12.35
150.81	904.84	V	-36.972	16.97
150.81	904.84	H	-35.912	15.91

High Power

Power Output		Limit		
dBm	Watts	dBc	dBm	
43.81	24.04	63.81	-20.00	
Tuned Freq MHz	Emission Frequency MHz	Antenna Polarity	ERP (dBm)	Margin (dB)
150.81	904.84	H	-27.452	7.45
150.81	904.84	V	-28.232	8.23
150.81	754.04	H	-40.273	20.27
150.81	603.23	H	-27.948	7.95
150.81	603.23	V	-26.928	6.93

FIELD STRENGTH OF SPURIOUS EMISSIONS

Test Data: 156.2225 MHz

Low Power

Power Output		Limit		
dBm	Watts	dBc	dBm	
30.02	1.00	50.02	-20.00	
Tuned Freq MHz	Emission Frequency MHz	Antenna Polarity	ERP (dBm)	Margin (dB)
156.22	624.89	V	-34.097	14.10
156.22	624.89	H	-38.227	18.23

Medium Power

Power Output		Limit		
dBm	Watts	dBc	dBm	
39.84	9.64	59.84	-20.00	
Tuned Freq MHz	Emission Frequency MHz	Antenna Polarity	ERP (dBm)	Margin (dB)
156.22	624.89	H	-22.687	2.69
156.22	624.98	V	-26.607	6.61
156.22	937.34	V	-24.430	4.43
156.22	937.34	H	-23.030	3.03

High Power

Power Output		Limit		
dBm	Watts	dBc	dBm	
43.81	24.04	63.81	-20.00	
Tuned Freq MHz	Emission Frequency MHz	Antenna Polarity	ERP (dBm)	Margin (dB)
156.22	624.89	H	-22.987	2.99
156.22	624.89	V	-22.177	2.18
156.22	781.11	H	-26.666	6.67
156.22	781.11	V	-30.136	10.14
156.22	937.34	H	-21.940	1.94
156.22	937.34	V	-21.470	1.47

FIELD STRENGTH OF SPURIOUS EMISSIONS

Test Data: 157.4575 MHz

Low Power

Power Output		Limit		
dBm	Watts	dBc	dBm	
30.02	1.00	50.02	-20.00	
Tuned Freq MHz	Emission Frequency MHz	Antenna Polarity	ERP (dBm)	Margin (dB)
157.45	629.77	H	-41.808	21.81
157.45	629.77	V	-40.428	20.43

Medium Power

Power Output		Limit		
dBm	Watts	dBc	dBm	
39.84	9.64	59.84	-20.00	
Tuned Freq MHz	Emission Frequency MHz	Antenna Polarity	ERP (dBm)	Margin (dB)
157.45	629.83	V	-21.918	1.92
157.45	629.83	H	-26.928	6.93
157.45	944.74	V	-21.278	1.28
157.45	944.74	H	-23.988	3.99

High Power

Power Output		Limit		
dBm	Watts	dBc	dBm	
43.81	24.04	63.81	-20.00	
Tuned Freq MHz	Emission Frequency MHz	Antenna Polarity	ERP (dBm)	Margin (dB)
157.46	629.83	V	-22.718	2.72
157.46	629.83	H	-24.308	4.31
157.46	787.29	V	-30.860	10.86
157.46	787.29	H	-26.920	6.92
157.46	944.74	V	-21.298	1.30
157.46	944.74	H	-21.848	1.85

FIELD STRENGTH OF SPURIOUS EMISSIONS

Test Data: 161.5525 MHz

Low Power

Power Output		Limit		
dBm	Watts	dBc	dBm	
30.02	1.00	50.02	-20.00	
Tuned Freq MHz	Emission Frequency MHz	Antenna Polarity	ERP (dBm)	Margin (dB)
161.55	969.49	V	-39.798	19.80
161.55	969.49	V	-43.508	23.51

Medium Power

Power Output		Limit		
dBm	Watts	dBc	dBm	
39.84	9.64	59.84	-20.00	
Tuned Freq MHz	Emission Frequency MHz	Antenna Polarity	ERP (dBm)	Margin (dB)
161.55	969.49	H	-28.128	8.13
161.55	969.49	V	-28.468	8.47
161.55	646.33	V	-33.537	13.54
161.55	646.33	H	-29.897	9.90

High Power

Power Output		Limit		
dBm	Watts	dBc	dBm	
43.81	24.04	63.81	-20.00	
Tuned Freq MHz	Emission Frequency MHz	Antenna Polarity	ERP (dBm)	Margin (dB)
161.55	646.33	H	-34.817	14.82
161.55	646.33	V	-34.797	14.80
161.55	807.91	V	-38.326	18.33
161.55	807.91	H	-31.316	11.32
161.55	969.49	H	-25.078	5.08
161.55	969.49	V	-25.348	5.35

FIELD STRENGTH OF SPURIOUS EMISSIONS

Test Data: 161.7875 MHz

Low Power

Power Output		Limit		
dBm	Watts	dBc	dBm	
30.02	1.00	50.02	-20.00	
Tuned Freq MHz	Emission Frequency MHz	Antenna Polarity	ERP (dBm)	Margin (dB)
161.78	970.70	V	-40.014	20.01
161.78	970.70	H	-43.154	23.15

Medium Power

Power Output		Limit		
dBm	Watts	dBc	dBm	
39.84	9.64	59.84	-20.00	
Tuned Freq MHz	Emission Frequency MHz	Antenna Polarity	ERP (dBm)	Margin (dB)
161.78	970.70	H	-28.204	8.20
161.78	970.70	V	-26.844	6.84
161.78	647.13	V	-34.037	14.04
161.78	647.13	H	-30.447	10.45

High Power

Power Output		Limit		
dBm	Watts	dBc	dBm	
43.81	24.04	63.81	-20.00	
Tuned Freq MHz	Emission Frequency MHz	Antenna Polarity	ERP (dBm)	Margin (dB)
161.78	647.13	H	-35.517	15.52
161.78	647.13	V	-36.017	16.02
161.78	808.91	V	-38.802	18.80
161.78	808.91	H	-30.912	10.91
161.78	970.70	H	-26.184	6.18
161.78	970.70	V	-26.684	6.68

FIELD STRENGTH OF SPURIOUS EMISSIONS

Test Data: 162.0450 MHz

Low Power

No Emissions Within 20 dB of the Specified Limit.

Medium Power

Power Output		Limit		
dBm	Watts	dBc	dBm	
39.84	9.64	59.84	-20.00	
Tuned Freq MHz	Emission Frequency MHz	Antenna Polarity	ERP (dBm)	Margin (dB)
162.04	648.18	V	-35.067	15.07
162.04	648.18	H	-30.257	10.26
162.04	972.27	H	-29.678	9.68
162.04	972.27	V	-29.538	9.54

High Power

Power Output		Limit		
dBm	Watts	dBc	dBm	
43.81	24.04	63.81	-20.00	
Tuned Freq MHz	Emission Frequency MHz	Antenna Polarity	ERP (dBm)	Margin (dB)
162.04	972.27	V	-25.098	5.10
162.04	972.27	H	-27.118	7.12
162.04	810.22	H	-31.057	11.06
162.04	810.22	V	-31.437	11.44

FIELD STRENGTH OF SPURIOUS EMISSIONS

Test Data: 167.0000 MHz

Low Power

Power Output		Limit		
dBm	Watts	dBc	dBm	
30.02	1.00	50.02	-20.00	
Tuned Freq MHz	Emission Frequency MHz	Antenna Polarity	ERP (dBm)	Margin (dB)
167.00	668.00	V	-22.273	2.27
167.00	668.00	H	-20.373	0.37

Medium Power

Power Output		Limit		
dBm	Watts	dBc	dBm	
39.84	9.64	59.84	-20.00	
Tuned Freq MHz	Emission Frequency MHz	Antenna Polarity	ERP (dBm)	Margin (dB)
167.00	668.00	H	-29.943	9.94
167.00	668.00	V	-30.603	10.60

High Power

Power Output		Limit		
dBm	Watts	dBc	dBm	
43.81	24.04	63.81	-20.00	
Tuned Freq MHz	Emission Frequency MHz	Antenna Polarity	ERP (dBm)	Margin (dB)
167.00	835.00	H	-29.692	9.69
167.00	835.00	V	-28.362	8.36
167.00	668.00	V	-37.423	17.42
167.00	668.00	H	-33.973	13.97
167.00	1002.00	V	-35.673	15.67
167.00	1002.00	H	-36.743	16.74

FIELD STRENGTH OF SPURIOUS EMISSIONS

Test Data: 173.3925 MHz

Low Power

Power Output		Limit		
dBm	Watts	dBc	dBm	
30.02	1.00	50.02	-20.00	
Tuned Freq MHz	Emission Frequency MHz	Antenna Polarity	ERP (dBm)	Margin (dB)
173.39	866.96	H	-40.066	20.07
173.39	866.96	V	-42.166	22.17

Medium Power

Power Output		Limit		
dBm	Watts	dBc	dBm	
39.84	9.64	59.84	-20.00	
Tuned Freq MHz	Emission Frequency MHz	Antenna Polarity	ERP (dBm)	Margin (dB)
173.39	866.96	V	-32.436	12.44
173.39	866.96	H	-34.686	14.69
173.39	693.57	H	-32.727	12.73
173.39	693.57	V	-32.937	12.94

High Power

Power Output		Limit		
dBm	Watts	dBc	dBm	
43.81	24.04	63.81	-20.00	
Tuned Freq MHz	Emission Frequency MHz	Antenna Polarity	ERP (dBm)	Margin (dB)
173.39	693.57	V	-33.197	13.20
173.39	693.57	H	-31.707	11.71
173.39	520.18	H	-40.067	20.07
173.39	520.18	V	-42.357	22.36
173.39	866.96	V	-33.876	13.88
173.39	866.96	H	-45.686	25.69

FREQUENCY STABILITY

FCC Rule Parts: FCC Part 2.1055(a)(2), 90.213

MINIMUM FREQUENCY STABILITY

[Parts per million (ppm)]

Frequency range (MHz)	Fixed and base stations	Mobile stations	
		Over 2 watts output power	2 watts or less output power
150-174	5 ¹¹ 5	6 ⁵	4 ⁶ 5 ⁰

⁶In the 150-174 MHz band, mobile stations designed to operate with a 12.5 kHz channel bandwidth or designed to operate on a frequency specifically designated for itinerant use or designed for low-power operation of two watts or less, must have a frequency stability of 5.0 ppm. Mobile stations designed to operate with a 6.25 kHz channel bandwidth must have a frequency stability of 2.0 ppm.

Method of Measurements: TIA 603-E, 2.2.2

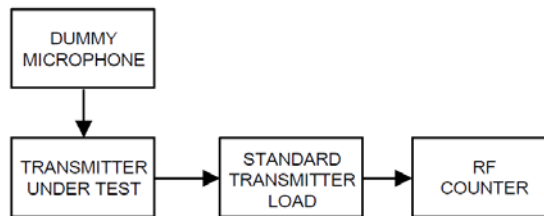

Test Data: Frequency Error Measurement Plot

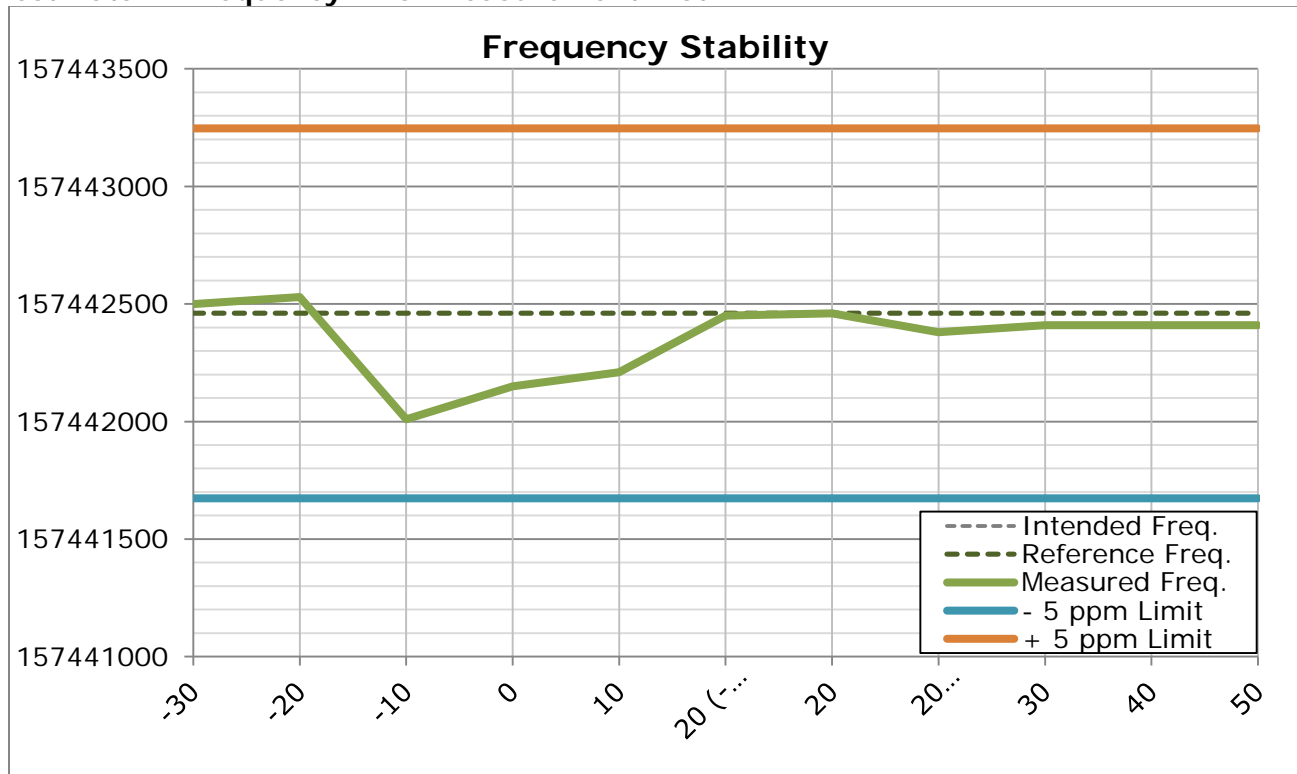

FREQUENCY STABILITY

Test Data: Frequency Error Measurement Table

Limit:		5 ppm		
Temperature (°C)	Supplied Voltage (VDC)	Intended Frequency (Hz)	Measured Reference Frequency (Hz)	Deviation (Hz)
20°C (reference)	13.8	157440000	157442460	-2460

@ 20°C (reference)				
Supplied Voltage (%)	Supplied Voltage (VDC)	Frequency (Hz)	Deviation (Hz)	PPM
-15%	11.73	157442450	10	0.064
15%	15.87	157442380	80	0.508

Temperature (°C)	Supplied Voltage (VDC)	Frequency (Hz)	Deviation (Hz)	PPM
50	13.8	157442410	50	0.318
40	13.8	157442410	50	0.318
30	13.8	157442410	50	0.318
20	13.8	157442460	0	0.000
10	13.8	157442210	250	1.588
0	13.8	157442150	310	1.969
-10	13.8	157442010	450	2.858
-20	13.8	157442530	70	-0.445
-30	13.8	157442500	40	-0.254

RESULT: Meets Requirements

TRANSIENT FREQUENCY BEHAVIOR

FCC Rule Parts: 90.214

Requirements:

Transmitters designed to operate in the 150-174 MHz and 421-512 MHz frequency bands must maintain transient frequencies within the maximum frequency difference limits during the time intervals indicated:

Time intervals ^{1 2}	Maximum frequency difference ³	All equipment
		150 to 174 MHz
Transient Frequency Behavior for Equipment Designed to Operate on 12.5 kHz Channels		
t_1 ⁴	± 12.5 kHz	5.0 ms
t_2	± 6.25 kHz	20.0 ms
t_3 ⁴	± 12.5 kHz	5.0 ms

¹ t_{on} is the instant when a 1 kHz test signal is completely suppressed, including any capture time due to phasing.

t_1 is the time period immediately following t_{on} .

t_2 is the time period immediately following t_1 .

t_3 is the time period from the instant when the transmitter is turned off until t_{off} .

t_{off} is the instant when the 1 kHz test signal starts to rise.

² During the time from the end of t_2 to the beginning of t_3 , the frequency difference must not exceed the limits specified in §90.213.

³ Difference between the actual transmitter frequency and the assigned transmitter frequency.

⁴ If the transmitter carrier output power rating is 6 watts or less, the frequency difference during this time period may exceed the maximum frequency difference for this time period.

Method of Measurement: TIA-603-E, 2.2.19.3

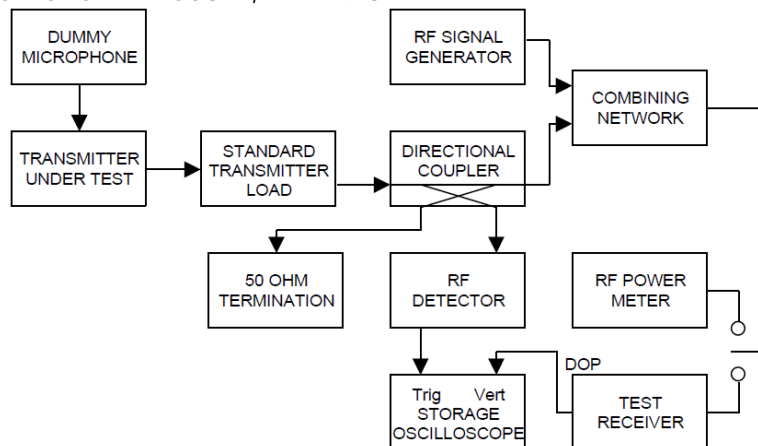

TRANSIENT FREQUENCY BEHAVIOR

Test Data: 12.5 kHz Turn-On Period (t_1)

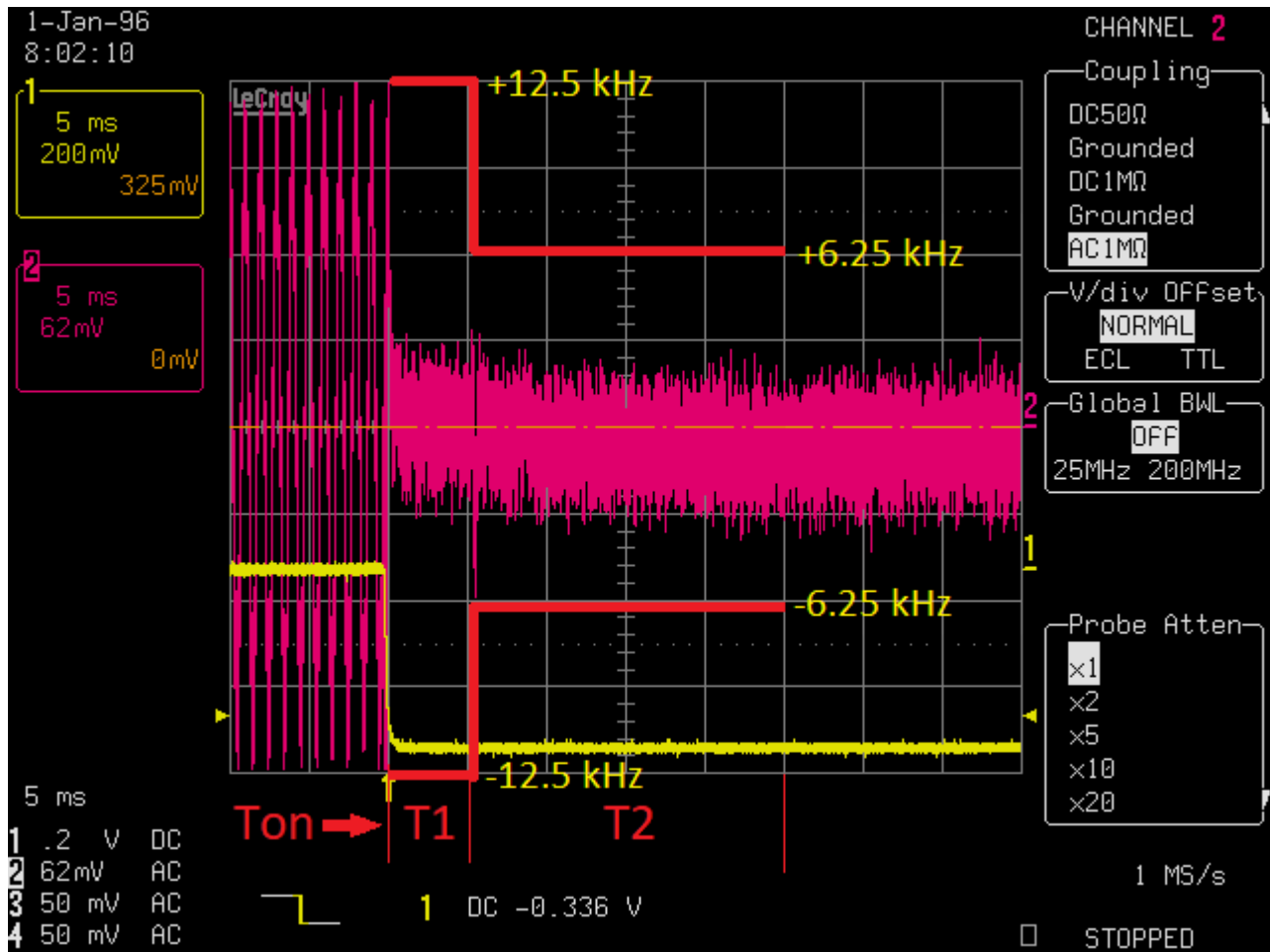

TRANSIENT FREQUENCY BEHAVIOR

Test Data: 12.5 kHz Turn-Off Period (t_3)

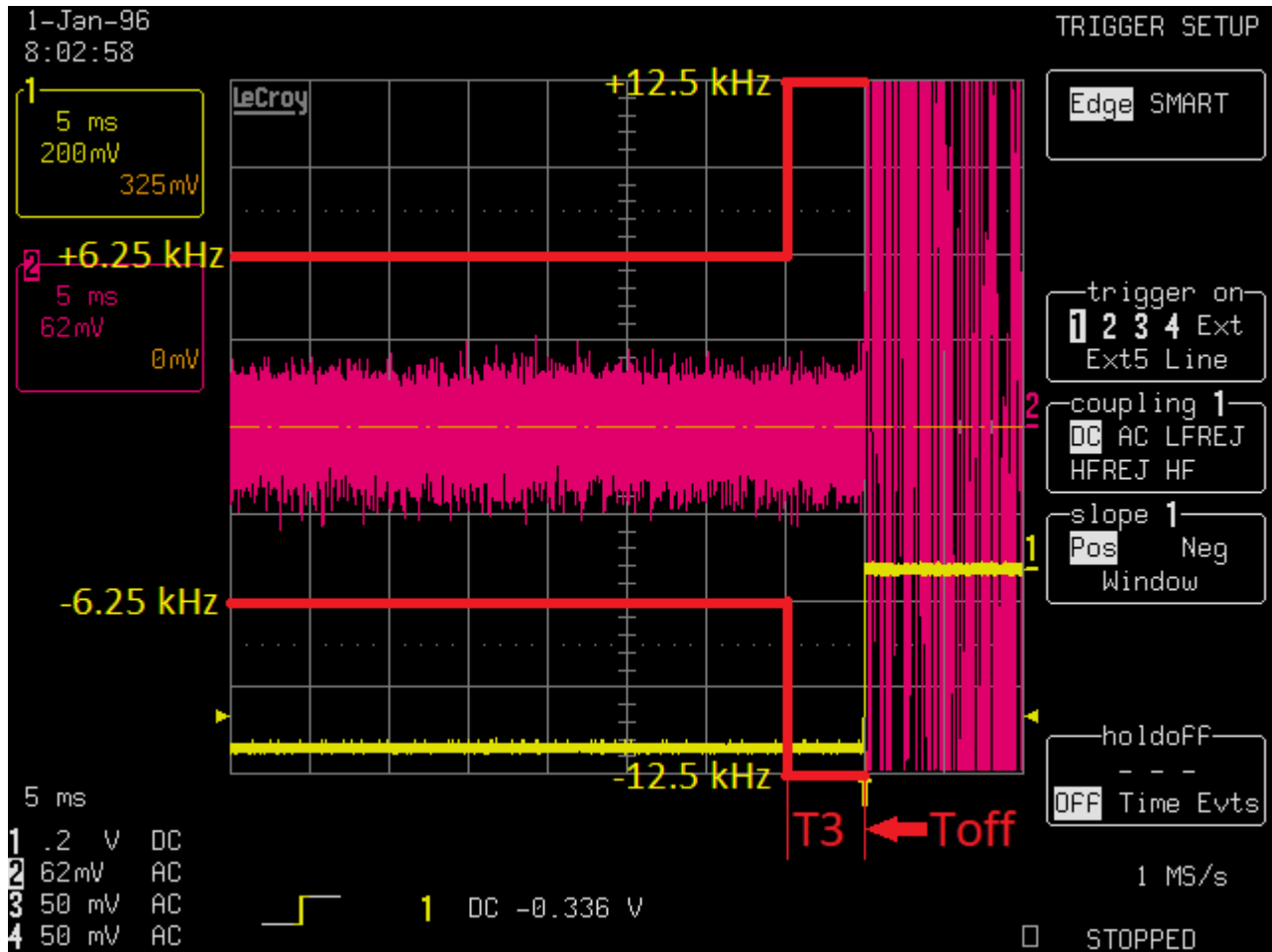

STATEMENT OF MEASUREMENT UNCERTAINTY

The data and results referenced in this document are true and accurate. The measurement uncertainty was calculated for all measurements listed in this test report according To CISPR 16-4 or ENTR 100-028 Specification for radio disturbance and immunity measuring apparatus and methods – Part 4: “Uncertainty in EMC Measurements” and is documented in the Timco Engineering, Inc. quality system according to DIN EN ISO/IEC 17025. Furthermore, component and process variability of devices similar to that tested may result in additional deviation. The manufacturer has the sole responsibility of continued compliance of the device.

Hereafter the best measurement capability for Timco Engineering, Inc. is reported:

Test Items	Measurement Uncertainty	Notes
RF Frequency Accuracy	± 49.5 Hz	(1)
RF Conducted Power	±0.93dB	(1)
Conducted spurious emission of transmitter valid up to 40GHz	±1.86dB	
Occupied Bandwidth	±2.65%	
Audio Frequency Response	±1.86dB	
Modulation limiting	±1.88%	
Radiated RF Power	±1.4dB	
Maximum frequency deviation: Within 300 Hz and 6kHz of audio freq.	±1.88%	
Within 6kHz and 25kHz of audio Freq.	±2.04%	
Rad Emissions Sub Meth up to 26.5GHz	±2.14dB	
Adjacent channel power	±1.47dB	(1)
Transient Frequency Response	±1.88%	
Temperature	±1.0°C	(1)
Humidity	±5.0%	

Notes: (1) This uncertainty represents an expanded uncertainty expressed at approximately the 95% confidence level using a coverage factor of k=1.96.

EMC EQUIPMENT LIST

Device	Manufacturer	Model	Serial Number	Cal/Char Date	Due Date
Coaxial Cable - BMBM-0065-01 Black DC-2G	Belden		BMBM-0065-01	07/18/16	07/18/18
Antenna: Biconical 1096	Eaton	94455-1	1096	08/01/17	08/01/19
Antenna: Log-Periodic 1122	Electro-Metrics	LPA-25	1122	07/26/17	07/26/19
Temperature Chamber LARGE	Tenney Engineering	TTRC	11717-7	09/01/16	09/01/18
Frequency Counter Small Chamber	HP	5385A	3242A07460	08/22/17	08/22/19
Coaxial Cable - Chamber 3 cable set (backup)	Micro-Coax	Chamber 3 cable set (backup)	KMKM-0244-02 KMKM-0670-01 KFKF-0197-00	N/A	N/A
CHAMBER	Panashield	3M	N/A	04/25/16	5/31/18
Antenna: Double-Ridged Horn/ETS Horn 2	ETS-Lindgren	3117	00041534	03/01/17	03/01/19
Software: Field Strength Program	Timco	N/A	Version 4.10.7.0	N/A	N/A
Antenna: Passive Loop	EMCO	6512	9706-1211	07/26/17	07/26/19
Type K J Thermometer	Martel	303	080504494	11/02/17	11/02/19
EMI Test Receiver R & S ESIB 40	Rohde & Schwarz	ESIB 40	100274	08/18/16	08/18/18
EMI Test Receiver R & S ESU 40	Rohde & Schwarz	ESU 40	100320	04/01/16	04/01/19
Attenuator N 20dB 20W DC-12G	Narda	768-20-SP	155	07/10/17	07/10/19
Attenuator N 20dB 20W DC-12G	Narda	768-20-SP	344	07/10/17	07/10/19
Attenuator N 30dB 100W DC-6G	Pasternack	PE7214-30	#109	05/24/17	05/24/19
Attenuator BNC 10dB DC-2G	MiniCircuits	HAT-10+	#54	07/14/17	07/14/19
Bore-sight Antenna Positioning Tower	Sunol Sciences	TLT2	N/A	N/A	N/A
Tunable Notch Filter 250-850 MHz	Eagle	TNF-200	250-850 MHz (#19)	11/19/17	11/19/19
Terminator N 20W DC-18G	Narda	8205	#14	04/06/17	04/06/19
Attenuator BNC 6dB 50Ohm DC-2G	Mini-Circuits	HAT-6+	#53	07/14/17	07/14/19
Attenuator N 30dB 100W DC-6G	Pasternack	PE7214-30	#109	05/24/17	05/23/19
DC Power Supply	HP	6286A	1744A03842	N/A	N/A
Modulation Analyzer	HP	8901A	3050A05856	04/13/17	04/13/19
Function Generator	Standford	DS340	25200	02/21/18	02/21/20
Terminator N 20W DC-18G	Narda	8205	#14	04/06/17	04/06/19

*EMI RECEIVER SOFTWARE VERSION

The receiver firmware used was version 4.43 Service Pack 3

END OF TEST REPORT