



FCC CFR 47 Part 90 Test Report

APPLICANT	STANDARD COMMUNICATIONS PTY.LTD.
ADDRESS	17 GIBBON ROAD WINSTON HILLS 2153 AUSTRALIA
FCC ID	TXJCM60UL25
MODEL NUMBER	CM60-UL25B, CM60-UL25D, CM60-UL25L, CM60-UL25P, CM60-UL25R, CM60-UL25S
PRODUCT DESCRIPTION	UHF MOBILE TRANSCEIVER
DATE SAMPLE RECEIVED	4/11/2018
FINAL TEST DATE	4/27/2018
TESTED BY	Franklin Rose
APPROVED BY	Tim Royer
TEST RESULTS	<input checked="" type="checkbox"/> PASS <input type="checkbox"/> FAIL

Report Number	Report Version	Description	Issue Date
484AUT18 PT90_TestReport_	Rev1	Initial Issue	04/27/2018
484AUT18 PT90_TestReport_	Rev2	Clerical Updates	05/25/2018
484AUT18 PT90_TestReport_	Rev3	Clerical Updates	05/30/2018
484AUT18 PT90_TestReport_	Rev4	Updated Model Numbers and Emission Designator – Pages 3 and 10	11/06/2018
484AUT18 PT90_TestReport_	Rev5	Updated address	12/28/2018

THE ATTACHED REPORT SHALL NOT BE REPRODUCED EXCEPT IN FULL WITHOUT THE WRITTEN APPROVAL OF TIMCO ENGINEERING, INC.



TABLE OF CONTENTS

GENERAL REMARKS	2
GENERAL INFORMATION	3
RESULTS SUMMARY	4
RF POWER OUTPUT	5
PART 2.1033 (c)(8) DC INPUT INTO FINAL AMPLIFIER.....	7
MODULATION CHARACTERISTICS	8
11K2F3E (NARROWBAND ANALOG FM VOICE) BANDWIDTH.....	8
8K10F1E/F1D (C4FM VOICE/DATA) BANDWIDTH.....	8
AUDIO FREQUENCY RESPONSE & LOW PASS FILTER	9
Test Data: 12.5 kHz FM Audio Frequency Response & Low Pass Filter.....	9
MODULATION LIMITING	10
Test Data: 12.5 kHz FM Modulation Limiting.....	10
OCCUPIED BANDWIDTH.....	11
TEST DATA: 11K2F3E (NARROWBAND ANALOG FM VOICE).....	12
TEST DATA: 8K10F1E/F1D (C4FM VOICE/DATA).....	13
EMISSION MASKS	14
EMISSION MASK D - NARROWBAND FM (12.5 kHz).....	15
Test Data: 406.10625 MHz	15
Test Data: 409.99375 MHz	18
Test Data: 420.00625 MHz	21
Test Data: 440.00 MHz.....	24
Test Data: 453.99375 MHz	27
Test Data: 456.00625 MHz	30
Test Data: 462.53125 MHz	33
Test Data: 462.74375 MHz	36
Test Data: 467.53125 MHz	39
Test Data: 467.74375 MHz	42
Test Data: 475.00 MHz.....	45
Test Data: 479.99375 MHz	48
EMISSION MASK D – P25 PHASE I C4FM (12.5 kHz)	51
Test Data: 406.10625 MHz	51
Test Data: 409.99375 MHz	54
Test Data: 420.00625 MHz	57
Test Data: 440.00 MHz.....	60
Test Data: 453.99375 MHz	63
Test Data: 456.00625 MHz	66
Test Data: 462.53125 MHz	69
Test Data: 462.74375 MHz	72
Test Data: 467.53125 MHz	75
Test Data: 467.74375 MHz	78
Test Data: 475.00 MHz.....	81
Test Data: 479.99375 MHz	84

SPURIOUS EMISSIONS AT ANTENNA TERMINALS (CONDUCTED).....	87
SPURIOUS EMISSIONS - NARROWBAND FM (12.5 kHz)	88
Test Data: 406.10625 MHz	88
Test Data: 409.99375 MHz	89
Test Data: 420.00625 MHz	90
Test Data: 440.00000 MHz	91
Test Data: 453.99375 MHz	92
Test Data: 456.00625 MHz	93
Test Data: 462.53125 MHz	94
Test Data: 462.74375 MHz	95
Test Data: 467.53125 MHz	96
Test Data: 467.74375 MHz	97
Test Data: 475.0000 MHz	98
Test Data: 479.99375 MHz	99
SPURIOUS EMISSIONS – P25 PHASE I C4FM	100
Test Data: 406.10625 MHz	100
Test Data: 409.99375 MHz	101
Test Data: 420.00625 MHz	102
Test Data: 440.00000 MHz	103
Test Data: 453.99375 MHz	104
Test Data: 456.00625 MHz	105
Test Data: 462.53125 MHz	106
Test Data: 462.74375 MHz	107
Test Data: 467.53125 MHz	108
Test Data: 467.74375 MHz	109
Test Data: 475.0000 MHz	110
Test Data: 479.99375 MHz	111
FIELD STRENGTH OF SPURIOUS EMISSIONS	112
TEST DATA: 406.10625 MHz	113
TEST DATA: 409.99375 MHz	115
TEST DATA: 420.00625 MHz	117
TEST DATA: 440.00 MHz.....	119
TEST DATA: 453.99375 MHz	121
TEST DATA: 456.00625 MHz	123
TEST DATA: 462.53125 MHz	126
TEST DATA: 462.74375 MHz	129
TEST DATA: 467.53125 MHz	132
TEST DATA: 467.74375 MHz	135
TEST DATA: 475.00 MHz.....	138
TEST DATA: 479.99375 MHz	139
FREQUENCY STABILITY	141
TRANSIENT FREQUENCY BEHAVIOR	144
TEST DATA: TURN-ON PERIOD (T_1)	145
TEST DATA: TURN-OFF PERIOD (T_3)	146
STATEMENT OF MEASUREMENT UNCERTAINTY	147
EMC EQUIPMENT LIST	148

GENERAL REMARKS

Summary

The device under test does:

- Fulfill the general approval requirements as identified in this test report and was selected by the customer.
- Not fulfill the general approval requirements as identified in this test report

Attestations

This equipment has been tested in accordance with the standards identified in this test report. To the best of my knowledge and belief, these tests were performed using the measurement procedures described in this report.

All instrumentation and accessories used to test products for compliance to the indicated standards are calibrated regularly in accordance with ISO 17025 requirements.

I attest that the necessary measurements were made at:

Timco Engineering Inc.
849 NW State Road 45
Newberry, FL 32669
Designation #: US1070

Tested by:



Name and Title Franklin Rose, Project Manager / EMC Testing Technician

Date 04/27/2018

Reviewed and Approved by:



Name and Title Tim Royer, Project Manager / EMC Testing Engineer

Date 04/27/2018

GENERAL INFORMATION

EUT Description	UHF MOBILE TRANSCEIVER
FCC ID	TXJCM60UL25
Model Number	CM60-UL25B, CM60-UL25D, CM60-UL25L, CM60-UL25P, CM60-UL25R, CM60-UL25S
Operating Frequency	Band 1: 406.1 – 480 MHz
Test Frequencies	Band 1: 406.10625, 409.99375 MHz Band 2: 420.00625, 440.00, 453.99375 MHz Band 3: 456.00625, 462.53125 MHz Band 4: 462.74375, 467.53125 MHz Band 5: 467.74375, 475.00, 479.99375 MHz
Type of Emission	11K2F3E (Narrowband Analog FM Voice), 8K10F1E (P25 Phase I C4FM Voice), 8K10F1D (P25 Phase I C4FM Data)
Modulation	FM
EUT Power Source	<input type="checkbox"/> 110–120Vac/50– 60Hz
	<input checked="" type="checkbox"/> DC Power (13.8 V)
	<input type="checkbox"/> Battery Operated Exclusively
Test Item	<input type="checkbox"/> Prototype
	<input checked="" type="checkbox"/> Pre-Production
	<input type="checkbox"/> Production
Type of Equipment	<input type="checkbox"/> Fixed
	<input checked="" type="checkbox"/> Mobile
	<input type="checkbox"/> Portable
Antenna Connector	BNC
Test Conditions	The temperature was 26°C Relative humidity of 50%.
Modification to the EUT	No Modification to EUT.
Test Exercise	The EUT was placed in continuous transmit and was operated in “Test Mode” for digital emissions tests.
Applicable Standards	ANSI/TIA 603-E:2016, ANSI C63.26 (2015), FCC CFR 47 Part 2, Part 90
Test Facility	Timco Engineering Inc. at 849 NW State Road 45 Newberry, FL 32669 USA. Designation #: US1070

RESULTS SUMMARY

Rule Part No.	Test Item	Results
2.1046(a), 90.205(g), (h), (i)	RF Power Output	PASS
2.1033(c)(4), 90.209(b)(5)	Modulation Characteristics	PASS
2.1047(a)	Audio Frequency Response and Low Filter	PASS
2.1047(b)	Modulation Limiting	PASS
2.1049 (c)	Occupied Bandwidth	PASS
90.210(d)(1), (2)	Emission Masks	PASS
2.1051(a), 90.210(d)(3)	Spurious Emissions at Antenna Terminals	PASS
2.1053(a), 90.210(d)(3)	Field Strength of Spurious Emissions	PASS
2.1055(a)(2), 90.213	Frequency Stability < 5 ppm	PASS
90.214	Transient Frequency Response	PASS

RF POWER OUTPUT

FCC Rule Parts: FCC Part 2.1046(a), 90.205(g), (h), (i)

(g) 421-430 MHz. Limitations on power and antenna heights are specified in §90.279.

(a) Base station authorizations in the 421-430 MHz band will be subject to Effective Radiated Power (ERP) and Effective Antenna Height (EAH) limitations as shown in the table below. ERP is defined as the product of the power supplied to the antenna and its gain relative to a half-wave dipole in a given direction. EAH is calculated by subtracting the Assumed Average Terrain Elevation (AATE) as listed in table 7 of §90.619 from the antenna height above mean sea level.

LIMITS OF EFFECTIVE RADIATED POWER (ERP) CORRESPONDING TO EFFECTIVE ANTENNA HEIGHTS (EAH) OF BASE STATIONS IN THE 421-430 MHz BAND

Effective antenna height (EAH) in meters (feet)	Maximum effective radiated power (ERP) (watts)
0-152 (0-500)	250
Above 152-305 (above 500-1000)	150
Above 305-457 (above 1000-1500)	75
Above 457-610 (above 1500-2000)	40
Above 610-762 (above 2000-2500)	20
Above 762-914 (above 2500-3000)	15
Above 914-1219 (above 3000-4000)	10
Above 1219 (above 4000)	5

RF POWER OUTPUT

(h) 450-470 MHz. (1) The maximum allowable station effective radiated power (ERP) is dependent upon the station's antenna HAAT and required service area and will be authorized in accordance with table 2. Applicants requesting an ERP in excess of that listed in table 2 must submit an engineering analysis based upon generally accepted engineering practices and standards that includes coverage contours to demonstrate that the requested station parameters will not produce coverage in excess of that which the applicant requires.

(2) Applications for stations where special circumstances exist that make it necessary to deviate from the ERP and antenna heights in Table 2 will be submitted to the frequency coordinator accompanied by a technical analysis, based upon generally accepted engineering practices and standards, that demonstrates that the requested station parameters will not produce a signal strength in excess of 39 dBu at any point along the edge of the requested service area. The coordinator may then recommend any ERP appropriate to meet this condition.

(3) An applicant for a station with a service area radius greater than 32 km (20 mi) must justify the requested service area radius, which may be authorized only in accordance with table 2, note 4. For base stations with service areas greater than 80 km, all operations 80 km or less from the base station will be on a primary basis and all operations outside of 80 km from the base station will be on a secondary basis and will be entitled to no protection from primary operations.

TABLE 2—450-470 MHz—MAXIMUM ERP/REFERENCE HAAT FOR A SPECIFIC SERVICE AREA RADIUS

	Service area radius (km)									
	3	8	13	16	24	32	40 ⁴	48 ⁴	64 ⁴	80 ⁴
Maximum ERP (w) ¹	2	100	2500	2500	2500	2500	2500	2500	2500	2500
Up to reference HAAT (m) ³	15	15	15	27	63	125	250	410	950	2700

¹Maximum ERP indicated provides for a 39 dBu signal strength at the edge of the service area per FCC Report R-6602, Fig. 29 (See §73.699, Fig. 10 b).

²Maximum ERP of 500 watts allowed. Signal strength at the service area contour may be less than 39 dBu.

³When the actual antenna HAAT is greater than the reference HAAT, the allowable ERP will be reduced in accordance with the following equation: $ERP_{allow} = ERP_{max} \times (HAAT_{ref} / HAAT_{actual})^2$.

⁴Applications for this service area radius may be granted upon specific request with justification and must include a technical demonstration that the signal strength at the edge of the service area does not exceed 39 dBu.

(i) 470-512 MHz. Power and height limitations are specified in §§90.307 and 90.309.

§90.307 Protection criteria.

The tables and figures listed in §90.309 shall be used to determine the effective radiated power (ERP) and antenna height of the proposed land mobile base station and the ERP for the associated control station (control station antenna height shall not exceed 31 meters (100 feet) above average terrain (AAT)).

(c) Mobile units and control stations operating on the frequencies available for land mobile use in any given urbanized area shall afford protection to co-channel and adjacent channel television stations in accordance with the values set forth in table C in §90.309 and paragraph (d) of this section except for channel 15 in New York, NY, and Cleveland, OH, and channel 16 in Detroit, MI, where protection will be in accordance with the values set forth in table D in §90.309 and paragraph (d) of this section.

RF POWER OUTPUT

Method of Measurement: TIA-603-E, 2.2.1

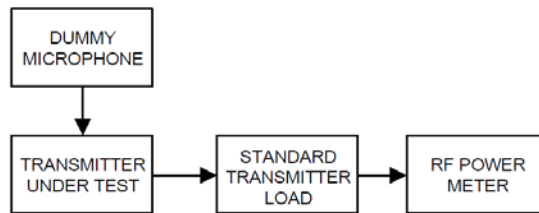

Test Data: Power Measurement Table

Peak Power Output					
dBm			Watts		
High	Med	Low	High	Med	Low
44.00	40.16	30.17	25.12	10.38	1.04

Part 2.1033 (c)(8) DC Input into Final Amplifier

INPUT POWER: (13.8 V) (6.0 A) = **82.8 Watts**

Result: Meets Requirements

MODULATION CHARACTERISTICS

FCC Rule Parts: Part 2.1033(c)(4), 90.209(b)(5)

STANDARD CHANNEL SPACING/BANDWIDTH

Frequency band (MHz)	Channel spacing (kHz)	Authorized bandwidth (kHz)
406-512 ²	¹ 6.25	¹³⁶ 20/11.25/6

¹For stations authorized on or after August 18, 1995.

²Bandwidths for radiolocation stations in the 420-450 MHz band and for stations operating in bands subject to this footnote will be reviewed and authorized on a case-by-case basis.

³Operations using equipment designed to operate with a 25 kHz channel bandwidth will be authorized a 20 kHz bandwidth. Operations using equipment designed to operate with a 12.5 kHz channel bandwidth will be authorized a 11.25 kHz bandwidth. Operations using equipment designed to operate with a 6.25 kHz channel bandwidth will be authorized a 6 kHz bandwidth. All stations must operate on channels with a bandwidth of 12.5 kHz or less beginning January 1, 2013, unless the operations meet the efficiency standard of §90.203(j)(3).

⁶Operations using equipment designed to operate with a 25 kHz channel bandwidth may be authorized up to a 22 kHz bandwidth if the equipment meets the Adjacent Channel Power limits of §90.221.

11K2F3E (Narrowband Analog FM Voice) Bandwidth

$$B_n = 2M + 2Dk$$

$$B_n = (2 \times 3) + (2 \times 2.5) = 11.0 \text{ kHz}$$

Where:

f_m = modulating frequency, kHz

f_d = deviation, kHz

k = constant (= 1)

Necessary Bandwidth for 11K2F3E = **11.0 kHz**

90. 209(b)(5) Authorized Bandwidth for 11K2F3E = **11.25 kHz**

8K10F1E/F1D (C4FM Voice/Data) Bandwidth

$$B_n = (R/\log_2 S) + 2DK$$

$$B_n = (9600/\log_2(4)) + 2(1800)(0.916)$$

$$B_n = 4800 + 3298$$

$$B_n = 8.10 \text{ kHz}$$

Where:

R (data rate) = 9600 bps

D (peak deviation) = 1800 Hz

S (symbols) = 4

K (constant) = 0.916

Necessary Bandwidth for 8K10F1E/F1D = **8.10 kHz**

90. 209(b)(5) Authorized Bandwidth for 8K10F1E/F1D = **11.25 kHz**

Result: Meets Requirements

Applicant: STANDARD COMMUNICATIONS PTY.LTD.

FCC ID: TXJCM60UL25

Report: 484AUT18 PT90_TestReport_Rev5

[Table of Contents](#)

Page 8 of 148

AUDIO FREQUENCY RESPONSE & LOW PASS FILTER

Rule Part No.: 2.1047(a)

Requirements:

(a) *Voice modulated communication equipment.* A curve or equivalent data showing the frequency response of the audio modulating circuit over a range of 100 to 5000 Hz shall be submitted. For equipment required to have an audio low-pass filter, a curve showing the frequency response of the filter, or of all circuitry installed between the modulation limiter and the modulated stage shall be submitted.

Test Procedure: TIA 603-E, 2.2.6.2.2, 2.2.15 (Using the Test Setup from section 2.2.6)

Note: The Low Pass Filter is digital, and has no "input" or "output" as found in the method of measurement, above. Testing has been altered accordingly to show the operation of the filter.

Note: Testing deviates from TIA 603-E 2.2.6.2.2 and 2.2.15. The Audio Frequency Response and Low Pass Filter Response plot data has been taken simultaneously using the Modulation Meter reading of Deviation (kHz), satisfying the requirements above.

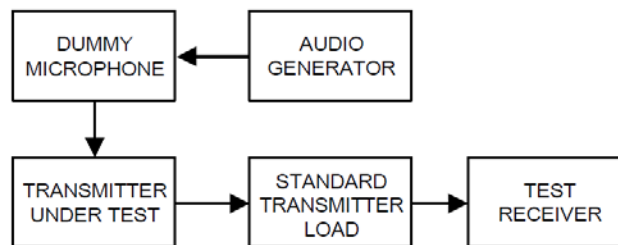

Test Data: 12.5 kHz FM Audio Frequency Response & Low Pass Filter

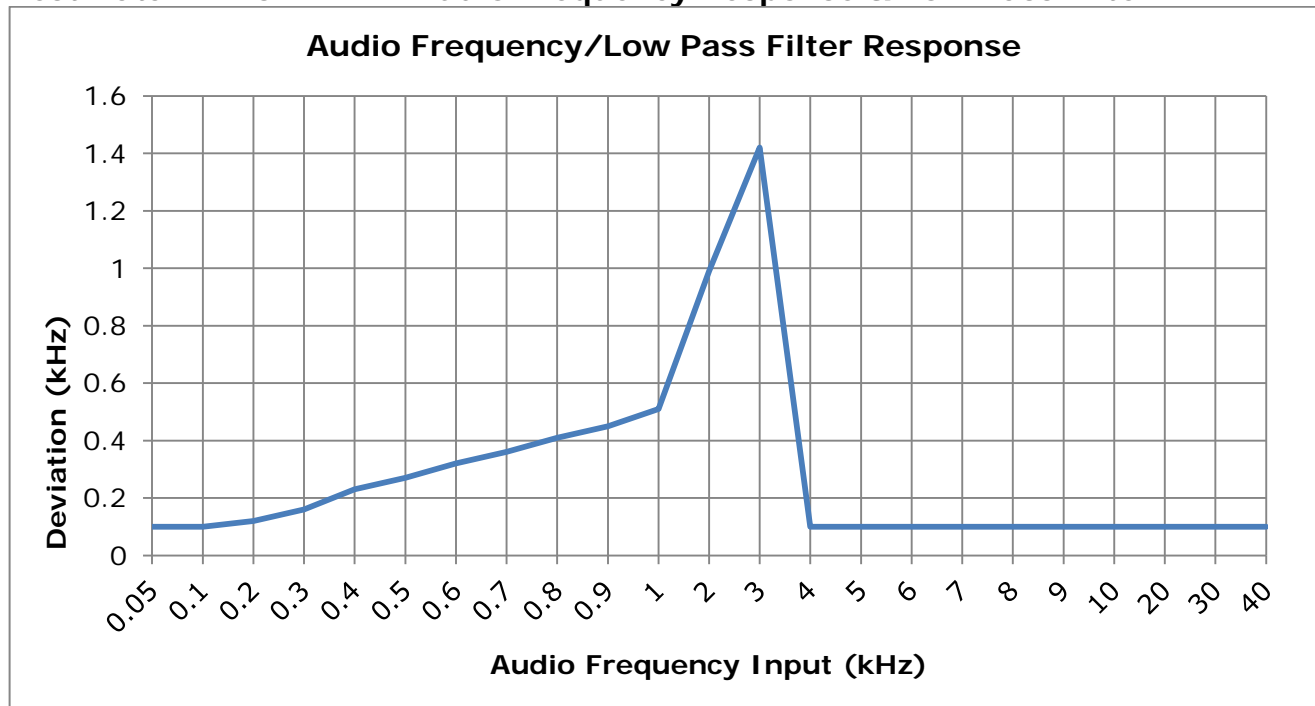

MODULATION LIMITING

Rule Part No.: 2.1047(b)

Requirements:

(b) *Equipment which employs modulation limiting.* A curve or family of curves showing the percentage of modulation versus the modulation input voltage shall be supplied. The information submitted shall be sufficient to show modulation limiting capability throughout the range of modulating frequencies and input modulating signal levels employed.

Test Procedure: TIA 603-E, 2.2.3

Note: The test method alone is not sufficient to meet the standard of FCC Pt. 2.1047(b). Deviation (kHz), as recorded from test equipment, has been converted into percentage as required above.

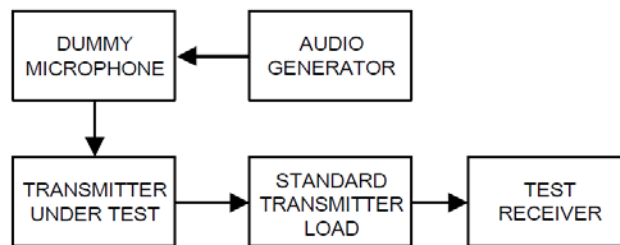

Test Data: 12.5 kHz FM Modulation Limiting

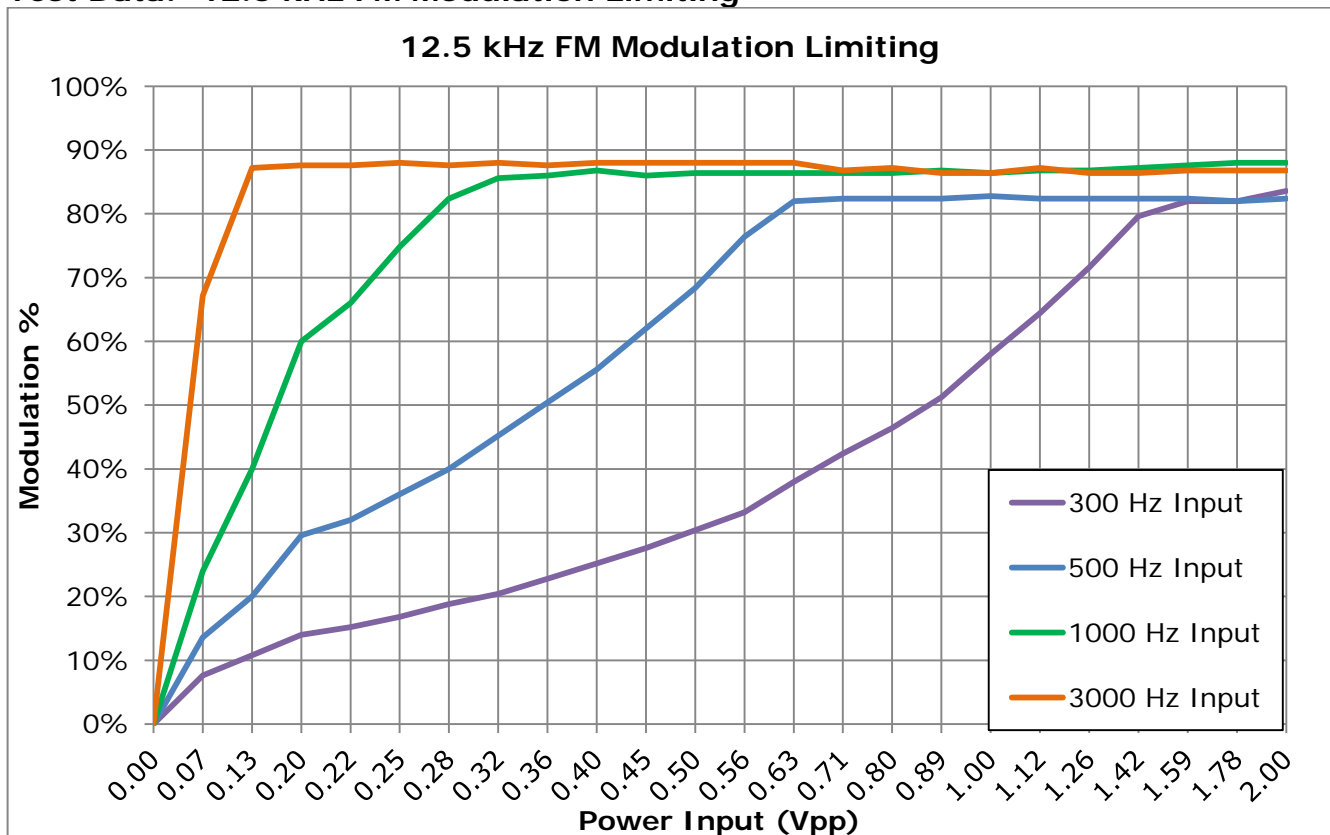

OCCUPIED BANDWIDTH

FCC Rule Parts: 2.1049 (c)

(c) Radiotelephone transmitters equipped with a device to limit modulation or peak envelope power shall be modulated as follows. For single sideband and independent sideband transmitters, the input level of the modulating signal shall be 10 dB greater than that necessary to produce rated peak envelope power.

(1) Other than single sideband or independent sideband transmitters—when modulated by a 2500 Hz tone at an input level 16 dB greater than that necessary to produce 50 percent modulation. The input level shall be established at the frequency of maximum response of the audio modulating circuit.

Method of Measurement: ANSI C63.26, 5.4.4 (using Test Setup from TIA 603-E 2.2.11, below)

Note: The receiver's automatic 99% Occupied Bandwidth function was used. The function is identical in operation to ANSI C63.26, 5.4.4, Step e).

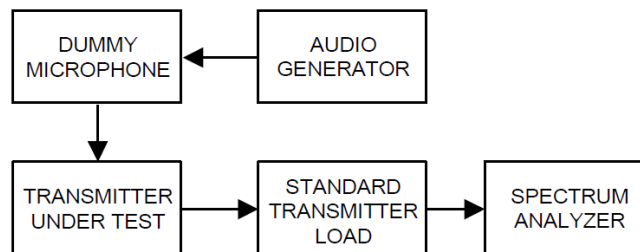

OCCUPIED BANDWIDTH 99%

Test Data: 11K2F3E (Narrowband Analog FM Voice)



Ref Lvl	44 dBm	Marker 1 [T1]	40.69 dBm	RBW	300 Hz	RF Att	20 dB
				VBW	3 kHz		
				SWT	1.4 s	Unit	dBm

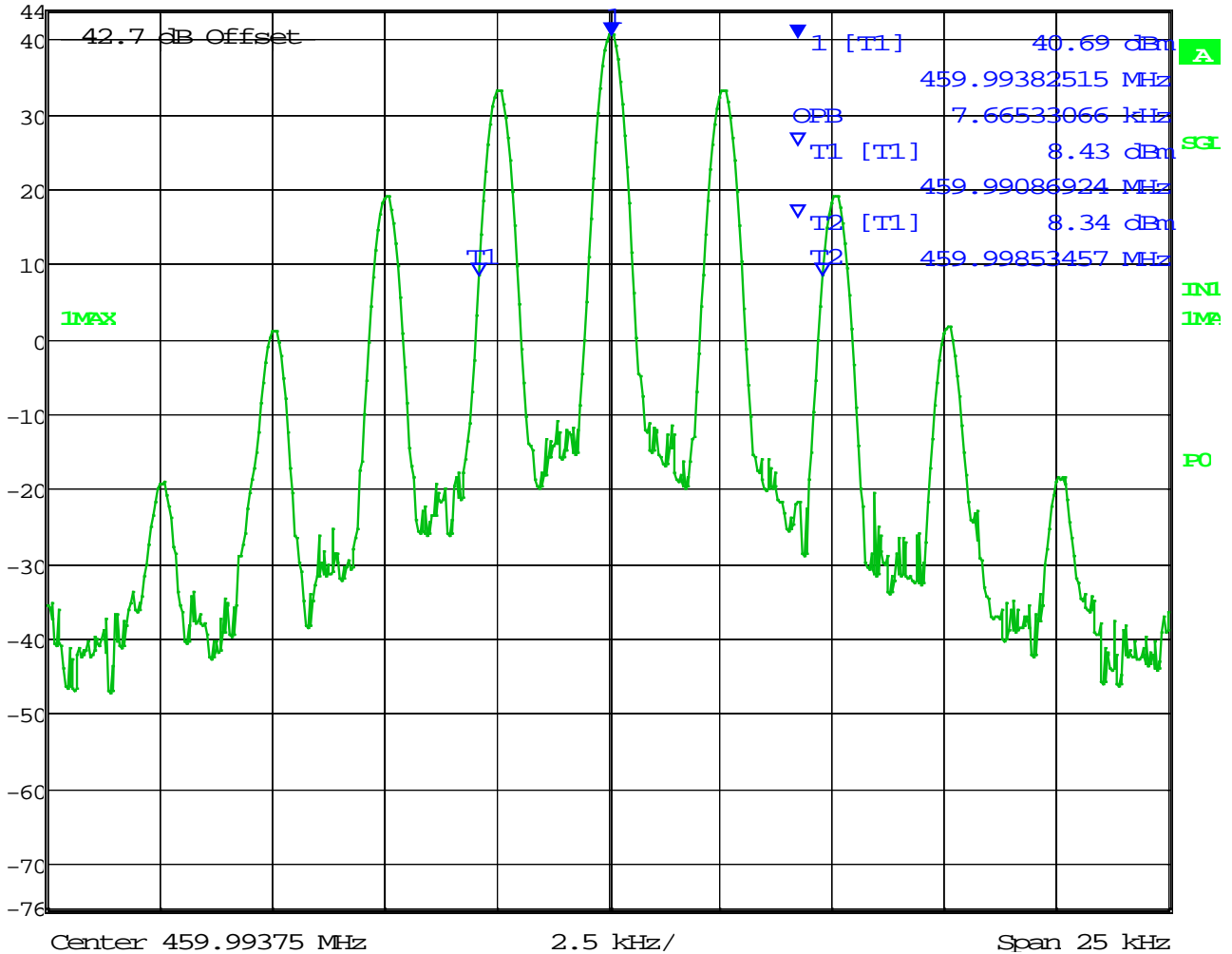

Date: 1.JAN.1997 02:26:53

99% OBW = 7.67 kHz

OCCUPIED BANDWIDTH 99%

Test Data: 8K10F1E/F1D (C4FM Voice/Data)



Ref Lvl	44 dBm	Marker 1 [T1]	39.91 dBm	RBW	300 Hz	RF Att	20 dB
			459.99407565 MHz	VBW	3 kHz		
				SWT	1.4 s	Unit	dBm

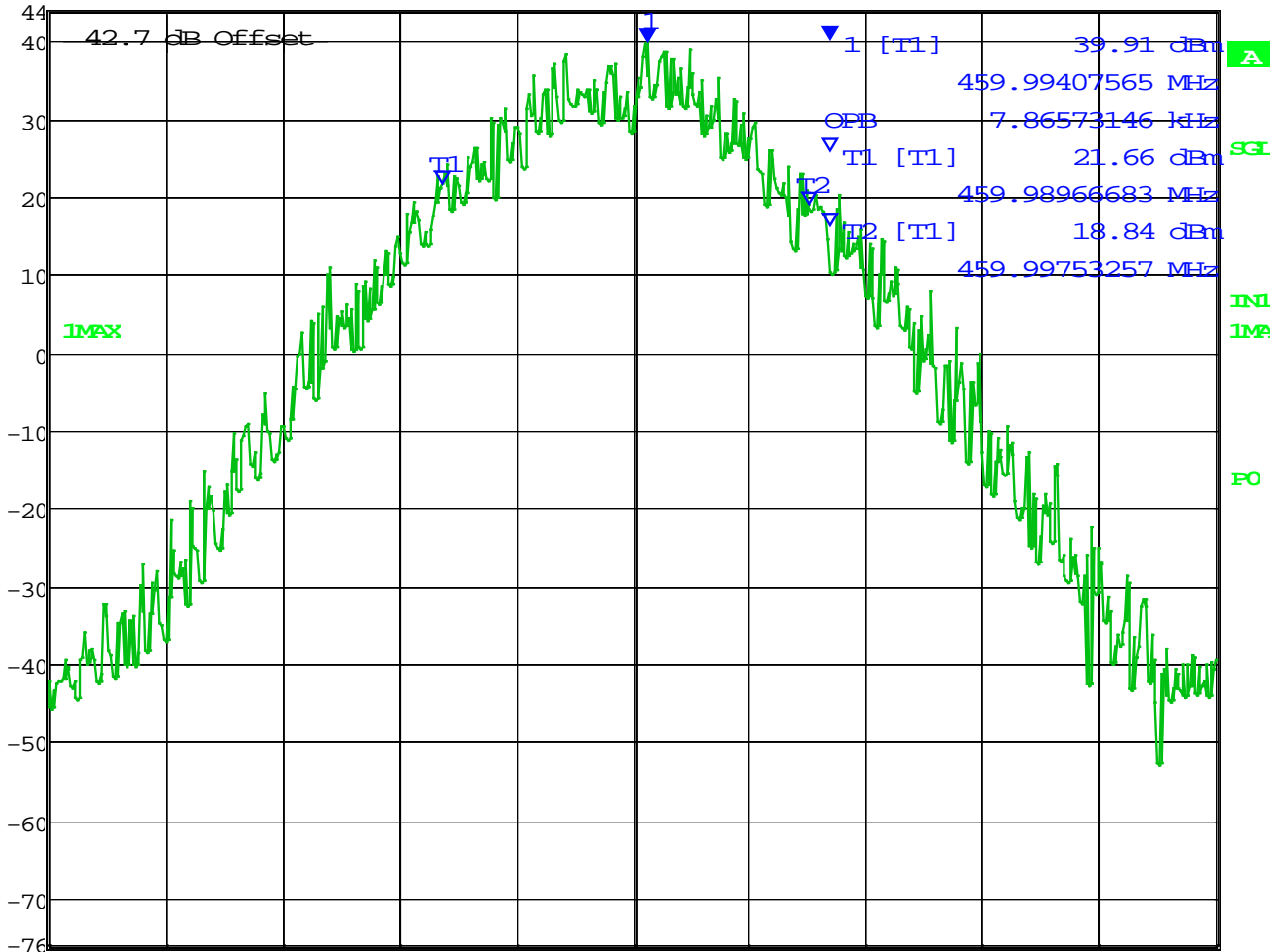

Center 459.99375 MHz 2.5 kHz/ Span 25 kHz

Date: 1.JAN.1997 02:29:30

99% OBW = 7.87 kHz

Result: Meets Requirements

EMISSION MASKS

FCC Rule Parts: 90.210(d)(1), (2)

APPLICABLE EMISSION MASKS

Frequency band (MHz)	Mask for equipment with audio low pass filter	Mask for equipment without audio low pass filter
421-512 ^{2 5}	B, D, or E	C, D, or E

²Equipment designed to operate with a 25 kHz channel bandwidth must meet the requirements of Emission Mask B or C, as applicable. Equipment designed to operate with a 12.5 kHz channel bandwidth must meet the requirements of Emission Mask D, and equipment designed to operate with a 6.25 kHz channel bandwidth must meet the requirements of Emission Mask E.

⁵Equipment may alternatively meet the Adjacent Channel Power limits of 590.221.

Requirements:

(d) *Emission Mask D—12.5 kHz channel bandwidth equipment.* For transmitters designed to operate with a 12.5 kHz channel bandwidth, any emission must be attenuated below the power (P) of the highest emission contained within the authorized bandwidth as follows:

(1) On any frequency from the center of the authorized bandwidth f_0 to 5.625 kHz removed from f_0 : Zero dB.

(2) On any frequency removed from the center of the authorized bandwidth by a displacement frequency (f_d in kHz) of more than 5.625 kHz but no more than 12.5 kHz: At least $7.27(f_d - 2.88)$ dB.

Method of Measurement: ANSI C63.26, 5.4.4 (using Test Setup from TIA 603-E 2.2.11, below)

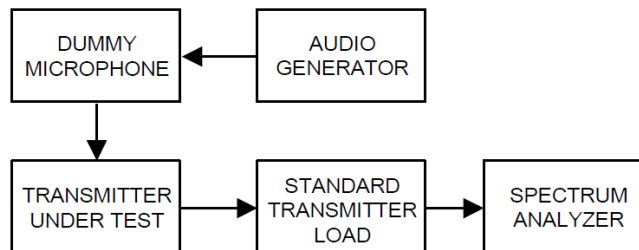

EMISSION MASK D - NARROWBAND FM (12.5 kHz)

Test Data: 406.10625 MHz

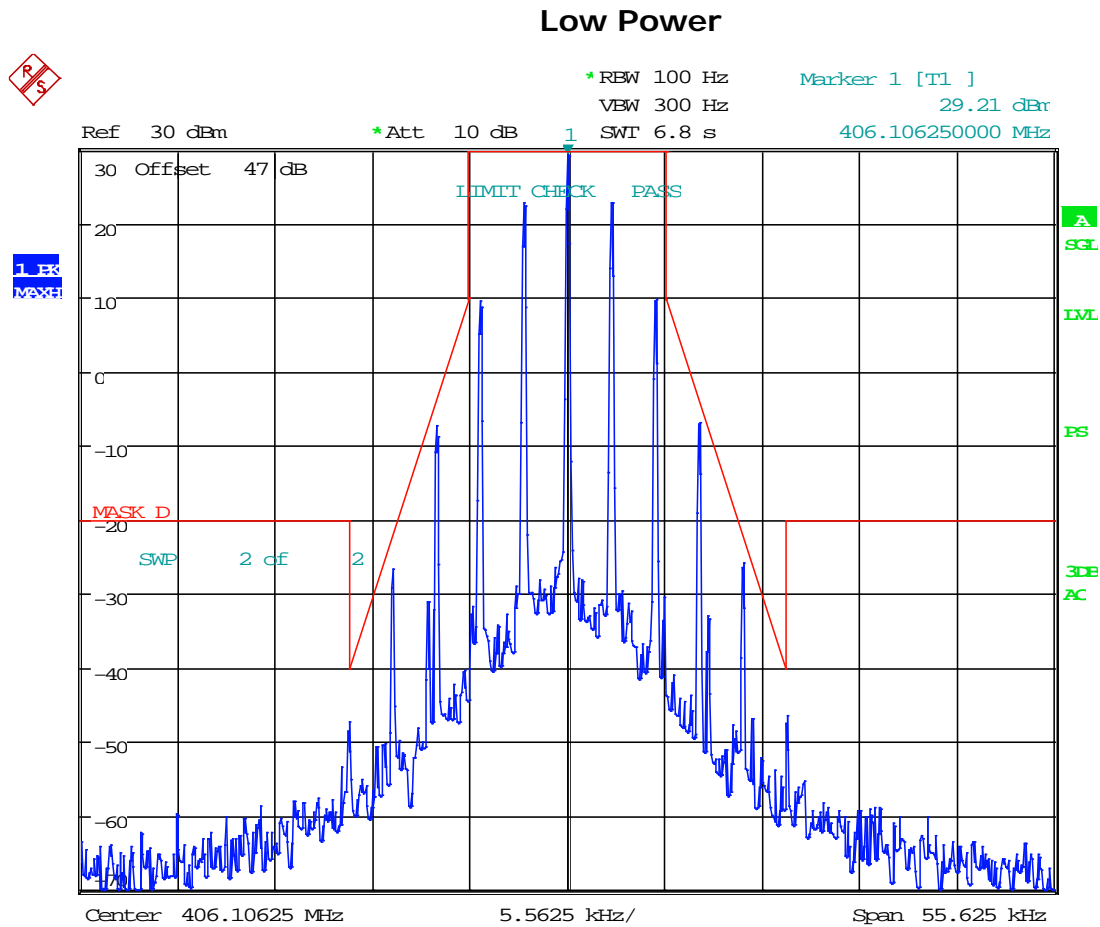

Date: 26.APR.2018 17:04:35

EMISSION MASK D

Medium Power

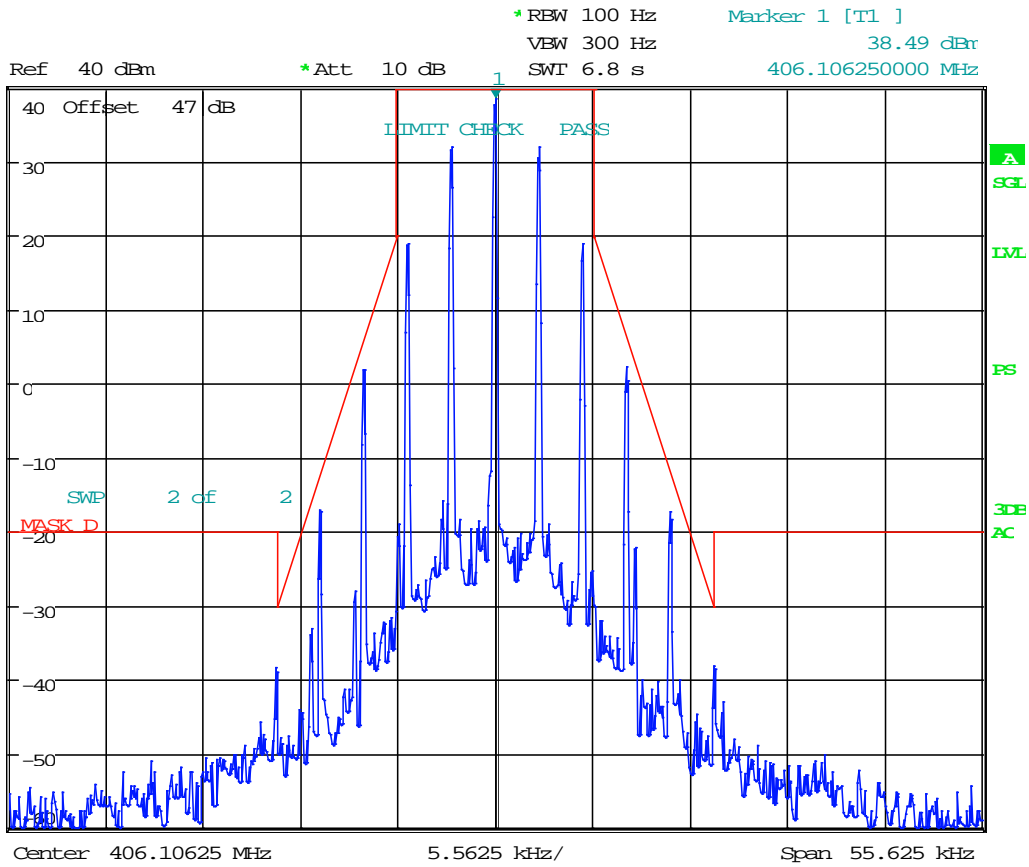

Date: 26.APR.2018 17:21:28

EMISSION MASK D

High Power



FLUX Meter

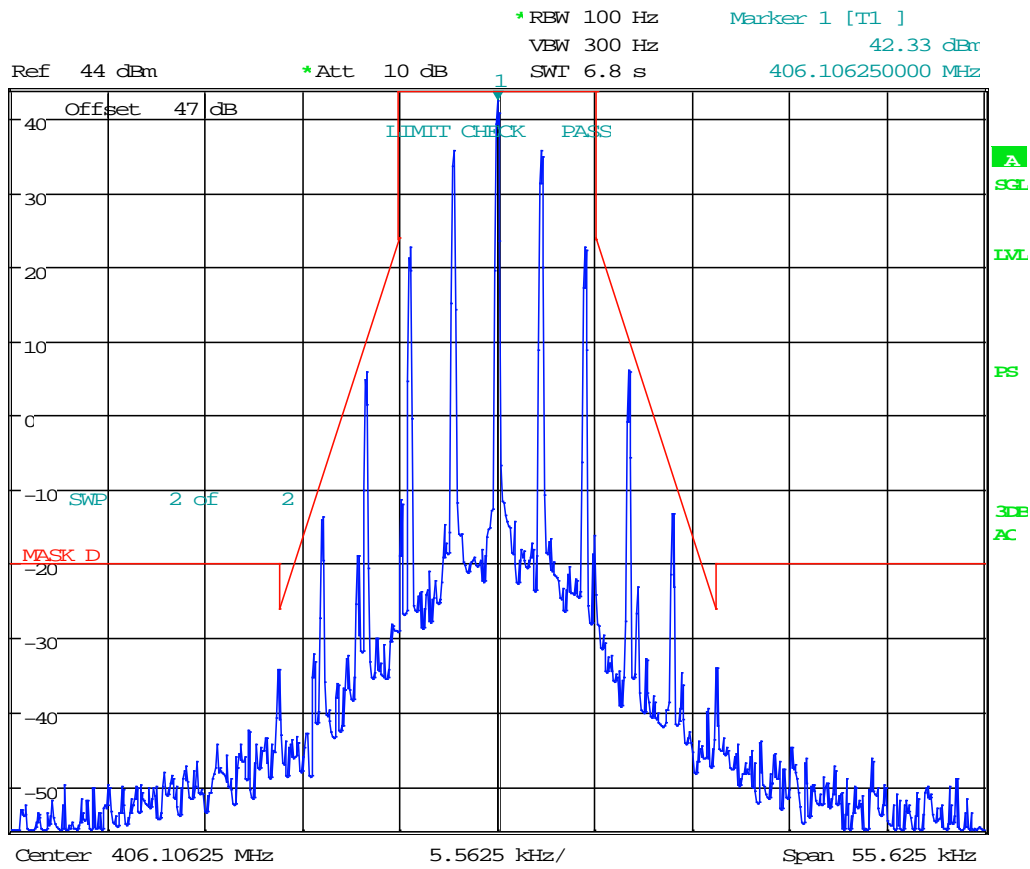

Date: 26.APR.2018 17:39:21

EMISSION MASK D

Test Data: 409.99375 MHz

Low Power

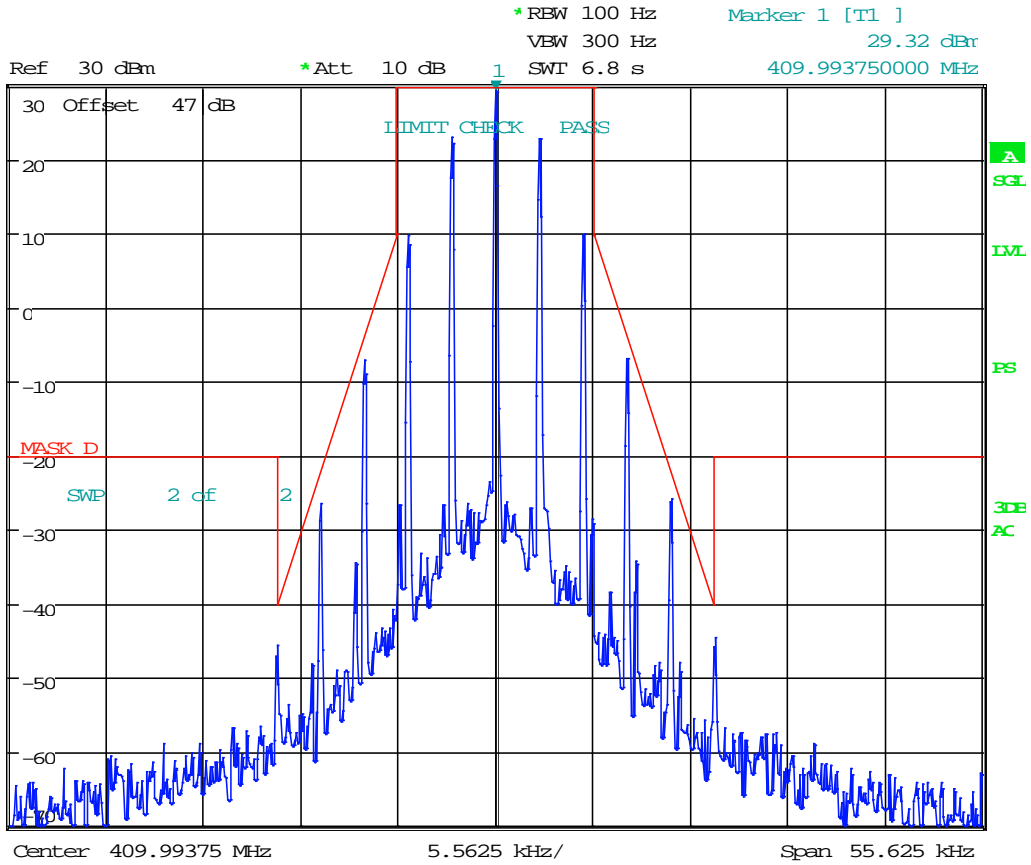

Date: 26.APR.2018 17:05:13

EMISSION MASK D

Medium Power

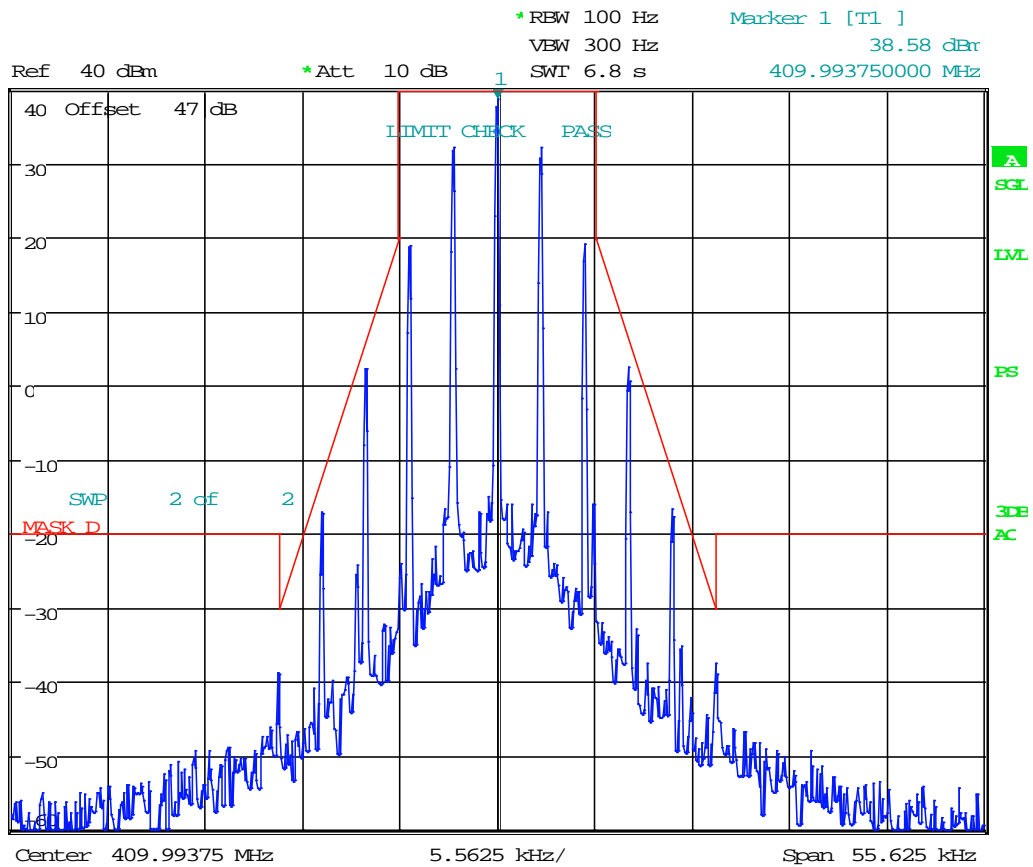

Date: 26.APR.2018 17:22:05

EMISSION MASK D

High Power



FLUX Meter

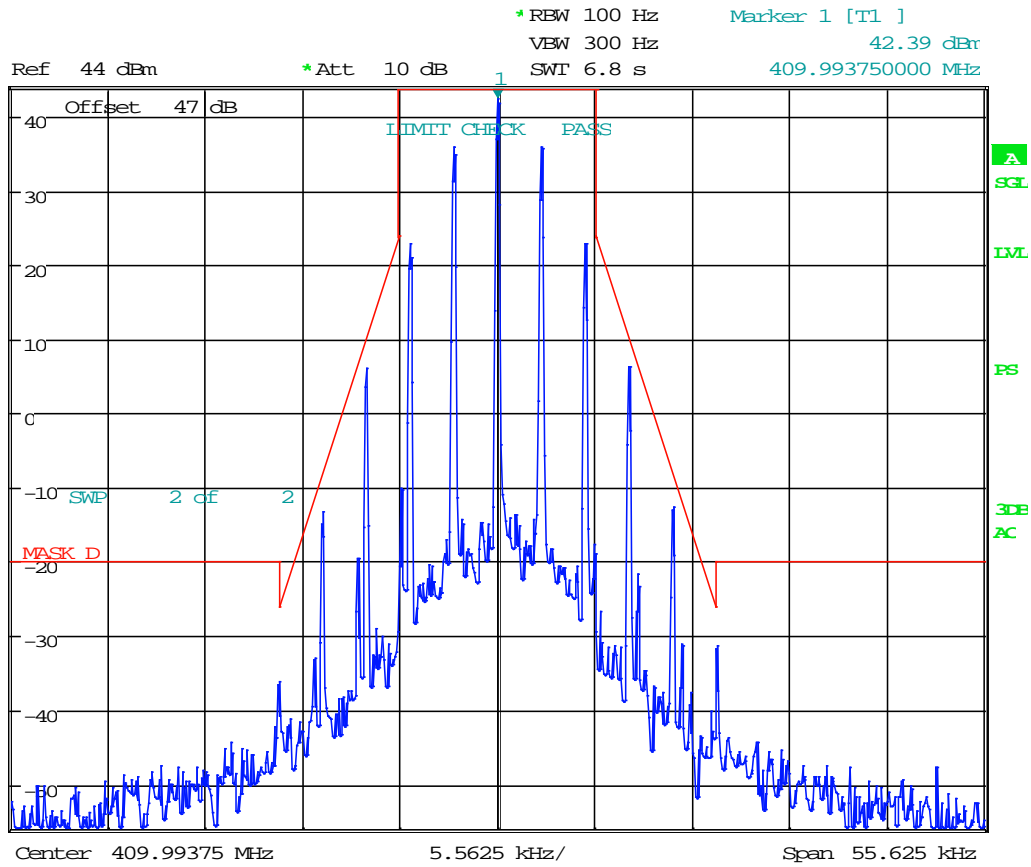

Date: 26.APR.2018 17:39:55

EMISSION MASK D

Test Data: 420.00625 MHz

Low Power

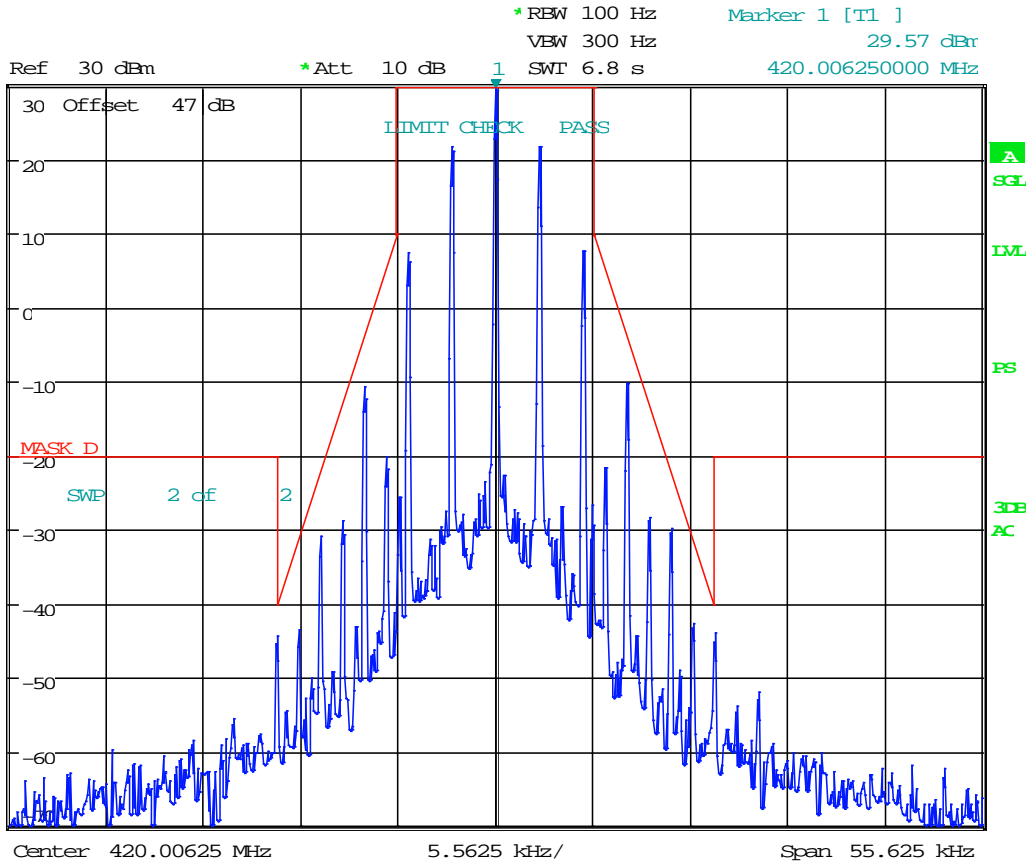

Date: 26.APR.2018 17:05:45

EMISSION MASK D

Medium Power

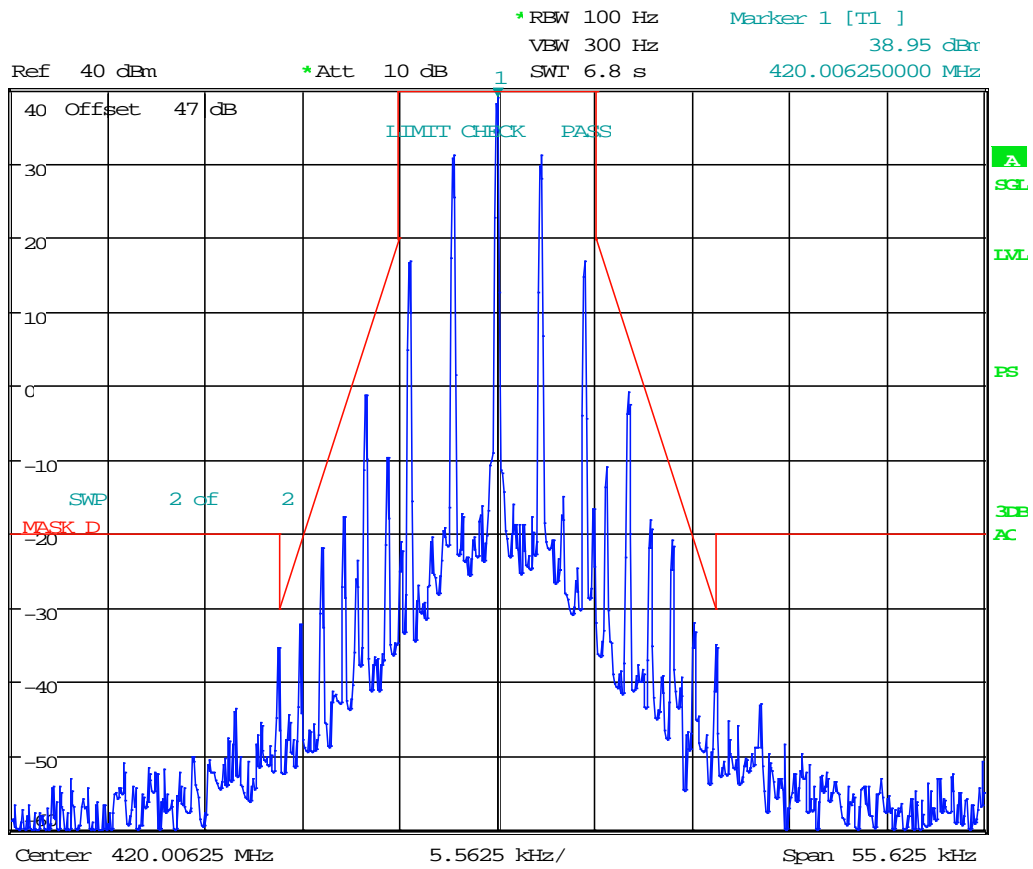

Date: 26.APR.2018 17:22:59

EMISSION MASK D

High Power



FLUX Meter

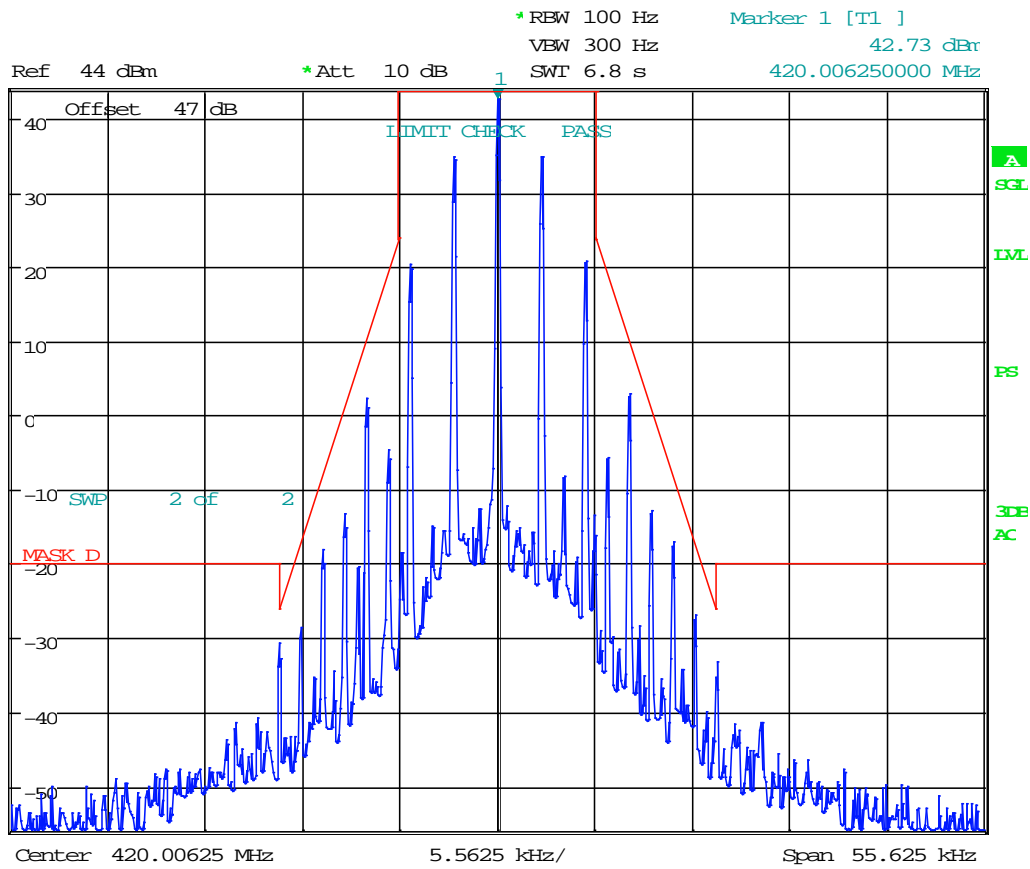

Date: 26.APR.2018 17:40:29

EMISSION MASK D

Test Data: 440.00 MHz

Low Power

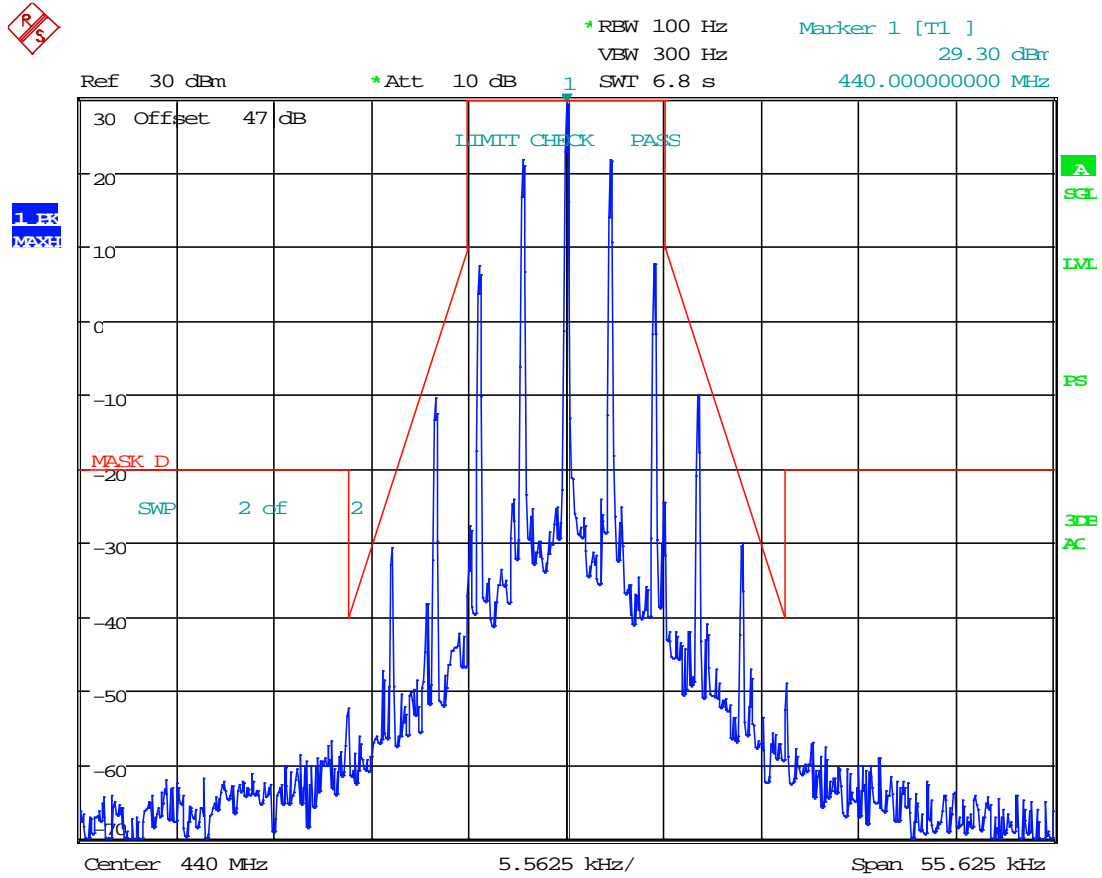

Date: 26.APR.2018 17:06:21

EMISSION MASK D

Medium Power

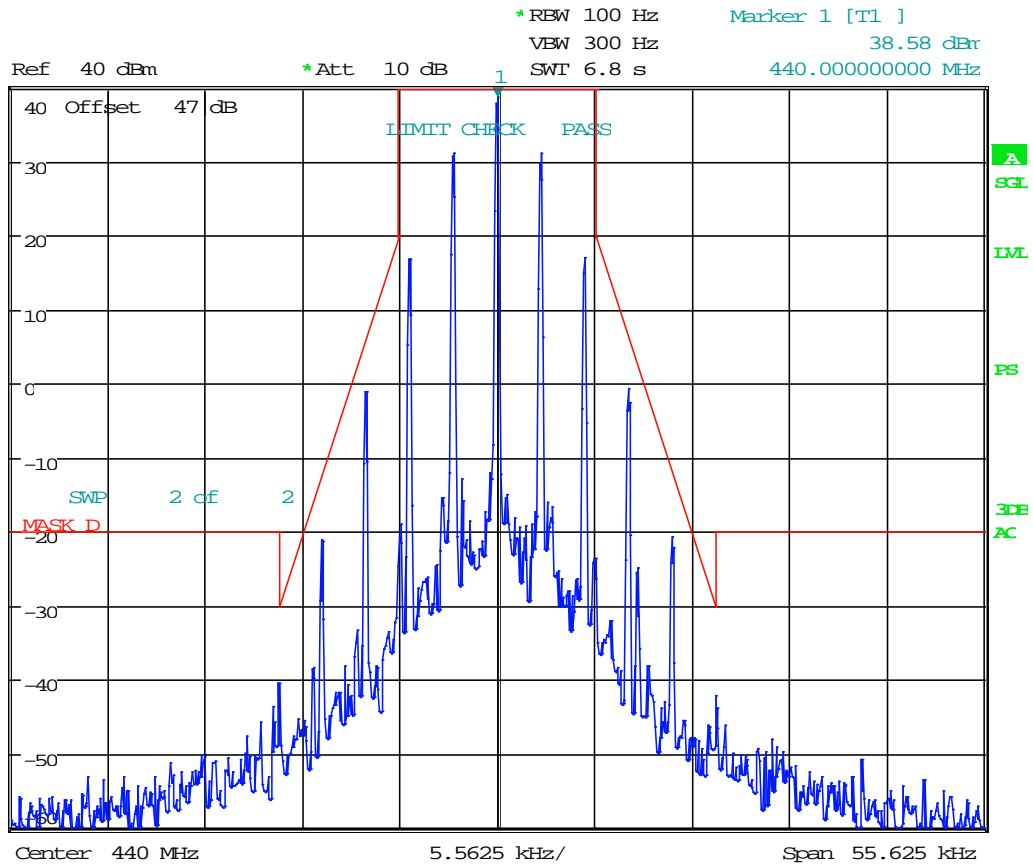

Date: 26.APR.2018 17:23:35

EMISSION MASK D

High Power



FLUX Meter

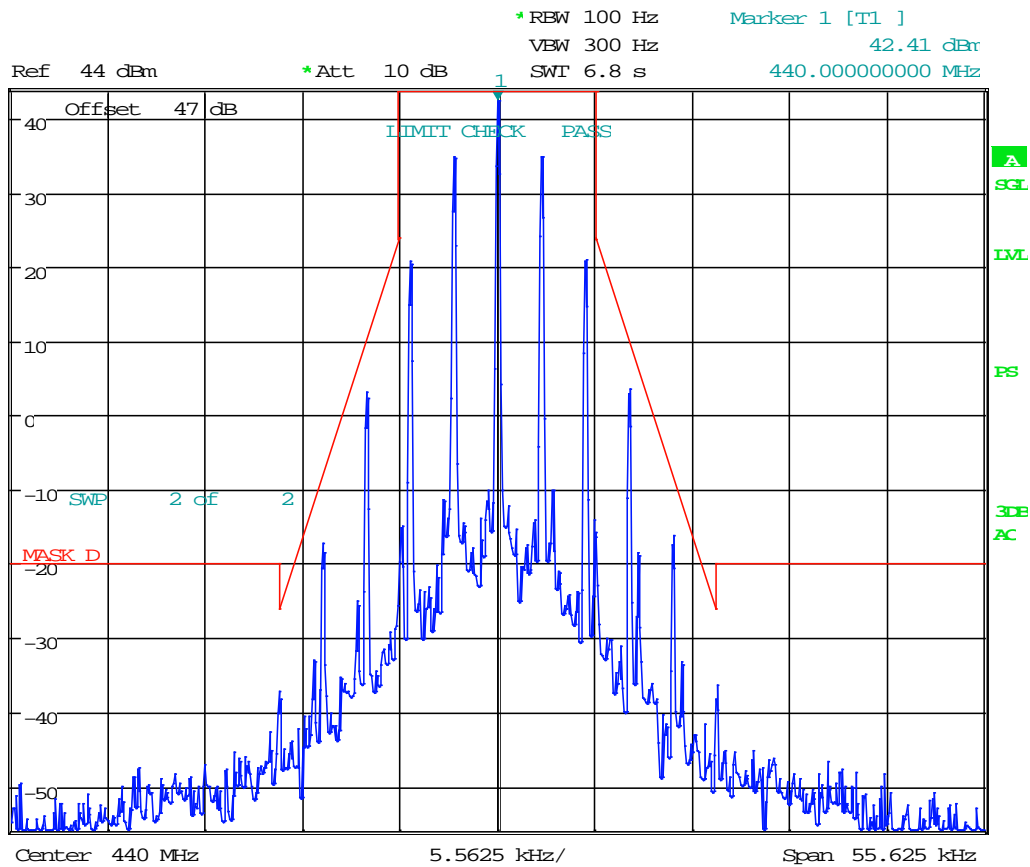

Date: 26.APR.2018 17:41:01

EMISSION MASK D

Test Data: 453.99375 MHz

Low Power

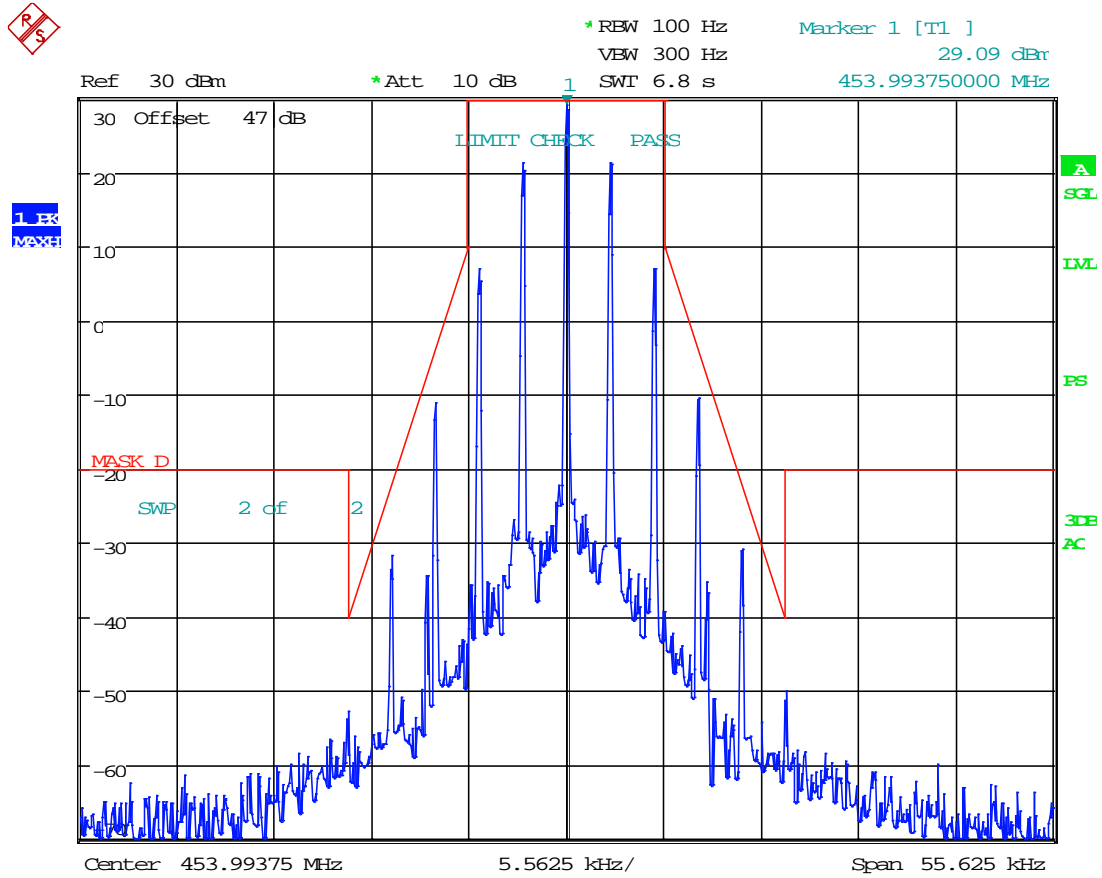

Date: 26.APR.2018 17:06:57

EMISSION MASK D

High Power



FLUX Meter

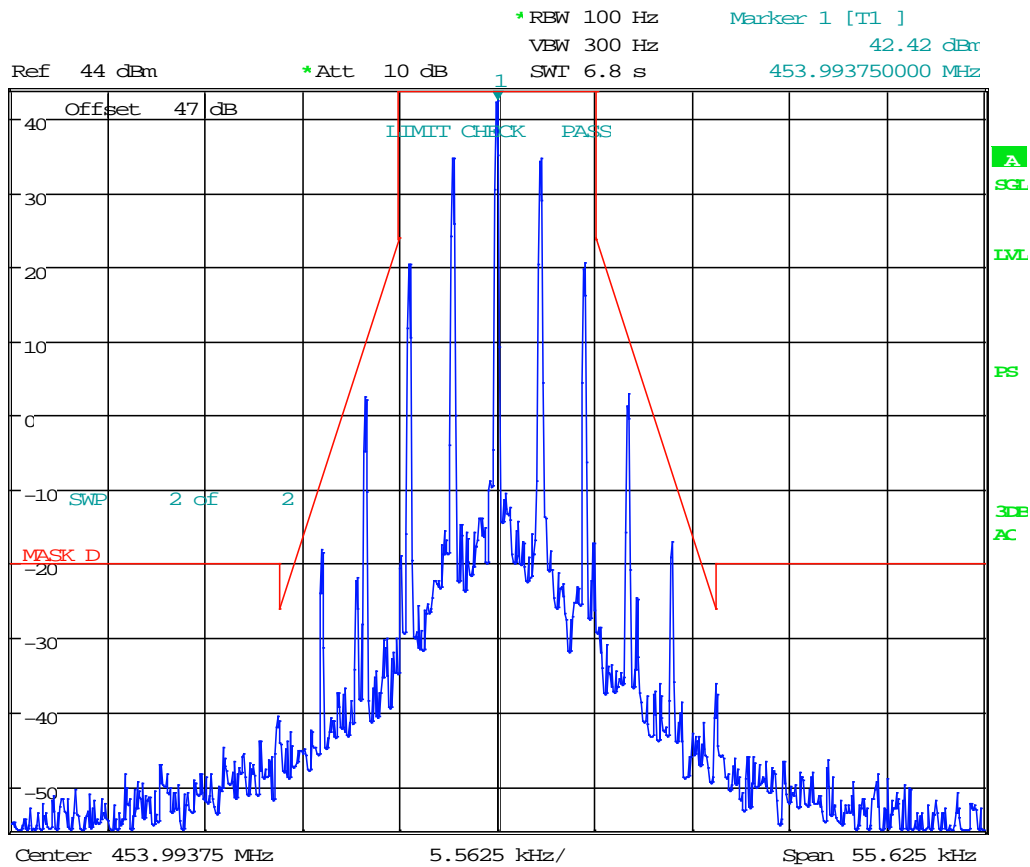

Date: 26.APR.2018 17:51:05

EMISSION MASK D

Test Data: 456.00625 MHz

Low Power

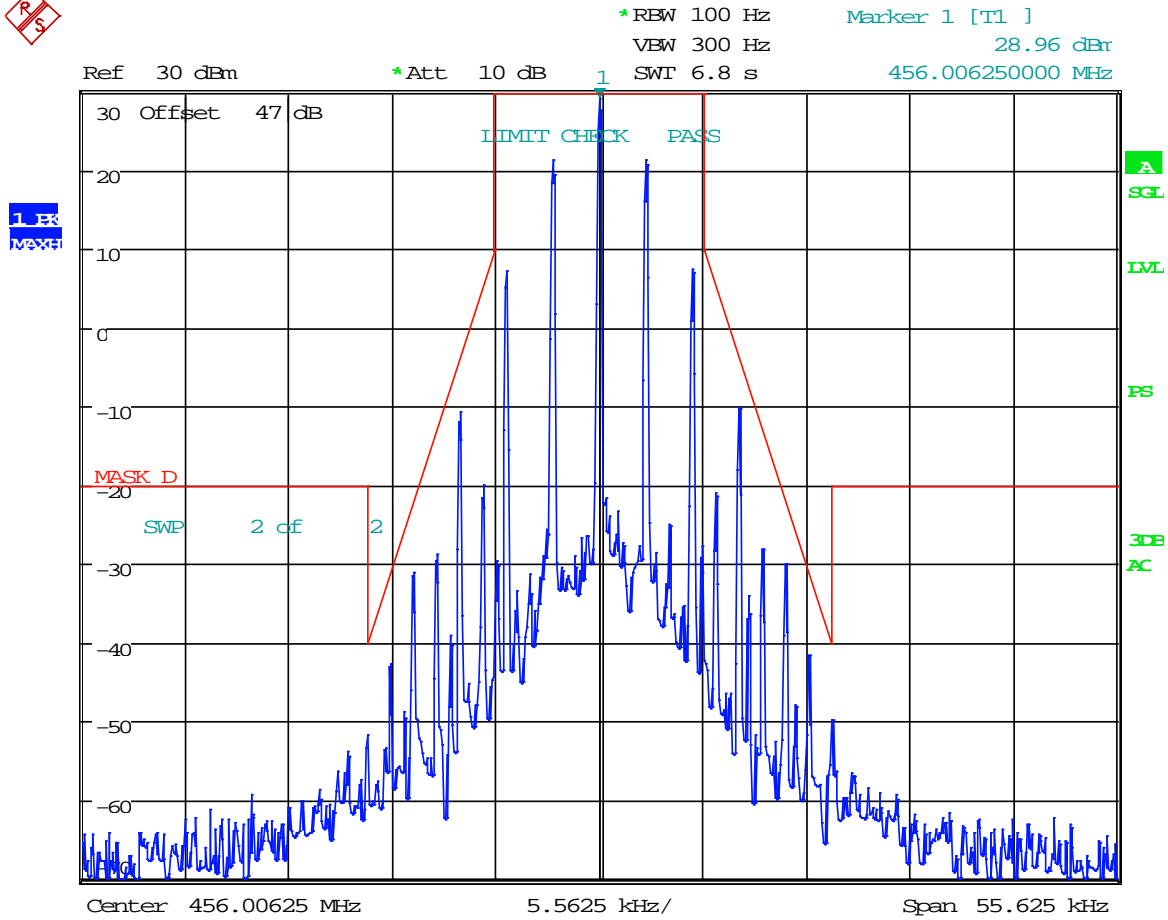

Date: 26.APR.2018 17:08:48

EMISSION MASK D

High Power



FLUX Meter

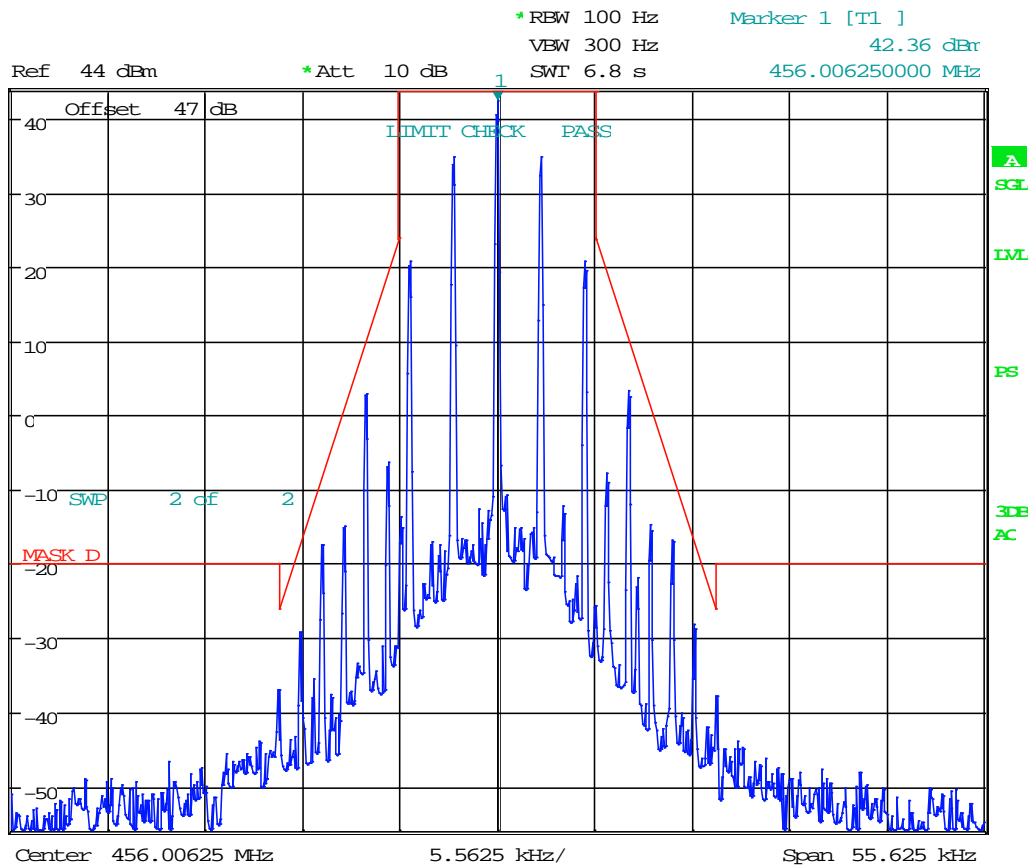

Date: 26.APR.2018 17:52:58

EMISSION MASK D

Test Data: 462.53125 MHz

Low Power

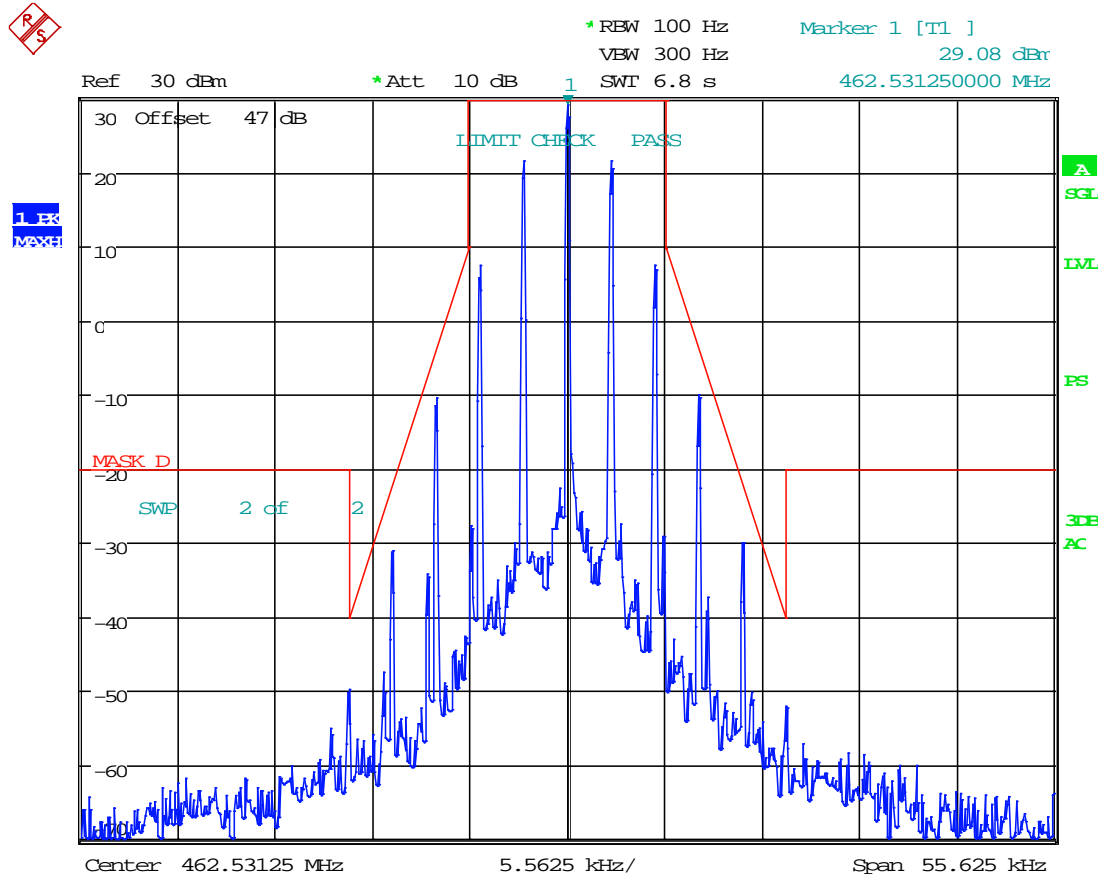

Date: 26.APR.2018 17:10:10

EMISSION MASK D

Medium Power

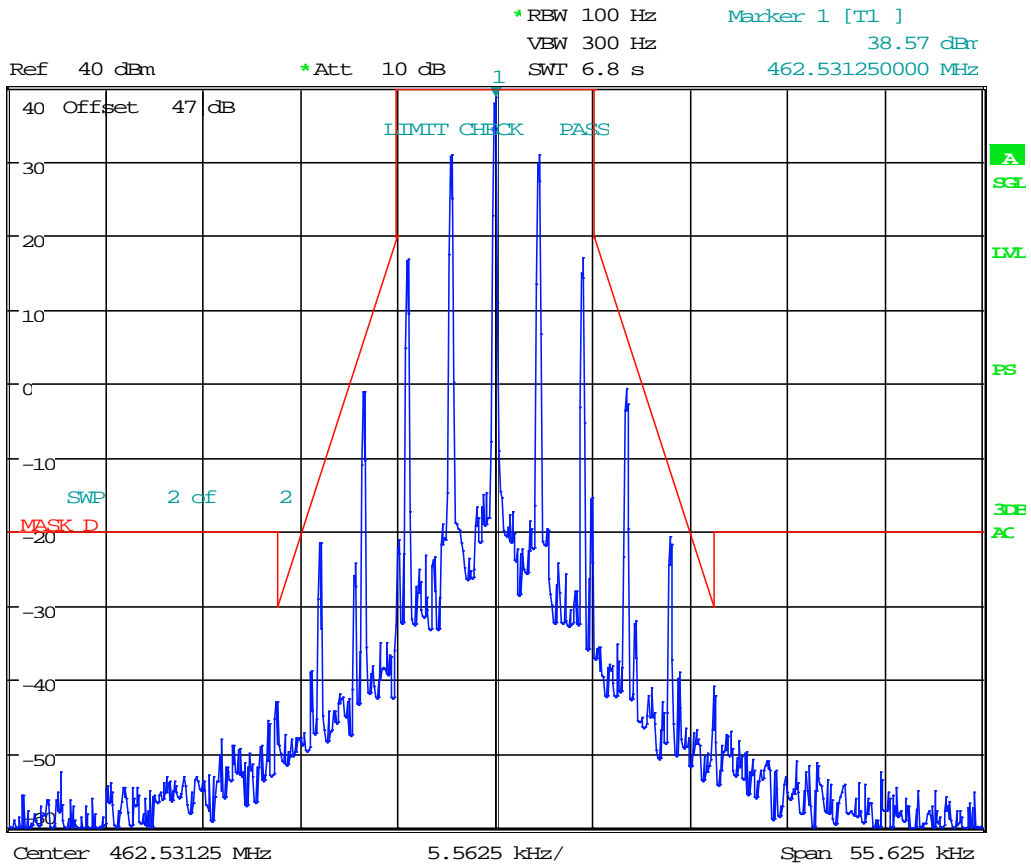

Date: 26.APR.2018 17:30:19

EMISSION MASK D

High Power



FLUX Meter

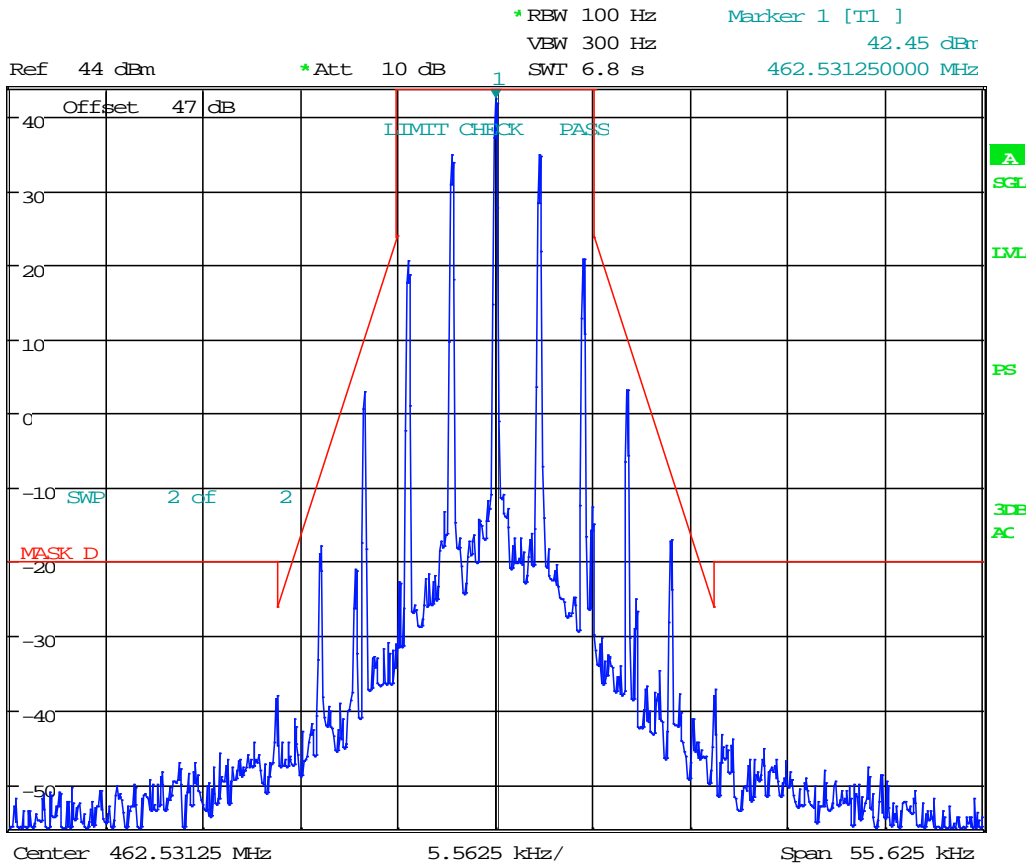

Date: 26.APR.2018 17:54:11

EMISSION MASK D

Test Data: 462.74375 MHz

Low Power

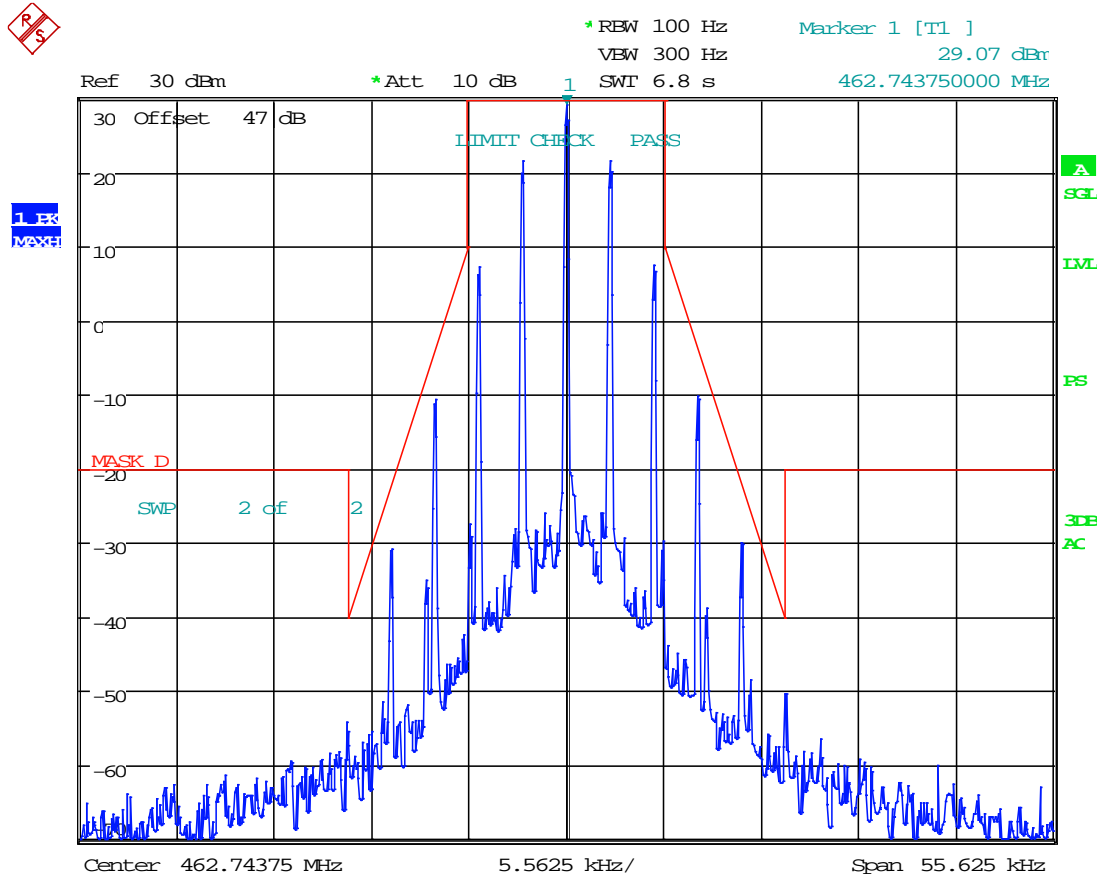

Date: 26.APR.2018 17:10:50

EMISSION MASK D

Medium Power

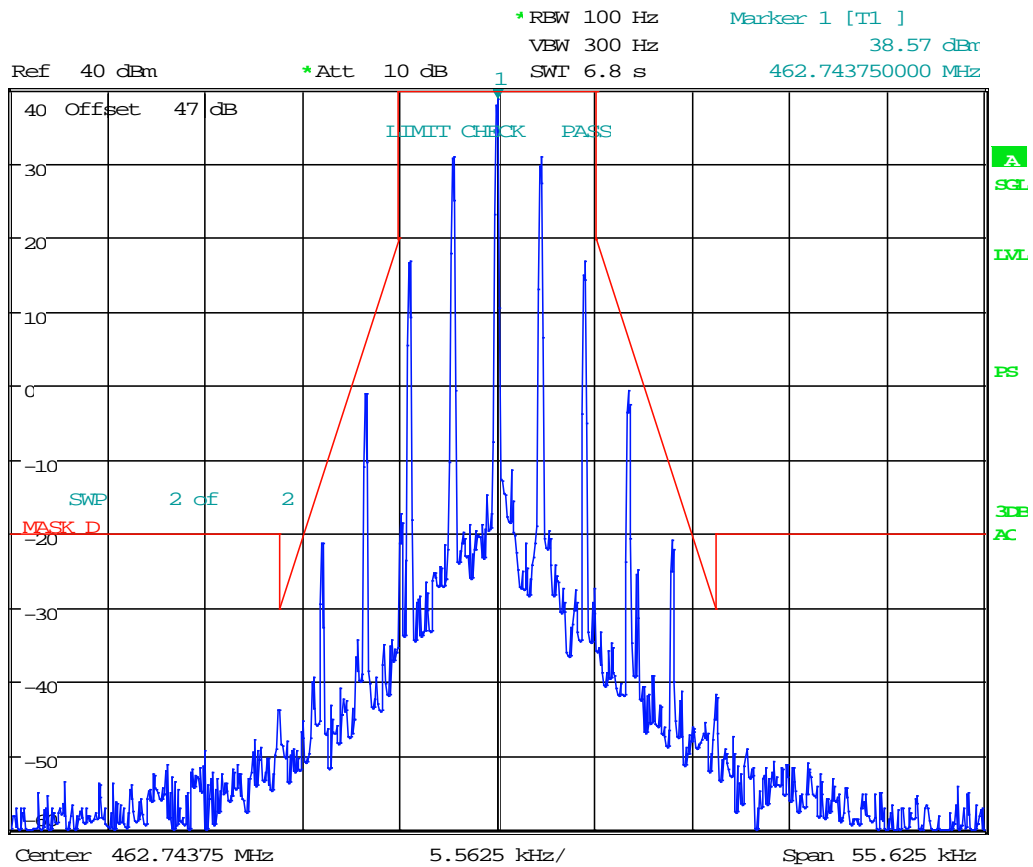

Date: 26.APR.2018 17:30:50

EMISSION MASK D

High Power



FLUX Meter

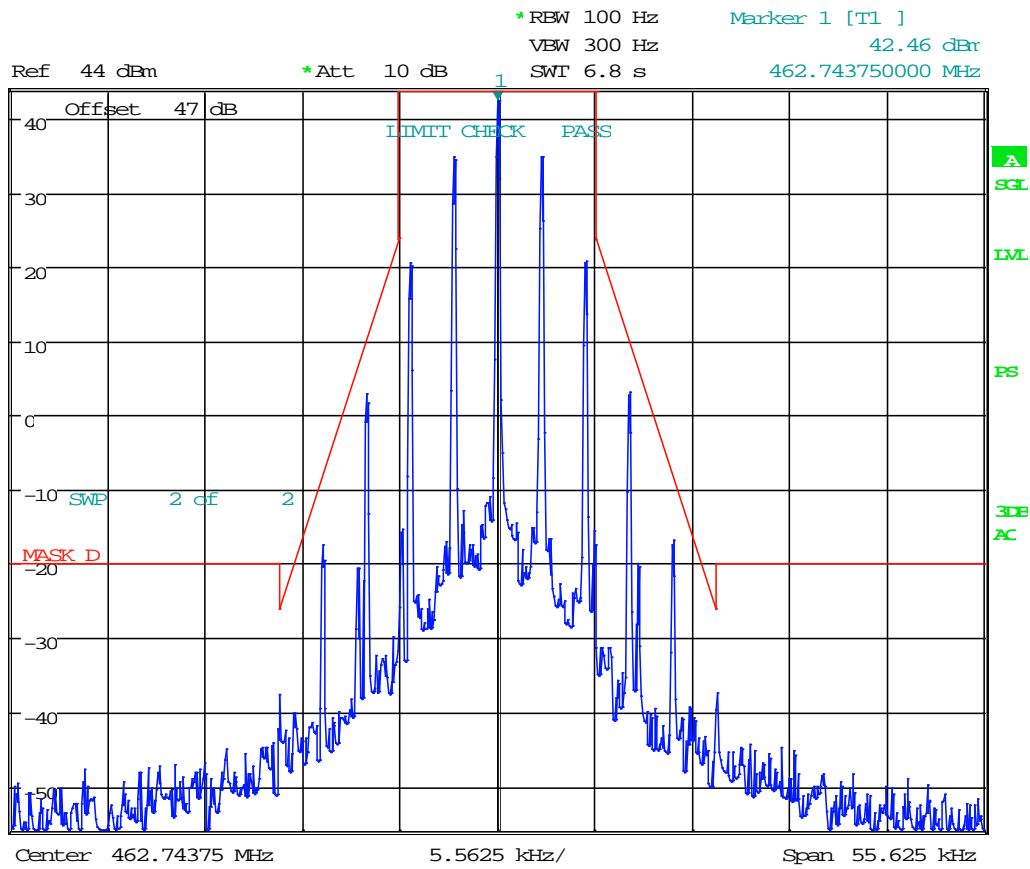

Date: 26.APR.2018 17:54:55

EMISSION MASK D

Test Data: 467.53125 MHz

Low Power

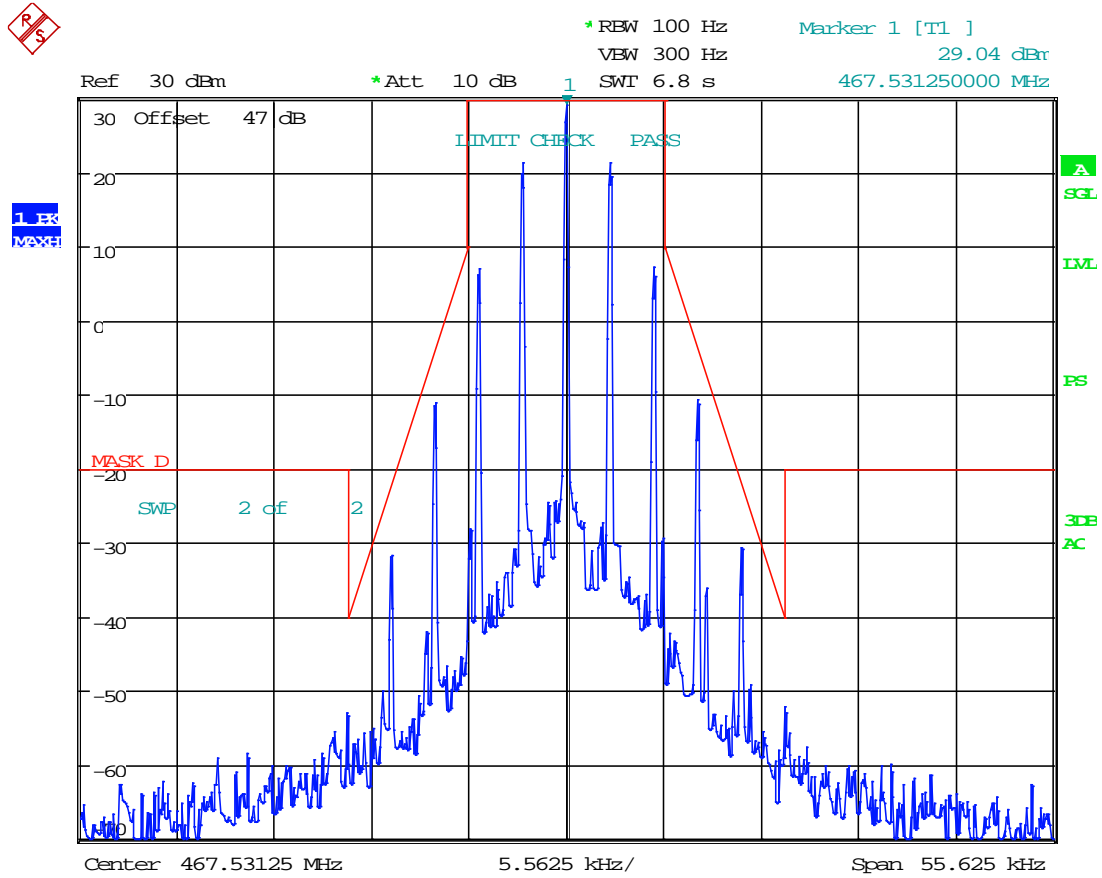

Date: 26.APR.2018 17:11:29

EMISSION MASK D

Medium Power

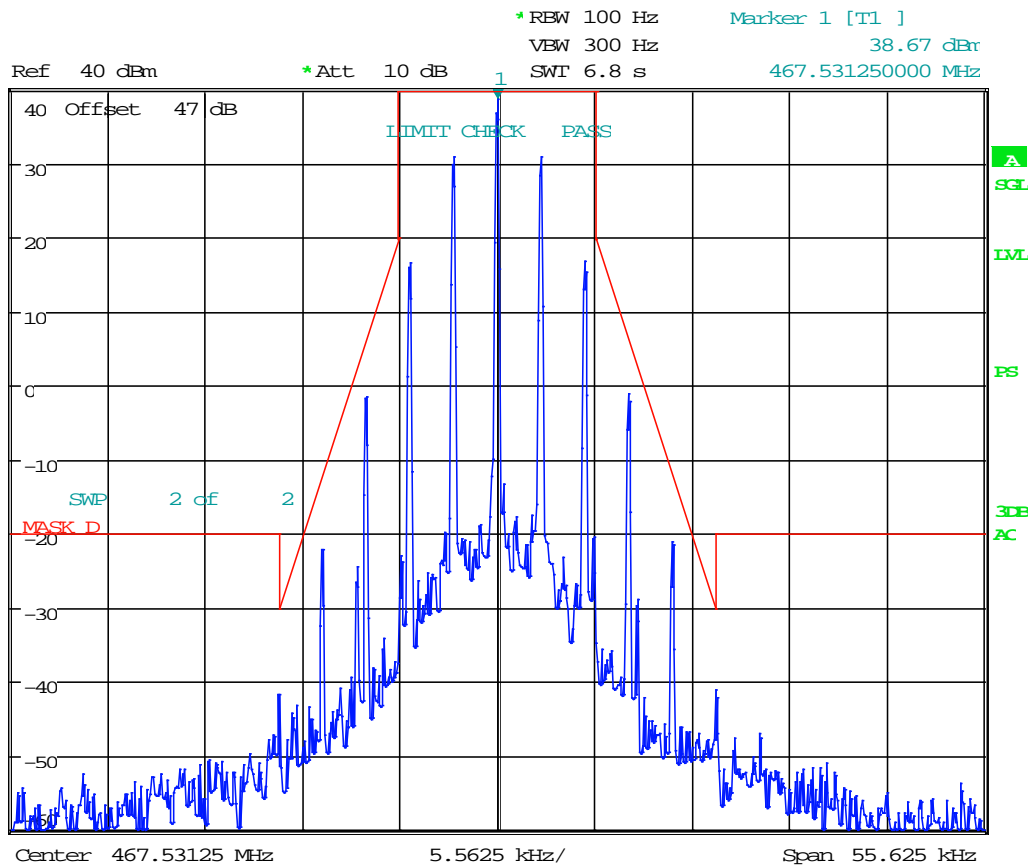

Date: 26.APR.2018 17:32:15

EMISSION MASK D

High Power

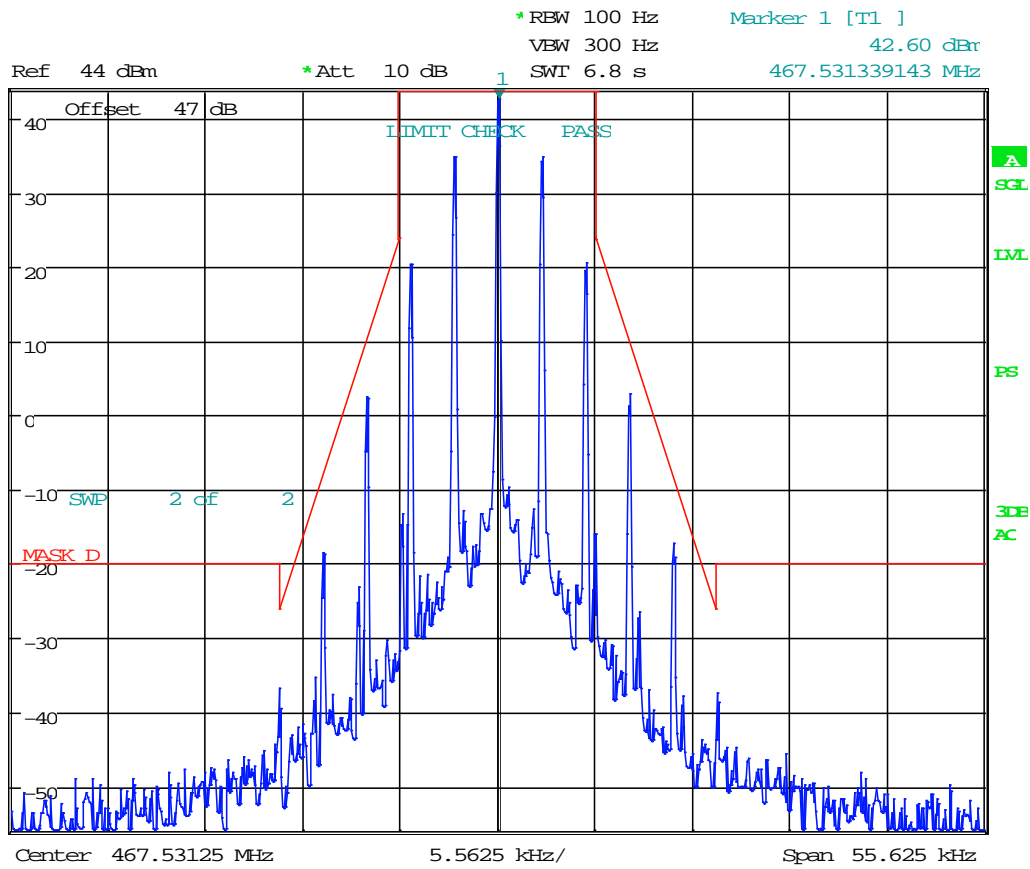

Date: 26.APR.2018 17:55:42

EMISSION MASK D

Test Data: 467.74375 MHz

Low Power

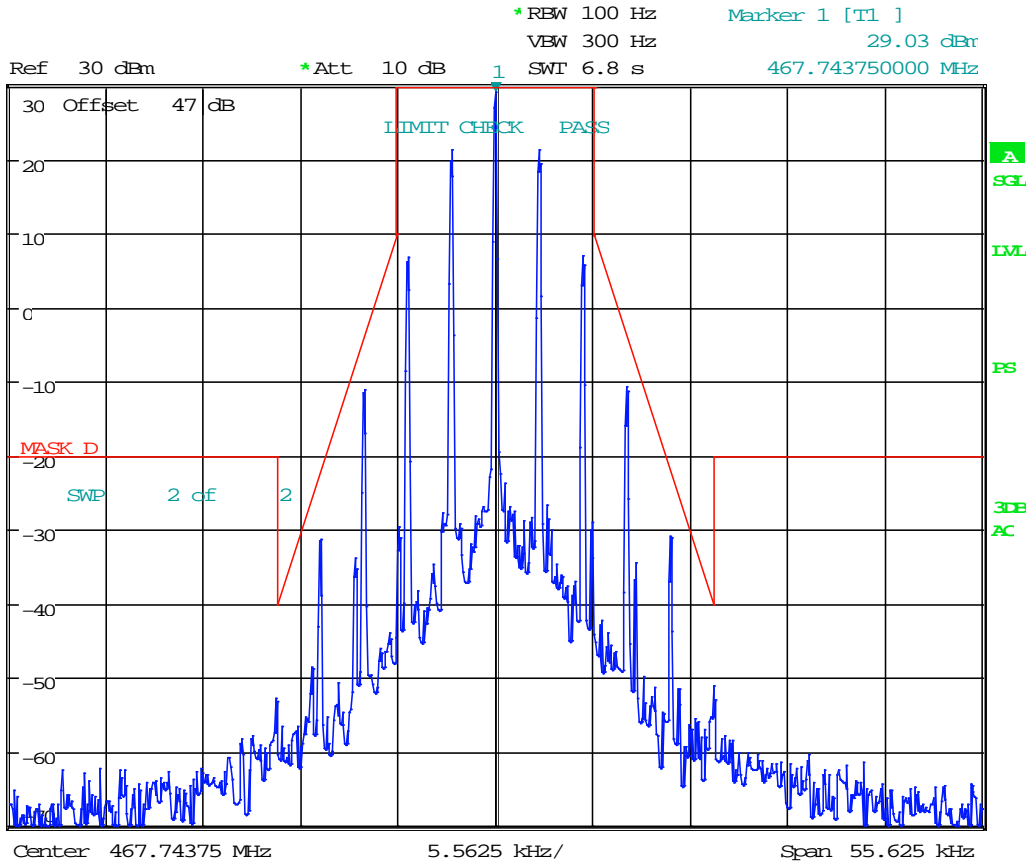

Date: 26.APR.2018 17:12:06

EMISSION MASK D

Medium Power

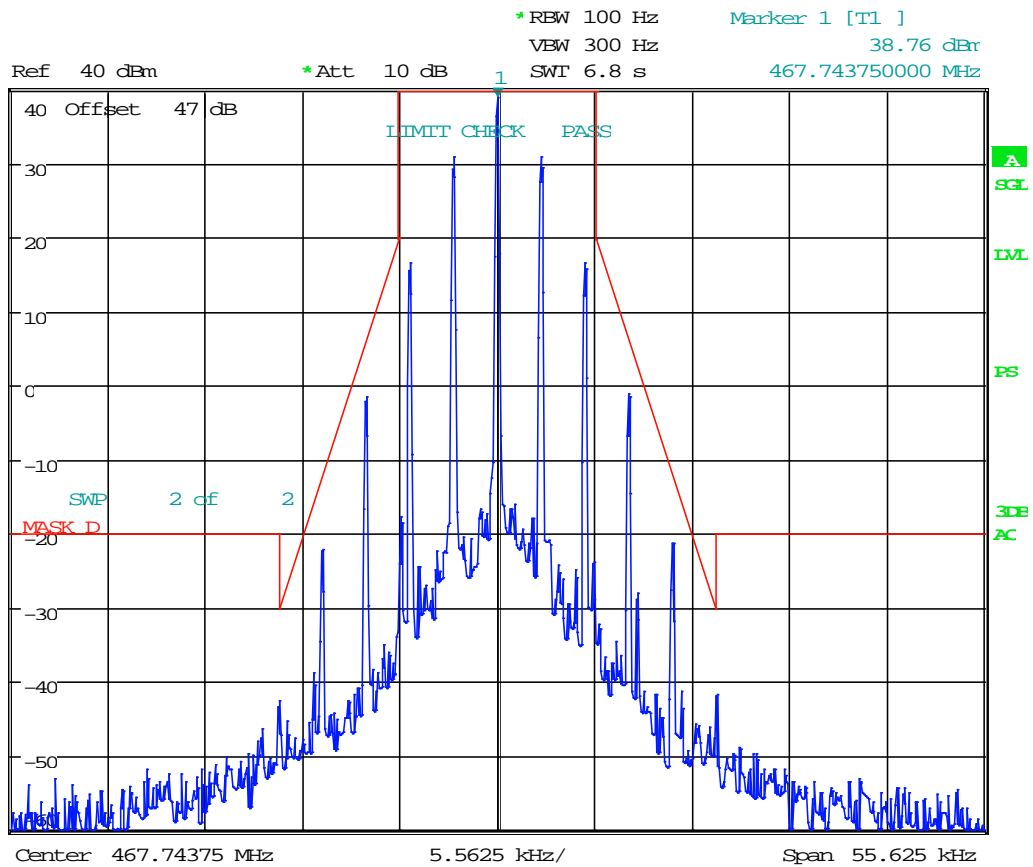

Date: 26.APR.2018 17:32:50

EMISSION MASK D

High Power



FLUX Meter

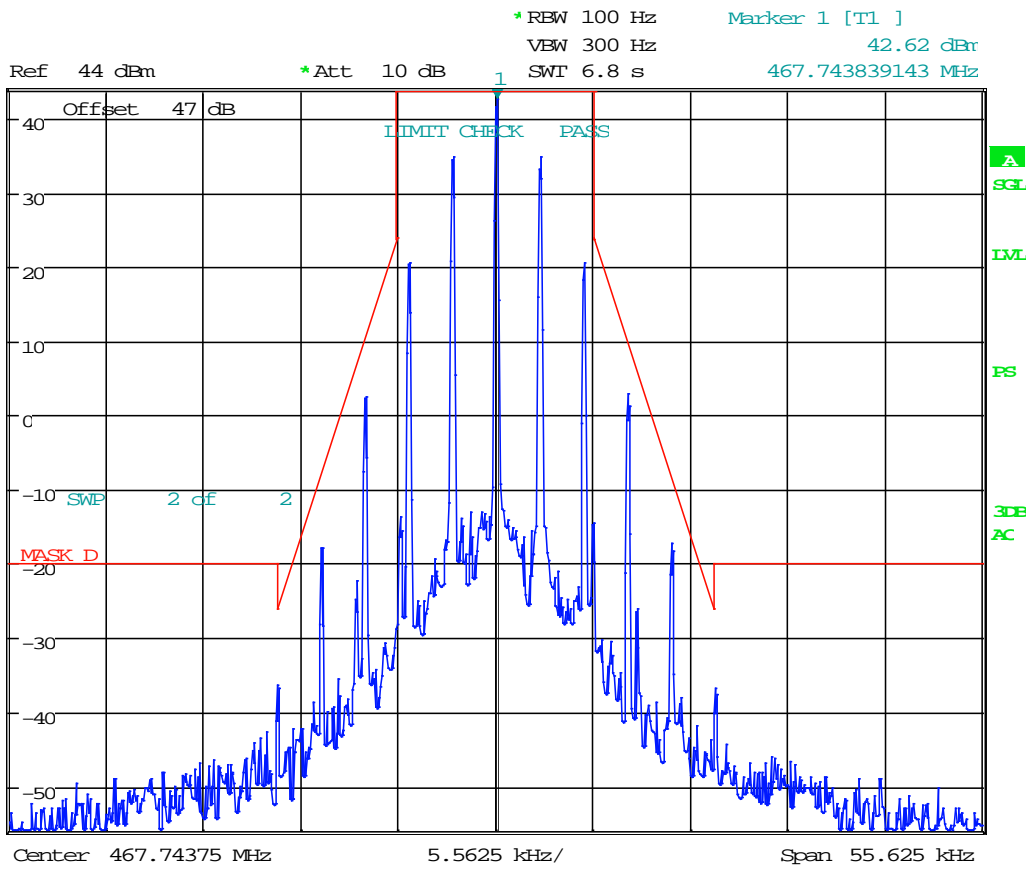

Date: 26.APR.2018 17:56:22

EMISSION MASK D

Test Data: 475.00 MHz

Low Power

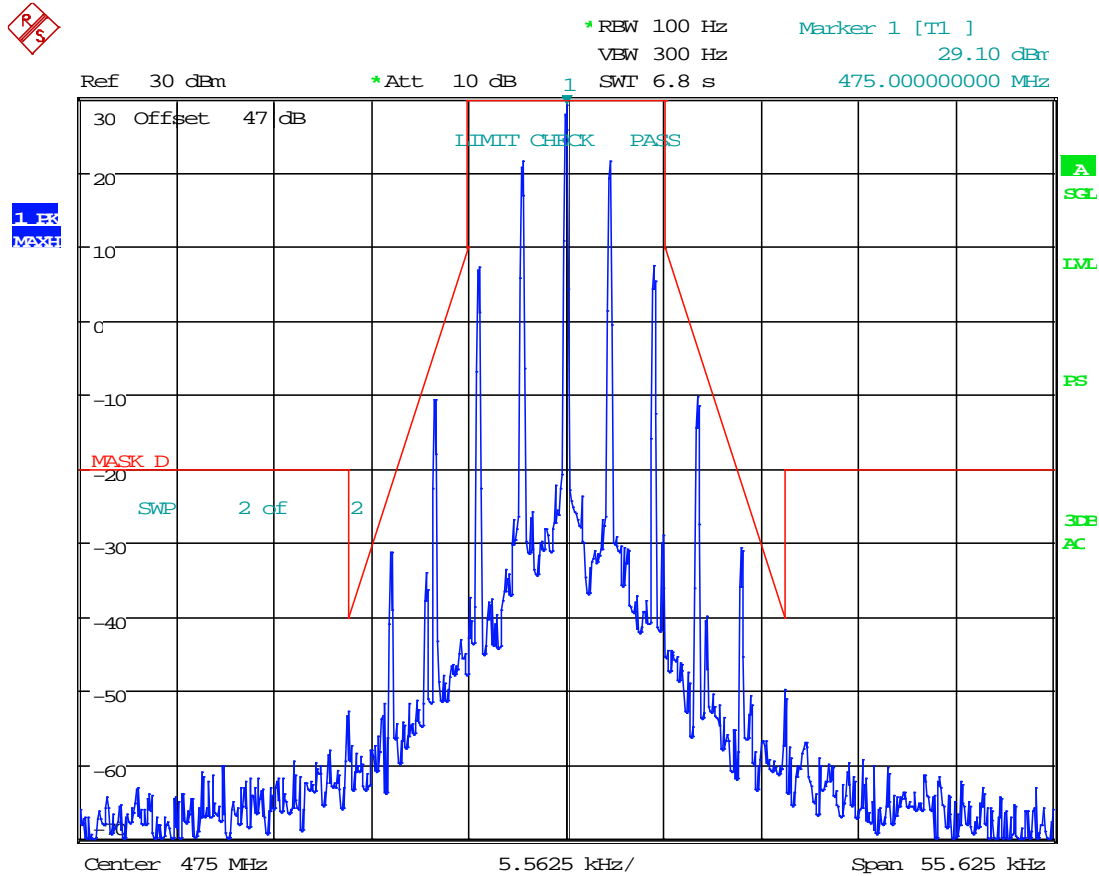

Date: 26.APR.2018 17:13:39

EMISSION MASK D

Medium Power

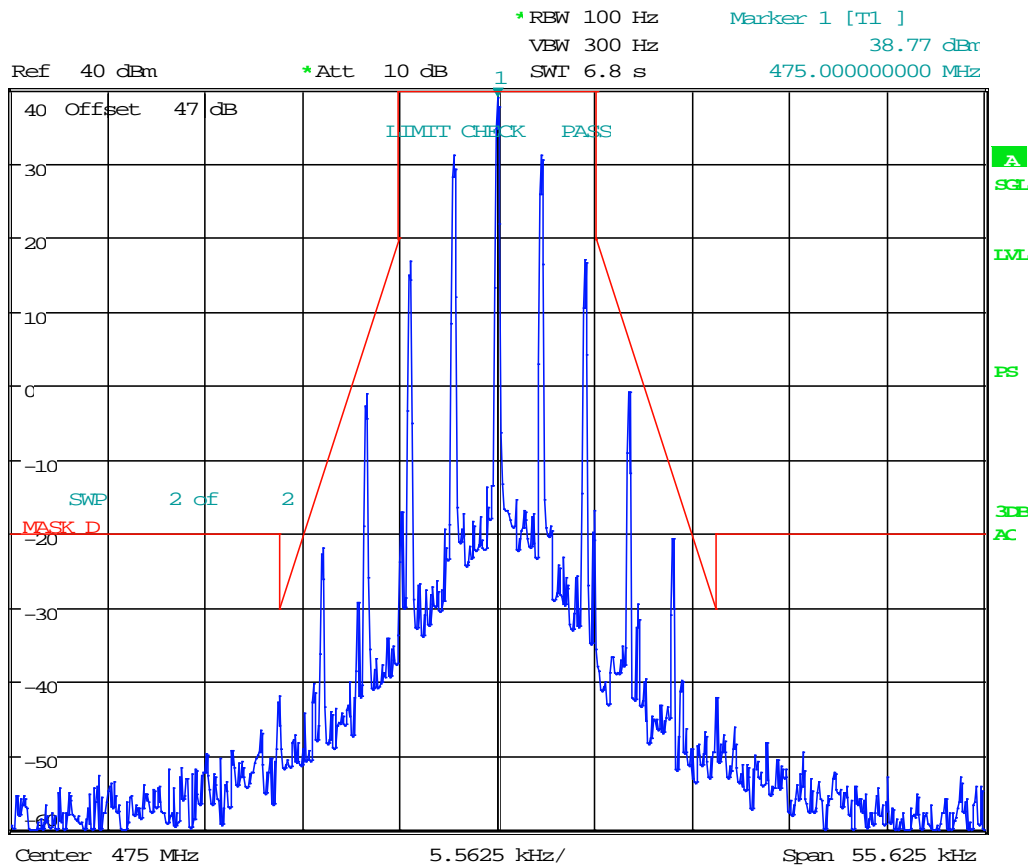

Date: 26.APR.2018 17:33:51

EMISSION MASK D

High Power

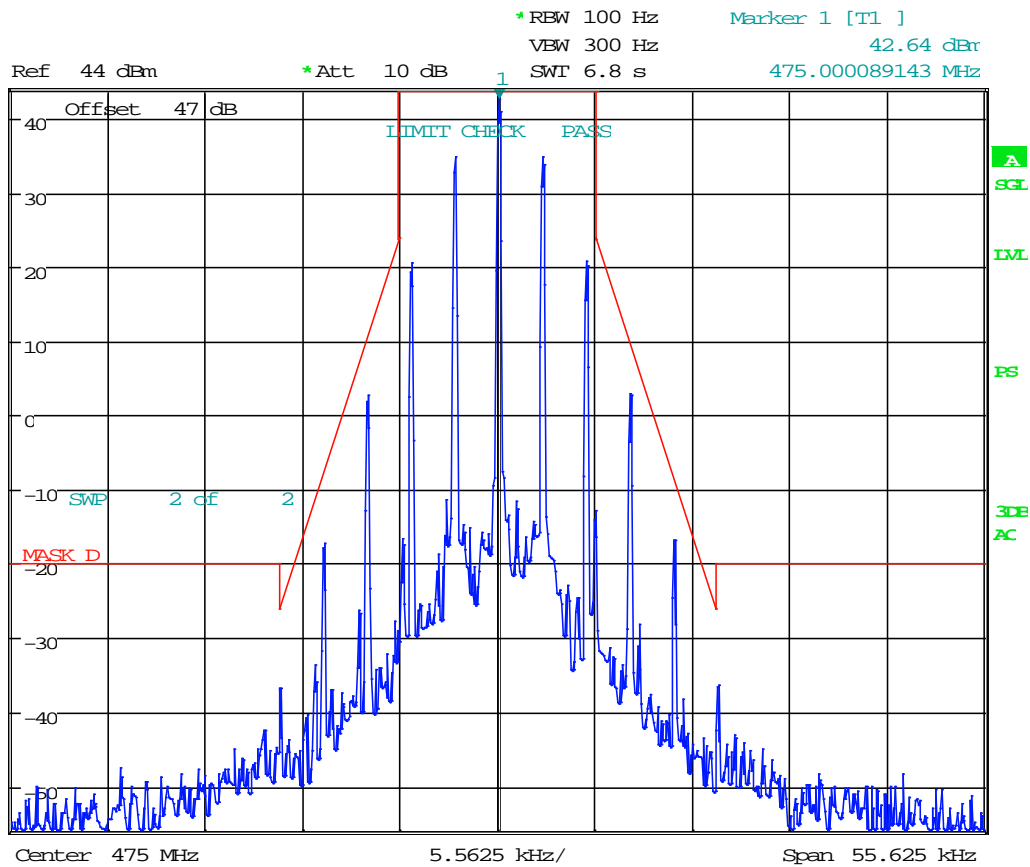

Date: 26.APR.2018 17:57:29

Result: Meets Requirements

EMISSION MASK D

Test Data: 479.99375 MHz

Low Power

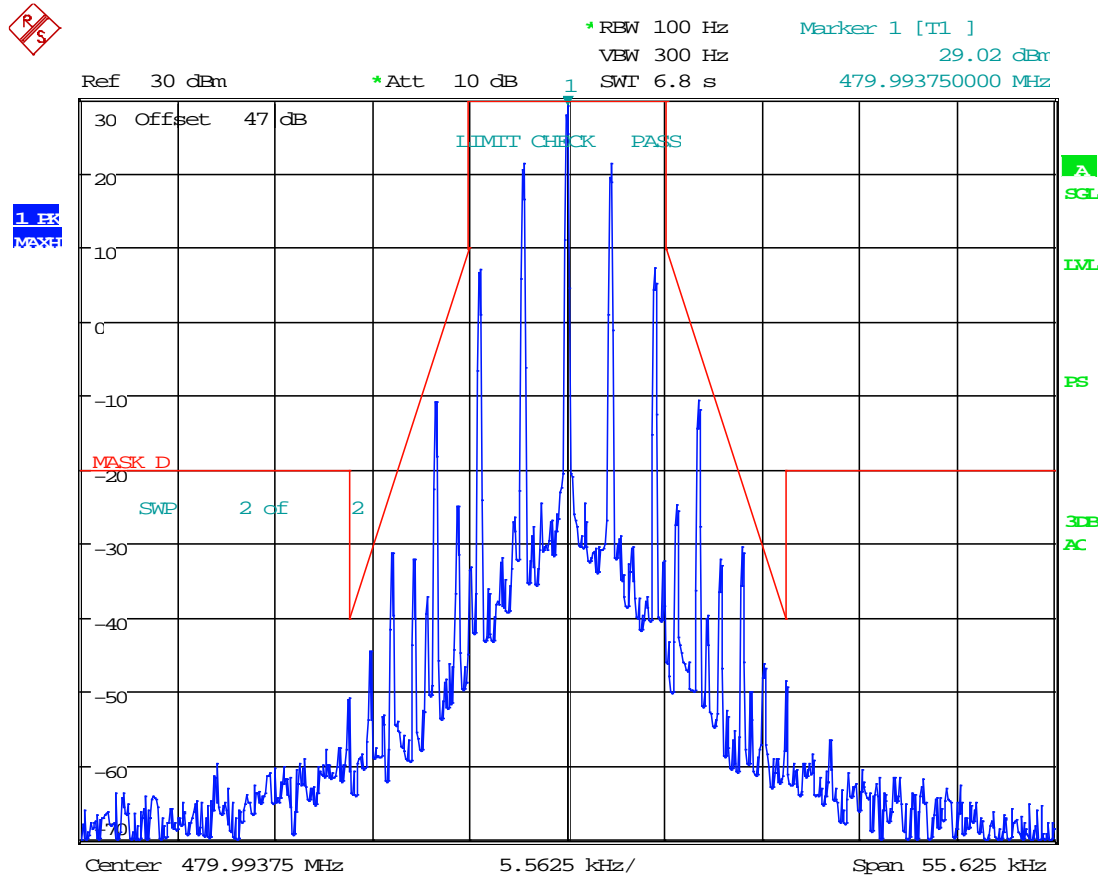

Date: 26.APR.2018 17:14:23

EMISSION MASK D

Medium Power

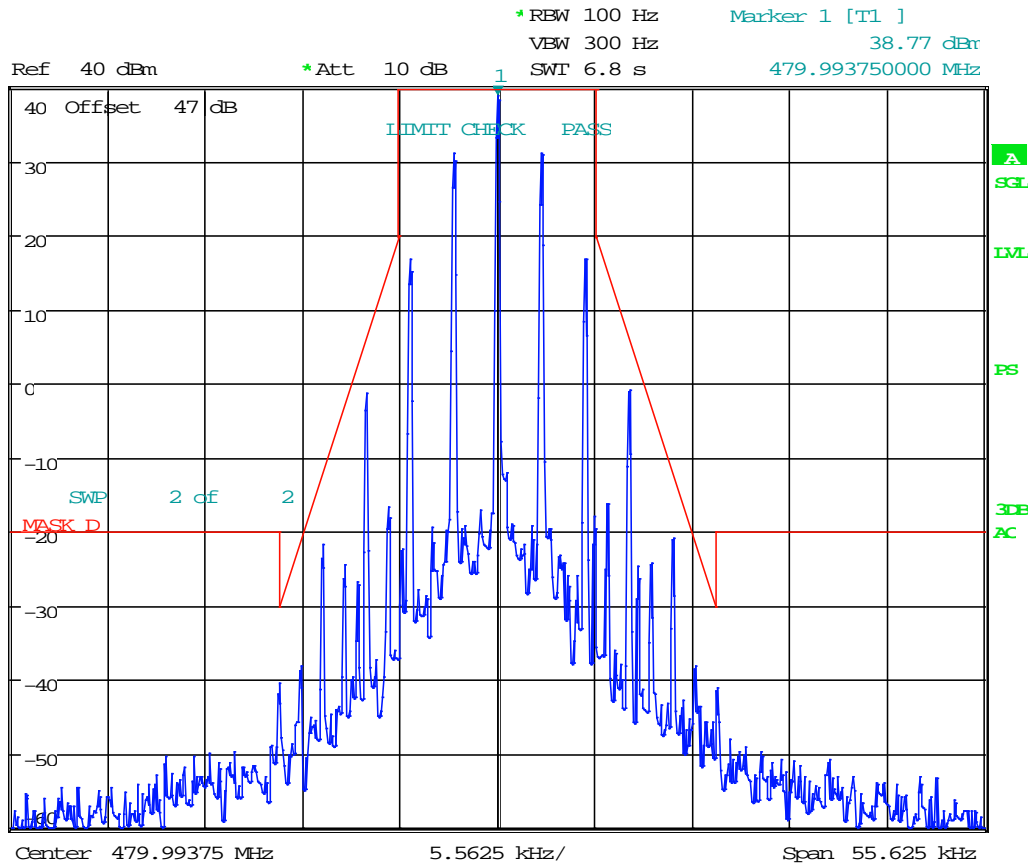

Date: 26.APR.2018 17:34:21

EMISSION MASK D

High Power

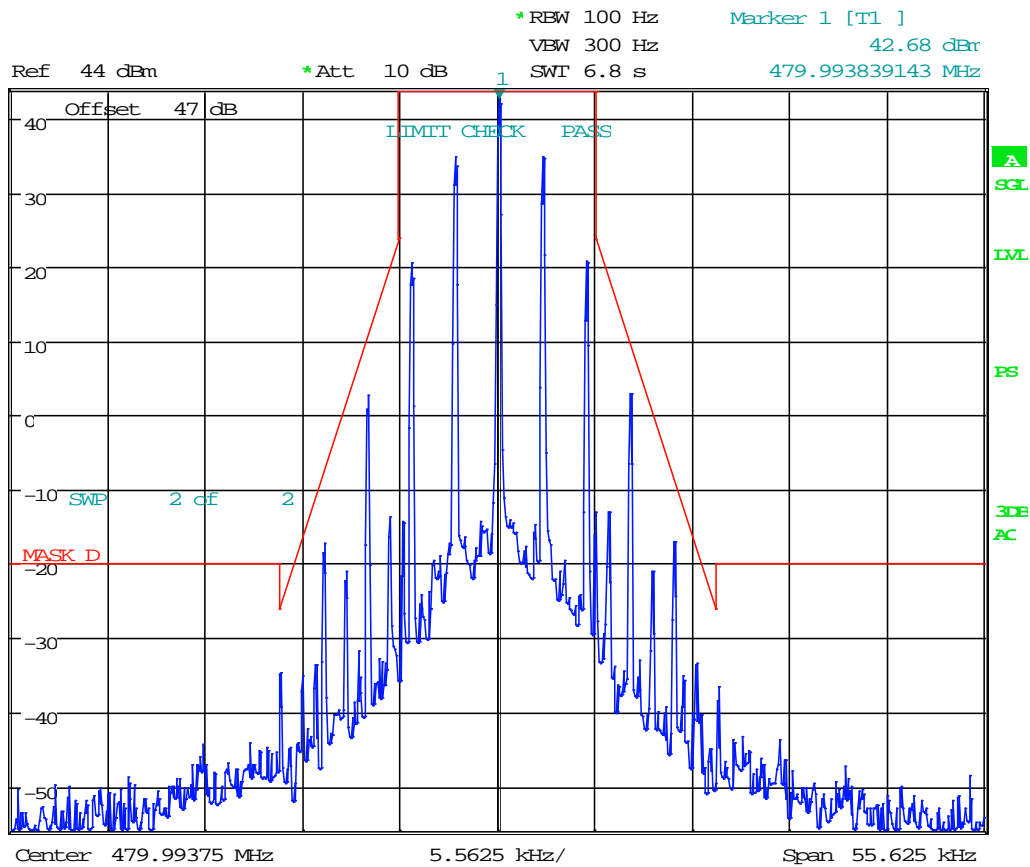

Date: 26.APR.2018 17:58:01

EMISSION MASK D – P25 Phase I C4FM (12.5 kHz)

Test Data: 406.10625 MHz

Low Power

	Marker 1 [T1]	RBW	100 Hz	RF Att	10 dB
	Ref Lvl	24.05 dBm	VBW	1 kHz	
	30 dBm	406.10664016 MHz	SWT	28 s	Unit dBm

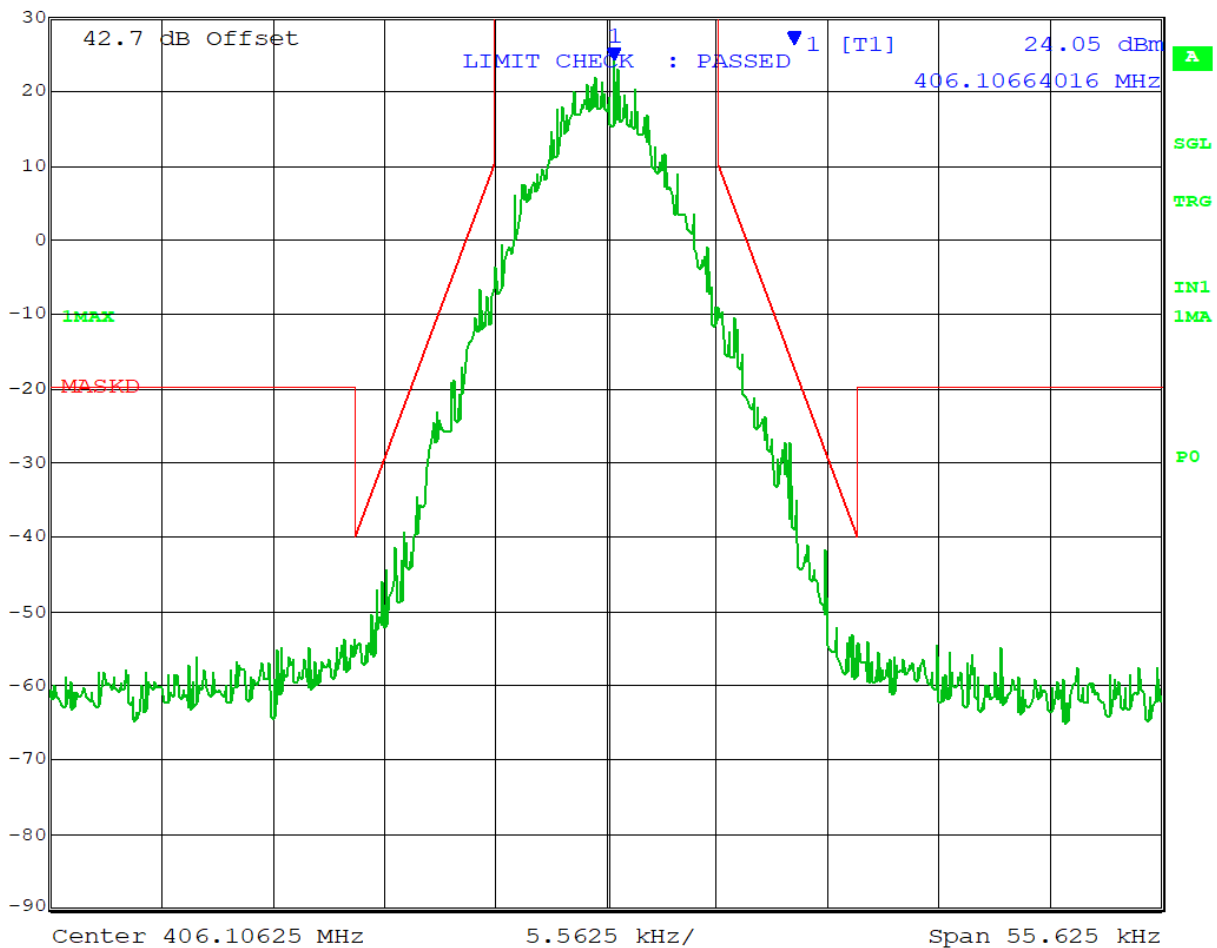

Date: 1.JAN.1997 01:19:49

EMISSION MASK D

Medium Power



Ref Lvl	Marker 1 [T1]	RBW	100 Hz	RF Att	20 dB
40 dBm	34.65 dBm	VBW	1 kHz		
	406.10664016 MHz	SWT	28 s	Unit	dBm

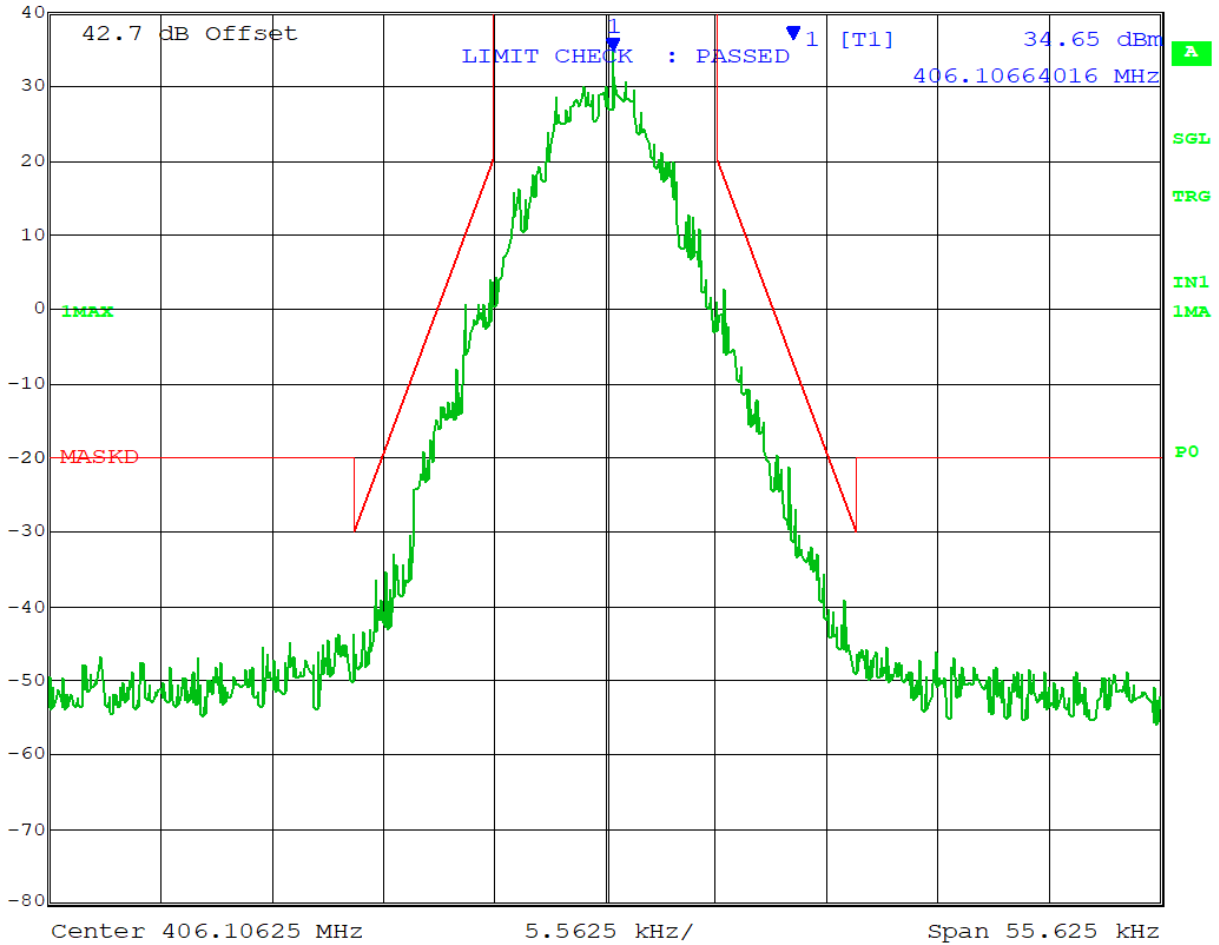

Date: 1.JAN.1997 08:27:46

EMISSION MASK D

High Power

	Marker 1 [T1]	RBW	100 Hz	RF Att	20 dB
	Ref Lvl	36.73 dBm	VBW	1 kHz	
	44 dBm	406.10675163 MHz	SWT	28 s	Unit
					dBm

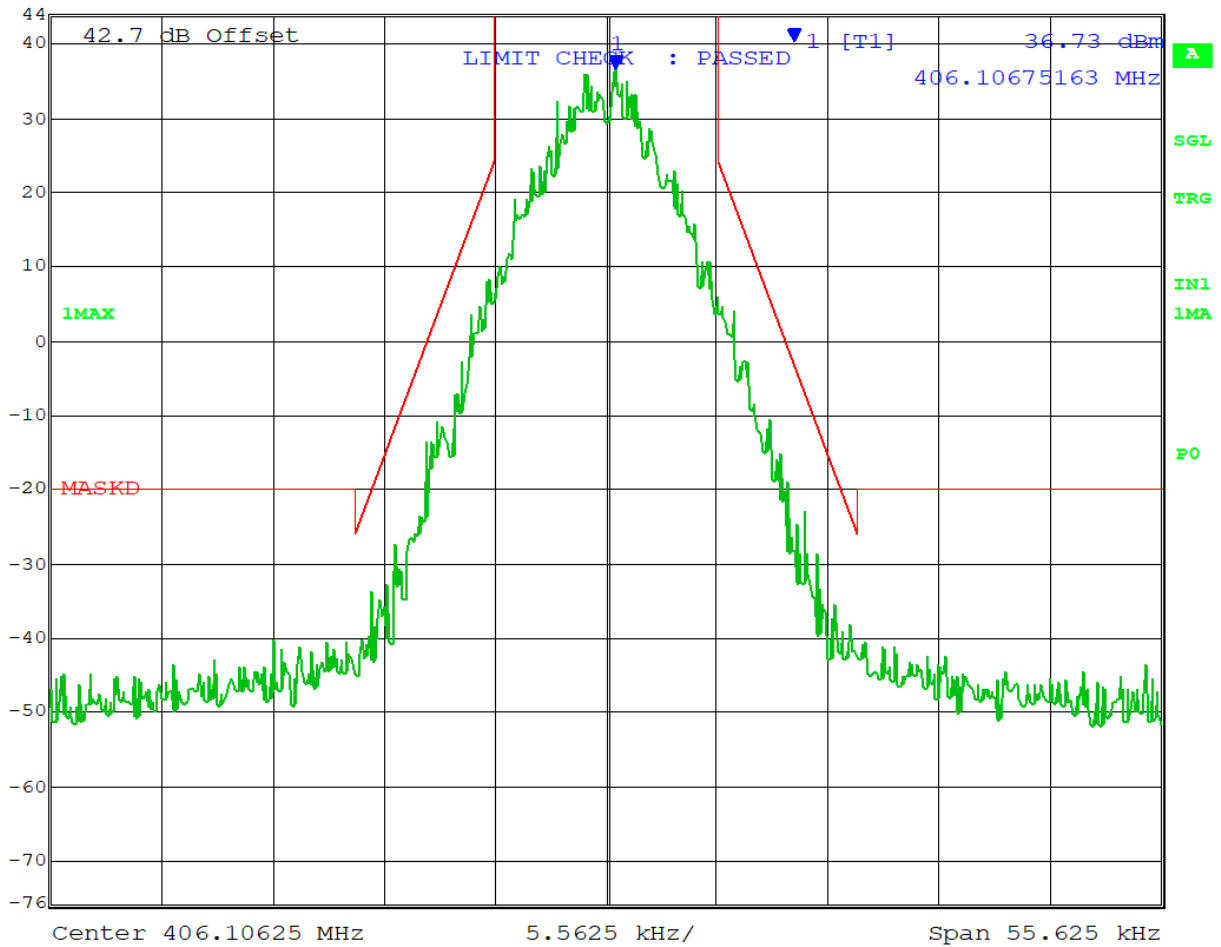

Date: 1.JAN.1997 07:16:42

EMISSION MASK D

Test Data: 409.99375 MHz

Low Power

	Marker 1 [T1]	RBW	100 Hz	RF Att	10 dB
	Ref Lvl	24.61 dBm	VBW	1 kHz	
	30 dBm	409.99425163 MHz	SWT	28 s	Unit dBm

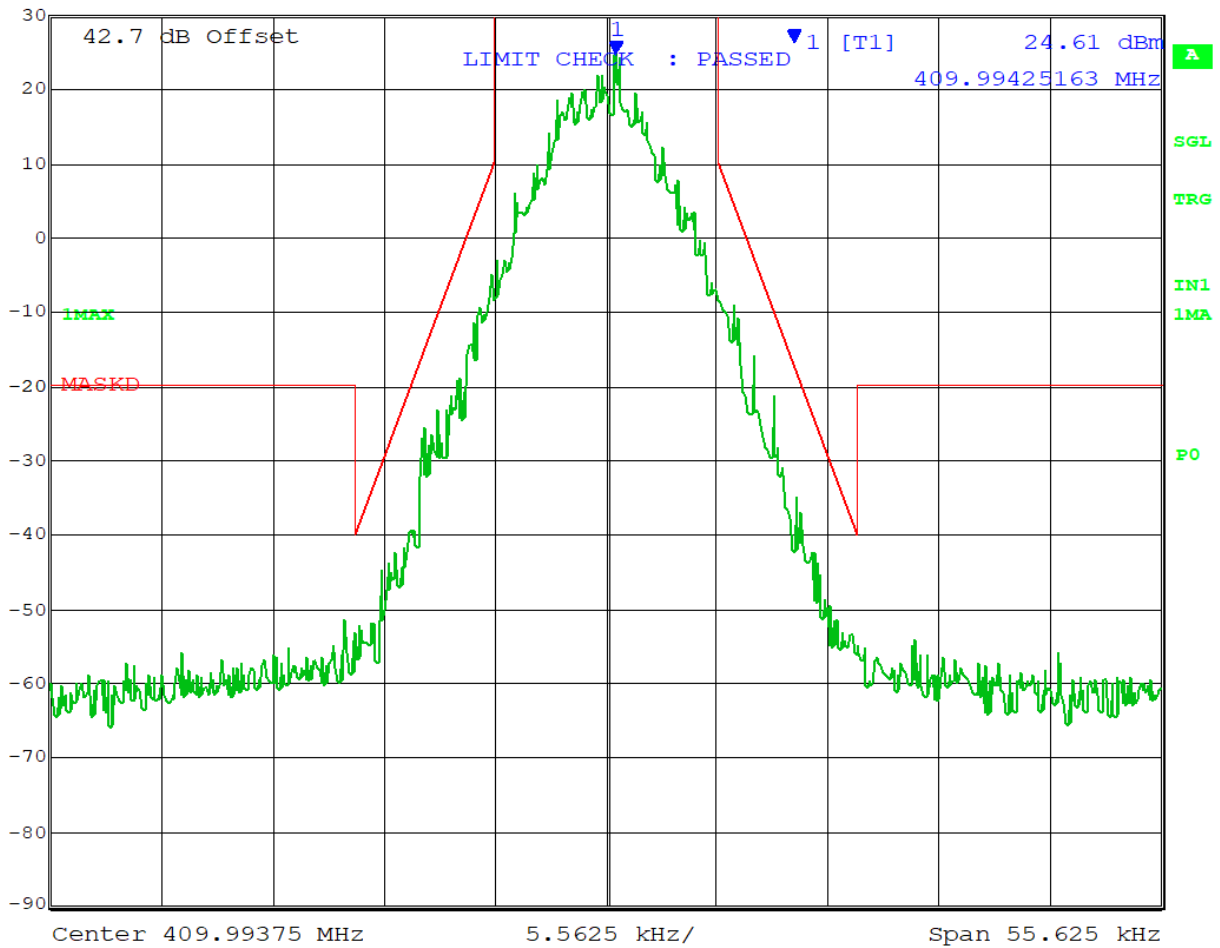

Date: 1.JAN.1997 01:22:45

EMISSION MASK D

Medium Power



Ref Lvl	Marker 1 [T1]	RBW	100 Hz	RF Att	20 dB
40 dBm	32.54 dBm	VBW	1 kHz		
	409.99425163 MHz	SWT	28 s	Unit	dBm

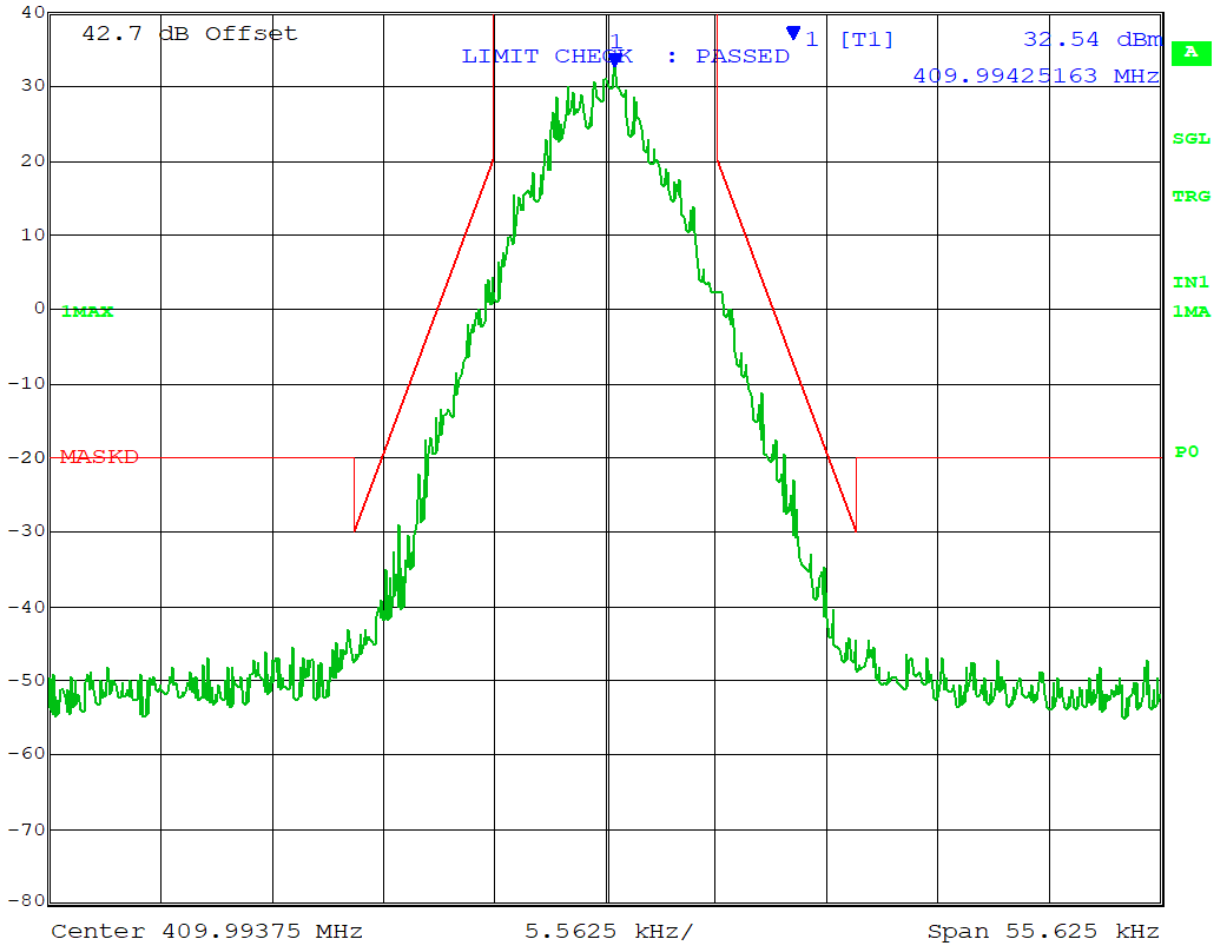

Date: 1.JAN.1997 08:29:26

EMISSION MASK D

High Power



Ref Lvl	44 dBm	Marker 1 [T1]	38.07 dBm	RBW	100 Hz	RF Att	20 dB
			409.99414016 MHz	VBW	1 kHz		
				SWT	28 s	Unit	dBm

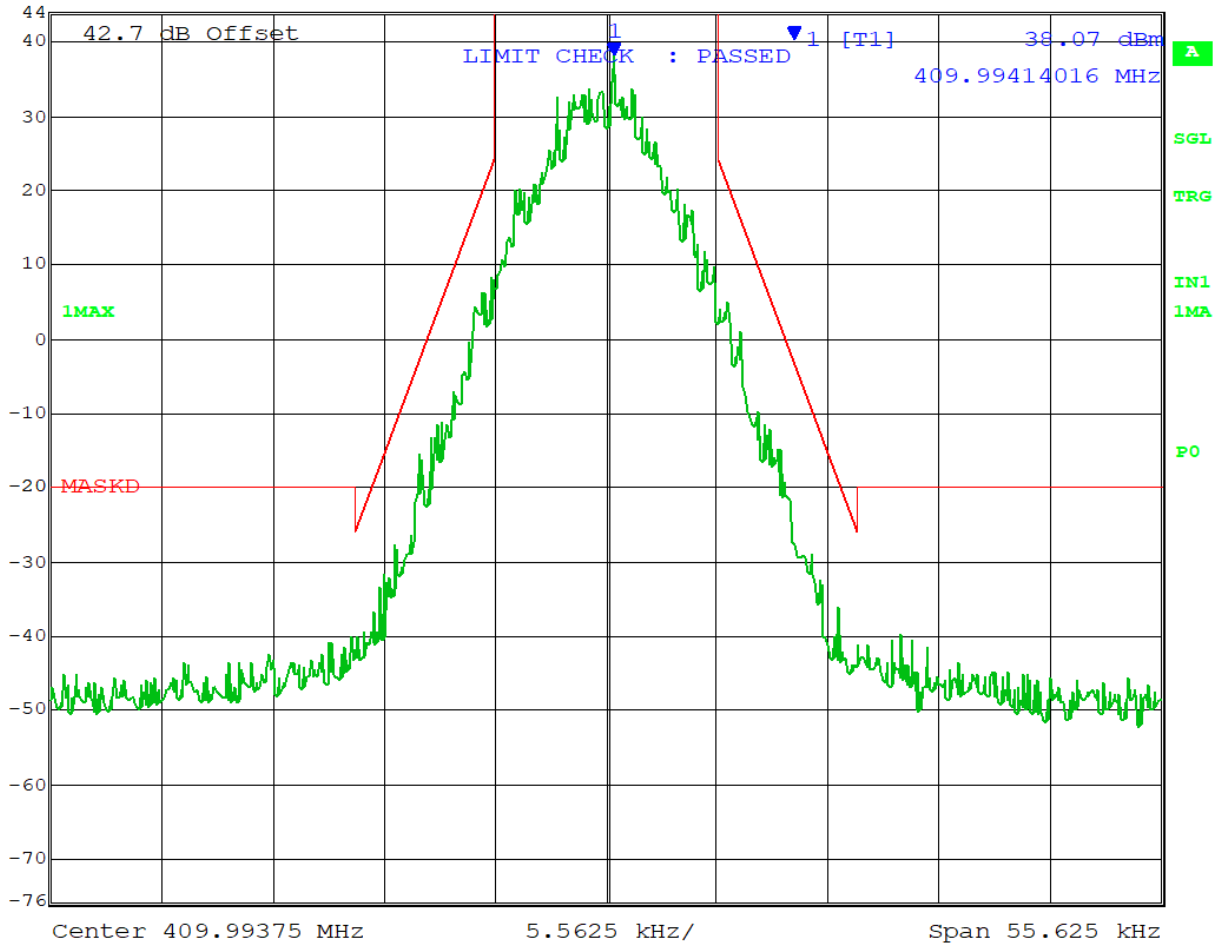

Date: 1.JAN.1997 07:30:03

EMISSION MASK D

Test Data: 420.00625 MHz

Low Power

	Marker 1 [T1]	RBW	100 Hz	RF Att	10 dB
	Ref Lvl	23.56 dBm	VBW	1 kHz	
	30 dBm	420.00675163 MHz	SWT	28 s	Unit dBm

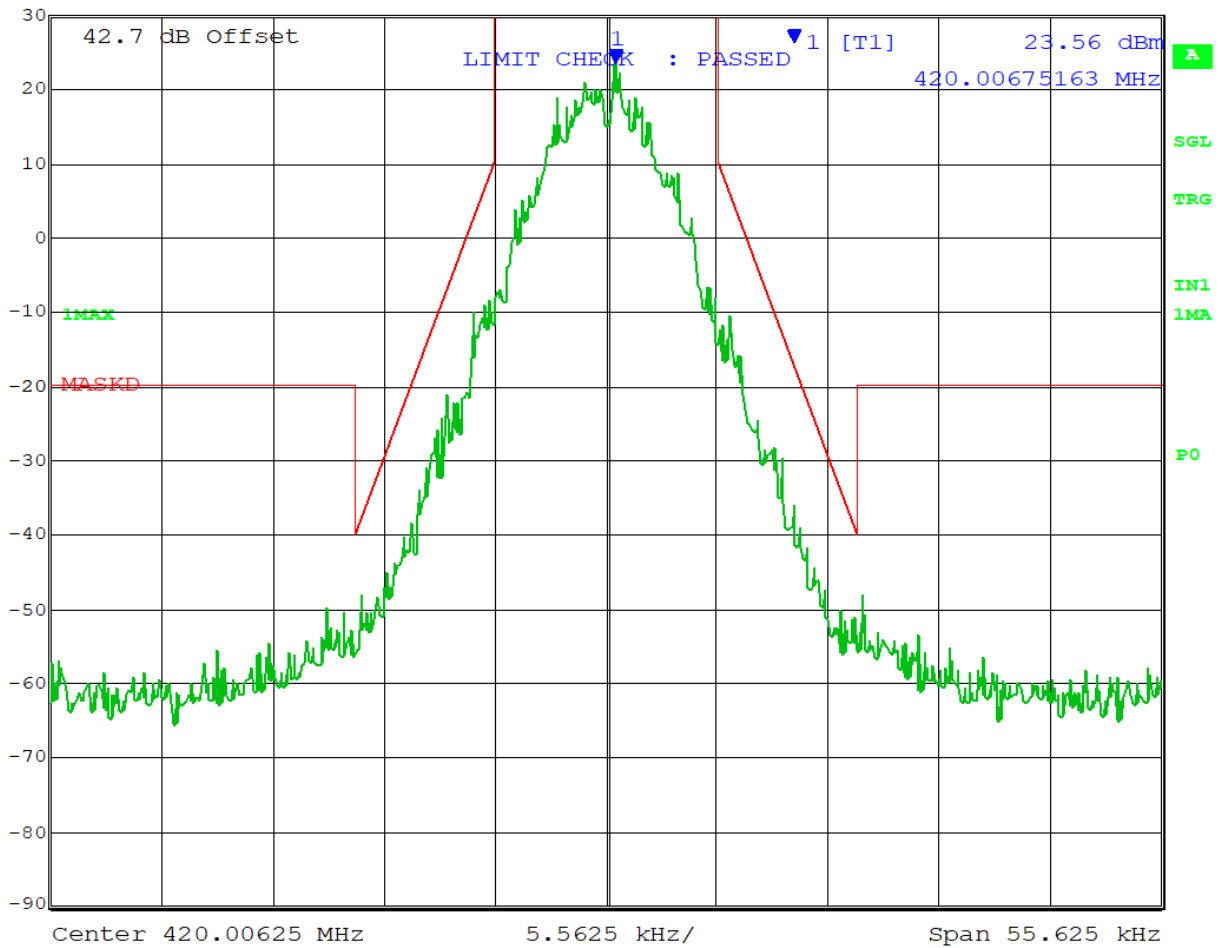

Date: 1.JAN.1997 01:23:41

EMISSION MASK D

Medium Power



Ref Lvl	Marker 1 [T1]	RBW	100 Hz	RF Att	20 dB
40 dBm	35.28 dBm	VBW	1 kHz		
	420.00664016 MHz	SWT	28 s	Unit	dBm

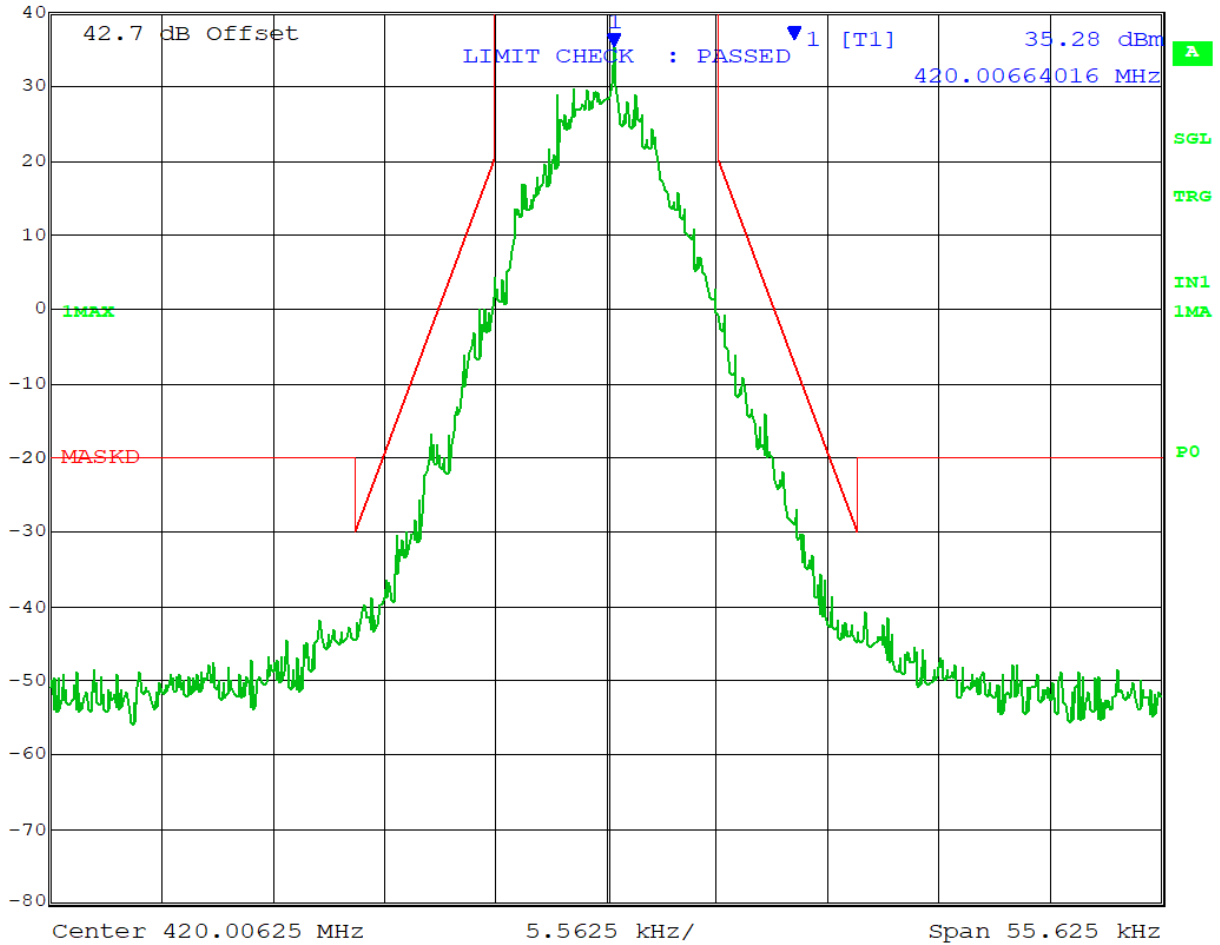

Date: 1.JAN.1997 08:30:23

EMISSION MASK D

High Power



Ref Lvl	44 dBm	Marker 1 [T1]	36.23 dBm	RBW	100 Hz	RF Att	20 dB
			420.00664016 MHz	VBW	1 kHz		
				SWT	28 s	Unit	dBm

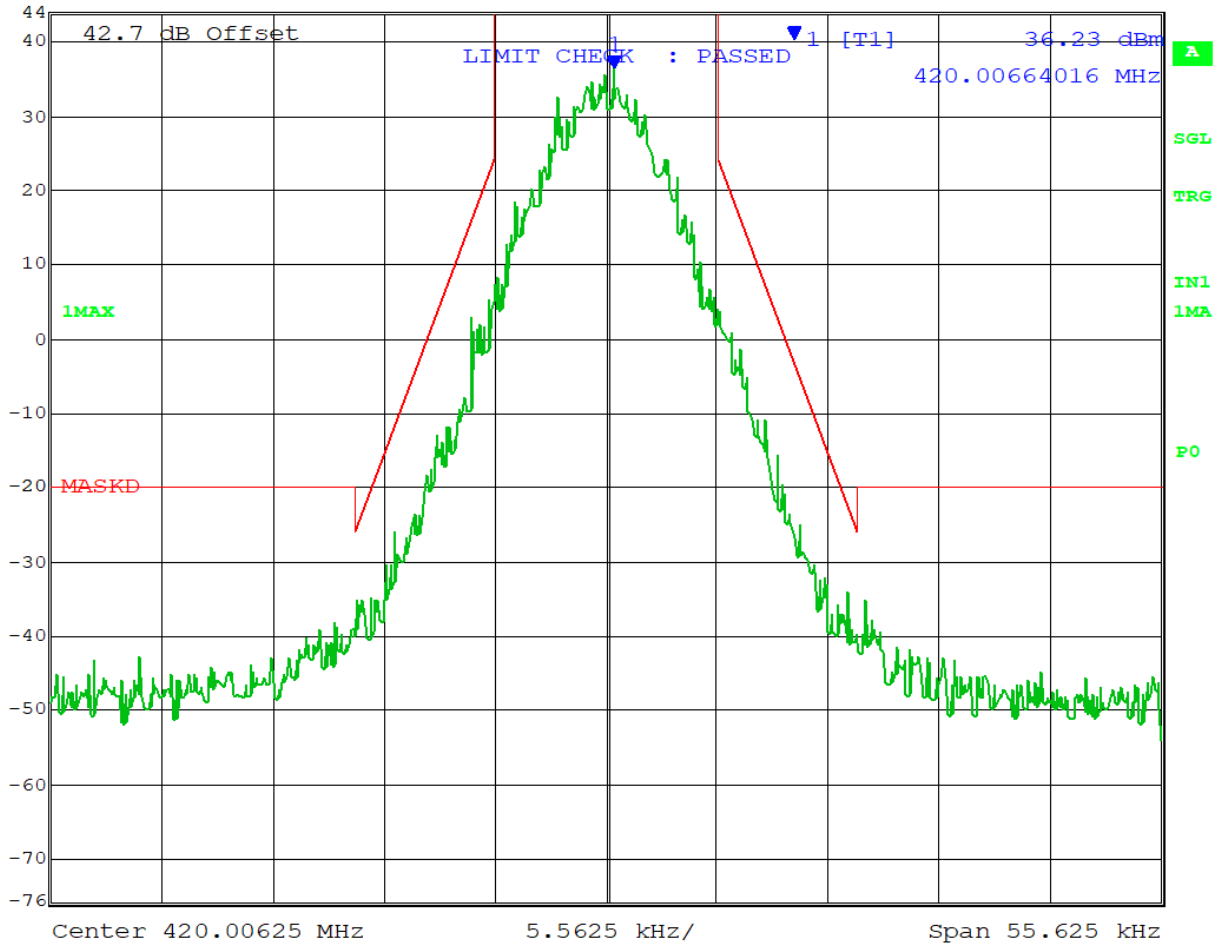

Date: 1.JAN.1997 07:32:15

EMISSION MASK D

Test Data: 440.00 MHz

Low Power

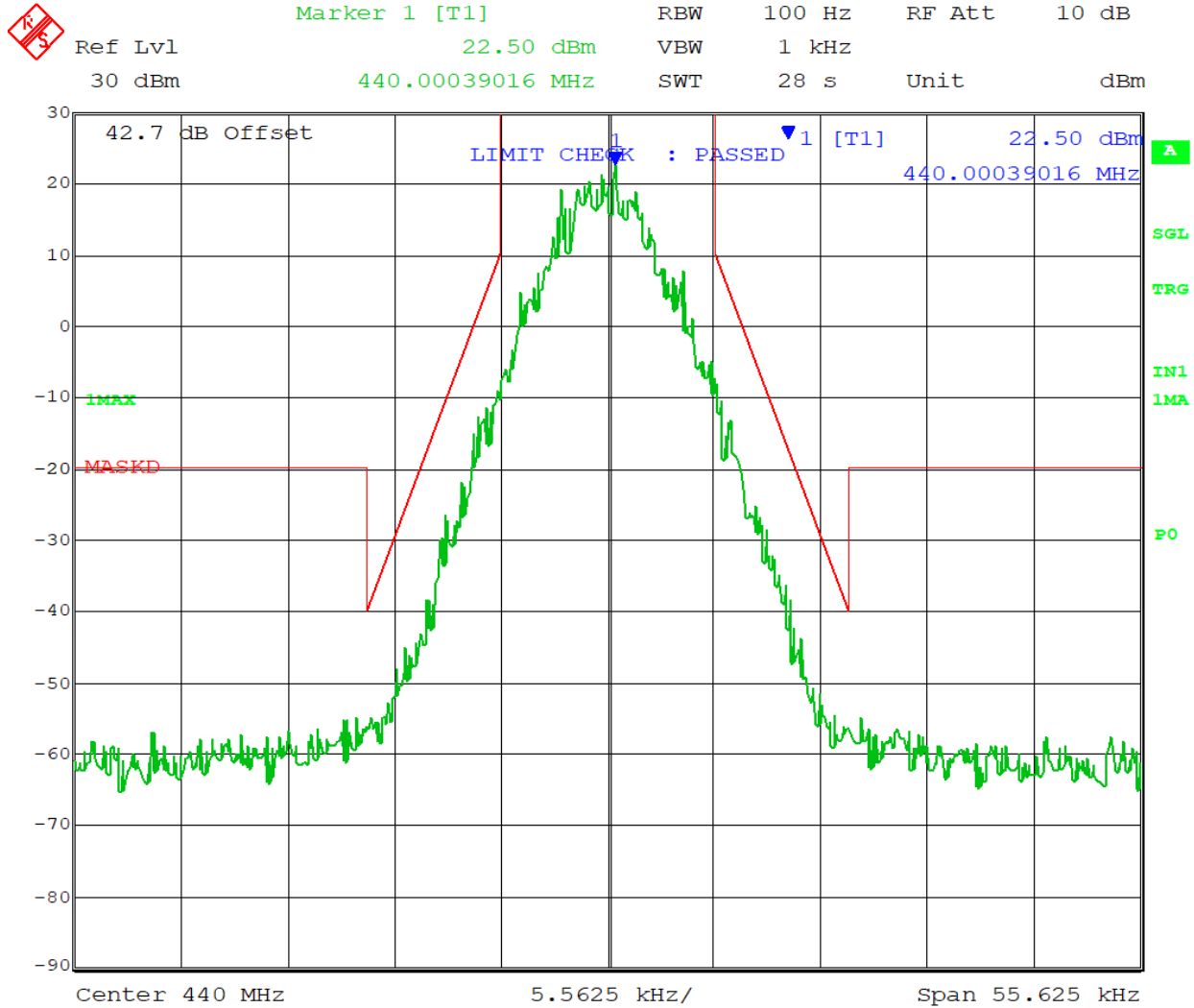

Date: 1.JAN.1997 01:24:32

EMISSION MASK D

Medium Power



Ref Lvl	Marker 1 [T1]	RBW	100 Hz	RF Att	20 dB
40 dBm	31.35 dBm	VBW	1 kHz		
	440.00050163 MHz	SWT	28 s	Unit	dBm

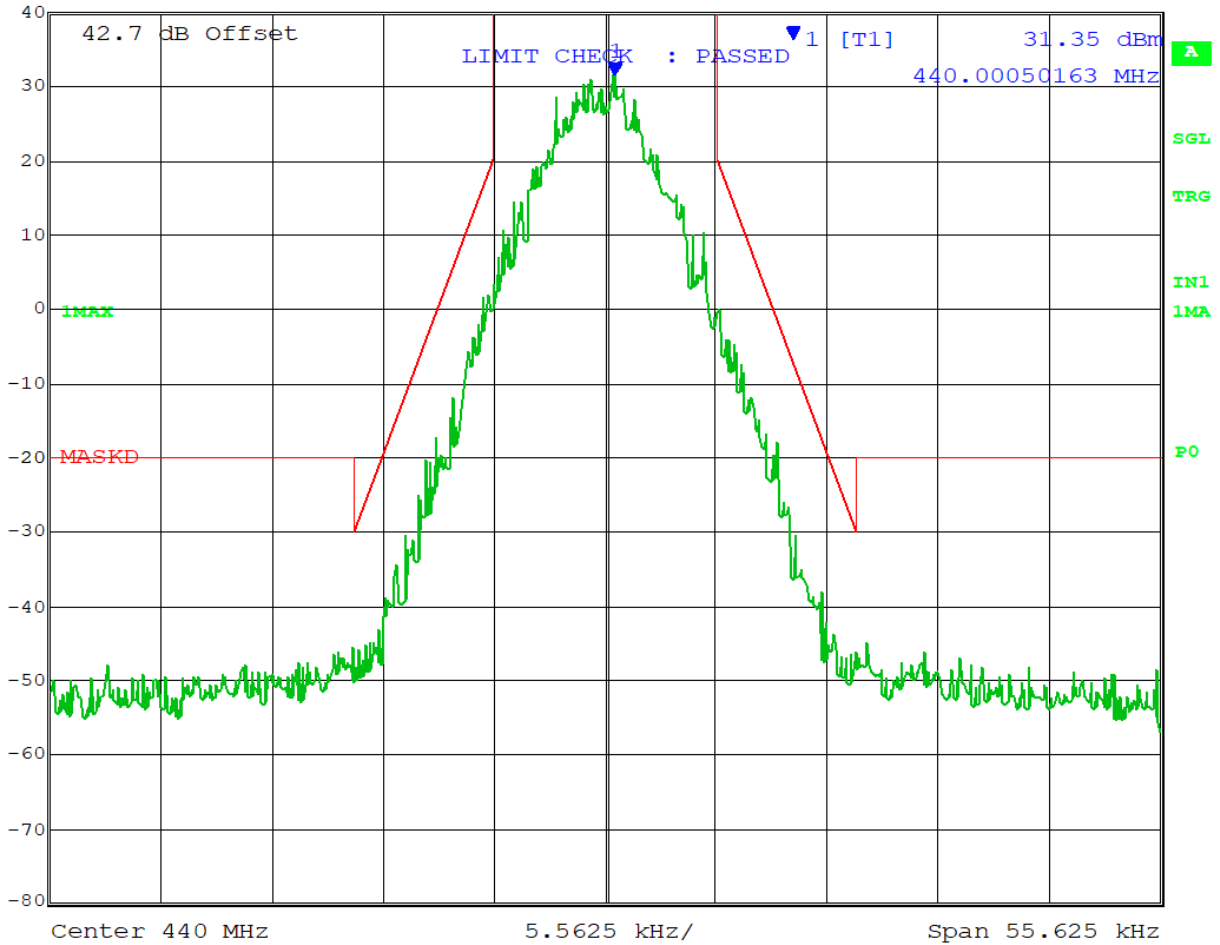

Date: 1.JAN.1997 08:31:24

EMISSION MASK D

High Power



Ref Lvl	Marker 1 [T1]	RBW	100 Hz	RF Att	20 dB
44 dBm	35.77 dBm	VBW	1 kHz		
	440.00039016 MHz	SWT	28 s	Unit	dBm

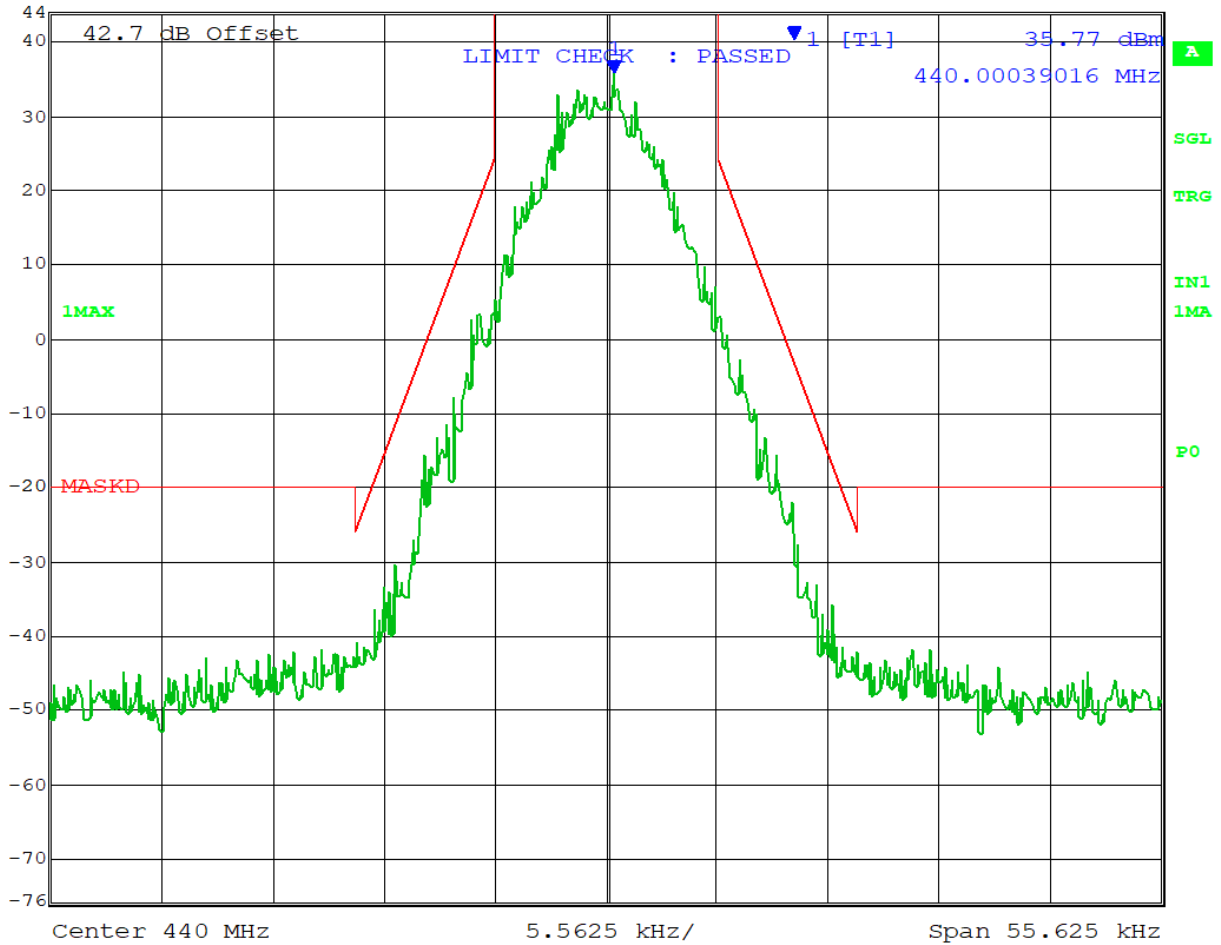

Date: 1.JAN.1997 07:33:09

EMISSION MASK D

Test Data: 453.99375 MHz

Low Power



Ref Lvl	30 dBm	Marker 1 [T1]	23.36 dBm	RBW	100 Hz	RF Att	10 dB
			453.99414016 MHz	VBW	1 kHz		
				SWT	28 s	Unit	dBm

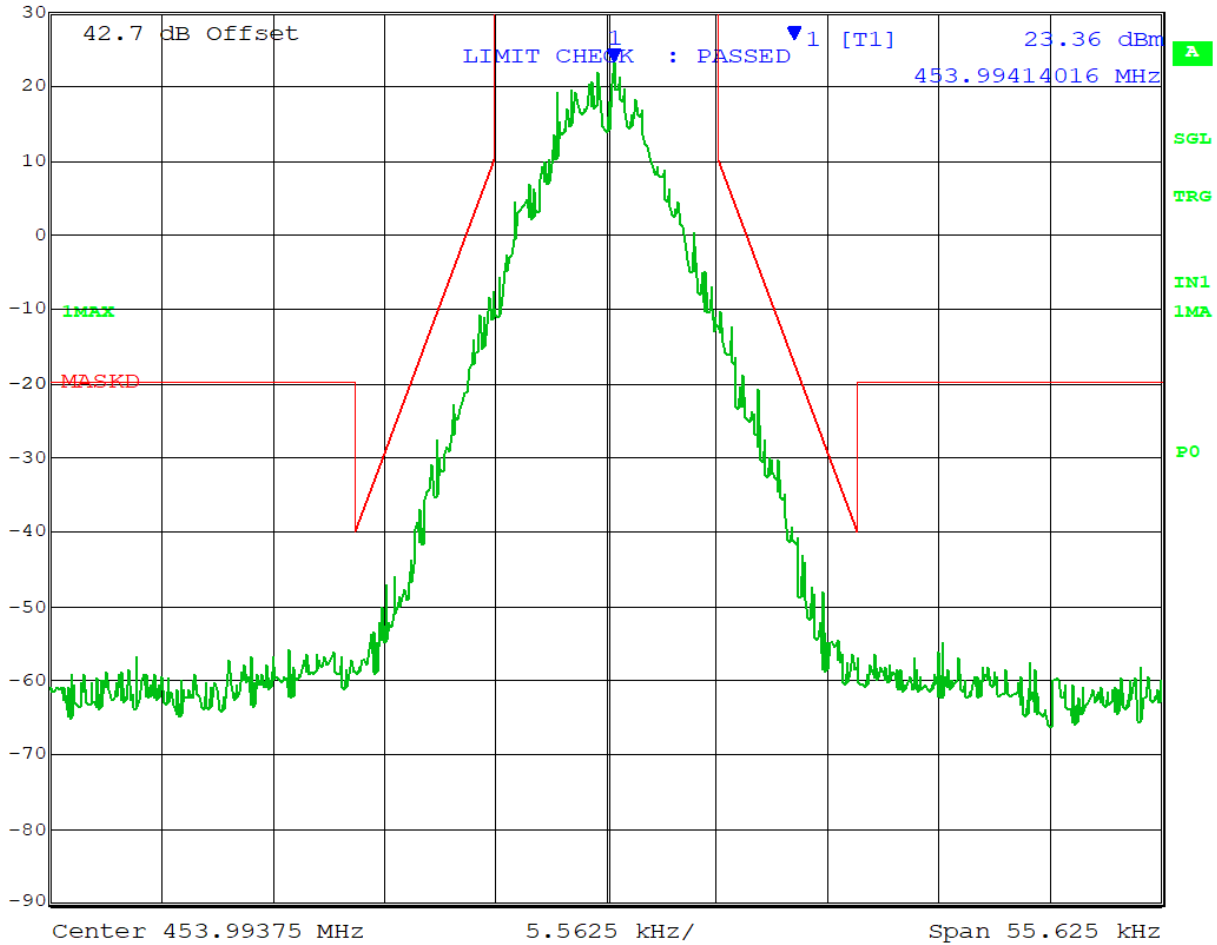

Date: 1.JAN.1997 01:25:30

EMISSION MASK D

Medium Power

	Marker 1 [T1]	RBW	100 Hz	RF Att	20 dB
	Ref Lvl	31.77 dBm	VBW	1 kHz	
	40 dBm	453.99414016 MHz	SWT	28 s	Unit dBm

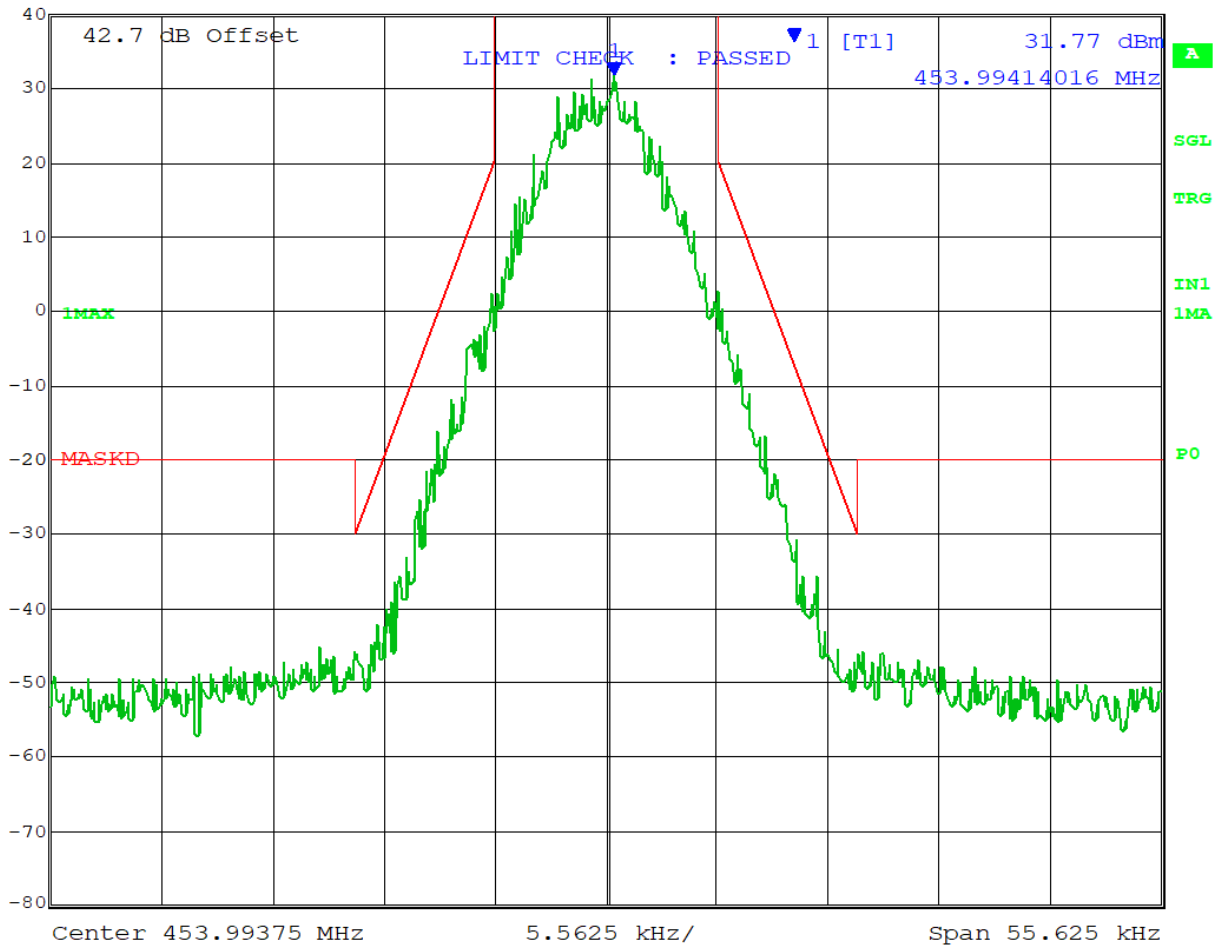

Date: 1.JAN.1997 08:32:48

EMISSION MASK D

High Power



Ref Lvl	Marker 1 [T1]	RBW	100 Hz	RF Att	20 dB
44 dBm	34.71 dBm	VBW	1 kHz		
	453.99414016 MHz	SWT	28 s	Unit	dBm

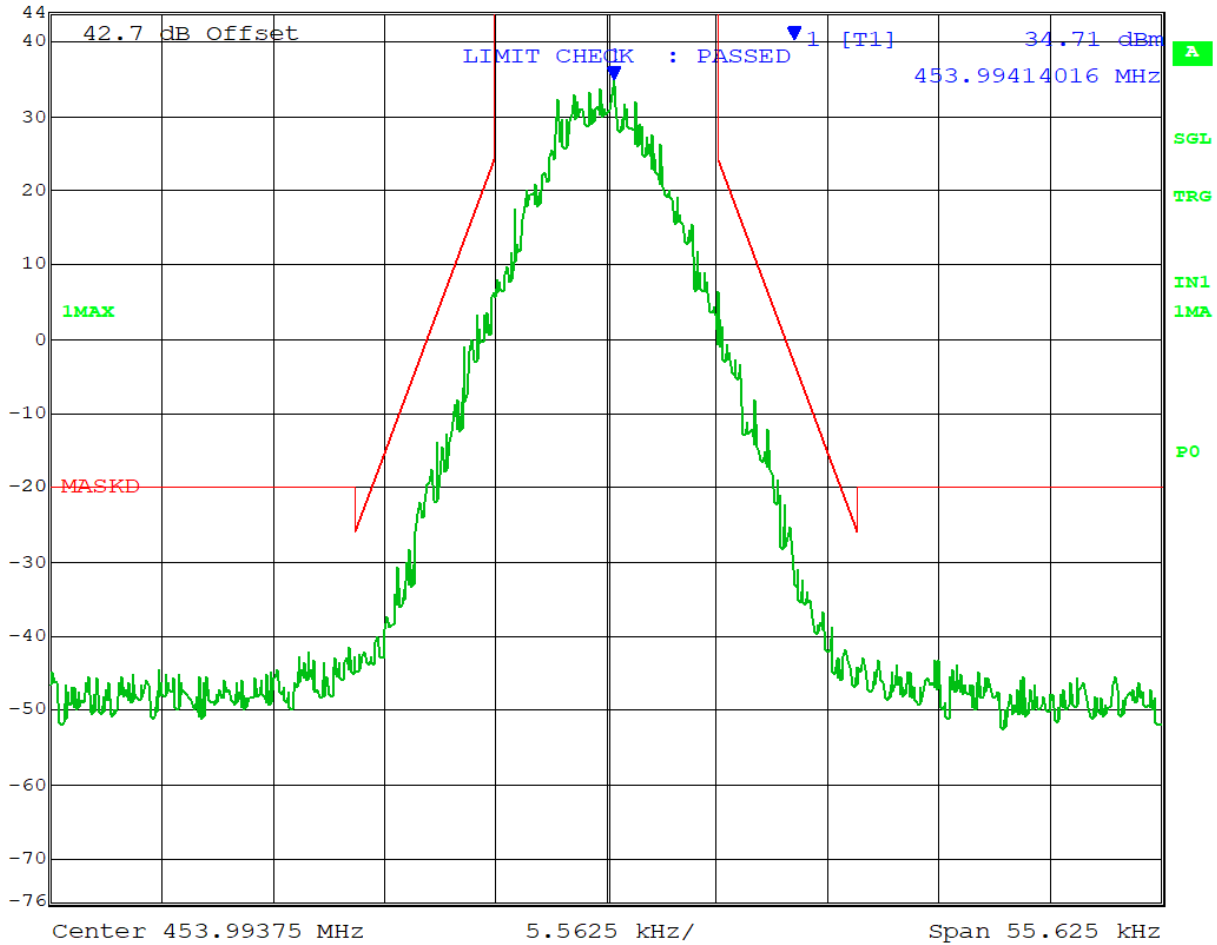

Date: 1.JAN.1997 07:34:55

EMISSION MASK D

Test Data: 456.00625 MHz

Low Power



Ref Lvl	Marker 1 [T1]	RBW	100 Hz	RF Att	10 dB
30 dBm	23.99 dBm	VBW	1 kHz		
	456.00664016 MHz	SWT	28 s	Unit	dBm

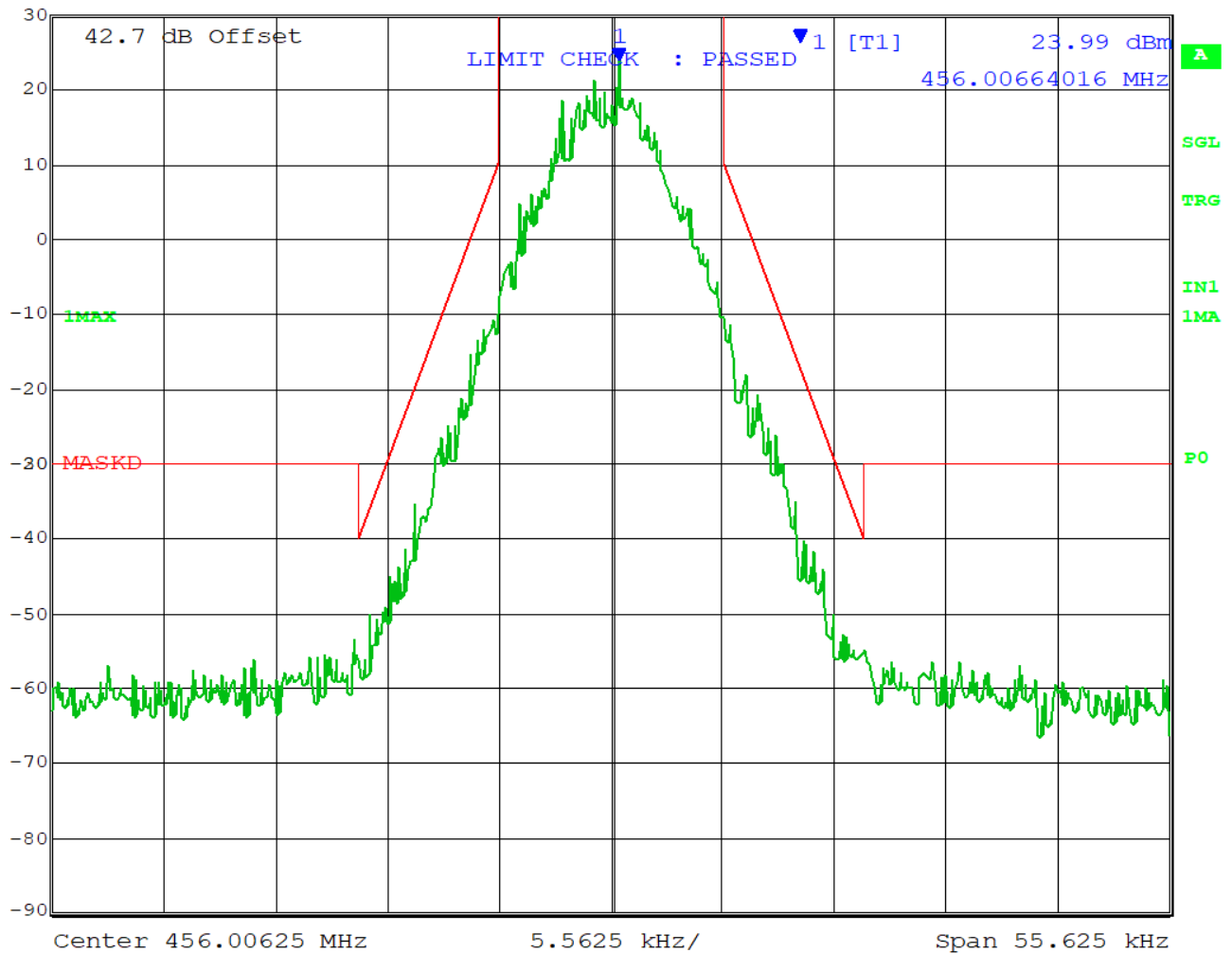

Date: 1.JAN.1997 01:28:27

EMISSION MASK D

Medium Power

	Marker 1 [T1]	RBW	100 Hz	RF Att	20 dB
	Ref Lvl	31.42 dBm	VBW	1 kHz	
	40 dBm	456.00664016 MHz	SWT	28 s	Unit

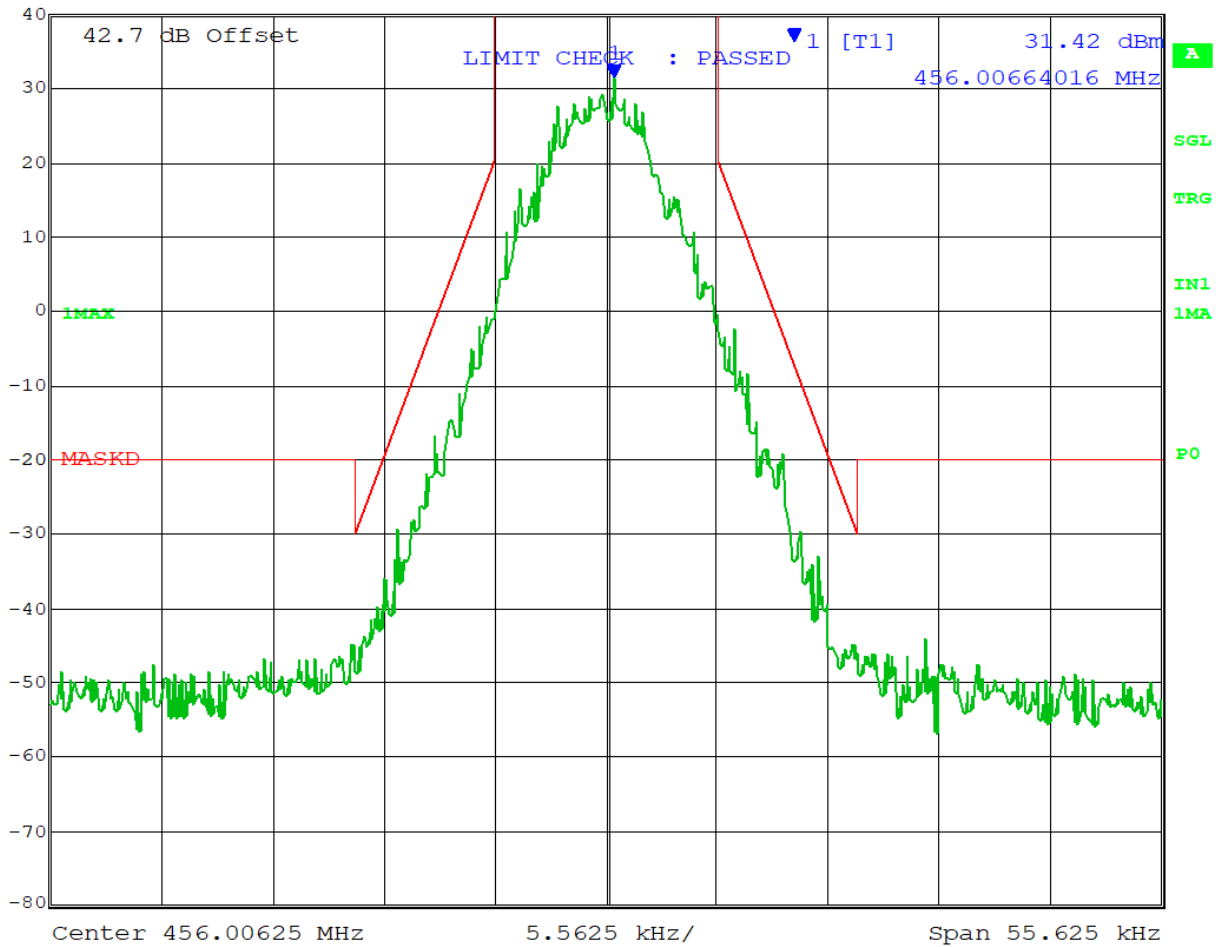

Date: 1.JAN.1997 08:40:43

EMISSION MASK D

High Power

	Marker 1 [T1]	RBW	100 Hz	RF Att	20 dB
	Ref Lvl	37.88 dBm	VBW	1 kHz	
	44 dBm	456.00675163 MHz	SWT	28 s	Unit dBm

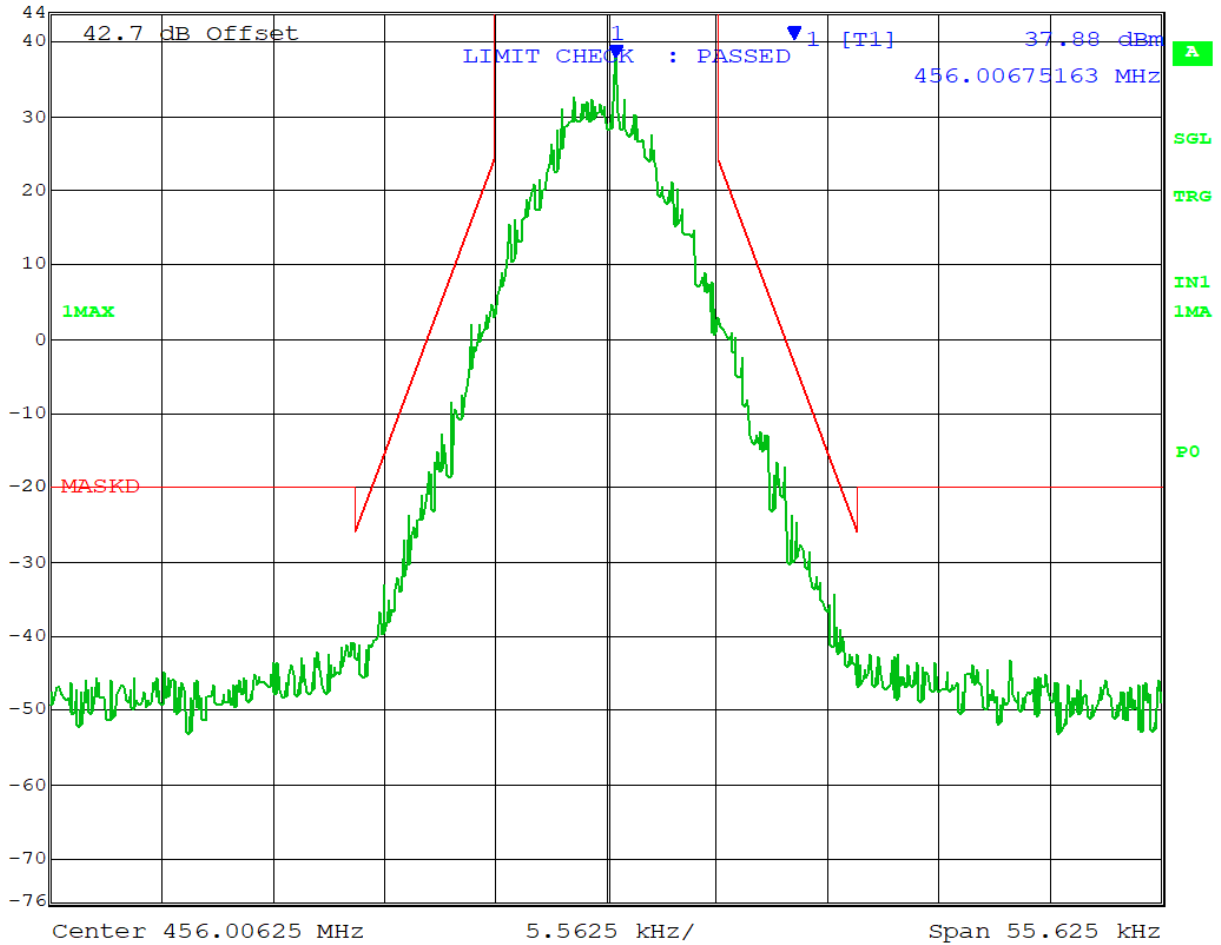

Date: 1.JAN.1997 07:37:44

EMISSION MASK D

Test Data: 462.53125 MHz

Low Power



Ref Lvl	Marker 1 [T1]	RBW	100 Hz	RF Att	10 dB
30 dBm	22.61 dBm	VBW	1 kHz		
	462.53164016 MHz	SWT	28 s	Unit	dBm

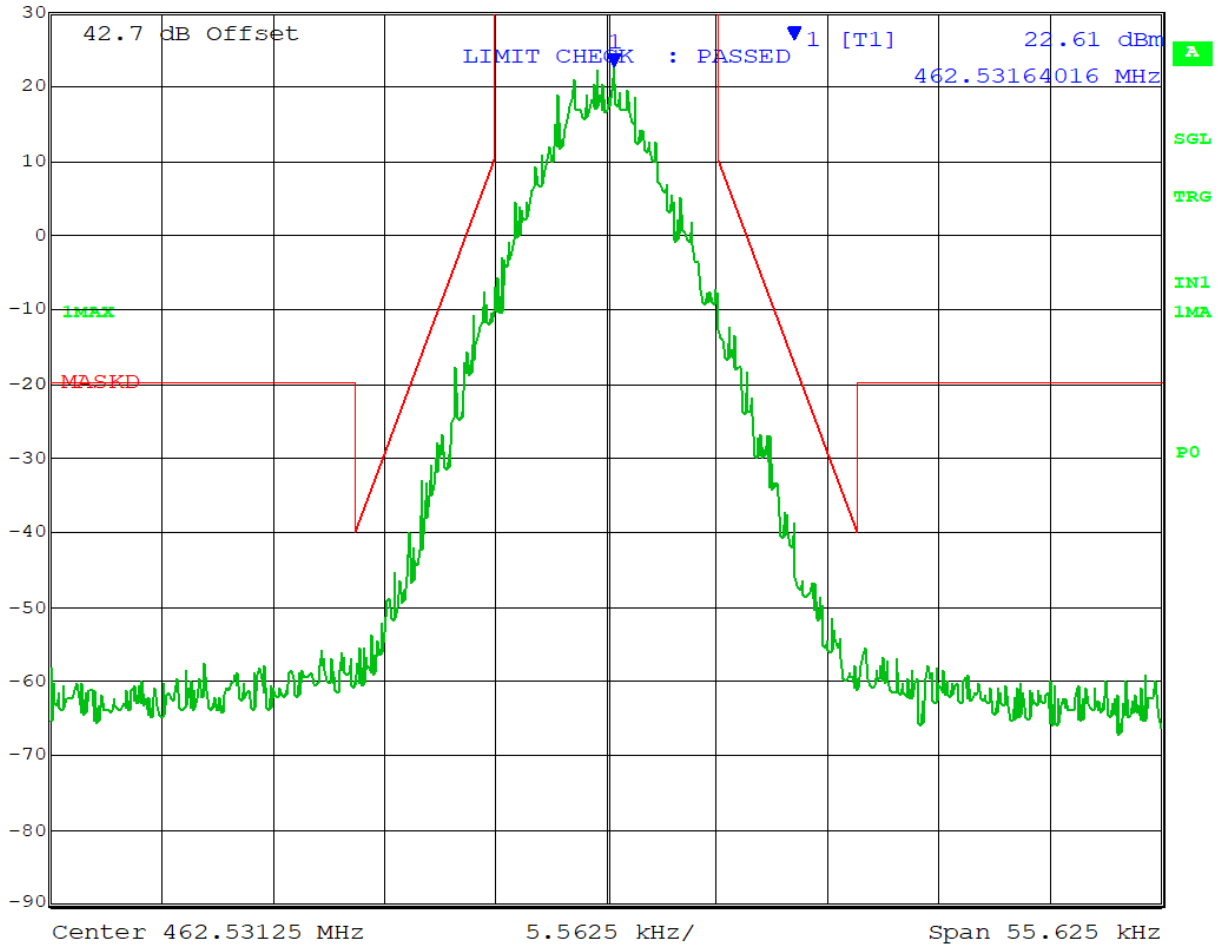

Date: 1.JAN.1997 01:31:56

EMISSION MASK D

Medium Power



Ref Lvl	Marker 1 [T1]	RBW	100 Hz	RF Att	20 dB
40 dBm	33.26 dBm	VBW	1 kHz		
	462.53164016 MHz	SWT	28 s	Unit	dBm

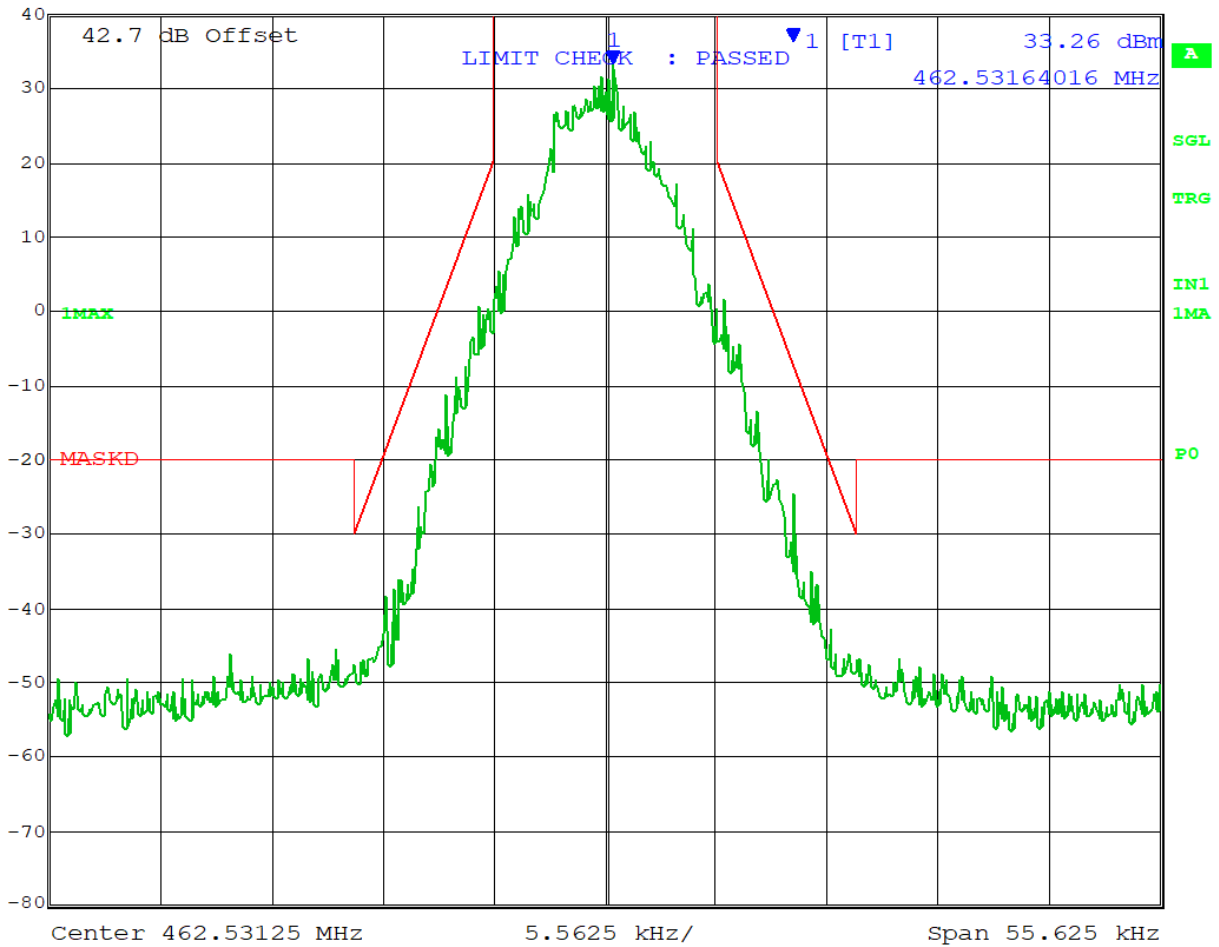

Date: 1.JAN.1997 08:42:33

EMISSION MASK D

High Power



Ref Lvl	44 dBm	Marker 1 [T1]	37.28 dBm	RBW	100 Hz	RF Att	20 dB
			462.53175163 MHz	VBW	1 kHz		
				SWT	28 s	Unit	dBm

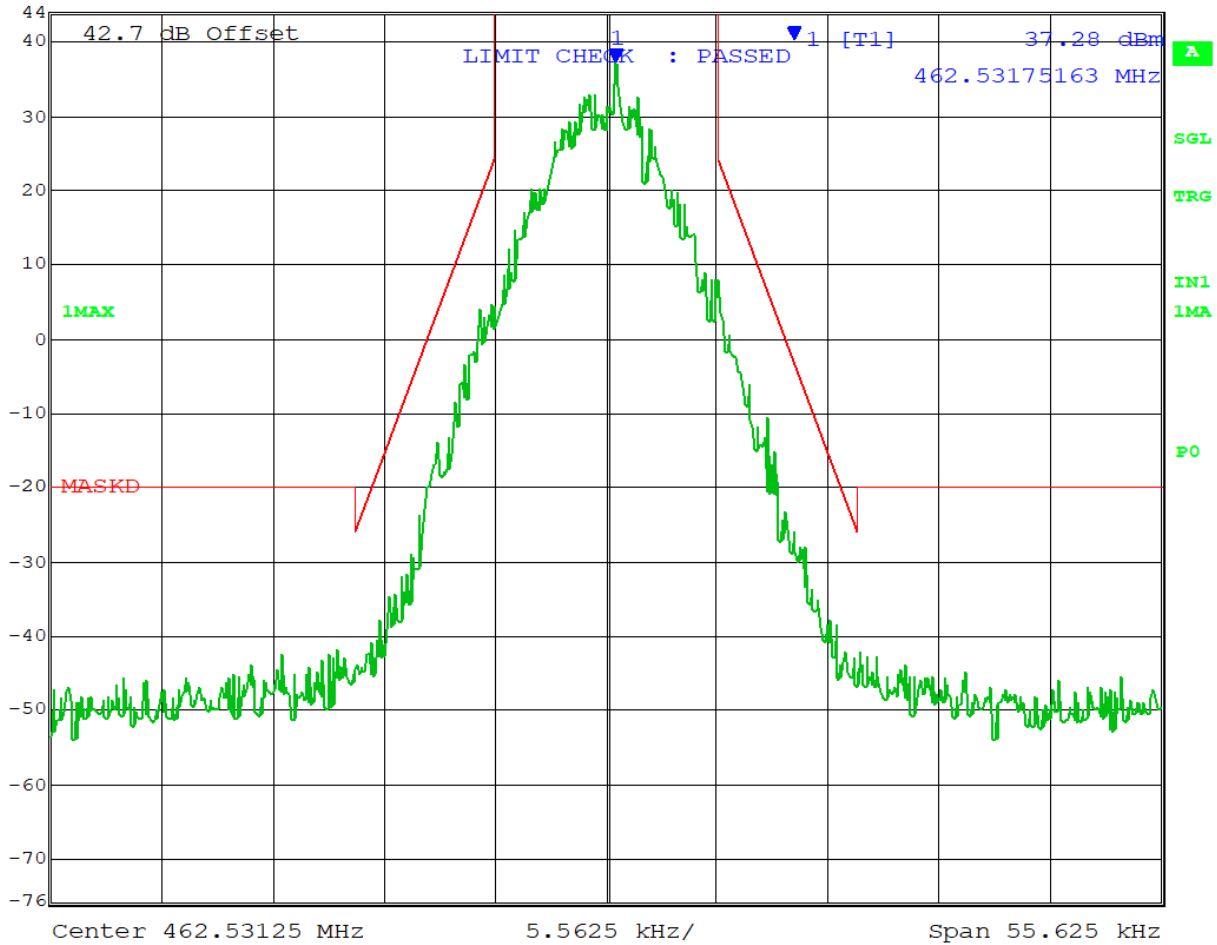

Date: 1.JAN.1997 07:39:39

EMISSION MASK D

Test Data: 462.74375 MHz

Low Power

	Marker 1 [T1]	RBW	100 Hz	RF Att	10 dB
	Ref Lvl	23.47 dBm	VBW	1 kHz	
	30 dBm	462.74414016 MHz	SWT	28 s	Unit dBm

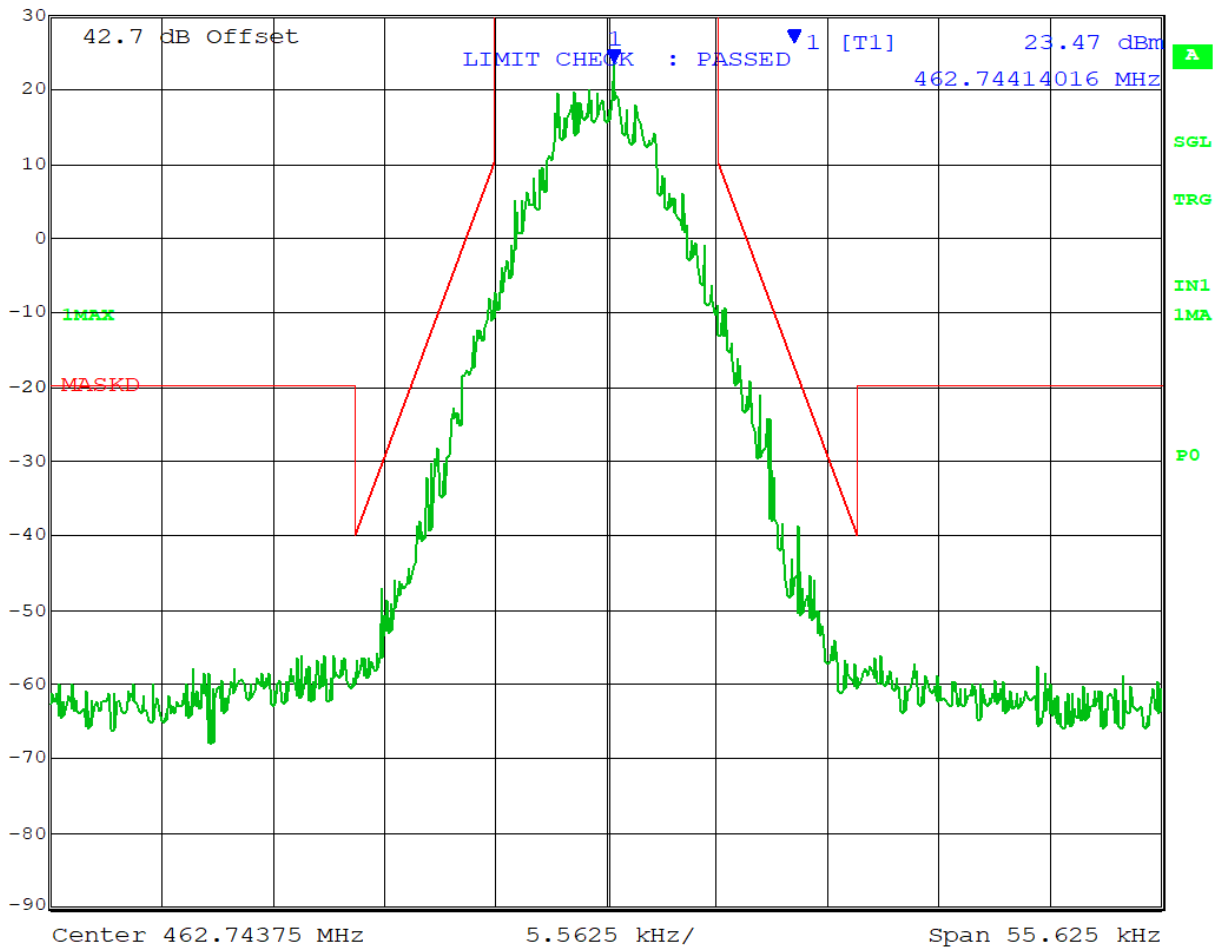

Date: 1.JAN.1997 01:32:57

EMISSION MASK D

Medium Power

	Marker 1 [T1]	RBW	100 Hz	RF Att	20 dB
	Ref Lvl	30.87 dBm	VBW	1 kHz	
	40 dBm	462.74425163 MHz	SWT	28 s	Unit dBm

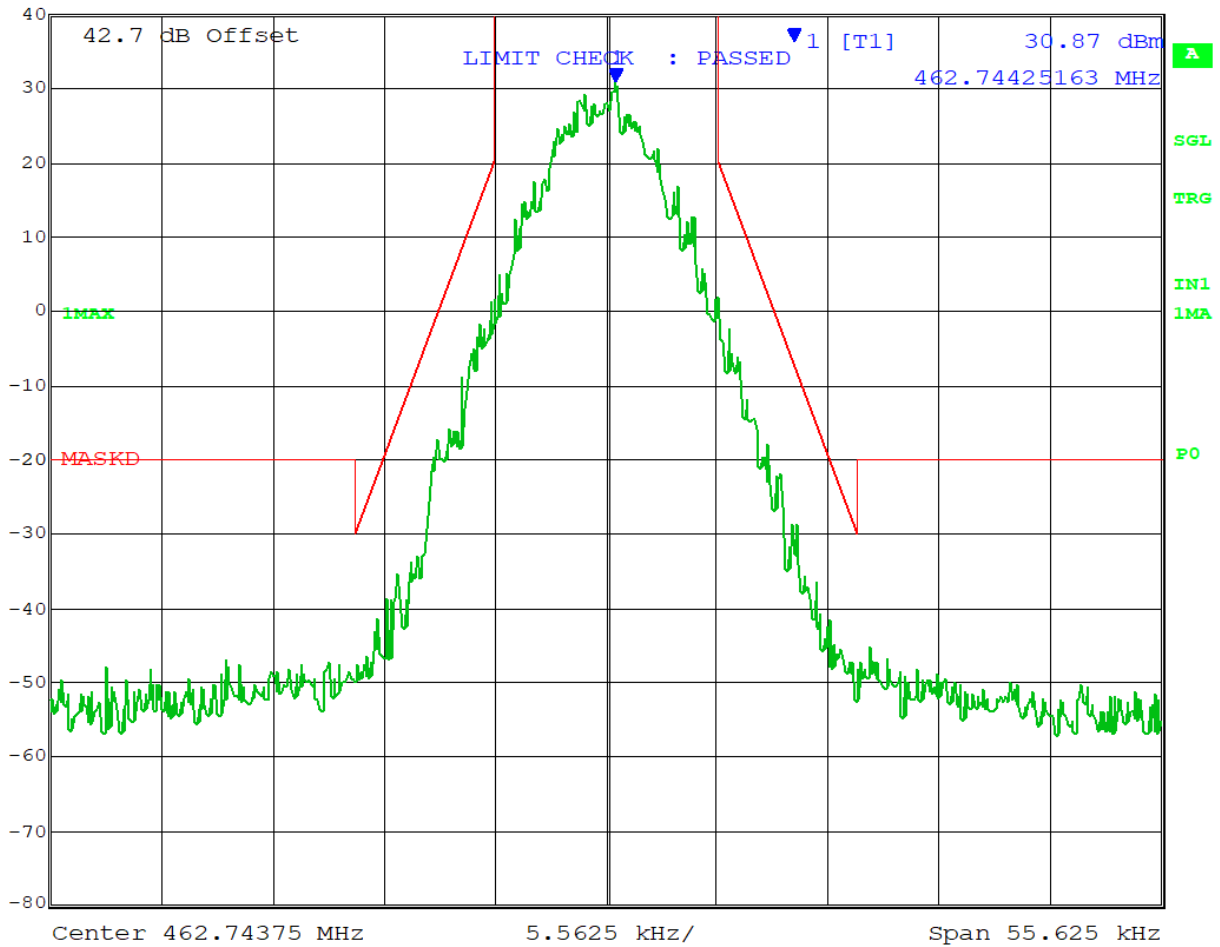

Date: 1.JAN.1997 08:43:25

EMISSION MASK D

High Power



Ref Lvl	44 dBm	Marker 1 [T1]	38.31 dBm	RBW	100 Hz	RF Att	20 dB
			462.74436310 MHz	VBW	1 kHz		
				SWT	28 s	Unit	dBm

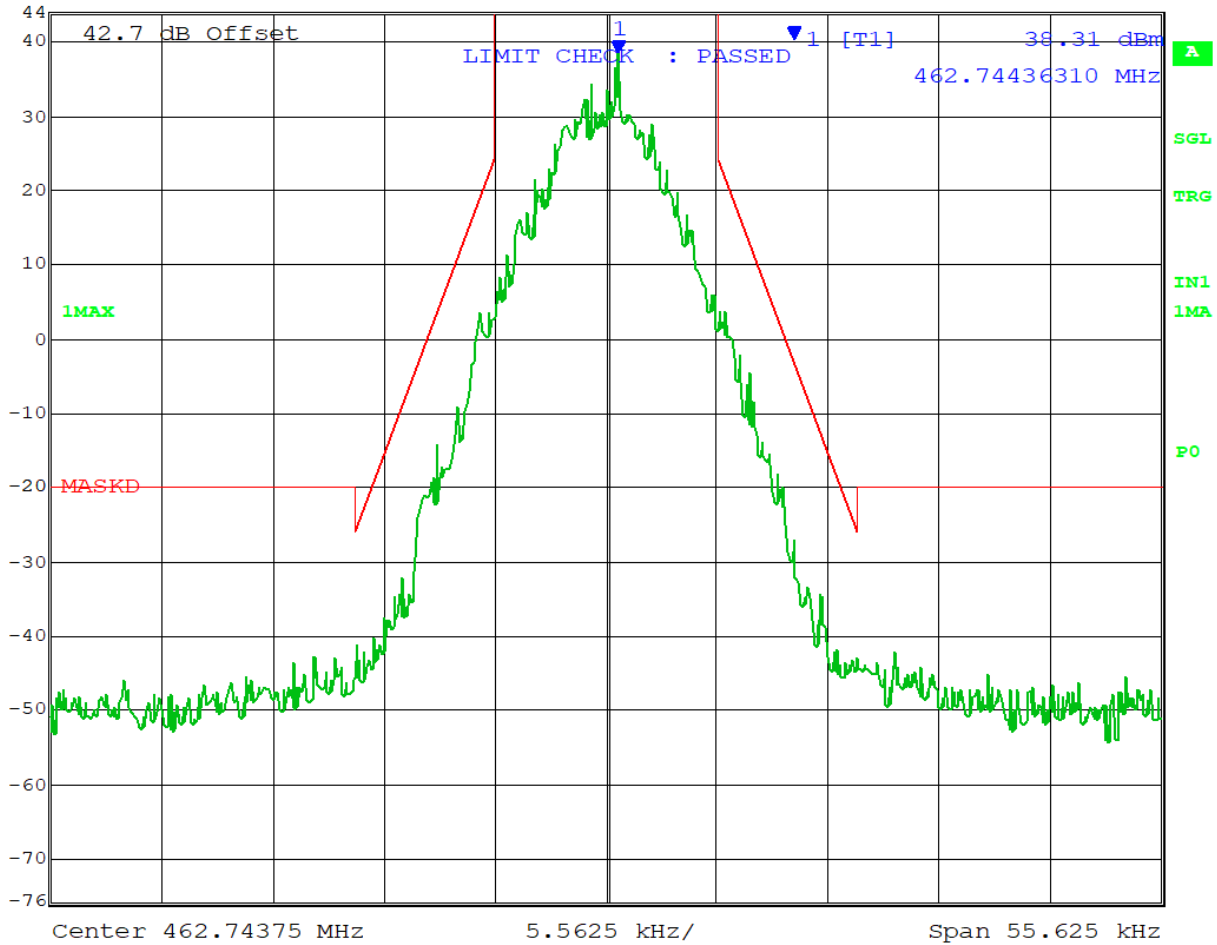

Date: 1.JAN.1997 07:40:38

EMISSION MASK D

Test Data: 467.53125 MHz

Low Power

	Marker 1 [T1]	RBW	100 Hz	RF Att	10 dB
	Ref Lvl	-64.86 dBm	VBW	1 kHz	
	30 dBm	467.50343750 MHz	SWT	28 s	Unit dBm

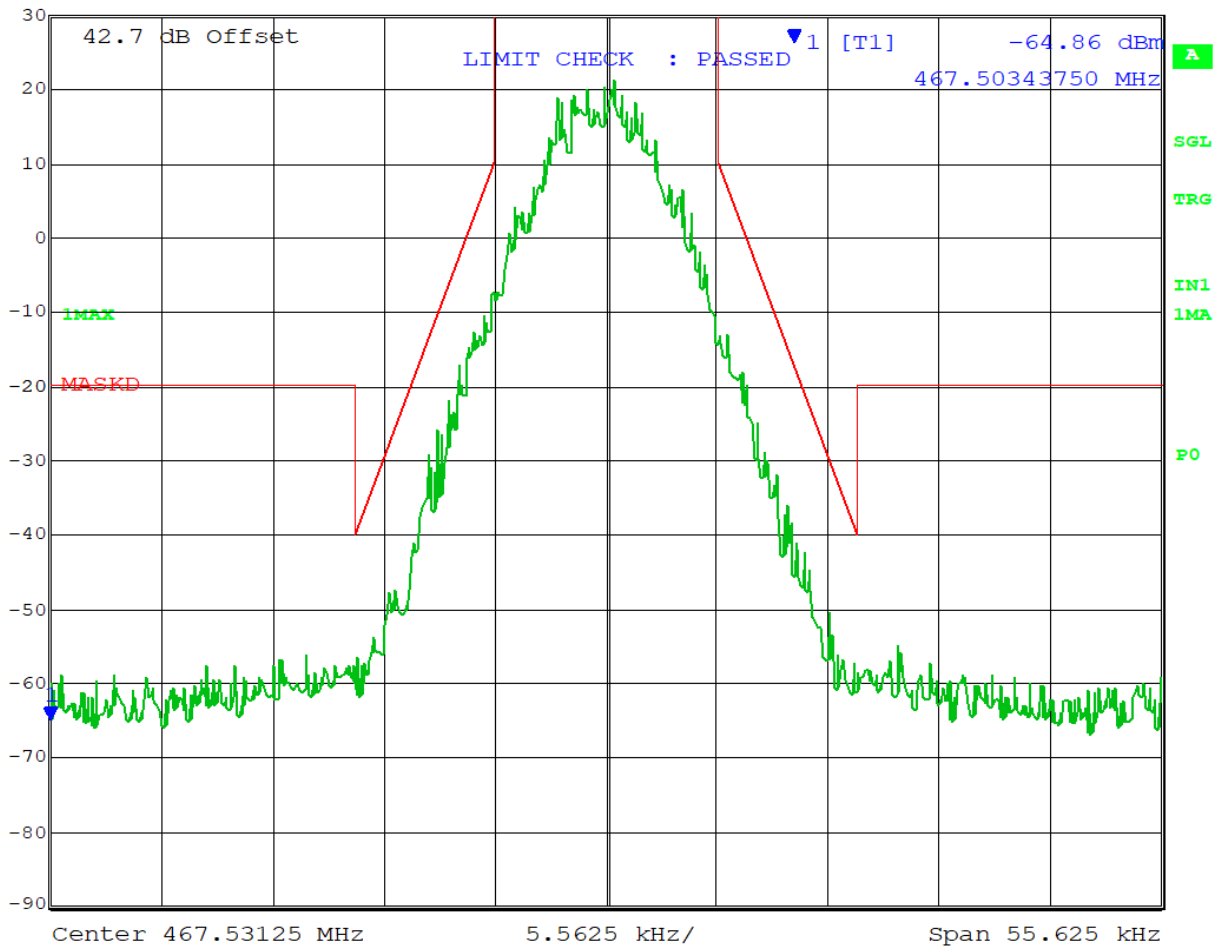

Date: 1.JAN.1997 01:34:16

EMISSION MASK D

Medium Power



Ref Lvl	Marker 1 [T1]	RBW	100 Hz	RF Att	20 dB
40 dBm	32.89 dBm	VBW	1 kHz		
	467.53175163 MHz	SWT	28 s	Unit	dBm

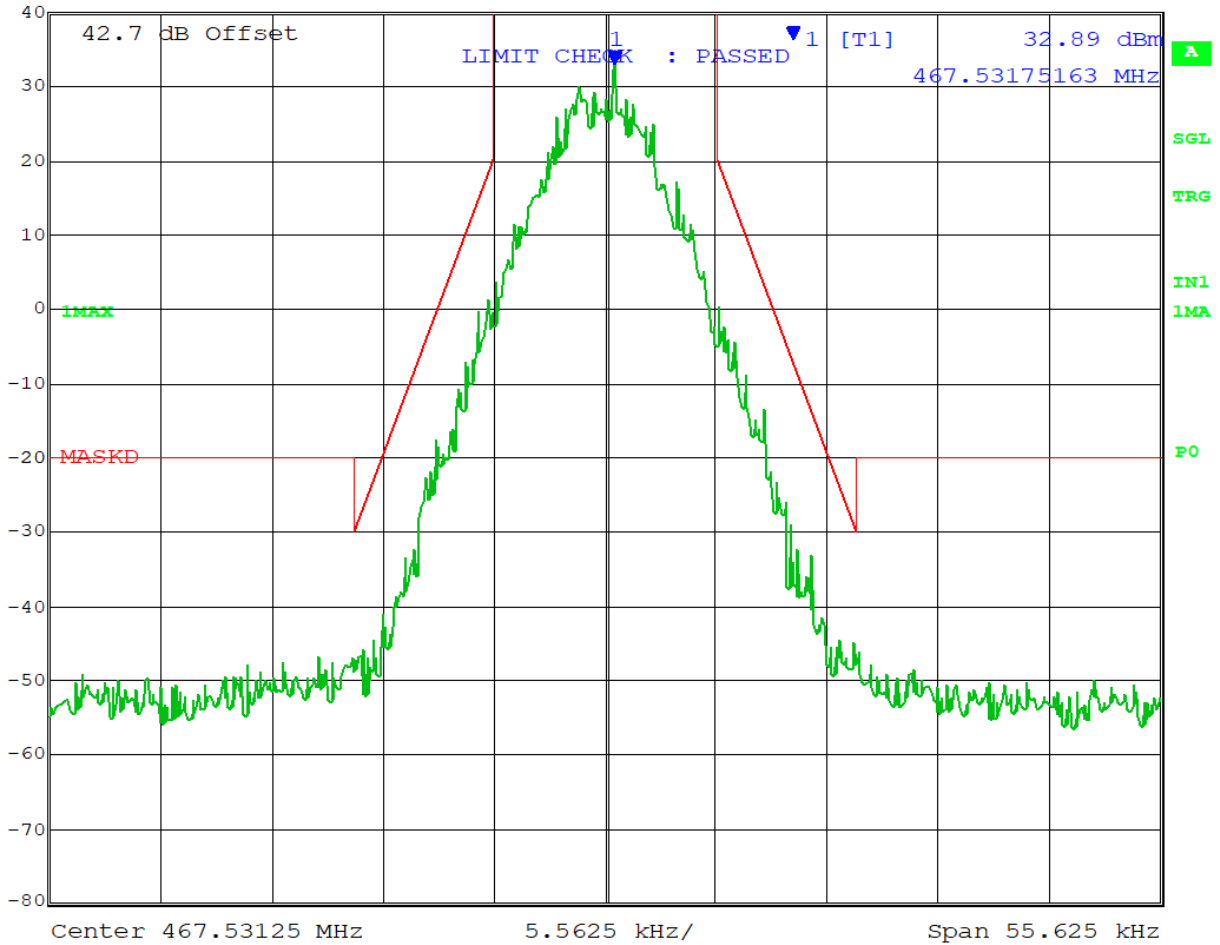

Date: 1.JAN.1997 08:44:24

EMISSION MASK D

High Power



Ref Lvl	44 dBm	Marker 1 [T1]	38.67 dBm	RBW	100 Hz	RF Att	20 dB
			467.53186310 MHz	VBW	1 kHz		
				SWT	28 s	Unit	dBm

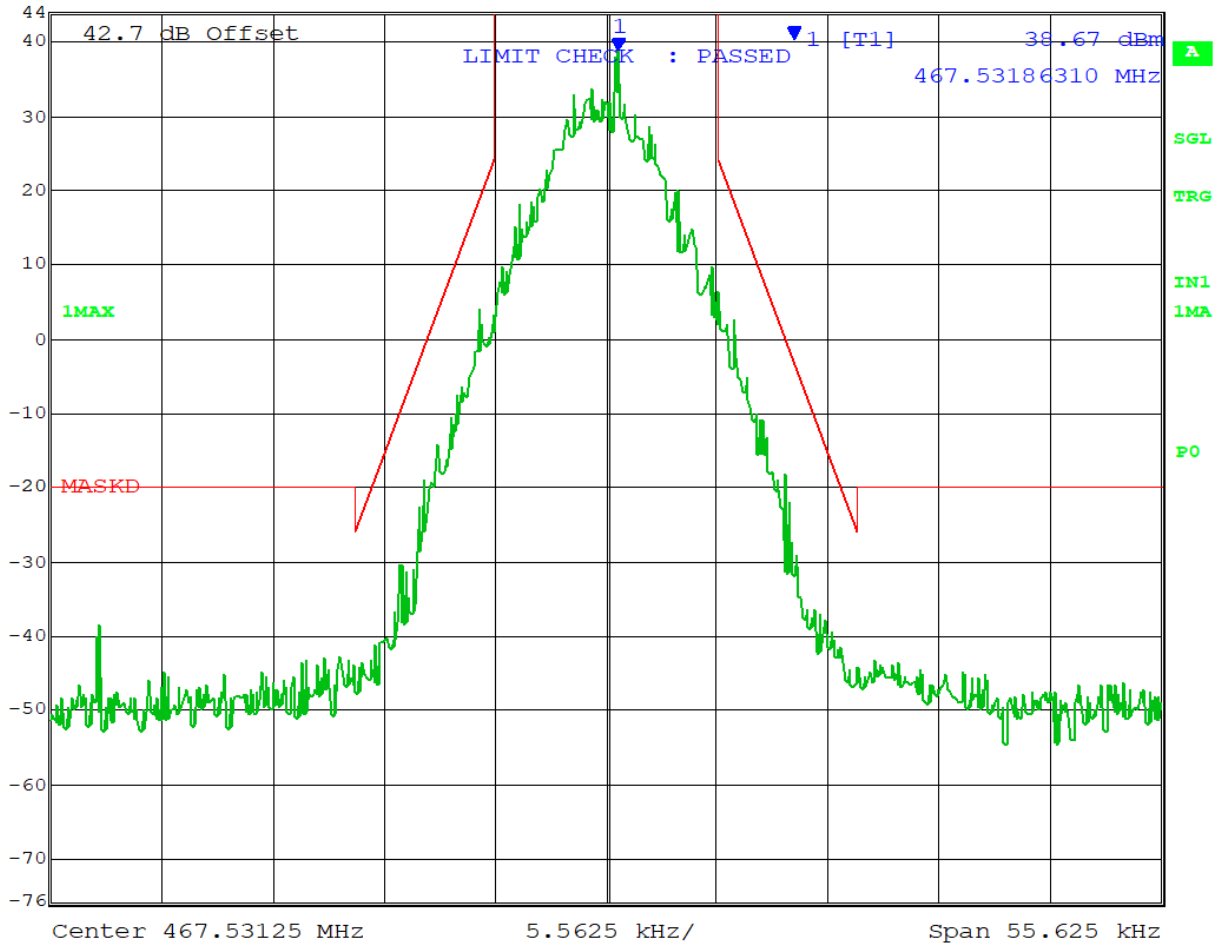

Date: 1.JAN.1997 07:41:54

EMISSION MASK D

Test Data: 467.74375 MHz

Low Power

	Marker 1 [T1]	RBW	100 Hz	RF Att	10 dB
	Ref Lvl	22.22 dBm	VBW	1 kHz	
	30 dBm	467.74414016 MHz	SWT	28 s	Unit dBm

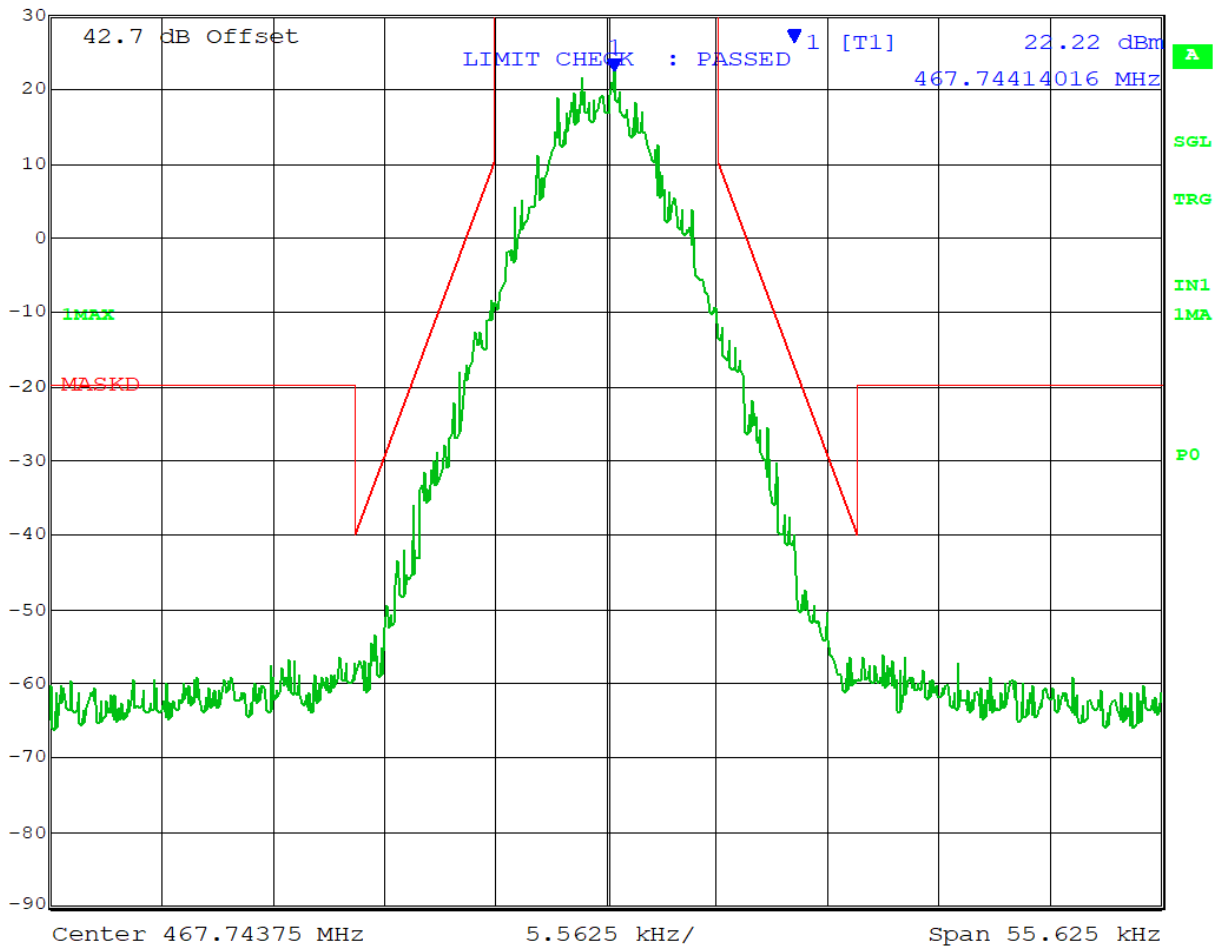

Date: 1.JAN.1997 01:35:18

EMISSION MASK D

High Power



Ref Lvl	44 dBm	Marker 1 [T1]	38.32 dBm	RBW	100 Hz	RF Att	20 dB
			467.74425163 MHz	VBW	1 kHz		
				SWT	28 s	Unit	dBm

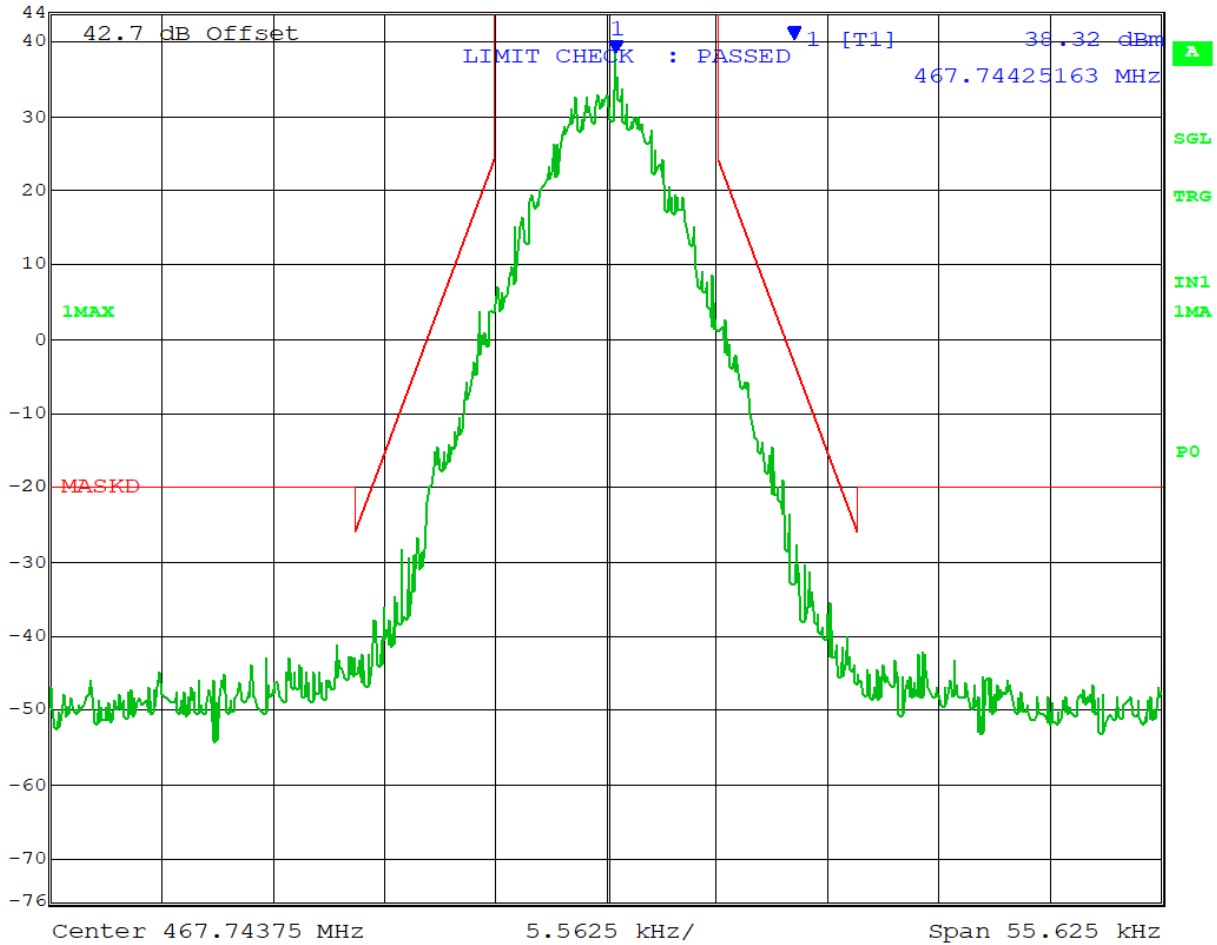

Date: 1.JAN.1997 07:42:48

EMISSION MASK D

Test Data: 475.00 MHz

Low Power

	Marker 1 [T1]	RBW	100 Hz	RF Att	10 dB
	Ref Lvl	22.92 dBm	VBW	1 kHz	
	30 dBm	475.00039016 MHz	SWT	28 s	Unit dBm

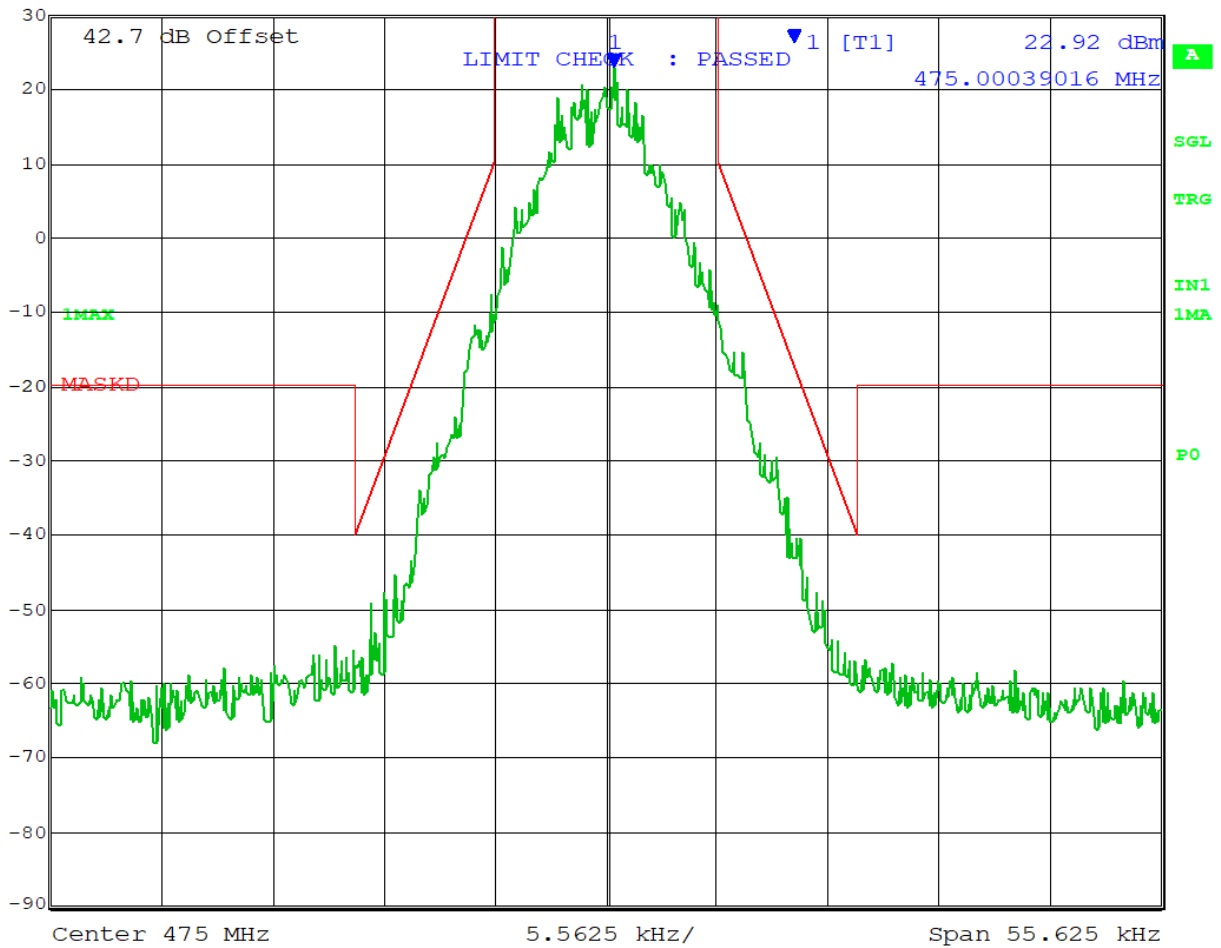

Date: 1.JAN.1997 01:37:11

EMISSION MASK D

Medium Power

	Marker 1 [T1]	RBW	100 Hz	RF Att	20 dB
	Ref Lvl	34.10 dBm	VBW	1 kHz	
	40 dBm	475.00050163 MHz	SWT	28 s	Unit dBm

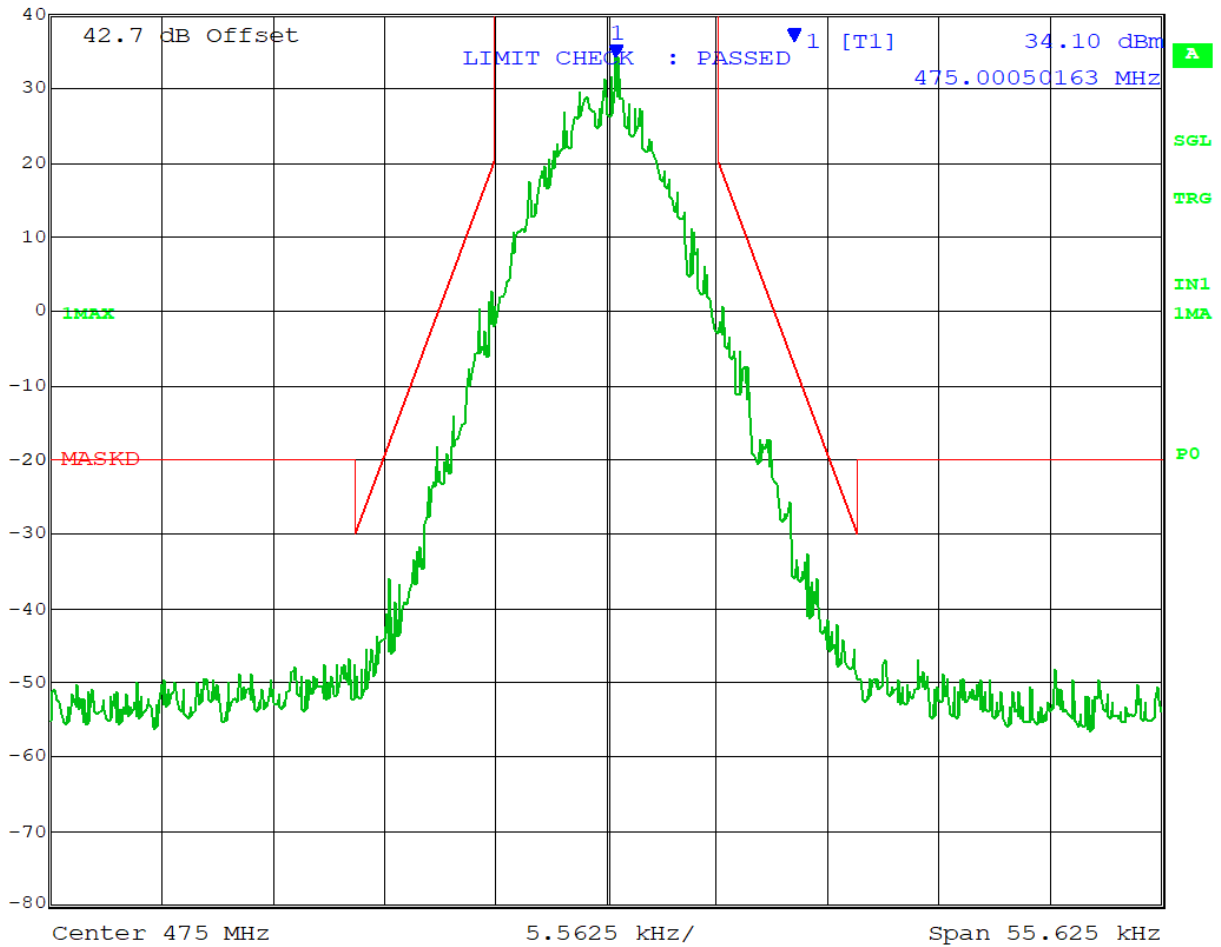

Date: 1.JAN.1997 08:47:02

EMISSION MASK D

High Power

	Marker 1 [T1]	RBW	100 Hz	RF Att	20 dB
	Ref Lvl	36.99 dBm	VBW	1 kHz	
	44 dBm	475.00050163 MHz	SWT	28 s	Unit dBm

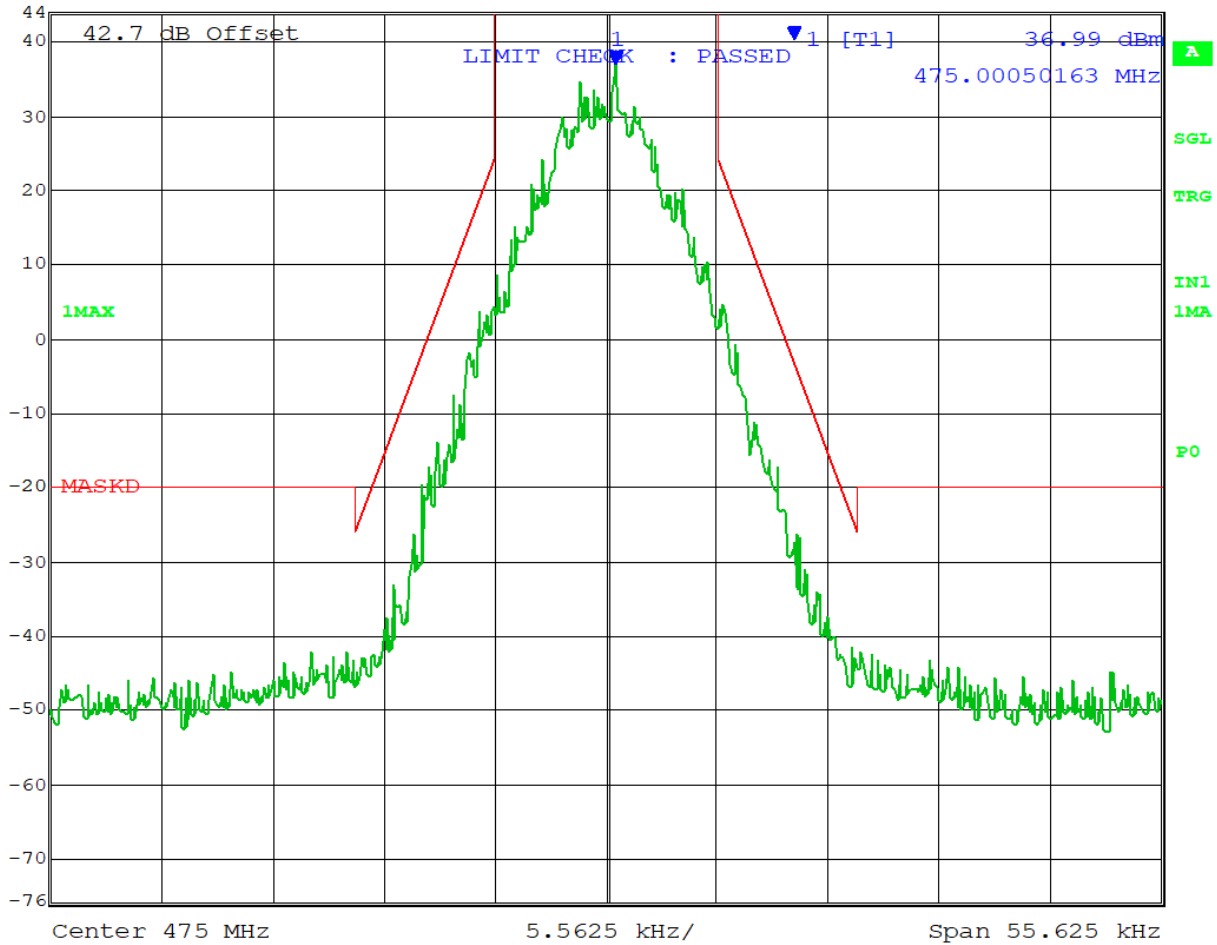

Date: 1.JAN.1997 07:44:38

Result: Meets Requirements

EMISSION MASK D

Test Data: 479.99375 MHz

Low Power



Ref Lvl	30 dBm	Marker 1 [T1]	20.83 dBm	RBW	100 Hz	RF Att	10 dB
			479.99414016 MHz	VBW	1 kHz		
				SWT	28 s	Unit	dBm

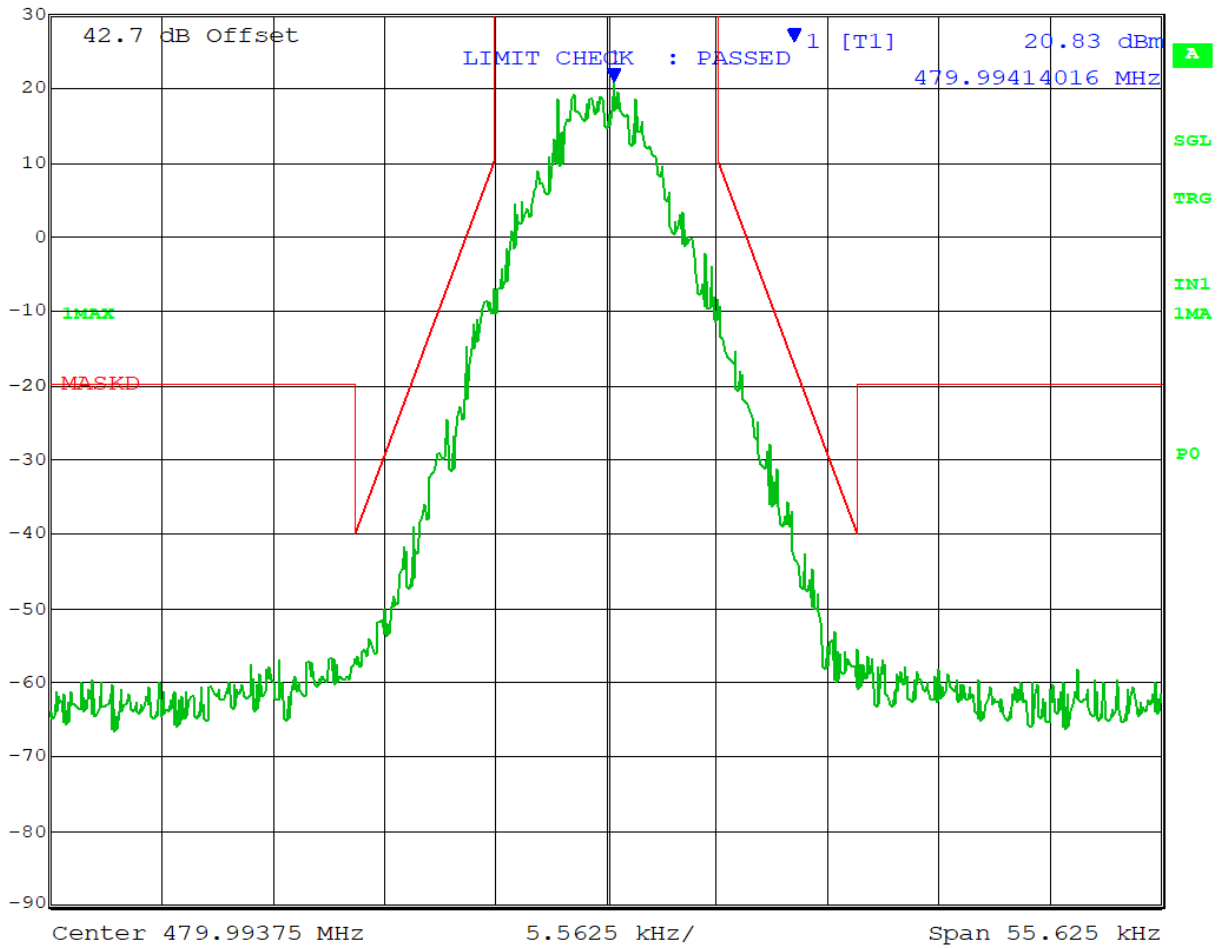

Date: 1.JAN.1997 01:38:04

EMISSION MASK D

Medium Power

	Marker 1 [T1]	RBW	100 Hz	RF Att	20 dB
	Ref Lvl	34.24 dBm	VBW	1 kHz	
	40 dBm	479.99436310 MHz	SWT	28 s	Unit dBm

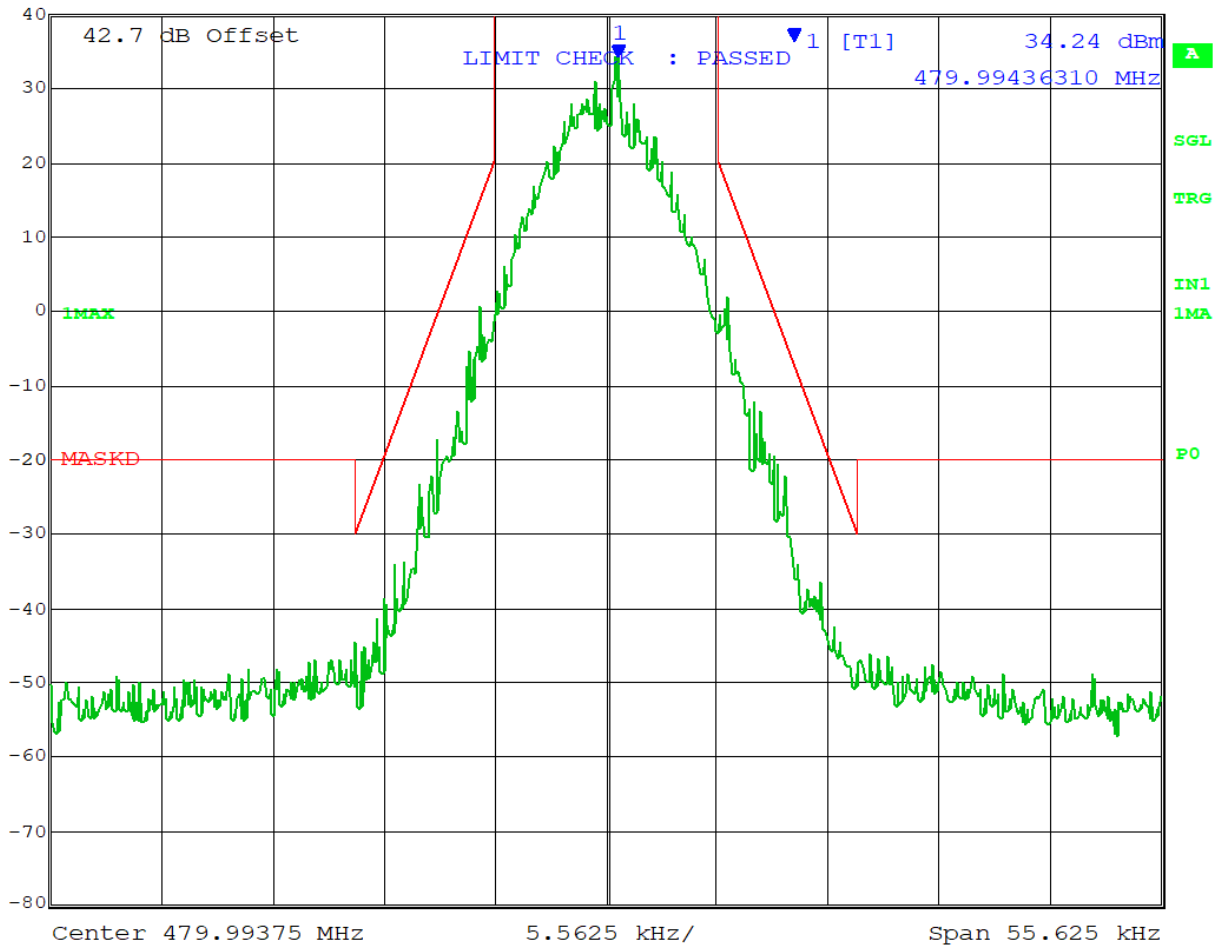

Date: 1.JAN.1997 08:47:55

EMISSION MASK D

High Power



Ref Lvl	44 dBm	Marker 1 [T1]	36.57 dBm	RBW	100 Hz	RF Att	20 dB
			479.99425163 MHz	VBW	1 kHz		
				SWT	28 s	Unit	dBm

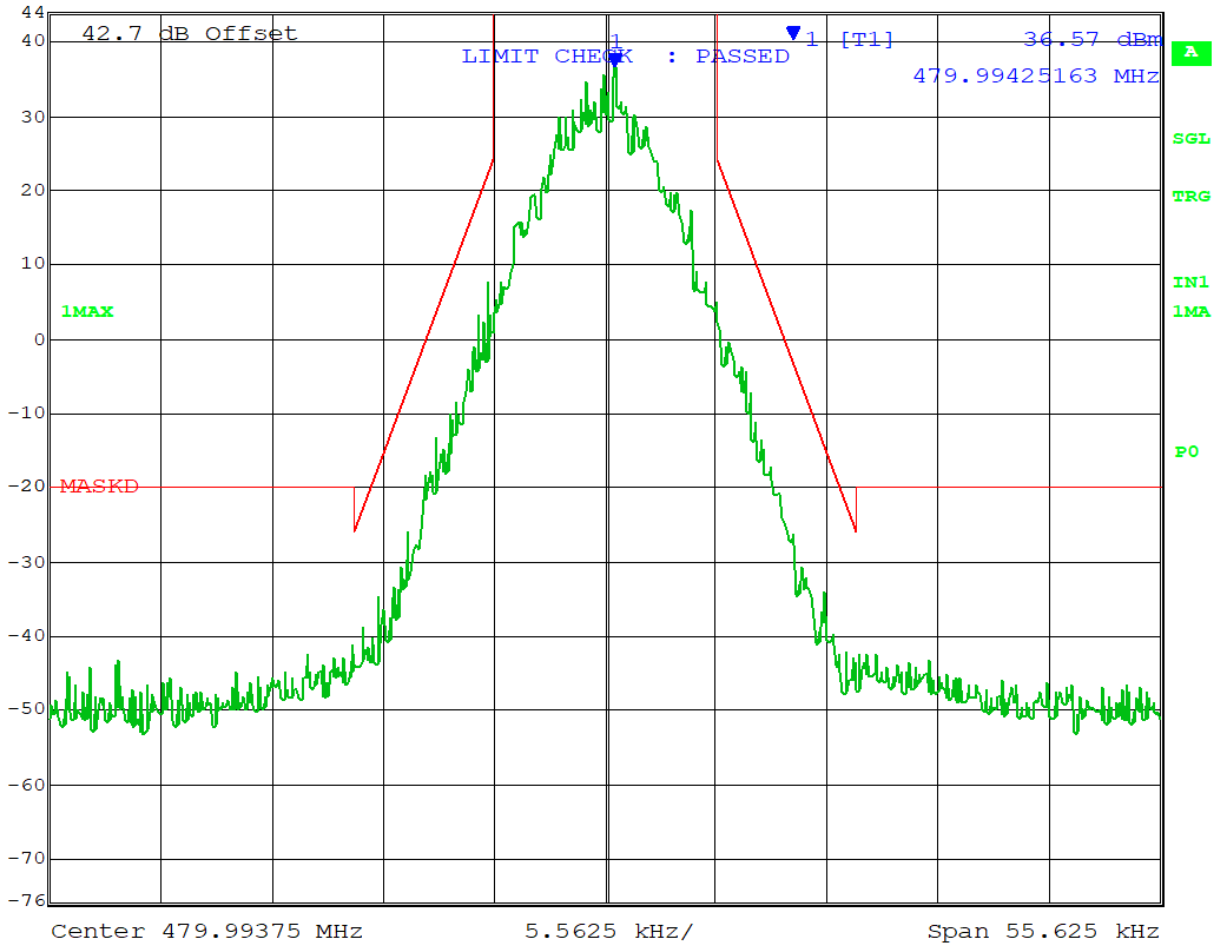

Date: 1.JAN.1997 07:45:37

SPURIOUS EMISSIONS AT ANTENNA TERMINALS (CONDUCTED)

FCC Rule Parts: FCC Part 2.1051(a), 90.210(d)(3)

Requirements:

(3) On any frequency removed from the center of the authorized bandwidth by a displacement frequency (f_d in kHz) of more than 12.5 kHz: At least $50 + 10 \log(P)$ dB or 70 dB, whichever is the lesser attenuation.

Method of Measurement: ANSI/TIA-603-E

Test Procedure: TIA 603-E, 2.2.13

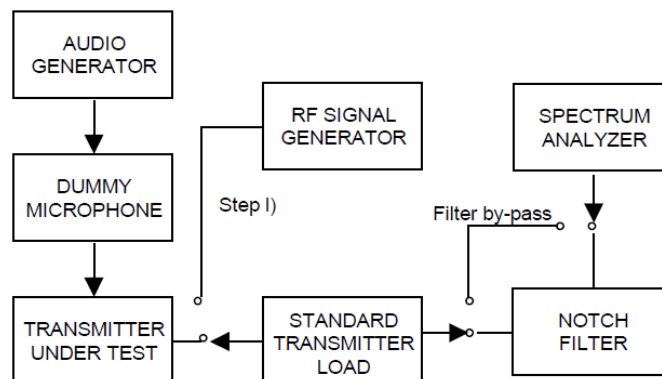

SPURIOUS EMISSIONS - NARROWBAND FM (12.5 kHz)

Test Data: 406.10625 MHz

Spurious Conducted Emissions, Narrowband FM (12.5 kHz), Mask D Limit (≥250% Authorized BW)	High Power		Med Power		Low Power	
	dBm	44.00	dBm	40.16	dBm	30.17
	Watts	25.12	Watts	10.38	Watts	1.04
	Limit (dBm)	-20	Limit (dBm)	-20	Limit (dBm)	-20
Frequency (MHz)	Peak (dBm)	Margin (dB)	Peak (dBm)	Margin (dB)	Peak (dBm)	Margin (dB)
Fundamental 406.1063	44.00	0.00	40.16	0.00	30.17	0.00
2nd Harmonic 812.2125	-32.61	12.61	-42.80	22.80	-42.93	22.93
3rd Harmonic 1218.3188	-37.63	17.63	-44.16	24.16	-48.53	28.53
4th Harmonic 1624.4250	-59.20	39.20	-59.01	39.01	-60.34	40.34
5th Harmonic 2030.5313	-51.17	31.17	-61.38	41.38 *	-59.48	39.48
6th Harmonic 2436.6375	-53.85	33.85	-61.64	41.64 *	-56.78	36.78
7th Harmonic 2842.7438	-56.95	36.95	-50.44	30.44	-49.49	29.49
8th Harmonic 3248.8500	-62.22	42.22	-61.52	41.52 *	-63.08	43.08 *
9th Harmonic 3654.9563	-61.31	41.31 *	-61.25	41.25 *	-62.81	42.81 *
10th Harmonic 4061.0625	-60.97	40.97 *	-60.91	40.91 *	-62.47	42.47 *

* Indicates Noise Floor of Measurement

SPURIOUS EMISSIONS AT ANTENNA TERMINALS

Test Data: 409.99375 MHz

Spurious Conducted Emissions, Narrowband FM (12.5 kHz), Mask D Limit (≥250% Authorized BW)	High Power		Med Power		Low Power	
	dBm	44.00	dBm	40.16	dBm	30.17
	Watts	25.12	Watts	10.38	Watts	1.04
	Limit (dBm)	-20	Limit (dBm)	-20	Limit (dBm)	-20
Frequency (MHz)	Peak (dBm)	Margin (dB)	Peak (dBm)	Margin (dB)	Peak (dBm)	Margin (dB)
Fundamental 409.9938	44.00	0.00	40.16	0.00	30.17	0.00
2nd Harmonic 819.9875	-34.69	14.69	-42.15	22.15	-43.06	23.06
3rd Harmonic 1229.9813	-37.49	17.49	-45.90	25.90	-50.52	30.52
4th Harmonic 1639.9750	-56.54	36.54	-56.88	36.88	-62.89	42.89 *
5th Harmonic 2049.9688	-61.44	41.44 *	-61.38	41.38 *	-62.94	42.94 *
6th Harmonic 2459.9625	-53.20	33.20	-57.59	37.59	-54.09	34.09
7th Harmonic 2869.9563	-61.56	41.56 *	-49.11	29.11	-49.65	29.65
8th Harmonic 3279.9500	-61.58	41.58 *	-61.52	41.52 *	-63.08	43.08 *
9th Harmonic 3689.9438	-61.31	41.31 *	-61.25	41.25 *	-62.81	42.81 *
10th Harmonic 4099.9375	-60.97	40.97 *	-60.91	40.91 *	-62.47	42.47 *

* Indicates Noise Floor of Measurement

SPURIOUS EMISSIONS AT ANTENNA TERMINALS

Test Data: 420.00625 MHz

Spurious Conducted Emissions, Narrowband FM (12.5 kHz), Mask D Limit (≥250% Authorized BW)	High Power		Med Power		Low Power	
	dBm	44.00	dBm	40.16	dBm	30.17
	Watts	25.12	Watts	10.38	Watts	1.04
	Limit (dBm)	-20	Limit (dBm)	-20	Limit (dBm)	-20
Frequency (MHz)	Peak (dBm)	Margin (dB)	Peak (dBm)	Margin (dB)	Peak (dBm)	Margin (dB)
Fundamental 420.0063	44.00	0.00	40.16	0.00	30.17	0.00
2nd Harmonic 840.0125	-40.24	20.24	-38.09	18.09	-39.38	19.38
3rd Harmonic 1260.0188	-36.77	16.77	-48.09	28.09	-55.50	35.50
4th Harmonic 1680.0250	-60.28	40.28	-61.33	41.33 *	-62.89	42.89 *
5th Harmonic 2100.0313	-55.07	35.07	-54.82	34.82	-59.68	39.68
6th Harmonic 2520.0375	-54.42	34.42	-55.06	35.06	-53.95	33.95
7th Harmonic 2940.0438	-50.35	30.35	-55.94	35.94	-54.16	34.16
8th Harmonic 3360.0500	-61.58	41.58 *	-61.52	41.52 *	-63.08	43.08 *
9th Harmonic 3780.0563	-61.31	41.31 *	-61.25	41.25 *	-62.81	42.81 *
10th Harmonic 4200.0625	-60.97	40.97 *	-60.91	40.91 *	-62.47	42.47 *

* Indicates Noise Floor of Measurement

SPURIOUS EMISSIONS AT ANTENNA TERMINALS

Test Data: 440.00000 MHz

Spurious Conducted Emissions, Narrowband FM (12.5 kHz), Mask D Limit (≥250% Authorized BW)	High Power		Med Power		Low Power	
	dBm	44.00	dBm	40.16	dBm	30.17
	Watts	25.12	Watts	10.38	Watts	1.04
	Limit (dBm)	-20	Limit (dBm)	-20	Limit (dBm)	-20
Frequency (MHz)	Peak (dBm)	Margin (dB)	Peak (dBm)	Margin (dB)	Peak (dBm)	Margin (dB)
Fundamental 440.0063	44.00	0.00	40.16	0.00	30.17	0.00
2nd Harmonic 880.0125	-33.35	13.35	-30.19	10.19	-32.26	12.26
3rd Harmonic 1320.0188	-41.15	21.15	-47.22	27.22	-51.80	31.80
4th Harmonic 1760.0250	-47.64	27.64	-56.06	36.06	-60.26	40.26
5th Harmonic 2200.0313	-53.93	33.93	-57.26	37.26	-56.89	36.89
6th Harmonic 2640.0375	-54.06	34.06	-59.58	39.58	-58.77	38.77
7th Harmonic 3080.0438	-59.44	39.44	-62.12	42.12	-61.75	41.75
8th Harmonic 3520.0500	-61.58	41.58 *	-61.52	41.52 *	-63.08	43.08 *
9th Harmonic 3960.0563	-61.31	41.31 *	-61.25	41.25 *	-62.81	42.81 *
10th Harmonic 4400.0625	-60.97	40.97 *	-60.91	40.91 *	-62.47	42.47 *

* Indicates Noise Floor of Measurement

SPURIOUS EMISSIONS AT ANTENNA TERMINALS

Test Data: 453.99375 MHz

Spurious Conducted Emissions, Narrowband FM (12.5 kHz), Mask D Limit (≥250% Authorized BW)	High Power		Med Power		Low Power	
	dBm	44.00	dBm	40.16	dBm	30.17
	Watts	25.12	Watts	10.38	Watts	1.04
	Limit (dBm)	-20	Limit (dBm)	-20	Limit (dBm)	-20
Frequency (MHz)	Peak (dBm)	Margin (dB)	Peak (dBm)	Margin (dB)	Peak (dBm)	Margin (dB)
Fundamental 453.9938	44.00	0.00	40.16	0.00	30.17	0.00
2nd Harmonic 907.9875	-32.60	12.60	-30.94	10.94	-31.06	11.06
3rd Harmonic 1361.9813	-43.06	23.06	-48.78	28.78	-54.43	34.43
4th Harmonic 1815.9750	-50.42	30.42	-56.43	36.43	-57.14	37.14
5th Harmonic 2269.9688	-58.08	38.08	-55.36	35.36	-54.14	34.14
6th Harmonic 2723.9625	-61.70	41.7 *	-61.64	41.64 *	-63.20	43.2 *
7th Harmonic 3177.9563	-61.56	41.56 *	-61.50	41.5 *	-63.06	43.06 *
8th Harmonic 3631.9500	-61.58	41.58 *	-61.52	41.52 *	-63.08	43.08 *
9th Harmonic 4085.9438	-61.31	41.31 *	-61.25	41.25 *	-62.81	42.81 *
10th Harmonic 4539.9375	-60.97	40.97 *	-60.91	40.91 *	-62.47	42.47 *

* Indicates Noise Floor of Measurement

SPURIOUS EMISSIONS AT ANTENNA TERMINALS

Test Data: 456.00625 MHz

Spurious Conducted Emissions, Narrowband FM (12.5 kHz), Mask D Limit (≥250% Authorized BW)	High Power		Med Power		Low Power	
	dBm	44.00	dBm	40.16	dBm	30.17
	Watts	25.12	Watts	10.38	Watts	1.04
	Limit (dBm)	-20	Limit (dBm)	-20	Limit (dBm)	-20
Frequency (MHz)	Peak (dBm)	Margin (dB)	Peak (dBm)	Margin (dB)	Peak (dBm)	Margin (dB)
Fundamental 456.0063	44.00	0.00	40.16	0.00	30.17	0.00
2nd Harmonic 912.0125	-32.47	12.47	-29.26	9.26	-30.23	10.23
3rd Harmonic 1368.0188	-42.96	22.96	-49.12	29.12	-54.55	34.55
4th Harmonic 1824.0250	-48.87	28.87	-54.59	34.59	-56.99	36.99
5th Harmonic 2280.0313	-55.05	35.05	-54.84	34.84	-52.46	32.46
6th Harmonic 2736.0375	-61.81	41.81	-61.75	41.75	-63.20	43.2 *
7th Harmonic 3192.0438	-61.56	41.56 *	-61.50	41.5 *	-63.06	43.06 *
8th Harmonic 3648.0500	-61.58	41.58 *	-61.52	41.52 *	-63.08	43.08 *
9th Harmonic 4104.0563	-61.31	41.31 *	-61.25	41.25 *	-62.81	42.81 *
10th Harmonic 4560.0625	-60.97	40.97 *	-60.91	40.91 *	-62.47	42.47 *

* Indicates Noise Floor of Measurement

SPURIOUS EMISSIONS AT ANTENNA TERMINALS

Test Data: 462.53125 MHz

Spurious Conducted Emissions, Narrowband FM (12.5 kHz), Mask D Limit (≥250% Authorized BW)	High Power		Med Power		Low Power	
	dBm	44.00	dBm	40.16	dBm	30.17
	Watts	25.12	Watts	10.38	Watts	1.04
	Limit (dBm)	-20	Limit (dBm)	-20	Limit (dBm)	-20
Frequency (MHz)	Peak (dBm)	Margin (dB)	Peak (dBm)	Margin (dB)	Peak (dBm)	Margin (dB)
Fundamental 462.5313	44.00	0.00	40.16	0.00	30.17	0.00
2nd Harmonic 925.0625	-33.36	13.36	-31.26	11.26	-32.51	12.51
3rd Harmonic 1387.5938	-44.04	24.04	-49.81	29.81	-54.52	34.52
4th Harmonic 1850.1250	-53.93	33.93	-56.48	36.48	-56.41	36.41
5th Harmonic 2312.6563	-55.69	35.69	-54.52	34.52	-54.24	34.24
6th Harmonic 2775.1875	-63.00	43.00	-61.58	41.58	-61.87	41.87
7th Harmonic 3237.7188	-60.82	40.82	-61.50	41.5 *	-63.06	43.06 *
8th Harmonic 3700.2500	-61.58	41.58 *	-61.52	41.52 *	-63.08	43.08 *
9th Harmonic 4162.7813	-61.31	41.31 *	-61.25	41.25 *	-62.81	42.81 *
10th Harmonic 4625.3125	-60.97	40.97 *	-60.91	40.91 *	-62.47	42.47 *

* Indicates Noise Floor of Measurement

SPURIOUS EMISSIONS AT ANTENNA TERMINALS

Test Data: 462.74375 MHz

Spurious Conducted Emissions, Narrowband FM (12.5 kHz), Mask D Limit (≥250% Authorized BW)	High Power		Med Power		Low Power	
	dBm	44.00	dBm	40.16	dBm	30.17
	Watts	25.12	Watts	10.38	Watts	1.04
	Limit (dBm)	-20	Limit (dBm)	-20	Limit (dBm)	-20
Frequency (MHz)	Peak (dBm)	Margin (dB)	Peak (dBm)	Margin (dB)	Peak (dBm)	Margin (dB)
Fundamental 462.7438	44.00	0.00	40.16	0.00	30.17	0.00
2nd Harmonic 925.4875	-34.00	14.00	-31.67	11.67	-32.65	12.65
3rd Harmonic 1388.2313	-44.37	24.37	-49.66	29.66	-53.39	33.39
4th Harmonic 1850.9750	-53.02	33.02	-56.05	36.05	-58.20	38.20
5th Harmonic 2313.7188	-55.81	35.81	-54.29	34.29	-53.93	33.93
6th Harmonic 2776.4625	-61.70	41.7 *	-61.47	41.47	-62.11	42.11
7th Harmonic 3239.2063	-61.56	41.56 *	-61.50	41.5 *	-63.06	43.06 *
8th Harmonic 3701.9500	-61.58	41.58 *	-61.52	41.52 *	-63.08	43.08 *
9th Harmonic 4164.6938	-61.31	41.31 *	-61.25	41.25 *	-62.81	42.81 *
10th Harmonic 4627.4375	-60.97	40.97 *	-60.91	40.91 *	-62.47	42.47 *

* Indicates Noise Floor of Measurement

SPURIOUS EMISSIONS AT ANTENNA TERMINALS

Test Data: 467.53125 MHz

Spurious Conducted Emissions, Narrowband FM (12.5 kHz), Mask D Limit (≥250% Authorized BW)	High Power		Med Power		Low Power	
	dBm	44.00	dBm	40.16	dBm	30.17
	Watts	25.12	Watts	10.38	Watts	1.04
	Limit (dBm)	-20	Limit (dBm)	-20	Limit (dBm)	-20
Frequency (MHz)	Peak (dBm)	Margin (dB)	Peak (dBm)	Margin (dB)	Peak (dBm)	Margin (dB)
Fundamental 467.5313	44.00	0.00	40.16	0.00	30.17	0.00
2nd Harmonic 935.0625	-34.98	14.98	-33.39	13.39	-35.15	15.15
3rd Harmonic 1402.5938	-46.17	26.17	-51.43	31.43	-53.61	33.61
4th Harmonic 1870.1250	-52.92	32.92	-52.01	32.01	-52.43	32.43
5th Harmonic 2337.6563	-53.72	33.72	-54.04	34.04	-58.69	38.69
6th Harmonic 2805.1875	-61.70	41.7 *	-61.64	41.64 *	-62.08	42.08
7th Harmonic 3272.7188	-61.56	41.56 *	-61.50	41.5 *	-63.06	43.06 *
8th Harmonic 3740.2500	-61.58	41.58 *	-61.52	41.52 *	-63.08	43.08 *
9th Harmonic 4207.7813	-61.31	41.31 *	-61.25	41.25 *	-62.81	42.81 *
10th Harmonic 4675.3125	-60.97	40.97 *	-60.91	40.91 *	-62.47	42.47 *

* Indicates Noise Floor of Measurement

SPURIOUS EMISSIONS AT ANTENNA TERMINALS

Test Data: 467.74375 MHz

Spurious Conducted Emissions, Narrowband FM (12.5 kHz), Mask D Limit (≥250% Authorized BW)	High Power		Med Power		Low Power	
	dBm	44.00	dBm	40.16	dBm	30.17
	Watts	25.12	Watts	10.38	Watts	1.04
	Limit (dBm)	-20	Limit (dBm)	-20	Limit (dBm)	-20
Frequency (MHz)	Peak (dBm)	Margin (dB)	Peak (dBm)	Margin (dB)	Peak (dBm)	Margin (dB)
Fundamental 467.7438	44.00	0.00	40.16	0.00	30.17	0.00
2nd Harmonic 935.4875	-39.03	19.03	-35.85	15.85	-36.60	16.60
3rd Harmonic 1403.2313	-46.93	26.93	-51.53	31.53	-53.95	33.95
4th Harmonic 1870.9750	-50.86	30.86	-52.55	32.55	-55.20	35.20
5th Harmonic 2338.7188	-54.01	34.01	-54.92	34.92	-58.46	38.46
6th Harmonic 2806.4625	-61.03	41.03	-61.64	41.64 *	-61.08	41.08
7th Harmonic 3274.2063	-61.97	41.97	-61.50	41.5 *	-62.23	42.23
8th Harmonic 3741.9500	-61.58	41.58 *	-61.52	41.52 *	-63.08	43.08 *
9th Harmonic 4209.6938	-61.31	41.31 *	-61.25	41.25 *	-62.81	42.81 *
10th Harmonic 4677.4375	-60.97	40.97 *	-60.91	40.91 *	-62.47	42.47 *

* Indicates Noise Floor of Measurement

SPURIOUS EMISSIONS AT ANTENNA TERMINALS

Test Data: 475.0000 MHz

Spurious Conducted Emissions, Narrowband FM (12.5 kHz), Mask D Limit (≥250% Authorized BW)	High Power		Med Power		Low Power	
	dBm	44.00	dBm	40.16	dBm	30.17
	Watts	25.12	Watts	10.38	Watts	1.04
	Limit (dBm)	-20	Limit (dBm)	-20	Limit (dBm)	-20
Frequency (MHz)	Peak (dBm)	Margin (dB)	Peak (dBm)	Margin (dB)	Peak (dBm)	Margin (dB)
Fundamental 475.0000	44.00	0.00	40.16	0.00	30.17	0.00
2nd Harmonic 950.0000	-39.87	19.87	-36.49	16.49	-37.14	17.14
3rd Harmonic 1425.0000	-49.80	29.80	-52.48	32.48	-50.38	30.38
4th Harmonic 1900.0000	-53.20	33.20	-53.05	33.05	-56.87	36.87
5th Harmonic 2375.0000	-52.54	32.54	-55.18	35.18	-57.74	37.74
6th Harmonic 2850.0000	-61.70	41.7 *	-61.64	41.64 *	-63.20	43.2 *
7th Harmonic 3325.0000	-61.56	41.56 *	-61.50	41.5 *	-63.06	43.06 *
8th Harmonic 3800.0000	-61.58	41.58 *	-61.52	41.52 *	-63.08	43.08 *
9th Harmonic 4275.0000	-61.31	41.31 *	-61.25	41.25 *	-62.81	42.81 *
10th Harmonic 4750.0000	-60.97	40.97 *	-60.91	40.91 *	-62.47	42.47 *

* Indicates Noise Floor of Measurement

SPURIOUS EMISSIONS AT ANTENNA TERMINALS

Test Data: 479.99375 MHz

Spurious Conducted Emissions, Narrowband FM (12.5 kHz), Mask D Limit (≥250% Authorized BW)	High Power		Med Power		Low Power	
	dBm	44.00	dBm	40.16	dBm	30.17
	Watts	25.12	Watts	10.38	Watts	1.04
	Limit (dBm)	-20	Limit (dBm)	-20	Limit (dBm)	-20
Frequency (MHz)	Peak (dBm)	Margin (dB)	Peak (dBm)	Margin (dB)	Peak (dBm)	Margin (dB)
Fundamental 479.9938	44.00	0.00	40.16	0.00	30.17	0.00
2nd Harmonic 959.9875	-40.73	20.73	-37.10	17.10	-37.37	17.37
3rd Harmonic 1439.9813	-49.67	29.67	-53.12	33.12	-51.26	31.26
4th Harmonic 1919.9750	-51.23	31.23	-53.80	33.80	-56.66	36.66
5th Harmonic 2399.9688	-56.43	36.43	-57.69	37.69	-59.99	39.99
6th Harmonic 2879.9625	-61.70	41.7 *	-61.64	41.64 *	-63.20	43.2 *
7th Harmonic 3359.9563	-61.56	41.56 *	-61.50	41.5 *	-63.06	43.06 *
8th Harmonic 3839.9500	-61.58	41.58 *	-61.52	41.52 *	-63.08	43.08 *
9th Harmonic 4319.9438	-61.31	41.31 *	-61.25	41.25 *	-62.81	42.81 *
10th Harmonic 4799.9375	-60.97	40.97 *	-60.91	40.91 *	-62.47	42.47 *

* Indicates Noise Floor of Measurement

Result: Meets Requirement

SPURIOUS EMISSIONS – P25 Phase I C4FM

Test Data: 406.10625 MHz

Spurious Conducted Emissions, C4FM, Mask D Limit (≥250% Authorized BW)	High Power		Med Power		Low Power	
	dBm	44.00	dBm	40.16	dBm	30.17
	Watts	25.12	Watts	10.38	Watts	1.04
	Limit (dBm)	-20	Limit (dBm)	-20	Limit (dBm)	-20
Frequency (MHz)	Peak (dBm)	Margin (dB)	Peak (dBm)	Margin (dB)	Peak (dBm)	Margin (dB)
Fundamental 406.1063	44.00	0.00	40.16	0.00	30.17	0.00
2nd Harmonic 812.2125	-45.08	25.08	-41.73	21.73	-43.08	23.08
3rd Harmonic 1218.3188	-39.01	19.01	-43.80	23.80	-54.62	34.62
4th Harmonic 1624.4250	-56.12	36.12	-59.62	39.62	-62.89	42.89 *
5th Harmonic 2030.5313	-61.44	41.44 *	-61.38	41.38 *	-62.94	42.94 *
6th Harmonic 2436.6375	-51.74	31.74	-58.08	38.08	-54.71	34.71
7th Harmonic 2842.7438	-58.55	38.55	-50.36	30.36	-49.87	29.87
8th Harmonic 3248.8500	-61.58	41.58 *	-61.52	41.52 *	-63.08	43.08 *
9th Harmonic 3654.9563	-61.31	41.31 *	-61.25	41.25 *	-62.81	42.81 *
10th Harmonic 4061.0625	-60.97	40.97 *	-60.91	40.91 *	-62.47	42.47 *

* Indicates Noise Floor of Measurement

SPURIOUS EMISSIONS AT ANTENNA TERMINALS

Test Data: 409.99375 MHz

Spurious Conducted Emissions, C4FM, Mask D Limit (≥250% Authorized BW)	High Power		Med Power		Low Power	
	dBm	44.00	dBm	40.16	dBm	30.17
	Watts	25.12	Watts	10.38	Watts	1.04
	Limit (dBm)	-20	Limit (dBm)	-20	Limit (dBm)	-20
Frequency (MHz)	Peak (dBm)	Margin (dB)	Peak (dBm)	Margin (dB)	Peak (dBm)	Margin (dB)
Fundamental 409.9938	44.00	0.00	40.16	0.00	30.17	0.00
2nd Harmonic 819.9875	-51.05	31.05	-44.36	24.36	-48.52	28.52
3rd Harmonic 1229.9813	-40.69	20.69	-47.09	27.09	-55.48	35.48
4th Harmonic 1639.9750	-55.68	35.68	-60.01	40.01	-62.89	42.89 *
5th Harmonic 2049.9688	-57.03	37.03	-61.38	41.38 *	-59.39	39.39
6th Harmonic 2459.9625	-52.05	32.05	-57.59	37.59	-53.53	33.53
7th Harmonic 2869.9563	-61.56	41.56 *	-49.20	29.20	-49.47	29.47
8th Harmonic 3279.9500	-61.58	41.58 *	-61.52	41.52 *	-63.08	43.08 *
9th Harmonic 3689.9438	-61.31	41.31 *	-61.25	41.25 *	-62.81	42.81 *
10th Harmonic 4099.9375	-60.97	40.97 *	-60.91	40.91 *	-62.47	42.47 *

* Indicates Noise Floor of Measurement

SPURIOUS EMISSIONS AT ANTENNA TERMINALS

Test Data: 420.00625 MHz

Spurious Conducted Emissions, C4FM, Mask D Limit (≥250% Authorized BW)	High Power		Med Power		Low Power	
	dBm	44.00	dBm	40.16	dBm	30.17
	Watts	25.12	Watts	10.38	Watts	1.04
	Limit (dBm)	-20	Limit (dBm)	-20	Limit (dBm)	-20
Frequency (MHz)	Peak (dBm)	Margin (dB)	Peak (dBm)	Margin (dB)	Peak (dBm)	Margin (dB)
Fundamental 420.0063	44.00	0.00	40.16	0.00	30.17	0.00
2nd Harmonic 840.0125	-46.81	26.81	-38.60	18.60	-43.38	23.38
3rd Harmonic 1260.0188	-37.93	17.93	-44.35	24.35	-63.21	43.21 *
4th Harmonic 1680.0250	-57.90	37.90	-61.68	41.68	-62.89	42.89 *
5th Harmonic 2100.0313	-56.43	36.43	-60.24	40.24	-62.94	42.94 *
6th Harmonic 2520.0375	-51.69	31.69	-56.36	36.36	-54.54	34.54
7th Harmonic 2940.0438	-50.31	30.31	-58.50	38.50	-56.34	36.34
8th Harmonic 3360.0500	-61.58	41.58 *	-61.52	41.52 *	-63.08	43.08 *
9th Harmonic 3780.0563	-61.31	41.31 *	-61.25	41.25 *	-62.81	42.81 *
10th Harmonic 4200.0625	-60.97	40.97 *	-60.91	40.91 *	-62.47	42.47 *

* Indicates Noise Floor of Measurement

SPURIOUS EMISSIONS AT ANTENNA TERMINALS

Test Data: 440.00000 MHz

Spurious Conducted Emissions, C4FM, Mask D Limit (≥250% Authorized BW)	High Power		Med Power		Low Power	
	dBm	44.00	dBm	40.16	dBm	30.17
	Watts	25.12	Watts	10.38	Watts	1.04
	Limit (dBm)	-20	Limit (dBm)	-20	Limit (dBm)	-20
Frequency (MHz)	Peak (dBm)	Margin (dB)	Peak (dBm)	Margin (dB)	Peak (dBm)	Margin (dB)
Fundamental 440.0000	44.00	0.00	40.16	0.00	30.17	0.00
2nd Harmonic 880.0000	-47.96	27.96	-40.98	20.98	-45.43	25.43
3rd Harmonic 1320.0000	-45.80	25.80	-46.73	26.73	-51.89	31.89
4th Harmonic 1760.0000	-46.85	26.85	-55.33	35.33	-58.95	38.95
5th Harmonic 2200.0000	-53.42	33.42	-55.42	35.42	-57.14	37.14
6th Harmonic 2640.0000	-53.73	33.73	-60.27	40.27	-59.05	39.05
7th Harmonic 3080.0000	-60.64	40.64	-61.50	41.5 *	-62.59	42.59
8th Harmonic 3520.0000	-61.58	41.58 *	-61.52	41.52 *	-63.08	43.08 *
9th Harmonic 3960.0000	-61.31	41.31 *	-61.25	41.25 *	-62.81	42.81 *
10th Harmonic 4400.0000	-60.97	40.97 *	-60.91	40.91 *	-62.47	42.47 *

* Indicates Noise Floor of Measurement

SPURIOUS EMISSIONS AT ANTENNA TERMINALS

Test Data: 453.99375 MHz

Spurious Conducted Emissions, C4FM, Mask D Limit (≥250% Authorized BW)	High Power		Med Power		Low Power	
	dBm	44.00	dBm	40.16	dBm	30.17
	Watts	25.12	Watts	10.38	Watts	1.04
	Limit (dBm)	-20	Limit (dBm)	-20	Limit (dBm)	-20
Frequency (MHz)	Peak (dBm)	Margin (dB)	Peak (dBm)	Margin (dB)	Peak (dBm)	Margin (dB)
Fundamental 453.9938	44.00	0.00	40.16	0.00	30.17	0.00
2nd Harmonic 907.9875	-46.52	26.52	-37.50	17.50	-38.18	18.18
3rd Harmonic 1361.9813	-45.76	25.76	-50.07	30.07	-52.93	32.93
4th Harmonic 1815.9750	-49.17	29.17	-55.42	35.42	-57.61	37.61
5th Harmonic 2269.9688	-54.67	34.67	-54.05	34.05	-51.02	31.02
6th Harmonic 2723.9625	-61.71	41.71	-62.95	42.95	-63.20	43.2 *
7th Harmonic 3177.9563	-61.56	41.56 *	-61.50	41.5 *	-63.06	43.06 *
8th Harmonic 3631.9500	-61.58	41.58 *	-61.15	41.15	-63.08	43.08 *
9th Harmonic 4085.9438	-61.31	41.31 *	-61.25	41.25 *	-62.81	42.81 *
10th Harmonic 4539.9375	-60.89	40.89	-61.95	41.95	-62.47	42.47 *

* Indicates Noise Floor of Measurement

SPURIOUS EMISSIONS AT ANTENNA TERMINALS

Test Data: 456.00625 MHz

Spurious Conducted Emissions, C4FM, Mask D Limit (≥250% Authorized BW)	High Power		Med Power		Low Power	
	dBm	44.00	dBm	40.16	dBm	30.17
	Watts	25.12	Watts	10.38	Watts	1.04
	Limit (dBm)	-20	Limit (dBm)	-20	Limit (dBm)	-20
Frequency (MHz)	Peak (dBm)	Margin (dB)	Peak (dBm)	Margin (dB)	Peak (dBm)	Margin (dB)
Fundamental 456.0063	44.00	0.00	40.16	0.00	30.17	0.00
2nd Harmonic 912.0125	-35.28	15.28	-33.66	13.66	-40.92	20.92
3rd Harmonic 1368.0188	-46.22	26.22	-48.88	28.88	-53.52	33.52
4th Harmonic 1824.0250	-53.02	33.02	-59.80	39.80	-60.90	40.90
5th Harmonic 2280.0313	-53.28	33.28	-55.35	35.35	-53.03	33.03
6th Harmonic 2736.0375	-62.04	42.04	-62.15	42.15	-63.20	43.2 *
7th Harmonic 3192.0438	-61.56	41.56 *	-61.50	41.5 *	-63.06	43.06 *
8th Harmonic 3648.0500	-62.62	42.62	-61.52	41.52 *	-63.08	43.08 *
9th Harmonic 4104.0563	-61.31	41.31 *	-61.25	41.25 *	-62.81	42.81 *
10th Harmonic 4560.0625	-60.97	40.97 *	-61.06	41.06	-62.47	42.47 *

* Indicates Noise Floor of Measurement

SPURIOUS EMISSIONS AT ANTENNA TERMINALS

Test Data: 462.53125 MHz

Spurious Conducted Emissions, C4FM, Mask D Limit (≥250% Authorized BW)	High Power		Med Power		Low Power	
	dBm	44.00	dBm	40.16	dBm	30.17
	Watts	25.12	Watts	10.38	Watts	1.04
	Limit (dBm)	-20	Limit (dBm)	-20	Limit (dBm)	-20
Frequency (MHz)	Peak (dBm)	Margin (dB)	Peak (dBm)	Margin (dB)	Peak (dBm)	Margin (dB)
Fundamental 462.5313	44.00	0.00	40.16	0.00	30.17	0.00
2nd Harmonic 925.0625	-43.55	23.55	-34.79	14.79	-34.62	14.62
3rd Harmonic 1387.5938	-45.09	25.09	-49.54	29.54	-51.06	31.06
4th Harmonic 1850.1250	-53.75	33.75	-59.80	39.80	-56.28	36.28
5th Harmonic 2312.6563	-55.28	35.28	-54.10	34.10	-54.67	34.67
6th Harmonic 2775.1875	-61.30	41.30	-61.02	41.02	-63.20	43.2 *
7th Harmonic 3237.7188	-61.56	41.56 *	-61.50	41.5 *	-63.06	43.06 *
8th Harmonic 3700.2500	-61.58	41.58 *	-61.52	41.52 *	-63.08	43.08 *
9th Harmonic 4162.7813	-61.31	41.31 *	-61.25	41.25 *	-62.81	42.81 *
10th Harmonic 4625.3125	-60.97	40.97 *	-60.91	40.91 *	-62.47	42.47 *

* Indicates Noise Floor of Measurement

SPURIOUS EMISSIONS AT ANTENNA TERMINALS

Test Data: 462.74375 MHz

Spurious Conducted Emissions, C4FM, Mask D Limit (≥250% Authorized BW)	High Power		Med Power		Low Power	
	dBm	44.00	dBm	40.16	dBm	30.17
	Watts	25.12	Watts	10.38	Watts	1.04
	Limit (dBm)	-20	Limit (dBm)	-20	Limit (dBm)	-20
Frequency (MHz)	Peak (dBm)	Margin (dB)	Peak (dBm)	Margin (dB)	Peak (dBm)	Margin (dB)
Fundamental 462.7438	44.00	0.00	40.16	0.00	30.17	0.00
2nd Harmonic 925.4875	-35.69	15.69	-33.08	13.08	-34.21	14.21
3rd Harmonic 1388.2313	-44.99	24.99	-49.32	29.32	-50.63	30.63
4th Harmonic 1850.9750	-50.49	30.49	-53.74	33.74	-57.67	37.67
5th Harmonic 2313.7188	-54.83	34.83	-53.94	33.94	-52.56	32.56
6th Harmonic 2776.4625	-61.70	41.7 *	-60.60	40.60	-63.20	43.2 *
7th Harmonic 3239.2063	-61.56	41.56 *	-61.50	41.5 *	-63.06	43.06 *
8th Harmonic 3701.9500	-61.58	41.58 *	-61.52	41.52 *	-63.08	43.08 *
9th Harmonic 4164.6938	-61.31	41.31 *	-61.25	41.25 *	-62.81	42.81 *
10th Harmonic 4627.4375	-60.97	40.97 *	-60.91	40.91 *	-62.47	42.47 *

* Indicates Noise Floor of Measurement

SPURIOUS EMISSIONS AT ANTENNA TERMINALS

Test Data: 467.53125 MHz

Spurious Conducted Emissions, C4FM, Mask D Limit (≥250% Authorized BW)	High Power		Med Power		Low Power	
	dBm	44.00	dBm	40.16	dBm	30.17
	Watts	25.12	Watts	10.38	Watts	1.04
	Limit (dBm)	-20	Limit (dBm)	-20	Limit (dBm)	-20
Frequency (MHz)	Peak (dBm)	Margin (dB)	Peak (dBm)	Margin (dB)	Peak (dBm)	Margin (dB)
Fundamental 467.5313	44.00	0.00	40.16	0.00	30.17	0.00
2nd Harmonic 935.0625	-36.64	16.64	-33.84	13.84	-34.28	14.28
3rd Harmonic 1402.5938	-46.16	26.16	-49.50	29.50	-50.64	30.64
4th Harmonic 1870.1250	-47.08	27.08	-51.03	31.03	-51.93	31.93
5th Harmonic 2337.6563	-52.20	32.20	-54.35	34.35	-57.04	37.04
6th Harmonic 2805.1875	-61.39	41.39	-61.64	41.64 *	-63.20	43.2 *
7th Harmonic 3272.7188	-61.56	41.56 *	-61.50	41.5 *	-63.06	43.06 *
8th Harmonic 3740.2500	-61.58	41.58 *	-61.52	41.52 *	-63.08	43.08 *
9th Harmonic 4207.7813	-61.31	41.31 *	-61.25	41.25 *	-62.81	42.81 *
10th Harmonic 4675.3125	-60.97	40.97 *	-60.91	40.91 *	-62.47	42.47 *

* Indicates Noise Floor of Measurement

SPURIOUS EMISSIONS AT ANTENNA TERMINALS

Test Data: 467.74375 MHz

Spurious Conducted Emissions, C4FM, Mask D Limit (≥250% Authorized BW)	High Power		Med Power		Low Power	
	dBm	44.00	dBm	40.16	dBm	30.17
	Watts	25.12	Watts	10.38	Watts	1.04
	Limit (dBm)	-20	Limit (dBm)	-20	Limit (dBm)	-20
Frequency (MHz)	Peak (dBm)	Margin (dB)	Peak (dBm)	Margin (dB)	Peak (dBm)	Margin (dB)
Fundamental 467.7438	44.00	0.00	40.16	0.00	30.17	0.00
2nd Harmonic 935.4875	-36.29	16.29	-35.54	15.54	-36.75	16.75
3rd Harmonic 1403.2313	-46.44	26.44	-49.52	29.52	-50.67	30.67
4th Harmonic 1870.9750	-48.18	28.18	-53.46	33.46	-56.56	36.56
5th Harmonic 2338.7188	-52.60	32.60	-52.93	32.93	-54.47	34.47
6th Harmonic 2806.4625	-61.01	41.01	-61.64	41.64 *	-63.20	43.2 *
7th Harmonic 3274.2063	-61.56	41.56 *	-61.50	41.5 *	-63.06	43.06 *
8th Harmonic 3741.9500	-61.58	41.58 *	-61.52	41.52 *	-63.08	43.08 *
9th Harmonic 4209.6938	-61.31	41.31 *	-61.25	41.25 *	-62.81	42.81 *
10th Harmonic 4677.4375	-60.97	40.97 *	-60.91	40.91 *	-62.47	42.47 *

* Indicates Noise Floor of Measurement

SPURIOUS EMISSIONS AT ANTENNA TERMINALS

Test Data: 475.0000 MHz

Spurious Conducted Emissions, C4FM, Mask D Limit ($\geq 250\%$ Authorized BW)	High Power		Med Power		Low Power	
	dBm	44.00	dBm	40.16	dBm	30.17
	Watts	25.12	Watts	10.38	Watts	1.04
	Limit (dBm)	-20	Limit (dBm)	-20	Limit (dBm)	-20
Frequency (MHz)	Peak (dBm)	Margin (dB)	Peak (dBm)	Margin (dB)	Peak (dBm)	Margin (dB)
Fundamental 475.0000	44.00	0.00	40.16	0.00	30.17	0.00
2nd Harmonic 950.0000	-36.63	16.63	-34.49	14.49	-35.51	15.51
3rd Harmonic 1425.0000	-48.67	28.67	-51.55	31.55	-51.74	31.74
4th Harmonic 1900.0000	-51.29	31.29	-53.02	33.02	-54.59	34.59
5th Harmonic 2375.0000	-53.47	33.47	-56.15	36.15	-61.06	41.06
6th Harmonic 2850.0000	-61.70	41.7 *	-61.64	41.64 *	-63.20	43.2 *
7th Harmonic 3325.0000	-61.56	41.56 *	-61.50	41.5 *	-63.06	43.06 *
8th Harmonic 3800.0000	-61.58	41.58 *	-61.35	41.35	-63.08	43.08 *
9th Harmonic 4275.0000	-61.31	41.31 *	-61.25	41.25 *	-62.81	42.81 *
10th Harmonic 4750.0000	-60.97	40.97 *	-60.91	40.91 *	-62.47	42.47 *

* Indicates Noise Floor of Measurement

SPURIOUS EMISSIONS AT ANTENNA TERMINALS

Test Data: 479.99375 MHz

Spurious Conducted Emissions, C4FM, Mask D Limit ($\geq 250\%$ Authorized BW)	High Power		Med Power		Low Power	
	dBm	44.00	dBm	40.16	dBm	30.17
	Watts	25.12	Watts	10.38	Watts	1.04
	Limit (dBm)	-20	Limit (dBm)	-20	Limit (dBm)	-20
Frequency (MHz)	Peak (dBm)	Margin (dB)	Peak (dBm)	Margin (dB)	Peak (dBm)	Margin (dB)
Fundamental 479.9938	44.00	0.00	40.16	0.00	30.17	0.00
2nd Harmonic 959.9875	-38.13	18.13	-37.11	17.11	-38.11	18.11
3rd Harmonic 1439.9813	-50.45	30.45	-53.47	33.47	-52.33	32.33
4th Harmonic 1919.9750	-49.58	29.58	-53.36	33.36	-55.26	35.26
5th Harmonic 2399.9688	-56.78	36.78	-57.56	37.56	-57.55	37.55
6th Harmonic 2879.9625	-61.70	41.7 *	-61.64	41.64 *	-62.46	42.46
7th Harmonic 3359.9563	-61.56	41.56 *	-61.50	41.5 *	-63.06	43.06 *
8th Harmonic 3839.9500	-61.58	41.58 *	-61.52	41.52 *	-63.08	43.08 *
9th Harmonic 4319.9438	-61.31	41.31 *	-61.25	41.25 *	-62.81	42.81 *
10th Harmonic 4799.9375	-60.97	40.97 *	-60.91	40.91 *	-62.47	42.47 *

* Indicates Noise Floor of Measurement

Result: Meets Requirement

FIELD STRENGTH OF SPURIOUS EMISSIONS

FCC Rule Parts: FCC Part 2.1053(a), 90.210(d)(3)

Method of Measurement: ANSI C63.26, 5.5.4

Test Site Setup:

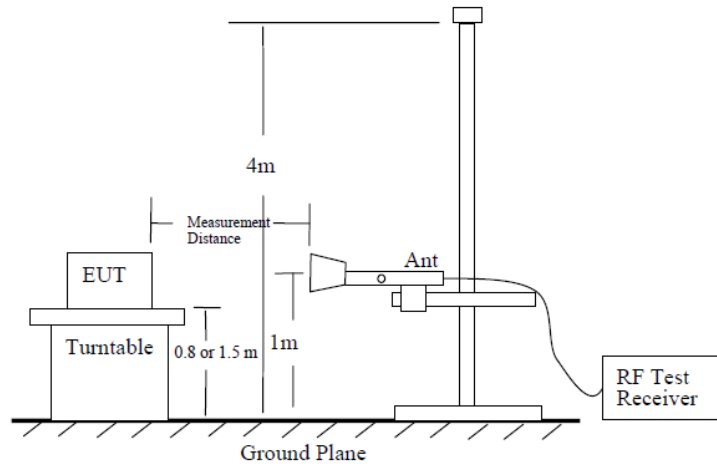

EUT Orientation(s):

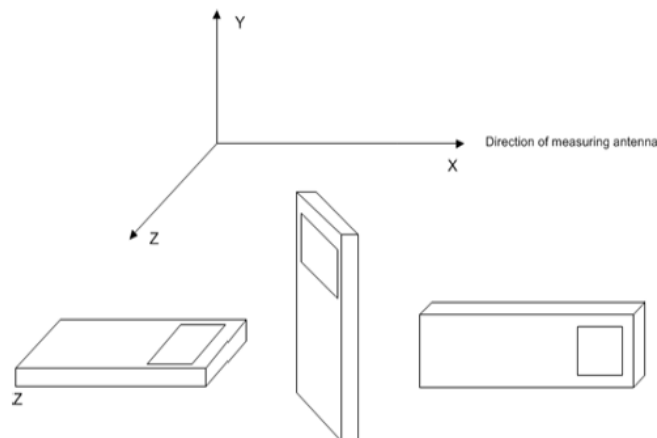

Note: The tabulated data shows the results of the radiated field strength emissions test. The spectrum was scanned from the lowest frequency generated internally to at least the tenth harmonic of the fundamental. This test was conducted in accordance with the standard listed above using the substitution method. Measurements were made at the test site of TIMCO ENGINEERING, INC. located at 849 NW State Road 45, Newberry, FL 32669. The measurements below represent the worst case of all the frequencies tested.

Note: The six (6) highest emissions or more of each worst-case operational modes of the EUT are represented below. Emissions 20 dB below the limit are not required to be reported.

FIELD STRENGTH OF SPURIOUS EMISSIONS

Test Data: 406.10625 MHz

Low Power

Power Output		Limit		
dBm	Watts	dBc	dBm	
30.17	1.04	50.17	-20.00	
Tuned Freq MHz	Emission Frequency MHz	Antenna Polarity	ERP (dBm)	Margin (dB)
406.11	812.21	V	-20.527	0.53
406.11	812.21	H	-25.347	5.35
406.11	1624.43	V	-40.077	20.08
406.11	2030.53	H	-40.957	20.96
406.11	2436.64	H	-39.067	19.07
406.11	2436.64	V	-38.747	18.75
406.11	2842.74	V	-38.587	18.59
406.11	3248.85	H	-40.537	20.54
406.11	3248.85	V	-40.347	20.35
406.11	3654.96	V	-40.347	20.35
406.11	3654.96	H	-40.347	20.35
406.11	4061.06	H	-40.347	20.35
406.11	4061.06	V	-40.347	20.35

Medium Power

Power Output		Limit		
dBm	Watts	dBc	dBm	
40.16	10.38	60.16	-20.00	
Tuned Freq MHz	Emission Frequency MHz	Antenna Polarity	ERP (dBm)	Margin (dB)
406.11	812.21	H	-20.477	0.48
406.11	812.21	V	-22.657	2.66
406.11	1218.32	H	-37.887	17.89
406.11	1624.43	H	-39.127	19.13
406.11	1624.43	V	-39.837	19.84
406.11	2030.53	H	-38.707	18.71
406.11	2436.64	H	-40.507	20.51
406.11	2436.64	V	-37.317	17.32
406.11	2842.74	V	-39.127	19.13
406.11	3248.85	V	-38.497	18.50

FIELD STRENGTH OF SPURIOUS EMISSIONS

High Power

Power Output		Limit		
dBm	Watts	dBc	dBm	
44	25.12	64	-20.00	
Tuned Freq MHz	Emission Frequency MHz	Antenna Polarity	ERP (dBm)	Margin (dB)
406.11	812.21	V	-20.217	0.22
406.11	812.21	H	-21.217	1.22
406.11	1218.32	V	-30.307	10.31
406.11	1218.32	H	-32.127	12.13
406.11	1624.43	H	-40.387	20.39
406.11	1624.43	V	-34.627	14.63
406.11	2030.53	V	-36.467	16.47
406.11	2030.53	H	-36.487	16.49
406.11	2436.64	H	-37.477	17.48
406.11	2842.74	V	-39.127	19.13
406.11	2842.74	H	-39.567	19.57

FIELD STRENGTH OF SPURIOUS EMISSIONS

Test Data: 409.99375 MHz

Low Power

Power Output		Limit		
dBm	Watts	dBc	dBm	
30.17	1.04	50.17	-20.00	
Tuned Freq MHz	Emission Frequency MHz	Antenna Polarity	ERP (dBm)	Margin (dB)
409.99	819.99	H	-29.147	9.15
409.99	819.99	V	-28.657	8.66
409.99	1639.97	H	-40.067	20.07
409.99	2049.97	H	-38.087	18.09
409.99	2049.97	V	-36.837	16.84
409.99	2459.96	V	-32.897	12.90
409.99	2869.96	V	-36.087	16.09
409.99	3279.95	V	-39.467	19.47

Medium Power

Power Output		Limit		
dBm	Watts	dBc	dBm	
40.16	10.38	60.16	-20.00	
Tuned Freq MHz	Emission Frequency MHz	Antenna Polarity	ERP (dBm)	Margin (dB)
409.99	819.99	V	-22.757	2.76
409.99	819.99	H	-27.277	7.28
409.99	1229.98	H	-40.697	20.70
409.99	1639.97	H	-39.407	19.41
409.99	1639.97	V	-40.167	20.17
409.99	2049.97	V	-37.047	17.05
409.99	2049.97	H	-37.007	17.01
409.99	2459.96	V	-34.687	14.69
409.99	2869.96	V	-35.777	15.78

FIELD STRENGTH OF SPURIOUS EMISSIONS

High Power

Power Output		Limit		
dBm	Watts	dBc	dBm	
44	25.12	64	-20.00	
Tuned Freq MHz	Emission Frequency MHz	Antenna Polarity	ERP (dBm)	Margin (dB)
409.99	819.99	H	-24.327	4.33
409.99	819.99	V	-22.587	2.59
409.99	1229.98	V	-37.237	17.24
409.99	1229.98	H	-32.497	12.50
409.99	1639.97	H	-39.337	19.34
409.99	1639.97	V	-39.227	19.23
409.99	2049.97	V	-33.627	13.63
409.99	2049.97	H	-33.597	13.60
409.99	2459.96	H	-39.967	19.97
409.99	2869.96	V	-35.657	15.66
409.99	2869.96	H	-40.477	20.48

FIELD STRENGTH OF SPURIOUS EMISSIONS

Test Data: 420.00625 MHz

Low Power

Power Output		Limit		
dBm	Watts	dBc	dBm	
30.17	1.04	50.17	-20.00	
Tuned Freq MHz	Emission Frequency MHz	Antenna Polarity	ERP (dBm)	Margin (dB)
420.01	840.01	V	-25.417	5.42
420.01	840.01	H	-25.577	5.58
420.01	2100.03	V	-33.127	13.13
420.01	2100.03	H	-33.127	13.13
420.01	2940.04	V	-40.327	20.33
420.01	3360.05	V	-40.687	20.69

Medium Power

Power Output		Limit		
dBm	Watts	dBc	dBm	
40.16	10.38	60.16	-20.00	
Tuned Freq MHz	Emission Frequency MHz	Antenna Polarity	ERP (dBm)	Margin (dB)
420.01	840.01	H	-21.447	1.45
420.01	1260.02	V	-44.497	24.50
420.01	1260.02	H	-42.497	22.50
420.01	1680.03	H	-39.397	19.40
420.01	1680.03	V	-40.877	20.88
420.01	2100.03	V	-30.707	10.71
420.01	2100.03	H	-32.377	12.38

FIELD STRENGTH OF SPURIOUS EMISSIONS

High Power

Power Output		Limit		
dBm	Watts	dBc	dBm	
44	25.12	64	-20.00	
Tuned Freq MHz	Emission Frequency MHz	Antenna Polarity	ERP (dBm)	Margin (dB)
420.01	840.01	V	-22.587	2.59
420.01	840.01	H	-26.767	6.77
420.01	1260.02	V	-36.567	16.57
420.01	1260.02	H	-39.087	19.09
420.01	1680.03	H	-36.687	16.69
420.01	1680.03	V	-37.687	17.69
420.01	2100.03	V	-30.637	10.64
420.01	2100.03	H	-33.747	13.75
420.01	2940.04	V	-37.747	17.75

FIELD STRENGTH OF SPURIOUS EMISSIONS

Test Data: 440.00 MHz

Low Power

Power Output		Limit		
dBm	Watts	dBc	dBm	
30.17	1.04	50.17	-20.00	
Tuned Freq MHz	Emission Frequency MHz	Antenna Polarity	ERP (dBm)	Margin (dB)
440.00	880.00	H	-23.107	3.11
440.00	880.00	V	-23.187	3.19
440.00	1760.00	V	-40.737	20.74
440.00	2200.00	H	-33.097	13.10
440.00	2200.00	V	-34.507	14.51

Medium Power

Power Output		Limit		
dBm	Watts	dBc	dBm	
40.16	10.38	60.16	-20.00	
Tuned Freq MHz	Emission Frequency MHz	Antenna Polarity	ERP (dBm)	Margin (dB)
440.00	880.00	V	-20.887	0.89
440.00	880.00	H	-21.057	1.06
440.00	1320.00	H	-39.177	19.18
440.00	1760.00	V	-38.347	18.35
440.00	1760.00	H	-37.917	17.92
440.00	2200.00	H	-33.257	13.26
440.00	2200.00	V	-33.157	13.16

FIELD STRENGTH OF SPURIOUS EMISSIONS

High Power

Power Output		Limit		
dBm	Watts	dBc	dBm	
44	25.12	64	-20.00	
Tuned Freq MHz	Emission Frequency MHz	Antenna Polarity	ERP (dBm)	Margin (dB)
440.00	880.00	H	-20.847	0.85
440.00	880.00	V	-20.917	0.92
440.00	1320.00	H	-34.437	14.44
440.00	1320.00	V	-33.387	13.39
440.00	1760.00	H	-36.247	16.25
440.00	2200.00	H	-32.277	12.28
440.00	2200.00	V	-35.137	15.14

FIELD STRENGTH OF SPURIOUS EMISSIONS

Test Data: 453.99375 MHz

Low Power

Power Output		Limit		
dBm	Watts	dBc	dBm	
30.17	1.04	50.17	-20.00	
Tuned Freq MHz	Emission Frequency MHz	Antenna Polarity	ERP (dBm)	Margin (dB)
453.99	907.99	V	-26.917	6.92
453.99	907.99	H	-27.077	7.08
453.99	1361.98	H	-37.727	17.73
453.99	1361.98	V	-36.797	16.80
453.99	1815.97	V	-40.317	20.32
453.99	2269.97	H	-37.617	17.62
453.99	2269.97	V	-38.187	18.19

Medium Power

Power Output		Limit		
dBm	Watts	dBc	dBm	
40.16	10.38	60.16	-20.00	
Tuned Freq MHz	Emission Frequency MHz	Antenna Polarity	ERP (dBm)	Margin (dB)
453.99	907.99	H	-26.697	6.70
453.99	907.99	V	-26.847	6.85
453.99	1361.98	H	-37.597	17.60
453.99	1361.98	V	-37.407	17.41
453.99	1815.97	V	-36.147	16.15
453.99	2269.97	H	-37.377	17.38
453.99	2269.97	V	-34.627	14.63

FIELD STRENGTH OF SPURIOUS EMISSIONS

High Power

Power Output		Limit		
dBm	Watts	dBc	dBm	
44	25.12	64	-20.00	
Tuned Freq MHz	Emission Frequency MHz	Antenna Polarity	ERP (dBm)	Margin (dB)
453.99	907.99	V	-27.837	7.84
453.99	907.99	H	-27.987	7.99
453.99	1361.98	H	-33.317	13.32
453.99	1361.98	V	-30.967	10.97
453.99	1815.97	V	-33.077	13.08
453.99	1815.97	H	-38.877	18.88
453.99	2269.97	H	-35.287	15.29
453.99	2269.97	V	-32.687	12.69

FIELD STRENGTH OF SPURIOUS EMISSIONS

Test Data: 456.00625 MHz

Low Power

Power Output		Limit		
dBm	Watts	dBc	dBm	
30.17	1.04	50.17	-20.00	
Tuned Freq MHz	Emission Frequency MHz	Antenna Polarity	ERP (dBm)	Margin (dB)
456.01	912.01	H	-25.997	6.00
456.01	912.01	V	-26.018	6.02
456.01	1368.02	H	-34.700	14.70
456.01	1368.02	V	-35.687	15.69
456.01	1824.03	V	-33.808	13.81
456.01	1824.03	H	-31.348	11.35
456.01	2280.03	H	-23.825	3.82
456.01	2280.03	V	-32.300	12.30
456.01	2736.04	V	-36.092	16.09
456.01	2736.04	H	-35.336	15.34
456.01	3192.04	V	-28.741	8.74
456.01	3192.04	H	-31.967	11.97
456.01	3648.05	H	-33.398	13.40
456.01	3648.05	V	-32.837	12.84
456.01	4104.06	V	-32.311	12.31
456.01	4104.06	H	-31.814	11.81
456.01	4560.06	H	-31.345	11.34
456.01	4560.06	V	-30.899	10.90

FIELD STRENGTH OF SPURIOUS EMISSIONS

Medium Power

Power Output		Limit		
dBm	Watts	dBc	dBm	
40.16	10.38	60.16	-20.00	
Tuned Freq MHz	Emission Frequency MHz	Antenna Polarity	ERP (dBm)	Margin (dB)
456.01	912.01	V	-28.277	8.28
456.01	912.01	H	-24.038	4.04
456.01	1368.02	H	-37.270	17.27
456.01	1368.02	V	-36.207	16.21
456.01	1824.03	V	-28.668	8.67
456.01	1824.03	H	-32.948	12.95
456.01	2280.03	H	-27.335	7.33
456.01	2280.03	V	-26.770	6.77
456.01	2736.04	V	-33.022	13.02
456.01	2736.04	H	-32.686	12.69
456.01	3192.04	H	-34.641	14.64
456.01	3192.04	V	-33.997	14.00
456.01	3648.05	V	-33.398	13.40
456.01	3648.05	H	-32.837	12.84
456.01	4104.06	H	-32.311	12.31
456.01	4104.06	V	-31.814	11.81
456.01	4560.06	V	-31.345	11.34
456.01	4560.06	H	-30.899	10.90

FIELD STRENGTH OF SPURIOUS EMISSIONS

High Power

Power Output		Limit		
dBm	Watts	dBc	dBm	
44	25.12	64	-20.00	
Tuned Freq MHz	Emission Frequency MHz	Antenna Polarity	ERP (dBm)	Margin (dB)
456.01	912.01	H	-27.117	7.12
456.01	912.01	V	-25.178	5.18
456.01	1368.02	H	-30.290	10.29
456.01	1368.02	V	-34.297	14.30
456.01	1824.03	V	-28.318	8.32
456.01	1824.03	H	-33.828	13.83
456.01	2280.03	H	-28.815	8.81
456.01	2280.03	V	-30.810	10.81
456.01	2736.04	V	-36.092	16.09
456.01	2736.04	H	-35.336	15.34
456.01	3192.04	H	-34.641	14.64
456.01	3192.04	V	-33.997	14.00
456.01	3648.05	V	-33.398	13.40
456.01	3648.05	H	-32.837	12.84
456.01	4104.06	H	-32.311	12.31
456.01	4104.06	V	-31.814	11.81
456.01	4560.06	V	-31.345	11.34
456.01	4560.06	H	-30.899	10.90

FIELD STRENGTH OF SPURIOUS EMISSIONS

Test Data: 462.53125 MHz

Low Power

Power Output		Limit		
dBm	Watts	dBc	dBm	
30.17	1.04	50.17	-20.00	
Tuned Freq MHz	Emission Frequency MHz	Antenna Polarity	ERP (dBm)	Margin (dB)
462.53	925.06	H	-22.797	2.80
462.53	925.06	V	-21.378	1.38
462.53	1387.59	V	-37.780	17.78
462.53	1387.59	H	-35.557	15.56
462.53	1850.13	H	-34.798	14.80
462.53	1850.13	V	-31.278	11.28
462.53	2312.66	V	-35.005	15.00
462.53	2312.66	H	-26.720	6.72
462.53	2775.19	H	-32.632	12.63
462.53	2775.19	V	-35.976	15.98
462.53	3237.72	V	-34.641	14.64
462.53	3237.72	H	-27.567	7.57
462.53	3700.25	H	-33.398	13.40
462.53	3700.25	V	-32.837	12.84
462.53	4162.78	V	-32.311	12.31
462.53	4162.78	H	-31.814	11.81
462.53	4625.31	H	-31.345	11.34
462.53	4625.31	V	-30.899	10.90

FIELD STRENGTH OF SPURIOUS EMISSIONS

Medium Power

Power Output		Limit		
dBm	Watts	dBc	dBm	
40.16	10.38	60.16	-20.00	
Tuned Freq MHz	Emission Frequency MHz	Antenna Polarity	ERP (dBm)	Margin (dB)
462.53	925.06	V	-23.627	3.63
462.53	925.06	H	-21.678	1.68
462.53	1387.59	H	-32.780	12.78
462.53	1387.59	V	-33.577	13.58
462.53	1850.13	V	-33.578	13.58
462.53	1850.13	H	-31.378	11.38
462.53	1850.13	H	-33.895	13.89
462.53	2312.66	V	-34.920	14.92
462.53	2312.66	H	-34.092	14.09
462.53	2775.19	H	-28.946	8.95
462.53	2775.19	V	-32.681	12.68
462.53	3237.72	V	-33.997	14.00
462.53	3237.72	H	-33.398	13.40
462.53	3700.25	H	-32.837	12.84
462.53	3700.25	V	-32.311	12.31
462.53	4162.78	V	-31.814	11.81
462.53	4162.78	H	-31.345	11.34
462.53	4625.31	H	-30.899	10.90
462.53	4625.31	V	-30.475	10.48

FIELD STRENGTH OF SPURIOUS EMISSIONS

High Power

Power Output		Limit		
dBm	Watts	dBc	dBm	
44	25.12	64	-20.00	
Tuned Freq MHz	Emission Frequency MHz	Antenna Polarity	ERP (dBm)	Margin (dB)
462.53	925.06	H	-20.117	0.12
462.53	925.06	V	-21.438	1.44
462.53	1387.59	V	-31.970	11.97
462.53	1387.59	H	-29.927	9.93
462.53	1850.13	H	-31.398	11.40
462.53	1850.13	V	-28.958	8.96
462.53	2312.66	V	-29.595	9.59
462.53	2312.66	H	-22.590	2.59
462.53	2775.19	H	-35.772	15.77
462.53	2775.19	V	-35.016	15.02
462.53	2775.19	V	-28.991	8.99
462.53	2775.19	H	-28.347	8.35
462.53	2775.19	H	-32.818	12.82
462.53	3237.72	H	-34.837	14.84
462.53	3237.72	V	-34.311	14.31
462.53	3700.25	V	-33.814	13.81
462.53	3700.25	H	-33.345	13.34
462.53	4162.78	H	-32.899	12.90
462.53	4162.78	V	-32.475	12.48
462.53	4625.31	V	-32.071	12.07
462.53	4625.31	H	-31.685	11.69

FIELD STRENGTH OF SPURIOUS EMISSIONS

Test Data: 462.74375 MHz

Low Power

Power Output		Limit		
dBm	Watts	dBc	dBm	
30.17	1.04	50.17	-20.00	
Tuned Freq MHz	Emission Frequency MHz	Antenna Polarity	ERP (dBm)	Margin (dB)
462.74	925.49	V	-24.507	4.51
462.74	925.49	H	-20.218	0.22
462.74	1388.23	H	-35.080	15.08
462.74	1388.23	V	-32.767	12.77
462.74	1850.97	V	-36.548	16.55
462.74	1850.97	H	-30.008	10.01
462.74	2313.72	H	-24.615	4.61
462.74	2313.72	V	-24.560	4.56
462.74	2776.46	V	-33.092	13.09
462.74	2776.46	H	-32.336	12.34
462.74	3239.21	H	-30.931	10.93
462.74	3239.21	V	-28.787	8.79
462.74	3701.95	V	-33.528	13.53
462.74	3701.95	H	-32.967	12.97
462.74	4164.69	H	-32.441	12.44
462.74	4164.69	V	-31.944	11.94
462.74	4627.44	V	-31.475	11.47
462.74	4627.44	H	-31.029	11.03

FIELD STRENGTH OF SPURIOUS EMISSIONS

Medium Power

Power Output		Limit		
dBm	Watts	dBc	dBm	
40.16	10.38	60.16	-20.00	
Tuned Freq MHz	Emission Frequency MHz	Antenna Polarity	ERP (dBm)	Margin (dB)
462.74	925.49	H	-22.487	2.49
462.74	925.49	V	-21.328	1.33
462.74	3239.21	H	-35.260	15.26
462.74	3239.21	V	-38.147	18.15
462.74	2776.46	V	-37.018	17.02
462.74	2776.46	H	-35.858	15.86
462.74	2313.72	V	-27.855	7.85
462.74	2313.72	H	-24.670	4.67
462.74	1850.97	H	-27.882	7.88
462.74	1850.97	V	-26.316	6.32
462.74	1388.23	V	-29.041	9.04
462.74	1388.23	H	-29.427	9.43
462.74	3701.95	H	-33.398	13.40
462.74	3701.95	V	-32.837	12.84
462.74	4164.69	V	-32.311	12.31
462.74	4164.69	H	-31.814	11.81
462.74	4627.44	H	-31.345	11.34
462.74	4627.44	V	-30.899	10.90

FIELD STRENGTH OF SPURIOUS EMISSIONS

High Power

Power Output		Limit		
dBm	Watts	dBc	dBm	
44	25.12	64	-20.00	
Tuned Freq MHz	Emission Frequency MHz	Antenna Polarity	ERP (dBm)	Margin (dB)
462.74	925.49	V	-24.287	4.29
462.74	925.49	H	-20.398	0.40
462.74	1388.23	V	-32.010	12.01
462.74	1388.23	H	-28.937	8.94
462.74	1850.97	H	-30.018	10.02
462.74	1850.97	V	-29.818	9.82
462.74	2313.72	V	-25.605	5.60
462.74	2313.72	H	-29.340	9.34
462.74	2776.46	H	-32.502	12.50
462.74	2776.46	V	-33.036	13.04
462.74	3239.21	H	-34.641	14.64
462.74	3239.21	V	-33.997	14.00
462.74	3701.95	V	-33.398	13.40
462.74	3701.95	H	-32.837	12.84
462.74	4164.69	H	-32.311	12.31
462.74	4164.69	V	-31.814	11.81
462.74	4627.44	V	-31.345	11.34
462.74	4627.44	H	-30.899	10.90

FIELD STRENGTH OF SPURIOUS EMISSIONS

Test Data: 467.53125 MHz

Low Power

Power Output		Limit		
dBm	Watts	dBc	dBm	
30.17	1.04	50.17	-20.00	
Tuned Freq MHz	Emission Frequency MHz	Antenna Polarity	ERP (dBm)	Margin (dB)
467.53	935.06	H	-22.387	2.39
467.53	935.06	V	-22.608	2.61
467.53	1402.59	V	-35.020	15.02
467.53	1402.59	H	-36.177	16.18
467.53	1870.13	H	-31.568	11.57
467.53	1870.13	V	-29.878	9.88
467.53	2337.66	V	-29.065	9.06
467.53	2337.66	H	-26.060	6.06
467.53	2337.66	V	-25.582	5.58
467.53	2805.19	V	-31.296	11.30
467.53	2805.19	H	-31.861	11.86
467.53	3272.72	H	-30.117	10.12
467.53	3272.72	V	-27.138	7.14
467.53	3740.25	V	-34.467	14.47
467.53	3740.25	H	-33.941	13.94
467.53	4207.78	H	-33.444	13.44
467.53	4207.78	V	-32.975	12.97
467.53	4675.31	V	-32.529	12.53
467.53	4675.31	H	10.217	-30.22

FIELD STRENGTH OF SPURIOUS EMISSIONS

Medium Power

Power Output		Limit		
dBm	Watts	dBc	dBm	
30.16	1.04	50.16	-20.00	
Tuned Freq MHz	Emission Frequency MHz	Antenna Polarity	ERP (dBm)	Margin (dB)
467.53	935.06	V	-25.127	5.13
467.53	935.06	H	-28.708	8.71
467.53	1402.59	H	-37.780	17.78
467.53	1402.59	V	-36.637	16.64
467.53	1870.13	V	-31.188	11.19
467.53	1870.13	H	-31.568	11.57
467.53	2337.66	H	-24.115	4.11
467.53	2337.66	V	-23.660	3.66
467.53	2805.19	V	-29.692	9.69
467.53	2805.19	H	-31.436	11.44
467.53	3272.72	H	-30.791	10.79
467.53	3272.72	V	-27.387	7.39
467.53	3740.25	V	-34.188	14.19
467.53	3740.25	H	-33.627	13.63
467.53	4207.78	H	-33.101	13.10
467.53	4207.78	V	-32.604	12.60
467.53	4675.31	V	-32.135	12.13
467.53	4675.31	H	-31.689	11.69

FIELD STRENGTH OF SPURIOUS EMISSIONS

High Power

Power Output		Limit		
dBm	Watts	dBc	dBm	
44	25.12	64	-20.00	
Tuned Freq MHz	Emission Frequency MHz	Antenna Polarity	ERP (dBm)	Margin (dB)
467.53	935.06	H	-22.137	2.14
467.53	935.06	V	-23.108	3.11
467.53	1402.59	H	-27.090	7.09
467.53	1402.59	V	-27.707	7.71
467.53	1870.13	V	-27.588	7.59
467.53	1870.13	H	-31.008	11.01
467.53	2337.66	H	-22.985	2.98
467.53	2337.66	V	-23.050	3.05
467.53	2805.19	V	-31.542	11.54
467.53	2805.19	H	-31.976	11.98
467.53	3272.72	H	-30.931	10.93
467.53	3272.72	V	-25.747	5.75
467.53	3740.25	V	-32.498	12.50
467.53	3740.25	H	-39.707	19.71
467.53	4207.78	H	-33.761	13.76
467.53	4207.78	V	-33.264	13.26
467.53	4675.31	V	-32.795	12.79
467.53	4675.31	H	-32.349	12.35

FIELD STRENGTH OF SPURIOUS EMISSIONS

Test Data: 467.74375 MHz

Low Power

Power Output		Limit		
dBm	Watts	dBc	dBm	
30.17	1.04	50.17	-20.00	
Tuned Freq MHz	Emission Frequency MHz	Antenna Polarity	ERP (dBm)	Margin (dB)
467.74	935.49	V	-26.017	6.02
467.74	935.49	H	-21.678	1.68
467.74	1403.23	H	-38.850	18.85
467.74	1403.23	V	-34.427	14.43
467.74	1870.97	V	-36.838	16.84
467.74	1870.97	H	-32.518	12.52
467.74	2338.72	H	-27.525	7.52
467.74	2338.72	V	-26.910	6.91
467.74	2806.46	V	-31.892	11.89
467.74	2806.46	H	-32.556	12.56
467.74	3274.21	H	-31.031	11.03
467.74	3274.21	V	-27.237	7.24
467.74	3741.95	V	-34.398	14.40
467.74	3741.95	H	-33.837	13.84
467.74	4209.69	H	-33.311	13.31
467.74	4209.69	V	-32.814	12.81
467.74	4677.44	V	-32.345	12.34
467.74	4677.44	H	-31.899	11.90

FIELD STRENGTH OF SPURIOUS EMISSIONS

Medium Power

Power Output		Limit		
dBm	Watts	dBc	dBm	
40.16	10.38	60.16	-20.00	
Tuned Freq MHz	Emission Frequency MHz	Antenna Polarity	ERP (dBm)	Margin (dB)
467.74	935.49	H	-25.227	5.23
467.74	935.49	V	-22.368	2.37
467.74	1403.23	V	-35.390	15.39
467.74	1403.23	H	-32.467	12.47
467.74	1870.97	H	-31.228	11.23
467.74	1870.97	V	-30.258	10.26
467.74	2338.72	V	-26.985	6.98
467.74	2338.72	H	-26.490	6.49
467.74	2806.46	H	-34.092	14.09
467.74	2806.46	V	-33.336	13.34
467.74	3274.21	V	-25.831	5.83
467.74	3274.21	H	-25.187	5.19
467.74	3741.95	H	-36.408	16.41
467.74	3741.95	V	-35.847	15.85
467.74	4209.69	V	-35.321	15.32
467.74	4209.69	H	-34.824	14.82
467.74	4677.44	H	-34.355	14.35
467.74	4677.44	V	-33.909	13.91

FIELD STRENGTH OF SPURIOUS EMISSIONS

High Power

Power Output		Limit		
dBm	Watts	dBc	dBm	
44	25.12	64	-20.00	
Tuned Freq MHz	Emission Frequency MHz	Antenna Polarity	ERP (dBm)	Margin (dB)
467.74	935.49	V	-24.587	4.59
467.74	935.49	H	-22.198	2.20
467.74	1403.23	V	-27.330	7.33
467.74	1403.23	H	-25.267	5.27
467.74	1870.97	H	-31.128	11.13
467.74	1870.97	V	-23.728	3.73
467.74	2338.72	V	-27.355	7.35
467.74	2338.72	H	-21.930	1.93
467.74	2806.46	V	-31.992	11.99
467.74	2806.46	H	-35.336	15.34
467.74	3274.21	V	-27.841	7.84
467.74	3274.21	V	-31.777	11.78
467.74	3741.95	V	-33.908	13.91
467.74	3741.95	H	-33.347	13.35
467.74	4209.69	H	-32.821	12.82
467.74	4209.69	V	-32.324	12.32
467.74	4677.44	V	-31.855	11.85
467.74	4677.44	H	-31.409	11.41

FIELD STRENGTH OF SPURIOUS EMISSIONS

Test Data: 475.00 MHz

Low Power

Power Output		Limit		
dBm	Watts	dBc	dBm	
30.17	1.04	50.17	-20.00	
Tuned Freq MHz	Emission Frequency MHz	Antenna Polarity	ERP (dBm)	Margin (dB)
475.00	950.00	V	-27.477	7.48
475.00	950.00	H	-30.147	10.15
475.00	1425.00	H	-40.817	20.82
475.00	1425.00	V	-38.707	18.71
475.00	2375.00	H	-39.227	19.23
475.00	3325.00	V	-39.877	19.88

Medium Power

Power Output		Limit		
dBm	Watts	dBc	dBm	
40.16	10.38	60.16	-20.00	
Tuned Freq MHz	Emission Frequency MHz	Antenna Polarity	ERP (dBm)	Margin (dB)
475.00	950.00	H	-27.587	7.59
475.00	950.00	V	-27.077	7.08
475.00	3325.00	H	-40.227	20.23
475.00	1900.00	H	-39.227	19.23

High Power

Power Output		Limit		
dBm	Watts	dBc	dBm	
44	25.12	64	-20.00	
Tuned Freq MHz	Emission Frequency MHz	Antenna Polarity	ERP (dBm)	Margin (dB)
475.00	950.00	V	-25.330	5.33
475.00	950.00	H	-28.167	8.17
475.00	1425.00	V	-33.887	13.89
475.00	1425.00	H	-34.277	14.28
475.00	2375.00	V	-38.477	18.48
475.00	2375.00	H	-40.507	20.51

FIELD STRENGTH OF SPURIOUS EMISSIONS

Test Data: 479.99375 MHz

Low Power

Power Output		Limit		
dBm	Watts	dBc	dBm	
30.17	1.04	50.17	-20.00	
Tuned Freq MHz	Emission Frequency MHz	Antenna Polarity	ERP (dBm)	Margin (dB)
479.99	959.99	H	-24.907	4.91
479.99	959.99	V	-21.487	1.49
479.99	2399.97	V	-36.777	16.78
479.99	2399.97	H	-40.497	20.50
479.99	1919.97	H	-37.087	17.09
479.99	1919.97	V	-36.647	16.65
479.99	1439.98	V	-38.617	18.62

Medium Power

Power Output		Limit		
dBm	Watts	dBc	dBm	
40.16	10.38	60.16	-20.00	
Tuned Freq MHz	Emission Frequency MHz	Antenna Polarity	ERP (dBm)	Margin (dB)
479.99	959.99	V	-21.147	1.15
479.99	959.99	H	-24.317	4.32
479.99	1439.98	H	-40.357	20.36
479.99	1439.98	V	-39.117	19.12
479.99	1919.97	H	-40.527	20.53
479.99	2399.97	H	-39.737	19.74

FIELD STRENGTH OF SPURIOUS EMISSIONS

High Power

Power Output		Limit		
dBm	Watts	dBc	dBm	
44	25.12	64	-20.00	
Tuned Freq MHz	Emission Frequency MHz	Antenna Polarity	ERP (dBm)	Margin (dB)
479.99	959.99	H	-25.547	5.55
479.99	959.99	V	-29.078	9.08
479.99	1439.98	V	-31.290	11.29
479.99	1439.98	H	-33.677	13.68
479.99	1919.97	H	-38.088	18.09
479.99	1919.97	V	-38.548	18.55
479.99	2399.97	V	-31.025	11.02
479.99	2399.97	H	-33.460	13.46
479.99	2879.96	H	-39.852	19.85
479.99	2879.96	V	-33.256	13.26
479.99	3359.96	H	-35.641	15.64
479.99	3359.96	V	-33.567	13.57
479.99	3839.95	V	-35.778	15.78
479.99	3839.95	H	-40.177	20.18
479.99	4319.94	H	-38.631	18.63
479.99	4319.94	V	-38.134	18.13
479.99	4799.94	V	-37.665	17.66
479.99	4799.94	H	-37.219	17.22

FREQUENCY STABILITY

FCC Rule Parts: FCC Part 2.1055(a)(2), 90.213

MINIMUM FREQUENCY STABILITY

[Parts per million (ppm)]

Frequency range (MHz)	Fixed and base stations	Mobile stations	
		Over 2 watts output power	2 watts or less output power
421-512	7 11 14, 2.5	8 ₅	8 ₅

⁷In the 421-512 MHz band, fixed and base stations with a 12.5 kHz channel bandwidth must have a frequency stability of 1.5 ppm. Fixed and base stations with a 6.25 kHz channel bandwidth must have a frequency stability of 0.5 ppm.

⁸In the 421-512 MHz band, mobile stations designed to operate with a 12.5 kHz channel bandwidth must have a frequency stability of 2.5 ppm. Mobile stations designed to operate with a 6.25 kHz channel bandwidth must have a frequency stability of 1.0 ppm.

¹¹Paging transmitters operating on paging-only frequencies must operate with frequency stability of 5 ppm in the 150-174 MHz band and 2.5 ppm in the 421-512 MHz band.

¹⁴Control stations may operate with the frequency tolerance specified for associated mobile frequencies.

Method of Measurements: TIA 603-E, 2.2.2

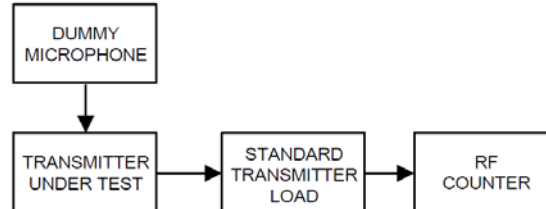

FREQUENCY STABILITY

Test Data: Frequency Error Measurement Plot

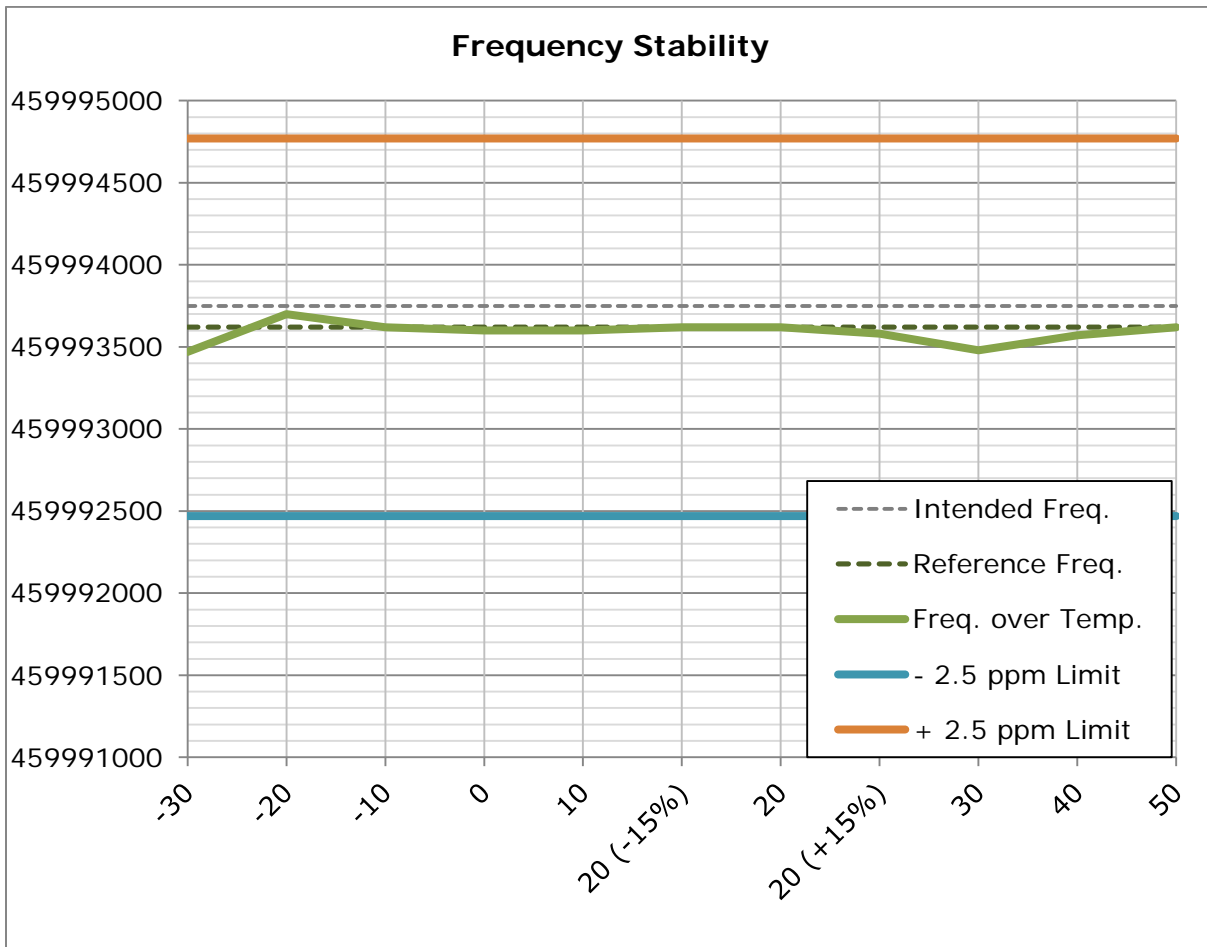

FREQUENCY STABILITY

Test Data: Frequency Error Measurement Table

Limit:		2.5 ppm		
Temperature (°C)	Supplied Voltage (VDC)	Intended Frequency (Hz)	Measured Reference Frequency (Hz)	Deviation (Hz)
20°C (reference)	13.8	459993750	459993620	130

@ 20°C (reference)				
Supplied Voltage (%)	Supplied Voltage (VDC)	Frequency (Hz)	Deviation (Hz)	PPM
-15%	11.73	459993620	0	0.000
15%	15.87	459993580	40	0.087

Temperature (°C)	Supplied Voltage (VDC)	Frequency (Hz)	Deviation (Hz)	PPM
50	13.8	459993620	0.00000	0.000
40	13.8	459993570	50.00000	0.109
30	13.8	459993480	140.00000	0.304
20	13.8	459993620	0.00000	0.000
10	13.8	459993600	20.00000	0.043
0	13.8	459993600	20.00000	0.043
-10	13.8	459993620	0.00000	0.000
-20	13.8	459993700	80.00000	-0.174
-30	13.8	459993470	150.00000	0.326

RESULT: Meets Requirements

TRANSIENT FREQUENCY BEHAVIOR

FCC Rule Parts: 90.214

Requirements:

Transmitters designed to operate in the 150-174 MHz and 421-512 MHz frequency bands must maintain transient frequencies within the maximum frequency difference limits during the time intervals indicated:

Time intervals ^{1 2}	Maximum frequency difference ³	All equipment	
		150 to 174 MHz	421 to 512 MHz
Transient Frequency Behavior for Equipment Designed to Operate on 25 kHz Channels			
t_1 ⁴	±25.0 kHz	5.0 ms	10.0 ms
t_2	±12.5 kHz	20.0 ms	25.0 ms
t_3 ⁴	±25.0 kHz	5.0 ms	10.0 ms
Transient Frequency Behavior for Equipment Designed to Operate on 12.5 kHz Channels			
t_1 ⁴	±12.5 kHz	5.0 ms	10.0 ms
t_2	±6.25 kHz	20.0 ms	25.0 ms
t_3 ⁴	±12.5 kHz	5.0 ms	10.0 ms
Transient Frequency Behavior for Equipment Designed to Operate on 6.25 kHz Channels			
t_1 ⁴	±6.25 kHz	5.0 ms	10.0 ms
t_2	±3.125 kHz	20.0 ms	25.0 ms
t_3 ⁴	±6.25 kHz	5.0 ms	10.0 ms

¹ t_{on} is the instant when a 1 kHz test signal is completely suppressed, including any capture time due to phasing.

t_1 is the time period immediately following t_{on} .

t_2 is the time period immediately following t_1 .

t_3 is the time period from the instant when the transmitter is turned off until t_{off} .

t_{off} is the instant when the 1 kHz test signal starts to rise.

² During the time from the end of t_2 to the beginning of t_3 , the frequency difference must not exceed the limits specified in §90.213.

³ Difference between the actual transmitter frequency and the assigned transmitter frequency.

⁴ If the transmitter carrier output power rating is 6 watts or less, the frequency difference during this time period may exceed the maximum frequency difference for this time period.

TRANSIENT FREQUENCY BEHAVIOR

Method of Measurement: TIA-603-E, 2.2.19.3

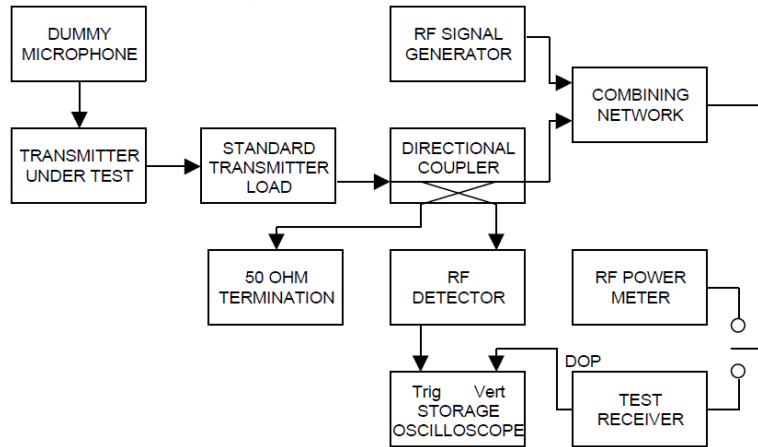

Test Data: 12.5 kHz FM Turn-On Period (t_1)

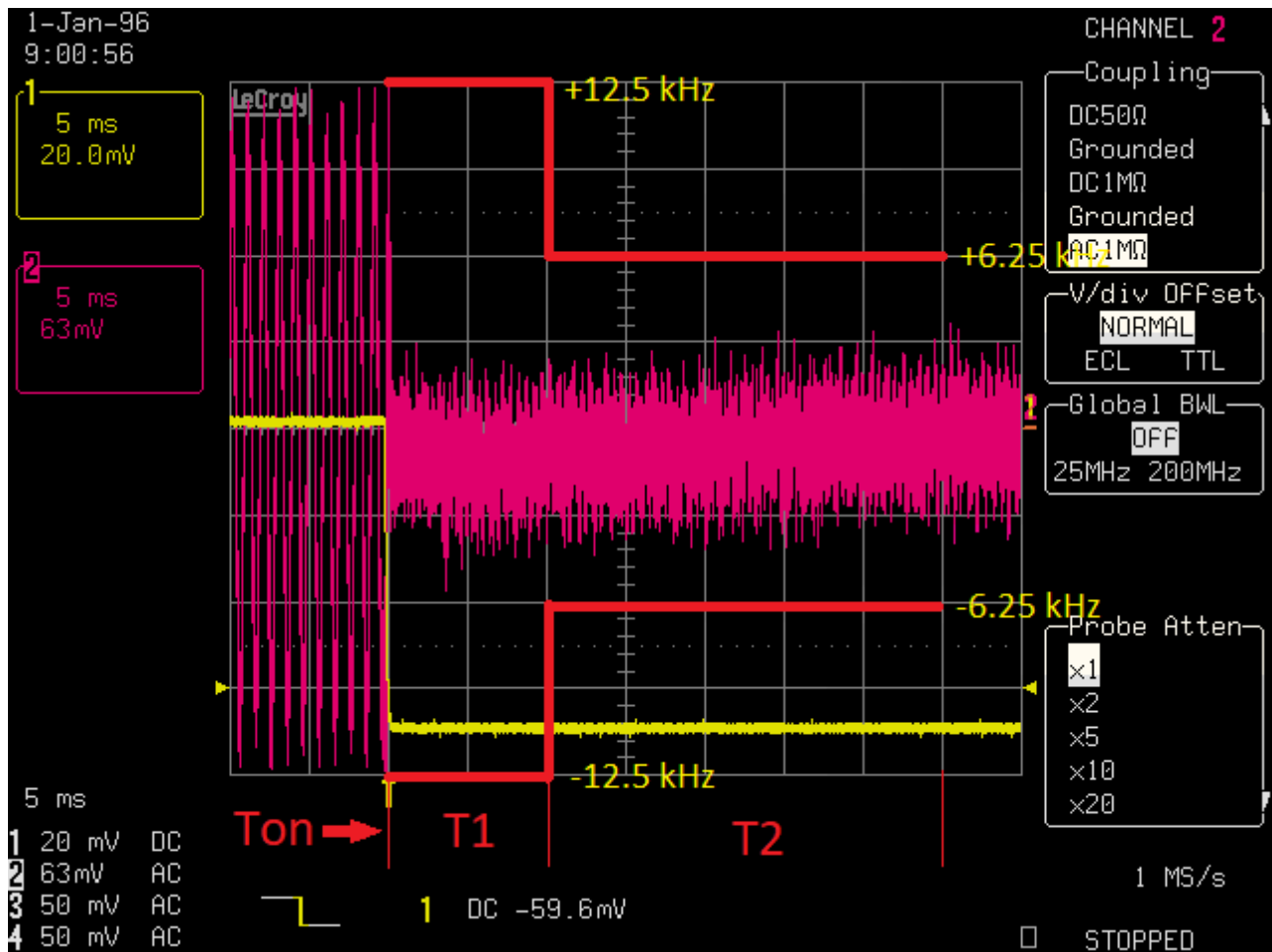

TRANSIENT FREQUENCY BEHAVIOR

Test Data: 12.5 kHz FM Turn-Off Period (t_3)

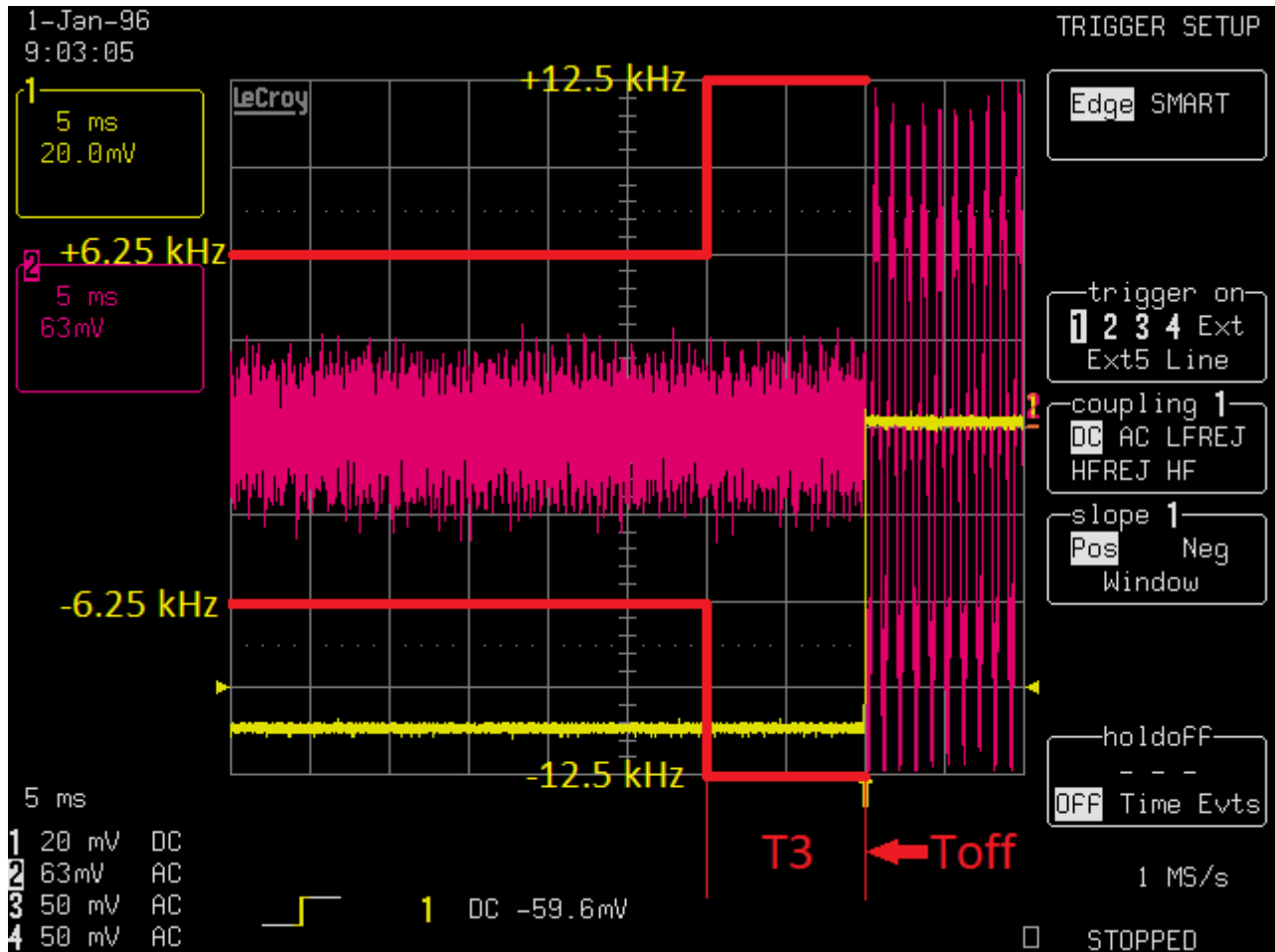

STATEMENT OF MEASUREMENT UNCERTAINTY

The data and results referenced in this document are true and accurate. The measurement uncertainty was calculated for all measurements listed in this test report according To CISPR 16-4 or ENTR 100-028 Specification for radio disturbance and immunity measuring apparatus and methods – Part 4: “Uncertainty in EMC Measurements” and is documented in the Timco Engineering, Inc. quality system according to DIN EN ISO/IEC 17025. Furthermore, component and process variability of devices similar to that tested may result in additional deviation. The manufacturer has the sole responsibility of continued compliance of the device.

Hereafter the best measurement capability for Timco Engineering, Inc. is reported:

Test Items	Measurement Uncertainty	Notes
RF Frequency Accuracy	± 49.5 Hz	(1)
RF Conducted Power	±0.93dB	(1)
Conducted spurious emission of transmitter valid up to 40GHz	±1.86dB	
Occupied Bandwidth	±2.65%	
Audio Frequency Response	±1.86dB	
Modulation limiting	±1.88%	
Radiated RF Power	±1.4dB	
Maximum frequency deviation: Within 300 Hz and 6kHz of audio freq.	±1.88%	
Within 6kHz and 25kHz of audio Freq.	±2.04%	
Rad Emissions Sub Meth up to 26.5GHz	±2.14dB	
Adjacent channel power	±1.47dB	(1)
Transient Frequency Response	±1.88%	
Temperature	±1.0°C	(1)
Humidity	±5.0%	

Notes: (1) This uncertainty represents an expanded uncertainty expressed at approximately the 95% confidence level using a coverage factor of k=1.96.

EMC EQUIPMENT LIST

Device	Manufacturer	Model	Serial Number	Cal/Char Date	Due Date
Coaxial Cable - BMBM-0065-01 Black DC-2G	Belden		BMBM-0065-01	07/18/16	07/18/18
Antenna: Biconical 1096	Eaton	94455-1	1096	08/01/17	08/01/19
Antenna: Log-Periodic 1122	Electro-Metrics	LPA-25	1122	07/26/17	07/26/19
Temperature Chamber LARGE	Tenney Engineering	TTRC	11717-7	09/01/16	09/01/18
Frequency Counter Small Chamber	HP	5385A	3242A07460	08/22/17	08/22/19
Coaxial Cable - Chamber 3 cable set (backup)	Micro-Coax	Chamber 3 cable set (backup)	KMKM-0244-02 KMKM-0670-01 KFKF-0197-00	N/A	N/A
CHAMBER	Panashield	3M	N/A	04/25/16	5/31/18
Antenna: Double-Ridged Horn/ETS Horn 2	ETS-Lindgren	3117	00041534	03/01/17	03/01/19
Software: Field Strength Program	Timco	N/A	Version 4.10.7.0	N/A	N/A
Antenna: Passive Loop	EMCO	6512	9706-1211	07/26/17	07/26/19
Type K J Thermometer	Martel	303	080504494	11/02/17	11/02/19
EMI Test Receiver R & S ESIB 40	Rohde & Schwarz	ESIB 40	100274	08/18/16	08/18/18
EMI Test Receiver R & S ESU 40	Rohde & Schwarz	ESU 40	100320	04/01/16	04/01/19
Attenuator N 20dB 20W DC-12G	Narda	768-20-SP	155	07/10/17	07/10/19
Attenuator N 20dB 20W DC-12G	Narda	768-20-SP	344	07/10/17	07/10/19
Attenuator N 30dB 100W DC-6G	Pasternack	PE7214-30	#109	05/24/17	05/24/19
Attenuator BNC 10dB DC-2G	MiniCircuits	HAT-10+	#54	07/14/17	07/14/19
Bore-sight Antenna Positioning Tower	Sunol Sciences	TLT2	N/A	N/A	N/A
Tunable Notch Filter 250-850 MHz	Eagle	TNF-200	250-850 MHz (#19)	11/19/17	11/19/19
Terminator N 20W DC-18G	Narda	8205	#14	04/06/17	04/06/19
Attenuator BNC 6dB 50Ohm DC-2G	Mini-Circuits	HAT-6+	#53	07/14/17	07/14/19
Attenuator N 30dB 100W DC-6G	Pasternack	PE7214-30	#109	05/24/17	05/23/19
DC Power Supply	HP	6286A	1744A03842	N/A	N/A
Modulation Analyzer	HP	8901A	3050A05856	04/13/17	04/13/19
Function Generator	Standford	DS340	25200	02/21/18	02/21/20
Terminator N 20W DC-18G	Narda	8205	#14	04/06/17	04/06/19

*EMI RECEIVER SOFTWARE VERSION

The receiver firmware used was version 4.43 Service Pack 3

END OF TEST REPORT