



FCC CFR 47 Part 22 E Test Report

APPLICANT	STANDARD COMMUNICATIONS PTY.LTD.
ADDRESS	PO BOX 96 WINSTON HILLS NSW 2153 AUSTRALIA
FCC ID	TXJCM60UL25
MODEL NUMBER	CM60-UL25
PRODUCT DESCRIPTION	UHF MOBILE TRANSCEIVER
DATE SAMPLE RECEIVED	4/11/2018
FINAL TEST DATE	4/27/2018
TESTED BY	Franklin Rose
APPROVED BY	Tim Royer
TEST RESULTS	<input checked="" type="checkbox"/> PASS <input type="checkbox"/> FAIL

Report Number	Report Version	Description	Issue Date
484CUT18 PT22_TestReport_	Rev1	Initial Issue	04/27/2018
484CUT18 PT22_TestReport_	Rev2	Clerical Updates	05/30/2018

THE ATTACHED REPORT SHALL NOT BE REPRODUCED EXCEPT IN FULL WITHOUT THE WRITTEN APPROVAL OF TIMCO ENGINEERING, INC.

TABLE OF CONTENTS

GENERAL REMARKS	2
GENERAL INFORMATION	3
RESULTS SUMMARY	4
RF POWER OUTPUT	5
PART 2.1033 (c)(8) DC INPUT INTO FINAL AMPLIFIER.....	5
MODULATION CHARACTERISTICS	6
11K2F3E (NARROWBAND ANALOG FM VOICE) BANDWIDTH.....	6
7K87F1E/F1D (C4FM VOICE/DATA) BANDWIDTH.....	6
AUDIO FREQUENCY RESPONSE & LOW PASS FILTER	7
Test Data: 12.5 kHz FM Audio Frequency Response & Low Pass Filter..	Error! Bookmark not defined.
MODULATION LIMITING	7
Test Data: 12.5 kHz FM Modulation Limiting.....	Error! Bookmark not defined.
OCCUPIED BANDWIDTH.....	8
TEST DATA: 11K2F3E (NARROWBAND ANALOG FM VOICE).....	10
TEST DATA: 7K87F1E/F1D (C4FM VOICE/DATA).....	11
SPURIOUS EMISSIONS AT ANTENNA TERMINALS (CONDUCTED).....	12
SPURIOUS EMISSIONS - NARROWBAND FM (12.5 kHz).....	13
Test Data: 454.00625 MHz	13
Test Data: 454.99375 MHz	14
Test Data: 456.00625 MHz	15
Test Data: 459.99375 MHz	16
Test Data: 470.00625 MHz	17
Test Data: 475.0000 MHz	18
Test Data: 479.99375 MHz	19
SPURIOUS EMISSIONS – P25 PHASE I C4FM	20
Test Data: 454.00625 MHz	20
Test Data: 454.99375 MHz	21
Test Data: 456.00625 MHz	22
Test Data: 459.99375 MHz	23
Test Data: 470.00625 MHz	24
Test Data: 475.0000 MHz	25
Test Data: 479.99375 MHz	26
FIELD STRENGTH OF SPURIOUS EMISSIONS	27
TEST DATA: 454.00625 MHz	28
TEST DATA: 454.99375 MHz	30
TEST DATA: 456.00625 MHz	33
TEST DATA: 459.99375 MHz	36
TEST DATA: 470.00625 MHz	39
TEST DATA: 475.00 MHz.....	40
TEST DATA: 479.99375 MHz	41
FREQUENCY STABILITY	43
STATEMENT OF MEASUREMENT UNCERTAINTY	46
EMC EQUIPMENT LIST	47

GENERAL REMARKS

Summary

The device under test does:

- Fulfill the general approval requirements as identified in this test report and was selected by the customer.
- Not fulfill the general approval requirements as identified in this test report

Attestations

This equipment has been tested in accordance with the standards identified in this test report. To the best of my knowledge and belief, these tests were performed using the measurement procedures described in this report.

All instrumentation and accessories used to test products for compliance to the indicated standards are calibrated regularly in accordance with ISO 17025 requirements.

I attest that the necessary measurements were made at:

Timco Engineering Inc.
849 NW State Road 45
Newberry, FL 32669
Designation #: US1070

Tested by:



Name and Title	Franklin Rose, Project Manager / EMC Testing Technician
Date	04/27/2018

Reviewed and Approved by:



Name and Title	Tim Royer, Project Manager / EMC Testing Engineer
Date	04/27/2018

GENERAL INFORMATION

EUT Specification

EUT Description	UHF MOBILE TRANSCEIVER
FCC ID	TXJCM60UL25
Model Number	CM60-UL25
Operating Frequency	Band 1: 454 – 455 MHz Band 2: 456 – 460 MHz Band 3: 470 - 480 MHz
Test Frequencies	Band 1: 454.00625, 454.99375 MHz Band 2: 456.00625, 459.99375 MHz Band 3: 470.00625, 475.00, 479.99375 MHz
Type of Emission	11K2F3E (Narrowband Analog FM Voice), 7K87F1E (P25 Phase I C4FM Voice), 7K87F1D (P25 Phase I C4FM Data)
Modulation	FM
EUT Power Source	<input type="checkbox"/> 110–120Vac/50– 60Hz
	<input checked="" type="checkbox"/> DC Power (13.8 V)
	<input type="checkbox"/> Battery Operated Exclusively
Test Item	<input type="checkbox"/> Prototype
	<input checked="" type="checkbox"/> Pre-Production
	<input type="checkbox"/> Production
Type of Equipment	<input type="checkbox"/> Fixed
	<input checked="" type="checkbox"/> Mobile
	<input type="checkbox"/> Portable
Antenna Connector	BNC
Test Conditions	The temperature was 26°C Relative humidity of 50%.
Modification to the EUT	No Modification to EUT.
Test Exercise	The EUT was placed in continuous transmit and was operated in “Test Mode” for digital emissions tests.
Applicable Standards	ANSI/TIA 603-E:2016, ANSI C63.26, FCC CFR 47 Part 2, Part 22
Test Facility	Timco Engineering Inc. at 849 NW State Road 45 Newberry, FL 32669 USA. Designation #: US1070

RESULTS SUMMARY

Rule Part No.	Test Item	Results
2.1046(a), 22.565(f), 22.593, 22.627(a), (b), 22.659(a)	RF Power Output	PASS
Part 2.1033(c)(4)	Modulation Characteristics	PASS
2.1047(a)	Audio Frequency Response and Low Filter	PASS
2.1047(b)	Modulation Limiting	PASS
2.1049 (c)	Occupied Bandwidth	PASS
2.1051(a), 22.359(a)	Spurious Emissions at Antenna Terminals	PASS
2.1053(a), 22.359(a)	Field Strength of Spurious Emissions	PASS
2.1055(a)(2), 22.355	Frequency Stability < 5 ppm	PASS

RF POWER OUTPUT

FCC Rule Parts: 2.1046(a), 22.565(f), 22.593, 22.627(a), (b), 22.659(a)

(f) *Mobile transmitters.* The transmitter output power of mobile transmitters must not exceed 60 watts.

The effective radiated power of fixed stations operating on the channels listed in §22.591 must not exceed 150 Watts. The equivalent isotropically radiated power of existing fixed microwave stations (2110-2130 and 2160-2180 MHz) licensed under this part (pursuant to former rules) must not exceed the applicable limits set forth in §101.113 of this chapter.

The effective radiated power (ERP) of transmitters operating on the channels listed in §22.621 must not exceed the limits in this section.

(a) *Maximum ERP.* The ERP must not exceed the applicable limits in this paragraph under any circumstances.

Frequency range (MHz)	Maximum ERP (watts)
470-512	1000
928-929	50
932-933	30
941-942	600
952-960	150

(b) *470-512 MHz limits.* The purpose of the rules in paragraphs (b)(1) through (b)(3) of this section is to reduce the likelihood that interference to television reception from public mobile operations on these channels will occur. The protected TV station locations specified in this section are the locations of record as of September 1974, and these do not change even though the TV stations may have been subsequently relocated.

(a) *Maximum ERP.* The ERP of base transmitters must not exceed 100 Watts under any circumstances. The ERP of mobile transmitters must not exceed 60 Watts under any circumstances.

Method of Measurement: TIA-603-E, 2.2.1

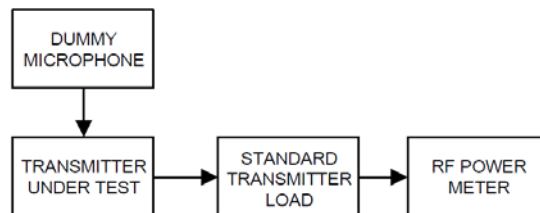

Test Data: Power Measurement Table

Peak Power Output					
dBm			Watts		
High	Med	Low	High	Med	Low
44.00	40.16	30.17	25.12	10.38	1.04

Part 2.1033 (c) (8) DC Input into Final Amplifier

INPUT POWER: (13.8 V) (6.0 A) = **82.8 Watts**

Result: Meets Requirements

Applicant: STANDARD COMMUNICATIONS PTY.LTD.
 FCC ID: TXJCM60UL25
 Report: 484CUT18 PT22_TestReport_Rev1

[Table of Contents](#)

MODULATION CHARACTERISTICS

FCC Rule Parts: Part 2.1033(c)(4)

11K2F3E (Narrowband Analog FM Voice) Bandwidth

$$B_n = 2M + 2Dk$$
$$B_n = (2 \times 3) + (2 \times 2.5) = 11.0 \text{ kHz}$$

Where:

f_m = modulating frequency, kHz

f_d = deviation, kHz

k = constant (= 1)

Necessary Bandwidth for 11K2F3E = **11.0 kHz**

90. 209(b)(5) Authorized Bandwidth for 11K2F3E = **11.25 kHz**

7K87F1E/F1D (C4FM Voice/Data) Bandwidth

Necessary Bandwidth for 7K87F1E/F1D (99% Occupied Bandwidth) = **8.61 kHz**

90. 209(b)(5) Authorized Bandwidth for 7K87F1E/F1D = **11.25 kHz**

Result: Meets Requirements

AUDIO FREQUENCY RESPONSE & LOW PASS FILTER

Rule Part No.: 2.1047(a)

Requirements:

(a) *Voice modulated communication equipment.* A curve or equivalent data showing the frequency response of the audio modulating circuit over a range of 100 to 5000 Hz shall be submitted. For equipment required to have an audio low-pass filter, a curve showing the frequency response of the filter, or of all circuitry installed between the modulation limiter and the modulated stage shall be submitted.

Test Procedure: TIA 603-E, 2.2.6.2.2, 2.2.15 (Using the Test Setup from section 2.2.6)

Note: The Low Pass Filter is digital, and has no "input" or "output" as found in the method of measurement, above. Testing has been altered accordingly to show the operation of the filter.

Note: Testing deviates from TIA 603-E 2.2.6.2.2 and 2.2.15. The Audio Frequency Response and Low Pass Filter Response plot data has been taken simultaneously using the Modulation Meter reading of Deviation (kHz), satisfying the requirements above.

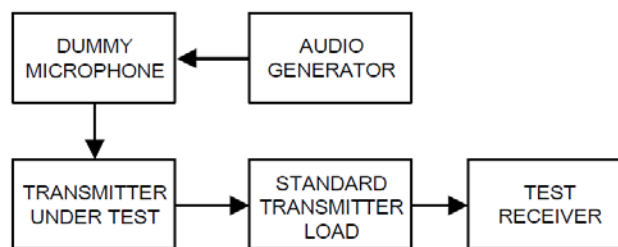

Test Data: 12.5 kHz FM Audio Frequency Response & Low Pass Filter

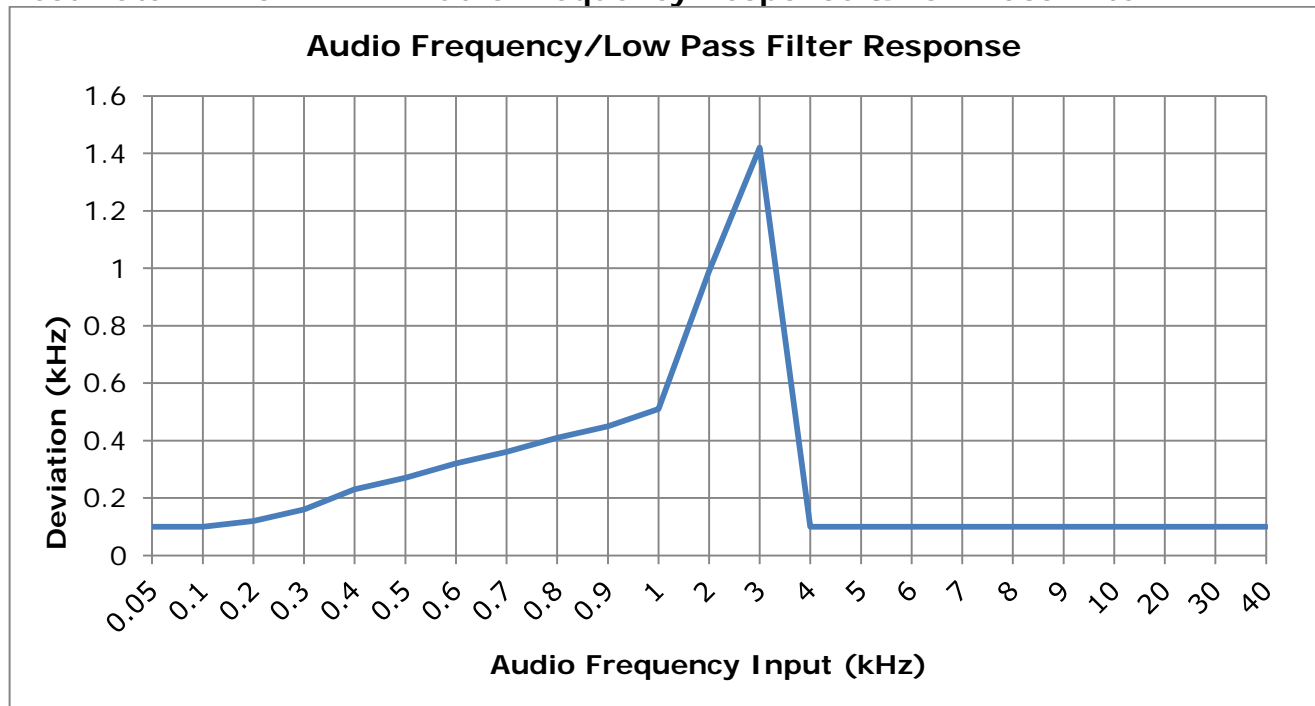

MODULATION LIMITING

Rule Part No.: 2.1047(b)

Requirements:

(b) *Equipment which employs modulation limiting.* A curve or family of curves showing the percentage of modulation versus the modulation input voltage shall be supplied. The information submitted shall be sufficient to show modulation limiting capability throughout the range of modulating frequencies and input modulating signal levels employed.

Test Procedure: TIA 603-E, 2.2.3

Note: The test method alone is not sufficient to meet the standard of FCC Pt. 2.1047(b). Deviation (kHz), as recorded from test equipment, has been converted into percentage as required above.

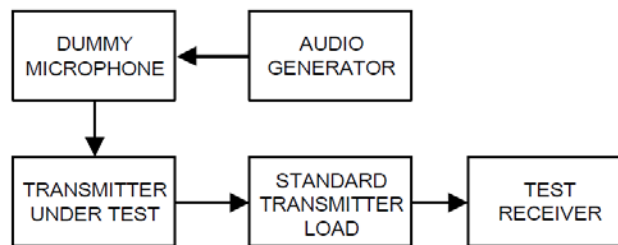

Test Data: 12.5 kHz FM Modulation Limiting

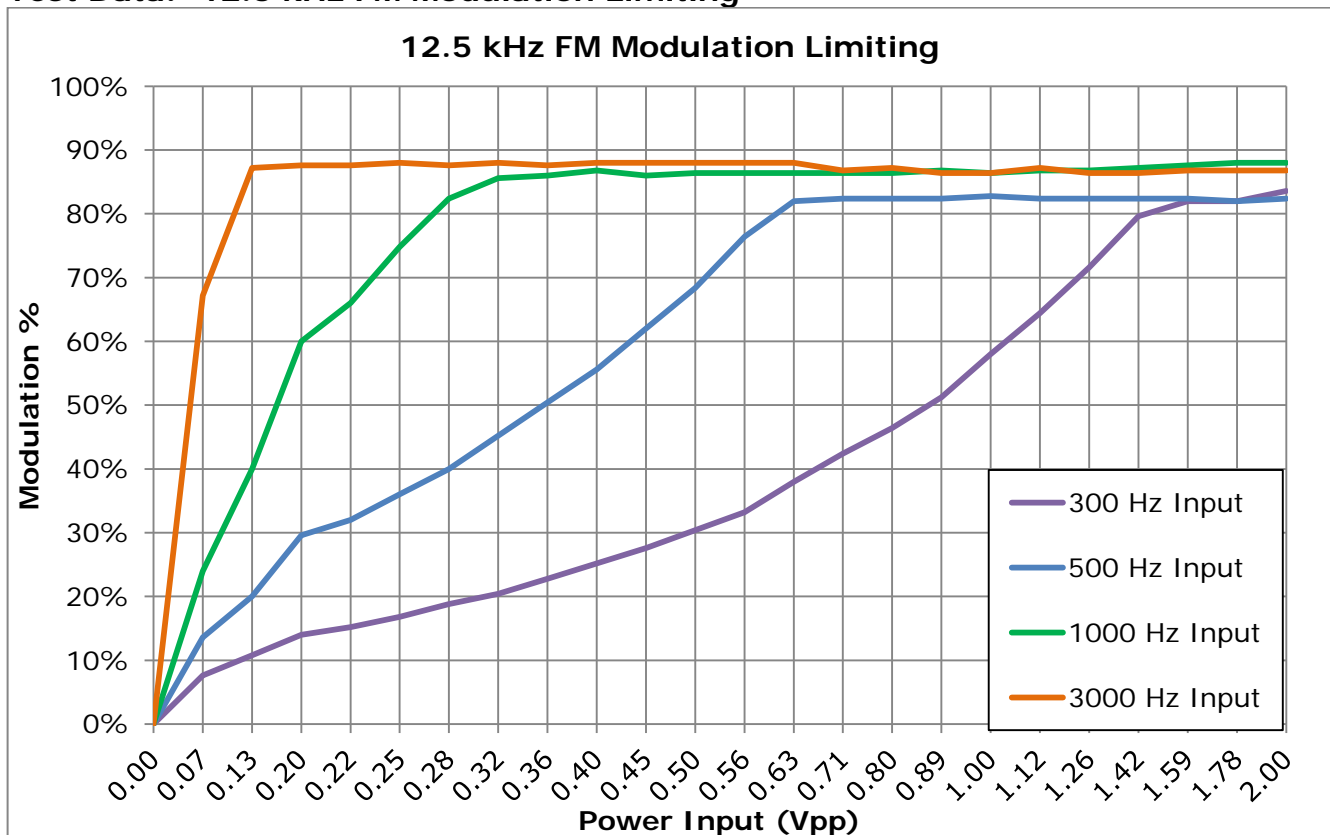

OCCUPIED BANDWIDTH

FCC Rule Parts: 2.1049 (c)

(c) Radiotelephone transmitters equipped with a device to limit modulation or peak envelope power shall be modulated as follows. For single sideband and independent sideband transmitters, the input level of the modulating signal shall be 10 dB greater than that necessary to produce rated peak envelope power.

(1) Other than single sideband or independent sideband transmitters—when modulated by a 2500 Hz tone at an input level 16 dB greater than that necessary to produce 50 percent modulation. The input level shall be established at the frequency of maximum response of the audio modulating circuit.

Method of Measurement: ANSI C63.26, 5.4.4 (using Test Setup from TIA 603-E 2.2.11, below)

Note: The receiver's automatic 99% Occupied Bandwidth function was used. The function is identical in operation to ANSI C63.26, 5.4.4, Step e).

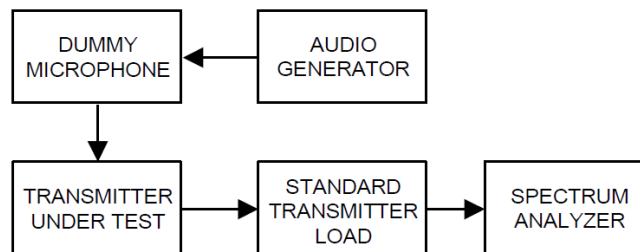

OCCUPIED BANDWIDTH 99%

Test Data: 11K2F3E (Narrowband Analog FM Voice)



Ref Lvl	44 dBm	Marker 1 [T1]	40.69 dBm	RBW	300 Hz	RF Att	20 dB
			459.99382515 MHz	VBW	3 kHz		
				SWT	1.4 s	Unit	dBm

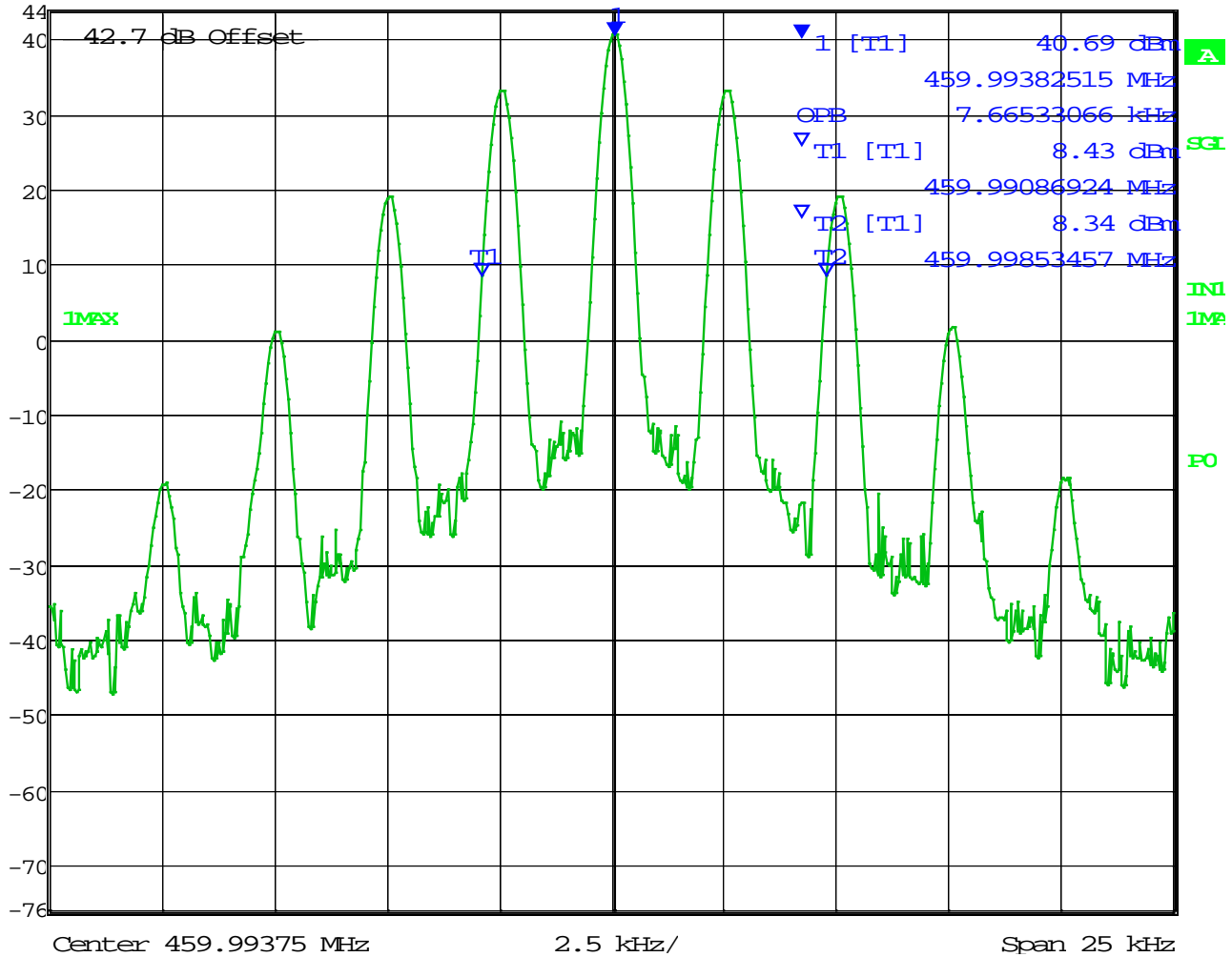

Date: 1.JAN.1997 02:26:53

99% OBW = 7.67 kHz

OCCUPIED BANDWIDTH 99%

Test Data: 7K87F1E/F1D (C4FM Voice/Data)



Ref Lvl	44 dBm	Marker 1 [T1]	39.91 dBm	RBW	300 Hz	RF Att	20 dB
			459.99407565 MHz	VBW	3 kHz		
				SWT	1.4 s	Unit	dBm

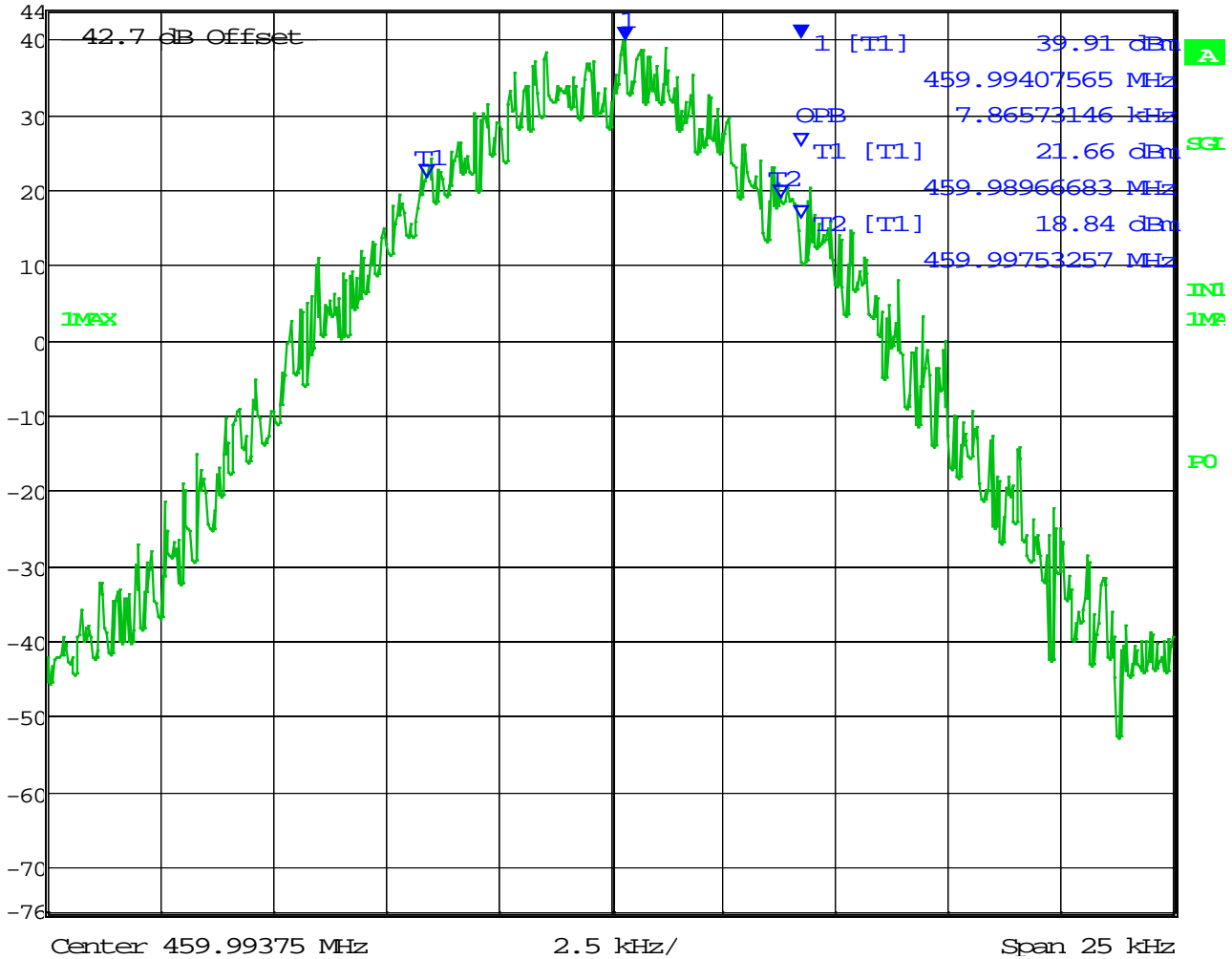

Date: 1.JAN.1997 02:29:30

99% OBW = 7.87 kHz

Result: Meets Requirements

SPURIOUS EMISSIONS AT ANTENNA TERMINALS (CONDUCTED)

FCC Rule Parts: 2.1051(a), 22.359(a)

Requirements:

(a) *Out of band emissions.* The power of any emission outside of the authorized operating frequency ranges must be attenuated below the transmitting power (P) by a factor of at least $43 + 10 \log (P)$ dB.

The limit below conforms to FCC CFR 47 Part 90.210(d)(3) and in all cases is more strict than that set forth in this rulepart. Please refer below:

FCC Rule Parts: 90.210(d)(3)

(3) On any frequency removed from the center of the authorized bandwidth by a displacement frequency (f_d in kHz) of more than 12.5 kHz: At least $50 + 10 \log (P)$ dB or 70 dB, whichever is the lesser attenuation.

Method of Measurement: ANSI/TIA-603-E

Test Procedure: TIA 603-E, 2.2.13

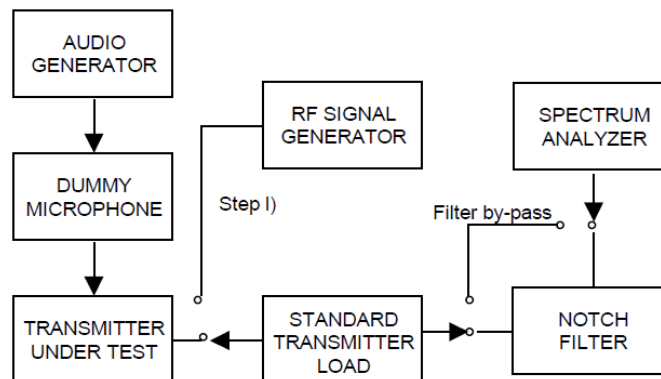

SPURIOUS EMISSIONS - NARROWBAND FM (12.5 kHz)

Test Data: 454.00625 MHz

Spurious Conducted Emissions, Narrowband FM (12.5 kHz), Mask D Limit (≥250% Authorized BW)	High Power		Med Power		Low Power	
	dBm	44.00	dBm	40.16	dBm	30.17
	Watts	25.12	Watts	10.38	Watts	1.04
	Limit (dBm)	-20	Limit (dBm)	-20	Limit (dBm)	-20
Frequency (MHz)	Peak (dBm)	Margin (dB)	Peak (dBm)	Margin (dB)	Peak (dBm)	Margin (dB)
Fundamental 454.0063	44.00	0.00	40.16	0.00	30.17	0.00
2nd Harmonic 908.0125	-32.91	12.91	-30.81	10.81	-31.32	11.32
3rd Harmonic 1362.0188	-42.88	22.88	-51.90	31.90	-54.49	34.49
4th Harmonic 1816.0250	-49.27	29.27	-53.93	33.93	-57.98	37.98
5th Harmonic 2270.0313	-57.10	37.10	-56.22	36.22	-53.06	33.06
6th Harmonic 2724.0375	-61.70	41.7 *	-61.20	41.20	-63.20	43.2 *
7th Harmonic 3178.0438	-61.56	41.56 *	-61.50	41.5 *	-63.06	43.06 *
8th Harmonic 3632.0500	-61.58	41.58 *	-61.52	41.52 *	-63.08	43.08 *
9th Harmonic 4086.0563	-61.31	41.31 *	-61.25	41.25 *	-62.81	42.81 *
10th Harmonic 4540.0625	-60.97	40.97 *	-60.91	40.91 *	-62.47	42.47 *

* Indicates Noise Floor of Measurement

SPURIOUS EMISSIONS AT ANTENNA TERMINALS

Test Data: 454.99375 MHz

Spurious Conducted Emissions, Narrowband FM (12.5 kHz), Mask D Limit (≥250% Authorized BW)	High Power		Med Power		Low Power	
	dBm	44.00	dBm	40.16	dBm	30.17
	Watts	25.12	Watts	10.38	Watts	1.04
	Limit (dBm)	-20	Limit (dBm)	-20	Limit (dBm)	-20
Frequency (MHz)	Peak (dBm)	Margin (dB)	Peak (dBm)	Margin (dB)	Peak (dBm)	Margin (dB)
Fundamental 454.9938	44.00	0.00	40.16	0.00	30.17	0.00
2nd Harmonic 909.9875	-32.60	12.60	-29.16	9.16	-30.07	10.07
3rd Harmonic 1364.9813	-42.71	22.71	-49.15	29.15	-54.25	34.25
4th Harmonic 1819.9750	-48.69	28.69	-54.25	34.25	-57.89	37.89
5th Harmonic 2274.9688	-54.31	34.31	-53.85	33.85	-52.73	32.73
6th Harmonic 2729.9625	-61.20	41.20	-61.66	41.66	-63.20	43.2 *
7th Harmonic 3184.9563	-61.56	41.56 *	-61.50	41.5 *	-63.06	43.06 *
8th Harmonic 3639.9500	-61.58	41.58 *	-61.52	41.52 *	-63.08	43.08 *
9th Harmonic 4094.9438	-61.31	41.31 *	-61.25	41.25 *	-62.81	42.81 *
10th Harmonic 4549.9375	-60.97	40.97 *	-60.91	40.91 *	-62.47	42.47 *

* Indicates Noise Floor of Measurement

SPURIOUS EMISSIONS AT ANTENNA TERMINALS

Test Data: 456.00625 MHz

Spurious Conducted Emissions, Narrowband FM (12.5 kHz), Mask D Limit (≥250% Authorized BW)	High Power		Med Power		Low Power	
	dBm	44.00	dBm	40.16	dBm	30.17
	Watts	25.12	Watts	10.38	Watts	1.04
	Limit (dBm)	-20	Limit (dBm)	-20	Limit (dBm)	-20
Frequency (MHz)	Peak (dBm)	Margin (dB)	Peak (dBm)	Margin (dB)	Peak (dBm)	Margin (dB)
Fundamental 456.0063	44.00	0.00	40.16	0.00	30.17	0.00
2nd Harmonic 912.0125	-32.47	12.47	-29.26	9.26	-30.23	10.23
3rd Harmonic 1368.0188	-42.96	22.96	-49.12	29.12	-54.55	34.55
4th Harmonic 1824.0250	-48.87	28.87	-54.59	34.59	-56.99	36.99
5th Harmonic 2280.0313	-55.05	35.05	-54.84	34.84	-52.46	32.46
6th Harmonic 2736.0375	-61.81	41.81	-61.75	41.75	-63.20	43.2 *
7th Harmonic 3192.0438	-61.56	41.56 *	-61.50	41.5 *	-63.06	43.06 *
8th Harmonic 3648.0500	-61.58	41.58 *	-61.52	41.52 *	-63.08	43.08 *
9th Harmonic 4104.0563	-61.31	41.31 *	-61.25	41.25 *	-62.81	42.81 *
10th Harmonic 4560.0625	-60.97	40.97 *	-60.91	40.91 *	-62.47	42.47 *

* Indicates Noise Floor of Measurement

SPURIOUS EMISSIONS AT ANTENNA TERMINALS

Test Data: 459.99375 MHz

Spurious Conducted Emissions, Narrowband FM (12.5 kHz), Mask D Limit (≥250% Authorized BW)	High Power		Med Power		Low Power	
	dBm	44.00	dBm	40.16	dBm	30.17
	Watts	25.12	Watts	10.38	Watts	1.04
	Limit (dBm)	-20	Limit (dBm)	-20	Limit (dBm)	-20
Frequency (MHz)	Peak (dBm)	Margin (dB)	Peak (dBm)	Margin (dB)	Peak (dBm)	Margin (dB)
Fundamental 459.9938	44.00	0.00	40.16	0.00	30.17	0.00
2nd Harmonic 919.9875	-32.45	12.45	-31.04	11.04	-31.80	11.80
3rd Harmonic 1379.9813	-43.61	23.61	-49.12	29.12	-53.85	33.85
4th Harmonic 1839.9750	-51.29	31.29	-56.32	36.32	-57.12	37.12
5th Harmonic 2299.9688	-55.28	35.28	-53.69	33.69	-53.29	33.29
6th Harmonic 2759.9625	-61.85	41.85	-60.57	40.57	-63.20	43.2 *
7th Harmonic 3219.9563	-61.56	41.56 *	-61.50	41.5 *	-63.06	43.06 *
8th Harmonic 3679.9500	-61.58	41.58 *	-61.52	41.52 *	-63.08	43.08 *
9th Harmonic 4139.9438	-61.31	41.31 *	-61.25	41.25 *	-62.81	42.81 *
10th Harmonic 4599.9375	-60.97	40.97 *	-60.91	40.91 *	-62.47	42.47 *

* Indicates Noise Floor of Measurement

SPURIOUS EMISSIONS AT ANTENNA TERMINALS

Test Data: 470.00625 MHz

Spurious Conducted Emissions, Narrowband FM (12.5 kHz), Mask D Limit (≥250% Authorized BW)	High Power		Med Power		Low Power	
	dBm	44.00	dBm	40.16	dBm	30.17
	Watts	25.12	Watts	10.38	Watts	1.04
	Limit (dBm)	-20	Limit (dBm)	-20	Limit (dBm)	-20
Frequency (MHz)	Peak (dBm)	Margin (dB)	Peak (dBm)	Margin (dB)	Peak (dBm)	Margin (dB)
Fundamental 470.0063	44.00	0.00	40.16	0.00	30.17	0.00
2nd Harmonic 940.0125	-39.20	19.20	-35.84	15.84	-36.12	16.12
3rd Harmonic 1410.0188	-47.42	27.42	-51.49	31.49	-51.34	31.34
4th Harmonic 1880.0250	-48.95	28.95	-54.07	34.07	-55.73	35.73
5th Harmonic 2350.0313	-54.82	34.82	-54.62	34.62	-57.50	37.50
6th Harmonic 2820.0375	-61.67	41.67	-61.64	41.64 *	-63.20	43.2 *
7th Harmonic 3290.0438	-61.56	41.56 *	-61.50	41.5 *	-63.06	43.06 *
8th Harmonic 3760.0500	-61.58	41.58 *	-61.52	41.52 *	-63.08	43.08 *
9th Harmonic 4230.0563	-61.31	41.31 *	-61.25	41.25 *	-62.81	42.81 *
10th Harmonic 4700.0625	-60.97	40.97 *	-60.91	40.91 *	-62.47	42.47 *

* Indicates Noise Floor of Measurement

SPURIOUS EMISSIONS AT ANTENNA TERMINALS

Test Data: 475.0000 MHz

Spurious Conducted Emissions, Narrowband FM (12.5 kHz), Mask D Limit (≥250% Authorized BW)	High Power		Med Power		Low Power	
	dBm	44.00	dBm	40.16	dBm	30.17
	Watts	25.12	Watts	10.38	Watts	1.04
	Limit (dBm)	-20	Limit (dBm)	-20	Limit (dBm)	-20
Frequency (MHz)	Peak (dBm)	Margin (dB)	Peak (dBm)	Margin (dB)	Peak (dBm)	Margin (dB)
Fundamental 475.0000	44.00	0.00	40.16	0.00	30.17	0.00
2nd Harmonic 950.0000	-39.87	19.87	-36.49	16.49	-37.14	17.14
3rd Harmonic 1425.0000	-49.80	29.80	-52.48	32.48	-50.38	30.38
4th Harmonic 1900.0000	-53.20	33.20	-53.05	33.05	-56.87	36.87
5th Harmonic 2375.0000	-52.54	32.54	-55.18	35.18	-57.74	37.74
6th Harmonic 2850.0000	-61.70	41.7 *	-61.64	41.64 *	-63.20	43.2 *
7th Harmonic 3325.0000	-61.56	41.56 *	-61.50	41.5 *	-63.06	43.06 *
8th Harmonic 3800.0000	-61.58	41.58 *	-61.52	41.52 *	-63.08	43.08 *
9th Harmonic 4275.0000	-61.31	41.31 *	-61.25	41.25 *	-62.81	42.81 *
10th Harmonic 4750.0000	-60.97	40.97 *	-60.91	40.91 *	-62.47	42.47 *

* Indicates Noise Floor of Measurement

SPURIOUS EMISSIONS AT ANTENNA TERMINALS

Test Data: 479.99375 MHz

Spurious Conducted Emissions, Narrowband FM (12.5 kHz), Mask D Limit (≥250% Authorized BW)	High Power		Med Power		Low Power	
	dBm	44.00	dBm	40.16	dBm	30.17
	Watts	25.12	Watts	10.38	Watts	1.04
	Limit (dBm)	-20	Limit (dBm)	-20	Limit (dBm)	-20
Frequency (MHz)	Peak (dBm)	Margin (dB)	Peak (dBm)	Margin (dB)	Peak (dBm)	Margin (dB)
Fundamental 479.9938	44.00	0.00	40.16	0.00	30.17	0.00
2nd Harmonic 959.9875	-40.73	20.73	-37.10	17.10	-37.37	17.37
3rd Harmonic 1439.9813	-49.67	29.67	-53.12	33.12	-51.26	31.26
4th Harmonic 1919.9750	-51.23	31.23	-53.80	33.80	-56.66	36.66
5th Harmonic 2399.9688	-56.43	36.43	-57.69	37.69	-59.99	39.99
6th Harmonic 2879.9625	-61.70	41.7 *	-61.64	41.64 *	-63.20	43.2 *
7th Harmonic 3359.9563	-61.56	41.56 *	-61.50	41.5 *	-63.06	43.06 *
8th Harmonic 3839.9500	-61.58	41.58 *	-61.52	41.52 *	-63.08	43.08 *
9th Harmonic 4319.9438	-61.31	41.31 *	-61.25	41.25 *	-62.81	42.81 *
10th Harmonic 4799.9375	-60.97	40.97 *	-60.91	40.91 *	-62.47	42.47 *

* Indicates Noise Floor of Measurement

Result: Meets Requirement

SPURIOUS EMISSIONS – P25 Phase I C4FM

Test Data: 454.00625 MHz

Spurious Conducted Emissions, C4FM, Mask D Limit (≥250% Authorized BW)	High Power		Med Power		Low Power	
	dBm	44.00	dBm	40.16	dBm	30.17
	Watts	25.12	Watts	10.38	Watts	1.04
	Limit (dBm)	-20	Limit (dBm)	-20	Limit (dBm)	-20
Frequency (MHz)	Peak (dBm)	Margin (dB)	Peak (dBm)	Margin (dB)	Peak (dBm)	Margin (dB)
Fundamental 454.0063	44.00	0.00	40.16	0.00	30.17	0.00
2nd Harmonic 908.0125	-39.31	19.31	-35.94	15.94	-35.93	15.93
3rd Harmonic 1362.0188	-42.61	22.61	-47.33	27.33	-53.23	33.23
4th Harmonic 1816.0250	-53.80	33.80	-57.79	37.79	-61.37	41.37
5th Harmonic 2270.0313	-53.57	33.57	-54.50	34.50	-52.12	32.12
6th Harmonic 2724.0375	-61.67	41.67	-61.64	41.64 *	-63.20	43.2 *
7th Harmonic 3178.0438	-61.56	41.56 *	-61.39	41.39	-63.06	43.06 *
8th Harmonic 3632.0500	-61.58	41.58 *	-61.52	41.52 *	-63.08	43.08 *
9th Harmonic 4086.0563	-61.31	41.31 *	-61.25	41.25 *	-62.81	42.81 *
10th Harmonic 4540.0625	-61.18	41.18	-60.91	40.91 *	-62.47	42.47 *

* Indicates Noise Floor of Measurement

SPURIOUS EMISSIONS AT ANTENNA TERMINALS

Test Data: 454.99375 MHz

Spurious Conducted Emissions, C4FM, Mask D Limit (≥250% Authorized BW)	High Power		Med Power		Low Power	
	dBm	44.00	dBm	40.16	dBm	30.17
	Watts	25.12	Watts	10.38	Watts	1.04
	Limit (dBm)	-20	Limit (dBm)	-20	Limit (dBm)	-20
Frequency (MHz)	Peak (dBm)	Margin (dB)	Peak (dBm)	Margin (dB)	Peak (dBm)	Margin (dB)
Fundamental 454.9938	44.00	0.00	40.16	0.00	30.17	0.00
2nd Harmonic 909.9875	-32.89	12.89	-36.55	16.55	-37.64	17.64
3rd Harmonic 1364.9813	-43.42	23.42	-50.04	30.04	-52.91	32.91
4th Harmonic 1819.9750	-54.00	34.00	-58.76	38.76	-61.54	41.54
5th Harmonic 2274.9688	-54.08	34.08	-54.77	34.77	-52.85	32.85
6th Harmonic 2729.9625	-61.16	41.16	-61.64	41.64 *	-63.20	43.2 *
7th Harmonic 3184.9563	-61.56	41.56 *	-61.50	41.5 *	-63.06	43.06 *
8th Harmonic 3639.9500	-61.58	41.58 *	-61.52	41.52 *	-63.08	43.08 *
9th Harmonic 4094.9438	-61.31	41.31 *	-61.25	41.25 *	-62.81	42.81 *
10th Harmonic 4549.9375	-60.97	40.97 *	-60.91	40.91 *	-62.47	42.47 *

* Indicates Noise Floor of Measurement

SPURIOUS EMISSIONS AT ANTENNA TERMINALS

Test Data: 456.00625 MHz

Spurious Conducted Emissions, C4FM, Mask D Limit (≥250% Authorized BW)	High Power		Med Power		Low Power	
	dBm	44.00	dBm	40.16	dBm	30.17
	Watts	25.12	Watts	10.38	Watts	1.04
	Limit (dBm)	-20	Limit (dBm)	-20	Limit (dBm)	-20
Frequency (MHz)	Peak (dBm)	Margin (dB)	Peak (dBm)	Margin (dB)	Peak (dBm)	Margin (dB)
Fundamental 456.0063	44.00	0.00	40.16	0.00	30.17	0.00
2nd Harmonic 912.0125	-35.28	15.28	-33.66	13.66	-40.92	20.92
3rd Harmonic 1368.0188	-46.22	26.22	-48.88	28.88	-53.52	33.52
4th Harmonic 1824.0250	-53.02	33.02	-59.80	39.80	-60.90	40.90
5th Harmonic 2280.0313	-53.28	33.28	-55.35	35.35	-53.03	33.03
6th Harmonic 2736.0375	-62.04	42.04	-62.15	42.15	-63.20	43.2 *
7th Harmonic 3192.0438	-61.56	41.56 *	-61.50	41.5 *	-63.06	43.06 *
8th Harmonic 3648.0500	-62.62	42.62	-61.52	41.52 *	-63.08	43.08 *
9th Harmonic 4104.0563	-61.31	41.31 *	-61.25	41.25 *	-62.81	42.81 *
10th Harmonic 4560.0625	-60.97	40.97 *	-61.06	41.06	-62.47	42.47 *

* Indicates Noise Floor of Measurement

SPURIOUS EMISSIONS AT ANTENNA TERMINALS

Test Data: 459.99375 MHz

Spurious Conducted Emissions, C4FM, Mask D Limit (≥250% Authorized BW)	High Power		Med Power		Low Power	
	dBm	44.00	dBm	40.16	dBm	30.17
	Watts	25.12	Watts	10.38	Watts	1.04
	Limit (dBm)	-20	Limit (dBm)	-20	Limit (dBm)	-20
Frequency (MHz)	Peak (dBm)	Margin (dB)	Peak (dBm)	Margin (dB)	Peak (dBm)	Margin (dB)
Fundamental 459.9938	44.00	0.00	40.16	0.00	30.17	0.00
2nd Harmonic 919.9875	-43.28	23.28	-33.39	13.39	-34.24	14.24
3rd Harmonic 1379.9813	-45.86	25.86	-49.01	29.01	-51.88	31.88
4th Harmonic 1839.9750	-53.59	33.59	-55.03	35.03	-59.70	39.70
5th Harmonic 2299.9688	-55.97	35.97	-58.52	38.52	-54.62	34.62
6th Harmonic 2759.9625	-62.17	42.17	-60.25	40.25	-63.20	43.2 *
7th Harmonic 3219.9563	-61.56	41.56 *	-61.50	41.5 *	-63.06	43.06 *
8th Harmonic 3679.9500	-61.58	41.58 *	-61.52	41.52 *	-63.08	43.08 *
9th Harmonic 4139.9438	-61.31	41.31 *	-61.25	41.25 *	-62.81	42.81 *
10th Harmonic 4599.9375	-60.97	40.97 *	-60.91	40.91 *	-62.47	42.47 *

* Indicates Noise Floor of Measurement

SPURIOUS EMISSIONS AT ANTENNA TERMINALS

Test Data: 470.00625 MHz

Spurious Conducted Emissions, C4FM, Mask D Limit ($\geq 250\%$ Authorized BW)	High Power		Med Power		Low Power	
	dBm	44.00	dBm	40.16	dBm	30.17
	Watts	25.12	Watts	10.38	Watts	1.04
	Limit (dBm)	-20	Limit (dBm)	-20	Limit (dBm)	-20
Frequency (MHz)	Peak (dBm)	Margin (dB)	Peak (dBm)	Margin (dB)	Peak (dBm)	Margin (dB)
Fundamental 470.0063	44.00	0.00	40.16	0.00	30.17	0.00
2nd Harmonic 940.0125	-36.55	16.55	-33.76	13.76	-35.10	15.10
3rd Harmonic 1410.0188	-46.77	26.77	-50.05	30.05	-50.86	30.86
4th Harmonic 1880.0250	-53.42	33.42	-54.56	34.56	-59.36	39.36
5th Harmonic 2350.0313	-52.70	32.70	-55.24	35.24	-58.43	38.43
6th Harmonic 2820.0375	-62.39	42.39	-61.64	41.64 *	-63.20	43.2 *
7th Harmonic 3290.0438	-61.56	41.56 *	-61.50	41.5 *	-63.06	43.06 *
8th Harmonic 3760.0500	-61.58	41.58 *	-61.52	41.52 *	-63.08	43.08 *
9th Harmonic 4230.0563	-61.31	41.31 *	-61.25	41.25 *	-62.81	42.81 *
10th Harmonic 4700.0625	-60.97	40.97 *	-60.91	40.91 *	-62.47	42.47 *

* Indicates Noise Floor of Measurement

SPURIOUS EMISSIONS AT ANTENNA TERMINALS

Test Data: 475.0000 MHz

Spurious Conducted Emissions, C4FM, Mask D Limit ($\geq 250\%$ Authorized BW)	High Power		Med Power		Low Power	
	dBm	44.00	dBm	40.16	dBm	30.17
	Watts	25.12	Watts	10.38	Watts	1.04
	Limit (dBm)	-20	Limit (dBm)	-20	Limit (dBm)	-20
Frequency (MHz)	Peak (dBm)	Margin (dB)	Peak (dBm)	Margin (dB)	Peak (dBm)	Margin (dB)
Fundamental 475.0000	44.00	0.00	40.16	0.00	30.17	0.00
2nd Harmonic 950.0000	-36.63	16.63	-34.49	14.49	-35.51	15.51
3rd Harmonic 1425.0000	-48.67	28.67	-51.55	31.55	-51.74	31.74
4th Harmonic 1900.0000	-51.29	31.29	-53.02	33.02	-54.59	34.59
5th Harmonic 2375.0000	-53.47	33.47	-56.15	36.15	-61.06	41.06
6th Harmonic 2850.0000	-61.70	41.7 *	-61.64	41.64 *	-63.20	43.2 *
7th Harmonic 3325.0000	-61.56	41.56 *	-61.50	41.5 *	-63.06	43.06 *
8th Harmonic 3800.0000	-61.58	41.58 *	-61.35	41.35	-63.08	43.08 *
9th Harmonic 4275.0000	-61.31	41.31 *	-61.25	41.25 *	-62.81	42.81 *
10th Harmonic 4750.0000	-60.97	40.97 *	-60.91	40.91 *	-62.47	42.47 *

* Indicates Noise Floor of Measurement

SPURIOUS EMISSIONS AT ANTENNA TERMINALS

Test Data: 479.99375 MHz

Spurious Conducted Emissions, C4FM, Mask D Limit ($\geq 250\%$ Authorized BW)	High Power		Med Power		Low Power	
	dBm	44.00	dBm	40.16	dBm	30.17
	Watts	25.12	Watts	10.38	Watts	1.04
	Limit (dBm)	-20	Limit (dBm)	-20	Limit (dBm)	-20
Frequency (MHz)	Peak (dBm)	Margin (dB)	Peak (dBm)	Margin (dB)	Peak (dBm)	Margin (dB)
Fundamental 479.9938	44.00	0.00	40.16	0.00	30.17	0.00
2nd Harmonic 959.9875	-38.13	18.13	-37.11	17.11	-38.11	18.11
3rd Harmonic 1439.9813	-50.45	30.45	-53.47	33.47	-52.33	32.33
4th Harmonic 1919.9750	-49.58	29.58	-53.36	33.36	-55.26	35.26
5th Harmonic 2399.9688	-56.78	36.78	-57.56	37.56	-57.55	37.55
6th Harmonic 2879.9625	-61.70	41.7 *	-61.64	41.64 *	-62.46	42.46
7th Harmonic 3359.9563	-61.56	41.56 *	-61.50	41.5 *	-63.06	43.06 *
8th Harmonic 3839.9500	-61.58	41.58 *	-61.52	41.52 *	-63.08	43.08 *
9th Harmonic 4319.9438	-61.31	41.31 *	-61.25	41.25 *	-62.81	42.81 *
10th Harmonic 4799.9375	-60.97	40.97 *	-60.91	40.91 *	-62.47	42.47 *

* Indicates Noise Floor of Measurement

Result: Meets Requirement

FIELD STRENGTH OF SPURIOUS EMISSIONS

FCC Rule Parts: 2.1053(a), 22.359(a)

Method of Measurement: ANSI C63.26, 5.5.4

Test Site Setup:

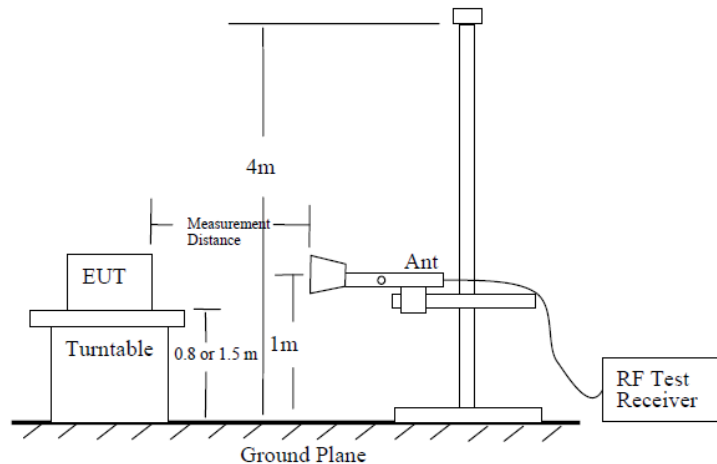

EUT Orientation(s):

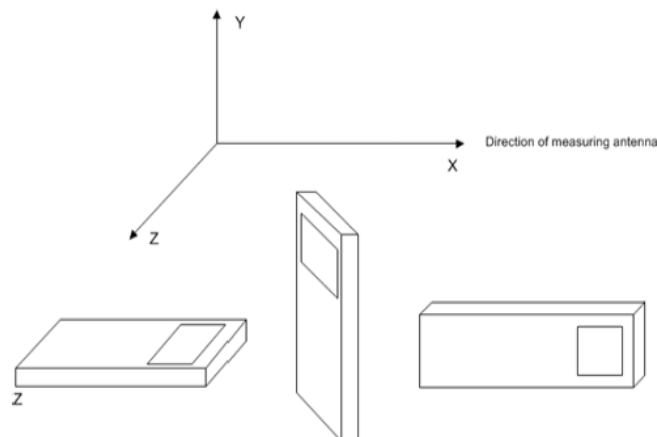

Note: The tabulated data shows the results of the radiated field strength emissions test. The spectrum was scanned from the lowest frequency generated internally to at least the tenth harmonic of the fundamental. This test was conducted in accordance with the standard listed above using the substitution method. Measurements were made at the test site of TIMCO ENGINEERING, INC. located at 849 NW State Road 45, Newberry, FL 32669. The measurements below represent the worst case of all the frequencies tested.

Note: The six (6) highest emissions or more of each worst-case operational modes of the EUT are represented below. Emissions 20 dB below the limit are not required to be reported.

FIELD STRENGTH OF SPURIOUS EMISSIONS

Test Data: 454.00625 MHz

Low Power

Power Output		Limit		
dBm	Watts	dBc	dBm	
30.17	1.04	50.17	-20.00	
Tuned Freq MHz	Emission Frequency MHz	Antenna Polarity	ERP (dBm)	Margin (dB)
454.01	908.01	H	-26.987	6.99
454.01	908.01	V	-32.877	12.88
454.01	1362.02	V	-39.357	19.36
454.01	1816.03	V	-39.987	19.99
454.01	2270.03	H	-37.867	17.87
454.01	2270.03	V	-39.717	19.72

Medium Power

Power Output		Limit		
dBm	Watts	dBc	dBm	
40.16	10.38	60.16	-20.00	
Tuned Freq MHz	Emission Frequency MHz	Antenna Polarity	ERP (dBm)	Margin (dB)
454.01	908.01	V	-32.027	12.03
454.01	908.01	H	-27.257	7.26
454.01	1362.02	V	-39.087	19.09
454.01	1362.02	H	-40.187	20.19
454.01	1816.03	H	-39.597	19.60
454.01	1816.03	V	-39.237	19.24
454.01	2270.03	V	-33.527	13.53
454.01	2270.03	H	-37.757	17.76

FIELD STRENGTH OF SPURIOUS EMISSIONS

High Power

Power Output		Limit		
dBm	Watts	dBc	dBm	
44	25.12	64	-20.00	
Tuned Freq MHz	Emission Frequency MHz	Antenna Polarity	ERP (dBm)	Margin (dB)
454.01	908.01	H	-27.297	7.30
454.01	908.01	V	-27.297	7.30
454.01	2724.04	H	-31.507	11.51
454.01	2724.04	V	-32.197	12.20
454.01	3178.04	V	-34.907	14.91
454.01	1362.02	V	-38.287	18.29
454.01	1816.03	V	-35.877	15.88
454.01	1816.03	H	-39.227	19.23
454.01	2270.03	H	-33.627	13.63
454.01	2270.03	V	-32.197	12.20
454.01	3632.05	V	-34.627	14.63

FIELD STRENGTH OF SPURIOUS EMISSIONS

Test Data: 454.99375 MHz

Low Power

Power Output		Limit		
dBm	Watts	dBc	dBm	
30.17	1.04	50.17	-20.00	
Tuned Freq MHz	Emission Frequency MHz	Antenna Polarity	ERP (dBm)	Margin (dB)
454.99	909.99	V	-31.957	11.96
454.99	909.99	H	-25.198	5.20
454.99	1364.98	V	-36.200	16.20
454.99	1364.98	H	-32.267	12.27
454.99	1819.97	H	-32.098	12.10
454.99	1819.97	V	-33.408	13.41
454.99	2274.97	V	-28.665	8.66
454.99	2274.97	H	-27.070	7.07
454.99	2729.96	H	-36.092	16.09
454.99	2729.96	V	-35.336	15.34
454.99	3184.96	V	-30.961	10.96
454.99	3184.96	H	-31.137	11.14
454.99	3639.95	H	-33.398	13.40
454.99	3639.95	V	-32.837	12.84
454.99	4094.94	V	-32.311	12.31
454.99	4094.94	H	-31.814	11.81
454.99	4549.94	H	-31.345	11.34
454.99	4549.94	V	-30.899	10.90

FIELD STRENGTH OF SPURIOUS EMISSIONS

Medium Power

Power Output		Limit		
dBm	Watts	dBc	dBm	
40.16	10.38	60.16	-20.00	
Tuned Freq MHz	Emission Frequency MHz	Antenna Polarity	ERP (dBm)	Margin (dB)
454.99	909.99	H	-28.067	8.07
454.99	909.99	V	-28.258	8.26
454.99	1364.98	V	-33.200	13.20
454.99	1364.98	V	-32.257	12.26
454.99	1819.97	V	-33.968	13.97
454.99	1819.97	H	-30.208	10.21
454.99	1819.97	V	-26.145	6.14
454.99	1819.97	H	-26.080	6.08
454.99	2274.97	H	-32.802	12.80
454.99	2274.97	V	-33.576	13.58
454.99	2729.96	V	-29.101	9.10
454.99	2729.96	H	-31.227	11.23
454.99	3184.96	H	-33.398	13.40
454.99	3184.96	V	-32.837	12.84
454.99	3639.95	V	-32.311	12.31
454.99	3639.95	H	-31.814	11.81
454.99	4094.94	H	-31.345	11.34
454.99	4094.94	V	-30.899	10.90
454.99	4549.94	V	-30.475	10.48
454.99	4549.94	H	-30.071	10.07

FIELD STRENGTH OF SPURIOUS EMISSIONS

High Power

Power Output		Limit		
dBm	Watts	dBc	dBm	
44	25.12	64	-20.00	
Tuned Freq MHz	Emission Frequency MHz	Antenna Polarity	ERP (dBm)	Margin (dB)
454.99	909.99	V	-27.747	7.75
454.99	909.99	H	-23.308	3.31
454.99	1364.98	H	-32.660	12.66
454.99	1364.98	V	-29.557	9.56
454.99	1819.97	V	-31.978	11.98
454.99	1819.97	H	-29.268	9.27
454.99	2274.97	H	-25.465	5.46
454.99	2274.97	V	-25.560	5.56
454.99	2729.96	V	-36.092	16.09
454.99	2729.96	H	-35.336	15.34
454.99	3184.96	H	-30.841	10.84
454.99	3184.96	V	-30.597	10.60
454.99	3639.95	V	-33.398	13.40
454.99	3639.95	H	-32.837	12.84
454.99	4094.94	H	-32.311	12.31
454.99	4094.94	V	-31.814	11.81
454.99	4549.94	V	-31.345	11.34
454.99	4549.94	H	-30.899	10.90

FIELD STRENGTH OF SPURIOUS EMISSIONS

Test Data: 456.00625 MHz

Low Power

Power Output		Limit		
dBm	Watts	dBc	dBm	
30.17	1.04	50.17	-20.00	
Tuned Freq MHz	Emission Frequency MHz	Antenna Polarity	ERP (dBm)	Margin (dB)
456.01	912.01	H	-25.997	6.00
456.01	912.01	V	-26.018	6.02
456.01	1368.02	H	-34.700	14.70
456.01	1368.02	V	-35.687	15.69
456.01	1824.03	V	-33.808	13.81
456.01	1824.03	H	-31.348	11.35
456.01	2280.03	H	-23.825	3.82
456.01	2280.03	V	-32.300	12.30
456.01	2736.04	V	-36.092	16.09
456.01	2736.04	H	-35.336	15.34
456.01	3192.04	V	-28.741	8.74
456.01	3192.04	H	-31.967	11.97
456.01	3648.05	H	-33.398	13.40
456.01	3648.05	V	-32.837	12.84
456.01	4104.06	V	-32.311	12.31
456.01	4104.06	H	-31.814	11.81
456.01	4560.06	H	-31.345	11.34
456.01	4560.06	V	-30.899	10.90

FIELD STRENGTH OF SPURIOUS EMISSIONS

Medium Power

Power Output		Limit		
dBm	Watts	dBc	dBm	
40.16	10.38	60.16	-20.00	
Tuned Freq MHz	Emission Frequency MHz	Antenna Polarity	ERP (dBm)	Margin (dB)
456.01	912.01	V	-28.277	8.28
456.01	912.01	H	-24.038	4.04
456.01	1368.02	H	-37.270	17.27
456.01	1368.02	V	-36.207	16.21
456.01	1824.03	V	-28.668	8.67
456.01	1824.03	H	-32.948	12.95
456.01	2280.03	H	-27.335	7.33
456.01	2280.03	V	-26.770	6.77
456.01	2736.04	V	-33.022	13.02
456.01	2736.04	H	-32.686	12.69
456.01	3192.04	H	-34.641	14.64
456.01	3192.04	V	-33.997	14.00
456.01	3648.05	V	-33.398	13.40
456.01	3648.05	H	-32.837	12.84
456.01	4104.06	H	-32.311	12.31
456.01	4104.06	V	-31.814	11.81
456.01	4560.06	V	-31.345	11.34
456.01	4560.06	H	-30.899	10.90

FIELD STRENGTH OF SPURIOUS EMISSIONS

High Power

Power Output		Limit		
dBm	Watts	dBc	dBm	
44	25.12	64	-20.00	
Tuned Freq MHz	Emission Frequency MHz	Antenna Polarity	ERP (dBm)	Margin (dB)
456.01	912.01	H	-27.117	7.12
456.01	912.01	V	-25.178	5.18
456.01	1368.02	H	-30.290	10.29
456.01	1368.02	V	-34.297	14.30
456.01	1824.03	V	-28.318	8.32
456.01	1824.03	H	-33.828	13.83
456.01	2280.03	H	-28.815	8.81
456.01	2280.03	V	-30.810	10.81
456.01	2736.04	V	-36.092	16.09
456.01	2736.04	H	-35.336	15.34
456.01	3192.04	H	-34.641	14.64
456.01	3192.04	V	-33.997	14.00
456.01	3648.05	V	-33.398	13.40
456.01	3648.05	H	-32.837	12.84
456.01	4104.06	H	-32.311	12.31
456.01	4104.06	V	-31.814	11.81
456.01	4560.06	V	-31.345	11.34
456.01	4560.06	H	-30.899	10.90

FIELD STRENGTH OF SPURIOUS EMISSIONS

Test Data: 459.99375 MHz

Low Power

Power Output		Limit		
dBm	Watts	dBc	dBm	
30.17	1.04	50.17	-20.00	
Tuned Freq MHz	Emission Frequency MHz	Antenna Polarity	ERP (dBm)	Margin (dB)
459.99	919.99	V	-25.957	5.96
459.99	919.99	H	-26.128	6.13
459.99	1379.98	V	-33.100	13.10
459.99	1379.98	H	-33.467	13.47
459.99	1839.97	H	-33.358	13.36
459.99	1839.97	V	-32.418	12.42
459.99	2299.97	V	-26.535	6.53
459.99	2299.97	H	-25.050	5.05
459.99	2759.96	H	-32.572	12.57
459.99	2759.96	V	-33.146	13.15
459.99	3219.96	V	-29.651	9.65
459.99	3219.96	H	-31.617	11.62
459.99	3679.95	H	-33.398	13.40
459.99	3679.95	V	-32.837	12.84
459.99	4139.94	V	-32.311	12.31
459.99	4139.94	H	-31.814	11.81
459.99	4599.94	H	-31.345	11.34
459.99	4599.94	V	-30.899	10.90

FIELD STRENGTH OF SPURIOUS EMISSIONS

Medium Power

Power Output		Limit		
dBm	Watts	dBc	dBm	
40.16	10.38	60.16	-20.00	
Tuned Freq MHz	Emission Frequency MHz	Antenna Polarity	ERP (dBm)	Margin (dB)
459.99	919.99	H	-28.847	8.85
459.99	919.99	V	-21.238	1.24
459.99	1379.98	V	-32.870	12.87
459.99	1379.98	H	-33.037	13.04
459.99	1839.97	V	-31.878	11.88
459.99	1839.97	H	-33.018	13.02
459.99	2299.97	H	-24.955	4.95
459.99	2299.97	V	-27.510	7.51
459.99	2759.96	V	-30.142	10.14
459.99	2759.96	H	-32.586	12.59
459.99	3219.96	H	-30.771	10.77
459.99	3219.96	V	-29.827	9.83
459.99	3679.95	V	-33.398	13.40
459.99	3679.95	H	-32.837	12.84
459.99	4139.94	H	-29.341	9.34
459.99	4139.94	V	-31.814	11.81
459.99	4599.94	V	-31.345	11.34
459.99	4599.94	H	-30.899	10.90

FIELD STRENGTH OF SPURIOUS EMISSIONS

High Power

Power Output		Limit		
dBm	Watts	dBc	dBm	
44	25.12	64	-20.00	
Tuned Freq MHz	Emission Frequency MHz	Antenna Polarity	ERP (dBm)	Margin (dB)
459.99	919.99	V	-28.157	8.16
459.99	919.99	H	-25.918	5.92
459.99	1379.98	H	-27.460	7.46
459.99	1379.98	V	-28.607	8.61
459.99	1839.97	V	-29.008	9.01
459.99	1839.97	H	-30.278	10.28
459.99	2299.97	H	-24.945	4.94
459.99	2299.97	V	-25.260	5.26
459.99	2759.96	V	-27.852	7.85
459.99	2759.96	H	-23.746	3.75
459.99	3219.96	H	-31.371	11.37
459.99	3219.96	V	-32.237	12.24
459.99	3679.95	V	-28.098	8.10
459.99	3679.95	H	-29.457	9.46
459.99	4139.94	H	-32.311	12.31
459.99	4139.94	V	-31.814	11.81
459.99	4599.94	V	-31.345	11.34
459.99	4599.94	H	-30.899	10.90

FIELD STRENGTH OF SPURIOUS EMISSIONS

Test Data: 470.00625 MHz

Low Power

Power Output		Limit		
dBm	Watts	dBc	dBm	
30.17	1.04	50.17	-20.00	
Tuned Freq MHz	Emission Frequency MHz	Antenna Polarity	ERP (dBm)	Margin (dB)
470.01	940.01	H	-21.067	1.07
470.01	940.01	V	-20.147	0.15
470.01	2350.03	V	-39.887	19.89
470.01	3290.04	V	-39.567	19.57

Medium Power

Power Output		Limit		
dBm	Watts	dBc	dBm	
40.16	10.38	60.16	-20.00	
Tuned Freq MHz	Emission Frequency MHz	Antenna Polarity	ERP (dBm)	Margin (dB)
470.01	940.01	V	-25.847	5.85
470.01	940.01	H	-27.037	7.04
470.01	1410.02	H	-40.287	20.29
470.01	1410.02	V	-38.547	18.55
470.01	1880.03	V	-37.917	17.92
470.01	1880.03	H	-37.127	17.13
470.01	2350.03	H	-33.917	13.92
470.01	2350.03	V	-38.387	18.39
470.01	3290.04	V	-40.107	20.11

High Power

Power Output		Limit		
dBm	Watts	dBc	dBm	
44	25.12	64	-20.00	
Tuned Freq MHz	Emission Frequency MHz	Antenna Polarity	ERP (dBm)	Margin (dB)
470.01	940.01	H	-24.467	4.47
470.01	940.01	V	-24.287	4.29
470.01	2350.03	H	-39.757	19.76
470.01	3290.04	V	-40.437	20.44

FIELD STRENGTH OF SPURIOUS EMISSIONS

Test Data: 475.00 MHz

Low Power

Power Output		Limit		
dBm	Watts	dBc	dBm	
30.17	1.04	50.17	-20.00	
Tuned Freq MHz	Emission Frequency MHz	Antenna Polarity	ERP (dBm)	Margin (dB)
475.00	950.00	V	-27.477	7.48
475.00	950.00	H	-30.147	10.15
475.00	1425.00	H	-40.817	20.82
475.00	1425.00	V	-38.707	18.71
475.00	2375.00	H	-39.227	19.23
475.00	3325.00	V	-39.877	19.88

Medium Power

Power Output		Limit		
dBm	Watts	dBc	dBm	
40.16	10.38	60.16	-20.00	
Tuned Freq MHz	Emission Frequency MHz	Antenna Polarity	ERP (dBm)	Margin (dB)
475.00	950.00	H	-27.587	7.59
475.00	950.00	V	-27.077	7.08
475.00	3325.00	H	-40.227	20.23
475.00	1900.00	H	-39.227	19.23

High Power

Power Output		Limit		
dBm	Watts	dBc	dBm	
44	25.12	64	-20.00	
Tuned Freq MHz	Emission Frequency MHz	Antenna Polarity	ERP (dBm)	Margin (dB)
475.00	950.00	V	-25.330	5.33
475.00	950.00	H	-28.167	8.17
475.00	1425.00	V	-33.887	13.89
475.00	1425.00	H	-34.277	14.28
475.00	2375.00	V	-38.477	18.48
475.00	2375.00	H	-40.507	20.51

FIELD STRENGTH OF SPURIOUS EMISSIONS

Test Data: 479.99375 MHz

Low Power

Power Output		Limit		
dBm	Watts	dBc	dBm	
30.17	1.04	50.17	-20.00	
Tuned Freq MHz	Emission Frequency MHz	Antenna Polarity	ERP (dBm)	Margin (dB)
479.99	959.99	H	-24.907	4.91
479.99	959.99	V	-21.487	1.49
479.99	2399.97	V	-36.777	16.78
479.99	2399.97	H	-40.497	20.50
479.99	1919.97	H	-37.087	17.09
479.99	1919.97	V	-36.647	16.65
479.99	1439.98	V	-38.617	18.62

Medium Power

Power Output		Limit		
dBm	Watts	dBc	dBm	
40.16	10.38	60.16	-20.00	
Tuned Freq MHz	Emission Frequency MHz	Antenna Polarity	ERP (dBm)	Margin (dB)
479.99	959.99	V	-21.147	1.15
479.99	959.99	H	-24.317	4.32
479.99	1439.98	H	-40.357	20.36
479.99	1439.98	V	-39.117	19.12
479.99	1919.97	H	-40.527	20.53
479.99	2399.97	H	-39.737	19.74

FIELD STRENGTH OF SPURIOUS EMISSIONS

High Power

Power Output		Limit		
dBm	Watts	dBc	dBm	
44	25.12	64	-20.00	
Tuned Freq MHz	Emission Frequency MHz	Antenna Polarity	ERP (dBm)	Margin (dB)
479.99	959.99	H	-25.547	5.55
479.99	959.99	V	-29.078	9.08
479.99	1439.98	V	-31.290	11.29
479.99	1439.98	H	-33.677	13.68
479.99	1919.97	H	-38.088	18.09
479.99	1919.97	V	-38.548	18.55
479.99	2399.97	V	-31.025	11.02
479.99	2399.97	H	-33.460	13.46
479.99	2879.96	H	-39.852	19.85
479.99	2879.96	V	-33.256	13.26
479.99	3359.96	H	-35.641	15.64
479.99	3359.96	V	-33.567	13.57
479.99	3839.95	V	-35.778	15.78
479.99	3839.95	H	-40.177	20.18
479.99	4319.94	H	-38.631	18.63
479.99	4319.94	V	-38.134	18.13
479.99	4799.94	V	-37.665	17.66
479.99	4799.94	H	-37.219	17.22

FREQUENCY STABILITY

FCC Rule Parts: 2.1055(a)(2), 22.355

TABLE C-1—FREQUENCY TOLERANCE FOR TRANSMITTERS IN THE PUBLIC MOBILE SERVICES

Frequency range (MHz)	Base, fixed (ppm)	Mobile >3 watts (ppm)	Mobile ≤3 watts (ppm)
450 to 512	2.5	5.0	5.0

The limit below conforms to FCC CFR 47 Part 90. 90.213 and in all cases is more strict than that set forth in this rulepart. Please refer below:

FCC Rule Parts: 90.213

MINIMUM FREQUENCY STABILITY

[Parts per million (ppm)]

Frequency range (MHz)	Fixed and base stations	Mobile stations	
		Over 2 watts output power	2 watts or less output power
421-512	7 ¹¹ 14 ¹⁴ 2.5	8 ⁵	8 ⁵

⁷In the 421-512 MHz band, fixed and base stations with a 12.5 kHz channel bandwidth must have a frequency stability of 1.5 ppm. Fixed and base stations with a 6.25 kHz channel bandwidth must have a frequency stability of 0.5 ppm.

⁸In the 421-512 MHz band, mobile stations designed to operate with a 12.5 kHz channel bandwidth must have a frequency stability of 2.5 ppm. Mobile stations designed to operate with a 6.25 kHz channel bandwidth must have a frequency stability of 1.0 ppm.

¹¹Paging transmitters operating on paging-only frequencies must operate with frequency stability of 5 ppm in the 150-174 MHz band and 2.5 ppm in the 421-512 MHz band.

¹⁴Control stations may operate with the frequency tolerance specified for associated mobile frequencies.

Method of Measurements: TIA 603-E, 2.2.2

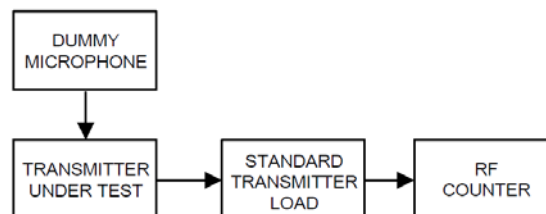

FREQUENCY STABILITY

Test Data: Frequency Error Measurement Plot

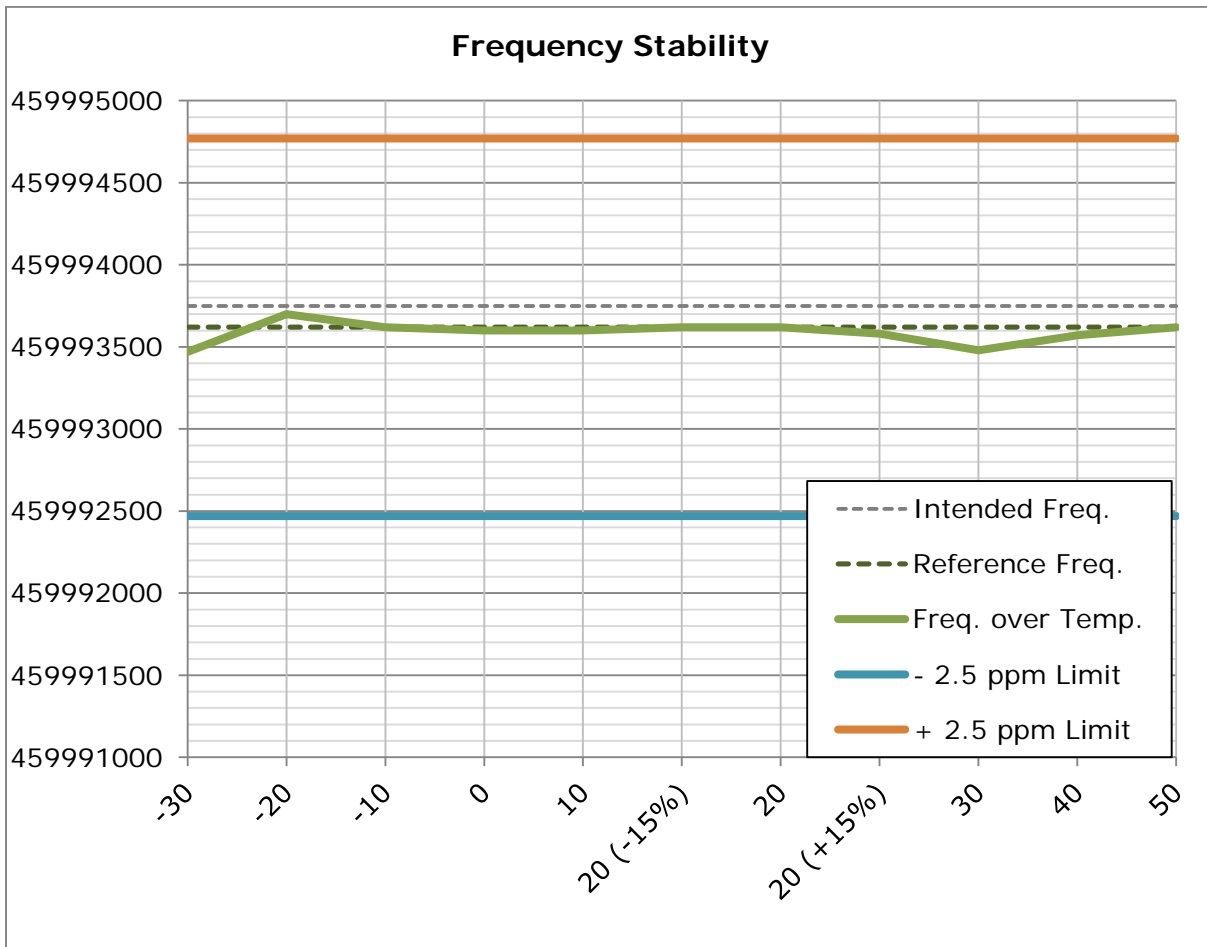

FREQUENCY STABILITY

Test Data: Frequency Error Measurement Table

Limit:		2.5 ppm		
Temperature (°C)	Supplied Voltage (VDC)	Intended Frequency (Hz)	Measured Reference Frequency (Hz)	Deviation (Hz)
20°C (reference)	13.8	459993750	459993620	130

@ 20°C (reference)				
Supplied Voltage (%)	Supplied Voltage (VDC)	Frequency (Hz)	Deviation (Hz)	PPM
-15%	11.73	459993620	0	0.000
15%	15.87	459993580	40	0.087

Temperature (°C)	Supplied Voltage (VDC)	Frequency (Hz)	Deviation (Hz)	PPM
50	13.8	459993620	0.00000	0.000
40	13.8	459993570	50.00000	0.109
30	13.8	459993480	140.00000	0.304
20	13.8	459993620	0.00000	0.000
10	13.8	459993600	20.00000	0.043
0	13.8	459993600	20.00000	0.043
-10	13.8	459993620	0.00000	0.000
-20	13.8	459993700	80.00000	-0.174
-30	13.8	459993470	150.00000	0.326

RESULT: Meets Requirements

STATEMENT OF MEASUREMENT UNCERTAINTY

The data and results referenced in this document are true and accurate. The measurement uncertainty was calculated for all measurements listed in this test report according To CISPR 16-4 or ENTR 100-028 Specification for radio disturbance and immunity measuring apparatus and methods – Part 4: “Uncertainty in EMC Measurements” and is documented in the Timco Engineering, Inc. quality system according to DIN EN ISO/IEC 17025. Furthermore, component and process variability of devices similar to that tested may result in additional deviation. The manufacturer has the sole responsibility of continued compliance of the device.

Hereafter the best measurement capability for Timco Engineering, Inc. is reported:

Test Items	Measurement Uncertainty	Notes
RF Frequency Accuracy	± 49.5 Hz	(1)
RF Conducted Power	±0.93dB	(1)
Conducted spurious emission of transmitter valid up to 40GHz	± 1.86dB	
Occupied Bandwidth	± 2.65%	
Audio Frequency Response	± 1.86dB	
Modulation limiting	± 1.88%	
Radiated RF Power	± 1.4dB	
Maximum frequency deviation: Within 300 Hz and 6kHz of audio freq.	± 1.88%	
Within 6kHz and 25kHz of audio Freq.	± 2.04%	
Rad Emissions Sub Meth up to 26.5GHz	± 2.14dB	
Adjacent channel power	± 1.47dB	(1)
Transient Frequency Response	± 1.88%	
Temperature	± 1.0°C	(1)
Humidity	± 5.0%	

This uncertainty represents an expanded uncertainty expressed at approximately the 95% confidence level using a coverage factor of $k=1.96$.

EMC EQUIPMENT LIST

Device	Manufacturer	Model	Serial Number	Cal/Char Date	Due Date
Coaxial Cable - BMBM-0065-01 Black DC-2G	Belden		BMBM-0065-01	07/18/16	07/18/18
Antenna: Biconical 1096	Eaton	94455-1	1096	08/01/17	08/01/19
Antenna: Log-Periodic 1122	Electro-Metrics	LPA-25	1122	07/26/17	07/26/19
Temperature Chamber LARGE	Tenney Engineering	TTRC	11717-7	09/01/16	09/01/18
Frequency Counter Small Chamber	HP	5385A	3242A07460	08/22/17	08/22/19
Coaxial Cable - Chamber 3 cable set (backup)	Micro-Coax	Chamber 3 cable set (backup)	KMKM-0244-02 KMKM-0670-01 KFKF-0197-00	N/A	N/A
CHAMBER	Panashield	3M	N/A	04/25/16	5/31/18
Antenna: Double-Ridged Horn/ETS Horn 2	ETS-Lindgren	3117	00041534	03/01/17	03/01/19
Software: Field Strength Program	Timco	N/A	Version 4.10.7.0	N/A	N/A
Antenna: Passive Loop	EMCO	6512	9706-1211	07/26/17	07/26/19
Type K J Thermometer	Martel	303	080504494	11/02/17	11/02/19
EMI Test Receiver R & S ESIB 40	Rohde & Schwarz	ESIB 40	100274	08/18/16	08/18/18
EMI Test Receiver R & S ESU 40	Rohde & Schwarz	ESU 40	100320	04/01/16	04/01/19
Attenuator N 20dB 20W DC-12G	Narda	768-20-SP	155	07/10/17	07/10/19
Attenuator N 20dB 20W DC-12G	Narda	768-20-SP	344	07/10/17	07/10/19
Attenuator N 30dB 100W DC-6G	Pasternack	PE7214-30	#109	05/24/17	05/24/19
Attenuator BNC 10dB DC-2G	MiniCircuits	HAT-10+	#54	07/14/17	07/14/19
Bore-sight Antenna Positioning Tower	Sunol Sciences	TLT2	N/A	N/A	N/A
Tunable Notch Filter 250-850 MHz	Eagle	TNF-200	250-850 MHz (#19)	11/19/17	11/19/19
Terminator N 20W DC-18G	Narda	8205	#14	04/06/17	04/06/19
Attenuator BNC 6dB 50Ohm DC-2G	Mini-Circuits	HAT-6+	#53	07/14/17	07/14/19
Attenuator N 30dB 100W DC-6G	Pasternack	PE7214-30	#109	05/24/17	05/23/19
DC Power Supply	HP	6286A	1744A03842	N/A	N/A
Modulation Analyzer	HP	8901A	3050A05856	04/13/17	04/13/19
Function Generator	Standford	DS340	25200	02/21/18	02/21/20
Terminator N 20W DC-18G	Narda	8205	#14	04/06/17	04/06/19

*EMI RECEIVER SOFTWARE VERSION

The receiver firmware used was version 4.43 Service Pack 3

END OF TEST REPORT