



FCC CFR 47 Part 22 E Test Report

APPLICANT	STANDARD COMMUNICATIONS PTY.LTD.
ADDRESS	17 GIBBON WINSTON HILLS 2153 AUSTRALIA
FCC ID	TXJCM60U25
MODEL NUMBER	CM60-U25B, CM60-U25D, CM60-U25L, CM60-U25P, CM60-U25R, CM60-U25S
PRODUCT DESCRIPTION	UHF MOBILE TRANSCEIVER
DATE SAMPLE RECEIVED	4/11/2018
FINAL TEST DATE	4/27/2018
TESTED BY	Franklin Rose
APPROVED BY	Tim Royer
TEST RESULTS	<input checked="" type="checkbox"/> PASS <input type="checkbox"/> FAIL

Report Number	Report Version	Description	Issue Date
492CUT18 PT22_TestReport_	Rev1	Initial Issue	04/27/2018
492CUT18 PT22_TestReport_	Rev2	Clerical Update	05/30/2018
492CUT18 PT22_TestReport_	Rev3	Updated Model Numbers and Emission Designator	11/06/2018
492CUT18 PT22_TestReport_	Rev4	Updated Address	12/28/2018

THE ATTACHED REPORT SHALL NOT BE REPRODUCED EXCEPT IN FULL WITHOUT THE WRITTEN APPROVAL OF TIMCO ENGINEERING, INC.

TABLE OF CONTENTS

GENERAL REMARKS	2
GENERAL INFORMATION	3
RESULTS SUMMARY	4
RF POWER OUTPUT	5
PART 2.1033 (c)(8) DC INPUT INTO FINAL AMPLIFIER.....	5
MODULATION CHARACTERISTICS	6
11K2F3E (NARROWBAND ANALOG FM VOICE) BANDWIDTH	6
8K10F1E/F1D (C4FM VOICE/DATA) BANDWIDTH	6
AUDIO FREQUENCY RESPONSE & LOW PASS FILTER	7
Test Data: 12.5 kHz FM Audio Frequency Response & Low Pass Filter.....	7
MODULATION LIMITING	8
Test Data: 12.5 kHz FM Modulation Limiting.....	8
OCCUPIED BANDWIDTH.....	9
TEST DATA: 11K2F3E (NARROWBAND ANALOG FM VOICE).....	10
TEST DATA: 8K10F1E/F1D (C4FM VOICE/DATA).....	11
SPURIOUS EMISSIONS AT ANTENNA TERMINALS (CONDUCTED).....	12
SPURIOUS EMISSIONS - NARROWBAND FM (12.5 kHz)	13
Test Data: 454.9925 MHz	13
Test Data: 456.0075 MHz	14
Test Data: 459.9925 MHz	15
Test Data: 470.0075 MHz	16
Test Data: 490.0000 MHz	17
Test Data: 511.9925 MHz	18
SPURIOUS EMISSIONS – P25 PHASE I C4FM (12.5 kHz)	19
Test Data: 454.9925 MHz	19
Test Data: 456.0075 MHz	20
Test Data: 459.9925 MHz	21
Test Data: 470.0075 MHz	22
Test Data: 490.0000 MHz	23
Test Data: 511.9925 MHz	24
FIELD STRENGTH OF SPURIOUS EMISSIONS	25
TEST DATA: 454.9925 MHz	26
TEST DATA: 456.0075 MHz	27
TEST DATA: 459.9925 MHz	28
TEST DATA: 470.0075 MHz	29
TEST DATA: 490.0000 MHz	30
TEST DATA: 511.9925 MHz	31
FREQUENCY STABILITY	32
STATEMENT OF MEASUREMENT UNCERTAINTY	35
EMC EQUIPMENT LIST	36

GENERAL REMARKS

Summary

The device under test does:

- Fulfill the general approval requirements as identified in this test report and was selected by the customer.
- Not fulfill the general approval requirements as identified in this test report

Attestations

This equipment has been tested in accordance with the standards identified in this test report. To the best of my knowledge and belief, these tests were performed using the measurement procedures described in this report.

All instrumentation and accessories used to test products for compliance to the indicated standards are calibrated regularly in accordance with ISO 17025 requirements.

I attest that the necessary measurements were made at:

Timco Engineering Inc.
849 NW State Road 45
Newberry, FL 32669
Designation #: US1070

Tested by:



Name and Title	Franklin Rose, Project Manager / EMC Testing Technician
Date	04/27/2018

Reviewed and Approved by:



Name and Title	Tim Royer, Project Manager / EMC Testing Engineer
Date	04/27/2018

GENERAL INFORMATION

EUT Specification

EUT Description	UHF MOBILE TRANSCEIVER
FCC ID	TXJCM60U25
Model Number	CM60-U25B, CM60-U25D, CM60-U25L, CM60-U25P, CM60-U25R, CM60-U25S
Operating Frequency	Band 1: 454 – 455 MHz Band 2: 456 – 460 MHz Band 3: 470 – 512 MHz
Test Frequencies	Band 1: 454.9925 MHz Band 2: 456.0075, 459.9925 MHz Band 3: 470.0075, 490.00, 511.9925 MHz
Type of Emission	11K2F3E (Narrowband Analog FM Voice), 8K10F1E (P25 Phase I C4FM Voice), 8K10F1D (P25 Phase I C4FM Data)
Modulation	FM
EUT Power Source	<input type="checkbox"/> 110–120Vac/50– 60Hz
	<input checked="" type="checkbox"/> DC Power (13.8 V)
	<input type="checkbox"/> Battery Operated Exclusively
Test Item	<input type="checkbox"/> Prototype
	<input checked="" type="checkbox"/> Pre-Production
	<input type="checkbox"/> Production
Type of Equipment	<input type="checkbox"/> Fixed
	<input checked="" type="checkbox"/> Mobile
	<input type="checkbox"/> Portable
Antenna Connector	BNC
Test Conditions	The temperature was 26°C Relative humidity of 50%.
Modification to the EUT	No Modification to EUT.
Test Exercise	The EUT was placed in continuous transmit and was operated in “Test Mode” for digital emissions tests.
Applicable Standards	ANSI/TIA 603-E:2016, ANSI C63.26, FCC CFR 47 Part 2, Part 22
Test Facility	Timco Engineering Inc. at 849 NW State Road 45 Newberry, FL 32669 USA. Designation #: US1070

RESULTS SUMMARY

Rule Part No.	Test Item	Results
2.1046(a), 22.565(f), 22.593, 22.627(a), (b), 22.659(a)	RF Power Output	PASS
Part 2.1033(c)(4)	Modulation Characteristics	PASS
2.1047(a)	Audio Frequency Response and Low Filter	PASS
2.1047(b)	Modulation Limiting	PASS
2.1049 (c)	Occupied Bandwidth	PASS
2.1051(a), 22.359(a)	Spurious Emissions at Antenna Terminals	PASS
2.1053(a), 22.359(a)	Field Strength of Spurious Emissions	PASS
2.1055(a)(2), 22.355	Frequency Stability < 5 ppm	PASS

RF POWER OUTPUT

FCC Rule Parts: 2.1046(a), 22.565(f), 22.593, 22.627(a), (b), 22.659(a)

(f) *Mobile transmitters.* The transmitter output power of mobile transmitters must not exceed 60 watts.

The effective radiated power of fixed stations operating on the channels listed in §22.591 must not exceed 150 Watts. The equivalent isotropically radiated power of existing fixed microwave stations (2110-2130 and 2160-2180 MHz) licensed under this part (pursuant to former rules) must not exceed the applicable limits set forth in §101.113 of this chapter.

The effective radiated power (ERP) of transmitters operating on the channels listed in §22.621 must not exceed the limits in this section.

(a) *Maximum ERP.* The ERP must not exceed the applicable limits in this paragraph under any circumstances.

Frequency range (MHz)	Maximum ERP (watts)
470-512	1000
928-929	50
932-933	30
941-942	600
952-960	150

(b) *470-512 MHz limits.* The purpose of the rules in paragraphs (b)(1) through (b)(3) of this section is to reduce the likelihood that interference to television reception from public mobile operations on these channels will occur. The protected TV station locations specified in this section are the locations of record as of September 1974, and these do not change even though the TV stations may have been subsequently relocated.

(a) *Maximum ERP.* The ERP of base transmitters must not exceed 100 Watts under any circumstances. The ERP of mobile transmitters must not exceed 60 Watts under any circumstances.

Method of Measurement: TIA-603-E, 2.2.1

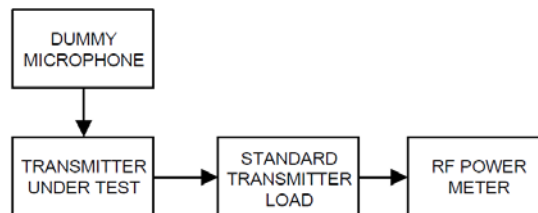

Test Data: Power Measurement Table

Peak Power Output					
dBm			Watts		
High	Med	Low	High	Med	Low
43.96	39.98	29.99	24.89	9.95	1.00

Part 2.1033 (c) (8) DC Input into Final Amplifier

INPUT POWER: (13.8 V) (6.0 A) = **82.8 Watts**

Result: Meets Requirements

Applicant: STANDARD COMMUNICATIONS PTY.LTD.
 FCC ID: TXJCM60U25
 Report: 492CUT18 PT22_TestReport_Rev4

[Table of Contents](#)

MODULATION CHARACTERISTICS

FCC Rule Parts: Part 2.1033(c)(4)

11K2F3E (Narrowband Analog FM Voice) Bandwidth

$$B_n = 2M + 2Dk$$
$$B_n = (2 \times 3) + (2 \times 2.5) = 11.0 \text{ kHz}$$

Where:

$$f_m = \text{modulating frequency, kHz}$$
$$f_d = \text{deviation, kHz}$$
$$k = \text{constant} (= 1)$$

Necessary Bandwidth for 11K2F3E = **11.0 kHz**

90. 209(b)(5) Authorized Bandwidth for 11K2F3E = **11.25 kHz**

8K10F1E/F1D (C4FM Voice/Data) Bandwidth

$$B_n = (R/\log_2 S) + 2DK$$
$$B_n = (9600/\log_2(4)) + 2(1800)(0.916)$$
$$B_n = 4800 + 3298$$
$$B_n = 8.10 \text{ kHz}$$

Where:

$$R \text{ (data rate)} = 9600 \text{ bps}$$
$$D \text{ (peak deviation)} = 1800 \text{ Hz}$$
$$S \text{ (symbols)} = 4$$
$$K \text{ (constant)} = 0.916$$

Necessary Bandwidth for 8K10F1E/F1D (99% Occupied Bandwidth) = **8.10 kHz**

90. 209(b)(5) Authorized Bandwidth for 8K10F1E/F1D = **11.25 kHz**

Note: This device is intended for operation also under FCC CFR 47 Part 90. Part 22 E "One-way or Two-way Mobile Operation" does not provide a bandwidth limitation, so Part 90 bandwidth limitations have been shown in this test report.

Result: Meets Requirements

AUDIO FREQUENCY RESPONSE & LOW PASS FILTER

Rule Part No.: 2.1047(a)

Requirements:

(a) *Voice modulated communication equipment.* A curve or equivalent data showing the frequency response of the audio modulating circuit over a range of 100 to 5000 Hz shall be submitted. For equipment required to have an audio low-pass filter, a curve showing the frequency response of the filter, or of all circuitry installed between the modulation limiter and the modulated stage shall be submitted.

Test Procedure: TIA 603-E, 2.2.6.2.2, 2.2.15 (Using the Test Setup from section 2.2.6)

Note: The Low Pass Filter is digital, and has no "input" or "output" as found in the method of measurement, above. Testing has been altered accordingly to show the operation of the filter.

Note: Testing deviates from TIA 603-E 2.2.6.2.2 and 2.2.15. The Audio Frequency Response and Low Pass Filter Response plot data has been taken simultaneously using the Modulation Meter reading of Deviation (kHz), satisfying the requirements above.

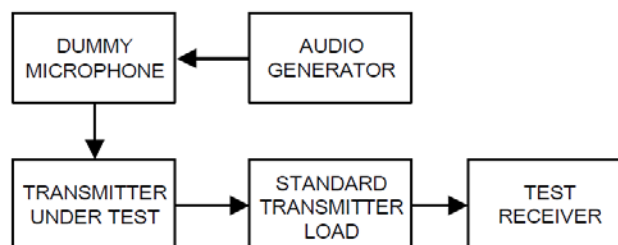

Test Data: 12.5 kHz FM Audio Frequency Response & Low Pass Filter

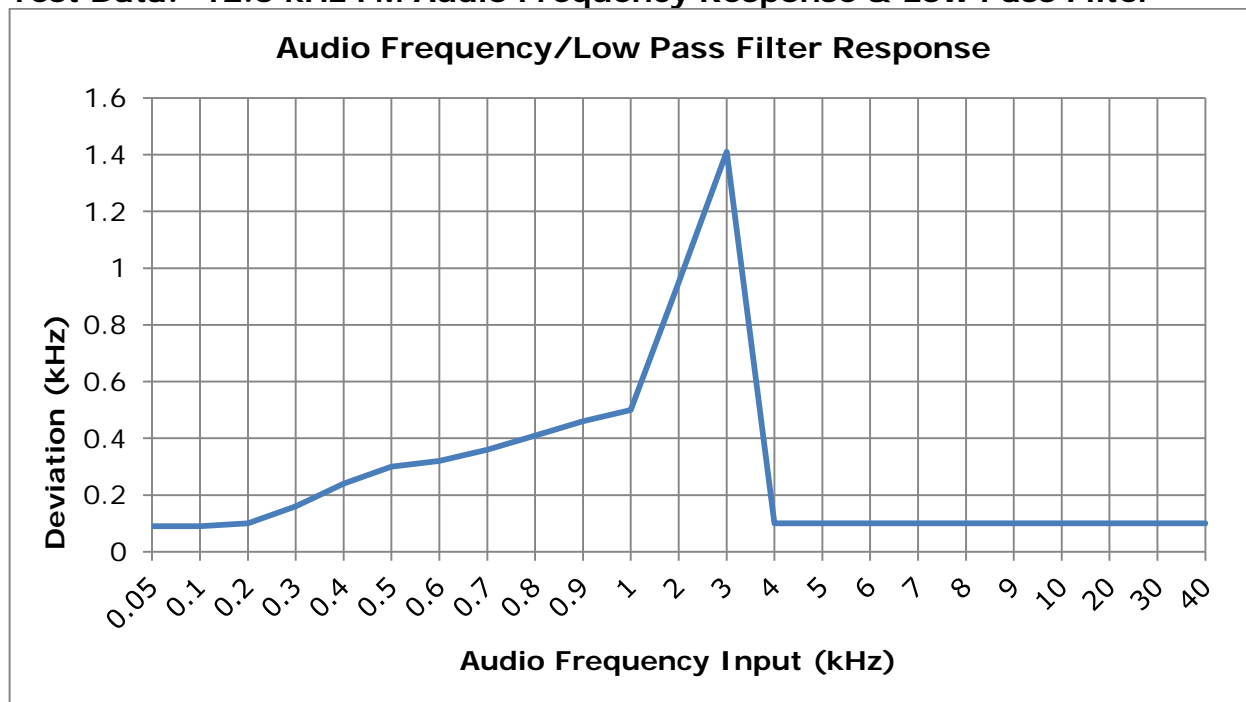

MODULATION LIMITING

Rule Part No.: 2.1047(b)

Requirements:

(b) *Equipment which employs modulation limiting.* A curve or family of curves showing the percentage of modulation versus the modulation input voltage shall be supplied. The information submitted shall be sufficient to show modulation limiting capability throughout the range of modulating frequencies and input modulating signal levels employed.

Test Procedure: TIA 603-E, 2.2.3

Note: The test method alone is not sufficient to meet the standard of FCC Pt. 2.1047(b). Deviation (kHz), as recorded from test equipment, has been converted into percentage as required above.

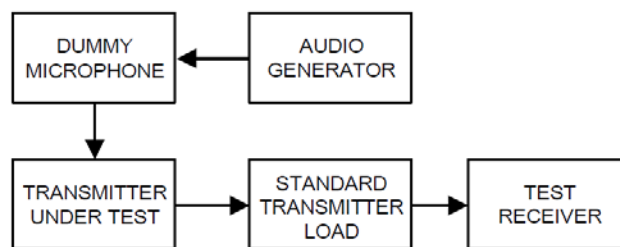

Test Data: 12.5 kHz FM Modulation Limiting

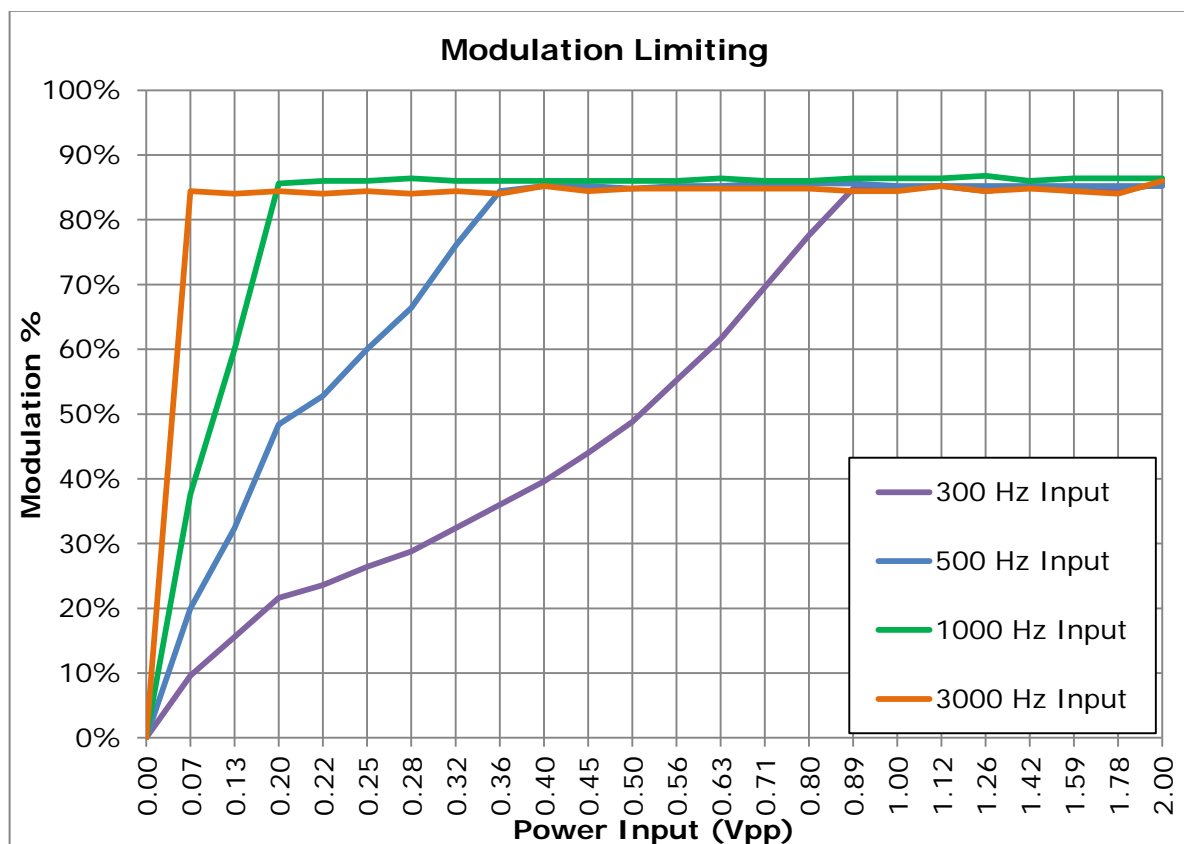

OCCUPIED BANDWIDTH

FCC Rule Parts: 2.1049 (c)

(c) Radiotelephone transmitters equipped with a device to limit modulation or peak envelope power shall be modulated as follows. For single sideband and independent sideband transmitters, the input level of the modulating signal shall be 10 dB greater than that necessary to produce rated peak envelope power.

(1) Other than single sideband or independent sideband transmitters—when modulated by a 2500 Hz tone at an input level 16 dB greater than that necessary to produce 50 percent modulation. The input level shall be established at the frequency of maximum response of the audio modulating circuit.

Method of Measurement: ANSI C63.26, 5.4.4 (using Test Setup from TIA 603-E 2.2.11, below)

Note: The receiver's automatic 99% Occupied Bandwidth function was used. The function is identical in operation to ANSI C63.26, 5.4.4, Step e).

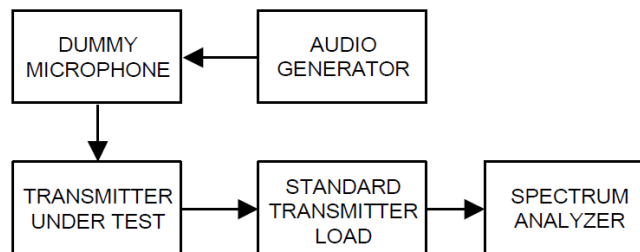

OCCUPIED BANDWIDTH 99%

Test Data: 11K2F3E (Narrowband Analog FM Voice)

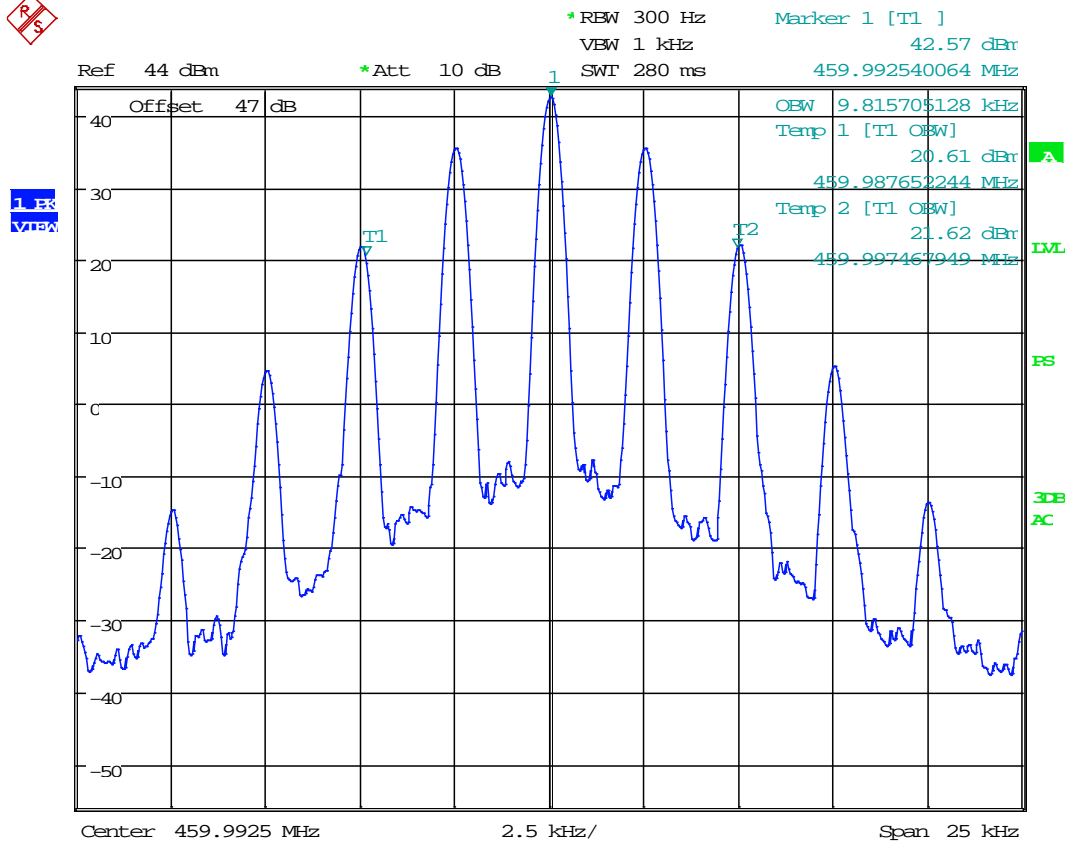

Date: 26.APR.2018 19:40:31

99% OBW = 9.82 kHz

OCCUPIED BANDWIDTH 99%

Test Data: 8K10F1E/F1D (C4FM Voice/Data)

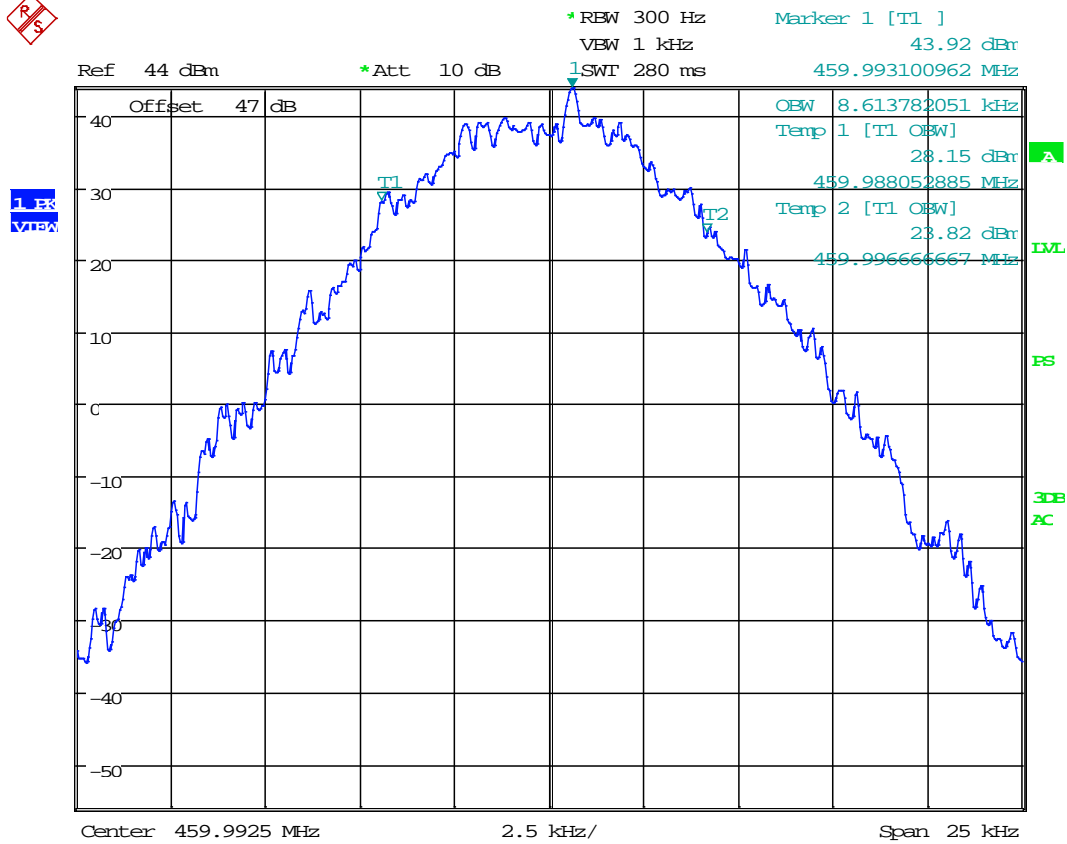

Date: 26.APR.2018 19:41:48

99% OBW = 8.61 kHz

Result: Meets Requirements

SPURIOUS EMISSIONS AT ANTENNA TERMINALS (CONDUCTED)

FCC Rule Parts: 2.1051(a), 22.359(a)

Requirements:

(a) *Out of band emissions.* The power of any emission outside of the authorized operating frequency ranges must be attenuated below the transmitting power (P) by a factor of at least $43 + 10 \log (P)$ dB.

The limit below conforms to FCC CFR 47 Part 90.210(d)(3) and in all cases is more strict than that set forth in this rulepart. Please refer below:

FCC Rule Parts: 90.210(d)(3)

(3) On any frequency removed from the center of the authorized bandwidth by a displacement frequency (f_d in kHz) of more than 12.5 kHz: At least $50 + 10 \log (P)$ dB or 70 dB, whichever is the lesser attenuation.

Method of Measurement: TIA-603-E

Test Procedure: TIA 603-E, 2.2.13

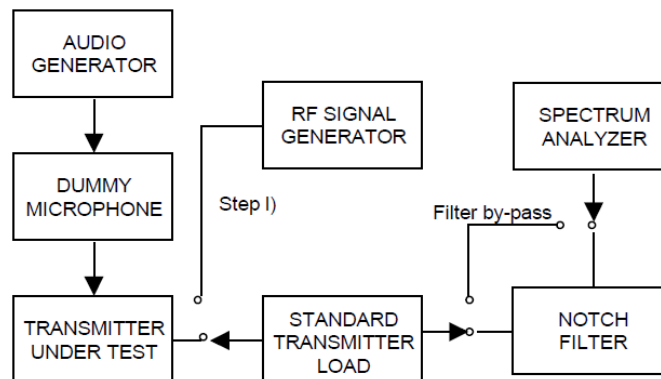

SPURIOUS EMISSIONS - NARROWBAND FM (12.5 kHz)

Test Data: 454.9925 MHz

Spurious Conducted Emissions, 12.5 kHz FM, Mask D Limit ($\geq 250\%$ Authorized BW)	High Power		Med Power		Low Power	
	dBm	43.96	dBm	39.98	dBm	29.99
	Watts	24.89	Watts	9.95	Watts	1.00
	Limit (dBm)	-20	Limit (dBm)	-20	Limit (dBm)	-20
Frequency (MHz)	Peak (dBm)	Margin (dB)	Peak (dBm)	Margin (dB)	Peak (dBm)	Margin (dB)
Fundamental 454.9925	43.96	0.00	39.98	0.00	29.99	0.00
2nd Harmonic 909.9850	-35.42	15.42	-38.17	18.17	-38.84	18.84
3rd Harmonic 1364.9775	-46.43	26.43	-48.53	28.53	-51.63	31.63
4th Harmonic 1819.9700	-46.72	26.72	-50.07	30.07	-52.28	32.28
5th Harmonic 2274.9625	-46.07	26.07	-52.02	32.02	-46.99	26.99
6th Harmonic 2729.9550	-53.28	33.28	-53.86	33.86	-57.57	37.57
7th Harmonic 3184.9475	-58.86	38.86 *	-58.86	38.86 *	-59.02	39.02 *
8th Harmonic 3639.9400	-58.88	38.88 *	-58.88	38.88 *	-59.04	39.04 *
9th Harmonic 4094.9325	-58.61	38.61 *	-58.61	38.61 *	-58.77	38.77 *
10th Harmonic 4549.9250	-58.27	38.27 *	-58.27	38.27 *	-58.43	38.43 *

* Indicates Noise Floor of Measurement

SPURIOUS EMISSIONS AT ANTENNA TERMINALS

Test Data: 456.0075 MHz

Spurious Conducted Emissions, 12.5 kHz FM, Mask D Limit ($\geq 250\%$ Authorized BW)	High Power		Med Power		Low Power	
	dBm	43.96	dBm	39.98	dBm	29.99
	Watts	24.89	Watts	9.95	Watts	1.00
	Limit (dBm)	-20	Limit (dBm)	-20	Limit (dBm)	-20
Frequency (MHz)	Peak (dBm)	Margin (dB)	Peak (dBm)	Margin (dB)	Peak (dBm)	Margin (dB)
Fundamental 456.0075	43.96	0.00	39.98	0.00	29.99	0.00
2nd Harmonic 912.0150	-35.97	15.97	-37.43	17.43	-38.75	18.75
3rd Harmonic 1368.0225	-43.72	23.72	-48.69	28.69	-51.56	31.56
4th Harmonic 1824.0300	-48.85	28.85	-50.99	30.99	-52.33	32.33
5th Harmonic 2280.0375	-44.49	24.49	-49.89	29.89	-46.89	26.89
6th Harmonic 2736.0450	-46.86	26.86	-52.69	32.69	-56.71	36.71
7th Harmonic 3192.0525	-58.01	38.01 *	-58.89	38.89 *	-58.86	38.86 *
8th Harmonic 3648.0600	-58.03	38.03 *	-58.91	38.91 *	-58.88	38.88 *
9th Harmonic 4104.0675	-57.76	37.76 *	-58.64	38.64 *	-58.61	38.61 *
10th Harmonic 4560.0750	-57.42	37.42 *	-58.30	38.3 *	-58.27	38.27 *

* Indicates Noise Floor of Measurement

SPURIOUS EMISSIONS AT ANTENNA TERMINALS

Test Data: 459.9925 MHz

Spurious Conducted Emissions, 12.5 kHz FM, Mask D Limit ($\geq 250\%$ Authorized BW)	High Power		Med Power		Low Power	
	dBm	43.96	dBm	39.98	dBm	29.99
	Watts	24.89	Watts	9.95	Watts	1.00
	Limit (dBm)	-20	Limit (dBm)	-20	Limit (dBm)	-20
Frequency (MHz)	Peak (dBm)	Margin (dB)	Peak (dBm)	Margin (dB)	Peak (dBm)	Margin (dB)
Fundamental 459.9925	43.96	0.00	39.98	0.00	29.99	0.00
2nd Harmonic 919.9850	-36.02	16.02	-37.50	17.50	-38.96	18.96
3rd Harmonic 1379.9775	-42.79	22.79	-46.67	26.67	-49.02	29.02
4th Harmonic 1839.9700	-55.12	35.12	-55.25	35.25	-56.73	36.73
5th Harmonic 2299.9625	-37.73	17.73	-42.81	22.81	-46.09	26.09
6th Harmonic 2759.9550	-48.08	28.08	-55.32	35.32	-57.44	37.44
7th Harmonic 3219.9475	-59.47	39.47	-59.00	39 *	-58.34	38.34 *
8th Harmonic 3679.9400	-58.56	38.56 *	-59.02	39.02 *	-58.36	38.36 *
9th Harmonic 4139.9325	-58.29	38.29 *	-58.75	38.75 *	-58.09	38.09 *
10th Harmonic 4599.9250	-57.95	37.95 *	-58.41	38.41 *	-57.75	37.75 *

* Indicates Noise Floor of Measurement

SPURIOUS EMISSIONS AT ANTENNA TERMINALS

Test Data: 470.0075 MHz

Spurious Conducted Emissions, 12.5 kHz FM, Mask D Limit ($\geq 250\%$ Authorized BW)	High Power		Med Power		Low Power	
	dBm	43.96	dBm	39.98	dBm	29.99
	Watts	24.89	Watts	9.95	Watts	1.00
	Limit (dBm)	-20	Limit (dBm)	-20	Limit (dBm)	-20
Frequency (MHz)	Peak (dBm)	Margin (dB)	Peak (dBm)	Margin (dB)	Peak (dBm)	Margin (dB)
Fundamental 470.0075	43.96	0.00	39.98	0.00	29.99	0.00
2nd Harmonic 940.0150	-37.52	17.52	-37.87	17.87	-39.07	19.07
3rd Harmonic 1410.0225	-47.99	27.99	-51.16	31.16	-50.39	30.39
4th Harmonic 1880.0300	-62.84	42.84	-60.69	40.69	-60.67	40.67
5th Harmonic 2350.0375	-34.67	14.67	-42.41	22.41	-44.02	24.02
6th Harmonic 2820.0450	-60.87	40.87	-60.50	40.50	-61.25	41.25
7th Harmonic 3290.0525	-58.85	38.85 *	-59.18	39.18 *	-58.06	38.06 *
8th Harmonic 3760.0600	-58.87	38.87 *	-59.20	39.2 *	-58.08	38.08 *
9th Harmonic 4230.0675	-57.70	37.70	-58.93	38.93 *	-57.81	37.81 *
10th Harmonic 4700.0750	-58.26	38.26 *	-58.59	38.59 *	-57.47	37.47 *

* Indicates Noise Floor of Measurement

SPURIOUS EMISSIONS AT ANTENNA TERMINALS

Test Data: 490.0000 MHz

Spurious Conducted Emissions, 12.5 kHz FM, Mask D Limit ($\geq 250\%$ Authorized BW)	High Power		Med Power		Low Power	
	dBm	43.96	dBm	39.98	dBm	29.99
	Watts	24.89	Watts	9.95	Watts	1.00
	Limit (dBm)	-20	Limit (dBm)	-20	Limit (dBm)	-20
Frequency (MHz)	Peak (dBm)	Margin (dB)	Peak (dBm)	Margin (dB)	Peak (dBm)	Margin (dB)
Fundamental 490.0000	43.96	0.00	39.98	0.00	29.99	0.00
2nd Harmonic 980.0000	-37.93	17.93	-37.22	17.22	-37.09	17.09
3rd Harmonic 1470.0000	-48.37	28.37	-52.38	32.38	-50.36	30.36
4th Harmonic 1960.0000	-50.41	30.41	-58.21	38.21	-62.00	42.00
5th Harmonic 2450.0000	-34.50	14.50	-44.21	24.21	-48.36	28.36
6th Harmonic 2940.0000	-55.85	35.85	-59.33	39.33	-60.93	40.93
7th Harmonic 3430.0000	-58.27	38.27 *	-58.67	38.67 *	-58.49	38.49 *
8th Harmonic 3920.0000	-58.29	38.29 *	-58.69	38.69 *	-58.51	38.51 *
9th Harmonic 4410.0000	-58.02	38.02 *	-58.42	38.42 *	-58.24	38.24 *
10th Harmonic 4900.0000	-57.68	37.68 *	-58.08	38.08 *	-57.90	37.9 *

* Indicates Noise Floor of Measurement

SPURIOUS EMISSIONS AT ANTENNA TERMINALS

Test Data: 511.9925 MHz

Spurious Conducted Emissions, 12.5 kHz FM, Mask D Limit ($\geq 250\%$ Authorized BW)	High Power		Med Power		Low Power	
	dBm	43.96	dBm	39.98	dBm	29.99
	Watts	24.89	Watts	9.95	Watts	1.00
	Limit (dBm)	-20	Limit (dBm)	-20	Limit (dBm)	-20
Frequency (MHz)	Peak (dBm)	Margin (dB)	Peak (dBm)	Margin (dB)	Peak (dBm)	Margin (dB)
Fundamental 490.0000	43.96	0.00	39.98	0.00	29.99	0.00
2nd Harmonic 980.0000	-31.02	11.02	-31.24	11.24	-31.46	11.46
3rd Harmonic 1470.0000	-46.67	26.67	-48.33	28.33	-49.77	29.77
4th Harmonic 1960.0000	-47.91	27.91	-54.16	34.16	-56.01	36.01
5th Harmonic 2450.0000	-48.54	28.54	-53.21	33.21	-55.45	35.45
6th Harmonic 2940.0000	-55.21	35.21	-55.05	35.05	-53.61	33.61
7th Harmonic 3430.0000	-58.91	38.91 *	-58.76	38.76	-59.31	39.31
8th Harmonic 3920.0000	-52.13	32.13	-58.94	38.94 *	-58.85	38.85 *
9th Harmonic 4410.0000	-58.66	38.66 *	-58.67	38.67 *	-58.58	38.58 *
10th Harmonic 4900.0000	-58.32	38.32 *	-58.33	38.33 *	-58.24	38.24 *

* Indicates Noise Floor of Measurement

Result: Meets Requirement

SPURIOUS EMISSIONS – P25 Phase I C4FM (12.5 kHz)

Test Data: 454.9925 MHz

Spurious Conducted Emissions, C4FM, Mask D Limit ($\geq 250\%$ Authorized BW)	High Power		Med Power		Low Power	
	dBm	43.96	dBm	39.98	dBm	29.99
	Watts	24.89	Watts	9.95	Watts	1.00
	Limit (dBm)	-20	Limit (dBm)	-20	Limit (dBm)	-20
Frequency (MHz)	Peak (dBm)	Margin (dB)	Peak (dBm)	Margin (dB)	Peak (dBm)	Margin (dB)
Fundamental 454.9925	43.96	0.00	39.98	0.00	29.99	0.00
2nd Harmonic 909.9850	-37.33	17.33	-37.01	17.01	-35.03	15.03
3rd Harmonic 1364.9775	-44.58	24.58	-53.42	33.42	-51.83	31.83
4th Harmonic 1819.9700	-52.96	32.96	-55.29	35.29	-51.77	31.77
5th Harmonic 2274.9625	-47.32	27.32	-52.48	32.48	-47.08	27.08
6th Harmonic 2729.9550	-48.07	28.07	-51.20	31.20	-56.50	36.50
7th Harmonic 3184.9475	-58.85	38.85 *	-58.88	38.88 *	-57.78	37.78 *
8th Harmonic 3639.9400	-58.87	38.87 *	-58.90	38.9 *	-57.80	37.8 *
9th Harmonic 4094.9325	-58.60	38.6 *	-58.63	38.63 *	-57.53	37.53 *
10th Harmonic 4549.9250	-58.26	38.26 *	-58.29	38.29 *	-57.19	37.19 *

* Indicates Noise Floor of Measurement

SPURIOUS EMISSIONS AT ANTENNA TERMINALS

Test Data: 456.0075 MHz

Spurious Conducted Emissions, C4FM, Mask D Limit ($\geq 250\%$ Authorized BW)	High Power		Med Power		Low Power	
	dBm	43.96	dBm	39.98	dBm	29.99
	Watts	24.89	Watts	9.95	Watts	1.00
	Limit (dBm)	-20	Limit (dBm)	-20	Limit (dBm)	-20
Frequency (MHz)	Peak (dBm)	Margin (dB)	Peak (dBm)	Margin (dB)	Peak (dBm)	Margin (dB)
Fundamental 456.0075	43.96	0.00	39.98	0.00	29.99	0.00
2nd Harmonic 912.0150	-36.68	16.68	-37.23	17.23	-38.84	18.84
3rd Harmonic 1368.0225	-43.71	23.71	-48.84	28.84	-51.42	31.42
4th Harmonic 1824.0300	-48.81	28.81	-50.89	30.89	-52.75	32.75
5th Harmonic 2280.0375	-44.23	24.23	-50.98	30.98	-47.27	27.27
6th Harmonic 2736.0450	-50.13	30.13	-53.96	33.96	-57.41	37.41
7th Harmonic 3192.0525	-58.85	38.85 *	-58.68	38.68 *	-58.99	38.99 *
8th Harmonic 3648.0600	-58.87	38.87 *	-58.70	38.7 *	-59.01	39.01 *
9th Harmonic 4104.0675	-58.60	38.6 *	-58.43	38.43 *	-58.74	38.74 *
10th Harmonic 4560.0750	-58.26	38.26 *	-58.09	38.09 *	-58.40	38.4 *

* Indicates Noise Floor of Measurement

SPURIOUS EMISSIONS AT ANTENNA TERMINALS

Test Data: 459.9925 MHz

Spurious Conducted Emissions, C4FM, Mask D Limit ($\geq 250\%$ Authorized BW)	High Power		Med Power		Low Power	
	dBm	43.96	dBm	39.98	dBm	29.99
	Watts	24.89	Watts	9.95	Watts	1.00
	Limit (dBm)	-20	Limit (dBm)	-20	Limit (dBm)	-20
Frequency (MHz)	Peak (dBm)	Margin (dB)	Peak (dBm)	Margin (dB)	Peak (dBm)	Margin (dB)
Fundamental 459.9925	43.96	0.00	39.98	0.00	29.99	0.00
2nd Harmonic 919.9850	-36.77	16.77	-37.52	17.52	-38.87	18.87
3rd Harmonic 1379.9775	-42.97	22.97	-46.84	26.84	-49.47	29.47
4th Harmonic 1839.9700	-54.34	34.34	-55.12	35.12	-56.41	36.41
5th Harmonic 2299.9625	-37.81	17.81	-42.86	22.86	-46.28	26.28
6th Harmonic 2759.9550	-49.23	29.23	-55.13	35.13	-57.85	37.85
7th Harmonic 3219.9475	-60.69	40.69	-59.01	39.01 *	-59.05	39.05 *
8th Harmonic 3679.9400	-57.87	37.87 *	-59.03	39.03 *	-59.07	39.07 *
9th Harmonic 4139.9325	-57.60	37.6 *	-58.76	38.76 *	-58.80	38.8 *
10th Harmonic 4599.9250	-57.26	37.26 *	-58.42	38.42 *	-58.46	38.46 *

* Indicates Noise Floor of Measurement

SPURIOUS EMISSIONS AT ANTENNA TERMINALS

Test Data: 470.0075 MHz

Spurious Conducted Emissions, C4FM, Mask D Limit ($\geq 250\%$ Authorized BW)	High Power		Med Power		Low Power	
	dBm	43.96	dBm	39.98	dBm	29.99
	Watts	24.89	Watts	9.95	Watts	1.00
	Limit (dBm)	-20	Limit (dBm)	-20	Limit (dBm)	-20
Frequency (MHz)	Peak (dBm)	Margin (dB)	Peak (dBm)	Margin (dB)	Peak (dBm)	Margin (dB)
Fundamental 470.0075	43.96	0.00	39.98	0.00	29.99	0.00
2nd Harmonic 940.0150	-37.66	17.66	-37.76	17.76	-38.99	18.99
3rd Harmonic 1410.0225	-47.76	27.76	-50.44	30.44	-50.53	30.53
4th Harmonic 1880.0300	-58.42	38.42 *	-59.46	39.46	-60.91	40.91
5th Harmonic 2350.0375	-34.72	14.72	-42.74	22.74	-43.85	23.85
6th Harmonic 2820.0450	-58.73	38.73 *	-60.60	40.60	-61.75	41.75
7th Harmonic 3290.0525	-58.59	38.59 *	-58.87	38.87 *	-59.30	39.3 *
8th Harmonic 3760.0600	-58.61	38.61 *	-58.89	38.89 *	-59.02	39.02
9th Harmonic 4230.0675	-56.97	36.97	-58.62	38.62 *	-59.05	39.05 *
10th Harmonic 4700.0750	-58.00	38 *	-58.28	38.28 *	-58.08	38.08

* Indicates Noise Floor of Measurement

SPURIOUS EMISSIONS AT ANTENNA TERMINALS

Test Data: 490.0000 MHz

Spurious Conducted Emissions, C4FM, Mask D Limit ($\geq 250\%$ Authorized BW)	High Power		Med Power		Low Power	
	dBm	43.96	dBm	39.98	dBm	29.99
	Watts	24.89	Watts	9.95	Watts	1.00
	Limit (dBm)	-20	Limit (dBm)	-20	Limit (dBm)	-20
Frequency (MHz)	Peak (dBm)	Margin (dB)	Peak (dBm)	Margin (dB)	Peak (dBm)	Margin (dB)
Fundamental 490.0000	43.96	0.00	39.98	0.00	29.99	0.00
2nd Harmonic 980.0000	-35.87	15.87	-36.66	16.66	-37.74	17.74
3rd Harmonic 1470.0000	-48.46	28.46	-50.53	30.53	-50.81	30.81
4th Harmonic 1960.0000	-50.77	30.77	-58.88	38.88	-60.21	40.21
5th Harmonic 2450.0000	-34.19	14.19	-40.88	20.88	-46.34	26.34
6th Harmonic 2940.0000	-48.47	28.47	-58.94	38.94	-59.41	39.41 *
7th Harmonic 3430.0000	-58.78	38.78 *	-59.05	39.05 *	-59.27	39.27 *
8th Harmonic 3920.0000	-58.80	38.8 *	-59.07	39.07 *	-59.29	39.29 *
9th Harmonic 4410.0000	-58.53	38.53 *	-58.80	38.8 *	-59.02	39.02 *
10th Harmonic 4900.0000	-58.19	38.19 *	-58.46	38.46 *	-58.68	38.68 *

* Indicates Noise Floor of Measurement

SPURIOUS EMISSIONS AT ANTENNA TERMINALS

Test Data: 511.9925 MHz

Spurious Conducted Emissions, C4FM, Mask D Limit ($\geq 250\%$ Authorized BW)	High Power		Med Power		Low Power	
	dBm	43.96	dBm	39.98	dBm	29.99
	Watts	24.89	Watts	9.95	Watts	1.00
	Limit (dBm)	-20	Limit (dBm)	-20	Limit (dBm)	-20
Frequency (MHz)	Peak (dBm)	Margin (dB)	Peak (dBm)	Margin (dB)	Peak (dBm)	Margin (dB)
Fundamental 490.0000	43.96	0.00	39.98	0.00	29.99	0.00
2nd Harmonic 980.0000	-30.68	10.68	-31.14	11.14	-31.57	11.57
3rd Harmonic 1470.0000	-41.91	21.91	-44.91	24.91	-48.28	28.28
4th Harmonic 1960.0000	-47.71	27.71	-54.11	34.11	-53.46	33.46
5th Harmonic 2450.0000	-44.57	24.57	-53.43	33.43	-53.16	33.16
6th Harmonic 2940.0000	-53.73	33.73	-53.22	33.22	-53.38	33.38
7th Harmonic 3430.0000	-58.65	38.65	-58.82	38.82 *	-59.48	39.48
8th Harmonic 3920.0000	-52.32	32.32	-58.83	38.83	-59.40	39.4 *
9th Harmonic 4410.0000	-58.06	38.06 *	-58.63	38.63	-59.13	39.13 *
10th Harmonic 4900.0000	-57.72	37.72 *	-58.23	38.23 *	-58.79	38.79 *

* Indicates Noise Floor of Measurement

Result: Meets Requirement

FIELD STRENGTH OF SPURIOUS EMISSIONS

FCC Rule Parts: 2.1053(a), 22.359(a)

Method of Measurement: ANSI C63.26, 5.5.4

Test Site Setup:

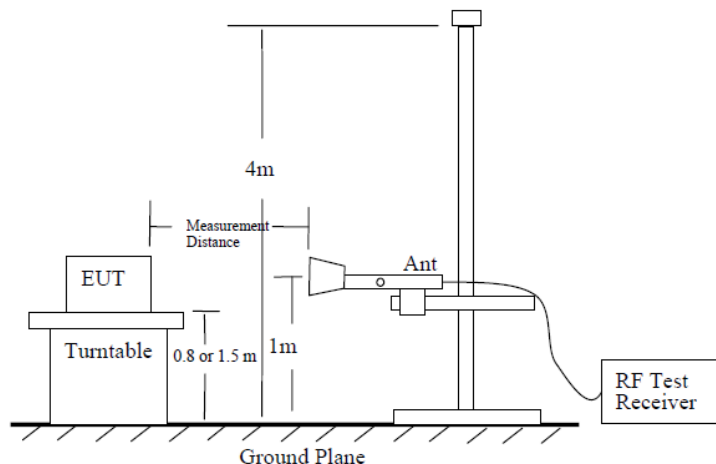

EUT Orientation(s):

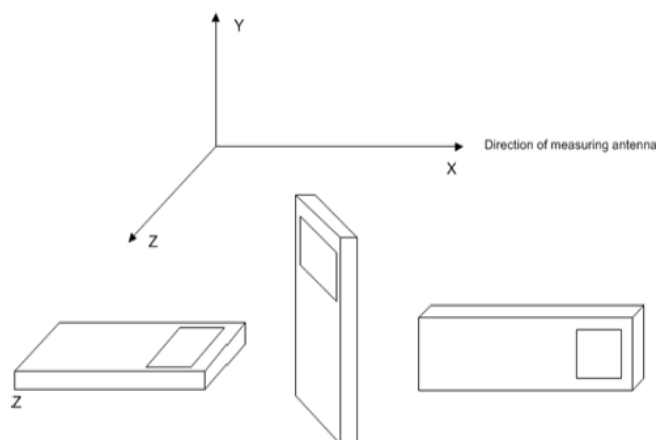

Note: The tabulated data shows the results of the radiated field strength emissions test. The spectrum was scanned from the lowest frequency generated internally to at least the tenth harmonic of the fundamental. This test was conducted in accordance with the standard listed above using the substitution method. Measurements were made at the test site of TIMCO ENGINEERING, INC. located at 849 NW State Road 45, Newberry, FL 32669. The measurements below represent the worst case of all the frequencies tested.

Note: The six (6) highest emissions or more of each worst-case operational modes of the EUT are represented below. Emissions 20 dB below the limit are not required to be reported.

FIELD STRENGTH OF SPURIOUS EMISSIONS

Test Data: 454.9925 MHz

Low Power

Power Output		Limit		
dBm	Watts	dBc	dBm	
29.99	1.00	49.99	-20.00	
Tuned Freq MHz	Emission Frequency MHz	Antenna Polarity	ERP (dBm)	Margin (dB)
454.99	909.99	H	-41.517	21.52
454.99	2274.98	V	-32.025	12.02
454.99	2274.98	H	-40.335	20.33

Medium Power

Power Output		Limit		
dBm	Watts	dBc	dBm	
39.98	9.95	59.98	-20.00	
Tuned Freq MHz	Emission Frequency MHz	Antenna Polarity	ERP (dBm)	Margin (dB)
454.99	909.99	H	-40.277	20.28
454.99	1819.98	V	-39.267	19.27
454.99	2729.97	H	-39.921	19.92
454.99	2729.97	V	-40.291	20.29

High Power

Power Output		Limit		
dBm	Watts	dBc	dBm	
43.96	24.89	63.96	-20.00	
Tuned Freq MHz	Emission Frequency MHz	Antenna Polarity	ERP (dBm)	Margin (dB)
454.99	909.99	H	-39.277	19.28
454.99	1819.98	H	-35.337	15.34
454.99	1819.98	V	-40.597	20.60
454.99	2729.97	V	-32.671	12.67
454.99	2729.97	H	-36.161	16.16

FIELD STRENGTH OF SPURIOUS EMISSIONS

Test Data: 456.0075 MHz

Low Power

Power Output		Limit		
dBm	Watts	dBc	dBm	
29.99	1.00	49.99	-20.00	
Tuned Freq MHz	Emission Frequency MHz	Antenna Polarity	ERP (dBm)	Margin (dB)
456.01	912.01	V	-41.311	21.31
456.01	2280.02	H	-40.119	20.12
456.01	2280.02	V	-41.179	21.18
456.01	2736.03	V	-33.394	13.39
456.01	2736.03	H	-37.834	17.83

Medium Power

Power Output		Limit		
dBm	Watts	dBc	dBm	
39.98	9.95	59.98	-20.00	
Tuned Freq MHz	Emission Frequency MHz	Antenna Polarity	ERP (dBm)	Margin (dB)
456.01	912.01	H	-38.421	18.42
456.01	912.01	H	-41.151	21.15
456.01	1824.02	H	-39.857	19.86
456.01	2280.02	V	-34.969	14.97
456.01	2280.02	H	-41.299	21.30

High Power

Power Output		Limit		
dBm	Watts	dBc	dBm	
43.96	24.89	63.96	-20.00	
Tuned Freq MHz	Emission Frequency MHz	Antenna Polarity	ERP (dBm)	Margin (dB)
456.01	912.01	H	-40.171	20.17
456.01	1824.02	V	-39.117	19.12
456.01	1824.02	H	-33.637	13.64
456.01	2736.03	H	-39.774	19.77
456.01	2736.03	V	-36.344	16.34

FIELD STRENGTH OF SPURIOUS EMISSIONS

Test Data: 459.9925 MHz

Low Power

Power Output		Limit		
dBm	Watts	dBc	dBm	
29.99	1.00	49.99	-20.00	
Tuned Freq MHz	Emission Frequency MHz	Antenna Polarity	ERP (dBm)	Margin (dB)
459.99	2299.98	H	-35.957	15.96
459.99	2299.98	V	-41.017	21.02
459.99	2759.97	V	-40.495	20.50
459.99	2759.97	H	-39.055	19.06

Medium Power

Power Output		Limit		
dBm	Watts	dBc	dBm	
39.98	9.95	59.98	-20.00	
Tuned Freq MHz	Emission Frequency MHz	Antenna Polarity	ERP (dBm)	Margin (dB)
459.99	919.99	H	-39.447	19.45
459.99	2299.98	V	-39.407	19.41
459.99	2299.98	H	-37.297	17.30

High Power

Power Output		Limit		
dBm	Watts	dBc	dBm	
43.96	24.89	63.96	-20.00	
Tuned Freq MHz	Emission Frequency MHz	Antenna Polarity	ERP (dBm)	Margin (dB)
459.99	919.99	H	-40.657	20.66
459.99	919.99	V	-40.587	20.59
459.99	1839.98	V	-39.687	19.69
459.99	1839.98	H	-38.827	18.83
459.99	2299.98	H	-33.047	13.05
459.99	2299.98	V	-36.457	16.46

FIELD STRENGTH OF SPURIOUS EMISSIONS

Test Data: 470.0075 MHz

Low Power

Power Output		Limit		
dBm	Watts	dBc	dBm	
29.99	1.00	49.99	-20.00	
Tuned Freq MHz	Emission Frequency MHz	Antenna Polarity	ERP (dBm)	Margin (dB)
470.01	940.01	V	-39.577	19.58
470.01	1880.02	V	-39.817	19.82
470.01	1880.02	H	-41.557	21.56
470.01	2350.02	H	-36.242	16.24
470.01	2350.02	V	-37.542	17.54

Medium Power

Power Output		Limit		
dBm	Watts	dBc	dBm	
39.98	9.95	59.98	-20.00	
Tuned Freq MHz	Emission Frequency MHz	Antenna Polarity	ERP (dBm)	Margin (dB)
470.01	1880.02	H	-40.927	20.93
470.01	2350.02	V	-33.652	13.65
470.01	2350.02	H	-33.792	13.79

High Power

Power Output		Limit		
dBm	Watts	dBc	dBm	
43.96	24.89	63.96	-20.00	
Tuned Freq MHz	Emission Frequency MHz	Antenna Polarity	ERP (dBm)	Margin (dB)
470.01	940.01	V	-40.447	20.45
470.01	1880.02	V	-35.067	15.07
470.01	1880.02	H	-33.037	13.04
470.01	2350.02	H	-31.412	11.41
470.01	2350.02	V	-28.202	8.20

FIELD STRENGTH OF SPURIOUS EMISSIONS

Test Data: 490.0000 MHz

Low Power

Power Output		Limit		
dBm	Watts	dBc	dBm	
29.99	1.00	49.99	-20.00	
Tuned Freq MHz	Emission Frequency MHz	Antenna Polarity	ERP (dBm)	Margin (dB)
490.00	980.00	H	-41.957	21.96
490.00	1470.00	V	-41.405	21.41

Medium Power

Power Output		Limit		
dBm	Watts	dBc	dBm	
39.98	9.95	59.98	-20.00	
Tuned Freq MHz	Emission Frequency MHz	Antenna Polarity	ERP (dBm)	Margin (dB)
490.00	980.00	V	-40.347	20.35
490.00	980.00	H	-40.117	20.12
490.00	1470.00	H	-40.145	20.15
490.00	2940.00	H	-41.587	21.59

High Power

Power Output		Limit		
dBm	Watts	dBc	dBm	
43.96	24.89	63.96	-20.00	
Tuned Freq MHz	Emission Frequency MHz	Antenna Polarity	ERP (dBm)	Margin (dB)
490.00	980.00	H	-39.297	19.30
490.00	980.00	V	-39.897	19.90
490.00	2940.00	V	-31.837	11.84
490.00	2940.00	H	-28.997	9.00

FIELD STRENGTH OF SPURIOUS EMISSIONS

Test Data: 511.9925 MHz

Low Power

Power Output		Limit		
dBm	Watts	dBc	dBm	
29.99	1.00	49.99	-20.00	
Tuned Freq MHz	Emission Frequency MHz	Antenna Polarity	ERP (dBm)	Margin (dB)
511.99	2047.98	H	-34.560	14.56
511.99	2047.98	V	-33.080	13.08

Medium Power

Power Output		Limit		
dBm	Watts	dBc	dBm	
39.98	9.95	59.98	-20.00	
Tuned Freq MHz	Emission Frequency MHz	Antenna Polarity	ERP (dBm)	Margin (dB)
511.99	2047.98	H	-30.860	10.86
511.99	2047.98	V	-32.000	12.00
511.99	3071.97	H	-39.924	19.92

High Power

Power Output		Limit		
dBm	Watts	dBc	dBm	
43.96	24.89	63.96	-20.00	
Tuned Freq MHz	Emission Frequency MHz	Antenna Polarity	ERP (dBm)	Margin (dB)
512.00	2047.98	H	-22.990	2.99
512.00	2047.98	V	-25.320	5.32
512.00	2559.98	V	-23.925	3.93
512.00	2559.98	H	-24.615	4.62
512.00	3583.97	V	-36.062	16.06
512.00	3583.97	H	-35.552	15.55

FREQUENCY STABILITY

FCC Rule Parts: 2.1055(a)(2), 22.355

TABLE C-1—FREQUENCY TOLERANCE FOR TRANSMITTERS IN THE PUBLIC MOBILE SERVICES

Frequency range (MHz)	Base, fixed (ppm)	Mobile >3 watts (ppm)	Mobile ≤3 watts (ppm)
450 to 512	2.5	5.0	5.0

The limit below conforms to FCC CFR 47 Part 90. 90.213 and in all cases is more strict than that set forth in this rulepart. Please refer below:

FCC Rule Parts: 90.213

MINIMUM FREQUENCY STABILITY

[Parts per million (ppm)]

Frequency range (MHz)	Fixed and base stations	Mobile stations	
		Over 2 watts output power	2 watts or less output power
421-512	7 ¹¹ 14 ¹⁴ 2.5	8 ⁵	8 ⁵

⁷In the 421-512 MHz band, fixed and base stations with a 12.5 kHz channel bandwidth must have a frequency stability of 1.5 ppm. Fixed and base stations with a 6.25 kHz channel bandwidth must have a frequency stability of 0.5 ppm.

⁸In the 421-512 MHz band, mobile stations designed to operate with a 12.5 kHz channel bandwidth must have a frequency stability of 2.5 ppm. Mobile stations designed to operate with a 6.25 kHz channel bandwidth must have a frequency stability of 1.0 ppm.

¹¹Paging transmitters operating on paging-only frequencies must operate with frequency stability of 5 ppm in the 150-174 MHz band and 2.5 ppm in the 421-512 MHz band.

¹⁴Control stations may operate with the frequency tolerance specified for associated mobile frequencies.

Method of Measurements: TIA 603-E, 2.2.2

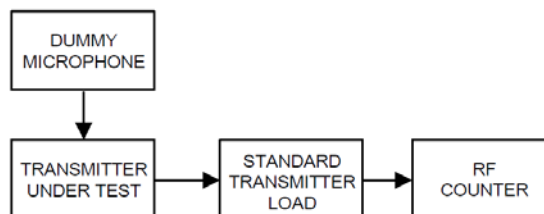

FREQUENCY STABILITY

Test Data: Frequency Error Measurement Plot

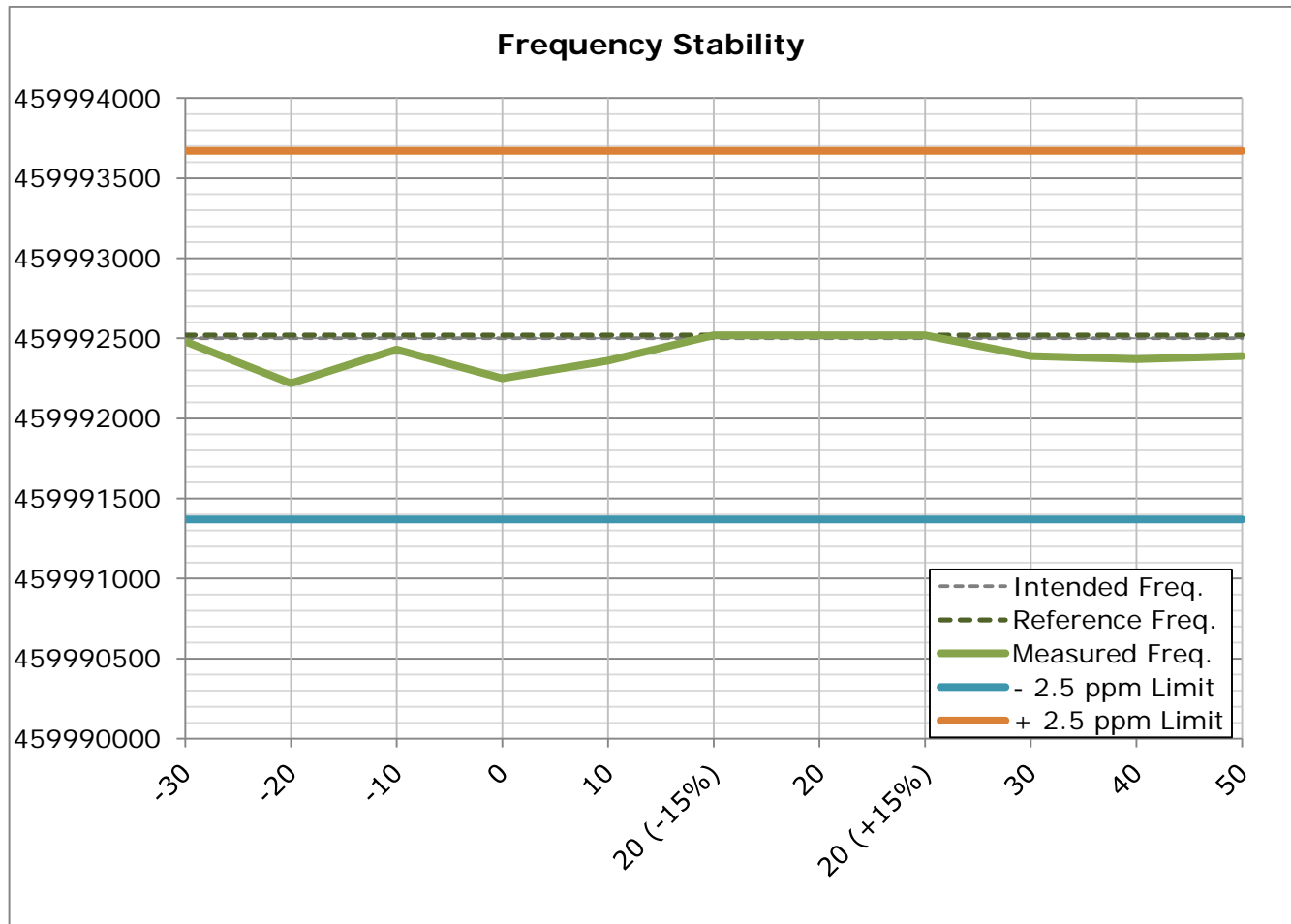

FREQUENCY STABILITY

Test Data: Frequency Error Measurement Table

Limit:		2.5	ppm	
Temperature (°C)	Supplied Voltage (VDC)	Intended Frequency (Hz)	Measured Reference Frequency (Hz)	Deviation (Hz)
20°C (reference)	13.8	459992500	459992520	-20

@ 20°C (reference)				
Supplied Voltage (%)	Supplied Voltage (VDC)	Frequency (Hz)	Deviation (Hz)	PPM
-15%	11.73	459992520	0	0.000
15%	15.87	459992520	0	0.000

Temperature (°C)	Supplied Voltage (VDC)	Frequency (Hz)	Deviation (Hz)	PPM
50	13.8	459992390	130	0.283
40	13.8	459992370	150	0.326
30	13.8	459992390	130	0.283
20	13.8	459992520	0	0.000
10	13.8	459992360	160	0.348
0	13.8	459992250	270	0.587
-10	13.8	459992430	90	0.196
-20	13.8	459992220	300	0.652
-30	13.8	459992480	40	0.087

RESULT: Meets Requirements

STATEMENT OF MEASUREMENT UNCERTAINTY

The data and results referenced in this document are true and accurate. The measurement uncertainty was calculated for all measurements listed in this test report according To CISPR 16-4 or ENTR 100-028 Specification for radio disturbance and immunity measuring apparatus and methods – Part 4: “Uncertainty in EMC Measurements” and is documented in the Timco Engineering, Inc. quality system according to DIN EN ISO/IEC 17025. Furthermore, component and process variability of devices similar to that tested may result in additional deviation. The manufacturer has the sole responsibility of continued compliance of the device.

Hereafter the best measurement capability for Timco Engineering, Inc. is reported:

Test Items	Measurement Uncertainty	Notes
RF Frequency Accuracy	± 49.5 Hz	(1)
RF Conducted Power	±0.93dB	(1)
Conducted spurious emission of transmitter valid up to 40GHz	± 1.86dB	
Occupied Bandwidth	± 2.65%	
Audio Frequency Response	± 1.86dB	
Modulation limiting	± 1.88%	
Radiated RF Power	± 1.4dB	
Maximum frequency deviation: Within 300 Hz and 6kHz of audio freq.	± 1.88%	
Within 6kHz and 25kHz of audio Freq.	± 2.04%	
Rad Emissions Sub Meth up to 26.5GHz	± 2.14dB	
Adjacent channel power	± 1.47dB	(1)
Transient Frequency Response	± 1.88%	
Temperature	± 1.0°C	(1)
Humidity	± 5.0%	

This uncertainty represents an expanded uncertainty expressed at approximately the 95% confidence level using a coverage factor of $k=1.96$.

EMC EQUIPMENT LIST

Device	Manufacturer	Model	Serial Number	Cal/Char Date	Due Date
Coaxial Cable - BMBM-0065-01 Black DC-2G	Belden		BMBM-0065-01	07/18/16	07/18/18
Antenna: Biconical 1096	Eaton	94455-1	1096	08/01/17	08/01/19
Antenna: Log-Periodic 1122	Electro-Metrics	LPA-25	1122	07/26/17	07/26/19
Temperature Chamber LARGE	Tenney Engineering	TTRC	11717-7	09/01/16	09/01/18
Frequency Counter Small Chamber	HP	5385A	3242A07460	08/22/17	08/22/19
Coaxial Cable - Chamber 3 cable set (backup)	Micro-Coax	Chamber 3 cable set (backup)	KMKM-0244-02 KMKM-0670-01 KFKF-0197-00	N/A	N/A
CHAMBER	Panashield	3M	N/A	04/25/16	5/31/18
Antenna: Double-Ridged Horn/ETS Horn 2	ETS-Lindgren	3117	00041534	03/01/17	03/01/19
Software: Field Strength Program	Timco	N/A	Version 4.10.7.0	N/A	N/A
Antenna: Passive Loop	EMCO	6512	9706-1211	07/26/17	07/26/19
Type K J Thermometer	Martel	303	080504494	11/02/17	11/02/19
EMI Test Receiver R & S ESIB 40	Rohde & Schwarz	ESIB 40	100274	08/18/16	08/18/18
EMI Test Receiver R & S ESU 40	Rohde & Schwarz	ESU 40	100320	04/01/16	04/01/19
Attenuator N 20dB 20W DC-12G	Narda	768-20-SP	155	07/10/17	07/10/19
Attenuator N 20dB 20W DC-12G	Narda	768-20-SP	344	07/10/17	07/10/19
Attenuator N 30dB 100W DC-6G	Pasternack	PE7214-30	#109	05/24/17	05/24/19
Attenuator BNC 10dB DC-2G	MiniCircuits	HAT-10+	#54	07/14/17	07/14/19
Bore-sight Antenna Positioning Tower	Sunol Sciences	TLT2	N/A	N/A	N/A
Tunable Notch Filter 250-850 MHz	Eagle	TNF-200	250-850 MHz (#19)	11/19/17	11/19/19
Terminator N 20W DC-18G	Narda	8205	#14	04/06/17	04/06/19
Attenuator BNC 6dB 50Ohm DC-2G	Mini-Circuits	HAT-6+	#53	07/14/17	07/14/19
Attenuator N 30dB 100W DC-6G	Pasternack	PE7214-30	#109	05/24/17	05/23/19
DC Power Supply	HP	6286A	1744A03842	N/A	N/A
Modulation Analyzer	HP	8901A	3050A05856	04/13/17	04/13/19
Function Generator	Standford	DS340	25200	02/21/18	02/21/20
Terminator N 20W DC-18G	Narda	8205	#14	04/06/17	04/06/19

*EMI RECEIVER SOFTWARE VERSION

The receiver firmware used was version 4.43 Service Pack 3

END OF TEST REPORT