



**FCC CFR47 PART 15 SUBPART C  
INDUSTRY CANADA RSS-247 ISSUE 2**

**Bluetooth Low Energy**

**CERTIFICATION TEST REPORT**

**FOR**

**RF4CE and BLE Hands-Free Remote**

**MODEL NUMBER : XR19-RQ**

**FCC ID: TX4XR19RQ**

**IC : 11438A-XR19RQ**

**REPORT NUMBER: 4789245332-FR1V2**

**ISSUE DATE: FEB 17, 2020**

*Prepared for*  
**Remote Solution Co., Ltd.**  
**326-14,Apo-Daero,Nam-Myeon,Gimcheon-Si,**  
**Gyeongsangbuk-Do,Korea**

*Prepared by*  
**UL Korea, Ltd.**  
**26th floor, 152, Teheran-ro, Gangnam-gu Seoul, 06236, Korea**

**Suwon Test Site: UL Korea, Ltd. Suwon Laboratory**  
**218 Maeyeong-ro, Yeongtong-gu,**  
**Suwon-si, Gyeonggi-do, 16675, Korea**  
**TEL: (031) 337-9902**  
**FAX: (031) 213-5433**



**ACCREDITED**

**Testing Laboratory**

**TL-637**

Revision History

<u>Rev.</u>	<u>Issue Date</u>	<u>Revisions</u>	<u>Revised By</u>
V1	01/20/20	Initial issue	Hoonpyo Lee
V2	02/17/20	Updated EUT description	Hoonpyo Lee

## TABLE OF CONTENTS

<b>1. ATTESTATION OF TEST RESULTS .....</b>	<b>5</b>
<b>2. TEST METHODOLOGY .....</b>	<b>6</b>
<b>3. FACILITIES AND ACCREDITATION .....</b>	<b>6</b>
<b>4. CALIBRATION AND UNCERTAINTY .....</b>	<b>6</b>
4.1. MEASURING INSTRUMENT CALIBRATION.....	6
4.2. SAMPLE CALCULATION.....	6
4.3. MEASUREMENT UNCERTAINTY .....	7
4.4. DECISION RULE .....	7
<b>5. EQUIPMENT UNDER TEST .....</b>	<b>8</b>
5.1. DESCRIPTION OF EUT.....	8
5.2. MAXIMUM OUTPUT POWER.....	8
5.3. DESCRIPTION OF AVAILABLE ANTENNAS .....	8
5.4. WORST-CASE CONFIGURATION AND MODE .....	9
5.5. DESCRIPTION OF TEST SETUP .....	10
<b>6. TEST AND MEASUREMENT EQUIPMENT .....</b>	<b>12</b>
<b>7. REFERENCE MEASUREMENT RESULTS.....</b>	<b>13</b>
7.1. ON TIME AND DUTY CYCLE RESULTS.....	13
7.2. 99% BANDWIDTH .....	14
<b>8. MEASUREMENT METHODS .....</b>	<b>16</b>
<b>9. SUMMARY TABLE .....</b>	<b>17</b>
<b>10. ANTENNA PORT TEST RESULTS .....</b>	<b>18</b>
10.1. 6 dB BANDWIDTH.....	18
10.2. OUTPUT POWER.....	20
10.3. AVERAGE POWER.....	22
10.4. PSD .....	23
10.5. OUT-OF-BAND EMISSIONS .....	25
<b>11. RADIATED TEST RESULTS.....</b>	<b>29</b>
11.1. LIMITS AND PROCEDURE .....	29
11.2. TRANSMITTER ABOVE 1 GHz .....	31
11.2.1. BLE MODE.....	31

11.3. WORST-CASE BELOW 1 GHz.....41

**12. AC POWER LINE CONDUCTED EMISSIONS .....43**

**13. SETUP PHOTOS.....46**

# 1. ATTESTATION OF TEST RESULTS

**COMPANY NAME:** Remote Solution Co., Ltd.  
**EUT DESCRIPTION:** RF4CE and BLE Hands-Free Remote  
**MODEL NUMBER:** XR19-RQ  
**SERIAL NUMBER:** proto type(RADIATED);  
proto type (CONDUCTED)  
**DATE TESTED:** DEC 3, 2019 – JAN 08, 2020

APPLICABLE STANDARDS	
STANDARD	TEST RESULTS
CFR 47 Part 15 Subpart C	Pass
INDUSTRY CANADA RSS-247 Issue 2	Pass
INDUSTRY CANADA RSS-GEN Issue 5	Pass

UL Korea, Ltd. tested the above equipment in accordance with the requirements set forth in the above standards. All indications of Pass/Fail in this report are opinions expressed by UL Korea, Ltd. based on interpretations and/or observations of test results. Measurement Uncertainties were not taken into account and are published for informational purposes only. The test results show that the equipment tested is capable of demonstrating compliance with the requirements as documented in this report.

**Note:** The results documented in this report apply only to the tested sample, under the conditions and modes of operation as described herein. This document may not be altered or revised in any way unless done so by UL Korea, Ltd. and all revisions are duly noted in the revisions section. Any alteration of this document not carried out by UL Korea, Ltd. will constitute fraud and shall nullify the document. This report must not be used by the client to claim product certification, approval, or endorsement by IAS, any agency of the Federal Government, or any agency of any government.

Approved & Released For  
UL Korea, Ltd. By:



Changyoung Choi  
Suwon Lab Engineer  
UL Korea, Ltd.

Tested By:



Jaejin Lee  
Suwon Lab Engineer  
UL Korea, Ltd.

## 2. TEST METHODOLOGY

The tests documented in this report were performed in accordance with following methods.

1. FCC CFR 47 Part 2.
2. FCC CFR 47 Part 15.
3. IC RSS-247 Issue 2
4. IC RSS-GEN Issue 5
5. KDB 558074 D01 15.247 Meas Guidance v05r02.
6. ANSI C63.10-2013.

## 3. FACILITIES AND ACCREDITATION

The test sites and measurement facilities used to collect data are located at 218 Maeyeong-ro, Yeongtong-gu, Suwon-si, Gyeonggi-do, 16675, Korea. Line conducted emissions are measured only at the 218 address. The following table identifies which facilities were utilized for radiated emission measurements documented in this report. Specific facilities are also identified in the test results sections.

218 Maeyeong-ro	
<input type="checkbox"/>	Chamber 1
<input type="checkbox"/>	Chamber 2
<input checked="" type="checkbox"/>	Chamber 3

UL Korea, Ltd. is accredited by IAS, Laboratory Code TL-637. The full scope of accreditation can be viewed at <http://www.iasonline.org/wp-content/uploads/2017/05/TL-637.pdf>.

## 4. CALIBRATION AND UNCERTAINTY

### 4.1. MEASURING INSTRUMENT CALIBRATION

The measuring equipment utilized to perform the tests documented in this report has been calibrated in accordance with the manufacturer's recommendations, and is traceable to recognized national standards.

### 4.2. SAMPLE CALCULATION

Where relevant, the following sample calculation is provided:

$$\begin{aligned} \text{Field Strength (dBuV/m)} &= \text{Measured Voltage (dBuV)} + \text{Antenna Factor (dB/m)} + \\ &\text{Cable Loss (dB)} - \text{Preamp Gain (dB)} \\ 36.5 \text{ dBuV} + 18.7 \text{ dB/m} + 0.6 \text{ dB} - 26.9 \text{ dB} &= 28.9 \text{ dBuV/m} \end{aligned}$$

### 4.3. MEASUREMENT UNCERTAINTY

Where relevant, the following measurement uncertainty levels have been estimated for tests performed on the apparatus:

PARAMETER	UNCERTAINTY
Conducted Disturbance, 0.15 to 30 MHz	2.32 dB
Radiated Disturbance, Below 1GHz	3.86 dB
Radiated Disturbance, Above 1 GHz	5.97 dB

Uncertainty figures are valid to a confidence level of 95%.

### 4.4. DECISION RULE

Decision rule for statement(s) of conformity is based on Procedure 1, Clause 4.4.2 in IEC Guide 115:2007.

## 5. EQUIPMENT UNDER TEST

### 5.1. DESCRIPTION OF EUT

The EUT is a RF4CE and BLE Hands-Free Remote.  
This test report addresses the DTS (BLE) operational mode.

### 5.2. MAXIMUM OUTPUT POWER

The transmitter has a maximum total conducted output power as follows:

Frequency Range [MHz]	Mode	Power Mode	Output Power [dBm]	Output Power [mW]
2402 - 2480	1Mbps	Peak	6.59	4.56
		Average	6.31	4.28

### 5.3. DESCRIPTION OF AVAILABLE ANTENNAS

The radio utilizes an internal antenna, with a maximum gain of -1.0 dBi.



#### **5.4. WORST-CASE CONFIGURATION AND MODE**

Radiated emission below 1GHz was performed with the EUT set to transmit at the channel with highest output power as worst-case scenario.

Radiated emission above 1GHz was performed with the EUT set to transmit low/mid/high channels.

The fundamental of the EUT was investigated in three orthogonal orientations X, Y and Z it was determined that X orientation was worst-case orientation; therefore, all final radiated testing was performed with the EUT in X orientation.

## 5.5. DESCRIPTION OF TEST SETUP

### SUPPORT EQUIPMENT

Support Equipment List				
Description	Manufacturer	Model	Serial Number	FCC ID
Adaptor	COMCAST	ML08-7050150-A1	None	None

### I/O CABLE

Cable No	Port	# of identical ports	Connector Type	Cable Type	Cable Length (m)	Remarks
N/A	N/A	N/A	N/A	N/A	N/A	N/A

### TEST SETUP

The EUT is a stand-alone unit during the tests.  
The EUT was forced to transmit using software.

**SETUP DIAGRAM FOR TESTS (CONDUCTED TEST SETUP)**

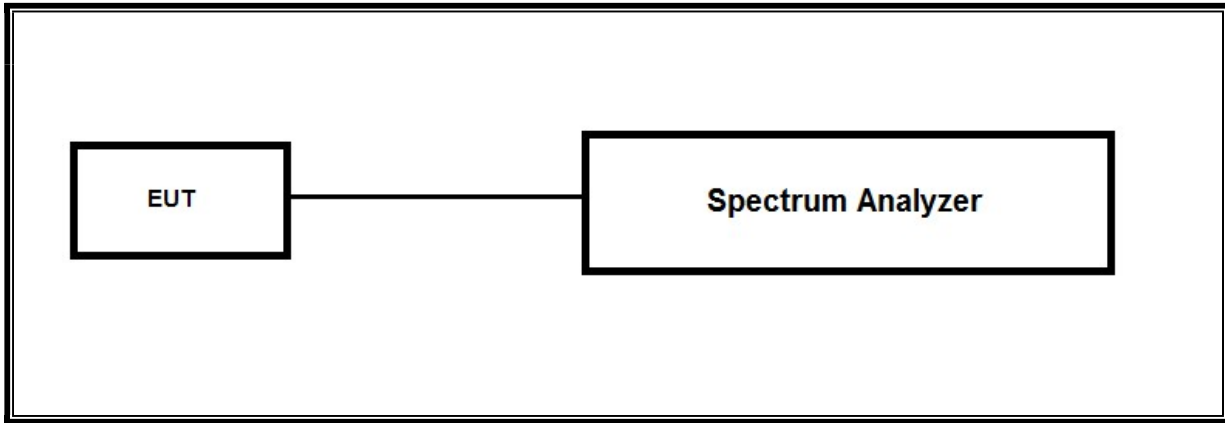

**SETUP DIAGRAM FOR TESTS (RADIATED TEST SETUP)**

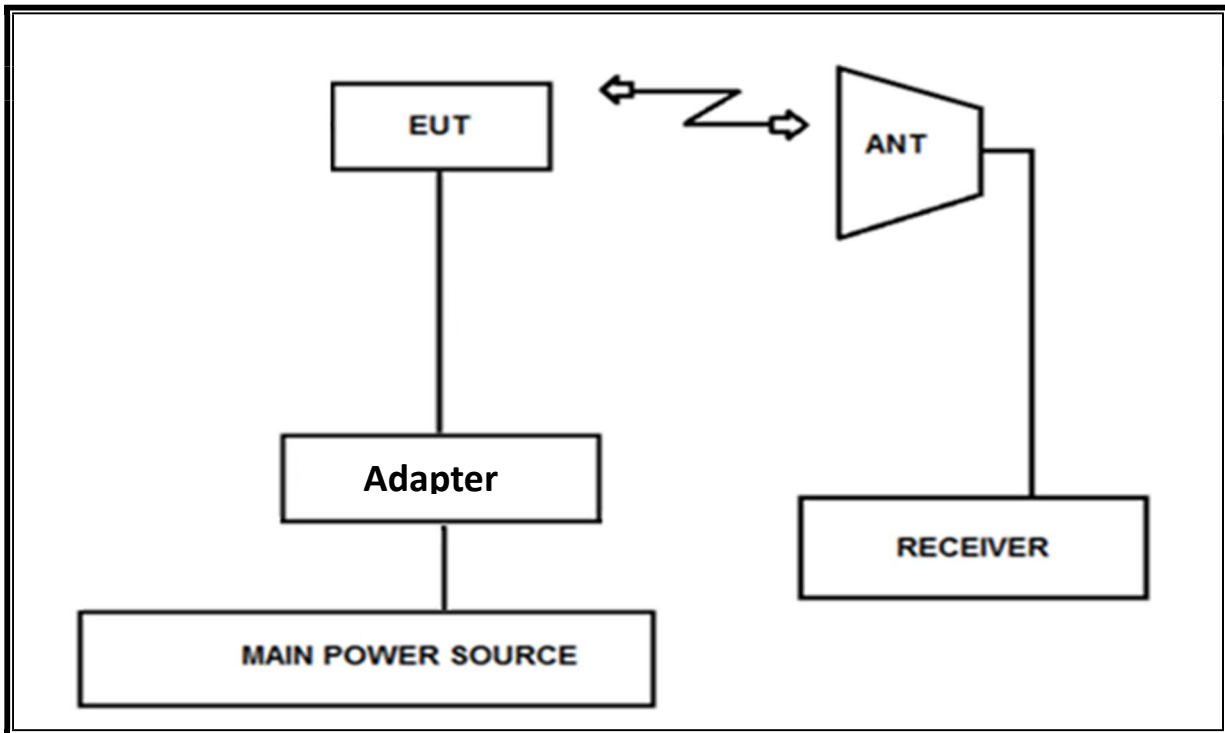

## 6. TEST AND MEASUREMENT EQUIPMENT

The following test and measurement equipment was utilized for the tests documented in this report:

Test Equipment List				
Description	Manufacturer	Model	S/N	Cal Due
Antenna, Bilog, 30MHz-1GHz	SCHWARZBECK	VULB9163	750	08-04-20
Antenna, Bilog, 30MHz-1GHz	SCHWARZBECK	VULB9163	749	08-04-20
Antenna, Bilog, 30MHz-1GHz	SCHWARZBECK	VULB9163	845	08-04-20
Antenna, Horn, 18 GHz	ETS	3115	00167211	08-04-20
Antenna, Horn, 18 GHz	ETS	3115	00161451	08-04-20
Antenna, Horn, 18 GHz	ETS	3117	00168724	08-04-20
Antenna, Horn, 18 GHz	ETS	3117	00168717	08-04-20
Antenna, Horn, 18 GHz	ETS	3117	00205959	08-04-20
Antenna, Horn, 40 GHz	ETS	3116C	00166155	08-14-20
Antenna, Horn, 40 GHz	ETS	3116C	00168645	10-02-21
Antenna, Horn, 40 GHz	ETS	3116C-PA	00168841	08-08-20
Preamplifier, 1000 MHz	Sonoma	310N	341282	08-05-20
Preamplifier, 1000 MHz	Sonoma	310N	351741	08-05-20
Preamplifier, 1000 MHz	Sonoma	310N	370599	08-05-20
Preamplifier, 18 GHz	Miteq	AFS42-00101800-25-S-42	1876511	08-05-20
Preamplifier, 18 GHz	Miteq	AFS42-00101800-25-S-42	1896138	08-06-20
Preamplifier, 18 GHz	Miteq	AFS42-00101800-25-S-42	2029169	08-06-20
Signal Analyzer, 40 GHz	R&S	FSV40	101237	08-05-20
Average Power Sensor	Agilent / HP	U2000	MY54270007	08-09-20
Attenuator	PASTERNAK	PE7087-10	A001	08-08-20
Attenuator	PASTERNAK	PE7087-10	A008	08-08-20
Attenuator	PASTERNAK	PE7087-10	2	08-08-20
EMI Test Receive, 40 GHz	R&S	ESU40	100439	08-06-20
EMI Test Receive, 40 GHz	R&S	ESU40	100457	08-06-20
EMI Test Receive, 44 GHz	R&S	ESW44	101590	08-05-20
EMI Test Receive, 3 GHz	R&S	ESR3	102592	06-28-20
Low Pass Filter 5GHz	Micro-Tronics	LPS17541	009	08-05-20
Low Pass Filter 5GHz	Micro-Tronics	LPS17541	015	08-06-20
Low Pass Filter 5GHz	Micro-Tronics	LPS17541	020	08-06-20
High Pass Filter 3GHz	Micro-Tronics	HPM17543	010	08-06-20
High Pass Filter 3GHz	Micro-Tronics	HPM17543	015	08-05-20
High Pass Filter 3GHz	Micro-Tronics	HPM17543	020	08-06-20
High Pass Filter 6GHz	Micro-Tronics	HPS17542	009	08-06-20
High Pass Filter 6GHz	Micro-Tronics	HPS17542	016	08-05-20
High Pass Filter 6GHz	Micro-Tronics	HPS17542	021	08-06-20
Antenna, Loop, 9kHz-30MHz	R&S	HFH2-Z2	100418	09-30-20
LISN	R&S	ENV216	102478	11-15-20
UL Software				
Description	Manufacturer	Model	Version	
Radiated software	UL	UL EMC	Ver 9.5	
AC Line Conducted software	R&S	EMC32	10.50.40	

## 7. REFERENCE MEASUREMENT RESULTS

### 7.1. ON TIME AND DUTY CYCLE RESULTS

#### LIMITS

None: for reporting purposes only.

Mode	ON Time B [msec]	Period [msec]	Duty Cycle x [linear]	Duty Cycle [%]	Duty Cycle Correction Factor [dB]	1/T Minimum VBW [kHz]
<b>2400MHz Bands</b>						
BLE	0.390	0.627	0.622	62.2%	2.06	2.564

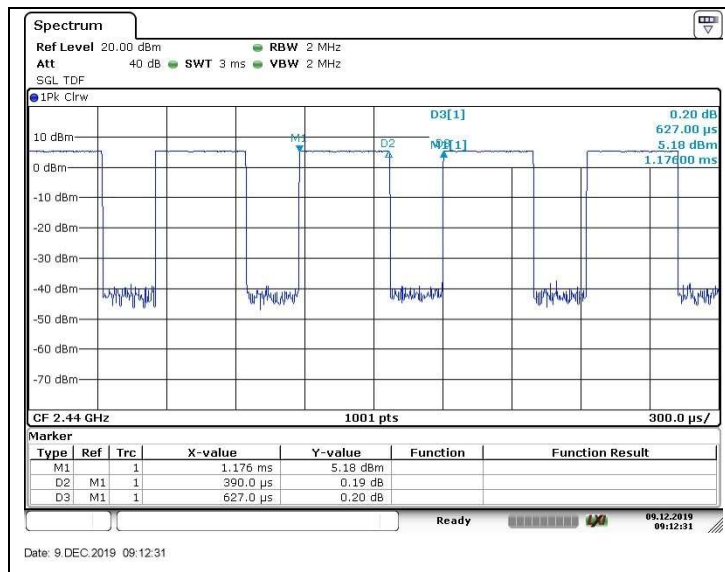

## 7.2. 99% BANDWIDTH

### LIMITS

None; for reporting purposes only.

### TEST PROCEDURE

The transmitter output is connected to the spectrum analyzer. The RBW is set to 1% to 3% of the 99 % bandwidth and to 1% of the span. The VBW is set to  $\geq 3$  times the RBW. The spectrum analyzer internal 99% bandwidth function is utilized.

### RESULTS

Channel	Frequency [MHz]	99% Bandwidth [MHz]
Low	2402	1.001
Mid	2440	1.004
High	2480	1.004
Worst		1.004

**99% BANDWIDTH PLOTS**

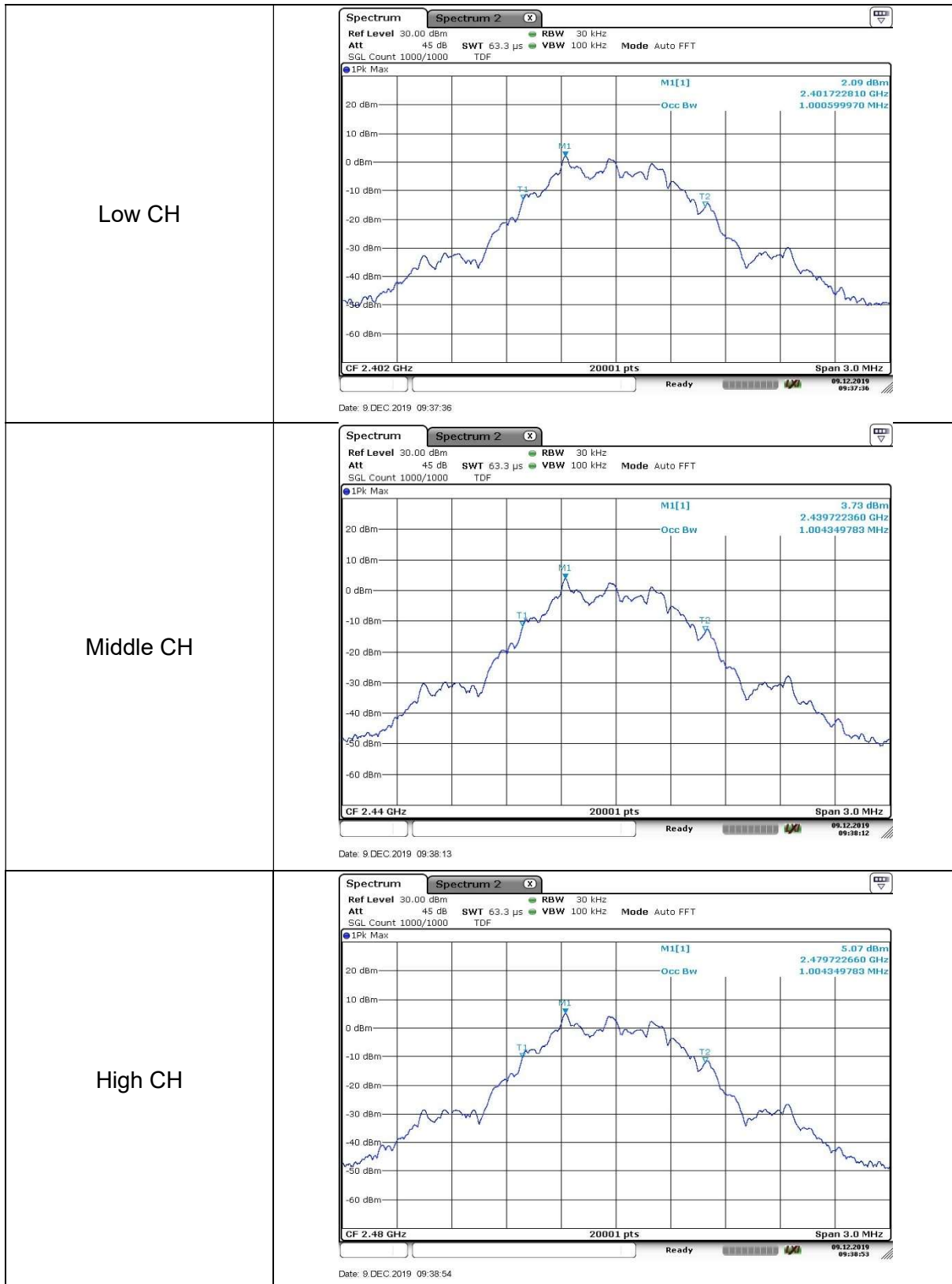

## 8. MEASUREMENT METHODS

6 dB BW : KDB 558074 D01 v05r02, Section 8.2.

OUTPUT POWER : KDB 558074 D01 v05r02, Section 8.3.1.1

POWER SPECTRAL DENSITY : KDB 558074 D01 v05r02, Section 8.4.

Out-of-band Emissions (Conducted) : KDB 558074 D01 v05r02, Section 8.5.

Out-of-band Emissions in Non-restricted Bands: KDB 558074 D01 v05r02, Section 8.5.

Out-of-band Emissions in Restricted Bands : KDB 558074 D01 v05r02, Section 8.6.

AC Power Line Conducted Emission : ANSI C63.10-2013, Section 6.2



## 9. SUMMARY TABLE

FCC Part Section	IC Section	Test Description	Test Limit	Test Condition	Test Result
15.247 (a)(2)	RSS-247 5.2(a)	Occupied Band width (6dB)	>500KHz	Conducted	Pass
2.1051, 15.247 (d)	RSS-247 5.5	Band Edge / Conducted Spurious Emission	-20dBc		Pass
15.247 (b)(3)	RSS-247 5.4(d)	TX conducted output power	<30dBm		Pass
15.247 (e)	RSS-247 5.2(b)	PSD	<8dBm		Pass
15.207 (a)	RSS-GEN Clause 8.8	AC Power Line conducted emissions	Section 10	Power Line conducted	Pass
15.205, 15.209	RSS-GEN Clause 7 & 8.9	Radiated Spurious Emission	< 54dBuV/m(Av)	Radiated	Pass

## 10. ANTENNA PORT TEST RESULTS

### 10.1. 6 dB BANDWIDTH

#### LIMITS

FCC §15.247 (a) (2) / IC RSS-247 §5.2 (a)

The minimum 6 dB bandwidth shall be at least 500 kHz.

#### TEST PROCEDURE

Reference to section 11.8 in ANSI C63.10(2013): The transmitter output is connected to a spectrum analyzer with the RBW set to 100kHz, the VBW  $\geq 3 \times$  RBW, peak detector and max hold.

#### RESULTS

Channel	Frequency [MHz]	6 dB Bandwidth [kHz]	Minimum Limit [kHz]
Low	2402	696.12	500.0
Mid	2440	703.99	500.0
High	2480	707.44	500.0
Worst		696.12	500.0

**6 dB BANDWIDTH PLOTS**

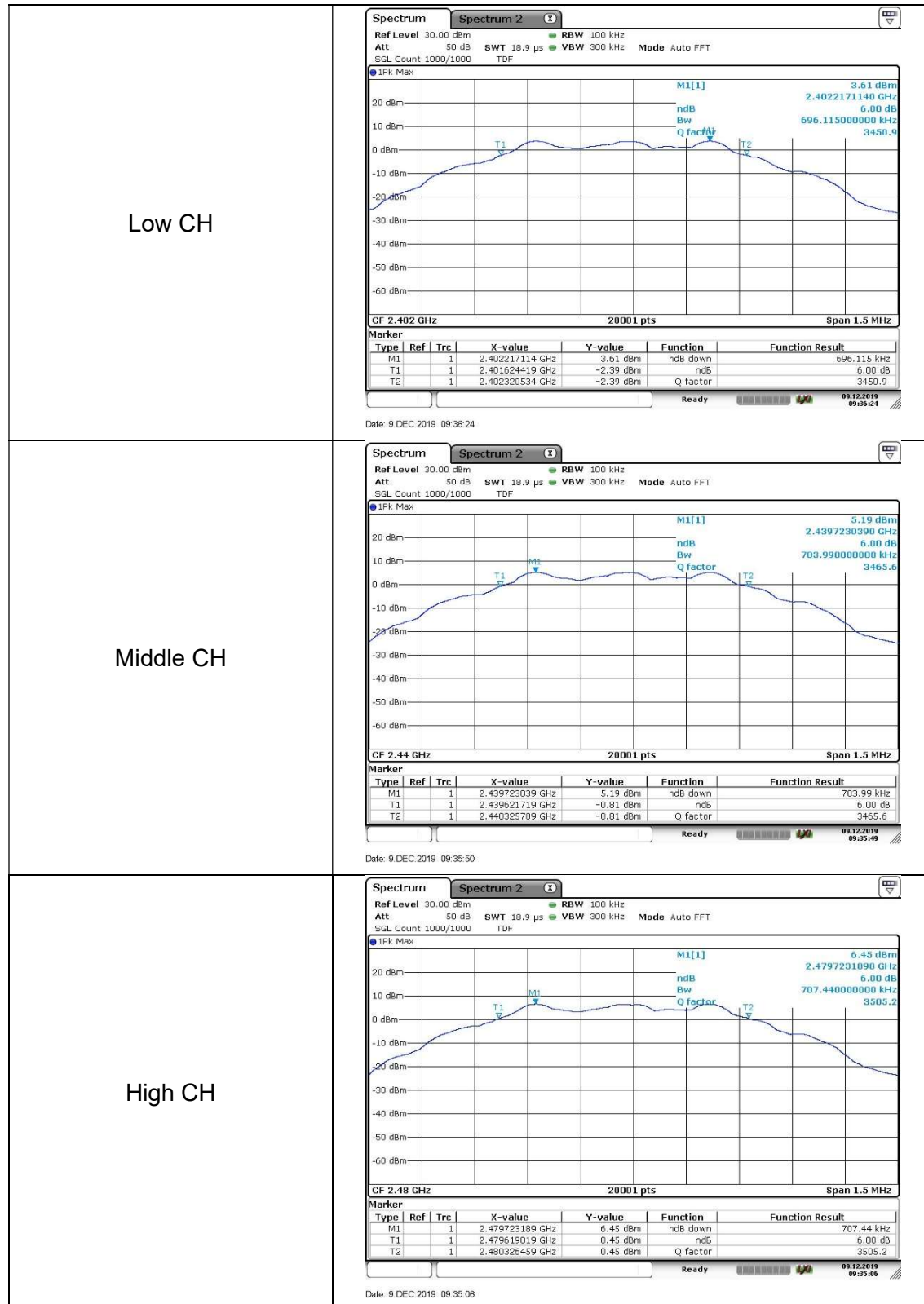

## 10.2. OUTPUT POWER

### LIMITS

FCC §15.247 (b) / IC RSS-247 §5.4 (d)

The maximum antenna gain is less than or equal to 6 dBi, therefore the limit is 30 dBm.

### TEST PROCEDURE

Peak power is measured using ANSI C63.10(2013) under section 11.9.1.1 utilizing spectrum analyzer.

### RESULTS

Channel	Frequency [MHz]	Peak Power Reading [dBm]	Limit [dBm]	Margin [dB]
Low	2402	3.74	30.00	-26.26
Mid	2440	5.33	30.00	-24.67
High	2480	6.59	30.00	-23.41
Worst		6.59	30.00	-23.41

**OUTPUT POWER PLOTS**

**- 1Mbps**

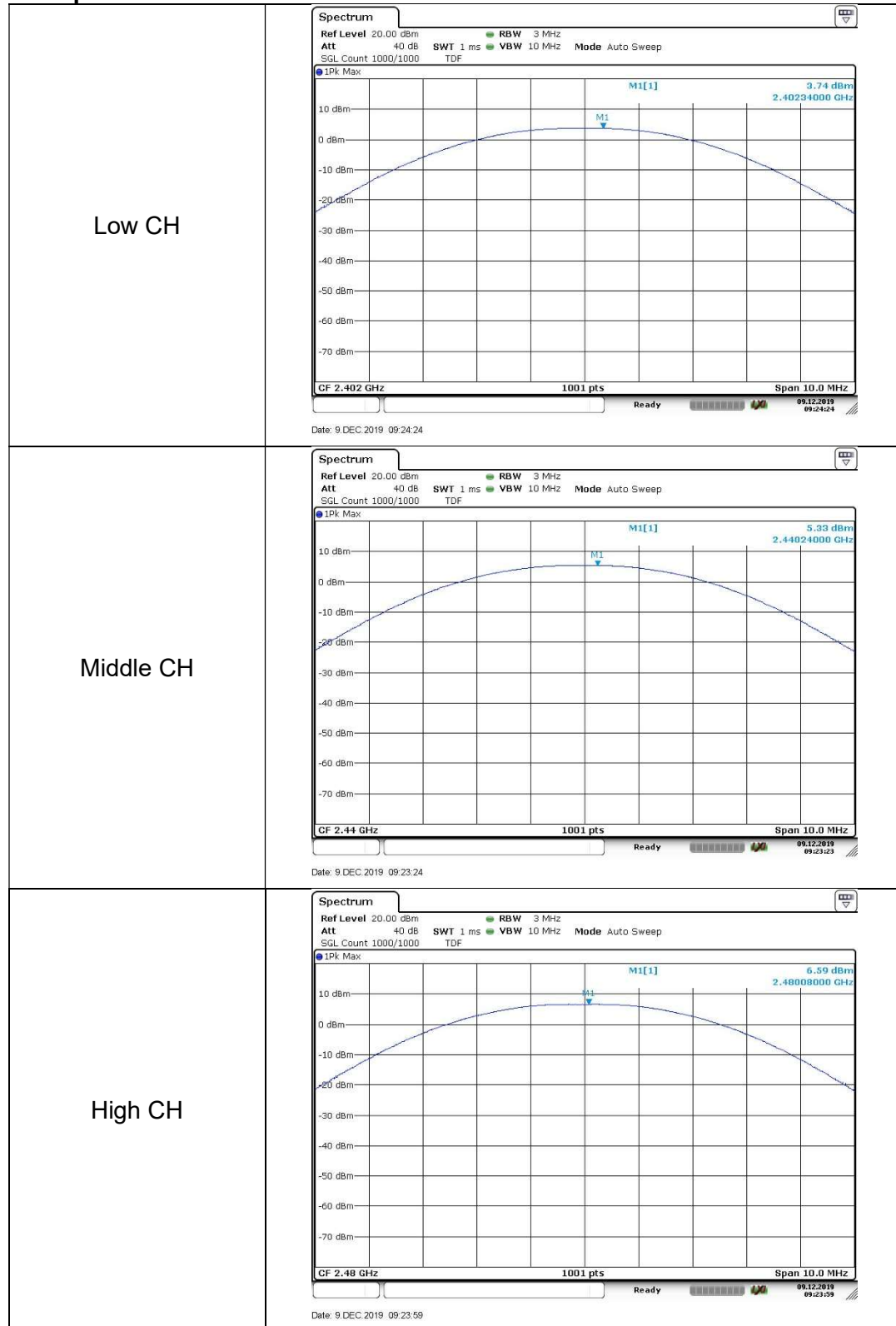

### 10.3. AVERAGE POWER

#### LIMITS

None; for reporting purposes only.

#### TEST PROCEDURE

The transmitter output is connected to a power meter.

#### RESULTS

The cable assembly insertion loss was entered as an offset in the power meter to allow for direct reading of power. The duty factor already has been added.

#### **- 1Mbps**

Channel	Frequency [MHz]	AV power [dBm]	AV power [mW]
Low	2402	3.43	2.20
Middle	2440	5.04	3.19
High	2480	<b>6.31</b>	<b>4.28</b>

## 10.4. PSD

### LIMITS

FCC §15.247 / IC RSS-247 §5.2 (b)

The power spectral density conducted from the transmitter to the antenna shall not be greater than 8 dBm in any 3 kHz band during any time interval of continuous transmission.

### TEST PROCEDURE

Power Spectral Density was performed utilizing the ANSI C63.10 section 11.10.2 (Method PKPSD).

### RESULTS

#### - 1Mbps

Channel	Frequency [MHz]	PSD [dBm/3kHz]	Limit [dBm/3kHz]	Margin [dB]
Low	2402	-9.53	8.00	-17.53
Mid	2440	-7.90	8.00	-15.90
High	2480	-6.50	8.00	-14.50

**POWER SPECTRAL DENSITY PLOTS**

- 1Mbps

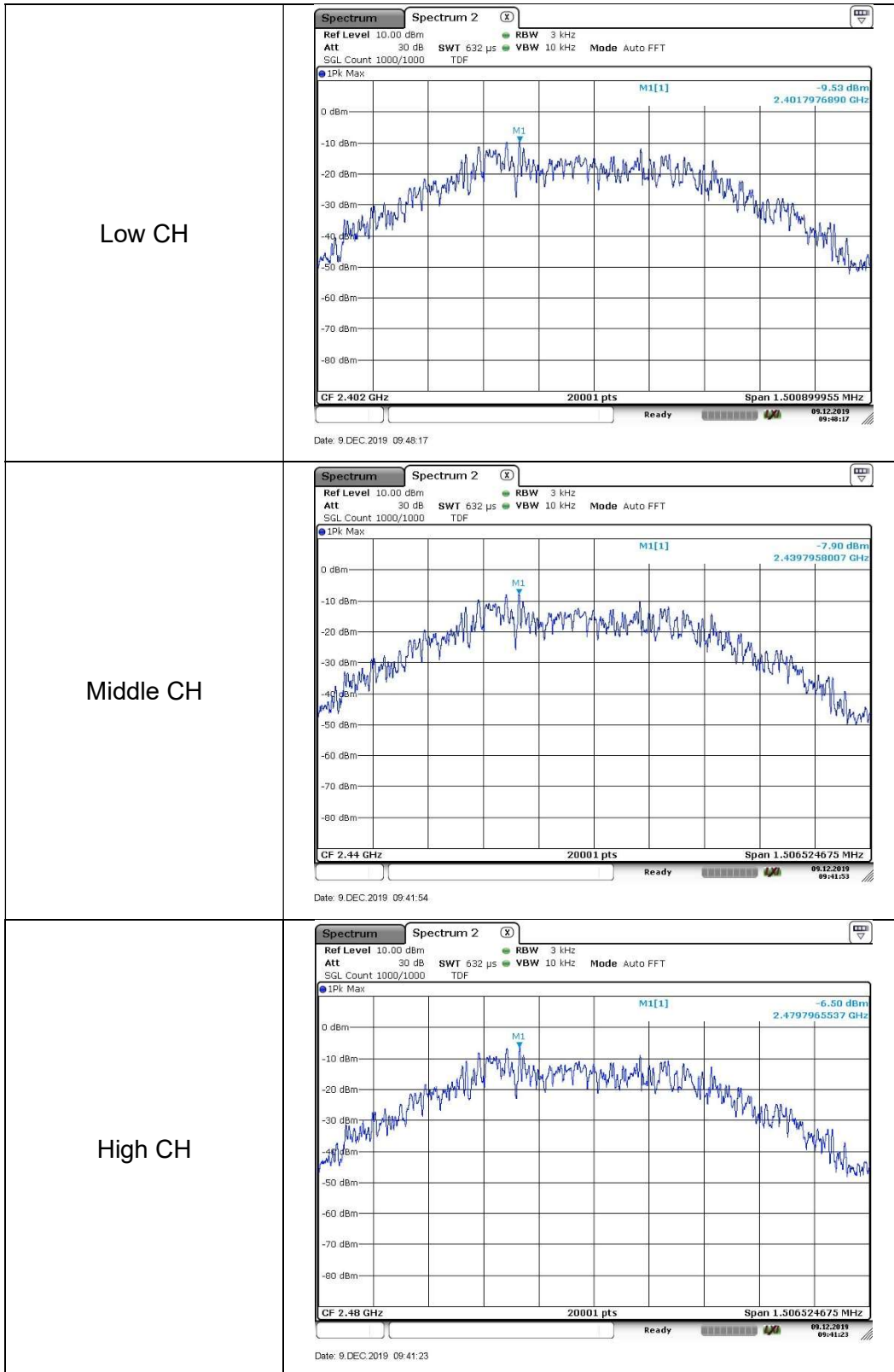



## **10.5. OUT-OF-BAND EMISSIONS**

### **LIMITS**

FCC §15.247 (d) / IC RSS-247 §5.5

In any 100 kHz bandwidth outside the frequency band in which the spread spectrum or digitally modulated intentional radiator is operating, the radio frequency power that is produced by the intentional radiator shall be at least 20 dB below that in the 100 kHz bandwidth within the band that contains the highest level of the desired power, based on either an RF conducted or a radiated measurement, provided the transmitter demonstrates compliance with the peak conducted power limits. If the transmitter complies with the conducted power limits based on the use of RMS averaging over a time interval, as permitted under paragraph (b)(3) of this section, the attenuation required under this paragraph shall be 30 dB instead of 20 dB. Attenuation below the general limits specified in §15.209(a) is not required.

### **TEST PROCEDURE**

The transmitter output is connected to a spectrum analyzer with RBW = 100 kHz, VBW = 300 kHz, peak detector, and max hold. Measurements utilizing these settings are made of the in-band reference level, bandedge (where measurements to the general radiated limits will not be made) and out-of-band emissions.

**RESULTS**

**BANDEDGE & SPURIOUS EMISSIONS, LOW CHANNEL**

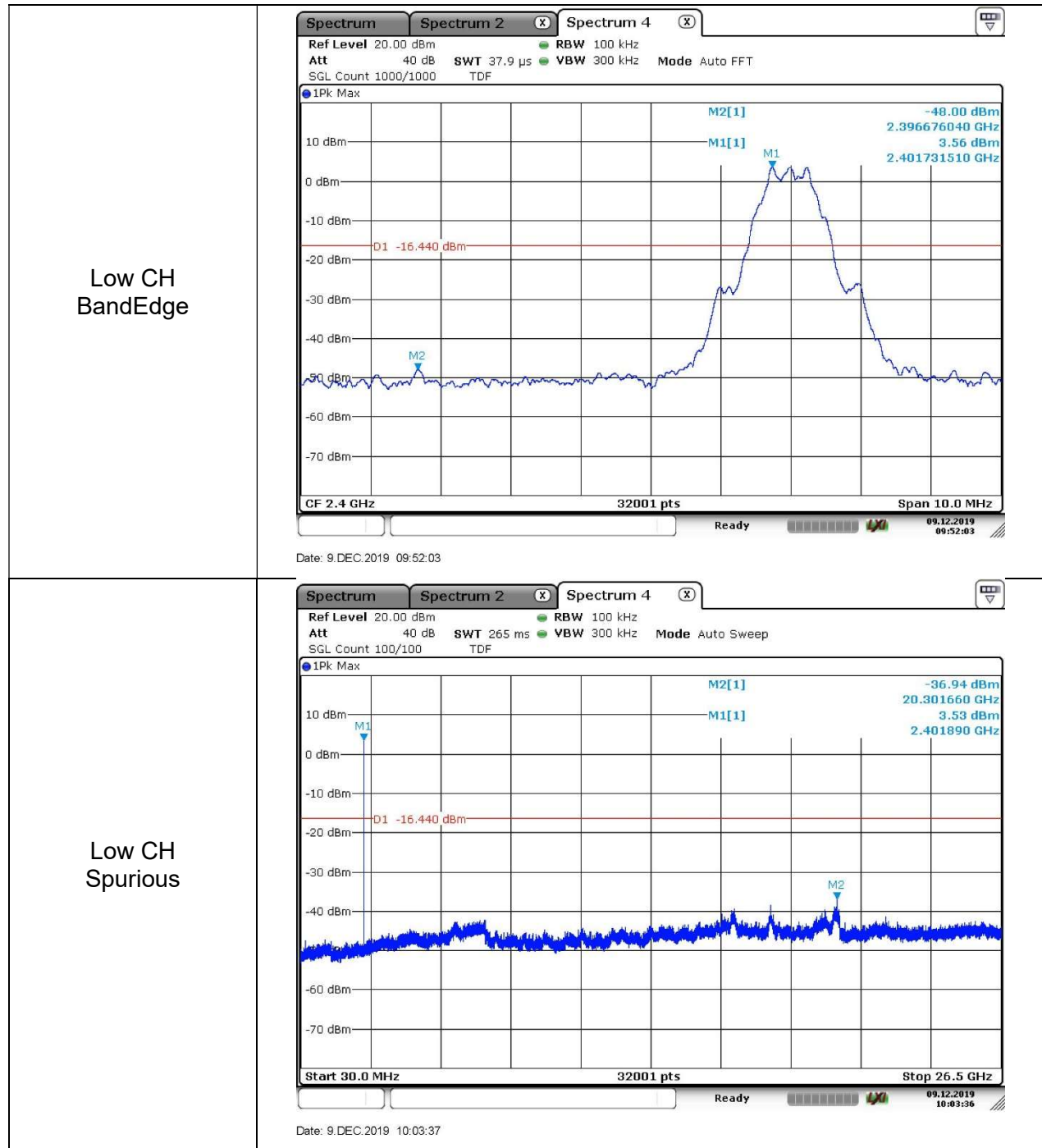

**SPURIOUS EMISSIONS, MID CHANNEL**

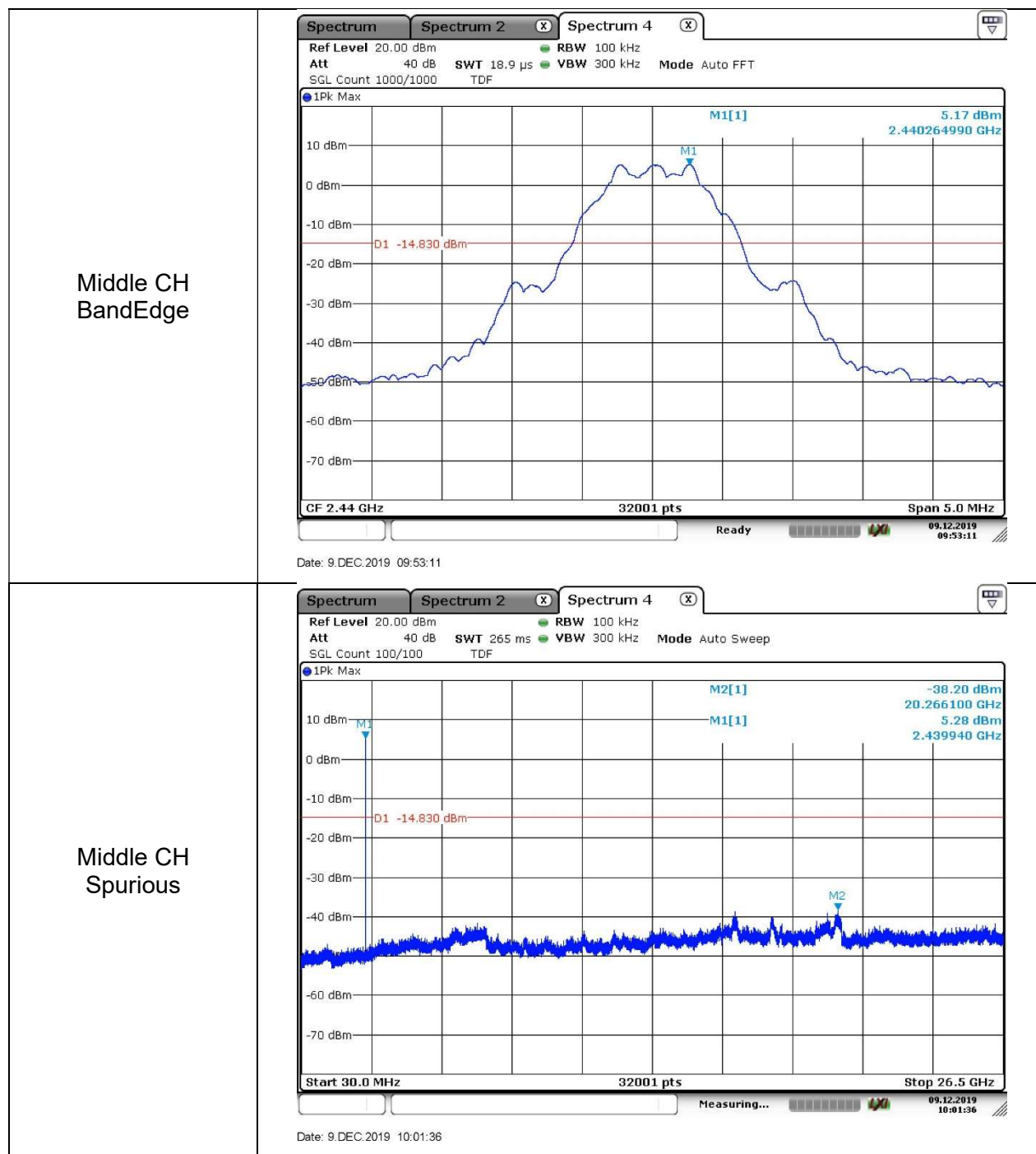

**SPURIOUS EMISSIONS, HIGH CHANNEL**

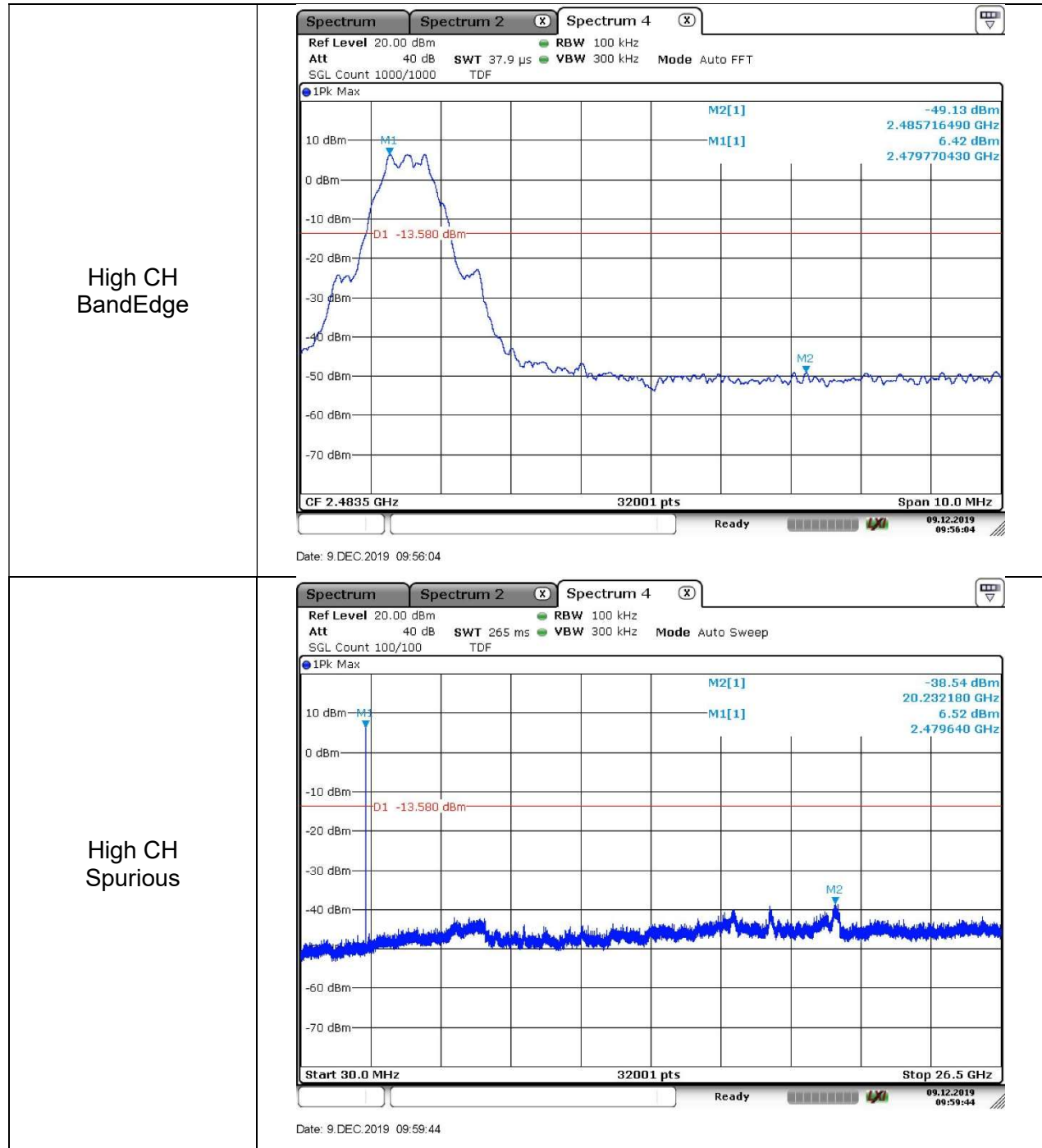

## 11. RADIATED TEST RESULTS

### 11.1. LIMITS AND PROCEDURE

#### LIMITS

FCC §15.205 and §15.209  
 IC RSS-GEN Clause 8.9 (Transmitter)  
 IC RSS-GEN Clause 7 (Receiver)  
 IC RSS-GEN Clause 8.10

Limits for radiated disturbance of an intentional radiator		
Frequency range (MHz)	Limits (µV/m)	Measurement Distance (m)
0.009 – 0.490	2400 / F (kHz)	300
0.490 – 1.705	24000 / F (kHz)	30
1.705 – 30.0	30	30
30 – 88	100**	3
88 - 216	150**	3
216 – 960	200**	3
Above 960	500	3

\*\* Except as provided in paragraph (g), fundamental emissions from intentional radiators operating under this section shall not be located in the frequency bands 54-72 MHz, 76-88 MHz, 174-216 MHz or 470-806 MHz. However, operation within these frequency bands is permitted under other sections of this part, e.g. §§ 15.231 and 15.241.

## **TEST PROCEDURE**

The EUT is placed on a non-conducting table 80 cm above the ground plane for below 1GHz and 150 cm for above 1GHz. The antenna to EUT distance is 3 meters. The EUT is configured in accordance with ANSI C63.10. The EUT is set to transmit in a continuous mode.

For measurements below 1 GHz the resolution bandwidth is set to 100 kHz for peak detection measurements or 120 kHz for quasi-peak detection measurements. Peak detection is used unless otherwise noted as quasi-peak.

For measurements above 1 GHz the resolution bandwidth is set to 1 MHz, then the video bandwidth is set to 3 MHz for peak measurements and add duty cycle factor for average measurements. (Restricted bandedge, Final detection of spurious harmonic emissions) Duty cycle factor =  $10 \log(1/x)$ . For this sample: DCF =  $10 \log(1/0.622) = 2.06$  dB (Spectrum Analyzer round it up to 2.06 dB).

Pre-scans to detect harmonic and spurious emissions, the resolution bandwidth is set to 1 MHz; the video bandwidth is set to 30 kHz for peak measurements.

The spectrum from 1 GHz to 26 GHz is investigated with the transmitter set to the lowest, middle, and highest channels in the 2.4 GHz band.  
(From 30MHz to 1GHz, test was performed with the EUT set to transmit at the channel with highest output power)

The frequency range of interest is monitored at a fixed antenna height and EUT azimuth. The EUT is rotated through 360 degrees to maximize emissions received. The antenna is scanned from 1 to 4 meters above the ground plane to further maximize the emission. Measurements are made with the antenna polarized in both the vertical and the horizontal positions.

Note : Emission was pre-scanned from 9kHz to 30MHz; No emissions were detected which was at least 20dB below the specification limit (consider distance correction factor).  
Per FCC part 15.31(o), test results were not reported.

Although these tests were performed other than open field test site, adequate comparison measurements were confirmed against 30 m open area test site.  
Therefore sufficient tests were made to demonstrate that the alternative site produces results that correlate with the one of tests made in an open field based on KDB 414788.

## 11.2. TRANSMITTER ABOVE 1 GHz

### 11.2.1. BLE MODE

#### RESTRICTED BANDEDGE (LOW CHANNEL)

#### HORIZONTAL PEAK AND AVERAGE PLOT

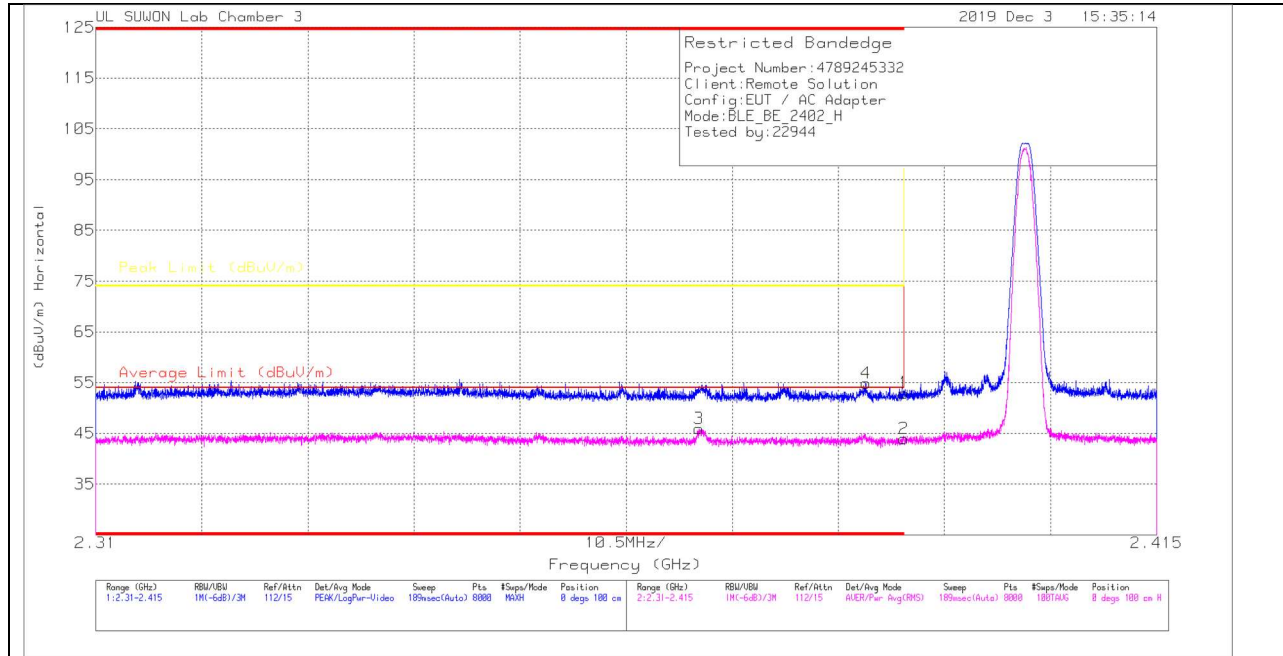

#### HORIZONTAL DATA

#### Trace Markers

Marker	Frequency (GHz)	Meter Reading (dBuV)	Det	3117_002059_59	10dB_ATT[dB]	DC Corr (dB)	Corrected Reading (dBuV/m)	Average Limit (dBuV/m)	Margin (dB)	Peak Limit (dBuV/m)	PK Margin (dB)	Azimuth (Degs)	Height (cm)	Polarizy
1	* 2.39	44.16	Pk	31.7	-22.9	0	52.96	-	-	74	-21.04	0	100	H
4	* 2.38622	46.12	PK	31.7	-22.9	0	54.92	-	-	74	-19.08	0	100	H
2	* 2.39	33.1	RMS	31.7	-22.9	2.06	43.96	54	-10.04	-	-	0	100	H
3	* 2.36973	35.17	RMS	31.6	-22.9	2.06	45.93	54	-8.07	-	-	0	100	H

\* - indicates frequency in CFR47 Pt 15 / IC RSS-Restricted Band  
 Pk - Peak detector  
 RMS - RMS detection

**VERTICAL PEAK AND AVERAGE PLOT**

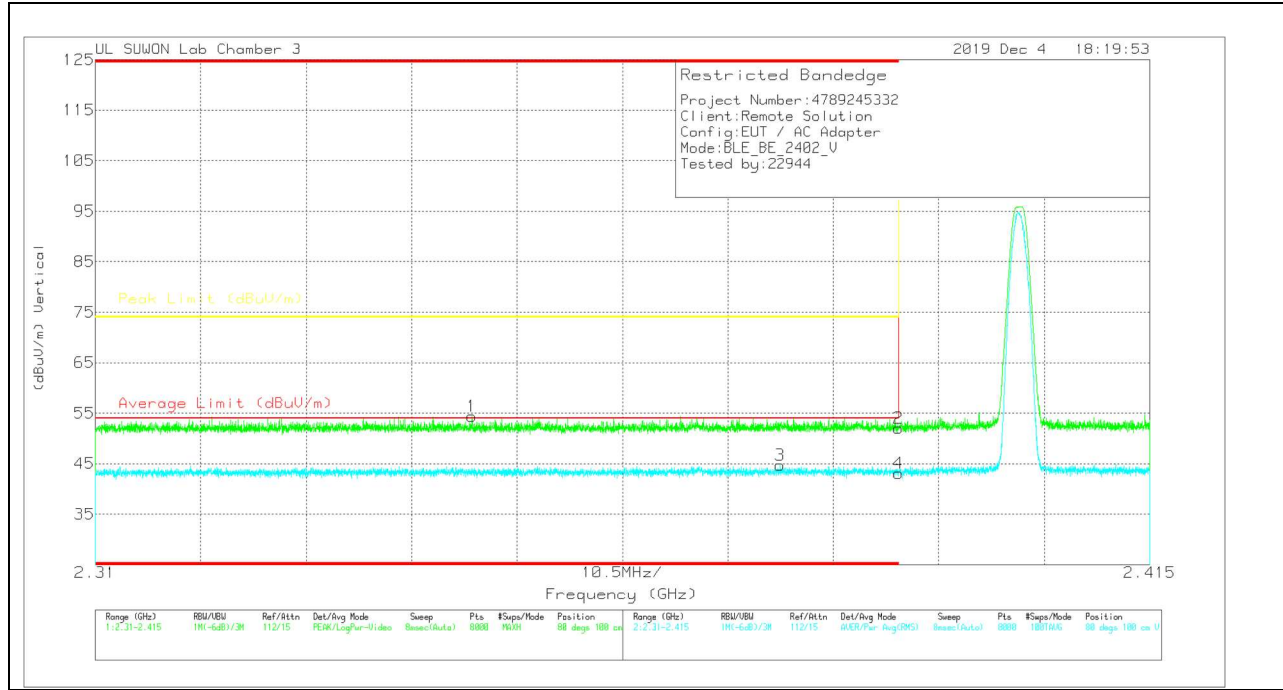

**VERTICAL DATA**

**Trace Markers**

Marker	Frequency (GHz)	Meter Reading (dBuV)	Det	3117_002059_59	10dB_ATT[dB]	DC Corr (dB)	Corrected Reading (dBuV/m)	Average Limit (dBuV/m)	Margin (dB)	Peak Limit (dBuV/m)	PK Margin (dB)	Azimuth (Degs)	Height (cm)	Polarit y
1	* 2.3475	45.74	Pk	31.6	-22.9	0	54.44	-	-	74	-19.56	80	100	V
2	* 2.39	43.19	Pk	31.7	-22.9	0	51.99	-	-	74	-22.01	80	100	V
3	* 2.37819	33.96	RMS	31.6	-22.9	2.06	44.72	54	-9.28	-	-	80	100	V
4	* 2.39	32.19	RMS	31.7	-22.9	2.06	43.05	54	-10.95	-	-	80	100	V

\* - indicates frequency in CFR47 Pt 15 / IC RSS-Restricted Band  
 Pk - Peak detector  
 RMS - RMS detection



### AUTHORIZED BANDEDGE (HIGH CHANNEL)

#### HORIZONTAL PEAK AND AVERAGE PLOT

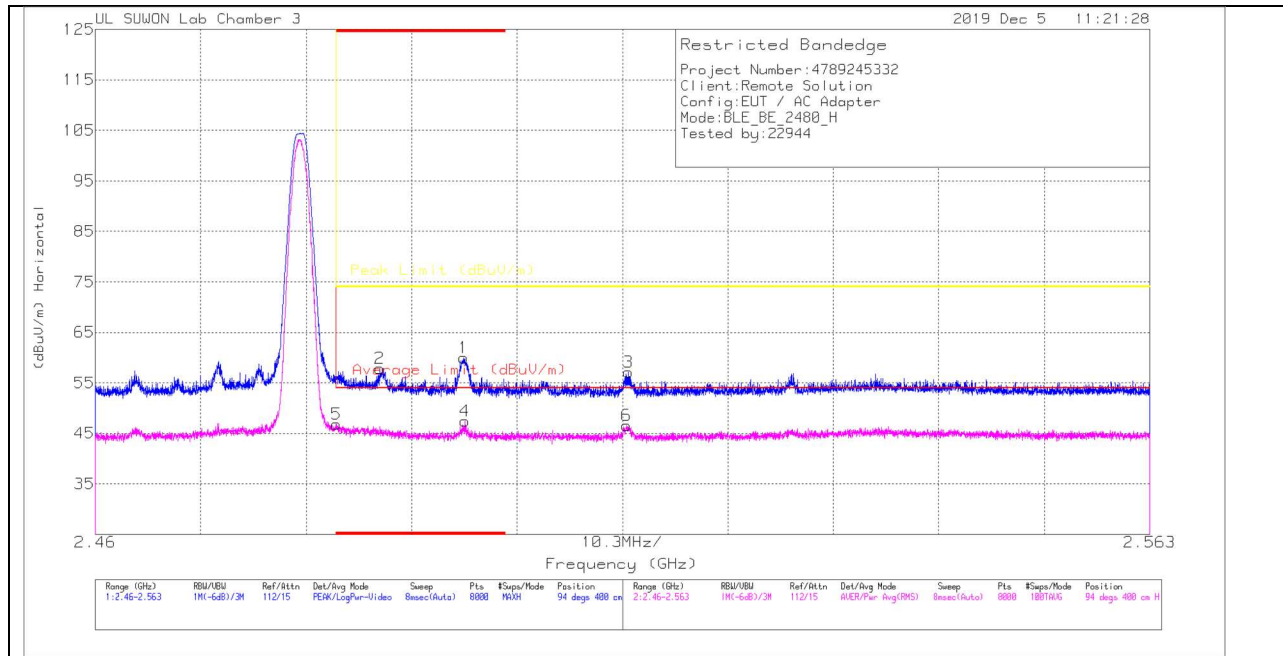

#### HORIZONTAL DATA

##### Trace Markers

Marker	Frequency (GHz)	Meter Reading (dBuV)	Det	3117_002059_59	10dB_ATT[dB]	DC Corr (dB)	Corrected Reading (dBuV/m)	Average Limit (dBuV/m)	Margin (dB)	Peak Limit (dBuV/m)	PK Margin (dB)	Azimuth (Degs)	Height (cm)	Polarity
1	* 2.49595	50.91	Pk	31.9	-22.8	0	60.01	-	-	74	-13.99	94	400	H
2	* 2.48779	48.73	Pk	31.9	-22.8	0	57.83	-	-	74	-16.17	94	400	H
3	2.51209	47.89	Pk	32	-22.8	0	57.09	-	-	74	-16.91	94	400	H
4	* 2.49609	36.27	RMS	31.9	-22.8	2.06	47.43	54	-6.57	-	-	94	400	H
5	* 2.48354	35.63	RMS	31.9	-22.8	2.06	46.79	54	-7.21	-	-	94	400	H
6	2.51192	35.3	RMS	32	-22.8	2.06	46.56	54	-7.44	-	-	94	400	H

\* - indicates frequency in CFR47 Pt 15 / IC RSS-Restricted Band

Pk - Peak detector

RMS - RMS detection

**VERTICAL PEAK AND AVERAGE PLOT**

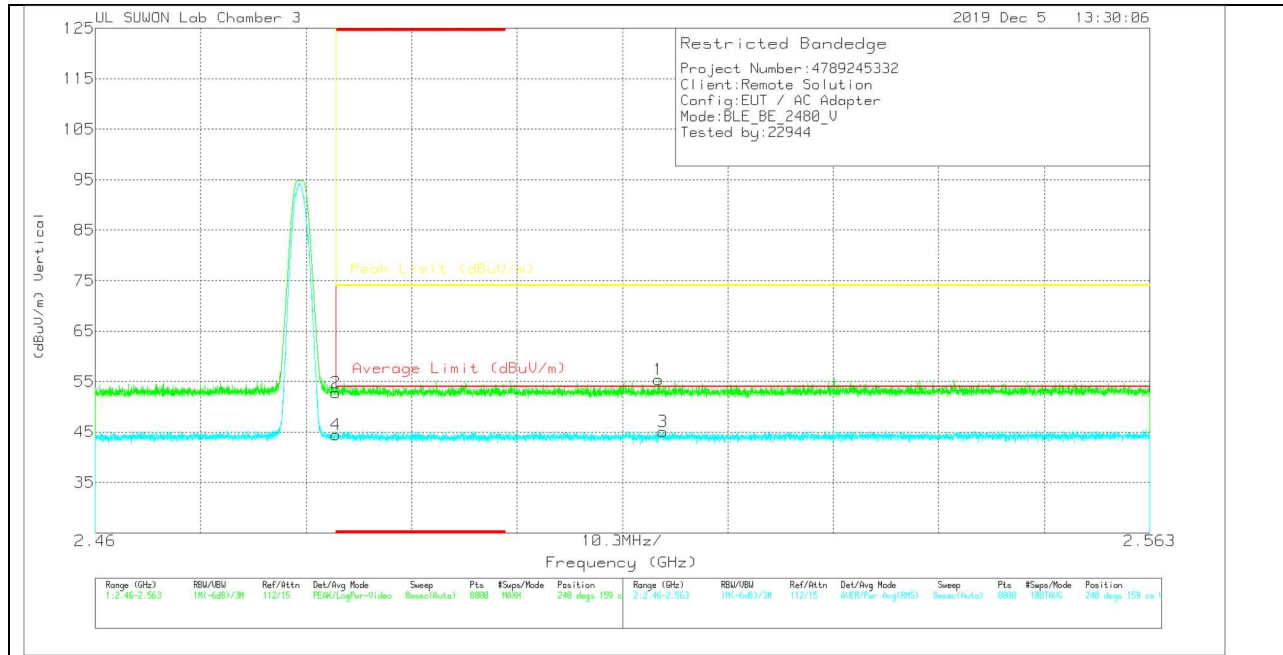

**VERTICAL DATA**

**Trace Markers**

Marker	Frequency (GHz)	Meter Reading (dBuV)	Det	3117_002059 59	10dB_ATT[dB]	DC Corr (dB)	Corrected Reading (dBuV/m)	Average Limit (dBuV/m)	Margin (dB)	Peak Limit (dBuV/m)	PK Margin (dB)	Azimuth (Degs)	Height (cm)	Polariz y
1	2.51502	46.04	Pk	32	-22.7	0	55.34	-	-	74	-18.66	240	159	V
2	* 2.4835	43.71	Pk	31.9	-22.8	0	52.81	-	-	74	-21.19	240	159	V
3	2.51546	33.67	RMS	32	-22.7	2.06	45.03	54	-8.97	-	-	240	159	V
4	* 2.4835	33.32	RMS	31.9	-22.8	2.06	44.48	54	-9.52	-	-	240	159	V

\* - indicates frequency in CFR47 Pt 15 / IC RSS-Restricted Band  
 Pk - Peak detector  
 RMS - RMS detection

**HARMONICS AND SPURIOUS EMISSIONS**

**LOW CHANNEL HORIZONTAL**

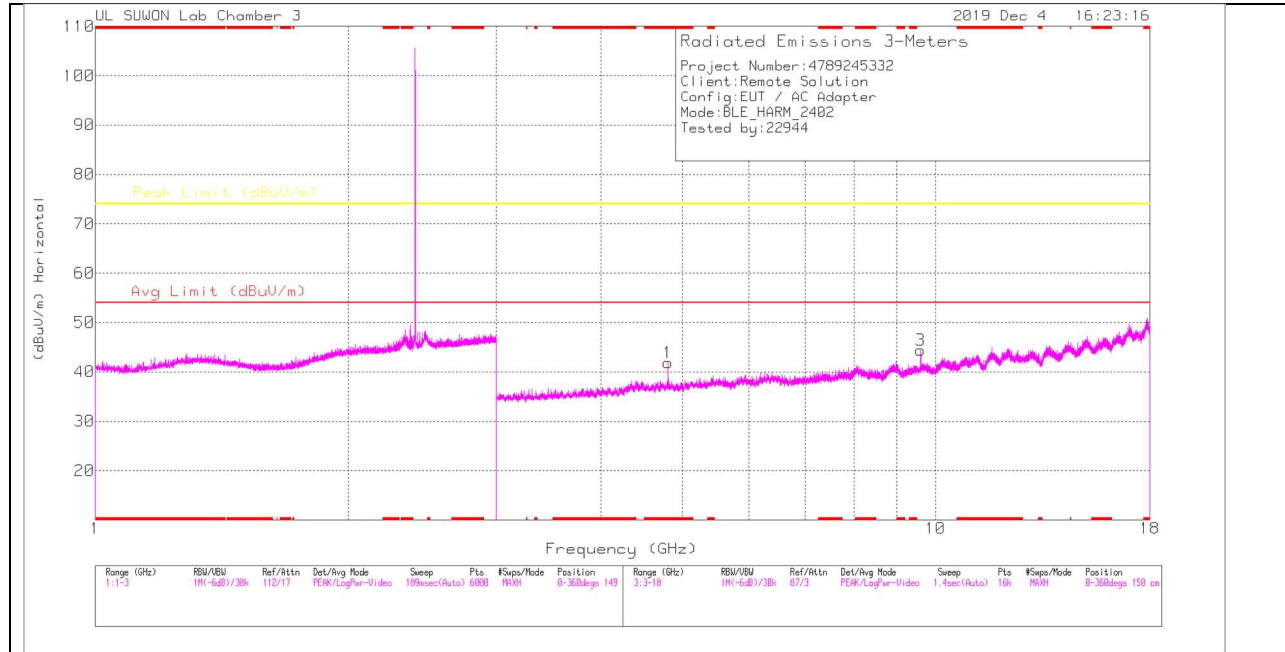

**LOW CHANNEL VERTICAL**

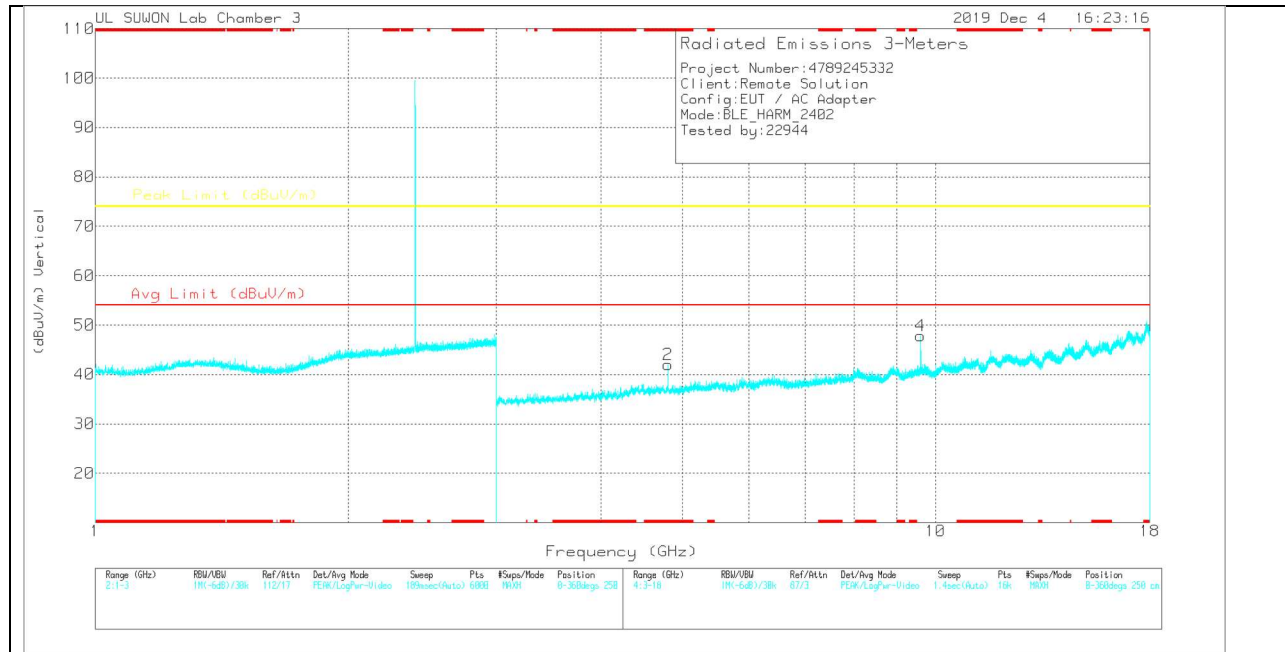

Note: Emission was scanned up to 26GHz; No emissions were detected above the noise floor which was at least 20dB below the specification limit.

### LOW CHANNEL DATA

#### Trace Markers

Marker	Frequency (GHz)	Meter Reading (dBuV)	Det	3117_00205 959	3GHz_HP[dB]	DC Corr (dB)	Corrected Reading (dBuV/m)	Avg Limit (dBuV/m)	Margin (dB)	Peak Limit (dBuV/m)	Margin (dB)	Azimuth (Degs)	Height (cm)	Polarity
1	* 4.80293	35.52	PK	34.2	-27.9	0	41.82	-	-	74	-32.18	0-360	250	H
3	9.60698	27.08	PK	37	-19.7	0	44.38	-	-	74	-29.62	0-360	250	H
2	* 4.80386	35.72	PK	34.2	-27.9	0	42.02	-	-	74	-31.98	0-360	250	V
4	9.60698	30.55	PK	37	-19.7	0	47.85	-	-	74	-26.15	0-360	250	V

\* - indicates frequency in CFR47 Pt 15 / IC RSS-Restricted Band

PK – Peak Detector

#### Radiated Emissions

Frequency (GHz)	Meter Reading (dBuV)	Det	3117_00205 959	3GHz_HP[dB]	DC Corr (dB)	Corrected Reading (dBuV/m)	Avg Limit (dBuV/m)	Margin (dB)	Peak Limit (dBuV/m)	Margin (dB)	Azimuth (Degs)	Height (cm)	Polarity
* 4.80357	43.22	PK2	34.2	-27.9	0	49.52	-	-	74	-24.48	206	125	H
* 4.80348	33.18	MAv1	34.2	-27.9	2.06	41.54	54	-12.46	-	-	206	125	H
9.60892	34.31	PK2	37	-19.7	0	51.61	-	-	74	-22.39	231	309	H
9.60696	23.41	MAv1	37	-19.7	2.06	42.77	-	-	-	-	231	309	H
* 4.80468	42.65	PK2	34.2	-27.9	0	48.95	-	-	74	-25.05	244	310	V
* 4.8036	33.22	MAv1	34.2	-27.9	2.06	41.58	54	-12.42	-	-	244	310	V
9.60698	36.78	PK2	37	-19.7	0	54.08	-	-	74	-19.92	89	230	V
9.60717	27.72	MAv1	37	-19.7	2.06	47.08	-	-	-	-	89	230	V

\* - indicates frequency in CFR47 Pt 15 / IC RSS-Restricted Band

PK2 - KDB558074 Method: Maximum Peak

MAv1 - KDB558074 Option 1 Maximum RMS Average

### MID CHANNEL HORIZONTAL

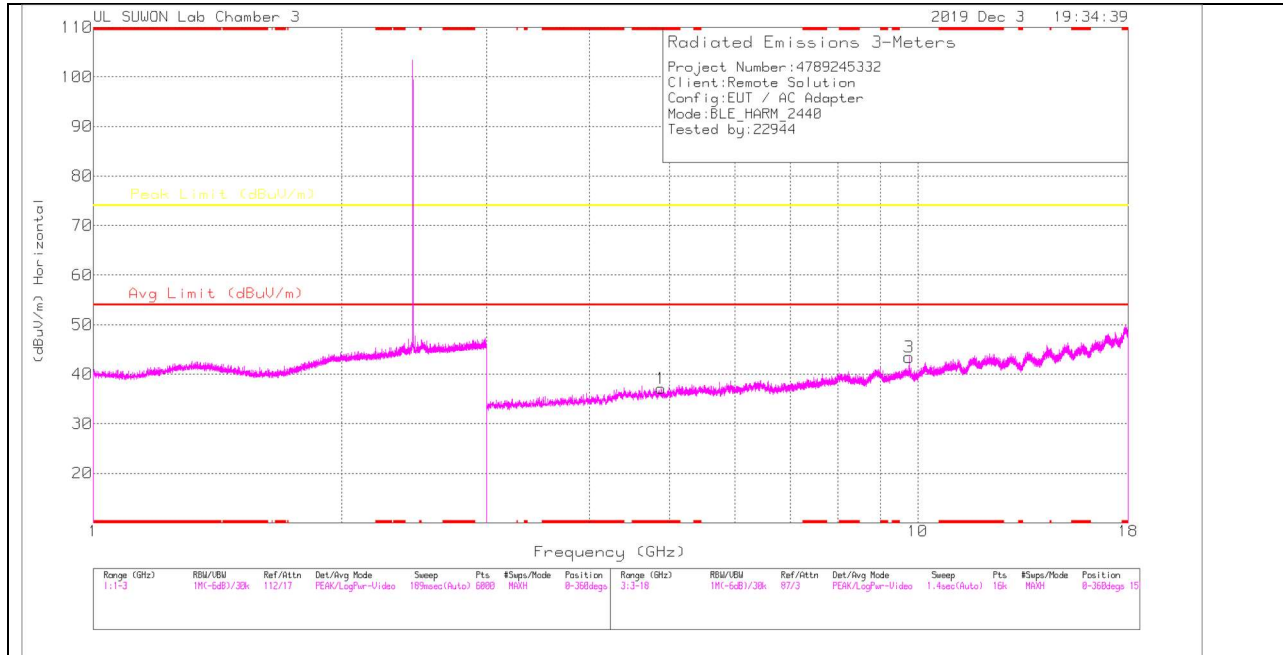

### MID CHANNEL VERTICAL

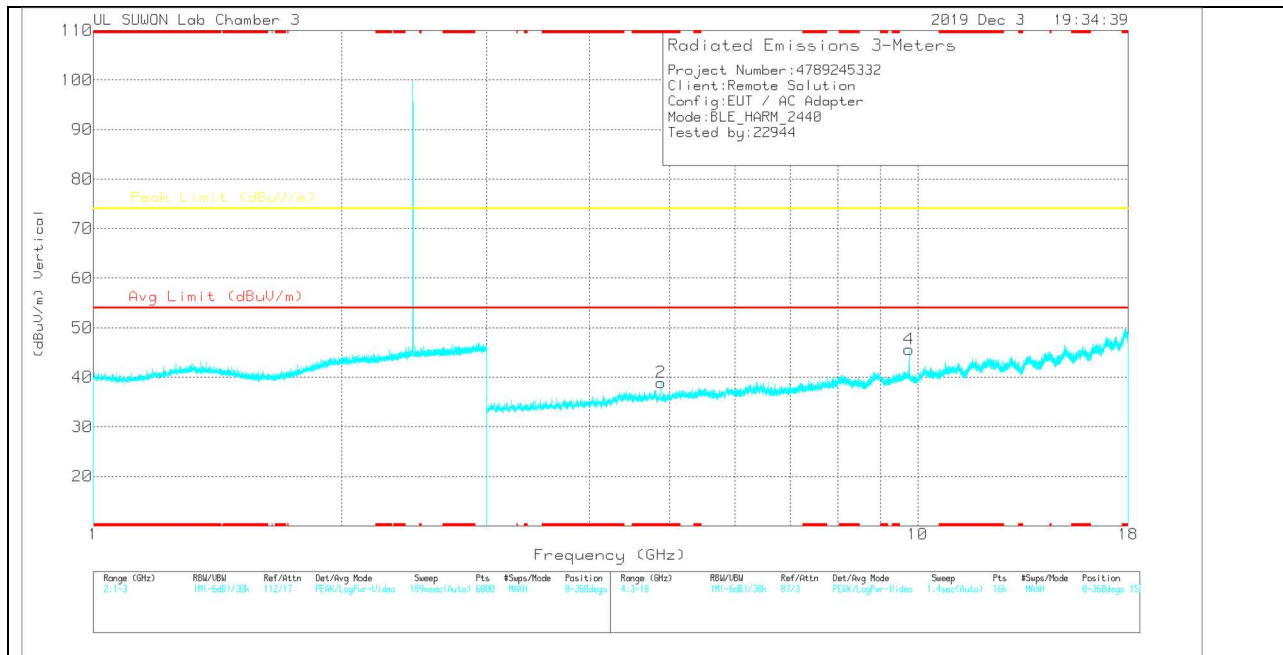

Note: Emission was scanned up to 26GHz; No emissions were detected above the noise floor which was at least 20dB below the specification limit.

**MID CHANNEL DATA**

**Trace Markers**

Marker	Frequency (GHz)	Meter Reading (dBuV)	Det	3117_00205959	3GHz_HP[dB]	DC Corr (dB)	Corrected Reading (dBuV/m)	Avg Limit (dBuV/m)	Margin (dB)	Peak Limit (dBuV/m)	Margin (dB)	Azimuth (Degs)	Height (cm)	Polarity
1	* 4.87981	31.63	PK	34.2	-28.7	0	37.13	-	-	74	-36.87	0-360	250	H
3	9.75886	25.54	PK	37.2	-19.3	0	43.44	-	-	74	-30.56	0-360	250	H
2	* 4.87887	33.44	PK	34.2	-28.7	0	38.94	-	-	74	-35.06	0-360	250	V
4	9.7598	27.77	PK	37.2	-19.3	0	45.67	-	-	74	-28.33	0-360	250	V

\* - indicates frequency in CFR47 Pt 15 / IC RSS-Restricted Band  
 PK – Peak Detector

**Radiated Emissions**

Frequency (GHz)	Meter Reading (dBuV)	Det	3117_00205959	3GHz_HP[dB]	DC Corr (dB)	Corrected Reading (dBuV/m)	Avg Limit (dBuV/m)	Margin (dB)	Peak Limit (dBuV/m)	Margin (dB)	Azimuth (Degs)	Height (cm)	Polarity
* 4.8795	41.79	PK2	34.2	-28.7	0	47.29	-	-	74	-26.71	225	100	H
* 4.87964	30.26	MAv1	34.2	-28.7	2.06	37.82	54	-16.18	-	-	225	100	H
9.76083	34.04	PK2	37.2	-19.3	0	51.94	-	-	74	-22.06	40	218	H
9.75899	23.33	MAv1	37.2	-19.3	2.06	43.29	-	-	-	-	40	218	H
* 4.87962	42.83	PK2	34.2	-28.7	0	48.33	-	-	74	-25.67	120	134	V
* 4.8795	30.79	MAv1	34.2	-28.7	2.06	38.35	54	-15.65	-	-	120	134	V
9.75994	35.77	PK2	37.2	-19.3	0	53.67	-	-	74	-20.33	119	106	V
9.759	25.64	MAv1	37.2	-19.3	2.06	45.6	-	-	-	-	119	106	V

\* - indicates frequency in CFR47 Pt 15 / IC RSS-Restricted Band  
 PK2 - KDB558074 Method: Maximum Peak  
 MAv1 - KDB558074 Option 1 Maximum RMS Average

### HIGH CHANNEL HORIZONTAL

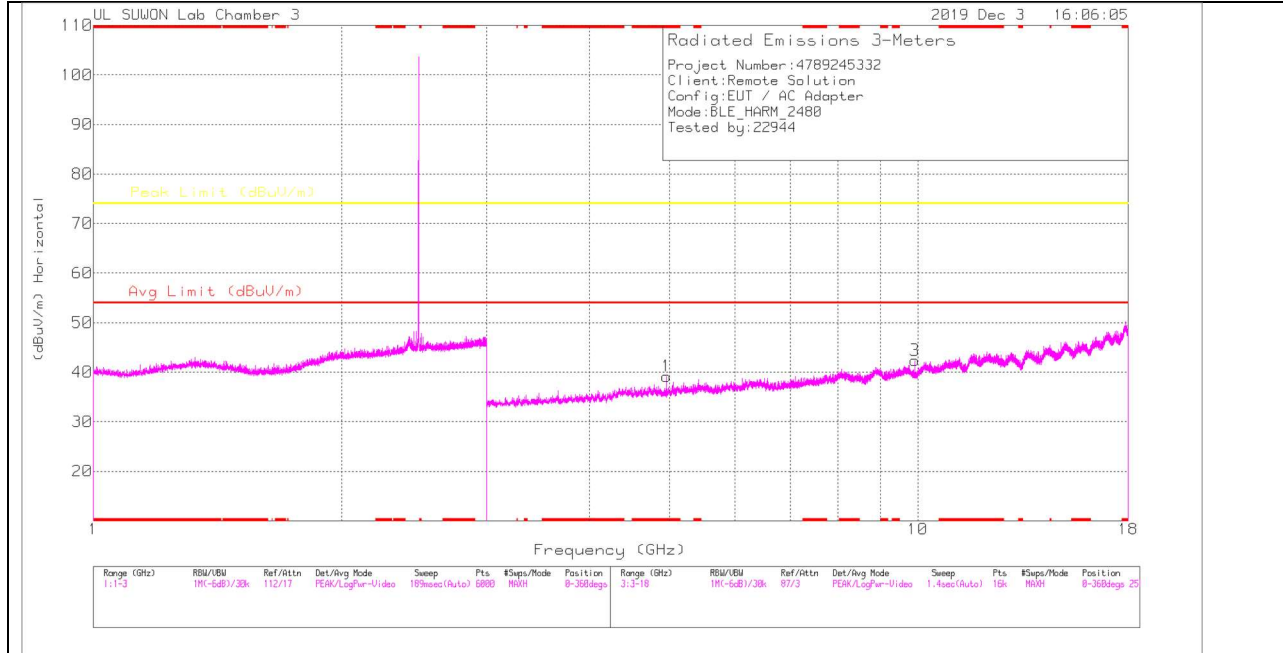

### HIGH CHANNEL VERTICAL

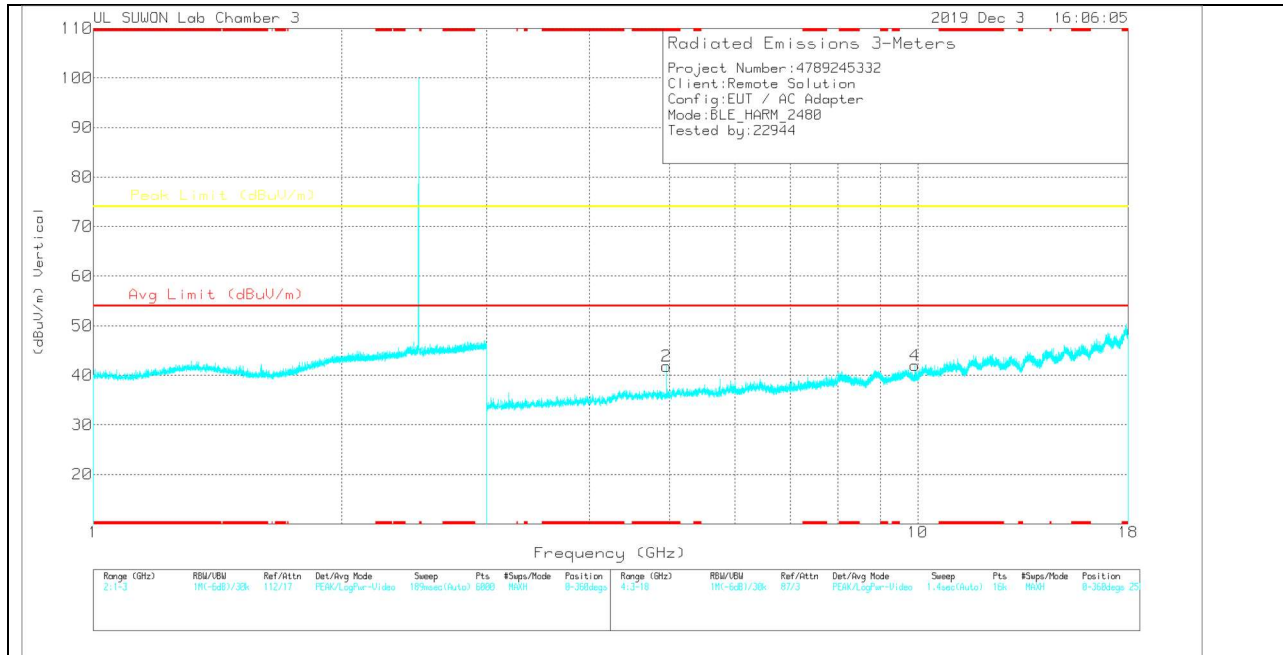

Note: Emission was scanned up to 26GHz; No emissions were detected above the noise floor which was at least 20dB below the specification limit.

**HIGH CHANNEL DATA**

**Trace Markers**

Marker	Frequency (GHz)	Meter Reading (dBuV)	Det	3117_00205959	3GHz_HP[dB]	DC Corr (dB)	Corrected Reading (dBuV/m)	Avg Limit (dBuV/m)	Margin (dB)	Peak Limit (dBuV/m)	Margin (dB)	Azimuth (Degs)	Height (cm)	Polarity
1	* 4.9595	33.48	PK	34.2	-28.5	0	39.18	-	-	74	-34.82	0-360	250	H
3	9.92106	24.39	PK	37.5	-19.5	0	42.39	-	-	74	-31.61	0-360	250	H
2	* 4.9595	36.13	PK	34.2	-28.5	0	41.83	-	-	74	-32.17	0-360	250	V
4	9.91919	23.98	PK	37.5	-19.5	0	41.98	-	-	74	-32.02	0-360	250	V

\* - indicates frequency in CFR47 Pt 15 / IC RSS-Restricted Band  
 PK – Peak Detector

**Radiated Emissions**

Frequency (GHz)	Meter Reading (dBuV)	Det	3117_00205959	3GHz_HP[dB]	DC Corr (dB)	Corrected Reading (dBuV/m)	Avg Limit (dBuV/m)	Margin (dB)	Peak Limit (dBuV/m)	Margin (dB)	Azimuth (Degs)	Height (cm)	Polarity
* 4.95937	43.89	PK2	34.2	-28.5	0	49.59	-	-	74	-24.41	187	102	H
* 4.95969	31.85	MAv1	34.2	-28.5	2.06	39.61	54	-14.39	-	-	187	102	H
9.91907	34.05	PK2	37.5	-19.5	0	52.05	-	-	74	-21.95	61	239	H
9.91902	23.44	MAv1	37.5	-19.5	2.06	43.5	-	-	-	-	61	239	H
* 4.95947	43.61	PK2	34.2	-28.5	0	49.31	-	-	74	-24.69	268	283	V
* 4.95963	34.31	MAv1	34.2	-28.5	2.06	42.07	54	-11.93	-	-	268	283	V
9.9202	34.25	PK2	37.5	-19.5	0	52.25	-	-	74	-21.75	108	230	V
9.92098	23.89	MAv1	37.5	-19.5	2.06	43.95	-	-	-	-	108	230	V

\* - indicates frequency in CFR47 Pt 15 / IC RSS-Restricted Band  
 PK2 - KDB558074 Method: Maximum Peak  
 MAv1 - KDB558074 Option 1 Maximum RMS Average



### 11.3. WORST-CASE BELOW 1 GHz

#### SPURIOUS EMISSIONS 30 TO 1000 MHz

#### HORIZONTAL PLOT

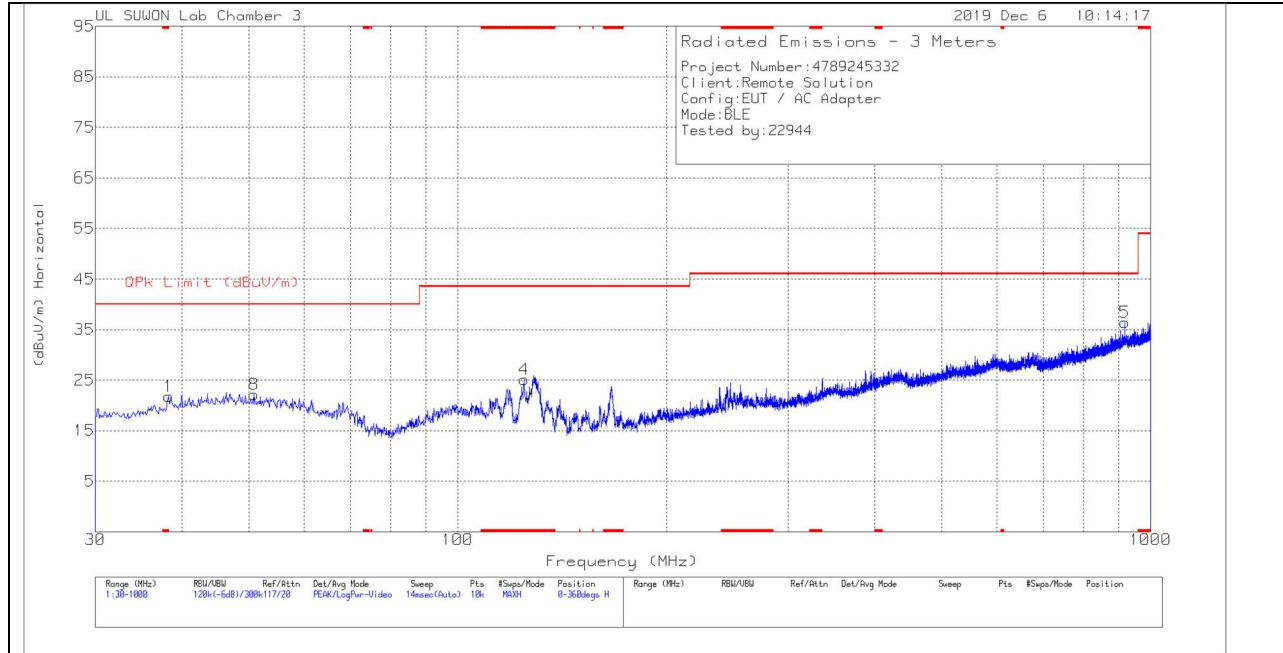

#### VERTICAL PLOT

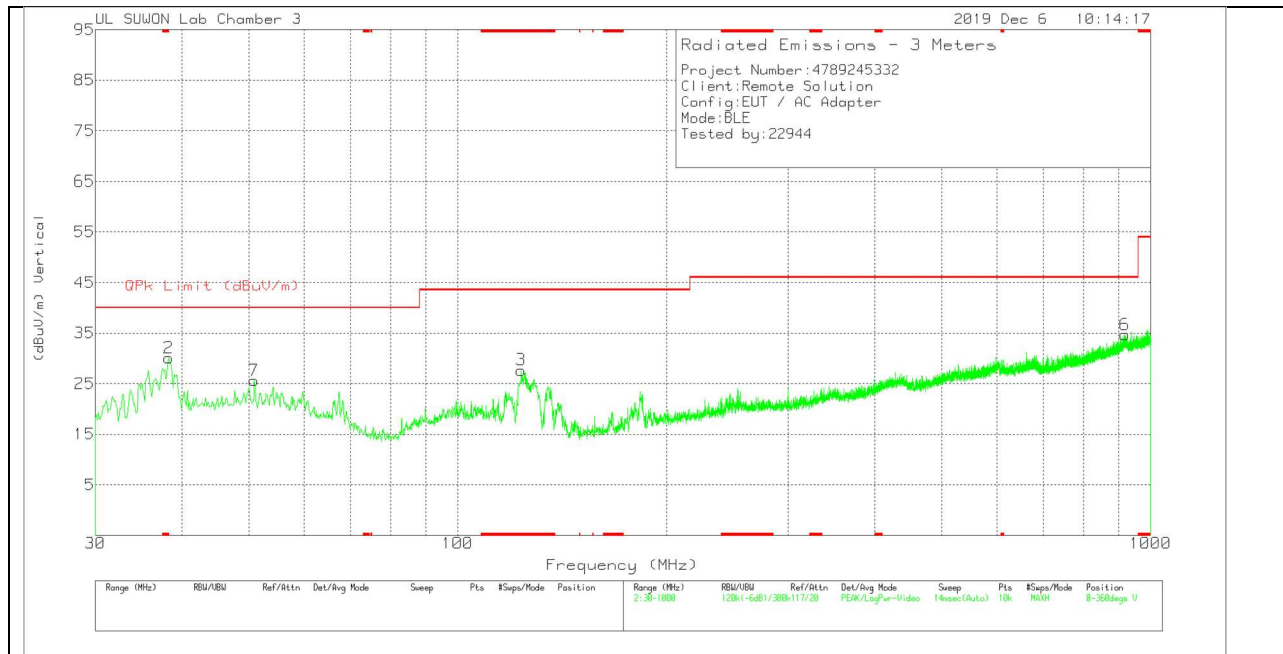

### BELOW 1 GHz TABLE

#### Trace Markers

Marker	Frequency (MHz)	Meter Reading (dBuV)	Det	VULB9163-845	Below_1G[dB]	Corrected Reading (dBuV/m)	QPk Limit (dBuV/m)	Margin (dB)	Azimuth (Degs)	Height (cm)	Polarity
1	* 38.2459	35.66	Pk	18.3	-32.2	21.76	40	-18.24	0-360	400	H
4	* 124.6818	41.29	Pk	15.3	-31.5	25.09	43.52	-18.43	0-360	200	H
5	917.5445	36.47	Pk	28.4	-28.4	36.47	46.02	-9.55	0-360	100	H
8	50.8572	34.32	Pk	20	-32.2	22.12	40	-17.88	0-360	400	H
2	* 38.2459	44.04	Pk	18.3	-32.2	30.14	40	-9.86	0-360	100	V
3	* 123.4206	43.78	Pk	15.5	-31.6	27.68	43.52	-15.84	0-360	100	V
6	917.5445	34.66	Pk	28.4	-28.4	34.66	46.02	-11.36	0-360	400	V
7	50.8572	37.83	Pk	20	-32.2	25.63	40	-14.37	0-360	100	V

\* - indicates frequency in CFR47 Pt 15 / IC RSS-Restricted Band

Pk - Peak detector

Note : Because peak result is lower than the Quasi-Peak limit that Quasi-Peak measurement can be saved.

## 12. AC POWER LINE CONDUCTED EMISSIONS

### LIMITS

FCC §15.207 (a)  
IC RSS-GEN Clause 8.8

Frequency of Emission (MHz)	Conducted Limit (dBuV)	
	Quasi-peak	Average
0.15-0.5	66 to 56*	56 to 46*
0.5-5	56	46
5-30	60	50

\*Decreases with the logarithm of the frequency.

### TEST PROCEDURE

The EUT is placed on a non-conducting table 40 cm from the vertical ground plane and 80 cm above the horizontal ground plane. The EUT is configured in accordance with ANSI C63.10.

The receiver is set to a resolution bandwidth of 9 kHz. Peak detection is used unless otherwise noted as quasi-peak or average.

Line conducted data is recorded for both NEUTRAL and HOT lines.

**RESULTS**

**WORST EMISSIONS**

**LINE 1 PLOT**

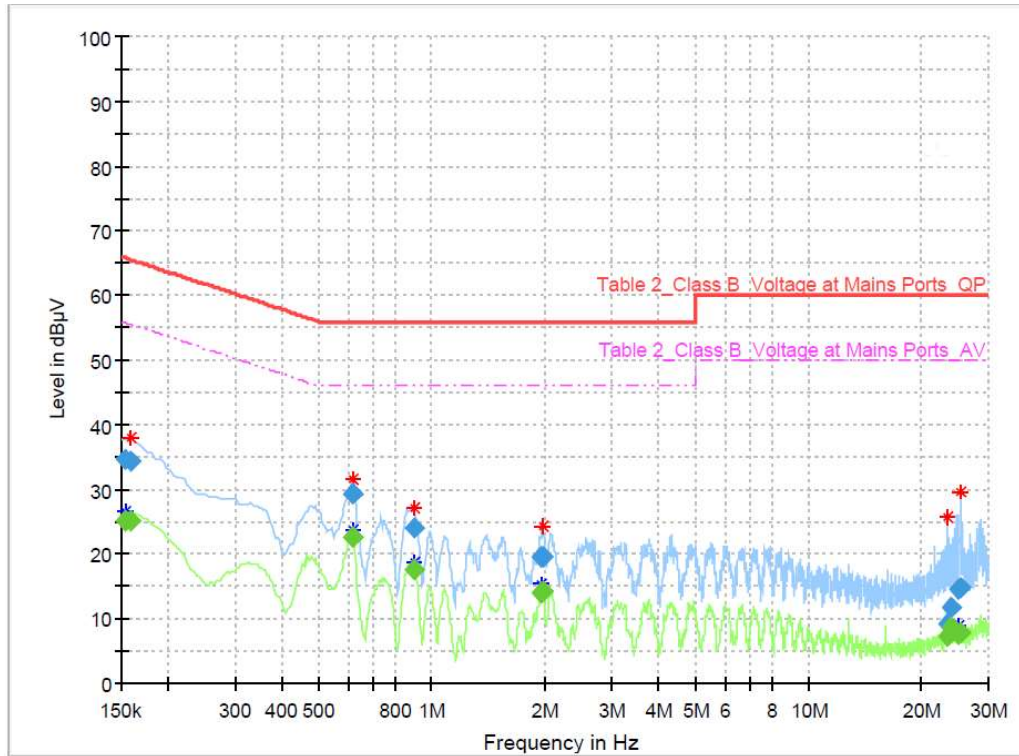

**LINE 1 RESULTS**

Frequency (MHz)	QuasiPeak (dBµV)	CAverage (dBµV)	Limit (dBµV)	Margin (dB)	Line	Corr. (dB)
0.154000	34.52	---	65.78	31.26	L1	9.9
0.154000	---	25.23	55.78	30.55	L1	9.9
0.158000	34.36	---	65.57	31.21	L1	10.0
0.158000	---	25.27	55.57	30.30	L1	10.0
0.616919	29.41	---	56.00	26.59	L1	10.1
0.616919	---	22.59	46.00	23.41	L1	10.1
0.617309	29.39	---	56.00	26.61	L1	10.1
0.617309	---	22.54	46.00	23.46	L1	10.1
0.892691	24.07	---	56.00	31.93	L1	10.0
0.892691	---	17.46	46.00	28.54	L1	10.0
1.948559	---	14.10	46.00	31.90	L1	10.0
1.948559	19.55	---	56.00	36.45	L1	10.0
1.959779	---	14.12	46.00	31.88	L1	10.0
1.959779	19.56	---	56.00	36.44	L1	10.0
23.432169	9.35	---	60.00	50.65	L1	10.9
23.432169	---	7.26	50.00	42.74	L1	10.9
24.001662	11.66	---	60.00	48.34	L1	10.9
24.001662	---	8.57	50.00	41.43	L1	10.9
24.877757	14.58	---	60.00	45.43	L1	11.0
24.877757	---	7.62	50.00	42.38	L1	11.0
25.156831	14.78	---	60.00	45.22	L1	11.0
25.156831	---	7.83	50.00	42.17	L1	11.0

**LINE 2 PLOT**

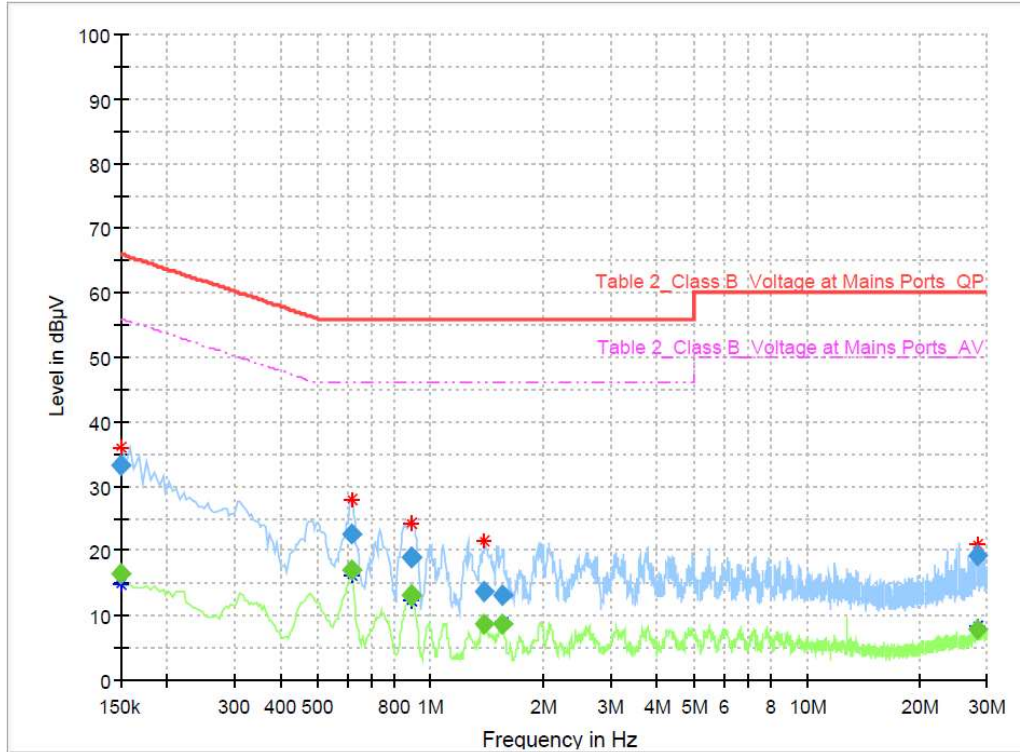

**LINE 2 RESULTS**

Frequency (MHz)	QuasiPeak (dBµV)	CAverage (dBµV)	Limit (dBµV)	Margin (dB)	Line	Corr. (dB)
0.150000	---	16.49	56.00	39.51	N	9.9
0.150000	33.25	---	66.00	32.75	N	9.9
0.613309	---	17.17	46.00	28.83	N	10.1
0.613309	22.75	---	56.00	33.25	N	10.1
0.884691	---	13.00	46.00	33.00	N	10.1
0.884691	19.09	---	56.00	36.91	N	10.1
0.885860	---	13.00	46.00	33.00	N	10.1
0.885860	19.13	---	56.00	36.87	N	10.1
1.390676	---	8.77	46.00	37.23	N	10.0
1.390676	13.65	---	56.00	42.35	N	10.0
1.559537	---	8.74	46.00	37.26	N	10.0
1.559537	13.01	---	56.00	42.99	N	10.0
28.437809	---	7.83	50.00	42.17	N	11.1
28.437809	19.22	---	60.00	40.78	N	11.1