

- Temperature sensor can be installed indoor such as house, office especially warehouse, bathroom and laundry room.
- The sensor can measure temperature and send temperature data to Ethernet gateway via RF communication.
- Low voltage communication and embedded RF amplifier can provide a wide range of communication.
- The sensor uses CR2032 coin cell battery. Battery lifetime is approx. 5years.
- The sensor reports temperature data to Ethernet gateway in every 15minutes.
- In case of damage, sensor can detects damage and notify Ethernet gateway.
- User can easily install using double sided tape.

(This product is working with ethernet gateway.)

Temperature Sensor

Document Number : Rev. 1.0

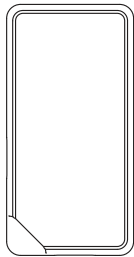

Pairing Guide

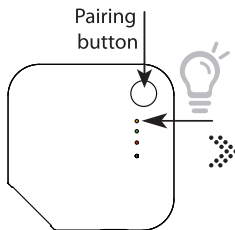

1. Press pairing button on the gateway.
2. The orange LED will blink then the gateway turn into the pairing standby mode. (The orange LED will keep blinking for 30seconds.)

- Sensor is designed to try pairing when pull tab is initially removed

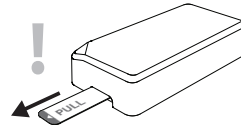

3. Pull battery tab from the sensor to try pairing with the gateway. (The sensor will try pairing for 30seconds.)
4. Once orange LED is off, pairing is done.

Pairing failure

The gateway and the sensor will try pairing for 30seconds. If they are failed to be paired within 30seconds, the orange LED will be off.

Please follow below instruction in case pairing is failed.

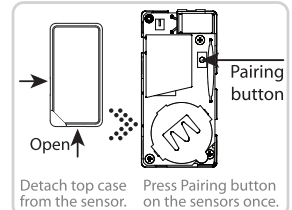

1. The sensors retry to pair with a red color LED blinking.
 2. The method of the registration as pairing is done.(Should check the list on the smart phone.)
- User can edit the text regarding registered sensors on DSR application.

Package Contents

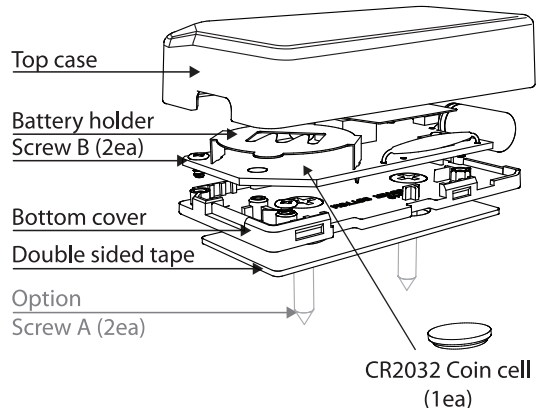

Please refer to this when changing the battery or using screws.



1 Attach double sided tape



2 Install on wall

Battery change

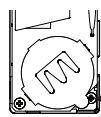

1 Open Top case

2 unscrew a screw. (see arrow)



3 Replace battery with arrow direction.

Insert
Remove

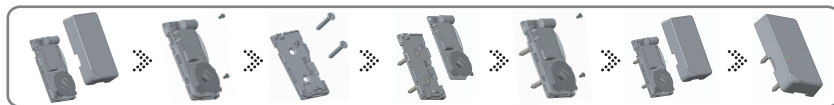

How to fix using screws

Dimensions	L= 28mm, W= 54.5mm, H= 11.3mm
Power source	CR2032(3V) Lithium Battery 1ea
Battery Lifetime	5 years at 25°C (77°F), typical, Indoor use
Operating Temperature	0°C ~50°C, Indoor use
Reporting range	(Temperature) 0°C ~ 50 °C, Accuracy ±2°C
Storage Temperature	-10°C ~ 60°C
Relative Humidity	up to 95% non-condensing

RF Performance Requirements

Protocols : Zigbee HA

Supported channels : IEEE802.15.4 CH11 to CH26

⚠ WARNING

DO NOT INGEST BATTERY.
CHEMICAL BURN HAZARD

[The sensor supplied with] This product contains a coin/button cell battery. If the coin/button cell battery is swallowed, it can cause severe internal burns in just 2 hours and can lead to death. Keep new and used batteries away from children. If the battery compartment does not close securely, stop using the product and keep it away from children. If you think batteries might have been swallowed or placed inside any part of the body, seek immediate medical attention.

FCC Compliance Statement

This equipment has been tested and found to comply with the limits for a Class B digital device, pursuant to part 15 of the FCC rules. These limits are designed to provide reasonable protection against harmful interference in a residential installation. This equipment generates, uses, and can radiate radio frequency energy and, if not used in accordance with the instructions, may cause harmful interference to radio communications.

There is no guarantee that interference will not occur in a particular installation. If this equipment does cause harmful interference to radio or television reception, the user is encouraged to try to correct the interference by one or more of the following measures :

- Reorient or relocate the receiving antenna.
- Increase or decrease the separation between the equipment and receiver.
- Connect the equipment into an outlet on a circuit different from that which the receiver is connected.
- Consult the dealer or an experienced remote control/TV technician for help.
- It is strongly recommended that the TV be plugged into a separate wall outlet.

The user is cautioned that changes and modifications made to the equipment without the approval of the manufacturer could void the user's authority to operate this equipment.

This device complies with part 15 of the FCC rules. Operation is subject to the following two conditions : (1) This device may not cause harmful interference, and (2) this device must accept any interference received, including interference that may cause undesired operation.

"CAUTION" : Exposure to Radio Frequency Radiation. Antenna shall be mounted in such a manner to minimize the potential for human contact to minimize the potential for human contact during normal operation. The antenna should not be contacted during operation to avoid the possibility of exceeding the FCC radio frequency exposure limit.

"CAUTION" : Exposure to Radio Frequency Radiation. This equipment complies with FCC radiation exposure limits set forth for an uncontrolled environment. This equipment must be installed and operated with minimum distance of 20cm between the radiator and your body. This transmit-ter module is authorized only for use in device where the antenna may be installed such that 20 cm may be maintained between the antenna and users.