



SPORTON International Inc.

No. 52, Hwa Ya 1st Rd., Kwei-Shan Hsiang, TaoYuan Hsien, Taiwan, R.O.C.
Ph: 886-3-327-3456 / FAX: 886-3-327-0973 / www.sporton.com.tw

FCC RADIO TEST REPORT

Applicant's company	Realtek Semiconductor Corp.
Applicant Address	No. 2, Innovation Road II, Hsinchu Science Park, Hsinchu 300, Taiwan
FCC ID	TX2RTU7105WGA
Manufacturer's company	Wistron Neweb Corporation
Manufacturer Address	No. 10-1, Li-Hsin Rd. 1, Science-Based Industrial Park, Hsinchu 300, Taiwan R.O.C

Product Name	UWB WGA Adapter
Brand Name	RTU7105 WGA
Model Name	Realtek
Test Rule Part(s)	47 CFR FCC Part 15 Subpart F § 15.517
Test Freq. Range	3100~4800MHz
Received Date	May 06, 2008
Final Test Date	Jun. 16, 2008
Submission Type	Original Equipment



Statement

The test result in this report refers exclusively to the presented test model / sample.

Without written approval of SPORTON International Inc., the test report shall not be reproduced except in full.

The measurements and test results shown in this test report were made in accordance with the procedures and found in compliance with the limit given in **ANSI C63.4-2003** and **47 CFR FCC Part 15 Subpart F**.

The test equipment used to perform the test is calibrated and traceable to NML/ROC.



Testing Laboratory
1190

ILAC MRA

Table of Contents

1. CERTIFICATE OF COMPLIANCE	3
2. SUMMARY OF THE TEST RESULT	4
3. GENERAL INFORMATION	5
3.1. Product Details.....	5
3.2. Accessories.....	5
3.3. Table for Carrier Frequencies	5
3.4. Table for Test Modes.....	6
3.5. Table for Testing Locations.....	6
3.6. Table for Supporting Units	7
3.7. Test Configurations	8
4. TEST RESULT	13
4.1. AC Power Line Conducted Emissions Measurement.....	13
4.2. Operational Limitations.....	18
4.3. UWB Bandwidth Measurement.....	19
4.4. Radiated Emissions Measurement	24
4.5. Radiated Emissions in GPS Bands Measurement	59
4.6. Peak Emissions within a 50 MHz Bandwidth Measurement	71
4.7. Labeling and Instruction Manual Requirements.....	75
4.8. Antenna Requirements	76
5. LIST OF MEASURING EQUIPMENTS	77
6. TEST LOCATION.....	79
7. TAF CERTIFICATE OF ACCREDITATION	80
APPENDIX A. PHOTOGRAPHS OF EUT.....	A1 ~ A15
APPENDIX B. TEST PHOTOS.....	B1 ~ B7



History of This Test Report

Original Issue Date: Jun. 23, 2008

Report No.: FR850606

No additional attachment.

Additional attachment were issued as following record:

Attachment No.	Issue Date	Description

1. CERTIFICATE OF COMPLIANCE

Product Name : UWB WVGA Adapter
Brand Name : RTU7105 WVGA
Model Name : Realtek
Applicant : Realtek Semiconductor Corp.
Test Rule Part(s) : 47 CFR FCC Part 15 Subpart F § 15.517

Sporton International as requested by the applicant to evaluate the EMC performance of the product sample received on May 06, 2008 would like to declare that the tested sample has been evaluated and found to be in compliance with the tested rule parts. The data recorded as well as the test configuration specified is true and accurate for showing the sample's EMC nature.



Reviewed By:

Wayne Hsu

2. SUMMARY OF THE TEST RESULT

Applied Standard: 47 CFR FCC Part 15 Subpart F				
Part	Rule Section	Description of Test	Result	Under Limit
4.1	15.207	AC Power Line Conducted Emissions	Complies	9.33 dB
4.2	15.517(a)	Operational Limitations	Complies	-
4.3	15.517(b)	UWB Bandwidth	Complies	-
4.4	15.517(c)/15.209	Radiated Emissions	Complies	1.31 dB
4.5	15.517(d)	Radiated Emissions in GPS Bands	Complies	1.84 dB
4.5	15.517(e)	Peak Emissions within a 50 MHz Bandwidth	Complies	6.55 dB
4.7	15.517(f)	Labeling Requirements	Complies	-
4.8	15.203	Antenna Requirements	Complies	-

Test Items	Uncertainty	Remark
AC Power Line Conducted Emissions	$\pm 2.3\text{dB}$	Confidence levels of 95%
UWB Bandwidth	$\pm 8.5 \times 10^{-8}$	Confidence levels of 95%
Radiated Emissions (9kHz~30MHz)	$\pm 0.8\text{dB}$	Confidence levels of 95%
Radiated Emissions (30MHz~1000MHz)	$\pm 1.9\text{dB}$	Confidence levels of 95%
Radiated Emissions / in GPS Bands (1GHz~18GHz)	$\pm 1.9\text{dB}$	Confidence levels of 95%
Radiated Emissions (18GHz~40GHz)	$\pm 1.9\text{dB}$	Confidence levels of 95%
Temperature	$\pm 0.7^{\circ}\text{C}$	Confidence levels of 95%
Humidity	$\pm 3.2\%$	Confidence levels of 95%
DC / AC Power Source	$\pm 1.4\%$	Confidence levels of 95%

3. GENERAL INFORMATION

3.1. Product Details

Items	Description
Power Type	Power Adapter
Modulation	Multi-band OFDM (QPSK / DCM)
Operation Frequency Range	3168 ~ 4752 MHz
10 dB Bandwidth	517 MHz
RF Output Rating	74.68 dBuV/m EIRP @ 3 meters
Carrier Frequencies	Please refer to section 3.3
Antenna	1.8dBi (external antenna) / 2.8dBi (external antenna)

3.2. Accessories

Power	Brand	Model	Rating
Adapter 1	OEM	ADS10-W050100	Input: 100-240V, 50/60Hz, 0.5A Output: 5V, 1.0A
Adapter 2	DVE	DSA-12PFA-05 FUS 050200	Input: 100-240V, 50/60Hz, 0.5A Output: 5V, 2A
Adapter 3	FAIRWAY	WRG10F-050A	Input: 100-240V, 47/63Hz, 0.5A Output: 5V, 2A

3.3. Table for Carrier Frequencies

Band Group	BAND_ID (nb)	Lower Frequency (MHz)	Center Frequency (MHz)	Upper Frequency (MHz)
1	1	3168	3432	3696
	2	3696	3960	4224
	3	4224	4488	4752

3.4. Table for Test Modes

Investigation has been done on all the possible configurations for searching the worst cases. The following table is a list of the test modes shown in this test report.

Test Items	Mode	BAND_ID (nb)	Antenna
AC Power Line Conducted Emissions	Normal Link	Auto	1/2
UWB Bandwidth	CTX	All Band	1/2
Radiated Emissions 9kHz~960MHz	Normal Link	Auto	1/2
Radiated Emissions above 960MHz	CTX	All Band	1/2
Peak Emissions within a 50 MHz Bandwidth	CTX	All Band	1/2

Note: CTX=continuously transmitting

Test mode:

Adapter 1 + EUT

Adapter 2 + EUT

Adapter 3 + EUT

For Conduction Emission test:

Due to Mode 3 generated the worst test result, so it was recorded in this report.

For Radiation Emission test:

Mode 1: Ant. 1(Gain 1.8dBi) + Adapter 1

Mode 2: Ant. 2(Gain 2.8dBi) + Adapter 1

Mode 3: Ant. 1(Gain 1.8dBi) + Adapter 2

Mode 4: Ant. 2(Gain 2.8dBi) + Adapter 2

Mode 5: Ant. 1(Gain 1.8dBi) + Adapter 3

Mode 6: Ant. 2(Gain 2.8dBi) + Adapter 3

Due to Mode 1 and Mode 4 generated the worst test result, so it was recorded in this report.

3.5. Table for Testing Locations

Test Site No.	Site Category	Location	FCC Reg. No.	IC File No.	VCCI Reg. No
03CH03-HY	SAC	Hwa Ya	101377	IC 4088	-
CO04-HY	Conduction	Hwa Ya	101377	IC 4088	-
TH01-HY	OVEN Room	Hwa Ya	-	-	-

Open Area Test Site (OATS); Semi Anechoic Chamber (SAC); Fully Anechoic Chamber (FAC).

Please refer section 6 for Test Site Address.



3.6. Table for Supporting Units

Support Unit	Brand	Model	FCC ID
Notebook	DELL	1200	E2K4965AGNM
Notebook	DELL	1200	E2K4965AGNM
LCD Monitor	DELL	1704FPT†	DoC
Mouse	QSKY	Lx-619B	DoC
DONGLE	N/A	N/A	N/A

3.7. Test Configurations

3.7.1. Radiation Emissions Test Configuration

30MHz~960MHz

Test Mode: Mode 1

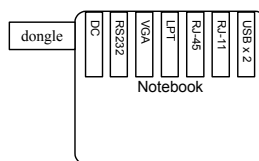
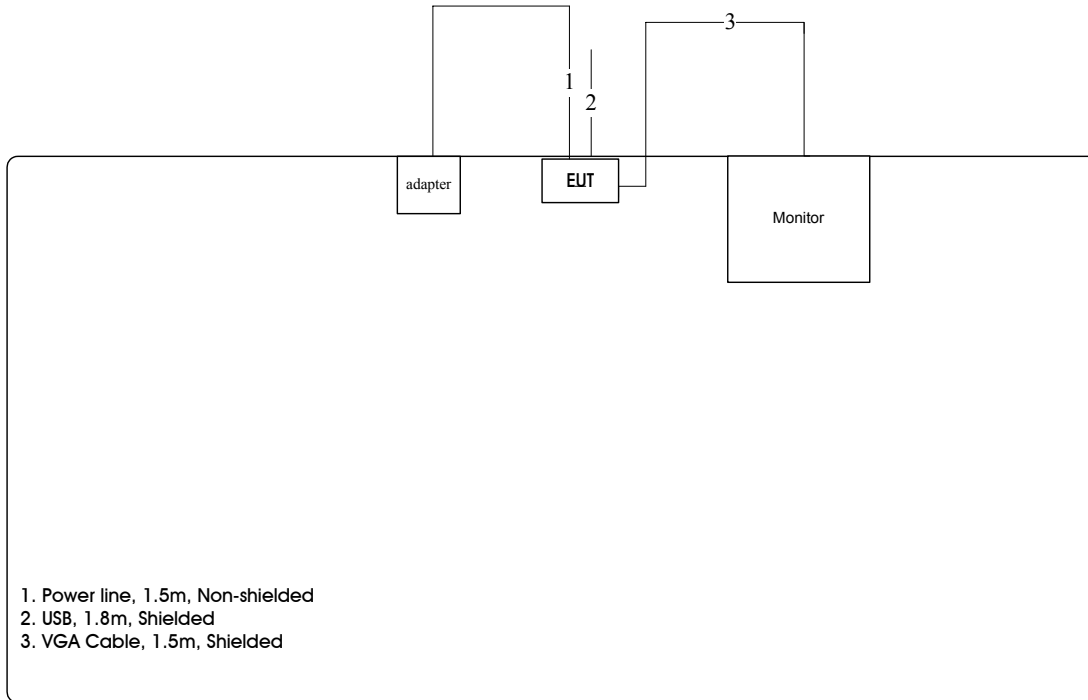

Test Mode: Mode 4

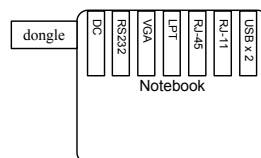
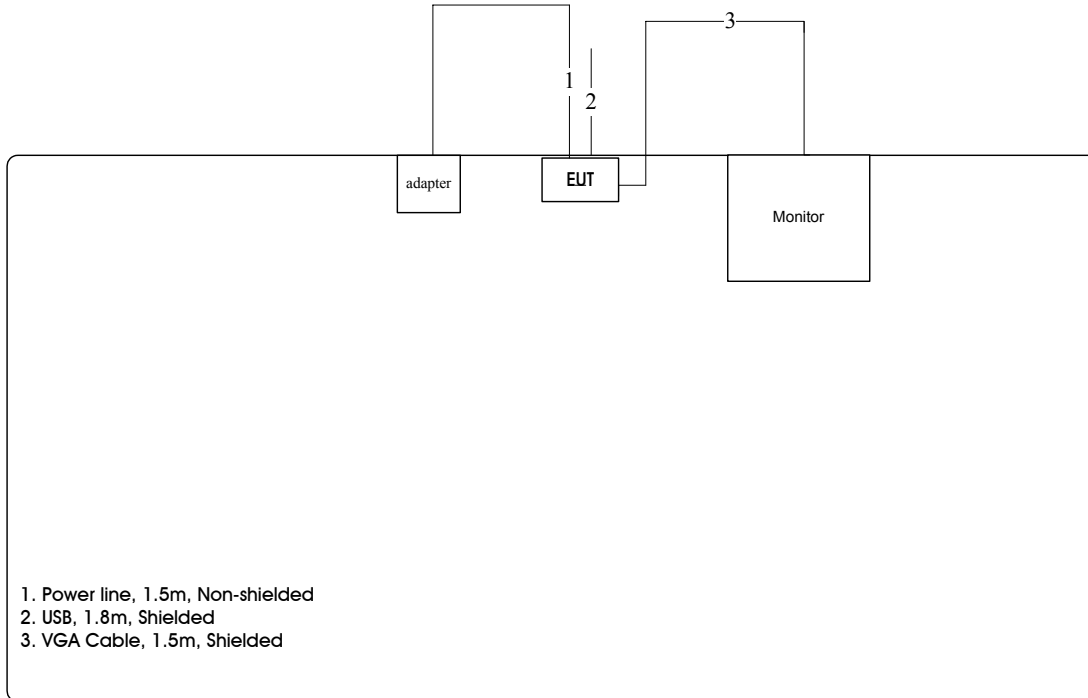

Above 960MHz

Test Mode: Mode 1

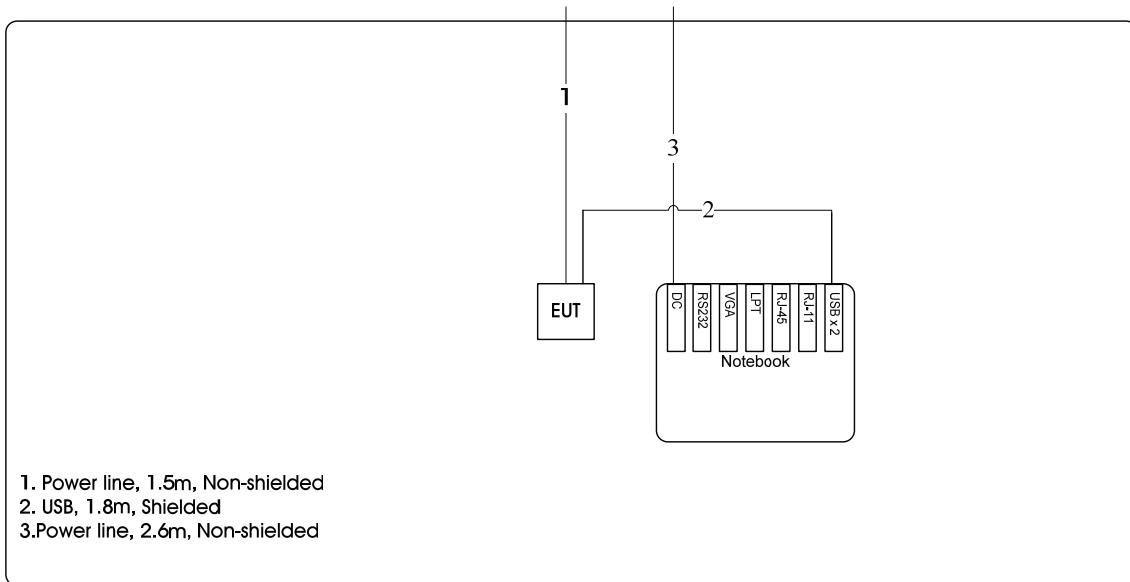

Test Mode: Mode 4

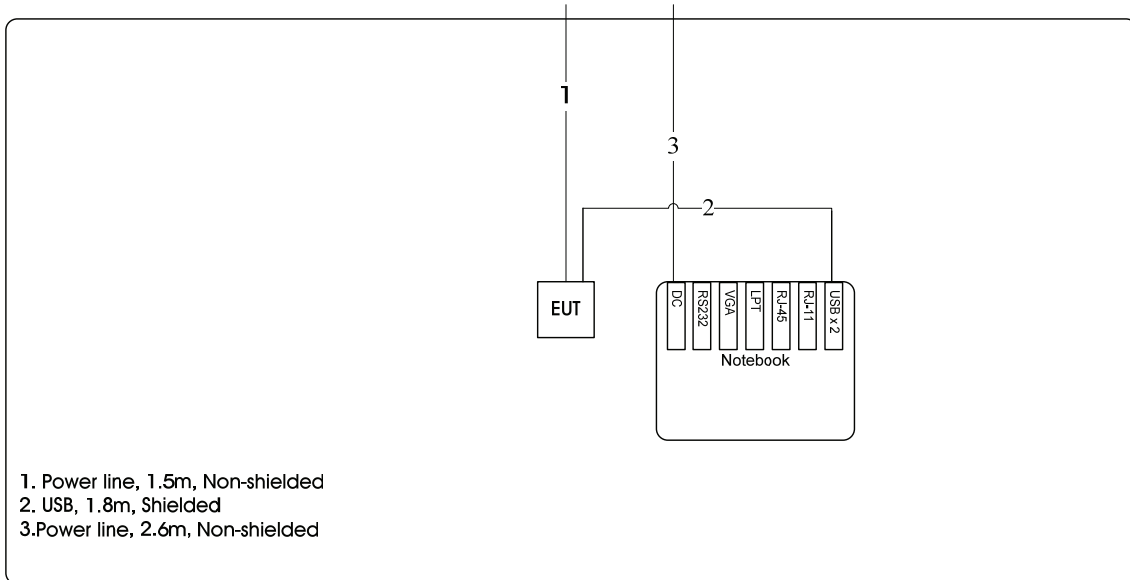

3.7.2. AC Power Line Conduction Emissions Test Configuration

Test Mode: Adapter 3

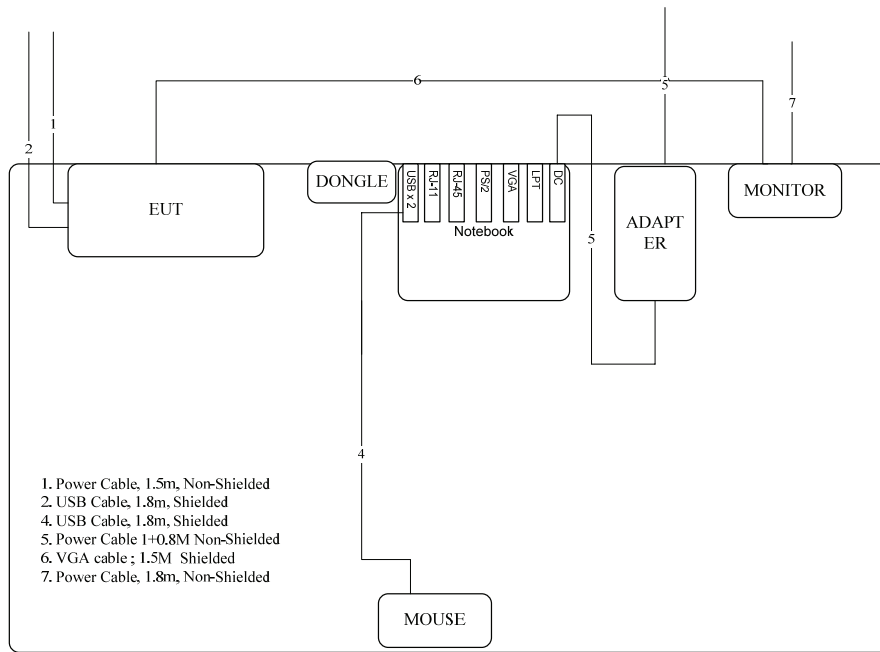

4. TEST RESULT

4.1. AC Power Line Conducted Emissions Measurement

4.1.1. Limit

For this product which is designed to be connected to the AC power line, the radio frequency voltage that is conducted back onto the AC power line on any frequency or frequencies within the band 150 kHz to 30 MHz shall not exceed below limits table.

Frequency (MHz)	QP Limit (dBuV)	AV Limit (dBuV)
0.15~0.5	66~56	56~46
0.5~5	56	46
5~30	60	50

4.1.2. Measuring Instruments and Setting

Please refer to section 5 of equipments list in this report. The following table is the setting of the receiver.

Receiver Parameters	Setting
Attenuation	10 dB
Start Frequency	0.15 MHz
Stop Frequency	30 MHz
IF Bandwidth	9 KHz

4.1.3. Test Procedures

1. Configure the EUT according to ANSI C63.4. The EUT or host of EUT has to be placed 0.4 meter far from the conducting wall of the shielding room and at least 80 centimeters from any other grounded conducting surface.
2. Connect EUT or host of EUT to the power mains through a line impedance stabilization network (LISN).
3. All the support units are connected to the other LISNs. The LISN should provide 50uH/50ohms coupling impedance.
4. The frequency range from 150 KHz to 30 MHz was searched.
5. Set the test-receiver system to Peak Detect Function and Specified Bandwidth with Maximum Hold Mode.
6. The measurement has to be done between each power line and ground at the power terminal.

4.1.4. Test Setup Layout

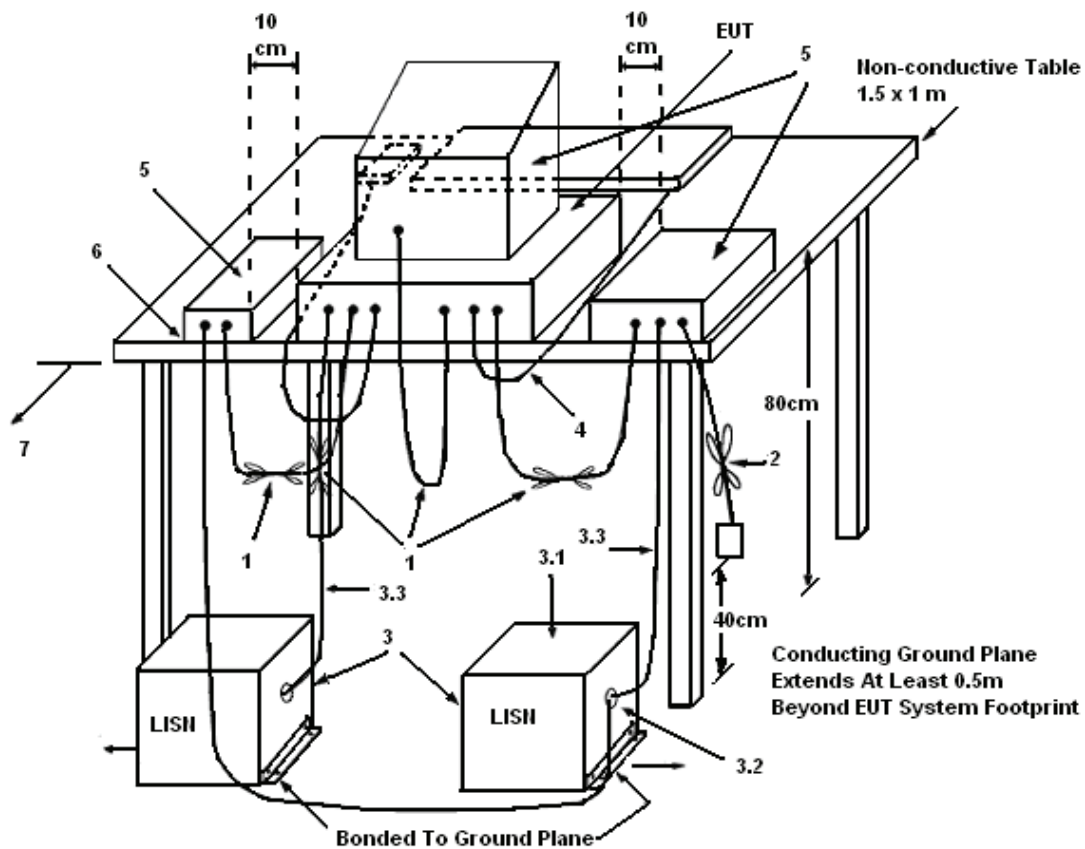

LEGEND:

- (1) Interconnecting cables that hang closer than 40 cm to the ground plane shall be folded back and forth in the center forming a bundle 30 to 40 cm long.
- (2) I/O cables that are not connected to a peripheral shall be bundled in the center. The end of the cable may be terminated, if required, using the correct terminating impedance. The overall length shall not exceed 1 m.
- (3) EUT connected to one LISN. Unused LISN measuring port connectors shall be terminated in 50 Ω. LISN can be placed on top of, or immediately beneath, reference ground plane.
 - (3.1) All other equipment powered from additional LISN(s).
 - (3.2) Multiple outlet strip can be used for multiple power cords of non-EUT equipment.
 - (3.3) LISN at least 80 cm from nearest part of EUT chassis.
- (4) Cables of hand-operated devices, such as keyboards, mice, etc., shall be placed as for normal use.
- (5) Non-EUT components of EUT system being tested.
- (6) Rear of EUT, including peripherals, shall all be aligned and flush with rear of tabletop.
- (7) Rear of tabletop shall be 40 cm removed from a vertical conducting plane that is bonded to the ground plane.

4.1.5. Test Deviation

There is no deviation with the original standard.

4.1.6. EUT Operation during Test

The EUT was placed on the test table and programmed in normal function.

4.1.7. Results of AC Power Line Conducted Emissions Measurement

Temperature	23°C	Humidity	54%
Test Engineer	Johnson Chang	Phase	Line
Configuration	Adapter 3		

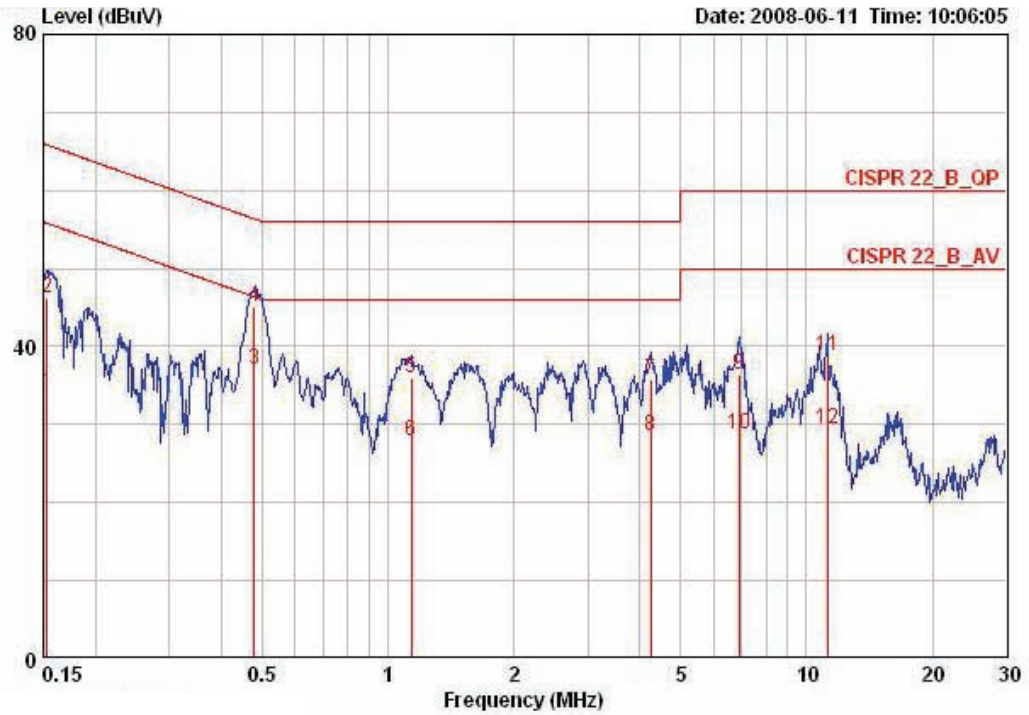

	Freq	Level	Over	Limit	Read	LISN	Cable	Remark
	MHz	dBuV	Limit	Line	Level	Factor	Loss	
			dB	dBuV	dBuV	dB	dB	
1	0.15321	34.01	-21.81	55.82	33.74	0.07	0.20	AVERAGE
2	0.15321	46.23	-19.59	65.82	45.96	0.07	0.20	QP
3	0.47865	37.04	-9.33	46.36	36.88	0.03	0.13	AVERAGE
4	0.47865	45.18	-11.19	56.36	45.02	0.03	0.13	QP
5	1.135	35.96	-20.04	56.00	35.76	0.03	0.17	QP
6	1.135	27.89	-18.11	46.00	27.69	0.03	0.17	AVERAGE
7	4.247	35.69	-20.31	56.00	35.27	0.12	0.30	QP
8	4.247	28.53	-17.47	46.00	28.11	0.12	0.30	AVERAGE
9	6.914	36.34	-23.66	60.00	35.78	0.25	0.31	QP
10	6.914	28.73	-21.27	50.00	28.17	0.25	0.31	AVERAGE
11	11.198	38.81	-21.19	60.00	38.00	0.41	0.40	QP
12	11.198	29.34	-20.66	50.00	28.53	0.41	0.40	AVERAGE

Temperature	23°C	Humidity	54%
Test Engineer	Johnson Chang	Phase	Neutral
Configuration	Adapter 3		

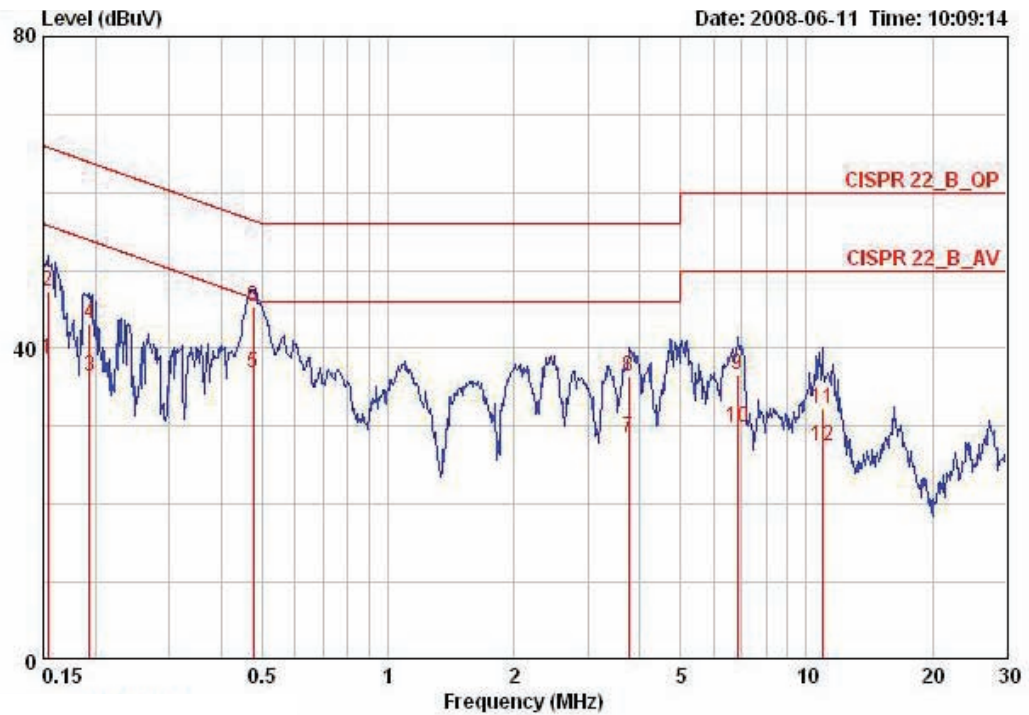

	Freq	Level	Over	Limit	Read	LISN	Cable	Remark
	MHz	dBuV	Limit	Line	Level	Factor	Loss	
			dB	dBuV	dBuV	dB	dB	
1	0.15403	38.65	-17.13	55.78	38.35	0.10	0.20	AVERAGE
2	0.15403	47.38	-18.40	65.78	47.08	0.10	0.20	QP
3	0.19344	36.33	-17.55	53.89	36.05	0.08	0.20	AVERAGE
4	0.19344	43.14	-20.74	63.89	42.86	0.08	0.20	QP
5	0.47612	36.77	-9.64	46.41	36.55	0.07	0.15	AVERAGE
6	0.47612	45.37	-11.04	56.41	45.15	0.07	0.15	QP
7	3.759	28.60	-17.40	46.00	28.16	0.14	0.30	AVERAGE
8	3.759	36.36	-19.64	56.00	35.92	0.14	0.30	QP
9	6.841	36.55	-23.45	60.00	35.94	0.29	0.33	QP
10	6.841	29.84	-20.16	50.00	29.23	0.29	0.33	AVERAGE
11	10.905	32.25	-27.75	60.00	31.42	0.43	0.40	QP
12	10.905	27.57	-22.43	50.00	26.74	0.43	0.40	AVERAGE

Note:

Level = Read Level + LISN Factor + Cable Loss.

4.2. Operational Limitations

4.2.1. Test Result of Operation Restriction

Operation Restriction	Informed the applicant	Not applicable	User Manual Informed	Passed
<input checked="" type="checkbox"/> 47 CFR FCC Part 15 Subpart F 15.517(a)				
(1) Indoor UWB devices & Fixed indoor infrastructure				
Must be capable of operation only indoors. The necessity to operate with a fixed indoor infrastructure. [A transmitter that had been connected to portable device e.g. Laptop PC...and be considered sufficient to demonstrate not a fixed infrastructure application.]	<input checked="" type="checkbox"/>	<input type="checkbox"/>	<input type="checkbox"/>	<input checked="" type="checkbox"/>
(2) Emissions from equipment				
The emissions from equipment operated shall not be intentionally directed outside of the building in which the equipment is located, such as through a window or a doorway, to perform an outside function, such as the detection of persons about to enter a building. [The applicant has been informed of this requirement.]	<input checked="" type="checkbox"/>	<input type="checkbox"/>	<input type="checkbox"/>	<input checked="" type="checkbox"/>
(3) Outdoor mounted antennas				
The use of outdoor mounted antennas, e.g., antennas mounted on the outside of a building or on a telephone pole, or any other outdoors infrastructure is prohibited. [The applicant has been informed of this requirement and instruct the caution in user manual.]	<input checked="" type="checkbox"/>	<input type="checkbox"/>	<input checked="" type="checkbox"/>	<input checked="" type="checkbox"/>
(4) Field disturbance sensors install				
Field disturbance sensors installed inside of metal or underground storage tanks are considered to operate indoors provided the emissions are directed towards the ground. [Not applicable for this client.]	<input checked="" type="checkbox"/>	<input checked="" type="checkbox"/>	<input type="checkbox"/>	<input checked="" type="checkbox"/>
(5) A communications system shall transmit only				
A communications system shall transmit only when the intentional radiator is sending information to an associated receiver. [The applicant has been informed of this requirement and is clearly stated on the users manual.]	<input checked="" type="checkbox"/>	<input type="checkbox"/>	<input checked="" type="checkbox"/>	<input checked="" type="checkbox"/>

4.3. UWB Bandwidth Measurement

4.3.1. Limit

Ultra-wideband (UWB) transmitter. An intentional radiator that, at any point in time, has a fractional bandwidth equal to or greater than 0.20 or has a UWB bandwidth equal to or greater than 500 MHz, regardless of the fractional bandwidth.

The UWB bandwidth is the frequency band bounded by the points that are 10 dB below the highest radiated emission, as based on the complete transmission system including the antenna. The upper boundary is designated f_H and the lower boundary is designated f_L . The frequency at which the highest radiated emission occurs is designated f_M .

Center frequency. The center frequency, f_c , equals $(f_H + f_L)/2$.

Fractional bandwidth. The fractional bandwidth equals $2(f_H - f_L) / (f_H + f_L)$.

The UWB bandwidth of a UWB system operating under the provisions of this section must be contained between 3100 MHz and 10,600 MHz.

4.3.2. Measuring Instruments and Setting

Please refer to section 5 of equipments list in this report. The following table is the setting of the spectrum analyzer.

Parameter	Setting
RB / VB	10 MHz
Detector	Peak
Trace	Max Hold
Sweep Time	Auto

4.3.3. Test Procedures

1. The EUT was placed on the top of the turntable 0.8 meter above ground. The phase center of the receiving antenna mounted on the top of a height-variable antenna tower was placed 1 meters far away from the turntable.
2. The horn receiving antenna was varied between one meter and four meters above ground to find the maximum emissions field strength of both horizontal and vertical polarization.
3. For maximum emission amplitude, the antenna tower was scan (from 1 M to 4 M) and then the turntable was rotated (from 0 degree to 360 degrees) to find the maximum reading and was used to determine the frequency at which the highest radiated emission occurs, f_M . Next, the points that are 10dB or more below the highest radiated emission were observed in a search from f_M in both the lower and higher frequency direction in the measured frequency EIRP graph, they are denoted as f_L and f_H , respectively. The UWB bandwidth is the difference between f_L and f_H .
4. The individual UWB bandwidths were measured for each BAND_ID (n_b) of the UWB spectrum. Both horizontal and vertical polarizations were taken into account to determine the full UWB BW on the maximized (in azimuth and elevation) signals.

4.3.4. Test Setup Layout

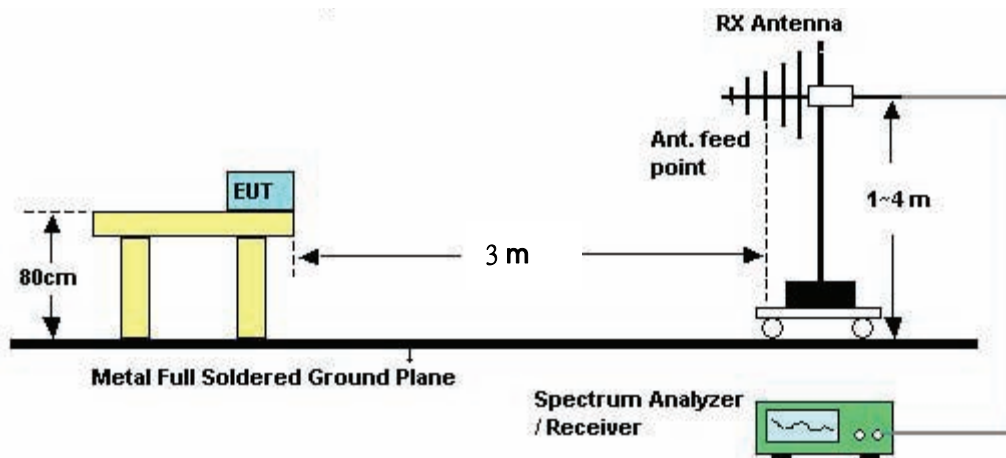

4.3.5. Test Deviation

There is no deviation with the original standard.

4.3.6. EUT Operation during Test

The EUT was programmed to be in continuously transmitting mode.

4.3.7. Test Result of UWB Bandwidth

UWB Bandwidth on BAND_ID (nb) 1 / Ant. 1

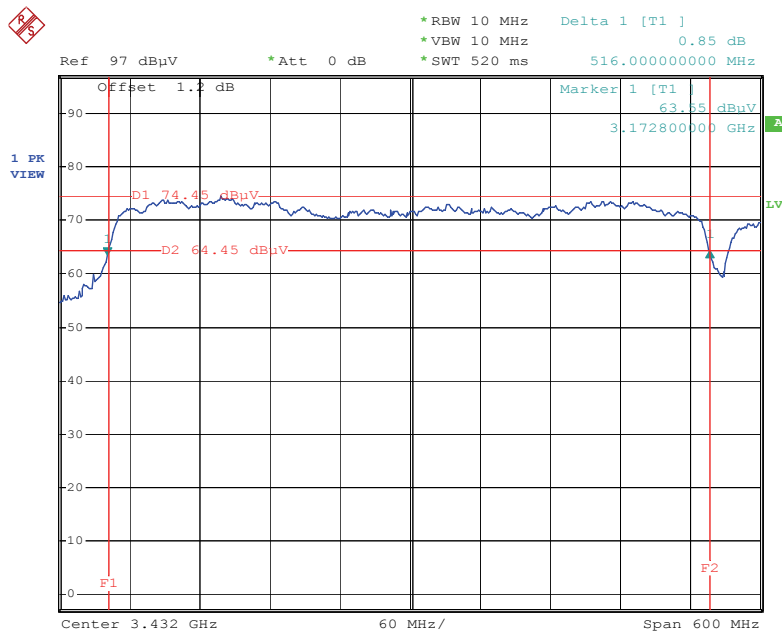

Date: 6.MAY.2008 15:04:57

UWB BW = 516.0 MHz

UWB Bandwidth on BAND_ID (nb) 2 / Ant. 1

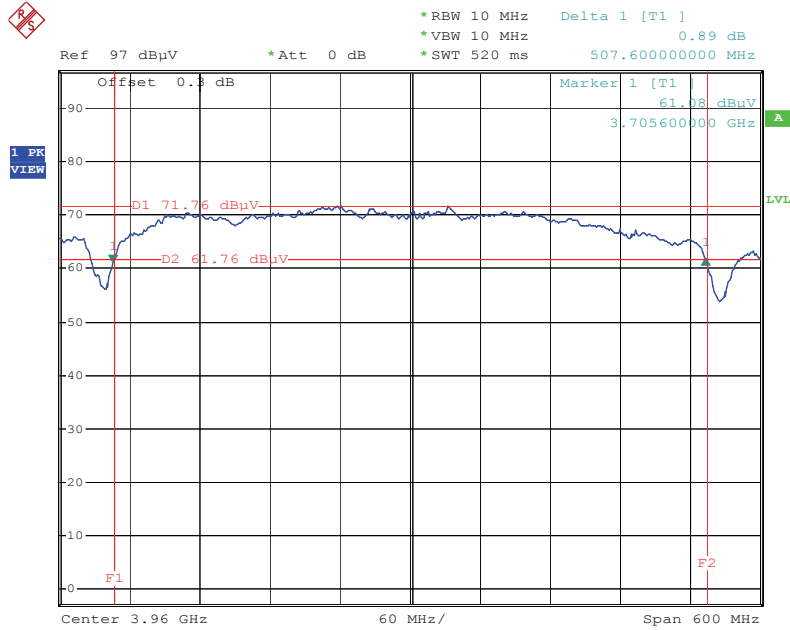

Date: 6.MAY.2008 15:01:37

UWB BW = 507.6 MHz

UWB Bandwidth on BAND_ID (nb) 3 / Ant. 1

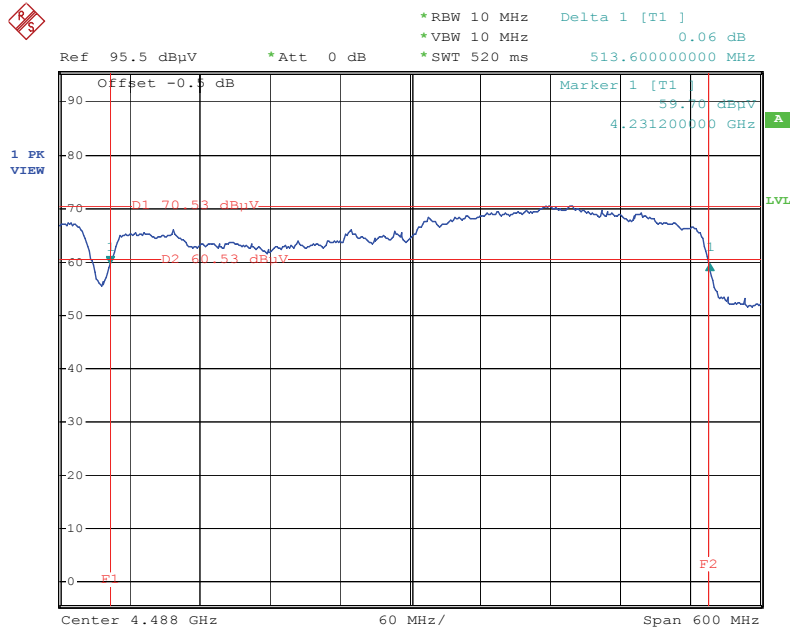

Date: 6.MAY.2008 15:07:17

UWB BW = 513.6 MHz

UWB Bandwidth on BAND_ID (nb) 1 / Ant. 2

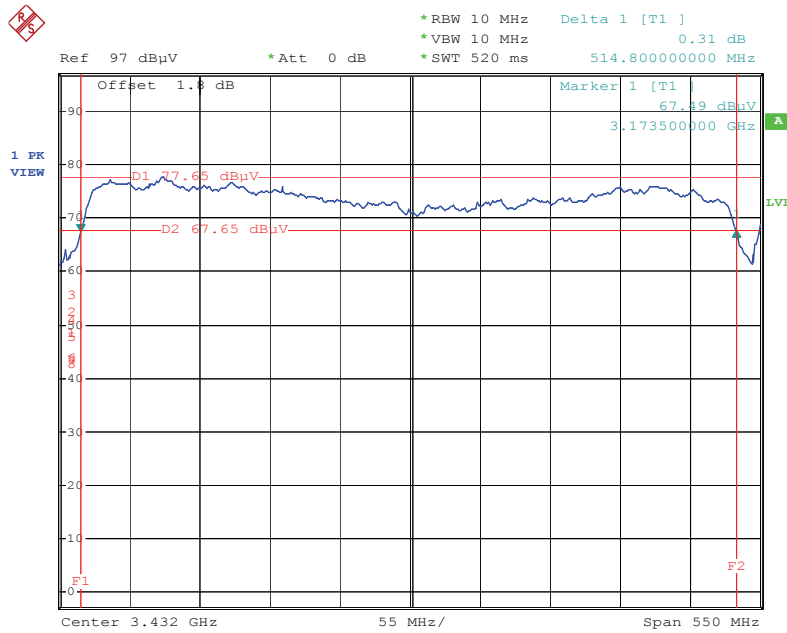

Date: 14.JUN.2008 08:04:20

UWB BW = 514.8 MHz

UWB Bandwidth on BAND_ID (nb) 2 / Ant. 2

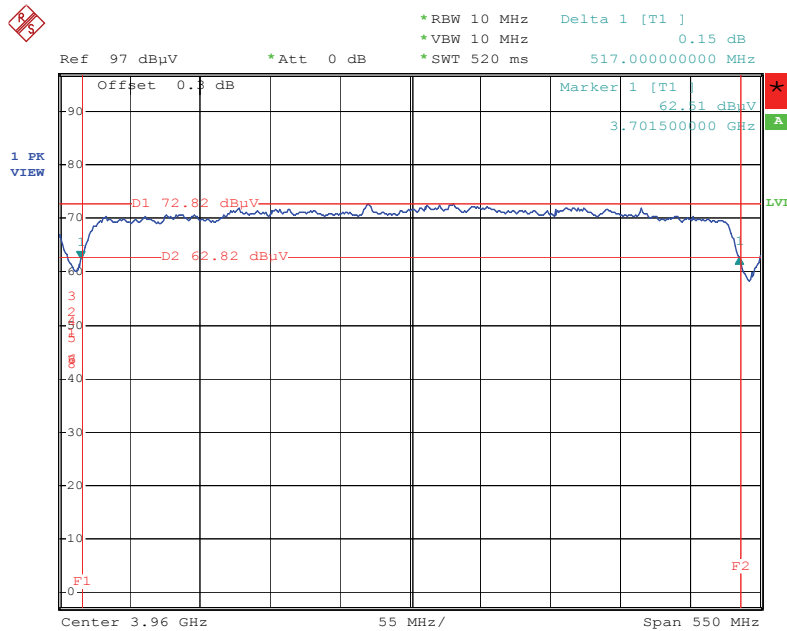

Date: 14.JUN.2008 08:08:53

UWB BW = 517.0 MHz

UWB Bandwidth on BAND_ID (nb) 3 / Ant. 2

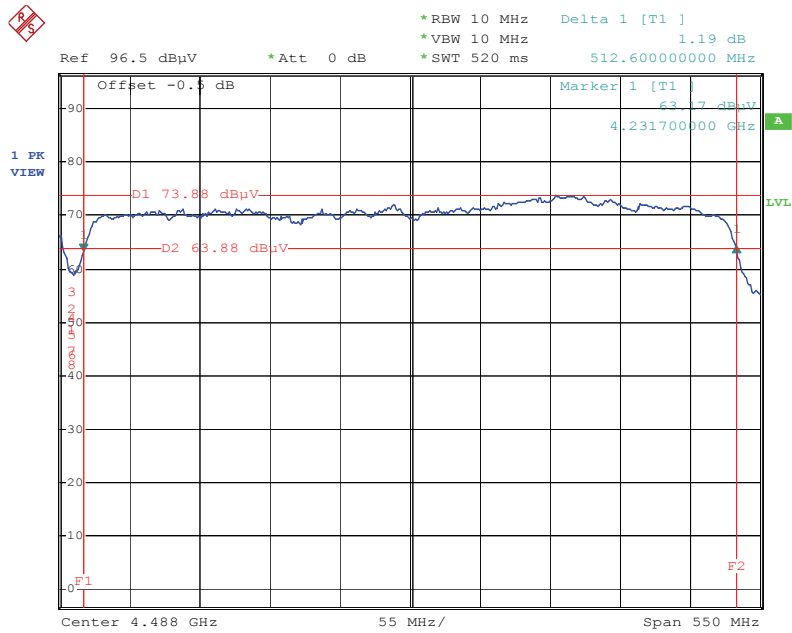

Date: 14.JUN.2008 08:12:34

UWB BW = 512.6 MHz

4.4. Radiated Emissions Measurement

4.4.1. Limit

1. The radiated emissions at or below 960 MHz from a device shall not exceed the emission levels in section 15.209(a) limit below.

Frequencies (MHz)	Field Strength (micorvolts/meter)	Measurement Distance (meters)
0.009~0.490	2400/F(KHz)	300
0.490~1.705	24000/F(KHz)	30
1.705~30.0	30	30
30~88	100	3
88~216	150	3
216~960	200	3

2. The radiated emissions above 960 MHz from a device shall not exceed the following average limits when measured using a resolution bandwidth of 1 MHz:

Freq. (MHz)	EIRP (dBm)	E- Field (dB μ V/m) at 3m	E- Field (dB μ V/m) at 1m	E- Field (dB μ V/m) at 0.5m
960-1610	-75.3	19.9	29.44	35.46
1610-1990	-53.3	41.9	51.44	57.46
1990-3100	-51.3	43.9	53.44	59.46
3100-10600	-41.3	53.9	63.44	69.46
10600 above	-51.3	43.9	53.44	59.46

Note 1: This may be converted to a peak field strength level at 3 meters using $E(\text{dB}\mu\text{V}/\text{m}) = P(\text{dBm EIRP}) + 95.2 \text{ dB}$.

Note 2: Above 960MHz shall be extrapolated to the specified distance using an extrapolation factor of 20 dB/decade form 3m to 1m. Distance extrapolation factor = $20 \log(\text{specific distance [3m]} / \text{test distance [1m]})$ (dB); Limit line = specific limits (dBuV) + distance extrapolation factor [9.54 dB]. form 3m to 0.5m. Distance extrapolation factor = $20 \log(\text{specific distance [3m]} / \text{test distance [0.5m]})$ (dB); Limit line = specific limits (dBuV) + distance extrapolation factor [15.56 dB].

3. From 47 CFR Section 15.521(c): Emissions from digital circuitry used to enable the operation of the UWB transmitter shall comply with the limits in Section 15.209 of this chapter, rather than the limits specified in this subpart, provided it can be clearly demonstrated that those emissions from the UWB device are due solely to emissions from digital circuitry contained within the transmitter and that the emissions are not intended to be radiated from the transmitter's antenna. Emissions from associated digital devices, as defined in Section 15.3(k) of this chapter, e.g., emissions from digital circuitry used to control additional functions or capabilities other than the UWB transmission, are subject to the limits contained in Subpart B of Part 15 of this chapter.

4.4.2. Measuring Instruments and Setting

Please refer to section 5 of equipments list in this report. The following table is the setting of the spectrum analyzer and receiver.

Spectrum Parameter	Setting
Attenuation	0 dB
Start Frequency	1000 MHz
Stop Frequency	10th carrier harmonic or 40 GHz
RB / VB	1MHz / 3MHz for RMS for Average, 1 msec averaging time were used for these measurement frequencies

Receiver Parameter	Setting
Attenuation	Auto
Start ~ Stop Frequency	9kHz~150kHz / RB 200Hz for QP
Start ~ Stop Frequency	150kHz~30MHz / RB 9kHz for QP
Start ~ Stop Frequency	30MHz~1000MHz / RB 120kHz for QP

4.4.3. Test Procedures

1. Configure the EUT according to ANSI C63.4. The EUT was placed on the top of the turntable 0.8 meter above ground. The phase center of the receiving antenna mounted on the top of a height-variable antenna tower was placed 3 meters far away from the turntable for measured the frequency range below 960 MHz and antenna tower was placed below 1 meters far away from the turntable for measured the frequency range above 960 MHz
2. Power on the EUT and all the supporting units. The turntable was rotated by 360 degrees to determine the position of the highest radiation.
3. The height of the broadband receiving antenna was varied between one meter and four meters above ground to find the maximum emissions field strength of both horizontal and vertical polarization.
4. For each suspected emissions, the antenna tower was scan (from 1 M to 4 M) and then the turntable was rotated (from 0 degree to 360 degrees) to find the maximum reading.
5. The measurements made over the frequency range from 9 kHz to 960 MHz were maximized using an EMI receiver with peak detector capabilities. Measurements of the radiated field from 9 kHz to 960 MHz were made with the measurement antenna located a distance of 3 meters from the EUT. If the emissions level of the EUT in peak mode was 3 dB lower than the limit specified, then testing will be stopped and peak values of EUT will be reported, otherwise, the emissions which do not have 3 dB margin will be repeated one by one using the quasi-peak method for below 1GHz.
6. Measurements above 960 MHz were maximized using a spectrum analyzer with RMS detector capabilities. A spectrum analyzer was used for the final measurements utilizing an RMS detector at the frequencies with the largest amplitudes. The prescribed RBW of 1 MHz and VBW of 3 MHz, and a

1 msec averaging time were used for these measurements. Measurements of the radiated field at frequencies above 960 MHz were made with the measurement antenna located a distance of below 1 meter from the EUT.

7. The spectrum between 9 kHz and 960 MHz contained no intentional radiation and lies below the limits. The spectrum from 960MHz to18GHz contained intentional UWB signals between 3100 MHz and 10600 MHz and lie below the limits. No other emissions above 10600 MHz were detected. The maximum frequency tested was 40 GHz.
8. Per 47 CFR, Part 15, Subpart F, §15.521(c) (§15.209) all digital emissions from the transmitter not intended to be radiated from the antenna port meet the 15.209 subpart C limits.
9. Additional measurements in the 960 MHz to 40 GHz range were performed to determine the nature of all unintentional emissions in this span. Conducted antenna port measurement and terminated antenna port measurement were done in the 960 MHz to 8 GHz range show that all noise peaks have the same frequency and polarization and are determined to be emission from the digital circuit and are not radiated from the antenna.

4.4.4. Test Setup Layout

For radiated emissions below 30MHz

Investigated emissions from digital circuitry used to control additional functions or capabilities other than the UWB transmission

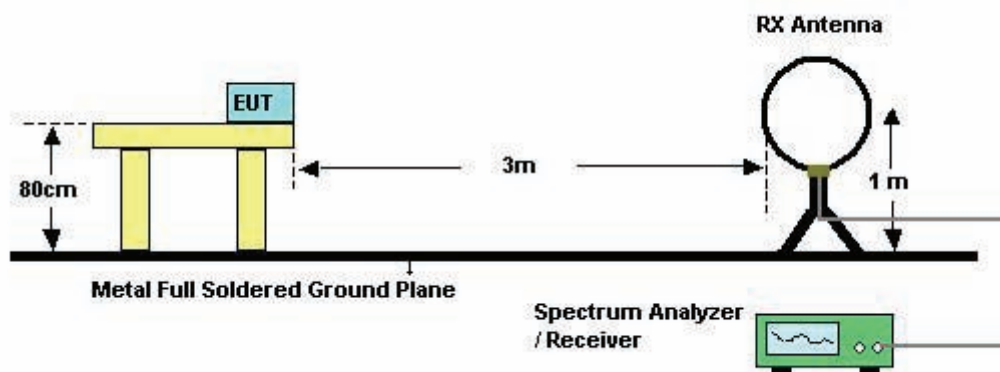

For radiated emissions from 30MHz~960MHz

Investigated emissions from digital circuitry used to control additional functions or capabilities other than the UWB transmission

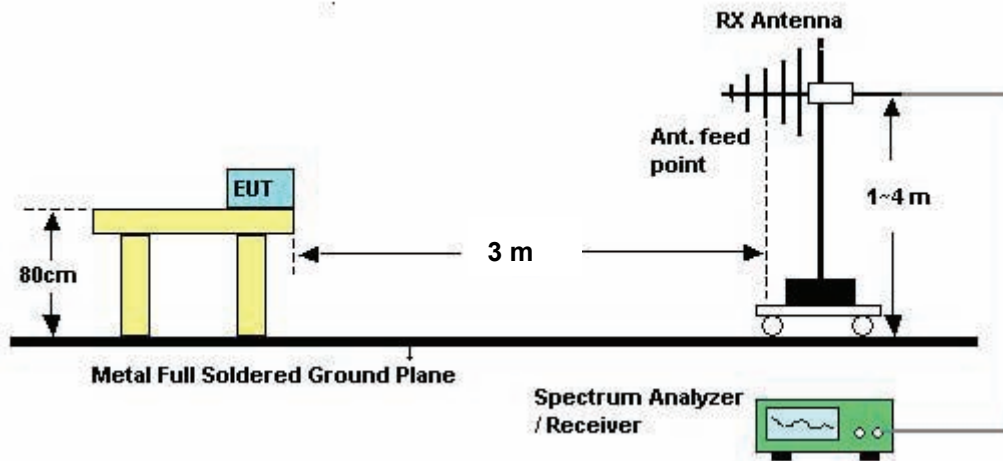

For radiated emissions above 960MHz

Investigated emissions from digital circuitry used to control additional functions or capabilities other than the UWB transmission

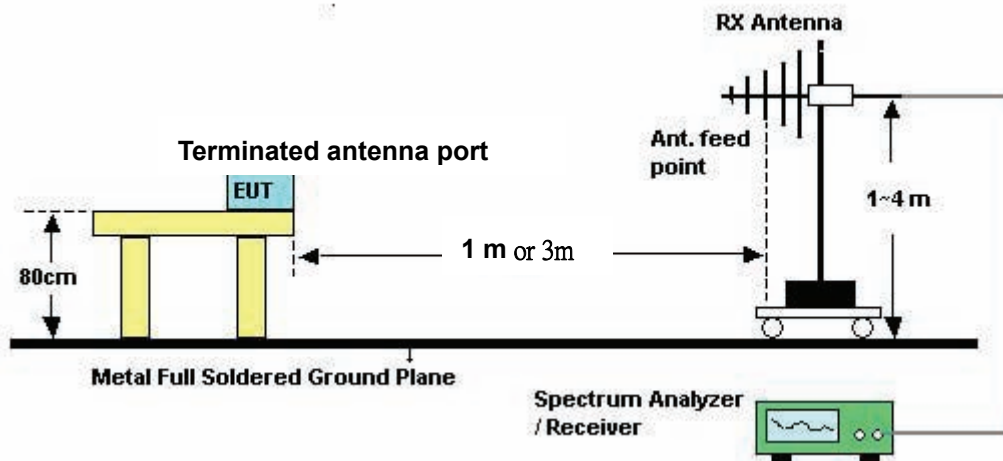

For conducted emissions above 960MHz (Conducted antenna port measurement)

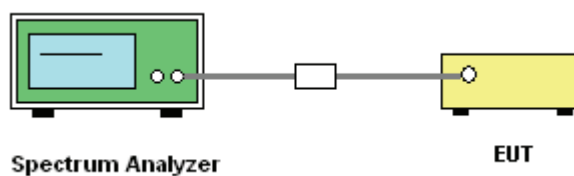

4.4.5. Test Deviation

There is no deviation with the original standard.

4.4.6. EUT Operation during Test

The EUT was programmed to be in continuously transmitting mode.

4.4.7. Results of Radiated Emissions

Radiated Emissions (9kHz~30MHz)

Temperature	26°C	Humidity	58%
Test Engineer	Sam Chen		

Freq. (MHz)	Level (dBuV)	Over Limit (dB)	Limit Line (dBuV)	Remark
-	-	-	-	See Note

Note:

The amplitude of spurious emissions which are attenuated by more than 20dB below the permissible value has no need to be reported.

Distance extrapolation factor = $40 \log(\text{specific distance} / \text{test distance})$ (dB);

Limit line = specific limits (dBuV) + distance extrapolation factor.

Radiated Emissions (30MHz~960MHz)

Temperature	26°C	Humidity	58%
Test Engineer	Sam Chen	Configurations	Mode 1

The distance: 3m

Horizontal

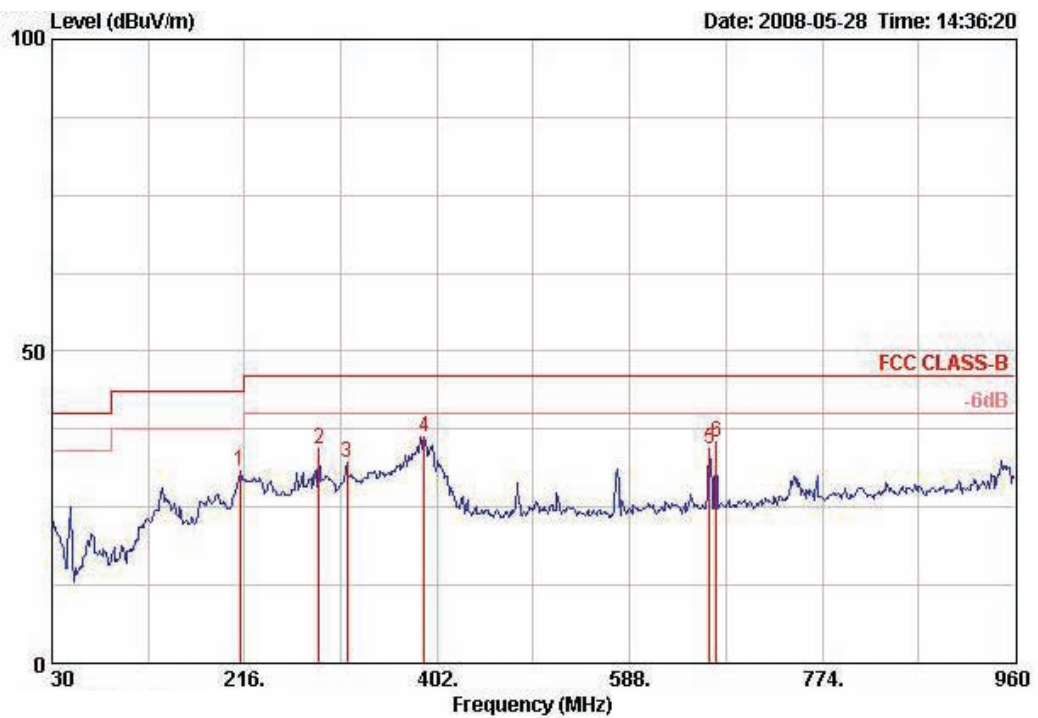

	Freq	Level	Over Limit	Limit Line	ReadAntenna	Cable	Preamp	Remark	Ant Pos	Table Pos	Pol/Phase
	MHz	dBUV/m	dB	dBUV/m	dBuV	dB/m	dB	dB	cm	deg	
1	211.390	30.75	-12.75	43.50	45.29	9.91	1.00	25.45 Peak	100	0	HORIZONTAL
2	288.020	34.40	-11.60	46.00	45.09	13.22	1.14	25.05 Peak	100	0	HORIZONTAL
3	315.180	32.08	-13.92	46.00	42.11	13.78	1.15	24.96 Peak	100	0	HORIZONTAL
4	389.870	36.15	-9.85	46.00	44.26	15.80	1.52	25.43 Peak	100	0	HORIZONTAL
5	665.350	34.44	-11.56	46.00	39.44	18.98	2.14	26.12 Peak	100	0	HORIZONTAL
6	672.140	35.50	-10.50	46.00	40.44	19.00	2.14	26.08 Peak	100	0	HORIZONTAL

The distance: 3m

Vertical

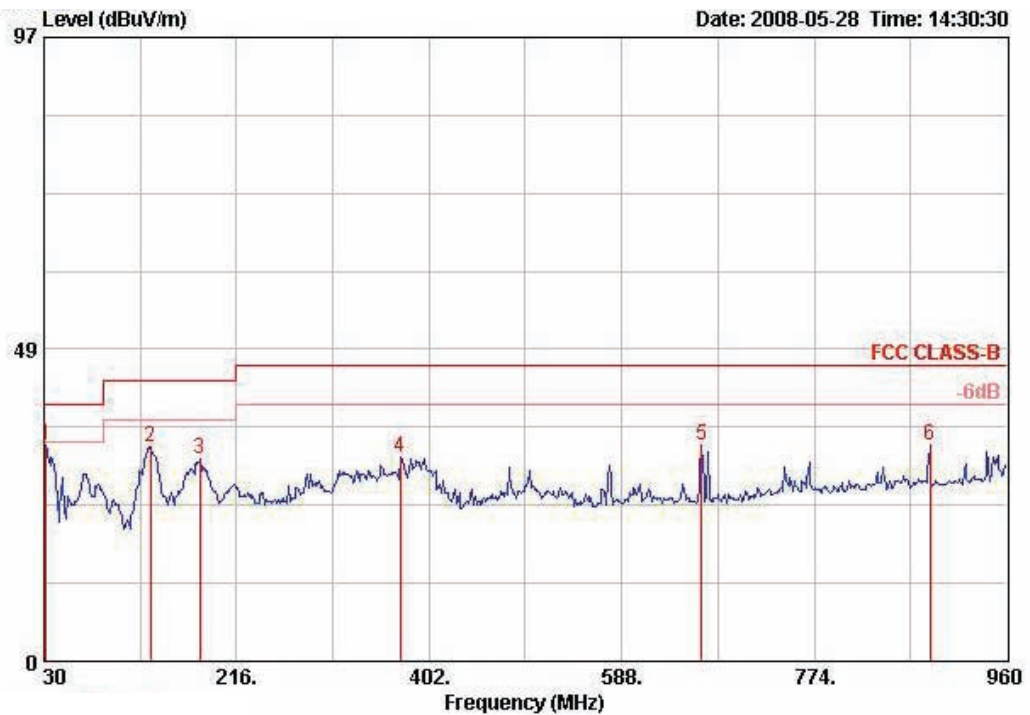

	Freq	Level	Over Limit	Limit Line	Read Level	Antenna Factor	Cable Loss	Preamp Factor	Remark	Ant Pos	Table Pos	Pol/Phase
	MHz	dBUV/m	dB	dBUV/m	dBuV	dB/m	dB	dB		cm	deg	
1 @	31.940	33.55	-6.45	40.00	42.03	17.69	0.32	26.49	Peak	400	0	VERTICAL
2	132.820	33.32	-10.18	43.50	46.28	12.28	0.62	25.87	Peak	400	0	VERTICAL
3	180.350	31.36	-12.14	43.50	42.90	13.14	0.68	25.36	Peak	400	0	VERTICAL
4	374.350	31.80	-14.20	46.00	40.30	15.38	1.38	25.26	Peak	400	0	VERTICAL
5	665.350	33.53	-12.47	46.00	38.53	18.98	2.14	26.12	Peak	400	0	VERTICAL
6	885.540	33.48	-12.52	46.00	35.55	20.42	2.65	25.14	Peak	400	0	VERTICAL

Note:

The amplitude of spurious emissions which are attenuated by more than 20dB below the permissible value has no need to be reported.

Corrected Reading: Antenna Factor + Cable Loss + Read Level - Preamp Factor = Level.

Temperature	26°C	Humidity	58%
Test Engineer	Sam Chen	Configurations	Mode 4

The distance: 3m

Horizontal

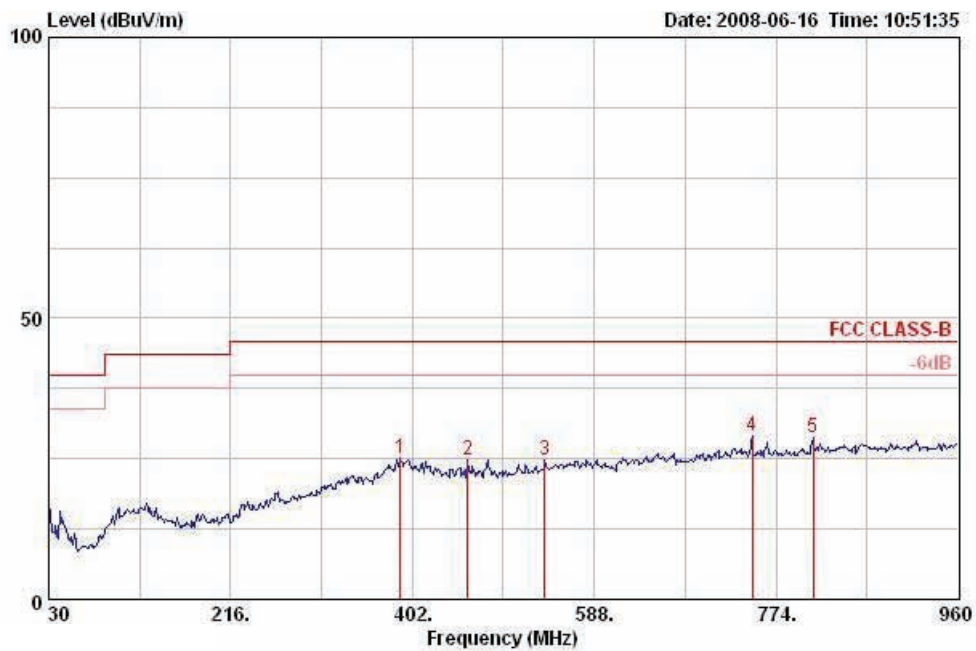

	Freq	Level	Over	Limit	Read	Antenna	Preamp	Cable	Table	Ant
	MHz	dBuV/m	dB	dBuV/m	Level	Factor	Factor	Loss	Pos	Pos
					dBuV	dB/m	dB	dB	deg	cm
1	389.870	25.05	-20.95	46.00	34.95	15.35	27.53	2.28	0	100
2	458.740	24.68	-21.32	46.00	33.58	16.38	27.89	2.62	0	100
3	537.310	24.74	-21.26	46.00	31.84	18.22	28.10	2.77	0	100
4	749.740	29.03	-16.97	46.00	33.26	20.07	27.80	3.50	0	100
5	811.820	28.67	-17.33	46.00	32.56	20.36	27.58	3.32	0	100
6	974.780	28.49	-25.51	54.00	31.38	20.56	27.10	3.65	0	100

The distance: 3m

Vertical

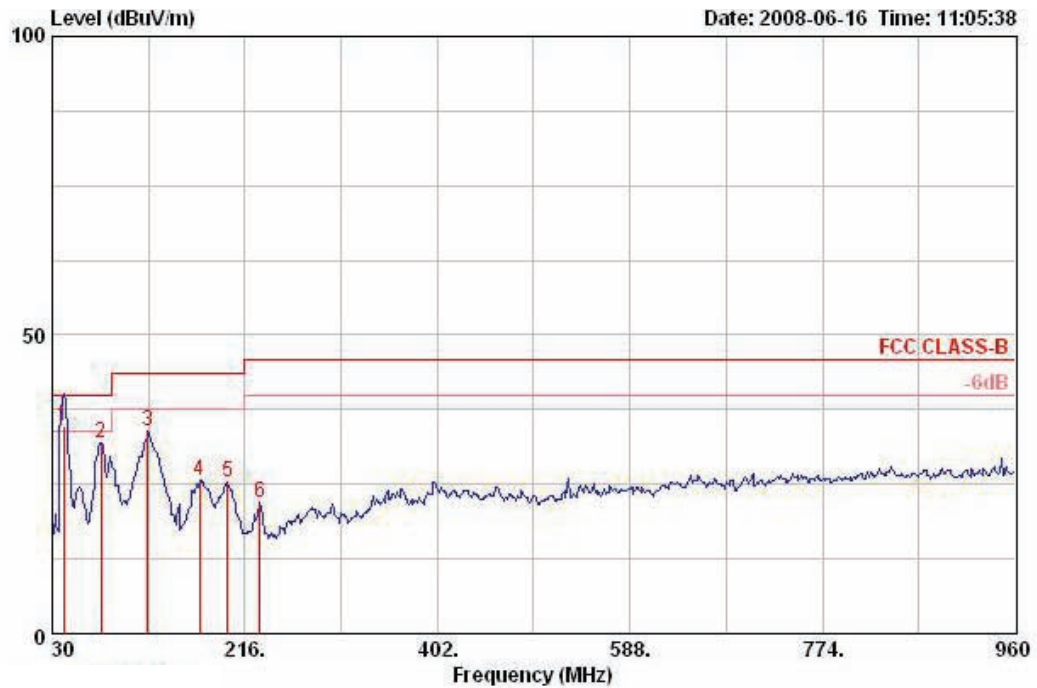

	Freq	Level	Over	Limit	Read	Antenna	Preamp	Cable	Table	Ant
	MHz	dBuV/m	Limit	Line	Level	Factor	Factor	Loss	Pos	Pos
			dB	dBuV/m	dBuV	dB/m	dB	dB	deg	cm
1	40.670	34.83	-5.17	40.00	50.48	11.45	27.80	0.70	158	100
2	77.530	31.80	-8.20	40.00	52.50	6.00	27.69	1.00	0	400
3	122.150	34.01	-9.49	43.50	48.62	11.66	27.49	1.22	0	400
4	172.590	25.64	-17.86	43.50	42.85	8.46	27.23	1.56	0	400
5	199.750	25.46	-18.04	43.50	41.96	8.90	27.10	1.70	0	400
6	230.790	21.87	-24.13	46.00	37.38	9.71	27.04	1.82	0	400

Note:

The amplitude of spurious emissions which are attenuated by more than 20dB below the permissible value has no need to be reported.

Corrected Reading: Antenna Factor + Cable Loss + Read Level - Preamp Factor = Level.



Radiated Emissions (960MHz~8GHz Emissions)

Temperature	26°C	Humidity	58%
Test Engineer	Sam Chen	Configurations	ALL BAND / Ant. 1

The distance: 3m

Horizontal

UWB Radiated Emissions 960 MHz to 8 GHz

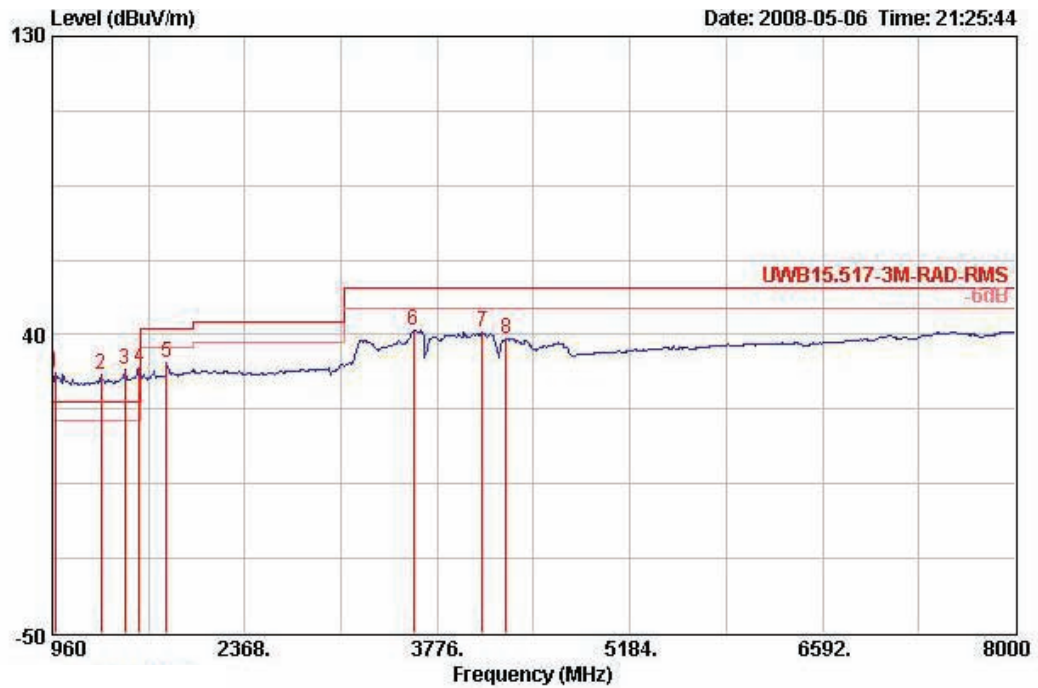

	Freq	Level	Over	Limit	Read	Antenna	Preamp	Cable	Table	Ant
	MHz	dBuV/m	Limit	Line	Level	Factor	Factor	Loss	Pos	Pos
			dB	dBuV/m	dBuV	dB/m	dB	dB	deg	cm
1 @	981.120	28.26			39.04	23.58	36.18	1.82	0	100 HORIZONTAL
2 @	1319.040	28.07			36.42	24.84	35.34	2.15	0	100 HORIZONTAL
3 @	1488.000	29.38			36.48	25.48	34.89	2.32	0	100 HORIZONTAL
4 @	1593.600	30.25			36.68	26.10	34.84	2.31	0	100 HORIZONTAL
5 @	1797.760	31.55	-10.35	41.90	36.94	27.30	35.13	2.44	0	100 HORIZONTAL
6 @	3600.000	41.27	-12.63	53.90	42.08	30.65	34.92	3.47	0	100 HORIZONTAL
7 @	4106.880	40.79	-13.11	53.90	41.01	31.67	35.28	3.40	0	100 HORIZONTAL
8 @	4275.840	38.93	-14.97	53.90	39.16	31.76	35.57	3.58	0	100 HORIZONTAL

Note: Measurements made with 1 MHz RBW/3MHz VBW (RMS detector) at 3m distance. 1 msec averaging time were used for these frequencies per bin point measurements. Emissions (Mark 1, 2, 3, 4) from digital circuitry used to enable the operation of the UWB transmitter shall comply with the limits in 47 CFR, Part 15, Subpart C, §15.209.

The distance: 3m

Vertical

UWB Radiated Emissions 960 MHz to 8 GHz

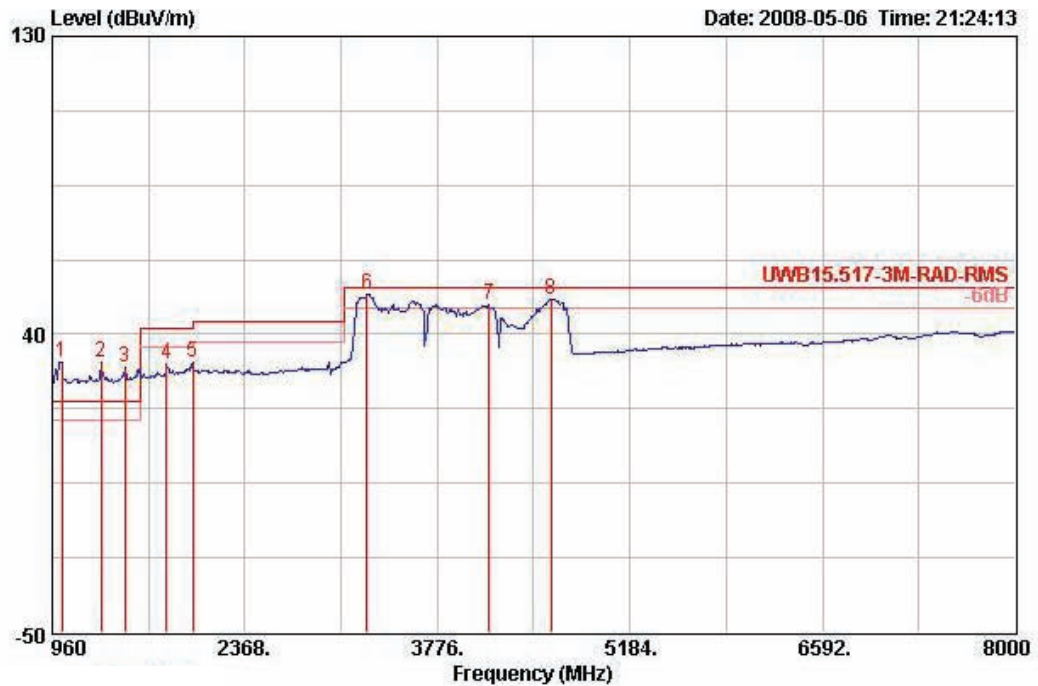

	Freq	Level	Over Limit	Limit Line	Read Level	Antenna Factor	Preamp Factor	Cable Loss	Remark	Table Pos	Ant Pos	Pol/Phase
	MHz	dBuV/m	dB	dBuV/m	dBuV	dB/m	dB	dB		deg	cm	
1	1030.400	31.77			42.31	23.73	36.12	1.85	Peak	360	100	VERTICAL
2	1319.040	31.55			39.89	24.84	35.34	2.15	Peak	360	100	VERTICAL
3	1488.000	29.98			37.09	25.46	34.89	2.32	Peak	360	100	VERTICAL
4	1797.760	31.03	-10.87	41.90	36.41	27.30	35.13	2.44	Peak	360	100	VERTICAL
5	1987.840	31.66	-10.24	41.90	35.61	28.40	34.94	2.59	Peak	360	100	VERTICAL
6	3262.080	52.22	-1.68	53.90	53.96	29.82	34.95	3.39	Peak	360	100	VERTICAL
7	4156.160	49.07	-4.83	53.90	49.31	31.69	35.38	3.44	Peak	360	100	VERTICAL
8	4606.720	50.73	-3.17	53.90	50.38	32.09	35.70	3.97	Peak	360	100	VERTICAL

Note: Measurements made with 1 MHz RBW/3MHz VBW (RMS detector) at 3m distance. 1 msec averaging time were used for these frequencies per bin point measurements. Emissions (Mark 1, 2, 3) from digital circuitry used to enable the operation of the UWB transmitter shall comply with the limits in 47 CFR, Part 15, Subpart C, §15.209.

Radiated Emissions with terminated antenna port (960MHz~8GHz)

Temperature	26°C	Humidity	58%
Test Engineer	Sam Chen	Configurations	ALL BAND / Ant. 1

The distance: 3m

Horizontal

Terminated antenna port:

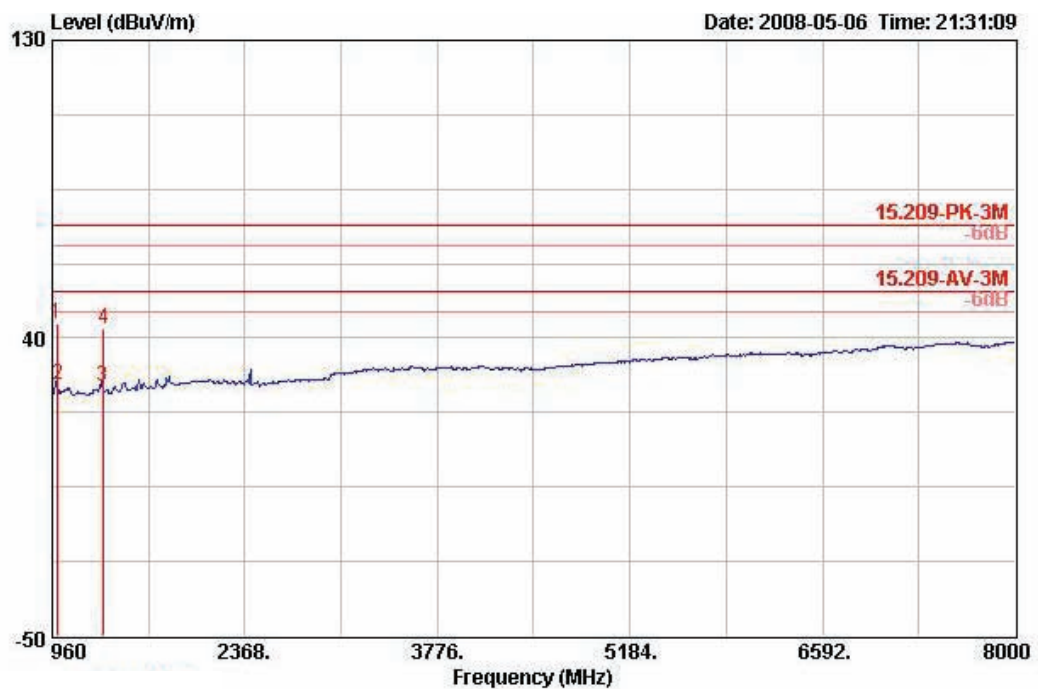

	Freq	Level	Over Limit	Limit Line	Read Level	Antenna Factor	Preamp Factor	Cable Loss	Remark	Table Pos	Ant Pos	Pol/Phase
	MHz	dBuV/m	dB	dBuV/m	dBuV	dB/m	dB	dB		deg	cm	
1	995.760	44.59	-29.41	74.00	55.32	23.64	36.18	1.82	PEAK	57	113	HORIZONTAL
2	997.380	25.93	-28.07	54.00	36.65	23.64	36.18	1.82	AVERAGE	57	113	HORIZONTAL
3	1331.360	25.58	-28.42	54.00	33.84	24.84	35.28	2.18	AVERAGE	333	100	HORIZONTAL
4	1332.900	43.02	-30.98	74.00	51.27	24.84	35.28	2.18	PEAK	333	100	HORIZONTAL

Note: For digital circuitry used to enable the operation of the UWB transmitter shall comply with the limits in 47 CFR, Part 15, Subpart C, §15.209.

The distance: 3m

Vertical

Terminated antenna port:

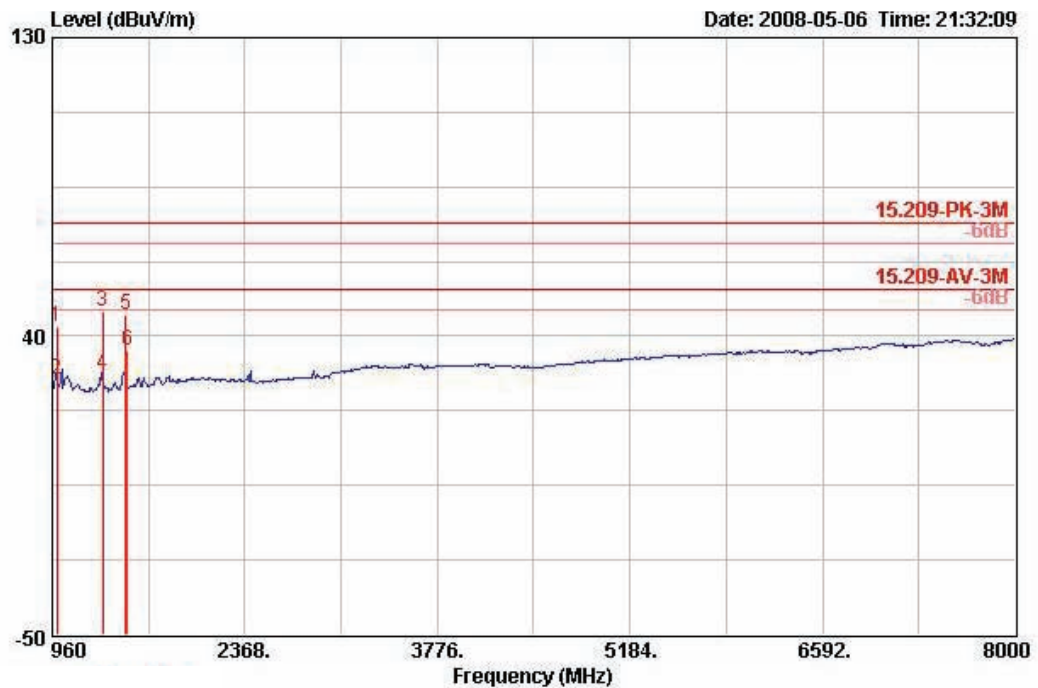

	Freq	Level	Over Limit	Limit Line	Read Level	Antenna Factor	Preamp Factor	Cable Loss	Remark	Table Pos	Ant Pos	Pol/Phase
	MHz	dBuV/m	dB	dBuV/m	dBuV	dB/m	dB	dB		deg	cm	
1	996.160	42.61	-31.39	74.00	53.37	23.60	36.18	1.82	PEAK	312	114	VERTICAL
2	997.080	26.80	-27.20	54.00	37.57	23.60	36.18	1.82	AVERAGE	312	114	VERTICAL
3	1330.880	47.57	-26.43	74.00	55.82	24.84	35.28	2.18	PEAK	90	100	VERTICAL
4	1331.080	28.69	-25.31	54.00	36.94	24.84	35.28	2.18	AVERAGE	90	100	VERTICAL
5	1498.360	46.38	-27.62	74.00	53.40	25.55	34.89	2.32	PEAK	200	114	VERTICAL
6	1506.680	35.79	-18.21	54.00	42.81	25.55	34.89	2.32	AVERAGE	200	114	VERTICAL

Note: For digital circuitry used to enable the operation of the UWB transmitter shall comply with the limits in 47 CFR, Part 15, Subpart C, §15.209.

Conducted Antenna Port Emissions (960MHz~8GHz)

Temperature	26°C	Humidity	58%
Test Engineer	Sam Chen	Configurations	ALL BAND / Ant. 1

Conducted antenna port:

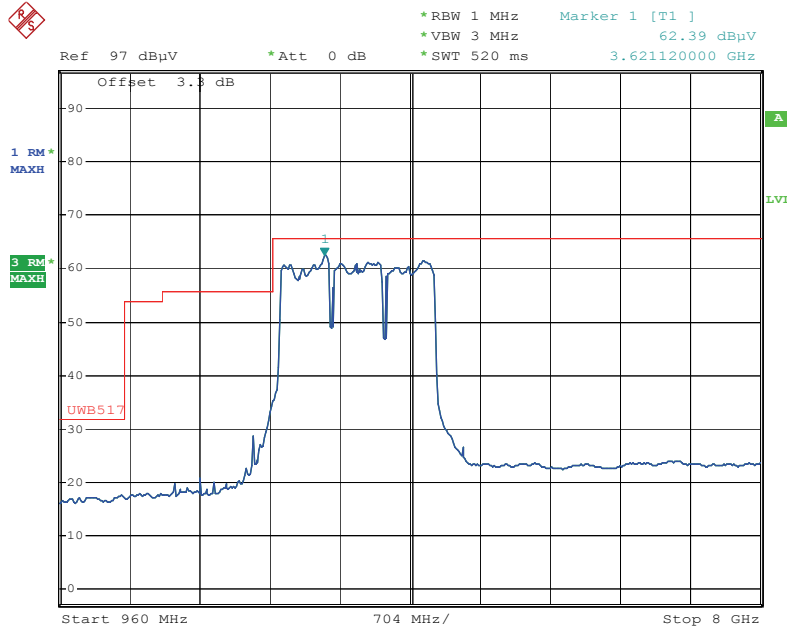

Date: 6.MAY.2008 15:29:47

Note: Conducted antenna port measurements made with 1 MHz RBW/3MHz VBW (RMS detector) at 50 ohm impedance. 1 msec averaging time were used for these frequencies per bin point measurements

The distance: 3m

Horizontal

UWB Radiated Emissions 3 GHz to 5 GHz

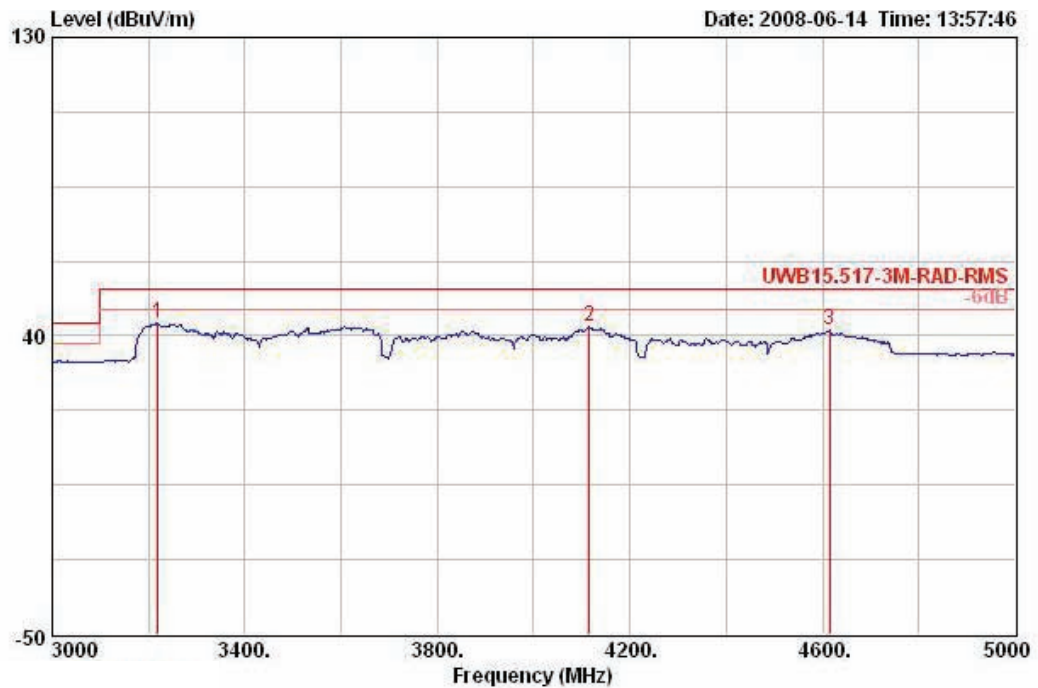

	Freq	Level	Over	Limit	Read	Antenna	Preamp	Cable	Table	Ant
	MHz	dBuV/m	dB	dBuV/m	Level	Factor	Factor	Loss	Pos	Pos
					dBuV	dB/m	dB	dB	deg	cm
1	3220.000	43.76	-10.14	53.90	45.63	29.74	34.96	3.35	23	110
2	4116.000	42.66	-11.24	53.90	42.85	31.67	35.28	3.42	102	100
3	4614.000	41.59	-12.31	53.90	41.17	32.09	35.67	4.00	156	100

Note: Measurements made with 1 MHz RBW/3MHz VBW (RMS detector) at 3m distance. 1 msec averaging time were used for these frequencies per bin point measurements.

The distance: 3m

Vertical

UWB Radiated Emissions 3 GHz to 5 GHz

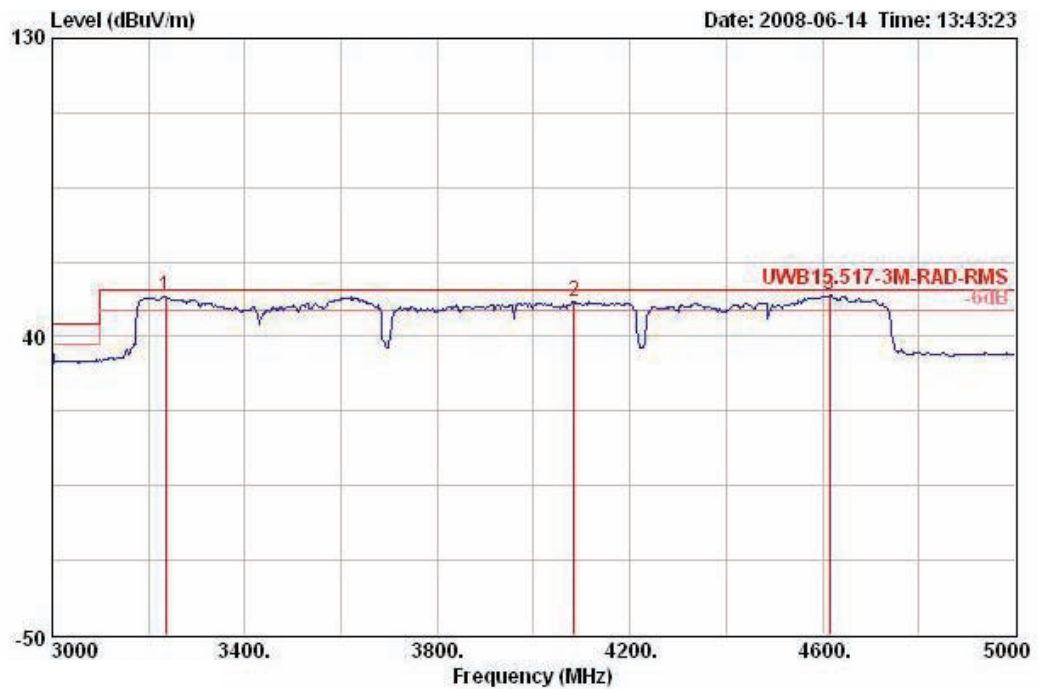

	Freq	Level	Over	Limit	Read	Antenna	Preamp	Cable	Table	Ant
	MHz	dBuV/m	dB	dBuV/m	Level	Factor	Factor	Loss	Pos	Pos
					dBuV	dB/m	dB	dB	deg	cm
1 @	3236.000	52.03	-1.87	53.90	53.84	29.78	34.96	3.37	79	100
2 @	4084.000	50.61	-3.29	53.90	50.80	31.65	35.23	3.40	102	100
3 @	4614.000	52.59	-1.31	53.90	52.17	32.09	35.67	4.00	269	100

Note: Measurements made with 1 MHz RBW/3MHz VBW (RMS detector) at 3m distance. 1 msec averaging time were used for these frequencies per bin point measurements.

The distance: 1m

Horizontal

UWB Radiated Emissions 8 GHz to 18 GHz

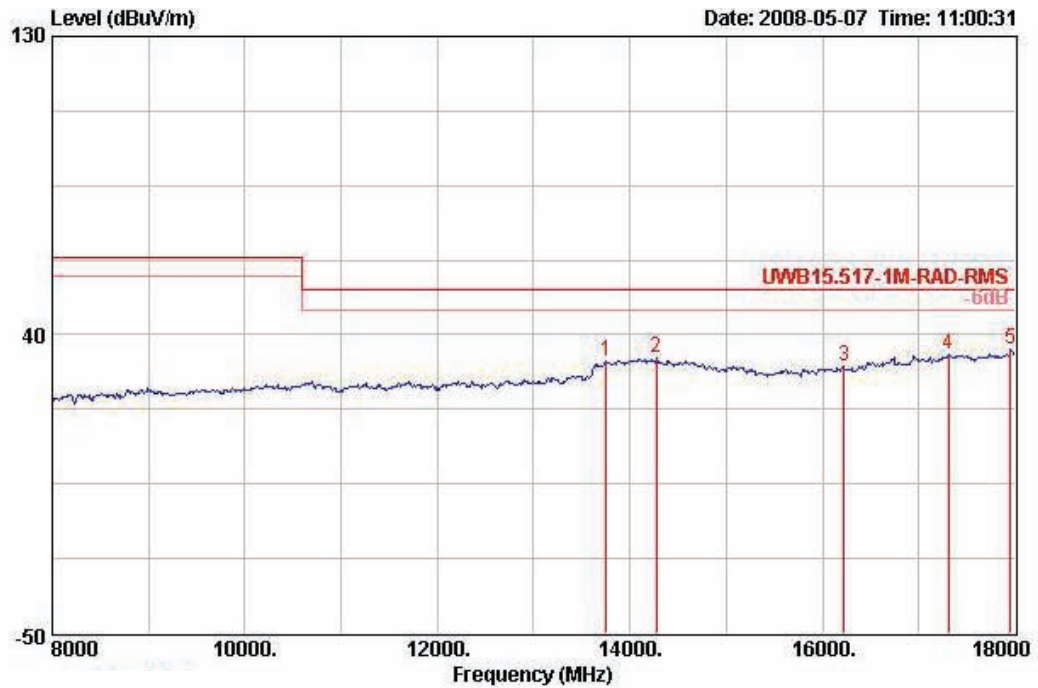

	Freq	Level	Over Limit	Limit Line	Read Level	Antenna Factor	Preamp Factor	Cable Loss	Remark	Table Pos	Ant Pos	Pol/Phase
	MHz	dBuV/m	dB	dBuV/m	dBuV	dB/m	dB	dB		deg	cm	
1	13750.000	31.86	-21.58	53.44	16.56	40.65	33.20	7.85	Peak	360	100	HORIZONTAL
2	14270.000	32.95	-20.49	53.44	17.23	40.78	33.27	8.20	Peak	360	100	HORIZONTAL
3	16220.000	30.49	-22.95	53.44	17.67	38.90	34.99	8.90	Peak	360	100	HORIZONTAL
4	17310.000	34.24	-19.20	53.44	17.21	41.92	33.97	9.07	Peak	360	100	HORIZONTAL
5	17950.000	35.47	-17.97	53.44	17.62	42.64	33.78	8.99	Peak	360	100	HORIZONTAL

Note: Measurements made with 1 MHz RBW/3MHz VBW (RMS detector) at 1m distance. 1 msec averaging time were used for these frequencies per bin point measurements.

The distance: 1m

Vertical

UWB Radiated Emissions 8 GHz to 18 GHz

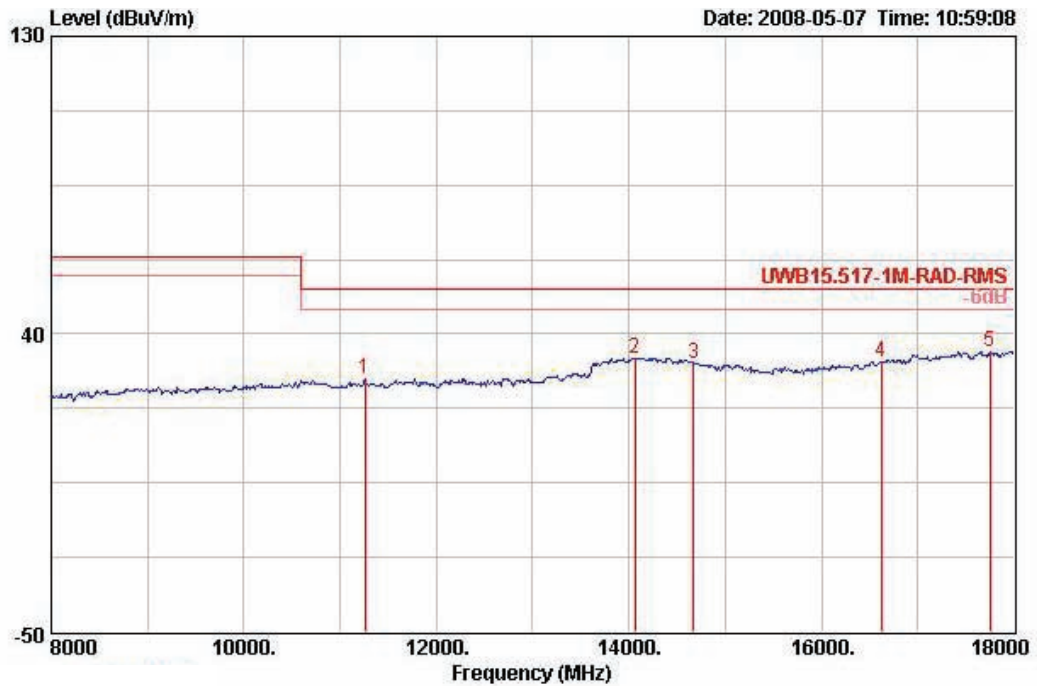

	Freq	Level	Over Limit	Limit Line	ReadAntenna	Preamp	Cable	Table	Ant
	MHz	dBuV/m	dB	dBuV/m	dBuV	dB/m	dB	deg	cm
1	11260.000	26.30	-27.14	53.44	15.47	38.45	34.73	7.10 Peak	0 100 VERTICAL
2	14060.000	32.78	-20.66	53.44	16.95	40.91	33.16	8.07 Peak	0 100 VERTICAL
3	14670.000	31.25	-22.19	53.44	16.50	40.10	33.62	8.28 Peak	0 100 VERTICAL
4	16620.000	31.61	-21.83	53.44	17.41	39.86	34.70	9.04 Peak	0 100 VERTICAL
5	17750.000	34.86	-18.58	53.44	17.26	42.39	33.84	9.05 Peak	0 100 VERTICAL

Note: Measurements made with 1 MHz RBW/3MHz VBW (RMS detector) at 1m distance. 1 msec averaging time were used for these frequencies per bin point measurements.

The distance: 1m

Horizontal

UWB Radiated Emissions 18 GHz to 26 GHz

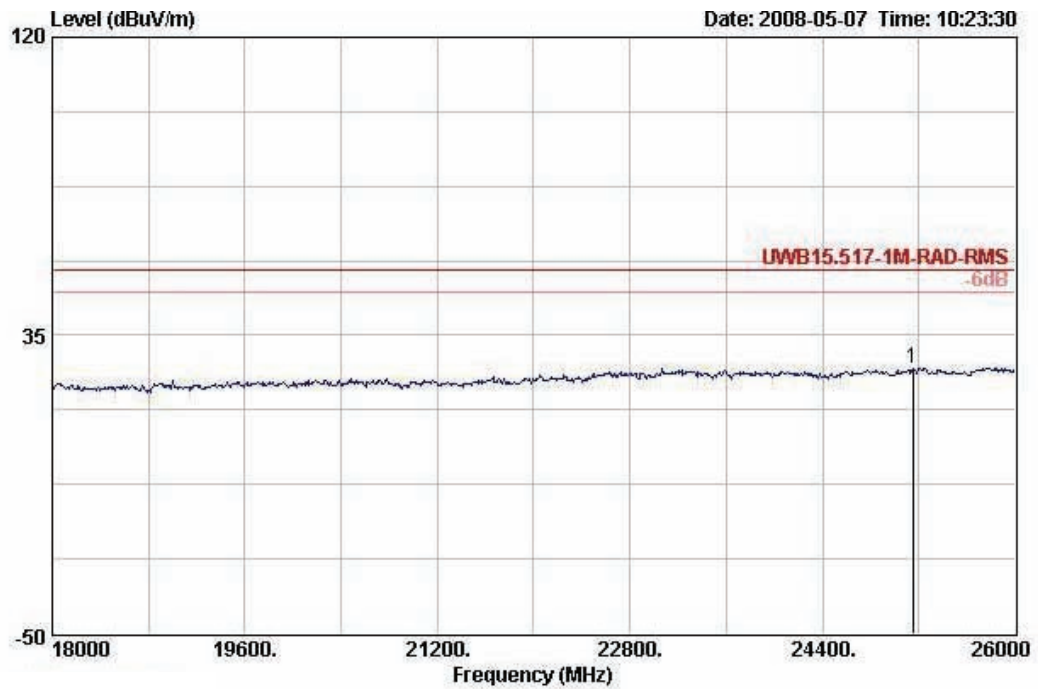

	Freq	Level	Over Limit	Limit Line	Read Level	Antenna Factor	Preamp Factor	Cable Loss	Remark	Table Pos	Ant Pos	Pol/Phase
	MHz	dBuV/m	dB	dBuV/m	dBuV	dB/m	dB	dB		deg	cm	
1	25152.000	25.70	-27.74	53.44	20.47	39.33	34.10	12.12	Peak	0	0	HORIZONTAL

Note: Measurements made with 1 MHz RBW/3MHz VBW (RMS detector) at 1m distance. 1 msec averaging time were used for these frequencies per bin point measurements.

The distance: 1m

Vertical

UWB Radiated Emissions 18 GHz to 26 GHz

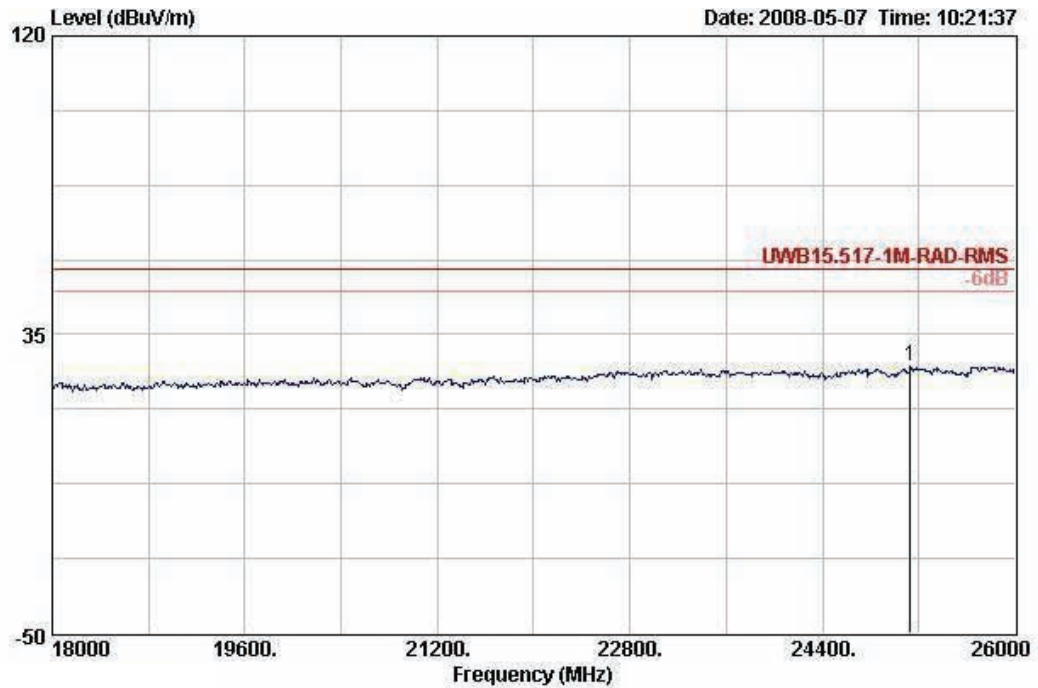

	Freq	Level	Over Limit	Limit Line	Read Level	Antenna Factor	Preamp Factor	Cable Loss	Remark	Table Pos	Ant Pos	Pol/Phase
	MHz	dBuV/m	dB	dBuV/m	dBuV	dB/m	dB	dB		deg	cm	
1	25128.000	25.85	-27.59	53.44	20.55	39.33	34.03	12.11	Peak	0	0	VERTICAL

Note: Measurements made with 1 MHz RBW/3MHz VBW (RMS detector) at 1m distance. 1 msec averaging time were used for these frequencies per bin point measurements.

The distance: 1m

Horizontal

UWB Radiated Emissions 26 GHz to 40 GHz

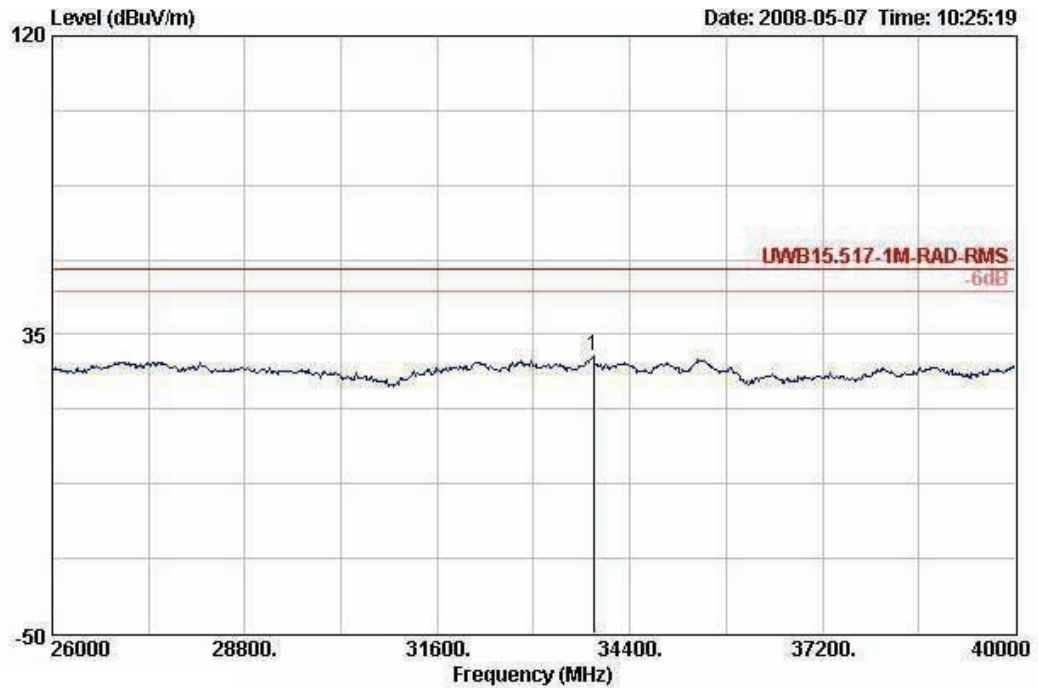

	Freq	Level	Over Limit	Limit Line	Read Level	Antenna Factor	Preamp Factor	Cable Loss	Table Pos	Ant Pos	Pol/Phase
	MHz	dBUV/m	dB	dBUV/m	dBUV	dB/m	dB	dB	deg	cm	
1	33868.000	28.89	-24.55	53.44	22.04	41.48	34.63	19.44	0	103	HORIZONTAL

Note: Measurements made with 1 MHz RBW/3MHz VBW (RMS detector) at 1m distance. 1 msec averaging time were used for these frequencies per bin point measurements.

The distance: 1m

Vertical

UWB Radiated Emissions 26 GHz to 40GHz

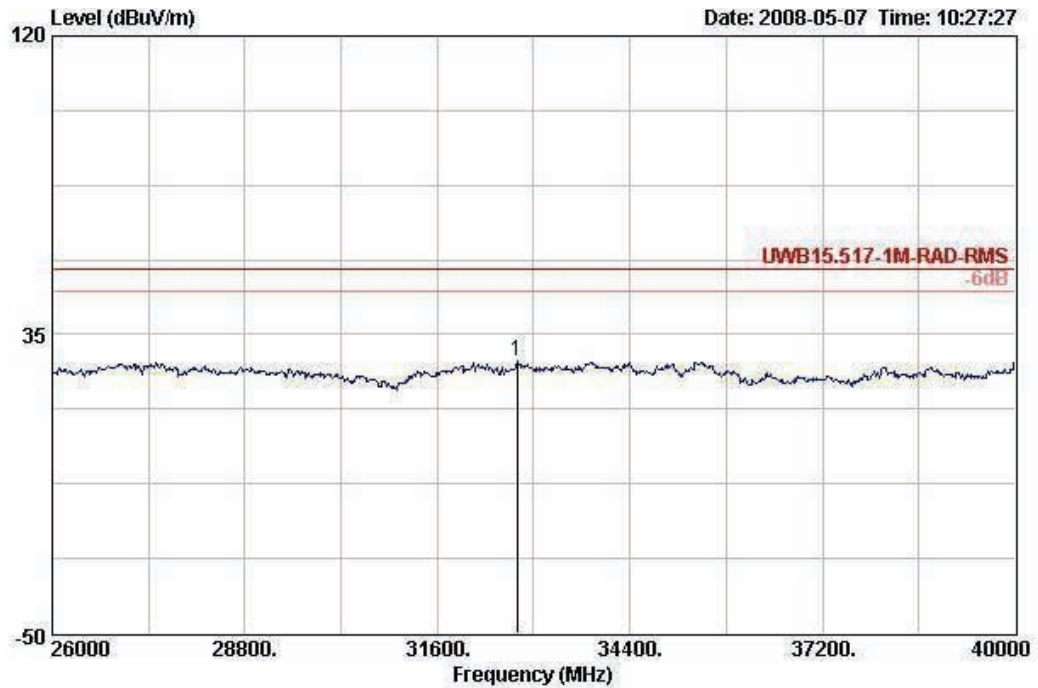

	Over	Limit	Read	Antenna	Preamp	Cable	Table	Ant	
1	Level	Line	Level	Factor	Factor	Loss	Pos	Pos	
	dB	dBuV/m	dBuV	dB/m	dB	dB	deg	cm	
32762.000	27.25	-26.19	53.44	19.21	41.31	33.27	17.97 Peak	360	100 VERTICAL

Note: Measurements made with 1 MHz RBW/3MHz VBW (RMS detector) at 1m distance. 1 msec averaging time were used for these frequencies per bin point measurements.

Temperature	26°C	Humidity	58%
Test Engineer	Sam Chen	Configurations	ALL BAND / Ant. 2

The distance: 3m

Horizontal

UWB Radiated Emissions 960 MHz to 8 GHz

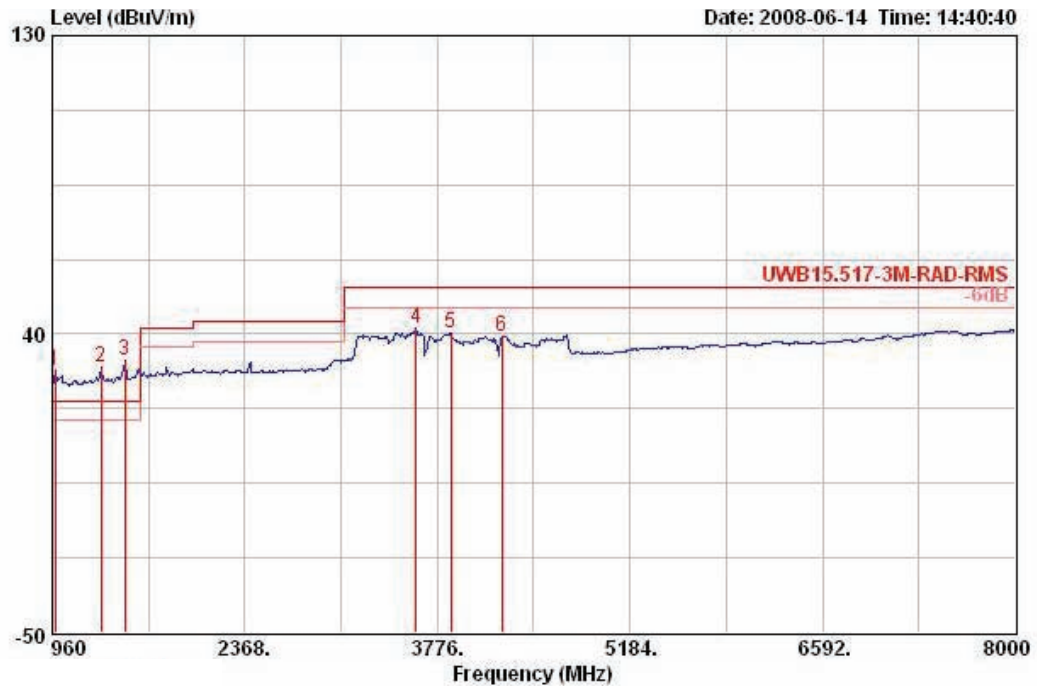

	Freq	Level	Over	Limit	Read	Antenna	Preamp	Cable	Table	Ant	
	MHz	dBuV/m	Limit	Line	Level	Factor	Factor	Loss	Pos	Pos	Pol/Phase
			dB	dBuV/m	dBuV	dB/m	dB	dB	deg	cm	
1 @	981.120	28.72			39.50	23.58	36.18	1.82	Peak	360	109 HORIZONTAL
2 @	1319.040	29.78			38.13	24.84	35.34	2.15	Peak	360	109 HORIZONTAL
3 @	1488.000	32.07			39.16	25.48	34.89	2.32	Peak	360	109 HORIZONTAL
4 @	3621.120	41.55	-12.35	53.90	42.32	30.69	34.93	3.47	Peak	360	109 HORIZONTAL
5 @	3874.560	40.15	-13.75	53.90	40.52	31.31	35.04	3.36	Peak	360	109 HORIZONTAL
6 @	4247.680	39.30	-14.60	53.90	39.52	31.75	35.52	3.55	Peak	360	109 HORIZONTAL

Note: Measurements made with 1 MHz RBW/3MHz VBW (RMS detector) at 3m distance. 1 msec averaging time were used for these frequencies per bin point measurements. Emissions (Mark 1, 2, 3) from digital circuitry used to enable the operation of the UWB transmitter shall comply with the limits in 47 CFR, Part 15, Subpart C, §15.209.