



# SPORTON International Inc.

No.8, Lane 724, Bo-ai St., Jhubei City, HsinChu County 302, Taiwan, R.O.C.  
Ph: 886-3-656-9065 / FAX: 886-3-656-9085 / www.sporton.com.tw

## FCC Dynamic Frequency Selection Test Report

Applicant's company	Realtek Semiconductor Corp.
Applicant Address	No. 2, Innovation Road II, Hsinchu Science Park, Hsinchu 300, Taiwan
FCC ID	TX2RTL8192DEB8
Manufacturer's company	Realtek Semiconductor Corp.
Manufacturer Address	No. 2, Innovation Road II, Hsinchu Science Park, Hsinchu 300, Taiwan

Product Name	802.11a/b/g/n RTL8192DE Combo miniCard
Brand Name	Realtek
Model Name	RTL8192DEB8
Test Standard(s)	47 CFR FCC Part 15 Subpart E § 15.407
Test Freq. Range	5250~5350 / 5470~5725 MHz
Received Date	Nov. 15, 2011
Final Test Date	Dec. 14, 2011
Submission Type	Original Equipment
Operating Mode	Client (without radar detection function)

### Statement

The test result in this report refers exclusively to the presented test model / sample.

Without written approval of SPORTON International Inc., the test report shall not be reproduced except in full.

The measurements and test results shown in this test report were made in accordance with the procedures and found in compliance with the limit given in FCC OET Order 06-96A (2006) and 47 CFR FCC Part 15 Subpart E § 15.407. The test equipment used to perform the test is calibrated and traceable to NML/ROC.



## Table of Contents

<b>1. CERTIFICATE OF COMPLIANCE .....</b>	<b>1</b>
<b>2. SUMMARY OF THE TEST RESULT .....</b>	<b>2</b>
<b>3. GENERAL INFORMATION .....</b>	<b>3</b>
3.1. Standard Requirement .....	3
3.2. Product Specification Table.....	3
3.3. Accessories.....	5
3.4. Table for DFS Band Carrier Frequencies .....	6
3.5. Antenna Information on DFS Band.....	7
<b>4. DFS DETECTION THRESHOLDS AND RADAR TEST WAVEFORMS .....</b>	<b>8</b>
4.1. Interference Threshold values, Master or Client incorporating In-Service Monitoring .....	8
4.2. DFS Response requirement values.....	8
4.3. Radar Test Waveforms Minimum Step.....	9
4.4. Short Pulse Radar Test Waveforms .....	9
4.5. Long Pulse Radar Test Waveform.....	11
4.6. Frequency Hopping Radar Test Waveform.....	14
4.7. Radiated Calibration Setup.....	16
4.8. Radar Waveform Calibration Procedure .....	16
4.9. Calibration Deviation.....	16
4.10. Radar Waveform Calibration Result .....	17
<b>5. TEST SETUP AND TEST RESULT.....</b>	<b>18</b>
5.1. Test setup .....	18
5.2. In-Service Monitoring for Channel Move Time, Channel Closing Transmission Time and Non-Occupancy Period Measurement...23	
<b>6. LIST OF MEASURING EQUIPMENTS .....</b>	<b>33</b>
<b>7. TEST LOCATION.....</b>	<b>34</b>
<b>8. TAF CERTIFICATE OF ACCREDITATION .....</b>	<b>35</b>
<b>APPENDIX A. ANTENNA LIST .....</b>	<b>A1 ~ A14</b>
<b>APPENDIX B. TEST PHOTO .....</b>	<b>B1 ~ B2</b>



## History of This Test Report

REPORT NO.	VERSION	DESCRIPTION	ISSUED DATE
FZ1N1521	Rev. 01	Initial issue of report	Jan. 02, 2012



## 1. CERTIFICATE OF COMPLIANCE

Product Name : 802.11a/b/g/n RTL8192DE Combo miniCard  
Brand Name : Realtek  
Model Name : RTL8192DEB8  
Applicant : Realtek Semiconductor Corp.  
Test Rule Part(s) : 47 CFR FCC Part 15 Subpart E § 15.407

Sporton International as requested by the applicant to evaluate the EMC performance of the product sample received on Nov. 15, 2011 would like to declare that the tested sample has been evaluated and found to be in compliance with the tested rule parts. The data recorded as well as the test configuration specified is true and accurate for showing the sample's EMC nature.

A handwritten signature in blue ink that reads 'Jordan Hsiao'.

Jordan Hsiao

SPORTON INTERNATIONAL INC.

## 2. SUMMARY OF THE TEST RESULT

Applied Standard: OET Order 06-96A (2006)			
Part	Appendix	Description of Test	Result
5.2	7.8.3	In-Service Monitoring for Channel Move Time, Channel Closing Transmission Time and Non-Occupancy Period	Complies

Note: Since the product is client without radar detection function, only Channel Move Time, Channel Closing Transmission Time and Non-Occupancy Period are required to be performed.

### 3. GENERAL INFORMATION

#### 3.1. Standard Requirement

FCC 15.407: U-NII devices operating in the 5.25-5.35 GHz band and the 5.47-5.725 GHz band shall employ a TPC mechanism. The U-NII device is required to have the capability to operate at least 6 dB below the mean EIRP value of 30 dBm. A TPC mechanism is not required for systems with an e.i.r.p. of less than 500 mW.

U-NII devices operating in the 5.25-5.35 GHz and 5.47-5.725 GHz bands shall employ a DFS radar detection mechanism to detect the presence of radar systems and to avoid co-channel operation with radar systems.

#### 3.2. Product Specification Table

Specification Items	Description
Product Type	802.11n WLAN (1TX / 2TX, 2RX) 802.11 a WLAN (1TX, 2RX)
Radio Type	Intentional Transceiver
Power Type	From Host System
Modulation	see the below table for 802.11n OFDM (BPSK / QPSK / 16QAM / 64QAM) for IEEE 802.11a
Data Rate (Mbps)	see the below table for 802.11n OFDM (6/9/12/18/24/36/48/54) for IEEE 802.11a
Operating Frequency Range	5250~5350 / 5470~5725 MHz
Channel Bandwidth	20/40 MHz operating channel bandwidth
DFS Function	Client (without radar detection function)
Max. Con. Power (DFS band)	1TX: Band 2: MCS0 (20MHz): 18.92 dBm ; MCS0 (40MHz): 17.15 dBm 1TX: Band 3: MCS0 (20MHz): 20.78 dBm ; MCS0 (40MHz): 18.15 dBm 2TX: Band 2: MCS8 (20MHz): 20.94 dBm ; MCS8 (40MHz): 18.17 dBm 2TX: Band 3: MCS8 (20MHz): 22.22 dBm ; MCS8 (40MHz): 21.11 dBm
Min. Con. Power (DFS band)	1TX: Band 2: MCS0 (20MHz): 12.92 dBm ; MCS0 (40MHz): 11.15 dBm 1TX: Band 3: MCS0 (20MHz): 14.78 dBm ; MCS0 (40MHz): 12.15 dBm 2TX: Band 2: MCS8 (20MHz): 14.94 dBm ; MCS8 (40MHz): 12.17 dBm 2TX: Band 3: MCS8 (20MHz): 16.22 dBm ; MCS8 (40MHz): 15.11 dBm
Max. EIRP Power (DFS band)	1TX: Band 2: MCS0 (20MHz): 15.76 dBm ; MCS0 (40MHz): 13.99 dBm 1TX: Band 3: MCS0 (20MHz): 17.62 dBm ; MCS0 (40MHz): 14.99 dBm 2TX: Band 2: MCS8 (20MHz): 17.78 dBm ; MCS8 (40MHz): 15.01 dBm 2TX: Band 3: MCS8 (20MHz): 19.06 dBm ; MCS8 (40MHz): 17.95 dBm

Min. EIRP Power (DFS band)	1TX: Band 2: MCS0 (20MHz): 9.76 dBm ; MCS0 (40MHz): 7.99 dBm 1TX: Band 3: MCS0 (20MHz): 11.62 dBm ; MCS0 (40MHz): 8.99 dBm 2TX: Band 2: MCS8 (20MHz): 11.78 dBm ; MCS8 (40MHz): 9.01 dBm 2TX: Band 3: MCS8 (20MHz): 13.06 dBm ; MCS8 (40MHz): 11.95 dBm
TPC Function	5260~5320 MHz ; 5500~5700 MHz
Operating Mode	Client (without radar detection function)
Communication Mode	IP based system
Power-on cycle	NA (No Channel Availability Check Function)
Software Version (Slave)	Realtek Semiconductor Corp 2002.1122.2011
Carrier Frequencies	Please refer to section 3.5
Antenna	Please refer to section 3.6

#### Antenna & Band width

Antenna	Single (TX)		Two (TX)	
	20 MHz	40 MHz	20 MHz	40 MHz
802.11a	V	X	X	X
802.11n	V	V	V	V

## 802.11n spec

MCS Index	Nss	Modulation	R	NBPS	NCBPS		NDBPS		Datarate(Mbps)			
					20MHz	40MHz	20MHz	40MHz	800nsGI		400nsGI	
									20MHz	40MHz	20MHz	40MHz
0	1	BPSK	1/2	1	52	108	26	54	6.5	13.5	7.200	15
1	1	QPSK	1/2	2	104	216	52	108	13.0	27.0	14.400	30
2	1	QPSK	3/4	2	104	216	78	162	19.5	40.5	21.700	45
3	1	16-QAM	1/2	4	208	432	104	216	26.0	54.0	28.900	60
4	1	16-QAM	3/4	4	208	432	156	324	39.0	81.0	43.300	90
5	1	64-QAM	2/3	6	312	648	208	432	52.0	108.0	57.800	120
6	1	64-QAM	3/4	6	312	648	234	486	58.5	121.5	65.000	135
7	1	64-QAM	5/6	6	312	648	260	540	65.0	135.0	72.200	150
8	2	BPSK	1/2	1	104	216	52	108	13.0	27.0	14.444	30
9	2	QPSK	1/2	2	208	432	104	216	26.0	54.0	28.889	60
10	2	QPSK	3/4	2	208	432	156	324	39.0	81.0	43.333	90
11	2	16-QAM	1/2	4	416	864	208	432	52.0	108.0	57.778	120
12	2	16-QAM	3/4	4	416	864	312	648	78.0	162.0	86.667	180
13	2	64-QAM	2/3	6	624	1296	416	864	104.0	216.0	115.556	240
14	2	64-QAM	3/4	6	624	1296	468	972	117.0	243.0	130.000	270
15	2	64-QAM	5/6	6	624	1296	520	1080	130.0	270.0	144.444	300

Symbol	Explanation
NSS	Number of spatial streams
R	Code rate
NBPS	Number of coded bits per single carrier
NCBPS	Number of coded bits per symbol
NDBPS	Number of data bits per symbol
GI	guard interval

## 3.3. Accessories

N/A



### 3.4. Table for DFS Band Carrier Frequencies

There are two bandwidth systems for 802.11n.

For both 20MHz bandwidth systems, use Channel 52, 56, 60, 64, 100, 104, 108, 112, 116, 120, 124, 128, 132, 136, 140.

For both 40MHz bandwidth systems, use Channel 54, 62, 102, 110, 118, 126, 134.

There is one bandwidth system for IEEE 802.11a.

For both 20MHz bandwidth systems, use Channel 52, 56, 60, 64, 100, 104, 108, 112, 116, 120, 124, 128, 132, 136, 140.

Frequency Band	Channel No.	Frequency	Channel No.	Frequency
5250~5350 MHz Band 2	52	5260 MHz	60	5300 MHz
	54	5270 MHz	62	5310 MHz
	56	5280 MHz	64	5320 MHz
5470~5725 MHz Band 3	100	5500 MHz	120	5600 MHz
	102	5510 MHz	124	5620 MHz
	104	5520 MHz	126	5630 MHz
	108	5540 MHz	128	5640 MHz
	110	5550 MHz	132	5660 MHz
	112	5560 MHz	134	5670 MHz
	116	5580 MHz	136	5680 MHz
	118	5590 MHz	140	5700 MHz

### 3.5. Antenna Information on DFS Band

Ant.	Brand	Model Name	Antenna Type	Connector	Gain (dBi)		Chain
					2.4GHz	5GHz	
1	JOYMAX	TWF-614XMPXX-500	Dipole Antenna	Reversed-SMA	3	5	Chain1/Chain2
2	LYNwave	ALA110-222050	PIFA Antenna	I-PEX	3.5	5	Chain1/Chain2

Note: The EUT has two different type antennas.

The detail information of antennas, please refer to Appendix A.

<5GHz WALN function with/without Bluetooth function:>

**For IEEE 802.11a/n Mode: (1TX, 2RX)**

Both Chain 1 and Chain 2 can be used as receiving antennas, and they can receive signal simultaneously.

The EUT supports the antenna with TX diversity function.

Both Chain 1 and Chain 2 can be used as transmitting antenna, but only one of them is used as transmitting antenna at the same time.

Due to Chain 1 generated higher output power, so all tests were base on this setting and recorded in this report.

**For IEEE 802.11n Mode: (2TX, 2RX)**

Both Chain 1 and Chain 2 can be used as transmitting/receiving antennas, and they can transmit/receive signal simultaneously.

Note: For 802.11n mode, only 2TX function was selected to test and record in the report and the single power of peak output power for 1TX function will follow this same test result.

**For Bluetooth Mode:**

Only Chain 2 can be used as transmitting/receiving antenna.

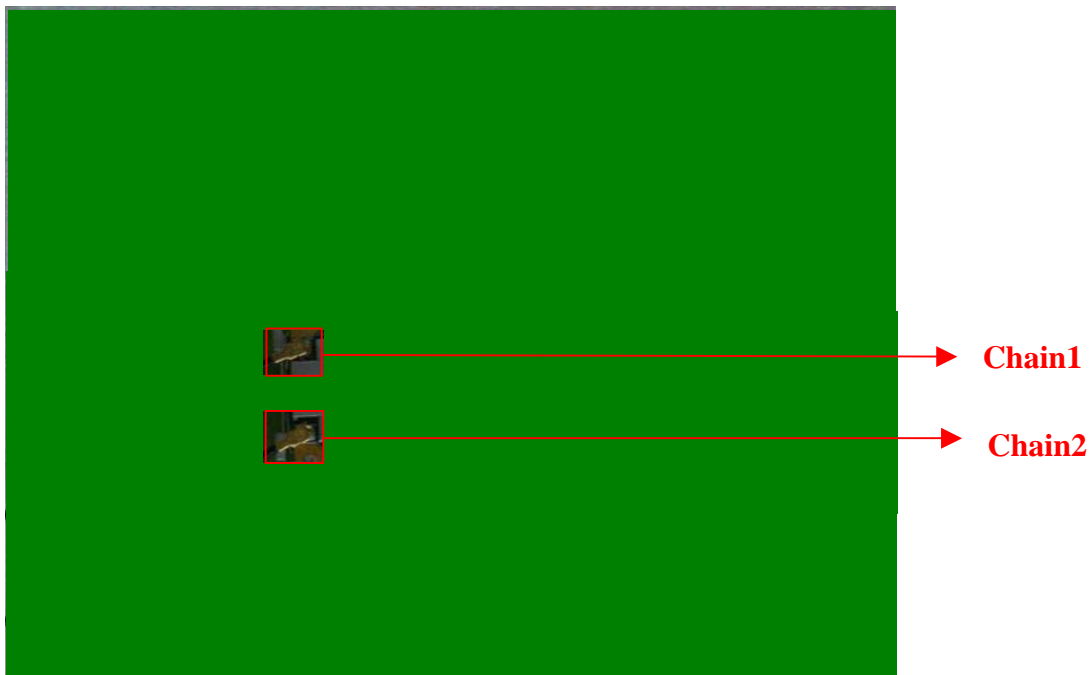

## 4. DFS DETECTION THRESHOLDS AND RADAR TEST WAVEFORMS

### 4.1. Interference Threshold values, Master or Client incorporating In-Service Monitoring

Maximum Transmit Power	Value (see note)
≥ 200 milliwatt	-64 dBm
< 200 milliwatt	-62 dBm

Note 1: This is the level at the input of the receiver assuming a 0 dBi receive antenna.

Note 2: Throughout these test procedures an additional 1 dB has been added to the amplitude of the test transmission waveforms to account for variations in measurement equipment. This will ensure that the test signal is at or above the detection threshold level to trigger a DFS response.

The radar *Detection Threshold*, lowest antenna gain is the parameter of Interference *radar DFS detection threshold*, The Interference *Detection Threshold* is the  $(-64\text{dBm}) + (0) [\text{dBi}] + 1 \text{ dB} = -63 \text{ dBm}$ .

### 4.2. DFS Response requirement values

Parameter	Value
<i>Non-occupancy period</i>	Minimum 30 minutes
<i>Channel Availability Check Time</i>	60 seconds
<i>Channel Move Time</i>	10 seconds See Note 1.
<i>Channel Closing Transmission Time</i>	200 milliseconds + an aggregate of 60 milliseconds over remaining 10 second period. See Notes 1 and 2.
<i>U-NII Detection Bandwidth</i>	Minimum 80% of the 99% power bandwidth See Note 3.

Note 1: The instant that the *Channel Move Time* and the *Channel Closing Transmission Time* begins is as follows:

- For the Short pulse radar Test Signals this instant is the end of the *Burst*.
- For the Frequency Hopping radar Test Signal, this instant is the end of the last radar *Burst* generated.
- For the Long Pulse radar Test Signal this instant is the end of the 12 second period defining the radar transmission.

Note 2: The *Channel Closing Transmission Time* is comprised of 200 milliseconds starting at the beginning of the *Channel Move Time* plus any additional intermittent control signals required to facilitate *Channel* changes (an aggregate of 60 milliseconds) during the remainder of the 10 second period. The aggregate duration of control signals will not count quiet periods in between transmissions.

Note 3: During the *U-NII Detection Bandwidth* detection test, radar type 1 is used and for each frequency step the minimum percentage of detection is 90%. Measurements are performed with no data traffic.

### 4.3. Radar Test Waveforms Minimum Step

Step intervals of 0.1 microsecond for Pulse Width, 1 microsecond for PRI, 1 MHz for chirp width and 1 for the number of pulses will be utilized for the random determination of specific test waveforms.

### 4.4. Short Pulse Radar Test Waveforms

Radar Type	Pulse Width ( $\mu\text{sec}$ )	PRI ( $\mu\text{sec}$ )	Number of Pulses	Minimum Percentage of Successful Detection	Minimum Trials
1	1	1428	18	60%	30
2	1-5	150-230	23-29	60%	30
3	6-10	200-500	16-18	60%	30
4	11-20	200-500	12-16	60%	30
Aggregate (Radar Types 1-4)				80%	120

A minimum of 30 unique waveforms are required for each of the short pulse radar types 2 through 4. For short pulse radar type 1, the same waveform is used a minimum of 30 times. If more than 30 waveforms are used for short pulse radar types 2 through 4, then each additional waveform must also be unique and not repeated from the previous waveforms. The aggregate is the average of the percentage of successful detections of short pulse radar types 1-4.

## FCC Radar Types (1~4) System Diagram

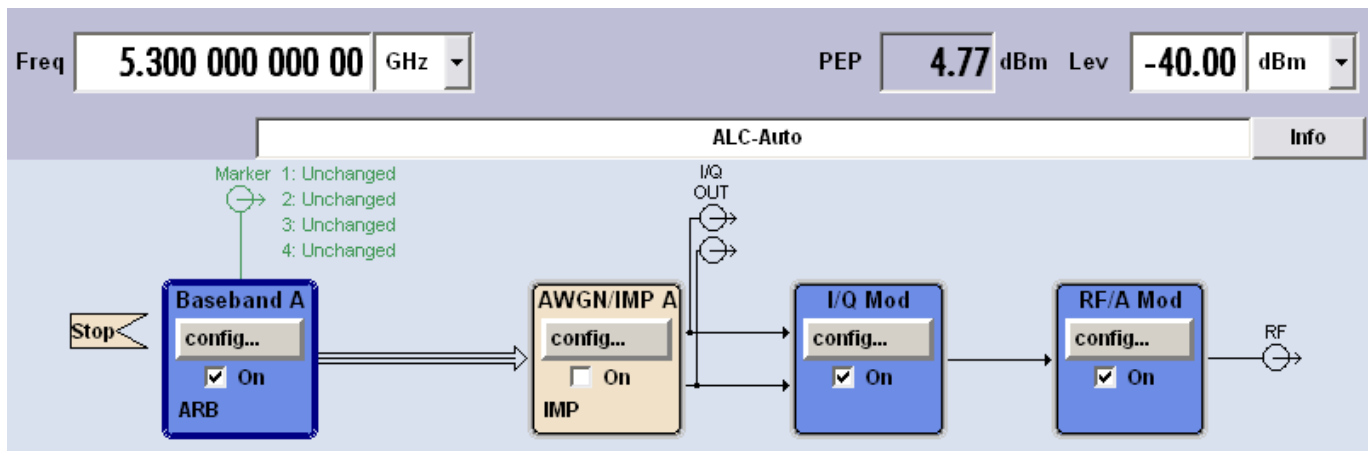

Used R&S SMU200A (Vector SG with one ARB) or SG + ARB

B11: Base-band Generator with ARB (16 M samples) and Digital Modulation

B13: Base-band Main Module

B106: frequency range (100 kHz to 6 GHz)

For selecting the waveform parameters from within the bounds of the signal type, system were random selection using uniform distribution.

#### 4.5. Long Pulse Radar Test Waveform

Radar Type	Pulse Width ( $\mu\text{sec}$ )	Chirp Width (MHz)	PRI ( $\mu\text{sec}$ )	Number of Pulses per Burst	Number of Bursts	Minimum Percentage of Successful Detection	Minimum Trials
5	50-100	5-20	1000-2000	1-3	8-20	80%	30

The parameters for this waveform are randomly chosen. Thirty unique waveforms are required for the Long Pulse radar test signal. If more than 30 waveforms are used for the Long Pulse radar test signal, then each additional waveform must also be unique and not repeated from the previous waveforms. Each waveform is defined as follows:

- (1) The transmission period for the Long Pulse Radar test signal is 12 seconds.
- (2) There are a total of 8 to 20 Bursts in the 12 second period, with the number of Bursts being randomly chosen. This number is Burst\_Count.
- (3) Each Burst consists of 1 to 3 pulses, with the number of pulses being randomly chosen. Each Burst within the 12 second sequence may have a different number of pulses.
- (4) The pulse width is between 50 and 100 microseconds, with the pulse width being randomly chosen. Each pulse within a Burst will have the same pulse width. Pulses in different Bursts may have different pulse widths.
- (5) Each pulse has a linear FM chirp between 5 and 20 MHz, with the chirp width being randomly chosen. Each pulse within a Burst will have the same chirp width. Pulses in different Bursts may have different chirp widths. The chirp is centered on the pulse. For example, with a radar frequency of 5300 MHz and a 20 MHz chirped signal, the chirp starts at 5290 MHz and ends at 5310 MHz.
- (6) If more than one pulse is present in a Burst, the time between the pulses will be between 1000 and 2000 microseconds, with the time being randomly chosen. If three pulses are present in a Burst, the time between the first and second pulses is chosen independently of the time between the second and third pulses.
- (7) The 12 second transmission period is divided into even intervals. The number of intervals is equal to Burst\_Count. Each interval is of length  $(12,000,000 / \text{Burst\_Count})$  microseconds. Each interval contains one Burst. The start time for the Burst, relative to the beginning of the interval, is between 1 and  $[(12,000,000 / \text{Burst\_Count}) - (\text{Total Burst Length}) + (\text{One Random PRI Interval})]$  microseconds, with the start time being randomly chosen. The step interval for the start time is 1 microsecond. The start time for each Burst is chosen independently.

A representative example of a Long Pulse radar test waveform:

- (1) The total test signal length is 12 seconds.
- (2) 8 Bursts are randomly generated for the Burst\_Count.
- (3) Burst 1 has 2 randomly generated pulses.
- (4) The pulse width (for both pulses) is randomly selected to be 75 microseconds.
- (5) The PRI is randomly selected to be at 1213 microseconds.

- (6) Bursts 2 through 8 are generated using steps 3 – 5.
- (7) Each Burst is contained in even intervals of 1,500,000 microseconds. The starting location for Pulse 1, Burst 1 is randomly generated (1 to 1,500,000 minus the total Burst 1 length + 1 random PRI interval) at the 325,001 microsecond step. Bursts 2 through 8 randomly fall in successive 1,500,000 microsecond intervals (i.e. Burst 2 falls in the 1,500,001 – 3,000,000 microsecond range).

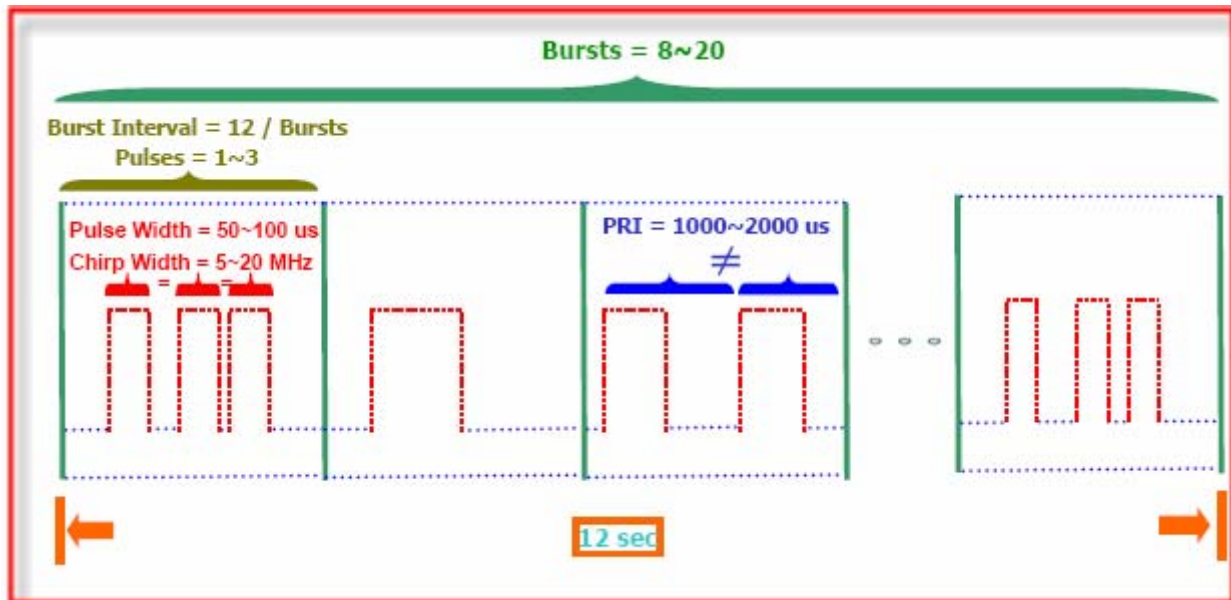

FCC Radar Types (5) System Diagram

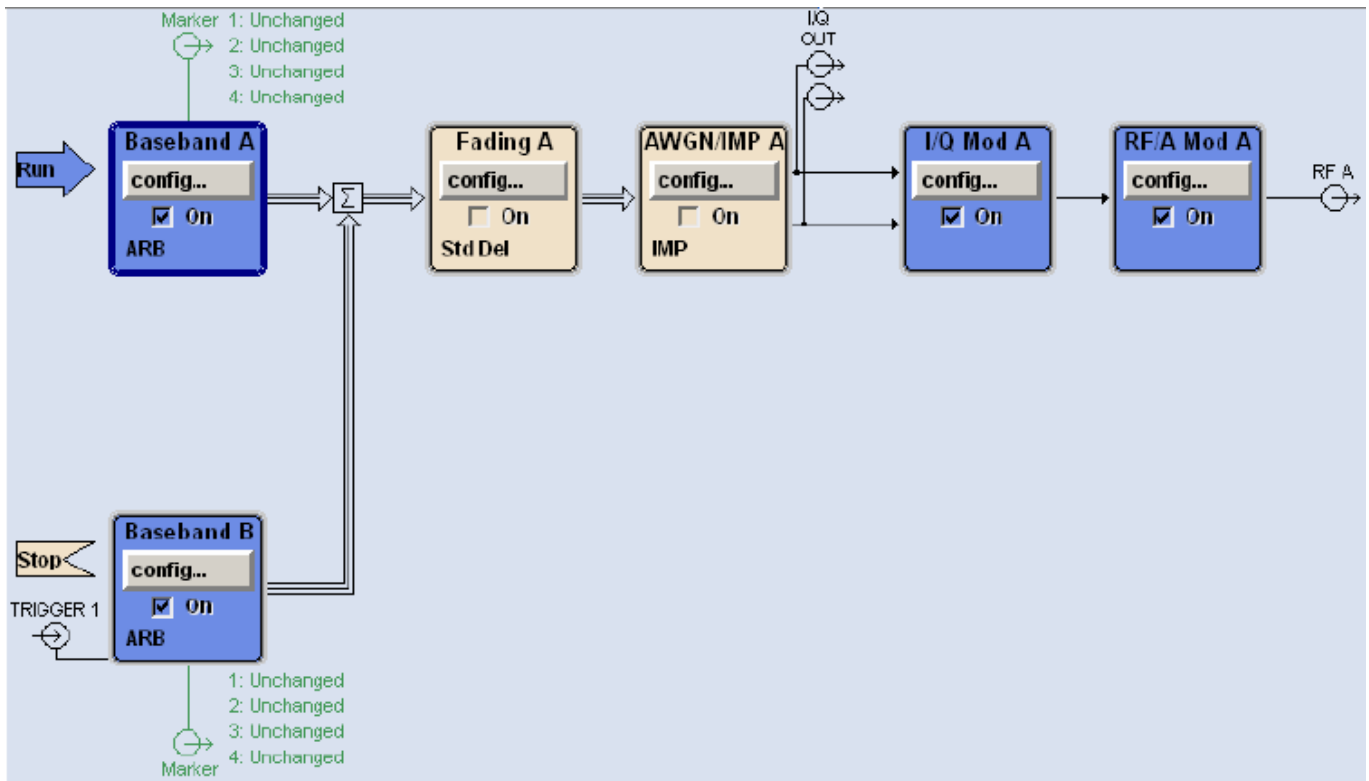

Used R&S SMU200A (Vector SG with two ARB)

Path A / Path B Two B11 : Base-band Generator with ARB (16 M samples) and Digital Modulation

B13: Base-band Main Module

B106: frequency range (100 kHz to 6 GHz)

For selecting the waveform parameters from within the bounds of the signal type, system was random selection using uniform distribution.



#### 4.6. Frequency Hopping Radar Test Waveform

Radar Type	Pulse Width ( $\mu\text{sec}$ )	PRI ( $\mu\text{sec}$ )	Pulses per Hop	Hopping Rate (kHz)	Hopping Sequence Length (msec)	Minimum Percentage of Successful Detection	Minimum Trials
6	1	333	9	0.333	300	70%	30

For the Frequency Hopping Radar Type, the same Burst parameters are used for each waveform. The hopping sequence is different for each waveform and a 100-length segment is selected from the hopping sequence defined by the following algorithm:

The first frequency in a hopping sequence is selected randomly from the group of 475 integer frequencies from 5250 – 5724 MHz. Next, the frequency that was just chosen is removed from the group and a frequency is randomly selected from the remaining 474 frequencies in the group. This process continues until all 475 frequencies are chosen for the set. For selection of a random frequency, the frequencies remaining within the group are always treated as equally likely.

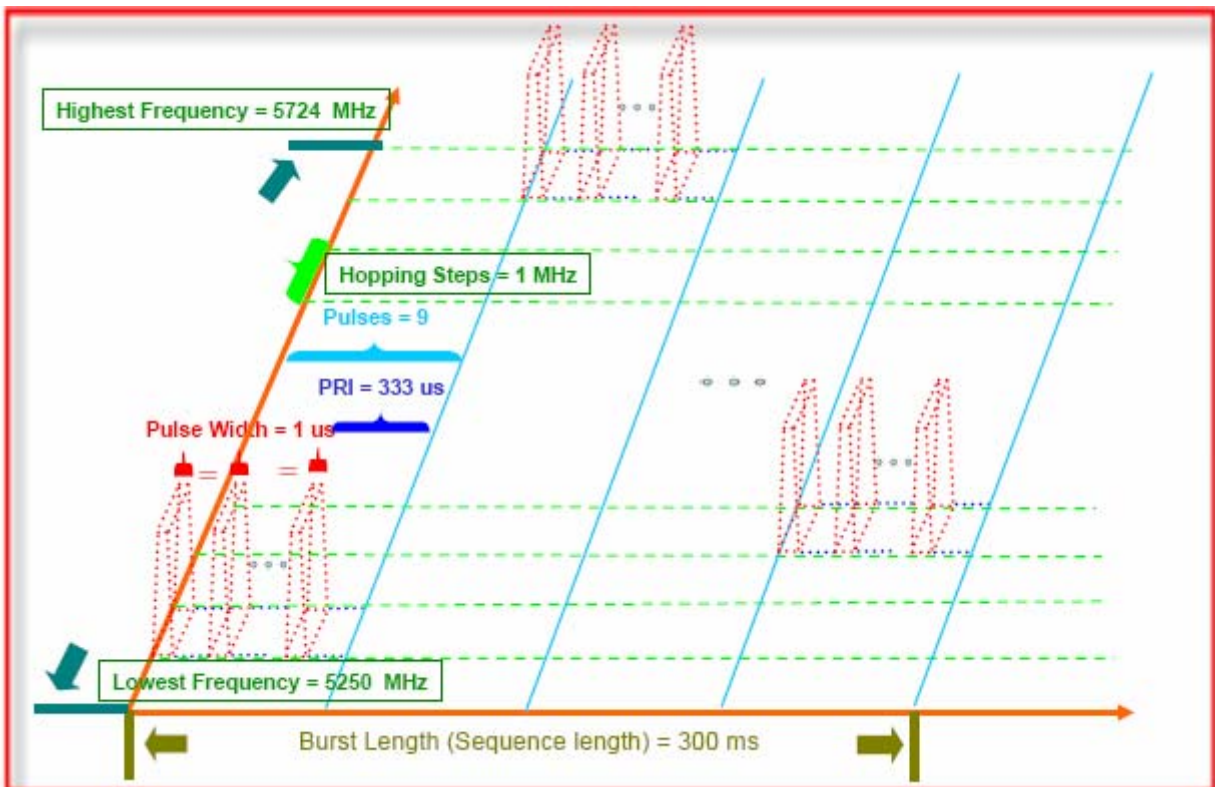

## FCC Radar Types (6) System Diagram

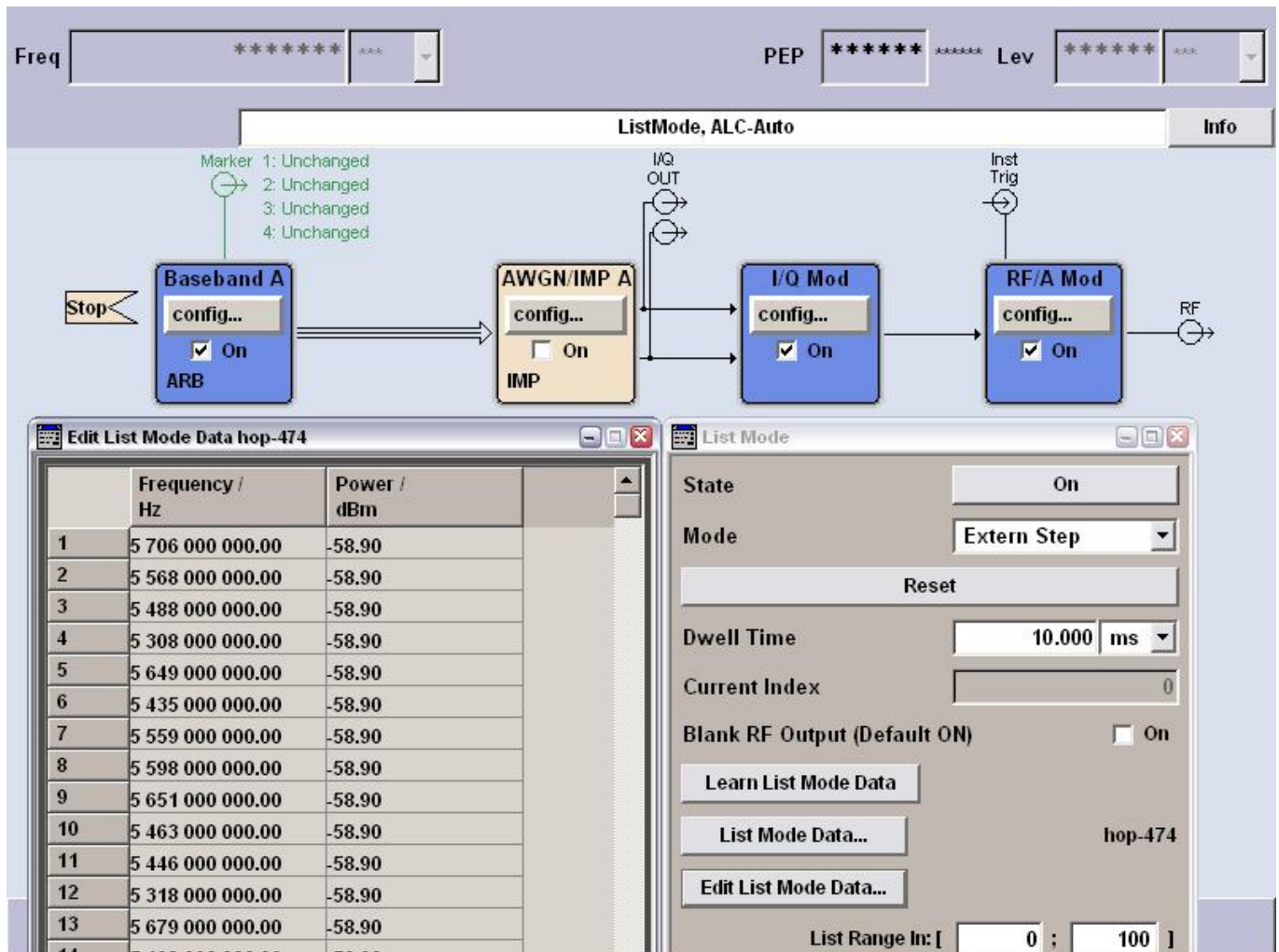

Used R&S SMU200A (Vector SG with one ARB)

B11: Base-band Generator with ARB (16 M samples) and Digital Modulation

B13: Base-band Main Module

B106: frequency range (100 kHz to 6 GHz)

For selecting the waveform parameters from within the bounds of the signal type, system were random selection using uniform distribution.

#### 4.7. Radiated Calibration Setup

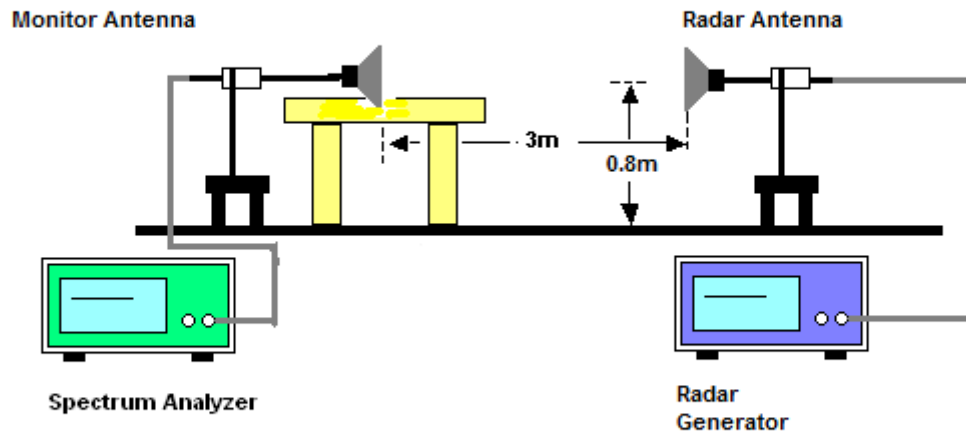

#### 4.8. Radar Waveform Calibration Procedure

The Interference **Radar Detection Threshold Level** is  $(-64\text{dBm}) + (0) [\text{dBi}] + 1 \text{ dB} = -63 \text{ dBm}$  that had been taken into account the output power range and antenna gain. The above equipment setup was used to calibrate the conducted Radar Waveform. A vector signal generator was utilized to establish the test signal level for each radar type. During this process there were replace 50ohm terminal form Master and Client device and no transmissions by either the Master or Client Device. The spectrum analyzer was switched to the zero span (Time Domain) at the frequency of the Radar Waveform generator. Peak detection was used. The spectrum analyzer resolution bandwidth (RBW) and video bandwidth (VBW) were set to at least 3 MHz. The vector signal generator amplitude was set so that the power level measured at the spectrum analyzer was  $(-64\text{dBm}) + (0) [\text{dBi}] + 1 \text{ dB} = -63 \text{ dBm}$ . Capture the spectrum analyzer plots on short pulse radar types, long pulse radar type and hopping radar waveform.

#### 4.9. Calibration Deviation

There is no deviation with the original standard.

### 4.10. Radar Waveform Calibration Result

#### Radar #1 DFS detection threshold level and the burst of pulses on the Channel frequency

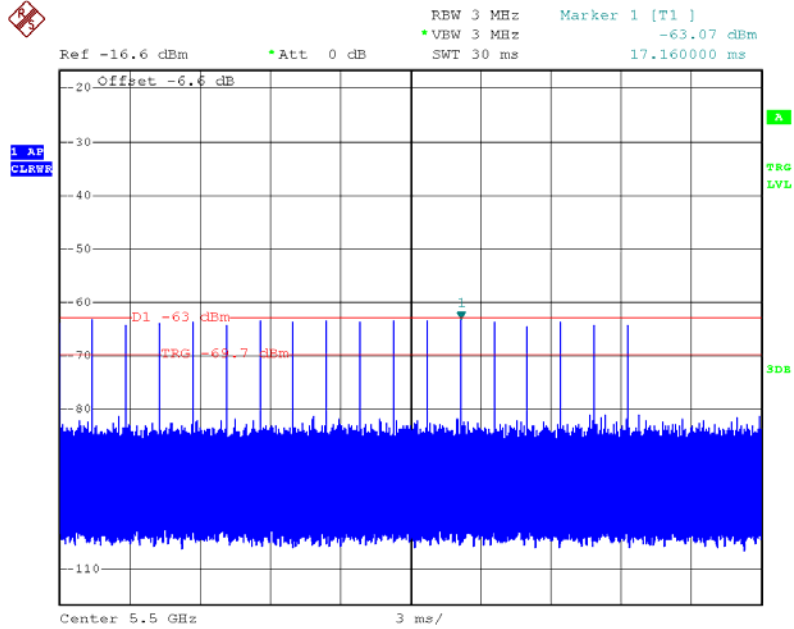

Date: 14.DEC.2011 10:10:32

#### Radar #2 DFS detection threshold level and the burst of pulses on the Channel frequency

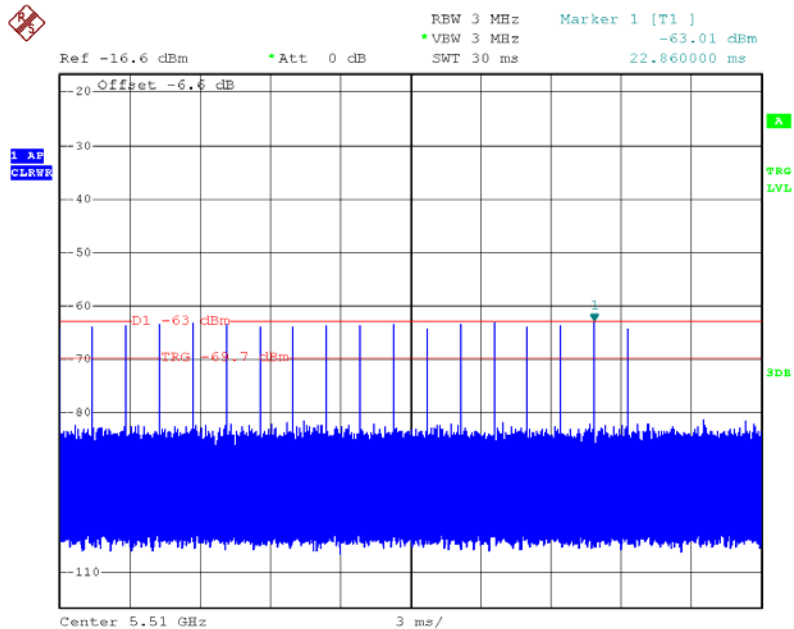

Date: 14.DEC.2011 10:11:17

## 5. TEST SETUP AND TEST RESULT

### 5.1. Test setup

#### 5.1.1. Test Setup Diagram

Following is the test setup for generate the radar waveforms and used to monitor UNII device.

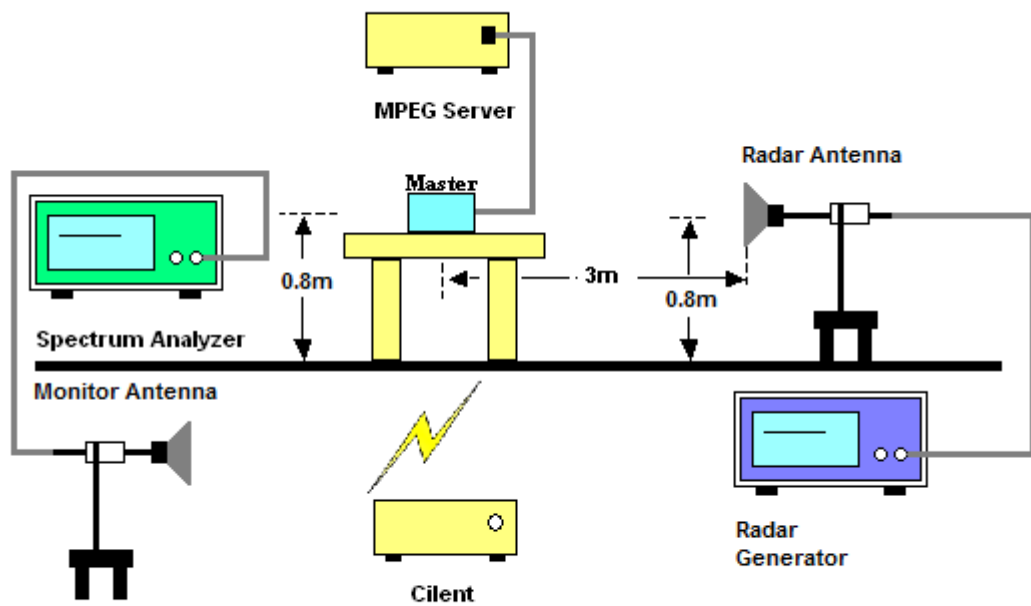

EUT (Slave) Data Traffic Plot (20 MHz)

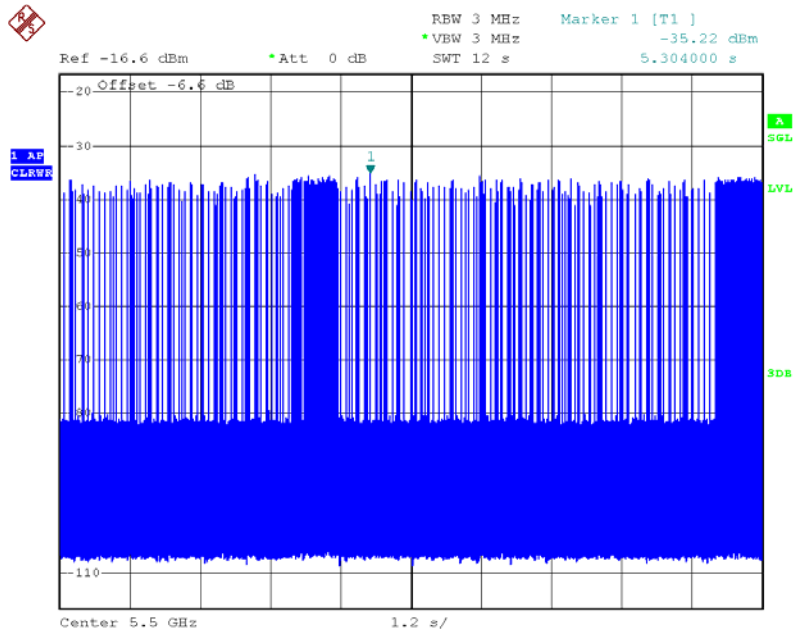

Date: 14.DEC.2011 07:22:19

EUT (Slave) Data Traffic Plot (40 MHz)

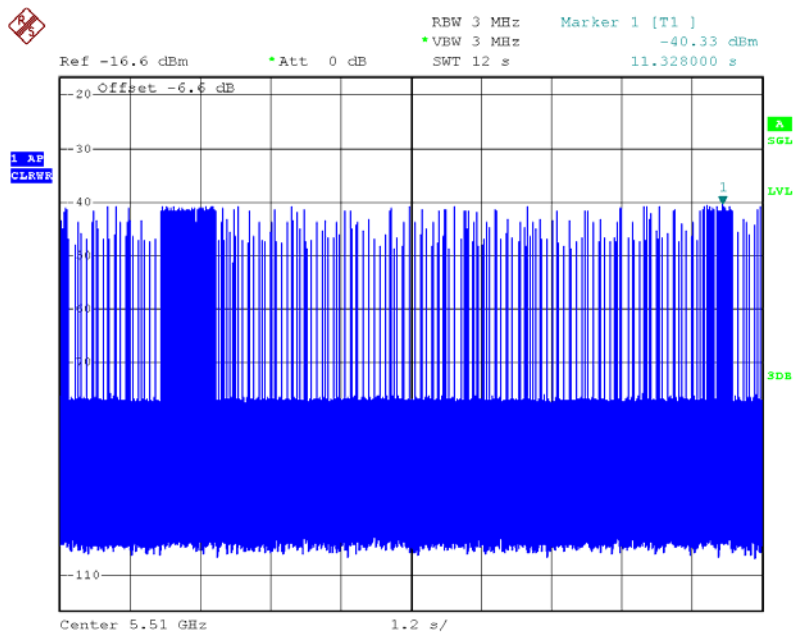

Date: 14.DEC.2011 07:40:54

### Master Data Traffic Plot (20MHz)

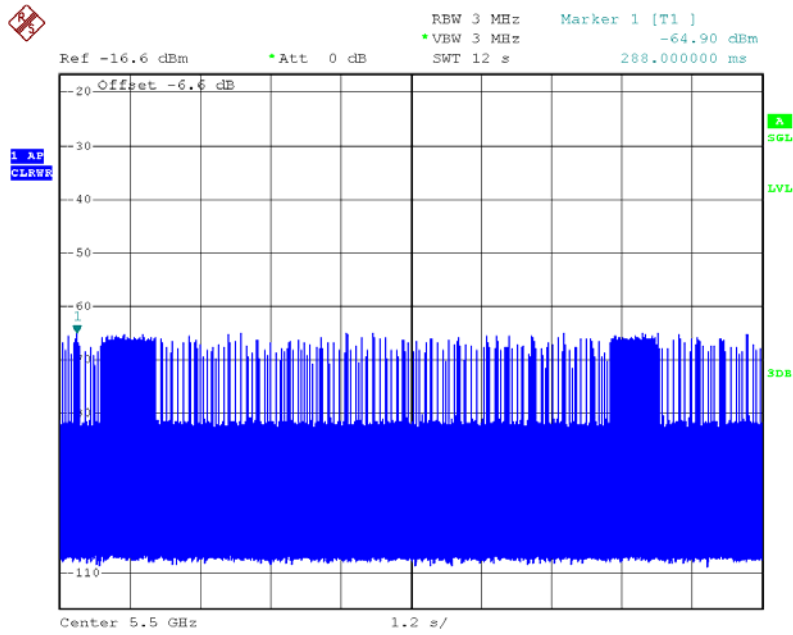

Date: 14.DEC.2011 07:33:00

### Master Data Traffic Plot (40MHz)

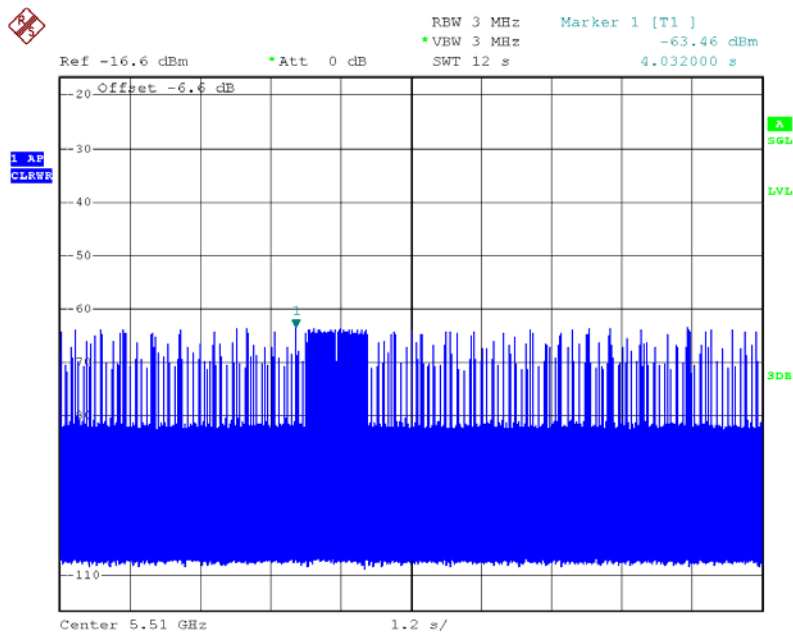

Date: 14.DEC.2011 07:42:14

Without Data Traffic Plot (Noise Plot) (20MHz)

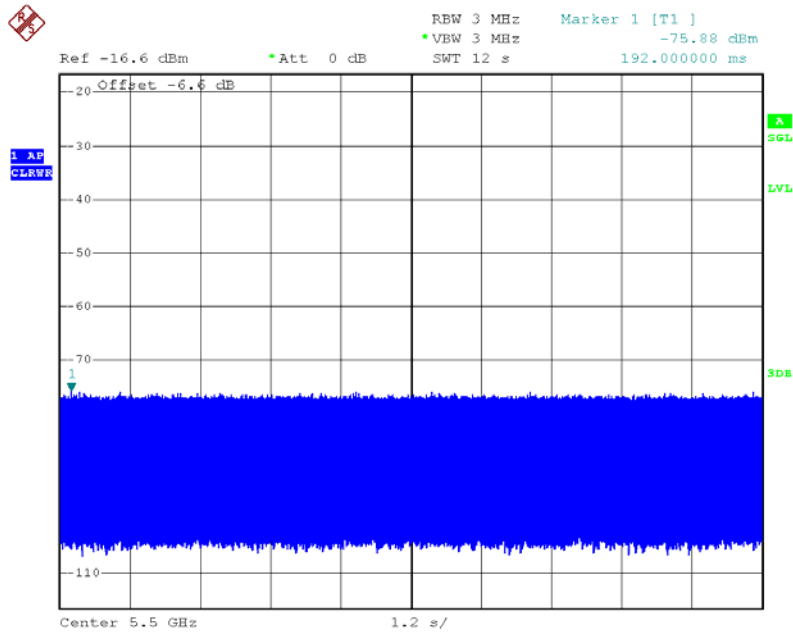

Date: 14.DEC.2011 07:29:54

Without Data Traffic Plot (Noise Plot) (40MHz)

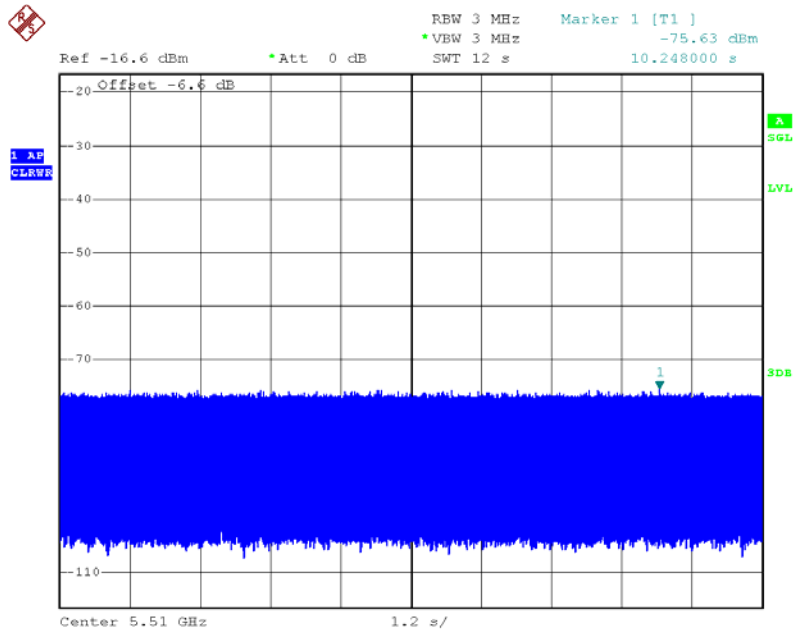

Date: 14.DEC.2011 07:38:28



### 5.1.2. Supporting Units

Support Units	Brand	Model No.	Serial No.	FCC ID	Software Version
Notebook	DELL	D520	NB-A	E2KWM3945ABG	Win 7
Notebook	DELL	M1330	NB-O	E2K4965AGNM	Win 7
Wireless AP	Metalink	Mtw_RGPlus_5.0_VB_001	AP	VT6-237VB-4B	(02.03.05.35)

### 5.1.3. Test Setup Operation

System testing was performed with the designated MPEG test file that streams full motion video from the Access Point to the Client in full motion video mode using the media player with the V2.61 Codec package.. This file is used by IP and Frame based systems for loading the test channel during the In-service compliance testing of the U-NII device.

The waveform parameters from within the bounds of the signal type are selected randomly using uniform distribution.

A spectrum analyzer is used as a monitor to verify that the EUT has vacated the Channel within the (Channel Closing Transmission Time and Channel Move Time, and does not transmit on a Channel during the Non-Occupancy Period after the detection and Channel move. It is also used to monitor EUT transmissions during the Channel Availability Check Time.

## 5.2. In-Service Monitoring for Channel Move Time, Channel Closing Transmission Time and Non-Occupancy Period Measurement

### 5.2.1. Limit

The EUT has In-Service Monitoring function to continuously monitor the radar signals, If radar is detected, must leave the channel (Shutdown). The Channel Move Time to cease all transmissions on the current Channel upon detection of a Radar Waveform above the DFS Detection Threshold within 10 sec. The total duration of Channel Closing Transmission Time is 260ms, consisting of data signals and the aggregate of control signals, by a U-NII device during the Channel Move Time. The Non-Occupancy Period time is 30 minute during which a Channel will not be utilized after a Radar Waveform is detected on that Channel.

### 5.2.2. Test Procedures

1. When a radar Burst with a level equal to the DFS Detection Threshold + 1dB is generated on the Operating Channel of the U-NII device. A U-NII device operating as a Client Device will associate with the Master at Channel. Stream the MPEG test file from the Master Device to the Client Device on the selected Channel for the entire period of the test. At time T<sub>0</sub> the Radar Waveform generator sends a Burst of pulses for each of the radar types at Detection Threshold + 1dB.
2. Observe the transmissions of the EUT at the end of the radar Burst on the Operating Channel. Measure and record the transmissions from the EUT during the observation time (Channel Move Time). One 10 second plot been reported for the Short Pulse Radar Types 1-4 and one for the Long Pulse Radar Type test in a 22 second plot. The plot for the Short Pulse Radar Types start at the end of the radar burst. The *Channel Move Time* will be calculated based on the plot of the Short Pulse Radar Type. The Long Pulse Radar Type plot show the device ceased transmissions within the 10 second window after detection has occurred. The plot for the Long Pulse Radar Type should start at the beginning of the 12 second waveform.
3. Measurement of the aggregate duration of the Channel Closing Transmission Time method. With the spectrum analyzer set to zero span tuned to the center frequency of the EUT operating channel at the radar simulated frequency, peak detection, and max hold, the dwell time per bin is given by: **Dwell (2ms) = S (1 sec) / B (500)** ; where **Dwell** is the dwell time per spectrum analyzer sampling bin, **S** is the sweep time and **B** is the number of spectrum analyzer sampling bins. An upper bound of the aggregate duration of the intermittent control signals of *Channel Closing Transmission Time* is calculated by: **20MHz: C (6 ms) = N (3) X Dwell (2 ms)**, **40MHz: C (8 ms) = N (4) X Dwell (2 ms)**; where **C** is the Closing Time, **N** is the number of spectrum analyzer sampling bins (intermittent control signals) showing a U-NII transmission and **Dwell** is the dwell time per bin.
4. Measure the EUT for more than 30 minutes following the channel close/move time to verify that the EUT does not resume any transmissions on this Channel.

### 5.2.3. Test Deviation

There is no deviation with the original standard.

### 5.2.4. Result of Channel Move Time, Channel Closing Transmission Time and Non-Occupancy Period

#### For 20MHz

Parameter	Test Result	Limit
	Type 1	
Test Channel (MHz)	5500 MHz	-
Channel Move Time (ms)	456	< 10s
Intermittent Control Signals (ms) (Note)	6	< 60ms
Non-Occupancy Period (min.)	$\geq 30$	$\geq 30$ min

Note: The Channel Closing Transmission Time is comprised of 200 milliseconds starting at the beginning of the Channel Move Time plus any additional intermittent control signals required to facilitate a Channel move (an aggregate of 60 milliseconds) during the remainder of the 10 seconds period. The aggregate duration of control signals will not count quiet periods in between transmissions.

#### For 40MHz

Parameter	Test Result	Limit
	Type 1	
Test Channel (MHz)	5510 MHz	-
Channel Move Time (ms)	480	< 10s
Intermittent Control Signals (ms) (Note)	8	< 60ms
Non-Occupancy Period (min.)	$\geq 30$	$\geq 30$ min

Note: The Channel Closing Transmission Time is comprised of 200 milliseconds starting at the beginning of the Channel Move Time plus any additional intermittent control signals required to facilitate a Channel move (an aggregate of 60 milliseconds) during the remainder of the 10 seconds period. The aggregate duration of control signals will not count quiet periods in between transmissions.

### 5.2.5. Channel Move Time Plot

For 20MHz

Radar #1 Channel Move Time

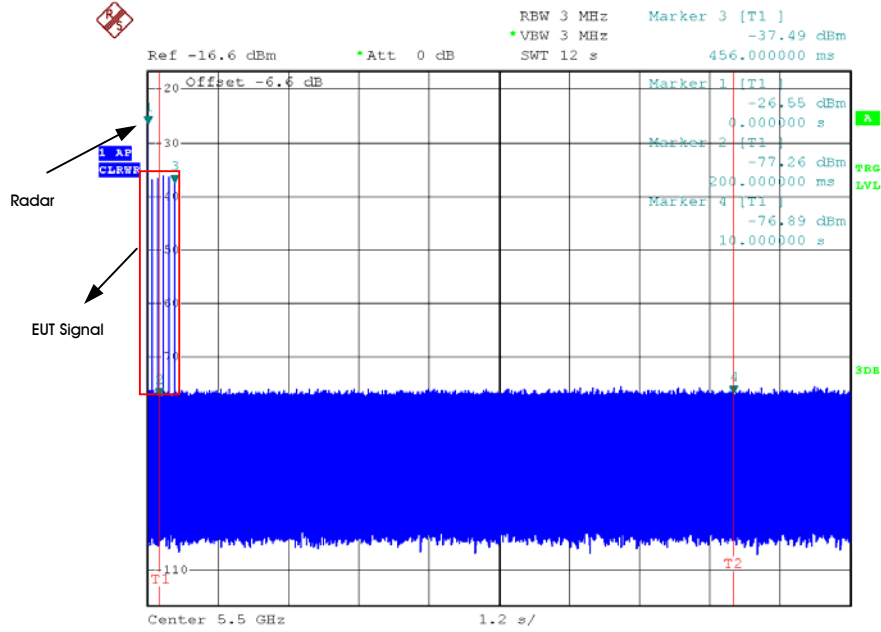

Date: 14.DEC.2011 07:26:24

For 40MHz

Radar #1 Channel Move Time

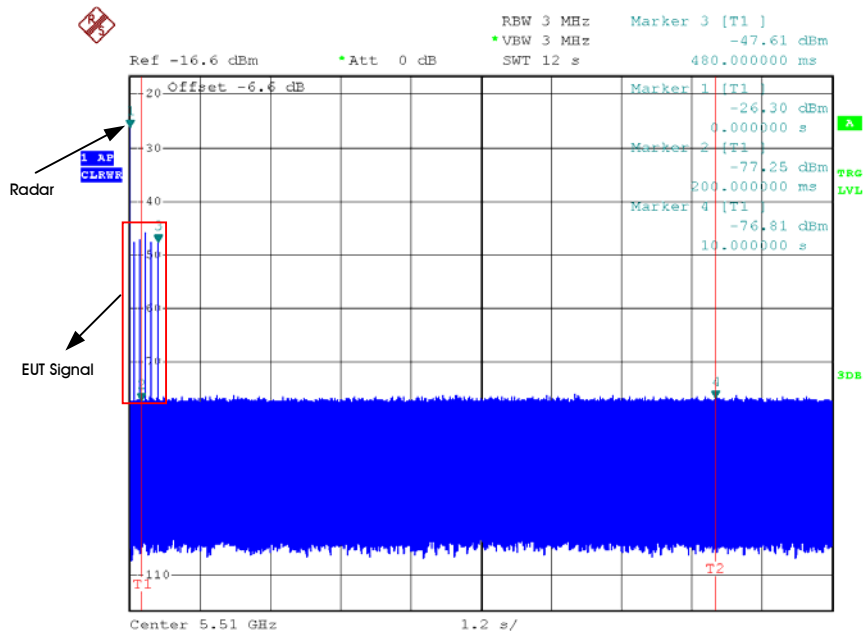

Date: 14.DEC.2011 07:45:11

### 5.2.6. Channel Closing Transmission Time Plot

For 20MHz

Radar #1 Channel Closing Transmission Time is comprised of 200 ms starting at the beginning of the Channel Move Time plus 60ms additional intermittent control signals

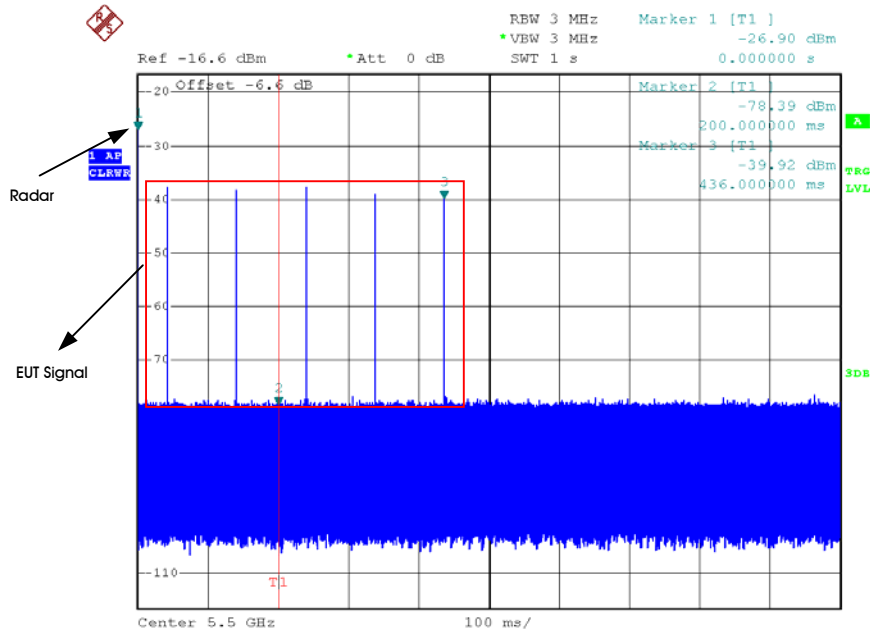

Date: 14.DEC.2011 07:34:41

Dwell is the dwell time per spectrum analyzer sampling bin.

S is the sweep time

B is the number of spectrum analyzer sampling bins

C is the intermittent control signals of Channel Closing Transmission Time

N is the number of spectrum analyzer sampling bins (intermittent control signals) showing a U-NII transmission

$$\text{Dwell (2 ms)} = \text{S (1 sec)} / \text{B (500)}$$

$$\text{C (6 ms)} = \text{N (3)} \times \text{Dwell (2 ms)}$$

For 40MHz

Radar #1 Channel Closing Transmission Time is comprised of 200 ms starting at the beginning of the Channel Move Time plus 60ms additional intermittent control signals

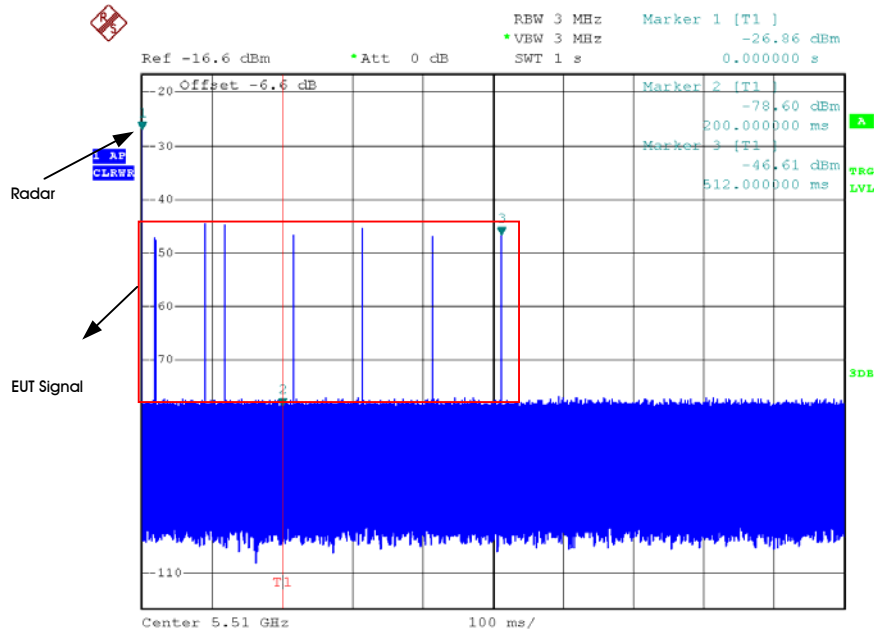

Date: 14.DEC.2011 07:49:46

Dwell is the dwell time per spectrum analyzer sampling bin.

S is the sweep time

B is the number of spectrum analyzer sampling bins

C is the intermittent control signals of Channel Closing Transmission Time

N is the number of spectrum analyzer sampling bins (intermittent control signals) showing a U-NII transmission

$$\text{Dwell (2 ms)} = S (1 \text{ sec}) / B (500)$$

$$C (8 \text{ ms}) = N (4) \times \text{Dwell (2 ms)}$$

### 5.2.7. Non-Occupancy Period Plot

For 20MHz

#### Non-Occupancy Period

During the 30 minutes observation time, UUT did not make any transmissions on a channel after a radar signal was detected on that channel by either the Channel Availability Check or the In-Service Monitoring.

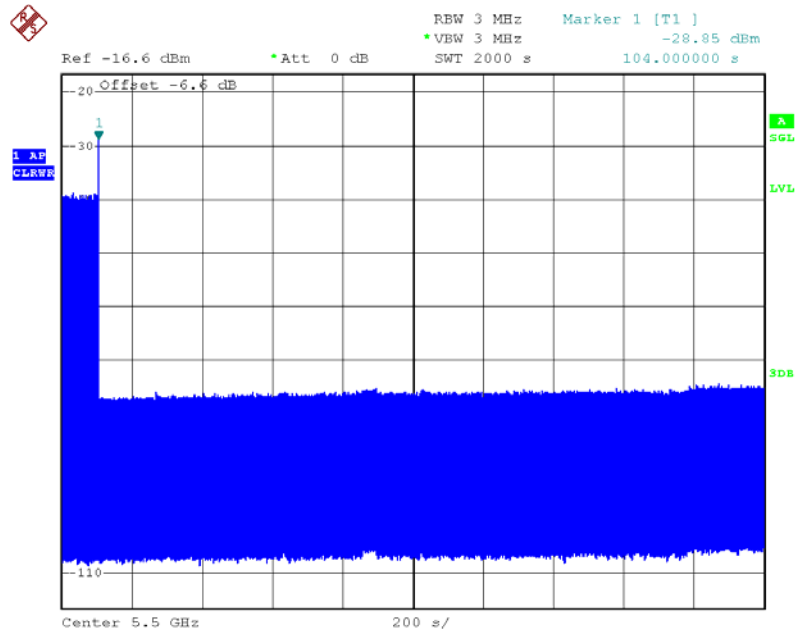

Date: 14.DEC.2011 09:16:12



### Non-associated test

Master was off.

During the 30 minutes observation time, The UUT did not make any transmissions in the DFS band after UUT power up.

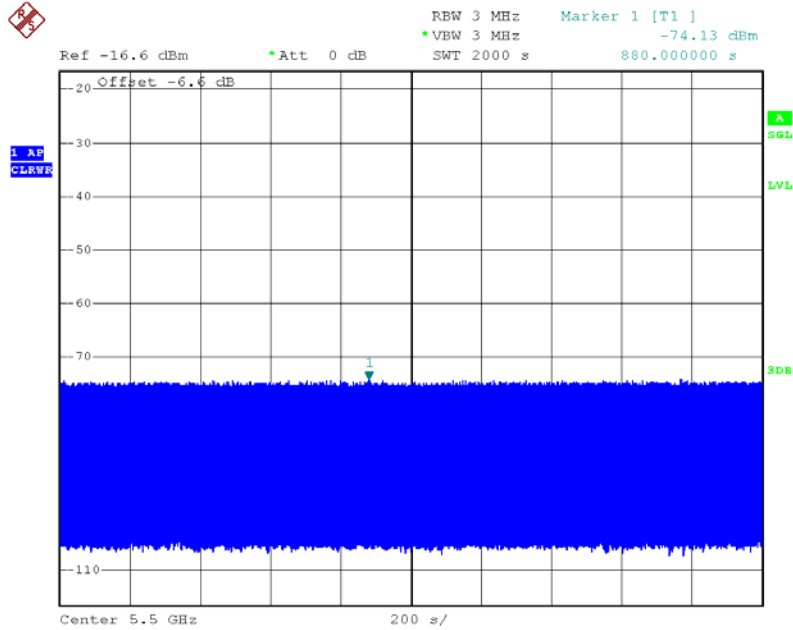

Date: 14.DEC.2011 09:50:17

**For 40MHz**

**Non-Occupancy Period**

During the 30 minutes observation time, UUT did not make any transmissions on a channel after a radar signal was detected on that channel by either the Channel Availability Check or the In-Service Monitoring.

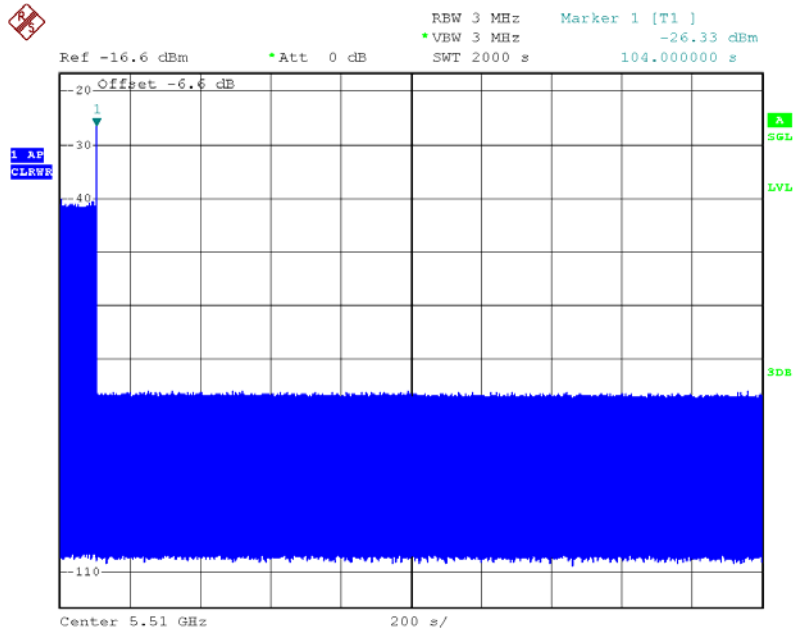

Date: 14.DEC.2011 08:30:34

### Non-associated test

Master was off.

During the 30 minutes observation time, The UUT did not make any transmissions in the DFS band after UUT power up.

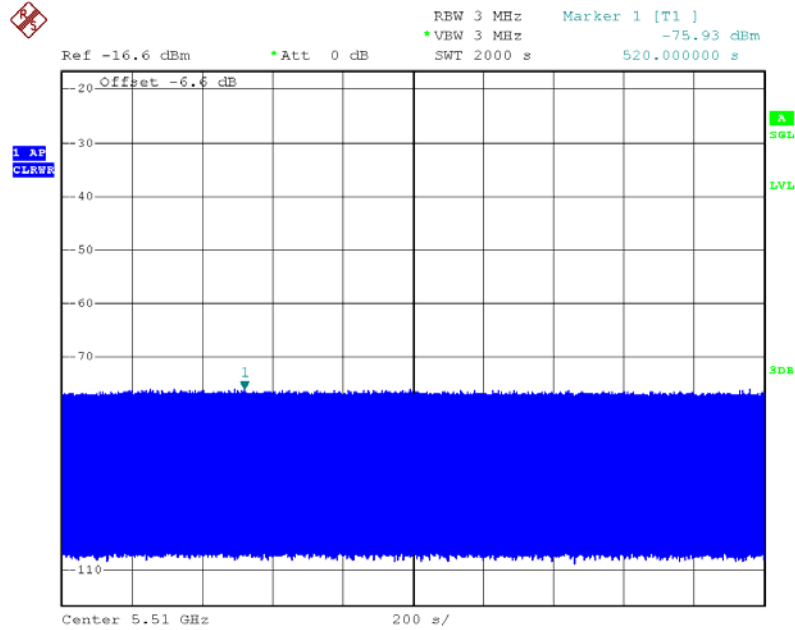

Date: 14.DEC.2011 08:33:30

## 6. LIST OF MEASURING EQUIPMENTS

Instrument	Manufacturer	Model No.	Serial No.	Characteristics	Calibration Date	Remark
Spectrum analyzer	R&S	FSV30	101026	9KHz~30GHz	Jul. 27, 2011	Conducted (TH01-CB)
Temp. and Humidity Chamber	Ten Billion	TTH-D3SP	TBN-931011	-30~100 degree	May 20, 2011	Conducted (TH01-CB)
Thermo-Hygro Meter	N/A	HC 520	#1	15~70 degree	Nov. 02, 2011	Conducted (TH01-CB)
RF Power Divider	HP	11636A	00306	2GHz ~ 18GHz	N/A	Conducted (TH01-CB)
RF Power Splitter	Anaren	44100	1839	2GHz ~ 18GHz	N/A	Conducted (TH01-CB)
RF Power Splitter	Anaren	42100	17930	2GHz ~ 18GHz	N/A	Conducted (TH01-CB)
Signal generator	R&S	SMU200A	102782	10MHz-40GHz	Jun. 07, 2011	Conducted (TH01-CB)
Horn Antenna	COM-POWER	AH-118	071187	1GHz – 18GHz	Mar. 18, 2011	Conducted (TH01-CB)
Horn Antenna	COM-POWER	AH-118	071042	1GHz – 18GHz	Nov. 01, 2011	Radiation (TH01-CB)
RF Cable-high	Woken	High Cable-7	-	1 GHz – 26.5 GHz	Nov. 17, 2011	Conducted (TH01-CB)
RF Cable-high	Woken	High Cable-8	-	1 GHz – 26.5 GHz	Nov. 17, 2011	Conducted (TH01-CB)
RF Cable-high	Woken	High Cable-9	-	1 GHz – 26.5 GHz	Nov. 17, 2011	Conducted (TH01-CB)
RF Cable-high	Woken	High Cable-10	-	1 GHz – 26.5 GHz	Nov. 17, 2011	Conducted (TH01-CB)
RF Cable-high	Woken	High Cable-11	-	1 GHz – 26.5 GHz	Nov. 17, 2011	Conducted (TH01-CB)
RF Cable-high	Woken	High Cable-12	-	1 GHz – 26.5 GHz	Nov. 17, 2011	Conducted (TH01-CB)
RF Cable-high	Woken	High Cable-13	-	1 GHz – 26.5 GHz	Nov. 17, 2011	Conducted (TH01-CB)

Note: Calibration Interval of instruments listed above is one year.

\* Calibration Interval of instruments listed above is two year.

NCR means Non-Calibration required.

## 7. TEST LOCATION

SHIJR	ADD : 6Fl., No. 106, Sec. 1, Shintai 5th Rd., Shijr City, Taipei, Taiwan 221, R.O.C. TEL : 886-2-2696-2468 FAX : 886-2-2696-2255
HWA YA	ADD : No. 52, Hwa Ya 1st Rd., Kwei-Shan Hsiang, Tao Yuan Hsien, Taiwan, R.O.C. TEL : 886-3-327-3456 FAX : 886-3-318-0055
LINKOU	ADD : No. 30-2, Dingfu Tsuen, Linkou Shiang, Taipei, Taiwan 244, R.O.C TEL : 886-2-2601-1640 FAX : 886-2-2601-1695
DUNGHU	ADD : No. 3, Lane 238, Kangle St., Neihu Chiu, Taipei, Taiwan 114, R.O.C. TEL : 886-2-2631-4739 FAX : 886-2-2631-9740
JUNGHE	ADD : 7Fl., No. 758, Jungjeng Rd., Junghe City, Taipei, Taiwan 235, R.O.C. TEL : 886-2-8227-2020 FAX : 886-2-8227-2626
NEIHU	ADD : 4Fl., No. 339, Hsin Hu 2 <sup>nd</sup> Rd., Taipei 114, Taiwan, R.O.C. TEL : 886-2-2794-8886 FAX : 886-2-2794-9777
JHUBEI	ADD : No.8, Lane 724, Bo-ai St., Jhubei City, HsinChu County 302, Taiwan, R.O.C. TEL : 886-3-656-9065 FAX : 886-3-656-9085

## 8. TAF CERTIFICATE OF ACCREDITATION



Certificate No. : L1190-110702

財團法人全國認證基金會  
Taiwan Accreditation Foundation

### Certificate of Accreditation

This is to certify that

**Sporton International Inc.**  
**EMC & Wireless Communications Laboratory**  
No.52, Hwa Ya 1st Road, Hwa Ya Technology Park, Kwei-Shan Hsiang, Tao Yuan Hsien,  
Taiwan, R.O.C.

**is accredited in respect of laboratory**

<b>Accreditation Criteria</b>	: ISO/IEC 17025:2005
<b>Accreditation Number</b>	: 1190
<b>Originally Accredited</b>	: December 15, 2003
<b>Effective Period</b>	: January 10, 2010 to January 09, 2013
<b>Accredited Scope</b>	: Testing Field, see described in the Appendix
<b>Specific Accreditation Program</b>	: Accreditation Program for Designated Testing Laboratory for Commodities Inspection Accreditation Program for Telecommunication Equipment Testing Laboratory Accreditation Program for BSMI Mutual Recognition Arrangement with Foreign Authorities

  
Jay-San Chen  
President, Taiwan Accreditation Foundation  
Date : July 02, 2011

P1, total 22 pages

The Appendix forms an integral part of this Certificate, which shall be invalid when use without the Appendix