



SPORTON International Inc.

No. 52, Hwa Ya 1st Rd., Kwei-Shan Hsiang, TaoYuan Hsien, Taiwan, R.O.C.
Ph: 886-3-327-3456 / FAX: 886-3-327-0973 / www.sporton.com.tw

FCC RADIO TEST REPORT

Applicant's company	Realtek Semiconductor Corp.
Applicant Address	No. 2, Innovation Road II, Hsinchu Science Park, Hsinchu 300, Taiwan
FCC ID	TX2RTL8188CUB8
Manufacturer's company	Realtek Semiconductor Corp.
Manufacturer Address	No. 2, Innovation Road II, Hsinchu Science Park, Hsinchu 300, Taiwan

Product Name	802.11b/g/n RTL8188CUS Slim Combo Card
Brand Name	Realtek
Model Name	RTL8188CUB8
Test Rule	47 CFR FCC Part 15 Subpart C § 15.247
Test Freq. Range	2400 ~ 2483.5MHz
Received Date	Sep. 30, 2010
Final Test Date	Oct. 30, 2010
Submission Type	Original Equipment

Statement

Test result included in this report is for the IEEE 802.11n and IEEE 802.11b/g part of the product.

The test result in this report refers exclusively to the presented test model / sample.

Without written approval of SPORTON International Inc., the test report shall not be reproduced except in full.

The measurements and test results shown in this test report were made in accordance with the procedures and found in compliance with the limit given in **ANSI C63.4-2003** and **47 CFR FCC Part 15 Subpart C**.

The test equipment used to perform the test is calibrated and traceable to NML/ROC.



Table of Contents

1. CERTIFICATE OF COMPLIANCE	1
2. SUMMARY OF THE TEST RESULT	2
3. GENERAL INFORMATION	3
3.1. Product Details.....	3
3.2. Accessories.....	5
3.3. Table for Filed Antenna.....	5
3.4. Table for Carrier Frequencies	6
3.5. Table for Test Modes.....	7
3.6. Table for Testing Locations.....	9
3.7. Table for Supporting Units	9
3.8. Table for Parameters of Test Software Setting	10
3.9. Test Configurations	12
4. TEST RESULT	15
4.1. AC Power Line Conducted Emissions Measurement.....	15
4.2. Conducted Peak Output Power Measurement.....	25
4.3. Power Spectral Density Measurement	34
4.4. 6dB Spectrum Bandwidth Measurement	55
4.5. Radiated Emissions Measurement	76
4.6. Band Edge Emissions Measurement	136
4.7. Antenna Requirements	169
5. LIST OF MEASURING EQUIPMENTS	170
6. TEST LOCATION.....	172
7. TAF CERTIFICATE OF ACCREDITATION	173
APPENDIX A. PHOTOGRAPHS OF EUT.....	A1 ~ A20
APPENDIX B. TEST PHOTOS.....	B1 ~ B17
APPENDIX C. MAXIMUM PERMISSIBLE EXPOSURE.....	C1 ~C5
APPENDIX D. CO-LOCATION REPORT	

History of This Test Report

Original Issue Date: Nov. 01, 2010

Report No.: FR000635AA

- No additional attachment.
- Additional attachment were issued as following record:

Attachment No.	Issue Date	Description

1. CERTIFICATE OF COMPLIANCE

Product Name : 802.11b/g/n RTL8188CUS Slim Combo Card
Brand Name : Realtek
Model Name : RTL8188CUB8
Applicant : Realtek Semiconductor Corp.
Test Rule Part(s) : 47 CFR FCC Part 15 Subpart C § 15.247

Sporton International as requested by the applicant to evaluate the EMC performance of the product sample received on Sep. 30, 2010 would like to declare that the tested sample has been evaluated and found to be in compliance with the tested rule parts. The data recorded as well as the test configuration specified is true and accurate for showing the sample's EMC nature.

Jordan Hsiao 2010.11.11

Jordan Hsiao

SPORTON INTERNATIONAL INC.

2. SUMMARY OF THE TEST RESULT

Applied Standard: 47 CFR FCC Part 15 Subpart C				
Part	Rule Section	Description of Test	Result	Under Limit
4.1	15.207	AC Power Line Conducted Emissions	Complies	8.35 dB
4.2	15.247(b)(3)	Conducted Peak Output Power	Complies	3.60 dB
4.3	15.247(e)	Power Spectral Density	Complies	18.17 dB
4.4	15.247(a)(2)	6dB Spectrum Bandwidth	Complies	-
4.5	15.247(d)	Radiated Emissions	Complies	2.50 dB
4.6	15.247(d)	Band Edge Emissions	Complies	1.27 dB
4.7	15.203	Antenna Requirements	Complies	-

Test Items	Uncertainty	Remark
AC Power Line Conducted Emissions	±2.3dB	Confidence levels of 95%
Maximum Conducted Output Power	±0.8dB	Confidence levels of 95%
Power Spectral Density	±0.5dB	Confidence levels of 95%
6dB Spectrum Bandwidth	±8.5×10 ⁻⁸	Confidence levels of 95%
Radiated Emissions (9kHz~30MHz)	±0.8dB	Confidence levels of 95%
Radiated Emissions (30MHz~1000MHz)	±1.9dB	Confidence levels of 95%
Radiated / Band Edge Emissions (1GHz~18GHz)	±1.9dB	Confidence levels of 95%
Radiated Emissions (18GHz~40GHz)	±1.9dB	Confidence levels of 95%
Temperature	±0.7°C	Confidence levels of 95%
Humidity	±3.2%	Confidence levels of 95%
DC / AC Power Source	±1.4%	Confidence levels of 95%

3. GENERAL INFORMATION

3.1. Product Details

IEEE 802.11n

Items	Description
Product Type	WLAN (1TX, 1RX)
Radio Type	Intentional Transceiver
Power Type	From Host System
Modulation	see the below table for IEEE 802.11n
Data Modulation	OFDM (BPSK / QPSK / 16QAM / 64QAM)
Data Rate (Mbps)	see the below table for IEEE 802.11n
Frequency Range	2400 ~ 2483.5MHz
Channel Number	11 for 20MHz bandwidth ; 7 for 40MHz bandwidth
Channel Band Width (99%)	MCS0 (20MHz): 17.68 MHz ; MCS0 (40MHz): 36.08 MHz
Conducted Output Power	MCS0 (20MHz): 26.23 dBm ; MCS0 (40MHz): 25.18 dBm
Carrier Frequencies	Please refer to section 3.4
Antenna	Please refer to section 3.3

IEEE 802.11b/g

Items	Description
Product Type	WLAN (1TX, 1RX)
Radio Type	Intentional Transceiver
Power Type	From Host System
Modulation	DSSS for IEEE 802.11b ; OFDM for IEEE 802.11g
Data Modulation	DSSS (BPSK / QPSK / CCK) ; OFDM (BPSK / QPSK / 16QAM / 64QAM)
Data Rate (Mbps)	DSSS (1/ 2/ 5.5/11) ; OFDM (6/9/12/18/24/36/48/54)
Frequency Range	2400 ~ 2483.5MHz
Channel Number	11
Channel Band Width (99%)	11b: 15.04 MHz ; 11g: 16.52 MHz
Conducted Output Power	11b: 21.99 dBm ; 11g: 26.40 dBm
Carrier Frequencies	Please refer to section 3.4
Antenna	Please refer to section 3.3

Antenna & Band width

Antenna	Single (TX)	
	20 MHz	40 MHz
Band width Mode		
IEEE 802.11b	V	X
IEEE 802.11g	V	X
IEEE 802.11n	V	V

IEEE 802.11n spec

MCS Index	Nss	Modulation	R	NBPCS	NCBPS		NDBPS		Datarate(Mbps)			
					20MHz	40MHz	20MHz	40MHz	800nsGI		400nsGI	
									20MHz	40MHz	20MHz	40MHz
0	1	BPSK	1/2	1	52	108	26	54	6.5	13.5	7.200	15
1	1	QPSK	1/2	2	104	216	52	108	13.0	27.0	14.400	30
2	1	QPSK	3/4	2	104	216	78	162	19.5	40.5	21.700	45
3	1	16-QAM	1/2	4	208	432	104	216	26.0	54.0	28.900	60
4	1	16-QAM	3/4	4	208	432	156	324	39.0	81.0	43.300	90
5	1	64-QAM	2/3	6	312	648	208	432	52.0	108.0	57.800	120
6	1	64-QAM	3/4	6	312	648	234	486	58.5	121.5	65.000	135
7	1	64-QAM	5/6	6	312	648	260	540	65.0	135.0	72.200	150
8	2	BPSK	1/2	1	104	216	52	108	13.0	27.0	14.444	30
9	2	QPSK	1/2	2	208	432	104	216	26.0	54.0	28.889	60
10	2	QPSK	3/4	2	208	432	156	324	39.0	81.0	43.333	90
11	2	16-QAM	1/2	4	416	864	208	432	52.0	108.0	57.778	120
12	2	16-QAM	3/4	4	416	864	312	648	78.0	162.0	86.667	180
13	2	64-QAM	2/3	6	624	1296	416	864	104.0	216.0	115.556	240
14	2	64-QAM	3/4	6	624	1296	468	972	117.0	243.0	130.000	270
15	2	64-QAM	5/6	6	624	1296	520	1080	130.0	270.0	144.444	300

Symbol	Explanation
NSS	Number of spatial streams
R	Code rate
NBPCS	Number of coded bits per single carrier
NCBPS	Number of coded bits per symbol
NDBPS	Number of data bits per symbol
GI	guard interval

3.2. Accessories

N/A

3.3. Table for Filed Antenna

<For WLAN Function>:

Ant.	Brand	Model Name	Antenna Type	Connector	Antenna Gain (dBi)	Remark
A	REALTEK	RTL8188CUB8/ RTL8188CUS	Printed Antenna	N/A	2.72	TX/RX
B	WNC	DQ661500301	PIFA Antenna	I-PEX	3.90	TX/RX

<For Bluetooth Function>:

Ant.	Brand	Model Name	Antenna Type	Connector	Antenna Gain (dBi)	Remark
A	REALTEK	RTL8188CUB8/ RTL8188CUS	Printed Antenna	N/A	0.08	TX/RX

Note:

There are two types of EUT; it would collocate with two sets of antenna.

Ant. A or Ant. B can be used as transmitting/ receiving antenna.

The antenna position is illustrated as below:

<For Ant. A (Printed Antenna) Position>:

The front side of EUT



Ant. A (for WLAN function)

The rear side of EUT



Ant. A (for Bluetooth function)

<For Ant. B (PIFA Antenna) Position>:

The front side of EUT



Ant. B (for WLAN function)

3.4. Table for Carrier Frequencies

There are two bandwidth systems for IEEE 802.11n.

For both 20MHz bandwidth systems, use Channel 1~Channel 11.

For both 40MHz bandwidth systems, use Channel 3~Channel 9.

Frequency Band	Channel No.	Frequency	Channel No.	Frequency
2400~2483.5MHz	1	2412 MHz	7	2442 MHz
	2	2417 MHz	8	2447 MHz
	3	2422 MHz	9	2452 MHz
	4	2427 MHz	10	2457 MHz
	5	2432 MHz	11	2462 MHz
	6	2437 MHz	-	-

3.5. Table for Test Modes

Preliminary tests were performed in different data rate to find the worst radiated emission. The data rate shown in the table below is the worst-case rate with respect to the specific test item. Investigation has been done on all the possible configurations for searching the worst cases. The following table is a list of the test modes shown in this test report.

Test Items	Mode	Data Rate	Channel	Antenna
AC Power Line Conducted Emissions	Normal Link	-	-	A, B
Conducted Peak Output Power	MCS0/20MHz	6.5 Mbps	1/6/11	A, B
	MCS0/40MHz	13.5 Mbps	3/6/9	A, B
	11b/BPSK	1 Mbps	1/6/11	A, B
	11g/BPSK	6 Mbps	1/6/11	A, B
Power Spectral Density 6dB Spectrum Bandwidth	MCS0/20MHz	6.5 Mbps	1/6/11	A, B
	MCS0/40MHz	13.5 Mbps	3/6/9	A, B
	11b/BPSK	1 Mbps	1/6/11	A, B
	11g/BPSK	6 Mbps	1/6/11	A, B
Radiated Emissions 9kHz~1GHz	Normal Link	-	-	A, B
Radiated Emissions 1GHz~10 th Harmonic	MCS0/20MHz	6.5 Mbps	1/6/11	A, B
	MCS0/40MHz	13.5 Mbps	3/6/9	A, B
	11b/BPSK	1 Mbps	1/6/11	A, B
	11g/BPSK	6 Mbps	1/6/11	A, B
Band Edge Emissions	MCS0/20MHz	6.5 Mbps	1/11	A, B
	MCS0/40MHz	13.5 Mbps	3/9	A, B
	11b/BPSK	1 Mbps	1/11	A, B
	11g/BPSK	6 Mbps	1/11	A, B

Note:

All the test modes were listed as following table.

Product Description:				
There are two types of EUT; it would collocate with two sets of antenna.				
The EUT could be divided into main source and second source.				
The difference between main source and second source is the manufacture of PCBA component.				
Gist	Product Detail	WLAN Function		Bluetooth Function
		Printed Antenna (Ant. A)	PIFA Antenna (Ant. B)	Printed Antenna (Ant. A)
Conducted Emissions and Radiated Emissions Test Below 1GHz				
Main Source	Mode 1	V	-	V
	Mode 2	-	V	V
Second Source	Mode 1	V	-	V
	Mode 2	-	V	V
Radiated Emissions Test Above 1GHz and Other Tests				
Main Source	Mode 1	V	-	-
	Mode 2	-	V	-
Second Source	Mode 1	V	-	-
	Mode 2	-	V	-
MPE and Co-location Test				
Mode 1: Main Source + Wireless LAN function + Bluetooth function				
Mode 2: Second Source + Wireless LAN function + Bluetooth function				
All the test modes were tested and recorded in this report.				
Remark:				
The EUT could be applied with Bluetooth and wireless LAN function; therefore Maximum Permissible Exposure (please refer to Appendix C) and Co-location (please refer to Appendix D) tests are added for simultaneously transmit between Bluetooth and wireless LAN function.				

3.6. Table for Testing Locations

Test Site No.	Site Category	Location	FCC Reg. No.	IC File No.	VCCI Reg. No
03CH01-CB	SAC	Hsin Chu	187376	IC 4086D	-
CO01-CB	Conduction	Hsin Chu	187376	IC 4086D	-
TH01-CB	OVEN Room	Hsin Chu	-	-	-

Open Area Test Site (OATS); Semi Anechoic Chamber (SAC); Fully Anechoic Chamber (FAC).

Please refer section 6 for Test Site Address.

3.7. Table for Supporting Units

Support Unit	Brand	Model	FCC ID
Notebook	DELL	M1330	E2K4965AGNM
Notebook	DELL	D400	E2K24GBRL
Wireless AP	Planex	GW-AP54SGX	N/A
USB Fixture	-	-	N/A

3.8. Table for Parameters of Test Software Setting

During testing, Channel & Power Controlling Software provided by the customer was used to control the operating channel as well as the output power level. The RF output power selection is for the setting of RF output power expected by the customer and is going to be fixed on the firmware of the final end product.

<For Main Source – Mode 1 with Printed Antenna>:

Power Parameters of IEEE 802.11n

Test Software Version	Realtek MP 0.0022.1005.2010		
Frequency	2412 MHz	2437 MHz	2462 MHz
MCS0 20MHz	49	57	49
Frequency	2422 MHz	2437 MHz	2452 MHz
MCS0 40MHz	50	55	49

Power Parameters of IEEE 802.11b/g

Test Software Version	Realtek MP 0.0022.1005.2010		
Frequency	2412 MHz	2437 MHz	2462 MHz
IEEE 802.11b	46	50	45
IEEE 802.11g	51	57	50

<For Main Source – Mode 2 with PIFA Antenna>:

Power Parameters of IEEE 802.11n

Test Software Version	Realtek MP 0.0022.1005.2010		
Frequency	2412 MHz	2437 MHz	2462 MHz
MCS0 20MHz	51	58	50
Frequency	2422 MHz	2437 MHz	2452 MHz
MCS0 40MHz	51	57	50

Power Parameters of IEEE 802.11b/g

Test Software Version	Realtek MP 0.0022.1005.2010		
Frequency	2412 MHz	2437 MHz	2462 MHz
IEEE 802.11b	47	52	47
IEEE 802.11g	52	58	52

<For Second Source - Mode 1 with Printed Antenna>:

Power Parameters of IEEE 802.11n

Test Software Version	Realtek MP 0.0022.1005.2010		
Frequency	2412 MHz	2437 MHz	2462 MHz
MCS0 20MHz	47	55	46
Frequency	2422 MHz	2437 MHz	2452 MHz
MCS0 40MHz	48	54	47

Power Parameters of IEEE 802.11b/g

Test Software Version	Realtek MP 0.0022.1005.2010		
Frequency	2412 MHz	2437 MHz	2462 MHz
IEEE 802.11b	44	47	43
IEEE 802.11g	49	55	49

<For Second Source - Mode 2 with PIFA Antenna>:

Power Parameters of IEEE 802.11n

Test Software Version	Realtek MP 0.0022.1005.2010		
Frequency	2412 MHz	2437 MHz	2462 MHz
MCS0 20MHz	48	56	47
Frequency	2422 MHz	2437 MHz	2452 MHz
MCS0 40MHz	49	54	48

Power Parameters of IEEE 802.11b/g

Test Software Version	Realtek MP 0.0022.1005.2010		
Frequency	2412 MHz	2437 MHz	2462 MHz
IEEE 802.11b	45	47	44
IEEE 802.11g	50	56	49

During the test, "Realtek MP 0.0022.1005.2010" under WIN XP was executed the test program to control the EUT continuously transmit RF signal.

3.9. Test Configurations

3.9.1. Radiation Emissions Test Configuration

<For WLAN Function>:

Test Configuration: 9KHz~1GHz

<For Main Source, Second Source– Mode 1 with Printed Antenna>

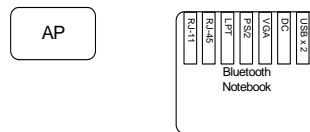
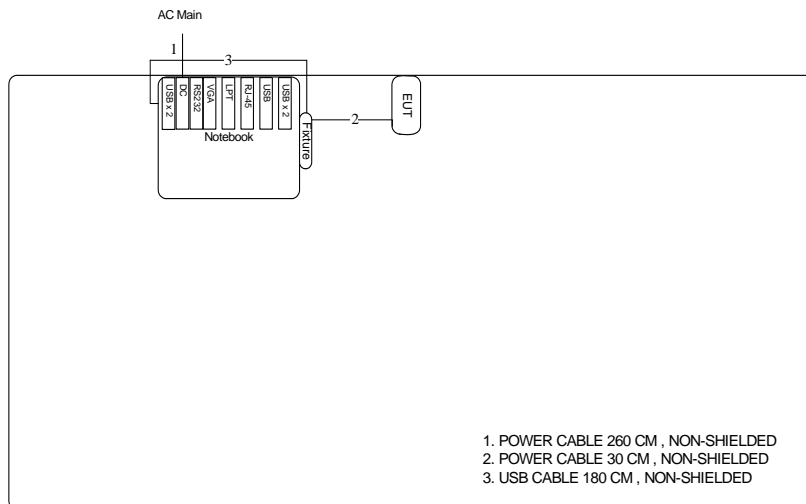

<For Main Source, Second Source– Mode 2 with PIFA Antenna>:

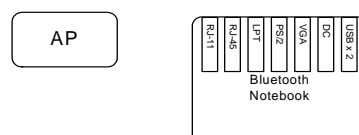
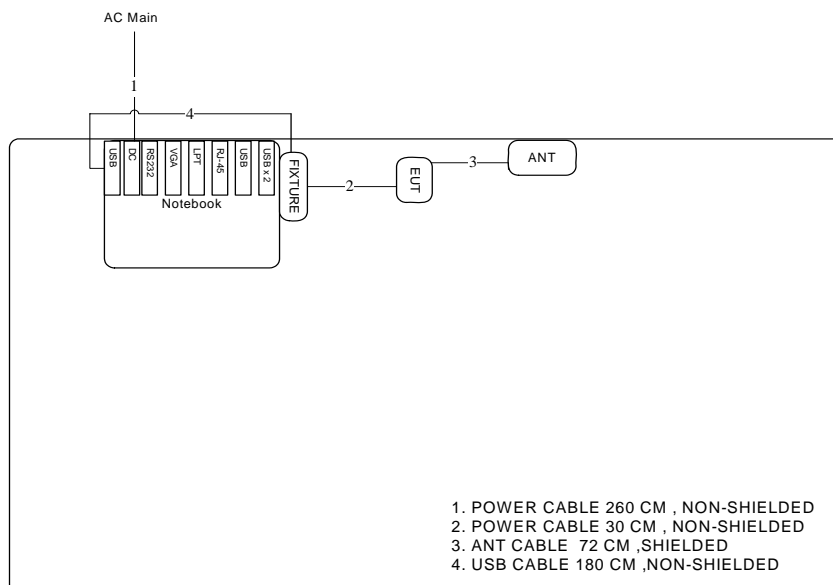

<For WLAN Function & Co-Location Function>:

Test Configuration: above 1GHz

<For Main Source, Second Source– Mode 1 with Printed Antenna>

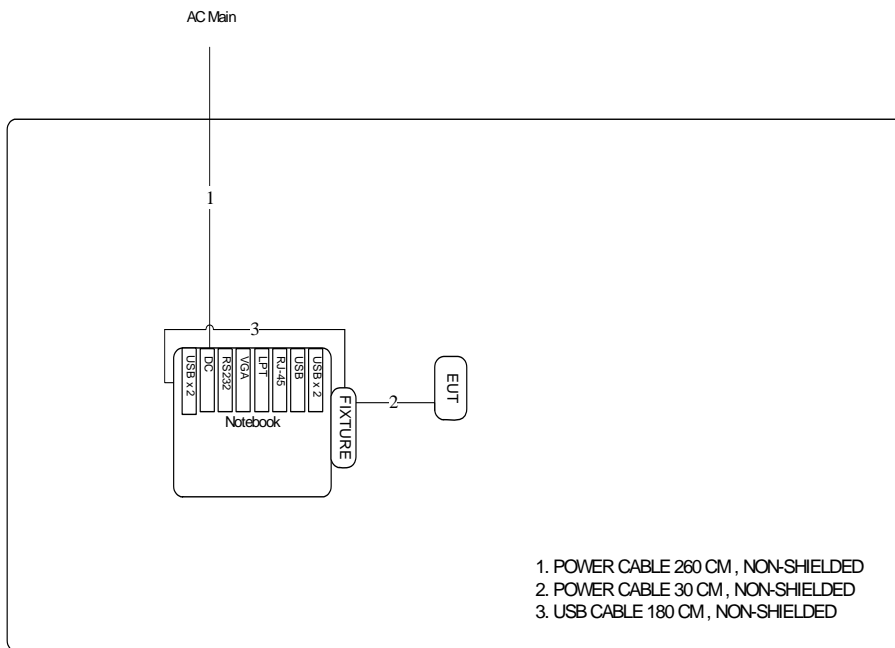

<For Main Source, Second Source– EUT 2 (Mode 2 with PIFA Antenna)>

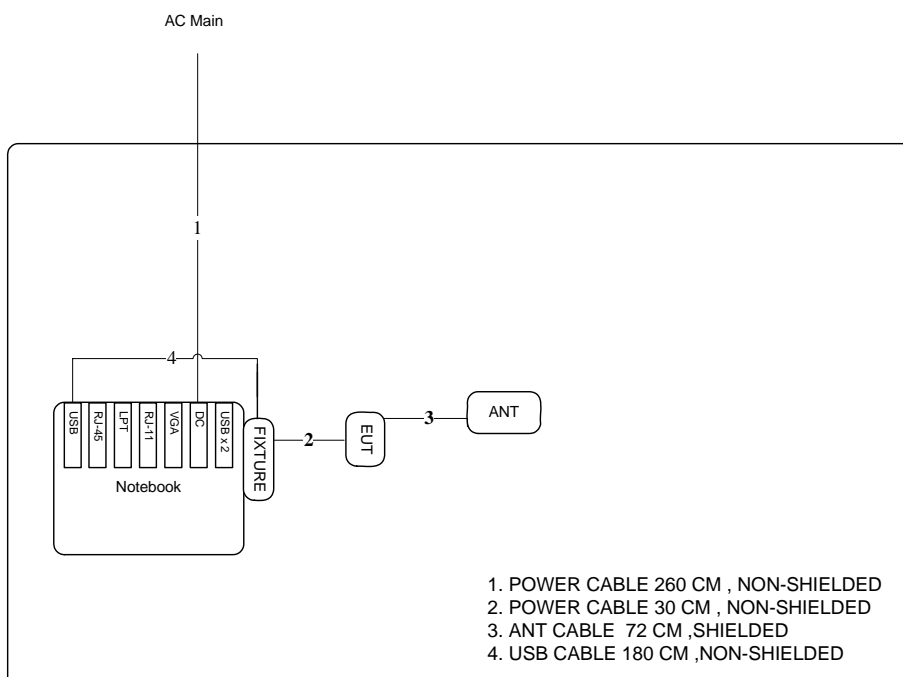

3.9.2. AC Power Line Conduction Emissions Test Configuration

<For Main Source, Second Source – Mode 1 with Printed Antenna>:

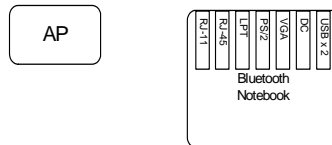
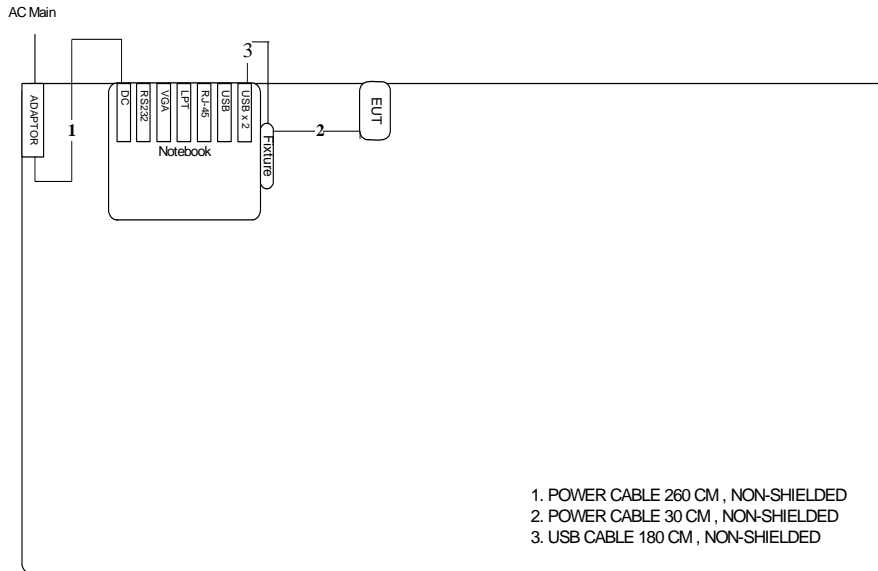

<For Main Source, Second Source – Mode 2 with PIFA Antenna>:

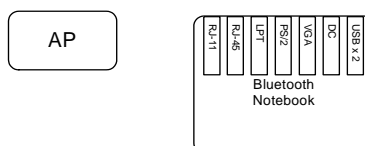
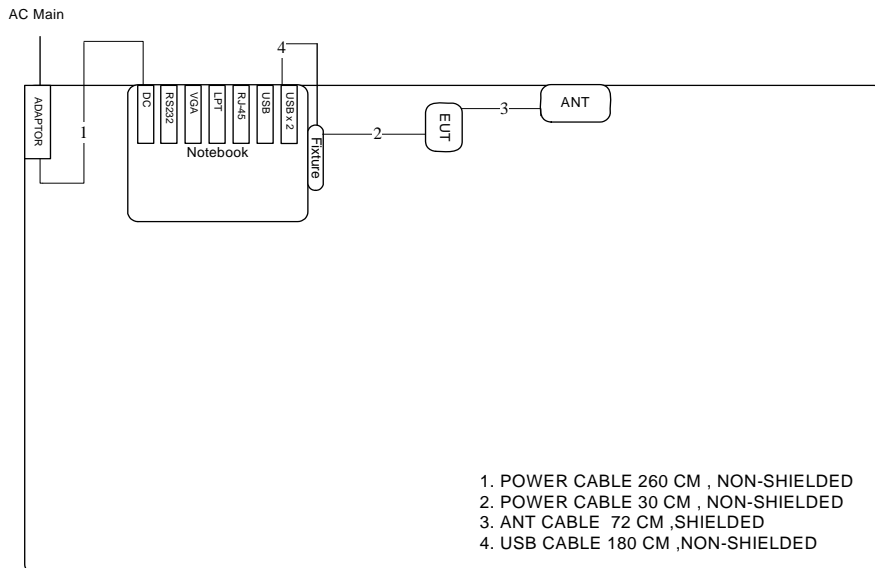

4. TEST RESULT

4.1. AC Power Line Conducted Emissions Measurement

4.1.1. Limit

For this product which is designed to be connected to the AC power line, the radio frequency voltage that is conducted back onto the AC power line on any frequency or frequencies within the band 150 kHz to 30 MHz shall not exceed below limits table.

Frequency (MHz)	QP Limit (dBuV)	AV Limit (dBuV)
0.15~0.5	66~56	56~46
0.5~5	56	46
5~30	60	50

4.1.2. Measuring Instruments and Setting

Please refer to section 5 of equipments list in this report. The following table is the setting of the receiver.

Receiver Parameters	Setting
Attenuation	10 dB
Start Frequency	0.15 MHz
Stop Frequency	30 MHz
IF Bandwidth	9 KHz

4.1.3. Test Procedures

1. Configure the EUT according to ANSI C63.4. The EUT or host of EUT has to be placed 0.4 meter far from the conducting wall of the shielding room and at least 80 centimeters from any other grounded conducting surface.
2. Connect EUT or host of EUT to the power mains through a line impedance stabilization network (LISN).
3. All the support units are connected to the other LISNs. The LISN should provide 50uH/50ohms coupling impedance.
4. The frequency range from 150 KHz to 30 MHz was searched.
5. Set the test-receiver system to Peak Detect Function and Specified Bandwidth with Maximum Hold Mode.
6. The measurement has to be done between each power line and ground at the power terminal.

4.1.4. Test Setup Layout

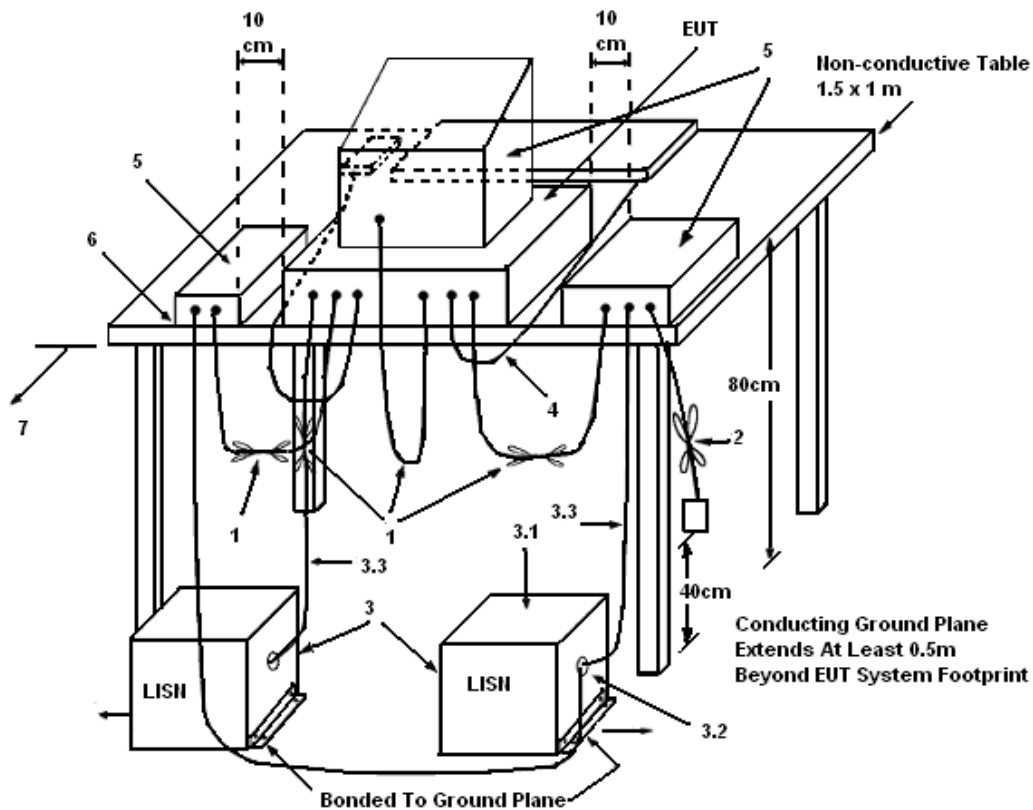

LEGEND:

- (1) Interconnecting cables that hang closer than 40 cm to the ground plane shall be folded back and forth in the center forming a bundle 30 to 40 cm long.
- (2) I/O cables that are not connected to a peripheral shall be bundled in the center. The end of the cable may be terminated, if required, using the correct terminating impedance. The overall length shall not exceed 1 m.
- (3) EUT connected to one LISN. Unused LISN measuring port connectors shall be terminated in 50 Ω. LISN can be placed on top of, or immediately beneath, reference ground plane.
 - (3.1) All other equipment powered from additional LISN(s).
 - (3.2) Multiple outlet strip can be used for multiple power cords of non-EUT equipment.
 - (3.3) LISN at least 80 cm from nearest part of EUT chassis.
- (4) Cables of hand-operated devices, such as keyboards, mice, etc., shall be placed as for normal use.
- (5) Non-EUT components of EUT system being tested.
- (6) Rear of EUT, including peripherals, shall all be aligned and flush with rear of tabletop.
- (7) Rear of tabletop shall be 40 cm removed from a vertical conducting plane that is bonded to the ground plane.

4.1.5. Test Deviation

There is no deviation with the original standard.

4.1.6. EUT Operation during Test

The EUT was placed on the test table and programmed in normal function.

4.1.7. Results of AC Power Line Conducted Emissions Measurement

<For Main Source – Mode 1 with Printed Antenna>:

Temperature	23°C	Humidity	55%
Test Engineer	Beck Wu	Phase	Line
Configuration	Normal Link		

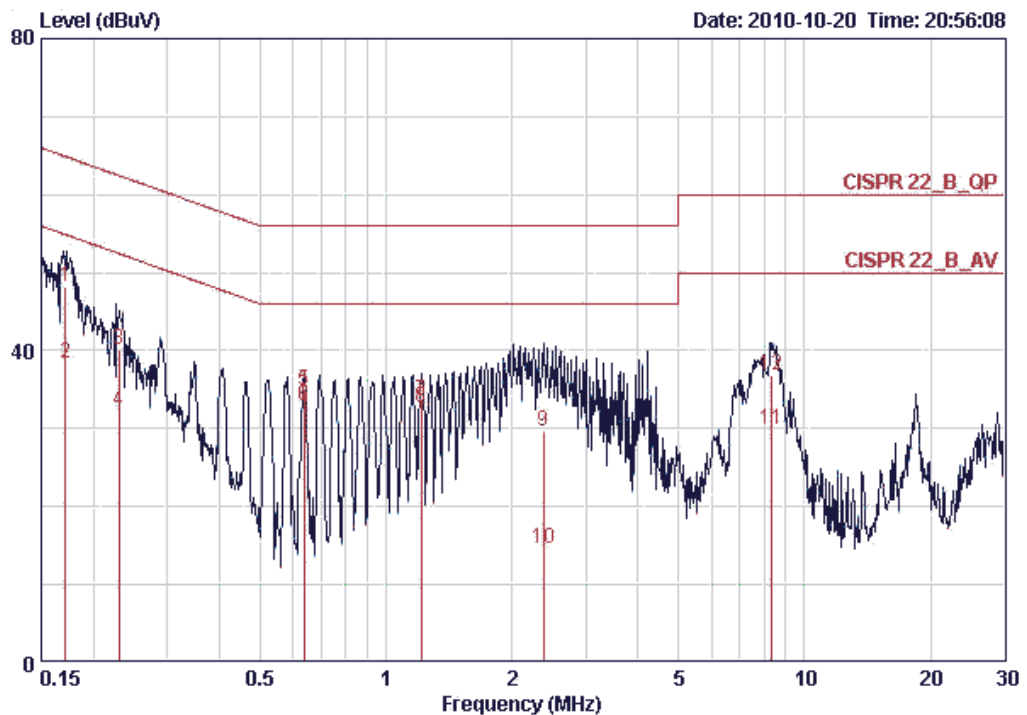

	Freq	Level	Over Limit	Limit Line	Read Level	LISN Factor	Cable Loss	Remark
	MHz	dBuV	dB	dBuV	dBuV	dB	dB	
1	0.17119	48.17	-16.73	64.90	47.91	0.06	0.20	QP
2	0.17119	38.35	-16.55	54.90	38.09	0.06	0.20	AVERAGE
3	0.23040	40.11	-22.33	62.44	39.86	0.05	0.20	QP
4	0.23040	32.33	-20.11	52.44	32.08	0.05	0.20	AVERAGE
5	0.63720	34.96	-21.04	56.00	34.73	0.03	0.20	QP
6	0.63720	32.92	-13.08	46.00	32.69	0.03	0.20	AVERAGE
7	1.216	33.66	-22.34	56.00	33.47	0.04	0.15	QP
8	1.216	32.76	-13.24	46.00	32.57	0.04	0.15	AVERAGE
9	2.384	29.74	-26.26	56.00	29.48	0.06	0.20	QP
10	2.384	14.50	-31.50	46.00	14.24	0.06	0.20	AVERAGE
11	8.323	29.78	-20.22	50.00	29.14	0.30	0.34	AVERAGE
12	8.323	36.93	-23.07	60.00	36.29	0.30	0.34	QP

Temperature	23°C	Humidity	55%
Test Engineer	Beck Wu	Phase	Neutral
Configuration	Normal Link		

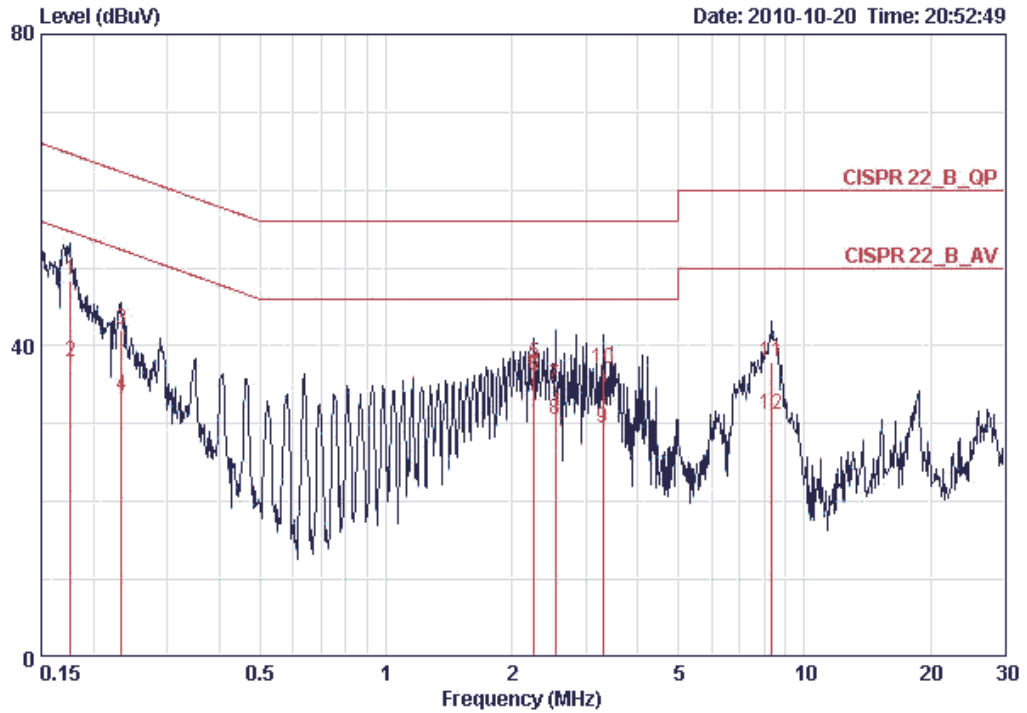

	Freq	Level	Over Limit	Limit Line	Read Level	LISN Factor	Cable Loss	Remark
	MHz	dBuV	dB	dBuV	dBuV	dB	dB	
1	0.17584	48.44	-16.24	64.68	48.15	0.09	0.20	QP
2	0.17584	37.96	-16.72	54.68	37.67	0.09	0.20	AVERAGE
3	0.23285	42.16	-20.19	62.35	41.88	0.08	0.20	QP
4	0.23285	33.56	-18.79	52.35	33.28	0.08	0.20	AVERAGE
5	2.254	37.81	-18.19	56.00	37.51	0.10	0.20	QP
6	2.254	36.12	-9.88	46.00	35.82	0.10	0.20	AVERAGE
7	2.540	34.87	-21.13	56.00	34.56	0.11	0.20	QP
8	2.540	30.43	-15.57	46.00	30.12	0.11	0.20	AVERAGE
9	3.293	29.50	-16.50	46.00	29.11	0.13	0.26	AVERAGE
10	3.293	37.06	-18.94	56.00	36.67	0.13	0.26	QP
11	8.367	37.91	-22.09	60.00	37.25	0.34	0.32	QP
12	8.367	31.22	-18.78	50.00	30.56	0.34	0.32	AVERAGE

Note:

Level = Read Level + LISN Factor + Cable Loss.

<For Main Source –Mode 2 with PIFA Antenna>:

Temperature	23°C	Humidity	55%
Test Engineer	Beck Wu	Phase	Line
Configuration	Normal Link		

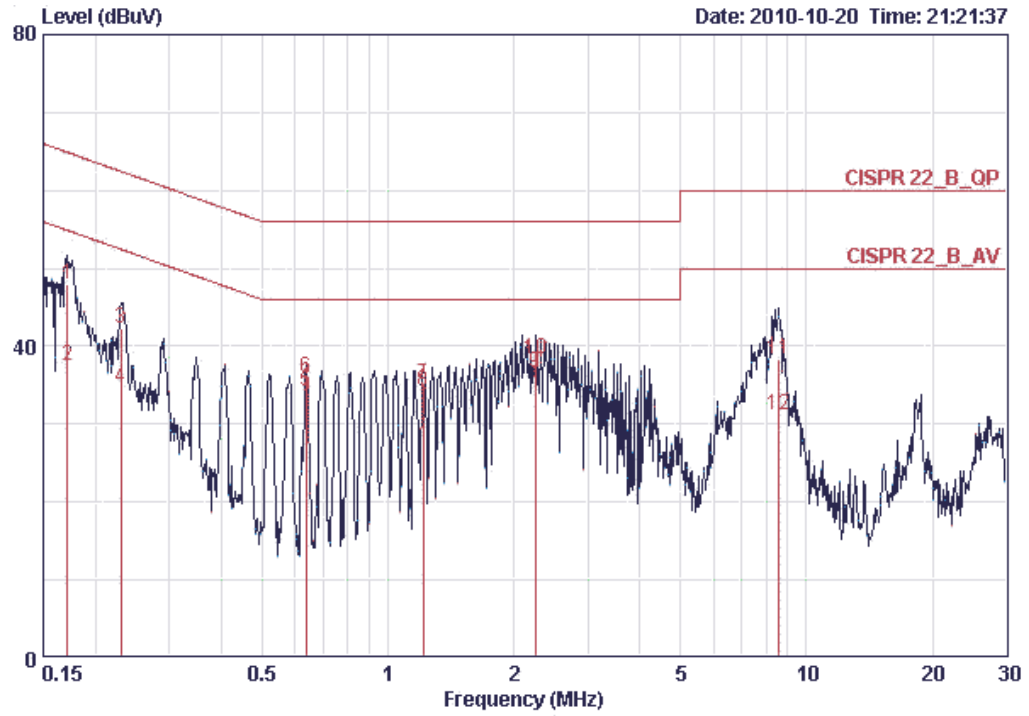

	Freq	Level	Over Limit	Limit Line	Read Level	LISN Factor	Cable Loss	Remark
	MHz	dBuV	dB	dBuV	dBuV	dB	dB	
1	0.17125	47.97	-16.93	64.90	47.71	0.06	0.20	QP
2	0.17125	37.46	-17.44	54.90	37.20	0.06	0.20	AVERAGE
3	0.23040	42.21	-20.23	62.44	41.96	0.05	0.20	QP
4	0.23040	34.59	-17.85	52.44	34.34	0.05	0.20	AVERAGE
5	0.63720	34.14	-11.86	46.00	33.91	0.03	0.20	AVERAGE
6	0.63720	35.89	-20.11	56.00	35.66	0.03	0.20	QP
7	1.216	34.99	-21.01	56.00	34.80	0.04	0.15	QP
8	1.216	34.13	-11.87	46.00	33.94	0.04	0.15	AVERAGE
9	2.254	36.71	-9.29	46.00	36.45	0.06	0.20	AVERAGE
10	2.254	38.40	-17.60	56.00	38.14	0.06	0.20	QP
11	8.592	38.39	-21.61	60.00	37.78	0.31	0.30	QP
12	8.592	31.22	-18.78	50.00	30.61	0.31	0.30	AVERAGE

Temperature	23°C	Humidity	54%
Test Engineer	Beck Wu	Phase	Neutral
Configuration	Normal Link		

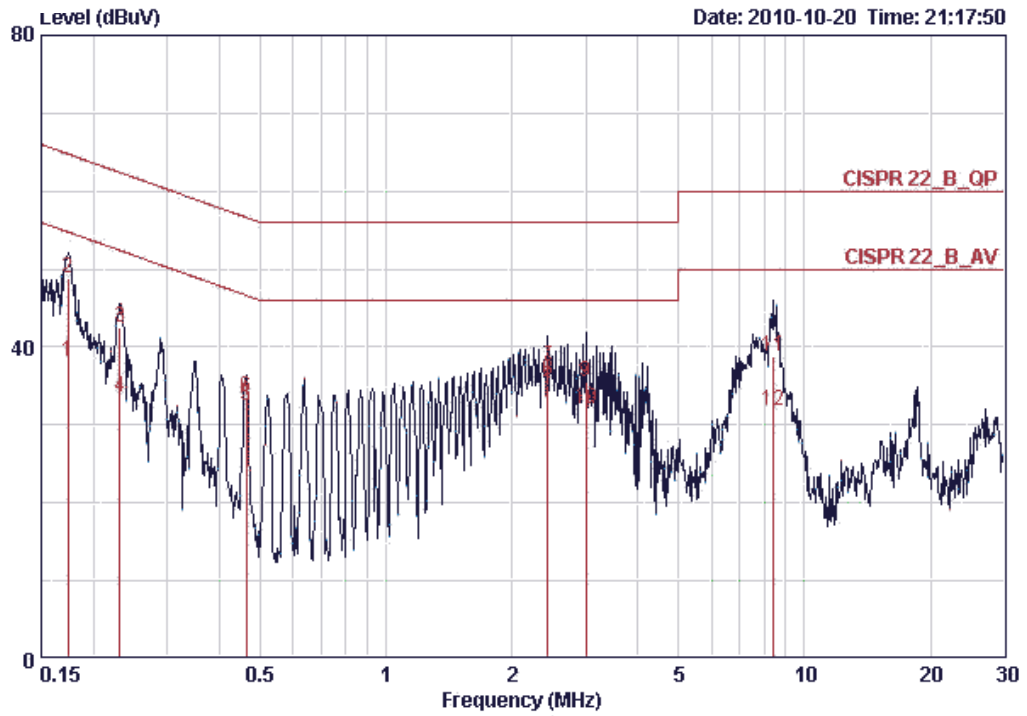

	Freq	Level	Over Limit	Limit Line	Read Level	LISN Factor	Cable Loss	Remark
	MHz	dBuV	dB	dBuV	dBuV	dB	dB	
1	0.17399	38.21	-16.56	54.77	37.92	0.09	0.20	AVERAGE
2	0.17399	48.74	-16.03	64.77	48.45	0.09	0.20	QP
3	0.23162	42.42	-19.97	62.39	42.14	0.08	0.20	QP
4	0.23162	33.56	-18.83	52.39	33.28	0.08	0.20	AVERAGE
5	0.46367	32.53	-14.10	46.63	32.26	0.07	0.20	AVERAGE
6	0.46367	33.67	-22.96	56.63	33.40	0.07	0.20	QP
7	2.430	37.43	-18.57	56.00	37.13	0.10	0.20	QP
8	2.430	35.78	-10.22	46.00	35.48	0.10	0.20	AVERAGE
9	3.009	35.50	-20.50	56.00	35.17	0.12	0.21	QP
10	3.009	32.07	-13.93	46.00	31.74	0.12	0.21	AVERAGE
11	8.412	38.70	-21.30	60.00	38.04	0.34	0.32	QP
12	8.412	31.74	-18.26	50.00	31.08	0.34	0.32	AVERAGE

Note:

Level = Read Level + LISN Factor + Cable Loss.

<For Second Source – Mode 1 with Printed Antenna>:

Temperature	23°C	Humidity	55%
Test Engineer	Beck Wu	Phase	Line
Configuration	Normal Link		

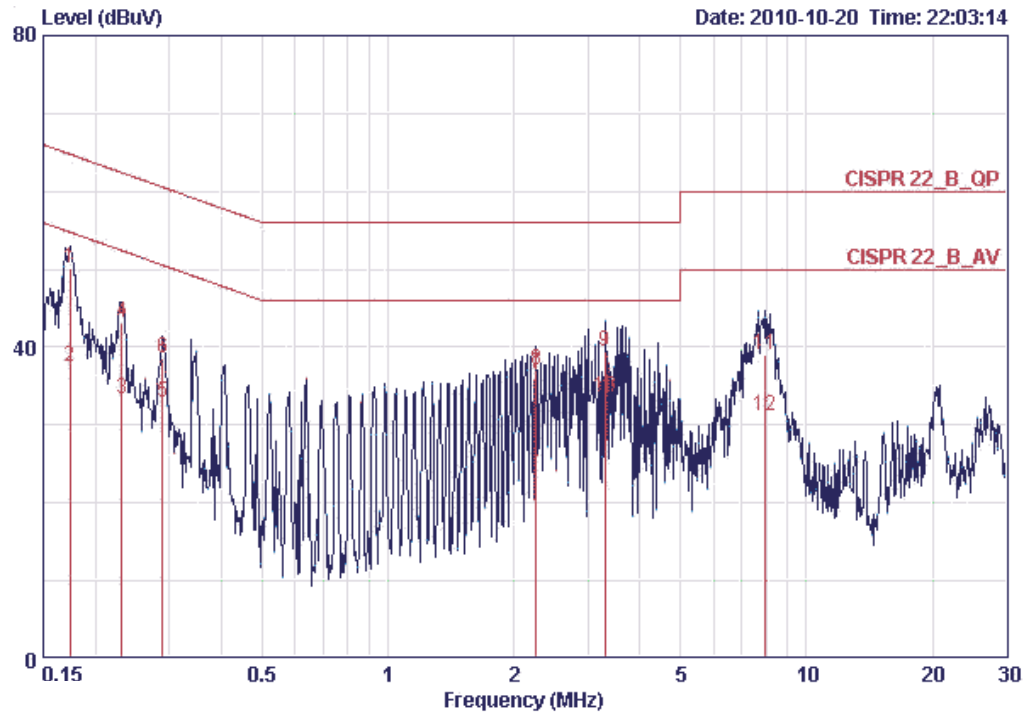

	Freq	Level	Over Limit	Limit Line	Read Level	LISN Factor	Cable Loss	Remark
	MHz	dBuV	dB	dBuV	dBuV	dB	dB	
1	0.17399	50.21	-14.56	64.77	49.95	0.06	0.20	QP
2	0.17399	37.59	-17.18	54.77	37.33	0.06	0.20	AVERAGE
3	0.23162	33.43	-18.97	52.39	33.18	0.05	0.20	AVERAGE
4	0.23162	43.12	-19.28	62.39	42.87	0.05	0.20	QP
5	0.28935	33.00	-17.54	50.54	32.76	0.04	0.20	AVERAGE
6	0.28935	38.57	-21.97	60.54	38.33	0.04	0.20	QP
7	2.255	36.65	-9.35	46.00	36.39	0.06	0.20	AVERAGE
8	2.255	37.09	-18.91	56.00	36.83	0.06	0.20	QP
9	3.293	39.48	-16.52	56.00	39.13	0.09	0.26	QP
10	3.293	33.60	-12.40	46.00	33.25	0.09	0.26	AVERAGE
11	7.935	38.93	-21.07	60.00	38.24	0.29	0.40	QP
12	7.935	31.16	-18.84	50.00	30.47	0.29	0.40	AVERAGE

Temperature	23°C	Humidity	55%
Test Engineer	Beck Wu	Phase	Neutral
Configuration	Normal Link		

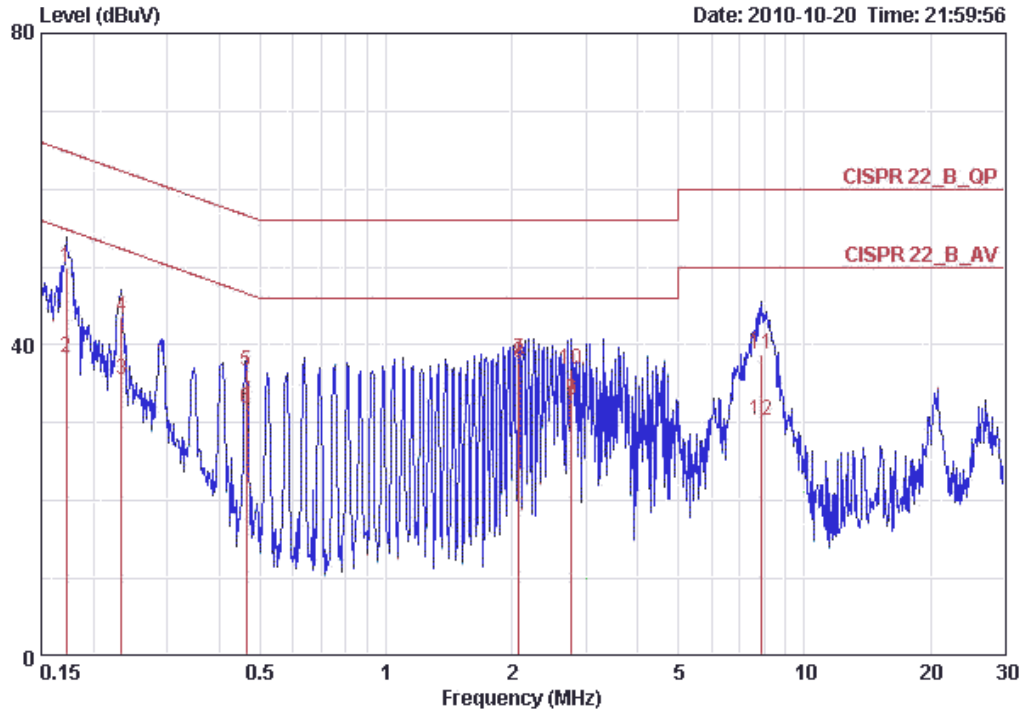

	Freq	Level	Over Limit	Limit Line	Read Level	LISN Factor	Cable Loss	Remark
	MHz	dBuV	dB	dBuV	dBuV	dB	dB	
1	0.17215	49.96	-14.89	64.86	49.67	0.09	0.20	QP
2	0.17215	38.26	-16.59	54.86	37.97	0.09	0.20	AVERAGE
3	0.23285	35.52	-16.83	52.35	35.24	0.08	0.20	AVERAGE
4	0.23285	43.49	-18.86	62.35	43.21	0.08	0.20	QP
5	0.46367	36.71	-19.92	56.63	36.44	0.07	0.20	QP
6	0.46367	31.85	-14.78	46.63	31.58	0.07	0.20	AVERAGE
7	2.080	38.14	-17.86	56.00	37.85	0.09	0.20	QP
8	2.080	37.65	-8.35	46.00	37.36	0.09	0.20	AVERAGE
9	2.774	32.97	-13.03	46.00	32.66	0.11	0.20	AVERAGE
10	2.774	36.87	-19.13	56.00	36.56	0.11	0.20	QP
11	7.852	38.71	-21.29	60.00	37.99	0.32	0.40	QP
12	7.852	30.23	-19.77	50.00	29.51	0.32	0.40	AVERAGE

Note:

Level = Read Level + LISN Factor + Cable Loss.

<For Second Source –Mode 2 with PIFA Antenna>:

Temperature	23°C	Humidity	55%
Test Engineer	Beck Wu	Phase	Line
Configuration	Normal Link		

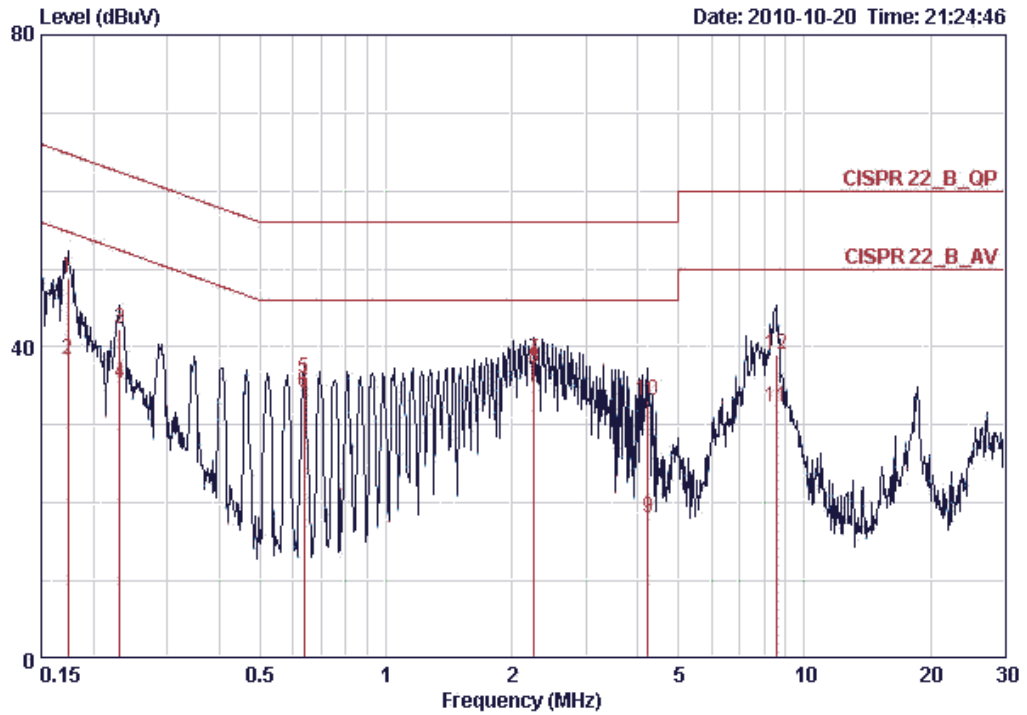

	Freq	Level	Over Limit	Limit Line	Read Level	LISN Factor	Cable Loss	Remark
	MHz	dBuV	dB	dBuV	dBuV	dB	dB	
1	0.17399	48.87	-15.90	64.77	48.61	0.06	0.20	QP
2	0.17399	38.45	-16.32	54.77	38.19	0.06	0.20	AVERAGE
3	0.23162	42.27	-20.13	62.39	42.02	0.05	0.20	QP
4	0.23162	35.25	-17.15	52.39	35.00	0.05	0.20	AVERAGE
5	0.63683	36.03	-19.97	56.00	35.80	0.03	0.20	QP
6	0.63683	34.32	-11.68	46.00	34.09	0.03	0.20	AVERAGE
7	2.255	38.44	-17.56	56.00	38.18	0.06	0.20	QP
8	2.255	37.17	-8.83	46.00	36.91	0.06	0.20	AVERAGE
9	4.224	18.17	-27.83	46.00	17.75	0.12	0.30	AVERAGE
10	4.224	33.16	-22.84	56.00	32.74	0.12	0.30	QP
11	8.546	32.34	-17.66	50.00	31.73	0.31	0.30	AVERAGE
12	8.546	39.08	-20.92	60.00	38.47	0.31	0.30	QP

Temperature	23°C	Humidity	55%
Test Engineer	Beck Wu	Phase	Neutral
Configuration	Normal Link		

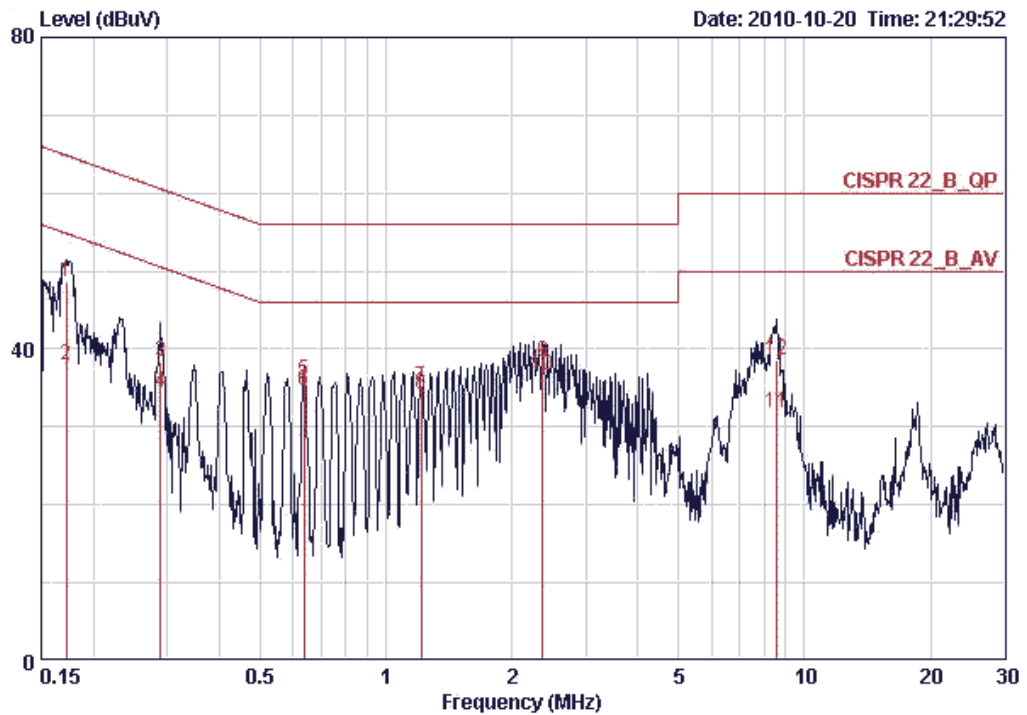

	Freq	Level	Over Limit	Limit Line	Read Level	LISN Factor	Cable Loss	Remark
	MHz	dBuV	dB	dBuV	dBuV	dB	dB	
1	0.17215	48.52	-16.33	64.86	48.23	0.09	0.20	QP
2	0.17215	37.92	-16.93	54.86	37.63	0.09	0.20	AVERAGE
3	0.28935	38.32	-22.22	60.54	38.05	0.07	0.20	QP
4	0.28935	34.46	-16.08	50.54	34.19	0.07	0.20	AVERAGE
5	0.63720	36.07	-19.93	56.00	35.80	0.07	0.20	QP
6	0.63720	34.70	-11.30	46.00	34.43	0.07	0.20	AVERAGE
7	1.216	35.05	-20.95	56.00	34.82	0.08	0.15	QP
8	1.216	34.26	-11.74	46.00	34.03	0.08	0.15	AVERAGE
9	2.371	38.44	-17.56	56.00	38.14	0.10	0.20	QP
10	2.371	36.57	-9.43	46.00	36.27	0.10	0.20	AVERAGE
11	8.546	31.89	-18.11	50.00	31.24	0.35	0.30	AVERAGE
12	8.546	38.64	-21.36	60.00	37.99	0.35	0.30	QP

Note:

Level = Read Level + LISN Factor + Cable Loss.

4.2. Conducted Peak Output Power Measurement

4.2.1. Limit

For systems using digital modulation in the 2400-2483.5MHz, the limit for peak output power is 30dBm. The limited has to be reduced by the amount in dB that the gain of the antenna exceed 6dBi. In case of point-to-point operation, the limit has to be reduced by 1dB for every 3dB that the directional gain of the antenna exceeds 6dBi.

4.2.2. Measuring Instruments and Setting

Please refer to section 5 of equipments list in this report. The following table is the setting of the spectrum analyzer.

Power Meter Parameter	Setting
Bandwidth	50MHz bandwidth is greater than the EUT emission bandwidth
Detector	Peak

4.2.3. Test Procedures

Spectrum Parameter	Setting
RF Output Power Method	<input checked="" type="checkbox"/> ANSI C63.10 clause 6.10.2.1 (a) power meter method
RF Output Power Method	<input type="checkbox"/> ANSI C63.10 clause 6.10.2.1 (b) channel integration method
RF Output Power Method	<input type="checkbox"/> ANSI C63.10 clause 6.10.3.1 Method 1 - spectral trace averaging
RF Output Power Method	<input type="checkbox"/> ANSI C63.10 clause 6.10.3.2 Method 2 - zero-span mode with trace averaging

4.2.4. Test Setup Layout

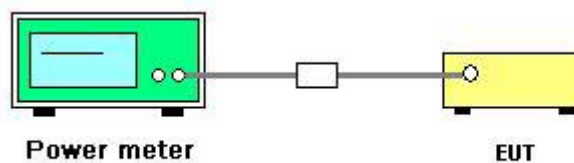

4.2.5. Test Deviation

There is no deviation with the original standard.

4.2.6. EUT Operation during Test

The EUT was programmed to be in continuously transmitting mode.

4.2.7. Test Result of Conducted Peak Output Power

<For Main Source – Mode 1 with Printed Antenna>:

Temperature	25°C	Humidity	60%
Test Engineer	Sean Ku	Configurations	IEEE 802.11n

Configuration IEEE 802.11n MCS0 20MHz

Channel	Frequency	Conducted Power (dBm)	Max. Limit (dBm)	Result
1	2412 MHz	22.26	30.00	Complies
6	2437 MHz	25.38	30.00	Complies
11	2462 MHz	22.73	30.00	Complies

Configuration IEEE 802.11n MCS0 40MHz

Channel	Frequency	Conducted Power (dBm)	Max. Limit (dBm)	Result
3	2422 MHz	22.68	30.00	Complies
6	2437 MHz	24.71	30.00	Complies
9	2452 MHz	22.10	30.00	Complies

Temperature	25°C	Humidity	60%
Test Engineer	Sean Ku	Configurations	IEEE 802.11b/g

Configuration IEEE 802.11b

Channel	Frequency	Conducted Power (dBm)	Max. Limit (dBm)	Result
1	2412 MHz	20.23	30.00	Complies
6	2437 MHz	21.54	30.00	Complies
11	2462 MHz	20.25	30.00	Complies

Configuration IEEE 802.11g

Channel	Frequency	Conducted Power (dBm)	Max. Limit (dBm)	Result
1	2412 MHz	23.72	30.00	Complies
6	2437 MHz	25.68	30.00	Complies
11	2462 MHz	23.78	30.00	Complies

<For Main Source – Mode 2 with PIFA Antenna>:

Temperature	25°C	Humidity	60%
Test Engineer	Sean Ku	Configurations	IEEE 802.11n

Configuration IEEE 802.11n MCS0 20MHz

Channel	Frequency	Conducted Power (dBm)	Max. Limit (dBm)	Result
1	2412 MHz	23.42	30.00	Complies
6	2437 MHz	26.23	30.00	Complies
11	2462 MHz	23.18	30.00	Complies

Configuration IEEE 802.11n MCS0 40MHz

Channel	Frequency	Conducted Power (dBm)	Max. Limit (dBm)	Result
3	2422 MHz	23.01	30.00	Complies
6	2437 MHz	25.08	30.00	Complies
9	2452 MHz	22.97	30.00	Complies

Temperature	25°C	Humidity	60%
Test Engineer	Sean Ku	Configurations	IEEE 802.11b/g

Configuration IEEE 802.11b

Channel	Frequency	Conducted Power (dBm)	Max. Limit (dBm)	Result
1	2412 MHz	19.83	30.00	Complies
6	2437 MHz	21.99	30.00	Complies
11	2462 MHz	19.86	30.00	Complies

Configuration IEEE 802.11g

Channel	Frequency	Conducted Power (dBm)	Max. Limit (dBm)	Result
1	2412 MHz	24.28	30.00	Complies
6	2437 MHz	26.40	30.00	Complies
11	2462 MHz	24.35	30.00	Complies

<For Second Source –Mode 1 with Printed Antenna>:

Temperature	25°C	Humidity	60%
Test Engineer	Sean Ku	Configurations	IEEE 802.11n

Configuration IEEE 802.11n MCS0 20MHz

Channel	Frequency	Conducted Power (dBm)	Max. Limit (dBm)	Result
1	2412 MHz	22.77	30.00	Complies
6	2437 MHz	25.33	30.00	Complies
11	2462 MHz	22.85	30.00	Complies

Configuration IEEE 802.11n MCS0 40MHz

Channel	Frequency	Conducted Power (dBm)	Max. Limit (dBm)	Result
3	2422 MHz	22.65	30.00	Complies
6	2437 MHz	24.88	30.00	Complies
9	2452 MHz	22.50	30.00	Complies

Temperature	25°C	Humidity	60%
Test Engineer	Sean Ku	Configurations	IEEE 802.11b/g

Configuration IEEE 802.11b

Channel	Frequency	Conducted Power (dBm)	Max. Limit (dBm)	Result
1	2412 MHz	20.22	30.00	Complies
6	2437 MHz	21.70	30.00	Complies
11	2462 MHz	20.01	30.00	Complies

Configuration IEEE 802.11g

Channel	Frequency	Conducted Power (dBm)	Max. Limit (dBm)	Result
1	2412 MHz	23.85	30.00	Complies
6	2437 MHz	25.63	30.00	Complies
11	2462 MHz	24.23	30.00	Complies

<For Second Source - Mode 2 with PIFA Antenna>:

Temperature	25°C	Humidity	60%
Test Engineer	Sean Ku	Configurations	IEEE 802.11n

Configuration IEEE 802.11n MCS0 20MHz

Channel	Frequency	Conducted Power (dBm)	Max. Limit (dBm)	Result
1	2412 MHz	23.41	30.00	Complies
6	2437 MHz	26.11	30.00	Complies
11	2462 MHz	23.28	30.00	Complies

Configuration IEEE 802.11n MCS0 40MHz

Channel	Frequency	Conducted Power (dBm)	Max. Limit (dBm)	Result
3	2422 MHz	23.23	30.00	Complies
6	2437 MHz	25.18	30.00	Complies
9	2452 MHz	23.25	30.00	Complies

Temperature	25°C	Humidity	60%
Test Engineer	Sean Ku	Configurations	IEEE 802.11b/g

Configuration IEEE 802.11b

Channel	Frequency	Conducted Power (dBm)	Max. Limit (dBm)	Result
1	2412 MHz	20.52	30.00	Complies
6	2437 MHz	21.67	30.00	Complies
11	2462 MHz	20.41	30.00	Complies

Configuration IEEE 802.11g

Channel	Frequency	Conducted Power (dBm)	Max. Limit (dBm)	Result
1	2412 MHz	24.55	30.00	Complies
6	2437 MHz	26.04	30.00	Complies
11	2462 MHz	24.23	30.00	Complies

4.3. Power Spectral Density Measurement

4.3.1. Limit

For digitally modulated systems, the power spectral density conducted from the intentional radiator to the antenna shall not be greater than 8 dBm in any 3 kHz band during any time interval of continuous transmission.

4.3.2. Measuring Instruments and Setting

Please refer to section 5 of equipments list in this report. The following table is the setting of Spectrum Analyzer.

Spectrum Parameter	Setting
Attenuation	Auto
Span Frequency	30 kHz
RB	3 kHz
VB	30 kHz
Detector	Peak

4.3.3. Test Procedures

Spectrum Parameter	Setting
Power Density Method	<input checked="" type="checkbox"/> UNII for ANSI C63.10 clause 6.11.2.3 Method 1 - peak measurement
Power Density Method	<input type="checkbox"/> UNII for ANSI C63.10 clause 6.11.2.4 Method 2 - trace averaging

4.3.4. Test Setup Layout

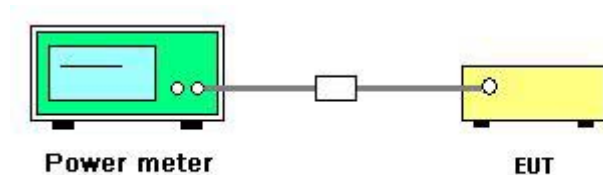

4.3.5. Test Deviation

There is no deviation with the original standard.

4.3.6. EUT Operation during Test

The EUT was programmed to be in continuously transmitting mode.

4.3.7. Test Result of Power Spectral Density

<For Main Source –Mode 1 with Printed Antenna>:

Temperature	25°C	Humidity	60%
Test Engineer	Sean Ku	Configurations	IEEE 802.11n

Configuration IEEE 802.11n MCS0 20MHz

Channel	Frequency	Power Density (dBm/3kHz)	Max. Limit (dBm/3kHz)	Result
1	2412 MHz	-14.72	8.00	Complies
6	2437 MHz	-10.43	8.00	Complies
11	2462 MHz	-14.78	8.00	Complies

Configuration IEEE 802.11n MCS0 40MHz

Channel	Frequency	Power Density (dBm/3kHz)	Max. Limit (dBm/3kHz)	Result
3	2422 MHz	-15.18	8.00	Complies
6	2437 MHz	-12.44	8.00	Complies
9	2452 MHz	-15.23	8.00	Complies

Temperature	25°C	Humidity	60%
Test Engineer	Sean Ku	Configurations	IEEE 802.11b/g

Configuration IEEE 802.11b

Channel	Frequency	Power Density (dBm/3kHz)	Max. Limit (dBm/3kHz)	Result
1	2412 MHz	-13.11	8.00	Complies
6	2437 MHz	-11.17	8.00	Complies
11	2462 MHz	-13.52	8.00	Complies

Configuration IEEE 802.11g

Channel	Frequency	Power Density (dBm/3kHz)	Max. Limit (dBm/3kHz)	Result
1	2412 MHz	-13.70	8.00	Complies
6	2437 MHz	-11.03	8.00	Complies
11	2462 MHz	-14.04	8.00	Complies

Note: All the test values were listed in the report.

For plots, only the worse case of DSSS and OFDM modulation were listed in the report.

<For Main Source – Mode 2 with PIFA Antenna>:

Temperature	25°C	Humidity	60%
Test Engineer	Sean Ku	Configurations	IEEE 802.11n

Configuration IEEE 802.11n MCS0 20MHz

Channel	Frequency	Power Density (dBm/3kHz)	Max. Limit (dBm/3kHz)	Result
1	2412 MHz	-14.27	8.00	Complies
6	2437 MHz	-10.66	8.00	Complies
11	2462 MHz	-14.59	8.00	Complies

Configuration IEEE 802.11n MCS0 40MHz

Channel	Frequency	Power Density (dBm/3kHz)	Max. Limit (dBm/3kHz)	Result
3	2422 MHz	-14.93	8.00	Complies
6	2437 MHz	-12.00	8.00	Complies
9	2452 MHz	-15.23	8.00	Complies

Temperature	25°C	Humidity	60%
Test Engineer	Sean Ku	Configurations	IEEE 802.11b/g

Configuration IEEE 802.11b

Channel	Frequency	Power Density (dBm/3kHz)	Max. Limit (dBm/3kHz)	Result
1	2412 MHz	-13.35	8.00	Complies
6	2437 MHz	-10.33	8.00	Complies
11	2462 MHz	-13.50	8.00	Complies

Configuration IEEE 802.11g

Channel	Frequency	Power Density (dBm/3kHz)	Max. Limit (dBm/3kHz)	Result
1	2412 MHz	-14.38	8.00	Complies
6	2437 MHz	-11.27	8.00	Complies
11	2462 MHz	-14.04	8.00	Complies

Note: All the test values were listed in the report.

For plots, only the worse case of DSSS and OFDM modulation were listed in the report.

<For Second Source –Mode 1 with Printed Antenna>:

Temperature	25°C	Humidity	60%
Test Engineer	Sean Ku	Configurations	IEEE 802.11n

Configuration IEEE 802.11n MCS0 20MHz

Channel	Frequency	Power Density (dBm/3kHz)	Max. Limit (dBm/3kHz)	Result
1	2412 MHz	-14.72	8.00	Complies
6	2437 MHz	-10.79	8.00	Complies
11	2462 MHz	-14.88	8.00	Complies

Configuration IEEE 802.11n MCS0 40MHz

Channel	Frequency	Power Density (dBm/3kHz)	Max. Limit (dBm/3kHz)	Result
3	2422 MHz	-14.96	8.00	Complies
6	2437 MHz	-12.26	8.00	Complies
9	2452 MHz	-15.16	8.00	Complies

Temperature	25°C	Humidity	56%
Test Engineer	Sean Ku	Configurations	IEEE 802.11b/g

Configuration IEEE 802.11b

Channel	Frequency	Power Density (dBm/3kHz)	Max. Limit (dBm/3kHz)	Result
1	2412 MHz	-13.28	8.00	Complies
6	2437 MHz	-11.46	8.00	Complies
11	2462 MHz	-13.48	8.00	Complies

Configuration IEEE 802.11g

Channel	Frequency	Power Density (dBm/3kHz)	Max. Limit (dBm/3kHz)	Result
1	2412 MHz	-14.11	8.00	Complies
6	2437 MHz	-11.41	8.00	Complies
11	2462 MHz	-14.24	8.00	Complies

Note: All the test values were listed in the report.

For plots, only the worse case of DSSS and OFDM modulation were listed in the report.

<For Second Source – Mode 2 with PIFA Antenna>:

Temperature	25°C	Humidity	56%
Test Engineer	Sean Ku	Configurations	IEEE 802.11n

Configuration IEEE 802.11n MCS0 20MHz

Channel	Frequency	Power Density (dBm/3kHz)	Max. Limit (dBm/3kHz)	Result
1	2412 MHz	-14.38	8.00	Complies
6	2437 MHz	-10.17	8.00	Complies
11	2462 MHz	-14.48	8.00	Complies

Configuration IEEE 802.11n MCS0 40MHz

Channel	Frequency	Power Density (dBm/3kHz)	Max. Limit (dBm/3kHz)	Result
3	2422 MHz	-14.60	8.00	Complies
6	2437 MHz	-11.79	8.00	Complies
9	2452 MHz	-14.90	8.00	Complies

Temperature	25°C	Humidity	60%
Test Engineer	Sean Ku	Configurations	IEEE 802.11b/g

Configuration IEEE 802.11b

Channel	Frequency	Power Density (dBm/3kHz)	Max. Limit (dBm/3kHz)	Result
1	2412 MHz	-12.77	8.00	Complies
6	2437 MHz	-11.52	8.00	Complies
11	2462 MHz	-13.00	8.00	Complies

Configuration IEEE 802.11g

Channel	Frequency	Power Density (dBm/3kHz)	Max. Limit (dBm/3kHz)	Result
1	2412 MHz	-13.80	8.00	Complies
6	2437 MHz	-10.94	8.00	Complies
11	2462 MHz	-14.02	8.00	Complies

Note: All the test values were listed in the report.

For plots, only the worse case of DSSS and OFDM modulation were listed in the report.

<For Main Source – Mode 1 with Printed Antenna>:

Power Density Plot on Configuration IEEE 802.11n MCS0 20MHz / 2412 MHz

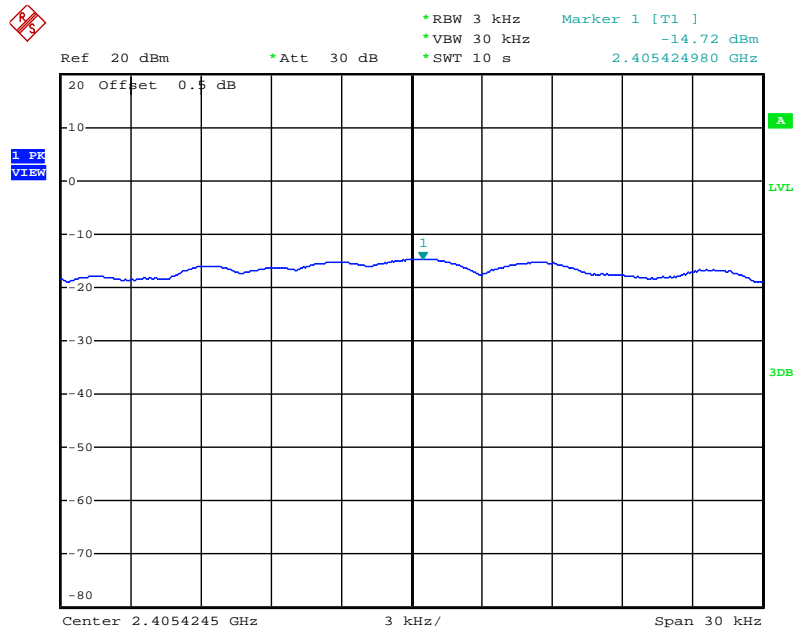

Date: 25.OCT.2010 19:58:58

Power Density Plot on Configuration IEEE 802.11n MCS0 20MHz / 2437 MHz

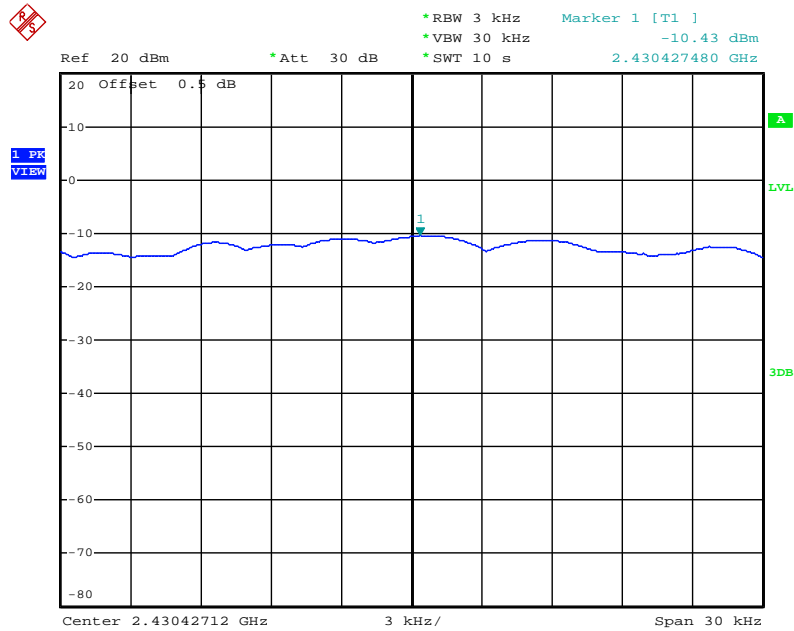

Date: 25.OCT.2010 20:01:02

Power Density Plot on Configuration IEEE 802.11n MCS0 20MHz / 2462 MHz

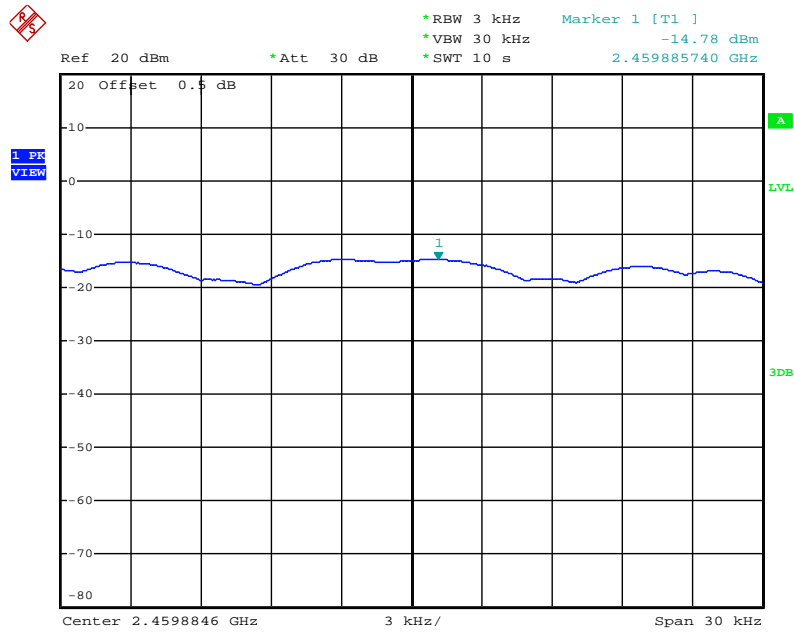

Date: 25.OCT.2010 20:03:53

Power Density Plot on Configuration IEEE 802.11b / 2412 MHz

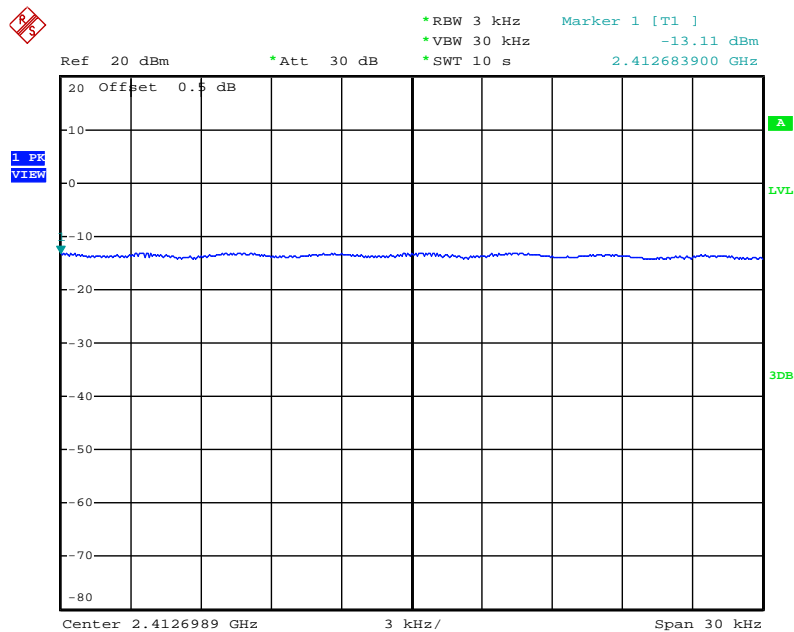

Date: 25.OCT.2010 19:43:22

Power Density Plot on Configuration IEEE 802.11b / 2437 MHz

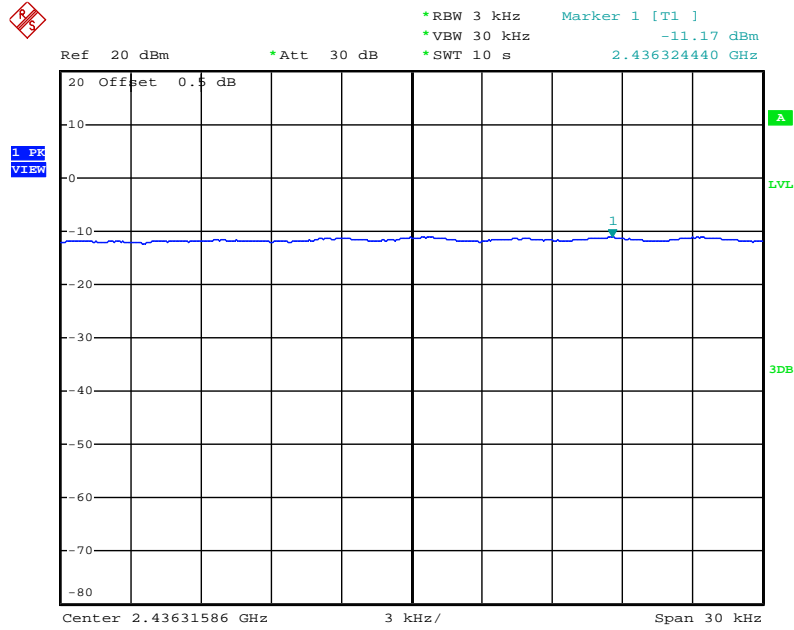

Date: 25.OCT.2010 19:46:23

Power Density Plot on Configuration IEEE 802.11b / 2462 MHz

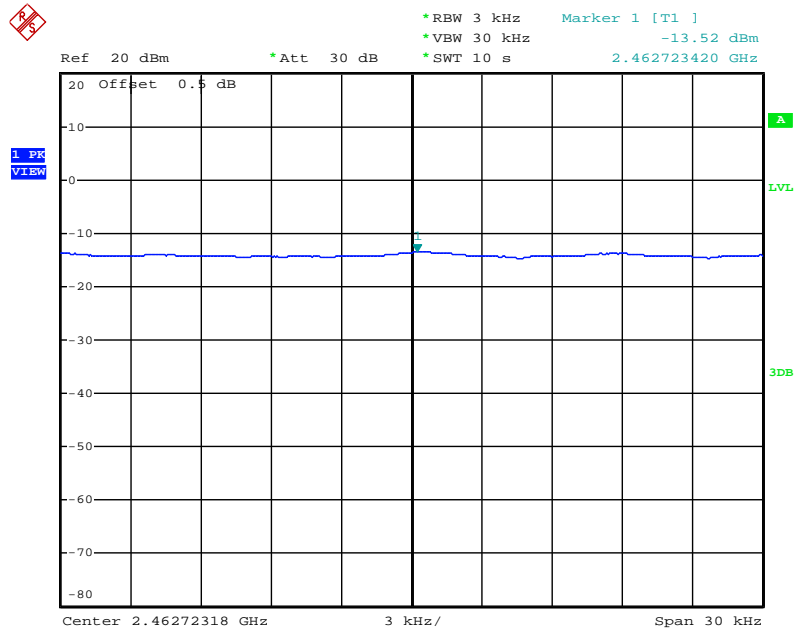

Date: 25.OCT.2010 19:48:46

<For Main Source – Mode 2 with PIFA Antenna>:

Power Density Plot on Configuration IEEE 802.11n MCS0 20MHz / 2412 MHz

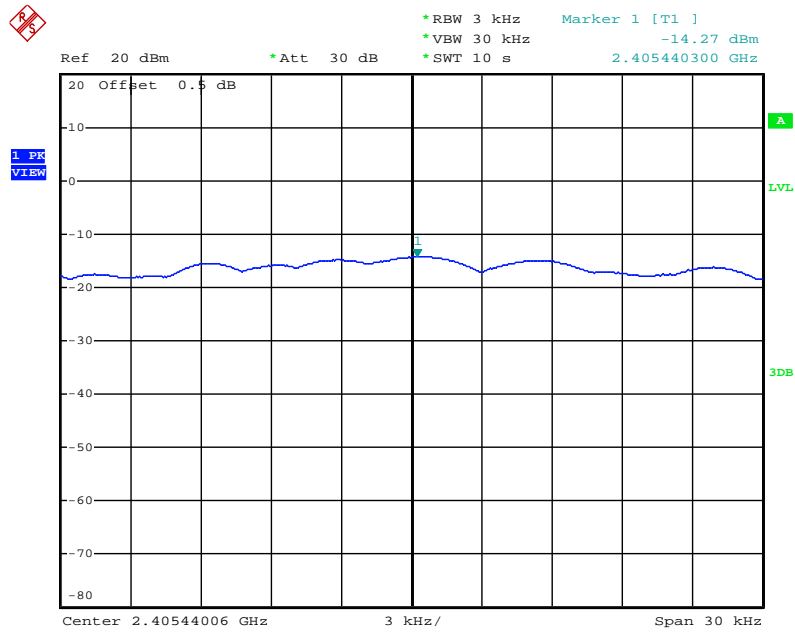

Date: 26.OCT.2010 09:44:27

Power Density Plot on Configuration IEEE 802.11n MCS0 20MHz / 2437 MHz

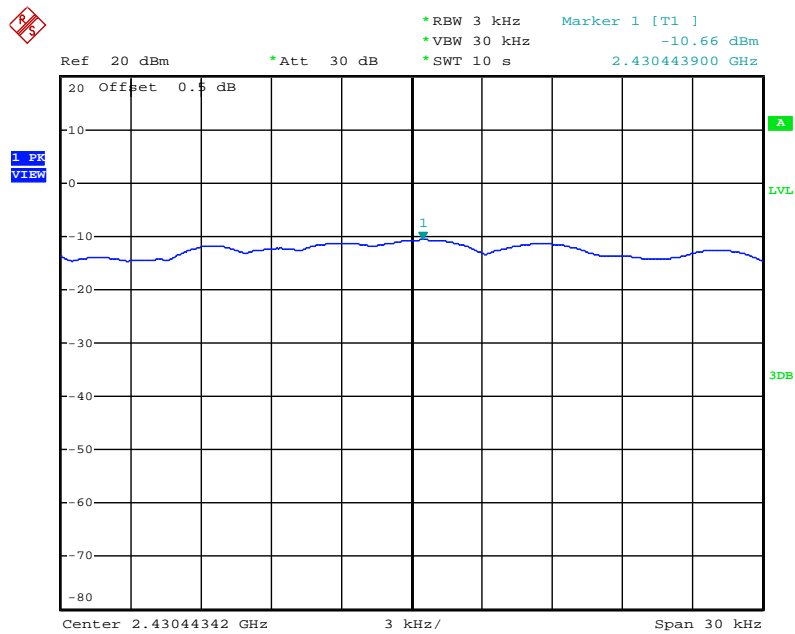

Date: 26.OCT.2010 09:46:51

Power Density Plot on Configuration IEEE 802.11n MCS0 20MHz / 2462 MHz

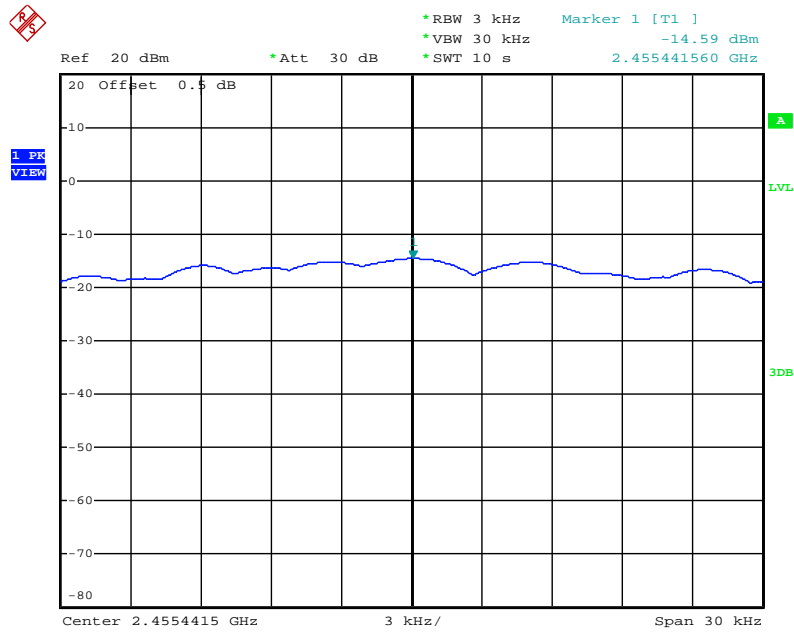

Date: 26.OCT.2010 09:49:29

Power Density Plot on Configuration IEEE 802.11b / 2412 MHz

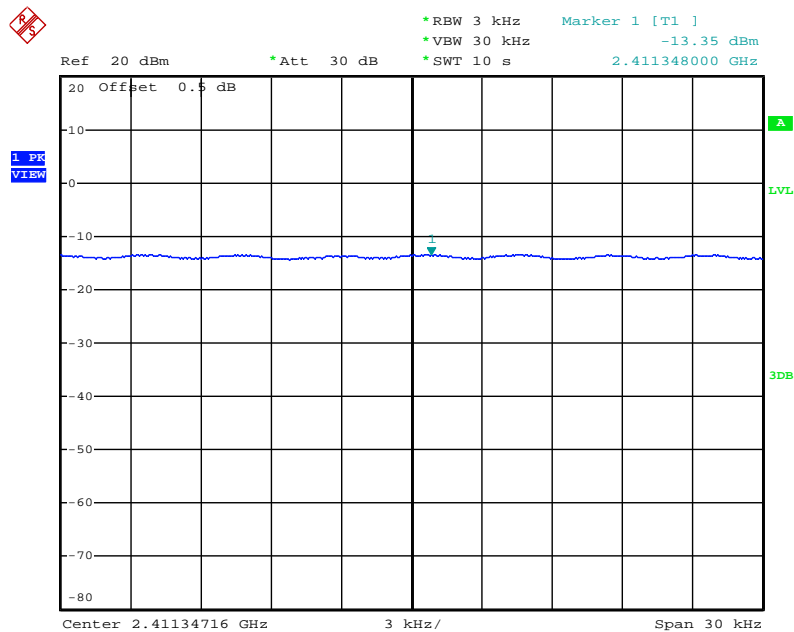

Date: 26.OCT.2010 09:23:52

Power Density Plot on Configuration IEEE 802.11b / 2437 MHz

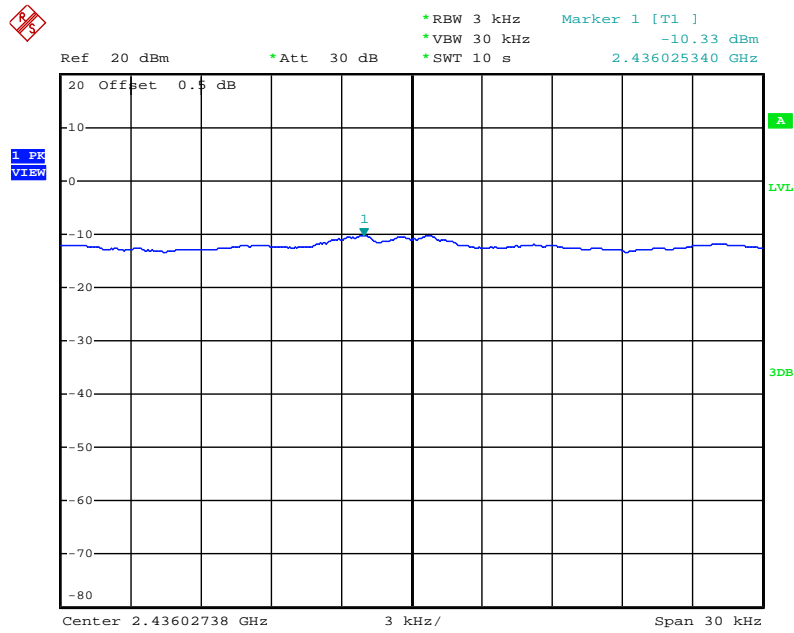

Date: 26.OCT.2010 09:27:13

Power Density Plot on Configuration IEEE 802.11b / 2462 MHz

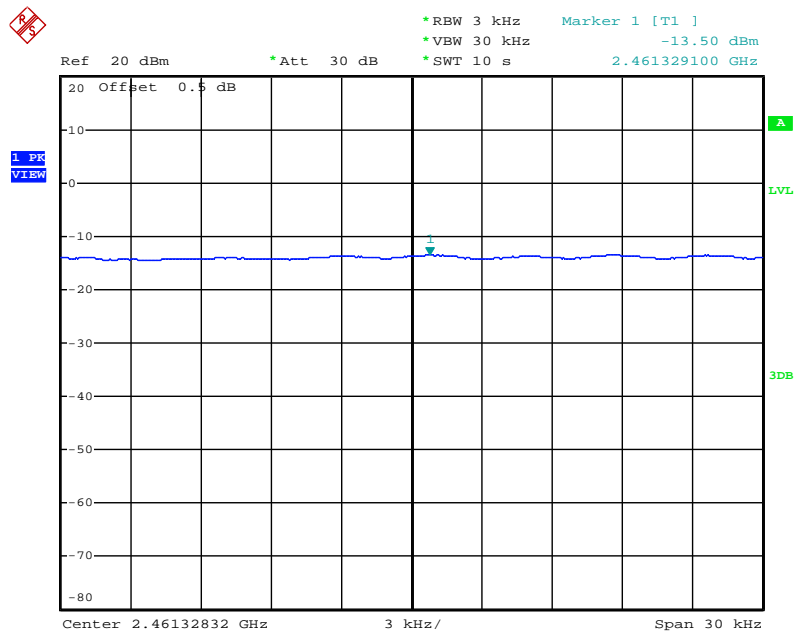

Date: 26.OCT.2010 09:30:05

<For Second Source – Mode 1 with Printed Antenna>:

Power Density Plot on Configuration IEEE 802.11n MCS0 20MHz / 2412 MHz

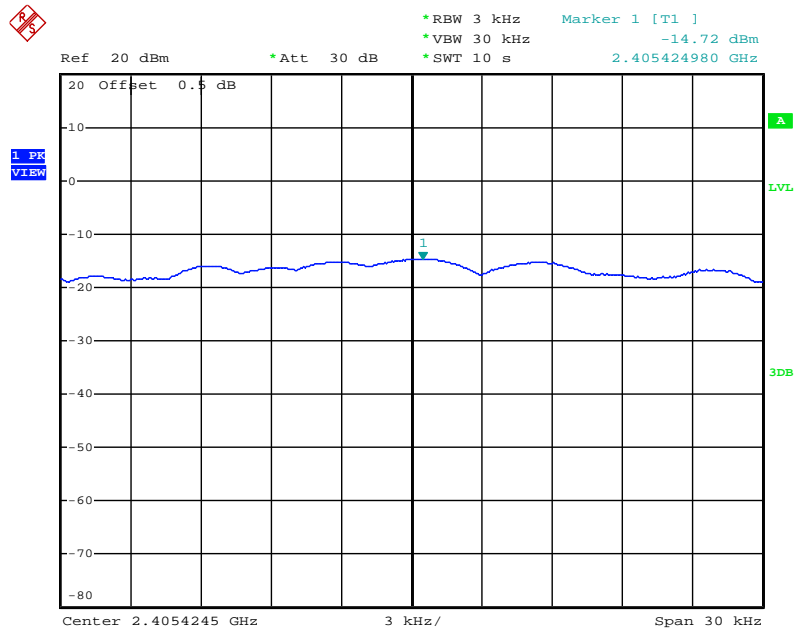

Date: 25.OCT.2010 19:58:58

Power Density Plot on Configuration IEEE 802.11n MCS0 20MHz / 2437 MHz

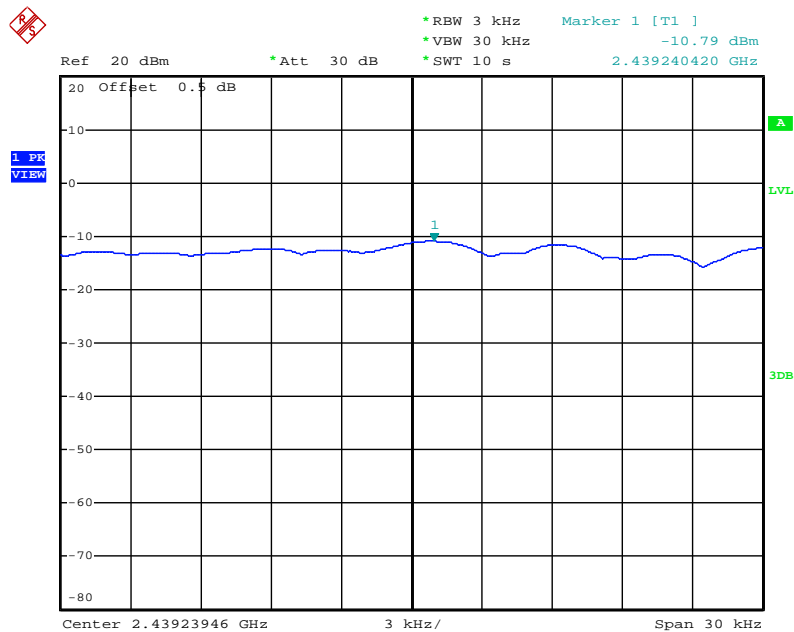

Date: 25.OCT.2010 21:12:05

Power Density Plot on Configuration IEEE 802.11n MCS0 20MHz / 2462 MHz

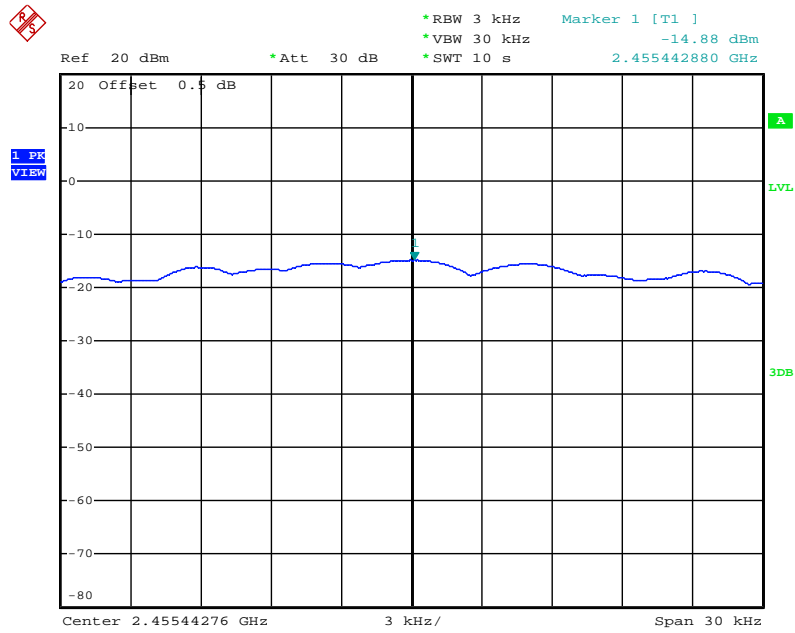

Date: 25.OCT.2010 21:14:07

Power Density Plot on Configuration IEEE 802.11b / 2412 MHz

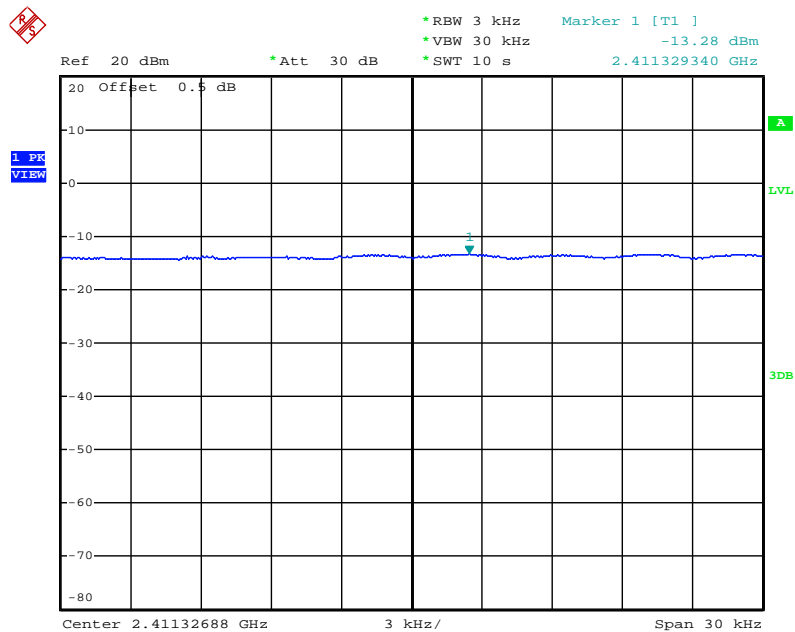

Date: 25.OCT.2010 20:54:17

Power Density Plot on Configuration IEEE 802.11b / 2437 MHz

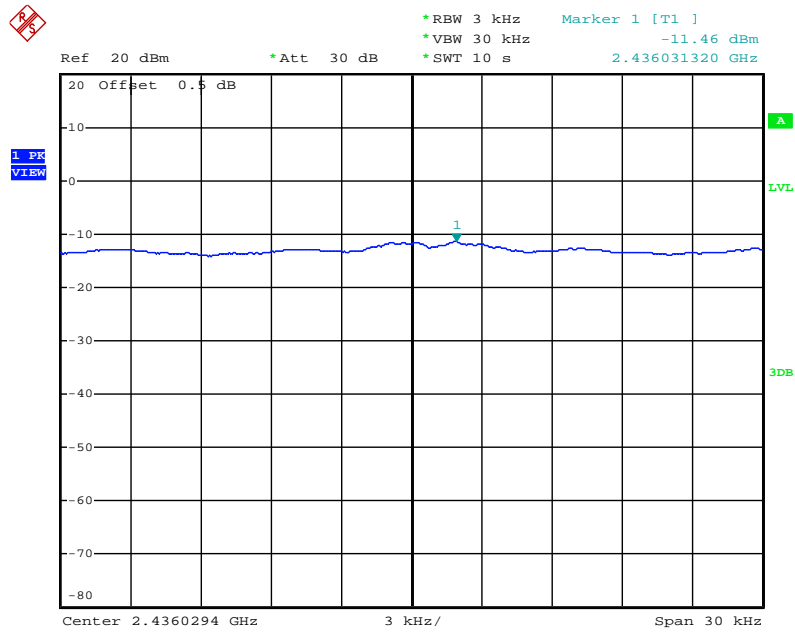

Date: 25.OCT.2010 20:59:41

Power Density Plot on Configuration IEEE 802.11b / 2462 MHz

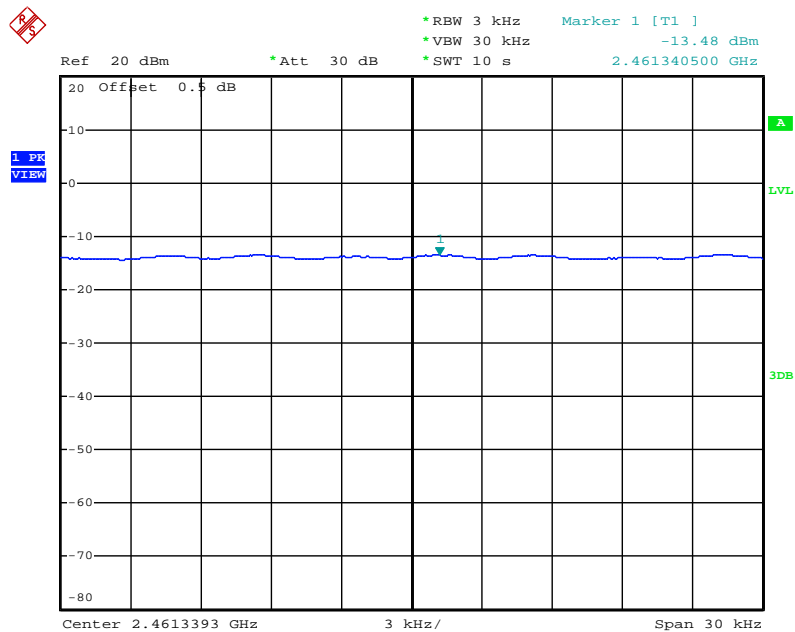

Date: 25.OCT.2010 20:57:10

<For Second Source – Mode 2 with PIFA Antenna>:

Power Density Plot on Configuration IEEE 802.11n MCS0 20MHz / 2412 MHz

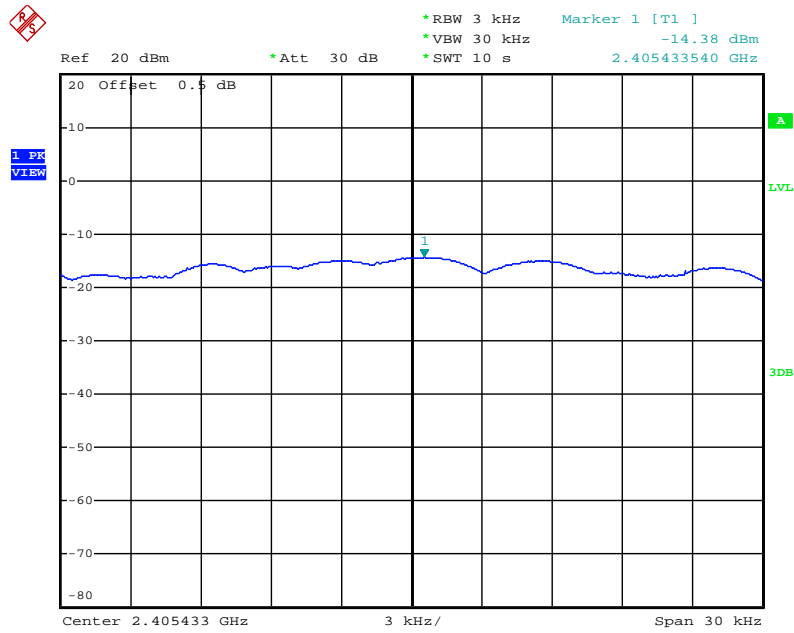

Date: 26.OCT.2010 10:56:14

Power Density Plot on Configuration IEEE 802.11n MCS0 20MHz / 2437 MHz

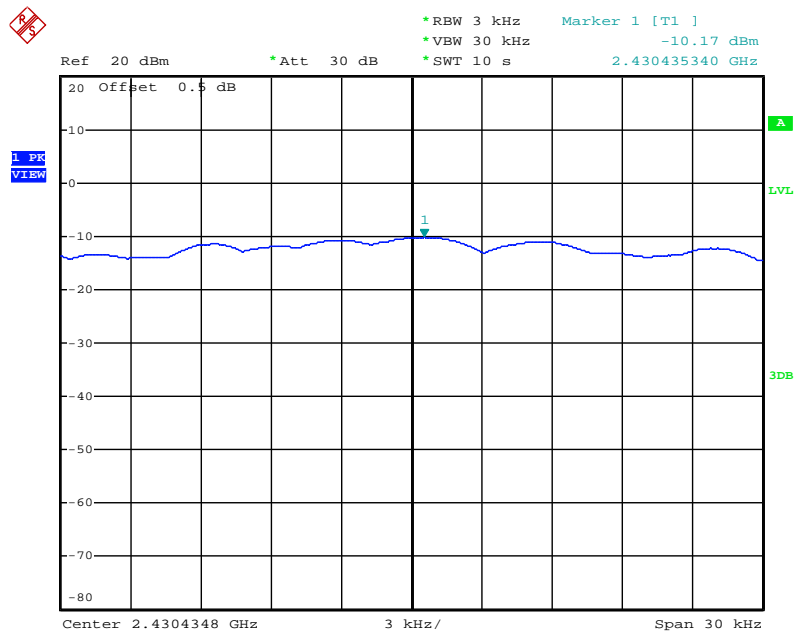

Date: 26.OCT.2010 10:58:29

Power Density Plot on Configuration IEEE 802.11n MCS0 20MHz / 2462 MHz

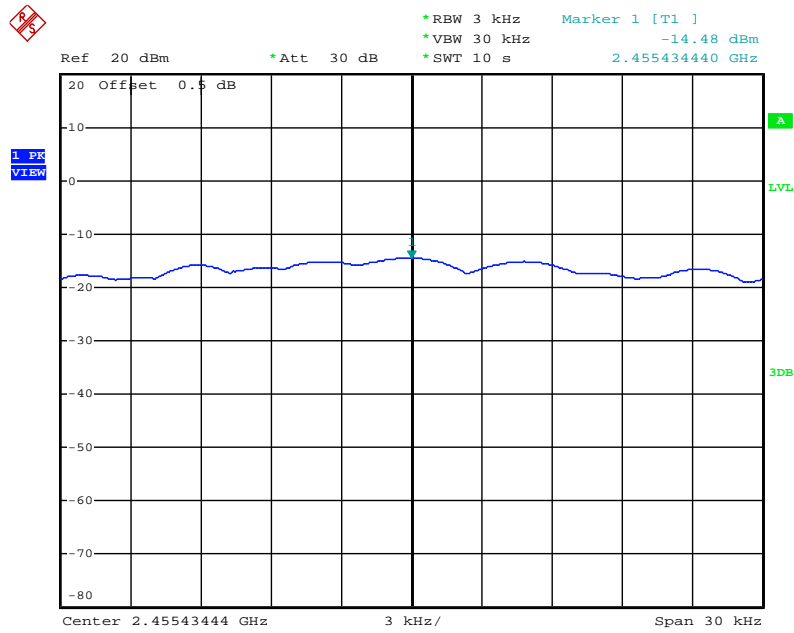

Date: 26.OCT.2010 11:00:40

Power Density Plot on Configuration IEEE 802.11b / 2412 MHz

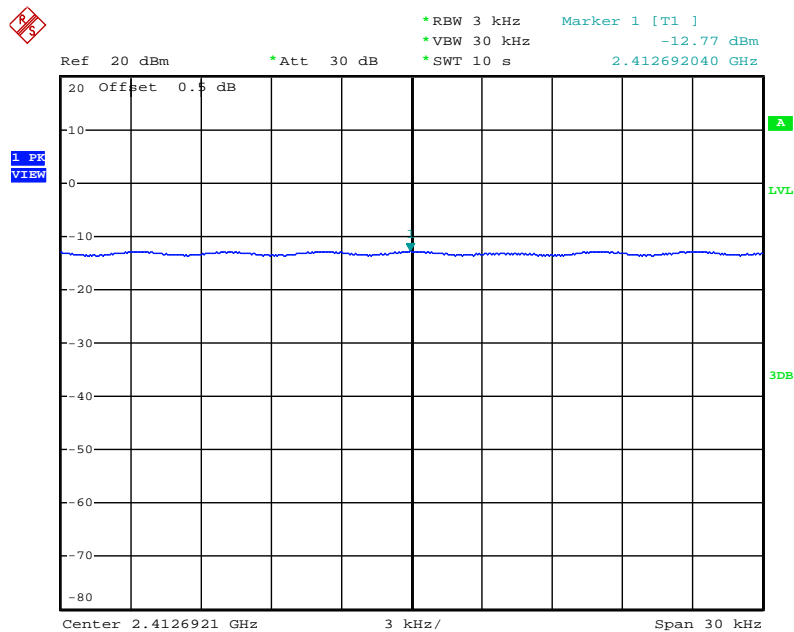

Date: 26.OCT.2010 11:30:32

Power Density Plot on Configuration IEEE 802.11b / 2437 MHz

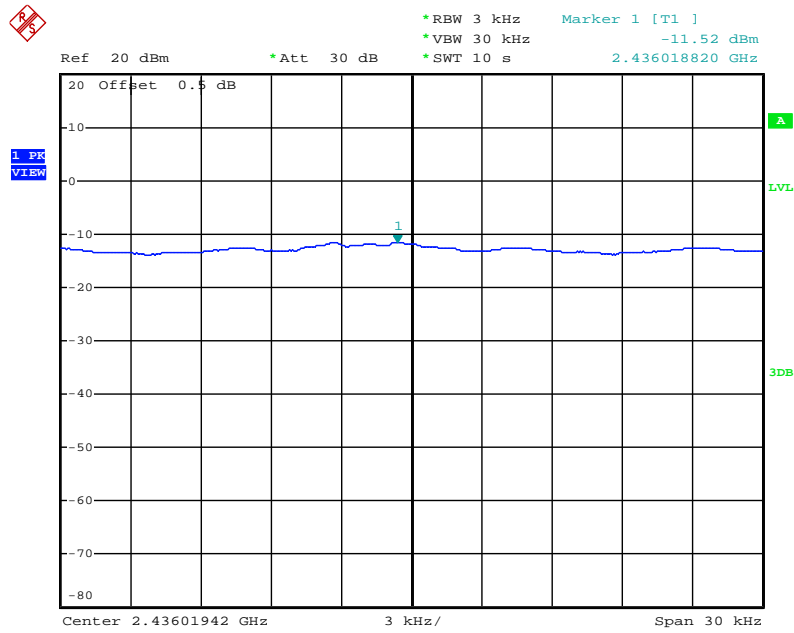

Date: 26.OCT.2010 10:43:31

Power Density Plot on Configuration IEEE 802.11b / 2462 MHz

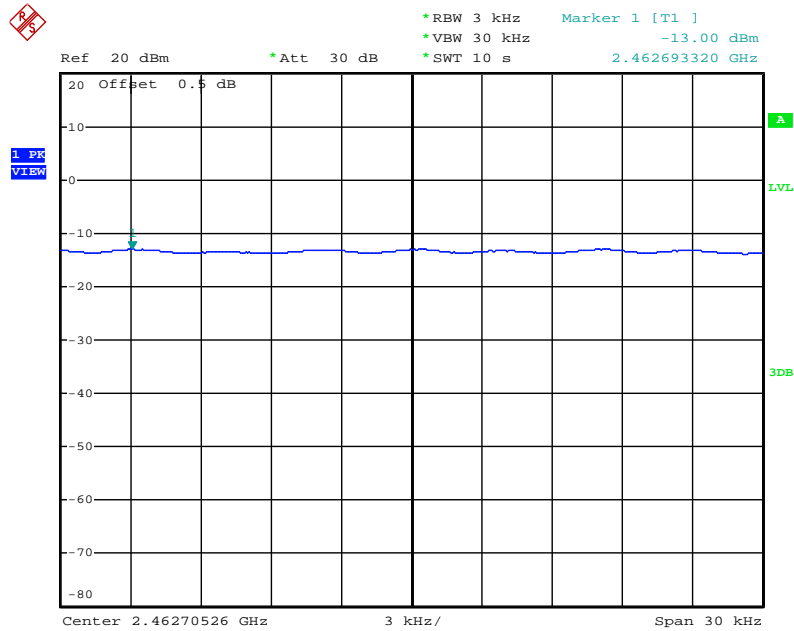

Date: 26.OCT.2010 10:45:48

4.4. 6dB Spectrum Bandwidth Measurement

4.4.1. Limit

For digital modulation systems, the minimum 6 dB bandwidth shall be at least 500 kHz.

4.4.2. Measuring Instruments and Setting

Please refer to section 5 of equipments list in this report. The following table is the setting of the Spectrum Analyzer.

Spectrum Parameters	Setting
Attenuation	Auto
Span Frequency	> 6dB Bandwidth
RB	100 kHz
VB	100 kHz
Detector	Peak
Trace	Max Hold
Sweep Time	Auto

4.4.3. Test Procedures

1. The transmitter output (antenna port) was connected to the spectrum analyzer in peak hold mode.
2. The resolution bandwidth of 100 kHz and the video bandwidth of 100 kHz were used.
3. Measured the spectrum width with power higher than 6dB below carrier.

4.4.4. Test Setup Layout

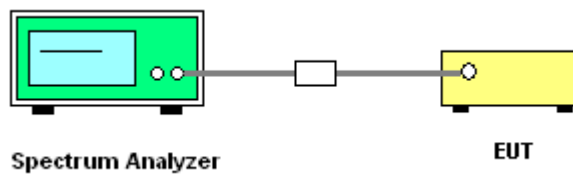

4.4.5. Test Deviation

There is no deviation with the original standard.

4.4.6. EUT Operation during Test

The EUT was programmed to be in continuously transmitting mode.

4.4.7. Test Result of 6dB Spectrum Bandwidth

<For Main Source – Mode 1 with Printed Antenna>:

Temperature	25°C	Humidity	60%
Test Engineer	Sean Ku	Configurations	IEEE 802.11n

Configuration IEEE 802.11n MCS0 20MHz

Channel	Frequency	6dB Bandwidth (MHz)	99% Occupied Bandwidth (MHz)	Min. Limit (kHz)	Test Result
1	2412 MHz	17.68	17.64	500	Complies
6	2437 MHz	17.80	17.68	500	Complies
11	2462 MHz	17.76	17.64	500	Complies

Configuration IEEE 802.11n MCS0 40MHz

Channel	Frequency	6dB Bandwidth (MHz)	99% Occupied Bandwidth (MHz)	Min. Limit (kHz)	Test Result
3	2422 MHz	36.40	36.08	500	Complies
6	2437 MHz	36.48	36.08	500	Complies
9	2452 MHz	36.40	36.08	500	Complies

Temperature	25°C	Humidity	60%
Test Engineer	Sean Ku	Configurations	IEEE 802.11b/g

Configuration IEEE 802.11b

Channel	Frequency	6dB Bandwidth (MHz)	99% Occupied Bandwidth (MHz)	Min. Limit (kHz)	Test Result
1	2412 MHz	10.12	14.80	500	Complies
6	2437 MHz	10.04	14.92	500	Complies
11	2462 MHz	10.12	14.88	500	Complies

Configuration IEEE 802.11g

Channel	Frequency	6dB Bandwidth (MHz)	99% Occupied Bandwidth (MHz)	Min. Limit (kHz)	Test Result
1	2412 MHz	16.60	16.48	500	Complies
6	2437 MHz	16.56	16.48	500	Complies
11	2462 MHz	16.56	16.48	500	Complies

Note: All the test values were listed in the report.

For plots, only the worse case of DSSS and OFDM modulation were listed in the report.

<For Main Source – Mode 2 with PIFA Antenna>:

Temperature	25°C	Humidity	60%
Test Engineer	Sean Ku	Configurations	IEEE 802.11n

Configuration IEEE 802.11n MCS0 20MHz

Channel	Frequency	6dB Bandwidth (MHz)	99% Occupied Bandwidth (MHz)	Min. Limit (kHz)	Test Result
1	2412 MHz	17.72	17.68	500	Complies
6	2437 MHz	17.72	17.68	500	Complies
11	2462 MHz	17.80	17.68	500	Complies

Configuration IEEE 802.11n MCS0 40MHz

Channel	Frequency	6dB Bandwidth (MHz)	99% Occupied Bandwidth (MHz)	Min. Limit (kHz)	Test Result
3	2422 MHz	36.40	36.08	500	Complies
6	2437 MHz	36.48	36.08	500	Complies
9	2452 MHz	36.40	36.08	500	Complies

Temperature	25°C	Humidity	60%
Test Engineer	Sean Ku	Configurations	IEEE 802.11b/g

Configuration IEEE 802.11b

Channel	Frequency	6dB Bandwidth (MHz)	99% Occupied Bandwidth (MHz)	Min. Limit (kHz)	Test Result
1	2412 MHz	10.08	14.92	500	Complies
6	2437 MHz	10.08	14.92	500	Complies
11	2462 MHz	10.12	14.92	500	Complies

Configuration IEEE 802.11g

Channel	Frequency	6dB Bandwidth (MHz)	99% Occupied Bandwidth (MHz)	Min. Limit (kHz)	Test Result
1	2412 MHz	16.56	16.44	500	Complies
6	2437 MHz	16.60	16.52	500	Complies
11	2462 MHz	16.56	16.44	500	Complies

Note: All the test values were listed in the report.

For plots, only the worse case of DSSS and OFDM modulation were listed in the report.

<For Second Source –Mode 1 with Printed Antenna>:

Temperature	25°C	Humidity	60%
Test Engineer	Sean Ku	Configurations	IEEE 802.11n

Configuration IEEE 802.11n MCS0 20MHz

Channel	Frequency	6dB Bandwidth (MHz)	99% Occupied Bandwidth (MHz)	Min. Limit (kHz)	Test Result
1	2412 MHz	17.68	17.64	500	Complies
6	2437 MHz	17.84	17.68	500	Complies
11	2462 MHz	17.68	17.68	500	Complies

Configuration IEEE 802.11n MCS0 40MHz

Channel	Frequency	6dB Bandwidth (MHz)	99% Occupied Bandwidth (MHz)	Min. Limit (kHz)	Test Result
3	2422 MHz	36.40	36.08	500	Complies
6	2437 MHz	36.40	36.08	500	Complies
9	2452 MHz	36.48	36.08	500	Complies

Temperature	25°C	Humidity	60%
Test Engineer	Sean Ku	Configurations	IEEE 802.11b/g

Configuration IEEE 802.11b

Channel	Frequency	6dB Bandwidth (MHz)	99% Occupied Bandwidth (MHz)	Min. Limit (kHz)	Test Result
1	2412 MHz	10.08	14.84	500	Complies
6	2437 MHz	10.08	15.04	500	Complies
11	2462 MHz	10.08	15.00	500	Complies

Configuration IEEE 802.11g

Channel	Frequency	6dB Bandwidth (MHz)	99% Occupied Bandwidth (MHz)	Min. Limit (kHz)	Test Result
1	2412 MHz	16.56	16.48	500	Complies
6	2437 MHz	16.52	16.44	500	Complies
11	2462 MHz	16.56	16.44	500	Complies

Note: All the test values were listed in the report.

For plots, only the worse case of DSSS and OFDM modulation were listed in the report.

<For Second Source – Mode 2 with PIFA Antenna>:

Temperature	23°C	Humidity	60%
Test Engineer	Sean Ku	Configurations	IEEE 802.11n

Configuration IEEE 802.11n MCS0 20MHz

Channel	Frequency	6dB Bandwidth (MHz)	99% Occupied Bandwidth (MHz)	Min. Limit (kHz)	Test Result
1	2412 MHz	17.72	17.64	500	Complies
6	2437 MHz	17.72	17.68	500	Complies
11	2462 MHz	17.76	17.68	500	Complies

Configuration IEEE 802.11n MCS0 40MHz

Channel	Frequency	6dB Bandwidth (MHz)	99% Occupied Bandwidth (MHz)	Min. Limit (kHz)	Test Result
3	2422 MHz	36.40	36.08	500	Complies
6	2437 MHz	36.40	36.08	500	Complies
9	2452 MHz	36.48	36.08	500	Complies

Temperature	23°C	Humidity	60%
Test Engineer	Sean Ku	Configurations	IEEE 802.11b/g

Configuration IEEE 802.11b

Channel	Frequency	6dB Bandwidth (MHz)	99% Occupied Bandwidth (MHz)	Min. Limit (kHz)	Test Result
1	2412 MHz	10.08	14.80	500	Complies
6	2437 MHz	10.04	14.96	500	Complies
11	2462 MHz	10.12	14.76	500	Complies

Configuration IEEE 802.11g

Channel	Frequency	6dB Bandwidth (MHz)	99% Occupied Bandwidth (MHz)	Min. Limit (kHz)	Test Result
1	2412 MHz	16.56	16.44	500	Complies
6	2437 MHz	16.56	16.44	500	Complies
11	2462 MHz	16.52	16.44	500	Complies

Note: All the test values were listed in the report.

For plots, only the worse case of DSSS and OFDM modulation were listed in the report.

<For Main Source – Mode 1 with Printed Antenna>:

6 dB Bandwidth Plot on Configuration IEEE 802.11b / 2412 MHz

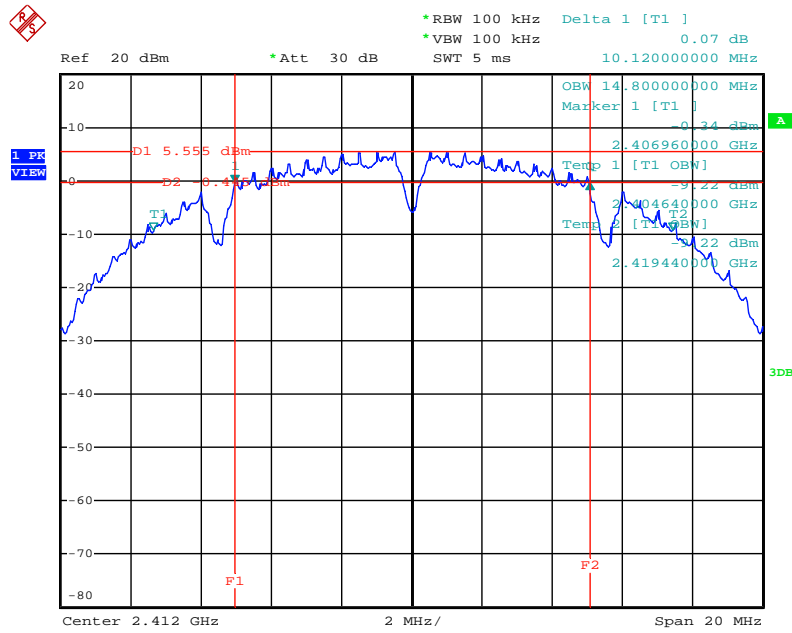

Date: 25.OCT.2010 19:41:54

6 dB Bandwidth Plot on Configuration IEEE 802.11b / 2437 MHz

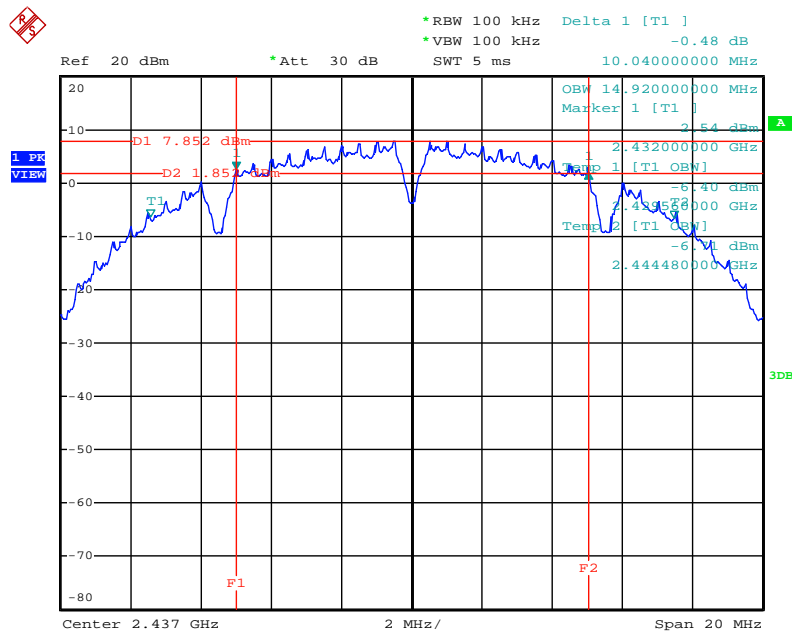

Date: 25.OCT.2010 19:44:55

6 dB Bandwidth Plot on Configuration IEEE 802.11b / 2462 MHz

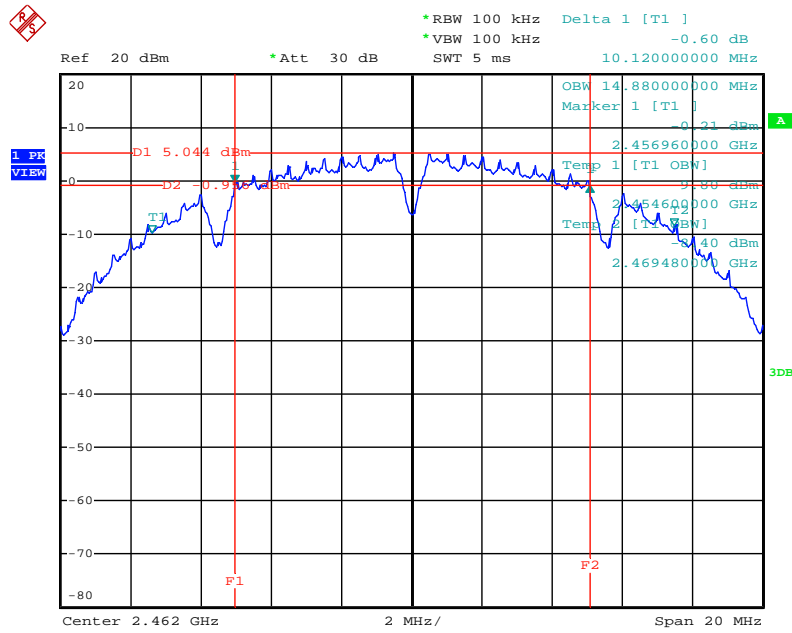

Date: 25.OCT.2010 19:47:18

6 dB Bandwidth Plot on Configuration IEEE 802.11g / 2412 MHz

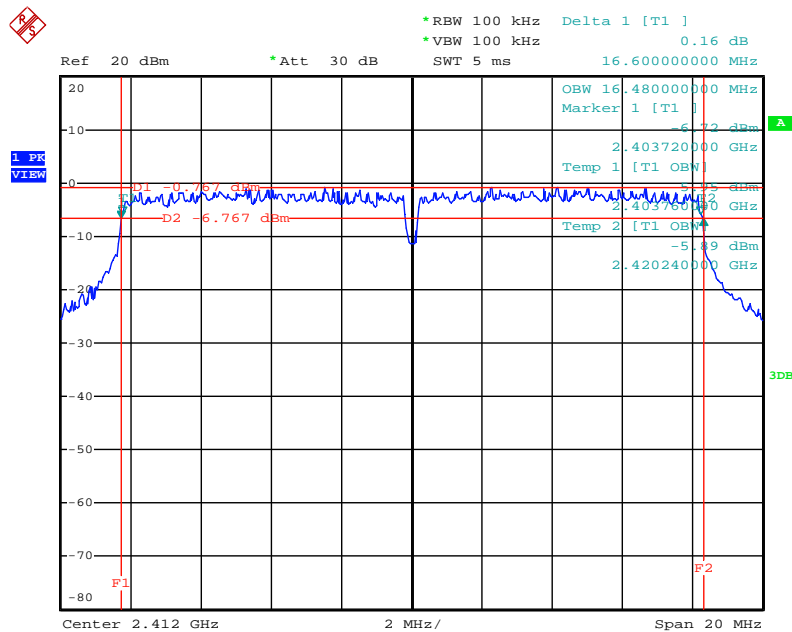

Date: 25.OCT.2010 19:54:47

6 dB Bandwidth Plot on Configuration IEEE 802.11g / 2437 MHz

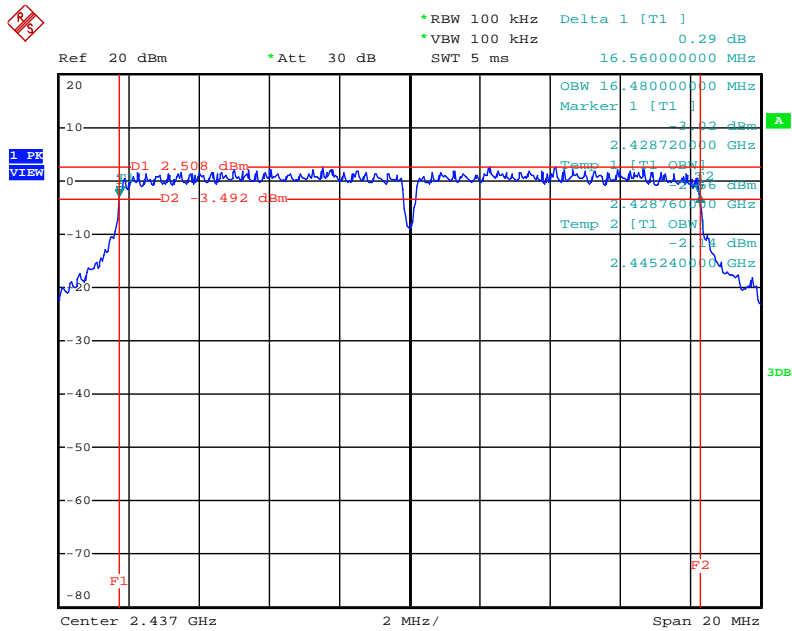

Date: 25.OCT.2010 19:52:41

6 dB Bandwidth Plot on Configuration IEEE 802.11g / 2462 MHz

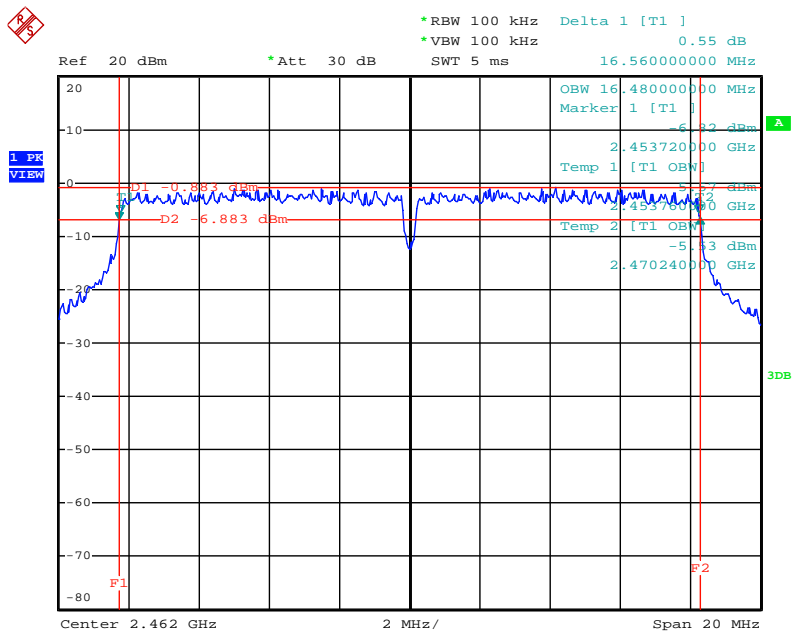

Date: 25.OCT.2010 19:50:31

<For Main Source – Mode 2 with PIFA Antenna>:

6 dB Bandwidth Plot on Configuration IEEE 802.11b / 2412 MHz

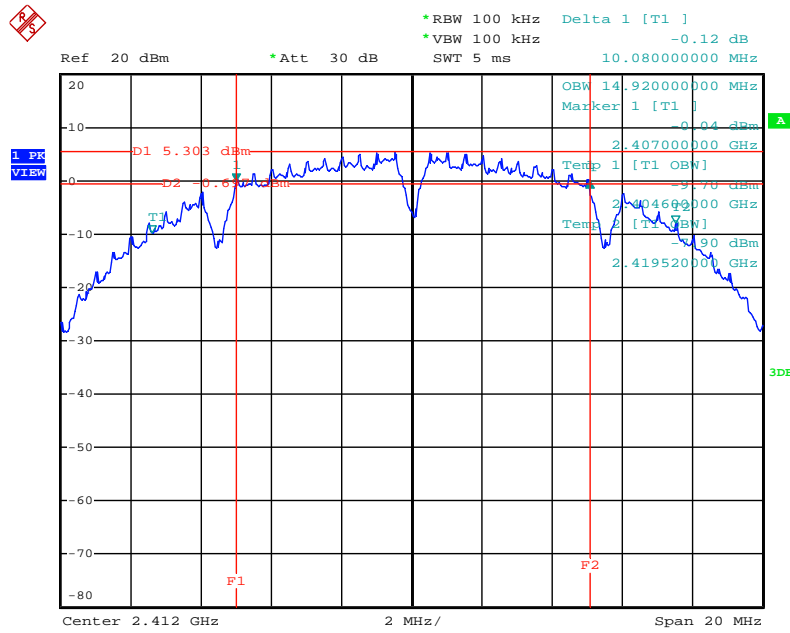

Date: 26.OCT.2010 09:22:24

6 dB Bandwidth Plot on Configuration IEEE 802.11b / 2437 MHz

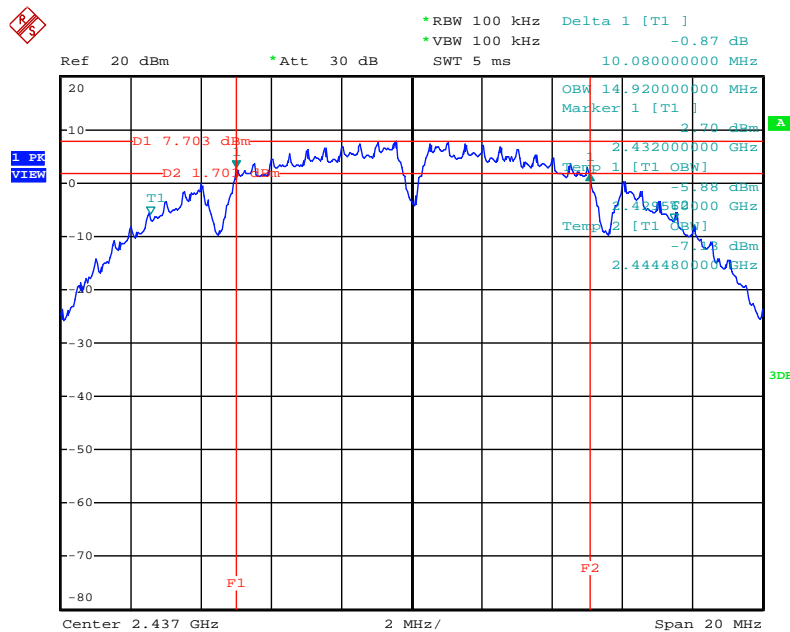

Date: 26.OCT.2010 09:25:44

6 dB Bandwidth Plot on Configuration IEEE 802.11b / 2462 MHz

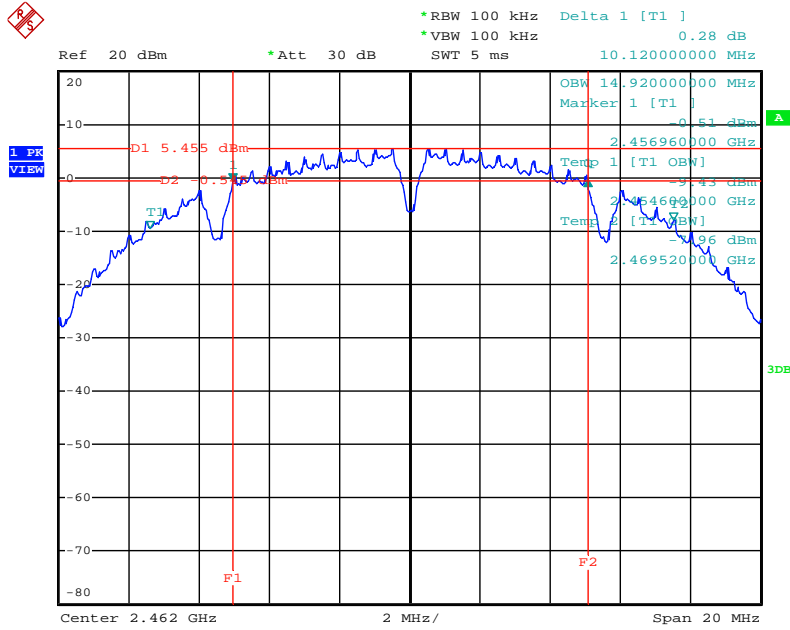

Date: 26.OCT.2010 09:28:38

6 dB Bandwidth Plot on Configuration IEEE 802.11g / 2412 MHz

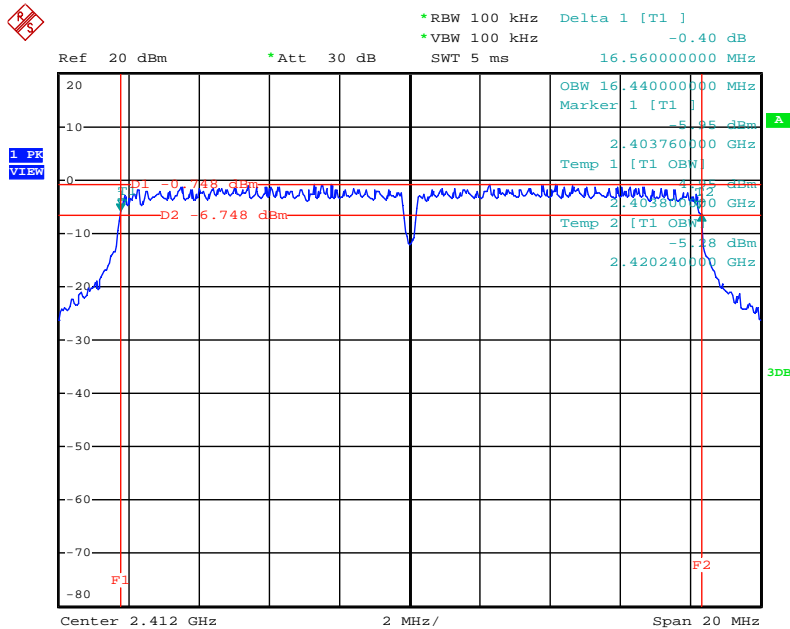

Date: 26.OCT.2010 09:31:26

6 dB Bandwidth Plot on Configuration IEEE 802.11g / 2437 MHz

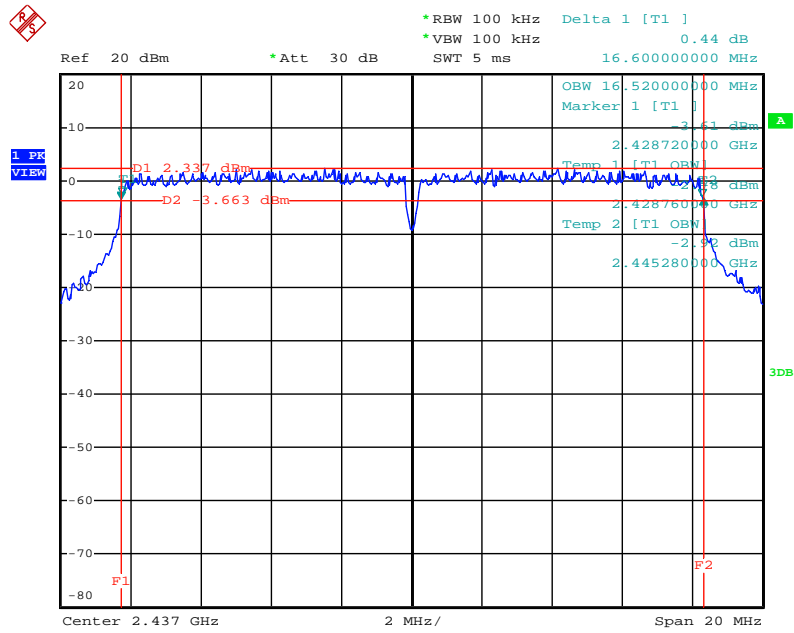

Date: 26.OCT.2010 09:36:51

6 dB Bandwidth Plot on Configuration IEEE 802.11g / 2462 MHz

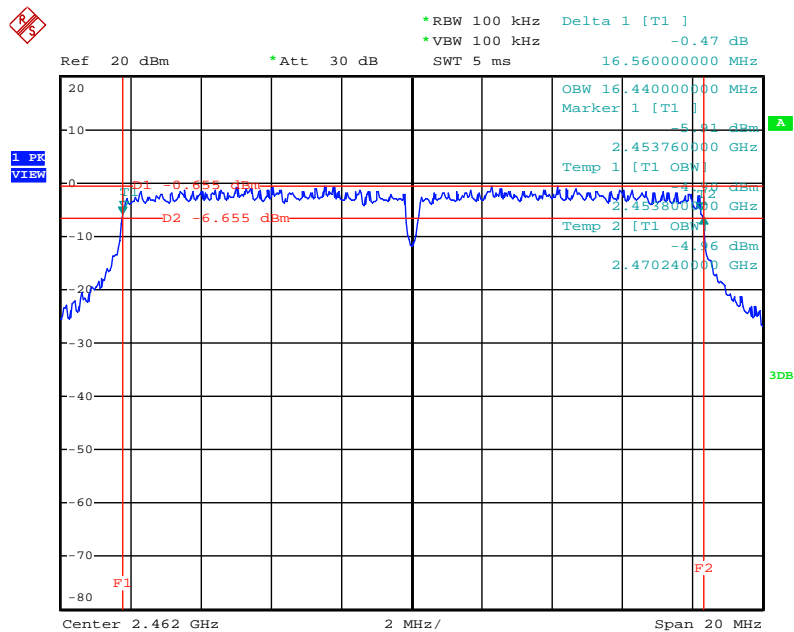

Date: 26.OCT.2010 09:39:38

<For Second Source – Mode 1 with Printed Antenna>:

6 dB Bandwidth Plot on Configuration IEEE 802.11b / 2412 MHz

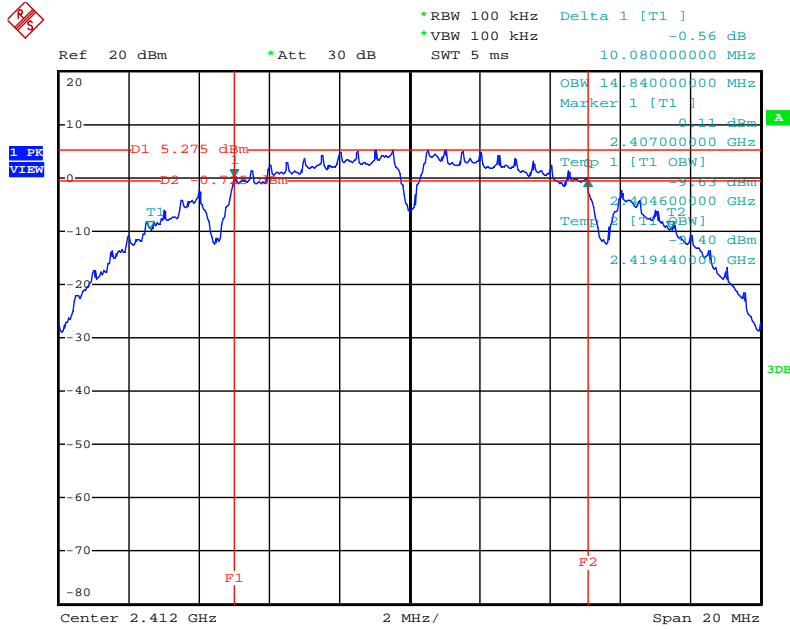

Date: 25.OCT.2010 20:52:50

6 dB Bandwidth Plot on Configuration IEEE 802.11b / 2437 MHz

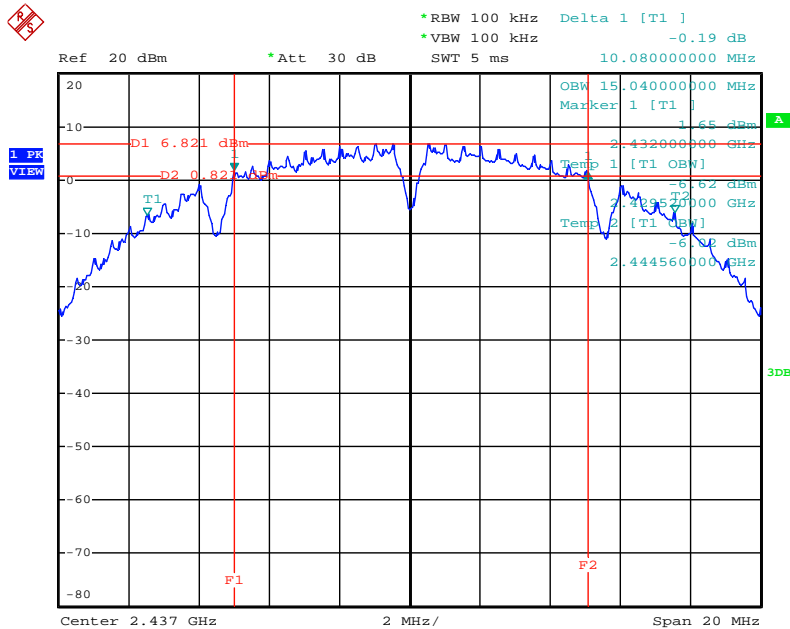

Date: 25.OCT.2010 20:58:12

6 dB Bandwidth Plot on Configuration IEEE 802.11b / 2462 MHz

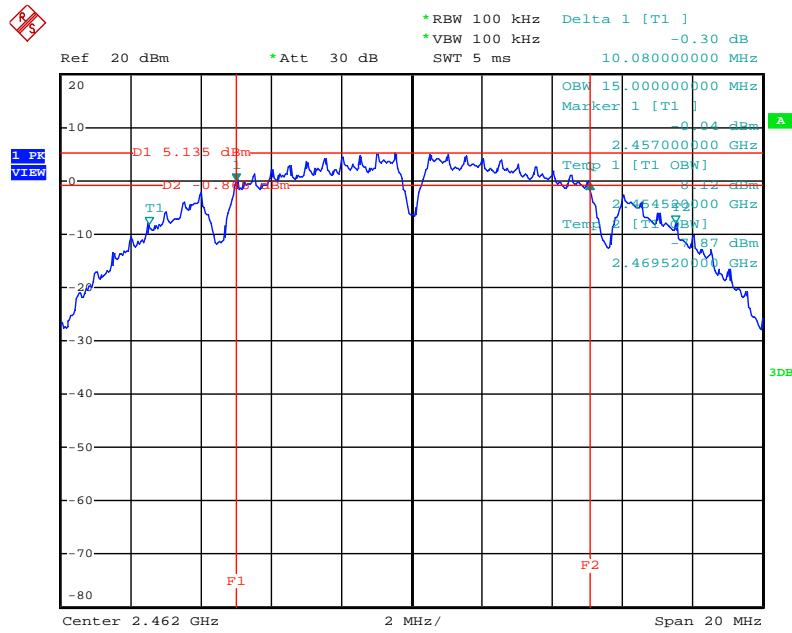

Date: 25.OCT.2010 20:55:42

6 dB Bandwidth Plot on Configuration IEEE 802.11g / 2412 MHz

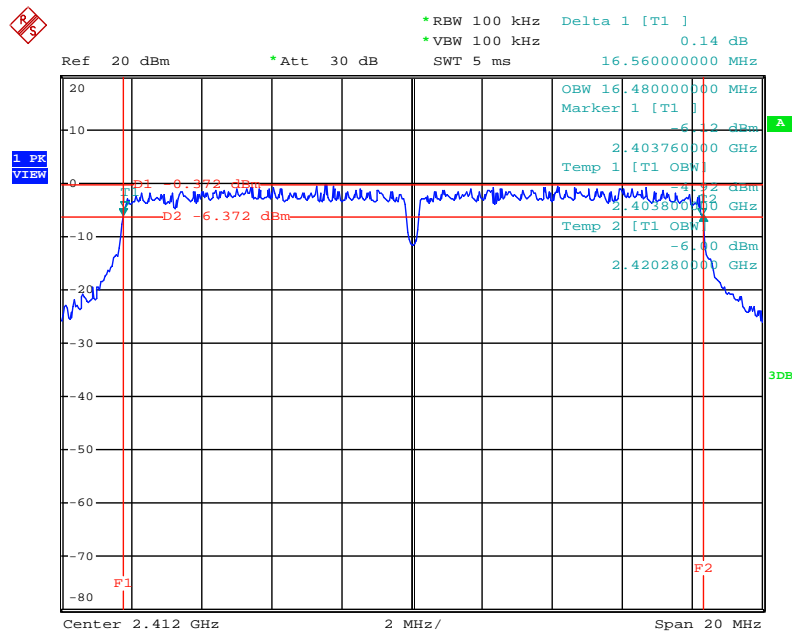

Date: 25.OCT.2010 21:55:52

6 dB Bandwidth Plot on Configuration IEEE 802.11g / 2437 MHz

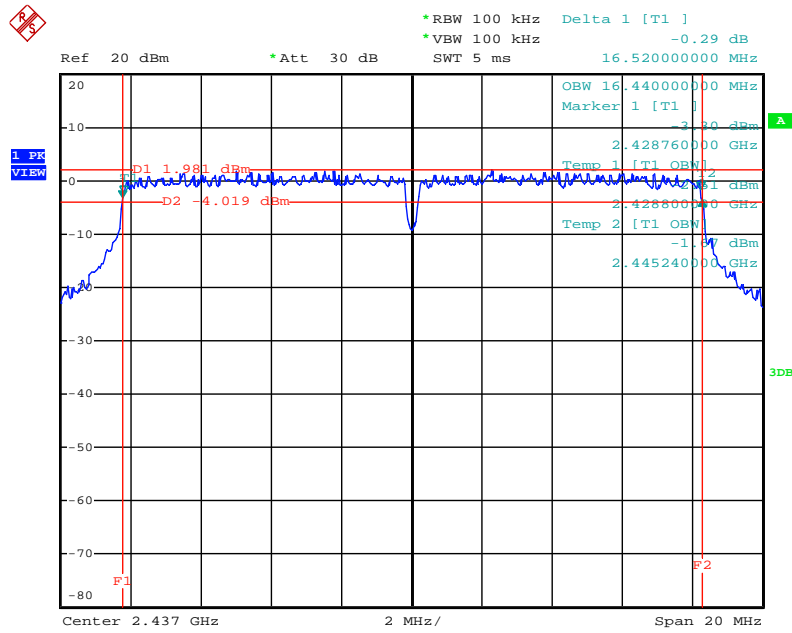

Date: 25.OCT.2010 21:03:24

6 dB Bandwidth Plot on Configuration IEEE 802.11g / 2462 MHz

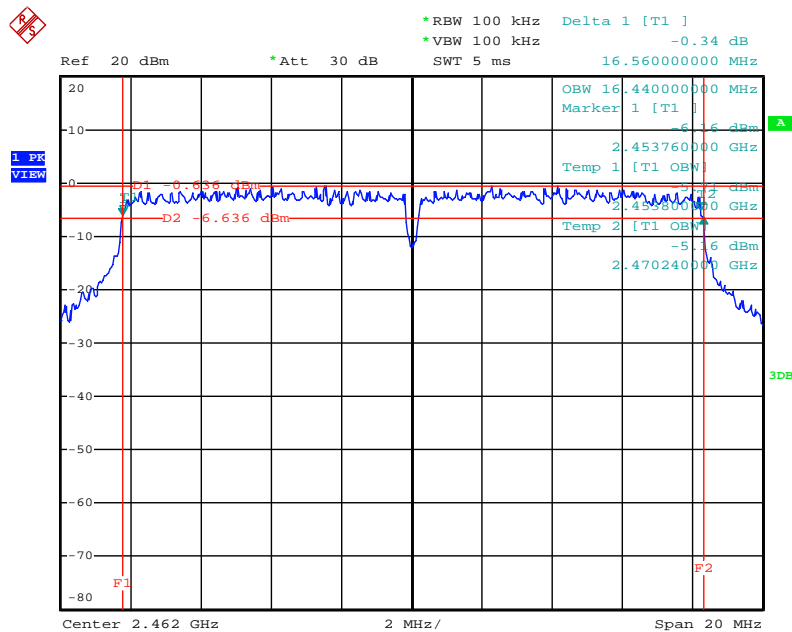

Date: 25.OCT.2010 21:06:06

<For Second Source – Mode 2 with PIFA Antenna>:

6 dB Bandwidth Plot on Configuration IEEE 802.11b / 2412 MHz

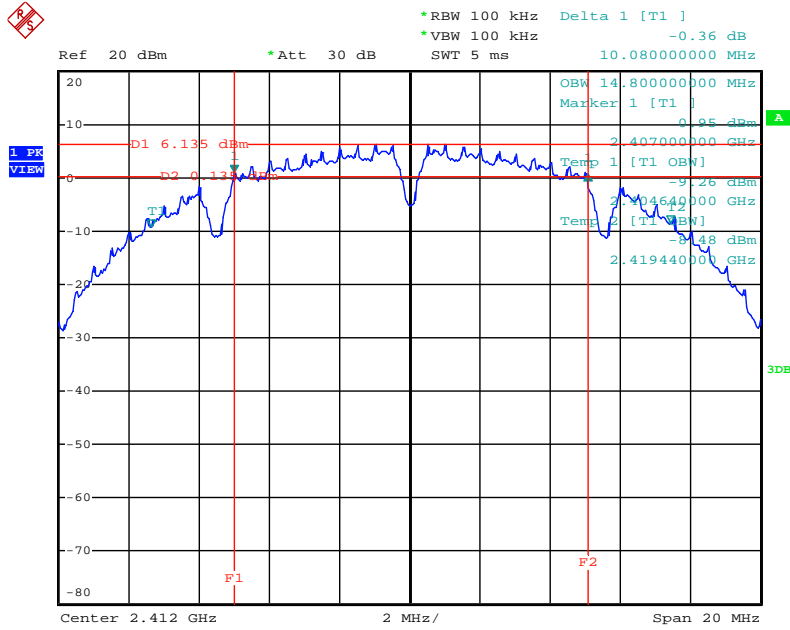

Date: 26.OCT.2010 11:29:05

6 dB Bandwidth Plot on Configuration IEEE 802.11b / 2437 MHz

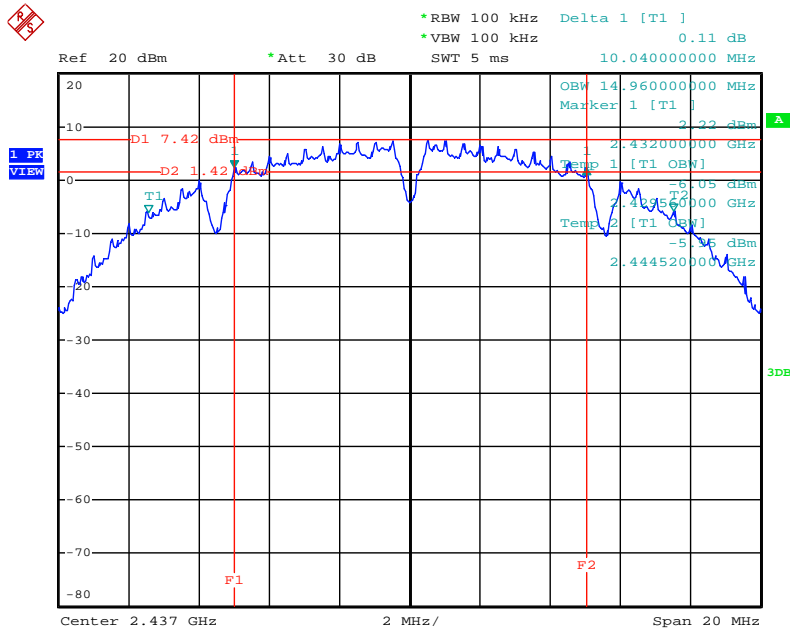

Date: 26.OCT.2010 10:42:02

6 dB Bandwidth Plot on Configuration IEEE 802.11b / 2462 MHz

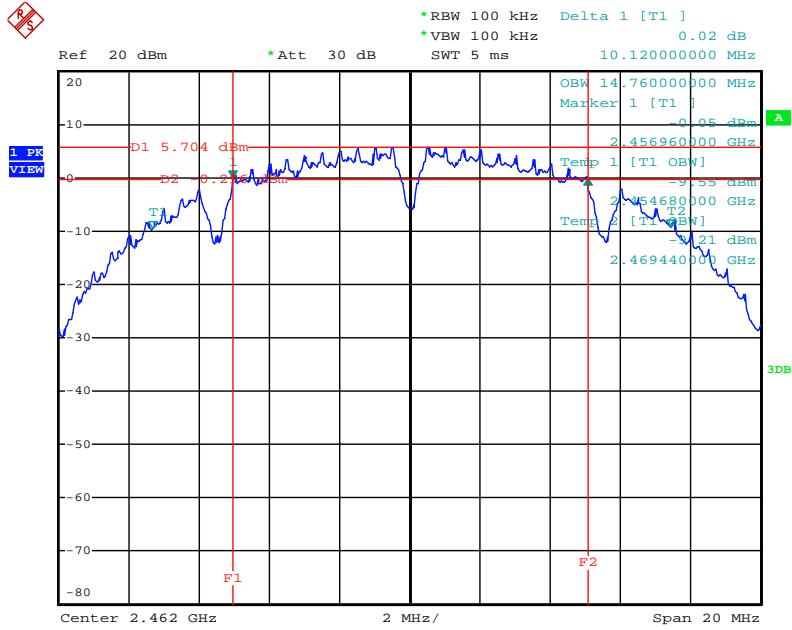

Date: 26.OCT.2010 10:44:20

6 dB Bandwidth Plot on Configuration IEEE 802.11g / 2412 MHz

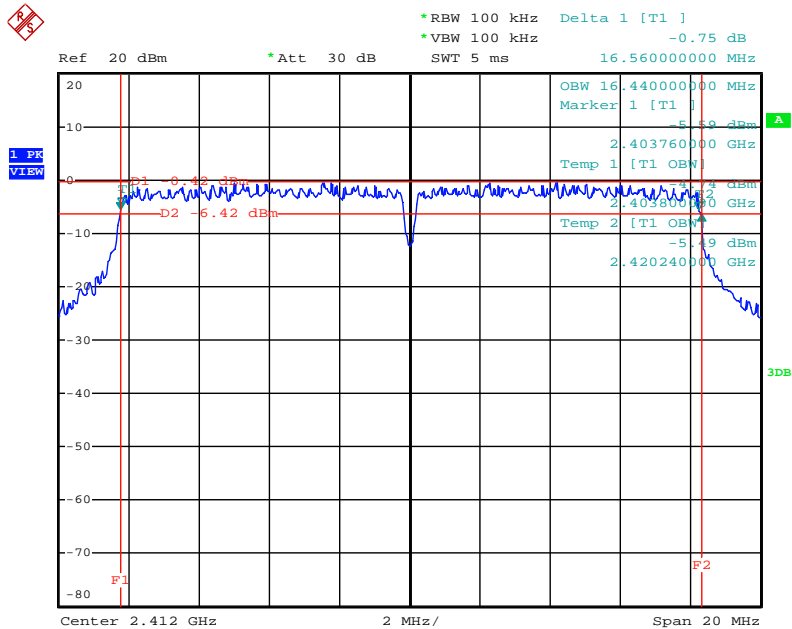

Date: 26.OCT.2010 10:46:51

6 dB Bandwidth Plot on Configuration IEEE 802.11g / 2437 MHz

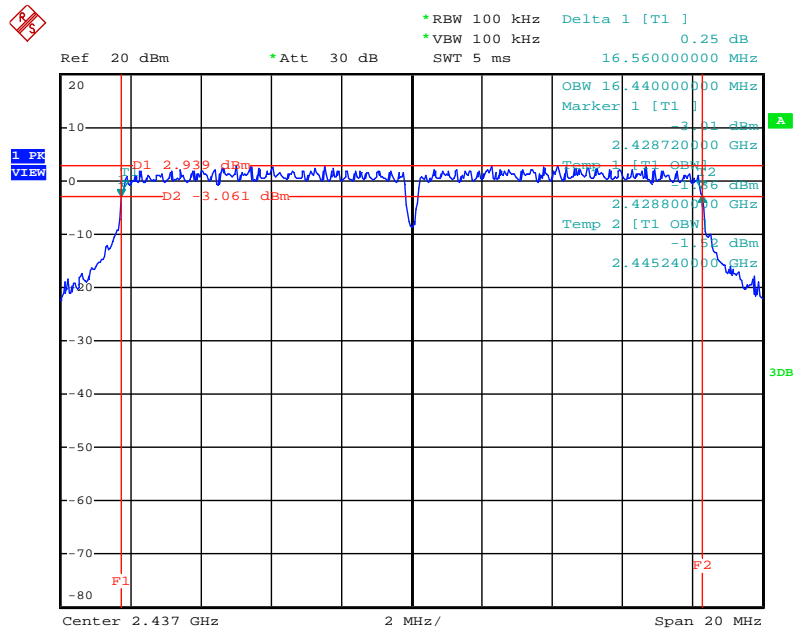

Date: 26.OCT.2010 10:48:55

6 dB Bandwidth Plot on Configuration IEEE 802.11g / 2462 MHz

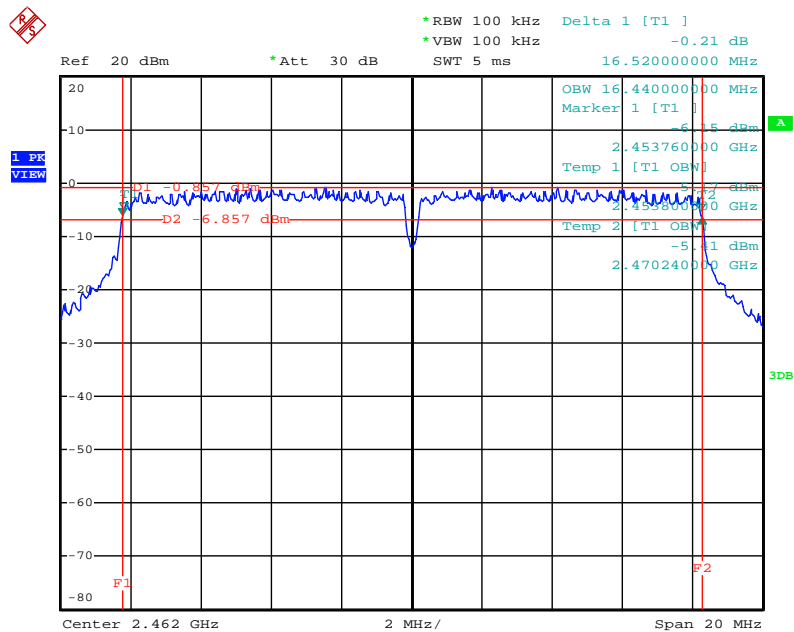

Date: 26.OCT.2010 10:51:10

4.5. Radiated Emissions Measurement

4.5.1. Limit

20dBc in any 100 kHz bandwidth outside the operating frequency band. In case the emission fall within the restricted band specified on 15.205(a), then the 15.209(a) limit in the table below has to be followed.

Frequencies (MHz)	Field Strength (micorvolts/meter)	Measurement Distance (meters)
0.009~0.490	2400/F(KHz)	300
0.490~1.705	24000/F(KHz)	30
1.705~30.0	30	30
30~88	100	3
88~216	150	3
216~960	200	3
Above 960	500	3

4.5.2. Measuring Instruments and Setting

Please refer to section 5 of equipments list in this report. The following table is the setting of spectrum analyzer and receiver.

Spectrum Parameter	Setting
Attenuation	Auto
Start Frequency	1000 MHz
Stop Frequency	10th carrier harmonic
RB / VB (Emission in restricted band)	1MHz / 1MHz for Peak, 1 MHz / 10Hz for Average
RB / VB (Emission in non-restricted band)	1MHz / 1MHz for peak

Receiver Parameter	Setting
Attenuation	Auto
Start ~ Stop Frequency	9kHz~150kHz / RB 200Hz for QP
Start ~ Stop Frequency	150kHz~30MHz / RB 9kHz for QP
Start ~ Stop Frequency	30MHz~1000MHz / RB 120kHz for QP

4.5.3. Test Procedures

1. Configure the EUT according to ANSI C63.4. The EUT was placed on the top of the turntable 0.8 meter above ground. The phase center of the receiving antenna mounted on the top of a height-variable antenna tower was placed 3 meters far away from the turntable.
2. Power on the EUT and all the supporting units. The turntable was rotated by 360 degrees to determine the position of the highest radiation.
3. The height of the broadband receiving antenna was varied between one meter and four meters above ground to find the maximum emissions field strength of both horizontal and vertical polarization.
4. For each suspected emissions, the antenna tower was scan (from 1 m to 4 m) and then the turntable was rotated (from 0 degree to 360 degrees) to find the maximum reading.
5. Set the test-receiver system to Peak or CISPR quasi-peak Detect Function with specified bandwidth under Maximum Hold Mode.
6. For emissions above 1GHz, use 1MHz VBW and RBW for peak reading. Then 1MHz RBW and 10Hz VBW for average reading in spectrum analyzer.
7. When the radiated emissions limits are expressed in terms of the average value of the emissions, and pulsed operation is employed, the measurement field strength shall be determined by averaging over one complete pulse train, including blanking intervals, as long as the pulse train does not exceed 0.1 seconds. As an alternative (provided the transmitter operates for longer than 0.1 seconds) or in cases where the pulse train exceeds 0.1 seconds, the measured field strength shall be determined from the average absolute voltage during a 0.1 second interval during which the field strength is at its maximum value.
8. If the emissions level of the EUT in peak mode was 3 dB lower than the average limit specified, then testing will be stopped and peak values of EUT will be reported, otherwise, the emissions which do not have 3 dB margin will be repeated one by one using the quasi-peak method for below 1GHz.
9. For testing above 1GHz, the emissions level of the EUT in peak mode was lower than average limit (that means the emissions level in peak mode also complies with the limit in average mode), then testing will be stopped and peak values of EUT will be reported, otherwise, the emissions will be measured in average mode again and reported.
10. In case the emission is lower than 30MHz, loop antenna has to be used for measurement and the recorded data should be QP measured by receiver. High – Low scan is not required in this case.

4.5.4. Test Setup Layout

For radiated emissions below 30MHz

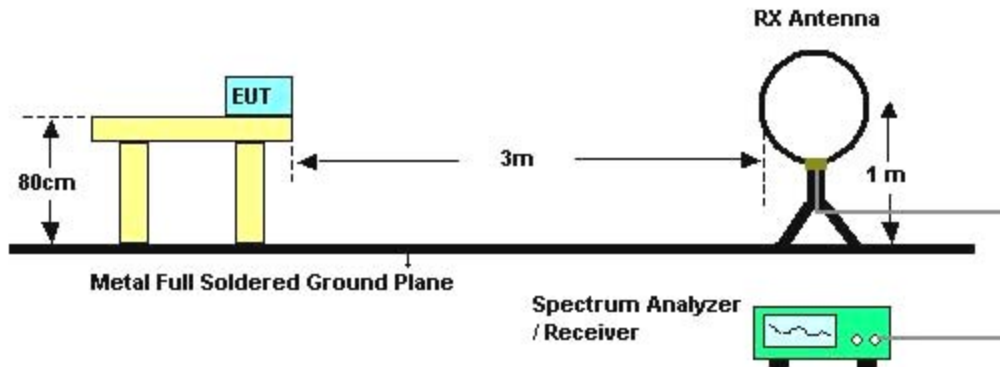

For radiated emissions above 30MHz

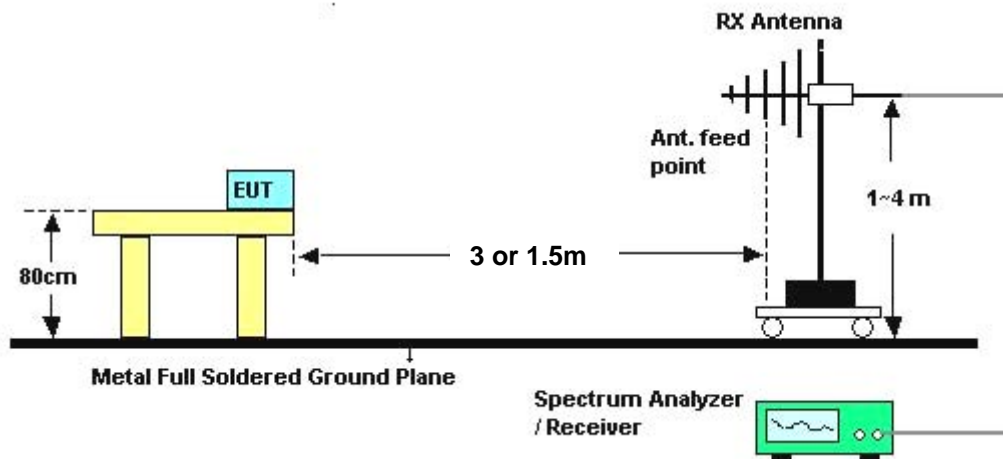

Above 10 GHz shall be extrapolated to the specified distance using an extrapolation factor of 20 dB/decade from 3m to 1.5m.

Distance extrapolation factor = $20 \log (\text{specific distance [3m]} / \text{test distance [1.5m]})$ (dB);

Limit line = specific limits (dBuV) + distance extrapolation factor [6 dB].

4.5.5. Test Deviation

There is no deviation with the original standard.

4.5.6. EUT Operation during Test

The EUT was programmed to be in continuously transmitting mode.

4.5.7. Results of Radiated Emissions (9kHz~30MHz)

Temperature	24.5°C	Humidity	57%
Test Engineer	Satoshi Yang	Configurations	Normal Link
Evaluating Date	Oct. 30, 2010		

Freq. (MHz)	Level (dBuV)	Over Limit (dB)	Limit Line (dBuV)	Remark
-	-	-	-	See Note

Note:

The amplitude of spurious emissions which are attenuated by more than 20 dB below the permissible value has no need to be reported.

Distance extrapolation factor = $40 \log(\text{specific distance} / \text{test distance})$ (dB);

Limit line = specific limits (dBuV) + distance extrapolation factor.

4.5.8. Results of Radiated Emissions (30MHz~1GHz)

<For Main Source – Mode 1 with Printed Antenna>:

Temperature	24.5°C	Humidity	57%
Test Engineer	Satoshi Yang	Configurations	Normal Link

Horizontal

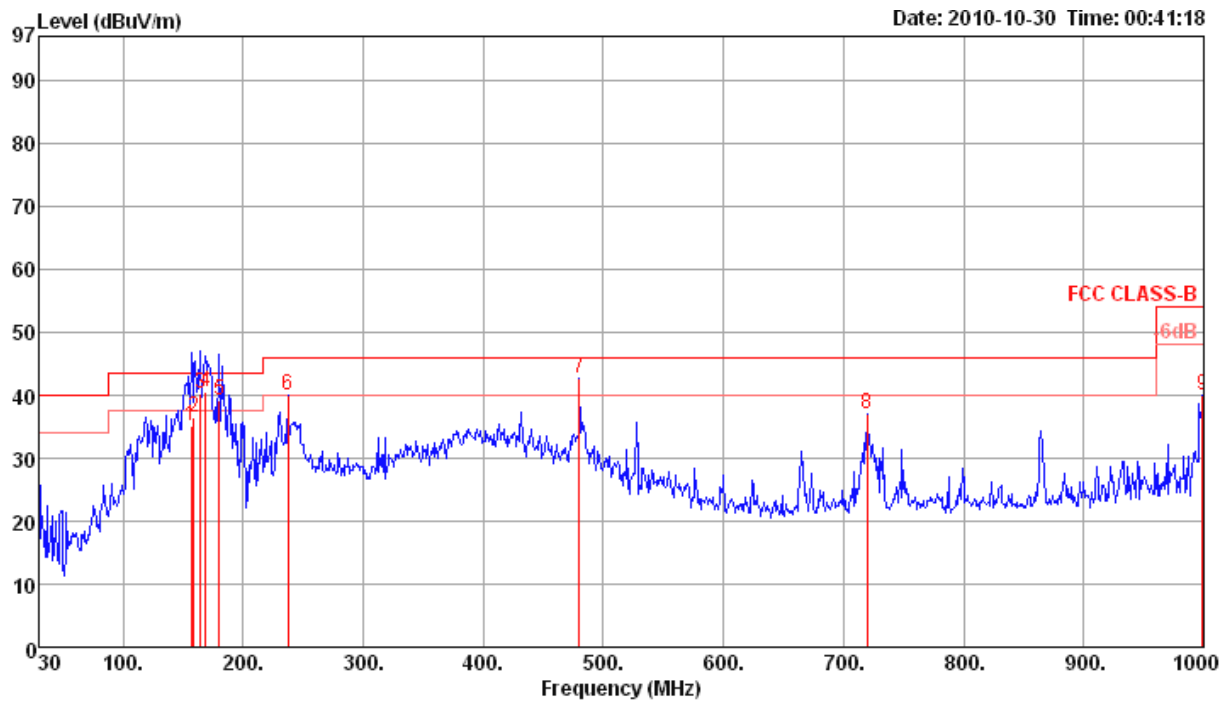

	Freq	Level	Limit	Over	Read	Cable	Preamp	Antenna	T/Pos	A/Pos	Remark	Pol/Phase
	MHz	dBuV/m	dBuV/m	dB	dBuV	dB	dB	dB/m	deg	cm		
1	157.12	35.07	43.50	-8.43	48.91	1.49	27.31	11.98	322	172	QP	HORIZONTAL
2	159.12	36.54	43.50	-6.96	50.34	1.50	27.31	12.01	319	169	QP	HORIZONTAL
3	164.41	40.19	43.50	-3.31	53.56	1.52	27.28	12.39	201	179	QP	HORIZONTAL
4	168.71	40.47	43.50	-3.03	53.50	1.54	27.25	12.68	202	174	QP	HORIZONTAL
5	180.00	39.04	43.50	-4.46	51.50	1.60	27.20	13.14	209	185	QP	HORIZONTAL
6	237.58	39.93	46.00	-6.07	53.26	1.85	27.02	11.84	0	100	Peak	HORIZONTAL
7	480.08	42.79	46.00	-3.21	50.82	2.66	28.00	17.31	0	100	Peak	HORIZONTAL
8	719.67	37.08	46.00	-8.92	42.40	3.38	27.92	19.22	0	100	Peak	HORIZONTAL
9	999.03	40.06	54.00	-13.94	42.09	3.70	27.01	21.28	0	100	Peak	HORIZONTAL

Vertical

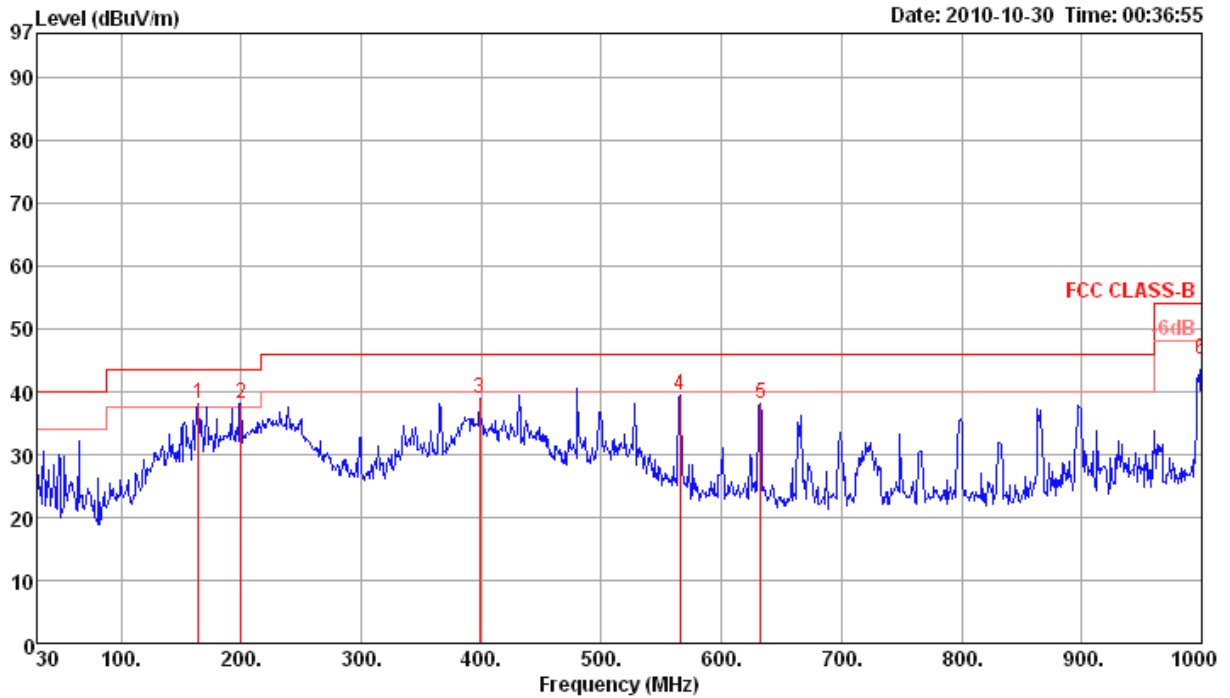

	Freq	Level	Limit	Over	Read	Cable	Preamp	Antenna	T/Pos	A/Pos	Remark	Pol/Phase
	MHz	dBuV/m	dBuV/m	dB	dBuV	dB	dB	dB/m	deg	cm		
1	164.83	38.15	43.50	-5.35	51.51	1.52	27.27	12.39	0	400	Peak	VERTICAL
2	199.75	38.02	43.50	-5.48	54.37	1.70	27.10	9.05	0	400	Peak	VERTICAL
3	398.60	38.81	46.00	-7.19	48.07	2.30	27.59	16.03	0	400	Peak	VERTICAL
4	565.44	39.42	46.00	-6.58	46.32	2.83	28.10	18.37	0	400	Peak	VERTICAL
5	632.37	38.18	46.00	-7.82	44.29	3.09	28.07	18.87	0	400	Peak	VERTICAL
6	1000.00	45.04	54.00	-8.96	47.05	3.70	27.00	21.29	0	400	Peak	VERTICAL

Note:

The amplitude of spurious emissions which are attenuated by more than 20dB below the permissible value has no need to be reported.

Corrected Reading: Antenna Factor + Cable Loss + Read Level - Preamp Factor = Level.

<For Main Source – Mode 2 with PIFA Antenna>:

Temperature	24.5°C	Humidity	57%
Test Engineer	Satoshi Yang	Configurations	Normal Link

Horizontal

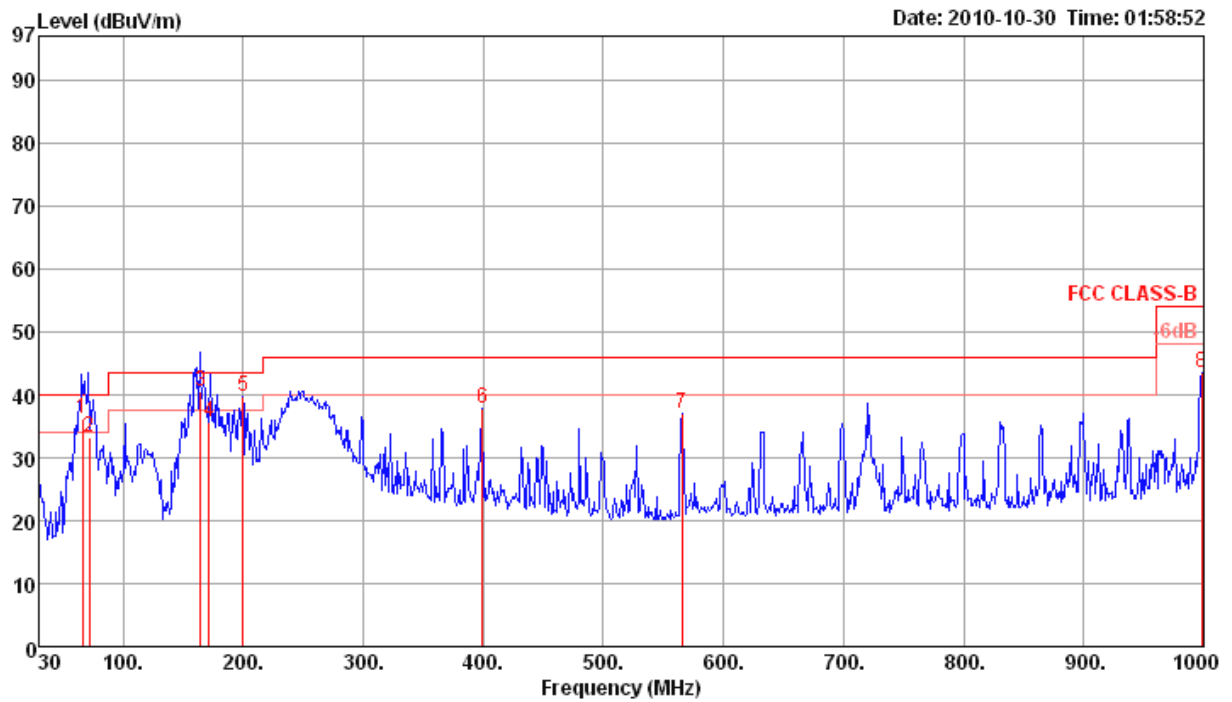

	Freq	Level	Line	Limit	Level	able	Preamp	Antenna	T/Pos	A/Pos	Remark	Pol/Phase
	MHz	dBuV/m	dBuV/m	dB	dBuV	Loss	Factor	Factor	deg	cm		
1	66.46	36.17	40.00	-3.83	56.36	0.86	27.73	6.68	193	274	QP	HORIZONTAL
2	72.00	33.26	40.00	-6.74	53.39	0.84	27.71	6.74	193	274	QP	HORIZONTAL
3	164.40	40.55	43.50	-2.95	53.99	1.52	27.28	12.32	202	178	QP	HORIZONTAL
4	172.00	35.57	43.50	-7.93	48.27	1.56	27.23	12.97	202	174	QP	HORIZONTAL
5	199.75	39.66	43.50	-3.84	56.01	1.70	27.10	9.05	0	100	Peak	HORIZONTAL
6	399.57	37.93	46.00	-8.07	47.17	2.30	27.60	16.06	0	100	Peak	HORIZONTAL
7	565.44	36.94	46.00	-9.06	43.84	2.83	28.10	18.37	0	100	Peak	HORIZONTAL
8	998.06	43.63	54.00	-10.37	45.66	3.70	27.01	21.28	0	100	Peak	HORIZONTAL

Vertical

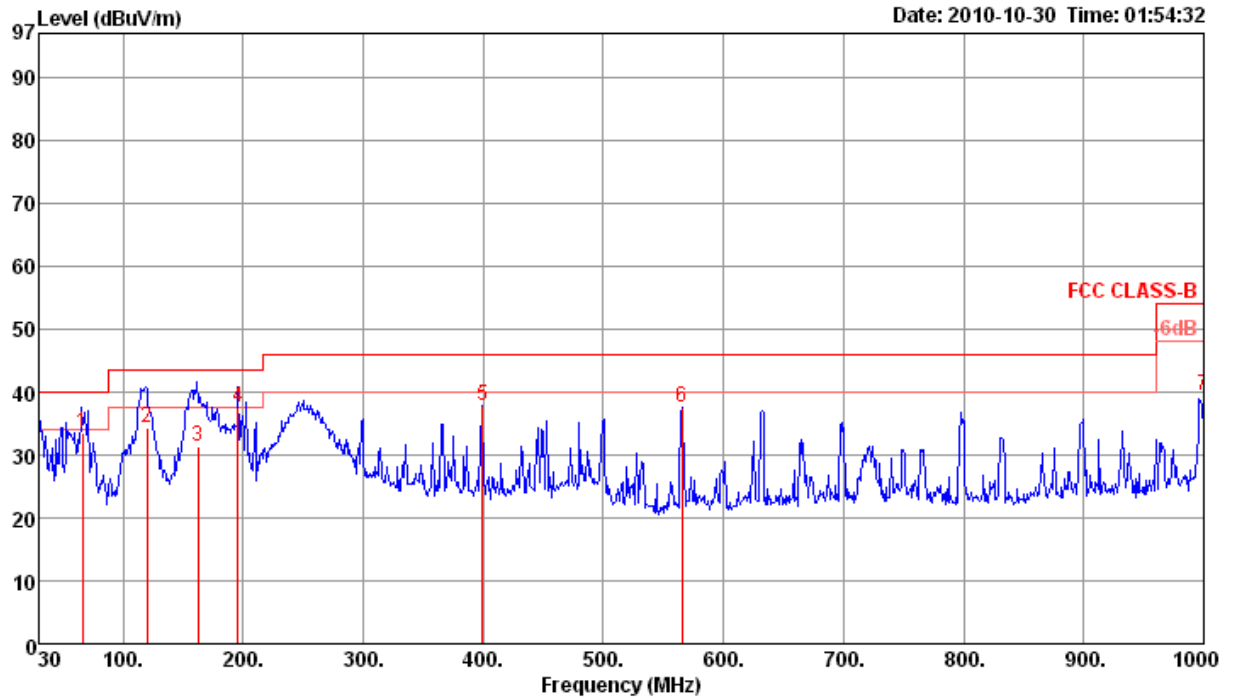

	Freq	Level	Limit	Over	Read	Cable	Preamp	Antenna	T/Pos	A/Pos	Remark	Pol/Phase
	MHz	dBuV/m	dBuV/m	dB	dBuV	dB	dB	dB/m	deg	cm		
1	66.46	33.39	40.00	-6.61	53.56	0.88	27.74	6.69	193	274	QP	VERTICAL
2	120.00	34.37	43.50	-9.13	48.21	1.20	27.50	12.46	201	169	QP	VERTICAL
3	162.33	31.41	43.50	-12.09	45.01	1.51	27.29	12.18	203	174	QP	VERTICAL
4	196.01	37.54	43.50	-5.96	53.11	1.68	27.12	9.87	203	175	QP	VERTICAL
5	399.57	37.72	46.00	-8.28	46.96	2.30	27.60	16.06	0	400	Peak	VERTICAL
6	565.44	37.44	46.00	-8.56	44.34	2.83	28.10	18.37	0	400	Peak	VERTICAL
7	1000.00	39.34	54.00	-14.66	41.35	3.70	27.00	21.29	0	400	Peak	VERTICAL

Note:

The amplitude of spurious emissions which are attenuated by more than 20dB below the permissible value has no need to be reported.

Corrected Reading: Antenna Factor + Cable Loss + Read Level - Preamp Factor = Level.

<For Second Source – Mode 1 with Printed Antenna>:

Temperature	24.5°C	Humidity	57%
Test Engineer	Satoshi Yang	Configurations	Normal Link

Horizontal

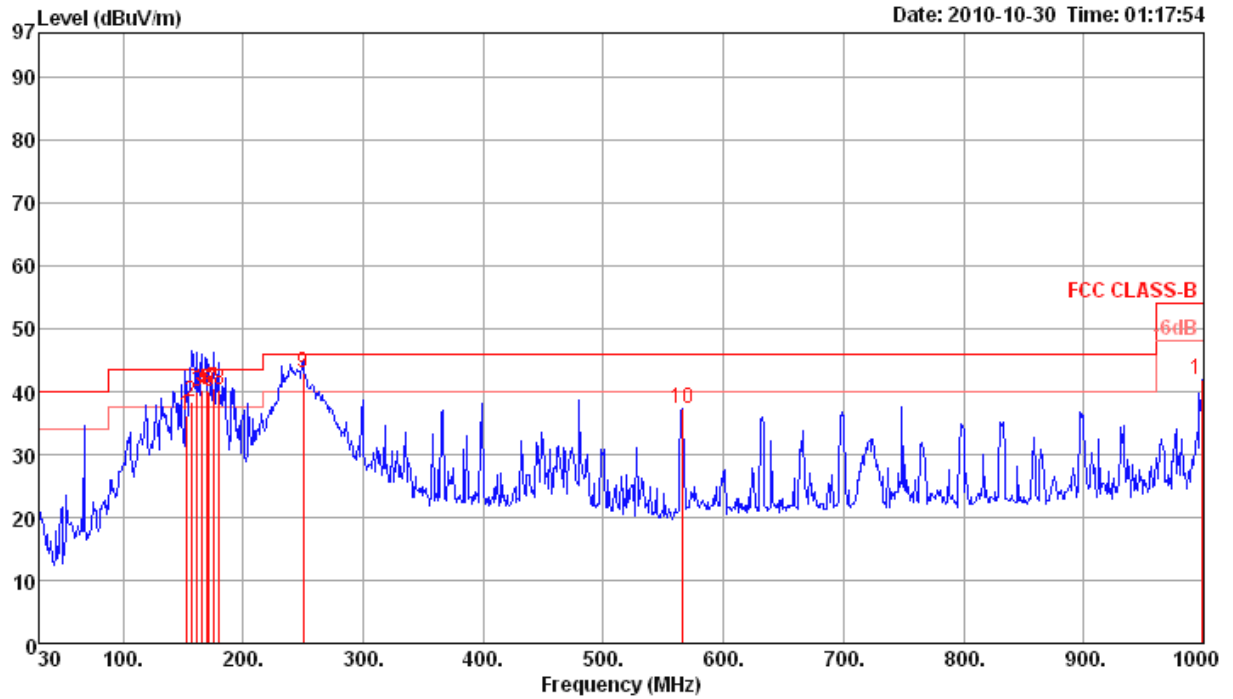

	Freq	Level	Limit	Over	Read	Cable	Preamp	Antenna	T/Pos	A/Pos	Remark	Pol/Phase
	MHz	dBuV/m	dBuV/m	dB	dBuV	dB	dB	dB/m	deg	cm		
1	152.50	36.21	43.50	-7.29	50.20	1.46	27.34	11.89	206	172	QP	HORIZONTAL
2	157.25	38.25	43.50	-5.25	52.09	1.49	27.31	11.98	212	168	QP	HORIZONTAL
3	162.00	39.89	43.50	-3.61	53.49	1.51	27.29	12.18	304	165	QP	HORIZONTAL
4	166.00	40.32	43.50	-3.18	53.59	1.53	27.27	12.47	342	165	QP	HORIZONTAL
5	169.50	40.15	43.50	-3.35	53.09	1.55	27.25	12.76	326	167	QP	HORIZONTAL
6	172.00	40.02	43.50	-3.48	52.80	1.56	27.24	12.90	305	182	QP	HORIZONTAL
7	175.50	40.48	43.50	-3.02	53.00	1.58	27.22	13.12	348	157	Peak	HORIZONTAL
8	180.00	40.33	43.50	-3.17	52.79	1.60	27.20	13.14	331	164	QP	HORIZONTAL
9	250.00	42.97	46.00	-3.03	55.30	1.90	27.00	12.77	304	173	QP	HORIZONTAL
10	565.44	37.39	46.00	-8.61	44.29	2.83	28.10	18.37	0	400	Peak	HORIZONTAL
11	999.03	41.91	54.00	-12.09	43.94	3.70	27.01	21.28	0	400	Peak	HORIZONTAL

Vertical

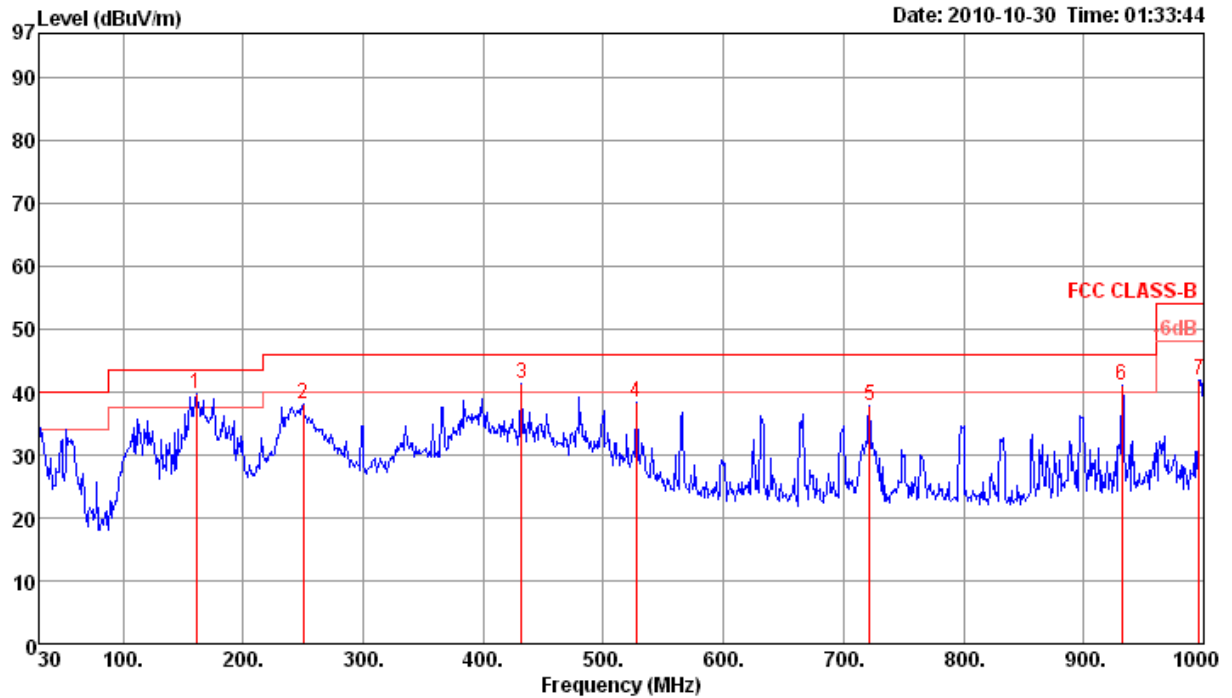

	Freq	Level	Limit	Over	Read	Cable	Preamp	Antenna	T/Pos	A/Pos	Remark	Pol/Phase
	MHz	dBuV/m	dBuV/m	dB	dBuV	dB	dB	dB/m	deg	cm		
1	p	160.95	39.85	43.50	-3.65	53.54	1.50	27.29	12.10	0	400 Peak	VERTICAL
2		250.19	38.17	46.00	-7.83	50.50	1.90	27.00	12.77	0	400 Peak	VERTICAL
3	!	431.58	41.41	46.00	-4.59	50.12	2.49	27.76	16.56	0	400 Peak	VERTICAL
4		527.61	38.26	46.00	-7.74	45.67	2.75	28.10	17.94	0	400 Peak	VERTICAL
5		721.61	37.84	46.00	-8.16	43.12	3.39	27.91	19.24	0	400 Peak	VERTICAL
6	!	932.10	41.09	46.00	-4.91	43.99	3.60	27.27	20.77	0	400 Peak	VERTICAL
7		996.12	42.01	54.00	-11.99	44.08	3.69	27.02	21.26	0	400 Peak	VERTICAL

Note:

The amplitude of spurious emissions which are attenuated by more than 20dB below the permissible value has no need to be reported.

Corrected Reading: Antenna Factor + Cable Loss + Read Level - Preamp Factor = Level.

<For Second Source – Mode 2 with PIFA Antenna>:

Temperature	24.5°C	Humidity	57%
Test Engineer	Satoshi Yang	Configurations	Normal Link

Horizontal

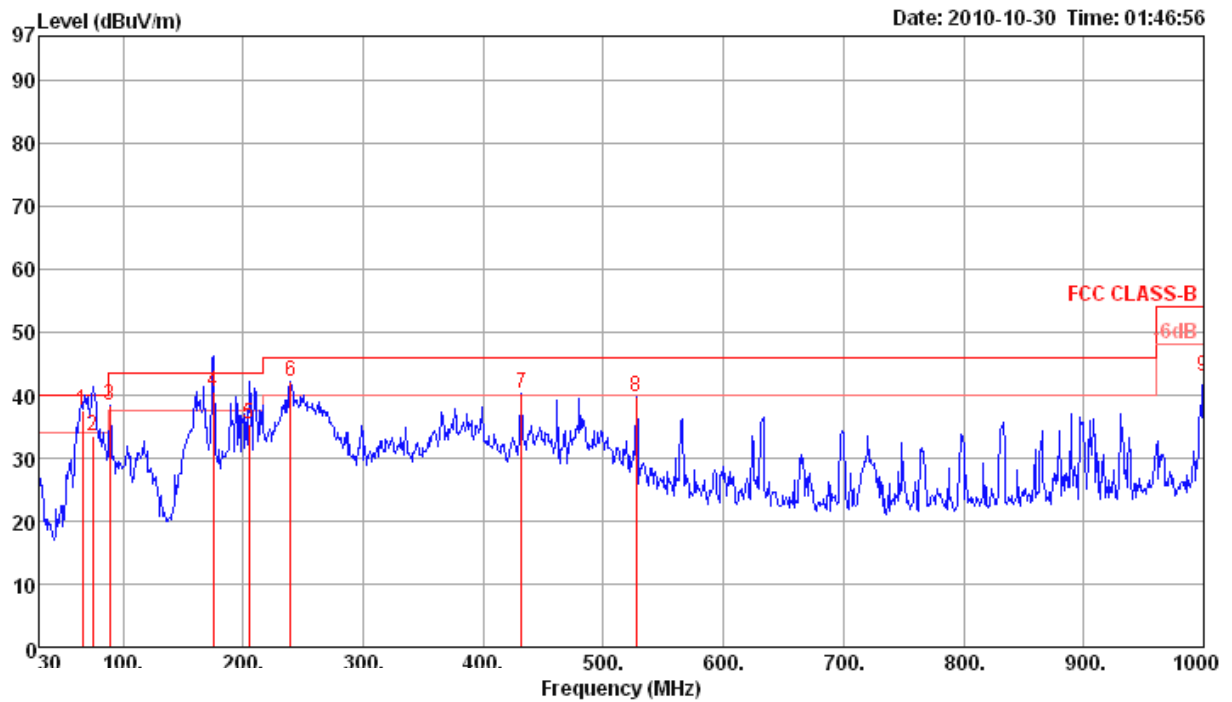

	Freq	Level	Limit	Over	Read	Cable	Preamp	Antenna	T/Pos	A/Pos	Remark	Pol/Phase
	MHz	dBuV/m	dBuV/m	dB	dBuV	dB	dB	dB/m	deg	cm		
1	q	66.46	37.50	40.00	-2.50	57.67	0.88	27.74	6.69	193	274 QP	HORIZONTAL
2		75.00	33.63	40.00	-6.37	53.55	0.90	27.70	6.88	193	274 QP	HORIZONTAL
3	!	89.17	38.48	43.50	-5.02	56.23	1.10	27.65	8.80	0	100 Peak	HORIZONTAL
4	!	175.00	40.63	43.50	-2.87	53.15	1.58	27.22	13.12	202	179 QP	HORIZONTAL
5		205.12	35.37	43.50	-8.13	51.26	1.72	27.09	9.48	209	185 QP	HORIZONTAL
6	p	239.52	42.20	46.00	-3.80	55.38	1.86	27.02	11.98	0	100 Peak	HORIZONTAL
7	!	431.58	40.18	46.00	-5.82	48.89	2.49	27.76	16.56	0	100 Peak	HORIZONTAL
8		527.61	39.69	46.00	-6.31	47.10	2.75	28.10	17.94	0	100 Peak	HORIZONTAL
9		1000.00	43.07	54.00	-10.93	45.08	3.70	27.00	21.29	0	100 Peak	HORIZONTAL

Vertical

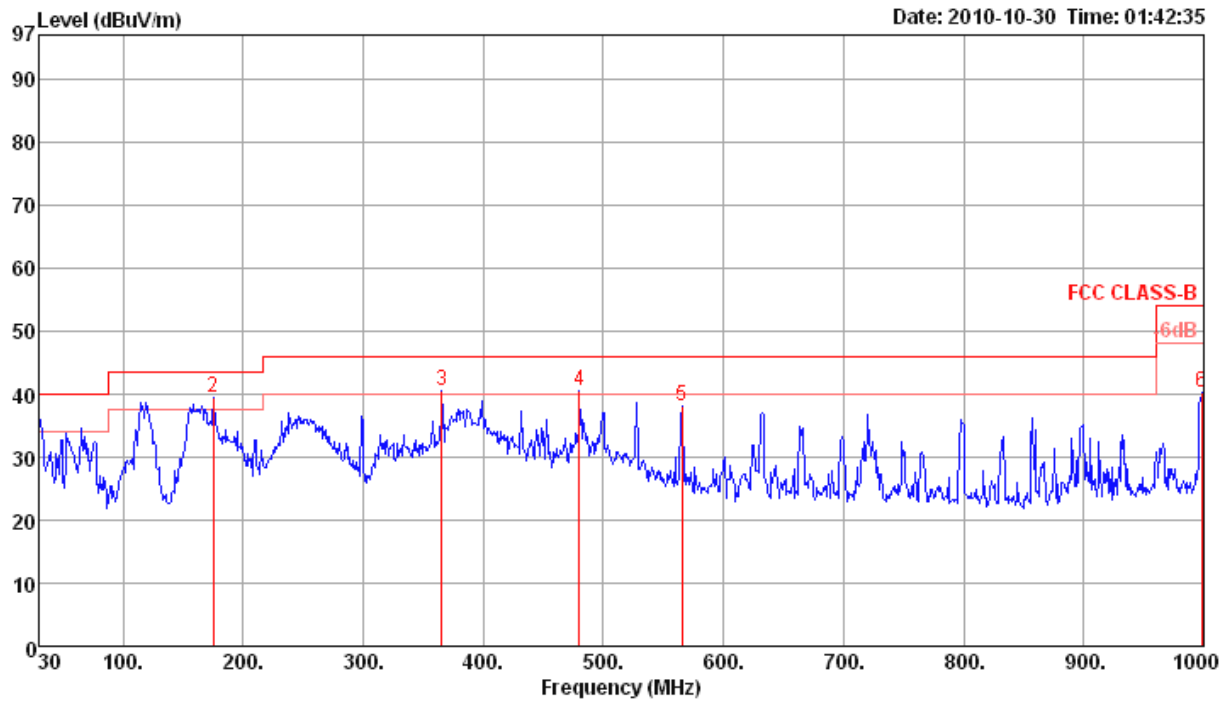

	Freq	Level	Limit	Over	Read	Cable	Preamp	Antenna	T/Pos	A/Pos	Remark	Pol/Phase
	MHz	dBuV/m	dBuV/m	dB	dBuV	dB	dB	dB/m	deg	cm		
1	30.00	36.74	40.00	-3.26	45.28	0.50	27.80	18.76	0	400	Peak	VERTICAL
2	175.50	39.44	43.50	-4.06	51.96	1.58	27.22	13.12	0	400	Peak	VERTICAL
3	365.62	40.57	46.00	-5.43	50.56	2.23	27.36	15.14	0	400	Peak	VERTICAL
4	480.08	40.50	46.00	-5.50	48.53	2.66	28.00	17.31	0	400	Peak	VERTICAL
5	565.44	38.16	46.00	-7.84	45.06	2.83	28.10	18.37	0	400	Peak	VERTICAL
6	998.06	40.23	54.00	-13.77	42.26	3.70	27.01	21.28	0	400	Peak	VERTICAL

Note:

The amplitude of spurious emissions which are attenuated by more than 20dB below the permissible value has no need to be reported.

Corrected Reading: Antenna Factor + Cable Loss + Read Level - Preamp Factor = Level.

4.5.9. Results for Radiated Emissions (1GHz~10th Harmonic)

<For Main Source – Mode 1 with Printed Antenna>:

Temperature	24.5°C	Humidity	57%
Test Engineer	Satoshi Yang	Configurations	IEEE 802.11n MCS0 20MHz Ch 1 / Mode 1
Test Date	Oct. 21, 2010		

Horizontal

	Freq	Level	Limit Line	Over Limit	Read Level	CableAntenna Loss	Antenna Factor	Preamp Factor	T/Pos	A/Pos	Remark	Pol/Phase
	MHz	dBuV/m	dBuV/m	dB	dBuV	dB	dB/m	dB	deg	cm		
1	4823.53	43.96	74.00	-30.04	42.62	3.31	33.06	35.03	331	100	Peak	HORIZONTAL
2	4823.97	32.65	54.00	-21.35	31.31	3.31	33.06	35.03	331	100	Average	HORIZONTAL

Vertical

	Freq	Level	Limit Line	Over Limit	Read Level	CableAntenna Loss	Antenna Factor	Preamp Factor	T/Pos	A/Pos	Remark	Pol/Phase
	MHz	dBuV/m	dBuV/m	dB	dBuV	dB	dB/m	dB	deg	cm		
1	4823.99	31.73	54.00	-22.27	30.39	3.31	33.06	35.03	263	100	Average	VERTICAL
2	4824.04	43.79	74.00	-30.21	42.45	3.31	33.06	35.03	263	100	Peak	VERTICAL

Temperature	24.5°C	Humidity	57%
Test Engineer	Satoshi Yang	Configurations	IEEE 802.11n MCS0 20MHz Ch 6 / Mode 1
Test Date	Oct. 21, 2010		

Horizontal

	Freq	Level	Limit Line	Over Limit	Read Level	CableAntenna Loss	Antenna Factor	Preamp Factor	T/Pos	A/Pos	Remark	Pol/Phase
	MHz	dBuV/m	dBuV/m	dB	dBuV	dB	dB/m	dB	deg	cm		
1	4873.29	47.83	74.00	-26.17	46.37	3.33	33.16	35.03	333	100	Peak	HORIZONTAL
2	4874.00	33.93	54.00	-20.07	32.47	3.33	33.16	35.03	333	100	Average	HORIZONTAL

Vertical

	Freq	Level	Limit Line	Over Limit	Read Level	CableAntenna Loss	Antenna Factor	Preamp Factor	T/Pos	A/Pos	Remark	Pol/Phase
	MHz	dBuV/m	dBuV/m	dB	dBuV	dB	dB/m	dB	deg	cm		
1	4873.99	31.97	54.00	-22.03	30.51	3.33	33.16	35.03	270	100	Average	VERTICAL
2	4874.15	44.71	74.00	-29.29	43.25	3.33	33.16	35.03	270	100	Peak	VERTICAL

Temperature	24.5°C	Humidity	57%
Test Engineer	Satoshi Yang	Configurations	IEEE 802.11n MCS0 20MHz Ch11 / Mode 1
Test Date	Oct. 21, 2010		

Horizontal

	Freq	Level	Limit Line	Over Limit	Read Level	CableAntenna Loss	Antenna Factor	Preamp Factor	T/Pos	A/Pos	Remark	Pol/Phase
	MHz	dBuV/m	dBuV/m	dB	dBuV	dB	dB/m	dB	deg	cm		
1	4924.03	32.67	54.00	-21.33	31.07	3.35	33.26	35.01	225	100	Average	HORIZONTAL
2	4924.18	45.00	74.00	-29.00	43.40	3.35	33.26	35.01	225	100	Peak	HORIZONTAL

Vertical

	Freq	Level	Limit Line	Over Limit	Read Level	CableAntenna Loss	Antenna Factor	Preamp Factor	T/Pos	A/Pos	Remark	Pol/Phase
	MHz	dBuV/m	dBuV/m	dB	dBuV	dB	dB/m	dB	deg	cm		
1	4924.00	31.08	54.00	-22.92	29.48	3.35	33.26	35.01	267	100	Average	VERTICAL
2	4924.10	44.33	74.00	-29.67	42.73	3.35	33.26	35.01	267	100	Peak	VERTICAL

Temperature	24.5°C	Humidity	57%
Test Engineer	Satoshi Yang	Configurations	IEEE 802.11n MCS0 40MHz Ch 3 / Mode 1
Test Date	Oct. 21, 2010		

Horizontal

	Freq	Level	Limit	Over	Read	CableAntenna	Preamp	T/Pos	A/Pos	Remark	Pol/Phase
	MHz	dBuV/m	dBuV/m	dB	dBuV	dB	dB/m	deg	cm		
1	4844.00	34.85	54.00	-19.15	33.47	3.32	33.09	35.03	214	100 Average	HORIZONTAL
2	4844.03	46.37	74.00	-27.63	44.99	3.32	33.09	35.03	214	100 Peak	HORIZONTAL

Vertical

	Freq	Level	Limit	Over	Read	CableAntenna	Preamp	T/Pos	A/Pos	Remark	Pol/Phase
	MHz	dBuV/m	dBuV/m	dB	dBuV	dB	dB/m	deg	cm		
1	4844.00	32.76	54.00	-21.24	31.38	3.32	33.09	35.03	99	103 Average	VERTICAL
2	4844.15	44.60	74.00	-29.40	43.22	3.32	33.09	35.03	99	103 Peak	VERTICAL

Temperature	24.5°C	Humidity	57%
Test Engineer	Satoshi Yang	Configurations	IEEE 802.11n MCS0 40MHz Ch 6 / Mode 1
Test Date	Oct. 21, 2010		

Horizontal

	Freq	Level	Limit Line	Over Limit	Read Level	Cable Loss	Preamp Factor	Antenna Factor	A/Pos	T/Pos	Remark	Pol/Phase
	MHz	dBuV/m	dBuV/m	dB	dBuV	dB	dB	dB/m	cm	deg		
1 p	4873.86	46.08	74.00	-27.92	45.66	3.01	35.15	32.56	100	198	Peak	HORIZONTAL
2 a	4874.03	35.13	54.00	-18.87	34.71	3.01	35.15	32.56	100	198	Average	HORIZONTAL

Vertical

	Freq	Level	Limit Line	Over Limit	Read Level	Cable Loss	Preamp Factor	Antenna Factor	A/Pos	T/Pos	Remark	Pol/Phase
	MHz	dBuV/m	dBuV/m	dB	dBuV	dB	dB	dB/m	cm	deg		
1 p	4874.06	43.20	74.00	-30.80	42.78	3.01	35.15	32.56	100	270	Peak	VERTICAL
2 a	4874.07	30.17	54.00	-23.83	29.75	3.01	35.15	32.56	100	270	Average	VERTICAL

Temperature	24.5°C	Humidity	57%
Test Engineer	Satoshi Yang	Configurations	IEEE 802.11n MCS0 40MHz Ch 9 / Mode 1
Test Date	Oct. 21, 2010		

Horizontal

	Freq	Level	Limit Line	Over Limit	Read Level	CableAntenna Loss	Antenna Factor	Preamp Factor	T/Pos	A/Pos	Remark	Pol/Phase
	MHz	dBuV/m	dBuV/m	dB	dBuV	dB	dB/m	dB	deg	cm		
1	4904.00	33.79	54.00	-20.21	32.28	3.34	33.19	35.02	332	100	Average	HORIZONTAL
2	4904.15	45.15	74.00	-28.85	43.64	3.34	33.19	35.02	332	100	Peak	HORIZONTAL

Vertical

	Freq	Level	Limit Line	Over Limit	Read Level	CableAntenna Loss	Antenna Factor	Preamp Factor	T/Pos	A/Pos	Remark	Pol/Phase
	MHz	dBuV/m	dBuV/m	dB	dBuV	dB	dB/m	dB	deg	cm		
1	4903.72	45.72	74.00	-28.28	44.21	3.34	33.19	35.02	150	102	Peak	VERTICAL
2	4904.00	33.92	54.00	-20.08	32.41	3.34	33.19	35.02	150	102	Average	VERTICAL

Note:

The amplitude of spurious emissions which are attenuated by more than 20 dB below the permissible value has no need to be reported.

Emission level (dBuV/m) = 20 log Emission level (uV/m).

Corrected Reading: Antenna Factor + Cable Loss + Read Level - Preamp Factor = Level.

Temperature	24.5°C	Humidity	57%
Test Engineer	Satoshi Yang	Configurations	IEEE 802.11b CH 1 / Mode 1
Test Date	Oct. 21, 2010		

Horizontal

	Freq	Level	Limit Line	Over Limit	Read Level	CableAntenna Loss	Antenna Factor	Preamp Factor	T/Pos	A/Pos	Remark	Pol/Phase
	MHz	dBuV/m	dBuV/m	dB	dBuV	dB	dB/m	dB	deg	cm		
1	4824.01	50.25	74.00	-23.75	48.91	3.31	33.06	35.03	28	158	Peak	HORIZONTAL
2	4824.01	46.86	54.00	-7.14	45.52	3.31	33.06	35.03	28	158	Average	HORIZONTAL

Vertical

	Freq	Level	Limit Line	Over Limit	Read Level	CableAntenna Loss	Antenna Factor	Preamp Factor	T/Pos	A/Pos	Remark	Pol/Phase
	MHz	dBuV/m	dBuV/m	dB	dBuV	dB	dB/m	dB	deg	cm		
1	4823.98	47.58	74.00	-26.42	46.24	3.31	33.06	35.03	270	100	Peak	VERTICAL
2	4824.00	42.49	54.00	-11.51	41.15	3.31	33.06	35.03	270	100	Average	VERTICAL

Temperature	24.5°C	Humidity	57%
Test Engineer	Satoshi Yang	Configurations	IEEE 802.11b CH 6 / Mode 1
Test Date	Oct. 21, 2010		

Horizontal

	Freq	Level	Limit Line	Over Limit	Read Level	CableAntenna Loss	Antenna Factor	Preamp Factor	T/Pos	A/Pos	Remark	Pol/Phase
	MHz	dBuV/m	dBuV/m	dB	dBuV	dB	dB/m	dB	deg	cm		
1	4874.00	52.64	74.00	-21.36	51.18	3.33	33.16	35.03	16	153	Peak	HORIZONTAL
2	4874.01	49.74	54.00	-4.26	48.28	3.33	33.16	35.03	16	153	Average	HORIZONTAL

Vertical

	Freq	Level	Limit Line	Over Limit	Read Level	CableAntenna Loss	Antenna Factor	Preamp Factor	T/Pos	A/Pos	Remark	Pol/Phase
	MHz	dBuV/m	dBuV/m	dB	dBuV	dB	dB/m	dB	deg	cm		
1	4874.02	46.02	54.00	-7.98	44.56	3.33	33.16	35.03	264	158	Average	VERTICAL
2	4874.02	49.87	74.00	-24.13	48.41	3.33	33.16	35.03	264	158	Peak	VERTICAL

Temperature	24.5°C	Humidity	57%
Test Engineer	Satoshi Yang	Configurations	IEEE 802.11b CH 11 / Mode 1
Test Date	Oct. 21, 2010		

Horizontal

	Freq	Level	Limit Line	Over Limit	Read Level	CableAntenna Loss	Antenna Factor	Preamp Factor	T/Pos	A/Pos	Remark	Pol/Phase
	MHz	dBuV/m	dBuV/m	dB	dBuV	dB	dB/m	dB	deg	cm		
1	4923.95	49.82	74.00	-24.18	48.22	3.35	33.26	35.01	218	100	Peak	HORIZONTAL
2	4924.02	46.01	54.00	-7.99	44.41	3.35	33.26	35.01	218	100	Average	HORIZONTAL

Vertical

	Freq	Level	Limit Line	Over Limit	Read Level	CableAntenna Loss	Antenna Factor	Preamp Factor	T/Pos	A/Pos	Remark	Pol/Phase
	MHz	dBuV/m	dBuV/m	dB	dBuV	dB	dB/m	dB	deg	cm		
1	4923.97	48.62	74.00	-25.38	47.02	3.35	33.26	35.01	325	103	Peak	VERTICAL
2	4924.00	43.38	54.00	-10.62	41.78	3.35	33.26	35.01	325	103	Average	VERTICAL

Temperature	24.5°C	Humidity	57%
Test Engineer	Satoshi Yang	Configurations	IEEE 802.11g CH 1 / Mode 1
Test Date	Oct. 21, 2010		

Horizontal

	Freq	Level	Limit Line	Over Limit	Read Level	CableAntenna Loss	Antenna Factor	Preamp Factor	T/Pos	A/Pos	Remark	Pol/Phase
	MHz	dBuV/m	dBuV/m	dB	dBuV	dB	dB/m	dB	deg	cm		
1	4824.02	35.55	54.00	-18.45	34.21	3.31	33.06	35.03	206	100	Average	HORIZONTAL
2	4824.11	47.21	74.00	-26.79	45.87	3.31	33.06	35.03	206	100	Peak	HORIZONTAL

Vertical

	Freq	Level	Limit Line	Over Limit	Read Level	CableAntenna Loss	Antenna Factor	Preamp Factor	T/Pos	A/Pos	Remark	Pol/Phase
	MHz	dBuV/m	dBuV/m	dB	dBuV	dB	dB/m	dB	deg	cm		
1	4824.00	33.42	54.00	-20.58	32.08	3.31	33.06	35.03	269	103	Average	VERTICAL
2	4824.58	44.65	74.00	-29.35	43.31	3.31	33.06	35.03	269	103	Peak	VERTICAL

Temperature	24.5°C	Humidity	57%
Test Engineer	Satoshi Yang	Configurations	IEEE 802.11g CH 6 / Mode 1
Test Date	Oct. 21, 2010		

Horizontal

	Freq	Level	Limit Line	Over Limit	Read Level	CableAntenna Loss	Antenna Factor	Preamp Factor	T/Pos	A/Pos	Remark	Pol/Phase
	MHz	dBuV/m	dBuV/m	dB	dBuV	dB	dB/m	dB	deg	cm		
1	4874.07	34.41	54.00	-19.59	32.95	3.33	33.16	35.03	223	100	Average	HORIZONTAL
2	4874.52	47.05	74.00	-26.95	45.59	3.33	33.16	35.03	223	100	Peak	HORIZONTAL

Vertical

	Freq	Level	Limit Line	Over Limit	Read Level	CableAntenna Loss	Antenna Factor	Preamp Factor	T/Pos	A/Pos	Remark	Pol/Phase
	MHz	dBuV/m	dBuV/m	dB	dBuV	dB	dB/m	dB	deg	cm		
1	4873.98	45.96	74.00	-28.04	44.50	3.33	33.16	35.03	100	117	Peak	VERTICAL
2	4874.00	33.15	54.00	-20.85	31.69	3.33	33.16	35.03	100	117	Average	VERTICAL

Temperature	24.5°C	Humidity	57%
Test Engineer	Satoshi Yang	Configurations	IEEE 802.11g CH 11 / Mode 1
Test Date	Oct. 21, 2010		

Horizontal

	Freq	Level	Limit	Over	Read	CableAntenna	Preamp	T/Pos	A/Pos	Remark	Pol/Phase
	MHz	dBuV/m	dBuV/m	dB	dBuV	dB	dB/m	dB	deg	cm	
1	4924.02	33.01	54.00	-20.99	31.41	3.35	33.26	35.01	219	100 Average	HORIZONTAL
2	4924.82	45.41	74.00	-28.59	43.81	3.35	33.26	35.01	219	100 Peak	HORIZONTAL

Vertical

	Freq	Level	Limit	Over	Read	CableAntenna	Preamp	T/Pos	A/Pos	Remark	Pol/Phase
	MHz	dBuV/m	dBuV/m	dB	dBuV	dB	dB/m	dB	deg	cm	
1	4924.03	31.24	54.00	-22.76	29.64	3.35	33.26	35.01	269	100 Average	VERTICAL
2	4924.27	44.09	74.00	-29.91	42.49	3.35	33.26	35.01	269	100 Peak	VERTICAL

Note:

The amplitude of spurious emissions that are attenuated by more than 20dB below the permissible value has no need to be reported.

Emission level (dBuV/m) = 20 log Emission level (uV/m).

Corrected Reading: Antenna Factor + Cable Loss + Read Level - Preamp Factor = Level.

<For Main Source – Mode 2 with PIFA Antenna>:

Temperature	24.5°C	Humidity	57%
Test Engineer	Satoshi Yang	Configurations	IEEE 802.11n MCS0 20MHz Ch 1 / Mode 2
Test Date	Oct. 13, 2010		

Horizontal

	Freq	Level	Limit Line	Over Limit	Read Level	CableAntenna Loss	Antenna Factor	Preamp Factor	T/Pos	A/Pos	Remark	Pol/Phase
	MHz	dBuV/m	dBuV/m	dB	dBuV	dB	dB/m	dB	deg	cm		
1	4822.43	46.12	74.00	-27.88	45.63	2.46	33.06	35.03	110	100	Peak	HORIZONTAL
2	4822.94	31.50	54.00	-22.50	31.01	2.46	33.06	35.03	110	100	Average	HORIZONTAL

Vertical

	Freq	Level	Limit Line	Over Limit	Read Level	CableAntenna Loss	Antenna Factor	Preamp Factor	T/Pos	A/Pos	Remark	Pol/Phase
	MHz	dBuV/m	dBuV/m	dB	dBuV	dB	dB/m	dB	deg	cm		
1	4823.93	33.54	54.00	-20.46	33.05	2.46	33.06	35.03	44	100	Average	VERTICAL
2	4824.21	48.48	74.00	-25.52	47.99	2.46	33.06	35.03	44	100	Peak	VERTICAL

Temperature	24.5°C	Humidity	57%
Test Engineer	Satoshi Yang	Configurations	IEEE 802.11n MCS0 20MHz Ch 6 / Mode 2
Test Date	Oct. 13, 2010		

Horizontal

	Freq	Level	Limit Line	Over Limit	Read Level	CableAntenna Loss	Antenna Factor	Preamp Factor	T/Pos	A/Pos	Remark	Pol/Phase
	MHz	dBuV/m	dBuV/m	dB	dBuV	dB	dB/m	dB	deg	cm		
1	4873.36	49.19	74.00	-24.81	48.59	2.47	33.16	35.03	106	100	Peak	HORIZONTAL
2	4873.62	34.10	54.00	-19.90	33.50	2.47	33.16	35.03	106	100	Average	HORIZONTAL

Vertical

	Freq	Level	Limit Line	Over Limit	Read Level	CableAntenna Loss	Antenna Factor	Preamp Factor	T/Pos	A/Pos	Remark	Pol/Phase
	MHz	dBuV/m	dBuV/m	dB	dBuV	dB	dB/m	dB	deg	cm		
1	4873.71	34.59	54.00	-19.41	33.99	2.47	33.16	35.03	40	100	Average	VERTICAL
2	4874.49	49.32	74.00	-24.68	48.72	2.47	33.16	35.03	40	100	Peak	VERTICAL

Temperature	24.5°C	Humidity	57%
Test Engineer	Satoshi Yang	Configurations	IEEE 802.11n MCS0 20MHz Ch11 / Mode 2
Test Date	Oct. 13, 2010		

Horizontal

	Freq	Level	Limit Line	Over Limit	Read Level	CableAntenna Loss	Antenna Factor	Preamp Factor	T/Pos	A/Pos	Remark	Pol/Phase
	MHz	dBuV/m	dBuV/m	dB	dBuV	dB	dB/m	dB	deg	cm		
1	4924.12	43.02	74.00	-30.98	42.30	2.47	33.26	35.01	107	100	Peak	HORIZONTAL
2	4924.13	30.00	54.00	-24.00	29.28	2.47	33.26	35.01	107	100	Average	HORIZONTAL

Vertical

	Freq	Level	Limit Line	Over Limit	Read Level	CableAntenna Loss	Antenna Factor	Preamp Factor	T/Pos	A/Pos	Remark	Pol/Phase
	MHz	dBuV/m	dBuV/m	dB	dBuV	dB	dB/m	dB	deg	cm		
1	4924.06	31.21	54.00	-22.79	30.49	2.47	33.26	35.01	33	100	Average	VERTICAL
2	4924.11	42.79	74.00	-31.21	42.07	2.47	33.26	35.01	33	100	Peak	VERTICAL

Temperature	24.5°C	Humidity	57%
Test Engineer	Satoshi Yang	Configurations	IEEE 802.11n MCS0 40MHz Ch 3 / Mode 2
Test Date	Oct. 13, 2010		

Horizontal

	Freq	Level	Limit Line	Over Limit	Read Level	CableAntenna Loss	Antenna Factor	Preamp Factor	T/Pos	A/Pos	Remark	Pol/Phase
	MHz	dBuV/m	dBuV/m	dB	dBuV	dB	dB/m	dB	deg	cm		
1	4842.75	42.75	74.00	-31.25	42.23	2.46	33.09	35.03	112	100	Peak	HORIZONTAL
2	4843.94	30.57	54.00	-23.43	30.05	2.46	33.09	35.03	112	100	Average	HORIZONTAL

Vertical

	Freq	Level	Limit Line	Over Limit	Read Level	CableAntenna Loss	Antenna Factor	Preamp Factor	T/Pos	A/Pos	Remark	Pol/Phase
	MHz	dBuV/m	dBuV/m	dB	dBuV	dB	dB/m	dB	deg	cm		
1	4844.01	30.85	54.00	-23.15	30.33	2.46	33.09	35.03	28	100	Average	VERTICAL
2	4846.22	41.98	74.00	-32.02	41.46	2.46	33.09	35.03	28	100	Peak	VERTICAL

Temperature	24.5°C	Humidity	57%
Test Engineer	Satoshi Yang	Configurations	IEEE 802.11n MCS0 40MHz Ch 6 / Mode 2
Test Date	Oct. 13, 2010		

Horizontal

	Freq	Level	Limit Line	Over Limit	Read Level	CableAntenna Loss	Antenna Factor	Preamp Factor	T/Pos	A/Pos	Remark	Pol/Phase
	MHz	dBuV/m	dBuV/m	dB	dBuV	dB	dB/m	dB	deg	cm		
1	4874.04	30.87	54.00	-23.13	30.27	2.47	33.16	35.03	111	101	Average	HORIZONTAL
2	4874.47	42.86	74.00	-31.14	42.26	2.47	33.16	35.03	111	101	Peak	HORIZONTAL

Vertical

	Freq	Level	Limit Line	Over Limit	Read Level	CableAntenna Loss	Antenna Factor	Preamp Factor	T/Pos	A/Pos	Remark	Pol/Phase
	MHz	dBuV/m	dBuV/m	dB	dBuV	dB	dB/m	dB	deg	cm		
1	4873.98	31.65	54.00	-22.35	31.05	2.47	33.16	35.03	40	100	Average	VERTICAL
2	4874.27	44.64	74.00	-29.36	44.04	2.47	33.16	35.03	40	100	Peak	VERTICAL

Temperature	24.5°C	Humidity	57%
Test Engineer	Satoshi Yang	Configurations	IEEE 802.11n MCS0 40MHz Ch 9 / Mode 2
Test Date	Oct. 13, 2010		

Horizontal

	Freq	Level	Limit Line	Over Limit	Read Level	CableAntenna Loss	Antenna Factor	Preamp Factor	T/Pos	A/Pos	Remark	Pol/Phase
	MHz	dBuV/m	dBuV/m	dB	dBuV	dB	dB/m	dB	deg	cm		
1	4904.08	29.14	54.00	-24.86	28.50	2.47	33.19	35.02	115	100	Average	HORIZONTAL
2	4905.00	41.61	74.00	-32.39	40.93	2.47	33.23	35.02	115	100	Peak	HORIZONTAL

Vertical

	Freq	Level	Limit Line	Over Limit	Read Level	CableAntenna Loss	Antenna Factor	Preamp Factor	T/Pos	A/Pos	Remark	Pol/Phase
	MHz	dBuV/m	dBuV/m	dB	dBuV	dB	dB/m	dB	deg	cm		
1	4904.16	30.85	54.00	-23.15	30.21	2.47	33.19	35.02	32	100	Average	VERTICAL
2	4904.22	41.97	74.00	-32.03	41.33	2.47	33.19	35.02	32	100	Peak	VERTICAL

Note:

The amplitude of spurious emissions which are attenuated by more than 20 dB below the permissible value has no need to be reported.

Emission level (dBuV/m) = 20 log Emission level (uV/m).

Corrected Reading: Antenna Factor + Cable Loss + Read Level - Preamp Factor = Level.

Temperature	24.5°C	Humidity	57%
Test Engineer	Satoshi Yang	Configurations	IEEE 802.11b CH 1 / Mode 2
Test Date	Oct. 13, 2010		

Horizontal

	Freq	Level	Limit Line	Over Limit	Read Level	CableAntenna Loss	Antenna Factor	Preamp Factor	T/Pos	A/Pos	Remark	Pol/Phase
	MHz	dBuV/m	dBuV/m	dB	dBuV	dB	dB/m	dB	deg	cm		
1	4823.98	50.54	74.00	-23.46	50.05	2.46	33.06	35.03	147	140	Peak	HORIZONTAL
2	4824.03	47.39	54.00	-6.61	46.90	2.46	33.06	35.03	147	140	Average	HORIZONTAL

Vertical

	Freq	Level	Limit Line	Over Limit	Read Level	CableAntenna Loss	Antenna Factor	Preamp Factor	T/Pos	A/Pos	Remark	Pol/Phase
	MHz	dBuV/m	dBuV/m	dB	dBuV	dB	dB/m	dB	deg	cm		
1	4824.03	47.07	54.00	-6.93	46.58	2.46	33.06	35.03	170	100	Average	VERTICAL
2	4824.04	50.46	74.00	-23.54	49.97	2.46	33.06	35.03	170	100	Peak	VERTICAL

Temperature	24.5°C	Humidity	57%
Test Engineer	Satoshi Yang	Configurations	IEEE 802.11b CH 6 / Mode 2
Test Date	Oct. 13, 2010		

Horizontal

	Freq	Level	Limit Line	Over Limit	Read Level	CableAntenna Loss Factor	Preamp Factor	T/Pos	A/Pos	Remark	Pol/Phase
	MHz	dBuV/m	dBuV/m	dB	dBuV	dB	dB/m	deg	cm		
1	4874.05	47.81	54.00	-6.19	47.21	2.47	33.16	35.03	109	104 Average	HORIZONTAL
2	4874.06	50.87	74.00	-23.13	50.27	2.47	33.16	35.03	109	104 Peak	HORIZONTAL

Vertical

	Freq	Level	Limit Line	Over Limit	Read Level	CableAntenna Loss Factor	Preamp Factor	T/Pos	A/Pos	Remark	Pol/Phase
	MHz	dBuV/m	dBuV/m	dB	dBuV	dB	dB/m	deg	cm		
1	4874.02	48.85	74.00	-25.15	48.25	2.47	33.16	35.03	73	100 Peak	VERTICAL
2	4874.06	44.93	54.00	-9.07	44.33	2.47	33.16	35.03	73	100 Average	VERTICAL

Temperature	24.5°C	Humidity	57%
Test Engineer	Satoshi Yang	Configurations	IEEE 802.11b CH 11 / Mode 2
Test Date	Oct. 13, 2010		

Horizontal

	Freq	Level	Limit Line	Over Limit	Read Level	CableAntenna Loss	Antenna Factor	Preamp Factor	T/Pos	A/Pos	Remark	Pol/Phase
	MHz	dBuV/m	dBuV/m	dB	dBuV	dB	dB/m	dB	deg	cm		
1	4924.04	48.78	74.00	-25.22	48.06	2.47	33.26	35.01	130	148	Peak	HORIZONTAL
2	4924.06	44.86	54.00	-9.14	44.14	2.47	33.26	35.01	130	148	Average	HORIZONTAL

Vertical

	Freq	Level	Limit Line	Over Limit	Read Level	CableAntenna Loss	Antenna Factor	Preamp Factor	T/Pos	A/Pos	Remark	Pol/Phase
	MHz	dBuV/m	dBuV/m	dB	dBuV	dB	dB/m	dB	deg	cm		
1	4924.02	48.16	74.00	-25.84	47.44	2.47	33.26	35.01	81	144	Peak	VERTICAL
2	4924.05	44.55	54.00	-9.45	43.83	2.47	33.26	35.01	81	144	Average	VERTICAL

Temperature	24.5°C	Humidity	57%
Test Engineer	Satoshi Yang	Configurations	IEEE 802.11g CH 1 / Mode 2
Test Date	Oct. 13, 2010		

Horizontal

	Freq	Level	Limit Line	Over Limit	Read Level	CableAntenna Loss	Antenna Factor	Preamp Factor	T/Pos	A/Pos	Remark	Pol/Phase
	MHz	dBuV/m	dBuV/m	dB	dBuV	dB	dB/m	dB	deg	cm		
1	4820.28	46.93	74.00	-27.07	46.44	2.46	33.06	35.03	110	100	Peak	HORIZONTAL
2	4822.36	32.99	54.00	-21.01	32.50	2.46	33.06	35.03	110	100	Average	HORIZONTAL

Vertical

	Freq	Level	Limit Line	Over Limit	Read Level	CableAntenna Loss	Antenna Factor	Preamp Factor	T/Pos	A/Pos	Remark	Pol/Phase
	MHz	dBuV/m	dBuV/m	dB	dBuV	dB	dB/m	dB	deg	cm		
1	4820.20	34.70	54.00	-19.30	34.21	2.46	33.06	35.03	34	100	Average	VERTICAL
2	4820.28	47.82	74.00	-26.18	47.33	2.46	33.06	35.03	34	100	Peak	VERTICAL

Temperature	24.5°C	Humidity	57%
Test Engineer	Satoshi Yang	Configurations	IEEE 802.11g CH 6 / Mode 2
Test Date	Oct. 13, 2010		

Horizontal

	Freq	Level	Limit Line	Over Limit	Read Level	CableAntenna Loss	Antenna Factor	Preamp Factor	T/Pos	A/Pos	Remark	Pol/Phase
	MHz	dBuV/m	dBuV/m	dB	dBuV	dB	dB/m	dB	deg	cm		
1	4870.28	48.11	74.00	-25.89	47.55	2.47	33.12	35.03	112	139	Peak	HORIZONTAL
2	4872.08	32.59	54.00	-21.41	31.99	2.47	33.16	35.03	112	139	Average	HORIZONTAL

Vertical

	Freq	Level	Limit Line	Over Limit	Read Level	CableAntenna Loss	Antenna Factor	Preamp Factor	T/Pos	A/Pos	Remark	Pol/Phase
	MHz	dBuV/m	dBuV/m	dB	dBuV	dB	dB/m	dB	deg	cm		
1	4870.24	46.67	74.00	-27.33	46.11	2.47	33.12	35.03	144	100	Peak	VERTICAL
2	4872.12	31.54	54.00	-22.46	30.94	2.47	33.16	35.03	144	100	Average	VERTICAL

Temperature	24.5°C	Humidity	57%
Test Engineer	Satoshi Yang	Configurations	IEEE 802.11g CH 11 / Mode 2
Test Date	Oct. 13, 2010		

Horizontal

	Freq	Level	Limit Line	Over Limit	Read Level	CableAntenna Loss	Antenna Factor	Preamp Factor	T/Pos	A/Pos	Remark	Pol/Phase
	MHz	dBuV/m	dBuV/m	dB	dBuV	dB	dB/m	dB	deg	cm		
1	4924.12	29.54	54.00	-24.46	28.82	2.47	33.26	35.01	135	100	Average	HORIZONTAL
2	4925.08	42.43	74.00	-31.57	41.71	2.47	33.26	35.01	135	100	Peak	HORIZONTAL

Vertical

	Freq	Level	Limit Line	Over Limit	Read Level	CableAntenna Loss	Antenna Factor	Preamp Factor	T/Pos	A/Pos	Remark	Pol/Phase
	MHz	dBuV/m	dBuV/m	dB	dBuV	dB	dB/m	dB	deg	cm		
1	4924.16	29.56	54.00	-24.44	28.84	2.47	33.26	35.01	88	144	Average	VERTICAL
2	4927.68	42.58	74.00	-31.42	41.86	2.47	33.26	35.01	88	144	Peak	VERTICAL

Note:

The amplitude of spurious emissions that are attenuated by more than 20dB below the permissible value has no need to be reported.

Emission level (dBuV/m) = 20 log Emission level (uV/m).

Corrected Reading: Antenna Factor + Cable Loss + Read Level - Preamp Factor = Level.

<For Second Source – Mode 1 with Printed Antenna>:

Temperature	24.5°C	Humidity	57%
Test Engineer	Satoshi Yang	Configurations	IEEE 802.11n MCS0 20MHz Ch 1 / Mode 1
Test Date	Oct. 22, 2010		

Horizontal

	Freq	Level	Limit Line	Over Limit	Read Level	CableAntenna Loss	Antenna Factor	Preamp Factor	T/Pos	A/Pos	Remark	Pol/Phase
	MHz	dBuV/m	dBuV/m	dB	dBuV	dB	dB/m	dB	deg	cm		
1	4823.86	45.61	74.00	-28.39	44.27	3.31	33.06	35.03	222	100	Peak	HORIZONTAL
2	4824.08	37.23	54.00	-16.77	35.89	3.31	33.06	35.03	222	100	Average	HORIZONTAL

Vertical

	Freq	Level	Limit Line	Over Limit	Read Level	CableAntenna Loss	Antenna Factor	Preamp Factor	T/Pos	A/Pos	Remark	Pol/Phase
	MHz	dBuV/m	dBuV/m	dB	dBuV	dB	dB/m	dB	deg	cm		
1	4824.00	34.43	54.00	-19.57	33.09	3.31	33.06	35.03	259	100	Average	VERTICAL
2	4824.04	43.51	74.00	-30.49	42.17	3.31	33.06	35.03	259	100	Peak	VERTICAL

Temperature	24.5°C	Humidity	57%
Test Engineer	Satoshi Yang	Configurations	IEEE 802.11n MCS0 20MHz Ch 6 / Mode 1
Test Date	Oct. 22, 2010		

Horizontal

	Freq	Level	Limit Line	Over Limit	Read Level	CableAntenna Loss	Antenna Factor	Preamp Factor	T/Pos	A/Pos	Remark	Pol/Phase
	MHz	dBuV/m	dBuV/m	dB	dBuV	dB	dB/m	dB	deg	cm		
1	4873.99	36.62	54.00	-17.38	35.16	3.33	33.16	35.03	218	100	Average	HORIZONTAL
2	4874.22	45.92	74.00	-28.08	44.46	3.33	33.16	35.03	218	100	Peak	HORIZONTAL

Vertical

	Freq	Level	Limit Line	Over Limit	Read Level	CableAntenna Loss	Antenna Factor	Preamp Factor	T/Pos	A/Pos	Remark	Pol/Phase
	MHz	dBuV/m	dBuV/m	dB	dBuV	dB	dB/m	dB	deg	cm		
1	4873.93	44.19	74.00	-29.81	42.73	3.33	33.16	35.03	177	100	Peak	VERTICAL
2	4874.07	33.98	54.00	-20.02	32.52	3.33	33.16	35.03	177	100	Average	VERTICAL

Temperature	24.5°C	Humidity	57%
Test Engineer	Satoshi Yang	Configurations	IEEE 802.11n MCS0 20MHz Ch11 / Mode 1
Test Date	Oct. 22, 2010		

Horizontal

	Freq	Level	Limit Line	Over Limit	Read Level	CableAntenna Loss	Antenna Factor	Preamp Factor	T/Pos	A/Pos	Remark	Pol/Phase
	MHz	dBuV/m	dBuV/m	dB	dBuV	dB	dB/m	dB	deg	cm		
1	4924.03	35.51	54.00	-18.49	33.91	3.35	33.26	35.01	333	100	Average	HORIZONTAL
2	4924.26	44.96	74.00	-29.04	43.36	3.35	33.26	35.01	333	100	Peak	HORIZONTAL

Vertical

	Freq	Level	Limit Line	Over Limit	Read Level	CableAntenna Loss	Antenna Factor	Preamp Factor	T/Pos	A/Pos	Remark	Pol/Phase
	MHz	dBuV/m	dBuV/m	dB	dBuV	dB	dB/m	dB	deg	cm		
1	4923.96	43.65	74.00	-30.35	42.05	3.35	33.26	35.01	183	100	Peak	VERTICAL
2	4924.00	33.23	54.00	-20.77	31.63	3.35	33.26	35.01	183	100	Average	VERTICAL

Temperature	24.5°C	Humidity	57%
Test Engineer	Satoshi Yang	Configurations	IEEE 802.11n MCS0 40MHz Ch 3 / Mode 1
Test Date	Oct. 22, 2010		

Horizontal

	Freq	Level	Limit Line	Over Limit	Read Level	CableAntenna Loss	Antenna Factor	Preamp Factor	T/Pos	A/Pos	Remark	Pol/Phase
	MHz	dBuV/m	dBuV/m	dB	dBuV	dB	dB/m	dB	deg	cm		
1	4843.93	44.87	74.00	-29.13	43.49	3.32	33.09	35.03	223	100	Peak	HORIZONTAL
2	4844.08	37.49	54.00	-16.51	36.11	3.32	33.09	35.03	223	100	Average	HORIZONTAL

Vertical

	Freq	Level	Limit Line	Over Limit	Read Level	CableAntenna Loss	Antenna Factor	Preamp Factor	T/Pos	A/Pos	Remark	Pol/Phase
	MHz	dBuV/m	dBuV/m	dB	dBuV	dB	dB/m	dB	deg	cm		
1	4843.99	43.35	74.00	-30.65	41.97	3.32	33.09	35.03	159	100	Peak	VERTICAL
2	4844.10	32.85	54.00	-21.15	31.47	3.32	33.09	35.03	159	100	Average	VERTICAL

Temperature	24.5°C	Humidity	57%
Test Engineer	Satoshi Yang	Configurations	IEEE 802.11n MCS0 40MHz Ch 6 / Mode 1
Test Date	Oct. 22, 2010		

Horizontal

	Freq	Level	Limit Line	Over Limit	Read Level	CableAntenna Loss Factor	Preamp Factor	T/Pos	A/Pos	Remark	Pol/Phase
	MHz	dBuV/m	dBuV/m	dB	dBuV	dB	dB/m	deg	cm		
1	4873.99	45.22	74.00	-28.78	43.76	3.33	33.16	35.03	216	100 Peak	HORIZONTAL
2	4874.02	35.36	54.00	-18.64	33.90	3.33	33.16	35.03	216	100 Average	HORIZONTAL

Vertical

	Freq	Level	Limit Line	Over Limit	Read Level	CableAntenna Loss Factor	Preamp Factor	T/Pos	A/Pos	Remark	Pol/Phase
	MHz	dBuV/m	dBuV/m	dB	dBuV	dB	dB/m	deg	cm		
1	4873.77	43.24	74.00	-30.76	41.78	3.33	33.16	35.03	183	100 Peak	VERTICAL
2	4874.03	32.85	54.00	-21.15	31.39	3.33	33.16	35.03	183	100 Average	VERTICAL

Temperature	24.5°C	Humidity	57%
Test Engineer	Satoshi Yang	Configurations	IEEE 802.11n MCS0 40MHz Ch 9 / Mode 1
Test Date	Oct. 22, 2010		

Horizontal

	Freq	Level	Limit	Over	Read	CableAntenna	Preamp	T/Pos	A/Pos	Remark	Pol/Phase
	MHz	dBuV/m	dBuV/m	dB	dBuV	dB	dB/m	deg	cm		
1	4903.97	44.82	74.00	-29.18	43.31	3.34	33.19	35.02	217	100 Peak	HORIZONTAL
2	4904.04	36.23	54.00	-17.77	34.72	3.34	33.19	35.02	217	100 Average	HORIZONTAL

Vertical

	Freq	Level	Limit	Over	Read	CableAntenna	Preamp	T/Pos	A/Pos	Remark	Pol/Phase
	MHz	dBuV/m	dBuV/m	dB	dBuV	dB	dB/m	deg	cm		
1	4904.06	33.34	54.00	-20.66	31.83	3.34	33.19	35.02	155	100 Average	VERTICAL
2	4904.20	43.70	74.00	-30.30	42.19	3.34	33.19	35.02	155	100 Peak	VERTICAL

Note:

The amplitude of spurious emissions which are attenuated by more than 20 dB below the permissible value has no need to be reported.

Emission level (dBuV/m) = 20 log Emission level (uV/m).

Corrected Reading: Antenna Factor + Cable Loss + Read Level - Preamp Factor = Level.

Temperature	24.5°C	Humidity	57%
Test Engineer	Satoshi Yang	Configurations	IEEE 802.11b CH 1 / Mode 1
Test Date	Oct. 22, 2010		

Horizontal

	Freq	Level	Limit	Over	Read	CableAntenna	Preamp	T/Pos	A/Pos	Remark	Pol/Phase	
	MHz	dBuV/m	dBuV/m	dB	dBuV	Loss	Factor	Factor	deg	cm		
1	4824.04	44.54	54.00	-9.46	43.20	3.31	33.06	35.03	231	101	Average	HORIZONTAL
2	4824.05	48.58	74.00	-25.42	47.24	3.31	33.06	35.03	231	101	Peak	HORIZONTAL

Vertical

	Freq	Level	Limit	Over	Read	CableAntenna	Preamp	T/Pos	A/Pos	Remark	Pol/Phase	
	MHz	dBuV/m	dBuV/m	dB	dBuV	Loss	Factor	Factor	deg	cm		
1	4824.06	44.76	54.00	-9.24	43.42	3.31	33.06	35.03	183	104	Average	VERTICAL
2	4824.10	49.10	74.00	-24.90	47.76	3.31	33.06	35.03	183	104	Peak	VERTICAL

Temperature	24.5°C	Humidity	57%
Test Engineer	Satoshi Yang	Configurations	IEEE 802.11b CH 6 / Mode 1
Test Date	Oct. 22, 2010		

Horizontal

	Freq	Level	Limit	Over	Read	CableAntenna	Preamp	T/Pos	A/Pos	Remark	Pol/Phase
	MHz	dBuV/m	dBuV/m	dB	dBuV	dB	dB/m	dB	deg	cm	
1	4874.08	45.11	54.00	-8.89	43.65	3.33	33.16	35.03	208	100 Average	HORIZONTAL
2	4874.11	49.08	74.00	-24.92	47.62	3.33	33.16	35.03	208	100 Peak	HORIZONTAL

Vertical

	Freq	Level	Limit	Over	Read	CableAntenna	Preamp	T/Pos	A/Pos	Remark	Pol/Phase
	MHz	dBuV/m	dBuV/m	dB	dBuV	dB	dB/m	dB	deg	cm	
1	4874.08	41.19	54.00	-12.81	39.73	3.33	33.16	35.03	317	118 Average	VERTICAL
2	4874.14	46.67	74.00	-27.33	45.21	3.33	33.16	35.03	317	118 Peak	VERTICAL

Temperature	24.5°C	Humidity	57%
Test Engineer	Satoshi Yang	Configurations	IEEE 802.11b CH 11 / Mode 1
Test Date	Oct. 22, 2010		

Horizontal

	Freq	Level	Limit	Over	Read	CableAntenna	Preamp	T/Pos	A/Pos	Remark	Pol/Phase	
	MHz	dBuV/m	dBuV/m	dB	dBuV	dB	dB/m	dB	deg	cm		
1	4923.97	48.76	74.00	-25.24	47.16	3.35	33.26	35.01	218	100	Peak	HORIZONTAL
2	4924.07	44.28	54.00	-9.72	42.68	3.35	33.26	35.01	218	100	Average	HORIZONTAL

Vertical

	Freq	Level	Limit	Over	Read	CableAntenna	Preamp	T/Pos	A/Pos	Remark	Pol/Phase	
	MHz	dBuV/m	dBuV/m	dB	dBuV	dB	dB/m	dB	deg	cm		
1	4924.07	40.84	54.00	-13.16	39.24	3.35	33.26	35.01	335	100	Average	VERTICAL
2	4924.20	46.87	74.00	-27.13	45.27	3.35	33.26	35.01	335	100	Peak	VERTICAL

Temperature	24.5°C	Humidity	57%
Test Engineer	Satoshi Yang	Configurations	IEEE 802.11g CH 1 / Mode 1
Test Date	Oct. 22, 2010		

Horizontal

	Freq	Level	Limit Line	Over Limit	Read Level	CableAntenna Loss	Antenna Factor	Preamp Factor	T/Pos	A/Pos	Remark	Pol/Phase
	MHz	dBuV/m	dBuV/m	dB	dBuV	dB	dB/m	dB	deg	cm		
1	4824.04	36.10	54.00	-17.90	34.76	3.31	33.06	35.03	220	100	Average	HORIZONTAL
2	4824.15	46.32	74.00	-27.68	44.98	3.31	33.06	35.03	220	100	Peak	HORIZONTAL

Vertical

	Freq	Level	Limit Line	Over Limit	Read Level	CableAntenna Loss	Antenna Factor	Preamp Factor	T/Pos	A/Pos	Remark	Pol/Phase
	MHz	dBuV/m	dBuV/m	dB	dBuV	dB	dB/m	dB	deg	cm		
1	4823.98	44.15	74.00	-29.85	42.81	3.31	33.06	35.03	259	100	Peak	VERTICAL
2	4824.06	33.16	54.00	-20.84	31.82	3.31	33.06	35.03	259	100	Average	VERTICAL

Temperature	24.5°C	Humidity	57%
Test Engineer	Satoshi Yang	Configurations	IEEE 802.11g CH 6 / Mode 1
Test Date	Oct. 22, 2010		

Horizontal

	Freq	Level	Limit Line	Over Limit	Read Level	CableAntenna Loss	Antenna Factor	Preamp Factor	T/Pos	A/Pos	Remark	Pol/Phase
	MHz	dBuV/m	dBuV/m	dB	dBuV	dB	dB/m	dB	deg	cm		
1	4874.11	35.67	54.00	-18.33	34.21	3.33	33.16	35.03	219	100	Average	HORIZONTAL
2	4874.52	45.46	74.00	-28.54	44.00	3.33	33.16	35.03	219	100	Peak	HORIZONTAL

Vertical

	Freq	Level	Limit Line	Over Limit	Read Level	CableAntenna Loss	Antenna Factor	Preamp Factor	T/Pos	A/Pos	Remark	Pol/Phase
	MHz	dBuV/m	dBuV/m	dB	dBuV	dB	dB/m	dB	deg	cm		
1	4874.07	42.70	74.00	-31.30	41.24	3.33	33.16	35.03	183	100	Peak	VERTICAL
2	4874.12	33.50	54.00	-20.50	32.04	3.33	33.16	35.03	183	100	Average	VERTICAL

Temperature	24.5°C	Humidity	57%
Test Engineer	Satoshi Yang	Configurations	IEEE 802.11g CH 11 / Mode 1
Test Date	Oct. 22, 2010		

Horizontal

	Freq	Level	Limit	Over	Read	CableAntenna	Preamp	T/Pos	A/Pos	Remark	Pol/Phase
	MHz	dBuV/m	dBuV/m	dB	dBuV	dB	dB/m	deg	cm		
1	4924.02	35.88	54.00	-18.12	34.28	3.35	33.26	35.01	218	100 Average	HORIZONTAL
2	4924.07	45.43	74.00	-28.57	43.83	3.35	33.26	35.01	218	100 Peak	HORIZONTAL

Vertical

	Freq	Level	Limit	Over	Read	CableAntenna	Preamp	T/Pos	A/Pos	Remark	Pol/Phase
	MHz	dBuV/m	dBuV/m	dB	dBuV	dB	dB/m	deg	cm		
1	4924.09	43.01	74.00	-30.99	41.41	3.35	33.26	35.01	184	100 Peak	VERTICAL
2	4924.16	33.00	54.00	-21.00	31.40	3.35	33.26	35.01	184	100 Average	VERTICAL

Note:

The amplitude of spurious emissions that are attenuated by more than 20dB below the permissible value has no need to be reported.

Emission level (dBuV/m) = 20 log Emission level (uV/m).

Corrected Reading: Antenna Factor + Cable Loss + Read Level - Preamp Factor = Level.

<For Second Source – Mode 2 with PIFA Antenna>:

Temperature	24.5°C	Humidity	57%
Test Engineer	Satoshi Yang	Configurations	IEEE 802.11n MCS0 20MHz Ch 1 / Mode 2
Test Date	Oct. 13, 2010		

Horizontal

	Freq	Level	Limit	Over	Read	CableAntenna	Preamp	T/Pos	A/Pos	Remark	Pol/Phase
	MHz	dBuV/m	dBuV/m	dB	dBuV	dB	dB/m	deg	cm		
1	4823.99	27.51	54.00	-26.49	27.02	2.46	33.06	35.03	138	100 Average	HORIZONTAL
2	4824.18	40.76	74.00	-33.24	40.27	2.46	33.06	35.03	138	100 Peak	HORIZONTAL

Vertical

	Freq	Level	Limit	Over	Read	CableAntenna	Preamp	T/Pos	A/Pos	Remark	Pol/Phase
	MHz	dBuV/m	dBuV/m	dB	dBuV	dB	dB/m	deg	cm		
1	4824.06	27.37	54.00	-26.63	26.88	2.46	33.06	35.03	270	100 Average	VERTICAL
2	4824.34	41.06	74.00	-32.94	40.57	2.46	33.06	35.03	270	100 Peak	VERTICAL

Temperature	24.5°C	Humidity	57%
Test Engineer	Satoshi Yang	Configurations	IEEE 802.11n MCS0 20MHz Ch 6 / Mode 2
Test Date	Oct. 13, 2010		

Horizontal

	Freq	Level	Limit Line	Over Limit	Read Level	CableAntenna Loss	Antenna Factor	Preamp Factor	T/Pos	A/Pos	Remark	Pol/Phase
	MHz	dBuV/m	dBuV/m	dB	dBuV	dB	dB/m	dB	deg	cm		
1	4873.76	27.28	54.00	-26.72	26.68	2.47	33.16	35.03	163	100	Average	HORIZONTAL
2	4874.29	41.38	74.00	-32.62	40.78	2.47	33.16	35.03	163	100	Peak	HORIZONTAL

Vertical

	Freq	Level	Limit Line	Over Limit	Read Level	CableAntenna Loss	Antenna Factor	Preamp Factor	T/Pos	A/Pos	Remark	Pol/Phase
	MHz	dBuV/m	dBuV/m	dB	dBuV	dB	dB/m	dB	deg	cm		
1	4873.57	41.09	74.00	-32.91	40.49	2.47	33.16	35.03	223	100	Peak	VERTICAL
2	4873.77	27.57	54.00	-26.43	26.97	2.47	33.16	35.03	223	100	Average	VERTICAL

Temperature	24.5°C	Humidity	57%
Test Engineer	Satoshi Yang	Configurations	IEEE 802.11n MCS0 20MHz Ch11 / Mode 2
Test Date	Oct. 13, 2010		

Horizontal

	Freq	Level	Limit Line	Over Limit	Read Level	CableAntenna Loss	Antenna Factor	Preamp Factor	T/Pos	A/Pos	Remark	Pol/Phase
	MHz	dBuV/m	dBuV/m	dB	dBuV	dB	dB/m	dB	deg	cm		
1	4924.03	27.46	54.00	-26.54	26.74	2.47	33.26	35.01	241	100	Average	HORIZONTAL
2	4924.13	40.92	74.00	-33.08	40.20	2.47	33.26	35.01	241	100	Peak	HORIZONTAL

Vertical

	Freq	Level	Limit Line	Over Limit	Read Level	CableAntenna Loss	Antenna Factor	Preamp Factor	T/Pos	A/Pos	Remark	Pol/Phase
	MHz	dBuV/m	dBuV/m	dB	dBuV	dB	dB/m	dB	deg	cm		
1	4924.03	30.79	54.00	-23.21	30.07	2.47	33.26	35.01	43	100	Average	VERTICAL
2	4924.08	44.16	74.00	-29.84	43.44	2.47	33.26	35.01	43	100	Peak	VERTICAL

Temperature	24.5°C	Humidity	57%
Test Engineer	Satoshi Yang	Configurations	IEEE 802.11n MCS0 40MHz Ch 3 / Mode 2
Test Date	Oct. 13, 2010		

Horizontal

	Freq	Level	Limit Line	Over Limit	Read Level	CableAntenna Loss	Antenna Factor	Preamp Factor	T/Pos	A/Pos	Remark	Pol/Phase
	MHz	dBuV/m	dBuV/m	dB	dBuV	dB	dB/m	dB	deg	cm		
1	4843.81	40.88	74.00	-33.12	40.36	2.46	33.09	35.03	209	100	Peak	HORIZONTAL
2	4844.12	27.49	54.00	-26.51	26.97	2.46	33.09	35.03	209	100	Average	HORIZONTAL

Vertical

	Freq	Level	Limit Line	Over Limit	Read Level	CableAntenna Loss	Antenna Factor	Preamp Factor	T/Pos	A/Pos	Remark	Pol/Phase
	MHz	dBuV/m	dBuV/m	dB	dBuV	dB	dB/m	dB	deg	cm		
1	4841.84	40.57	74.00	-33.43	40.05	2.46	33.09	35.03	249	100	Peak	VERTICAL
2	4853.80	28.90	54.00	-25.10	28.35	2.46	33.12	35.03	249	100	Average	VERTICAL

Temperature	24.5°C	Humidity	57%
Test Engineer	Satoshi Yang	Configurations	IEEE 802.11n MCS0 40MHz Ch 6 / Mode 2
Test Date	Oct. 13, 2010		

Horizontal

	Freq	Level	Limit Line	Over Limit	Read Level	CableAntenna Loss	Antenna Factor	Preamp Factor	T/Pos	A/Pos	Remark	Pol/Phase
	MHz	dBuV/m	dBuV/m	dB	dBuV	dB	dB/m	dB	deg	cm		
1	4873.77	27.40	54.00	-26.60	26.80	2.47	33.16	35.03	118	100	Average	HORIZONTAL
2	4874.08	41.27	74.00	-32.73	40.67	2.47	33.16	35.03	118	100	Peak	HORIZONTAL

Vertical

	Freq	Level	Limit Line	Over Limit	Read Level	CableAntenna Loss	Antenna Factor	Preamp Factor	T/Pos	A/Pos	Remark	Pol/Phase
	MHz	dBuV/m	dBuV/m	dB	dBuV	dB	dB/m	dB	deg	cm		
1	4874.06	29.43	54.00	-24.57	28.83	2.47	33.16	35.03	43	100	Average	VERTICAL
2	4874.06	42.91	74.00	-31.09	42.31	2.47	33.16	35.03	43	100	Peak	VERTICAL

Temperature	24.5°C	Humidity	57%
Test Engineer	Satoshi Yang	Configurations	IEEE 802.11n MCS0 40MHz Ch 9 / Mode 2
Test Date	Oct. 13, 2010		

Horizontal

	Freq	Level	Limit Line	Over Limit	Read Level	CableAntenna Loss	Antenna Factor	Preamp Factor	T/Pos	A/Pos	Remark	Pol/Phase
	MHz	dBuV/m	dBuV/m	dB	dBuV	dB	dB/m	dB	deg	cm		
1	4904.01	26.62	54.00	-27.38	25.98	2.47	33.19	35.02	194	100	Average	HORIZONTAL
2	4904.35	41.18	74.00	-32.82	40.54	2.47	33.19	35.02	194	100	Peak	HORIZONTAL

Vertical

	Freq	Level	Limit Line	Over Limit	Read Level	CableAntenna Loss	Antenna Factor	Preamp Factor	T/Pos	A/Pos	Remark	Pol/Phase
	MHz	dBuV/m	dBuV/m	dB	dBuV	dB	dB/m	dB	deg	cm		
1	4904.11	27.32	54.00	-26.68	26.68	2.47	33.19	35.02	255	100	Average	VERTICAL
2	4904.37	40.65	74.00	-33.35	40.01	2.47	33.19	35.02	255	100	Peak	VERTICAL

Note:

The amplitude of spurious emissions which are attenuated by more than 20 dB below the permissible value has no need to be reported.

Emission level (dBuV/m) = 20 log Emission level (uV/m).

Corrected Reading: Antenna Factor + Cable Loss + Read Level - Preamp Factor = Level.

Temperature	24.5°C	Humidity	57%
Test Engineer	Satoshi Yang	Configurations	IEEE 802.11b CH 1 / Mode 2
Test Date	Oct. 13, 2010		

Horizontal

	Freq	Level	Limit Line	Over Limit	Read Level	CableAntenna Loss	Antenna Factor	Preamp Factor	T/Pos	A/Pos	Remark	Pol/Phase
	MHz	dBuV/m	dBuV/m	dB	dBuV	dB	dB/m	dB	deg	cm		
1	4823.91	46.81	74.00	-27.19	46.32	2.46	33.06	35.03	117	147	Peak	HORIZONTAL
2	4824.03	41.18	54.00	-12.82	40.69	2.46	33.06	35.03	117	147	Average	HORIZONTAL

Vertical

	Freq	Level	Limit Line	Over Limit	Read Level	CableAntenna Loss	Antenna Factor	Preamp Factor	T/Pos	A/Pos	Remark	Pol/Phase
	MHz	dBuV/m	dBuV/m	dB	dBuV	dB	dB/m	dB	deg	cm		
1	4824.01	50.29	74.00	-23.71	49.80	2.46	33.06	35.03	41	101	Peak	VERTICAL
2	4824.04	46.89	54.00	-7.11	46.40	2.46	33.06	35.03	41	101	Average	VERTICAL

Temperature	24.5°C	Humidity	57%
Test Engineer	Satoshi Yang	Configurations	IEEE 802.11b CH 6 / Mode 2
Test Date	Oct. 13, 2010		

Horizontal

	Freq	Level	Limit	Over	Read	CableAntenna	Preamp	T/Pos	A/Pos	Remark	Pol/Phase
	MHz	dBuV/m	dBuV/m	dB	dBuV	dB	dB/m	dB	deg	cm	
1	4874.04	30.88	54.00	-23.12	30.28	2.47	33.16	35.03	115	100 Average	HORIZONTAL
2	4874.12	42.22	74.00	-31.78	41.62	2.47	33.16	35.03	115	100 Peak	HORIZONTAL

Vertical

	Freq	Level	Limit	Over	Read	CableAntenna	Preamp	T/Pos	A/Pos	Remark	Pol/Phase
	MHz	dBuV/m	dBuV/m	dB	dBuV	dB	dB/m	dB	deg	cm	
1	4874.04	38.33	54.00	-15.67	37.73	2.47	33.16	35.03	16	100 Average	VERTICAL
2	4874.12	44.77	74.00	-29.23	44.17	2.47	33.16	35.03	16	100 Peak	VERTICAL

Temperature	24.5°C	Humidity	57%
Test Engineer	Satoshi Yang	Configurations	IEEE 802.11b CH 11 / Mode 2
Test Date	Oct. 13, 2010		

Horizontal

	Freq	Level	Limit Line	Over Limit	Read Level	CableAntenna Loss	Antenna Factor	Preamp Factor	T/Pos	A/Pos	Remark	Pol/Phase
	MHz	dBuV/m	dBuV/m	dB	dBuV	dB	dB/m	dB	deg	cm		
1	4924.06	40.28	54.00	-13.72	39.56	2.47	33.26	35.01	11	100	Average	HORIZONTAL
2	4924.06	45.93	74.00	-28.07	45.21	2.47	33.26	35.01	11	100	Peak	HORIZONTAL

Vertical

	Freq	Level	Limit Line	Over Limit	Read Level	CableAntenna Loss	Antenna Factor	Preamp Factor	T/Pos	A/Pos	Remark	Pol/Phase
	MHz	dBuV/m	dBuV/m	dB	dBuV	dB	dB/m	dB	deg	cm		
1	4924.05	45.90	54.00	-8.10	45.18	2.47	33.26	35.01	45	100	Average	VERTICAL
2	4924.14	49.57	74.00	-24.43	48.85	2.47	33.26	35.01	45	100	Peak	VERTICAL

Temperature	24.5°C	Humidity	57%
Test Engineer	Satoshi Yang	Configurations	IEEE 802.11g CH 1 / Mode 2
Test Date	Oct. 13, 2010		

Horizontal

	Freq	Level	Limit Line	Over Limit	Read Level	CableAntenna Loss	Antenna Factor	Preamp Factor	T/Pos	A/Pos	Remark	Pol/Phase
	MHz	dBuV/m	dBuV/m	dB	dBuV	dB	dB/m	dB	deg	cm		
1	4824.10	28.34	54.00	-25.66	27.85	2.46	33.06	35.03	111	100	Average	HORIZONTAL
2	4824.14	41.50	74.00	-32.50	41.01	2.46	33.06	35.03	111	100	Peak	HORIZONTAL

Vertical

	Freq	Level	Limit Line	Over Limit	Read Level	CableAntenna Loss	Antenna Factor	Preamp Factor	T/Pos	A/Pos	Remark	Pol/Phase
	MHz	dBuV/m	dBuV/m	dB	dBuV	dB	dB/m	dB	deg	cm		
1	4822.96	44.06	74.00	-29.94	43.57	2.46	33.06	35.03	51	100	Peak	VERTICAL
2	4824.04	29.99	54.00	-24.01	29.50	2.46	33.06	35.03	51	100	Average	VERTICAL

Temperature	24.5°C	Humidity	57%
Test Engineer	Satoshi Yang	Configurations	IEEE 802.11g CH 6 / Mode 2
Test Date	Oct. 13, 2010		

Horizontal

	Freq	Level	Limit Line	Over Limit	Read Level	CableAntenna Loss	Antenna Factor	Preamp Factor	T/Pos	A/Pos	Remark	Pol/Phase
	MHz	dBuV/m	dBuV/m	dB	dBuV	dB	dB/m	dB	deg	cm		
1	4873.67	27.34	54.00	-26.66	26.74	2.47	33.16	35.03	157	100	Average	HORIZONTAL
2	4873.72	41.52	74.00	-32.48	40.92	2.47	33.16	35.03	157	100	Peak	HORIZONTAL

Vertical

	Freq	Level	Limit Line	Over Limit	Read Level	CableAntenna Loss	Antenna Factor	Preamp Factor	T/Pos	A/Pos	Remark	Pol/Phase
	MHz	dBuV/m	dBuV/m	dB	dBuV	dB	dB/m	dB	deg	cm		
1	4873.56	41.89	74.00	-32.11	41.29	2.47	33.16	35.03	270	100	Peak	VERTICAL
2	4873.76	27.98	54.00	-26.02	27.38	2.47	33.16	35.03	270	100	Average	VERTICAL

Temperature	24.5°C	Humidity	57%
Test Engineer	Satoshi Yang	Configurations	IEEE 802.11g CH 11 / Mode 2
Test Date	Oct. 13, 2010		

Horizontal

	Freq	Level	Limit Line	Over Limit	Read Level	CableAntenna Loss	Antenna Factor	Preamp Factor	T/Pos	A/Pos	Remark	Pol/Phase
	MHz	dBuV/m	dBuV/m	dB	dBuV	dB	dB/m	dB	deg	cm		
1	4923.92	41.54	74.00	-32.46	40.82	2.47	33.26	35.01	130	100	Peak	HORIZONTAL
2	4924.07	28.37	54.00	-25.63	27.65	2.47	33.26	35.01	130	100	Average	HORIZONTAL

Vertical

	Freq	Level	Limit Line	Over Limit	Read Level	CableAntenna Loss	Antenna Factor	Preamp Factor	T/Pos	A/Pos	Remark	Pol/Phase
	MHz	dBuV/m	dBuV/m	dB	dBuV	dB	dB/m	dB	deg	cm		
1	4924.10	31.27	54.00	-22.73	30.55	2.47	33.26	35.01	44	100	Average	VERTICAL
2	4924.46	44.12	74.00	-29.88	43.40	2.47	33.26	35.01	44	100	Peak	VERTICAL

Note:

The amplitude of spurious emissions that are attenuated by more than 20dB below the permissible value has no need to be reported.

Emission level (dBuV/m) = 20 log Emission level (uV/m).

Corrected Reading: Antenna Factor + Cable Loss + Read Level - Preamp Factor = Level.

4.6. Band Edge Emissions Measurement

4.6.1. Limit

20dBc in any 100 kHz bandwidth outside the operating frequency band. In case the emission fall within the restricted band specified on 15.205(a), then the 15.209(a) limit in the table below has to be followed.

Frequencies (MHz)	Field Strength (micorvolts/meter)	Measurement Distance (meters)
0.009~0.490	2400/F(KHz)	300
0.490~1.705	24000/F(KHz)	30
1.705~30.0	30	30
30~88	100	3
88~216	150	3
216~960	200	3
Above 960	500	3

4.6.2. Measuring Instruments and Setting

Please refer to section 5 of equipments list in this report. The following table is the setting of the spectrum analyzer.

Spectrum Parameter	Setting
Attenuation	Auto
Span Frequency	100 MHz
RB / VB (Emission in restricted band)	1 MHz / 1MHz for Peak, 1 MHz / 10Hz for Average
RB / VB (Emission in non-restricted band)	100 KHz /100 KHz for Peak

4.6.3. Test Procedures

1. The test procedure is the same as section 4.5.3, only the frequency range investigated is limited to 100MHz around bandedges.
2. In case the emission is fail due to the used RB/VB is too wide, marker-delta method of FCC Public Notice DA00-705 will be followed.

4.6.4. Test Setup Layout

This test setup layout is the same as that shown in section 4.5.4.

4.6.5. Test Deviation

There is no deviation with the original standard.

4.6.6. EUT Operation during Test

The EUT was programmed to be in continuously transmitting mode.

4.6.7. Test Result of Band Edge and Fundamental Emissions

<For Main Source – Mode 1 with Printed Antenna>:

Temperature	24.5°C	Humidity	57%
Test Engineer	Satoshi Yang	Configurations	IEEE 802.11n MCS0 20MHz Ch 1,6, 11 / Mode 1
Test Date	Oct. 21, 2010		

Channel 1

	Freq	Level	Limit Line	Over Limit	Read Level	CableAntenna Loss	Preamp Factor	T/Pos	A/Pos	Remark	Pol/Phase
	MHz	dBuV/m	dBuV/m	dB	dBuV	dB	dB/m	deg	cm		
1	2390.00	47.39	54.00	-6.61	17.00	2.22	28.17	0.00	191	116 Average	HORIZONTAL
2	2390.00	60.26	74.00	-13.74	29.87	2.22	28.17	0.00	191	116 Peak	HORIZONTAL
3	2407.20	107.97	74.00			2.22	28.21	0.00	191	116 Peak	HORIZONTAL
4	2415.20	98.81	54.00			2.22	28.21	0.00	191	116 Average	HORIZONTAL

Item 3, 4 are the fundamental frequency at 2412 MHz

Channel 6

	Freq	Level	Limit Line	Over Limit	Read Level	CableAntenna Loss	Preamp Factor	T/Pos	A/Pos	Remark	Pol/Phase
	MHz	dBuV/m	dBuV/m	dB	dBuV	dB	dB/m	deg	cm		
1	2389.80	56.39	74.00	-17.61	26.00	2.22	28.17	0.00	198	113 Peak	HORIZONTAL
2	2390.00	44.44	54.00	-9.56	14.05	2.22	28.17	0.00	198	113 Average	HORIZONTAL
3	2439.60	111.99	74.00			2.23	28.29	0.00	198	113 Peak	HORIZONTAL
4	2440.20	102.84	54.00			2.23	28.29	0.00	198	113 Average	HORIZONTAL
5	2483.50	46.49	54.00	-7.51	15.85	2.26	28.38	0.00	198	113 Average	HORIZONTAL
6	2484.30	59.35	74.00	-14.65	28.71	2.26	28.38	0.00	198	113 Peak	HORIZONTAL

Item 3, 4 are the fundamental frequency at 2437MHz.

Channel 11

	Freq	Level	Limit Line	Over Limit	Read Level	CableAntenna Loss	Preamp Factor	T/Pos	A/Pos	Remark	Pol/Phase
	MHz	dBuV/m	dBuV/m	dB	dBuV	dB	dB/m	deg	cm		
1	2465.20	107.96	74.00			2.24	28.33	0.00	206	114 Peak	HORIZONTAL
2	2467.40	99.01	54.00			2.26	28.33	0.00	206	114 Average	HORIZONTAL
3	2483.50	50.05	54.00	-3.95	19.41	2.26	28.38	0.00	206	114 Average	HORIZONTAL
4	2485.90	62.70	74.00	-11.30	32.02	2.26	28.42	0.00	206	114 Peak	HORIZONTAL

Item 1, 2 are the fundamental frequency at 2462 MHz.

Temperature	24.5°C	Humidity	57%
Test Engineer	Satoshi Yang	Configurations	IEEE 802.11n MCS0 40MHz Ch 3, 6, 9 / Mode 1
Test Date	Oct. 21, 2010		

Channel 3

	Freq	Level	Limit	Over	Read	Cable	Preamp	Antenna	A/Pos	T/Pos	Remark	Pol/Phase
	MHz	dBuV/m	dBuV/m	dB	dBuV	dB	dB	dB/m	cm	deg		
1	2388.40	66.40	74.00	-7.60	36.49	2.04	0.00	27.87	122	347	Peak	HORIZONTAL
2 !	2390.00	51.05	54.00	-2.95	21.13	2.05	0.00	27.87	122	347	Average	HORIZONTAL
3 p	2426.80	105.53	74.00			2.07	0.00	27.81	122	347	Peak	HORIZONTAL
4 a	2437.60	96.43	54.00			2.07	0.00	27.78	122	347	Average	HORIZONTAL

Item 3, 4 are the fundamental frequency at 2422 MHz.

Channel 6

	Freq	Level	Limit	Over	Read	Cable	Preamp	Antenna	A/Pos	T/Pos	Remark	Pol/Phase
	MHz	dBuV/m	dBuV/m	dB	dBuV	dB	dB	dB/m	cm	deg		
1 !	2390.00	50.95	54.00	-3.05	21.03	2.05	0.00	27.87	122	353	Average	HORIZONTAL
2	2390.00	65.39	74.00	-8.61	35.47	2.05	0.00	27.87	122	353	Peak	HORIZONTAL
3 a	2427.40	98.37	54.00			2.07	0.00	27.81	122	353	Average	HORIZONTAL
4 p	2429.00	107.69	74.00			2.07	0.00	27.81	122	353	Peak	HORIZONTAL
5 !	2483.50	50.85	54.00	-3.15	21.02	2.10	0.00	27.73	122	353	Average	HORIZONTAL
6	2483.50	65.75	74.00	-8.25	35.92	2.10	0.00	27.73	122	353	Peak	HORIZONTAL

Item 3, 4 are the fundamental frequency at 2437MHz.

Channel 9

	Freq	Level	Limit	Over	Read	Cable	Preamp	Antenna	A/Pos	T/Pos	Remark	Pol/Phase
	MHz	dBuV/m	dBuV/m	dB	dBuV	dB	dB	dB/m	cm	deg		
1 p	2449.60	105.61	74.00			2.08	0.00	27.78	118	343	Peak	HORIZONTAL
2 a	2461.20	96.71	54.00			2.08	0.00	27.76	118	343	Average	HORIZONTAL
3 !	2485.90	51.84	54.00	-2.16	22.01	2.10	0.00	27.73	118	343	Average	HORIZONTAL
4	2489.10	63.96	74.00	-10.04	34.16	2.10	0.00	27.70	118	343	Peak	HORIZONTAL

Item 1, 2 are the fundamental frequency at 2452 MHz.

Note: Emission level (dBuV/m) = 20 log Emission level (uV/m).

Corrected Reading: Antenna Factor + Cable Loss + Read Level - Preamp Factor = Level.

Temperature	24.5°C	Humidity	57%
Test Engineer	Satoshi Yang	Configurations	IEEE 802.11b CH 1, 6, 11 / Mode 1
Test Date	Oct. 21, 2010		

Channel 1

	Freq	Level	Limit Line	Over Limit	Read Level	CableAntenna Loss	Antenna Factor	Preamp Factor	T/Pos	A/Pos	Remark	Pol/Phase
	MHz	dBuV/m	dBuV/m	dB	dBuV	dB	dB/m	dB	deg	cm		
1	2386.00	57.28	74.00	-16.72	26.90	2.21	28.17	0.00	354	147	Peak	HORIZONTAL
2	2386.60	48.47	54.00	-5.53	18.09	2.21	28.17	0.00	354	147	Average	HORIZONTAL
3	2411.20	105.93	54.00			2.22	28.21	0.00	354	147	Average	HORIZONTAL
4	2411.20	109.27	74.00			2.22	28.21	0.00	354	147	Peak	HORIZONTAL

Item 1, 2 are the fundamental frequency at 2412 MHz.

Channel 6

	Freq	Level	Limit Line	Over Limit	Read Level	CableAntenna Loss	Antenna Factor	Preamp Factor	T/Pos	A/Pos	Remark	Pol/Phase
	MHz	dBuV/m	dBuV/m	dB	dBuV	dB	dB/m	dB	deg	cm		
1	2389.80	53.75	74.00	-20.25	23.36	2.22	28.17	0.00	323	146	Peak	HORIZONTAL
2	2390.00	43.65	54.00	-10.35	13.26	2.22	28.17	0.00	323	146	Average	HORIZONTAL
3	2436.20	105.80	54.00			2.23	28.29	0.00	323	146	Average	HORIZONTAL
4	2438.00	109.53	74.00			2.23	28.29	0.00	323	146	Peak	HORIZONTAL
5	2483.50	43.69	54.00	-10.31	13.05	2.26	28.38	0.00	323	146	Average	HORIZONTAL
6	2483.70	54.58	74.00	-19.42	23.94	2.26	28.38	0.00	323	146	Peak	HORIZONTAL

Item 3, 4 are the fundamental frequency at 2437MHz.

Channel 11

	Freq	Level	Limit Line	Over Limit	Read Level	CableAntenna Loss	Antenna Factor	Preamp Factor	T/Pos	A/Pos	Remark	Pol/Phase
	MHz	dBuV/m	dBuV/m	dB	dBuV	dB	dB/m	dB	deg	cm		
1	2461.20	105.87	54.00			2.24	28.33	0.00	346	117	Average	HORIZONTAL
2	2461.20	109.48	74.00			2.24	28.33	0.00	346	117	Peak	HORIZONTAL
3	2483.50	46.85	54.00	-7.15	16.21	2.26	28.38	0.00	346	117	Average	HORIZONTAL
4	2483.50	56.63	74.00	-17.37	25.99	2.26	28.38	0.00	346	117	Peak	HORIZONTAL

Item 1, 2 are the fundamental frequency at 2462 MHz.

Temperature	24.5°C	Humidity	57%
Test Engineer	Satoshi Yang	Configurations	IEEE 802.11g CH 1, 6, 11 / Mode 1
Test Date	Oct. 21, 2010		

Channel 1

	Freq	Level	Limit Line	Over Limit	Read Level	Cable Loss	Antenna Factor	Preamp Factor	T/Pos	A/Pos	Remark	Pol/Phase
	MHz	dBuV/m	dBuV/m	dB	dBuV	dB	dB/m	dB	deg	cm		
1	2389.20	60.83	74.00	-13.17	30.45	2.21	28.17	0.00	186	146	Peak	HORIZONTAL
2	2390.00	47.95	54.00	-6.05	17.56	2.22	28.17	0.00	186	146	Average	HORIZONTAL
3	2405.60	107.61	74.00			2.22	28.21	0.00	186	146	Peak	HORIZONTAL
4	2406.00	98.19	54.00			2.22	28.21	0.00	186	146	Average	HORIZONTAL

Item 3, 4 are the fundamental frequency at 2412 MHz.

Channel 6

	Freq	Level	Limit Line	Over Limit	Read Level	Cable Loss	Antenna Factor	Preamp Factor	T/Pos	A/Pos	Remark	Pol/Phase
	MHz	dBuV/m	dBuV/m	dB	dBuV	dB	dB/m	dB	deg	cm		
1	2389.80	55.99	74.00	-18.01	25.60	2.22	28.17	0.00	207	117	Peak	HORIZONTAL
2	2390.00	44.90	54.00	-9.10	14.51	2.22	28.17	0.00	207	117	Average	HORIZONTAL
3	2438.80	111.21	74.00			2.23	28.29	0.00	207	117	Peak	HORIZONTAL
4	2439.20	102.10	54.00			2.23	28.29	0.00	207	117	Average	HORIZONTAL
5	2483.50	45.82	54.00	-8.18	15.18	2.26	28.38	0.00	207	117	Average	HORIZONTAL
6	2483.70	56.71	74.00	-17.29	26.07	2.26	28.38	0.00	207	117	Peak	HORIZONTAL

Item 3, 4 are the fundamental frequency at 2437 MHz.

Channel 11

	Freq	Level	Limit Line	Over Limit	Read Level	Cable Loss	Antenna Factor	Preamp Factor	T/Pos	A/Pos	Remark	Pol/Phase
	MHz	dBuV/m	dBuV/m	dB	dBuV	dB	dB/m	dB	deg	cm		
1	2458.20	109.59	74.00			2.24	28.33	0.00	193	111	Peak	HORIZONTAL
2	2459.40	100.47	54.00			2.24	28.33	0.00	193	111	Average	HORIZONTAL
3	2483.50	50.79	54.00	-3.21	20.15	2.26	28.38	0.00	193	111	Average	HORIZONTAL
4	2486.30	65.28	74.00	-8.72	34.60	2.26	28.42	0.00	193	111	Peak	HORIZONTAL

Item 1, 2 are the fundamental frequency at 2462 MHz.

Note: Emission level (dBuV/m) = 20 log Emission level (uV/m).

Corrected Reading: Antenna Factor + Cable Loss + Read Level - Preamp Factor = Level.

<For Main Source – Mode 2 with PIFA Antenna>:

Temperature	24.5°C	Humidity	57%
Test Engineer	Satoshi Yang	Configurations	IEEE 802.11n MCS0 20MHz Ch 1, 6, 11 / Mode 2
Test Date	Oct. 13, 2010		

Channel 1

	Freq	Level	Limit Line	Over Limit	Read Level	CableAntenna Loss	Antenna Factor	Preamp Factor	T/Pos	A/Pos	Remark	Pol/Phase
	MHz	dBuV/m	dBuV/m	dB	dBuV	dB	dB/m	dB	deg	cm		
1	2390.00	47.88	54.00	-6.12	17.95	1.76	28.17	0.00	318	100	Average	VERTICAL
2	2390.00	66.30	74.00	-7.70	36.37	1.76	28.17	0.00	318	100	Peak	VERTICAL
3	2408.80	93.62	54.00			1.77	28.21	0.00	318	100	Average	VERTICAL
4	2409.00	103.31	74.00			1.77	28.21	0.00	318	100	Peak	VERTICAL

Item 3, 4 are the fundamental frequency at 2412 MHz

Channel 6

	Freq	Level	Limit Line	Over Limit	Read Level	CableAntenna Loss	Antenna Factor	Preamp Factor	T/Pos	A/Pos	Remark	Pol/Phase
	MHz	dBuV/m	dBuV/m	dB	dBuV	dB	dB/m	dB	deg	cm		
1	2390.00	43.41	54.00	-10.59	13.48	1.76	28.17	0.00	173	135	Average	HORIZONTAL
2	2390.00	56.24	74.00	-17.76	26.31	1.76	28.17	0.00	173	135	Peak	HORIZONTAL
3	2431.60	106.07	74.00			1.78	28.25	0.00	173	135	Peak	HORIZONTAL
4	2433.80	96.74	54.00			1.78	28.25	0.00	173	135	Average	HORIZONTAL
5	2483.50	44.90	54.00	-9.10	14.71	1.81	28.38	0.00	173	135	Average	HORIZONTAL
6	2485.10	58.41	74.00	-15.59	28.18	1.81	28.42	0.00	173	135	Peak	HORIZONTAL

Item 3, 4 are the fundamental frequency at 2437MHz.

Channel 11

	Freq	Level	Limit Line	Over Limit	Read Level	CableAntenna Loss	Antenna Factor	Preamp Factor	T/Pos	A/Pos	Remark	Pol/Phase
	MHz	dBuV/m	dBuV/m	dB	dBuV	dB	dB/m	dB	deg	cm		
1	2459.20	104.05	74.00			1.80	28.33	0.00	186	107	Peak	HORIZONTAL
2	2467.40	94.49	54.00			1.80	28.33	0.00	186	107	Average	HORIZONTAL
3	2483.50	49.79	54.00	-4.21	19.60	1.81	28.38	0.00	186	107	Average	HORIZONTAL
4	2484.30	63.40	74.00	-10.60	33.21	1.81	28.38	0.00	186	107	Peak	HORIZONTAL

Item 1, 2 are the fundamental frequency at 2462 MHz.

Temperature	24.5°C	Humidity	57%
Test Engineer	Satoshi Yang	Configurations	IEEE 802.11n MCS0 40MHz Ch 3, 6, 9 / Mode 2
Test Date	Oct. 13, 2010		

Channel 3

	Freq	Level	Limit Line	Over Limit	Read Level	Cable Loss	Antenna Factor	Preamp Factor	T/Pos	A/Pos	Remark	Pol/Phase
	MHz	dBuV/m	dBuV/m	dB	dBuV	dB	dB/m	dB	deg	cm		
1	2388.80	68.57	74.00	-5.43	38.64	1.76	28.17	0.00	319	100	Peak	VERTICAL
2	2390.00	51.75	54.00	-2.25	21.82	1.76	28.17	0.00	319	100	Average	VERTICAL
3	2406.00	101.71	74.00			1.77	28.21	0.00	319	100	Peak	VERTICAL
4	2406.40	92.88	54.00			1.77	28.21	0.00	319	100	Average	VERTICAL

Item 3, 4 are the fundamental frequency at 2422 MHz.

Channel 6

	Freq	Level	Limit Line	Over Limit	Read Level	Cable Loss	Antenna Factor	Preamp Factor	T/Pos	A/Pos	Remark	Pol/Phase
	MHz	dBuV/m	dBuV/m	dB	dBuV	dB	dB/m	dB	deg	cm		
1	2390.00	50.90	54.00	-3.10	20.97	1.76	28.17	0.00	210	100	Average	VERTICAL
2	2390.00	65.34	74.00	-8.66	35.41	1.76	28.17	0.00	210	100	Peak	VERTICAL
3	2427.40	94.95	54.00			1.77	28.25	0.00	210	100	Average	VERTICAL
4	2429.40	104.41	74.00			1.78	28.25	0.00	210	100	Peak	VERTICAL
5	2483.50	50.47	54.00	-3.53	20.29	1.81	28.37	0.00	210	100	Average	VERTICAL
6	2483.50	63.53	74.00	-10.47	33.35	1.81	28.37	0.00	210	100	Peak	VERTICAL

Item 3, 4 are the fundamental frequency at 2437MHz.

Channel 9

	Freq	Level	Limit Line	Over Limit	Read Level	Cable Loss	Antenna Factor	Preamp Factor	T/Pos	A/Pos	Remark	Pol/Phase
	MHz	dBuV/m	dBuV/m	dB	dBuV	dB	dB/m	dB	deg	cm		
1	2468.00	90.31	54.00			1.80	28.33	0.00	183	128	Average	HORIZONTAL
2	2468.00	99.05	74.00			1.80	28.33	0.00	183	128	Peak	HORIZONTAL
3	2484.30	51.57	54.00	-2.43	21.38	1.81	28.38	0.00	183	128	Average	HORIZONTAL
4	2487.90	64.55	74.00	-9.45	34.32	1.81	28.42	0.00	183	128	Peak	HORIZONTAL

Item 1, 2 are the fundamental frequency at 2452 MHz.

Note: Emission level (dBuV/m) = 20 log Emission level (uV/m).

Corrected Reading: Antenna Factor + Cable Loss + Read Level - Preamp Factor = Level.

Temperature	24.5°C	Humidity	57%
Test Engineer	Satoshi Yang	Configurations	IEEE 802.11b CH 1, 6, 11 / Mode 2
Test Date	Oct. 13, 2010		

Channel 1

	Freq	Level	Limit Line	Over Limit	Read Level	CableAntenna Loss	Antenna Factor	Preamp Factor	T/Pos	A/Pos	Remark	Pol/Phase
	MHz	dBuV/m	dBuV/m	dB	dBuV	dB	dB/m	dB	deg	cm		
1	2376.40	54.15	74.00	-19.85	24.28	1.74	28.13	0.00	177	125	Peak	VERTICAL
2	2386.20	43.84	54.00	-10.16	13.91	1.76	28.17	0.00	177	125	Average	VERTICAL
3	2411.20	101.25	54.00			1.77	28.21	0.00	177	125	Average	VERTICAL
4	2411.20	104.82	74.00			1.77	28.21	0.00	177	125	Peak	VERTICAL

Item 1, 2 are the fundamental frequency at 2412 MHz.

Channel 6

	Freq	Level	Limit Line	Over Limit	Read Level	CableAntenna Loss	Antenna Factor	Preamp Factor	T/Pos	A/Pos	Remark	Pol/Phase
	MHz	dBuV/m	dBuV/m	dB	dBuV	dB	dB/m	dB	deg	cm		
1	2389.60	52.15	74.00	-21.85	22.22	1.76	28.17	0.00	192	109	Peak	HORIZONTAL
2	2390.00	42.33	54.00	-11.67	12.40	1.76	28.17	0.00	192	109	Average	HORIZONTAL
3	2436.20	103.57	54.00			1.78	28.29	0.00	192	109	Average	HORIZONTAL
4	2436.20	107.06	74.00			1.78	28.29	0.00	192	109	Peak	HORIZONTAL
5	2484.90	44.63	54.00	-9.37	14.44	1.81	28.38	0.00	192	109	Average	HORIZONTAL
6	2484.90	55.77	74.00	-18.23	25.58	1.81	28.38	0.00	192	109	Peak	HORIZONTAL

Item 3, 4 are the fundamental frequency at 2437MHz.

Channel 11

	Freq	Level	Limit Line	Over Limit	Read Level	CableAntenna Loss	Antenna Factor	Preamp Factor	T/Pos	A/Pos	Remark	Pol/Phase
	MHz	dBuV/m	dBuV/m	dB	dBuV	dB	dB/m	dB	deg	cm		
1	2461.20	101.75	54.00			1.80	28.33	0.00	159	109	Average	HORIZONTAL
2	2463.20	105.25	74.00			1.80	28.33	0.00	159	109	Peak	HORIZONTAL
3	2487.90	48.02	54.00	-5.98	17.79	1.81	28.42	0.00	159	109	Average	HORIZONTAL
4	2488.10	56.66	74.00	-17.34	26.43	1.81	28.42	0.00	159	109	Peak	HORIZONTAL

Item 1, 2 are the fundamental frequency at 2462 MHz.

Temperature	24.5°C	Humidity	57%
Test Engineer	Satoshi Yang	Configurations	IEEE 802.11g CH 1, 6, 11 / Mode 2
Test Date	Oct. 13, 2010		

Channel 1

	Freq	Level	Limit	Over	Read	Cable	Antenna	Preamp	T/Pos	A/Pos	Remark	Pol/Phase
	MHz	dBuV/m	dBuV/m	dB	dBuV	dB	dB/m	dB	deg	cm		
1	2390.00	46.04	54.00	-7.96	16.11	1.76	28.17	0.00	183	121	Average	VERTICAL
2	2390.00	59.28	74.00	-14.72	29.35	1.76	28.17	0.00	183	121	Peak	VERTICAL
3	2405.80	105.43	74.00			1.77	28.21	0.00	183	121	Peak	VERTICAL
4	2408.80	96.26	54.00			1.77	28.21	0.00	183	121	Average	VERTICAL

Item 3, 4 are the fundamental frequency at 2412 MHz.

Channel 6

	Freq	Level	Limit	Over	Read	Cable	Antenna	Preamp	T/Pos	A/Pos	Remark	Pol/Phase
	MHz	dBuV/m	dBuV/m	dB	dBuV	dB	dB/m	dB	deg	cm		
1	2389.60	53.68	74.00	-20.32	23.75	1.76	28.17	0.00	196	109	Peak	HORIZONTAL
2	2390.00	42.83	54.00	-11.17	12.90	1.76	28.17	0.00	196	109	Average	HORIZONTAL
3	2433.20	107.71	74.00			1.78	28.25	0.00	196	109	Peak	HORIZONTAL
4	2434.40	98.62	54.00			1.78	28.29	0.00	196	109	Average	HORIZONTAL
5	2483.50	45.24	54.00	-8.76	15.05	1.81	28.38	0.00	196	109	Average	HORIZONTAL
6	2484.50	56.21	74.00	-17.79	26.02	1.81	28.38	0.00	196	109	Peak	HORIZONTAL

Item 3, 4 are the fundamental frequency at 2437 MHz.

Channel 11

	Freq	Level	Limit	Over	Read	Cable	Antenna	Preamp	T/Pos	A/Pos	Remark	Pol/Phase
	MHz	dBuV/m	dBuV/m	dB	dBuV	dB	dB/m	dB	deg	cm		
1	2455.60	102.37	74.00			1.80	28.33	0.00	189	128	Peak	HORIZONTAL
2	2467.60	93.26	54.00			1.80	28.33	0.00	189	128	Average	HORIZONTAL
3	2483.50	47.57	54.00	-6.43	17.38	1.81	28.38	0.00	189	128	Average	HORIZONTAL
4	2486.50	61.61	74.00	-12.39	31.38	1.81	28.42	0.00	189	128	Peak	HORIZONTAL

Item 1, 2 are the fundamental frequency at 2462 MHz.

Note: Emission level (dBuV/m) = 20 log Emission level (uV/m).

Corrected Reading: Antenna Factor + Cable Loss + Read Level - Preamp Factor = Level.

<For Second Source – Mode 1 with Printed Antenna>:

Temperature	24.5°C	Humidity	57%
Test Engineer	Satoshi Yang	Configurations	IEEE 802.11n MCS0 20MHz Ch 1, 6, 11 / Mode 1
Test Date	Oct. 21, 2010		

Channel 1

	Freq	Level	Limit	Over	Read	CableAntenna	Preamp	T/Pos	A/Pos	Remark	Pol/Phase	
	MHz	dBuV/m	dBuV/m	dB	dBuV	Loss	Factor	Factor	deg	cm		
1	2389.80	59.33	74.00	-14.67	28.94	2.22	28.17	0.00	360	140	Peak	HORIZONTAL
2	2390.00	47.97	54.00	-6.03	17.58	2.22	28.17	0.00	360	140	Average	HORIZONTAL
3	2409.00	107.12	74.00			2.22	28.21	0.00	360	140	Peak	HORIZONTAL
4	2415.20	97.97	54.00			2.22	28.21	0.00	360	140	Average	HORIZONTAL

Item 3, 4 are the fundamental frequency at 2412 MHz

Channel 6

	Freq	Level	Limit	Over	Read	CableAntenna	Preamp	T/Pos	A/Pos	Remark	Pol/Phase	
	MHz	dBuV/m	dBuV/m	dB	dBuV	Loss	Factor	Factor	deg	cm		
1	2389.80	55.31	74.00	-18.69	24.92	2.22	28.17	0.00	357	135	Peak	HORIZONTAL
2	2390.00	43.85	54.00	-10.15	13.46	2.22	28.17	0.00	357	135	Average	HORIZONTAL
3	2440.20	102.16	54.00			2.23	28.29	0.00	357	135	Average	HORIZONTAL
4	2440.40	111.49	74.00			2.23	28.29	0.00	357	135	Peak	HORIZONTAL
5	2483.70	45.78	54.00	-8.22	15.14	2.26	28.38	0.00	357	135	Average	HORIZONTAL
6	2484.10	57.85	74.00	-16.15	27.21	2.26	28.38	0.00	357	135	Peak	HORIZONTAL

Item 3, 4 are the fundamental frequency at 2437MHz.

Channel 11

	Freq	Level	Limit	Over	Read	CableAntenna	Preamp	T/Pos	A/Pos	Remark	Pol/Phase	
	MHz	dBuV/m	dBuV/m	dB	dBuV	Loss	Factor	Factor	deg	cm		
1	2457.40	108.58	74.00			2.24	28.33	0.00	343	116	Peak	HORIZONTAL
2	2458.80	99.33	54.00			2.24	28.33	0.00	343	116	Average	HORIZONTAL
3	2483.50	49.07	54.00	-4.93	18.43	2.26	28.38	0.00	343	116	Average	HORIZONTAL
4	2488.30	61.57	74.00	-12.43	30.89	2.26	28.42	0.00	343	116	Peak	HORIZONTAL

Item 1, 2 are the fundamental frequency at 2462 MHz.

Temperature	24.5°C	Humidity	57%
Test Engineer	Satoshi Yang	Configurations	IEEE 802.11n MCS0 40MHz Ch 3, 6, 9 / Mode 1
Test Date	Oct. 21, 2010		

Channel 3

	Freq	Level	Limit Line	Over Limit	Read Level	CableAntenna Loss	Preamp Factor	T/Pos	A/Pos	Remark	Pol/Phase
	MHz	dBuV/m	dBuV/m	dB	dBuV	dB	dB/m	deg	cm		
1	2385.60	59.69	74.00	-14.31	29.31	2.21	28.17	0.00	5	100 Peak	VERTICAL
2	2390.00	47.58	54.00	-6.42	17.19	2.22	28.17	0.00	5	100 Average	VERTICAL
3	2426.40	91.10	54.00			2.23	28.25	0.00	5	100 Average	VERTICAL
4	2432.00	99.75	74.00			2.23	28.25	0.00	5	100 Peak	VERTICAL

Item 3, 4 are the fundamental frequency at 2422 MHz.

Channel 6

	Freq	Level	Limit Line	Over Limit	Read Level	CableAntenna Loss	Preamp Factor	T/Pos	A/Pos	Remark	Pol/Phase
	MHz	dBuV/m	dBuV/m	dB	dBuV	dB	dB/m	deg	cm		
1	2389.20	65.20	74.00	-8.80	34.82	2.21	28.17	0.00	361	139 Peak	HORIZONTAL
2	2390.00	51.81	54.00	-2.19	21.42	2.22	28.17	0.00	361	139 Average	HORIZONTAL
3	2446.20	99.34	54.00			2.24	28.29	0.00	361	139 Average	HORIZONTAL
4	2447.80	108.93	74.00			2.24	28.29	0.00	361	139 Peak	HORIZONTAL
5	2483.50	51.77	54.00	-2.23	21.13	2.26	28.38	0.00	361	139 Average	HORIZONTAL
6	2483.50	66.74	74.00	-7.26	36.10	2.26	28.38	0.00	361	139 Peak	HORIZONTAL

Item 3, 4 are the fundamental frequency at 2437MHz.

Channel 9

	Freq	Level	Limit Line	Over Limit	Read Level	CableAntenna Loss	Preamp Factor	T/Pos	A/Pos	Remark	Pol/Phase
	MHz	dBuV/m	dBuV/m	dB	dBuV	dB	dB/m	deg	cm		
1	2461.20	96.26	54.00			2.24	28.33	0.00	344	114 Average	HORIZONTAL
2	2462.40	105.43	74.00			2.24	28.33	0.00	344	114 Peak	HORIZONTAL
3	2483.50	51.09	54.00	-2.91	20.45	2.26	28.38	0.00	344	114 Average	HORIZONTAL
4	2483.90	62.41	74.00	-11.59	31.77	2.26	28.38	0.00	344	114 Peak	HORIZONTAL

Item 1, 2 are the fundamental frequency at 2452 MHz.

Note: Emission level (dBuV/m) = 20 log Emission level (uV/m).

Corrected Reading: Antenna Factor + Cable Loss + Read Level - Preamp Factor = Level.

Temperature	24.5°C	Humidity	57%
Test Engineer	Satoshi Yang	Configurations	IEEE 802.11b CH 1, 6, 11 / Mode 1
Test Date	Oct. 21, 2010		

Channel 1

	Freq	Level	Limit Line	Over Limit	Read Level	CableAntenna Loss	Antenna Factor	Preamp Factor	T/Pos	A/Pos	Remark	Pol/Phase
	MHz	dBuV/m	dBuV/m	dB	dBuV	dB	dB/m	dB	deg	cm		
1	2385.20	58.01	74.00	-15.99	27.63	2.21	28.17	0.00	213	147	Peak	HORIZONTAL
2	2386.20	49.65	54.00	-4.35	19.27	2.21	28.17	0.00	213	147	Average	HORIZONTAL
3	2411.20	105.13	54.00			2.22	28.21	0.00	213	147	Average	HORIZONTAL
4	2413.00	108.78	74.00			2.22	28.21	0.00	213	147	Peak	HORIZONTAL

Item 1, 2 are the fundamental frequency at 2412 MHz.

Channel 6

	Freq	Level	Limit Line	Over Limit	Read Level	CableAntenna Loss	Antenna Factor	Preamp Factor	T/Pos	A/Pos	Remark	Pol/Phase
	MHz	dBuV/m	dBuV/m	dB	dBuV	dB	dB/m	dB	deg	cm		
1	2389.60	54.87	74.00	-19.13	24.49	2.21	28.17	0.00	352	141	Peak	HORIZONTAL
2	2389.80	44.95	54.00	-9.05	14.56	2.22	28.17	0.00	352	141	Average	HORIZONTAL
3	2437.80	108.92	54.00			2.23	28.29	0.00	352	141	Average	HORIZONTAL
4	2438.00	112.69	74.00			2.23	28.29	0.00	352	141	Peak	HORIZONTAL
5	2483.50	45.30	54.00	-8.70	14.66	2.26	28.38	0.00	352	141	Average	HORIZONTAL
6	2484.70	56.07	74.00	-17.93	25.43	2.26	28.38	0.00	352	141	Peak	HORIZONTAL

Item 3, 4 are the fundamental frequency at 2437MHz.

Channel 11

	Freq	Level	Limit Line	Over Limit	Read Level	CableAntenna Loss	Antenna Factor	Preamp Factor	T/Pos	A/Pos	Remark	Pol/Phase
	MHz	dBuV/m	dBuV/m	dB	dBuV	dB	dB/m	dB	deg	cm		
1	2461.20	105.29	54.00			2.24	28.33	0.00	326	133	Average	HORIZONTAL
2	2461.20	108.74	74.00			2.24	28.33	0.00	326	133	Peak	HORIZONTAL
3	2487.90	57.44	74.00	-16.56	26.76	2.26	28.42	0.00	326	133	Peak	HORIZONTAL
4	2488.50	48.18	54.00	-5.82	17.50	2.26	28.42	0.00	326	133	Average	HORIZONTAL

Item 1, 2 are the fundamental frequency at 2462 MHz.

Temperature	24.5°C	Humidity	57%
Test Engineer	Satoshi Yang	Configurations	IEEE 802.11g CH 1, 6, 11 / Mode 1
Test Date	Oct. 21, 2010		

Channel 1

	Freq	Level	Limit	Over	Read	Cable	Antenna	Preamp	T/Pos	A/Pos	Remark	Pol/Phase
	MHz	dBuV/m	dBuV/m	dB	dBuV	dB	dB/m	dB	deg	cm		
1	2389.40	60.75	74.00	-13.25	30.37	2.21	28.17	0.00	360	142	Peak	HORIZONTAL
2	2390.00	48.59	54.00	-5.41	18.20	2.22	28.17	0.00	360	142	Average	HORIZONTAL
3	2414.80	108.18	74.00			2.22	28.21	0.00	360	142	Peak	HORIZONTAL
4	2416.00	98.98	54.00			2.23	28.21	0.00	360	142	Average	HORIZONTAL

Item 3, 4 are the fundamental frequency at 2412 MHz.

Channel 6

	Freq	Level	Limit	Over	Read	Cable	Antenna	Preamp	T/Pos	A/Pos	Remark	Pol/Phase
	MHz	dBuV/m	dBuV/m	dB	dBuV	dB	dB/m	dB	deg	cm		
1	2389.60	55.39	74.00	-18.61	25.01	2.21	28.17	0.00	356	139	Peak	HORIZONTAL
2	2390.00	44.59	54.00	-9.41	14.20	2.22	28.17	0.00	356	139	Average	HORIZONTAL
3	2441.00	103.15	54.00			2.24	28.29	0.00	356	139	Average	HORIZONTAL
4	2441.80	112.25	74.00			2.24	28.29	0.00	356	139	Peak	HORIZONTAL
5	2483.50	46.06	54.00	-7.94	15.42	2.26	28.38	0.00	356	139	Average	HORIZONTAL
6	2484.50	57.11	74.00	-16.89	26.47	2.26	28.38	0.00	356	139	Peak	HORIZONTAL

Item 3, 4 are the fundamental frequency at 2437 MHz.

Channel 11

	Freq	Level	Limit	Over	Read	Cable	Antenna	Preamp	T/Pos	A/Pos	Remark	Pol/Phase
	MHz	dBuV/m	dBuV/m	dB	dBuV	dB	dB/m	dB	deg	cm		
1	2459.40	99.63	54.00			2.24	28.33	0.00	208	111	Average	HORIZONTAL
2	2465.40	108.67	74.00			2.24	28.33	0.00	208	111	Peak	HORIZONTAL
3	2483.50	51.40	54.00	-2.60	20.76	2.26	28.38	0.00	208	111	Average	HORIZONTAL
4	2486.10	65.79	74.00	-8.21	35.11	2.26	28.42	0.00	208	111	Peak	HORIZONTAL

Item 1, 2 are the fundamental frequency at 2462 MHz.

Note: Emission level (dBuV/m) = 20 log Emission level (uV/m).

Corrected Reading: Antenna Factor + Cable Loss + Read Level - Preamp Factor = Level.

<For Second Source – Mode 2 with PIFA Antenna>:

Temperature	24.5°C	Humidity	57%
Test Engineer	Satoshi Yang	Configurations	IEEE 802.11n MCS0 20MHz Ch 1, 6, 11 / Mode 2
Test Date	Oct. 13, 2010		

Channel 1

	Freq	Level	Limit Line	Over Limit	Read Level	CableAntenna Loss	Antenna Factor	Preamp Factor	T/Pos	A/Pos	Remark	Pol/Phase
	MHz	dBuV/m	dBuV/m	dB	dBuV	dB	dB/m	dB	deg	cm		
1	2389.80	59.45	74.00	-14.55	29.52	1.76	28.17	0.00	0	100	Peak	VERTICAL
2	2390.00	45.80	54.00	-8.20	15.87	1.76	28.17	0.00	0	100	Average	VERTICAL
3	2406.40	93.94	54.00			1.77	28.21	0.00	0	100	Average	VERTICAL
4	2409.00	103.65	74.00			1.77	28.21	0.00	0	100	Peak	VERTICAL

Item 3, 4 are the fundamental frequency at 2412 MHz

Channel 6

	Freq	Level	Limit Line	Over Limit	Read Level	CableAntenna Loss	Antenna Factor	Preamp Factor	T/Pos	A/Pos	Remark	Pol/Phase
	MHz	dBuV/m	dBuV/m	dB	dBuV	dB	dB/m	dB	deg	cm		
1	2389.60	53.02	74.00	-20.98	23.09	1.76	28.17	0.00	182	107	Peak	HORIZONTAL
2	2390.00	42.76	54.00	-11.24	12.83	1.76	28.17	0.00	182	107	Average	HORIZONTAL
3	2434.00	105.91	74.00			1.78	28.29	0.00	182	107	Peak	HORIZONTAL
4	2442.40	96.51	54.00			1.78	28.29	0.00	182	107	Average	HORIZONTAL
5	2483.50	44.69	54.00	-9.31	14.50	1.81	28.38	0.00	182	107	Average	HORIZONTAL
6	2484.30	56.46	74.00	-17.54	26.27	1.81	28.38	0.00	182	107	Peak	HORIZONTAL

Item 3, 4 are the fundamental frequency at 2437MHz.

Channel 11

	Freq	Level	Limit Line	Over Limit	Read Level	CableAntenna Loss	Antenna Factor	Preamp Factor	T/Pos	A/Pos	Remark	Pol/Phase
	MHz	dBuV/m	dBuV/m	dB	dBuV	dB	dB/m	dB	deg	cm		
1	2456.80	92.48	54.00			1.80	28.33	0.00	180	105	Average	HORIZONTAL
2	2459.00	102.75	74.00			1.80	28.33	0.00	180	105	Peak	HORIZONTAL
3	2483.50	47.49	54.00	-6.51	17.30	1.81	28.38	0.00	180	105	Average	HORIZONTAL
4	2483.50	60.83	74.00	-13.17	30.64	1.81	28.38	0.00	180	105	Peak	HORIZONTAL

Item 1, 2 are the fundamental frequency at 2462 MHz.

Temperature	24.5°C	Humidity	57%
Test Engineer	Satoshi Yang	Configurations	IEEE 802.11n MCS0 40MHz Ch 3, 6, 9 / Mode 2
Test Date	Oct. 13, 2010		

Channel 3

	Freq	Level	Limit	Over	Read	CableAntenna	Preamp	T/Pos	A/Pos	Remark	Pol/Phase
	MHz	dBuV/m	dBuV/m	dB	dBuV	dB	dB/m	deg	cm		
1	2388.80	61.78	74.00	-12.22	31.85	1.76	28.17	0.00	0	100 Peak	VERTICAL
2	2390.00	46.63	54.00	-7.37	16.70	1.76	28.17	0.00	0	100 Average	VERTICAL
3	2405.60	99.88	74.00			1.77	28.21	0.00	0	100 Peak	VERTICAL
4	2406.40	90.71	54.00			1.77	28.21	0.00	0	100 Average	VERTICAL

Item 3, 4 are the fundamental frequency at 2422 MHz.

Channel 6

	Freq	Level	Limit	Over	Read	CableAntenna	Preamp	T/Pos	A/Pos	Remark	Pol/Phase
	MHz	dBuV/m	dBuV/m	dB	dBuV	dB	dB/m	deg	cm		
1	2390.00	47.62	54.00	-6.38	17.69	1.76	28.17	0.00	185	105 Average	HORIZONTAL
2	2390.00	60.20	74.00	-13.80	30.27	1.76	28.17	0.00	185	105 Peak	HORIZONTAL
3	2447.40	103.13	74.00			1.78	28.29	0.00	185	105 Peak	HORIZONTAL
4	2452.60	93.39	54.00			1.78	28.33	0.00	185	105 Average	HORIZONTAL
5	2483.50	52.73	54.00	-1.27	22.54	1.81	28.38	0.00	185	105 Average	HORIZONTAL
6	2483.50	68.07	74.00	-5.93	37.88	1.81	28.38	0.00	185	105 Peak	HORIZONTAL

Item 3, 4 are the fundamental frequency at 2437MHz.

Channel 9

	Freq	Level	Limit	Over	Read	CableAntenna	Preamp	T/Pos	A/Pos	Remark	Pol/Phase
	MHz	dBuV/m	dBuV/m	dB	dBuV	dB	dB/m	deg	cm		
1	2456.40	90.20	54.00			1.80	28.33	0.00	187	104 Average	HORIZONTAL
2	2458.80	100.14	74.00			1.80	28.33	0.00	187	104 Peak	HORIZONTAL
3	2483.50	50.14	54.00	-3.86	19.95	1.81	28.38	0.00	187	104 Average	HORIZONTAL
4	2487.90	62.02	74.00	-11.98	31.79	1.81	28.42	0.00	187	104 Peak	HORIZONTAL

Item 1, 2 are the fundamental frequency at 2452 MHz.

Note: Emission level (dBuV/m) = 20 log Emission level (uV/m).

Corrected Reading: Antenna Factor + Cable Loss + Read Level - Preamp Factor = Level.

Temperature	24.5°C	Humidity	57%
Test Engineer	Satoshi Yang	Configurations	IEEE 802.11b CH 1, 6, 11 / Mode 2
Test Date	Oct. 13, 2010		

Channel 1

	Freq	Level	Limit	Over	Read	CableAntenna	Preamp	T/Pos	A/Pos	Remark	Pol/Phase
	MHz	dBuV/m	dBuV/m	dB	dBuV	dB	dB/m	dB	deg	cm	
1	2386.00	56.30	74.00	-17.70	26.37	1.76	28.17	0.00	319	100 Peak	VERTICAL
2	2386.30	46.83	54.00	-7.17	16.90	1.76	28.17	0.00	319	100 Average	VERTICAL
3	2411.20	101.52	54.00			1.77	28.21	0.00	319	100 Average	VERTICAL
4	2411.20	105.19	74.00			1.77	28.21	0.00	319	100 Peak	VERTICAL

Item 3, 4 are the fundamental frequency at 2412 MHz.

Channel 6

	Freq	Level	Limit	Over	Read	CableAntenna	Preamp	T/Pos	A/Pos	Remark	Pol/Phase
	MHz	dBuV/m	dBuV/m	dB	dBuV	dB	dB/m	dB	deg	cm	
1	2389.00	52.83	74.00	-21.17	22.90	1.76	28.17	0.00	179	108 Peak	HORIZONTAL
2	2390.00	42.77	54.00	-11.23	12.84	1.76	28.17	0.00	179	108 Average	HORIZONTAL
3	2436.20	102.64	54.00			1.78	28.29	0.00	179	108 Average	HORIZONTAL
4	2436.20	106.18	74.00			1.78	28.29	0.00	179	108 Peak	HORIZONTAL
5	2483.50	43.56	54.00	-10.44	13.37	1.81	28.38	0.00	179	108 Average	HORIZONTAL
6	2483.50	53.35	74.00	-20.65	23.16	1.81	28.38	0.00	179	108 Peak	HORIZONTAL

Item 3, 4 are the fundamental frequency at 2437MHz.

Channel 11

	Freq	Level	Limit	Over	Read	CableAntenna	Preamp	T/Pos	A/Pos	Remark	Pol/Phase
	MHz	dBuV/m	dBuV/m	dB	dBuV	dB	dB/m	dB	deg	cm	
1	2461.20	101.24	54.00			1.80	28.33	0.00	183	104 Average	HORIZONTAL
2	2461.20	104.95	74.00			1.80	28.33	0.00	183	104 Peak	HORIZONTAL
3	2487.50	56.80	74.00	-17.20	26.57	1.81	28.42	0.00	183	104 Peak	HORIZONTAL
4	2487.90	49.72	54.00	-4.28	19.49	1.81	28.42	0.00	183	104 Average	HORIZONTAL

Item 1, 2 are the fundamental frequency at 2462 MHz.

Temperature	24.5°C	Humidity	57%
Test Engineer	Satoshi Yang	Configurations	IEEE 802.11g CH 1, 6, 11 / Mode 2
Test Date	Oct. 13, 2010		

Channel 1

	Freq	Level	Limit	Over	Read	CableAntenna	Preamp	T/Pos	A/Pos	Remark	Pol/Phase	
	MHz	dBuV/m	dBuV/m	dB	dBuV	dB	dB/m	dB	deg	cm		
1	2389.20	61.07	74.00	-12.93	31.14	1.76	28.17	0.00	0	100	Peak	VERTICAL
2	2390.00	47.04	54.00	-6.96	17.11	1.76	28.17	0.00	0	100	Average	VERTICAL
3	2405.80	104.12	74.00			1.77	28.21	0.00	0	100	Peak	VERTICAL
4	2406.00	94.48	54.00			1.77	28.21	0.00	0	100	Average	VERTICAL

Item 3, 4 are the fundamental frequency at 2412 MHz.

Channel 6

	Freq	Level	Limit	Over	Read	CableAntenna	Preamp	T/Pos	A/Pos	Remark	Pol/Phase	
	MHz	dBuV/m	dBuV/m	dB	dBuV	dB	dB/m	dB	deg	cm		
1	2390.00	42.69	54.00	-11.31	12.76	1.76	28.17	0.00	183	107	Average	HORIZONTAL
2	2390.00	53.79	74.00	-20.21	23.86	1.76	28.17	0.00	183	107	Peak	HORIZONTAL
3	2432.20	96.87	54.00			1.78	28.25	0.00	183	107	Average	HORIZONTAL
4	2433.20	106.29	74.00			1.78	28.25	0.00	183	107	Peak	HORIZONTAL
5	2483.50	44.99	54.00	-9.01	14.80	1.81	28.38	0.00	183	107	Average	HORIZONTAL
6	2484.30	56.85	74.00	-17.15	26.66	1.81	28.38	0.00	183	107	Peak	HORIZONTAL

Item 3, 4 are the fundamental frequency at 2437 MHz.

Channel 11

	Freq	Level	Limit	Over	Read	CableAntenna	Preamp	T/Pos	A/Pos	Remark	Pol/Phase	
	MHz	dBuV/m	dBuV/m	dB	dBuV	dB	dB/m	dB	deg	cm		
1	2466.00	95.28	54.00			1.80	28.33	0.00	163	104	Average	HORIZONTAL
2	2466.80	104.51	74.00			1.80	28.33	0.00	163	104	Peak	HORIZONTAL
3	2483.50	48.18	54.00	-5.82	17.99	1.81	28.38	0.00	163	104	Average	HORIZONTAL
4	2485.10	62.51	74.00	-11.49	32.28	1.81	28.42	0.00	163	104	Peak	HORIZONTAL

Item 1, 2 are the fundamental frequency at 2462 MHz.

Note: Emission level (dBuV/m) = 20 log Emission level (uV/m).

Corrected Reading: Antenna Factor + Cable Loss + Read Level - Preamp Factor = Level.

<For Main Source – Mode 1 with Printed Antenna>:

For Emission not in Restricted Band

Low Band Edge Plot on Configuration IEEE 802.11n MCS0 20MHz / 2412 MHz

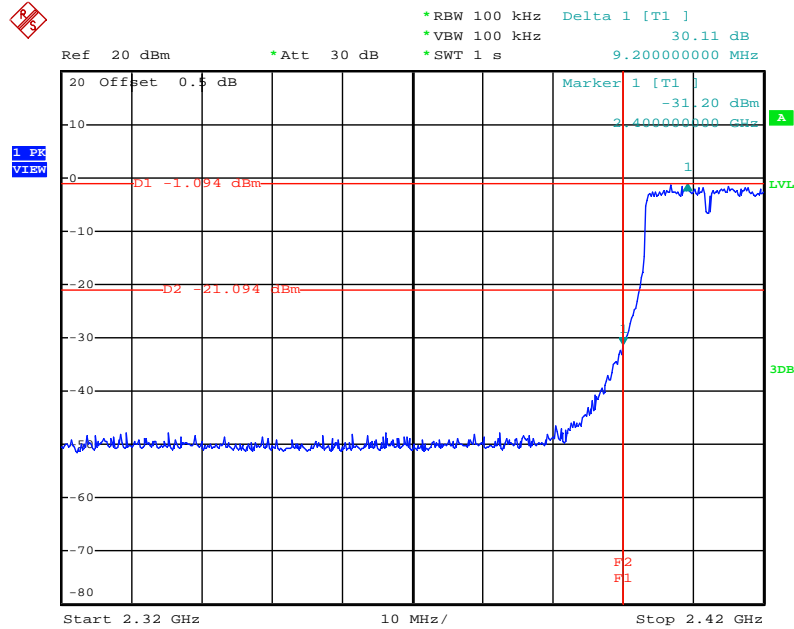

Date: 25.OCT.2010 19:59:06

High Band Edge Plot on Configuration IEEE 802.11n MCS0 20MHz / 2462 MHz

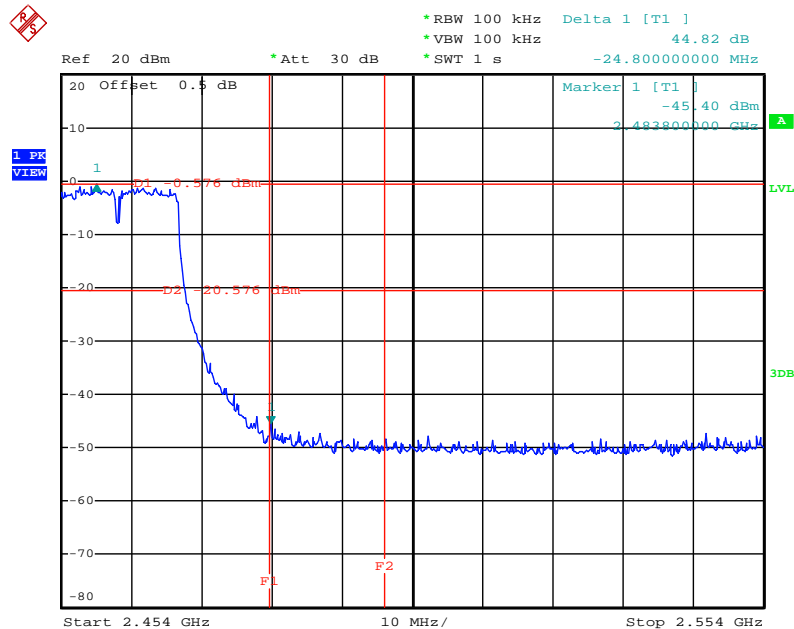

Date: 25.OCT.2010 20:04:01

Low Band Edge Plot on Configuration IEEE 802.11n MCS0 40MHz / 2422 MHz

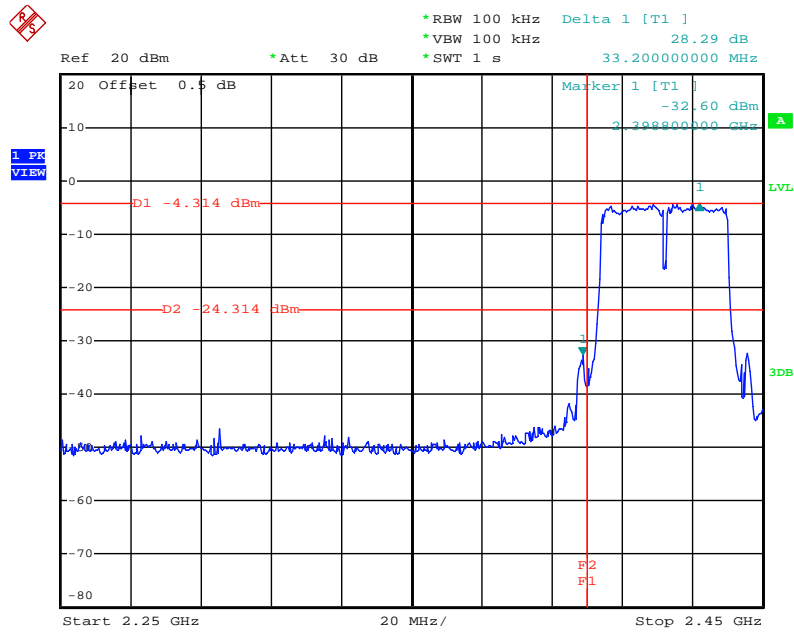

Date: 25.OCT.2010 20:06:19

High Band Edge Plot on Configuration IEEE 802.11n MCS0 40MHz / 2452 MHz

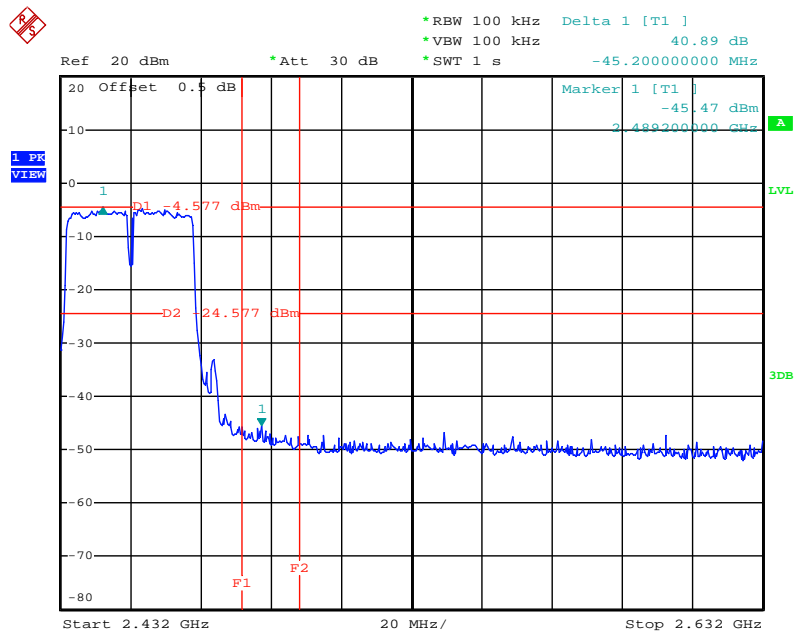

Date: 25.OCT.2010 20:10:59

Low Band Edge Plot on Configuration IEEE 802.11b / 2412 MHz

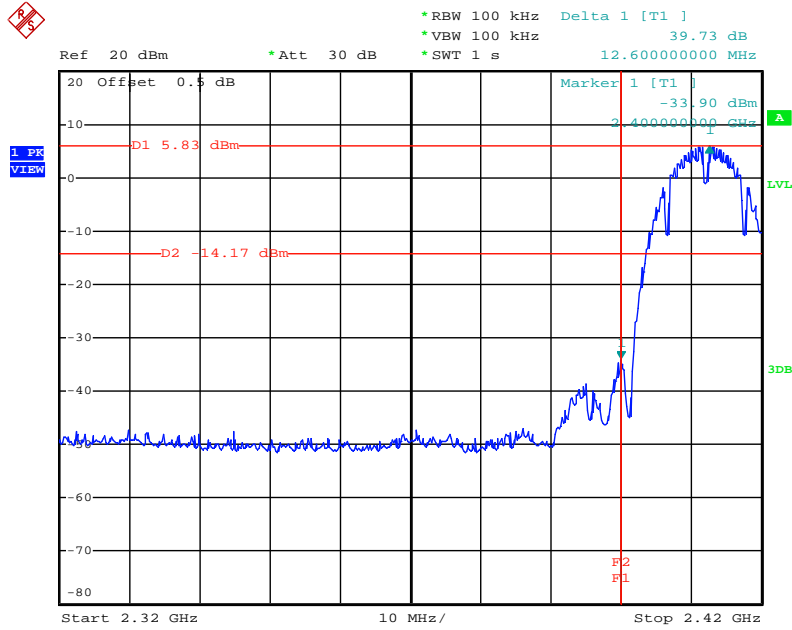

Date: 25.OCT.2010 19:43:29

High Band Edge Plot on Configuration IEEE 802.11b / 2462 MHz

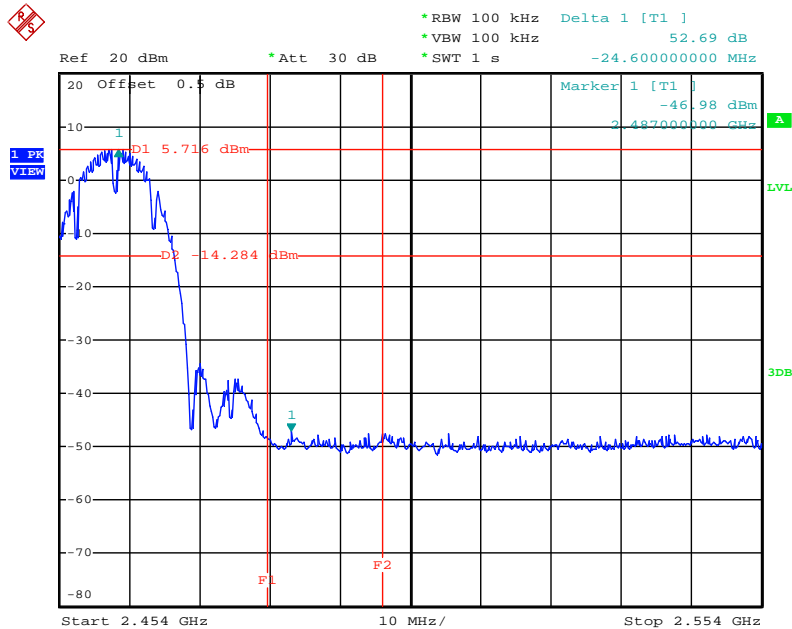

Date: 25.OCT.2010 19:48:54

Low Band Edge Plot on Configuration IEEE 802.11g / 2412 MHz

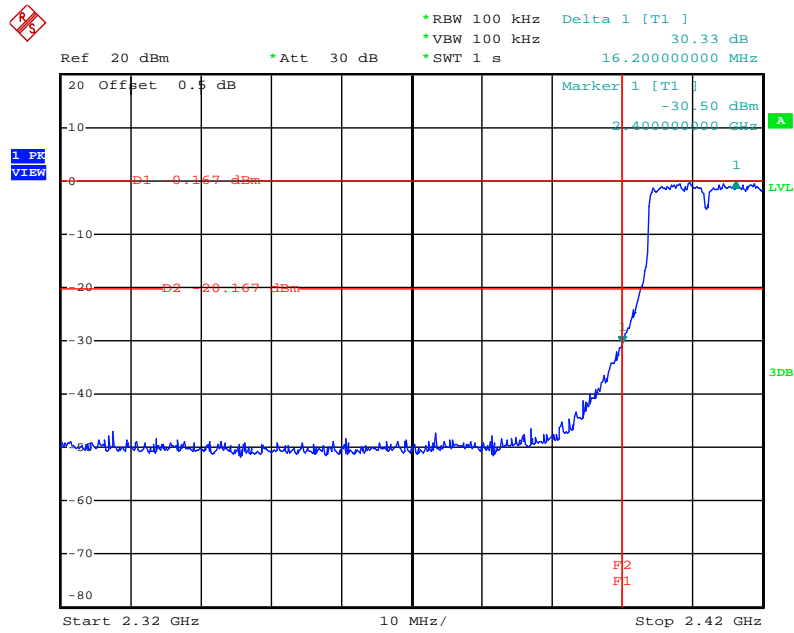

Date: 25.OCT.2010 19:56:23

High Band Edge Plot on Configuration IEEE 802.11g / 2462 MHz

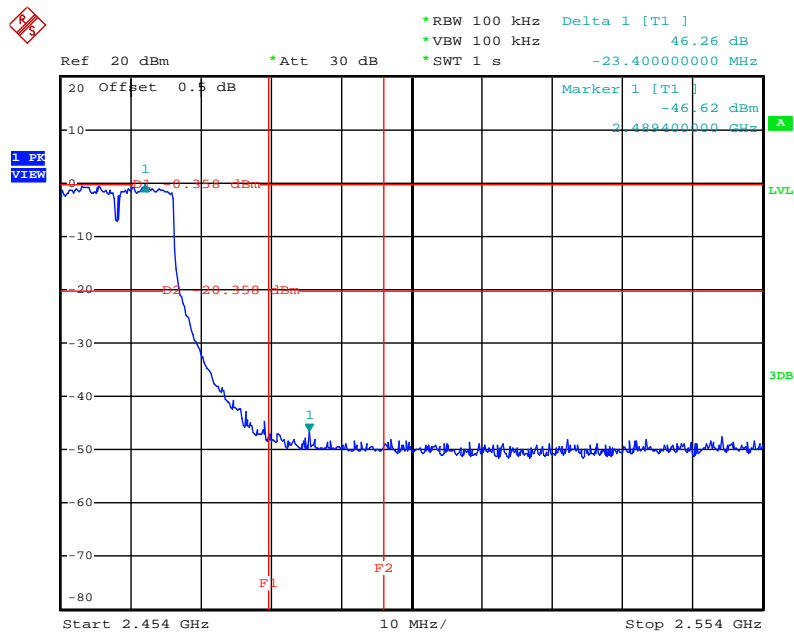

Date: 25.OCT.2010 19:52:07

<For Main Source – Mode 2 with PIFA Antenna>:

For Emission not in Restricted Band

Low Band Edge Plot on Configuration IEEE 802.11n MCS0 20MHz / 2412 MHz

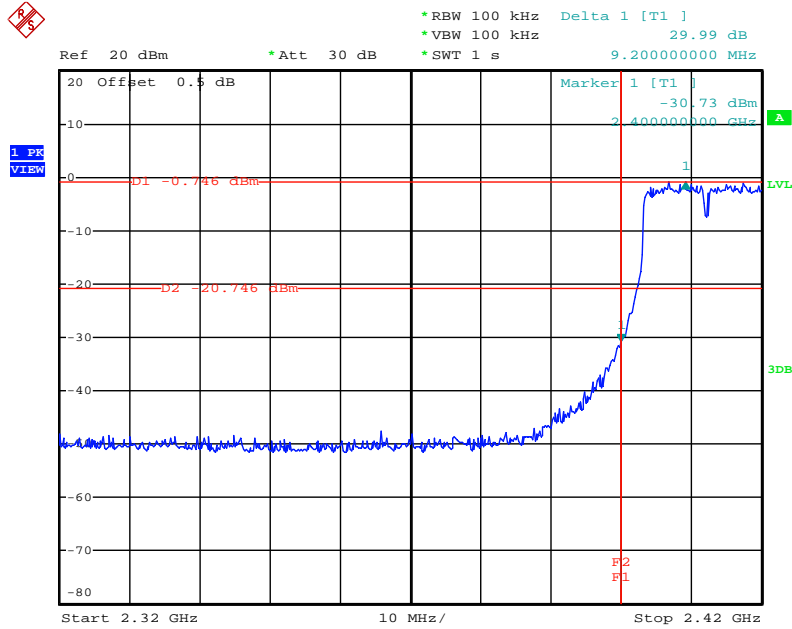

Date: 26.OCT.2010 09:44:35

High Band Edge Plot on Configuration IEEE 802.11n MCS0 20MHz / 2462 MHz

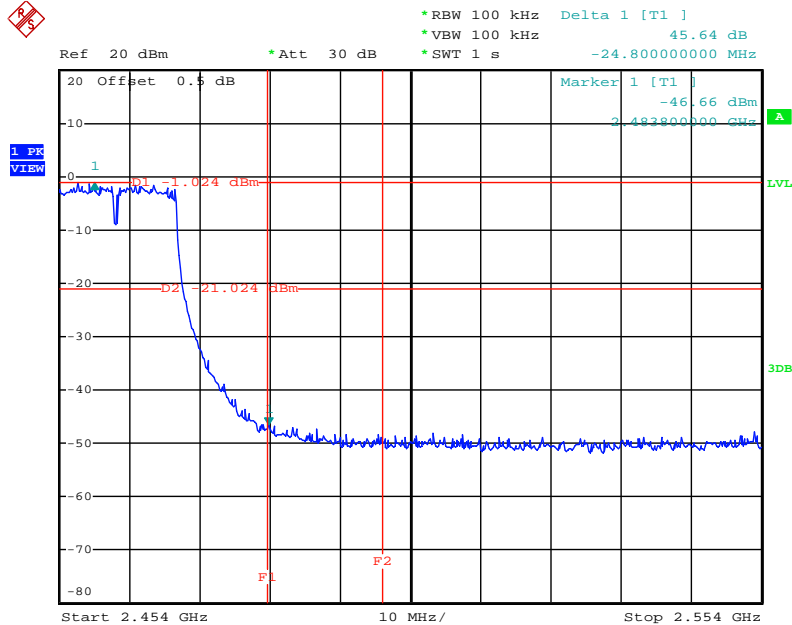

Date: 26.OCT.2010 09:49:37

Low Band Edge Plot on Configuration IEEE 802.11n MCS0 40MHz / 2422 MHz

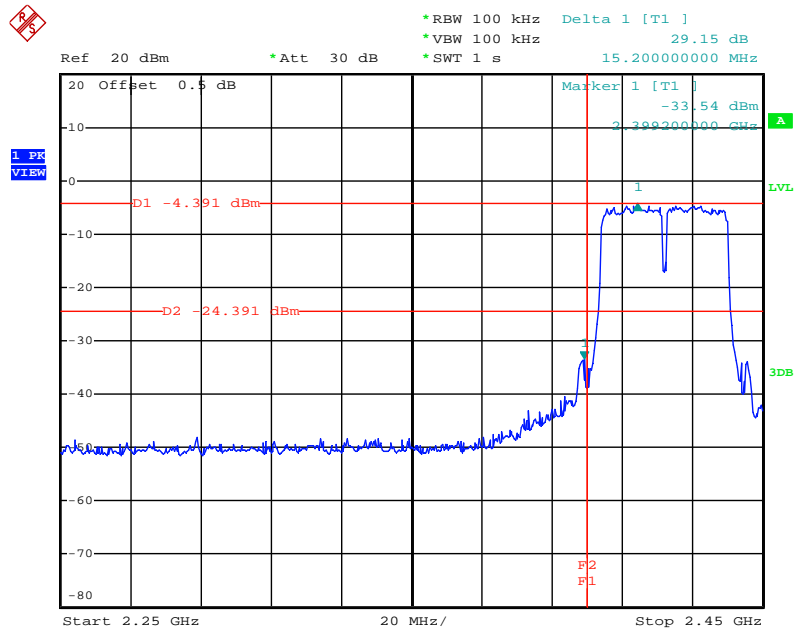

Date: 26.OCT.2010 09:52:41

High Band Edge Plot on Configuration IEEE 802.11n MCS0 40MHz / 2452 MHz

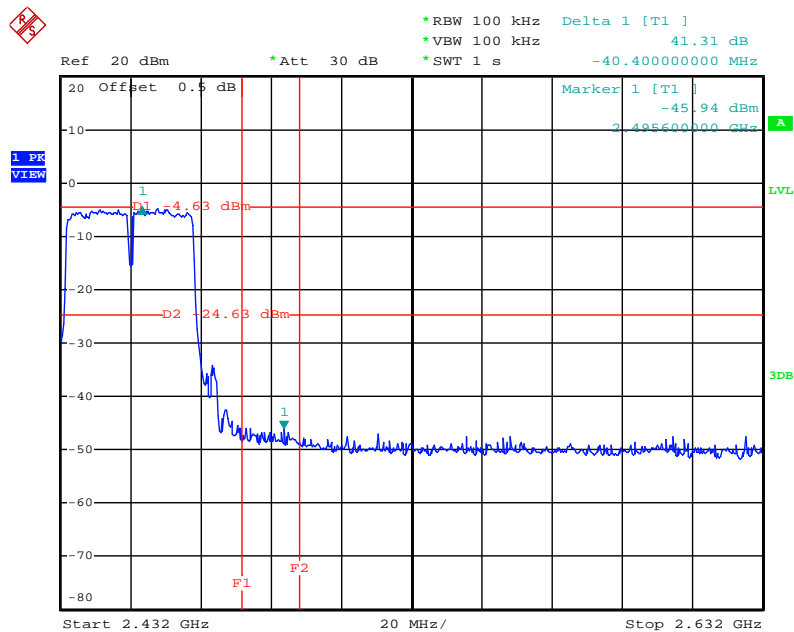

Date: 26.OCT.2010 09:58:08

Low Band Edge Plot on Configuration IEEE 802.11b / 2412 MHz

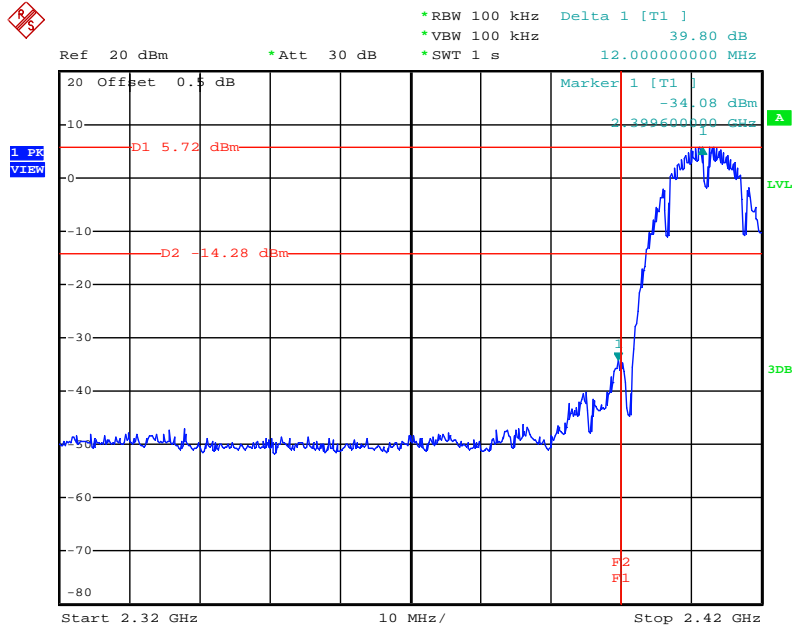

Date: 26.OCT.2010 09:24:00

High Band Edge Plot on Configuration IEEE 802.11b / 2462 MHz

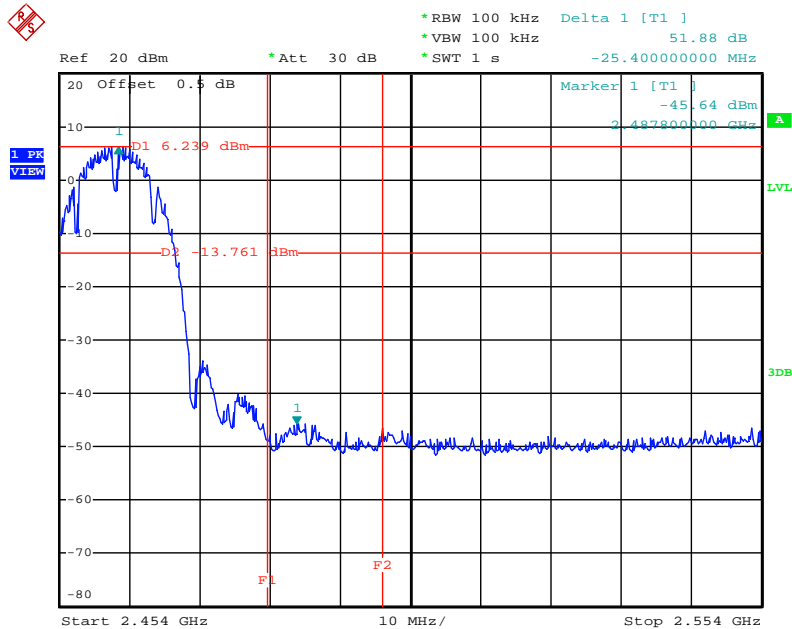

Date: 26.OCT.2010 09:30:13

Low Band Edge Plot on Configuration IEEE 802.11g / 2412 MHz

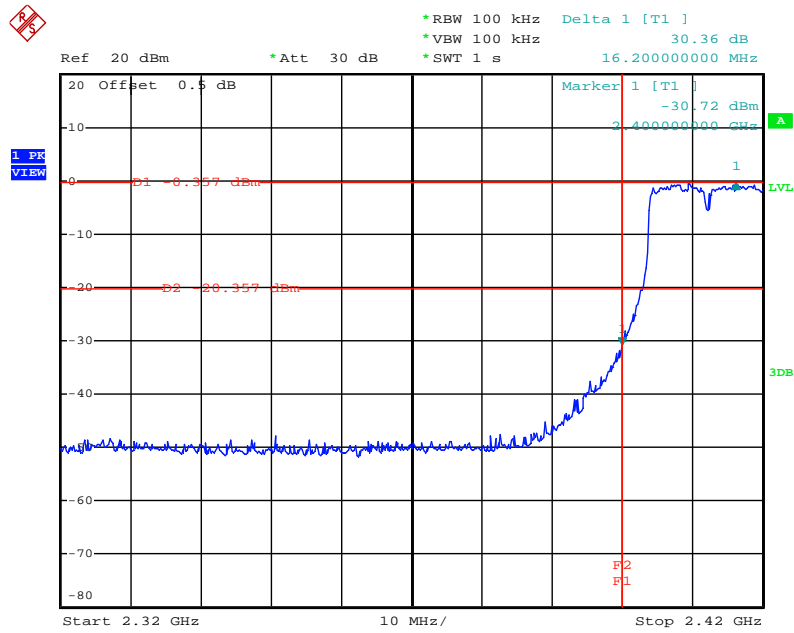

Date: 26.OCT.2010 09:33:02

High Band Edge Plot on Configuration IEEE 802.11g / 2462 MHz

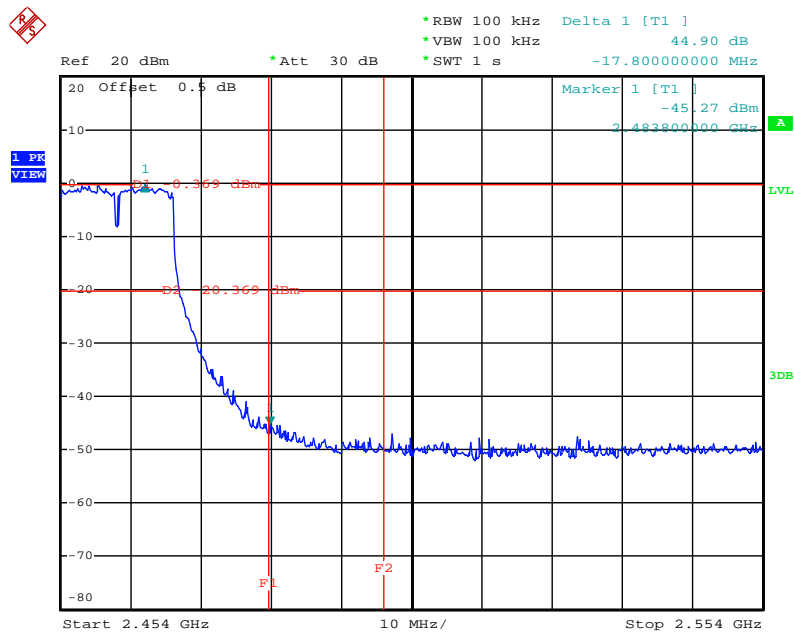

Date: 26.OCT.2010 09:41:14

<For Second Source – Mode 1 with Printed Antenna>:

For Emission not in Restricted Band

Low Band Edge Plot on Configuration IEEE 802.11n MCS0 20MHz / 2412 MHz

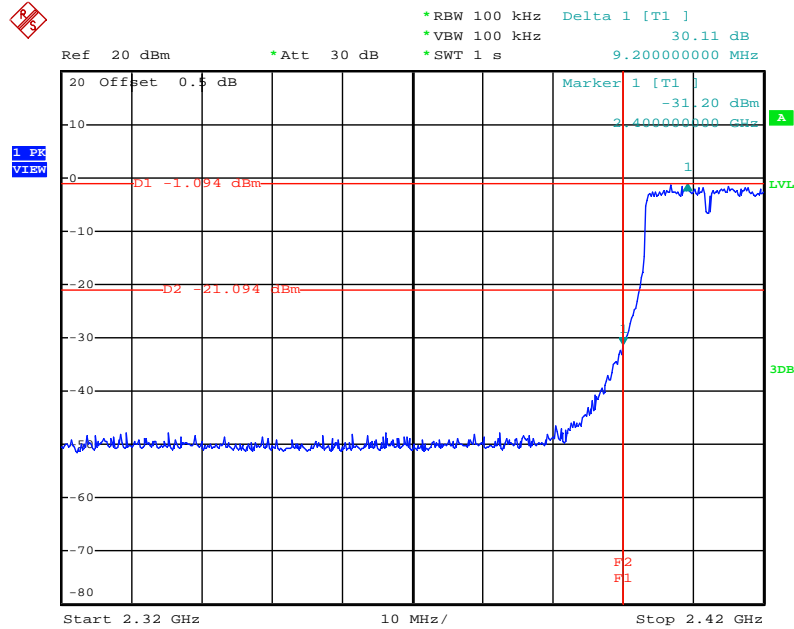

Date: 25.OCT.2010 19:59:06

High Band Edge Plot on Configuration IEEE 802.11n MCS0 20MHz / 2462 MHz

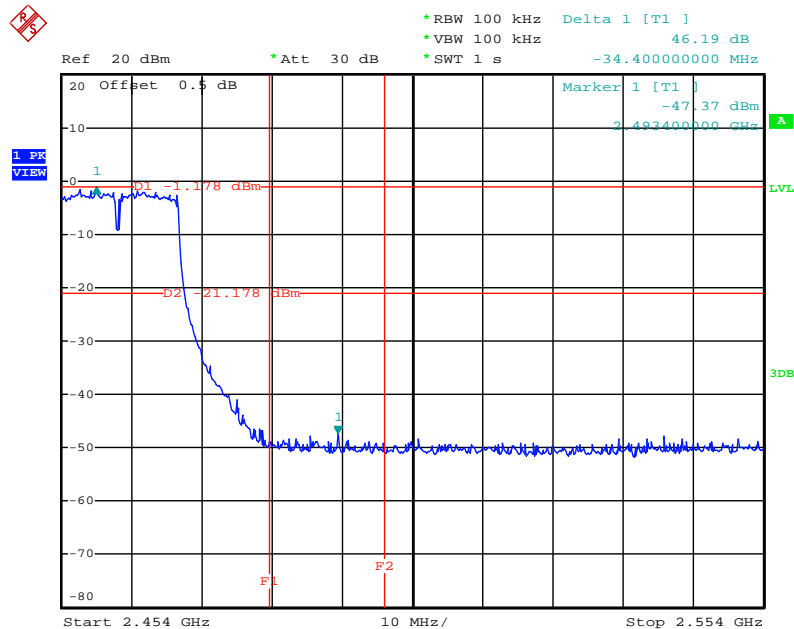

Date: 25.OCT.2010 21:14:15

Low Band Edge Plot on Configuration IEEE 802.11n MCS0 40MHz / 2422 MHz

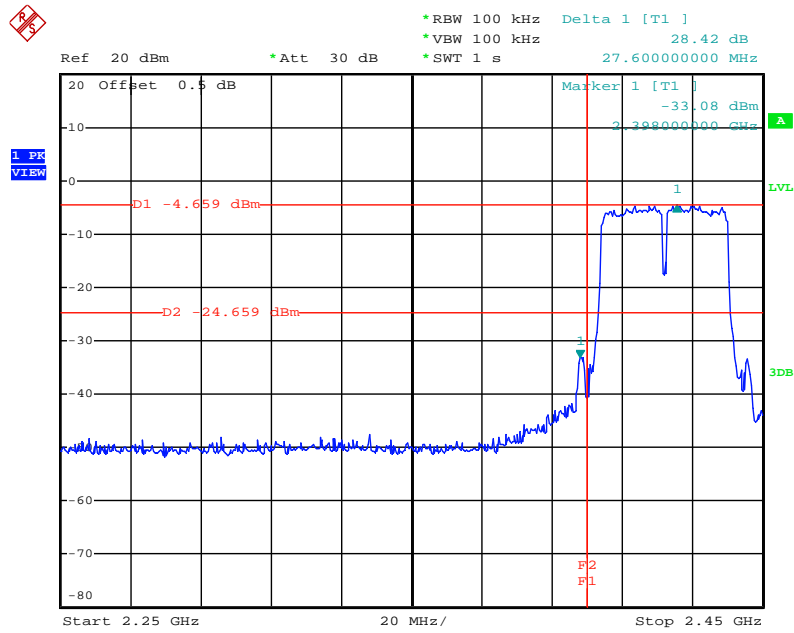

Date: 25.OCT.2010 21:16:36

High Band Edge Plot on Configuration IEEE 802.11n MCS0 40MHz / 2452 MHz

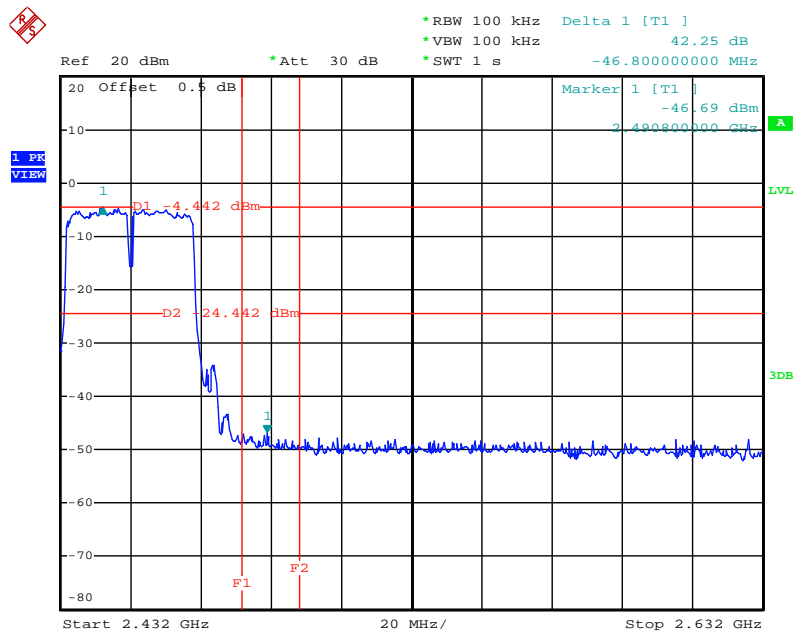

Date: 25.OCT.2010 21:21:20

Low Band Edge Plot on Configuration IEEE 802.11b / 2412 MHz

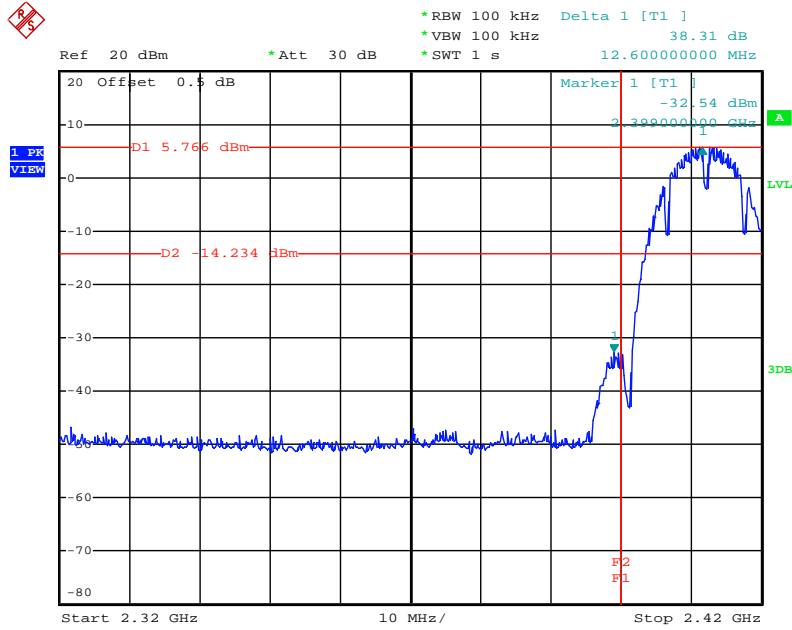

Date: 25.OCT.2010 20:54:25

High Band Edge Plot on Configuration IEEE 802.11b / 2462 MHz

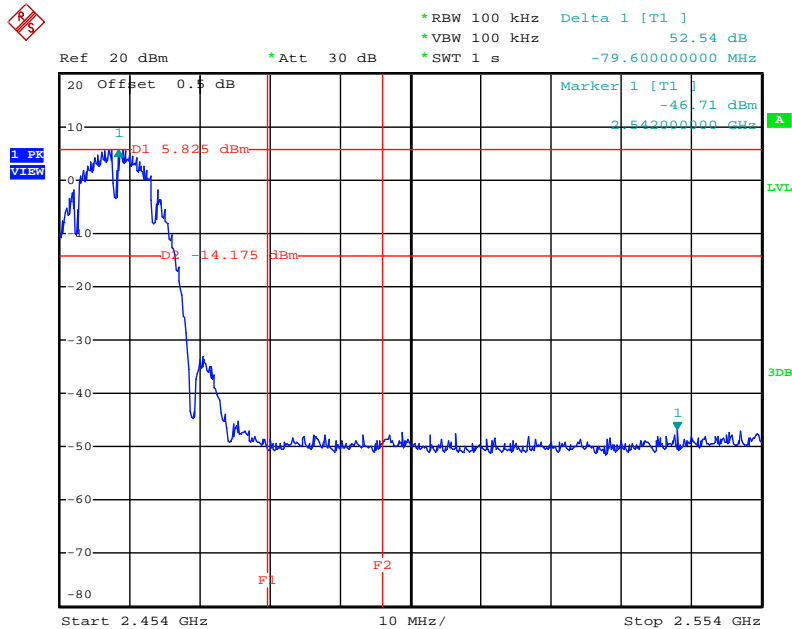

Date: 25.OCT.2010 20:57:18

Low Band Edge Plot on Configuration IEEE 802.11g / 2412 MHz

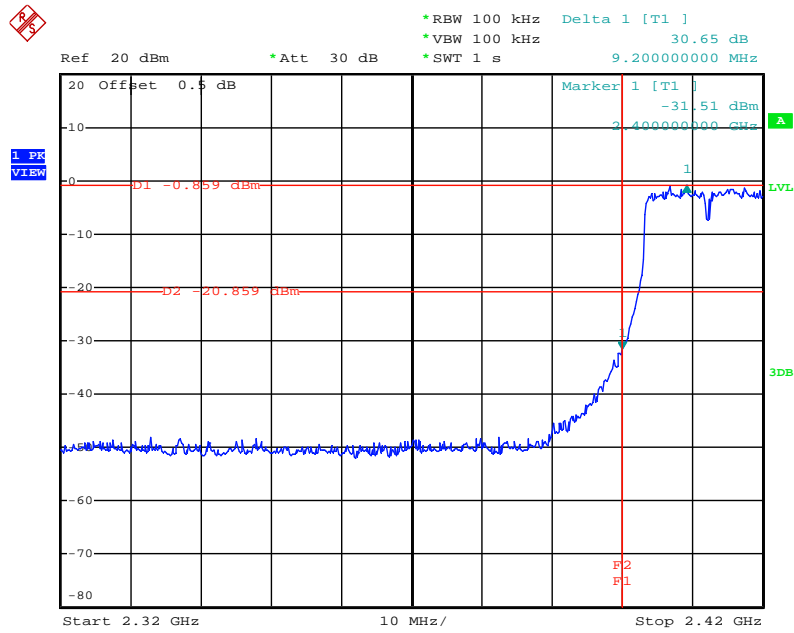

Date: 25.OCT.2010 21:09:54

High Band Edge Plot on Configuration IEEE 802.11g / 2462 MHz

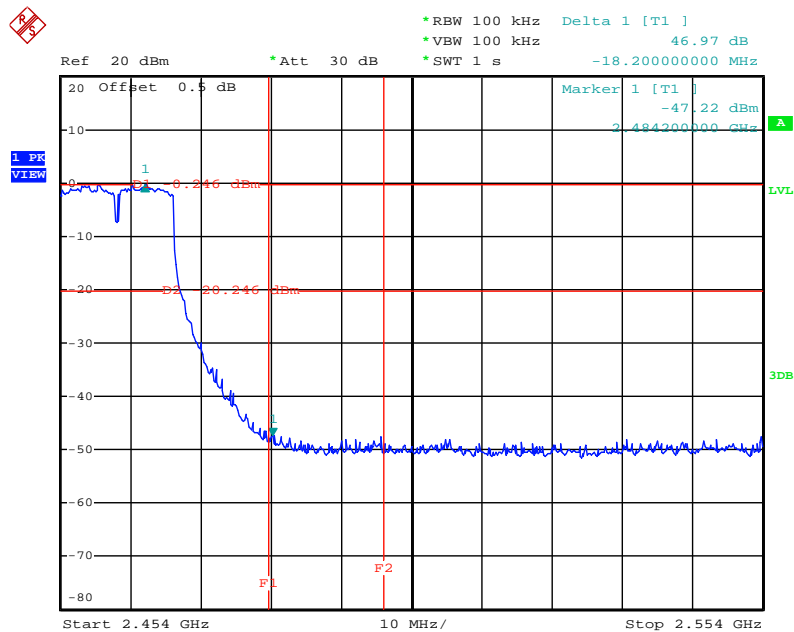

Date: 25.OCT.2010 21:07:41

<For Second Source – Mode 2 with PIFA Antenna>:

For Emission not in Restricted Band

Low Band Edge Plot on Configuration IEEE 802.11n MCS0 20MHz / 2412 MHz

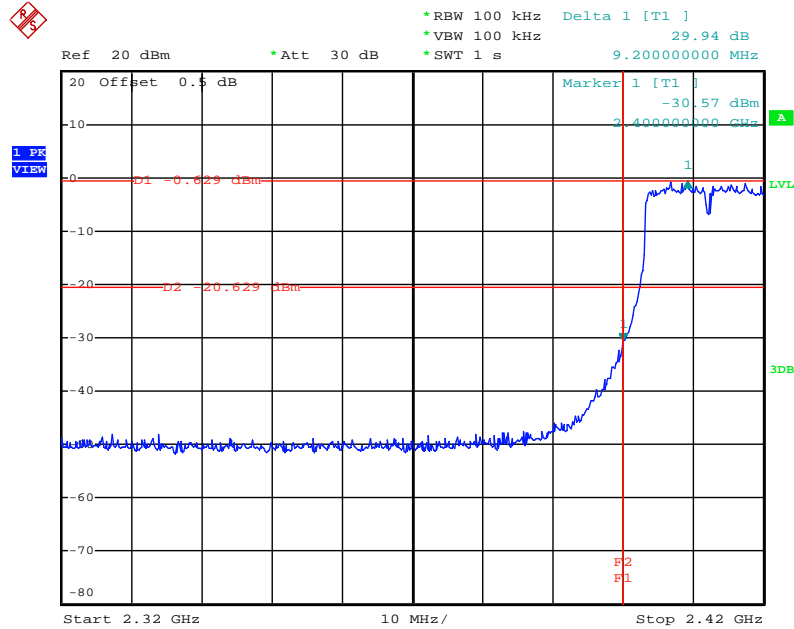

Date: 26.OCT.2010 10:56:22

High Band Edge Plot on Configuration IEEE 802.11n MCS0 20MHz / 2462 MHz

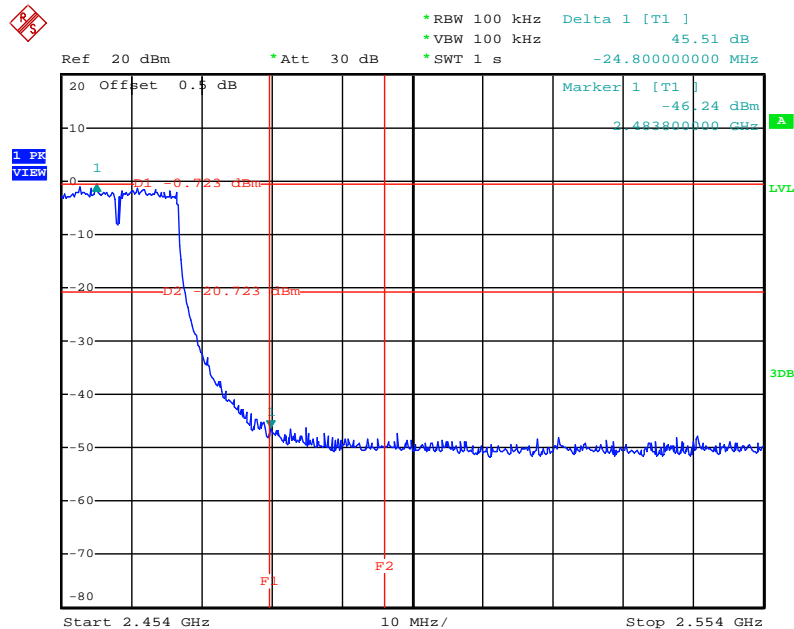

Date: 26.OCT.2010 11:00:49

Low Band Edge Plot on Configuration IEEE 802.11n MCS0 40MHz / 2422 MHz

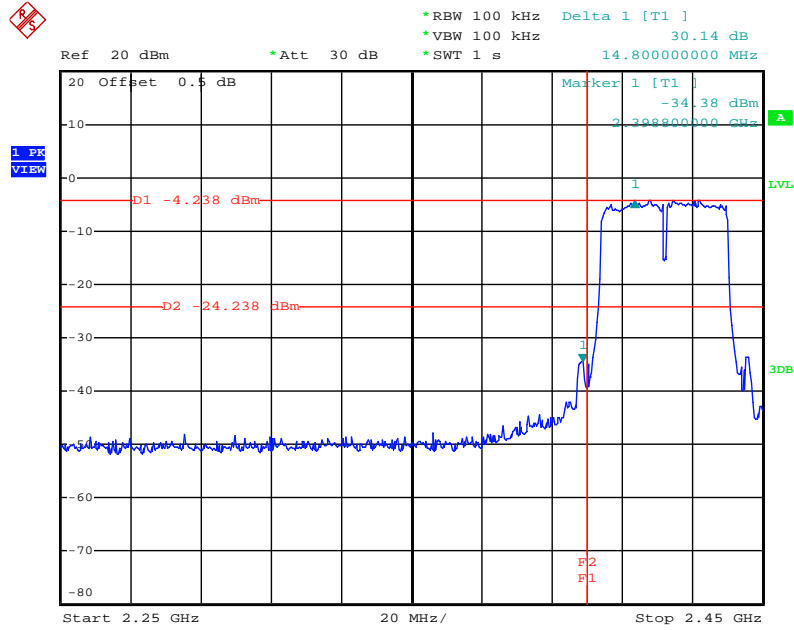

Date: 26.OCT.2010 11:03:25

High Band Edge Plot on Configuration IEEE 802.11n MCS0 40MHz / 2452 MHz

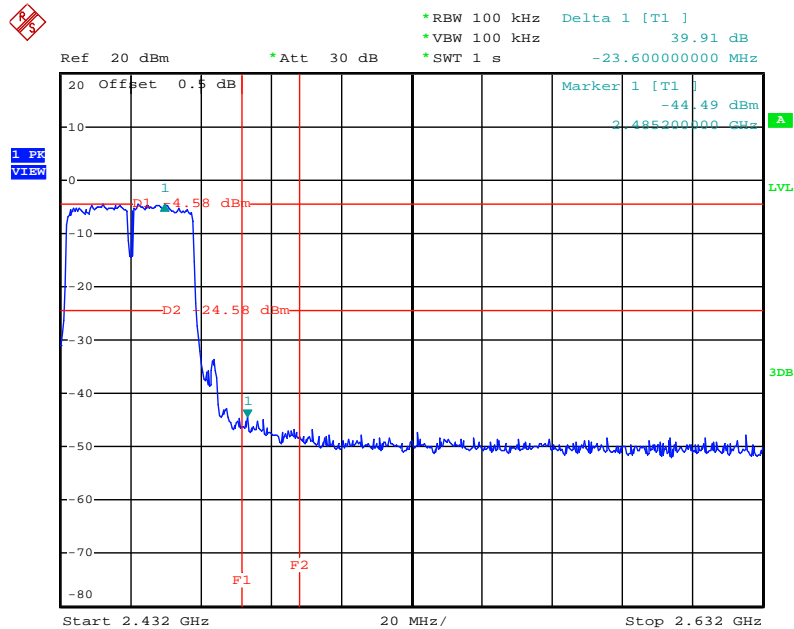

Date: 26.OCT.2010 11:07:52

Low Band Edge Plot on Configuration IEEE 802.11b / 2412 MHz

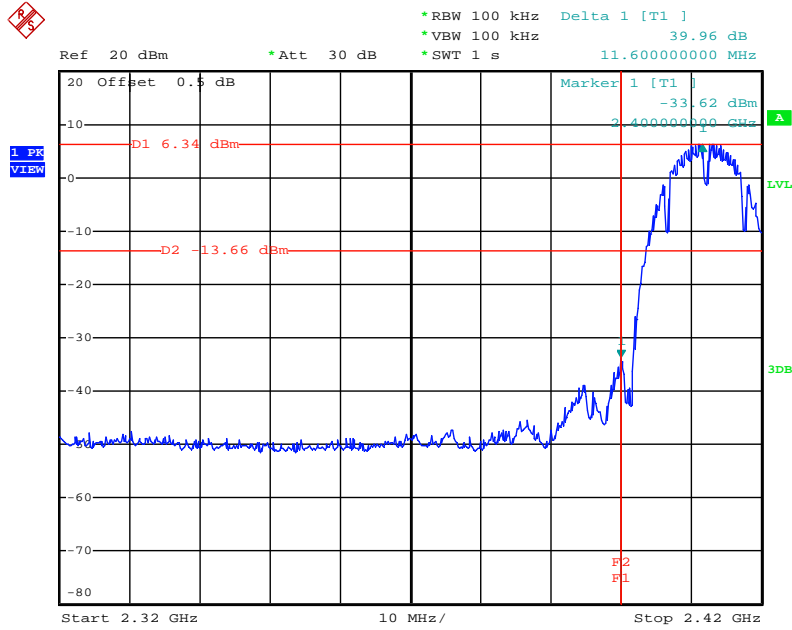

Date: 26.OCT.2010 11:30:41

High Band Edge Plot on Configuration IEEE 802.11b / 2462 MHz

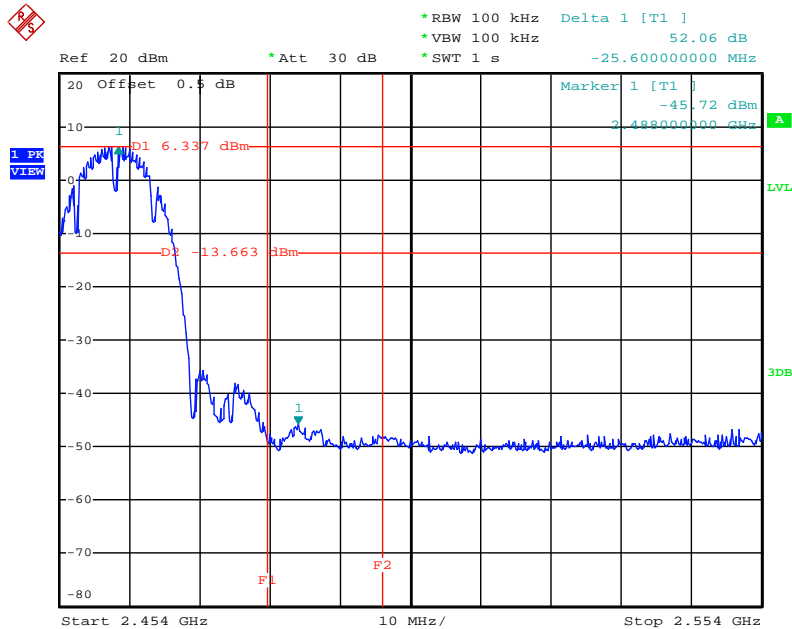

Date: 26.OCT.2010 10:45:56

Low Band Edge Plot on Configuration IEEE 802.11g / 2412 MHz

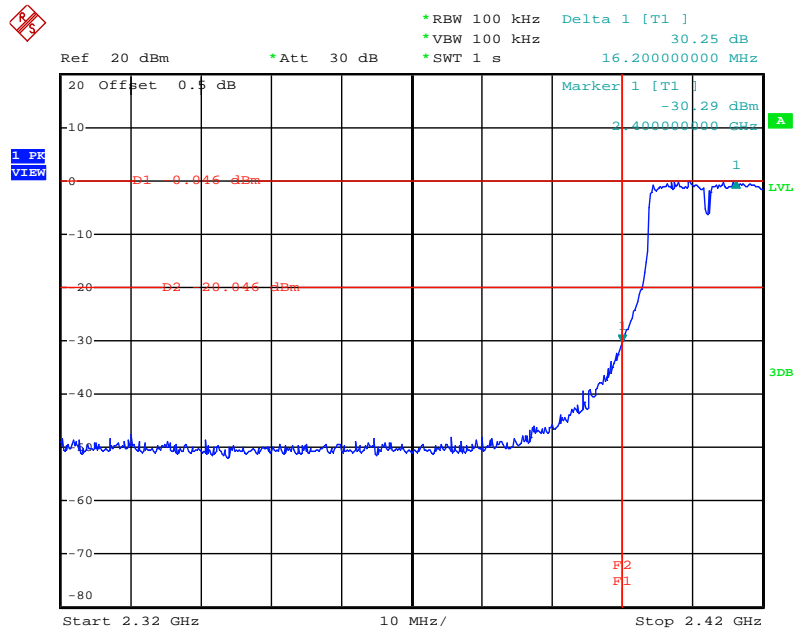

Date: 26.OCT.2010 10:48:26

High Band Edge Plot on Configuration IEEE 802.11g / 2462 MHz

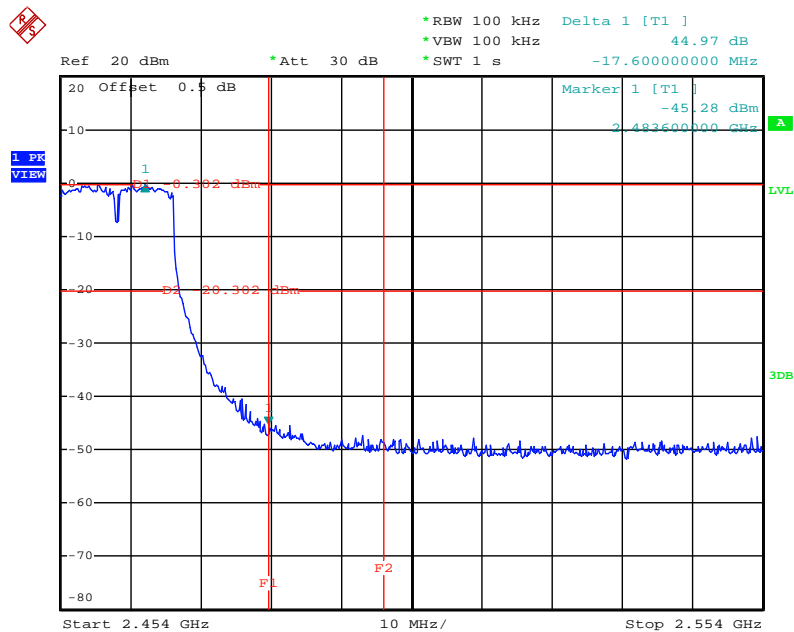

Date: 26.OCT.2010 10:52:46

4.7. Antenna Requirements

4.7.1. Limit

Except for special regulations, the Low-power Radio-frequency Devices must not be equipped with any jacket for installing an antenna with extension cable. An intentional radiator shall be designed to ensure that no antenna other than that furnished by the responsible party shall be used with the device. The use of a permanently attached antenna or of an antenna that uses a unique coupling to the intentional radiator shall be considered sufficient to comply with the provisions of this Section. The manufacturer may design the unit so that the user can replace a broken antenna, but the use of a standard antenna jack or electrical connector is prohibited. Further, this requirement does not apply to intentional radiators that must be professionally installed.

4.7.2. Antenna Connector Construction

Please refer to section 3.3 in this test report; antenna connector complied with the requirements.

5. LIST OF MEASURING EQUIPMENTS

Instrument	Manufacturer	Model No.	Serial No.	Characteristics	Calibration Date	Remark
EMI Test Receiver	R&S	ESCS 30	100377	9kHz ~ 2.75GHz	Sep. 01, 2010	Conduction (CO01-CB)
LISN	F.C.C.	FCC-LISN-50-16-2	04083	150kHz ~ 100MHz	Apr. 24, 2010	Conduction (CO01-CB)
V- LISN	Schwarzbeck	NSLK 8127	8127-478	9K ~ 30MHz	Oct. 30, 2009	Conduction (CO01-CB)
PULSE LIMITER	R&S	ESH3-Z2	100430	9K~30MHz	Jan. 04, 2010	Conduction (CO01-CB)
COND Cable	-	Cable	-	0.15MHz~30MHz	Dec. 04, 2009	Conduction (CO01-CB)
BILOG ANTENNA	Schaffner	CBL6112D	22021	20MHz ~ 2GHz	Oct. 17, 2010	Radiation (03CH01-CB)
Horn Antenna	EMCO	3115	00075790	750MHz~18GHz	Nov. 13, 2009	Radiation (03CH01-CB)
Horn Antenna	SCHWARZBEAK	BBHA 9170	BBHA9170252	15GHz ~ 40GHz	Oct. 08, 2010	Radiation (03CH01-CB)
Pre-Amplifier	Agilent	8447D	2944A10991	0.1MHz ~ 1.3GHz	Nov. 17, 2009	Radiation (03CH01-CB)
Pre-Amplifier	Agilent	8449B	3008A02310	1GHz ~ 26.5GHz	Nov. 06, 2009	Radiation (03CH01-CB)
Pre-Amplifier	WM	TF-130N-R1	923365	26.5GHz ~ 40GHz	Nov. 17, 2009	Radiation (03CH01-CB)
Spectrum analyzer	R&S	FSP	100304	9kHz ~ 40GHz	Nov. 06, 2009	Radiation (03CH01-CB)
EMI Test Receiver	R&S	ESCS 30	100355	9KHz ~ 2.75GHz	Mar. 06, 2010	Radiation (03CH01-CB)
Loop Antenna	R&S	HFH2-Z2	860004/001	9 kHz - 30 MHz	Jul. 28, 2009*	Radiation (03CH01-CB)
Turn Table	INN CO	CO 2000	N/A	0 ~ 360 degree	N/A	Radiation (03CH01-CB)
Antenna Mast	INN CO	CO2000	N/A	1 m - 4 m	N/A	Radiation (03CH01-CB)
RF Cable-low	Woken	Low Cable-1	-	30 MHz - 1 GHz	Nov. 17, 2009	Radiation (03CH01-CB)
RF Cable-high	Woken	High Cable-1	-	1 GHz – 26.5 GHz	Nov. 17, 2009	Radiation (03CH01-CB)
RF Cable-high	Woken	High Cable-2	-	1 GHz – 26.5 GHz	Nov. 17, 2009	Radiation (03CH01-CB)
RF Cable-high	Woken	High Cable-3	-	1 GHz - 40 GHz	Nov. 17, 2009	Radiation (03CH01-CB)
RF Cable-high	Woken	High Cable-4	-	1 GHz - 40 GHz	Nov. 17, 2009	Radiation (03CH01-CB)
Spectrum analyzer	R&S	FSP30	100023	9KHz~30GHz	Mar. 05, 2010	Conducted (TH01-CB)
Temp. and Humidity Chamber	TEN BILLION	TTH-D3SP	TBN-931011	-30~100°C	May. 21, 2010	Conducted (TH01-CB)
Signal Generator	R&S	SMR40	100302	10MHz-40GHz	Nov. 25, 2009	Conducted (TH01-CB)
RF Power Divider	HP	11636A	00306	2GHz ~ 18GHz	N/A	Conducted (TH01-CB)
RF Power Splitter	Anaren	44100	1839	2GHz ~ 18GHz	N/A	Conducted (TH01-CB)

Instrument	Manufacturer	Model No.	Serial No.	Characteristics	Calibration Date	Remark
RF Power Splitter	Anaren	42100	17930	2GHz ~ 18GHz	N/A	Conducted (TH01-CB)
Signal generator	R&S	SMU200A	102782	10MHz-40GHz	Mar. 09, 2010	Conducted (TH01-CB)
Horn Antenna	COM-POWER	AH-118	071187	1GHz – 18GHz	Apr. 16, 2010	Conducted (TH01-CB)
Horn Antenna	COM-POWER	AH-118	071042	1GHz – 18GHz	Oct. 14, 2010	Conducted (TH01-CB)
RF Cable-high	Woken	High Cable-7	-	1 GHz – 26.5 GHz	Nov. 17, 2009	Conducted (TH01-CB)
RF Cable-high	Woken	High Cable-8	-	1 GHz – 26.5 GHz	Nov. 17, 2009	Conducted (TH01-CB)
RF Cable-high	Woken	High Cable-9	-	1 GHz – 26.5 GHz	Nov. 17, 2009	Conducted (TH01-CB)
RF Cable-high	Woken	High Cable-10	-	1 GHz – 26.5 GHz	Nov. 17, 2009	Conducted (TH01-CB)
RF Cable-high	Woken	High Cable-11	-	1 GHz – 26.5 GHz	Nov. 17, 2009	Conducted (TH01-CB)
RF Cable-high	Woken	High Cable-12	-	1 GHz – 26.5 GHz	Nov. 17, 2009	Conducted (TH01-CB)
RF Cable-high	Woken	High Cable-13	-	1 GHz – 26.5 GHz	Nov. 17, 2009	Conducted (TH01-CB)
Power Sensor	Anritsu	MA2411B	0917223	300MHz~40GHz	Sep. 13, 2010	Conducted (TH01-CB)
Power Meter	Anritsu	ML2495A	1035008	300MHz~40GHz	Sep. 08, 2010	Conducted (TH01-CB)

Note: Calibration Interval of instruments listed above is one year.

Note: For “*” Calibration Interval of instruments listed above is two years.

6. TEST LOCATION

SHIJR	ADD : 6Fl., No. 106, Sec. 1, Shintai 5th Rd., Shijr City, Taipei, Taiwan 221, R.O.C. TEL : 886-2-2696-2468 FAX : 886-2-2696-2255
HWA YA	ADD : No. 52, Hwa Ya 1st Rd., Kwei-Shan Hsiang, Tao Yuan Hsien, Taiwan, R.O.C. TEL : 886-3-327-3456 FAX : 886-3-318-0055
LINKOU	ADD : No. 30-2, Dingfu Tsuen, Linkou Shiang, Taipei, Taiwan 244, R.O.C TEL : 886-2-2601-1640 FAX : 886-2-2601-1695
DUNGHU	ADD : No. 3, Lane 238, Kangle St., Neihu Chiu, Taipei, Taiwan 114, R.O.C. TEL : 886-2-2631-4739 FAX : 886-2-2631-9740
JUNGHE	ADD : 7Fl., No. 758, Jungjeng Rd., Junghe City, Taipei, Taiwan 235, R.O.C. TEL : 886-2-8227-2020 FAX : 886-2-8227-2626
NEIHU	ADD : 4Fl., No. 339, Hsin Hu 2 nd Rd., Taipei 114, Taiwan, R.O.C. TEL : 886-2-2794-8886 FAX : 886-2-2794-9777
JHUBEI	ADD : No.8, Lane 724, Bo-ai St., Jhubei City, HsinChu County 302, Taiwan, R.O.C. TEL : 886-3-656-9065 FAX : 886-3-656-9085

7. TAF CERTIFICATE OF ACCREDITATION



Certificate No. : L1190-091230

財團法人全國認證基金會
Taiwan Accreditation Foundation

Certificate of Accreditation

This is to certify that

Sporton International Inc.
EMC & Wireless Communications Laboratory
No.52, Hwa Ya 1st Rd., Hwa Ya Technology Park, Kwei-Shan Hsiang, Tao Yuan Hsien,
Taiwan, R.O.C.

is accredited in respect of laboratory

Accreditation Criteria	: ISO/IEC 17025:2005
Accreditation Number	: 1190
Originally Accredited	: December 15, 2003
Effective Period	: January 10, 2010 to January 09, 2013
Accredited Scope	: Testing Field, see described in the Appendix
Specific Accreditation Program	: Accreditation Program for Designated Testing Laboratory for Commodities Inspection Accreditation Program for Telecommunication Equipment Testing Laboratory Accreditation Program for BSMI Mutual Recognition Arrangement with Foreign Authorities

Jay-san Chen

Jay-San Chen
President, Taiwan Accreditation Foundation
Date : December 30, 2009

Pl, total 22 pages

The Appendix forms an integral part of this Certificate, which shall be invalid when use without the Appendix