

TEST REPORT

CERTIFICATE OF CONFORMITY

Standard: 47 CFR FCC Part 15, Subpart E (Section 15.407)

Report No.: RFBBUI-WTW-P22100653-1

FCC ID: TX2-RTL8851BE

Product: 11ax RTL8851BE Combo module

Brand: REALTEK

Model No.: RTL8851BE

Received Date: 2022/10/25

Test Date: 2022/12/20 ~ 2023/3/24

Issued Date: 2023/4/24

Applicant: Realtek Semiconductor Corp.

Address: No. 2, Innovation Road II, Hsinchu Science Park, Hsinchu 300, Taiwan

Issued By: Bureau Veritas Consumer Products Services (H.K.) Ltd., Taoyuan Branch
Hsin Chu Laboratory

Lab Address: E-2, No.1, Li Hsin 1st Road, Hsinchu Science Park, Hsinchu City 300, Taiwan

Test Location: E-2, No.1, Li Hsin 1st Road, Hsinchu Science Park, Hsinchu City 300, Taiwan

FCC Registration / 723255 / TW2022

Designation Number:

Approved by: _____

May Chen / Manager

, Date: _____

2023/4/24

This test report consists of 626 pages in total. It may be duplicated completely for legal use with the approval of the applicant. It should not be reproduced except in full, without the written approval of our laboratory. The test results in the report only apply to the tested sample. The test results in this report are traceable to the national or international standards.

Prepared by : Luna Yu / Specialist



This report is governed by, and incorporates by reference, the Conditions of Testing as posted at the date of issuance of this report at <http://www.bureauveritas.com/home/about-us/our-business/cps/about-us/terms-conditions/> and is intended for your exclusive use. Any copying or replication of this report to or for any other person or entity, or use of our name or trademark, is permitted only with our prior written permission. This report sets forth our findings solely with respect to the test samples identified herein. The results set forth in this report are not indicative or representative of the quality or characteristics of the lot from which a test sample was taken or any similar or identical product unless specifically and expressly noted. Our report includes all of the tests requested by you and the results thereof based upon the information that you provided to us. Measurement uncertainty is only provided upon request for accredited tests. Statements of conformity are based on simple acceptance criteria without taking measurement uncertainty into account, unless otherwise requested in writing. You have 60 days from date of issuance of this report to notify us of any material error or omission caused by our negligence or if you require measurement uncertainty; provided, however, that such notice shall be in writing and shall specifically address the issue you wish to raise. A failure to raise such issue within the prescribed time shall constitute your unqualified acceptance of the completeness of this report, the tests conducted and the correctness of the report contents.

Table of Contents

Release Control Record	4
1 Certificate	5
2 Summary of Test Results	6
2.1 Measurement Uncertainty	6
2.2 Supplementary Information	6
3 General Information	7
3.1 General Description of EUT	7
3.2 Antenna Description of EUT	8
3.3 Channel List	9
3.4 Test Mode Applicability and Tested Channel Detail	11
3.5 Duty Cycle of Test Signal	15
3.6 Test Program Used and Operation Descriptions	19
3.7 Connection Diagram of EUT and Peripheral Devices	19
3.8 Configuration of Peripheral Devices and Cable Connections	20
4 Test Instruments	21
4.1 26 dB Bandwidth	21
4.2 RF Output Power	21
4.3 Power Spectral Density	21
4.4 6 dB Bandwidth	21
4.5 Occupied Bandwidth	21
4.6 Frequency Stability	22
4.7 AC Power Conducted Emissions	22
4.8 Unwanted Emissions below 1 GHz	23
4.9 Unwanted Emissions above 1 GHz	24
5 Limits of Test Items	25
5.1 26 dB Bandwidth	25
5.2 RF Output Power	25
5.3 Power Spectral Density	25
5.4 6 dB Bandwidth	25
5.5 Occupied Bandwidth	25
5.6 Frequency Stability	25
5.7 AC Power Conducted Emissions	26
5.8 Unwanted Emissions below 1 GHz	26
5.9 Unwanted Emissions above 1 GHz	27
6 Test Arrangements	28
6.1 26 dB Bandwidth	28
6.1.1 Test Setup	28
6.1.2 Test Procedure	28
6.2 RF Output Power	29
6.2.1 Test Setup	29
6.2.2 Test Procedure	29
6.3 Power Spectral Density	30
6.3.1 Test Setup	30
6.3.2 Test Procedure	30
6.4 6 dB Bandwidth	31
6.4.1 Test Setup	31
6.4.2 Test Procedure	31
6.5 Occupied Bandwidth	31
6.5.1 Test Setup	31
6.5.2 Test Procedure	31
6.6 Frequency Stability	32
6.6.1 Test Setup	32
6.6.2 Test Procedure	32
6.7 AC Power Conducted Emissions	33



6.7.1	Test Setup	33
6.7.2	Test Procedure	33
6.8	Unwanted Emissions below 1 GHz	34
6.8.1	Test Setup	34
6.8.2	Test Procedure	35
6.9	Unwanted Emissions above 1 GHz	36
6.9.1	Test Setup	36
6.9.2	Test Procedure	36
7	Test Results of Test Item	37
7.1	26 dB Bandwidth	37
7.2	RF Output Power	44
7.3	Power Spectral Density	55
7.4	6 dB Bandwidth	63
7.5	Occupied Bandwidth	66
7.6	Frequency Stability	74
7.7	AC Power Conducted Emissions	75
7.8	Unwanted Emissions below 1 GHz	77
7.9	Unwanted Emissions above 1 GHz	83
8	Pictures of Test Arrangements	625
9	Information of the Testing Laboratories	626



Release Control Record

Issue No.	Description	Date Issued
RFBBUI-WTW-P22100653-1	Original release.	2023/4/24

1 Certificate

Product: 11ax RTL8851BE Combo module

Brand: REALTEK

Test Model: RTL8851BE

Sample Status: Engineering sample

Applicant: Realtek Semiconductor Corp.

Test Date: 2022/12/20 ~ 2023/3/24

Standard: 47 CFR FCC Part 15, Subpart E (Section 15.407)

Measurement ANSI C63.10-2013

procedure: KDB 789033 D02 General UNII Test Procedure New Rules v02r01

The above equipment has been tested by **Bureau Veritas Consumer Products Services (H.K.) Ltd., Taoyuan Branch**, and found compliance with the requirement of the above standards. The test record, data evaluation & Equipment Under Test (EUT) configurations represented herein are true and accurate accounts of the measurements of the sample's RF characteristics under the conditions specified in this report.

2 Summary of Test Results

47 CFR FCC Part 15, Subpart E (Section 15.407)			
Clause	Test Item	Result	Remark
15.407(a)(2)	26 dB Bandwidth	-	For U-NII-2A U-NII-2C Band output power limitation is determined based on 26dBc bandwidth.
15.407(a)(1) 15.407(a)(2) 15.407(a)(3)	RF Output Power	Pass	Meet the requirement of limit.
15.407(a)(1) 15.407(a)(2) 15.407(a)(3)	Power Spectral Density	Pass	Meet the requirement of limit.
15.407(e)	6 dB Bandwidth	Pass	Meet the requirement of limit. (U-NII-3 Band only)
---	Occupied Bandwidth	-	Reference only.
15.407(g)	Frequency Stability	Pass	Meet the requirement of limit.
15.407(b)(9)	AC Power Conducted Emissions	Pass	Minimum passing margin is -8.73 dB at 0.18516 MHz
15.407(b)(9)	Unwanted Emissions below 1 GHz	Pass	Minimum passing margin is -6.7 dB at 44.70 MHz
15.407(b) (1/10) 15.407(b) (2/10) 15.407(b) (3/10) 15.407(b) (4(i)/10)	Unwanted Emissions above 1 GHz	Pass	Minimum passing margin is -0.3 dB at 5725.00 MHz
15.203	Antenna Requirement	Pass	Antenna connector is IPEX4 not a standard connector.

Note: Determining compliance based on the results of the compliance measurement, not taking into account measurement instrumentation uncertainty.

2.1 Measurement Uncertainty

Where relevant, the following measurement uncertainty levels have been estimated for tests performed on the EUT as specified in CISPR 16-4-2:

Measurement	Specification	Expanded Uncertainty (k=2) (±)
AC Power Conducted Emissions	150 kHz ~ 30 MHz	1.9 dB
Unwanted Emissions below 1 GHz	9 kHz ~ 30 MHz	3.1 dB
	30 MHz ~ 1 GHz	5.1 dB
Unwanted Emissions above 1 GHz	1 GHz ~ 18 GHz	5.1 dB
	18 GHz ~ 40 GHz	5.3 dB

The other instruments specified are routine verified to remain within the calibrated levels, no measurement uncertainty is required to be calculated.

2.2 Supplementary Information

There is not any deviation from the test standards for the test method, and no modifications required for compliance.

3 General Information

3.1 General Description of EUT

Product	11ax RTL8851BE Combo module
Brand	REALTEK
Test Model	RTL8851BE
Status of EUT	Engineering sample
Power Supply Rating	3.3Vdc from host equipment
Modulation Type	64QAM, 16QAM, QPSK, BPSK for OFDM 256QAM for OFDM in 11ac mode 1024QAM for OFDMA in 11ax mode
Modulation Technology	OFDM, OFDMA
Transfer Rate	802.11a: up to 54 Mbps 802.11n: up to 150 Mbps 802.11ac: up to 433.3 Mbps 802.11ax: up to 600.4 Mbps
Operating Frequency	5.18 GHz ~ 5.24 GHz 5.26 GHz ~ 5.32 GHz 5.5 GHz ~ 5.72 GHz 5.745 GHz ~ 5.825 GHz
Number of Channel	802.11a, 802.11n (HT20), 802.11ac (VHT20), 802.11ax (HE20): 25 802.11n (HT40), 802.11ac (VHT40), 802.11ax (HE40): 12 802.11ac (VHT80), 802.11ax (HE80): 6
Output Power	5.18 GHz ~ 5.24 GHz: 183.654 mW (22.64 dBm) 5.26 GHz ~ 5.32 GHz: 182.39 mW (22.61 dBm) 5.5 GHz ~ 5.72 GHz: 150.661 mW (21.78 dBm) 5.745 GHz ~ 5.825 GHz: 200.447 mW (23.02 dBm)
EUT Category	Client device

Note:

1. The EUT has below HW SKU configuration, as below table:

SKU No.	Product name	HW Configuration
1	11ax RTL8851BE Combo module	PCIe + USB interface + Dual antenna port

2. There are Bluetooth and WLAN (2.4 GHz & 5 GHz) technology used for the EUT.

3. Simultaneously transmission condition.

Condition	Technology	
1	WLAN (5 GHz)	Bluetooth
2	WLAN (2.4 GHz)	Bluetooth

Note: The emission of the simultaneous operation has been evaluated and no non-compliance was found.

4. The EUT support OFDMA and Partial RU mode, therefore partial RU combination were investigated and the worst case scenario was identified.

5. The above EUT information is declared by manufacturer and for more detailed features description, please refer to the manufacturer's specifications or user's manual.

3.2 Antenna Description of EUT

1. The antenna information is listed as below.

Antenna NO.	RF Chain NO.	Brand	Model	Antenna Net Gain(dBi)	Frequency range	Antenna Type	Connector Type	Cable Length (mm)
1	Chain 1	REALTEK	RTK-ANT-0022	3.4	2.4~2.4835GHz	PIFA	IPEX4	300
				5	5.15~5.895GHz			
	Chain 2	REALTEK	RTK-ANT-0022	3.4	2.4~2.4835GHz	PIFA	IPEX4	300
				5	5.15~5.895GHz			
2	Chain 1	Aristotle	RFA-27-C38H1-MHF4300	3	2.4~2.4835GHz	Dipole	IPEX4	300
				5	5.15~5.895GHz			
	Chain 2	Aristotle	RFA-27-C38H1-MHF4300	3	2.4~2.4835GHz	Dipole	IPEX4	300
				5	5.15~5.895GHz			
3	Chain 1	LYNwave	ALX22F-120AA0-00	3.2	2.4~2.4835GHz	Monopole	IPEX4	200
				4	5.15~5.895GHz			
	Chain 2	LYNwave	ALX22F-120AA0-00	3.2	2.4~2.4835GHz	Monopole	IPEX4	200
				4	5.15~5.895GHz			

Note:

1. Max. gain was selected for the final test, except for Unwanted Emissions.

* Detail antenna specification please refer to antenna datasheet and/or antenna measurement report.

2. The EUT incorporates a SISO function:

5 GHz Band		
Modulation Mode	TX & RX Configuration	
802.11a	1TX Diversity	1RX
802.11n (HT20)	1TX Diversity	1RX
802.11n (HT40)	1TX Diversity	1RX
802.11ac (VHT20)	1TX Diversity	1RX
802.11ac (VHT40)	1TX Diversity	1RX
802.11ac (VHT80)	1TX Diversity	1RX
802.11ax (HE20)	1TX Diversity	1RX
802.11ax (HE40)	1TX Diversity	1RX
802.11ax (HE80)	1TX Diversity	1RX
802.11ax (RU26/52/106/242/484/996)	1TX Diversity	1RX

Note:

1. The modulation and bandwidth are similar for 802.11n mode for 20 MHz (40 MHz), 802.11ac mode for 20 MHz (40 MHz, 80 MHz) and 802.11ax mode for 20 MHz (40 MHz, 80 MHz), therefore the manufacturer will control the power for 802.11n/ac mode is the same as the 802.11ax or more lower than it and investigated worst case to representative mode in test report.

3.3 Channel List

FOR 5180 ~ 5320 MHz

8 channels are provided for 802.11a, 802.11n (HT20), 802.11ac (VHT20), 802.11ax (HE20):

Channel	Frequency	Channel	Frequency
36	5180 MHz	52	5260 MHz
40	5200 MHz	56	5280 MHz
44	5220 MHz	60	5300 MHz
48	5240 MHz	64	5320 MHz

4 channels are provided for 802.11n (HT40), 802.11ac (VHT40), 802.11ax (HE40):

Channel	Frequency	Channel	Frequency
38	5190 MHz	54	5270 MHz
46	5230 MHz	62	5310 MHz

2 channels are provided for 802.11ac (VHT80), 802.11ax (HE80):

Channel	Frequency	Channel	Frequency
42	5210 MHz	58	5290 MHz

FOR 5500 ~ 5720 MHz

12 channels are provided for 802.11a, 802.11n (HT20), 802.11ac (VHT20), 802.11ax (HE20):

Channel	Frequency	Channel	Frequency
100	5500 MHz	124	5620 MHz
104	5520 MHz	128	5640 MHz
108	5540 MHz	132	5660 MHz
112	5560 MHz	136	5680 MHz
116	5580 MHz	140	5700 MHz
120	5600 MHz	144	5720 MHz

6 channels are provided for 802.11n (HT40), 802.11ac (VHT40), 802.11ax (HE40):

Channel	Frequency	Channel	Frequency
102	5510 MHz	126	5630 MHz
110	5550 MHz	134	5670 MHz
118	5590 MHz	142	5710 MHz

3 channels are provided for 802.11ac (VHT80), 802.11ax (HE80):

Channel	Frequency	Channel	Frequency
106	5530 MHz	138	5690 MHz
122	5610 MHz		

FOR 5745 ~ 5825 MHz:

5 channels are provided for 802.11a, 802.11n (HT20), 802.11ac (VHT20), 802.11ax (HE20):

Channel	Frequency	Channel	Frequency
149	5745 MHz	161	5805 MHz
153	5765 MHz	165	5825 MHz
157	5785 MHz		

2 channels are provided for 802.11n (HT40), 802.11ac (VHT40), 802.11ax (HE40):

Channel	Frequency	Channel	Frequency
151	5755 MHz	159	5795 MHz

1 channel is provided for 802.11ac (VHT80), 802.11ax (HE80):

Channel	Frequency
155	5775 MHz

3.4 Test Mode Applicability and Tested Channel Detail

Pre-Scan:	<p>1. PIFA/Monopole ANT can be used in the following ways: X / Y / Z axis. Pre-scan in these ways and find the worst case as a representative test condition.</p> <p>2. For Partial RU modes of 20MHz, 40MHz and 80MHz bandwidth needs to be pre-worst.</p> <p>3. EUT has two antennas, but only single antenna diversity function: Chain1 / Chain2. Prescan in these ways to find the worst case as a representative test condition.</p> <p>4. Pre-Scan has been conducted to determine the worst-case mode from all possible combinations between available modulations, data rates and antenna ports (if EUT with antenna diversity architecture).</p>
Worst Case:	<p>1. PIFA / Monopole ANT the worst case was found when positioned on (X / Y / Z axis): Unwanted Emissions below 1 GHz Y axis worst, and Unwanted Emissions above 1 GHz Y axis worst for PIFA ANT; Unwanted Emissions below 1 GHz X axis worst, and Unwanted Emissions above 1 GHz X axis worst for Monopole ANT.</p> <p>2. The worst case occurs in 20MHz bandwidth (partial RU 26 / 52 / 106).</p> <p>3. Chain1 / Chain2 single-antenna transmission Worst Condition: Chain1.</p> <p>4. Dipole ANT was used typical placement for the test: Y axis.</p>

Following channel(s) was (were) selected for the final test as listed below:

Test Item	EUT Configure Mode	Mode	Tested Channel	Modulation	Data Rate Parameter	RU Configuration
26 dB Bandwidth	-	802.11a	52, 60, 64, 100, 116, 140, 144	BPSK	6Mb/s	-
		802.11ax (HE20)	52, 60, 64, 100, 116, 140, 144	BPSK	MCS0	-
		802.11ax (HE40)	54, 62, 102, 110, 134, 142	BPSK	MCS0	-
		802.11ax (HE80)	58, 106, 122, 138	BPSK	MCS0	-
		20 MHz Preamble 802.11ax (RU26)	52, 60, 64, 100, 116, 140, 144	BPSK	MCS0	26/0, 26/4, 26/8, 26/0, 26/4, 26/8, 26/8
		20 MHz Preamble 802.11ax (RU52)	52, 60, 64, 100, 116, 140, 144	BPSK	MCS0	52/37, 52/39, 52/40, 52/37, 52/39, 52/40, 52/40
		20 MHz Preamble 802.11ax (RU106)	52, 60, 64, 100, 116, 140, 144	BPSK	MCS0	106/53, 106/54, 106/54, 106/53, 106/53, 106/54, 106/54
RF Output Power	-	802.11a	36, 40, 48, 52, 60, 64, 100, 116, 140, 144, 149, 157, 165	BPSK	6Mb/s	-
		802.11ac (VHT20)	36, 40, 48, 52, 60, 64, 100, 116, 140, 144, 149, 157, 165	BPSK	MCS0	-
		802.11ac (VHT40)	38, 46, 54, 62, 102, 110, 134, 142, 151, 159	BPSK	MCS0	-
		802.11ac (VHT80)	42, 58, 106, 122, 138, 155	BPSK	MCS0	-
		802.11ax (HE20)	36, 40, 48, 52, 60, 64, 100, 116, 140, 144, 149, 157, 165	BPSK	MCS0	-

Test Item	EUT Configure Mode	Mode	Tested Channel	Modulation	Data Rate Parameter	RU Configuration
		802.11ax (HE40)	38, 46, 54, 62, 102, 110, 134, 142, 151, 159	BPSK	MCS0	-
RF Output Power	-	802.11ax (HE80)	42, 58, 106, 122, 138, 155	BPSK	MCS0	-
		20 MHz Preamble 802.11ax (RU26)	36, 40, 48, 52, 60, 64, 100, 116, 140, 144, 149, 157, 165	BPSK	MCS0	26/0, 26/4, 26/8, 26/0, 26/4, 26/8, 26/0, 26/4, 26/8, 26/0, 26/4, 26/8
		20 MHz Preamble 802.11ax (RU52)	36, 40, 48, 52, 60, 64, 100, 116, 140, 144, 149, 157, 165	BPSK	MCS0	52/37, 52/39, 52/40, 52/37, 52/39, 52/40, 52/37, 52/39, 52/40, 52/37, 52/39, 52/40
		20 MHz Preamble 802.11ax (RU106)	36, 40, 48, 52, 60, 64, 100, 116, 140, 144, 149, 157, 165	BPSK	MCS0	106/53, 106/53, 106/54, 106/53, 106/54, 106/54, 106/53, 106/53, 106/54, 106/54, 106/53, 106/54, 106/54, 106/53, 106/54, 106/54, 106/53, 106/54, 106/54
6 dB Bandwidth	-	802.11a	144 (U-NII-3 Band), 149, 157, 165	BPSK	6Mb/s	-
		802.11ax (HE20)	144 (U-NII-3 Band), 149, 157, 165	BPSK	MCS0	-
		802.11ax (HE40)	142 (U-NII-3 Band), 151, 159	BPSK	MCS0	-
		802.11ax (HE80)	138 (U-NII-3 Band), 155	BPSK	MCS0	-
		20 MHz Preamble 802.11ax (RU26)	144 (U-NII-3 Band), 149, 157, 165	BPSK	MCS0	26/8, 26/0, 26/4, 26/8
		20 MHz Preamble 802.11ax (RU52)	144 (U-NII-3 Band), 149, 157, 165	BPSK	MCS0	52/40, 52/37, 52/39, 52/40
		20 MHz Preamble 802.11ax (RU106)	144 (U-NII-3 Band), 149, 157, 165	BPSK	MCS0	106/54, 106/53, 106/54, 106/54
Power Spectral Density / Occupied Bandwidth	-	802.11a	36, 40, 48, 52, 60, 64, 100, 116, 140, 144, 149, 157, 165	BPSK	6Mb/s	-

Test Item	EUT Configure Mode	Mode	Tested Channel	Modulation	Data Rate Parameter	RU Configuration
		802.11ax (HE20)	36, 40, 48, 52, 60, 64, 100, 116, 140, 144, 149, 157, 165	BPSK	MCS0	-
Power Spectral Density / Occupied Bandwidth	-	802.11ax (HE40)	38, 46, 54, 62, 102, 110, 134, 142, 151, 159	BPSK	MCS0	-
		802.11ax (HE80)	42, 58, 106, 122, 138, 155	BPSK	MCS0	-
		20 MHz Preamble 802.11ax (RU26)	36, 40, 48, 52, 60, 64, 100, 116, 140, 144, 149, 157, 165	BPSK	MCS0	26/0, 26/4, 26/8, 26/0, 26/4, 26/8, 26/4, 26/8, 26/0, 26/4, 26/8, 26/8
		20 MHz Preamble 802.11ax (RU52)	36, 40, 48, 52, 60, 64, 100, 116, 140, 144, 149, 157, 165	BPSK	MCS0	52/37, 52/39, 52/40, 52/37, 52/39, 52/40, 52/37, 52/39, 52/40, 52/40, 52/37, 52/39, 52/40
		20 MHz Preamble 802.11ax (RU106)	36, 40, 48, 52, 60, 64, 100, 116, 140, 144, 149, 157, 165	BPSK	MCS0	106/53, 106/53, 106/54, 106/53, 106/54, 106/54, 106/54, 106/53, 106/53, 106/54, 106/54, 106/53, 106/54, 106/54, 106/53, 106/54, 106/54
Frequency Stability	-	802.11a	36	un-modulation	-	-
AC Power Conducted Emissions	B	802.11ax (HE20)	165	BPSK	MCS0	-
Unwanted Emissions below 1 GHz	A, B, C	802.11ax (HE20)	165	BPSK	MCS0	-
Unwanted Emissions above 1 GHz	A, B, C	802.11a	36, 40, 48, 52, 60, 64, 100, 116, 140, 144, 149, 157, 165	BPSK	6Mb/s	-
		802.11ax (HE20)	36, 40, 48, 52, 60, 64, 100, 116, 140, 144, 149, 157, 165	BPSK	MCS0	-
		802.11ax (HE40)	38, 46, 54, 62, 102, 110, 134, 142, 151, 159	BPSK	MCS0	-
		802.11ax (HE80)	42, 58, 106, 122, 138, 155	BPSK	MCS0	-



Test Item	EUT Configure Mode	Mode	Tested Channel	Modulation	Data Rate Parameter	RU Configuration
		20 MHz Preamble 802.11ax (RU26)	36, 40, 48, 52, 60, 64, 100, 116, 140, 144, 149, 157, 165	BPSK	MCS0	26/0, 26/4, 26/8, 26/0, 26/4, 26/8, 26/0, 26/4, 26/8, 26/8, 26/0, 26/4, 26/8
Unwanted Emissions above 1 GHz	A, B, C	20 MHz Preamble 802.11ax (RU52)	36, 40, 48, 52, 60, 64, 100, 116, 140, 144, 149, 157, 165	BPSK	MCS0	52/37, 52/39, 52/40, 52/37, 52/39, 52/40, 52/37, 52/39, 52/40, 52/40, 52/37, 52/39, 52/40
		20 MHz Preamble 802.11ax (RU106)	36, 40, 48, 52, 60, 64, 100, 116, 140, 144, 149, 157, 165	BPSK	MCS0	106/53, 106/53, 106/54, 106/53, 106/54, 106/54, 106/54, 106/53, 106/53, 106/54, 106/54, 106/53, 106/54, 106/53, 106/54, 106/54, 106/53, 106/54, 106/54
EUT Configure Mode:	A	with Dipole Antenna				
	B	with PIFA Antenna				
	C	with Monopole Antenna				

3.5 Duty Cycle of Test Signal

802.11a: Duty cycle = 1.363 ms / 1.368 ms x 100% = 99.6%

802.11ac (VHT20): Duty cycle = 1.159 ms / 1.171 ms x 100% = 99.0%

802.11ac (VHT40): Duty cycle = 0.616 ms / 0.624 ms x 100% = 98.7%

802.11ac (VHT80): Duty cycle = 0.333 ms / 0.34 ms x 100% = 97.9%, duty factor = 10 * log (1/Duty cycle) = 0.09 dB

802.11ax (HE20): Duty cycle = 1.159 ms / 1.171 ms x 100% = 99.0%

802.11ax (HE40): Duty cycle = 0.616 ms / 0.624 ms x 100% = 98.7%

802.11ax (HE80): Duty cycle = 0.333 ms / 0.34 ms x 100% = 97.9%, duty factor = 10 * log (1/Duty cycle) = 0.09 dB

20 MHz Preamble 802.11ax (RU26): Duty cycle = 5.434 ms / 5.439 ms x 100% = 99.9%

20 MHz Preamble 802.11ax (RU52): Duty cycle = 2.757 ms / 2.763 ms x 100% = 99.8%

20 MHz Preamble 802.11ax (RU106): Duty cycle = 1.328 ms / 1.336 ms x 100% = 99.4%

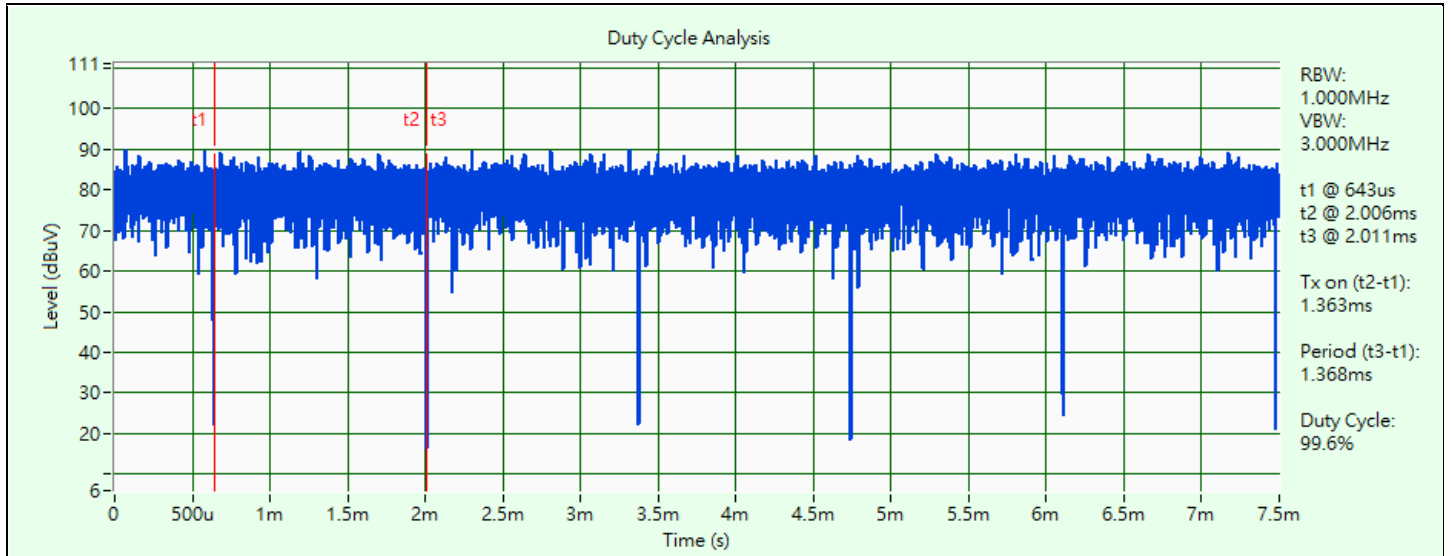

802.11a

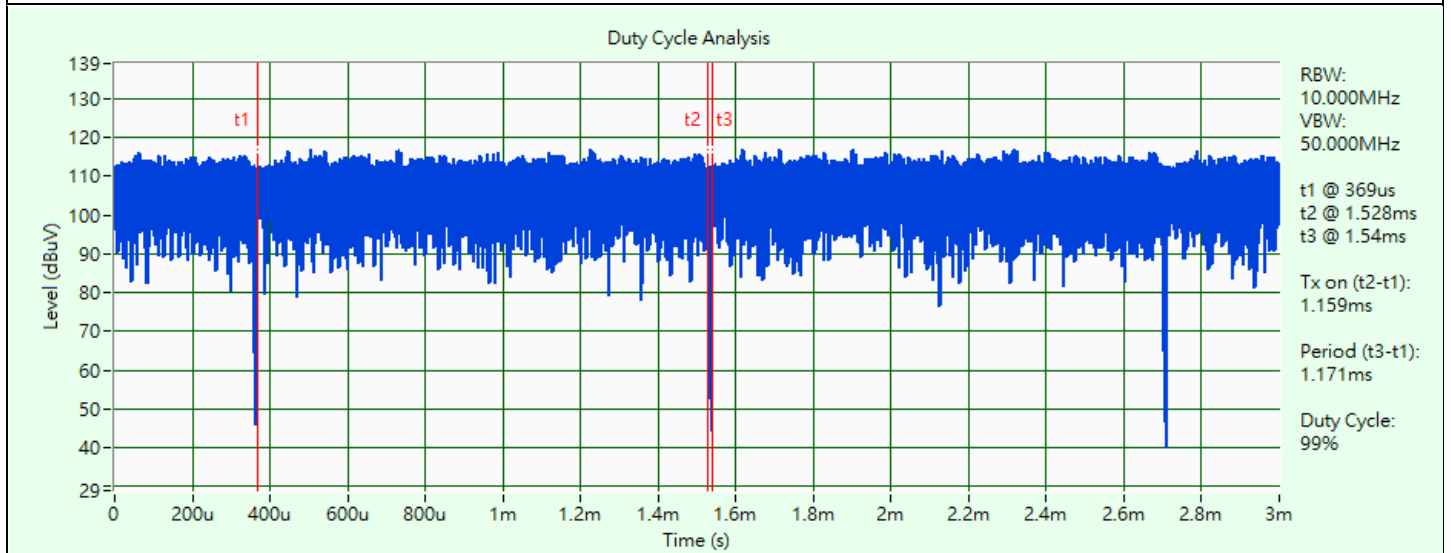

802.11ac (VHT20)

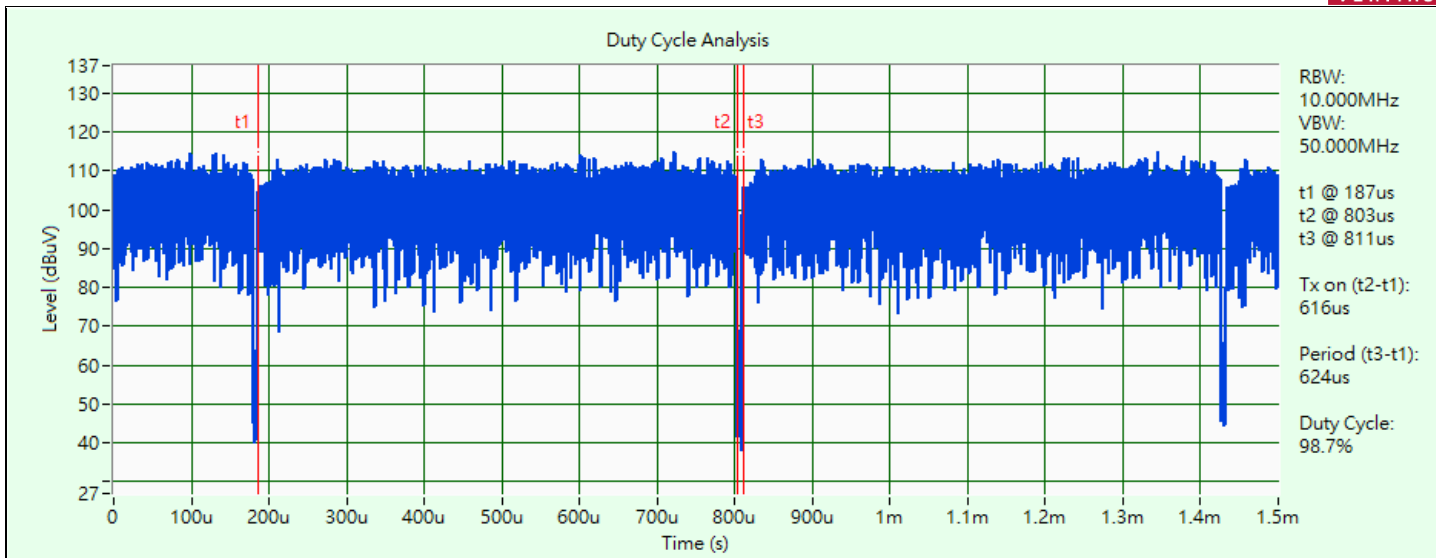

802.11ac (VHT40)

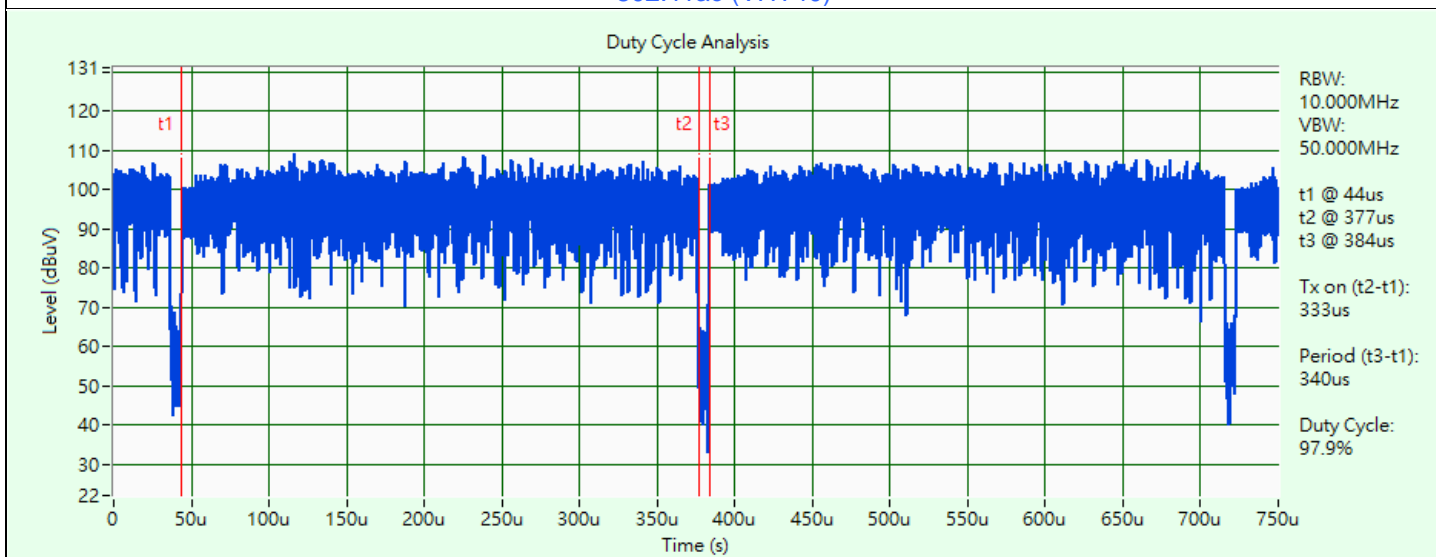

802.11ac (VHT80)

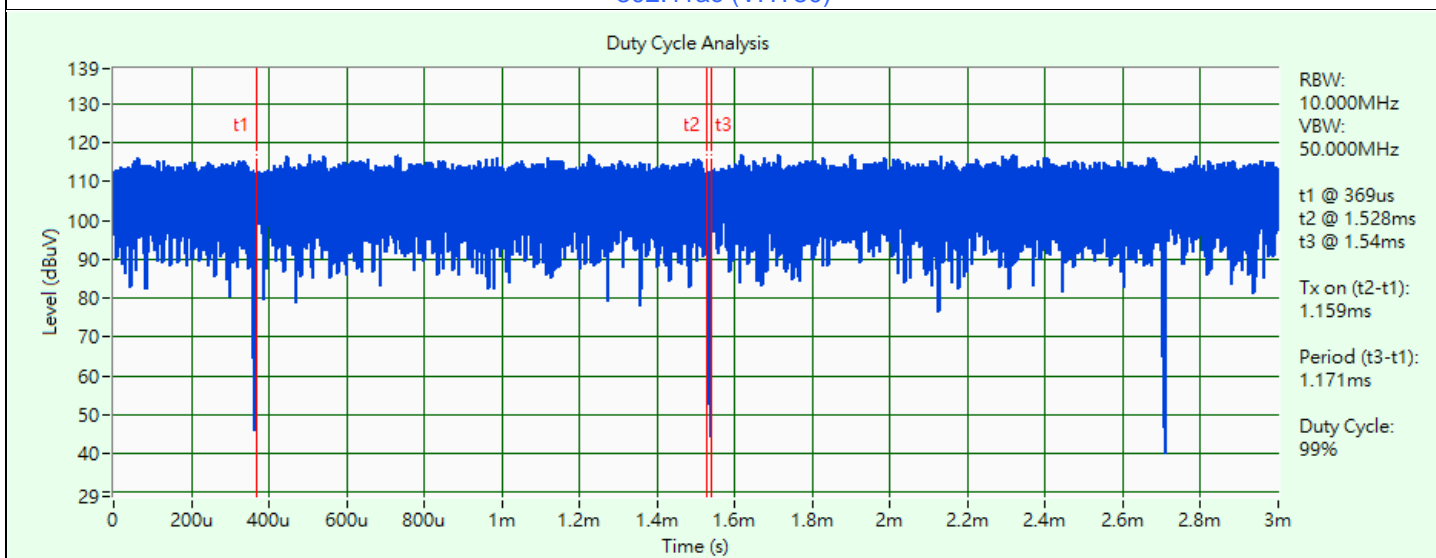

802.11ax (HE20)

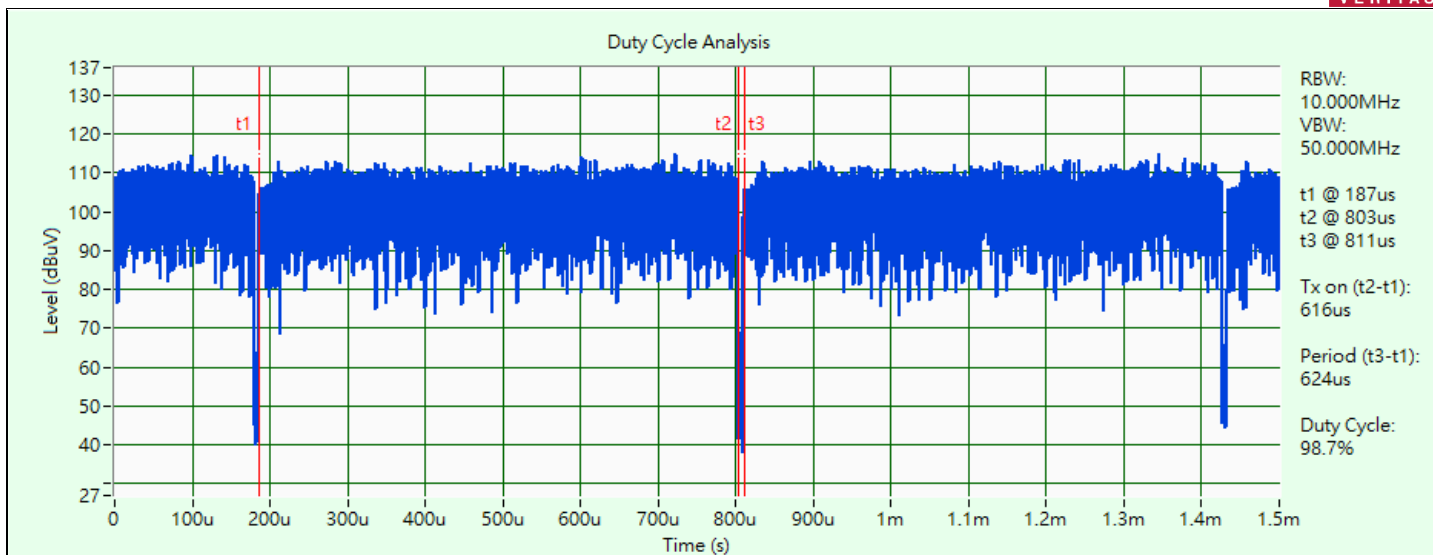

802.11ax (HE40)

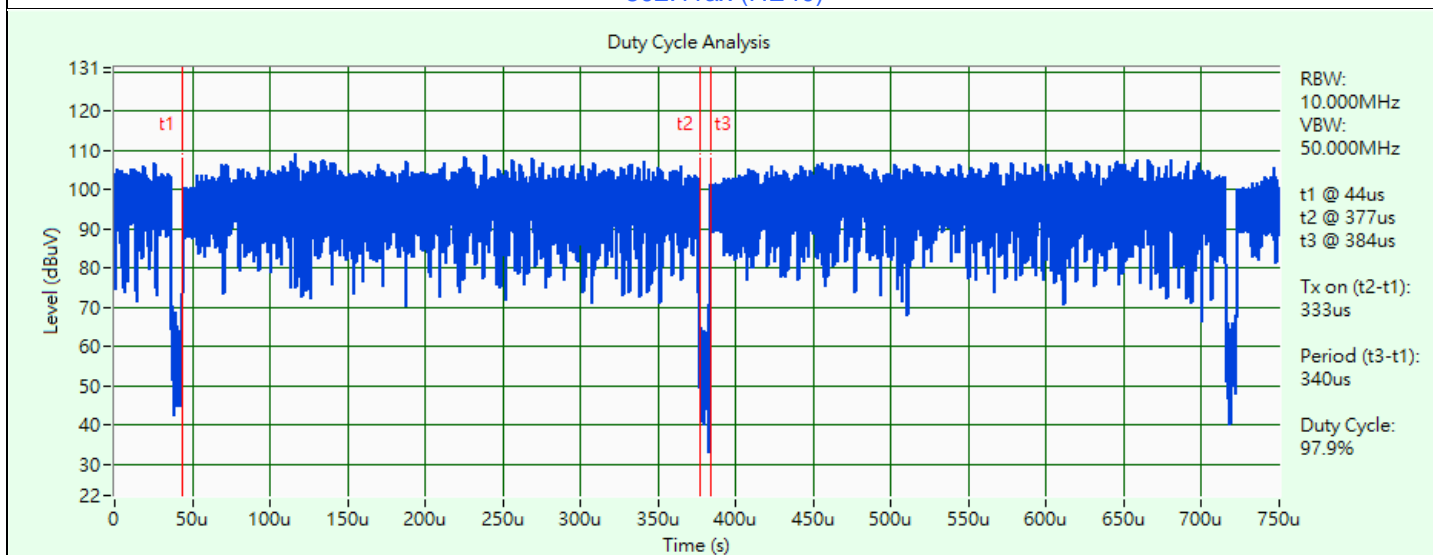

802.11ax (HE80)

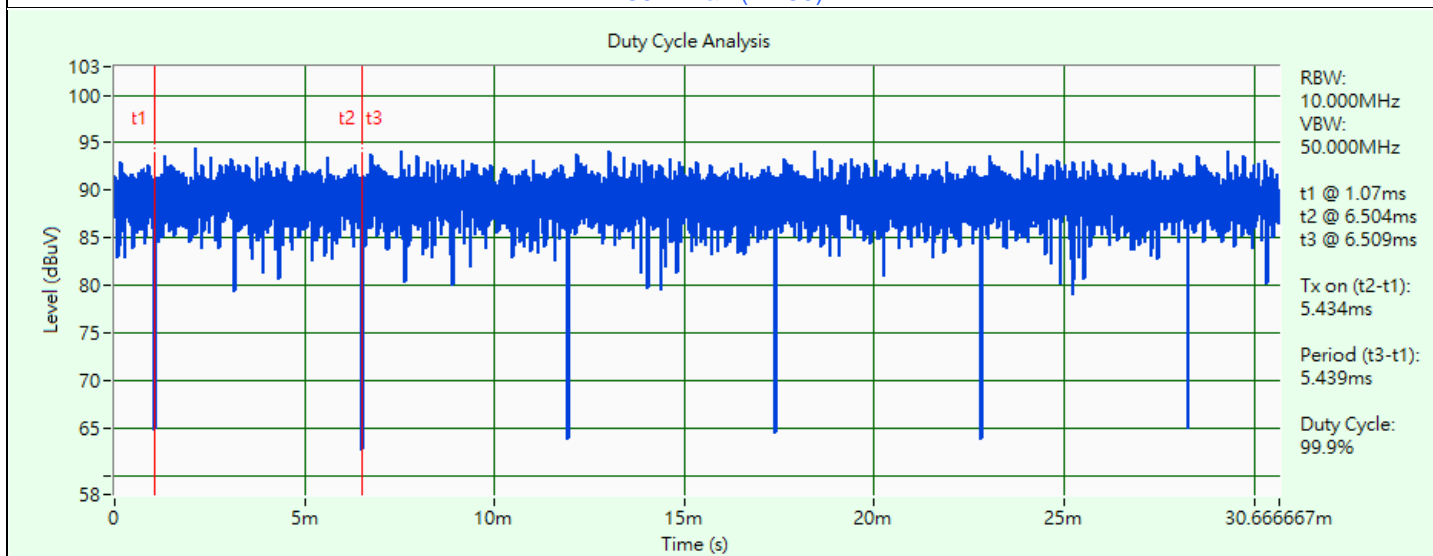

20 MHz Preamble 802.11ax (RU26)

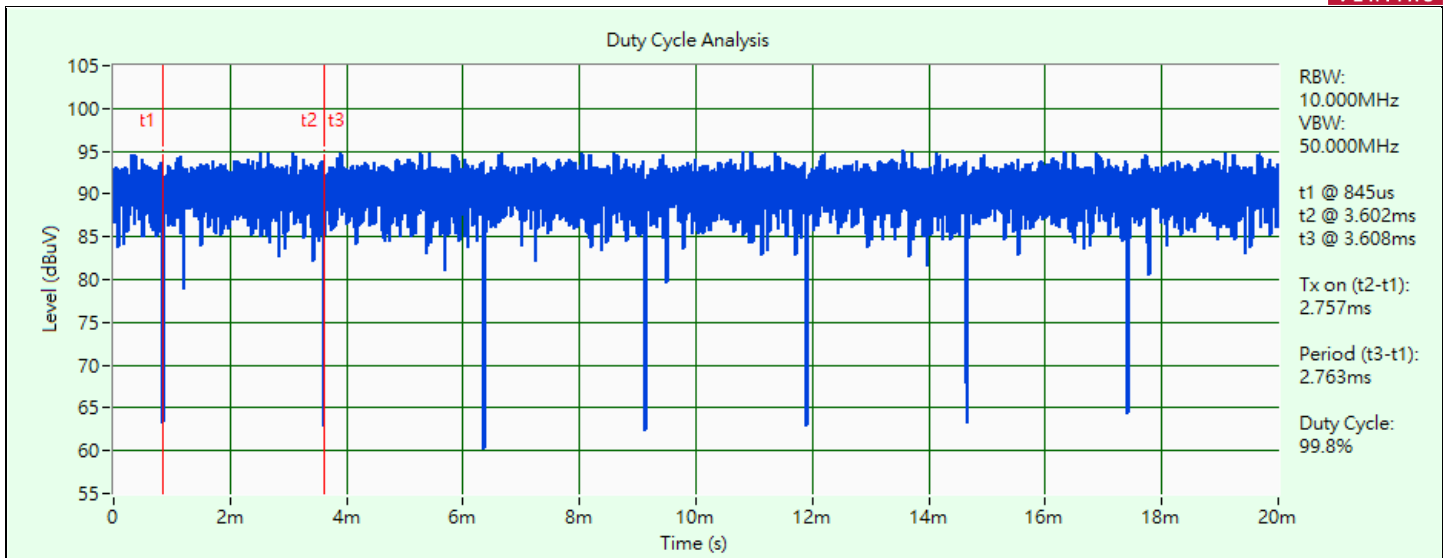

20 MHz Preamble 802.11ax (RU52)

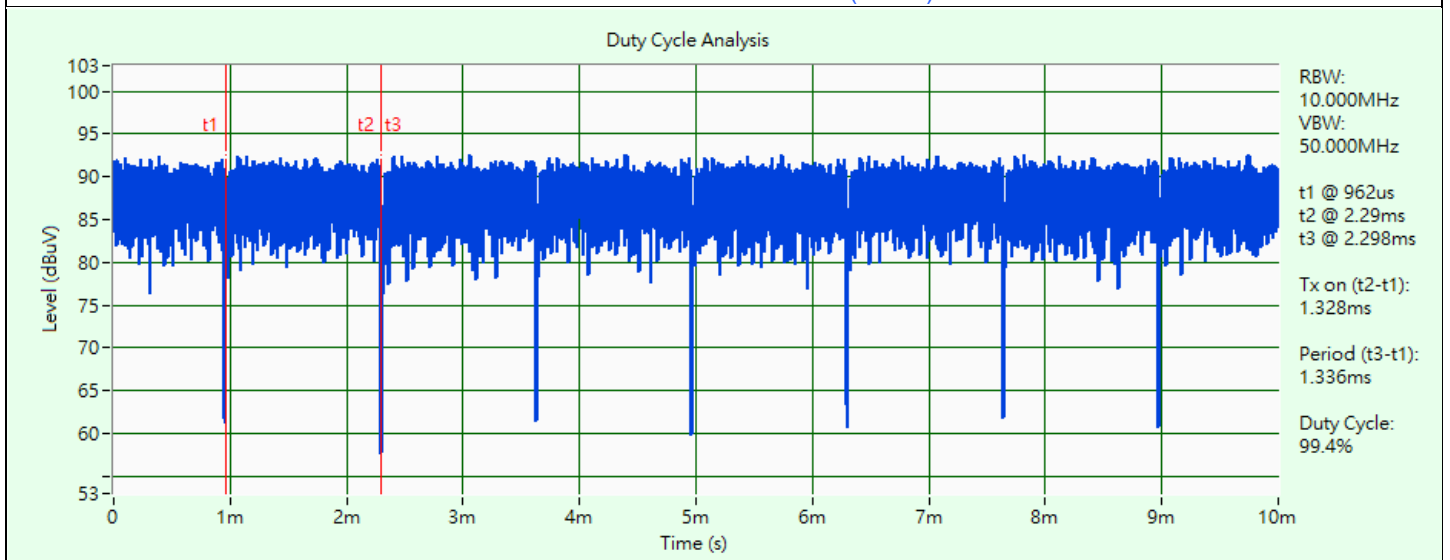

20 MHz Preamble 802.11ax (RU106)

3.6 Test Program Used and Operation Descriptions

Controlling software (RTL8851B_PCIE_MP_Package_ALPHA_v2.0.20_homologation(94894)) has been activated to set the EUT under transmission condition continuously at specific channel frequency.

3.7 Connection Diagram of EUT and Peripheral Devices

For Unwanted Emission Test

Mode A

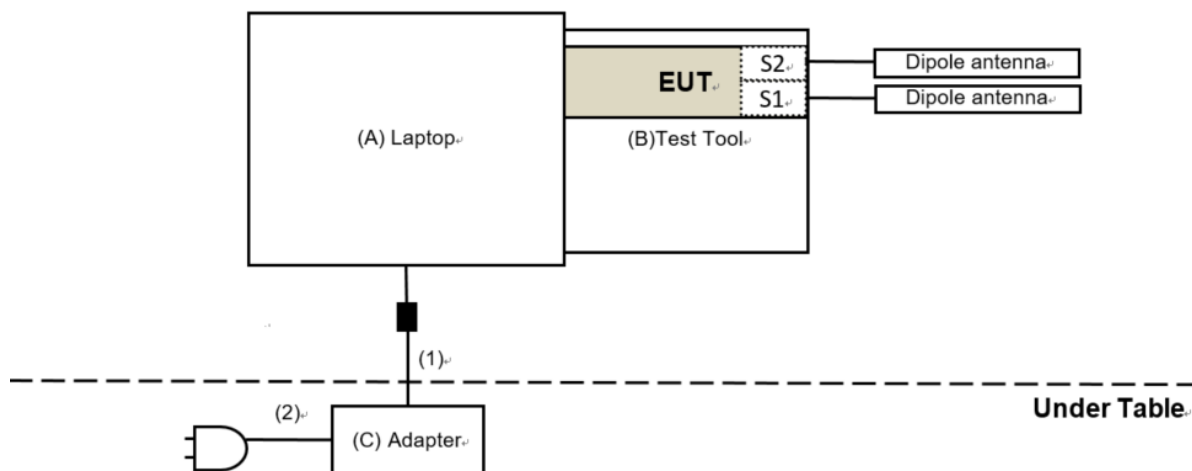

Mode B

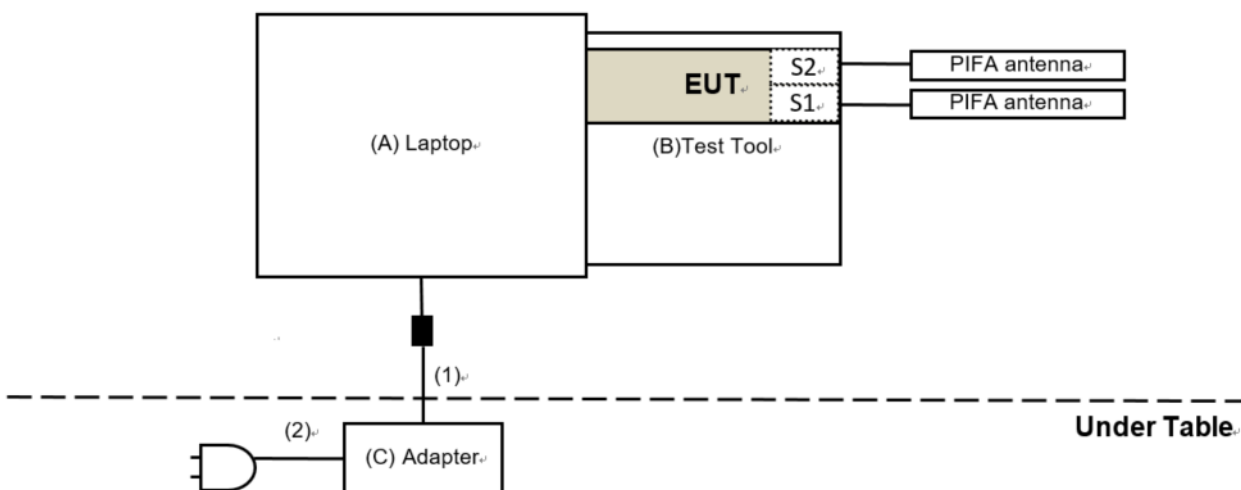

Mode C

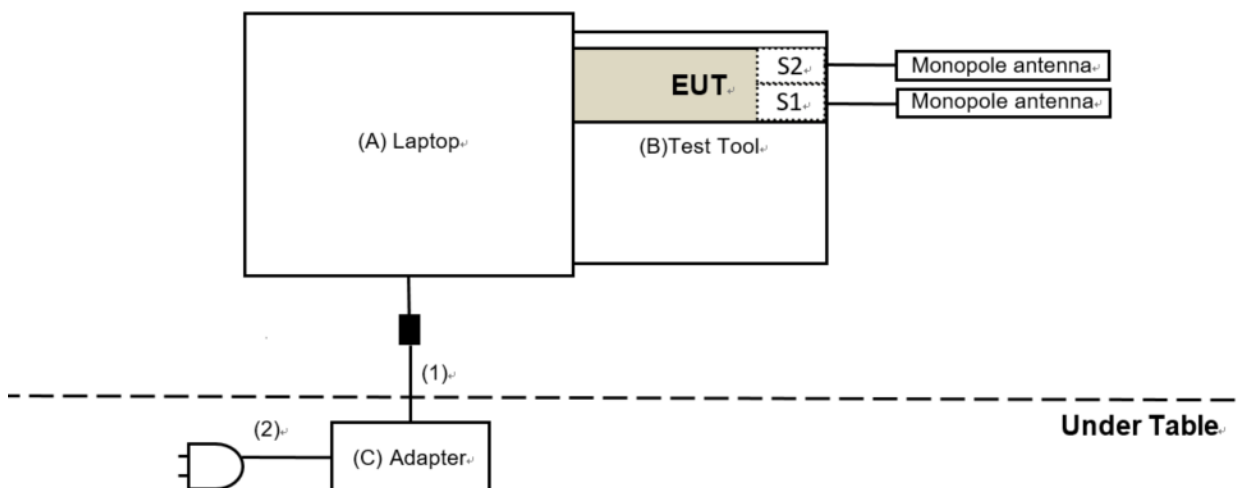

For AC Power Conducted Emission Test

Mode B

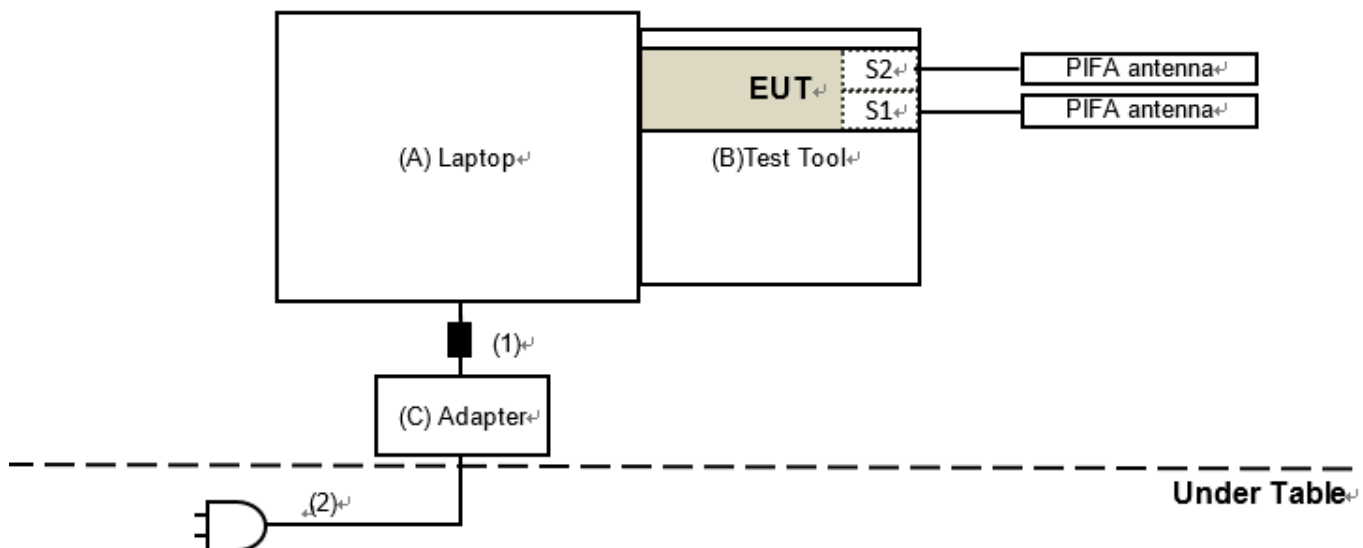

3.8 Configuration of Peripheral Devices and Cable Connections

ID	Product	Brand	Model No.	Serial No.	FCC ID	Remarks
A	Laptop	Dell	E5420	FHNS4S1	N/A	Provided by Lab
B	Test Tool	Realtek	N/A	N/A	N/A	Supplied by applicant
C	Adapter	Dell	FA65NE0-00	N/A	N/A	Supplied by applicant

ID	Cable Descriptions	Qty.	Length (m)	Shielding (Yes/No)	Cores (Qty.)	Remarks
1	DC Cable	1	1.8	No	1	Provided by Lab
2	AC Cable	0	1	No	0	Provided by Lab

4 Test Instruments

The calibration interval of the all test instruments are 12 months and the calibrations are traceable to NML/ROC and NIST/USA.

4.1 26 dB Bandwidth

Description Manufacturer	Model No.	Serial No.	Calibrated Date	Calibrated Until
Attenuator WOKEN	MDCS18N-10	MDCS18N-10-01	2022/4/5	2023/4/4
Software	ADT_RF Test Software V6.6.5.4	N/A	N/A	N/A
Spectrum Analyzer Keysight	N9020B	MY60112409	2022/3/11	2023/3/10

Notes:

1. The test was performed in Oven room 2.
2. Tested Date: 2023/2/10

4.2 RF Output Power

Description Manufacturer	Model No.	Serial No.	Calibrated Date	Calibrated Until
Attenuator WOKEN	MDCS18N-10	MDCS18N-10-01	2022/4/5	2023/4/4
Power Meter Anritsu	ML2495A	1529002	2022/6/22	2023/6/21
Pulse Power Sensor Anritsu	MA2411B	1726434	2022/6/22	2023/6/21
Software	ADT_RF Test Software V6.6.5.4	N/A	N/A	N/A
Spectrum Analyzer Keysight	N9020B	MY60112409	2022/3/11	2023/3/10

Notes:

1. The test was performed in Oven room 2.
2. Tested Date: 2023/2/10

4.3 Power Spectral Density

Refer to section 4.1 to get information of the instruments.

4.4 6 dB Bandwidth

Refer to section 4.1 to get information of the instruments.

4.5 Occupied Bandwidth

Refer to section 4.1 to get information of the instruments.

4.6 Frequency Stability

Description Manufacturer	Model No.	Serial No.	Calibrated Date	Calibrated Until
Attenuator WOKEN	MDCS18N-10	MDCS18N-10-01	2022/4/5	2023/4/4
DC POWER SUPPLY Topward	6603D	795558	N/A	N/A
Software	ADT_RF Test Software V6.6.5.4	N/A	N/A	N/A
Spectrum Analyzer Keysight	N9020B	MY60112409	2022/3/11	2023/3/10
Temperature & Humidity Chamber Giant Force	GTH-150-40-SP-AR	MAA0812-008	2022/12/26	2023/12/25
True RMS Clamp Meter Fluke	325	31130711WS	2022/6/9	2023/6/8

Notes:

1. The test was performed in Oven room 2.
2. Tested Date: 2023/2/10

4.7 AC Power Conducted Emissions

Description Manufacturer	Model No.	Serial No.	Calibrated Date	Calibrated Until
50 ohm terminal resistance	N/A	EMC-01	2022/9/27	2023/9/26
Fixed attenuator STI	STI02-2200-10	005	2022/8/24	2023/8/23
LISN R&S	ESH3-Z5	848773/004	2022/10/18	2023/10/17
RF Coaxial Cable JYEBO	5D-FB	COCCAB-001	2022/8/24	2023/8/23
Software BVADT	BVADT_Cond_V7.3.7.4	N/A	N/A	N/A
TEST RECEIVER R&S	ESCS 30	847124/029	2022/10/14	2023/10/13

Notes:

1. The test was performed in Conduction 1
2. Tested Date: 2023/3/21

4.8 Unwanted Emissions below 1 GHz

Description Manufacturer	Model No.	Serial No.	Calibrated Date	Calibrated Until
Bilog Antenna Schwarzbeck	VULB 9168	9168-0842	2022/10/24	2023/10/23
Boresight Antenna Tower & Turn Table Max-Full	MF-7802BS	MF780208530	N/A	N/A
Fixed attenuator Mini-Circuits	UNAT-5+	PAD-ATT5-02	2022/12/28	2023/12/27
LOOP ANTENNA Electro-Metrics	EM-6879	264	2023/2/21	2024/2/20
Pre_Amplifier Agilent	8447D	2944A10636	2023/3/12	2024/3/11
Pre_Amplifier EMCI	EMC330N	980538	2022/4/25	2023/4/24
RF Coaxial Cable COMMATE/PEWC	8D	966-5-1	2023/2/18	2024/2/17
		966-5-2	2023/2/18	2024/2/17
		966-5-3	2023/2/18	2024/2/17
RF Coaxial Cable JYEBO	5D-FB	LOOPCAB-001	2022/12/19	2023/12/18
		LOOPCAB-002	2022/12/19	2023/12/18
Software	ADT_Radiated_V8.7.08	N/A	N/A	N/A
Spectrum Analyzer Keysight	N9020B	MY60112410	2023/3/6	2024/3/5
Test Receiver R&S	ESR3	102528	2023/2/10	2024/2/9

Notes:

1. The test was performed in 966 Chamber No. 5.
2. Tested Date: 2023/3/24

4.9 Unwanted Emissions above 1 GHz

Description Manufacturer	Model No.	Serial No.	Calibrated Date	Calibrated Until
Boresight Antenna Tower & Turn Table Max-Full	MF-7802BS	MF780208530	N/A	N/A
Horn Antenna Schwarzbeck	BBHA 9120D	9120D-1819	2022/11/13	2023/11/12
	BBHA 9170	9170-739	2022/11/13	2023/11/12
Pre_Amplifier EMCI	EMC12630SE	980509	2022/4/25	2023/4/24
	EMC184045SE	980387	2022/1/10 2022/12/28	2023/1/9 2023/12/27
RF Cable-Frequency range: 1- 40GHz EMCI	EMC102-KM-KM-1200	160924	2022/1/10 2022/12/28	2023/1/9 2023/12/27
RF Coaxial Cable EMCI	EMC-KM-KM-4000	200214	2022/3/8 2023/2/20	2023/3/7 2024/2/19
	EMC104-SM-SM-1500	180503	2022/4/25	2023/4/24
	EMC104-SM-SM-2000	180501	2022/4/25	2023/4/24
	EMC104-SM-SM-6000	180506	2022/4/25	2023/4/24
Software	ADT_Radiated_V8.7.08	N/A	N/A	N/A
Spectrum Analyzer Keysight	N9020B	MY60112410	2022/3/13 2023/3/6	2023/3/12 2024/3/5
Test Receiver R&S	ESR3	102528	2022/2/25 2023/2/10	2023/2/24 2024/2/9

Notes:

1. The test was performed in 966 Chamber No. 5.
2. Tested Date: 2022/12/20 ~ 2023/3/16

5 Limits of Test Items

5.1 26 dB Bandwidth

The results are for reference only.

5.2 RF Output Power

Operation Band	EUT Category	Limit
U-NII-1	Outdoor Access Point	1 Watt (30 dBm) (Max. e.i.r.p \leq 125mW(21 dBm) at any elevation angle above 30 degrees as measured from the horizon)
	Fixed point-to-point Access Point	1 Watt (30 dBm)
	Indoor Access Point	1 Watt (30 dBm)
	Mobile and Portable client device	250mW (24 dBm)

Operation Band	Limit
U-NII-2A	250 mW (24 dBm) or 11 dBm+10 log B*
U-NII-2C	250 mW (24 dBm) or 11 dBm+10 log B*
U-NII-3	1 Watt (30 dBm)

*B is the 26 dB emission bandwidth in megahertz

5.3 Power Spectral Density

Operation Band	EUT Category	Limit
U-NII-1	Outdoor Access Point	17 dBm/MHz
	Fixed point-to-point Access Point	
	Indoor Access Point	
	Mobile and Portable client device	11 dBm/MHz

Operation Band	Limit
U-NII-2A	11 dBm/MHz
U-NII-2C	11 dBm/MHz
U-NII-3	30 dBm/500 kHz

5.4 6 dB Bandwidth

Within the 5.725-5.850 GHz band, the minimum 6 dB bandwidth of U-NII devices shall be at least 500 kHz.

5.5 Occupied Bandwidth

The results are for reference only.

5.6 Frequency Stability

The frequency of the carrier signal shall be maintained within band of operation.

5.7 AC Power Conducted Emissions

Frequency (MHz)	Conducted Limit (dBuV)	
	Quasi-peak	Average
0.15 - 0.5	66 - 56	56 - 46
0.50 - 5.0	56	46
5.0 - 30.0	60	50

Notes:

1. The lower limit shall apply at the transition frequencies.
2. The limit decreases in line with the logarithm of the frequency in the range of 0.15 to 0.50 MHz.

5.8 Unwanted Emissions below 1 GHz

Radiated emissions which fall in the restricted bands must comply with the radiated emission limits specified as below table.

Frequencies (MHz)	Field Strength (microvolts/meter)	Measurement Distance (meters)
0.009 ~ 0.490	2400/F(kHz)	300
0.490 ~ 1.705	24000/F(kHz)	30
1.705 ~ 30.0	30	30
30 ~ 88	100	3
88 ~ 216	150	3
216 ~ 960	200	3
Above 960	500	3

Notes:

1. The lower limit shall apply at the transition frequencies.
2. Emission level (dBuV/m) = 20 log Emission level (uV/m).

5.9 Unwanted Emissions above 1 GHz

Radiated emissions which fall in the restricted bands must comply with the radiated emission limits specified as below table.

Frequencies (MHz)	Field Strength (microvolts/meter)	Measurement Distance (meters)
Above 960	500	3

Notes:

1. The lower limit shall apply at the transition frequencies.
2. Emission level (dBuV/m) = 20 log Emission level (uV/m).
3. For frequencies above 1000 MHz, the field strength limits are based on average detector, however, the peak field strength of any emission shall not exceed the maximum permitted average limits, specified above by more than 20 dB under any condition of modulation.

Limits of unwanted emission out of the restricted bands

Applicable To	Limit	
789033 D02 General UNII Test Procedure New Rules v02r01	Field Strength at 3 m	
	PK: 74 (dBμV/m)	AV: 54 (dBμV/m)

For transmitters operating in the 5.15-5.25 GHz band:

Applicable To	EIRP Limit	Equivalent Field Strength at 3 m
15.407(b)(1)	PK: -27 (dBm/MHz)	PK: 68.2 (dBμV/m)

For transmitters operating in the 5.25-5.35 GHz band:

Applicable To	EIRP Limit	Equivalent Field Strength at 3 m
15.407(b)(2)	PK: -27 (dBm/MHz)	PK: 68.2 (dBμV/m)

For transmitters operating in the 5.47-5.725 GHz band:

Applicable To	EIRP Limit	Equivalent Field Strength at 3 m
15.407(b)(3)	PK: -27 (dBm/MHz)	PK: 68.2 (dBμV/m)

For transmitters operating in the 5.725-5.850 GHz band:

Applicable To	EIRP Limit	Equivalent Field Strength at 3 m
15.407(b)(4)(i)	PK: -27 (dBm/MHz) ^{*1}	PK: 68.2 (dBμV/m) ^{*1}
	PK: 10 (dBm/MHz) ^{*2}	PK: 105.2 (dBμV/m) ^{*2}
	PK: 15.6 (dBm/MHz) ^{*3}	PK: 110.8 (dBμV/m) ^{*3}
	PK: 27 (dBm/MHz) ^{*4}	PK: 122.2 (dBμV/m) ^{*4}

^{*1} beyond 75 MHz or more above of the band edge.

^{*2} below the band edge increasing linearly to 10 dBm/MHz at 25 MHz above.

^{*3} below the band edge increasing linearly to a level of 15.6 dBm/MHz at 5 MHz above.

^{*4} from 5 MHz above or below the band edge increasing linearly to a level of 27 dBm/MHz at the band edge.

Note: The following formula is used to convert the equipment isotropic radiated power (eirp) to field strength:

$$E = \frac{1000000\sqrt{30P}}{3} \mu\text{V/m, where P is the eirp (Watts).}$$

6 Test Arrangements

6.1 26 dB Bandwidth

6.1.1 Test Setup

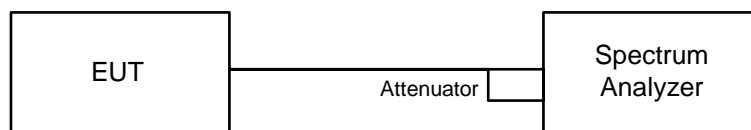

6.1.2 Test Procedure

- a. Set RBW = approximately 1% of the emission bandwidth.
- b. Set the VBW > RBW.
- c. Detector = Peak.
- d. Trace mode = max hold.
- e. Measure the maximum width of the emission that is 26 dB down from the peak of the emission. Compare this with the RBW setting of the analyzer. Readjust RBW and repeat measurement as needed until the RBW/EBW ratio is approximately 1%.

6.2 RF Output Power

6.2.1 Test Setup

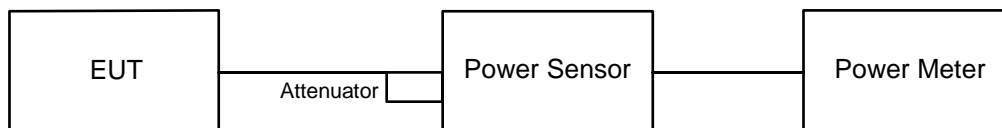

For channel straddling:

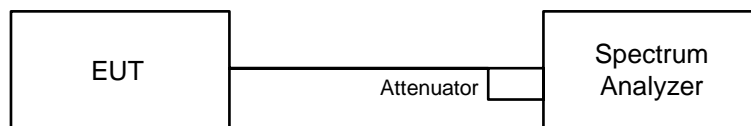

6.2.2 Test Procedure

Method PM is used to perform output power measurement, trigger and gating function of wide band power meter is enabled to measure max output power of TX on burst and set the detector to average. Duty factor is not added to measured value.

For channel straddling:

Method SA-1

- Set span to encompass the entire emission bandwidth (EBW) of the signal.
- Set RBW = 1 MHz, Set VBW \geq 3 MHz, Detector = RMS
- Sweep points \geq $[2 \times \text{span} / \text{RBW}]$. (This gives bin-to-bin spacing \leq RBW / 2, so that narrowband signals are not lost between frequency bins.)
- Sweep time = auto, trigger set to "free run".
- Trace average at least 100 traces in power averaging mode.
- Record the max value

Note: When measuring straddle channel power, use compute power by integrating the spectrum across the 26 dB EBW or 99% OBW of the signal using the instrument's band power measurement function, with band limits set equal to the EBW or OBW band edges. If the instrument does not have a band power function, then sum the spectrum levels (in power units) at 1 MHz intervals extending across the 26 dB EBW or 99% OBW of the spectrum.

For channel straddling:

Method SA-2

- Set span to encompass the entire emission bandwidth (EBW) of the signal.
- Set RBW = 1 MHz, Set VBW \geq 3 MHz, Detector = RMS
- Sweep points \geq $[2 \times \text{span} / \text{RBW}]$. (This gives bin-to-bin spacing \leq RBW / 2, so that narrowband signals are not lost between frequency bins.) Sweep time = auto, trigger set to "free run".
- Trace average at least 100 traces in power averaging mode.
- Use the peak search function on the instrument to find the peak of the spectrum and record its value.
- Record the max value and add $10 \log (1/\text{duty cycle})$.

Note: When measuring straddle channel power, use compute power by integrating the spectrum across the 26 dB EBW or 99% OBW of the signal using the instrument's band power measurement function, with band limits set equal to the EBW or OBW band edges. If the instrument does not have a band power function, then sum the spectrum levels (in power units) at 1 MHz intervals extending across the 26 dB EBW or 99% OBW of the spectrum.

6.3 Power Spectral Density

6.3.1 Test Setup

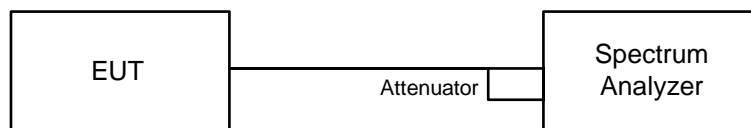

6.3.2 Test Procedure

For specified measurement bandwidth 1 MHz:

Method SA-1

- Set span to encompass the entire emission bandwidth (EBW) of the signal.
- Set RBW = 1 MHz, Set VBW \geq 3 MHz, Detector = RMS
- Sweep points $\geq [2 \times \text{span} / \text{RBW}]$. (This gives bin-to-bin spacing \leq RBW / 2, so that narrowband signals are not lost between frequency bins.)
- Sweep time = auto, trigger set to "free run".
- Trace average at least 100 traces in power averaging mode.
- Record the max value

For specified measurement bandwidth 1 MHz:

Method SA-2

- Set span to encompass the entire emission bandwidth (EBW) of the signal.
- Set RBW = 1 MHz, Set VBW \geq 3 MHz, Detector = RMS
- Sweep points $\geq [2 \times \text{span} / \text{RBW}]$. (This gives bin-to-bin spacing \leq RBW / 2, so that narrowband signals are not lost between frequency bins.)
- Sweep time = auto, trigger set to "free run".
- Trace average at least 100 traces in power averaging mode.
- Use the peak search function on the instrument to find the peak of the spectrum and record its value.
- Record the max value and add 10 log (1/duty cycle).

For specified measurement bandwidth 500 kHz:

Method SA-1

- Set span to encompass the entire emission bandwidth (EBW) of the signal.
- Set RBW = 300 kHz, Set VBW \geq 1 MHz, Detector = RMS
- Scale the observed power level to an equivalent value in 500 kHz by adjusting (increasing) the measured power by a bandwidth correction factor (BWCF) where $\text{BWCF} = 10\log(500 \text{ kHz}/300 \text{ kHz})$
- Sweep points $\geq [2 \times \text{span} / \text{RBW}]$. (This gives bin-to-bin spacing \leq RBW / 2, so that narrowband signals are not lost between frequency bins.)
- Sweep time = auto, trigger set to "free run".
- Trace average at least 100 traces in power averaging mode.
- Record the max value

For specified measurement bandwidth 500 kHz:

Method SA-2

- Set span to encompass the entire emission bandwidth (EBW) of the signal.
- Set RBW = 300 kHz, Set VBW \geq 1 MHz, Detector = RMS
- Scale the observed power level to an equivalent value in 500 kHz by adjusting (increasing) the measured power by a bandwidth correction factor (BWCF) where $BWCF = 10\log(500 \text{ kHz}/300 \text{ kHz})$
- Sweep points $\geq [2 \times \text{span} / \text{RBW}]$. (This gives bin-to-bin spacing $\leq \text{RBW} / 2$, so that narrowband signals are not lost between frequency bins.)
- Sweep time = auto, trigger set to "free run".
- Trace average at least 100 traces in power averaging mode.
- Use the peak search function on the instrument to find the peak of the spectrum and record its value.
- Record the max value and add $10 \log (1/\text{duty cycle})$.

6.4 6 dB Bandwidth

6.4.1 Test Setup

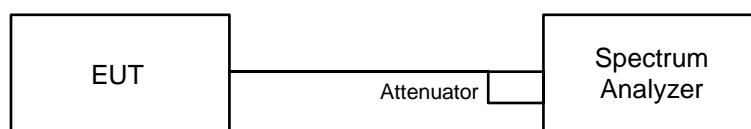

6.4.2 Test Procedure

- Set resolution bandwidth (RBW) = 100 kHz.
- Set the video bandwidth (VBW) $\geq 3 \times \text{RBW}$, Detector = Peak.
- Trace mode = max hold.
- Sweep = auto couple.
- Measure the maximum width of the emission that is constrained by the frequencies associated with the two amplitude points (upper and lower) that are attenuated by 6 dB relative to the maximum level measured in the fundamental emission.

6.5 Occupied Bandwidth

6.5.1 Test Setup

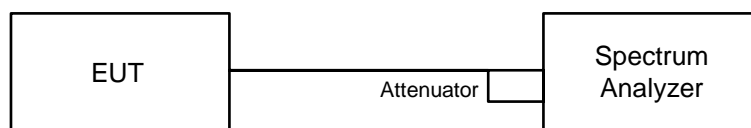

6.5.2 Test Procedure

The transmitter output was connected to the spectrum analyzer through an attenuator. The bandwidth of the fundamental frequency was measured by spectrum analyzer with resolution bandwidth in the range of 1% to 5% of the anticipated emission bandwidth, and a video bandwidth at least 3x the resolution bandwidth and set the detector to Sampling. The width of a frequency band such that, below the lower and above the upper frequency limits, the mean powers emitted are each equal to a specified percentage 0.5% of the total mean power of a given emission.

6.6 Frequency Stability

6.6.1 Test Setup

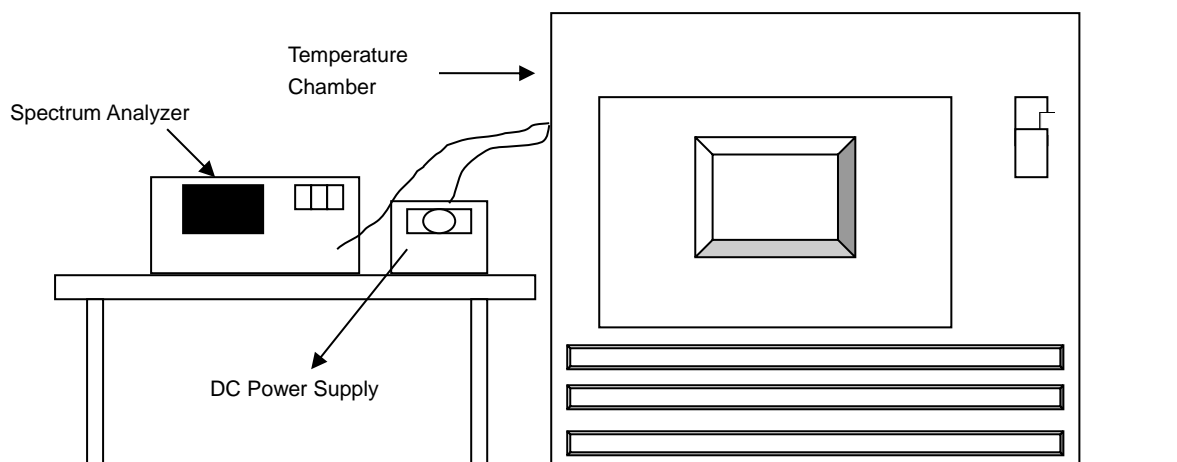

6.6.2 Test Procedure

- The EUT was placed inside the environmental test chamber and powered by nominal DC voltage.
- Turn the EUT on and couple its output to a spectrum analyzer.
- Turn the EUT off and set the chamber to the highest temperature specified.
- Allow sufficient time (approximately 30 min) for the temperature of the chamber to stabilize, turn the EUT on and measure the operating frequency after 2, 5, and 10 Minutes.
- Repeat step (d) with the temperature chamber set to the next desired temperature until measurements down to the lowest specified temperature have been completed.
- The test chamber was allowed to stabilize at +20 degree C for a minimum of 30 Minutes. The supply voltage was then adjusted on the EUT from 85% to 115% and the frequency record.

6.7 AC Power Conducted Emissions

6.7.1 Test Setup

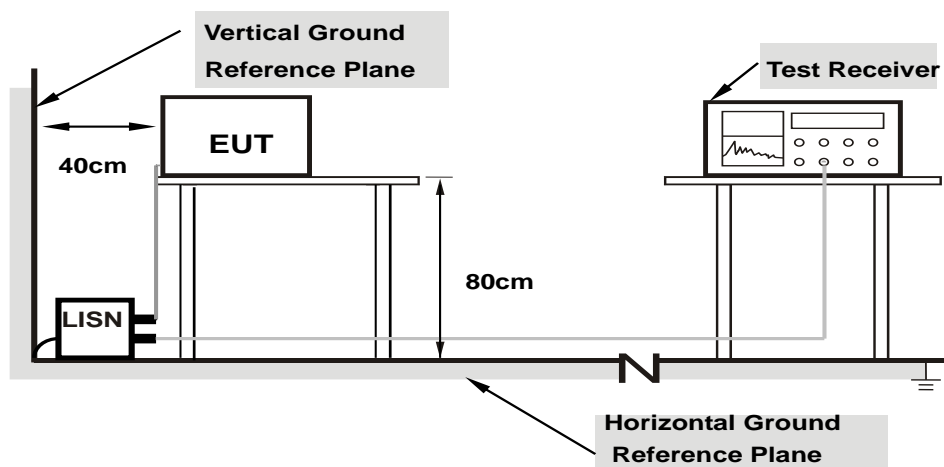

Note: 1.Support units were connected to second LISN.

For the actual test configuration, please refer to the attached file (Test Setup Photo).

6.7.2 Test Procedure

- The EUT was placed on a 0.8 meter to the top of table and placed 0.4 meters from the conducting wall of the shielded room with EUT being connected to the power mains through a line impedance stabilization network (LISN). Other support units were connected to the power mains through another LISN. The two LISNs provide 50 ohm/ 50 uH of coupling impedance for the measuring instrument.
- Both lines of the power mains connected to the EUT were checked for maximum conducted interference.
- The frequency range from 150 kHz to 30 MHz was searched. Emission levels under (Limit – 20 dB) was not recorded.

Note: The resolution bandwidth and video bandwidth of test receiver is 9 kHz for quasi-peak detection (QP) and average detection (AV) at frequency 0.15 MHz-30 MHz.

6.8 Unwanted Emissions below 1 GHz

6.8.1 Test Setup

For Radiated emission below 30 MHz

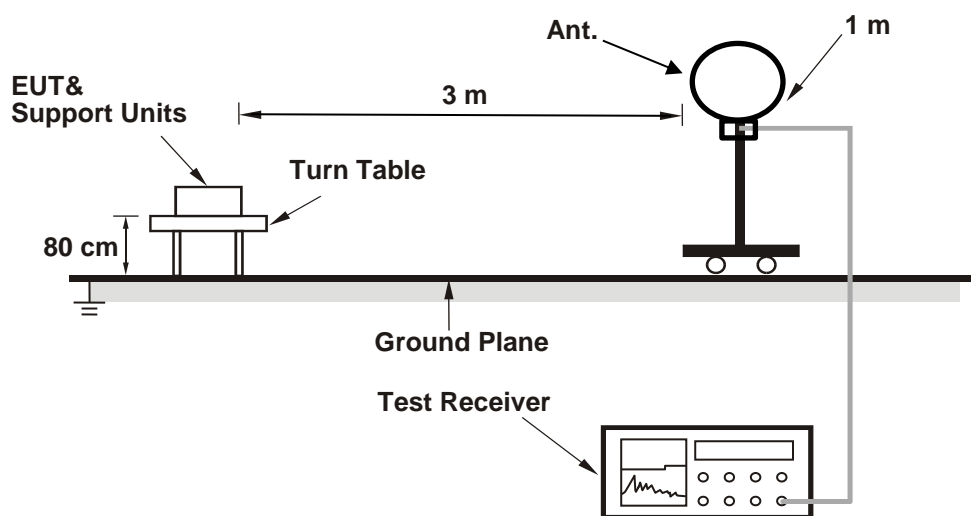

For Radiated emission above 30 MHz

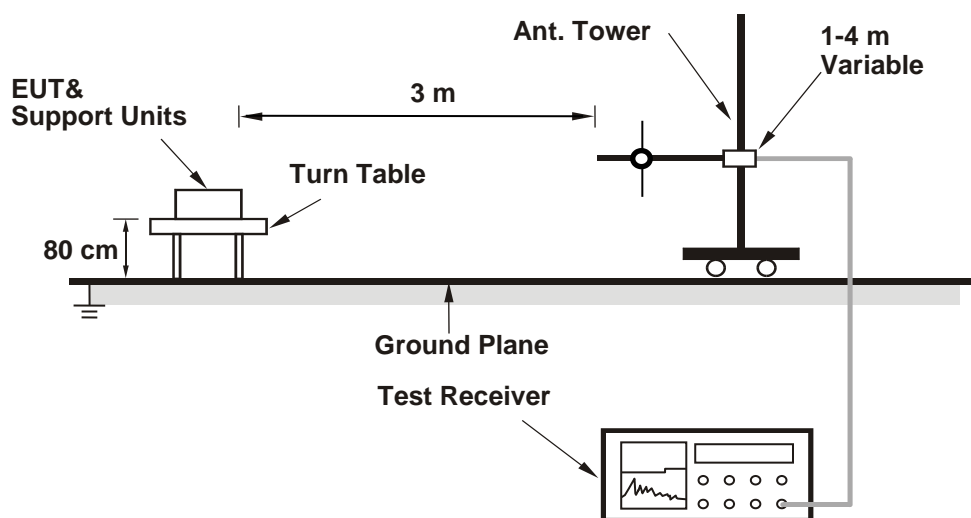

For the actual test configuration, please refer to the attached file (Test Setup Photo).

6.8.2 Test Procedure

For Radiated emission below 30 MHz

- a. The EUT was placed on the top of a rotating table 0.8 meters above the ground at 3 meter chamber room for test. The table was rotated 360 degrees to determine the position of the highest radiation.
- b. The EUT was set 3 meters away from the interference-receiving antenna, which was mounted on the top of a variable-height antenna tower.
- c. Parallel, perpendicular, and ground-parallel orientations of the antenna are set to make the measurement.
- d. For each suspected emission, the EUT was arranged to its worst case and the rotatable table was turned from 0 degrees to 360 degrees to find the maximum reading.
- e. The test-receiver system was set to Quasi-Peak Detect Function and Specified Bandwidth with Maximum Hold Mode, except for the frequency band (9 kHz to 90 kHz and 110 kHz to 490 kHz) set to average detect function and peak detect function.

Notes:

1. The resolution bandwidth and video bandwidth of test receiver/spectrum analyzer is 200 Hz at frequency below 150 kHz.
2. The resolution bandwidth and video bandwidth of test receiver/spectrum analyzer is 9 kHz or 10 kHz at frequency (150 kHz to 30 MHz).
3. All modes of operation were investigated and the worst-case emissions are reported.

For Radiated emission above 30 MHz

- a. The EUT was placed on the top of a rotating table 0.8 meters above the ground at 3 meter chamber room for test. The table was rotated 360 degrees to determine the position of the highest radiation.
- b. The EUT was set 3 meters away from the interference-receiving antenna, which was mounted on the top of a variable-height antenna tower.
- c. The height of antenna is varied from one meter to four meters above the ground to determine the maximum value of the field strength. Both horizontal and vertical polarizations of the antenna are set to make the measurement.
- d. For each suspected emission, the EUT was arranged to its worst case and then the antenna was tuned to heights from 1 meter to 4 meters and the rotatable table was turned from 0 degrees to 360 degrees to find the maximum reading.
- e. The test-receiver system was set to quasi-peak detect function and specified bandwidth with maximum hold mode when the test frequency is below 1 GHz.

Notes:

1. The resolution bandwidth and video bandwidth of test receiver/spectrum analyzer is 120 kHz for Quasi-peak detection (QP) at frequency below 1 GHz.
2. All modes of operation were investigated and the worst-case emissions are reported.

6.9 Unwanted Emissions above 1 GHz

6.9.1 Test Setup

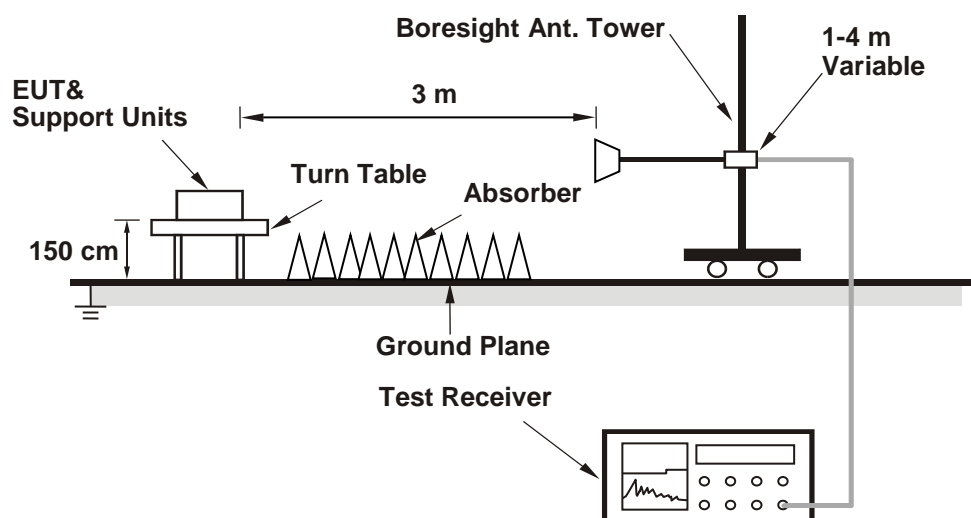

For the actual test configuration, please refer to the attached file (Test Setup Photo).

6.9.2 Test Procedure

- The EUT was placed on the top of a rotating table 1.5 meters above the ground at 3 meter chamber room for test. The table was rotated 360 degrees to determine the position of the highest radiation.
- The EUT was set 3 meters away from the interference-receiving antenna, which was mounted on the top of a variable-height antenna tower.
- The height of antenna is varied from one meter to four meters above the ground to determine the maximum value of the field strength. Both horizontal and vertical polarizations of the antenna are set to make the measurement.
- For each suspected emission, the EUT was arranged to its worst case and then the antenna was tuned to heights from 1 meter to 4 meters and the rotatable table was turned from 0 degrees to 360 degrees to find the maximum reading.
- The test-receiver system was set to peak and average detects function and specified bandwidth with maximum hold mode when the test frequency is above 1 GHz. If the peak reading value also meets average limit, measurement with the average detector is unnecessary.

Notes:

- The resolution bandwidth of test receiver/spectrum analyzer is 1 MHz and the video bandwidth is 3 MHz for Peak detection (PK) and Average detection (AV) at frequency above 1 GHz.
- For fundamental and harmonic signal measurement, the resolution bandwidth of test receiver/spectrum analyzer is 1 MHz and the video bandwidth is $\geq 1/T$ (Duty cycle $< 98\%$) or 10 Hz (Duty cycle $\geq 98\%$) for Average detection (AV) at frequency above 1 GHz.
- All modes of operation were investigated and the worst-case emissions are reported.

7 Test Results of Test Item

7.1 26 dB Bandwidth

Input Power:	3.3 Vdc	Environmental Conditions:	25°C, 60% RH	Tested By:	Katina Lu
--------------	---------	---------------------------	--------------	------------	-----------

802.11a

Channel	Frequency (MHz)	26dB Bandwidth (MHz)
52	5260	24.75
60	5300	25.53
64	5320	18.64
100	5500	18.51
116	5580	24.53
140	5700	18.49
144 (U-NII-2C)	5720	14.38
144 (U-NII-3)	5720	4.59

Determined Output Power Limit			
Channel Number	Freq.(MHz)	Min. B(MHz)	Determined Conducted Power Limit (dBm)
52	5260	24.75	24.93 > 24
60	5300	25.53	25.07 > 24
64	5320	18.64	23.7 < 24
100	5500	18.51	23.67 < 24
116	5580	24.53	24.89 > 24
140	5700	18.49	23.66 < 24
144 (U-NII-2C)	5720	14.38	22.57 < 24

Note: For U-NII-2A, U-NII-2C Band output power limitation is determined based on 26dBc bandwidth.

802.11ax (HE20)

Channel	Frequency (MHz)	26dB Bandwidth (MHz)
52	5260	20.5
60	5300	20.46
64	5320	20.4
100	5500	20.42
116	5580	20.47
140	5700	20.45
144 (U-NII-2C)	5720	15.21
144 (U-NII-3)	5720	5.16

Determined Output Power Limit			
Channel Number	Freq.(MHz)	Min. B(MHz)	Determined Conducted Power Limit (dBm)
52	5260	20.50	24.11 > 24
60	5300	20.46	24.1 > 24
64	5320	20.40	24.09 > 24
100	5500	20.42	24.1 > 24
116	5580	20.47	24.11 > 24
140	5700	20.45	24.1 > 24
144 (U-NII-2C)	5720	15.21	22.82 < 24

Note: For U-NII-2A, U-NII-2C Band output power limitation is determined based on 26dBc bandwidth.

802.11ax (HE40)

Channel	Frequency (MHz)	26dB Bandwidth (MHz)
54	5270	40.83
62	5310	40.86
102	5510	40.86
110	5550	40.82
134	5670	40.9
142 (U-NII-2C)	5710	35.44
142 (U-NII-3)	5710	5.38

Determined Output Power Limit			
Channel Number	Freq.(MHz)	Min. B(MHz)	Determined Conducted Power Limit (dBm)
54	5270	40.83	27.1 > 24
62	5310	40.86	27.11 > 24
102	5510	40.86	27.11 > 24
110	5550	40.82	27.1 > 24
134	5670	40.90	27.11 > 24
142 (U-NII-2C)	5710	35.44	26.49 > 24

Note: For U-NII-2A, U-NII-2C Band output power limitation is determined based on 26dBc bandwidth.

802.11ax (HE80)

Channel	Frequency (MHz)	26dB Bandwidth (MHz)
58	5290	81.37
106	5530	81.44
122	5610	81.38
138 (U-NII-2C)	5690	75.71
138 (U-NII-3)	5690	5.7

Determined Output Power Limit			
Channel Number	Freq.(MHz)	Min. B(MHz)	Determined Conducted Power Limit (dBm)
58	5290	81.37	30.1 > 24
106	5530	81.44	30.1 > 24
122	5610	81.38	30.1 > 24
138 (U-NII-2C)	5690	75.71	29.79 > 24

Note: For U-NII-2A, U-NII-2C Band output power limitation is determined based on 26dBc bandwidth.

20 MHz Preamble 802.11ax (RU26)

Channel	Frequency (MHz)	26dB Bandwidth (MHz)
52	5260	19.56
60	5300	18.15
64	5320	19.64
100	5500	19.64
116	5580	18.19
140	5700	19.68
144 (U-NII-2C)	5720	14.05
144 (U-NII-3)	5720	5.57

Determined Output Power Limit			
Channel Number	Freq.(MHz)	Min. B(MHz)	Determined Conducted Power Limit (dBm)
52	5260	19.56	23.91 < 24
60	5300	18.15	23.58 < 24
64	5320	19.64	23.93 < 24
100	5500	19.64	23.93 < 24
116	5580	18.19	23.59 < 24
140	5700	19.68	23.94 < 24
144 (U-NII-2C)	5720	14.05	22.47 < 24

Note: For U-NII-2A, U-NII-2C Band output power limitation is determined based on 26dBc bandwidth.

20 MHz Preamble 802.11ax (RU52)

Channel	Frequency (MHz)	26dB Bandwidth (MHz)
52	5260	19.77
60	5300	18.53
64	5320	19.74
100	5500	19.73
116	5580	18.51
140	5700	19.73
144 (U-NII-2C)	5720	14.13
144 (U-NII-3)	5720	5.61

Determined Output Power Limit			
Channel Number	Freq.(MHz)	Min. B(MHz)	Determined Conducted Power Limit (dBm)
52	5260	19.77	23.96 < 24
60	5300	18.53	23.67 < 24
64	5320	19.74	23.95 < 24
100	5500	19.73	23.95 < 24
116	5580	18.51	23.67 < 24
140	5700	19.73	23.95 < 24
144 (U-NII-2C)	5720	14.13	22.5 < 24

Note: For U-NII-2A, U-NII-2C Band output power limitation is determined based on 26dBc bandwidth.



20 MHz Preamble 802.11ax (RU106)

Channel	Frequency (MHz)	26dB Bandwidth (MHz)
52	5260	19.78
60	5300	19.77
64	5320	19.87
100	5500	19.77
116	5580	19.78
140	5700	19.79
144 (U-NII-2C)	5720	14.2
144 (U-NII-3)	5720	5.7

Determined Output Power Limit			
Channel Number	Freq.(MHz)	Min. B(MHz)	Determined Conducted Power Limit (dBm)
52	5260	19.78	23.96 < 24
60	5300	19.77	23.96 < 24
64	5320	19.87	23.98 < 24
100	5500	19.77	23.96 < 24
116	5580	19.78	23.96 < 24
140	5700	19.79	23.96 < 24
144 (U-NII-2C)	5720	14.20	22.52 < 24

Note: For U-NII-2A, U-NII-2C Band output power limitation is determined based on 26dBc bandwidth.

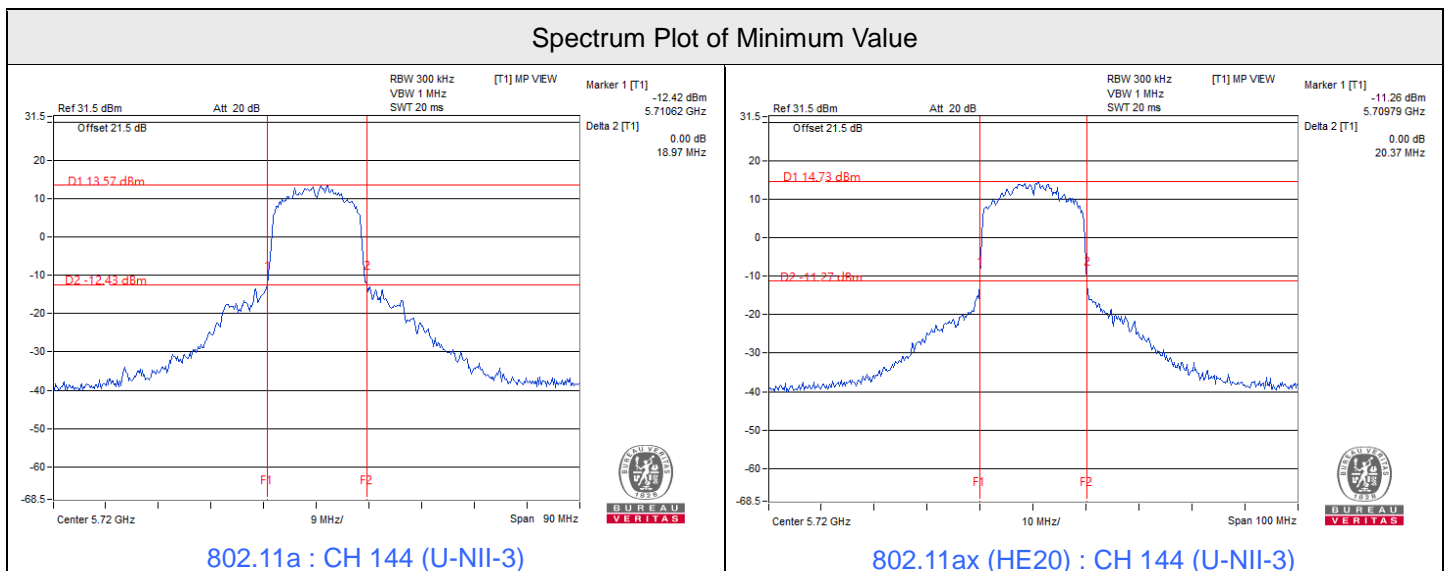

Spectrum Plot of Minimum Value

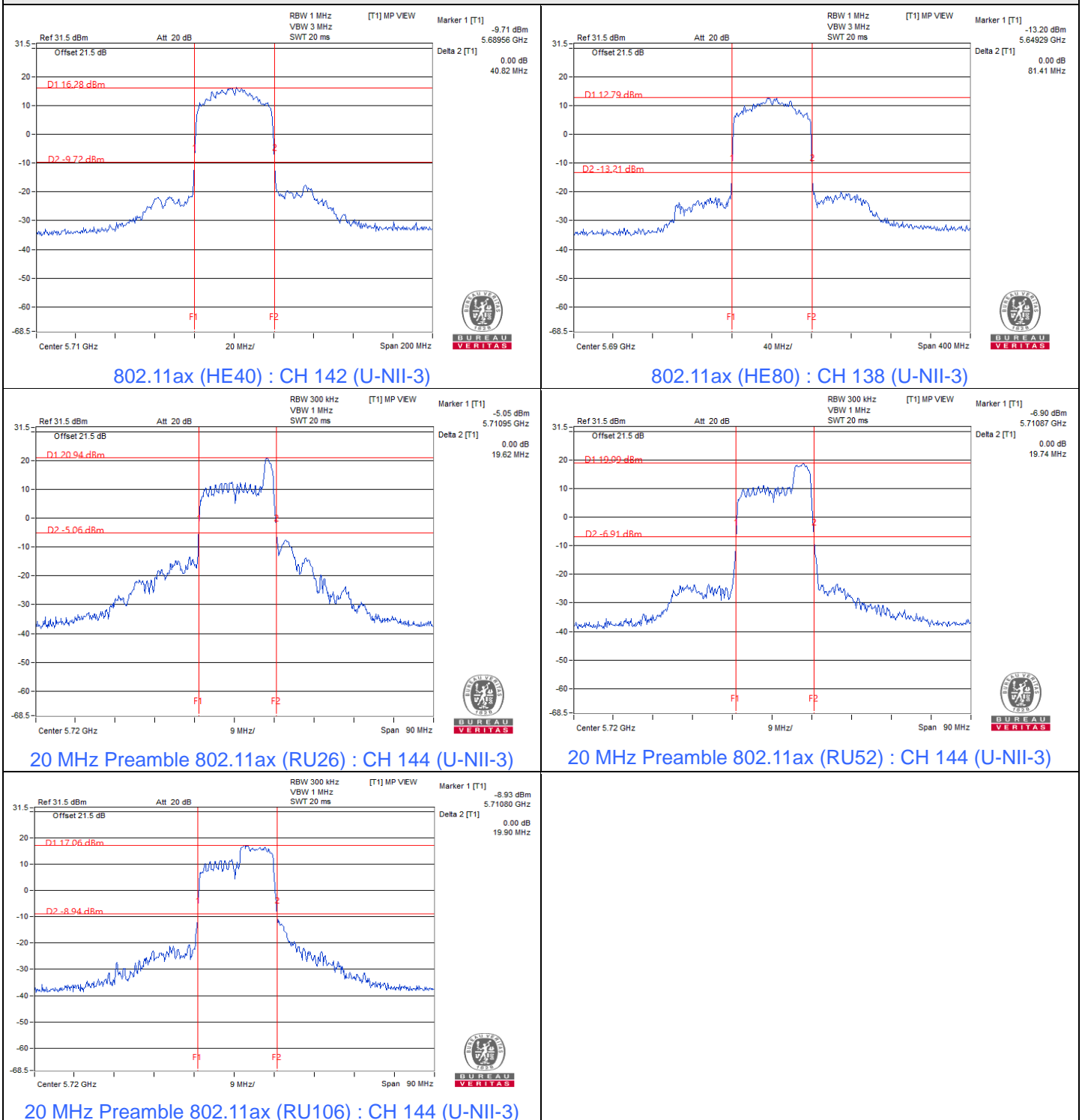
**Notes:**

1. For U-NII-2C straddle channel = 5725 MHz - Marker 1
2. For U-NII-3 straddle channel = Marker 1 + Delta 2 - 5725 MHz

7.2 RF Output Power

Input Power:	3.3 Vdc	Environmental Conditions:	25°C, 60% RH	Tested By:	Katina Lu
--------------	---------	---------------------------	--------------	------------	-----------

802.11a

Chan.	Chan. Freq. (MHz)	Average Power (mW)	Average Power (dBm)	Power Limit (dBm)	Test Result
36	5180	127.644	21.06	24	Pass
40	5200	183.654	22.64	24	Pass
48	5240	179.473	22.54	24	Pass
52	5260	176.604	22.47	24	Pass
60	5300	177.828	22.50	24	Pass
64	5320	114.288	20.58	23.7	Pass
100	5500	108.393	20.35	23.67	Pass
116	5580	150.661	21.78	24	Pass
140	5700	80.538	19.06	23.66	Pass
*144 (U-NII-2C)	5720	117.761	20.71	22.57	Pass
*144 (U-NII-3)	5720	16.866	12.27	30	Pass
149	5745	184.502	22.66	30	Pass
157	5785	190.546	22.80	30	Pass
165	5825	188.799	22.76	30	Pass

Notes:

- * : Test was performed in accordance with measurement follow FCC KDB 789033 UNII test procedure Method SA-1 and use spectrum analyzer test.
- For U-NII-1, the antenna gain is 5 dBi < 6 dBi, so the output power limit shall not be reduced.
- For U-NII-2A, the antenna gain is 5 dBi < 6 dBi, so the output power limit shall not be reduced.
- For U-NII-2C, the antenna gain is 5 dBi < 6 dBi, so the output power limit shall not be reduced.
- For U-NII-3, the antenna gain is 5 dBi < 6 dBi, so the output power limit shall not be reduced.

802.11ac (VHT20)

Chan.	Chan. Freq. (MHz)	Average Power (mW)	Average Power (dBm)	Power Limit (dBm)	Test Result
36	5180	104.954	20.21	24	Pass
40	5200	164.816	22.17	24	Pass
48	5240	148.936	21.73	24	Pass
52	5260	166.341	22.21	24	Pass
60	5300	155.597	21.92	24	Pass
64	5320	92.897	19.68	24	Pass
100	5500	95.719	19.81	24	Pass
116	5580	133.968	21.27	24	Pass
140	5700	81.47	19.11	24	Pass
*144 (U-NII-2C)	5720	107.399	20.31	22.82	Pass
*144 (U-NII-3)	5720	17.906	12.53	30	Pass
149	5745	167.109	22.23	30	Pass
157	5785	172.187	22.36	30	Pass
165	5825	182.39	22.61	30	Pass

Notes:

- * : Test was performed in accordance with measurement follow FCC KDB 789033 UNII test procedure Method SA-1 and use spectrum analyzer test.
- For U-NII-1, the antenna gain is 5 dBi < 6 dBi, so the output power limit shall not be reduced.
- For U-NII-2A, the antenna gain is 5 dBi < 6 dBi, so the output power limit shall not be reduced.
- For U-NII-2C, the antenna gain is 5 dBi < 6 dBi, so the output power limit shall not be reduced.
- For U-NII-3, the antenna gain is 5 dBi < 6 dBi, so the output power limit shall not be reduced.

802.11ac (VHT40)

Chan.	Chan. Freq. (MHz)	Average Power (mW)	Average Power (dBm)	Power Limit (dBm)	Test Result
38	5190	57.943	17.63	24	Pass
46	5230	140.605	21.48	24	Pass
54	5270	139.316	21.44	24	Pass
62	5310	52.723	17.22	24	Pass
102	5510	56.105	17.49	24	Pass
110	5550	120.781	20.82	24	Pass
134	5670	92.897	19.68	24	Pass
*142 (U-NII-2C)	5710	98.175	19.92	24	Pass
*142 (U-NII-3)	5710	5.117	7.09	30	Pass
151	5755	155.955	21.93	30	Pass
159	5795	162.555	22.11	30	Pass

Notes:

- * : Test was performed in accordance with measurement follow FCC KDB 789033 UNII test procedure Method SA-1 and use spectrum analyzer test.
- For U-NII-1, the antenna gain is 5 dBi < 6 dBi, so the output power limit shall not be reduced.
- For U-NII-2A, the antenna gain is 5 dBi < 6 dBi, so the output power limit shall not be reduced.
- For U-NII-2C, the antenna gain is 5 dBi < 6 dBi, so the output power limit shall not be reduced.
- For U-NII-3, the antenna gain is 5 dBi < 6 dBi, so the output power limit shall not be reduced.

802.11ac (VHT80)

Chan.	Chan. Freq. (MHz)	Average Power (mW)	Average Power (dBm)	Power Limit (dBm)	Test Result
42	5210	104.232	20.18	24	Pass
58	5290	48.641	16.87	24	Pass
106	5530	55.463	17.44	24	Pass
122	5610	119.399	20.77	24	Pass
*138 (U-NII-2C)	5690	91.419	19.61	24	Pass
*138 (U-NII-3)	5690	2.014	3.04	30	Pass
155	5775	109.144	20.38	30	Pass

Notes:

- * : Test was performed in accordance with measurement follow FCC KDB 789033 UNII test procedure Method SA-2 and use spectrum analyzer test , the duty factor was included in the total power.
- For U-NII-1, the antenna gain is 5 dBi < 6 dBi, so the output power limit shall not be reduced.
- For U-NII-2A, the antenna gain is 5 dBi < 6 dBi, so the output power limit shall not be reduced.
- For U-NII-2C, the antenna gain is 5 dBi < 6 dBi, so the output power limit shall not be reduced.
- For U-NII-3, the antenna gain is 5 dBi < 6 dBi, so the output power limit shall not be reduced.

802.11ax (HE20)

Chan.	Chan. Freq. (MHz)	Average Power (mW)	Average Power (dBm)	Power Limit (dBm)	Test Result
36	5180	115.611	20.63	24	Pass
40	5200	182.81	22.62	24	Pass
48	5240	166.725	22.22	24	Pass
52	5260	182.39	22.61	24	Pass
60	5300	171.002	22.33	24	Pass
64	5320	103.039	20.13	24	Pass
100	5500	105.439	20.23	24	Pass
116	5580	146.893	21.67	24	Pass
140	5700	90.365	19.56	24	Pass
*144 (U-NII-2C)	5720	107.399	20.31	22.82	Pass
*144 (U-NII-3)	5720	17.906	12.53	30	Pass
149	5745	184.077	22.65	30	Pass
157	5785	190.108	22.79	30	Pass
165	5825	200.447	23.02	30	Pass

Notes:

1. * : Test was performed in accordance with measurement follow FCC KDB 789033 UNII test procedure Method SA-1 and use spectrum analyzer test.
2. For U-NII-1, the antenna gain is 5 dBi < 6 dBi, so the output power limit shall not be reduced.
3. For U-NII-2A, the antenna gain is 5 dBi < 6 dBi, so the output power limit shall not be reduced.
4. For U-NII-2C, the antenna gain is 5 dBi < 6 dBi, so the output power limit shall not be reduced.
5. For U-NII-3, the antenna gain is 5 dBi < 6 dBi, so the output power limit shall not be reduced.

802.11ax (HE40)

Chan.	Chan. Freq. (MHz)	Average Power (mW)	Average Power (dBm)	Power Limit (dBm)	Test Result
38	5190	63.533	18.03	24	Pass
46	5230	157.398	21.97	24	Pass
54	5270	152.757	21.84	24	Pass
62	5310	58.076	17.64	24	Pass
102	5510	62.373	17.95	24	Pass
110	5550	133.352	21.25	24	Pass
134	5670	103.514	20.15	24	Pass
*142 (U-NII-2C)	5710	98.175	19.92	24	Pass
*142 (U-NII-3)	5710	5.117	7.09	30	Pass
151	5755	173.78	22.40	30	Pass
159	5795	179.061	22.53	30	Pass

Notes:

- * : Test was performed in accordance with measurement follow FCC KDB 789033 UNII test procedure Method SA-1 and use spectrum analyzer test.
- For U-NII-1, the antenna gain is 5 dBi < 6 dBi, so the output power limit shall not be reduced.
- For U-NII-2A, the antenna gain is 5 dBi < 6 dBi, so the output power limit shall not be reduced.
- For U-NII-2C, the antenna gain is 5 dBi < 6 dBi, so the output power limit shall not be reduced.
- For U-NII-3, the antenna gain is 5 dBi < 6 dBi, so the output power limit shall not be reduced.

802.11ax (HE80)

Chan.	Chan. Freq. (MHz)	Average Power (mW)	Average Power (dBm)	Power Limit (dBm)	Test Result
42	5210	113.24	20.54	24	Pass
58	5290	50.933	17.07	24	Pass
106	5530	60.395	17.81	24	Pass
122	5610	127.938	21.07	24	Pass
*138 (U-NII-2C)	5690	91.419	19.61	24	Pass
*138 (U-NII-3)	5690	2.014	3.04	30	Pass
155	5775	120.781	20.82	30	Pass

Notes:

- * : Test was performed in accordance with measurement follow FCC KDB 789033 UNII test procedure Method SA-2 and use spectrum analyzer test , the duty factor was included in the total power.
- For U-NII-1, the antenna gain is 5 dBi < 6 dBi, so the output power limit shall not be reduced.
- For U-NII-2A, the antenna gain is 5 dBi < 6 dBi, so the output power limit shall not be reduced.
- For U-NII-2C, the antenna gain is 5 dBi < 6 dBi, so the output power limit shall not be reduced.
- For U-NII-3, the antenna gain is 5 dBi < 6 dBi, so the output power limit shall not be reduced.

20 MHz Preamble 802.11ax (RU26)

Chan.	Chan. Freq. (MHz)	Average Power (mW)	Average Power (dBm)	Power Limit (dBm)	Test Result
36	5180	27.99	14.47	24	Pass
40	5200	33.189	15.21	24	Pass
48	5240	27.861	14.45	24	Pass
52	5260	28.973	14.62	23.91	Pass
60	5300	37.154	15.70	23.58	Pass
64	5320	35.563	15.51	23.93	Pass
100	5500	30.761	14.88	23.93	Pass
116	5580	30.269	14.81	23.59	Pass
140	5700	37.67	15.76	23.94	Pass
*144 (U-NII-2C)	5720	0.2307	-6.37	22.47	Pass
*144 (U-NII-3)	5720	79.433	19.00	30	Pass
149	5745	72.946	18.63	30	Pass
157	5785	80.538	19.06	30	Pass
165	5825	50.582	17.04	30	Pass

Notes:

- * : Test was performed in accordance with measurement follow FCC KDB 789033 UNII test procedure Method SA-1 and use spectrum analyzer test.
- For U-NII-1, the antenna gain is 5 dBi < 6 dBi, so the output power limit shall not be reduced.
- For U-NII-2A, the antenna gain is 5 dBi < 6 dBi, so the output power limit shall not be reduced.
- For U-NII-2C, the antenna gain is 5 dBi < 6 dBi, so the output power limit shall not be reduced.
- For U-NII-3, the antenna gain is 5 dBi < 6 dBi, so the output power limit shall not be reduced.

20 MHz Preamble 802.11ax (RU52)

Chan.	Chan. Freq. (MHz)	Average Power (mW)	Average Power (dBm)	Power Limit (dBm)	Test Result
36	5180	57.81	17.62	24	Pass
40	5200	64.417	18.09	24	Pass
48	5240	49.204	16.92	24	Pass
52	5260	50.466	17.03	23.96	Pass
60	5300	53.211	17.26	23.67	Pass
64	5320	55.719	17.46	23.95	Pass
100	5500	49.774	16.97	23.95	Pass
116	5580	54.954	17.40	23.67	Pass
140	5700	59.704	17.76	23.95	Pass
*144 (U-NII-2C)	5720	0.798	-0.98	22.5	Pass
*144 (U-NII-3)	5720	97.724	19.90	30	Pass
149	5745	159.221	22.02	30	Pass
157	5785	130.617	21.16	30	Pass
165	5825	162.181	22.10	30	Pass

Notes:

1. * : Test was performed in accordance with measurement follow FCC KDB 789033 UNII test procedure Method SA-1 and use spectrum analyzer test.
2. For U-NII-1, the antenna gain is 5 dBi < 6 dBi, so the output power limit shall not be reduced.
3. For U-NII-2A, the antenna gain is 5 dBi < 6 dBi, so the output power limit shall not be reduced.
4. For U-NII-2C, the antenna gain is 5 dBi < 6 dBi, so the output power limit shall not be reduced.
5. For U-NII-3, the antenna gain is 5 dBi < 6 dBi, so the output power limit shall not be reduced.



20 MHz Preamble 802.11ax (RU106)

Chan.	Chan. Freq. (MHz)	Average Power (mW)	Average Power (dBm)	Power Limit (dBm)	Test Result
36	5180	121.06	20.83	24	Pass
40	5200	97.499	19.89	24	Pass
48	5240	100.231	20.01	24	Pass
52	5260	98.401	19.93	23.96	Pass
60	5300	100.693	20.03	23.96	Pass
64	5320	143.219	21.56	23.98	Pass
100	5500	89.95	19.54	23.96	Pass
116	5580	77.625	18.90	23.96	Pass
140	5700	80.538	19.06	23.96	Pass
*144 (U-NII-2C)	5720	66.834	18.25	22.52	Pass
*144 (U-NII-3)	5720	74.131	18.70	30	Pass
149	5745	184.077	22.65	30	Pass
157	5785	139.637	21.45	30	Pass
165	5825	154.525	21.89	30	Pass

Notes:

- * : Test was performed in accordance with measurement follow FCC KDB 789033 UNII test procedure Method SA-1 and use spectrum analyzer test.
- For U-NII-1, the antenna gain is 5 dBi < 6 dBi, so the output power limit shall not be reduced.
- For U-NII-2A, the antenna gain is 5 dBi < 6 dBi, so the output power limit shall not be reduced.
- For U-NII-2C, the antenna gain is 5 dBi < 6 dBi, so the output power limit shall not be reduced.
- For U-NII-3, the antenna gain is 5 dBi < 6 dBi, so the output power limit shall not be reduced.

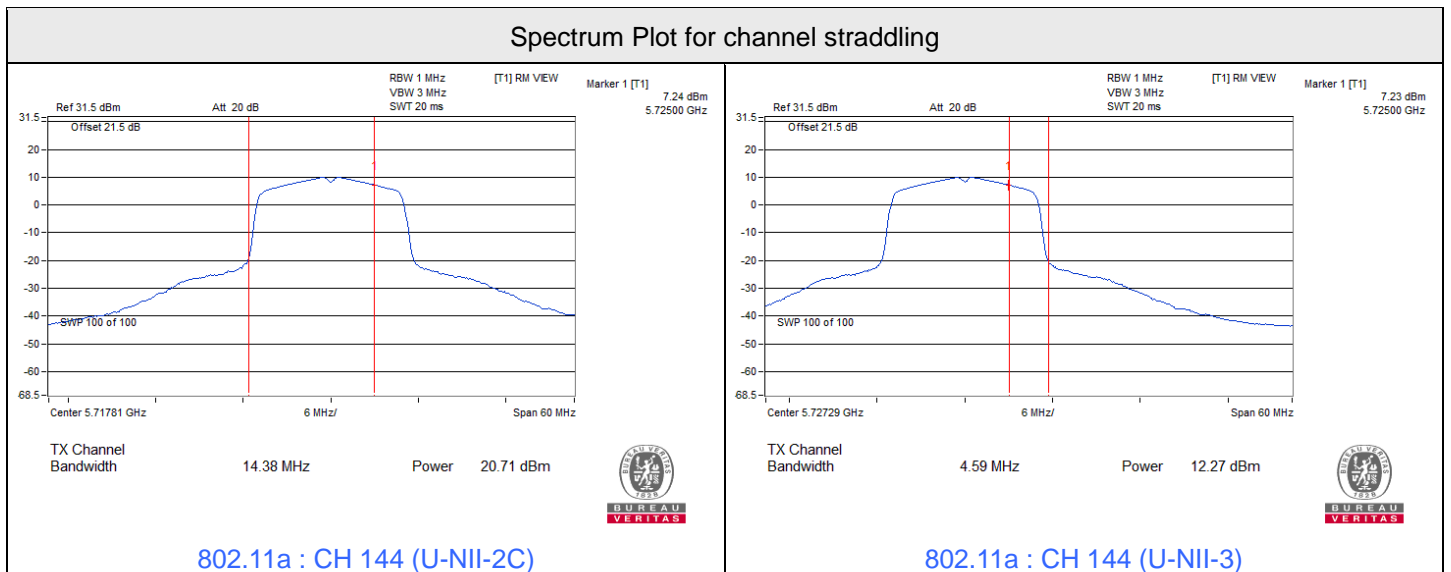



Spectrum Plot for channel straddling

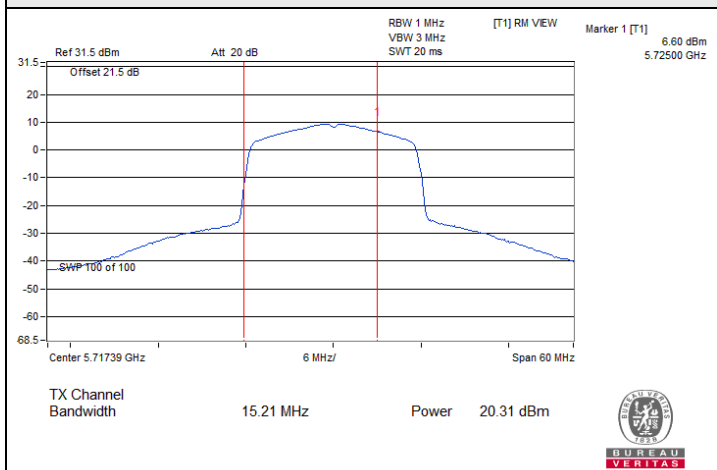

802.11ac (VHT20) : CH 144 (U-NII-2C)

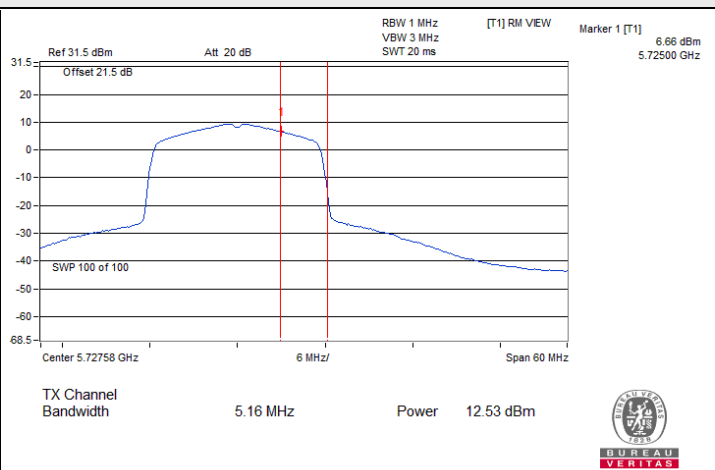

802.11ac (VHT20) : CH 144 (U-NII-3)

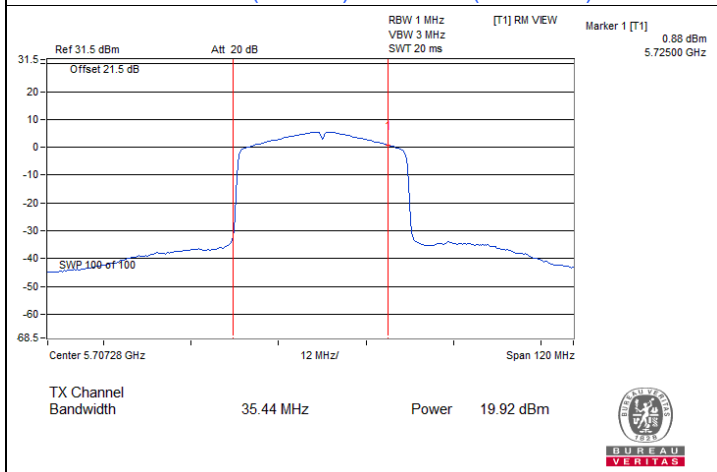

802.11ac (VHT40) : CH 142 (U-NII-2C)

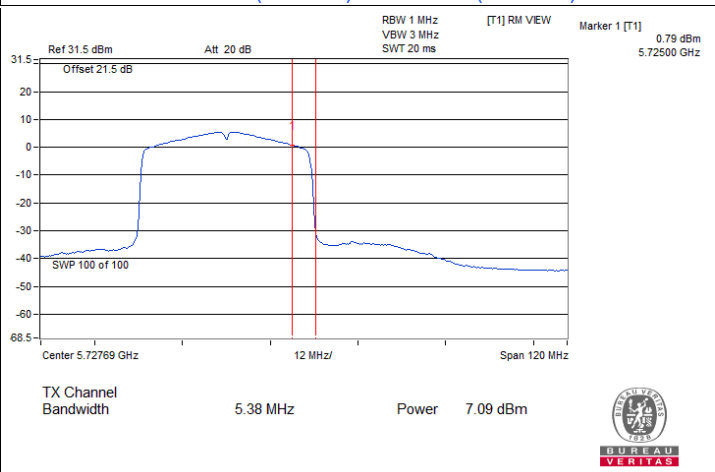

802.11ac (VHT40) : CH 142 (U-NII-3)

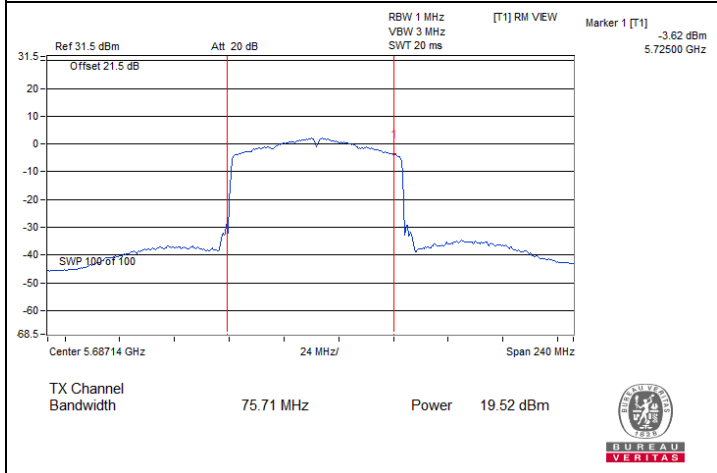

802.11ac (VHT80) : CH 138 (U-NII-2C)

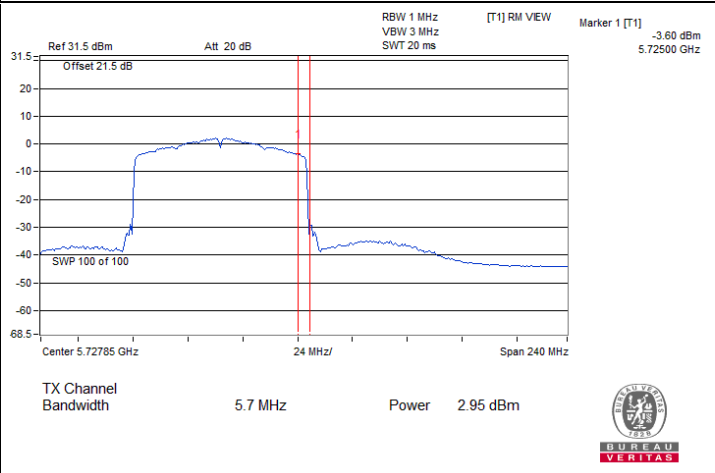

802.11ac (VHT80) : CH 138 (U-NII-3)



Spectrum Plot for channel straddling

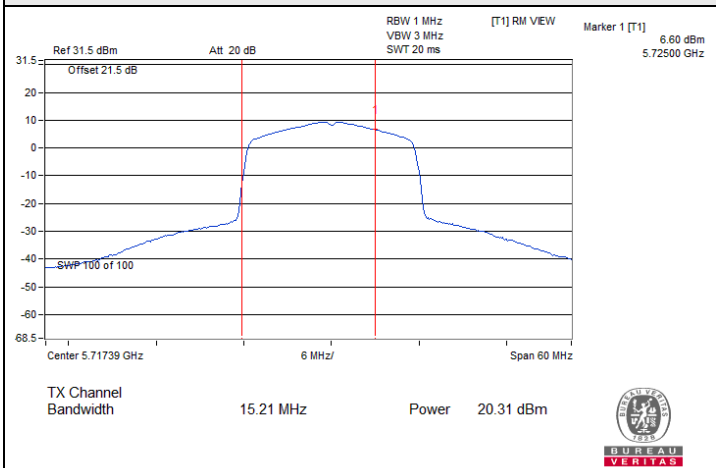

802.11ax (HE20) : CH 144 (U-NII-2C)

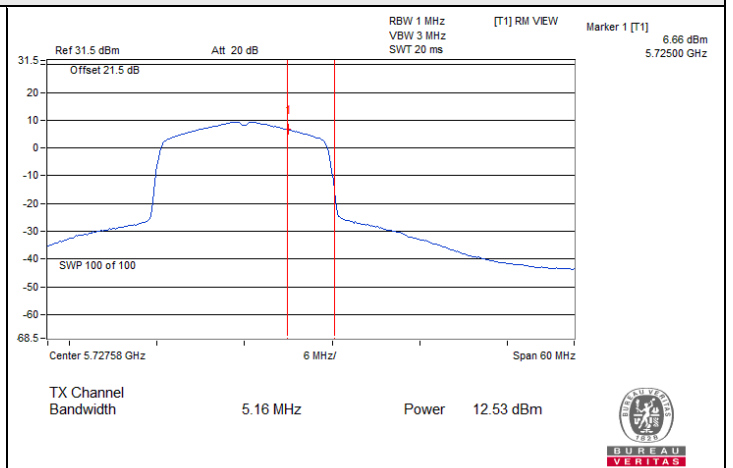

802.11ax (HE20) : CH 144 (U-NII-3)

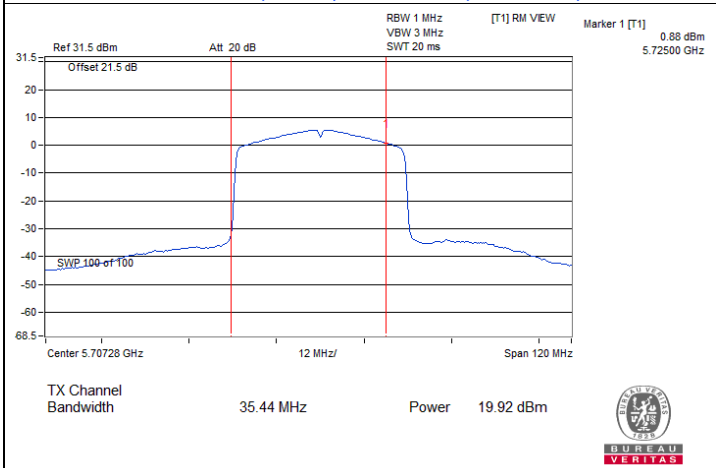

802.11ax (HE40) : CH 142 (U-NII-2C)

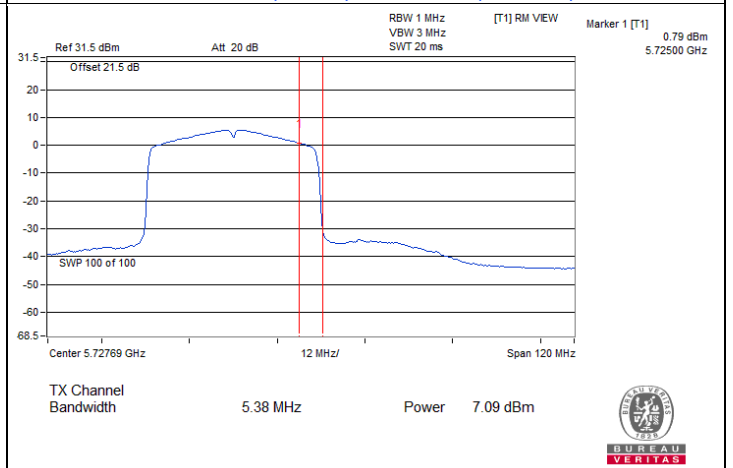

802.11ax (HE40) : CH 142 (U-NII-3)

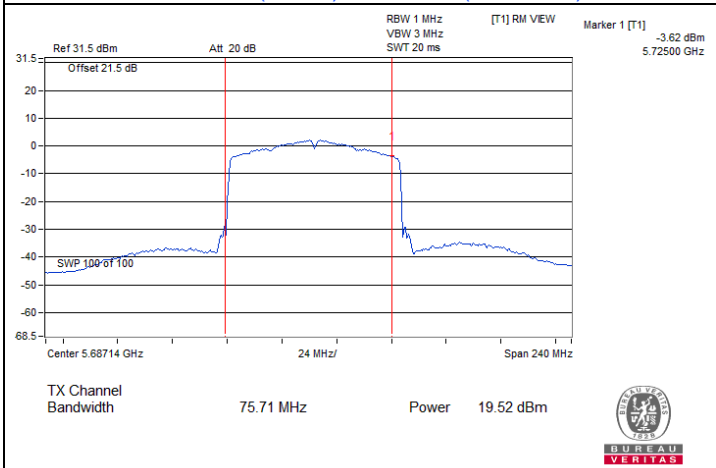

802.11ax (HE80) : CH 138 (U-NII-2C)

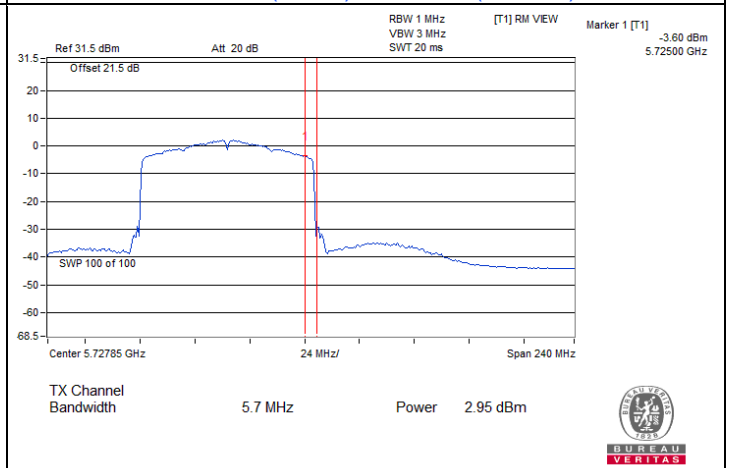

802.11ax (HE80) : CH 138 (U-NII-3)



Spectrum Plot for channel straddling

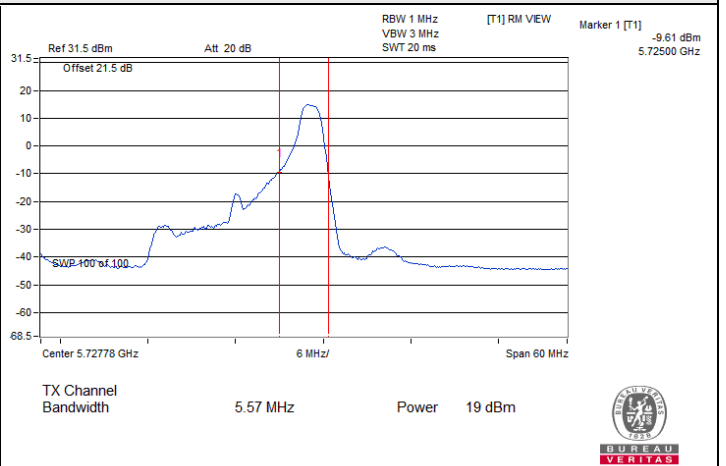
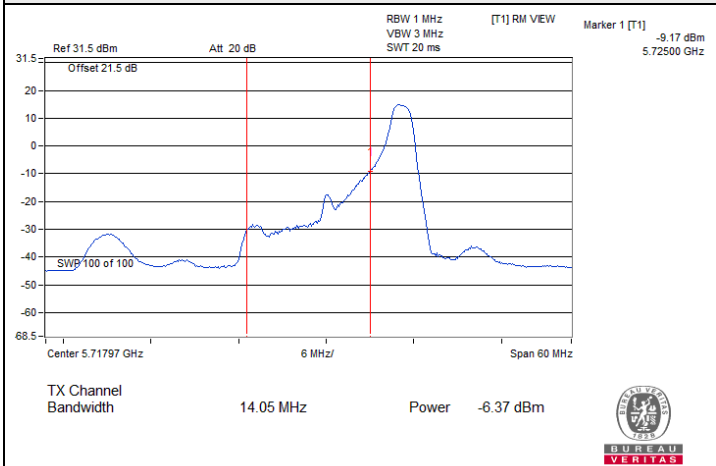

20 MHz Preamble 802.11ax (RU26) : CH 144 (U-NII-2C)

20 MHz Preamble 802.11ax (RU26) : CH 144 (U-NII-3)

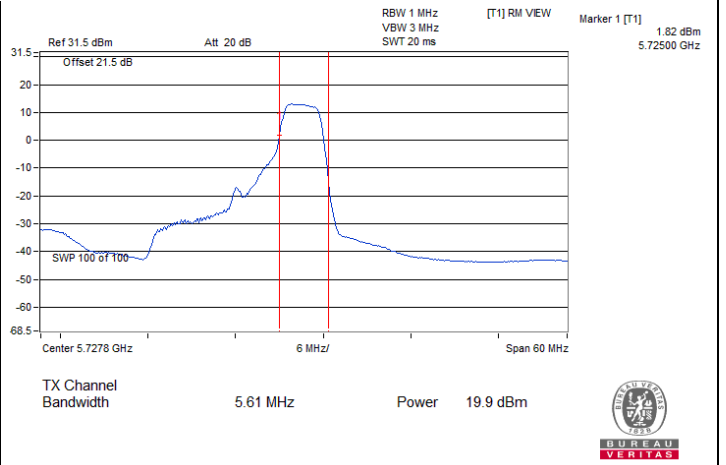
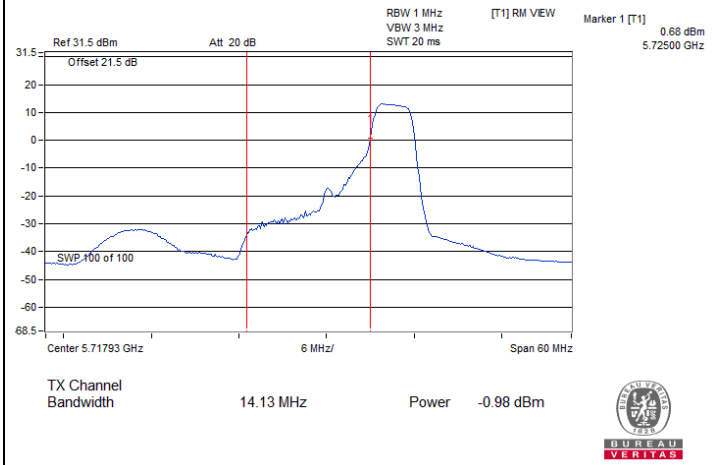

20 MHz Preamble 802.11ax (RU52) : CH 144 (U-NII-2C)

20 MHz Preamble 802.11ax (RU52) : CH 144 (U-NII-3)

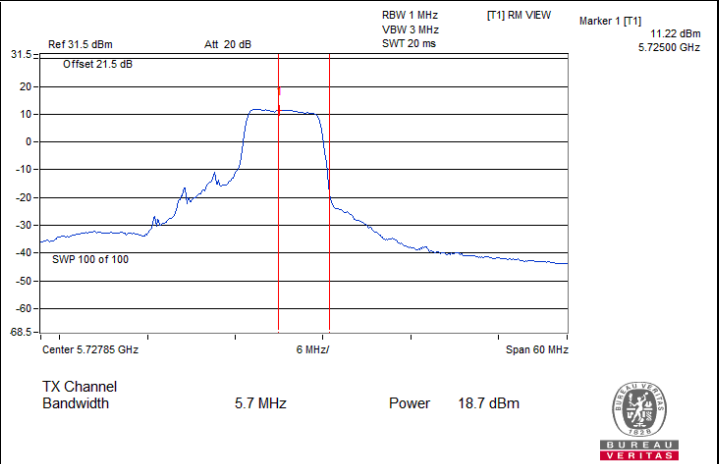
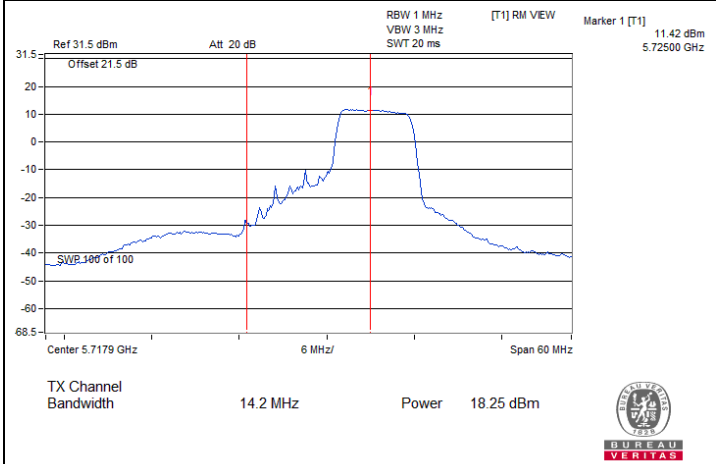

20 MHz Preamble 802.11ax (RU106) : CH 144 (U-NII-2C)

20 MHz Preamble 802.11ax (RU106) : CH 144 (U-NII-3)

7.3 Power Spectral Density

Input Power:	3.3 Vdc	Environmental Conditions:	25°C, 60% RH	Tested By:	Katina Lu
--------------	---------	---------------------------	--------------	------------	-----------

802.11a

Chan.	Chan. Freq. (MHz)	PSD (dBm/MHz)	Max. PSD Limit (dBm/MHz)	Test Result
36	5180	8.89	11	Pass
40	5200	10.92	11	Pass
48	5240	10.97	11	Pass
52	5260	10.85	11	Pass
60	5300	10.93	11	Pass
64	5320	10.51	11	Pass
100	5500	9.53	11	Pass
116	5580	10.83	11	Pass
140	5700	7.76	11	Pass
144 (U-NII-2C)	5720	9.95	11	Pass

Notes:

1. For U-NII-1, the antenna gain is 5 dBi < 6 dBi, so the power density limit shall not be reduced.
2. For U-NII-2A, the antenna gain is 5 dBi < 6 dBi, so the power density limit shall not be reduced.
3. For U-NII-2C, the antenna gain is 5 dBi < 6 dBi, so the power density limit shall not be reduced.

802.11ax (HE20)

Chan.	Chan. Freq. (MHz)	PSD (dBm/MHz)	Max. PSD Limit (dBm/MHz)	Test Result
36	5180	8.66	11	Pass
40	5200	10.96	11	Pass
48	5240	10.87	11	Pass
52	5260	10.99	11	Pass
60	5300	10.71	11	Pass
64	5320	7.56	11	Pass
100	5500	9.09	11	Pass
116	5580	10.32	11	Pass
140	5700	6.86	11	Pass
144 (U-NII-2C)	5720	9.40	11	Pass

Notes:

1. For U-NII-1, the antenna gain is 5 dBi < 6 dBi, so the power density limit shall not be reduced.
2. For U-NII-2A, the antenna gain is 5 dBi < 6 dBi, so the power density limit shall not be reduced.
3. For U-NII-2C, the antenna gain is 5 dBi < 6 dBi, so the power density limit shall not be reduced.

802.11ax (HE40)

Chan.	Chan. Freq. (MHz)	PSD (dBm/MHz)	Max. PSD Limit (dBm/MHz)	Test Result
38	5190	3.84	11	Pass
46	5230	7.60	11	Pass
54	5270	7.36	11	Pass
62	5310	2.86	11	Pass
102	5510	3.86	11	Pass
110	5550	6.65	11	Pass
134	5670	5.13	11	Pass
142 (U-NII-2C)	5710	5.46	11	Pass

Notes:

1. For U-NII-1, the antenna gain is 5 dBi < 6 dBi, so the power density limit shall not be reduced.
2. For U-NII-2A, the antenna gain is 5 dBi < 6 dBi, so the power density limit shall not be reduced.
3. For U-NII-2C, the antenna gain is 5 dBi < 6 dBi, so the power density limit shall not be reduced.

802.11ax (HE80)

Chan.	Chan. Freq. (MHz)	PSD w/o Duty Factor (dBm/MHz)	Duty Factor (dB)	PSD (dBm/MHz)	Max. PSD Limit (dBm/MHz)	Test Result
42	5210	-0.95	0.09	-0.86	11	Pass
58	5290	-1.15	0.09	-1.06	11	Pass
106	5530	0.04	0.09	0.13	11	Pass
122	5610	1.67	0.09	1.76	11	Pass
138 (U-NII-2C)	5690	2.15	0.09	2.24	11	Pass

Notes:

1. For U-NII-1, the antenna gain is 5 dBi < 6 dBi, so the power density limit shall not be reduced.
2. For U-NII-2A, the antenna gain is 5 dBi < 6 dBi, so the power density limit shall not be reduced.
3. For U-NII-2C, the antenna gain is 5 dBi < 6 dBi, so the power density limit shall not be reduced.

20 MHz Preamble 802.11ax (RU26)

Chan.	Chan. Freq. (MHz)	PSD (dBm/MHz)	Max. PSD Limit (dBm/MHz)	Test Result
36	5180	10.90	11	Pass
40	5200	10.85	11	Pass
48	5240	10.64	11	Pass
52	5260	10.70	11	Pass
60	5300	10.98	11	Pass
64	5320	10.85	11	Pass
100	5500	10.80	11	Pass
116	5580	10.70	11	Pass
140	5700	10.94	11	Pass
144 (U-NII-2C)	5720	-7.95	11	Pass

Notes:

1. For U-NII-1, the antenna gain is 5 dBi < 6 dBi, so the power density limit shall not be reduced.
2. For U-NII-2A, the antenna gain is 5 dBi < 6 dBi, so the power density limit shall not be reduced.
3. For U-NII-2C, the antenna gain is 5 dBi < 6 dBi, so the power density limit shall not be reduced.

20 MHz Preamble 802.11ax (RU52)

Chan.	Chan. Freq. (MHz)	PSD (dBm/MHz)	Max. PSD Limit (dBm/MHz)	Test Result
36	5180	10.88	11	Pass
40	5200	10.75	11	Pass
48	5240	10.63	11	Pass
52	5260	10.51	11	Pass
60	5300	10.65	11	Pass
64	5320	10.44	11	Pass
100	5500	10.53	11	Pass
116	5580	10.96	11	Pass
140	5700	10.82	11	Pass
144 (U-NII-2C)	5720	0.54	11	Pass

Notes:

1. For U-NII-1, the antenna gain is 5 dBi < 6 dBi, so the power density limit shall not be reduced.
2. For U-NII-2A, the antenna gain is 5 dBi < 6 dBi, so the power density limit shall not be reduced.
3. For U-NII-2C, the antenna gain is 5 dBi < 6 dBi, so the power density limit shall not be reduced.

20 MHz Preamble 802.11ax (RU106)

Chan.	Chan. Freq. (MHz)	PSD (dBm/MHz)	Max. PSD Limit (dBm/MHz)	Test Result
36	5180	10.64	11	Pass
40	5200	10.79	11	Pass
48	5240	10.70	11	Pass
52	5260	10.79	11	Pass
60	5300	10.58	11	Pass
64	5320	10.51	11	Pass
100	5500	10.41	11	Pass
116	5580	10.49	11	Pass
140	5700	10.71	11	Pass
144 (U-NII-2C)	5720	10.44	11	Pass

Notes:

1. For U-NII-1, the antenna gain is 5 dBi < 6 dBi, so the power density limit shall not be reduced.
2. For U-NII-2A, the antenna gain is 5 dBi < 6 dBi, so the power density limit shall not be reduced.
3. For U-NII-2C, the antenna gain is 5 dBi < 6 dBi, so the power density limit shall not be reduced.

802.11a

Chan.	Chan. Freq. (MHz)	PSD (dBm/300kHz)	PSD (dBm/500kHz)	PSD Limit (dBm/500kHz)	Test Result
144 (U-NII-3)	5720	-1.28	0.94	30	Pass
149	5745	2.71	4.93	30	Pass
157	5785	3.4	5.62	30	Pass
165	5825	3.57	5.79	30	Pass

Note: For U-NII-3, the antenna gain is 5 dBi < 6 dBi, so the power density limit shall not be reduced.

802.11ax (HE20)

Chan.	Chan. Freq. (MHz)	PSD (dBm/300kHz)	PSD (dBm/500kHz)	PSD Limit (dBm/500kHz)	Test Result
144 (U-NII-3)	5720	-2.34	-0.12	30	Pass
149	5745	1.9	4.12	30	Pass
157	5785	2.37	4.59	30	Pass
165	5825	2.56	4.78	30	Pass

Note: For U-NII-3, the antenna gain is 5 dBi < 6 dBi, so the power density limit shall not be reduced.

802.11ax (HE40)

Chan.	Chan. Freq. (MHz)	PSD (dBm/300kHz)	PSD (dBm/500kHz)	PSD Limit (dBm/500kHz)	Test Result
142 (U-NII-3)	5710	-8.37	-6.15	30	Pass
151	5755	-2.25	-0.03	30	Pass
159	5795	-1.77	0.45	30	Pass

Note: For U-NII-3, the antenna gain is 5 dBi < 6 dBi, so the power density limit shall not be reduced.

802.11ax (HE80)

Chan.	Chan. Freq. (MHz)	PSD w/o Duty Factor (dBm/300kHz)	Duty Factor (dB)	PSD (dBm/500kHz)	PSD Limit (dBm/500kHz)	Test Result
138 (U-NII-3)	5690	-12.62	0.09	-10.31	30	Pass
155	5775	-6.47	0.09	-4.16	30	Pass

Note: For U-NII-3, the antenna gain is 5 dBi < 6 dBi, so the power density limit shall not be reduced.

20 MHz Preamble 802.11ax (RU26)

Chan.	Chan. Freq. (MHz)	PSD (dBm/300kHz)	PSD (dBm/500kHz)	PSD Limit (dBm/500kHz)	Test Result
144 (U-NII-3)	5720	10.24	12.46	30	Pass
149	5745	0.97	3.19	30	Pass
157	5785	5.27	7.49	30	Pass
165	5825	0.79	3.01	30	Pass

Note: For U-NII-3, the antenna gain is 5 dBi < 6 dBi, so the power density limit shall not be reduced.

20 MHz Preamble 802.11ax (RU52)

Chan.	Chan. Freq. (MHz)	PSD (dBm/300kHz)	PSD (dBm/500kHz)	PSD Limit (dBm/500kHz)	Test Result
144 (U-NII-3)	5720	1.14	3.36	30	Pass
149	5745	2.93	5.15	30	Pass
157	5785	4.38	6.60	30	Pass
165	5825	4.07	6.29	30	Pass

Note: For U-NII-3, the antenna gain is 5 dBi < 6 dBi, so the power density limit shall not be reduced.



20 MHz Preamble 802.11ax (RU106)

Chan.	Chan. Freq. (MHz)	PSD (dBm/300kHz)	PSD (dBm/500kHz)	PSD Limit (dBm/500kHz)	Test Result
144 (U-NII-3)	5720	0.96	3.18	30	Pass
149	5745	2.44	4.66	30	Pass
157	5785	1.21	3.43	30	Pass
165	5825	2.22	4.44	30	Pass

Note: For U-NII-3, the antenna gain is 5 dBi < 6 dBi, so the power density limit shall not be reduced.

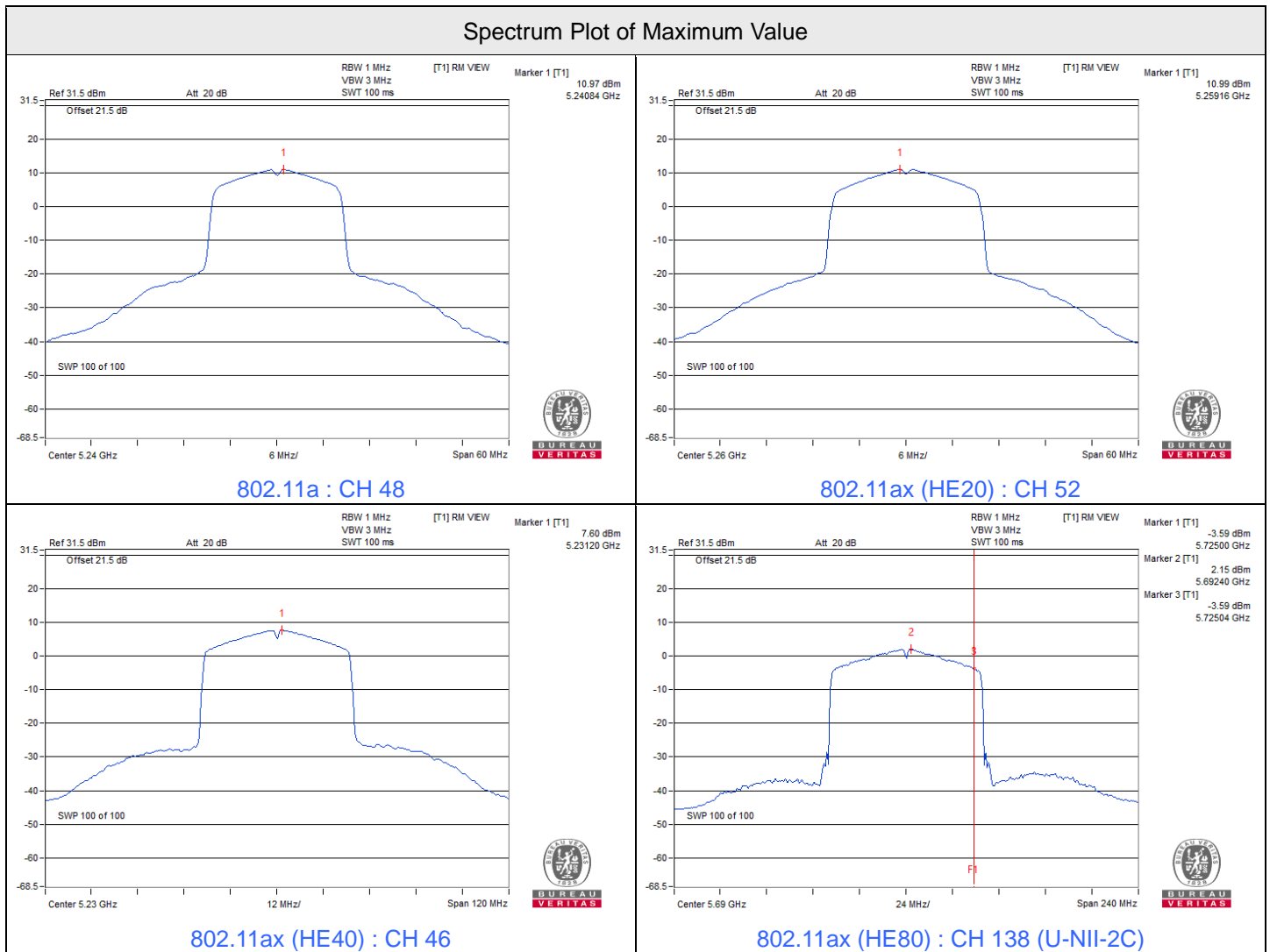



Spectrum Plot of Maximum Value

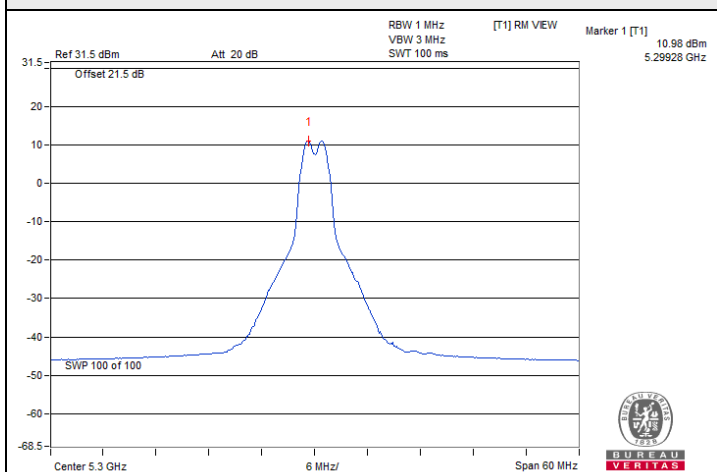

20 MHz Preamble 802.11ax (RU26) : CH 60

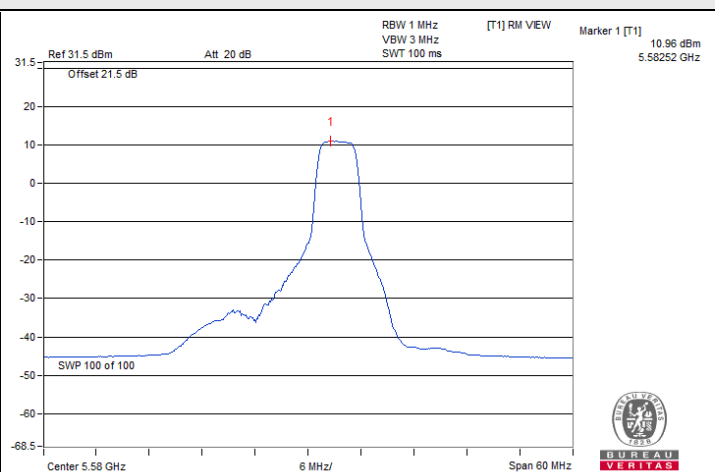

20 MHz Preamble 802.11ax (RU52) : CH 116

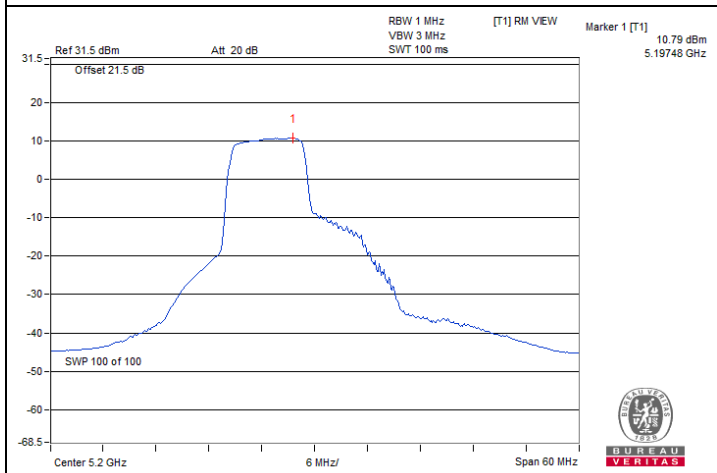

20 MHz Preamble 802.11ax (RU106) : CH 40

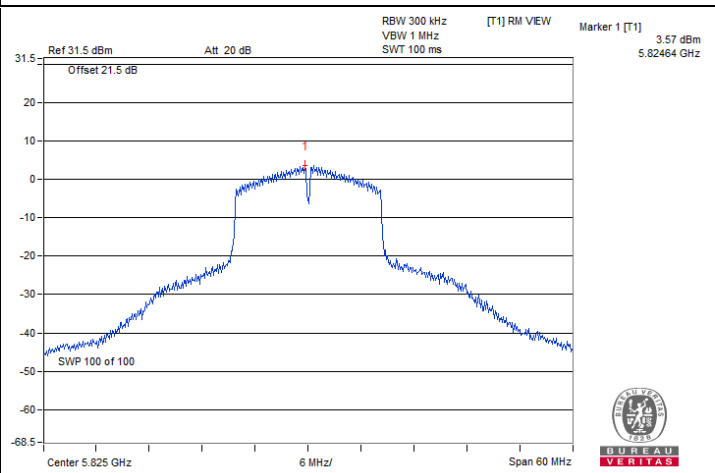

802.11a : CH 165

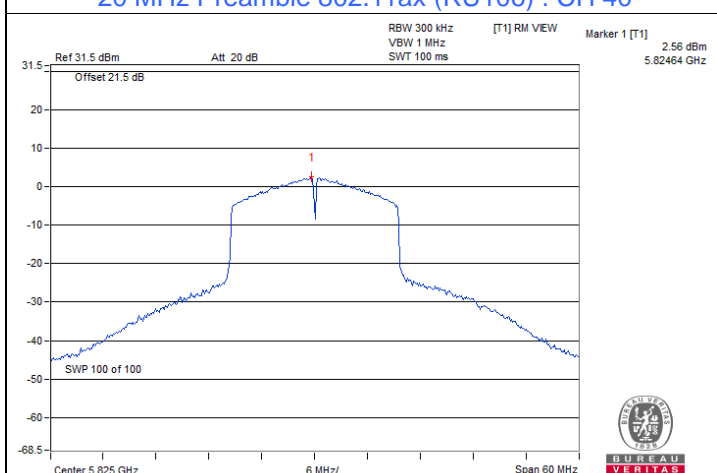

802.11ax (HE20) : CH 165

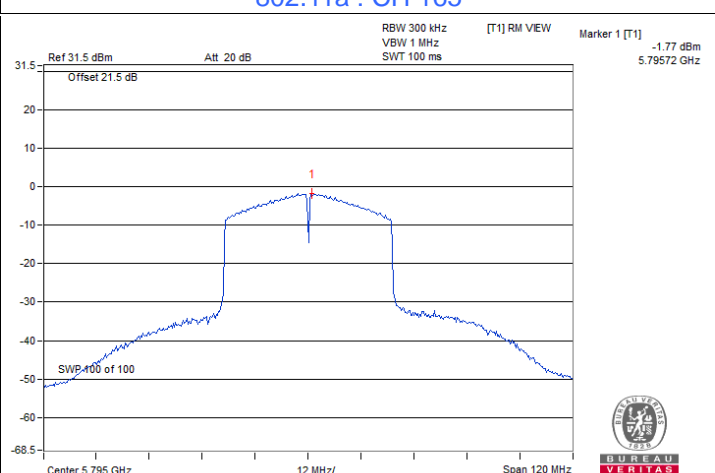

802.11ax (HE40) : CH 159



Spectrum Plot of Maximum Value

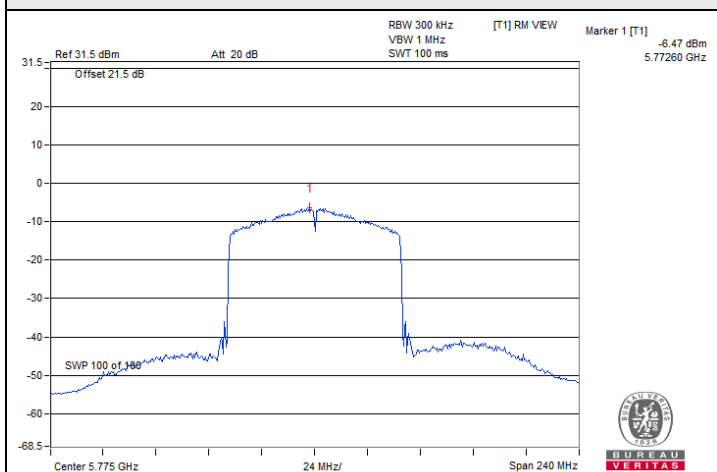

802.11ax (HE80) : CH 155

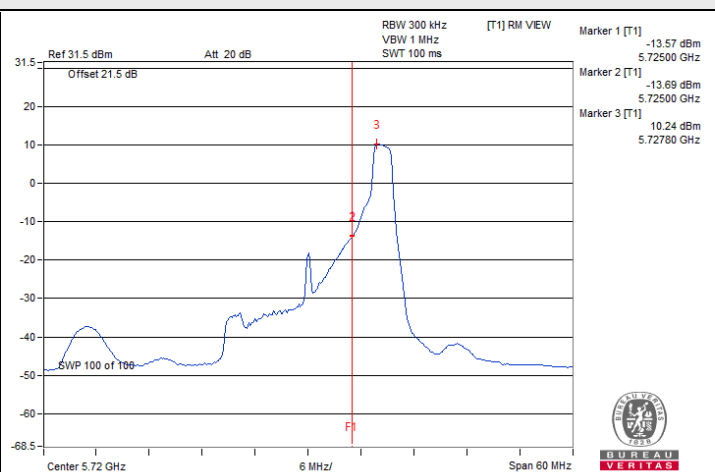

20 MHz Preamble 802.11ax (RU26) : CH 144 (U-NII-3)

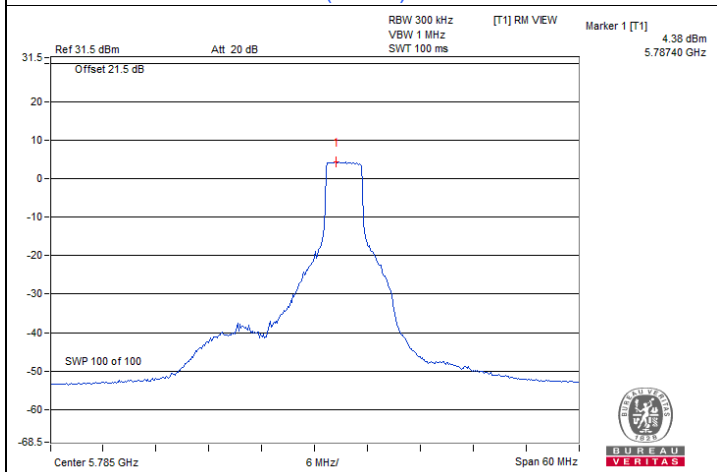

20 MHz Preamble 802.11ax (RU52) : CH 157

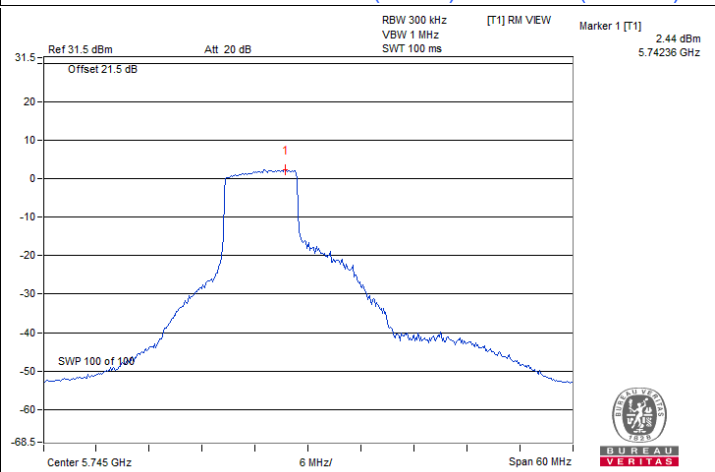

20 MHz Preamble 802.11ax (RU106) : CH 149

7.4 6 dB Bandwidth

Input Power:	3.3 Vdc	Environmental Conditions:	25°C, 60% RH	Tested By:	Katina Lu
--------------	---------	---------------------------	--------------	------------	-----------

802.11a

Channel	Frequency (MHz)	6dB Bandwidth (MHz)	Minimum Limit (MHz)	Test Result
144 (U-NII-3)	5720	2.56	0.5	Pass
149	5745	15.13	0.5	Pass
157	5785	15.13	0.5	Pass
165	5825	15.13	0.5	Pass

802.11ax (HE20)

Channel	Frequency (MHz)	6dB Bandwidth (MHz)	Minimum Limit (MHz)	Test Result
144 (U-NII-3)	5720	2.56	0.5	Pass
149	5745	15.14	0.5	Pass
157	5785	15.14	0.5	Pass
165	5825	15.15	0.5	Pass

802.11ax (HE40)

Channel	Frequency (MHz)	6dB Bandwidth (MHz)	Minimum Limit (MHz)	Test Result
142 (U-NII-3)	5710	2.55	0.5	Pass
151	5755	35.15	0.5	Pass
159	5795	35.04	0.5	Pass

802.11ax (HE80)

Channel	Frequency (MHz)	6dB Bandwidth (MHz)	Minimum Limit (MHz)	Test Result
138 (U-NII-3)	5690	2.63	0.5	Pass
155	5775	71.53	0.5	Pass



20 MHz Preamble 802.11ax (RU26)

Channel	Frequency (MHz)	6dB Bandwidth (MHz)	Minimum Limit (MHz)	Test Result
144 (U-NII-3)	5720	4.62	0.5	Pass
149	5745	14.55	0.5	Pass
157	5785	2.66	0.5	Pass
165	5825	15.77	0.5	Pass

20 MHz Preamble 802.11ax (RU52)

Channel	Frequency (MHz)	6dB Bandwidth (MHz)	Minimum Limit (MHz)	Test Result
144 (U-NII-3)	5720	4.61	0.5	Pass
149	5745	17.02	0.5	Pass
157	5785	13.84	0.5	Pass
165	5825	17.02	0.5	Pass

20 MHz Preamble 802.11ax (RU106)

Channel	Frequency (MHz)	6dB Bandwidth (MHz)	Minimum Limit (MHz)	Test Result
144 (U-NII-3)	5720	4.72	0.5	Pass
149	5745	17.16	0.5	Pass
157	5785	17.22	0.5	Pass
165	5825	17.21	0.5	Pass

Spectrum Plot of Minimum Value

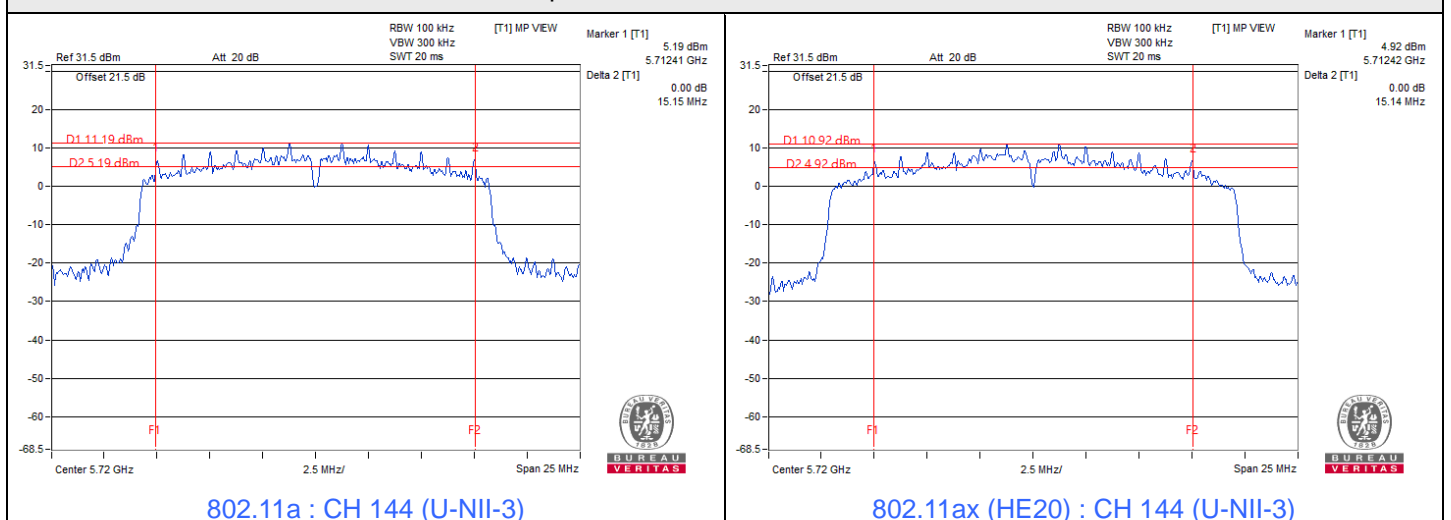

Spectrum Plot of Minimum Value

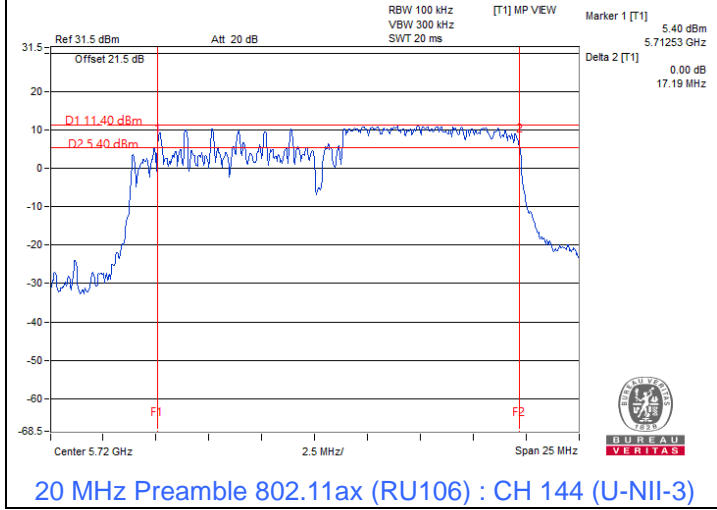
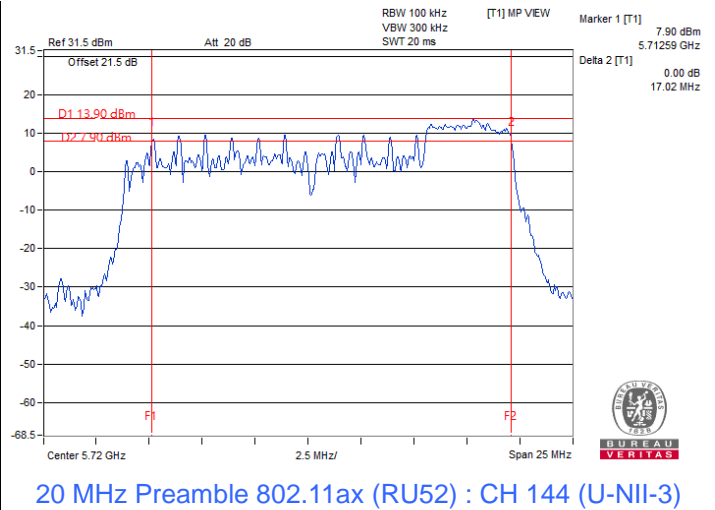
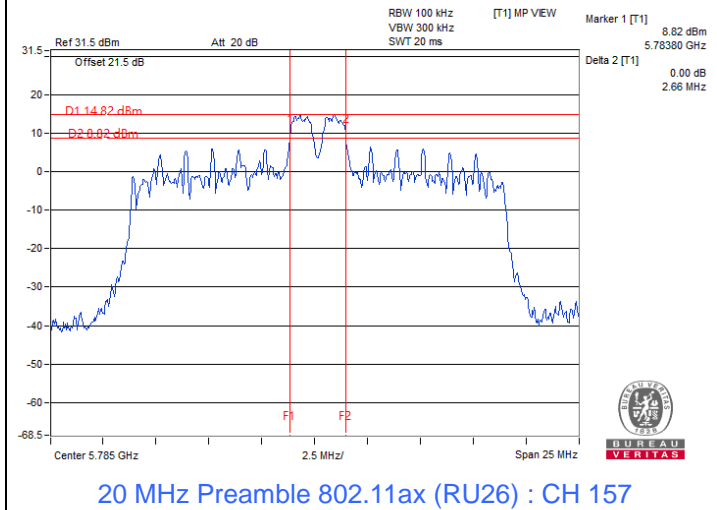
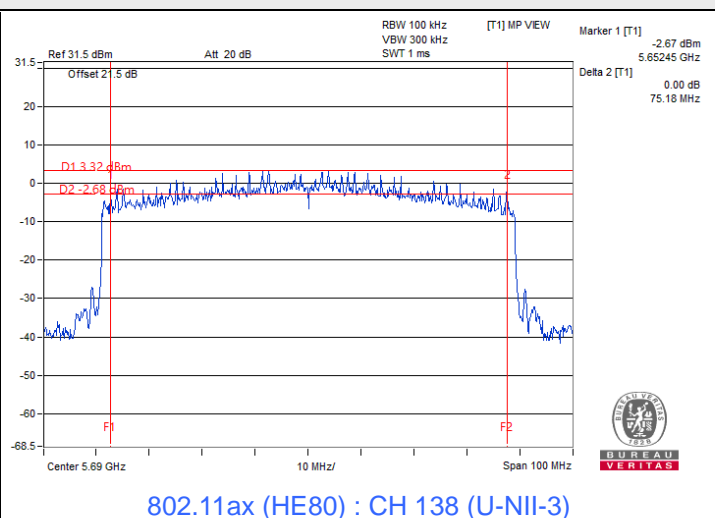
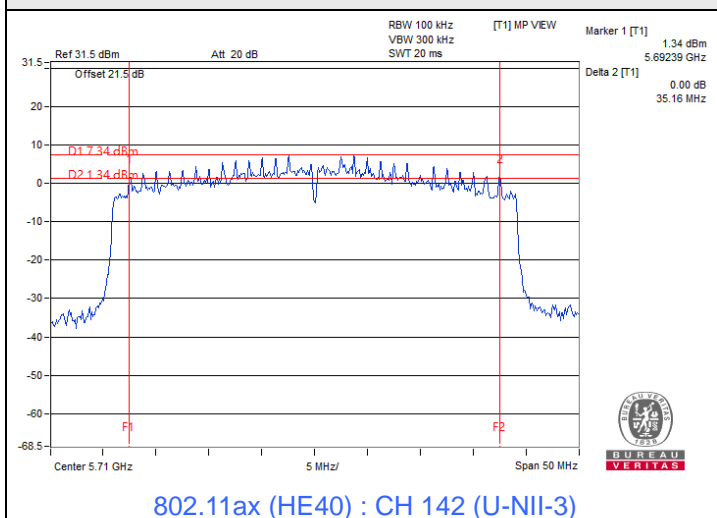

Notes:
1. For U-NII-3 straddle channel = Marker 1 + Delta 2 - 5725 MHz

7.5 Occupied Bandwidth

Input Power:	3.3 Vdc	Environmental Conditions:	25°C, 60% RH	Tested By:	Katina Lu
--------------	---------	---------------------------	--------------	------------	-----------

802.11a

Channel	Frequency (MHz)	Occupied Bandwidth (MHz)
36	5180	16.32
40	5200	16.56
48	5240	16.44
52	5260	16.32
60	5300	16.56
64	5320	16.2
100	5500	16.2
116	5580	16.32
140	5700	16.2
144 (U-NII-2C)	5720	13.16
144 (U-NII-3)	5720	3.16
149	5745	16.56
157	5785	17.04
165	5825	16.8

802.11ax (HE20)

Channel	Frequency (MHz)	Occupied Bandwidth (MHz)
36	5180	18.72
40	5200	18.72
48	5240	18.72
52	5260	18.72
60	5300	18.72
64	5320	18.6
100	5500	18.6
116	5580	18.72
140	5700	18.6
144 (U-NII-2C)	5720	14.36
144 (U-NII-3)	5720	4.24
149	5745	18.72
157	5785	18.72
165	5825	18.84

802.11ax (HE40)

Channel	Frequency (MHz)	Occupied Bandwidth (MHz)
38	5190	37.68
46	5230	37.2
54	5270	37.92
62	5310	37.2
102	5510	37.2
110	5550	37.2
134	5670	37.2
142 (U-NII-2C)	5710	33.72
142 (U-NII-3)	5710	3.48
151	5755	37.44
159	5795	37.44

802.11ax (HE80)

Channel	Frequency (MHz)	Occupied Bandwidth (MHz)
42	5210	0
58	5290	76.32
106	5530	75.84
122	5610	75.84
138 (U-NII-2C)	5690	72.92
138 (U-NII-3)	5690	3.4
155	5775	76.32

20 MHz Preamble 802.11ax (RU26)

Channel	Frequency (MHz)	Occupied Bandwidth (MHz)
36	5180	18.18
40	5200	16.32
48	5240	18.24
52	5260	18.18
60	5300	16.32
64	5320	18.24
100	5500	18.24
116	5580	16.32
140	5700	18.24
144 (U-NII-2C)	5720	13.4
144 (U-NII-3)	5720	4.84
149	5745	18.36
157	5785	16.35
165	5825	18.18

20 MHz Preamble 802.11ax (RU52)

Channel	Frequency (MHz)	Occupied Bandwidth (MHz)
36	5180	18.09
40	5200	16.68
48	5240	18.12
52	5260	18.12
60	5300	16.68
64	5320	18.12
100	5500	18
116	5580	16.68
140	5700	18.12
144 (U-NII-2C)	5720	13.4
144 (U-NII-3)	5720	4.72
149	5745	18.12
157	5785	16.68
165	5825	18.12



20 MHz Preamble 802.11ax (RU106)

Channel	Frequency (MHz)	Occupied Bandwidth (MHz)
36	5180	18.09
40	5200	18.12
48	5240	18.12
52	5260	18.12
60	5300	18
64	5320	18.12
100	5500	18.12
116	5580	18.12
140	5700	18.12
144 (U-NII-2C)	5720	13.4
144 (U-NII-3)	5720	4.72
149	5745	18.12
157	5785	18.12
165	5825	18.12

Spectrum Plot of Maximum Value

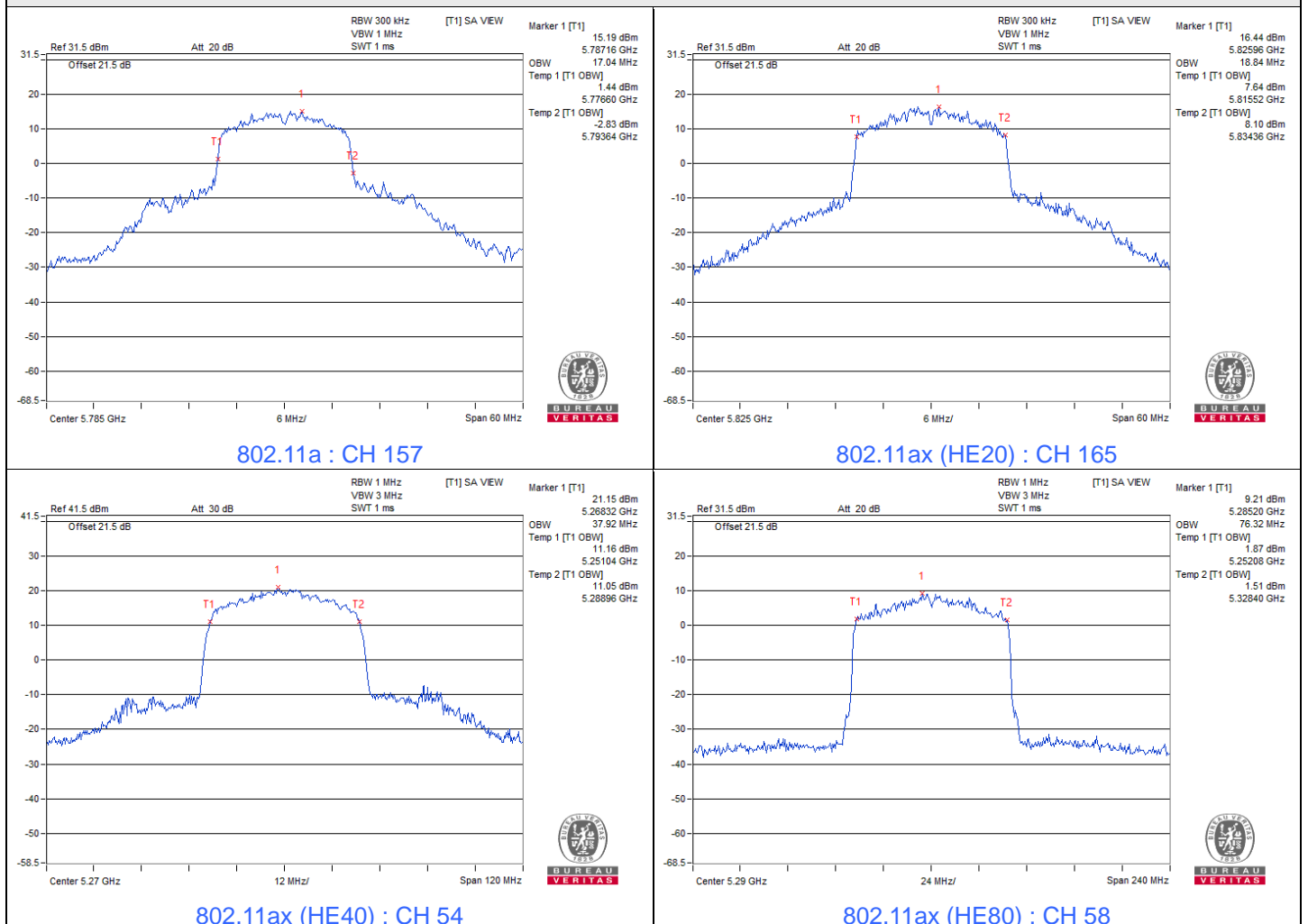

Spectrum Plot of Maximum Value

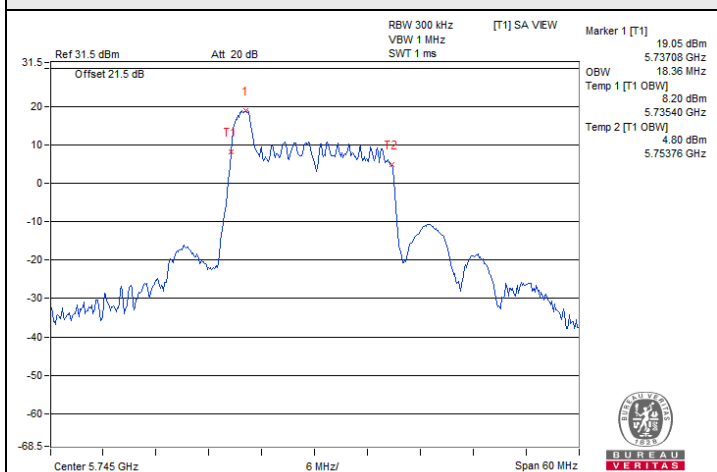

20 MHz Preamble 802.11ax (RU26) : CH 149

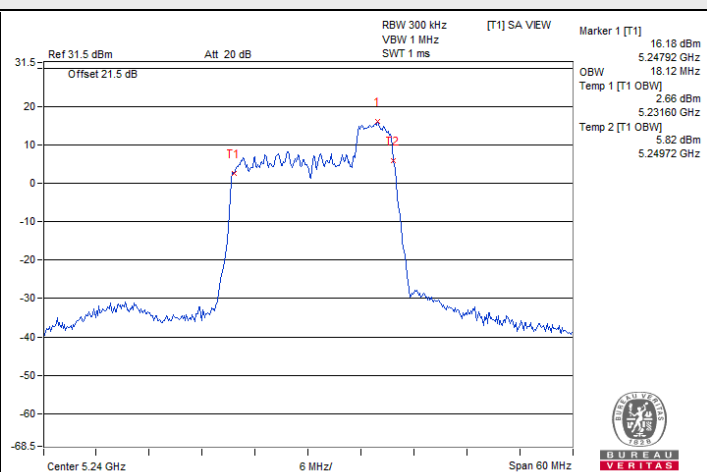

20 MHz Preamble 802.11ax (RU52) : CH 48

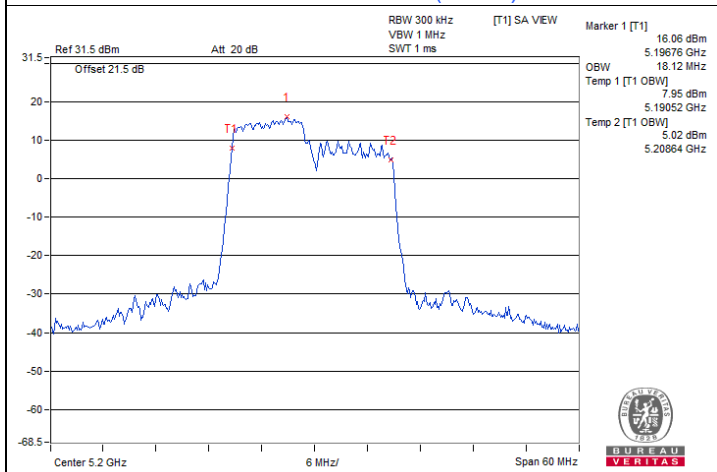

20 MHz Preamble 802.11ax (RU106) : CH 40

Spectrum Plot for nearby DFS band (DFS is required, if 99% OCP straddle into U-NII-2A)

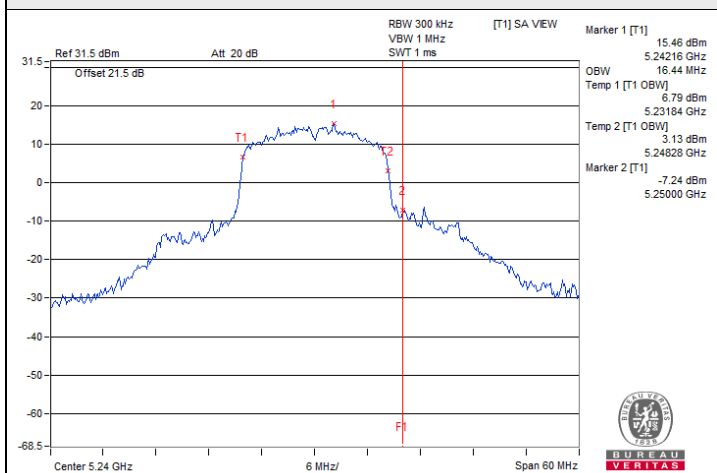

802.11a : CH 48

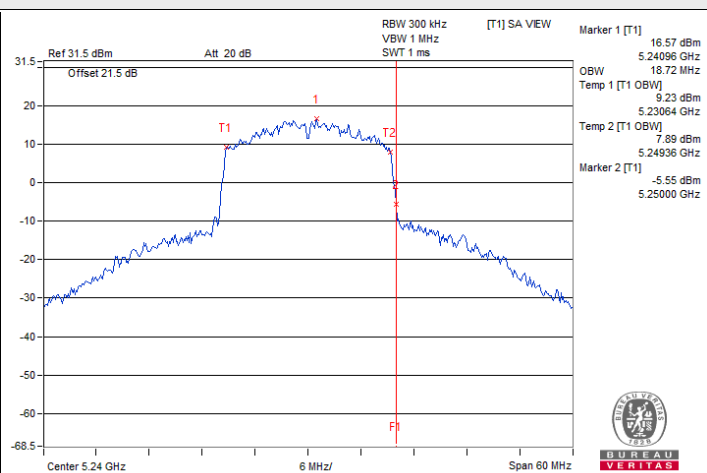

802.11ax (HE20) : CH 48

Spectrum Plot for nearby DFS band
(DFS is required, if 99% OCP straddle into U-NII-2A)

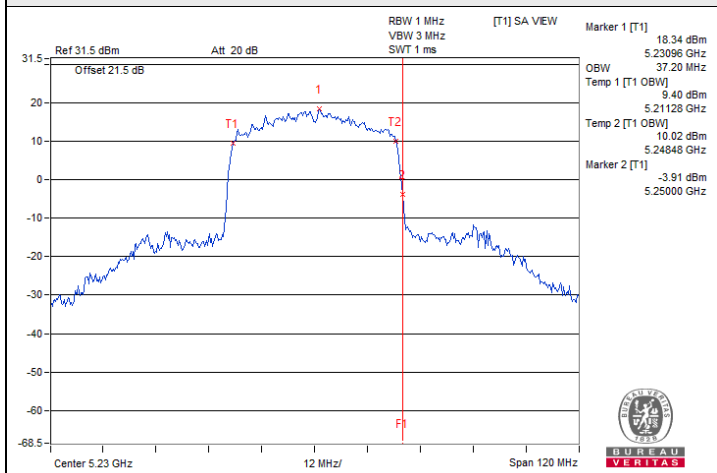

802.11ax (HE40) : CH 46

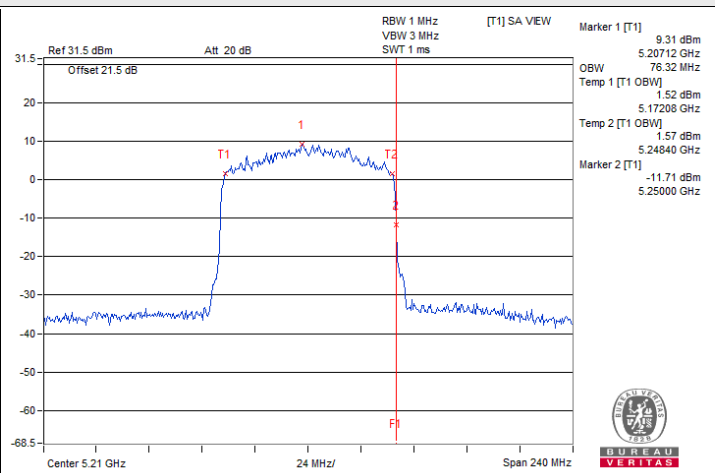

802.11ax (HE80) : CH 42

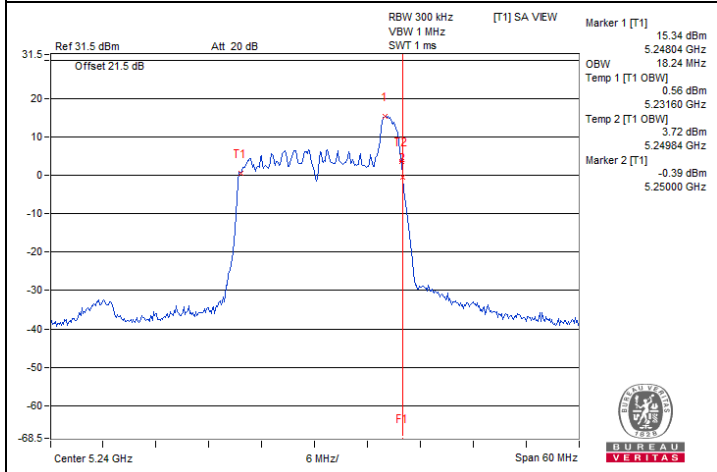

20 MHz Preamble 802.11ax (RU26) : CH 48

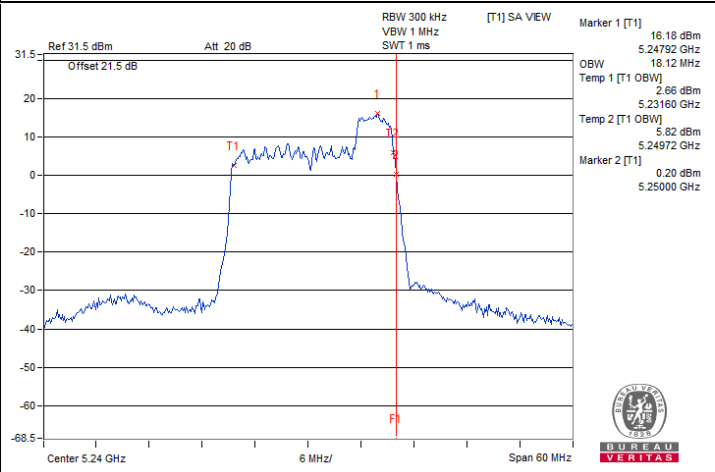

20 MHz Preamble 802.11ax (RU52) : CH 48

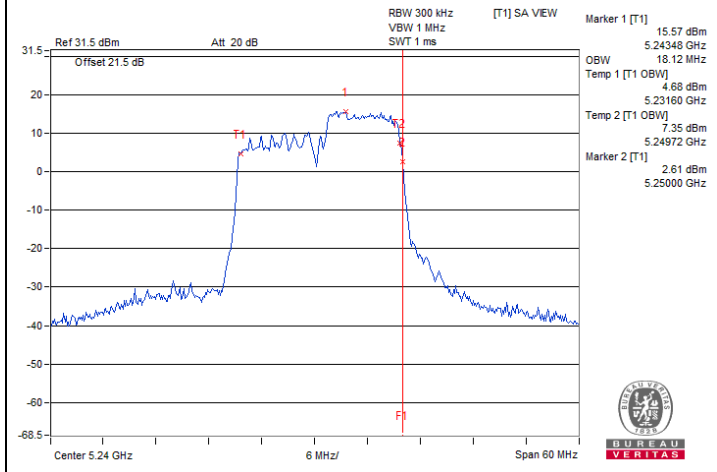

20 MHz Preamble 802.11ax (RU106) : CH 48



Spectrum Plot for nearby DFS band (DFS is required, if 99% OCP straddle into U-NII-2C)

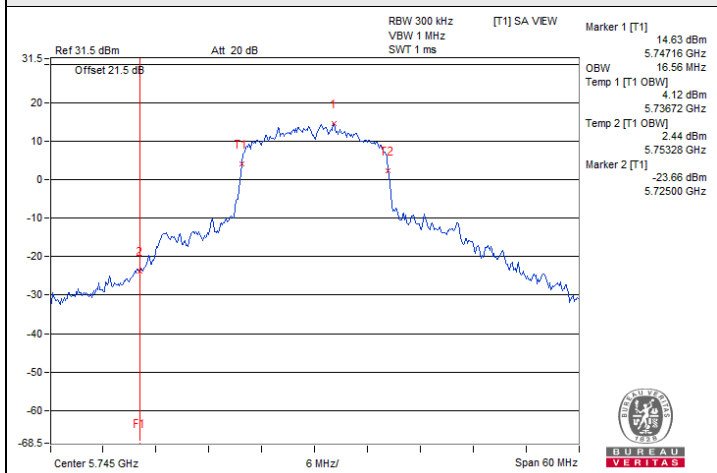

802.11a : CH 149

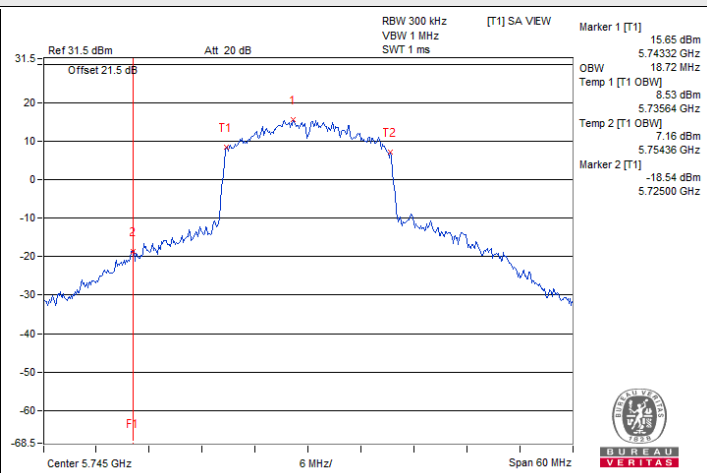

802.11a (HE20) : CH 149

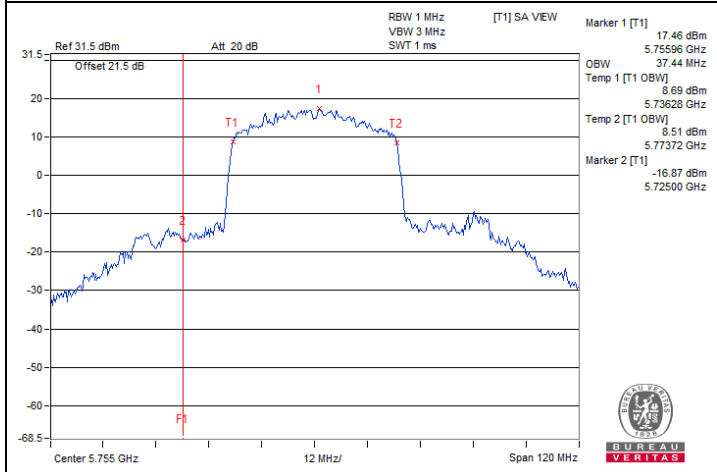

802.11ax (HE40) : CH 151

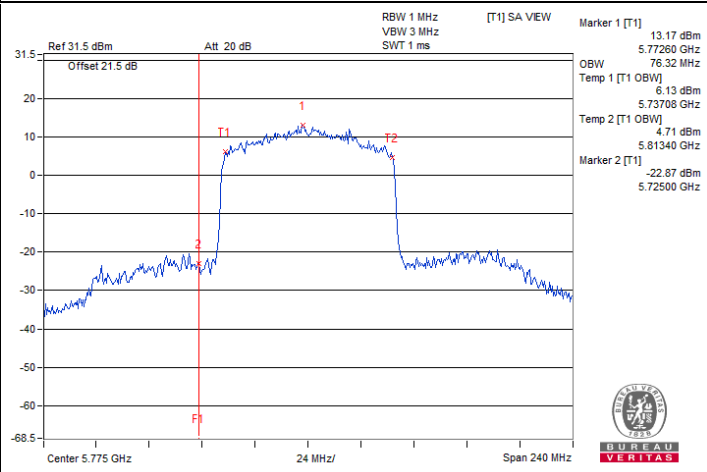

802.11ax (HE80) : CH 155

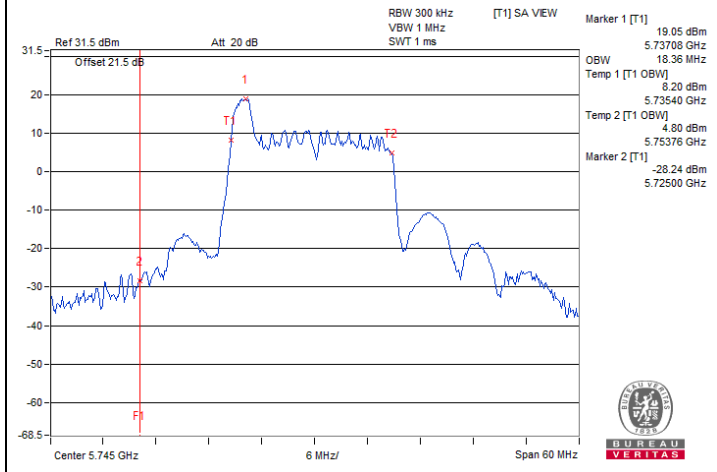

20 MHz Preamble 802.11ax (RU26) : CH 149

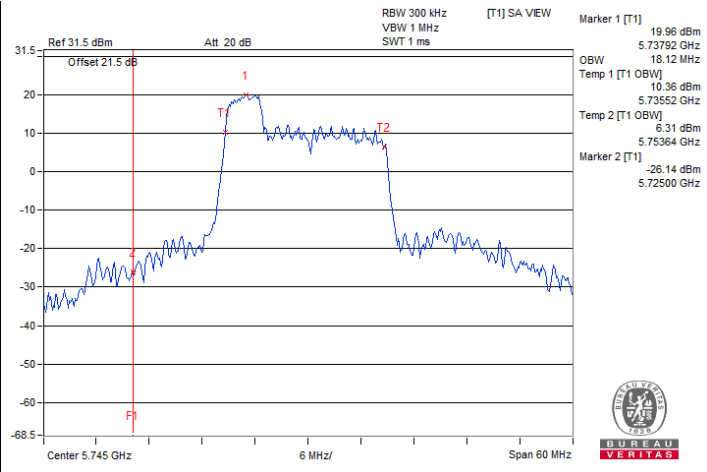

20 MHz Preamble 802.11ax (RU52) : CH 149



Spectrum Plot for nearby DFS band (DFS is required, if 99% OCP straddle into U-NII-2C)

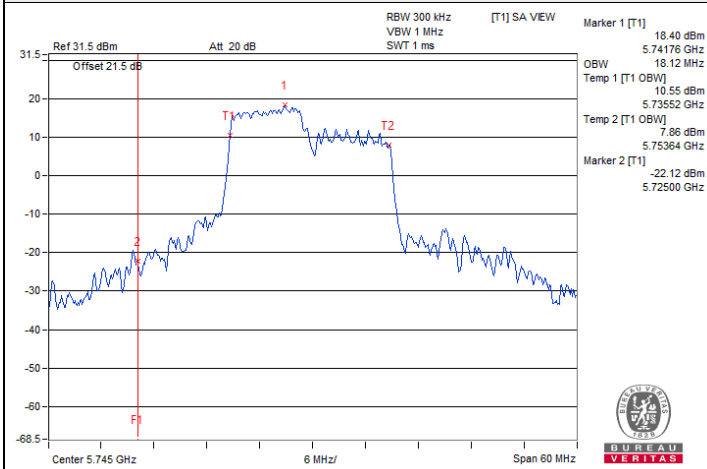

20 MHz Preamble 802.11ax (RU106) : CH 149

7.6 Frequency Stability

Input Power:	3.3 Vdc	Environmental Conditions:	25°C, 60% RH	Tested By:	Katina Lu
--------------	---------	---------------------------	--------------	------------	-----------

802.11a

Frequency Stability Versus Temperature									
Operating Frequency: 5180 MHz									
Temp. (°C)	Power Supply (Vdc)	0 Minute		2 Minutes		5 Minutes		10 Minutes	
		Measured Frequency (MHz)	Test Result	Measured Frequency (MHz)	Test Result	Measured Frequency (MHz)	Test Result	Measured Frequency (MHz)	Test Result
70	3.3	5180.0106	Pass	5180.0108	Pass	5180.0077	Pass	5180.0119	Pass
60	3.3	5180.0121	Pass	5180.009	Pass	5180.0072	Pass	5180.0072	Pass
50	3.3	5180.0142	Pass	5180.0117	Pass	5180.0139	Pass	5180.0152	Pass
40	3.3	5180.0255	Pass	5180.0235	Pass	5180.0272	Pass	5180.0225	Pass
30	3.3	5180.0005	Pass	5180.0002	Pass	5179.9996	Pass	5180.0031	Pass
20	3.3	5180.0117	Pass	5180.0139	Pass	5180.0112	Pass	5180.0118	Pass
10	3.3	5179.9951	Pass	5179.9954	Pass	5179.9969	Pass	5179.9939	Pass
0	3.3	5179.9954	Pass	5179.9964	Pass	5179.9959	Pass	5179.9947	Pass
-10	3.3	5180.0107	Pass	5180.0127	Pass	5180.0146	Pass	5180.014	Pass
-20	3.3	5180.0008	Pass	5180.0017	Pass	5180.0018	Pass	5180.0016	Pass

Frequency Stability Versus Voltage									
Operating Frequency: 5180 MHz									
Temp. (°C)	Power Supply (Vdc)	0 Minute		2 Minutes		5 Minutes		10 Minutes	
		Measured Frequency (MHz)	Test Result	Measured Frequency (MHz)	Test Result	Measured Frequency (MHz)	Test Result	Measured Frequency (MHz)	Test Result
20	3.795	5180.0078	Pass	5180.0123	Pass	5180.0092	Pass	5180.0122	Pass
	3.3	5180.0117	Pass	5180.0139	Pass	5180.0112	Pass	5180.0118	Pass
	2.805	5180.0044	Pass	5180.006	Pass	5180.0064	Pass	5180.0066	Pass

7.7 AC Power Conducted Emissions

Mode B

RF Mode	802.11ax (HE20)	Channel	CH 165 : 5825 MHz
Frequency Range	150kHz ~ 30MHz	Detector Function & Resolution Bandwidth	Quasi-Peak (QP) / Average (AV), 9 kHz
Input Power (System)	120 Vac, 60 Hz	Environmental Conditions	23°C, 71% RH
Tested By	Sampson Chen		

Phase Of Power : Line (L)										
No	Frequency (MHz)	Correction Factor (dB)	Reading Value (dBuV)		Emission Level (dBuV)		Limit (dBuV)		Margin (dB)	
			Q.P.	AV.	Q.P.	AV.	Q.P.	AV.	Q.P.	AV.
1	0.18516	9.96	45.56	31.72	55.52	41.68	64.25	54.25	-8.73	-12.57
2	0.24766	9.96	36.38	21.94	46.34	31.90	61.84	51.84	-15.50	-19.94
3	0.31406	9.97	28.91	13.40	38.88	23.37	59.86	49.86	-20.98	-26.49
4	3.61328	10.13	29.26	21.03	39.39	31.16	56.00	46.00	-16.61	-14.84
5	4.00781	10.15	28.71	20.62	38.86	30.77	56.00	46.00	-17.14	-15.23
6	28.22266	11.23	31.97	28.79	43.20	40.02	60.00	50.00	-16.80	-9.98

Remarks:

1. Q.P. and AV. are abbreviations of quasi-peak and average individually.
2. The emission levels of other frequencies were very low against the limit.
3. Margin value = Emission level – Limit value
4. Correction factor = Insertion loss + Cable loss
5. Emission Level = Correction Factor + Reading Value

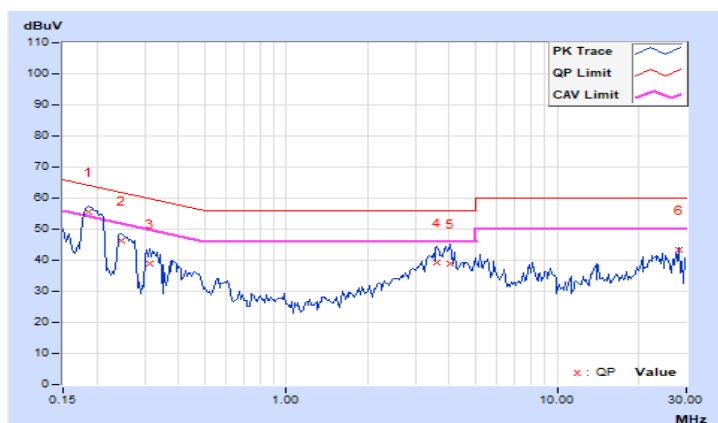

RF Mode	802.11ax (HE20)	Channel	CH 165 : 5825 MHz
Frequency Range	150kHz ~ 30MHz	Detector Function & Resolution Bandwidth	Quasi-Peak (QP) / Average (AV), 9 kHz
Input Power (System)	120 Vac, 60 Hz	Environmental Conditions	23°C, 71% RH
Tested By	Sampson Chen		

Phase Of Power : Neutral (N)										
No	Frequency (MHz)	Correction Factor (dB)	Reading Value (dBuV)		Emission Level (dBuV)		Limit (dBuV)		Margin (dB)	
			Q.P.	AV.	Q.P.	AV.	Q.P.	AV.	Q.P.	AV.
1	0.18516	9.94	45.07	30.57	55.01	40.51	64.25	54.25	-9.24	-13.74
2	0.25156	9.94	35.09	17.97	45.03	27.91	61.71	51.71	-16.68	-23.80
3	0.32188	9.94	26.69	7.30	36.63	17.24	59.66	49.66	-23.03	-32.42
4	3.74609	10.09	29.93	21.83	40.02	31.92	56.00	46.00	-15.98	-14.08
5	4.05859	10.10	29.34	20.36	39.44	30.46	56.00	46.00	-16.56	-15.54
6	27.46094	10.87	32.99	29.59	43.86	40.46	60.00	50.00	-16.14	-9.54

Remarks:

1. Q.P. and AV. are abbreviations of quasi-peak and average individually.
2. The emission levels of other frequencies were very low against the limit.
3. Margin value = Emission level – Limit value
4. Correction factor = Insertion loss + Cable loss
5. Emission Level = Correction Factor + Reading Value

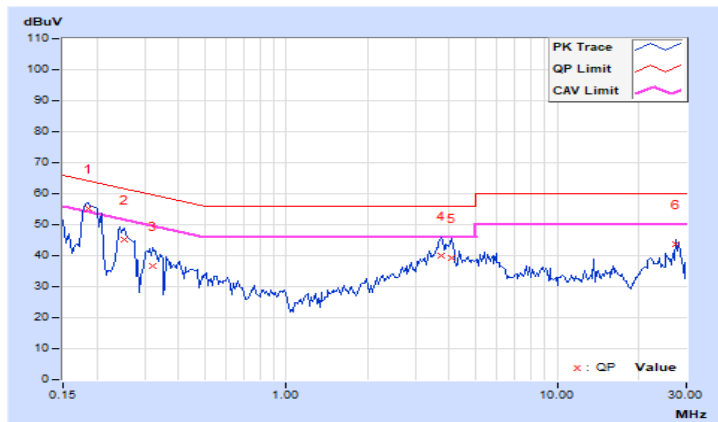

7.8 Unwanted Emissions below 1 GHz

Mode A

RF Mode	802.11ax (HE20)	Channel	CH 165 : 5825 MHz
Frequency Range	30 MHz ~ 1 GHz	Detector Function & Bandwidth	(QP) RB = 120kHz
Input Power (System)	120 Vac, 60 Hz	Environmental Conditions	28°C, 76% RH
Tested By	Louis Yang		

Antenna Polarity & Test Distance : Horizontal at 3 m

No	Frequency (MHz)	Emission Level (dBuV/m)	Limit (dBuV/m)	Margin (dB)	Antenna Height (m)	Table Angle (Degree)	Raw Value (dBuV)	Correction Factor (dB/m)
1	41.50	30.6 QP	40.0	-9.4	1.12 H	360	43.6	-13.0
2	77.10	21.7 QP	40.0	-18.3	1.00 H	325	38.5	-16.8
3	237.80	30.2 QP	46.0	-15.8	1.52 H	360	44.8	-14.6
4	282.60	30.5 QP	46.0	-15.5	1.50 H	74	43.2	-12.7
5	284.09	21.6 QP	46.0	-24.4	1.05 H	360	34.2	-12.6
6	454.20	25.5 QP	46.0	-20.5	1.00 H	122	33.6	-8.1

Remarks:

1. Emission Level(dBuV/m) = Raw Value(dBuV) + Correction Factor(dB/m)
2. Correction Factor(dB/m) = Antenna Factor(dB/m) + Cable Factor(dB) – Pre-Amplifier Factor(dB)
3. Margin value = Emission Level – Limit value
4. The other emission levels were very low against the limit of frequency range 30 MHz ~ 1 GHz.
5. The emission levels were very low against the limit of frequency range 9 kHz ~ 30 MHz: the amplitude of spurious emissions attenuated more than 20 dB below the permissible value to be report.

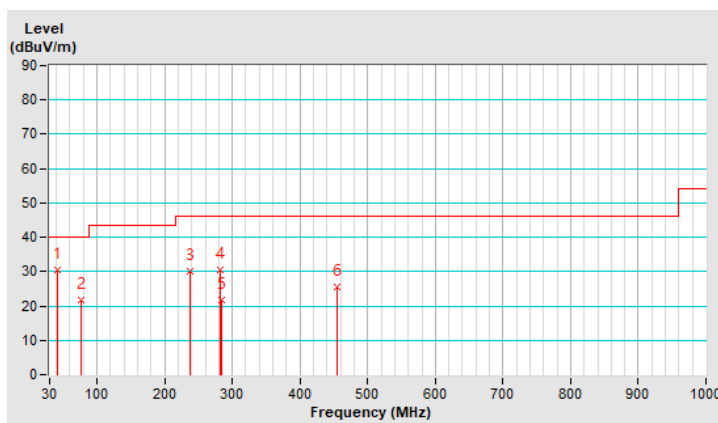

RF Mode	802.11ax (HE20)	Channel	CH 165 : 5825 MHz
Frequency Range	30 MHz ~ 1 GHz	Detector Function & Bandwidth	(QP) RB = 120kHz
Input Power (System)	120 Vac, 60 Hz	Environmental Conditions	28°C, 76% RH
Tested By	Louis Yang		

Antenna Polarity & Test Distance : Vertical at 3 m								
No	Frequency (MHz)	Emission Level (dBuV/m)	Limit (dBuV/m)	Margin (dB)	Antenna Height (m)	Table Angle (Degree)	Raw Value (dBuV)	Correction Factor (dB/m)
1	40.90	27.8 QP	40.0	-12.2	1.05 V	62	40.8	-13.0
2	142.50	30.6 QP	43.5	-12.9	1.00 V	325	43.5	-12.9
3	181.00	23.3 QP	43.5	-20.2	1.00 V	299	37.9	-14.6
4	236.41	32.5 QP	46.0	-13.5	1.00 V	172	47.2	-14.7
5	369.00	22.4 QP	46.0	-23.6	1.00 V	38	33.1	-10.7
6	643.50	27.4 QP	46.0	-18.6	1.12 V	355	31.8	-4.4

Remarks:

1. Emission Level(dBuV/m) = Raw Value(dBuV) + Correction Factor(dB/m)
2. Correction Factor(dB/m) = Antenna Factor(dB/m) + Cable Factor(dB) – Pre-Amplifier Factor(dB)
3. Margin value = Emission Level – Limit value
4. The other emission levels were very low against the limit of frequency range 30 MHz ~ 1 GHz.
5. The emission levels were very low against the limit of frequency range 9 kHz ~ 30 MHz: the amplitude of spurious emissions attenuated more than 20 dB below the permissible value to be report.

