

TEST REPORT

CERTIFICATE OF CONFORMITY

Standard: 47 CFR FCC Part 15, Subpart E (Section 15.407)
Report No.: RFBBUI-WTW-P22100654-5
FCC ID: TX2-RTL8851B
Product: 11ax RTL8851BE one antenna Combo module
Brand: REALTEK
Model No.: RTL8851B
Received Date: 2022/10/25
Test Date: 2022/12/23 ~ 2023/5/3
Issued Date: 2023/5/15

Applicant: Realtek Semiconductor Corp.
Address: No. 2, Innovation Road II, Hsinchu Science Park, Hsinchu 300, Taiwan
Issued By: Bureau Veritas Consumer Products Services (H.K.) Ltd., Taoyuan Branch
Hsin Chu Laboratory
Lab Address: E-2, No.1, Li Hsin 1st Road, Hsinchu Science Park, Hsinchu City 300, Taiwan
Test Location: E-2, No.1, Li Hsin 1st Road, Hsinchu Science Park, Hsinchu City 300, Taiwan

FCC Registration / 723255 / TW2022
Designation Number:

Approved by:  _____, **Date:** 2023/5/15
May Chen / Manager

This test report consists of 196 pages in total. It may be duplicated completely for legal use with the approval of the applicant. It should not be reproduced except in full, without the written approval of our laboratory. The test results in the report only apply to the tested sample. The test results in this report are traceable to the national or international standards.

Prepared by : Vito Lung / Specialist



This report is governed by, and incorporates by reference, the Conditions of Testing as posted at the date of issuance of this report at <http://www.bureauveritas.com/home/about-us/our-business/cps/about-us/terms-conditions/> and is intended for your exclusive use. Any copying or replication of this report to or for any other person or entity, or use of our name or trademark, is permitted only with our prior written permission. This report sets forth our findings solely with respect to the test samples identified herein. The results set forth in this report are not indicative or representative of the quality or characteristics of the lot from which a test sample was taken or any similar or identical product unless specifically and expressly noted. Our report includes all of the tests requested by you and the results thereof based upon the information that you provided to us. Measurement uncertainty is only provided upon request for accredited tests. Statements of conformity are based on simple acceptance criteria without taking measurement uncertainty into account, unless otherwise requested in writing. You have 60 days from date of issuance of this report to notify us of any material error or omission caused by our negligence or if you require measurement uncertainty; provided, however, that such notice shall be in writing and shall specifically address the issue you wish to raise. A failure to raise such issue within the prescribed time shall constitute your unqualified acceptance of the completeness of this report, the tests conducted and the correctness of the report contents.

Table of Contents

Release Control Record	4
1 Certificate	5
2 Summary of Test Results	6
2.1 Measurement Uncertainty	6
2.2 Supplementary Information	6
3 General Information	7
3.1 General Description of EUT	7
3.2 Antenna Description of EUT	8
3.3 Channel List	9
3.4 Test Mode Applicability and Tested Channel Detail	10
3.5 Duty Cycle of Test Signal	12
3.6 Test Program Used and Operation Descriptions	15
3.7 Connection Diagram of EUT and Peripheral Devices	15
3.8 Configuration of Peripheral Devices and Cable Connections	17
4 Test Instruments	18
4.1 RF Output Power	18
4.2 Power Spectral Density	18
4.3 6 dB Bandwidth	18
4.4 Frequency Stability	19
4.5 AC Power Conducted Emissions	19
4.6 Unwanted Emissions below 1 GHz	20
4.7 Unwanted Emissions above 1 GHz	21
5 Limits of Test Items	22
5.1 RF Output Power	22
5.2 Power Spectral Density	22
5.3 6 dB Bandwidth	22
5.4 Frequency Stability	22
5.5 AC Power Conducted Emissions	22
5.6 Unwanted Emissions below 1 GHz	23
5.7 Unwanted Emissions above 1 GHz	23
6 Test Arrangements	24
6.1 RF Output Power	24
6.1.1 Test Setup	24
6.1.2 Test Procedure	24
6.2 Power Spectral Density	24
6.2.1 Test Setup	24
6.2.2 Test Procedure	24
6.3 6 dB Bandwidth	25
6.3.1 Test Setup	25
6.3.2 Test Procedure	25
6.4 Frequency Stability	25
6.4.1 Test Setup	25
6.4.2 Test Procedure	25
6.5 AC Power Conducted Emissions	26
6.5.1 Test Setup	26
6.5.2 Test Procedure	26
6.6 Unwanted Emissions below 1 GHz	27
6.6.1 Test Setup	27
6.6.2 Test Procedure	28
6.7 Unwanted Emissions above 1 GHz	29
6.7.1 Test Setup	29
6.7.2 Test Procedure	29
7 Test Results of Test Item	30



7.1	RF Output Power.....	30
7.2	Power Spectral Density.....	33
7.3	6 dB Bandwidth.....	36
7.4	Frequency Stability.....	39
7.5	AC Power Conducted Emissions.....	40
7.6	Unwanted Emissions below 1 GHz.....	42
7.7	Unwanted Emissions above 1 GHz.....	48
8	Operational Restrictions for 5.85-5.895 GHz U-NII Devices.....	194
9	Pictures of Test Arrangements.....	195
10	Information of the Testing Laboratories.....	196



Release Control Record

Issue No.	Description	Date Issued
RFBBUI-WTW-P22100654-5	Original release.	2023/5/15

1 Certificate

Product: 11ax RTL8851BE one antenna Combo module

Brand: REALTEK

Test Model: RTL8851B

Sample Status: Engineering sample

Applicant: Realtek Semiconductor Corp.

Test Date: 2022/12/23 ~ 2023/5/3

Standard: 47 CFR FCC Part 15, Subpart E (Section 15.407)

Measurement ANSI C63.10-2013

procedure: KDB 291074 D02 EMC Measurement v01

KDB 789033 D02 General UNII Test Procedure New Rules v02r01

The above equipment has been tested by **Bureau Veritas Consumer Products Services (H.K.) Ltd., Taoyuan Branch**, and found compliance with the requirement of the above standards. The test record, data evaluation & Equipment Under Test (EUT) configurations represented herein are true and accurate accounts of the measurements of the sample's RF characteristics under the conditions specified in this report.

2 Summary of Test Results

47 CFR FCC Part 15, Subpart E (Section 15.407)			
Clause	Test Item	Result	Remark
15.407(a)(3)	RF Output Power	Pass	Meet the requirement of limit.
15.407(a)(3)	Power Spectral Density	Pass	Meet the requirement of limit.
15.407(b)(9)	AC Power Conducted Emissions	Pass	Minimum passing margin is -9.76 dB at 0.18516 MHz
15.407(b)(9)	Unwanted Emissions below 1 GHz	Pass	Minimum passing margin is -8.3 dB at 44.90 MHz
15.407(b)(5) 15.407(b)(10)	Unwanted Emissions above 1 GHz	Pass	Minimum passing margin is -1.6 dB at 5927.20 MHz
15.407(e)	6 dB Bandwidth	Pass	Meet the requirement of limit.
15.407(g)	Frequency Stability	Pass	Meet the requirement of limit.
15.403	Operational restrictions U-NII 4 devices	-	Declaration by applicant.
15.203	Antenna Requirement	Pass	Antenna connector is IPEX4 not a standard connector.

Note: Determining compliance based on the results of the compliance measurement, not taking into account measurement instrumentation uncertainty.

2.1 Measurement Uncertainty

Where relevant, the following measurement uncertainty levels have been estimated for tests performed on the EUT as specified in CISPR 16-4-2:

Measurement	Specification	Expanded Uncertainty (k=2) (±)
AC Power Conducted Emissions	150 kHz ~ 30 MHz	1.9 dB
Unwanted Emissions below 1 GHz	9 kHz ~ 30 MHz	3.1 dB
	30 MHz ~ 1 GHz	5.1 dB
Unwanted Emissions above 1 GHz	1 GHz ~ 18 GHz	5.1 dB
	18 GHz ~ 40 GHz	5.3 dB

The other instruments specified are routine verified to remain within the calibrated levels, no measurement uncertainty is required to be calculated.

2.2 Supplementary Information

There is not any deviation from the test standards for the test method, and no modifications required for compliance.

3 General Information

3.1 General Description of EUT

Product	11ax RTL8851BE one antenna Combo module
Brand	REALTEK
Test Model	RTL8851B
Status of EUT	Engineering sample
Power Supply Rating	3.3 Vdc Hz from host equipment
Modulation Type	64QAM, 16QAM, QPSK, BPSK for OFDM 256QAM for OFDM in 11ac mode 1024QAM for OFDMA in 11ax mode
Modulation Technology	OFDM, OFDMA
Transfer Rate	802.11a: up to 54 Mbps 802.11n: up to 150 Mbps 802.11ac: up to 433.3 Mbps 802.11ax: up to 600.4 Mbps
Operating Frequency	5.835 GHz ~ 5.885 GHz
Number of Channel	802.11a, 802.11n (HT20), 802.11ac (VHT20), 802.11ax (HE20): 3 802.11n (HT40), 802.11ac (VHT40), 802.11ax (HE40): 2 802.11ac (VHT80), 802.11ax (HE80): 1
Resource Unit (RU)	Single RU: 26-tone, 52-tone, 106-tone, 242-tone, 484-tone, 996-tone
Output Power	EIRP: 751.623 mW (28.76 dBm)
EUT Category	Client device

Note:

1. There are Bluetooth and WLAN (2.4 GHz & 5 GHz) technology used for the EUT.
2. Simultaneously transmission condition.

Condition	Technology	
1	WLAN (5 GHz)	Bluetooth

Note: The emission of the simultaneous operation has been evaluated and no non-compliance was found.

3. The EUT support OFDMA and Partial RU mode, therefore partial RU combination were investigated and the worst case scenario was identified.
4. The above EUT information is declared by manufacturer and for more detailed features description, please refers to the manufacturer's specifications or user's manual.

3.2 Antenna Description of EUT

1. The antenna information is listed as below.

Antenna NO.	RF Chain NO.	Brand	Model	Antenna Net Gain(dBi)	Frequency range	Antenna Type	Connector Type	Cable Length (mm)
1	Chain 1	REALTEK	RTK-ANT-0022	3.4	2.4~2.4835GHz	PIFA	IPEX4	300
				5	5.15~5.895GHz			
2	Chain 1	Aristotle	RFA-27-C38H1-MHF4300	3	2.4~2.4835GHz	Dipole	IPEX4	300
				5	5.15~5.895GHz			
3	Chain 1	LYNwave	ALX22F-120AA0-00	3.2	2.4~2.4835GHz	Monopole	IPEX4	200
				4	5.15~5.895GHz			

Note: Max. gain was selected for the final test, except for Unwanted Emissions.

* Detail antenna specification please refer to antenna datasheet and/or antenna measurement report.

2. The EUT incorporates a SISO function:

5 GHz Band		
Modulation Mode	TX & RX Configuration	
802.11a	1TX	1RX
802.11n (HT20)	1TX	1RX
802.11n (HT40)	1TX	1RX
802.11ac (VHT20)	1TX	1RX
802.11ac (VHT40)	1TX	1RX
802.11ac (VHT80)	1TX	1RX
802.11ax (HE20)	1TX	1RX
802.11ax (HE40)	1TX	1RX
802.11ax (HE80)	1TX	1RX
802.11ax (RU26/52/106/242/484/996)	1TX	1RX

Note:

- The modulation and bandwidth are similar for 802.11n mode for 20 MHz (40 MHz), 802.11ac mode for 20 MHz (40 MHz, 80 MHz) and 802.11ax mode for 20 MHz (40 MHz, 80 MHz), therefore the manufacturer will control the power for 802.11n/ac mode is the same as the 802.11ax or more lower than it and investigated worst case to representative mode in test report.

3.3 Channel List

For U-NII-4

3 channels are provided for 802.11a, 802.11n (HT20), 802.11ac (VHT20), 802.11ax (HE20):

Channel	Frequency	Channel	Frequency	Channel	Frequency
*169	5845 MHz	173	5865 MHz	177	5885 MHz

2 channels are provided for 802.11n (HT40), 802.11ac (VHT40), 802.11ax (HE40):

Channel	Frequency	Channel	Frequency
*167	5835 MHz	175	5875 MHz

1 channel is provided for 802.11ac (VHT80), 802.11ax (HE80):

Channel	Frequency
*171	5855 MHz

Note: * U-NII-3 & -4 span channels.

3.4 Test Mode Applicability and Tested Channel Detail

Pre-Scan:	<p>1. PIFA/Monopole ANT can be used in the following ways: X / Y / Z axis. Pre-scan in these ways and find the worst case as a representative test condition.</p> <p>2. For Partial RU modes of 20MHz, 40MHz and 80MHz bandwidth needs to be pre-worst.</p> <p>3. Pre-Scan has been conducted to determine the worst-case mode from all possible combinations between available modulations, data rates and antenna ports (if EUT with antenna diversity architecture).</p>
Worst Case:	<p>1. PIFA/Monopole ANT the worst case was found when positioned on (X / Y / Z axis): Unwanted Emissions below 1 GHz Y axis worst, and Unwanted Emissions above 1 GHz Y axis worst for PIFA ANT; Unwanted Emissions below 1 GHz X axis worst, and Unwanted Emissions above 1 GHz X axis worst for Monopole ANT.</p> <p>2. The worst case occurs in 20MHz bandwidth (partial RU 26/52/106).</p> <p>3. Dipole ANT was used typical placement for the test: Y axis.</p>

Following channel(s) was (were) selected for the final test as listed below:

Test Item	EUT Configure Mode	Mode	Tested Channel	Modulation	Data Rate Parameter	RU Configuration
RF Output Power	-	802.11a	169, 173, 177	BPSK	6Mb/s	-
		802.11ac (VHT20)	169, 173, 177	BPSK	MCS0	-
		802.11ac (VHT40)	167, 175	BPSK	MCS0	-
		802.11ac (VHT80)	171	BPSK	MCS0	-
		802.11ax (HE20)	169, 173, 177	BPSK	MCS0	-
		802.11ax (HE40)	167, 175	BPSK	MCS0	-
		802.11ax (HE80)	171	BPSK	MCS0	-
		20 MHz Preamble 802.11ax (RU26)	169, 173, 177	BPSK	MCS0	26/0, 26/4, 26/8
		20 MHz Preamble 802.11ax (RU52)	169, 173, 177	BPSK	MCS0	52/37, 52/39, 52/40
		20 MHz Preamble 802.11ax (RU106)	169, 173, 177	BPSK	MCS0	106/53, 106/54, 106/54

Power Spectral Density / 6 dB Bandwidth	-	802.11a	169, 173, 177	BPSK	6Mb/s	-
		802.11ax (HE20)	169, 173, 177	BPSK	MCS0	-
		802.11ax (HE40)	167, 175	BPSK	MCS0	-
		802.11ax (HE80)	171	BPSK	MCS0	-
		20 MHz Preamble 802.11ax (RU26)	169, 173, 177	BPSK	MCS0	26/0, 26/4, 26/8
		20 MHz Preamble 802.11ax (RU52)	169, 173, 177	BPSK	MCS0	52/37, 52/39, 52/40
		20 MHz Preamble 802.11ax (RU106)	169, 173, 177	BPSK	MCS0	106/53, 106/54, 106/54
Frequency Stability	-	802.11a	169	un-modulation	-	-
AC Power Conducted Emissions	B	802.11ax (HE40)	167	BPSK	MCS0	-
Unwanted Emissions below 1 GHz	A, B, C	802.11ax (HE40)	167	BPSK	MCS0	-
Unwanted Emissions above 1 GHz	A, B, C	802.11a	169, 173, 177	BPSK	6Mb/s	-
		802.11ax (HE20)	169, 173, 177	BPSK	MCS0	-
		802.11ax (HE40)	167, 175	BPSK	MCS0	-
		802.11ax (HE80)	171	BPSK	MCS0	-
		20 MHz Preamble 802.11ax (RU26)	169, 173, 177	BPSK	MCS0	26/0, 26/4, 26/8
		20 MHz Preamble 802.11ax (RU52)	169, 173, 177	BPSK	MCS0	52/37, 52/39, 52/40
		20 MHz Preamble 802.11ax (RU106)	169, 173, 177	BPSK	MCS0	106/53, 106/54, 106/54
EUT Configure Mode:	A	with Dipole Antenna				
	B	with PIFA Antenna				
	C	with Monopole Antenna				

3.5 Duty Cycle of Test Signal

802.11a: Duty cycle = 1.36 ms / 1.367 ms x 100% = 99.5%

802.11ax (HE20): Duty cycle = 1.165 ms / 1.172 ms x 100% = 99.4%

802.11ax (HE40): Duty cycle = 0.617 ms / 0.624 ms x 100% = 98.9%

802.11ax (HE80): Duty cycle = 0.316 ms / 0.323 ms x 100% = 97.8%, duty factor = 10 * log (1/Duty cycle) = 0.10 dB

802.11ax (HE) 26-tone RU: Duty cycle = 5.433 ms / 5.437 ms x 100% = 99.9%

802.11ax (HE) 52-tone RU: Duty cycle = 2.757 ms / 2.762 ms x 100% = 99.8%

802.11ax (HE) 106-tone RU: Duty cycle = 1.328 ms / 1.335 ms x 100% = 99.5%

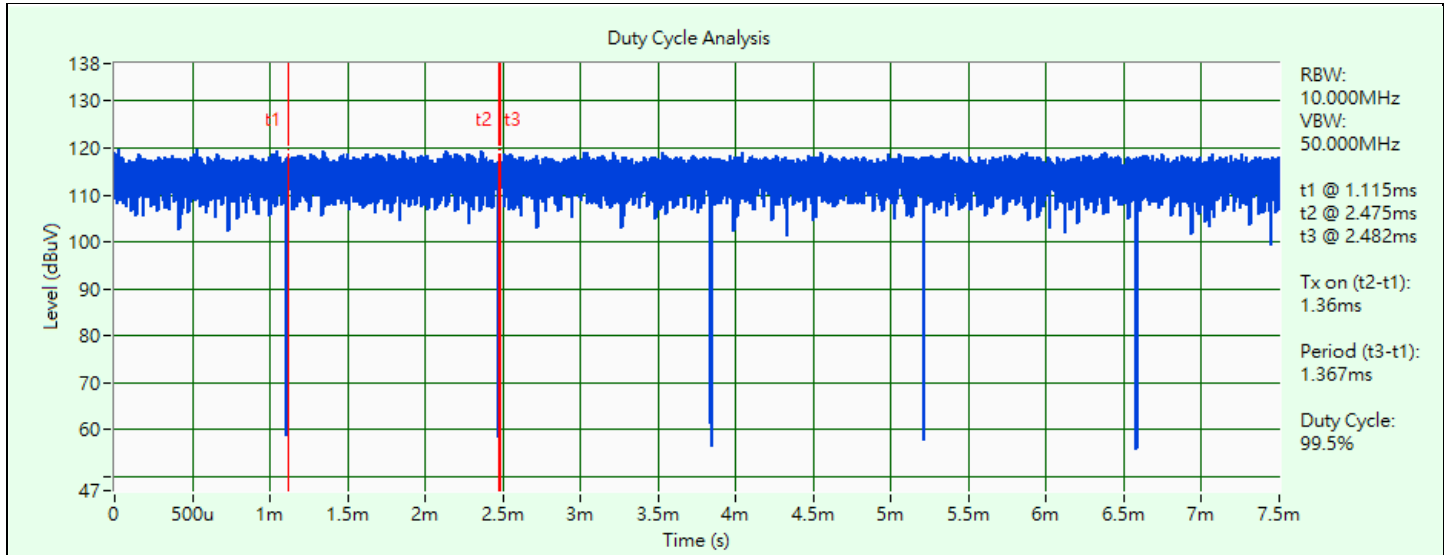

802.11a

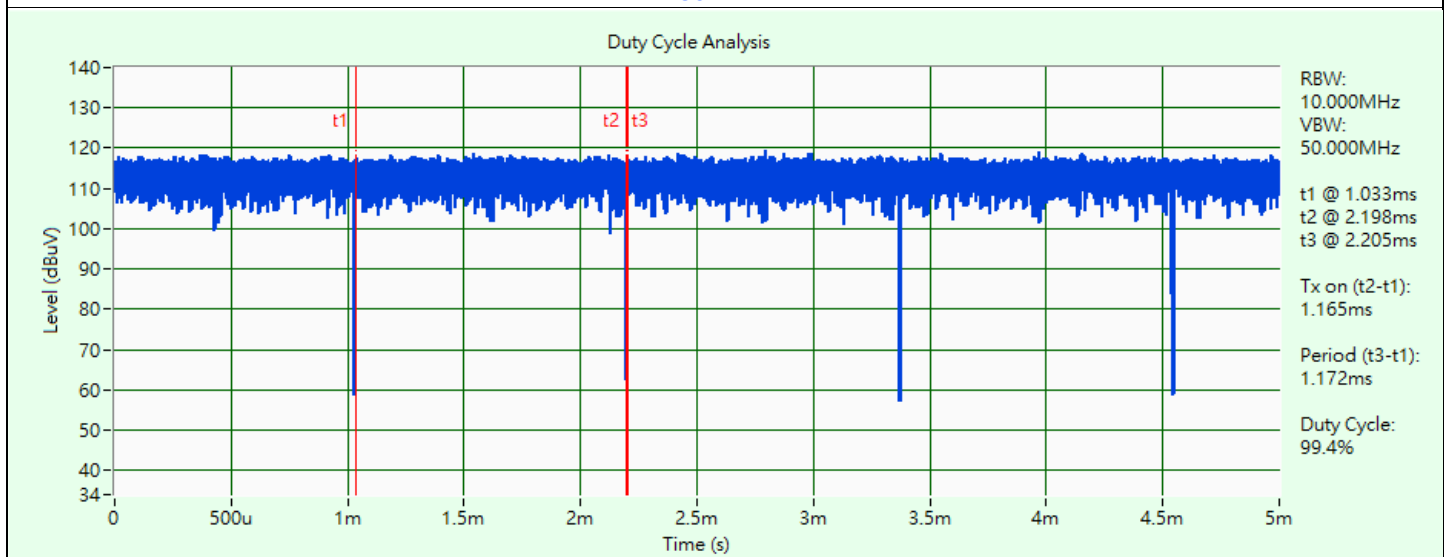

802.11ax (HE20)

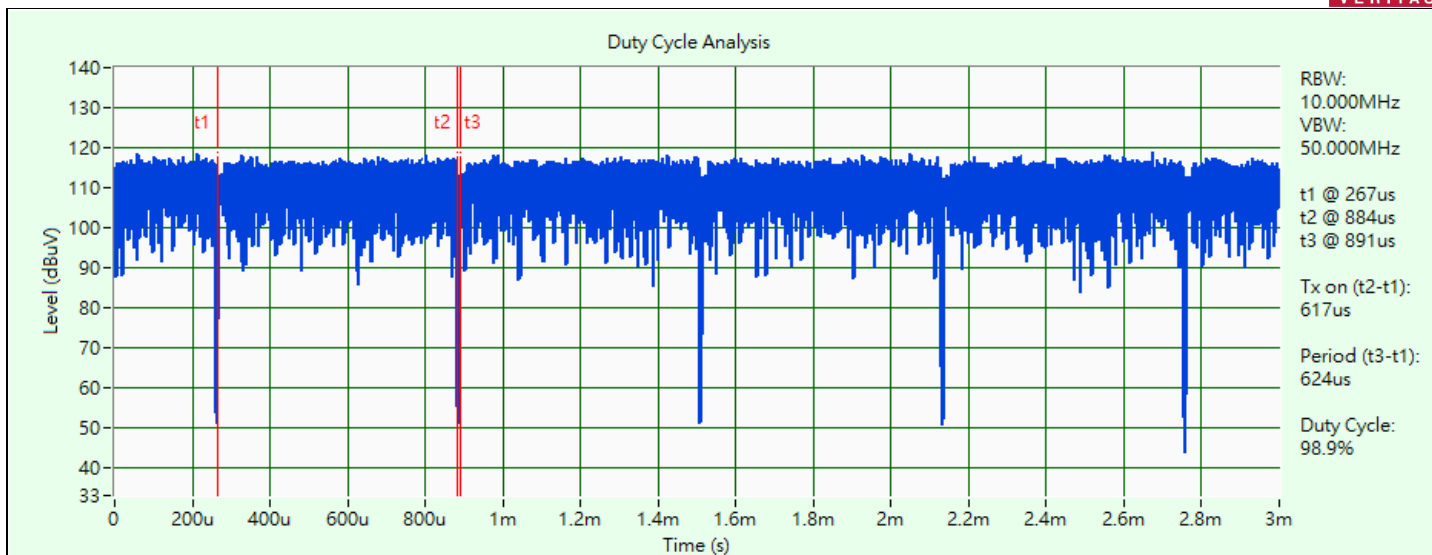

802.11ax (HE40)

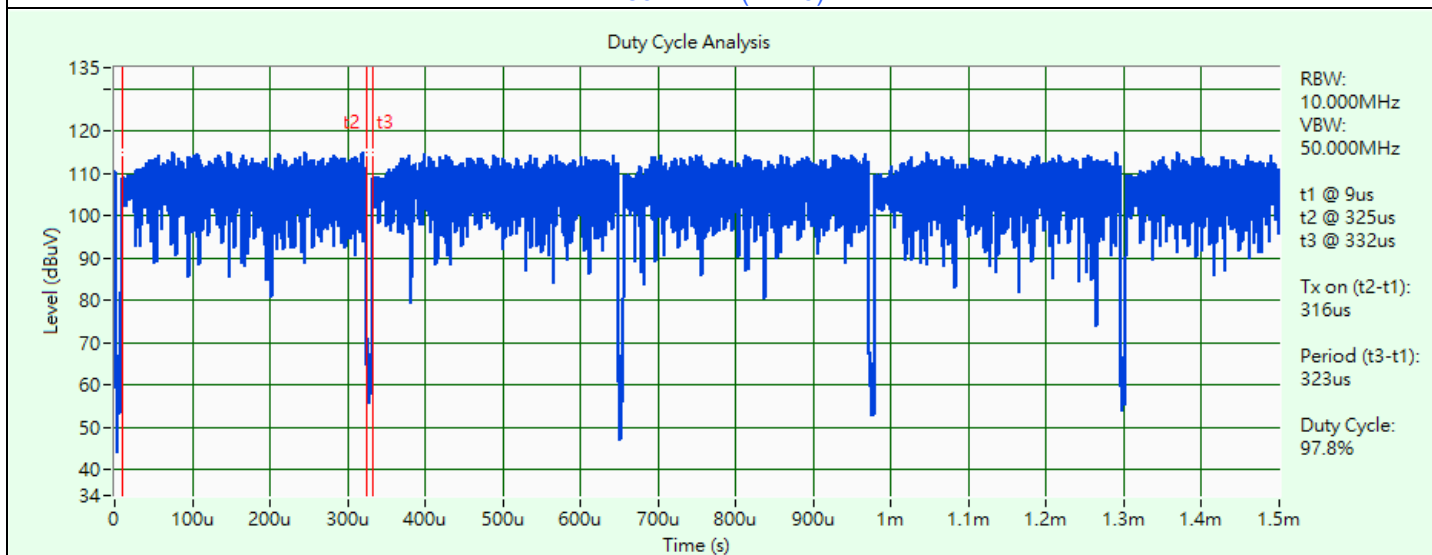

802.11ax (HE80)

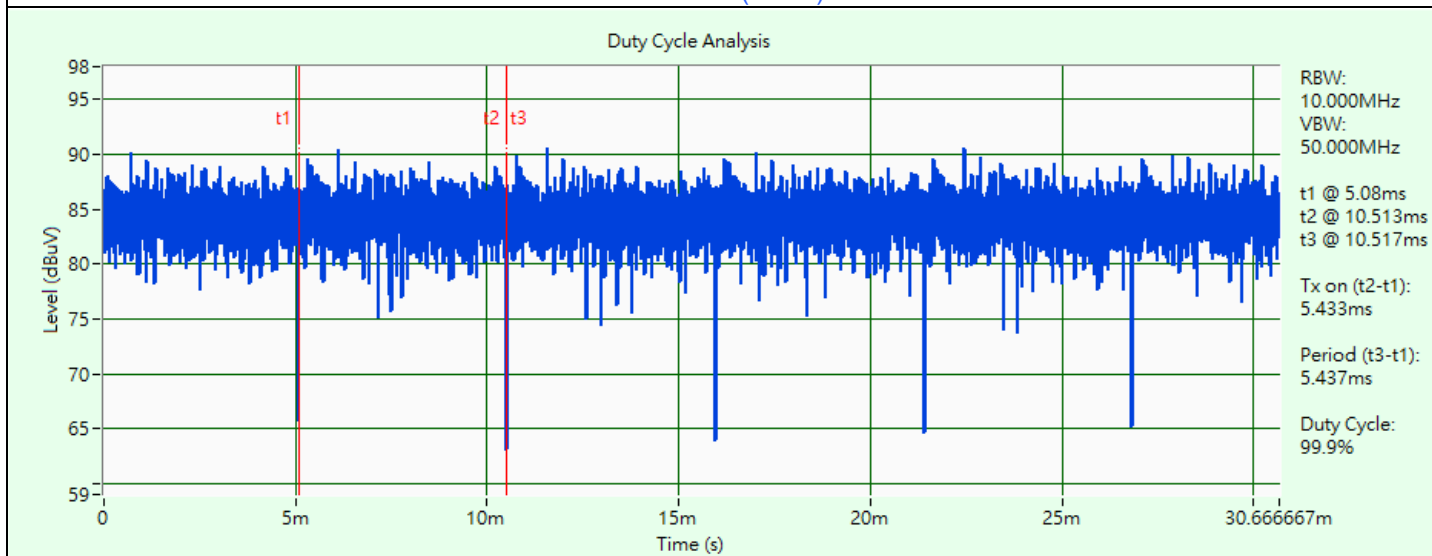

802.11ax (HE) 26-tone RU

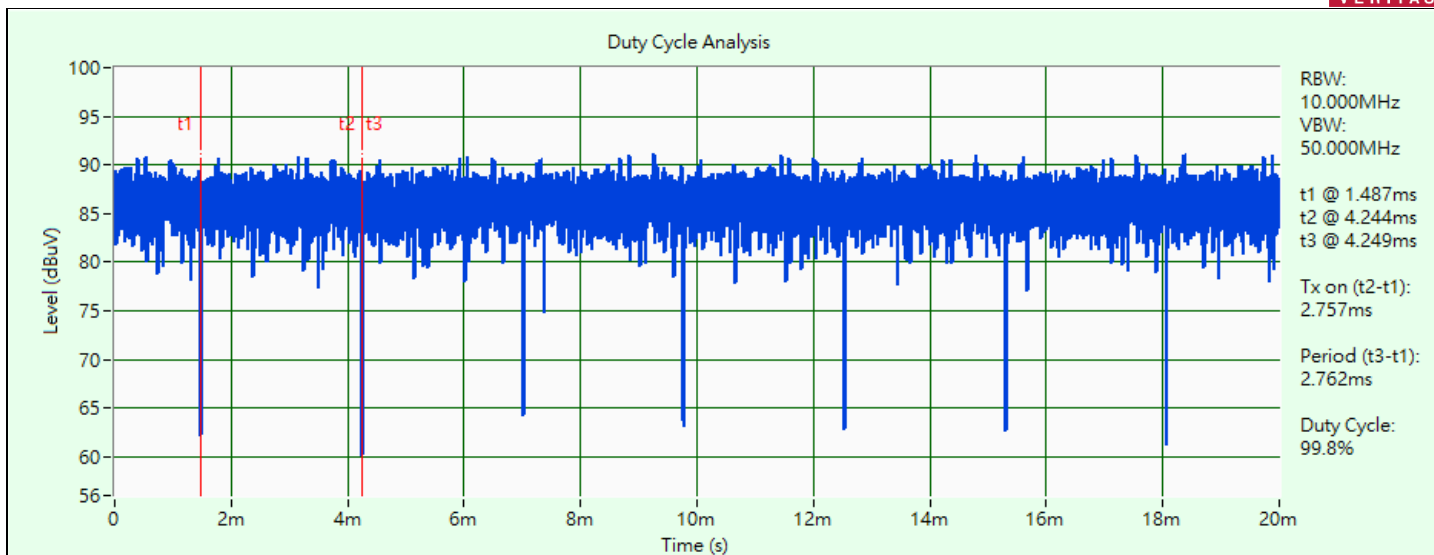

802.11ax (HE) 52-tone RU

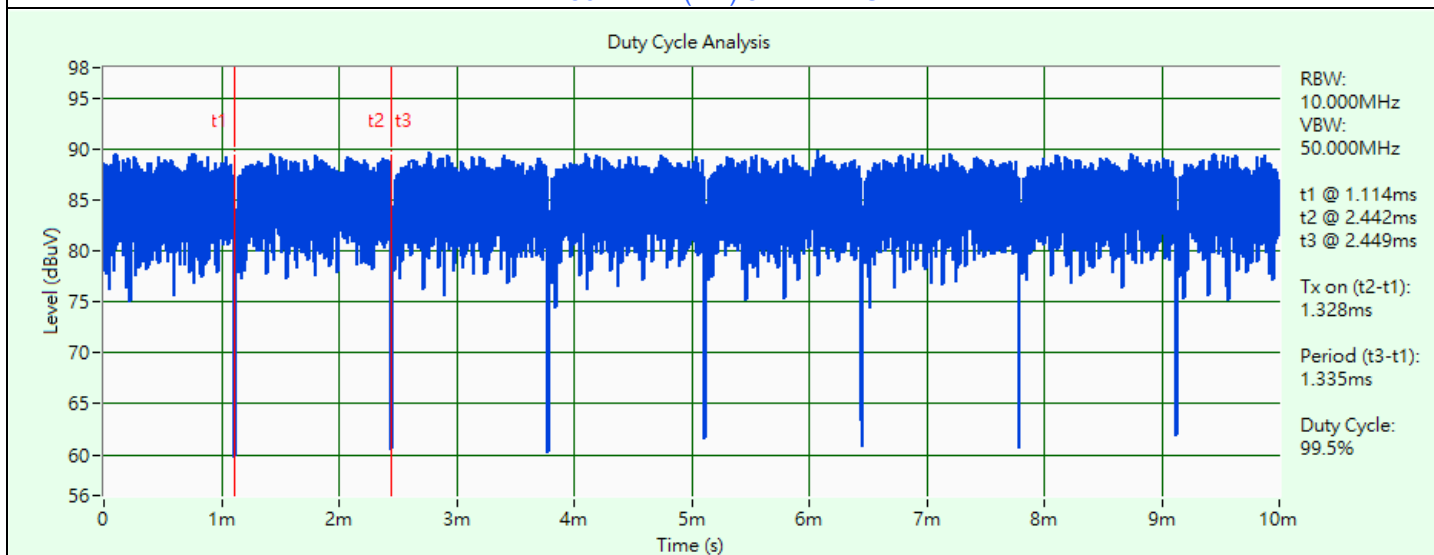

802.11ax (HE) 106-tone RU

3.6 Test Program Used and Operation Descriptions

Controlling software (RTL8851B_PCIE_MP_Package_ALPHA_v2.0.20_homologation (94894)) has been activated to set the EUT under transmission condition continuously at specific channel frequency.

3.7 Connection Diagram of EUT and Peripheral Devices

For Unwanted Emission Test Mode A

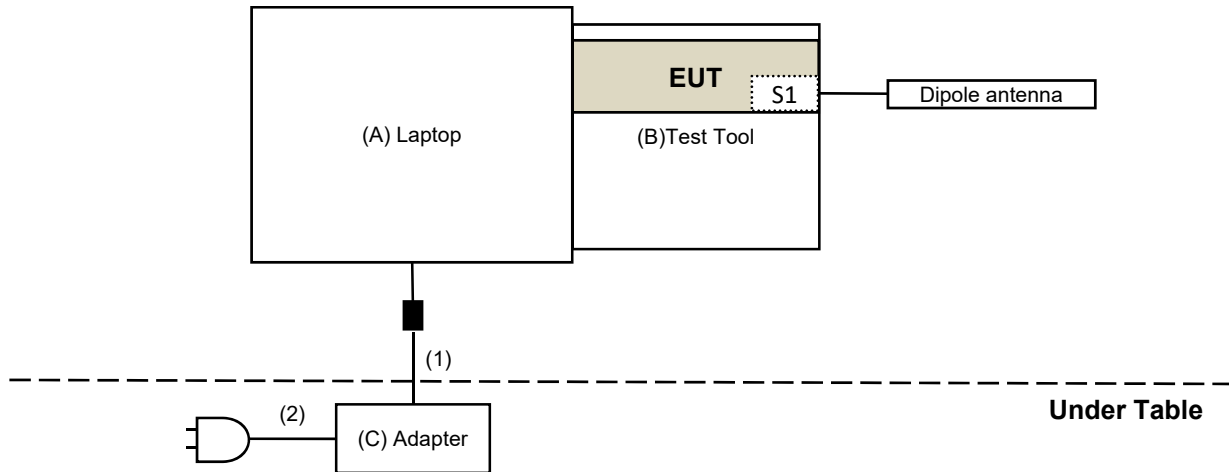

Mode B

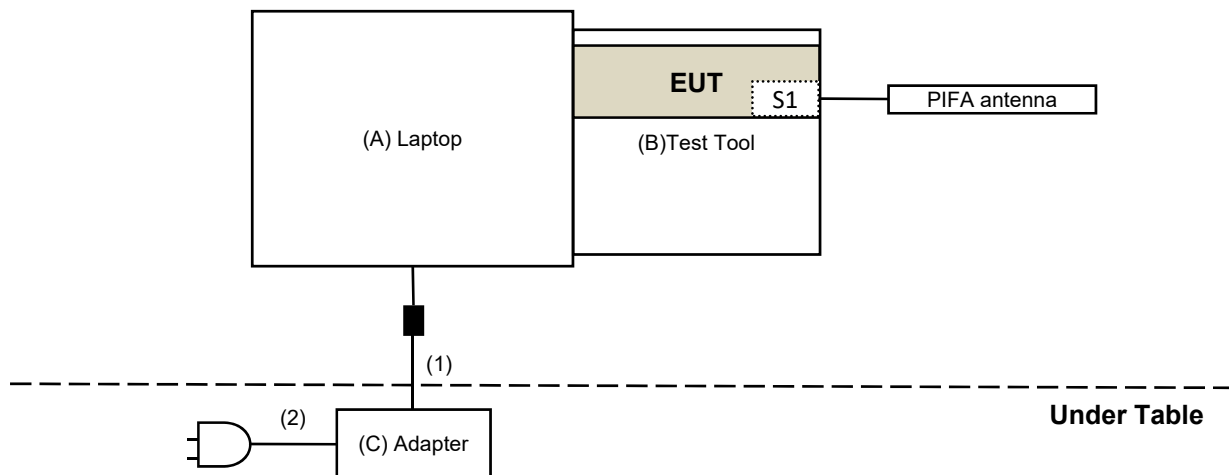

Mode C

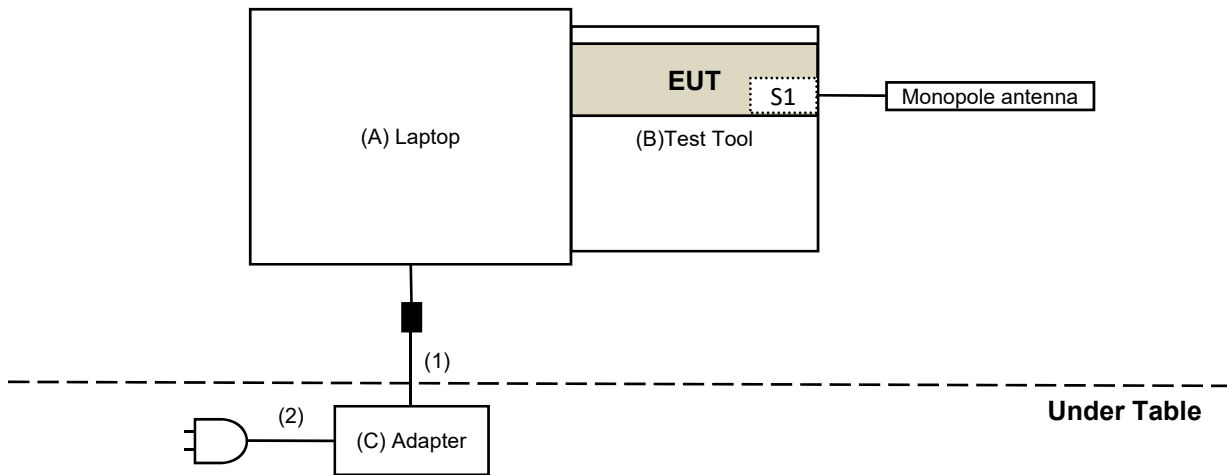

For AC Power Conducted Emission Test Mode B

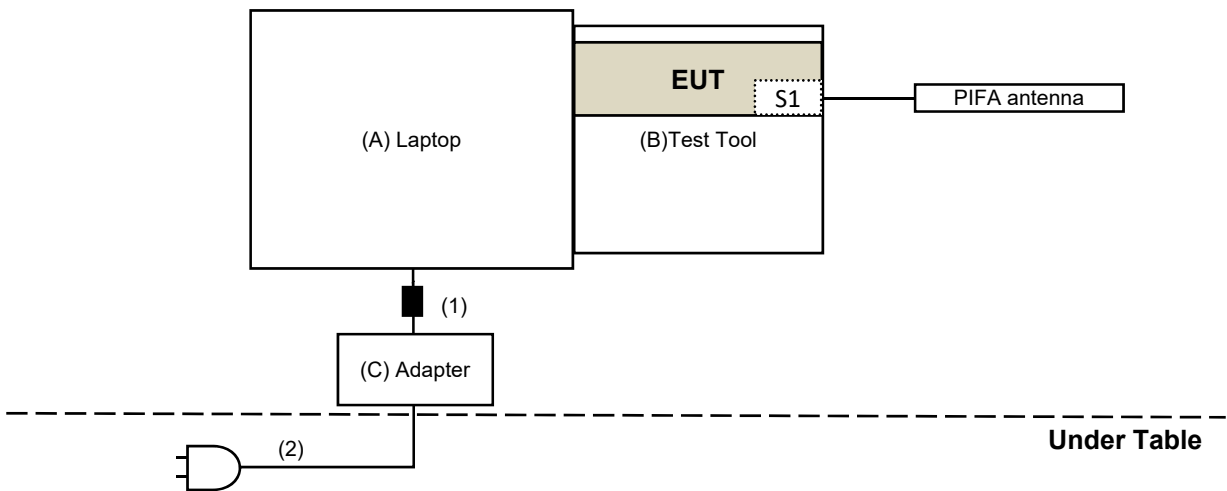

3.8 Configuration of Peripheral Devices and Cable Connections

ID	Product	Brand	Model No.	Serial No.	FCC ID	Remarks
A	Laptop	Dell	E5420	FHNS4S1	N/A	Provided by Lab
B	Test Tool	Realtek	N/A	N/A	N/A	Supplied by applicant
C	Adapter	Dell	LA65NS2-01	N/A	N/A	Supplied by applicant

ID	Cable Descriptions	Qty.	Length (m)	Shielding (Yes/No)	Cores (Qty.)	Remarks
1	DC Cable	1	1.8	No	1	Provided by Lab
2	AC Cable	0	1	No	0	Provided by Lab

4 Test Instruments

The calibration interval of the all test instruments are 12 months and the calibrations are traceable to NML/ROC and NIST/USA.

4.1 RF Output Power

Description Manufacturer	Model No.	Serial No.	Calibrated Date	Calibrated Until
Power Meter Anritsu	ML2495A	1529002	2022/6/22	2023/6/21
Pulse Power Sensor Anritsu	MA2411B	1726434	2022/6/22	2023/6/21
Attenuator WOKEN	MDCS18N-10	MDCS18N-10-01	2023/3/27	2024/3/26

Notes:

1. The test was performed in Oven room 2.
2. Tested Date: 2023/3/29

4.2 Power Spectral Density

Description Manufacturer	Model No.	Serial No.	Calibrated Date	Calibrated Until
Attenuator WOKEN	MDCS18N-10	MDCS18N-10-01	2022/4/5	2023/4/4
Software	ADT_RF Test Software V6.6.5.4	N/A	N/A	N/A
Spectrum Analyzer Keysight	N9020B	MY60112409	2023/2/18	2024/2/17

Notes:

1. The test was performed in Oven room 2.
2. Tested Date: 2023/3/29

4.3 6 dB Bandwidth

Refer to section 4.2 to get information of the instruments.

4.4 Frequency Stability

Description Manufacturer	Model No.	Serial No.	Calibrated Date	Calibrated Until
DC Power Source GOOD WILL	6905S	1991551	N/A	N/A
Attenuator WOKEN	MDCS18N-10	MDCS18N-10-01	2022/4/5	2023/4/4
Software	ADT_RF Test Software V6.6.5.4	N/A	N/A	N/A
Spectrum Analyzer Keysight	N9020B	MY60112409	2023/2/18	2024/2/17
Temperature & Humidity Chamber Giant Force	GTH-150-40-SP-AR	MAA0812-008	2022/12/26	2023/12/25
True RMS Clamp Meter Fluke	325	31130711WS	2022/6/9	2023/6/8

Notes:

1. The test was performed in Oven room 2.
2. Tested Date: 2023/3/29

4.5 AC Power Conducted Emissions

Description Manufacturer	Model No.	Serial No.	Calibrated Date	Calibrated Until
50 ohm terminal resistance	N/A	EMC-01	2022/9/27	2023/9/26
Fixed attenuator STI	STI02-2200-10	005	2022/8/24	2023/8/23
LISN R&S	ESH3-Z5	848773/004	2022/10/18	2023/10/17
RF Coaxial Cable JYEBO	5D-FB	COCCAB-001	2022/8/24	2023/8/23
Software BVADT	BVADT_Cond_V7.3.7.4	N/A	N/A	N/A
TEST RECEIVER R&S	ESCS 30	847124/029	2022/10/14	2023/10/13

Notes:

1. The test was performed in Conduction 1
2. Tested Date: 2023/3/21

4.6 Unwanted Emissions below 1 GHz

Description Manufacturer	Model No.	Serial No.	Calibrated Date	Calibrated Until
Bilog Antenna Schwarzbeck	VULB 9168	9168-0842	2022/10/24	2023/10/23
Boresight Antenna Tower & Turn Table Max-Full	MF-7802BS	MF780208530	N/A	N/A
Fixed attenuator Mini-Circuits	UNAT-5+	PAD-ATT5-02	2022/12/28	2023/12/27
LOOP ANTENNA Electro-Metrics	EM-6879	264	2023/2/21	2024/2/20
Pre_Amplifier Agilent	8447D	2944A10636	2023/3/12	2024/3/11
Pre_Amplifier EMCI	EMC330N	980538	2022/4/25	2023/4/24
RF Coaxial Cable COMMATE/PEWC	8D	966-5-1	2023/2/18	2024/2/17
		966-5-2	2023/2/18	2024/2/17
		966-5-3	2023/2/18	2024/2/17
RF Coaxial Cable JYEBO	5D-FB	LOOPCAB-001	2022/12/19	2023/12/18
		LOOPCAB-002	2022/12/19	2023/12/18
Software	ADT_Radiated_V8.7.08	N/A	N/A	N/A
Spectrum Analyzer Keysight	N9020B	MY60112410	2023/3/6	2024/3/5
Test Receiver R&S	ESR3	102528	2023/2/10	2024/2/9

Notes:

1. The test was performed in 966 Chamber No. 5.
2. Tested Date: 2023/3/24

4.7 Unwanted Emissions above 1 GHz

Description Manufacturer	Model No.	Serial No.	Calibrated Date	Calibrated Until
Boresight Antenna Tower & Turn Table Max-Full	MF-7802BS	MF780208530	N/A	N/A
Horn Antenna Schwarzbeck	BBHA 9120D	9120D-1819	2022/11/13	2023/11/12
	BBHA 9170	9170-739	2022/11/13	2023/11/12
Pre_Amplifier EMCI	EMC12630SE	980509	2022/4/25 2023/4/7	2023/4/24 2024/4/6
	EMC184045SE	980387	2022/1/10 2022/12/28	2023/1/9 2023/12/27
RF Cable-Frequency range: 1- 40GHz EMCI	EMC102-KM-KM-1200	160924	2022/1/10 2022/12/28	2023/1/9 2023/12/27
RF Coaxial Cable EMCI	EMC-KM-KM-4000	200214	2022/3/8 2023/2/20	2023/3/7 2024/2/19
	EMC104-SM-SM-1500	180503	2022/4/25 2023/4/7	2023/4/24 2024/4/6
	EMC104-SM-SM-2000	180501	2022/4/25 2023/4/7	2023/4/24 2024/4/6
	EMC104-SM-SM-6000	180506	2022/4/25 2023/4/7	2023/4/24 2024/4/6
Software	ADT_Radiated_V8.7.08	N/A	N/A	N/A
Spectrum Analyzer Keysight	N9020B	MY60112410	2022/3/13 2023/3/6	2023/3/12 2024/3/5
Test Receiver R&S	ESR3	102528	2022/2/25 2023/2/10	2023/2/24 2024/2/9

Notes:

1. The test was performed in 966 Chamber No. 5.
2. Tested Date: 2022/12/23 ~ 2023/5/3

5 Limits of Test Items

5.1 RF Output Power

Device Category	Limit (Max Average Power)
Indoor access point	EIRP 36 dBm
Subordinate device	EIRP 36 dBm
Client device	EIRP 30 dBm

Note: For all U-NII-4 and U-NII-3 & -4 span channels shall met above EIRP values.

5.2 Power Spectral Density

Device Category	Limit
Indoor access point	EIRP 20 dBm/MHz
Subordinate device	EIRP 20 dBm/MHz
Client device	EIRP 14 dBm/MHz

Note: For all U-NII-4 and U-NII-3 & -4 span channels shall met above EIRP values.

5.3 6 dB Bandwidth

Within the 5.725-5.850 GHz and 5.850-5.895 GHz bands, the minimum 6 dB bandwidth of U-NII devices shall be at least 500 kHz.

5.4 Frequency Stability

The frequency of the carrier signal shall be maintained within band of operation.

5.5 AC Power Conducted Emissions

Frequency (MHz)	Conducted Limit (dBuV)	
	Quasi-peak	Average
0.15 - 0.5	66 - 56	56 - 46
0.50 - 5.0	56	46
5.0 - 30.0	60	50

Notes:

1. The lower limit shall apply at the transition frequencies.
2. The limit decreases in line with the logarithm of the frequency in the range of 0.15 to 0.50 MHz.

5.6 Unwanted Emissions below 1 GHz

Radiated emissions which fall in the restricted bands must comply with the radiated emission limits specified as below table.

Frequencies (MHz)	Field Strength (microvolts/meter)	Measurement Distance (meters)
0.009 ~ 0.490	2400/F(kHz)	300
0.490 ~ 1.705	24000/F(kHz)	30
1.705 ~ 30.0	30	30
30 ~ 88	100	3
88 ~ 216	150	3
216 ~ 960	200	3
Above 960	500	3

Notes:

1. The lower limit shall apply at the transition frequencies.
2. Emission level (dBuV/m) = 20 log Emission level (uV/m).

5.7 Unwanted Emissions above 1 GHz

- (i) For an indoor access point or subordinate device, all emissions at or above 5.895 GHz shall not exceed an e.i.r.p. of 15 dBm/MHz and shall decrease linearly to an e.i.r.p. of -7 dBm/MHz at or above 5.925 GHz.
- (ii) For a client device, all emissions at or above 5.895 GHz shall not exceed an e.i.r.p. of -5 dBm/MHz and shall decrease linearly to an e.i.r.p. of -27 dBm/MHz at or above 5.925 GHz.
- (iii) For a client device or indoor access point or subordinate device, all emissions below 5.725 GHz shall not exceed an e.i.r.p. of -27 dBm/MHz at 5.65 GHz increasing linearly to 10 dBm/MHz at 5.7 GHz, and from 5.7 GHz increasing linearly to a level of 15.6 dBm/MHz at 5.72 GHz, and from 5.72 GHz increasing linearly to a level of 27 dBm/MHz at 5.725 GHz.

Note:

The following formula is used to convert the equipment isotropic radiated power (eirp) to field strength:

$$E = \frac{1000000\sqrt{30P}}{3} \mu\text{V/m, where } P \text{ is the eirp (Watts).}$$

6 Test Arrangements

6.1 RF Output Power

6.1.1 Test Setup

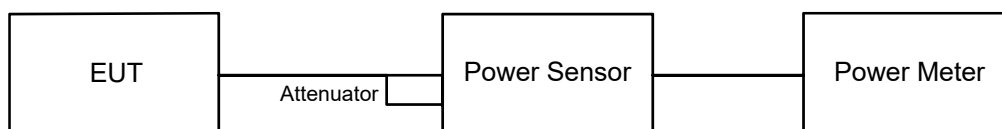

6.1.2 Test Procedure

Method PM is used to perform output power measurement, trigger and gating function of wide band power meter is enabled to measure max output power of TX on burst and set the detector to average. Duty factor is not added to measured value.

6.2 Power Spectral Density

6.2.1 Test Setup

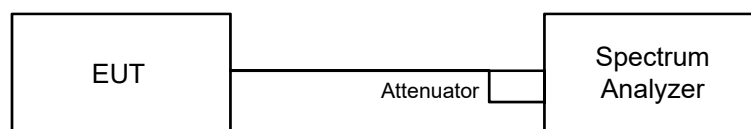

6.2.2 Test Procedure

For specified measurement bandwidth 1 MHz:

Method SA-1

- Set span to encompass the entire emission bandwidth (EBW) of the signal.
- Set RBW = 300 kHz, Set VBW ≥ 1 MHz, Detector = RMS
- Scale the observed power level to an equivalent value in 1 MHz by adjusting (increasing) the measured power by a bandwidth correction factor (BWCF) where $BWCF = 10\log(1\text{ MHz}/300\text{ kHz})$
- Sweep points ≥ $[2 \times \text{span} / \text{RBW}]$. (This gives bin-to-bin spacing ≤ $\text{RBW} / 2$, so that narrowband signals are not lost between frequency bins.)
- Sweep time = auto, trigger set to “free run”.
- Trace average at least 100 traces in power averaging mode.
- Record the max value

For specified measurement bandwidth 1 MHz:

Method SA-2

- Set span to encompass the entire emission bandwidth (EBW) of the signal.
- Set RBW = 300 kHz, Set VBW ≥ 1 MHz, Detector = RMS
- Scale the observed power level to an equivalent value in 1 MHz by adjusting (increasing) the measured power by a bandwidth correction factor (BWCF) where $BWCF = 10\log(1\text{ MHz}/300\text{ kHz})$
- Sweep points ≥ $[2 \times \text{span} / \text{RBW}]$. (This gives bin-to-bin spacing ≤ $\text{RBW} / 2$, so that narrowband signals are not lost between frequency bins.)
- Sweep time = auto, trigger set to “free run”.
- Trace average at least 100 traces in power averaging mode.
- Use the peak search function on the instrument to find the peak of the spectrum and record its value.
- Record the max value and add $10 \log(1/\text{duty cycle})$.

6.3 6 dB Bandwidth

6.3.1 Test Setup

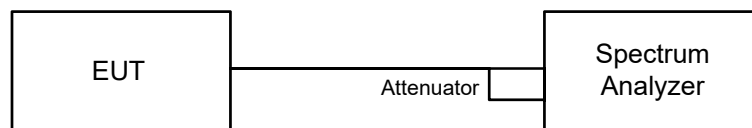

6.3.2 Test Procedure

- Set resolution bandwidth (RBW) = 100 kHz.
- Set the video bandwidth (VBW) $\geq 3 \times$ RBW, Detector = Peak.
- Trace mode = max hold.
- Sweep = auto couple.
- Measure the maximum width of the emission that is constrained by the frequencies associated with the two amplitude points (upper and lower) that are attenuated by 6 dB relative to the maximum level measured in the fundamental emission.

6.4 Frequency Stability

6.4.1 Test Setup

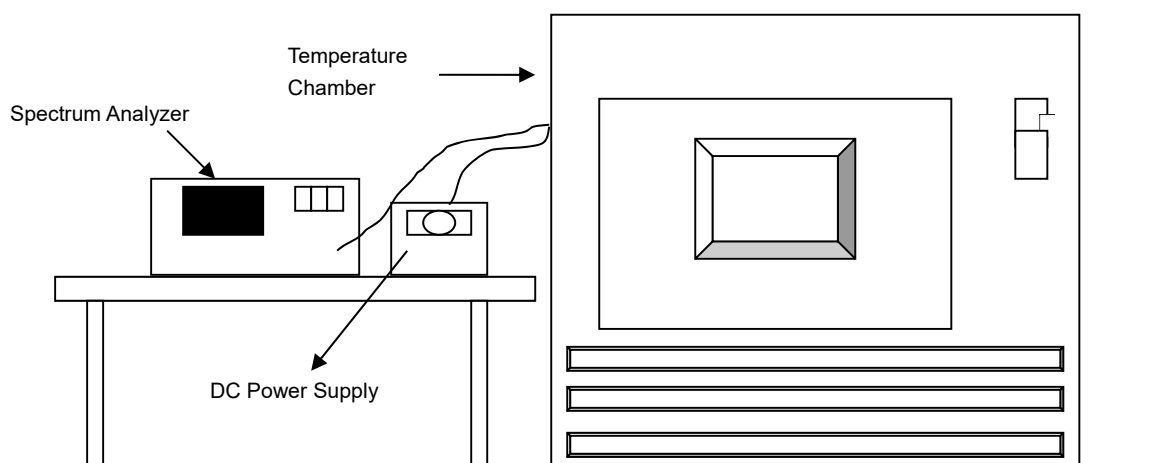

6.4.2 Test Procedure

- The EUT was placed inside the environmental test chamber and powered by nominal DC voltage.
- Turn the EUT on and couple its output to a spectrum analyzer.
- Turn the EUT off and set the chamber to the highest temperature specified.
- Allow sufficient time (approximately 30 min) for the temperature of the chamber to stabilize, turn the EUT on and measure the operating frequency after 2, 5, and 10 Minutes.
- Repeat step (d) with the temperature chamber set to the next desired temperature until measurements down to the lowest specified temperature have been completed.
- The test chamber was allowed to stabilize at +20 degree C for a minimum of 30 Minutes. The supply voltage was then adjusted on the EUT from 85% to 115% and the frequency record.

6.5 AC Power Conducted Emissions

6.5.1 Test Setup

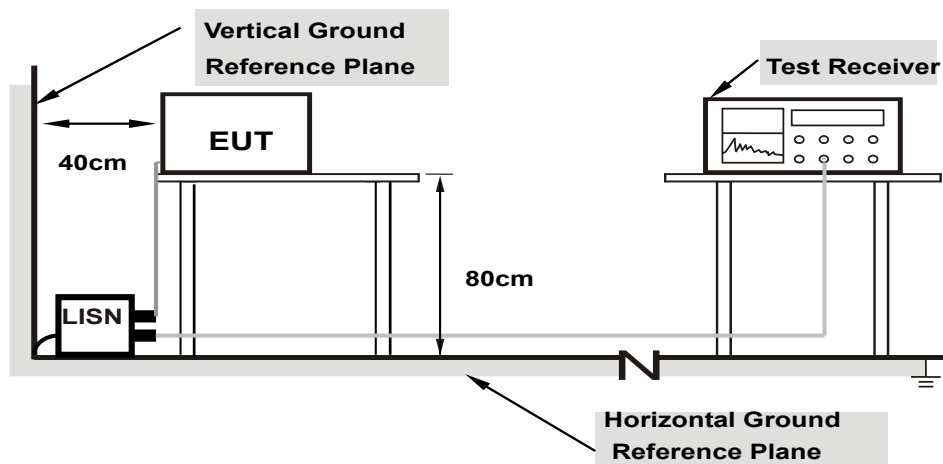

Note: 1. Support units were connected to second LISN.

For the actual test configuration, please refer to the attached file (Test Setup Photo).

6.5.2 Test Procedure

- The EUT was placed on a 0.8 meter to the top of table and placed 0.4 meters from the conducting wall of the shielded room with EUT being connected to the power mains through a line impedance stabilization network (LISN). Other support units were connected to the power mains through another LISN. The two LISNs provide 50 ohm/ 50 uH of coupling impedance for the measuring instrument.
- Both lines of the power mains connected to the EUT were checked for maximum conducted interference.
- The frequency range from 150 kHz to 30 MHz was searched. Emission levels under (Limit – 20 dB) was not recorded.

Note: The resolution bandwidth and video bandwidth of test receiver is 9 kHz for quasi-peak detection (QP) and average detection (AV) at frequency 0.15 MHz-30 MHz.

6.6 Unwanted Emissions below 1 GHz

6.6.1 Test Setup

For Radiated emission below 30 MHz

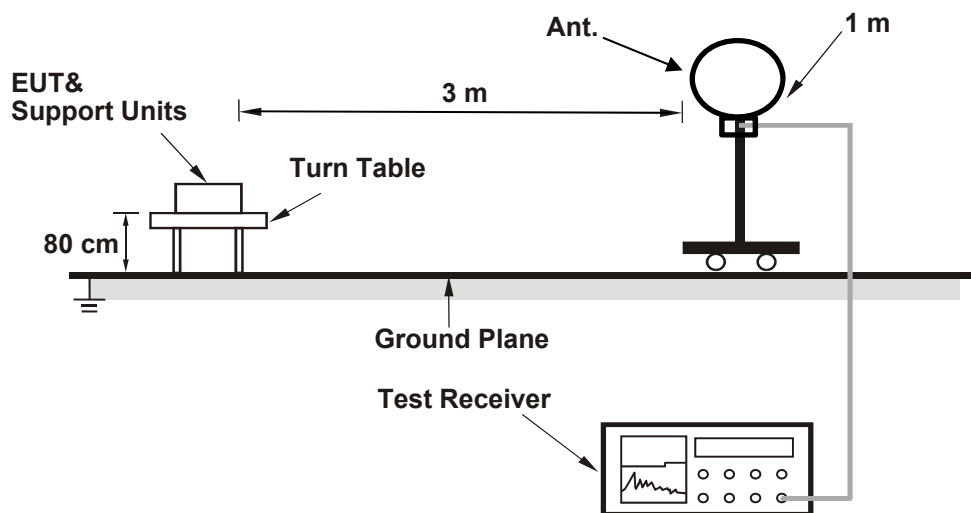

For Radiated emission above 30 MHz

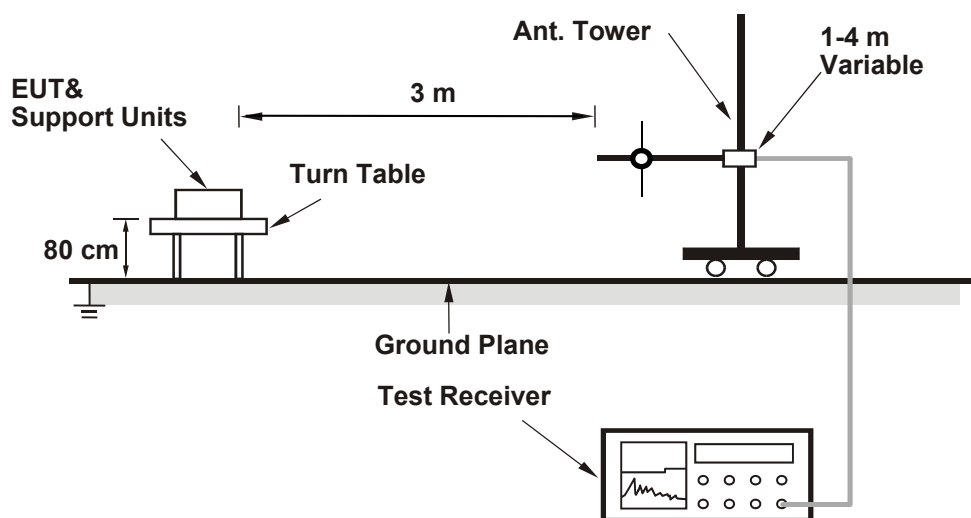

For the actual test configuration, please refer to the attached file (Test Setup Photo).

6.6.2 Test Procedure

For Radiated emission below 30 MHz

- a. The EUT was placed on the top of a rotating table 0.8 meters above the ground at 3 meter chamber room for test. The table was rotated 360 degrees to determine the position of the highest radiation.
- b. The EUT was set 3 meters away from the interference-receiving antenna, which was mounted on the top of a variable-height antenna tower.
- c. Parallel, perpendicular, and ground-parallel orientations of the antenna are set to make the measurement.
- d. For each suspected emission, the EUT was arranged to its worst case and the rotatable table was turned from 0 degrees to 360 degrees to find the maximum reading.
- e. The test-receiver system was set to Quasi-Peak Detect Function and Specified Bandwidth with Maximum Hold Mode, except for the frequency band (9 kHz to 90 kHz and 110 kHz to 490 kHz) set to average detect function and peak detect function.

Notes:

1. The resolution bandwidth and video bandwidth of test receiver/spectrum analyzer is 200 Hz at frequency below 150 kHz.
2. The resolution bandwidth and video bandwidth of test receiver/spectrum analyzer is 9 kHz or 10 kHz at frequency (150 kHz to 30 MHz).
3. All modes of operation were investigated and the worst-case emissions are reported.

For Radiated emission above 30 MHz

- a. The EUT was placed on the top of a rotating table 0.8 meters above the ground at 3 meter chamber room for test. The table was rotated 360 degrees to determine the position of the highest radiation.
- b. The EUT was set 3 meters away from the interference-receiving antenna, which was mounted on the top of a variable-height antenna tower.
- c. The height of antenna is varied from one meter to four meters above the ground to determine the maximum value of the field strength. Both horizontal and vertical polarizations of the antenna are set to make the measurement.
- d. For each suspected emission, the EUT was arranged to its worst case and then the antenna was tuned to heights from 1 meter to 4 meters and the rotatable table was turned from 0 degrees to 360 degrees to find the maximum reading.
- e. The test-receiver system was set to quasi-peak detect function and specified bandwidth with maximum hold mode when the test frequency is below 1 GHz.

Notes:

1. The resolution bandwidth and video bandwidth of test receiver/spectrum analyzer is 120 kHz for Quasi-peak detection (QP) at frequency below 1 GHz.
2. All modes of operation were investigated and the worst-case emissions are reported.

6.7 Unwanted Emissions above 1 GHz

6.7.1 Test Setup

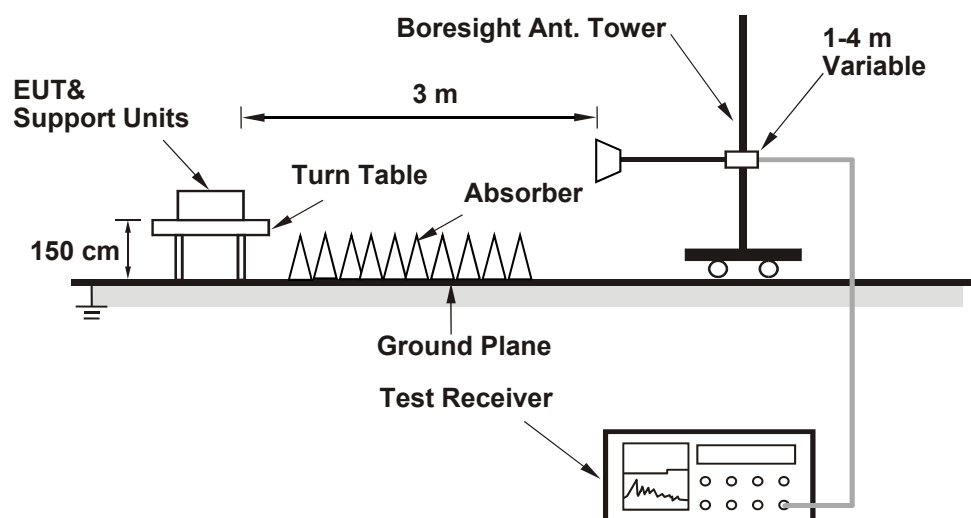

For the actual test configuration, please refer to the attached file (Test Setup Photo).

6.7.2 Test Procedure

- The EUT was placed on the top of a rotating table 1.5 meters above the ground at 3 meter chamber room for test. The table was rotated 360 degrees to determine the position of the highest radiation.
- The EUT was set 3 meters away from the interference-receiving antenna, which was mounted on the top of a variable-height antenna tower.
- The height of antenna is varied from one meter to four meters above the ground to determine the maximum value of the field strength. Both horizontal and vertical polarizations of the antenna are set to make the measurement.
- For each suspected emission, the EUT was arranged to its worst case and then the antenna was tuned to heights from 1 meter to 4 meters and the rotatable table was turned from 0 degrees to 360 degrees to find the maximum reading.
- The test-receiver system was set to peak and average detects function and specified bandwidth with maximum hold mode when the test frequency is above 1 GHz. If the peak reading value also meets average limit, measurement with the average detector is unnecessary.

Notes:

- The resolution bandwidth of test receiver/spectrum analyzer is 1 MHz and the video bandwidth is 3 MHz for Peak detection (PK) and Average detection (AV) at frequency above 1 GHz.
- For fundamental and harmonic signal measurement, the resolution bandwidth of test receiver/spectrum analyzer is 1 MHz and the video bandwidth is $\geq 1/T$ (Duty cycle $< 98\%$) or 10 Hz (Duty cycle $\geq 98\%$) for Average detection (AV) at frequency above 1 GHz.
- All modes of operation were investigated and the worst-case emissions are reported.

7 Test Results of Test Item

7.1 RF Output Power

Input Power:	3.3 Vdc	Environmental Conditions:	25°C, 60% RH	Tested By:	Katina Lu
--------------	---------	---------------------------	--------------	------------	-----------

802.11a

Chan.	Chan. Freq. (MHz)	Average Power (mW)	Average Power (dBm)	Antenna Gain (dBi)	EIRP (mW)	EIRP (dBm)	EIRP Limit (dBm)	Test Result
169	5845	88.105	19.45	5	278.612	24.45	30	Pass
173	5865	89.536	19.52	5	283.138	24.52	30	Pass
177	5885	87.902	19.44	5	277.971	24.44	30	Pass

Note: The antenna gain is 5 dBi

802.11ac (VHT20)

Chan.	Chan. Freq. (MHz)	Average Power (mW)	Average Power (dBm)	Antenna Gain (dBi)	EIRP (mW)	EIRP (dBm)	EIRP Limit (dBm)	Test Result
169	5845	102.094	20.09	5	322.85	25.09	30	Pass
173	5865	101.391	20.06	5	320.626	25.06	30	Pass
177	5885	103.992	20.17	5	328.852	25.17	30	Pass

Note: The antenna gain is 5 dBi

802.11ac (VHT40)

Chan.	Chan. Freq. (MHz)	Average Power (mW)	Average Power (dBm)	Antenna Gain (dBi)	EIRP (mW)	EIRP (dBm)	EIRP Limit (dBm)	Test Result
167	5835	231.739	23.65	5	732.823	28.65	30	Pass
175	5875	225.944	23.54	5	714.498	28.54	30	Pass

Note: The antenna gain is 5 dBi

802.11ac (VHT80)

Chan.	Chan. Freq. (MHz)	Average Power (mW)	Average Power (dBm)	Antenna Gain (dBi)	EIRP (mW)	EIRP (dBm)	EIRP Limit (dBm)	Test Result
171	5855	100.925	20.04	5	319.153	25.04	30	Pass

Note: The antenna gain is 5 dBi

802.11ax (HE20)

Chan.	Chan. Freq. (MHz)	Average Power (mW)	Average Power (dBm)	Antenna Gain (dBi)	EIRP (mW)	EIRP (dBm)	EIRP Limit (dBm)	Test Result
169	5845	105.196	20.22	5	332.659	25.22	30	Pass
173	5865	106.17	20.26	5	335.739	25.26	30	Pass
177	5885	108.893	20.37	5	344.35	25.37	30	Pass

Note: The antenna gain is 5 dBi

802.11ax (HE40)

Chan.	Chan. Freq. (MHz)	Average Power (mW)	Average Power (dBm)	Antenna Gain (dBi)	EIRP (mW)	EIRP (dBm)	EIRP Limit (dBm)	Test Result
167	5835	237.684	23.76	5	751.623	28.76	30	Pass
175	5875	232.809	23.67	5	736.207	28.67	30	Pass

Note: The antenna gain is 5 dBi

802.11ax (HE80)

Chan.	Chan. Freq. (MHz)	Average Power (mW)	Average Power (dBm)	Antenna Gain (dBi)	EIRP (mW)	EIRP (dBm)	EIRP Limit (dBm)	Test Result
171	5855	103.514	20.15	5	327.34	25.15	30	Pass

Note: The antenna gain is 5 dBi

802.11ax (HE) 26-tone RU

Chan.	Chan. Freq. (MHz)	Average Power (mW)	Average Power (dBm)	Antenna Gain (dBi)	EIRP (mW)	EIRP (dBm)	EIRP Limit (dBm)	Test Result
169	5845	16.444	12.16	5	52	17.16	30	Pass
173	5865	17.179	12.35	5	54.325	17.35	30	Pass
177	5885	14.521	11.62	5	45.919	16.62	30	Pass

Note: The antenna gain is 5 dBi

802.11ax (HE) 52-tone RU

Chan.	Chan. Freq. (MHz)	Average Power (mW)	Average Power (dBm)	Antenna Gain (dBi)	EIRP (mW)	EIRP (dBm)	EIRP Limit (dBm)	Test Result
169	5845	31.333	14.96	5	99.084	19.96	30	Pass
173	5865	30.061	14.78	5	95.061	19.78	30	Pass
177	5885	28.774	14.59	5	90.991	19.59	30	Pass

Note: The antenna gain is 5 dBi

802.11ax (HE) 106-tone RU

Chan.	Chan. Freq. (MHz)	Average Power (mW)	Average Power (dBm)	Antenna Gain (dBi)	EIRP (mW)	EIRP (dBm)	EIRP Limit (dBm)	Test Result
169	5845	59.156	17.72	5	187.068	22.72	30	Pass
173	5865	56.754	17.54	5	179.472	22.54	30	Pass
177	5885	49.204	16.92	5	155.597	21.92	30	Pass

Note: The antenna gain is 5 dBi

7.2 Power Spectral Density

Input Power:	3.3 Vdc	Environmental Conditions:	25°C, 60% RH	Tested By:	Katina Lu
--------------	---------	---------------------------	--------------	------------	-----------

802.11a

Chan.	Chan. Freq. (MHz)	PSD (dBm/300kHz)	PSD (dBm/MHz)	Antenna Gain (dBi)	EIRP PSD (dBm/MHz)	EIRP PSD Limit (dBm/MHz)	Test Result
169	5845	3.52	8.75	5	13.75	14	Pass
173	5865	3.62	8.85	5	13.85	14	Pass
177	5885	3.54	8.77	5	13.77	14	Pass

Note: The antenna gain is 5 dBi

802.11ax (HE20)

Chan.	Chan. Freq. (MHz)	PSD (dBm/300kHz)	PSD (dBm/MHz)	Antenna Gain (dBi)	EIRP PSD (dBm/MHz)	EIRP PSD Limit (dBm/MHz)	Test Result
169	5845	3.62	8.85	5	13.85	14	Pass
173	5865	3.68	8.91	5	13.91	14	Pass
177	5885	3.67	8.90	5	13.9	14	Pass

Note: The antenna gain is 5 dBi

802.11ax (HE40)

Chan.	Chan. Freq. (MHz)	PSD (dBm/300kHz)	PSD (dBm/MHz)	Antenna Gain (dBi)	EIRP PSD (dBm/MHz)	EIRP PSD Limit (dBm/MHz)	Test Result
167	5835	3.65	8.88	5	13.88	14	Pass
175	5875	3.52	8.75	5	13.75	14	Pass

Note: The antenna gain is 5 dBi

802.11ax (HE80)

Chan.	Chan. Freq. (MHz)	PSD w/o Duty Factor (dBm/300kHz)	Duty Factor (dB)	PSD (dBm/MHz)	Antenna Gain (dBi)	EIRP PSD (dBm/MHz)	EIRP PSD Limit (dBm/MHz)	Test Result
171	5855	-3.25	0.1	2.08	5	7.08	14	Pass

Note: The antenna gain is 5 dBi

802.11ax (HE) 26-tone RU

Chan.	Chan. Freq. (MHz)	PSD (dBm/300kHz)	PSD (dBm/MHz)	Antenna Gain (dBi)	EIRP PSD (dBm/MHz)	EIRP PSD Limit (dBm/MHz)	Test Result
169	5845	3.6	8.83	5	13.83	14	Pass
173	5865	3.74	8.97	5	13.97	14	Pass
177	5885	3.72	8.95	5	13.95	14	Pass

Note: The antenna gain is 5 dBi

802.11ax (HE) 52-tone RU

Chan.	Chan. Freq. (MHz)	PSD (dBm/300kHz)	PSD (dBm/MHz)	Antenna Gain (dBi)	EIRP PSD (dBm/MHz)	EIRP PSD Limit (dBm/MHz)	Test Result
169	5845	3.6	8.83	5	13.83	14	Pass
173	5865	3.6	8.83	5	13.83	14	Pass
177	5885	3.7	8.93	5	13.93	14	Pass

Note: The antenna gain is 5 dBi

802.11ax (HE) 106-tone RU

Chan.	Chan. Freq. (MHz)	PSD (dBm/300kHz)	PSD (dBm/MHz)	Antenna Gain (dBi)	EIRP PSD (dBm/MHz)	EIRP PSD Limit (dBm/MHz)	Test Result
169	5845	3.7	8.93	5	13.93	14	Pass
173	5865	3.72	8.95	5	13.95	14	Pass
177	5885	3.64	8.87	5	13.87	14	Pass

Note: The antenna gain is 5 dBi

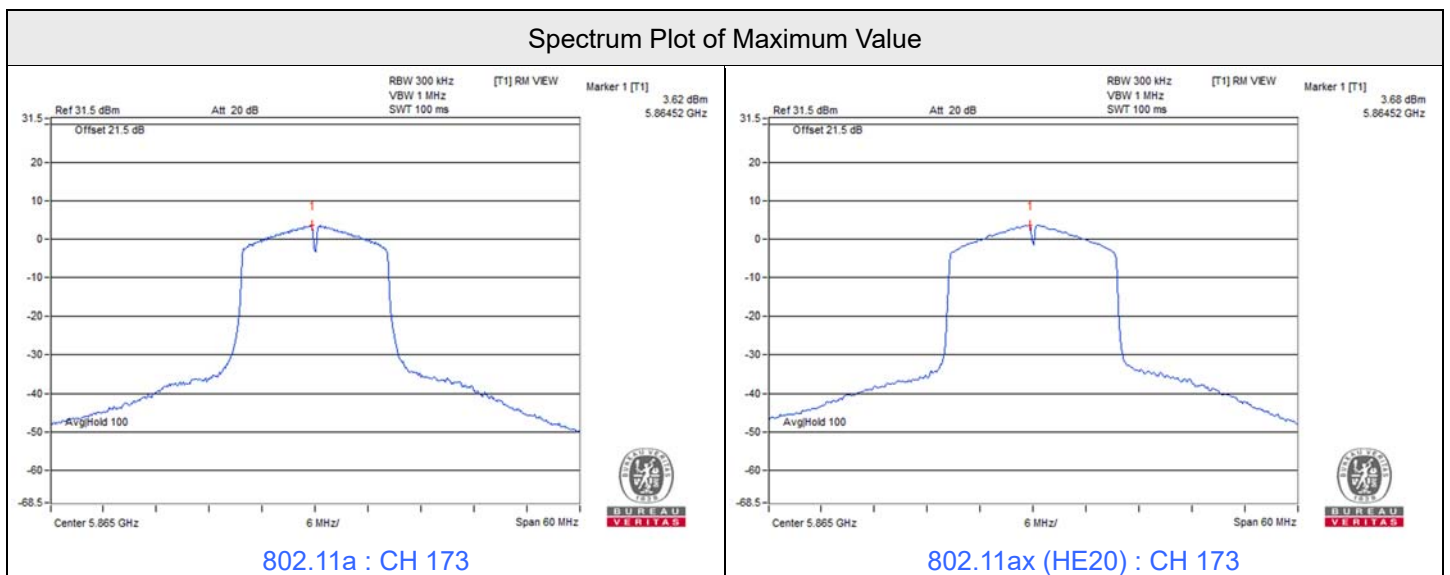

Spectrum Plot of Maximum Value

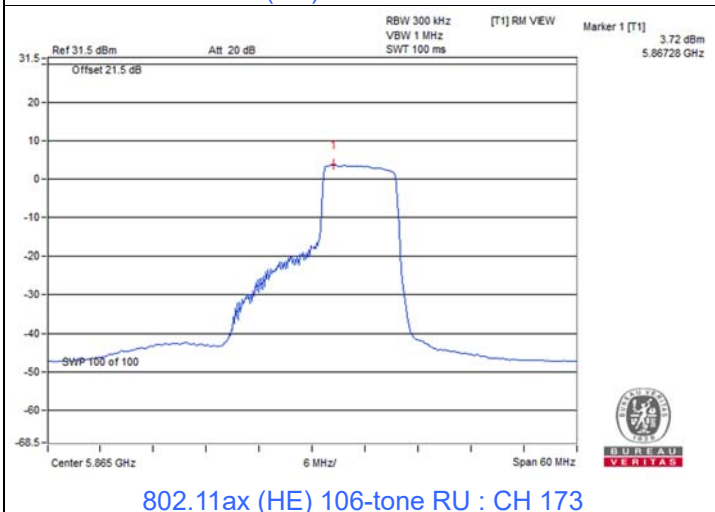
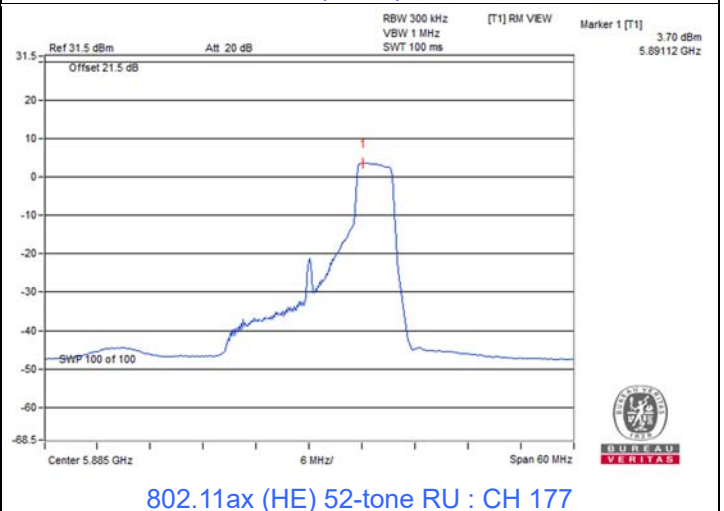
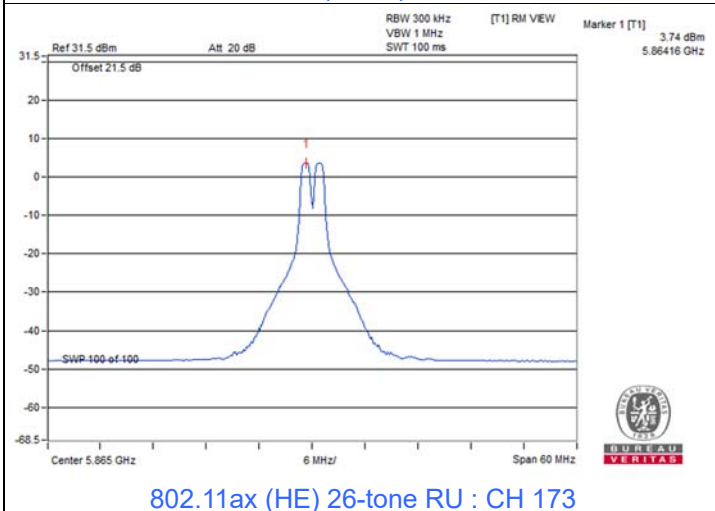
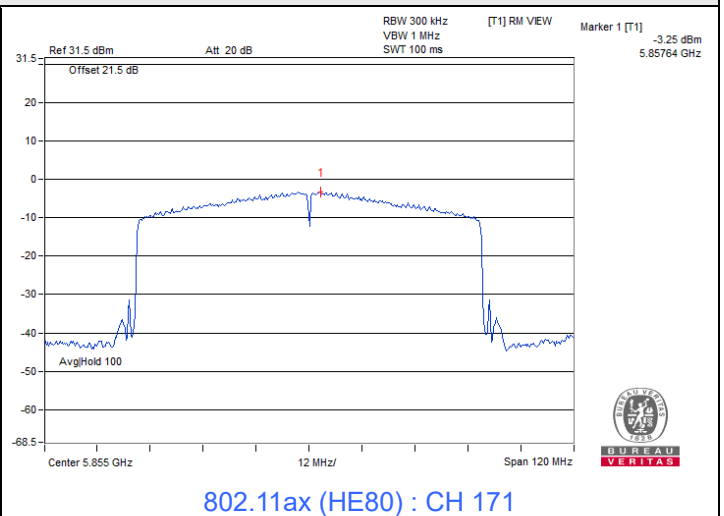
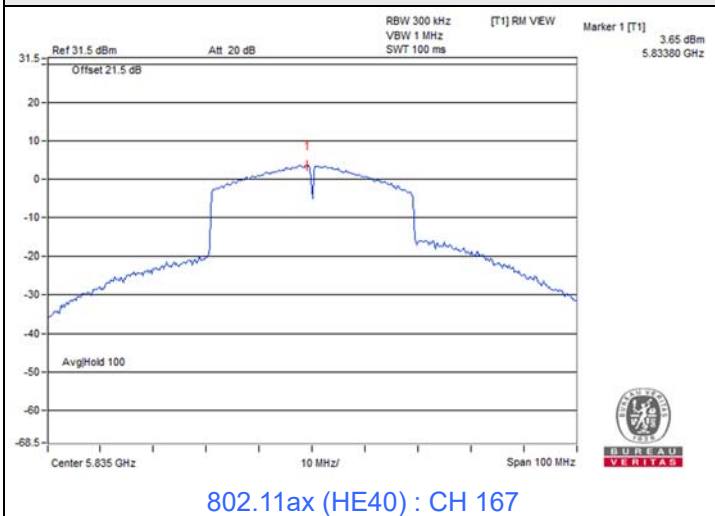

7.3 6 dB Bandwidth

Input Power:	3.3 Vdc	Environmental Conditions:	25°C, 60% RH	Tested By:	Katina Lu
--------------	---------	---------------------------	--------------	------------	-----------

802.11a

Channel	Frequency (MHz)	6dB Bandwidth (MHz)	Minimum Limit (MHz)	Test Result
169	5845	15.13	0.5	Pass
173	5865	15.13	0.5	Pass
177	5885	15.13	0.5	Pass

802.11ax (HE20)

Channel	Frequency (MHz)	6dB Bandwidth (MHz)	Minimum Limit (MHz)	Test Result
169	5845	15.15	0.5	Pass
173	5865	15.14	0.5	Pass
177	5885	15.14	0.5	Pass

802.11ax (HE40)

Channel	Frequency (MHz)	6dB Bandwidth (MHz)	Minimum Limit (MHz)	Test Result
167	5835	33.84	0.5	Pass
175	5875	32.66	0.5	Pass

802.11ax (HE80)

Channel	Frequency (MHz)	6dB Bandwidth (MHz)	Minimum Limit (MHz)	Test Result
171	5855	71.42	0.5	Pass

802.11ax (HE) 26-tone RU

Channel	Frequency (MHz)	6dB Bandwidth (MHz)	Minimum Limit (MHz)	Test Result
169	5845	14.52	0.5	Pass
173	5865	2.66	0.5	Pass
177	5885	15.79	0.5	Pass



802.11ax (HE) 52-tone RU

Channel	Frequency (MHz)	6dB Bandwidth (MHz)	Minimum Limit (MHz)	Test Result
169	5845	17.01	0.5	Pass
173	5865	13.81	0.5	Pass
177	5885	17.01	0.5	Pass

802.11ax (HE) 106-tone RU

Channel	Frequency (MHz)	6dB Bandwidth (MHz)	Minimum Limit (MHz)	Test Result
169	5845	17.14	0.5	Pass
173	5865	17.19	0.5	Pass
177	5885	17.19	0.5	Pass

Spectrum Plot of Minimum Value

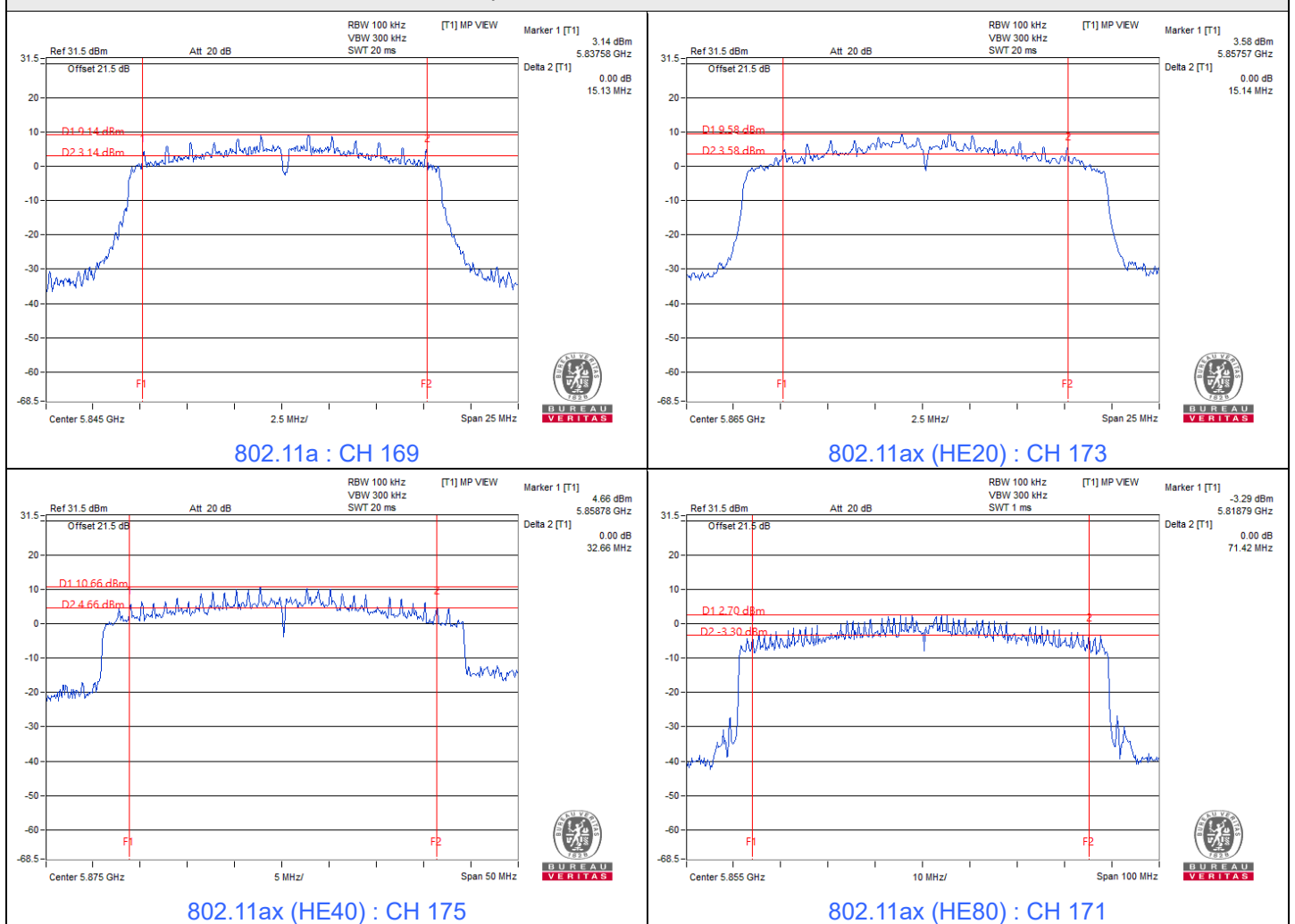

Spectrum Plot of Minimum Value

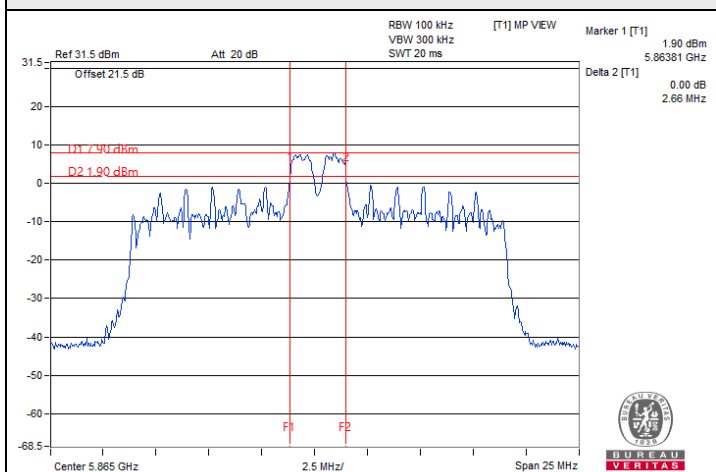

802.11ax (HE) 26-tone RU : CH 173

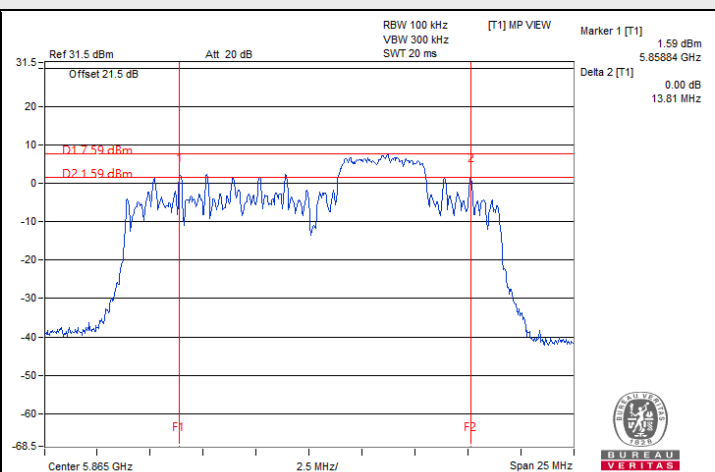

802.11ax (HE) 52-tone RU : CH 173

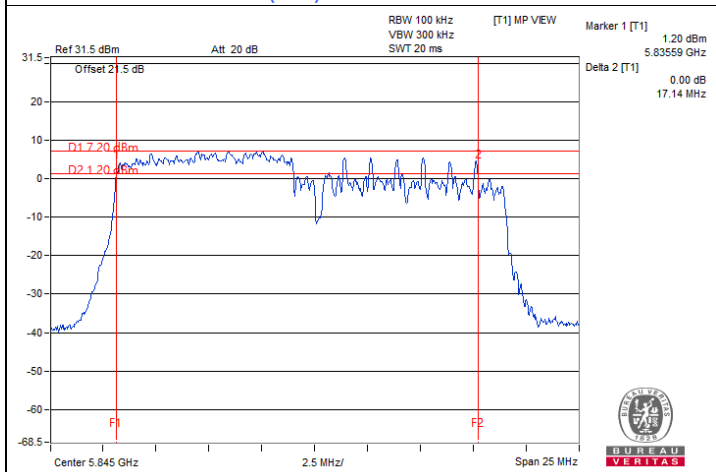

802.11ax (HE) 106-tone RU : CH 169

7.4 Frequency Stability

Input Power:	3.3 Vdc	Environmental Conditions:	25°C, 60% RH	Tested By:	Katina Lu
--------------	---------	---------------------------	--------------	------------	-----------

802.11a

Frequency Stability Versus Temperature									
Operating Frequency: 5865 MHz									
Temp. (°C)	Power Supply (Vdc)	0 Minute		2 Minutes		5 Minutes		10 Minutes	
		Measured Frequency (MHz)	Test Result	Measured Frequency (MHz)	Test Result	Measured Frequency (MHz)	Test Result	Measured Frequency (MHz)	Test Result
50	3.3	5865.0068	Pass	5865.0087	Pass	5865.0091	Pass	5865.0035	Pass
40	3.3	5865.0206	Pass	5865.0223	Pass	5865.0215	Pass	5865.0197	Pass
30	3.3	5865.0224	Pass	5865.0188	Pass	5865.022	Pass	5865.0226	Pass
20	3.3	5864.9809	Pass	5864.9833	Pass	5864.9789	Pass	5864.9834	Pass
10	3.3	5864.9997	Pass	5865.0023	Pass	5865.0021	Pass	5864.9994	Pass
0	3.3	5865.0119	Pass	5865.0103	Pass	5865.0107	Pass	5865.0078	Pass
-10	3.3	5864.9692	Pass	5864.9685	Pass	5864.9705	Pass	5864.9702	Pass
-20	3.3	5865.0182	Pass	5865.0209	Pass	5865.02	Pass	5865.0196	Pass
-30	3.3	5865.0106	Pass	5865.0122	Pass	5865.0147	Pass	5865.0133	Pass

Frequency Stability Versus Voltage									
Operating Frequency: 5865 MHz									
Temp. (°C)	Power Supply (Vdc)	0 Minute		2 Minutes		5 Minutes		10 Minutes	
		Measured Frequency (MHz)	Test Result	Measured Frequency (MHz)	Test Result	Measured Frequency (MHz)	Test Result	Measured Frequency (MHz)	Test Result
20	3.795	5864.9833	Pass	5864.9828	Pass	5864.9861	Pass	5864.9863	Pass
	3.3	5864.9809	Pass	5864.9833	Pass	5864.9789	Pass	5864.9834	Pass
	2.805	5864.9767	Pass	5864.9773	Pass	5864.9782	Pass	5864.977	Pass

7.5 AC Power Conducted Emissions

Mode B

RF Mode	802.11ax (HE40)	Channel	CH 167 : 5835 MHz
Frequency Range	150kHz ~ 30MHz	Detector Function & Resolution Bandwidth	Quasi-Peak (QP) / Average (AV), 9 kHz
Input Power (System)	120 Vac, 60 Hz	Environmental Conditions	23°C, 71% RH
Tested By	Sampson Chen		

Phase Of Power : Line (L)										
No	Frequency (MHz)	Correction Factor (dB)	Reading Value (dBuV)		Emission Level (dBuV)		Limit (dBuV)		Margin (dB)	
			Q.P.	AV.	Q.P.	AV.	Q.P.	AV.	Q.P.	AV.
1	0.18516	9.96	44.53	28.78	54.49	38.74	64.25	54.25	-9.76	-15.51
2	0.25547	9.96	33.56	14.61	43.52	24.57	61.58	51.58	-18.06	-27.01
3	0.32578	9.97	25.03	7.91	35.00	17.88	59.56	49.56	-24.56	-31.68
4	3.91406	10.15	29.69	21.63	39.84	31.78	56.00	46.00	-16.16	-14.22
5	5.24219	10.22	25.07	16.34	35.29	26.56	60.00	50.00	-24.71	-23.44
6	28.30469	11.23	31.72	26.47	42.95	37.70	60.00	50.00	-17.05	-12.30

Remarks:

1. Q.P. and AV. are abbreviations of quasi-peak and average individually.
2. The emission levels of other frequencies were very low against the limit.
3. Margin value = Emission level – Limit value
4. Correction factor = Insertion loss + Cable loss
5. Emission Level = Correction Factor + Reading Value

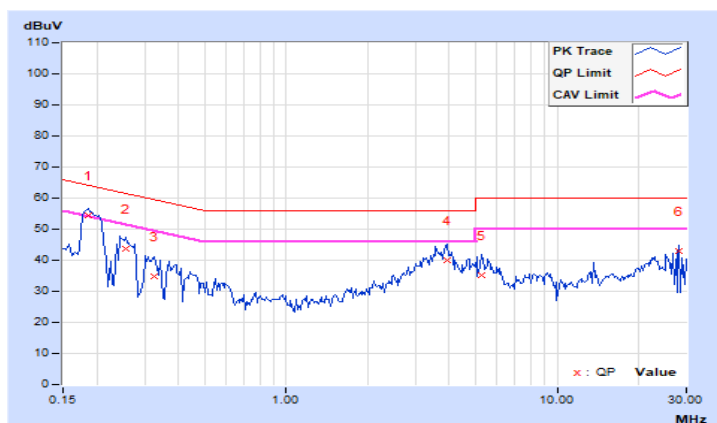

RF Mode	802.11ax (HE40)	Channel	CH 167 : 5835 MHz
Frequency Range	150kHz ~ 30MHz	Detector Function & Resolution Bandwidth	Quasi-Peak (QP) / Average (AV), 9 kHz
Input Power (System)	120 Vac, 60 Hz	Environmental Conditions	23°C, 71% RH
Tested By	Sampson Chen		

Phase Of Power : Neutral (N)										
No	Frequency (MHz)	Correction Factor (dB)	Reading Value (dBuV)		Emission Level (dBuV)		Limit (dBuV)		Margin (dB)	
			Q.P.	AV.	Q.P.	AV.	Q.P.	AV.	Q.P.	AV.
1	0.18906	9.94	44.03	28.80	53.97	38.74	64.08	54.08	-10.11	-15.34
2	0.24375	9.94	35.94	18.48	45.88	28.42	61.97	51.97	-16.09	-23.55
3	0.32188	9.94	26.81	6.89	36.75	16.83	59.66	49.66	-22.91	-32.83
4	4.05469	10.10	29.31	20.68	39.41	30.78	56.00	46.00	-16.59	-15.22
5	14.00391	10.56	21.59	10.48	32.15	21.04	60.00	50.00	-27.85	-28.96
6	28.27313	10.87	31.46	28.73	42.33	39.60	60.00	50.00	-17.67	-10.40

Remarks:

1. Q.P. and AV. are abbreviations of quasi-peak and average individually.
2. The emission levels of other frequencies were very low against the limit.
3. Margin value = Emission level – Limit value
4. Correction factor = Insertion loss + Cable loss
5. Emission Level = Correction Factor + Reading Value

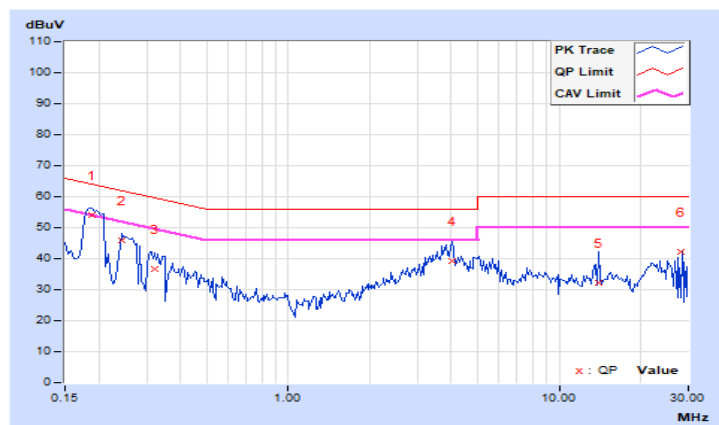

7.6 Unwanted Emissions below 1 GHz

Mode A

RF Mode	802.11ax (HE40)	Channel	CH 167 : 5835 MHz
Frequency Range	30 MHz ~ 1 GHz	Detector Function & Bandwidth	(QP) RB = 120kHz
Input Power (System)	120 Vac, 60 Hz	Environmental Conditions	28°C, 76% RH
Tested By	Louis Yang		

Antenna Polarity & Test Distance : Horizontal at 3 m

No	Frequency (MHz)	Emission Level (dBuV/m)	Limit (dBuV/m)	Margin (dB)	Antenna Height (m)	Table Angle (Degree)	Raw Value (dBuV)	Correction Factor (dB/m)
1	40.00	28.9 QP	40.0	-11.1	1.12 H	360	42.1	-13.2
2	75.80	18.8 QP	40.0	-21.2	1.00 H	325	35.2	-16.4
3	231.50	31.5 QP	46.0	-14.5	1.52 H	360	46.8	-15.3
4	274.10	27.9 QP	46.0	-18.1	1.50 H	74	40.9	-13.0
5	381.00	19.2 QP	46.0	-26.8	1.05 H	360	29.6	-10.4
6	449.40	23.2 QP	46.0	-22.8	1.00 H	122	31.4	-8.2

Remarks:

1. Emission Level(dBuV/m) = Raw Value(dBuV) + Correction Factor(dB/m)
2. Correction Factor(dB/m) = Antenna Factor(dB/m) + Cable Factor(dB) – Pre-Amplifier Factor(dB)
3. Margin value = Emission Level – Limit value
4. The other emission levels were very low against the limit of frequency range 30 MHz ~ 1 GHz.
5. The emission levels were very low against the limit of frequency range 9 kHz ~ 30 MHz: the amplitude of spurious emissions attenuated more than 20 dB below the permissible value to be report.

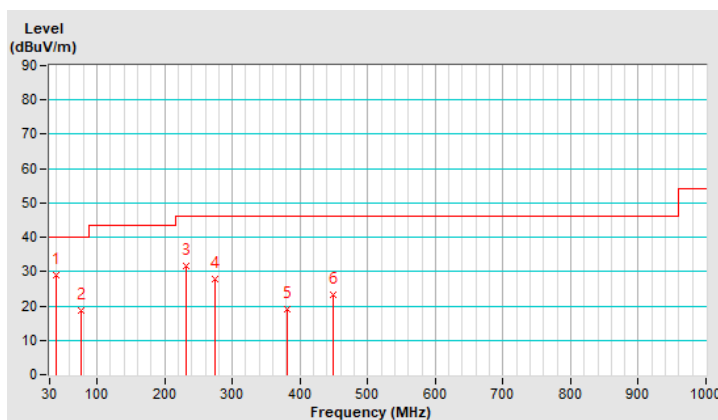

RF Mode	802.11ax (HE40)	Channel	CH 167 : 5835 MHz
Frequency Range	30 MHz ~ 1 GHz	Detector Function & Bandwidth	(QP) RB = 120kHz
Input Power (System)	120 Vac, 60 Hz	Environmental Conditions	28°C, 76% RH
Tested By	Louis Yang		

Antenna Polarity & Test Distance : Vertical at 3 m								
No	Frequency (MHz)	Emission Level (dBuV/m)	Limit (dBuV/m)	Margin (dB)	Antenna Height (m)	Table Angle (Degree)	Raw Value (dBuV)	Correction Factor (dB/m)
1	38.00	25.0 QP	40.0	-15.0	1.05 V	62	38.3	-13.3
2	136.20	25.2 QP	43.5	-18.3	1.00 V	325	38.6	-13.4
3	172.20	22.6 QP	43.5	-20.9	1.00 V	299	36.1	-13.5
4	234.10	32.3 QP	46.0	-13.7	1.00 V	172	47.2	-14.9
5	361.40	27.6 QP	46.0	-18.4	1.00 V	38	38.6	-11.0
6	632.40	26.4 QP	46.0	-19.6	1.12 V	355	31.1	-4.7

Remarks:

1. Emission Level(dBuV/m) = Raw Value(dBuV) + Correction Factor(dB/m)
2. Correction Factor(dB/m) = Antenna Factor(dB/m) + Cable Factor(dB) – Pre-Amplifier Factor(dB)
3. Margin value = Emission Level – Limit value
4. The other emission levels were very low against the limit of frequency range 30 MHz ~ 1 GHz.
5. The emission levels were very low against the limit of frequency range 9 kHz ~ 30 MHz: the amplitude of spurious emissions attenuated more than 20 dB below the permissible value to be report.

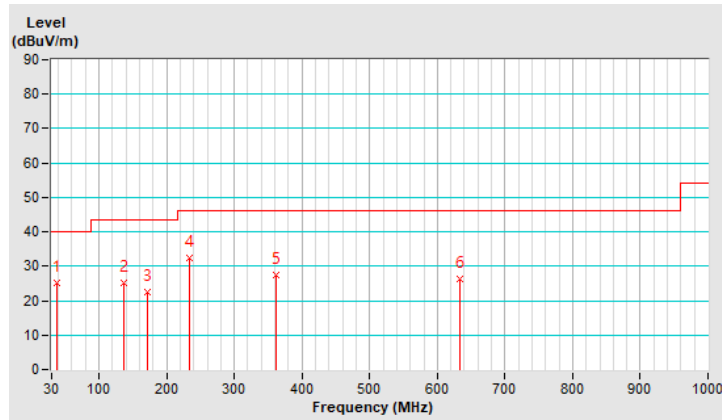

Mode B

RF Mode	802.11ax (HE40)	Channel	CH 167 : 5835 MHz
Frequency Range	30 MHz ~ 1 GHz	Detector Function & Bandwidth	(QP) RB = 120kHz
Input Power (System)	120 Vac, 60 Hz	Environmental Conditions	28°C, 76% RH
Tested By	Louis Yang		

Antenna Polarity & Test Distance : Horizontal at 3 m

No	Frequency (MHz)	Emission Level (dBuV/m)	Limit (dBuV/m)	Margin (dB)	Antenna Height (m)	Table Angle (Degree)	Raw Value (dBuV)	Correction Factor (dB/m)
1	40.80	29.4 QP	40.0	-10.6	1.12 H	360	42.4	-13.0
2	76.70	18.8 QP	40.0	-21.2	1.00 H	325	35.5	-16.7
3	231.10	29.4 QP	46.0	-16.6	1.52 H	360	44.7	-15.3
4	283.00	29.1 QP	46.0	-16.9	1.50 H	74	41.8	-12.7
5	381.60	19.5 QP	46.0	-26.5	1.05 H	360	29.9	-10.4
6	451.00	22.5 QP	46.0	-23.5	1.00 H	122	30.7	-8.2

Remarks:

1. Emission Level(dBuV/m) = Raw Value(dBuV) + Correction Factor(dB/m)
2. Correction Factor(dB/m) = Antenna Factor(dB/m) + Cable Factor(dB) – Pre-Amplifier Factor(dB)
3. Margin value = Emission Level – Limit value
4. The other emission levels were very low against the limit of frequency range 30 MHz ~ 1 GHz.
5. The emission levels were very low against the limit of frequency range 9 kHz ~ 30 MHz: the amplitude of spurious emissions attenuated more than 20 dB below the permissible value to be report.

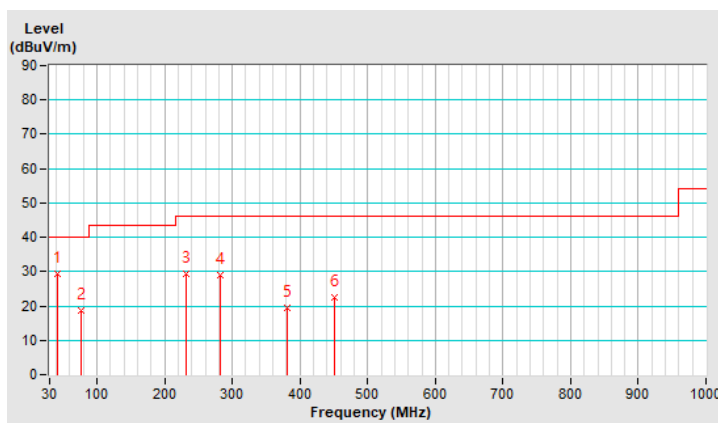

RF Mode	802.11ax (HE40)	Channel	CH 167 : 5835 MHz
Frequency Range	30 MHz ~ 1 GHz	Detector Function & Bandwidth	(QP) RB = 120kHz
Input Power (System)	120 Vac, 60 Hz	Environmental Conditions	28°C, 76% RH
Tested By	Louis Yang		

Antenna Polarity & Test Distance : Vertical at 3 m								
No	Frequency (MHz)	Emission Level (dBuV/m)	Limit (dBuV/m)	Margin (dB)	Antenna Height (m)	Table Angle (Degree)	Raw Value (dBuV)	Correction Factor (dB/m)
1	34.40	22.5 QP	40.0	-17.5	1.05 V	62	36.2	-13.7
2	135.40	24.4 QP	43.5	-19.1	1.00 V	325	37.9	-13.5
3	174.30	19.3 QP	43.5	-24.2	1.00 V	299	32.9	-13.6
4	228.70	31.6 QP	46.0	-14.4	1.00 V	172	47.3	-15.7
5	361.70	21.3 QP	46.0	-24.7	1.00 V	38	32.3	-11.0
6	635.50	22.3 QP	46.0	-23.7	1.12 V	355	27.0	-4.7

Remarks:

1. Emission Level(dBuV/m) = Raw Value(dBuV) + Correction Factor(dB/m)
2. Correction Factor(dB/m) = Antenna Factor(dB/m) + Cable Factor(dB) – Pre-Amplifier Factor(dB)
3. Margin value = Emission Level – Limit value
4. The other emission levels were very low against the limit of frequency range 30 MHz ~ 1 GHz.
5. The emission levels were very low against the limit of frequency range 9 kHz ~ 30 MHz: the amplitude of spurious emissions attenuated more than 20 dB below the permissible value to be report.

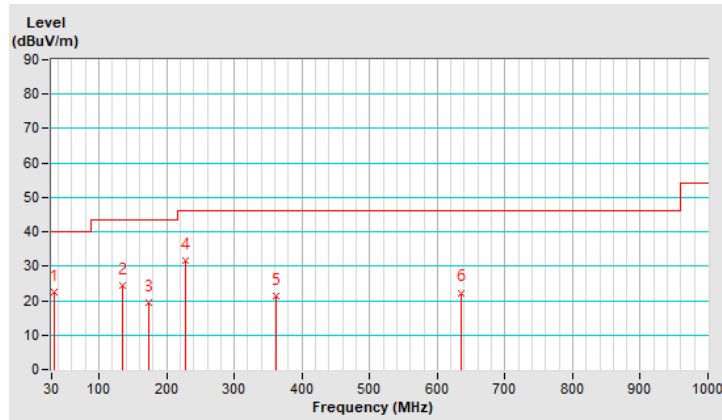

Mode C

RF Mode	802.11ax (HE40)	Channel	CH 167 : 5835 MHz
Frequency Range	30 MHz ~ 1 GHz	Detector Function & Bandwidth	(QP) RB = 120kHz
Input Power (System)	120 Vac, 60 Hz	Environmental Conditions	28°C, 76% RH
Tested By	Louis Yang		

Antenna Polarity & Test Distance : Horizontal at 3 m								
No	Frequency (MHz)	Emission Level (dBuV/m)	Limit (dBuV/m)	Margin (dB)	Antenna Height (m)	Table Angle (Degree)	Raw Value (dBuV)	Correction Factor (dB/m)
1	44.90	31.7 QP	40.0	-8.3	1.12 H	360	44.5	-12.8
2	79.20	20.3 QP	40.0	-19.7	1.00 H	325	37.7	-17.4
3	235.00	32.0 QP	46.0	-14.0	1.52 H	360	46.8	-14.8
4	284.90	32.2 QP	46.0	-13.8	1.50 H	74	44.8	-12.6
5	384.20	22.5 QP	46.0	-23.5	1.05 H	360	32.8	-10.3
6	453.90	25.7 QP	46.0	-20.3	1.00 H	122	33.8	-8.1

Remarks:

1. Emission Level(dBuV/m) = Raw Value(dBuV) + Correction Factor(dB/m)
2. Correction Factor(dB/m) = Antenna Factor(dB/m) + Cable Factor(dB) – Pre-Amplifier Factor(dB)
3. Margin value = Emission Level – Limit value
4. The other emission levels were very low against the limit of frequency range 30 MHz ~ 1 GHz.
5. The emission levels were very low against the limit of frequency range 9 kHz ~ 30 MHz: the amplitude of spurious emissions attenuated more than 20 dB below the permissible value to be report.

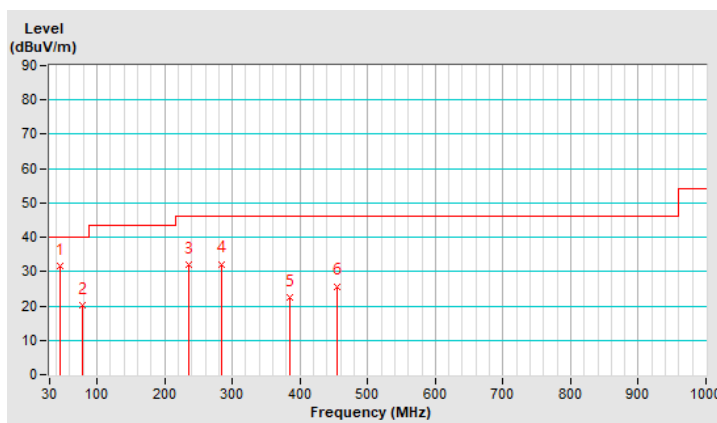

RF Mode	802.11ax (HE40)	Channel	CH 167 : 5835 MHz
Frequency Range	30 MHz ~ 1 GHz	Detector Function & Bandwidth	(QP) RB = 120kHz
Input Power (System)	120 Vac, 60 Hz	Environmental Conditions	28°C, 76% RH
Tested By	Louis Yang		

Antenna Polarity & Test Distance : Vertical at 3 m								
No	Frequency (MHz)	Emission Level (dBuV/m)	Limit (dBuV/m)	Margin (dB)	Antenna Height (m)	Table Angle (Degree)	Raw Value (dBuV)	Correction Factor (dB/m)
1	35.00	23.4 QP	40.0	-16.6	1.05 V	62	36.9	-13.5
2	136.00	25.7 QP	43.5	-17.8	1.00 V	325	39.1	-13.4
3	174.70	19.4 QP	43.5	-24.1	1.00 V	299	33.1	-13.7
4	229.20	32.0 QP	46.0	-14.0	1.00 V	172	47.6	-15.6
5	363.50	20.1 QP	46.0	-25.9	1.00 V	38	31.0	-10.9
6	635.90	22.4 QP	46.0	-23.6	1.12 V	355	27.1	-4.7

Remarks:

1. Emission Level(dBuV/m) = Raw Value(dBuV) + Correction Factor(dB/m)
2. Correction Factor(dB/m) = Antenna Factor(dB/m) + Cable Factor(dB) – Pre-Amplifier Factor(dB)
3. Margin value = Emission Level – Limit value
4. The other emission levels were very low against the limit of frequency range 30 MHz ~ 1 GHz.
5. The emission levels were very low against the limit of frequency range 9 kHz ~ 30 MHz: the amplitude of spurious emissions attenuated more than 20 dB below the permissible value to be report.

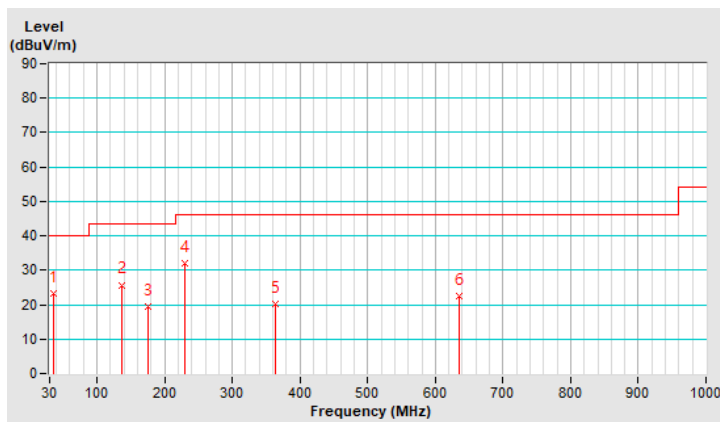

7.7 Unwanted Emissions above 1 GHz

Mode A

RF Mode	802.11a	Channel	CH 169 : 5845 MHz
Frequency Range	1 GHz ~ 40 GHz	Detector Function & Bandwidth	(PK) RB = 1 MHz, VB = 3 MHz (AV) RB = 1 MHz, VB = 10 Hz
Input Power (System)	120 Vac, 60 Hz	Environmental Conditions	28°C, 75% RH
Tested By	Louis Yang		

Antenna Polarity & Test Distance : Horizontal at 3 m								
No	Frequency (MHz)	Emission Level (dBuV/m)	Limit (dBuV/m)	Margin (dB)	Antenna Height (m)	Table Angle (Degree)	Raw Value (dBuV)	Correction Factor (dB/m)
1	#5630.90	49.4 PK	68.2	-18.8	1.14 H	348	48.2	1.2
2	*5845.00	103.8 PK			1.14 H	348	102.0	1.8
3	*5845.00	96.3 AV			1.14 H	348	94.5	1.8
4	#5895.50	60.3 PK	109.8	-49.5	1.14 H	348	58.4	1.9
5	#5895.50	48.2 AV	89.8	-41.6	1.14 H	348	46.3	1.9
6	11690.00	61.0 PK	74.0	-13.0	2.43 H	302	49.3	11.7
7	11690.00	46.6 AV	54.0	-7.4	2.43 H	302	34.9	11.7
8	#17535.00	57.7 PK	88.2	-30.5	3.10 H	288	40.1	17.6
9	#17535.00	43.7 AV	68.2	-24.5	3.10 H	288	26.1	17.6

Remarks:

1. Emission Level(dBuV/m) = Raw Value(dBuV) + Correction Factor(dB/m)
2. Correction Factor(dB/m) = Antenna Factor(dB/m) + Cable Factor(dB) – Pre-Amplifier Factor(dB)
3. Margin value = Emission Level – Limit value
4. The other emission levels were very low against the limit.
5. " * " : Fundamental frequency, the limit was restricted at the RF Output Power.
6. " # " : The radiated frequency is out of the restricted band.

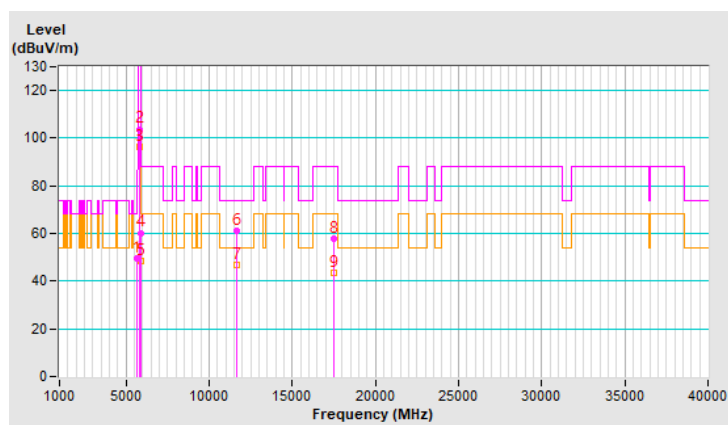

RF Mode	802.11a	Channel	CH 169 : 5845 MHz
Frequency Range	1 GHz ~ 40 GHz	Detector Function & Bandwidth	(PK) RB = 1 MHz, VB = 3 MHz (AV) RB = 1 MHz, VB = 10 Hz
Input Power (System)	120 Vac, 60 Hz	Environmental Conditions	28°C, 75% RH
Tested By	Louis Yang		

Antenna Polarity & Test Distance : Vertical at 3 m								
No	Frequency (MHz)	Emission Level (dBuV/m)	Limit (dBuV/m)	Margin (dB)	Antenna Height (m)	Table Angle (Degree)	Raw Value (dBuV)	Correction Factor (dB/m)
1	#5612.00	51.0 PK	68.2	-17.2	1.78 V	59	49.8	1.2
2	*5845.00	113.9 PK			1.78 V	59	112.1	1.8
3	*5845.00	104.9 AV			1.78 V	59	103.1	1.8
4	#5908.00	68.2 PK	100.7	-32.5	1.78 V	59	66.3	1.9
5	#5908.00	58.7 AV	80.7	-22.0	1.78 V	59	56.8	1.9
6	11690.00	62.0 PK	74.0	-12.0	1.49 V	159	50.3	11.7
7	11690.00	48.2 AV	54.0	-5.8	1.49 V	159	36.5	11.7
8	#17535.00	55.4 PK	88.2	-32.8	1.42 V	316	37.8	17.6
9	#17535.00	41.8 AV	68.2	-26.4	1.42 V	316	24.2	17.6

Remarks:

1. Emission Level(dBuV/m) = Raw Value(dBuV) + Correction Factor(dB/m)
2. Correction Factor(dB/m) = Antenna Factor(dB/m) + Cable Factor(dB) – Pre-Amplifier Factor(dB)
3. Margin value = Emission Level – Limit value
4. The other emission levels were very low against the limit.
5. " * " : Fundamental frequency, the limit was restricted at the RF Output Power.
6. " # " : The radiated frequency is out of the restricted band.

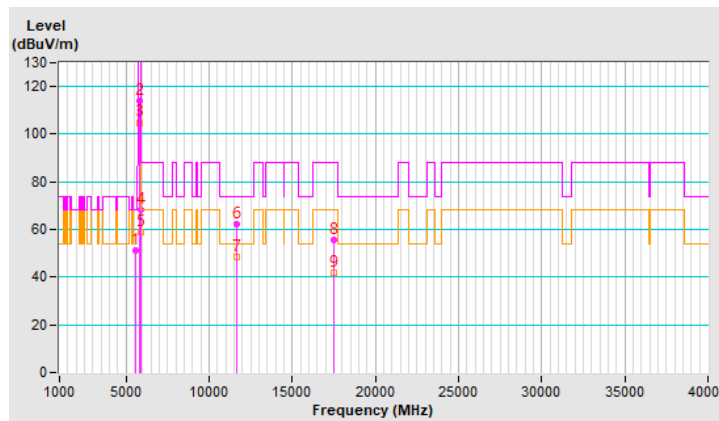

RF Mode	802.11a	Channel	CH 173 : 5865 MHz
Frequency Range	1 GHz ~ 40 GHz	Detector Function & Bandwidth	(PK) RB = 1 MHz, VB = 3 MHz (AV) RB = 1 MHz, VB = 10 Hz
Input Power (System)	120 Vac, 60 Hz	Environmental Conditions	28°C, 75% RH
Tested By	Louis Yang		

Antenna Polarity & Test Distance : Horizontal at 3 m								
No	Frequency (MHz)	Emission Level (dBuV/m)	Limit (dBuV/m)	Margin (dB)	Antenna Height (m)	Table Angle (Degree)	Raw Value (dBuV)	Correction Factor (dB/m)
1	#5650.00	50.4 PK	68.2	-17.8	1.49 H	360	49.1	1.3
2	*5865.00	104.3 PK			1.49 H	360	102.5	1.8
3	*5865.00	96.3 AV			1.49 H	360	94.5	1.8
4	#5895.00	69.8 PK	110.2	-40.4	1.49 H	360	67.9	1.9
5	#5895.00	57.4 AV	90.2	-32.8	1.49 H	360	55.5	1.9
6	11730.00	59.5 PK	74.0	-14.5	2.41 H	303	48.0	11.5
7	11730.00	45.9 AV	54.0	-8.1	2.41 H	303	34.4	11.5
8	#17595.00	57.1 PK	88.2	-31.1	3.10 H	325	39.2	17.9
9	#17595.00	43.4 AV	68.2	-24.8	3.10 H	325	25.5	17.9

Remarks:

1. Emission Level(dBuV/m) = Raw Value(dBuV) + Correction Factor(dB/m)
2. Correction Factor(dB/m) = Antenna Factor(dB/m) + Cable Factor(dB) – Pre-Amplifier Factor(dB)
3. Margin value = Emission Level – Limit value
4. The other emission levels were very low against the limit.
5. " * " : Fundamental frequency, the limit was restricted at the RF Output Power.
6. " # " : The radiated frequency is out of the restricted band.

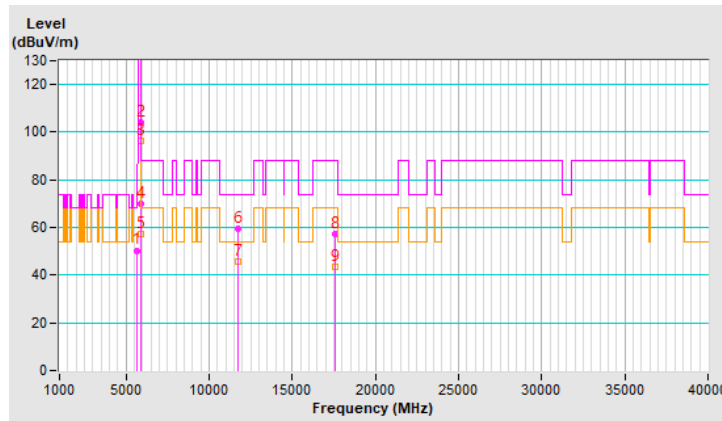

RF Mode	802.11a	Channel	CH 173 : 5865 MHz
Frequency Range	1 GHz ~ 40 GHz	Detector Function & Bandwidth	(PK) RB = 1 MHz, VB = 3 MHz (AV) RB = 1 MHz, VB = 10 Hz
Input Power (System)	120 Vac, 60 Hz	Environmental Conditions	28°C, 75% RH
Tested By	Louis Yang		

Antenna Polarity & Test Distance : Vertical at 3 m								
No	Frequency (MHz)	Emission Level (dBuV/m)	Limit (dBuV/m)	Margin (dB)	Antenna Height (m)	Table Angle (Degree)	Raw Value (dBuV)	Correction Factor (dB/m)
1	#5650.00	50.5 PK	68.2	-17.7	1.38 V	124	49.2	1.3
2	*5865.00	113.7 PK			1.38 V	124	111.9	1.8
3	*5865.00	104.6 AV			1.38 V	124	102.8	1.8
4	#5895.00	79.3 PK	110.2	-30.9	1.38 V	124	77.4	1.9
5	#5895.00	66.7 AV	90.2	-23.5	1.38 V	124	64.8	1.9
6	11730.00	63.2 PK	74.0	-10.8	1.55 V	179	51.7	11.5
7	11730.00	49.3 AV	54.0	-4.7	1.55 V	179	37.8	11.5
8	#17595.00	56.6 PK	88.2	-31.6	1.55 V	312	38.7	17.9
9	#17595.00	41.7 AV	68.2	-26.5	1.55 V	312	23.8	17.9

Remarks:

1. Emission Level(dBuV/m) = Raw Value(dBuV) + Correction Factor(dB/m)
2. Correction Factor(dB/m) = Antenna Factor(dB/m) + Cable Factor(dB) – Pre-Amplifier Factor(dB)
3. Margin value = Emission Level – Limit value
4. The other emission levels were very low against the limit.
5. " * " : Fundamental frequency, the limit was restricted at the RF Output Power.
6. " # " : The radiated frequency is out of the restricted band.

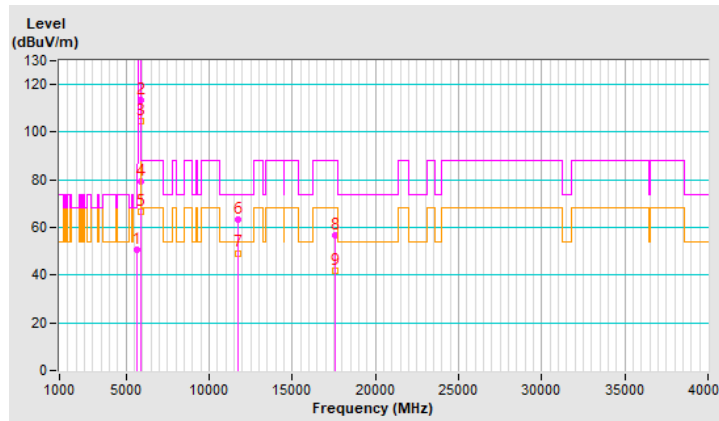

RF Mode	802.11a	Channel	CH 177 : 5885 MHz
Frequency Range	1 GHz ~ 40 GHz	Detector Function & Bandwidth	(PK) RB = 1 MHz, VB = 3 MHz (AV) RB = 1 MHz, VB = 10 Hz
Input Power (System)	120 Vac, 60 Hz	Environmental Conditions	28°C, 75% RH
Tested By	Louis Yang		

Antenna Polarity & Test Distance : Horizontal at 3 m								
No	Frequency (MHz)	Emission Level (dBuV/m)	Limit (dBuV/m)	Margin (dB)	Antenna Height (m)	Table Angle (Degree)	Raw Value (dBuV)	Correction Factor (dB/m)
1	#5647.70	49.6 PK	68.2	-18.6	1.39 H	343	48.3	1.3
2	*5885.00	104.2 PK			1.39 H	343	102.3	1.9
3	*5885.00	95.7 AV			1.39 H	343	93.8	1.9
4	#5895.10	79.6 PK	110.1	-30.5	1.39 H	343	77.7	1.9
5	#5895.10	67.1 AV	90.1	-23.0	1.39 H	343	65.2	1.9
6	11770.00	59.8 PK	74.0	-14.2	2.37 H	280	48.4	11.4
7	11770.00	45.8 AV	54.0	-8.2	2.37 H	280	34.4	11.4
8	#17655.00	55.3 PK	88.2	-32.9	2.94 H	328	37.2	18.1
9	#17655.00	41.3 AV	68.2	-26.9	2.94 H	328	23.2	18.1

Remarks:

1. Emission Level(dBuV/m) = Raw Value(dBuV) + Correction Factor(dB/m)
2. Correction Factor(dB/m) = Antenna Factor(dB/m) + Cable Factor(dB) – Pre-Amplifier Factor(dB)
3. Margin value = Emission Level – Limit value
4. The other emission levels were very low against the limit.
5. " * " : Fundamental frequency, the limit was restricted at the RF Output Power.
6. " # " : The radiated frequency is out of the restricted band.

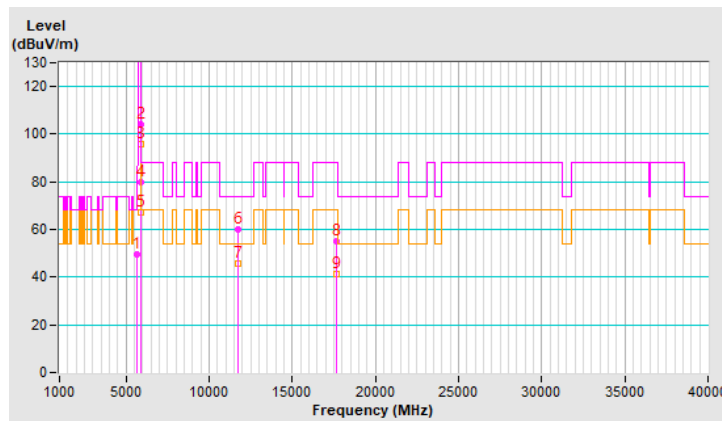

RF Mode	802.11a	Channel	CH 177 : 5885 MHz
Frequency Range	1 GHz ~ 40 GHz	Detector Function & Bandwidth	(PK) RB = 1 MHz, VB = 3 MHz (AV) RB = 1 MHz, VB = 10 Hz
Input Power (System)	120 Vac, 60 Hz	Environmental Conditions	28°C, 75% RH
Tested By	Louis Yang		

Antenna Polarity & Test Distance : Vertical at 3 m								
No	Frequency (MHz)	Emission Level (dBuV/m)	Limit (dBuV/m)	Margin (dB)	Antenna Height (m)	Table Angle (Degree)	Raw Value (dBuV)	Correction Factor (dB/m)
1	#5647.70	50.2 PK	68.2	-18.0	1.50 V	146	48.9	1.3
2	*5885.00	113.6 PK			1.50 V	146	111.7	1.9
3	*5885.00	104.7 AV			1.50 V	146	102.8	1.9
4	#5895.10	79.5 PK	110.1	-30.6	1.50 V	146	77.6	1.9
5	#5895.10	66.6 AV	90.1	-23.5	1.50 V	146	64.7	1.9
6	11770.00	62.1 PK	74.0	-11.9	1.58 V	160	50.7	11.4
7	11770.00	47.9 AV	54.0	-6.1	1.58 V	160	36.5	11.4
8	#17655.00	54.6 PK	88.2	-33.6	1.38 V	308	36.5	18.1
9	#17655.00	40.7 AV	68.2	-27.5	1.38 V	308	22.6	18.1

Remarks:

1. Emission Level(dBuV/m) = Raw Value(dBuV) + Correction Factor(dB/m)
2. Correction Factor(dB/m) = Antenna Factor(dB/m) + Cable Factor(dB) – Pre-Amplifier Factor(dB)
3. Margin value = Emission Level – Limit value
4. The other emission levels were very low against the limit.
5. " * " : Fundamental frequency, the limit was restricted at the RF Output Power.
6. " # " : The radiated frequency is out of the restricted band.

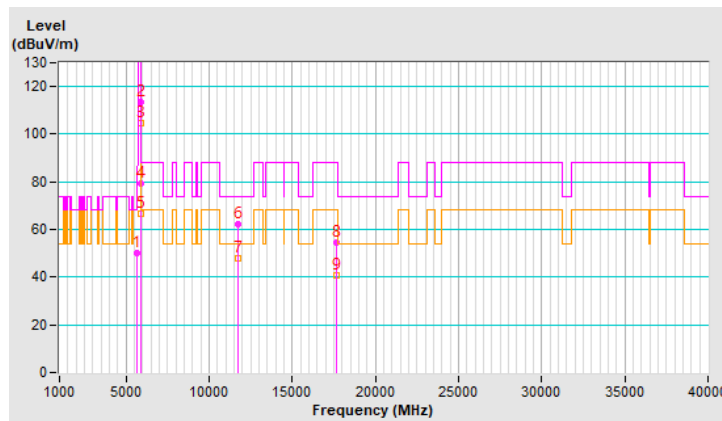

RF Mode	802.11ax (HE20)	Channel	CH 169 : 5845 MHz
Frequency Range	1 GHz ~ 40 GHz	Detector Function & Bandwidth	(PK) RB = 1 MHz, VB = 3 MHz (AV) RB = 1 MHz, VB = 10 Hz
Input Power (System)	120 Vac, 60 Hz	Environmental Conditions	28°C, 75% RH
Tested By	Louis Yang		

Antenna Polarity & Test Distance : Horizontal at 3 m								
No	Frequency (MHz)	Emission Level (dBuV/m)	Limit (dBuV/m)	Margin (dB)	Antenna Height (m)	Table Angle (Degree)	Raw Value (dBuV)	Correction Factor (dB/m)
1	#5559.08	49.5 PK	68.2	-18.7	1.45 H	344	48.4	1.1
2	*5845.00	108.0 PK			1.45 H	344	106.2	1.8
3	*5845.00	98.9 AV			1.45 H	344	97.1	1.8
4	#6017.63	56.1 PK	88.2	-32.1	1.45 H	344	54.0	2.1
5	#6017.63	45.5 AV	68.2	-22.7	1.45 H	344	43.4	2.1
6	11690.00	60.8 PK	74.0	-13.2	2.42 H	309	49.1	11.7
7	11690.00	46.7 AV	54.0	-7.3	2.42 H	309	35.0	11.7
8	#17535.00	55.8 PK	88.2	-32.4	3.01 H	293	38.2	17.6
9	#17535.00	42.4 AV	68.2	-25.8	3.01 H	293	24.8	17.6

Remarks:

1. Emission Level(dBuV/m) = Raw Value(dBuV) + Correction Factor(dB/m)
2. Correction Factor(dB/m) = Antenna Factor(dB/m) + Cable Factor(dB) – Pre-Amplifier Factor(dB)
3. Margin value = Emission Level – Limit value
4. The other emission levels were very low against the limit.
5. " * " : Fundamental frequency, the limit was restricted at the RF Output Power.
6. " # " : The radiated frequency is out of the restricted band.

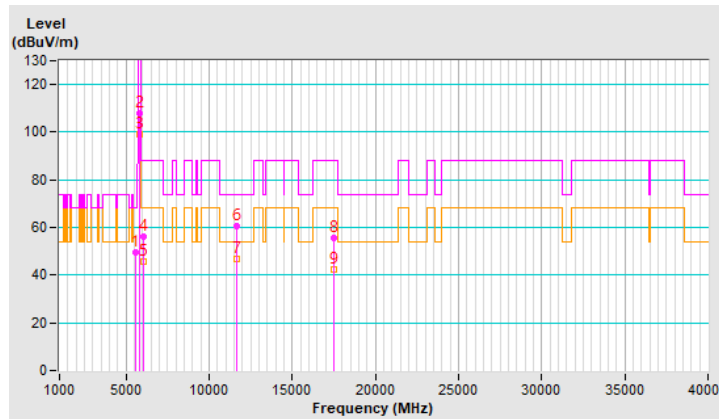

RF Mode	802.11ax (HE20)	Channel	CH 169 : 5845 MHz
Frequency Range	1 GHz ~ 40 GHz	Detector Function & Bandwidth	(PK) RB = 1 MHz, VB = 3 MHz (AV) RB = 1 MHz, VB = 10 Hz
Input Power (System)	120 Vac, 60 Hz	Environmental Conditions	28°C, 75% RH
Tested By	Louis Yang		

Antenna Polarity & Test Distance : Vertical at 3 m								
No	Frequency (MHz)	Emission Level (dBuV/m)	Limit (dBuV/m)	Margin (dB)	Antenna Height (m)	Table Angle (Degree)	Raw Value (dBuV)	Correction Factor (dB/m)
1	#5639.00	50.5 PK	68.2	-17.7	1.62 V	112	49.3	1.2
2	*5845.00	114.5 PK			1.62 V	112	112.7	1.8
3	*5845.00	104.7 AV			1.62 V	112	102.9	1.8
4	#5897.60	63.2 PK	108.3	-45.1	1.62 V	112	61.3	1.9
5	#5897.60	53.5 AV	88.3	-34.8	1.62 V	112	51.6	1.9
6	11690.00	62.3 PK	74.0	-11.7	1.48 V	160	50.6	11.7
7	11690.00	48.6 AV	54.0	-5.4	1.48 V	160	36.9	11.7
8	#17535.00	56.8 PK	88.2	-31.4	1.63 V	333	39.2	17.6
9	#17535.00	42.3 AV	68.2	-25.9	1.63 V	333	24.7	17.6

Remarks:

1. Emission Level(dBuV/m) = Raw Value(dBuV) + Correction Factor(dB/m)
2. Correction Factor(dB/m) = Antenna Factor(dB/m) + Cable Factor(dB) – Pre-Amplifier Factor(dB)
3. Margin value = Emission Level – Limit value
4. The other emission levels were very low against the limit.
5. " * " : Fundamental frequency, the limit was restricted at the RF Output Power.
6. " # " : The radiated frequency is out of the restricted band.

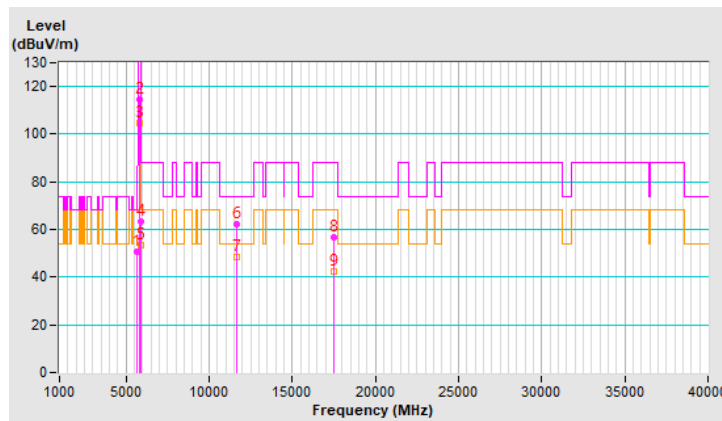

RF Mode	802.11ax (HE20)	Channel	CH 173 : 5865 MHz
Frequency Range	1 GHz ~ 40 GHz	Detector Function & Bandwidth	(PK) RB = 1 MHz, VB = 3 MHz (AV) RB = 1 MHz, VB = 10 Hz
Input Power (System)	120 Vac, 60 Hz	Environmental Conditions	28°C, 75% RH
Tested By	Louis Yang		

Antenna Polarity & Test Distance : Horizontal at 3 m								
No	Frequency (MHz)	Emission Level (dBuV/m)	Limit (dBuV/m)	Margin (dB)	Antenna Height (m)	Table Angle (Degree)	Raw Value (dBuV)	Correction Factor (dB/m)
1	#5647.60	48.9 PK	68.2	-19.3	1.58 H	346	47.6	1.3
2	*5865.00	104.1 PK			1.58 H	346	102.3	1.8
3	*5865.00	94.9 AV			1.58 H	346	93.1	1.8
4	#5896.10	66.9 PK	109.4	-42.5	1.58 H	346	65.0	1.9
5	#5896.10	56.4 AV	89.4	-33.0	1.58 H	346	54.5	1.9
6	11730.00	60.4 PK	74.0	-13.6	2.35 H	308	48.9	11.5
7	11730.00	45.7 AV	54.0	-8.3	2.35 H	308	34.2	11.5
8	#17595.00	58.4 PK	88.2	-29.8	3.12 H	302	40.5	17.9
9	#17595.00	44.6 AV	68.2	-23.6	3.12 H	302	26.7	17.9

Remarks:

1. Emission Level(dBuV/m) = Raw Value(dBuV) + Correction Factor(dB/m)
2. Correction Factor(dB/m) = Antenna Factor(dB/m) + Cable Factor(dB) – Pre-Amplifier Factor(dB)
3. Margin value = Emission Level – Limit value
4. The other emission levels were very low against the limit.
5. " * " : Fundamental frequency, the limit was restricted at the RF Output Power.
6. " # " : The radiated frequency is out of the restricted band.

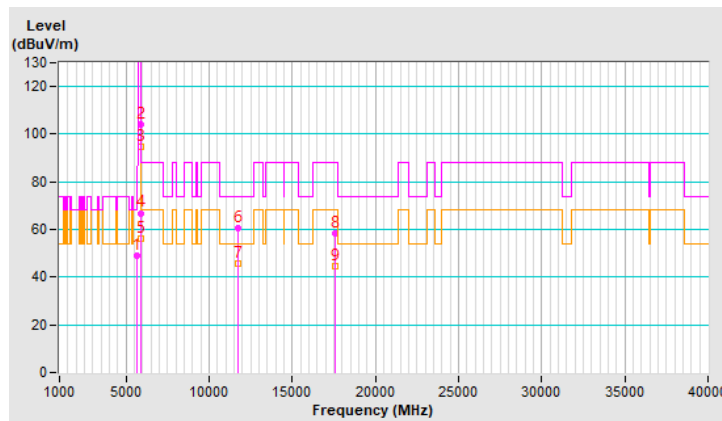

RF Mode	802.11ax (HE20)	Channel	CH 173 : 5865 MHz
Frequency Range	1 GHz ~ 40 GHz	Detector Function & Bandwidth	(PK) RB = 1 MHz, VB = 3 MHz (AV) RB = 1 MHz, VB = 10 Hz
Input Power (System)	120 Vac, 60 Hz	Environmental Conditions	28°C, 75% RH
Tested By	Louis Yang		

Antenna Polarity & Test Distance : Vertical at 3 m								
No	Frequency (MHz)	Emission Level (dBuV/m)	Limit (dBuV/m)	Margin (dB)	Antenna Height (m)	Table Angle (Degree)	Raw Value (dBuV)	Correction Factor (dB/m)
1	#5640.00	52.8 PK	68.2	-15.4	1.63 V	116	51.6	1.2
2	*5865.00	115.2 PK			1.63 V	116	113.4	1.8
3	*5865.00	105.1 AV			1.63 V	116	103.3	1.8
4	#5895.67	79.4 PK	109.7	-30.3	1.63 V	116	77.5	1.9
5	#5895.67	66.9 AV	89.7	-22.8	1.63 V	116	65.0	1.9
6	11730.00	63.5 PK	74.0	-10.5	1.42 V	159	52.0	11.5
7	11730.00	49.6 AV	54.0	-4.4	1.42 V	159	38.1	11.5
8	#17595.00	56.9 PK	88.2	-31.3	1.59 V	337	39.0	17.9
9	#17595.00	42.2 AV	68.2	-26.0	1.59 V	337	24.3	17.9

Remarks:

1. Emission Level(dBuV/m) = Raw Value(dBuV) + Correction Factor(dB/m)
2. Correction Factor(dB/m) = Antenna Factor(dB/m) + Cable Factor(dB) – Pre-Amplifier Factor(dB)
3. Margin value = Emission Level – Limit value
4. The other emission levels were very low against the limit.
5. " * " : Fundamental frequency, the limit was restricted at the RF Output Power.
6. " # " : The radiated frequency is out of the restricted band.

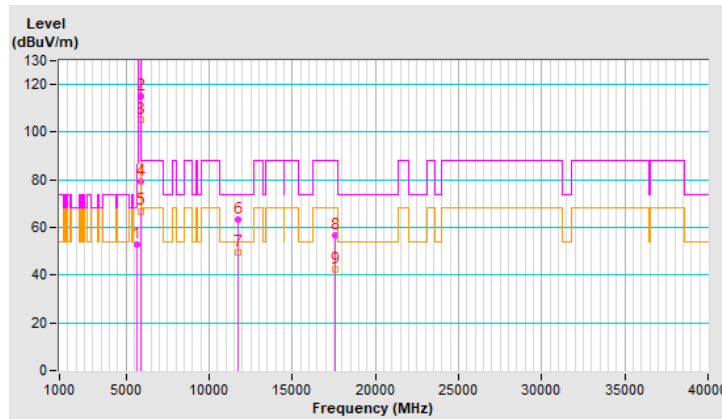

RF Mode	802.11ax (HE20)	Channel	CH 177 : 5885 MHz
Frequency Range	1 GHz ~ 40 GHz	Detector Function & Bandwidth	(PK) RB = 1 MHz, VB = 3 MHz (AV) RB = 1 MHz, VB = 10 Hz
Input Power (System)	120 Vac, 60 Hz	Environmental Conditions	28°C, 75% RH
Tested By	Louis Yang		

Antenna Polarity & Test Distance : Horizontal at 3 m								
No	Frequency (MHz)	Emission Level (dBuV/m)	Limit (dBuV/m)	Margin (dB)	Antenna Height (m)	Table Angle (Degree)	Raw Value (dBuV)	Correction Factor (dB/m)
1	#5578.70	50.9 PK	68.2	-17.3	1.25 H	333	49.8	1.1
2	*5885.00	104.8 PK			1.25 H	333	102.9	1.9
3	*5885.00	94.4 AV			1.25 H	333	92.5	1.9
4	#5897.60	79.4 PK	108.3	-28.9	1.25 H	333	77.5	1.9
5	#5897.60	66.8 AV	88.3	-21.5	1.25 H	333	64.9	1.9
6	11770.00	58.2 PK	74.0	-15.8	2.44 H	282	46.8	11.4
7	11770.00	45.1 AV	54.0	-8.9	2.44 H	282	33.7	11.4
8	#17655.00	55.8 PK	88.2	-32.4	2.96 H	317	37.7	18.1
9	#17655.00	40.9 AV	68.2	-27.3	2.96 H	317	22.8	18.1

Remarks:

1. Emission Level(dBuV/m) = Raw Value(dBuV) + Correction Factor(dB/m)
2. Correction Factor(dB/m) = Antenna Factor(dB/m) + Cable Factor(dB) – Pre-Amplifier Factor(dB)
3. Margin value = Emission Level – Limit value
4. The other emission levels were very low against the limit.
5. " * " : Fundamental frequency, the limit was restricted at the RF Output Power.
6. " # " : The radiated frequency is out of the restricted band.

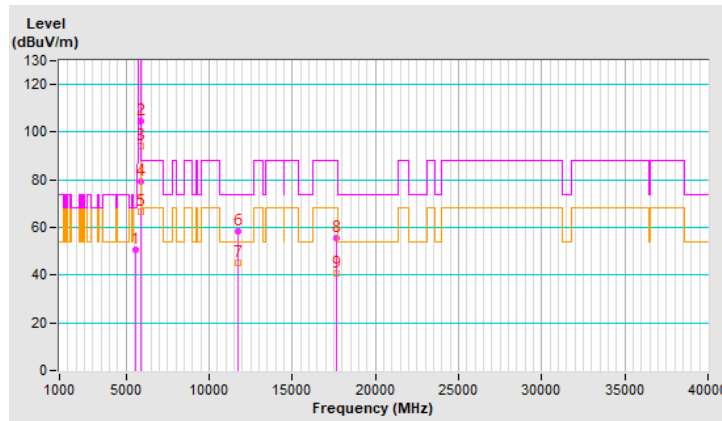

RF Mode	802.11ax (HE20)	Channel	CH 177 : 5885 MHz
Frequency Range	1 GHz ~ 40 GHz	Detector Function & Bandwidth	(PK) RB = 1 MHz, VB = 3 MHz (AV) RB = 1 MHz, VB = 10 Hz
Input Power (System)	120 Vac, 60 Hz	Environmental Conditions	28°C, 75% RH
Tested By	Louis Yang		

Antenna Polarity & Test Distance : Vertical at 3 m								
No	Frequency (MHz)	Emission Level (dBuV/m)	Limit (dBuV/m)	Margin (dB)	Antenna Height (m)	Table Angle (Degree)	Raw Value (dBuV)	Correction Factor (dB/m)
1	#5621.30	48.8 PK	68.2	-19.4	1.23 V	164	47.6	1.2
2	*5885.00	114.5 PK			1.23 V	164	112.6	1.9
3	*5885.00	103.6 AV			1.23 V	164	101.7	1.9
4	#5897.60	79.6 PK	108.3	-28.7	1.23 V	164	77.7	1.9
5	#5897.60	67.1 AV	88.3	-21.2	1.23 V	164	65.2	1.9
6	11770.00	62.5 PK	74.0	-11.5	1.56 V	159	51.1	11.4
7	11770.00	48.7 AV	54.0	-5.3	1.56 V	159	37.3	11.4
8	#17655.00	56.4 PK	88.2	-31.8	1.38 V	324	38.3	18.1
9	#17655.00	42.8 AV	68.2	-25.4	1.38 V	324	24.7	18.1

Remarks:

1. Emission Level(dBuV/m) = Raw Value(dBuV) + Correction Factor(dB/m)
2. Correction Factor(dB/m) = Antenna Factor(dB/m) + Cable Factor(dB) – Pre-Amplifier Factor(dB)
3. Margin value = Emission Level – Limit value
4. The other emission levels were very low against the limit.
5. " * " : Fundamental frequency, the limit was restricted at the RF Output Power.
6. " # " : The radiated frequency is out of the restricted band.

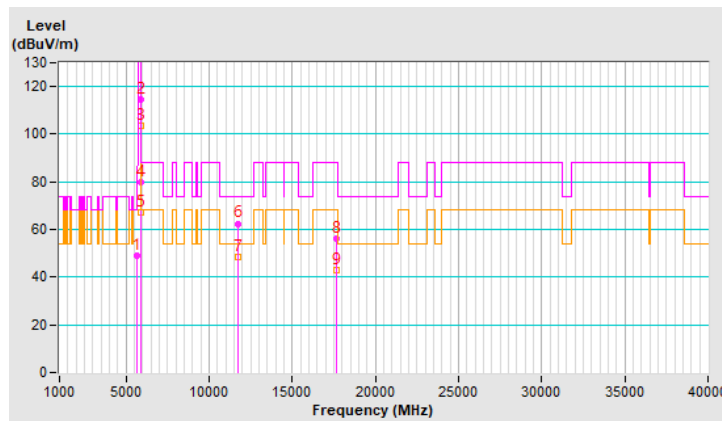

RF Mode	802.11ax (HE40)	Channel	CH 167 : 5835 MHz
Frequency Range	1 GHz ~ 40 GHz	Detector Function & Bandwidth	(PK) RB = 1 MHz, VB = 3 MHz (AV) RB = 1 MHz, VB = 10 Hz
Input Power (System)	120 Vac, 60 Hz	Environmental Conditions	28°C, 75% RH
Tested By	Louis Yang		

Antenna Polarity & Test Distance : Horizontal at 3 m								
No	Frequency (MHz)	Emission Level (dBuV/m)	Limit (dBuV/m)	Margin (dB)	Antenna Height (m)	Table Angle (Degree)	Raw Value (dBuV)	Correction Factor (dB/m)
1	#5643.60	50.9 PK	68.2	-17.3	1.72 H	356	49.7	1.2
2	*5835.00	104.0 PK			1.72 H	356	102.2	1.8
3	*5835.00	93.1 AV			1.72 H	356	91.3	1.8
4	#5900.28	69.7 PK	106.3	-36.6	1.72 H	356	67.8	1.9
5	#5900.28	58.5 AV	86.3	-27.8	1.72 H	356	56.6	1.9
6	11670.00	60.8 PK	74.0	-13.2	2.44 H	300	49.2	11.6
7	11670.00	46.9 AV	54.0	-7.1	2.44 H	300	35.3	11.6
8	#17505.00	57.0 PK	88.2	-31.2	2.99 H	335	39.5	17.5
9	#17505.00	43.6 AV	68.2	-24.6	2.99 H	335	26.1	17.5

Remarks:

1. Emission Level(dBuV/m) = Raw Value(dBuV) + Correction Factor(dB/m)
2. Correction Factor(dB/m) = Antenna Factor(dB/m) + Cable Factor(dB) – Pre-Amplifier Factor(dB)
3. Margin value = Emission Level – Limit value
4. The other emission levels were very low against the limit.
5. " * " : Fundamental frequency, the limit was restricted at the RF Output Power.
6. " # " : The radiated frequency is out of the restricted band.

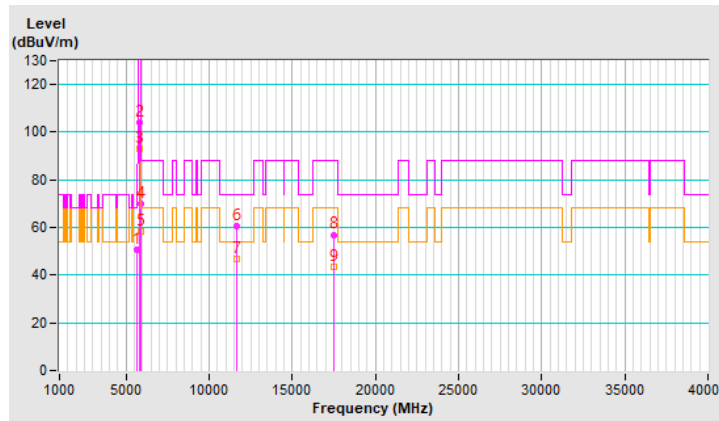

RF Mode	802.11ax (HE40)	Channel	CH 167 : 5835 MHz
Frequency Range	1 GHz ~ 40 GHz	Detector Function & Bandwidth	(PK) RB = 1 MHz, VB = 3 MHz (AV) RB = 1 MHz, VB = 10 Hz
Input Power (System)	120 Vac, 60 Hz	Environmental Conditions	28°C, 75% RH
Tested By	Louis Yang		

Antenna Polarity & Test Distance : Vertical at 3 m								
No	Frequency (MHz)	Emission Level (dBuV/m)	Limit (dBuV/m)	Margin (dB)	Antenna Height (m)	Table Angle (Degree)	Raw Value (dBuV)	Correction Factor (dB/m)
1	#5650.00	56.1 PK	68.2	-12.1	1.83 V	239	54.8	1.3
2	*5835.00	111.4 PK			1.83 V	239	109.6	1.8
3	*5835.00	101.2 AV			1.83 V	239	99.4	1.8
4	#5895.00	80.3 PK	110.2	-29.9	1.83 V	239	78.4	1.9
5	#5895.00	66.8 AV	90.2	-23.4	1.83 V	239	64.9	1.9
6	11670.00	63.0 PK	74.0	-11.0	1.59 V	153	51.4	11.6
7	11670.00	48.9 AV	54.0	-5.1	1.59 V	153	37.3	11.6
8	#17505.00	57.1 PK	88.2	-31.1	1.35 V	355	39.6	17.5
9	#17505.00	42.9 AV	68.2	-25.3	1.35 V	355	25.4	17.5

Remarks:

1. Emission Level(dBuV/m) = Raw Value(dBuV) + Correction Factor(dB/m)
2. Correction Factor(dB/m) = Antenna Factor(dB/m) + Cable Factor(dB) – Pre-Amplifier Factor(dB)
3. Margin value = Emission Level – Limit value
4. The other emission levels were very low against the limit.
5. " * " : Fundamental frequency, the limit was restricted at the RF Output Power.
6. " # " : The radiated frequency is out of the restricted band.

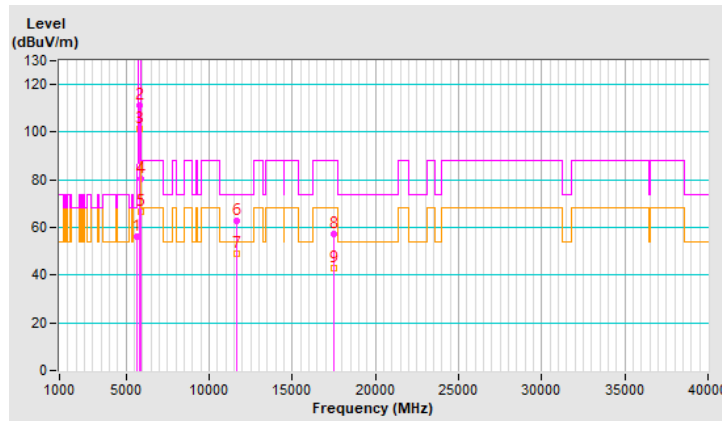

RF Mode	802.11ax (HE40)	Channel	CH 175 : 5875 MHz
Frequency Range	1 GHz ~ 40 GHz	Detector Function & Bandwidth	(PK) RB = 1 MHz, VB = 3 MHz (AV) RB = 1 MHz, VB = 10 Hz
Input Power (System)	120 Vac, 60 Hz	Environmental Conditions	28°C, 75% RH
Tested By	Louis Yang		

Antenna Polarity & Test Distance : Horizontal at 3 m								
No	Frequency (MHz)	Emission Level (dBuV/m)	Limit (dBuV/m)	Margin (dB)	Antenna Height (m)	Table Angle (Degree)	Raw Value (dBuV)	Correction Factor (dB/m)
1	#5631.30	48.7 PK	68.2	-19.5	1.28 H	321	47.5	1.2
2	*5875.00	99.6 PK			1.28 H	321	97.8	1.8
3	*5875.00	90.8 AV			1.28 H	321	89.0	1.8
4	#5901.43	75.8 PK	105.5	-29.7	1.28 H	321	73.9	1.9
5	#5901.43	66.6 AV	85.5	-18.9	1.28 H	321	64.7	1.9
6	11750.00	57.9 PK	74.0	-16.1	2.30 H	313	46.3	11.6
7	11750.00	45.4 AV	54.0	-8.6	2.30 H	313	33.8	11.6
8	#17625.00	55.2 PK	88.2	-33.0	3.08 H	339	37.2	18.0
9	#17625.00	40.7 AV	68.2	-27.5	3.08 H	339	22.7	18.0

Remarks:

1. Emission Level(dBuV/m) = Raw Value(dBuV) + Correction Factor(dB/m)
2. Correction Factor(dB/m) = Antenna Factor(dB/m) + Cable Factor(dB) – Pre-Amplifier Factor(dB)
3. Margin value = Emission Level – Limit value
4. The other emission levels were very low against the limit.
5. " * " : Fundamental frequency, the limit was restricted at the RF Output Power.
6. " # " : The radiated frequency is out of the restricted band.

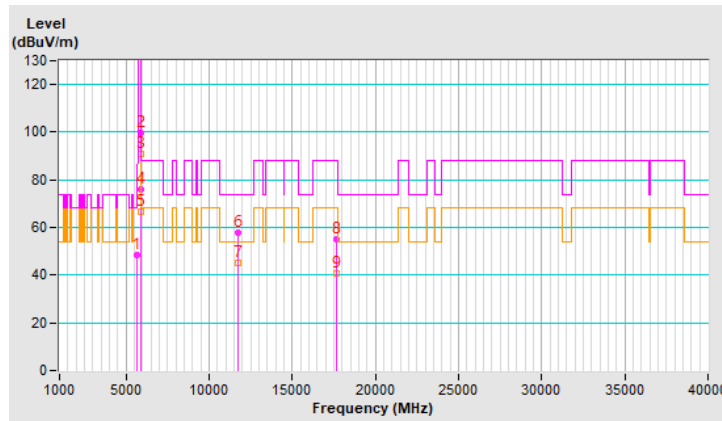

RF Mode	802.11ax (HE40)	Channel	CH 175 : 5875 MHz
Frequency Range	1 GHz ~ 40 GHz	Detector Function & Bandwidth	(PK) RB = 1 MHz, VB = 3 MHz (AV) RB = 1 MHz, VB = 10 Hz
Input Power (System)	120 Vac, 60 Hz	Environmental Conditions	28°C, 75% RH
Tested By	Louis Yang		

Antenna Polarity & Test Distance : Vertical at 3 m								
No	Frequency (MHz)	Emission Level (dBuV/m)	Limit (dBuV/m)	Margin (dB)	Antenna Height (m)	Table Angle (Degree)	Raw Value (dBuV)	Correction Factor (dB/m)
1	#5650.00	50.9 PK	68.2	-17.3	1.47 V	113	49.6	1.3
2	*5875.00	108.3 PK			1.47 V	113	106.5	1.8
3	*5875.00	99.1 AV			1.47 V	113	97.3	1.8
4	#5895.00	79.5 PK	110.2	-30.7	1.47 V	113	77.6	1.9
5	#5895.00	67.0 AV	90.2	-23.2	1.47 V	113	65.1	1.9
6	11750.00	61.6 PK	74.0	-12.4	1.45 V	146	50.0	11.6
7	11750.00	48.0 AV	54.0	-6.0	1.45 V	146	36.4	11.6
8	#17625.00	54.2 PK	88.2	-34.0	1.26 V	360	36.2	18.0
9	#17625.00	40.9 AV	68.2	-27.3	1.26 V	360	22.9	18.0

Remarks:

1. Emission Level(dBuV/m) = Raw Value(dBuV) + Correction Factor(dB/m)
2. Correction Factor(dB/m) = Antenna Factor(dB/m) + Cable Factor(dB) – Pre-Amplifier Factor(dB)
3. Margin value = Emission Level – Limit value
4. The other emission levels were very low against the limit.
5. " * " : Fundamental frequency, the limit was restricted at the RF Output Power.
6. " # " : The radiated frequency is out of the restricted band.

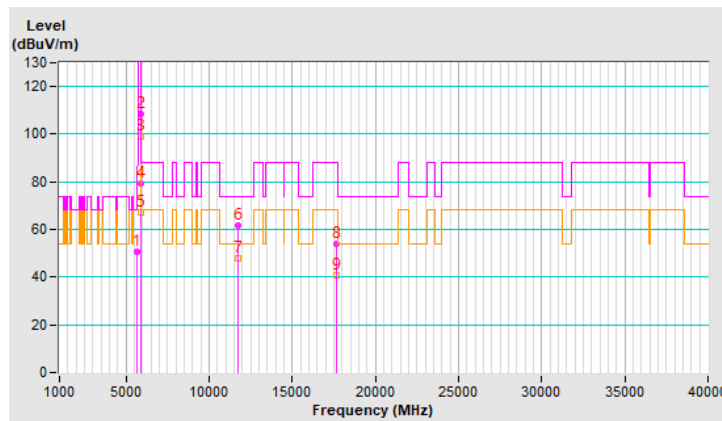

RF Mode	802.11ax (HE80)	Channel	CH 171 : 5855 MHz
Frequency Range	1 GHz ~ 40 GHz	Detector Function & Bandwidth	(PK) RB = 1 MHz, VB = 3 MHz (AV) RB = 1 MHz, VB = 5.1 kHz
Input Power (System)	120 Vac, 60 Hz	Environmental Conditions	28°C, 75% RH
Tested By	Louis Yang		

Antenna Polarity & Test Distance : Horizontal at 3 m								
No	Frequency (MHz)	Emission Level (dBuV/m)	Limit (dBuV/m)	Margin (dB)	Antenna Height (m)	Table Angle (Degree)	Raw Value (dBuV)	Correction Factor (dB/m)
1	#5650.00	49.6 PK	68.2	-18.6	1.45 H	322	48.3	1.3
2	*5855.00	96.5 PK			1.45 H	322	94.7	1.8
3	*5855.00	86.7 AV			1.45 H	322	84.9	1.8
4	#5925.00	67.3 PK	88.2	-20.9	1.45 H	322	65.3	2.0
5	#5925.00	59.6 AV	68.2	-8.6	1.45 H	322	57.6	2.0
6	11710.00	58.6 PK	74.0	-15.4	2.22 H	292	47.0	11.6
7	11710.00	44.4 AV	54.0	-9.6	2.22 H	292	32.8	11.6
8	#17565.00	56.5 PK	88.2	-31.7	3.01 H	343	38.8	17.7
9	#17565.00	41.0 AV	68.2	-27.2	3.01 H	343	23.3	17.7

Remarks:

1. Emission Level(dBuV/m) = Raw Value(dBuV) + Correction Factor(dB/m)
2. Correction Factor(dB/m) = Antenna Factor(dB/m) + Cable Factor(dB) – Pre-Amplifier Factor(dB)
3. Margin value = Emission Level – Limit value
4. The other emission levels were very low against the limit.
5. " * " : Fundamental frequency, the limit was restricted at the RF Output Power.
6. " # " : The radiated frequency is out of the restricted band.

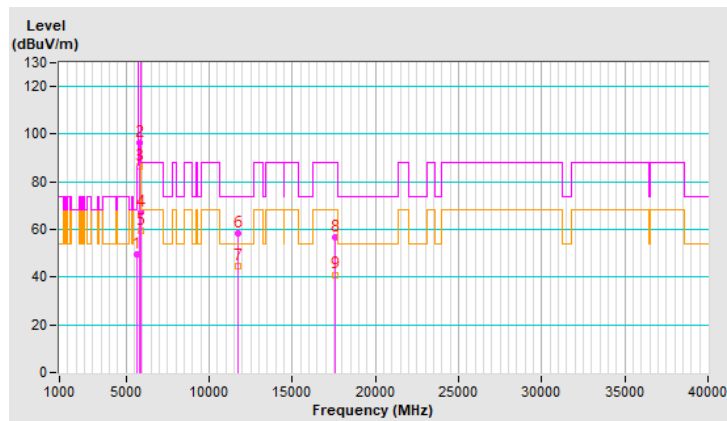

RF Mode	802.11ax (HE80)	Channel	CH 171 : 5855 MHz
Frequency Range	1 GHz ~ 40 GHz	Detector Function & Bandwidth	(PK) RB = 1 MHz, VB = 3 MHz (AV) RB = 1 MHz, VB = 5.1 kHz
Input Power (System)	120 Vac, 60 Hz	Environmental Conditions	28°C, 75% RH
Tested By	Louis Yang		

Antenna Polarity & Test Distance : Vertical at 3 m								
No	Frequency (MHz)	Emission Level (dBuV/m)	Limit (dBuV/m)	Margin (dB)	Antenna Height (m)	Table Angle (Degree)	Raw Value (dBuV)	Correction Factor (dB/m)
1	#5650.00	52.6 PK	68.2	-15.6	1.57 V	141	51.3	1.3
2	*5855.00	103.8 PK			1.57 V	141	102.0	1.8
3	*5855.00	93.9 AV			1.57 V	141	92.1	1.8
4	#5925.00	78.1 PK	88.2	-10.1	1.57 V	141	76.1	2.0
5	#5925.00	65.8 AV	68.2	-2.4	1.57 V	141	63.8	2.0
6	11710.00	59.6 PK	74.0	-14.4	1.56 V	159	48.0	11.6
7	11710.00	46.8 AV	54.0	-7.2	1.56 V	159	35.2	11.6
8	#17565.00	54.9 PK	88.2	-33.3	1.48 V	360	37.2	17.7
9	#17565.00	40.7 AV	68.2	-27.5	1.48 V	360	23.0	17.7

Remarks:

1. Emission Level(dBuV/m) = Raw Value(dBuV) + Correction Factor(dB/m)
2. Correction Factor(dB/m) = Antenna Factor(dB/m) + Cable Factor(dB) – Pre-Amplifier Factor(dB)
3. Margin value = Emission Level – Limit value
4. The other emission levels were very low against the limit.
5. " * " : Fundamental frequency, the limit was restricted at the RF Output Power.
6. " # " : The radiated frequency is out of the restricted band.

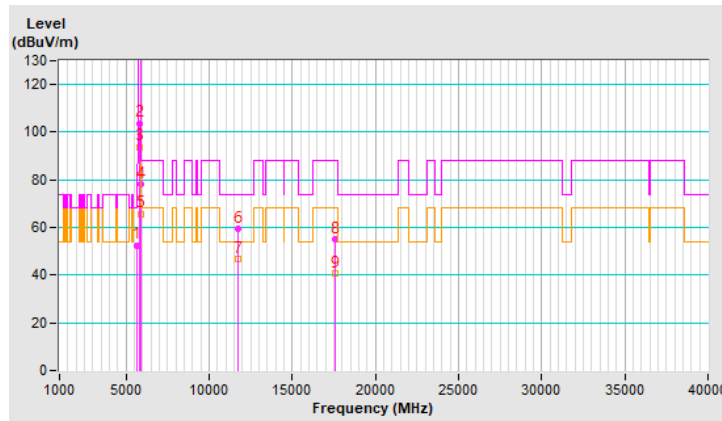

RF Mode	802.11ax (HE20) 26-tone RU	Channel	CH 169 : 5845 MHz
Frequency Range	1 GHz ~ 40 GHz	Detector Function & Bandwidth	(PK) RB = 1 MHz, VB = 3 MHz (AV) RB = 1 MHz, VB = 10 Hz
Input Power (System)	120 Vac, 60 Hz	Environmental Conditions	22°C, 70% RH
Tested By	Louis Yang		

Antenna Polarity & Test Distance : Horizontal at 3 m								
No	Frequency (MHz)	Emission Level (dBuV/m)	Limit (dBuV/m)	Margin (dB)	Antenna Height (m)	Table Angle (Degree)	Raw Value (dBuV)	Correction Factor (dB/m)
1	#5624.40	48.0 PK	68.2	-20.2	1.57 H	120	46.1	1.9
2	*5845.00	111.6 PK			1.57 H	120	109.3	2.3
3	*5845.00	103.9 AV			1.57 H	120	101.6	2.3
4	#5951.60	48.2 PK	88.2	-40.0	1.57 H	120	45.6	2.6
5	#5951.60	29.5 AV	68.2	-38.7	1.57 H	120	26.9	2.6
6	11690.00	59.8 PK	74.0	-14.2	2.62 H	341	47.4	12.4
7	11690.00	47.7 AV	54.0	-6.3	2.62 H	341	35.3	12.4
8	#17535.00	60.2 PK	88.2	-28.0	2.14 H	348	41.0	19.2
9	#17535.00	42.7 AV	68.2	-25.5	2.14 H	348	23.5	19.2

Remarks:

1. Emission Level(dBuV/m) = Raw Value(dBuV) + Correction Factor(dB/m)
2. Correction Factor(dB/m) = Antenna Factor(dB/m) + Cable Factor(dB) – Pre-Amplifier Factor(dB)
3. Margin value = Emission Level – Limit value
4. The other emission levels were very low against the limit.
5. " * " : Fundamental frequency, the limit was restricted at the RF Output Power.
6. " # " : The radiated frequency is out of the restricted band.

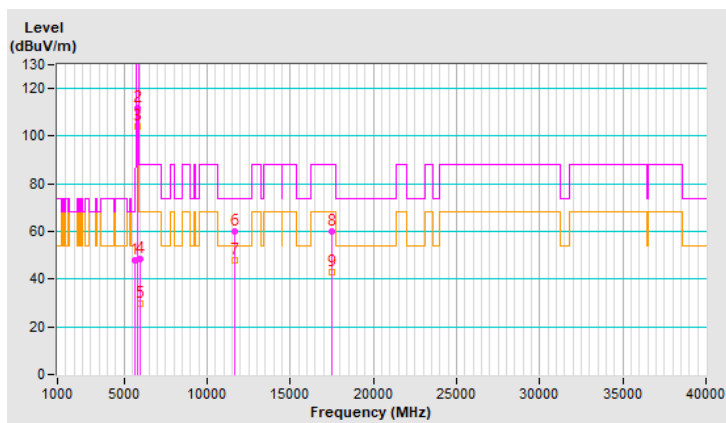

RF Mode	802.11ax (HE20) 26-tone RU	Channel	CH 169 : 5845 MHz
Frequency Range	1 GHz ~ 40 GHz	Detector Function & Bandwidth	(PK) RB = 1 MHz, VB = 3 MHz (AV) RB = 1 MHz, VB = 10 Hz
Input Power (System)	120 Vac, 60 Hz	Environmental Conditions	22°C, 70% RH
Tested By	Louis Yang		

Antenna Polarity & Test Distance : Vertical at 3 m								
No	Frequency (MHz)	Emission Level (dBuV/m)	Limit (dBuV/m)	Margin (dB)	Antenna Height (m)	Table Angle (Degree)	Raw Value (dBuV)	Correction Factor (dB/m)
1	#5650.00	49.5 PK	68.2	-18.7	1.33 V	267	47.5	2.0
2	*5845.00	116.2 PK			1.33 V	267	113.9	2.3
3	*5845.00	108.8 AV			1.33 V	267	106.5	2.3
4	#5895.00	58.1 PK	110.2	-52.1	1.33 V	267	55.7	2.4
5	#5895.00	39.4 AV	90.2	-50.8	1.33 V	267	37.0	2.4
6	11690.00	62.3 PK	74.0	-11.7	2.71 V	360	49.9	12.4
7	11690.00	51.0 AV	54.0	-3.0	2.71 V	360	38.6	12.4
8	#17535.00	57.1 PK	88.2	-31.1	1.66 V	360	37.9	19.2
9	#17535.00	42.9 AV	68.2	-25.3	1.66 V	360	23.7	19.2

Remarks:

1. Emission Level(dBuV/m) = Raw Value(dBuV) + Correction Factor(dB/m)
2. Correction Factor(dB/m) = Antenna Factor(dB/m) + Cable Factor(dB) – Pre-Amplifier Factor(dB)
3. Margin value = Emission Level – Limit value
4. The other emission levels were very low against the limit.
5. " * " : Fundamental frequency, the limit was restricted at the RF Output Power.
6. " # " : The radiated frequency is out of the restricted band.

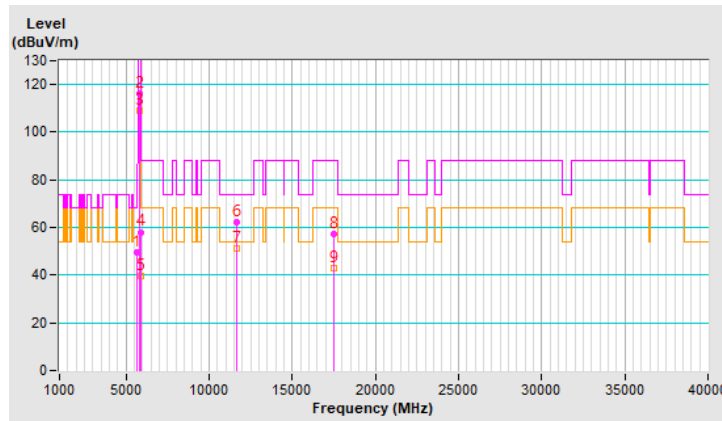

RF Mode	802.11ax (HE20) 26-tone RU	Channel	CH 173 : 5865 MHz
Frequency Range	1 GHz ~ 40 GHz	Detector Function & Bandwidth	(PK) RB = 1 MHz, VB = 3 MHz (AV) RB = 1 MHz, VB = 10 Hz
Input Power (System)	120 Vac, 60 Hz	Environmental Conditions	22°C, 70% RH
Tested By	Louis Yang		

Antenna Polarity & Test Distance : Horizontal at 3 m								
No	Frequency (MHz)	Emission Level (dBuV/m)	Limit (dBuV/m)	Margin (dB)	Antenna Height (m)	Table Angle (Degree)	Raw Value (dBuV)	Correction Factor (dB/m)
1	#5645.50	55.7 PK	68.2	-12.5	1.44 H	109	53.7	2.0
2	*5865.00	109.1 PK			1.44 H	109	106.8	2.3
3	*5865.00	98.9 AV			1.44 H	109	96.6	2.3
4	#5901.40	48.9 PK	105.5	-56.6	1.44 H	109	46.5	2.4
5	#5901.40	26.2 AV	85.5	-59.3	1.44 H	109	23.8	2.4
6	11730.00	60.7 PK	74.0	-13.3	2.59 H	353	48.5	12.2
7	11730.00	48.4 AV	54.0	-5.6	2.59 H	353	36.2	12.2
8	#17595.00	58.9 PK	88.2	-29.3	2.01 H	346	39.2	19.7
9	#17595.00	42.3 AV	68.2	-25.9	2.01 H	346	22.6	19.7

Remarks:

1. Emission Level(dBuV/m) = Raw Value(dBuV) + Correction Factor(dB/m)
2. Correction Factor(dB/m) = Antenna Factor(dB/m) + Cable Factor(dB) – Pre-Amplifier Factor(dB)
3. Margin value = Emission Level – Limit value
4. The other emission levels were very low against the limit.
5. " * " : Fundamental frequency, the limit was restricted at the RF Output Power.
6. " # " : The radiated frequency is out of the restricted band.

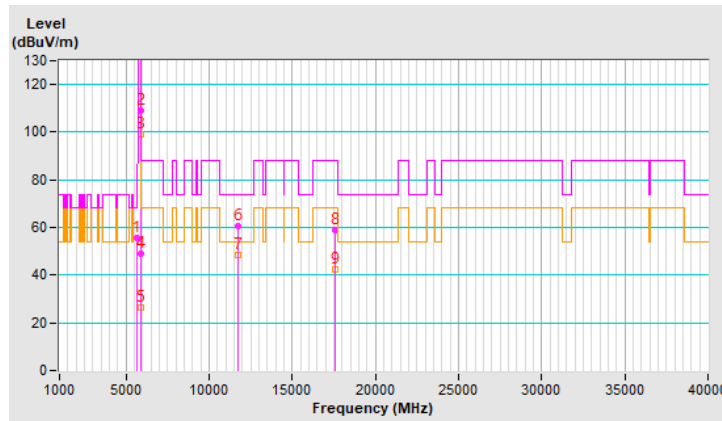

RF Mode	802.11ax (HE20) 26-tone RU	Channel	CH 173 : 5865 MHz
Frequency Range	1 GHz ~ 40 GHz	Detector Function & Bandwidth	(PK) RB = 1 MHz, VB = 3 MHz (AV) RB = 1 MHz, VB = 10 Hz
Input Power (System)	120 Vac, 60 Hz	Environmental Conditions	22°C, 70% RH
Tested By	Louis Yang		

Antenna Polarity & Test Distance : Vertical at 3 m								
No	Frequency (MHz)	Emission Level (dBuV/m)	Limit (dBuV/m)	Margin (dB)	Antenna Height (m)	Table Angle (Degree)	Raw Value (dBuV)	Correction Factor (dB/m)
1	#5650.00	58.3 PK	68.2	-9.9	1.48 V	296	56.3	2.0
2	*5865.00	116.1 PK			1.48 V	296	113.8	2.3
3	*5865.00	105.7 AV			1.48 V	296	103.4	2.3
4	#5895.00	57.4 PK	110.2	-52.8	1.48 V	296	55.0	2.4
5	#5895.00	34.1 AV	90.2	-56.1	1.48 V	296	31.7	2.4
6	11730.00	62.9 PK	74.0	-11.1	2.72 V	347	50.7	12.2
7	11730.00	51.2 AV	54.0	-2.8	2.72 V	347	39.0	12.2
8	#17595.00	56.5 PK	88.2	-31.7	1.74 V	360	36.8	19.7
9	#17595.00	42.9 AV	68.2	-25.3	1.74 V	360	23.2	19.7

Remarks:

1. Emission Level(dBuV/m) = Raw Value(dBuV) + Correction Factor(dB/m)
2. Correction Factor(dB/m) = Antenna Factor(dB/m) + Cable Factor(dB) – Pre-Amplifier Factor(dB)
3. Margin value = Emission Level – Limit value
4. The other emission levels were very low against the limit.
5. " * " : Fundamental frequency, the limit was restricted at the RF Output Power.
6. " # " : The radiated frequency is out of the restricted band.

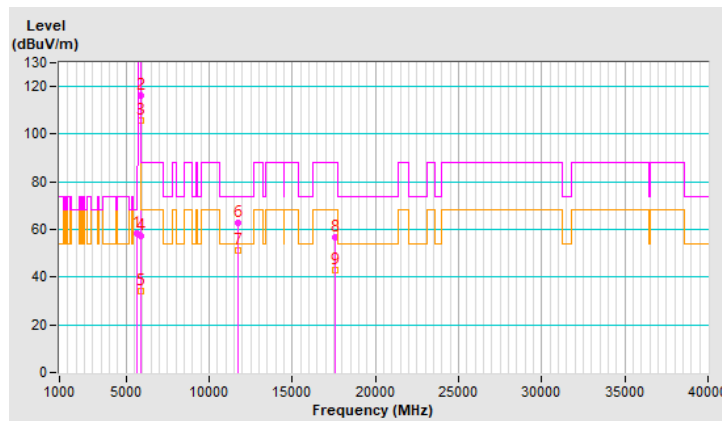

RF Mode	802.11ax (HE20) 26-tone RU	Channel	CH 177 : 5885 MHz
Frequency Range	1 GHz ~ 40 GHz	Detector Function & Bandwidth	(PK) RB = 1 MHz, VB = 3 MHz (AV) RB = 1 MHz, VB = 10 Hz
Input Power (System)	120 Vac, 60 Hz	Environmental Conditions	22°C, 70% RH
Tested By	Louis Yang		

Antenna Polarity & Test Distance : Horizontal at 3 m								
No	Frequency (MHz)	Emission Level (dBuV/m)	Limit (dBuV/m)	Margin (dB)	Antenna Height (m)	Table Angle (Degree)	Raw Value (dBuV)	Correction Factor (dB/m)
1	#5650.00	47.6 PK	68.2	-20.6	1.48 H	127	45.6	2.0
2	*5885.00	110.5 PK			1.48 H	127	108.1	2.4
3	*5885.00	103.3 AV			1.48 H	127	100.9	2.4
4	#5898.50	94.8 PK	107.6	-12.8	1.48 H	127	92.4	2.4
5	#5898.50	77.6 AV	87.6	-10.0	1.48 H	127	75.2	2.4
6	11770.00	59.5 PK	74.0	-14.5	2.74 H	333	47.3	12.2
7	11770.00	46.6 AV	54.0	-7.4	2.74 H	333	34.4	12.2
8	#17655.00	60.2 PK	88.2	-28.0	2.05 H	306	40.2	20.0
9	#17655.00	42.3 AV	68.2	-25.9	2.05 H	306	22.3	20.0

Remarks:

1. Emission Level(dBuV/m) = Raw Value(dBuV) + Correction Factor(dB/m)
2. Correction Factor(dB/m) = Antenna Factor(dB/m) + Cable Factor(dB) – Pre-Amplifier Factor(dB)
3. Margin value = Emission Level – Limit value
4. The other emission levels were very low against the limit.
5. " * " : Fundamental frequency, the limit was restricted at the RF Output Power.
6. " # " : The radiated frequency is out of the restricted band.

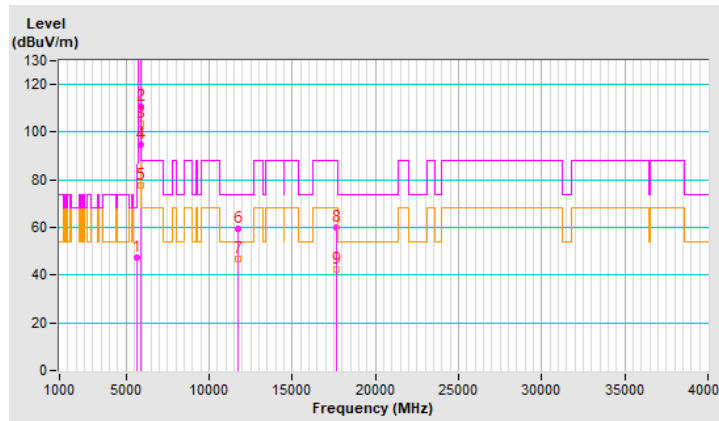

RF Mode	802.11ax (HE20) 26-tone RU	Channel	CH 177 : 5885 MHz
Frequency Range	1 GHz ~ 40 GHz	Detector Function & Bandwidth	(PK) RB = 1 MHz, VB = 3 MHz (AV) RB = 1 MHz, VB = 10 Hz
Input Power (System)	120 Vac, 60 Hz	Environmental Conditions	22°C, 70% RH
Tested By	Louis Yang		

Antenna Polarity & Test Distance : Vertical at 3 m								
No	Frequency (MHz)	Emission Level (dBuV/m)	Limit (dBuV/m)	Margin (dB)	Antenna Height (m)	Table Angle (Degree)	Raw Value (dBuV)	Correction Factor (dB/m)
1	#5650.00	50.3 PK	68.2	-17.9	1.61 V	320	48.3	2.0
2	*5885.00	119.2 PK			1.61 V	320	116.8	2.4
3	*5885.00	112.3 AV			1.61 V	320	109.9	2.4
4	#5895.00	102.7 PK	110.2	-7.5	1.61 V	320	100.3	2.4
5	#5895.00	85.7 AV	90.2	-4.5	1.61 V	320	83.3	2.4
6	11770.00	64.6 PK	74.0	-9.4	2.72 V	326	52.4	12.2
7	11770.00	50.4 AV	54.0	-3.6	2.72 V	326	38.2	12.2
8	#17655.00	60.2 PK	88.2	-28.0	2.08 V	290	40.2	20.0
9	#17655.00	42.2 AV	68.2	-26.0	2.08 V	290	22.2	20.0

Remarks:

1. Emission Level(dBuV/m) = Raw Value(dBuV) + Correction Factor(dB/m)
2. Correction Factor(dB/m) = Antenna Factor(dB/m) + Cable Factor(dB) – Pre-Amplifier Factor(dB)
3. Margin value = Emission Level – Limit value
4. The other emission levels were very low against the limit.
5. " * " : Fundamental frequency, the limit was restricted at the RF Output Power.
6. " # " : The radiated frequency is out of the restricted band.

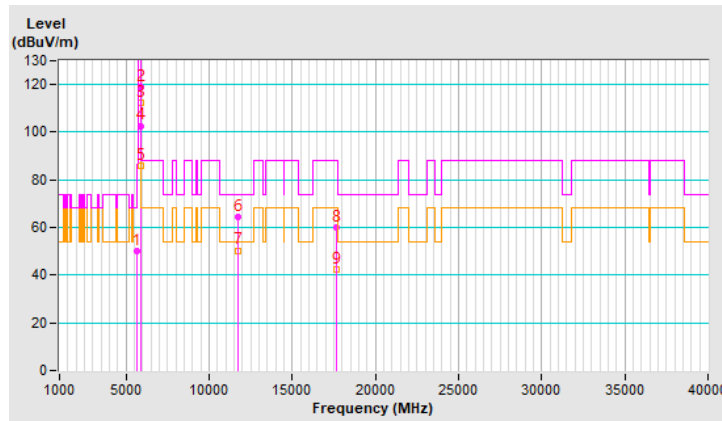

RF Mode	802.11ax (HE20) 52-tone RU	Channel	CH 169 : 5845 MHz
Frequency Range	1 GHz ~ 40 GHz	Detector Function & Bandwidth	(PK) RB = 1 MHz, VB = 3 MHz (AV) RB = 1 MHz, VB = 10 Hz
Input Power (System)	120 Vac, 60 Hz	Environmental Conditions	22°C, 70% RH
Tested By	Louis Yang		

Antenna Polarity & Test Distance : Horizontal at 3 m								
No	Frequency (MHz)	Emission Level (dBuV/m)	Limit (dBuV/m)	Margin (dB)	Antenna Height (m)	Table Angle (Degree)	Raw Value (dBuV)	Correction Factor (dB/m)
1	#5646.70	48.7 PK	68.2	-19.5	1.49 H	108	46.7	2.0
2	*5845.00	110.7 PK			1.49 H	108	108.4	2.3
3	*5845.00	101.1 AV			1.49 H	108	98.8	2.3
4	#5922.60	44.9 PK	90.0	-45.1	1.49 H	108	42.4	2.5
5	#5922.60	29.4 AV	70.0	-40.6	1.49 H	108	26.9	2.5
6	11690.00	60.8 PK	74.0	-13.2	2.85 H	334	48.4	12.4
7	11690.00	48.1 AV	54.0	-5.9	2.85 H	334	35.7	12.4
8	#17535.00	60.6 PK	88.2	-27.6	2.14 H	317	41.4	19.2
9	#17535.00	42.8 AV	68.2	-25.4	2.14 H	317	23.6	19.2

Remarks:

1. Emission Level(dBuV/m) = Raw Value(dBuV) + Correction Factor(dB/m)
2. Correction Factor(dB/m) = Antenna Factor(dB/m) + Cable Factor(dB) – Pre-Amplifier Factor(dB)
3. Margin value = Emission Level – Limit value
4. The other emission levels were very low against the limit.
5. " * " : Fundamental frequency, the limit was restricted at the RF Output Power.
6. " # " : The radiated frequency is out of the restricted band.

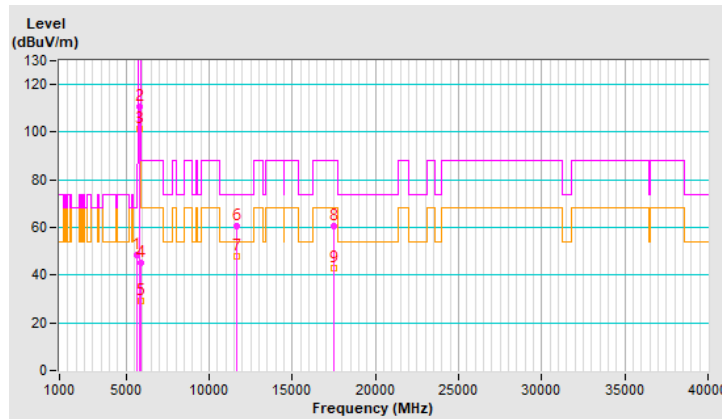

RF Mode	802.11ax (HE20) 52-tone RU	Channel	CH 169 : 5845 MHz
Frequency Range	1 GHz ~ 40 GHz	Detector Function & Bandwidth	(PK) RB = 1 MHz, VB = 3 MHz (AV) RB = 1 MHz, VB = 10 Hz
Input Power (System)	120 Vac, 60 Hz	Environmental Conditions	22°C, 70% RH
Tested By	Louis Yang		

Antenna Polarity & Test Distance : Vertical at 3 m								
No	Frequency (MHz)	Emission Level (dBuV/m)	Limit (dBuV/m)	Margin (dB)	Antenna Height (m)	Table Angle (Degree)	Raw Value (dBuV)	Correction Factor (dB/m)
1	#5650.00	48.8 PK	68.2	-19.4	1.44 V	245	46.8	2.0
2	*5845.00	116.7 PK			1.44 V	245	114.4	2.3
3	*5845.00	106.8 AV			1.44 V	245	104.5	2.3
4	#5895.00	55.2 PK	110.2	-55.0	1.44 V	245	52.8	2.4
5	#5895.00	39.2 AV	90.2	-51.0	1.44 V	245	36.8	2.4
6	11690.00	63.4 PK	74.0	-10.6	2.74 V	335	51.0	12.4
7	11690.00	51.5 AV	54.0	-2.5	2.74 V	335	39.1	12.4
8	#17535.00	54.9 PK	88.2	-33.3	2.77 V	358	35.7	19.2
9	#17535.00	42.6 AV	68.2	-25.6	2.77 V	358	23.4	19.2

Remarks:

1. Emission Level(dBuV/m) = Raw Value(dBuV) + Correction Factor(dB/m)
2. Correction Factor(dB/m) = Antenna Factor(dB/m) + Cable Factor(dB) – Pre-Amplifier Factor(dB)
3. Margin value = Emission Level – Limit value
4. The other emission levels were very low against the limit.
5. " * " : Fundamental frequency, the limit was restricted at the RF Output Power.
6. " # " : The radiated frequency is out of the restricted band.

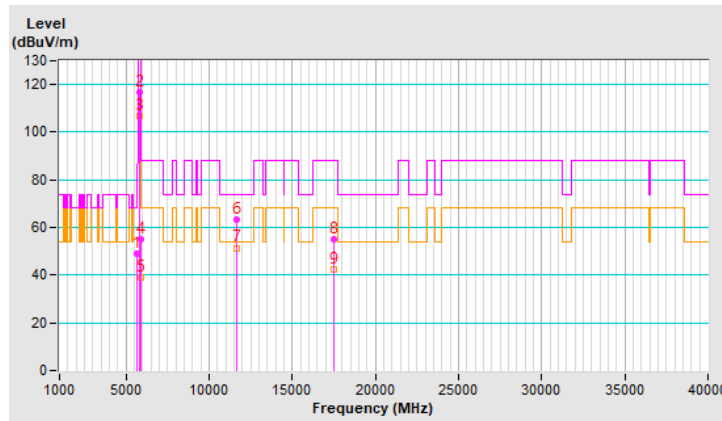

RF Mode	802.11ax (HE20) 52-tone RU	Channel	CH 173 : 5865 MHz
Frequency Range	1 GHz ~ 40 GHz	Detector Function & Bandwidth	(PK) RB = 1 MHz, VB = 3 MHz (AV) RB = 1 MHz, VB = 10 Hz
Input Power (System)	120 Vac, 60 Hz	Environmental Conditions	22°C, 70% RH
Tested By	Louis Yang		

Antenna Polarity & Test Distance : Horizontal at 3 m								
No	Frequency (MHz)	Emission Level (dBuV/m)	Limit (dBuV/m)	Margin (dB)	Antenna Height (m)	Table Angle (Degree)	Raw Value (dBuV)	Correction Factor (dB/m)
1	#5650.00	50.2 PK	68.2	-18.0	1.44 H	101	48.2	2.0
2	*5865.00	110.7 PK			1.44 H	101	108.4	2.3
3	*5865.00	103.0 AV			1.44 H	101	100.7	2.3
4	#5895.00	67.1 PK	110.2	-43.1	1.44 H	101	64.7	2.4
5	#5895.00	35.1 AV	90.2	-55.1	1.44 H	101	32.7	2.4
6	11730.00	60.3 PK	74.0	-13.7	2.80 H	360	48.1	12.2
7	11730.00	47.5 AV	54.0	-6.5	2.80 H	360	35.3	12.2
8	#17595.00	59.4 PK	88.2	-28.8	2.08 H	327	39.7	19.7
9	#17595.00	42.7 AV	68.2	-25.5	2.08 H	327	23.0	19.7

Remarks:

1. Emission Level(dBuV/m) = Raw Value(dBuV) + Correction Factor(dB/m)
2. Correction Factor(dB/m) = Antenna Factor(dB/m) + Cable Factor(dB) – Pre-Amplifier Factor(dB)
3. Margin value = Emission Level – Limit value
4. The other emission levels were very low against the limit.
5. " * " : Fundamental frequency, the limit was restricted at the RF Output Power.
6. " # " : The radiated frequency is out of the restricted band.

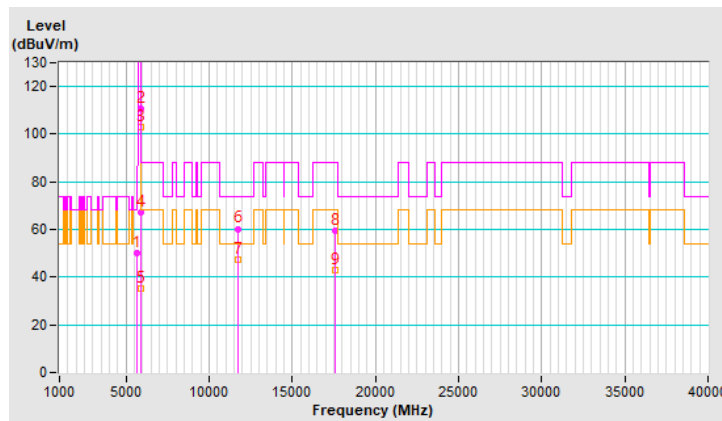

RF Mode	802.11ax (HE20) 52-tone RU	Channel	CH 173 : 5865 MHz
Frequency Range	1 GHz ~ 40 GHz	Detector Function & Bandwidth	(PK) RB = 1 MHz, VB = 3 MHz (AV) RB = 1 MHz, VB = 10 Hz
Input Power (System)	120 Vac, 60 Hz	Environmental Conditions	22°C, 70% RH
Tested By	Louis Yang		

Antenna Polarity & Test Distance : Vertical at 3 m								
No	Frequency (MHz)	Emission Level (dBuV/m)	Limit (dBuV/m)	Margin (dB)	Antenna Height (m)	Table Angle (Degree)	Raw Value (dBuV)	Correction Factor (dB/m)
1	#5650.00	49.3 PK	68.2	-18.9	1.58 V	306	47.3	2.0
2	*5865.00	118.4 PK			1.58 V	306	116.1	2.3
3	*5865.00	110.3 AV			1.58 V	306	108.0	2.3
4	#5895.00	77.5 PK	110.2	-32.7	1.58 V	306	75.1	2.4
5	#5895.00	45.3 AV	90.2	-44.9	1.58 V	306	42.9	2.4
6	11730.00	66.3 PK	74.0	-7.7	2.79 V	328	54.1	12.2
7	11730.00	51.7 AV	54.0	-2.3	2.79 V	328	39.5	12.2
8	#17595.00	55.5 PK	88.2	-32.7	2.79 V	326	35.8	19.7
9	#17595.00	42.6 AV	68.2	-25.6	2.79 V	326	22.9	19.7

Remarks:

1. Emission Level(dBuV/m) = Raw Value(dBuV) + Correction Factor(dB/m)
2. Correction Factor(dB/m) = Antenna Factor(dB/m) + Cable Factor(dB) – Pre-Amplifier Factor(dB)
3. Margin value = Emission Level – Limit value
4. The other emission levels were very low against the limit.
5. " * " : Fundamental frequency, the limit was restricted at the RF Output Power.
6. " # " : The radiated frequency is out of the restricted band.

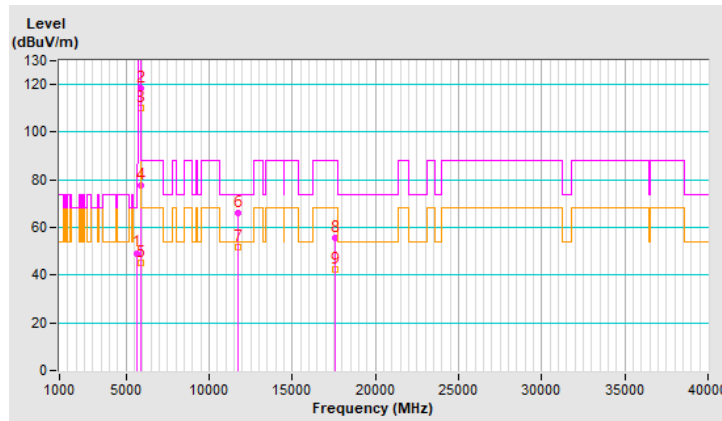

RF Mode	802.11ax (HE20) 52-tone RU	Channel	CH 177 : 5885 MHz
Frequency Range	1 GHz ~ 40 GHz	Detector Function & Bandwidth	(PK) RB = 1 MHz, VB = 3 MHz (AV) RB = 1 MHz, VB = 10 Hz
Input Power (System)	120 Vac, 60 Hz	Environmental Conditions	22°C, 70% RH
Tested By	Louis Yang		

Antenna Polarity & Test Distance : Horizontal at 3 m								
No	Frequency (MHz)	Emission Level (dBuV/m)	Limit (dBuV/m)	Margin (dB)	Antenna Height (m)	Table Angle (Degree)	Raw Value (dBuV)	Correction Factor (dB/m)
1	#5625.50	49.1 PK	68.2	-19.1	1.49 H	129	47.2	1.9
2	*5885.00	108.8 PK			1.49 H	129	106.4	2.4
3	*5885.00	102.9 AV			1.49 H	129	100.5	2.4
4	#5897.40	89.8 PK	108.4	-18.6	1.49 H	129	87.4	2.4
5	#5897.40	71.7 AV	88.4	-16.7	1.49 H	129	69.3	2.4
6	11770.00	62.0 PK	74.0	-12.0	2.69 H	318	49.8	12.2
7	11770.00	48.8 AV	54.0	-5.2	2.69 H	318	36.6	12.2
8	#17655.00	59.0 PK	88.2	-29.2	1.96 H	360	39.0	20.0
9	#17655.00	42.3 AV	68.2	-25.9	1.96 H	360	22.3	20.0

Remarks:

1. Emission Level(dBuV/m) = Raw Value(dBuV) + Correction Factor(dB/m)
2. Correction Factor(dB/m) = Antenna Factor(dB/m) + Cable Factor(dB) – Pre-Amplifier Factor(dB)
3. Margin value = Emission Level – Limit value
4. The other emission levels were very low against the limit.
5. " * " : Fundamental frequency, the limit was restricted at the RF Output Power.
6. " # " : The radiated frequency is out of the restricted band.

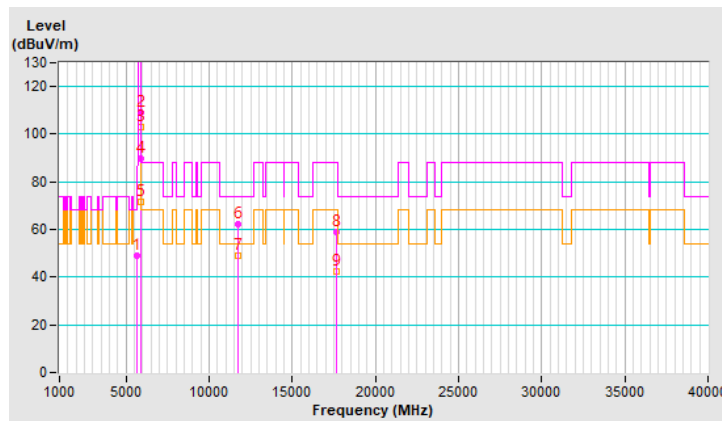

RF Mode	802.11ax (HE20) 52-tone RU	Channel	CH 177 : 5885 MHz
Frequency Range	1 GHz ~ 40 GHz	Detector Function & Bandwidth	(PK) RB = 1 MHz, VB = 3 MHz (AV) RB = 1 MHz, VB = 10 Hz
Input Power (System)	120 Vac, 60 Hz	Environmental Conditions	22°C, 70% RH
Tested By	Louis Yang		

Antenna Polarity & Test Distance : Vertical at 3 m								
No	Frequency (MHz)	Emission Level (dBuV/m)	Limit (dBuV/m)	Margin (dB)	Antenna Height (m)	Table Angle (Degree)	Raw Value (dBuV)	Correction Factor (dB/m)
1	#5650.00	51.0 PK	68.2	-17.2	1.35 V	252	49.0	2.0
2	*5885.00	115.4 PK			1.35 V	252	113.0	2.4
3	*5885.00	109.1 AV			1.35 V	252	106.7	2.4
4	#5895.00	99.1 PK	110.2	-11.1	1.35 V	252	96.7	2.4
5	#5895.00	80.7 AV	90.2	-9.5	1.35 V	252	78.3	2.4
6	11770.00	64.0 PK	74.0	-10.0	2.62 V	348	51.8	12.2
7	11770.00	51.8 AV	54.0	-2.2	2.62 V	348	39.6	12.2
8	#17655.00	57.4 PK	88.2	-30.8	2.62 V	352	37.4	20.0
9	#17655.00	42.2 AV	68.2	-26.0	2.62 V	352	22.2	20.0

Remarks:

1. Emission Level(dBuV/m) = Raw Value(dBuV) + Correction Factor(dB/m)
2. Correction Factor(dB/m) = Antenna Factor(dB/m) + Cable Factor(dB) – Pre-Amplifier Factor(dB)
3. Margin value = Emission Level – Limit value
4. The other emission levels were very low against the limit.
5. " * " : Fundamental frequency, the limit was restricted at the RF Output Power.
6. " # " : The radiated frequency is out of the restricted band.

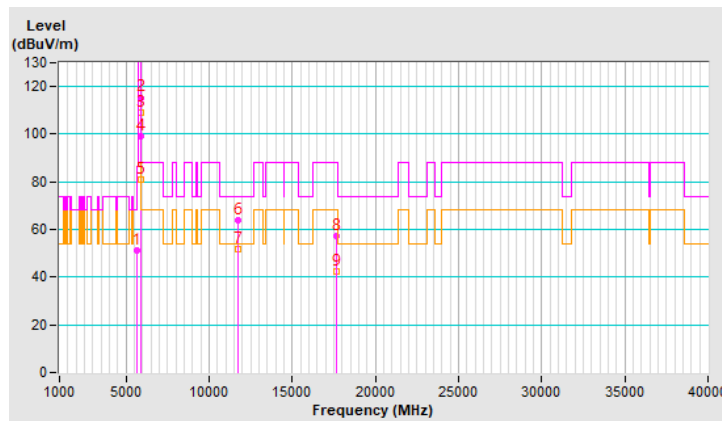

RF Mode	802.11ax (HE20) 106-tone RU	Channel	CH 169 : 5845 MHz
Frequency Range	1 GHz ~ 40 GHz	Detector Function & Bandwidth	(PK) RB = 1 MHz, VB = 3 MHz (AV) RB = 1 MHz, VB = 10 Hz
Input Power (System)	120 Vac, 60 Hz	Environmental Conditions	22°C, 70% RH
Tested By	Louis Yang		

Antenna Polarity & Test Distance : Horizontal at 3 m								
No	Frequency (MHz)	Emission Level (dBuV/m)	Limit (dBuV/m)	Margin (dB)	Antenna Height (m)	Table Angle (Degree)	Raw Value (dBuV)	Correction Factor (dB/m)
1	#5643.70	49.3 PK	68.2	-18.9	1.67 H	92	47.4	1.9
2	*5845.00	109.7 PK			1.67 H	92	107.4	2.3
3	*5845.00	100.3 AV			1.67 H	92	98.0	2.3
4	#5897.10	51.4 PK	108.7	-57.3	1.67 H	92	49.0	2.4
5	#5897.10	26.7 AV	88.7	-62.0	1.67 H	92	24.3	2.4
6	11690.00	61.1 PK	74.0	-12.9	2.62 H	336	48.7	12.4
7	11690.00	47.9 AV	54.0	-6.1	2.62 H	336	35.5	12.4
8	#17535.00	60.3 PK	88.2	-27.9	2.18 H	358	41.1	19.2
9	#17535.00	42.6 AV	68.2	-25.6	2.18 H	358	23.4	19.2

Remarks:

1. Emission Level(dBuV/m) = Raw Value(dBuV) + Correction Factor(dB/m)
2. Correction Factor(dB/m) = Antenna Factor(dB/m) + Cable Factor(dB) – Pre-Amplifier Factor(dB)
3. Margin value = Emission Level – Limit value
4. The other emission levels were very low against the limit.
5. " * " : Fundamental frequency, the limit was restricted at the RF Output Power.
6. " # " : The radiated frequency is out of the restricted band.

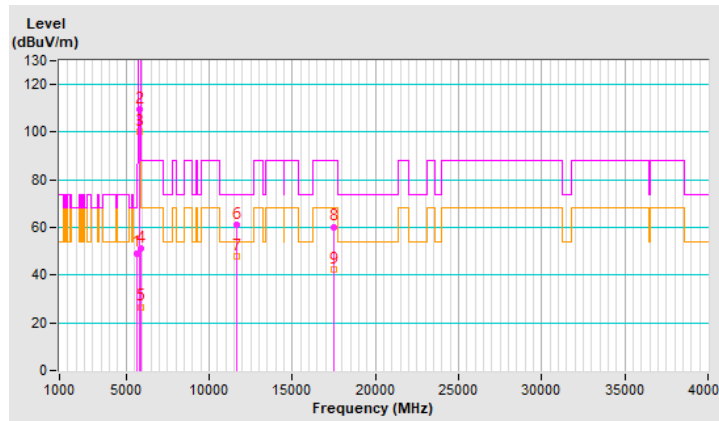

RF Mode	802.11ax (HE20) 106-tone RU	Channel	CH 169 : 5845 MHz
Frequency Range	1 GHz ~ 40 GHz	Detector Function & Bandwidth	(PK) RB = 1 MHz, VB = 3 MHz (AV) RB = 1 MHz, VB = 10 Hz
Input Power (System)	120 Vac, 60 Hz	Environmental Conditions	22°C, 70% RH
Tested By	Louis Yang		

Antenna Polarity & Test Distance : Vertical at 3 m								
No	Frequency (MHz)	Emission Level (dBuV/m)	Limit (dBuV/m)	Margin (dB)	Antenna Height (m)	Table Angle (Degree)	Raw Value (dBuV)	Correction Factor (dB/m)
1	#5650.00	49.4 PK	68.2	-18.8	1.37 V	204	47.4	2.0
2	*5845.00	116.0 PK			1.37 V	204	113.7	2.3
3	*5845.00	106.5 AV			1.37 V	204	104.2	2.3
4	#5895.00	60.6 PK	110.2	-49.6	1.37 V	204	58.2	2.4
5	#5895.00	35.6 AV	90.2	-54.6	1.37 V	204	33.2	2.4
6	11690.00	63.4 PK	74.0	-10.6	2.58 V	357	51.0	12.4
7	11690.00	49.8 AV	54.0	-4.2	2.58 V	357	37.4	12.4
8	#17535.00	55.9 PK	88.2	-32.3	1.57 V	360	36.7	19.2
9	#17535.00	42.8 AV	68.2	-25.4	1.57 V	360	23.6	19.2

Remarks:

1. Emission Level(dBuV/m) = Raw Value(dBuV) + Correction Factor(dB/m)
2. Correction Factor(dB/m) = Antenna Factor(dB/m) + Cable Factor(dB) – Pre-Amplifier Factor(dB)
3. Margin value = Emission Level – Limit value
4. The other emission levels were very low against the limit.
5. " * " : Fundamental frequency, the limit was restricted at the RF Output Power.
6. " # " : The radiated frequency is out of the restricted band.

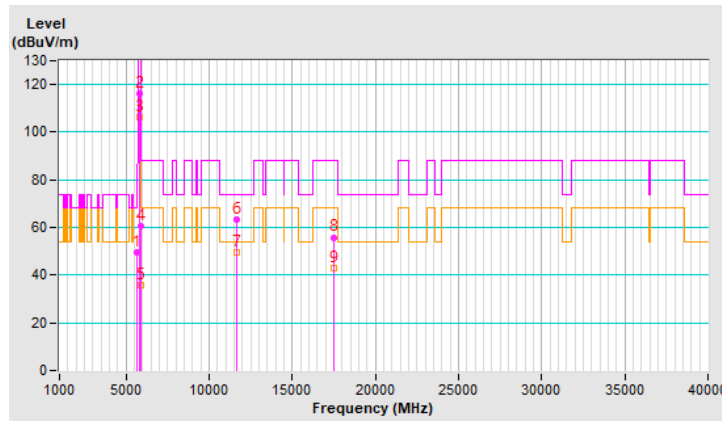

RF Mode	802.11ax (HE20) 106-tone RU	Channel	CH 173 : 5865 MHz
Frequency Range	1 GHz ~ 40 GHz	Detector Function & Bandwidth	(PK) RB = 1 MHz, VB = 3 MHz (AV) RB = 1 MHz, VB = 10 Hz
Input Power (System)	120 Vac, 60 Hz	Environmental Conditions	22°C, 70% RH
Tested By	Louis Yang		

Antenna Polarity & Test Distance : Horizontal at 3 m								
No	Frequency (MHz)	Emission Level (dBuV/m)	Limit (dBuV/m)	Margin (dB)	Antenna Height (m)	Table Angle (Degree)	Raw Value (dBuV)	Correction Factor (dB/m)
1	#5650.00	50.7 PK	68.2	-17.5	1.53 H	78	48.7	2.0
2	*5865.00	110.1 PK			1.53 H	78	107.8	2.3
3	*5865.00	99.6 AV			1.53 H	78	97.3	2.3
4	#5895.00	69.0 PK	110.2	-41.2	1.53 H	78	66.6	2.4
5	#5895.00	39.2 AV	90.2	-51.0	1.53 H	78	36.8	2.4
6	11730.00	61.6 PK	74.0	-12.4	2.59 H	328	49.4	12.2
7	11730.00	49.3 AV	54.0	-4.7	2.59 H	328	37.1	12.2
8	#17595.00	60.1 PK	88.2	-28.1	2.06 H	346	40.4	19.7
9	#17595.00	42.4 AV	68.2	-25.8	2.06 H	346	22.7	19.7

Remarks:

1. Emission Level(dBuV/m) = Raw Value(dBuV) + Correction Factor(dB/m)
2. Correction Factor(dB/m) = Antenna Factor(dB/m) + Cable Factor(dB) – Pre-Amplifier Factor(dB)
3. Margin value = Emission Level – Limit value
4. The other emission levels were very low against the limit.
5. " * " : Fundamental frequency, the limit was restricted at the RF Output Power.
6. " # " : The radiated frequency is out of the restricted band.

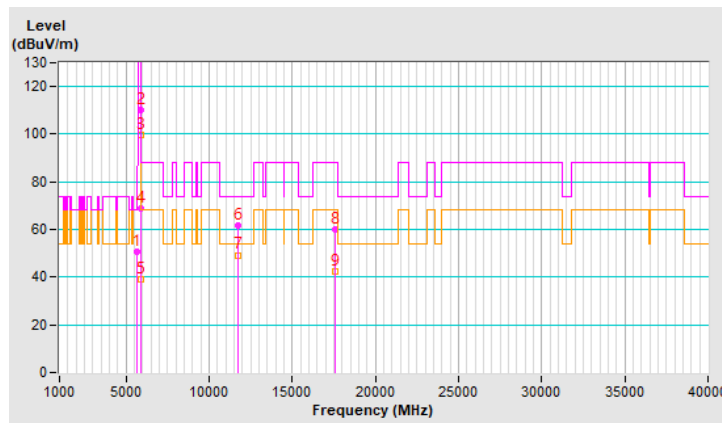

RF Mode	802.11ax (HE20) 106-tone RU	Channel	CH 173 : 5865 MHz
Frequency Range	1 GHz ~ 40 GHz	Detector Function & Bandwidth	(PK) RB = 1 MHz, VB = 3 MHz (AV) RB = 1 MHz, VB = 10 Hz
Input Power (System)	120 Vac, 60 Hz	Environmental Conditions	22°C, 70% RH
Tested By	Louis Yang		

Antenna Polarity & Test Distance : Vertical at 3 m								
No	Frequency (MHz)	Emission Level (dBuV/m)	Limit (dBuV/m)	Margin (dB)	Antenna Height (m)	Table Angle (Degree)	Raw Value (dBuV)	Correction Factor (dB/m)
1	#5650.00	49.3 PK	68.2	-18.9	1.43 V	259	47.3	2.0
2	*5865.00	113.9 PK			1.43 V	259	111.6	2.3
3	*5865.00	104.5 AV			1.43 V	259	102.2	2.3
4	#5895.00	77.8 PK	110.2	-32.4	1.43 V	259	75.4	2.4
5	#5895.00	47.6 AV	90.2	-42.6	1.43 V	259	45.2	2.4
6	11730.00	65.1 PK	74.0	-8.9	1.76 V	338	52.9	12.2
7	11730.00	49.7 AV	54.0	-4.3	1.76 V	338	37.5	12.2
8	#17595.00	55.2 PK	88.2	-33.0	1.84 V	332	35.5	19.7
9	#17595.00	42.6 AV	68.2	-25.6	1.84 V	332	22.9	19.7

Remarks:

1. Emission Level(dBuV/m) = Raw Value(dBuV) + Correction Factor(dB/m)
2. Correction Factor(dB/m) = Antenna Factor(dB/m) + Cable Factor(dB) – Pre-Amplifier Factor(dB)
3. Margin value = Emission Level – Limit value
4. The other emission levels were very low against the limit.
5. " * ": Fundamental frequency, the limit was restricted at the RF Output Power.
6. " # ": The radiated frequency is out of the restricted band.

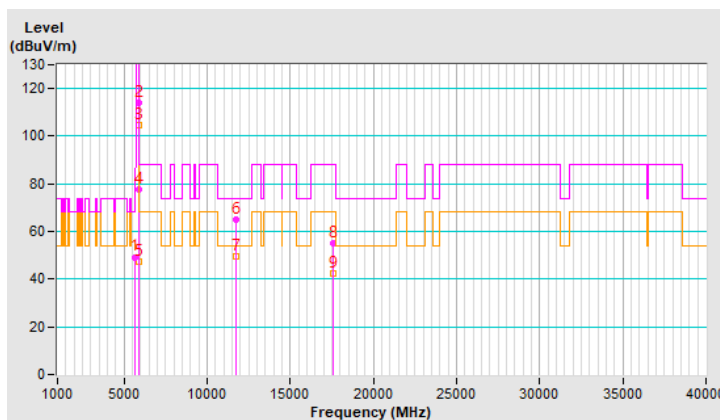

RF Mode	802.11ax (HE20) 106-tone RU	Channel	CH 177 : 5885 MHz
Frequency Range	1 GHz ~ 40 GHz	Detector Function & Bandwidth	(PK) RB = 1 MHz, VB = 3 MHz (AV) RB = 1 MHz, VB = 10 Hz
Input Power (System)	120 Vac, 60 Hz	Environmental Conditions	22°C, 70% RH
Tested By	Louis Yang		

Antenna Polarity & Test Distance : Horizontal at 3 m								
No	Frequency (MHz)	Emission Level (dBuV/m)	Limit (dBuV/m)	Margin (dB)	Antenna Height (m)	Table Angle (Degree)	Raw Value (dBuV)	Correction Factor (dB/m)
1	#5650.00	49.6 PK	68.2	-18.6	1.57 H	93	47.6	2.0
2	*5885.00	103.4 PK			1.57 H	93	101.0	2.4
3	*5885.00	94.0 AV			1.57 H	93	91.6	2.4
4	#5895.00	85.9 PK	110.2	-24.3	1.57 H	93	83.5	2.4
5	#5895.00	78.4 AV	90.2	-11.8	1.57 H	93	76.0	2.4
6	11770.00	60.0 PK	74.0	-14.0	2.66 H	322	47.8	12.2
7	11770.00	47.7 AV	54.0	-6.3	2.66 H	322	35.5	12.2
8	#17655.00	60.2 PK	88.2	-28.0	2.00 H	287	40.2	20.0
9	#17655.00	42.5 AV	68.2	-25.7	2.00 H	287	22.5	20.0

Remarks:

1. Emission Level(dBuV/m) = Raw Value(dBuV) + Correction Factor(dB/m)
2. Correction Factor(dB/m) = Antenna Factor(dB/m) + Cable Factor(dB) – Pre-Amplifier Factor(dB)
3. Margin value = Emission Level – Limit value
4. The other emission levels were very low against the limit.
5. " * " : Fundamental frequency, the limit was restricted at the RF Output Power.
6. " # " : The radiated frequency is out of the restricted band.

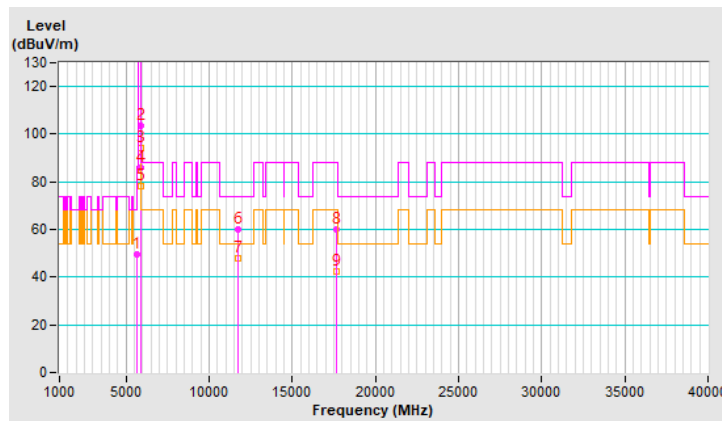

Mode B

RF Mode	802.11a	Channel	CH 169 : 5845 MHz
Frequency Range	1 GHz ~ 40 GHz	Detector Function & Bandwidth	(PK) RB = 1 MHz, VB = 3 MHz (AV) RB = 1 MHz, VB = 10 Hz
Input Power (System)	120 Vac, 60 Hz	Environmental Conditions	28°C, 75% RH
Tested By	Louis Yang		

Antenna Polarity & Test Distance : Horizontal at 3 m								
No	Frequency (MHz)	Emission Level (dBuV/m)	Limit (dBuV/m)	Margin (dB)	Antenna Height (m)	Table Angle (Degree)	Raw Value (dBuV)	Correction Factor (dB/m)
1	#5650.00	52.0 PK	68.2	-16.2	2.55 H	61	50.7	1.3
2	*5845.00	114.4 PK			2.55 H	61	112.6	1.8
3	*5845.00	104.8 AV			2.55 H	61	103.0	1.8
4	#5895.00	71.7 PK	110.2	-38.5	2.55 H	61	69.8	1.9
5	#5895.00	61.2 AV	90.2	-29.0	2.55 H	61	59.3	1.9
6	11690.00	60.4 PK	74.0	-13.6	2.47 H	302	48.7	11.7
7	11690.00	46.2 AV	54.0	-7.8	2.47 H	302	34.5	11.7
8	#17535.00	56.2 PK	88.2	-32.0	3.11 H	333	38.6	17.6
9	#17535.00	43.4 AV	68.2	-24.8	3.11 H	333	25.8	17.6

Remarks:

1. Emission Level(dBuV/m) = Raw Value(dBuV) + Correction Factor(dB/m)
2. Correction Factor(dB/m) = Antenna Factor(dB/m) + Cable Factor(dB) – Pre-Amplifier Factor(dB)
3. Margin value = Emission Level – Limit value
4. The other emission levels were very low against the limit.
5. " * " : Fundamental frequency, the limit was restricted at the RF Output Power.
6. " # " : The radiated frequency is out of the restricted band.

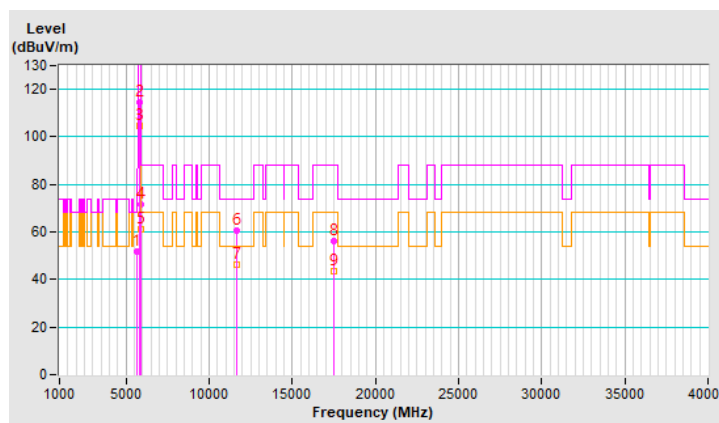

RF Mode	802.11a	Channel	CH 169 : 5845 MHz
Frequency Range	1 GHz ~ 40 GHz	Detector Function & Bandwidth	(PK) RB = 1 MHz, VB = 3 MHz (AV) RB = 1 MHz, VB = 10 Hz
Input Power (System)	120 Vac, 60 Hz	Environmental Conditions	28°C, 75% RH
Tested By	Louis Yang		

Antenna Polarity & Test Distance : Vertical at 3 m								
No	Frequency (MHz)	Emission Level (dBuV/m)	Limit (dBuV/m)	Margin (dB)	Antenna Height (m)	Table Angle (Degree)	Raw Value (dBuV)	Correction Factor (dB/m)
1	#5650.00	51.2 PK	68.2	-17.0	1.48 V	18	49.9	1.3
2	*5845.00	112.2 PK			1.48 V	18	110.4	1.8
3	*5845.00	102.1 AV			1.48 V	18	100.3	1.8
4	#5895.00	63.3 PK	110.2	-46.9	1.48 V	18	61.4	1.9
5	#5895.00	53.0 AV	90.2	-37.2	1.48 V	18	51.1	1.9
6	11690.00	54.6 PK	74.0	-19.4	1.35 V	9	42.9	11.7
7	11690.00	44.2 AV	54.0	-9.8	1.35 V	9	32.5	11.7
8	#17535.00	54.1 PK	88.2	-34.1	1.21 V	3	36.5	17.6
9	#17535.00	42.2 AV	68.2	-26.0	1.21 V	3	24.6	17.6

Remarks:

1. Emission Level(dBuV/m) = Raw Value(dBuV) + Correction Factor(dB/m)
2. Correction Factor(dB/m) = Antenna Factor(dB/m) + Cable Factor(dB) – Pre-Amplifier Factor(dB)
3. Margin value = Emission Level – Limit value
4. The other emission levels were very low against the limit.
5. " * " : Fundamental frequency, the limit was restricted at the RF Output Power.
6. " # " : The radiated frequency is out of the restricted band.

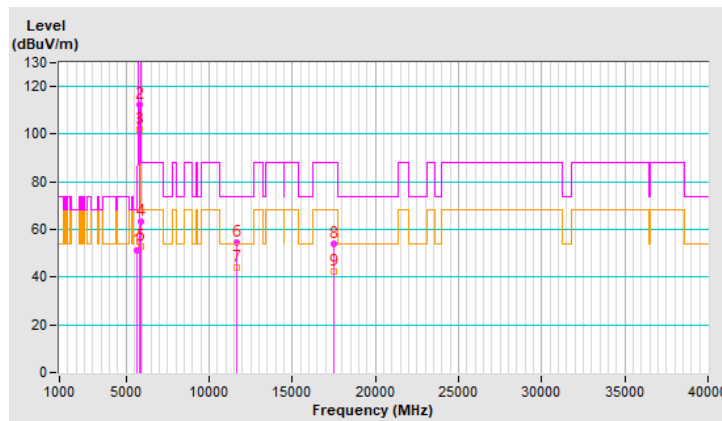

RF Mode	802.11a	Channel	CH 173 : 5865 MHz
Frequency Range	1 GHz ~ 40 GHz	Detector Function & Bandwidth	(PK) RB = 1 MHz, VB = 3 MHz (AV) RB = 1 MHz, VB = 10 Hz
Input Power (System)	120 Vac, 60 Hz	Environmental Conditions	28°C, 75% RH
Tested By	Louis Yang		

Antenna Polarity & Test Distance : Horizontal at 3 m								
No	Frequency (MHz)	Emission Level (dBuV/m)	Limit (dBuV/m)	Margin (dB)	Antenna Height (m)	Table Angle (Degree)	Raw Value (dBuV)	Correction Factor (dB/m)
1	#5650.00	51.5 PK	68.2	-16.7	2.37 H	53	50.2	1.3
2	*5865.00	111.5 PK			2.37 H	53	109.7	1.8
3	*5865.00	103.1 AV			2.37 H	53	101.3	1.8
4	#5895.00	75.4 PK	110.2	-34.8	2.37 H	53	73.5	1.9
5	#5895.00	63.3 AV	90.2	-26.9	2.37 H	53	61.4	1.9
6	11730.00	60.1 PK	74.0	-13.9	2.46 H	323	48.6	11.5
7	11730.00	45.8 AV	54.0	-8.2	2.46 H	323	34.3	11.5
8	#17595.00	56.5 PK	88.2	-31.7	3.01 H	339	38.6	17.9
9	#17595.00	43.1 AV	68.2	-25.1	3.01 H	339	25.2	17.9

Remarks:

1. Emission Level(dBuV/m) = Raw Value(dBuV) + Correction Factor(dB/m)
2. Correction Factor(dB/m) = Antenna Factor(dB/m) + Cable Factor(dB) – Pre-Amplifier Factor(dB)
3. Margin value = Emission Level – Limit value
4. The other emission levels were very low against the limit.
5. " * " : Fundamental frequency, the limit was restricted at the RF Output Power.
6. " # " : The radiated frequency is out of the restricted band.

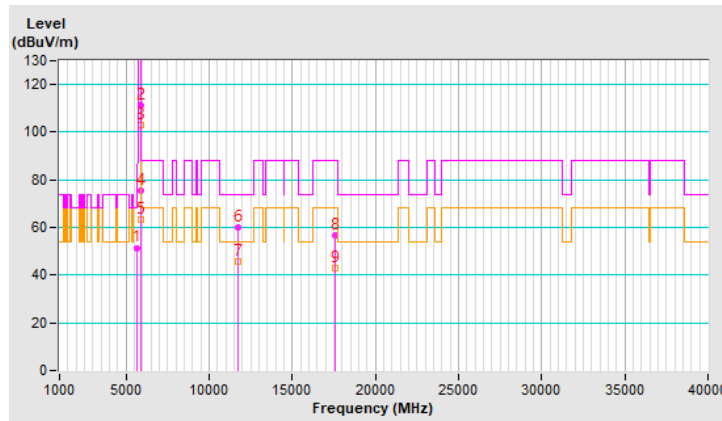

RF Mode	802.11a	Channel	CH 173 : 5865 MHz
Frequency Range	1 GHz ~ 40 GHz	Detector Function & Bandwidth	(PK) RB = 1 MHz, VB = 3 MHz (AV) RB = 1 MHz, VB = 10 Hz
Input Power (System)	120 Vac, 60 Hz	Environmental Conditions	28°C, 75% RH
Tested By	Louis Yang		

Antenna Polarity & Test Distance : Vertical at 3 m								
No	Frequency (MHz)	Emission Level (dBuV/m)	Limit (dBuV/m)	Margin (dB)	Antenna Height (m)	Table Angle (Degree)	Raw Value (dBuV)	Correction Factor (dB/m)
1	#5650.00	50.6 PK	68.2	-17.6	1.50 V	40	49.3	1.3
2	*5865.00	113.3 PK			1.50 V	40	111.5	1.8
3	*5865.00	104.1 AV			1.50 V	40	102.3	1.8
4	#5895.00	69.4 PK	110.2	-40.8	1.50 V	40	67.5	1.9
5	#5895.00	65.7 AV	90.2	-24.5	1.50 V	40	63.8	1.9
6	11730.00	55.2 PK	74.0	-18.8	1.43 V	65	43.7	11.5
7	11730.00	44.9 AV	54.0	-9.1	1.43 V	65	33.4	11.5
8	#17595.00	54.0 PK	88.2	-34.2	1.30 V	40	36.1	17.9
9	#17595.00	42.1 AV	68.2	-26.1	1.30 V	40	24.2	17.9

Remarks:

1. Emission Level(dBuV/m) = Raw Value(dBuV) + Correction Factor(dB/m)
2. Correction Factor(dB/m) = Antenna Factor(dB/m) + Cable Factor(dB) – Pre-Amplifier Factor(dB)
3. Margin value = Emission Level – Limit value
4. The other emission levels were very low against the limit.
5. " * " : Fundamental frequency, the limit was restricted at the RF Output Power.
6. " # " : The radiated frequency is out of the restricted band.

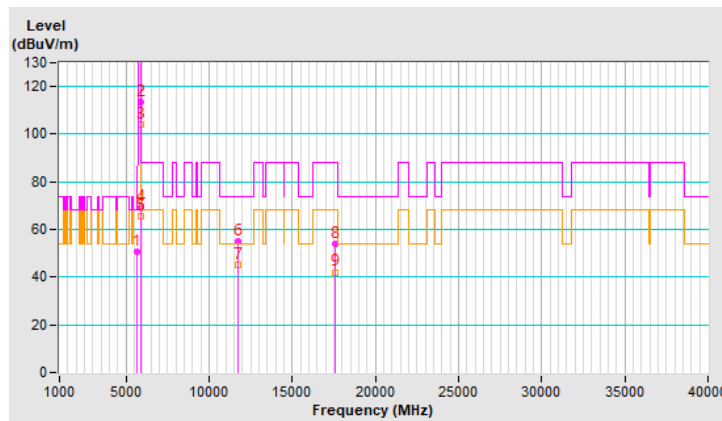

RF Mode	802.11a	Channel	CH 177 : 5885 MHz
Frequency Range	1 GHz ~ 40 GHz	Detector Function & Bandwidth	(PK) RB = 1 MHz, VB = 3 MHz (AV) RB = 1 MHz, VB = 10 Hz
Input Power (System)	120 Vac, 60 Hz	Environmental Conditions	28°C, 75% RH
Tested By	Louis Yang		

Antenna Polarity & Test Distance : Horizontal at 3 m								
No	Frequency (MHz)	Emission Level (dBuV/m)	Limit (dBuV/m)	Margin (dB)	Antenna Height (m)	Table Angle (Degree)	Raw Value (dBuV)	Correction Factor (dB/m)
1	#5650.00	51.9 PK	68.2	-16.3	2.41 H	72	50.6	1.3
2	*5885.00	113.9 PK			2.41 H	72	112.0	1.9
3	*5885.00	105.2 AV			2.41 H	72	103.3	1.9
4	#5895.10	86.8 PK	110.1	-23.3	2.41 H	72	84.9	1.9
5	#5895.10	64.2 AV	90.1	-25.9	2.41 H	72	62.3	1.9
6	11770.00	60.7 PK	74.0	-13.3	2.46 H	330	49.3	11.4
7	11770.00	47.0 AV	54.0	-7.0	2.46 H	330	35.6	11.4
8	#17655.00	56.4 PK	88.2	-31.8	3.01 H	329	38.3	18.1
9	#17655.00	42.8 AV	68.2	-25.4	3.01 H	329	24.7	18.1

Remarks:

1. Emission Level(dBuV/m) = Raw Value(dBuV) + Correction Factor(dB/m)
2. Correction Factor(dB/m) = Antenna Factor(dB/m) + Cable Factor(dB) – Pre-Amplifier Factor(dB)
3. Margin value = Emission Level – Limit value
4. The other emission levels were very low against the limit.
5. " * " : Fundamental frequency, the limit was restricted at the RF Output Power.
6. " # " : The radiated frequency is out of the restricted band.

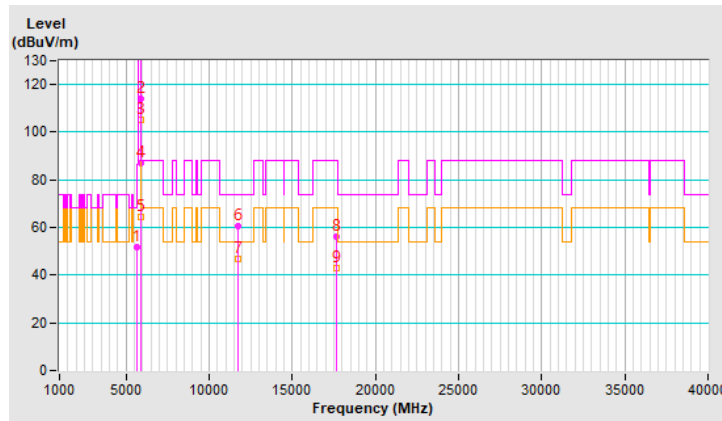

RF Mode	802.11a	Channel	CH 177 : 5885 MHz
Frequency Range	1 GHz ~ 40 GHz	Detector Function & Bandwidth	(PK) RB = 1 MHz, VB = 3 MHz (AV) RB = 1 MHz, VB = 10 Hz
Input Power (System)	120 Vac, 60 Hz	Environmental Conditions	28°C, 75% RH
Tested By	Louis Yang		

Antenna Polarity & Test Distance : Vertical at 3 m								
No	Frequency (MHz)	Emission Level (dBuV/m)	Limit (dBuV/m)	Margin (dB)	Antenna Height (m)	Table Angle (Degree)	Raw Value (dBuV)	Correction Factor (dB/m)
1	#5650.00	52.4 PK	68.2	-15.8	1.42 V	17	51.1	1.3
2	*5885.00	112.4 PK			1.42 V	17	110.5	1.9
3	*5885.00	103.0 AV			1.42 V	17	101.1	1.9
4	#5895.00	84.2 PK	110.2	-26.0	1.42 V	17	82.3	1.9
5	#5895.00	66.2 AV	90.2	-24.0	1.42 V	17	64.3	1.9
6	11770.00	54.7 PK	74.0	-19.3	1.17 V	45	43.3	11.4
7	11770.00	44.9 AV	54.0	-9.1	1.17 V	45	33.5	11.4
8	#17655.00	54.0 PK	88.2	-34.2	1.19 V	27	35.9	18.1
9	#17655.00	41.8 AV	68.2	-26.4	1.19 V	27	23.7	18.1

Remarks:

1. Emission Level(dBuV/m) = Raw Value(dBuV) + Correction Factor(dB/m)
2. Correction Factor(dB/m) = Antenna Factor(dB/m) + Cable Factor(dB) – Pre-Amplifier Factor(dB)
3. Margin value = Emission Level – Limit value
4. The other emission levels were very low against the limit.
5. " * " : Fundamental frequency, the limit was restricted at the RF Output Power.
6. " # " : The radiated frequency is out of the restricted band.

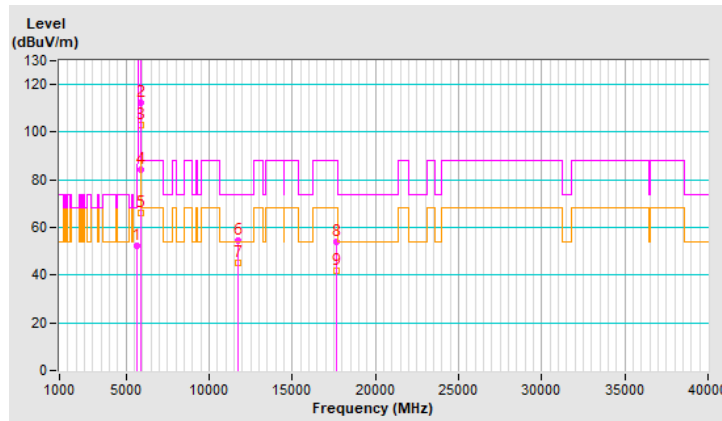

RF Mode	802.11ax (HE20)	Channel	CH 169 : 5845 MHz
Frequency Range	1 GHz ~ 40 GHz	Detector Function & Bandwidth	(PK) RB = 1 MHz, VB = 3 MHz (AV) RB = 1 MHz, VB = 10 Hz
Input Power (System)	120 Vac, 60 Hz	Environmental Conditions	28°C, 75% RH
Tested By	Louis Yang		

Antenna Polarity & Test Distance : Horizontal at 3 m								
No	Frequency (MHz)	Emission Level (dBuV/m)	Limit (dBuV/m)	Margin (dB)	Antenna Height (m)	Table Angle (Degree)	Raw Value (dBuV)	Correction Factor (dB/m)
1	#5650.00	51.4 PK	68.2	-16.8	1.38 H	84	50.1	1.3
2	*5845.00	112.9 PK			1.38 H	84	111.1	1.8
3	*5845.00	103.6 AV			1.38 H	84	101.8	1.8
4	#5895.00	59.6 PK	110.2	-50.6	1.38 H	84	57.7	1.9
5	#5895.00	53.0 AV	90.2	-37.2	1.38 H	84	51.1	1.9
6	11690.00	53.7 PK	74.0	-20.3	1.46 H	149	42.0	11.7
7	11690.00	44.3 AV	54.0	-9.7	1.46 H	149	32.6	11.7
8	#17535.00	53.7 PK	88.2	-34.5	1.40 H	324	36.1	17.6
9	#17535.00	41.9 AV	68.2	-26.3	1.40 H	324	24.3	17.6

Remarks:

1. Emission Level(dBuV/m) = Raw Value(dBuV) + Correction Factor(dB/m)
2. Correction Factor(dB/m) = Antenna Factor(dB/m) + Cable Factor(dB) – Pre-Amplifier Factor(dB)
3. Margin value = Emission Level – Limit value
4. The other emission levels were very low against the limit.
5. " * " : Fundamental frequency, the limit was restricted at the RF Output Power.
6. " # " : The radiated frequency is out of the restricted band.

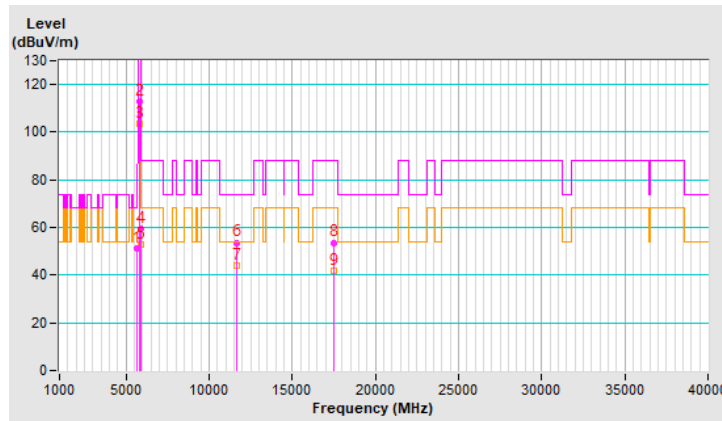

RF Mode	802.11ax (HE20)	Channel	CH 169 : 5845 MHz
Frequency Range	1 GHz ~ 40 GHz	Detector Function & Bandwidth	(PK) RB = 1 MHz, VB = 3 MHz (AV) RB = 1 MHz, VB = 10 Hz
Input Power (System)	120 Vac, 60 Hz	Environmental Conditions	28°C, 75% RH
Tested By	Louis Yang		

Antenna Polarity & Test Distance : Vertical at 3 m								
No	Frequency (MHz)	Emission Level (dBuV/m)	Limit (dBuV/m)	Margin (dB)	Antenna Height (m)	Table Angle (Degree)	Raw Value (dBuV)	Correction Factor (dB/m)
1	#5650.00	51.4 PK	68.2	-16.8	1.38 V	84	50.1	1.3
2	*5845.00	112.9 PK			1.38 V	84	111.1	1.8
3	*5845.00	103.6 AV			1.38 V	84	101.8	1.8
4	#5895.00	59.6 PK	110.2	-50.6	1.38 V	84	57.7	1.9
5	#5895.00	53.0 AV	90.2	-37.2	1.38 V	84	51.1	1.9
6	11690.00	53.7 PK	74.0	-20.3	1.46 V	149	42.0	11.7
7	11690.00	44.3 AV	54.0	-9.7	1.46 V	149	32.6	11.7
8	#17535.00	53.7 PK	88.2	-34.5	1.40 V	324	36.1	17.6
9	#17535.00	41.9 AV	68.2	-26.3	1.40 V	324	24.3	17.6

Remarks:

1. Emission Level(dBuV/m) = Raw Value(dBuV) + Correction Factor(dB/m)
2. Correction Factor(dB/m) = Antenna Factor(dB/m) + Cable Factor(dB) – Pre-Amplifier Factor(dB)
3. Margin value = Emission Level – Limit value
4. The other emission levels were very low against the limit.
5. " * " : Fundamental frequency, the limit was restricted at the RF Output Power.
6. " # " : The radiated frequency is out of the restricted band.

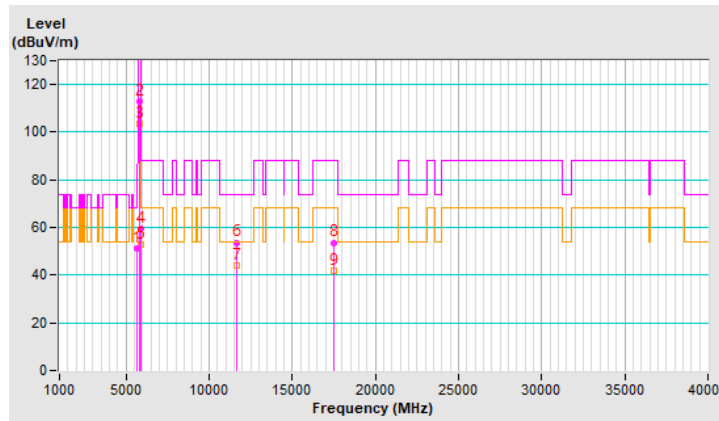

RF Mode	802.11ax (HE20)	Channel	CH 173 : 5865 MHz
Frequency Range	1 GHz ~ 40 GHz	Detector Function & Bandwidth	(PK) RB = 1 MHz, VB = 3 MHz (AV) RB = 1 MHz, VB = 10 Hz
Input Power (System)	120 Vac, 60 Hz	Environmental Conditions	28°C, 75% RH
Tested By	Louis Yang		

Antenna Polarity & Test Distance : Horizontal at 3 m								
No	Frequency (MHz)	Emission Level (dBuV/m)	Limit (dBuV/m)	Margin (dB)	Antenna Height (m)	Table Angle (Degree)	Raw Value (dBuV)	Correction Factor (dB/m)
1	#5650.00	51.9 PK	68.2	-16.3	2.46 H	68	50.6	1.3
2	*5865.00	114.6 PK			2.46 H	68	112.8	1.8
3	*5865.00	104.3 AV			2.46 H	68	102.5	1.8
4	#5895.00	67.8 PK	110.2	-42.4	2.46 H	68	65.9	1.9
5	#5895.00	57.5 AV	90.2	-32.7	2.46 H	68	55.6	1.9
6	11730.00	59.6 PK	74.0	-14.4	2.28 H	307	48.1	11.5
7	11730.00	46.1 AV	54.0	-7.9	2.28 H	307	34.6	11.5
8	#17595.00	54.8 PK	88.2	-33.4	3.17 H	341	36.9	17.9
9	#17595.00	42.3 AV	68.2	-25.9	3.17 H	341	24.4	17.9

Remarks:

1. Emission Level(dBuV/m) = Raw Value(dBuV) + Correction Factor(dB/m)
2. Correction Factor(dB/m) = Antenna Factor(dB/m) + Cable Factor(dB) – Pre-Amplifier Factor(dB)
3. Margin value = Emission Level – Limit value
4. The other emission levels were very low against the limit.
5. " * " : Fundamental frequency, the limit was restricted at the RF Output Power.
6. " # " : The radiated frequency is out of the restricted band.

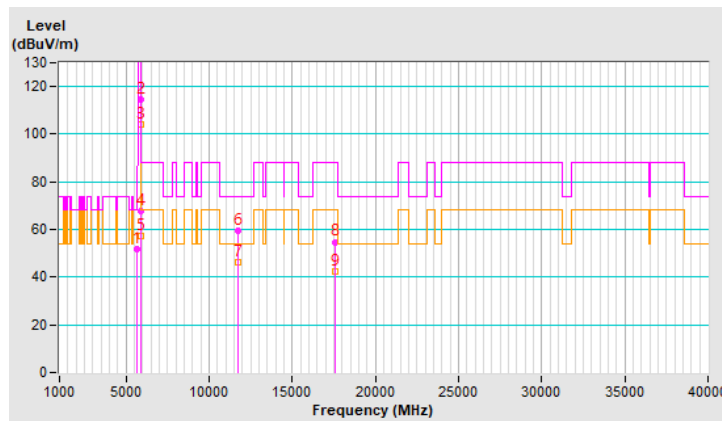

RF Mode	802.11ax (HE20)	Channel	CH 173 : 5865 MHz
Frequency Range	1 GHz ~ 40 GHz	Detector Function & Bandwidth	(PK) RB = 1 MHz, VB = 3 MHz (AV) RB = 1 MHz, VB = 10 Hz
Input Power (System)	120 Vac, 60 Hz	Environmental Conditions	28°C, 75% RH
Tested By	Louis Yang		

Antenna Polarity & Test Distance : Vertical at 3 m								
No	Frequency (MHz)	Emission Level (dBuV/m)	Limit (dBuV/m)	Margin (dB)	Antenna Height (m)	Table Angle (Degree)	Raw Value (dBuV)	Correction Factor (dB/m)
1	#5650.00	50.6 PK	68.2	-17.6	1.64 V	33	49.3	1.3
2	*5865.00	112.7 PK			1.64 V	33	110.9	1.8
3	*5865.00	103.1 AV			1.64 V	33	101.3	1.8
4	#5895.00	68.0 PK	110.2	-42.2	1.64 V	33	66.1	1.9
5	#5895.00	57.8 AV	90.2	-32.4	1.64 V	33	55.9	1.9
6	11730.00	53.9 PK	74.0	-20.1	1.49 V	121	42.4	11.5
7	11730.00	43.8 AV	54.0	-10.2	1.49 V	121	32.3	11.5
8	#17595.00	54.4 PK	88.2	-33.8	1.40 V	304	36.5	17.9
9	#17595.00	42.3 AV	68.2	-25.9	1.40 V	304	24.4	17.9

Remarks:

1. Emission Level(dBuV/m) = Raw Value(dBuV) + Correction Factor(dB/m)
2. Correction Factor(dB/m) = Antenna Factor(dB/m) + Cable Factor(dB) – Pre-Amplifier Factor(dB)
3. Margin value = Emission Level – Limit value
4. The other emission levels were very low against the limit.
5. " * " : Fundamental frequency, the limit was restricted at the RF Output Power.
6. " # " : The radiated frequency is out of the restricted band.

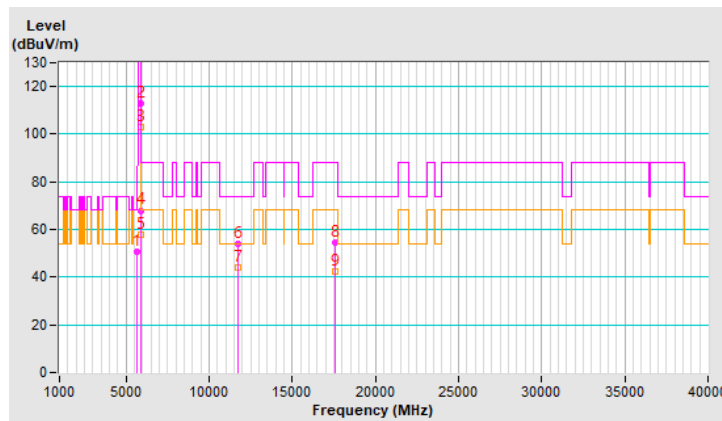

RF Mode	802.11ax (HE20)	Channel	CH 177 : 5885 MHz
Frequency Range	1 GHz ~ 40 GHz	Detector Function & Bandwidth	(PK) RB = 1 MHz, VB = 3 MHz (AV) RB = 1 MHz, VB = 10 Hz
Input Power (System)	120 Vac, 60 Hz	Environmental Conditions	28°C, 75% RH
Tested By	Louis Yang		

Antenna Polarity & Test Distance : Horizontal at 3 m								
No	Frequency (MHz)	Emission Level (dBuV/m)	Limit (dBuV/m)	Margin (dB)	Antenna Height (m)	Table Angle (Degree)	Raw Value (dBuV)	Correction Factor (dB/m)
1	#5650.00	50.6 PK	68.2	-17.6	2.55 H	60	49.3	1.3
2	*5885.00	114.0 PK			2.55 H	60	112.1	1.9
3	*5885.00	103.8 AV			2.55 H	60	101.9	1.9
4	#5897.00	68.4 PK	108.7	-40.3	2.55 H	60	66.5	1.9
5	#5897.00	58.0 AV	88.7	-30.7	2.55 H	60	56.1	1.9
6	11770.00	58.7 PK	74.0	-15.3	2.57 H	299	47.3	11.4
7	11770.00	45.3 AV	54.0	-8.7	2.57 H	299	33.9	11.4
8	#17655.00	55.5 PK	88.2	-32.7	3.02 H	333	37.4	18.1
9	#17655.00	42.2 AV	68.2	-26.0	3.02 H	333	24.1	18.1

Remarks:

1. Emission Level(dBuV/m) = Raw Value(dBuV) + Correction Factor(dB/m)
2. Correction Factor(dB/m) = Antenna Factor(dB/m) + Cable Factor(dB) – Pre-Amplifier Factor(dB)
3. Margin value = Emission Level – Limit value
4. The other emission levels were very low against the limit.
5. " * " : Fundamental frequency, the limit was restricted at the RF Output Power.
6. " # " : The radiated frequency is out of the restricted band.

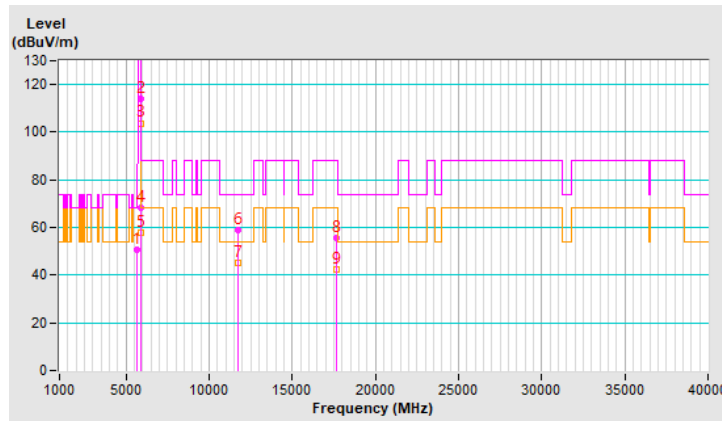

RF Mode	802.11ax (HE20)	Channel	CH 177 : 5885 MHz
Frequency Range	1 GHz ~ 40 GHz	Detector Function & Bandwidth	(PK) RB = 1 MHz, VB = 3 MHz (AV) RB = 1 MHz, VB = 10 Hz
Input Power (System)	120 Vac, 60 Hz	Environmental Conditions	28°C, 75% RH
Tested By	Louis Yang		

Antenna Polarity & Test Distance : Vertical at 3 m								
No	Frequency (MHz)	Emission Level (dBuV/m)	Limit (dBuV/m)	Margin (dB)	Antenna Height (m)	Table Angle (Degree)	Raw Value (dBuV)	Correction Factor (dB/m)
1	#5650.00	50.2 PK	68.2	-18.0	1.51 V	40	48.9	1.3
2	*5885.00	112.6 PK			1.51 V	40	110.7	1.9
3	*5885.00	103.2 AV			1.51 V	40	101.3	1.9
4	#5895.00	67.7 PK	110.2	-42.5	1.51 V	40	65.8	1.9
5	#5895.00	57.8 AV	90.2	-32.4	1.51 V	40	55.9	1.9
6	11770.00	54.9 PK	74.0	-19.1	1.56 V	127	43.5	11.4
7	11770.00	44.1 AV	54.0	-9.9	1.56 V	127	32.7	11.4
8	#17655.00	53.9 PK	88.2	-34.3	1.49 V	304	35.8	18.1
9	#17655.00	41.9 AV	68.2	-26.3	1.49 V	304	23.8	18.1

Remarks:

1. Emission Level(dBuV/m) = Raw Value(dBuV) + Correction Factor(dB/m)
2. Correction Factor(dB/m) = Antenna Factor(dB/m) + Cable Factor(dB) – Pre-Amplifier Factor(dB)
3. Margin value = Emission Level – Limit value
4. The other emission levels were very low against the limit.
5. " * " : Fundamental frequency, the limit was restricted at the RF Output Power.
6. " # " : The radiated frequency is out of the restricted band.

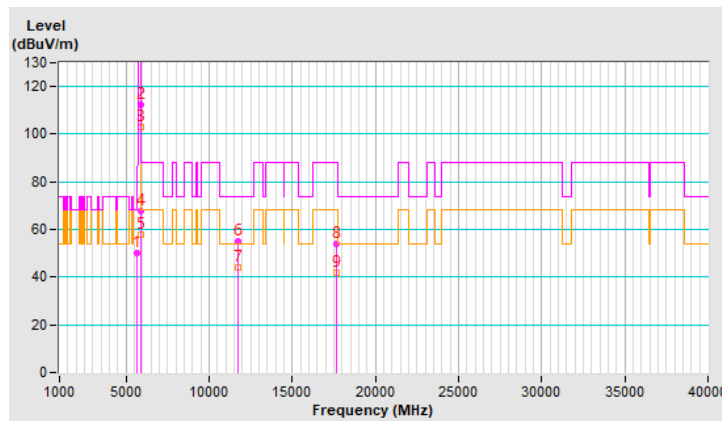

RF Mode	802.11ax (HE40)	Channel	CH 167 : 5835 MHz
Frequency Range	1 GHz ~ 40 GHz	Detector Function & Bandwidth	(PK) RB = 1 MHz, VB = 3 MHz (AV) RB = 1 MHz, VB = 10 Hz
Input Power (System)	120 Vac, 60 Hz	Environmental Conditions	28°C, 75% RH
Tested By	Louis Yang		

Antenna Polarity & Test Distance : Horizontal at 3 m								
No	Frequency (MHz)	Emission Level (dBuV/m)	Limit (dBuV/m)	Margin (dB)	Antenna Height (m)	Table Angle (Degree)	Raw Value (dBuV)	Correction Factor (dB/m)
1	#5650.00	52.2 PK	68.2	-16.0	2.57 H	59	50.9	1.3
2	*5835.00	113.5 PK			2.57 H	59	111.7	1.8
3	*5835.00	102.9 AV			2.57 H	59	101.1	1.8
4	#5895.00	68.1 PK	110.2	-42.1	2.57 H	59	66.2	1.9
5	#5895.00	58.1 AV	90.2	-32.1	2.57 H	59	56.2	1.9
6	11670.00	59.2 PK	74.0	-14.8	2.44 H	317	47.6	11.6
7	11670.00	45.6 AV	54.0	-8.4	2.44 H	317	34.0	11.6
8	#17505.00	56.0 PK	88.2	-32.2	3.09 H	318	38.5	17.5
9	#17505.00	42.7 AV	68.2	-25.5	3.09 H	318	25.2	17.5

Remarks:

1. Emission Level(dBuV/m) = Raw Value(dBuV) + Correction Factor(dB/m)
2. Correction Factor(dB/m) = Antenna Factor(dB/m) + Cable Factor(dB) – Pre-Amplifier Factor(dB)
3. Margin value = Emission Level – Limit value
4. The other emission levels were very low against the limit.
5. " * " : Fundamental frequency, the limit was restricted at the RF Output Power.
6. " # " : The radiated frequency is out of the restricted band.

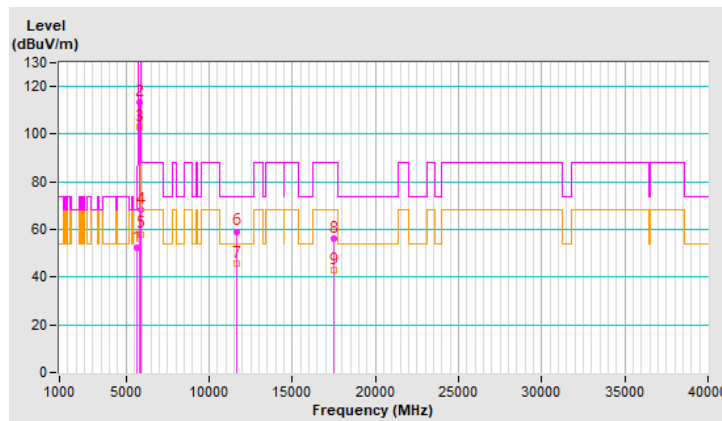

RF Mode	802.11ax (HE40)	Channel	CH 167 : 5835 MHz
Frequency Range	1 GHz ~ 40 GHz	Detector Function & Bandwidth	(PK) RB = 1 MHz, VB = 3 MHz (AV) RB = 1 MHz, VB = 10 Hz
Input Power (System)	120 Vac, 60 Hz	Environmental Conditions	28°C, 75% RH
Tested By	Louis Yang		

Antenna Polarity & Test Distance : Vertical at 3 m								
No	Frequency (MHz)	Emission Level (dBuV/m)	Limit (dBuV/m)	Margin (dB)	Antenna Height (m)	Table Angle (Degree)	Raw Value (dBuV)	Correction Factor (dB/m)
1	#5650.00	50.5 PK	68.2	-17.7	1.56 V	11	49.2	1.3
2	*5835.00	112.6 PK			1.56 V	11	110.8	1.8
3	*5835.00	101.6 AV			1.56 V	11	99.8	1.8
4	#5895.00	64.2 PK	110.2	-46.0	1.56 V	11	62.3	1.9
5	#5895.00	60.9 AV	90.2	-29.3	1.56 V	11	59.0	1.9
6	11670.00	54.4 PK	74.0	-19.6	1.58 V	147	42.8	11.6
7	11670.00	44.5 AV	54.0	-9.5	1.58 V	147	32.9	11.6
8	#17505.00	54.5 PK	88.2	-33.7	1.44 V	360	37.0	17.5
9	#17505.00	42.1 AV	68.2	-26.1	1.44 V	360	24.6	17.5

Remarks:

1. Emission Level(dBuV/m) = Raw Value(dBuV) + Correction Factor(dB/m)
2. Correction Factor(dB/m) = Antenna Factor(dB/m) + Cable Factor(dB) – Pre-Amplifier Factor(dB)
3. Margin value = Emission Level – Limit value
4. The other emission levels were very low against the limit.
5. " * " : Fundamental frequency, the limit was restricted at the RF Output Power.
6. " # " : The radiated frequency is out of the restricted band.

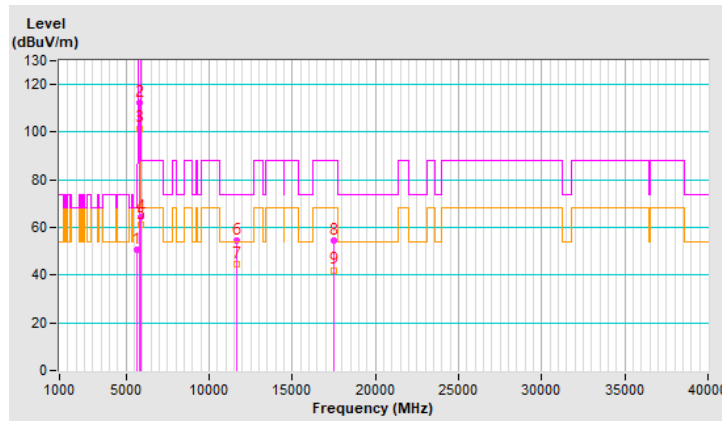

RF Mode	802.11ax (HE40)	Channel	CH 175 : 5875 MHz
Frequency Range	1 GHz ~ 40 GHz	Detector Function & Bandwidth	(PK) RB = 1 MHz, VB = 3 MHz (AV) RB = 1 MHz, VB = 10 Hz
Input Power (System)	120 Vac, 60 Hz	Environmental Conditions	28°C, 75% RH
Tested By	Louis Yang		

Antenna Polarity & Test Distance : Horizontal at 3 m								
No	Frequency (MHz)	Emission Level (dBuV/m)	Limit (dBuV/m)	Margin (dB)	Antenna Height (m)	Table Angle (Degree)	Raw Value (dBuV)	Correction Factor (dB/m)
1	#5650.00	51.3 PK	68.2	-16.9	2.67 H	55	50.0	1.3
2	*5875.00	111.2 PK			2.67 H	55	109.4	1.8
3	*5875.00	100.5 AV			2.67 H	55	98.7	1.8
4	#5895.00	67.4 PK	110.2	-42.8	2.67 H	55	65.5	1.9
5	#5895.00	57.3 AV	90.2	-32.9	2.67 H	55	55.4	1.9
6	11750.00	61.3 PK	74.0	-12.7	2.34 H	358	49.7	11.6
7	11750.00	46.4 AV	54.0	-7.6	2.34 H	358	34.8	11.6
8	#17625.00	56.6 PK	88.2	-31.6	3.09 H	340	38.6	18.0
9	#17625.00	43.5 AV	68.2	-24.7	3.09 H	340	25.5	18.0

Remarks:

1. Emission Level(dBuV/m) = Raw Value(dBuV) + Correction Factor(dB/m)
2. Correction Factor(dB/m) = Antenna Factor(dB/m) + Cable Factor(dB) – Pre-Amplifier Factor(dB)
3. Margin value = Emission Level – Limit value
4. The other emission levels were very low against the limit.
5. " * " : Fundamental frequency, the limit was restricted at the RF Output Power.
6. " # " : The radiated frequency is out of the restricted band.

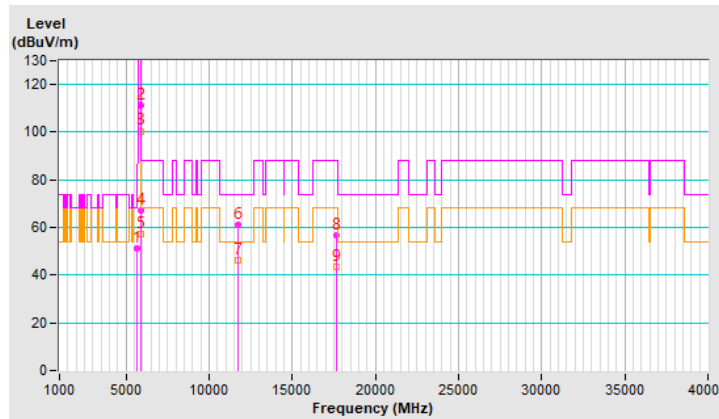

RF Mode	802.11ax (HE40)	Channel	CH 175 : 5875 MHz
Frequency Range	1 GHz ~ 40 GHz	Detector Function & Bandwidth	(PK) RB = 1 MHz, VB = 3 MHz (AV) RB = 1 MHz, VB = 10 Hz
Input Power (System)	120 Vac, 60 Hz	Environmental Conditions	28°C, 75% RH
Tested By	Louis Yang		

Antenna Polarity & Test Distance : Vertical at 3 m								
No	Frequency (MHz)	Emission Level (dBuV/m)	Limit (dBuV/m)	Margin (dB)	Antenna Height (m)	Table Angle (Degree)	Raw Value (dBuV)	Correction Factor (dB/m)
1	#5650.00	51.1 PK	68.2	-17.1	1.46 V	22	49.8	1.3
2	*5875.00	111.7 PK			1.46 V	22	109.9	1.8
3	*5875.00	102.1 AV			1.46 V	22	100.3	1.8
4	#5895.00	67.6 PK	110.2	-42.6	1.46 V	22	65.7	1.9
5	#5895.00	57.5 AV	90.2	-32.7	1.46 V	22	55.6	1.9
6	11750.00	55.1 PK	74.0	-18.9	1.61 V	159	43.5	11.6
7	11750.00	44.5 AV	54.0	-9.5	1.61 V	159	32.9	11.6
8	#17625.00	54.2 PK	88.2	-34.0	1.45 V	298	36.2	18.0
9	#17625.00	42.1 AV	68.2	-26.1	1.45 V	298	24.1	18.0

Remarks:

1. Emission Level(dBuV/m) = Raw Value(dBuV) + Correction Factor(dB/m)
2. Correction Factor(dB/m) = Antenna Factor(dB/m) + Cable Factor(dB) – Pre-Amplifier Factor(dB)
3. Margin value = Emission Level – Limit value
4. The other emission levels were very low against the limit.
5. " * " : Fundamental frequency, the limit was restricted at the RF Output Power.
6. " # " : The radiated frequency is out of the restricted band.

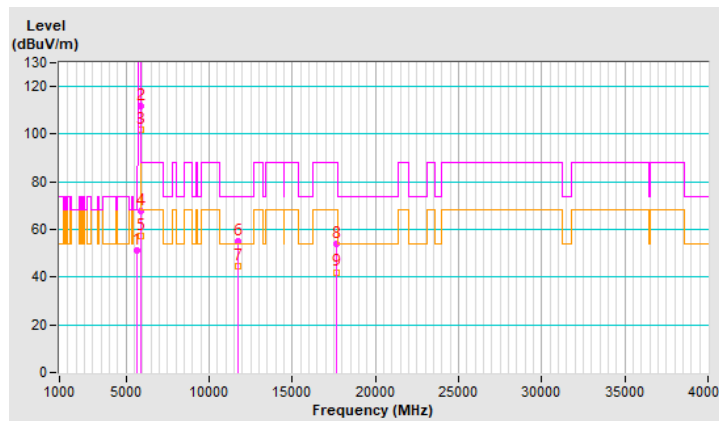

RF Mode	802.11ax (HE80)	Channel	CH 171 : 5855 MHz
Frequency Range	1 GHz ~ 40 GHz	Detector Function & Bandwidth	(PK) RB = 1 MHz, VB = 3 MHz (AV) RB = 1 MHz, VB = 5.1 kHz
Input Power (System)	120 Vac, 60 Hz	Environmental Conditions	28°C, 75% RH
Tested By	Louis Yang		

Antenna Polarity & Test Distance : Horizontal at 3 m								
No	Frequency (MHz)	Emission Level (dBuV/m)	Limit (dBuV/m)	Margin (dB)	Antenna Height (m)	Table Angle (Degree)	Raw Value (dBuV)	Correction Factor (dB/m)
1	#5650.00	53.1 PK	68.2	-15.1	2.42 H	79	51.8	1.3
2	*5855.00	108.6 PK			2.42 H	79	106.8	1.8
3	*5855.00	98.4 AV			2.42 H	79	96.6	1.8
4	#5895.00	75.1 PK	110.2	-35.1	2.42 H	79	73.2	1.9
5	#5895.00	66.0 AV	90.2	-24.2	2.42 H	79	64.1	1.9
6	11710.00	59.9 PK	74.0	-14.1	2.38 H	341	48.3	11.6
7	11710.00	46.6 AV	54.0	-7.4	2.38 H	341	35.0	11.6
8	#17565.00	58.0 PK	88.2	-30.2	3.07 H	302	40.3	17.7
9	#17565.00	44.5 AV	68.2	-23.7	3.07 H	302	26.8	17.7

Remarks:

1. Emission Level(dBuV/m) = Raw Value(dBuV) + Correction Factor(dB/m)
2. Correction Factor(dB/m) = Antenna Factor(dB/m) + Cable Factor(dB) – Pre-Amplifier Factor(dB)
3. Margin value = Emission Level – Limit value
4. The other emission levels were very low against the limit.
5. " * " : Fundamental frequency, the limit was restricted at the RF Output Power.
6. " # " : The radiated frequency is out of the restricted band.

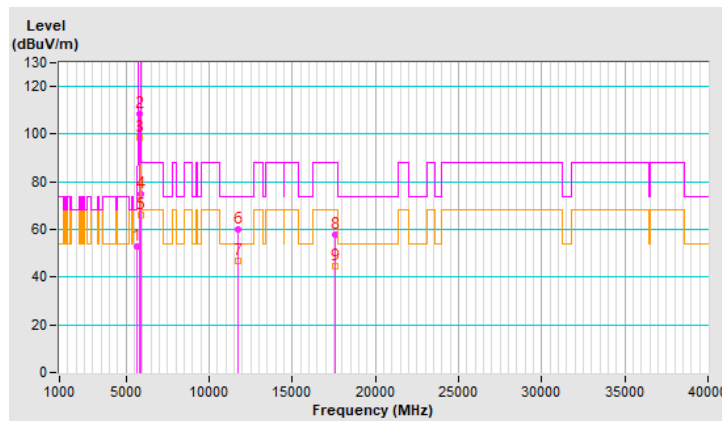

RF Mode	802.11ax (HE80)	Channel	CH 171 : 5855 MHz
Frequency Range	1 GHz ~ 40 GHz	Detector Function & Bandwidth	(PK) RB = 1 MHz, VB = 3 MHz (AV) RB = 1 MHz, VB = 5.1 kHz
Input Power (System)	120 Vac, 60 Hz	Environmental Conditions	28°C, 75% RH
Tested By	Louis Yang		

Antenna Polarity & Test Distance : Vertical at 3 m								
No	Frequency (MHz)	Emission Level (dBuV/m)	Limit (dBuV/m)	Margin (dB)	Antenna Height (m)	Table Angle (Degree)	Raw Value (dBuV)	Correction Factor (dB/m)
1	#5650.00	51.6 PK	68.2	-16.6	1.35 V	24	50.3	1.3
2	*5855.00	107.6 PK			1.35 V	24	105.8	1.8
3	*5855.00	97.5 AV			1.35 V	24	95.7	1.8
4	#5895.00	75.6 PK	110.2	-34.6	1.35 V	24	73.7	1.9
5	#5895.00	67.1 AV	90.2	-23.1	1.35 V	24	65.2	1.9
6	11710.00	55.4 PK	74.0	-18.6	1.72 V	114	43.8	11.6
7	11710.00	45.5 AV	54.0	-8.5	1.72 V	114	33.9	11.6
8	#17565.00	54.2 PK	88.2	-34.0	1.34 V	304	36.5	17.7
9	#17565.00	42.3 AV	68.2	-25.9	1.34 V	304	24.6	17.7

Remarks:

1. Emission Level(dBuV/m) = Raw Value(dBuV) + Correction Factor(dB/m)
2. Correction Factor(dB/m) = Antenna Factor(dB/m) + Cable Factor(dB) – Pre-Amplifier Factor(dB)
3. Margin value = Emission Level – Limit value
4. The other emission levels were very low against the limit.
5. " * " : Fundamental frequency, the limit was restricted at the RF Output Power.
6. " # " : The radiated frequency is out of the restricted band.

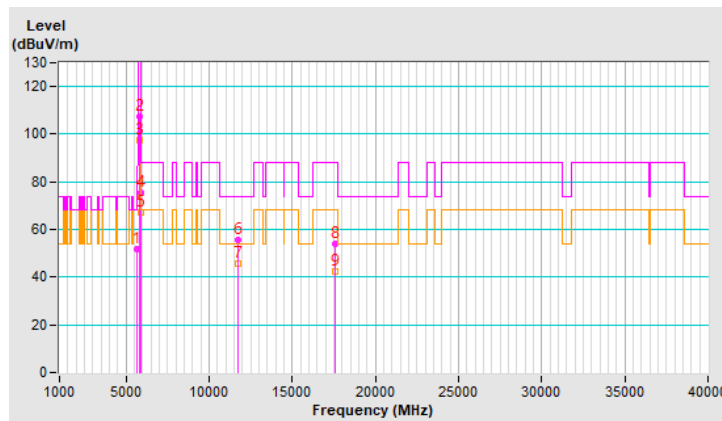

RF Mode	802.11ax (HE20) 26-tone RU	Channel	CH 169 : 5845 MHz
Frequency Range	1 GHz ~ 40 GHz	Detector Function & Bandwidth	(PK) RB = 1 MHz, VB = 3 MHz (AV) RB = 1 MHz, VB = 10 Hz
Input Power (System)	120 Vac, 60 Hz	Environmental Conditions	22°C, 70% RH
Tested By	Louis Yang		

Antenna Polarity & Test Distance : Horizontal at 3 m								
No	Frequency (MHz)	Emission Level (dBuV/m)	Limit (dBuV/m)	Margin (dB)	Antenna Height (m)	Table Angle (Degree)	Raw Value (dBuV)	Correction Factor (dB/m)
1	#5650.00	45.5 PK	68.2	-22.7	1.60 H	94	43.5	2.0
2	*5845.00	110.9 PK			1.60 H	94	108.6	2.3
3	*5845.00	99.7 AV			1.60 H	94	97.4	2.3
4	#5895.00	46.5 PK	110.2	-63.7	1.60 H	94	44.1	2.4
5	#5895.00	39.7 AV	90.2	-50.5	1.60 H	94	37.3	2.4
6	11690.00	60.2 PK	74.0	-13.8	2.10 H	18	47.8	12.4
7	11690.00	47.6 AV	54.0	-6.4	2.10 H	18	35.2	12.4
8	#17535.00	62.9 PK	88.2	-25.3	1.90 H	22	43.7	19.2
9	#17535.00	50.6 AV	68.2	-17.6	1.90 H	22	31.4	19.2

Remarks:

1. Emission Level(dBuV/m) = Raw Value(dBuV) + Correction Factor(dB/m)
2. Correction Factor(dB/m) = Antenna Factor(dB/m) + Cable Factor(dB) – Pre-Amplifier Factor(dB)
3. Margin value = Emission Level – Limit value
4. The other emission levels were very low against the limit.
5. " * " : Fundamental frequency, the limit was restricted at the RF Output Power.
6. " # " : The radiated frequency is out of the restricted band.

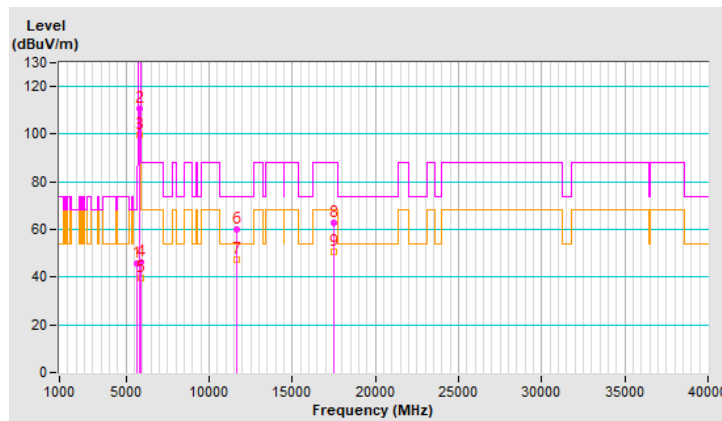

RF Mode	802.11ax (HE20) 26-tone RU	Channel	CH 169 : 5845 MHz
Frequency Range	1 GHz ~ 40 GHz	Detector Function & Bandwidth	(PK) RB = 1 MHz, VB = 3 MHz (AV) RB = 1 MHz, VB = 10 Hz
Input Power (System)	120 Vac, 60 Hz	Environmental Conditions	22°C, 70% RH
Tested By	Louis Yang		

Antenna Polarity & Test Distance : Vertical at 3 m								
No	Frequency (MHz)	Emission Level (dBuV/m)	Limit (dBuV/m)	Margin (dB)	Antenna Height (m)	Table Angle (Degree)	Raw Value (dBuV)	Correction Factor (dB/m)
1	#5650.00	49.5 PK	68.2	-18.7	1.70 V	54	47.5	2.0
2	*5845.00	115.8 PK			1.70 V	54	113.5	2.3
3	*5845.00	105.2 AV			1.70 V	54	102.9	2.3
4	#5895.00	50.4 PK	110.2	-59.8	1.70 V	54	48.0	2.4
5	#5895.00	41.8 AV	90.2	-48.4	1.70 V	54	39.4	2.4
6	11690.00	65.8 PK	74.0	-8.2	1.54 V	32	53.4	12.4
7	11690.00	51.5 AV	54.0	-2.5	1.54 V	32	39.1	12.4
8	#17535.00	63.8 PK	88.2	-24.4	1.61 V	40	44.6	19.2
9	#17535.00	52.6 AV	68.2	-15.6	1.61 V	40	33.4	19.2

Remarks:

1. Emission Level(dBuV/m) = Raw Value(dBuV) + Correction Factor(dB/m)
2. Correction Factor(dB/m) = Antenna Factor(dB/m) + Cable Factor(dB) – Pre-Amplifier Factor(dB)
3. Margin value = Emission Level – Limit value
4. The other emission levels were very low against the limit.
5. " * " : Fundamental frequency, the limit was restricted at the RF Output Power.
6. " # " : The radiated frequency is out of the restricted band.

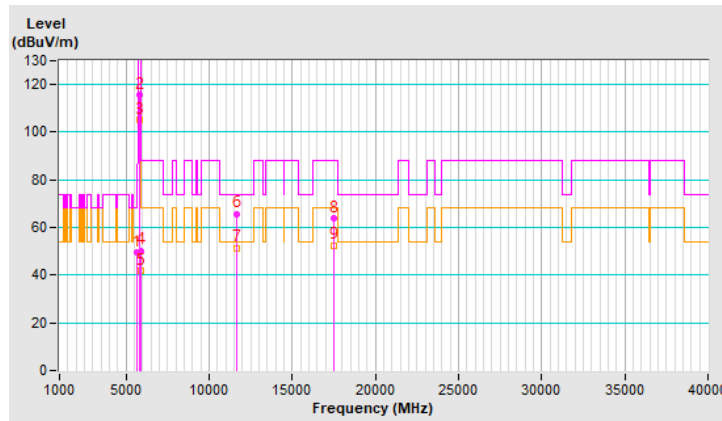

RF Mode	802.11ax (HE20) 26-tone RU	Channel	CH 173 : 5865 MHz
Frequency Range	1 GHz ~ 40 GHz	Detector Function & Bandwidth	(PK) RB = 1 MHz, VB = 3 MHz (AV) RB = 1 MHz, VB = 10 Hz
Input Power (System)	120 Vac, 60 Hz	Environmental Conditions	22°C, 70% RH
Tested By	Louis Yang		

Antenna Polarity & Test Distance : Horizontal at 3 m								
No	Frequency (MHz)	Emission Level (dBuV/m)	Limit (dBuV/m)	Margin (dB)	Antenna Height (m)	Table Angle (Degree)	Raw Value (dBuV)	Correction Factor (dB/m)
1	#5650.00	45.3 PK	68.2	-22.9	1.59 H	85	43.3	2.0
2	*5865.00	111.4 PK			1.59 H	85	109.1	2.3
3	*5865.00	99.9 AV			1.59 H	85	97.6	2.3
4	#5895.00	46.2 PK	110.2	-64.0	1.59 H	85	43.8	2.4
5	#5895.00	39.6 AV	90.2	-50.6	1.59 H	85	37.2	2.4
6	11730.00	59.8 PK	74.0	-14.2	2.10 H	36	47.6	12.2
7	11730.00	46.5 AV	54.0	-7.5	2.10 H	36	34.3	12.2
8	#17595.00	63.0 PK	88.2	-25.2	1.84 H	19	43.3	19.7
9	#17595.00	50.8 AV	68.2	-17.4	1.84 H	19	31.1	19.7

Remarks:

1. Emission Level(dBuV/m) = Raw Value(dBuV) + Correction Factor(dB/m)
2. Correction Factor(dB/m) = Antenna Factor(dB/m) + Cable Factor(dB) – Pre-Amplifier Factor(dB)
3. Margin value = Emission Level – Limit value
4. The other emission levels were very low against the limit.
5. " * " : Fundamental frequency, the limit was restricted at the RF Output Power.
6. " # " : The radiated frequency is out of the restricted band.

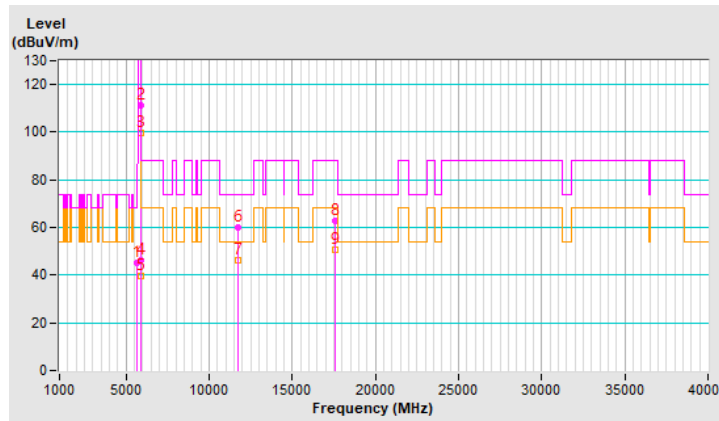

RF Mode	802.11ax (HE20) 26-tone RU	Channel	CH 173 : 5865 MHz
Frequency Range	1 GHz ~ 40 GHz	Detector Function & Bandwidth	(PK) RB = 1 MHz, VB = 3 MHz (AV) RB = 1 MHz, VB = 10 Hz
Input Power (System)	120 Vac, 60 Hz	Environmental Conditions	22°C, 70% RH
Tested By	Louis Yang		

Antenna Polarity & Test Distance : Vertical at 3 m								
No	Frequency (MHz)	Emission Level (dBuV/m)	Limit (dBuV/m)	Margin (dB)	Antenna Height (m)	Table Angle (Degree)	Raw Value (dBuV)	Correction Factor (dB/m)
1	#5650.00	50.4 PK	68.2	-17.8	1.64 V	53	48.4	2.0
2	*5865.00	114.9 PK			1.64 V	53	112.6	2.3
3	*5865.00	105.0 AV			1.64 V	53	102.7	2.3
4	#5895.00	56.9 PK	110.2	-53.3	1.64 V	53	54.5	2.4
5	#5895.00	46.6 AV	90.2	-43.6	1.64 V	53	44.2	2.4
6	11730.00	66.4 PK	74.0	-7.6	1.49 V	34	54.2	12.2
7	11730.00	51.0 AV	54.0	-3.0	1.49 V	34	38.8	12.2
8	#17595.00	63.6 PK	88.2	-24.6	1.59 V	33	43.9	19.7
9	#17595.00	52.2 AV	68.2	-16.0	1.59 V	33	32.5	19.7

Remarks:

1. Emission Level(dBuV/m) = Raw Value(dBuV) + Correction Factor(dB/m)
2. Correction Factor(dB/m) = Antenna Factor(dB/m) + Cable Factor(dB) – Pre-Amplifier Factor(dB)
3. Margin value = Emission Level – Limit value
4. The other emission levels were very low against the limit.
5. " * " : Fundamental frequency, the limit was restricted at the RF Output Power.
6. " # " : The radiated frequency is out of the restricted band.

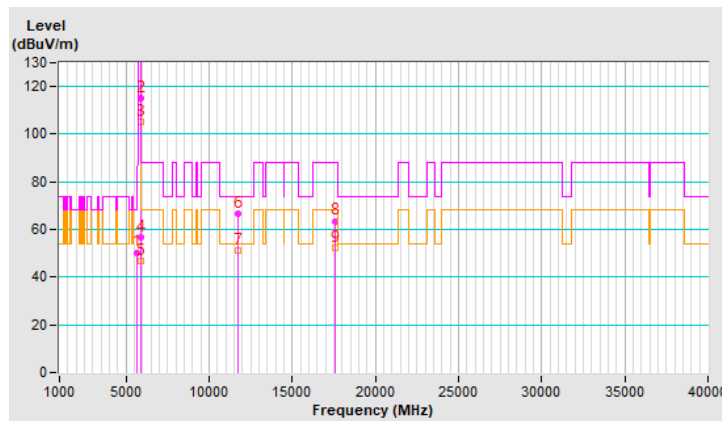

RF Mode	802.11ax (HE20) 26-tone RU	Channel	CH 177 : 5885 MHz
Frequency Range	1 GHz ~ 40 GHz	Detector Function & Bandwidth	(PK) RB = 1 MHz, VB = 3 MHz (AV) RB = 1 MHz, VB = 10 Hz
Input Power (System)	120 Vac, 60 Hz	Environmental Conditions	22°C, 70% RH
Tested By	Louis Yang		

Antenna Polarity & Test Distance : Horizontal at 3 m								
No	Frequency (MHz)	Emission Level (dBuV/m)	Limit (dBuV/m)	Margin (dB)	Antenna Height (m)	Table Angle (Degree)	Raw Value (dBuV)	Correction Factor (dB/m)
1	#5650.00	46.7 PK	68.2	-21.5	1.81 H	100	44.7	2.0
2	*5885.00	111.2 PK			1.81 H	100	108.8	2.4
3	*5885.00	100.4 AV			1.81 H	100	98.0	2.4
4	#5897.00	47.0 PK	108.7	-61.7	1.81 H	100	44.6	2.4
5	#5897.00	39.3 AV	88.7	-49.4	1.81 H	100	36.9	2.4
6	11770.00	60.2 PK	74.0	-13.8	2.10 H	11	48.0	12.2
7	11770.00	47.6 AV	54.0	-6.4	2.10 H	11	35.4	12.2
8	#17655.00	63.2 PK	88.2	-25.0	2.01 H	29	43.2	20.0
9	#17655.00	50.8 AV	68.2	-17.4	2.01 H	29	30.8	20.0

Remarks:

1. Emission Level(dBuV/m) = Raw Value(dBuV) + Correction Factor(dB/m)
2. Correction Factor(dB/m) = Antenna Factor(dB/m) + Cable Factor(dB) – Pre-Amplifier Factor(dB)
3. Margin value = Emission Level – Limit value
4. The other emission levels were very low against the limit.
5. " * " : Fundamental frequency, the limit was restricted at the RF Output Power.
6. " # " : The radiated frequency is out of the restricted band.

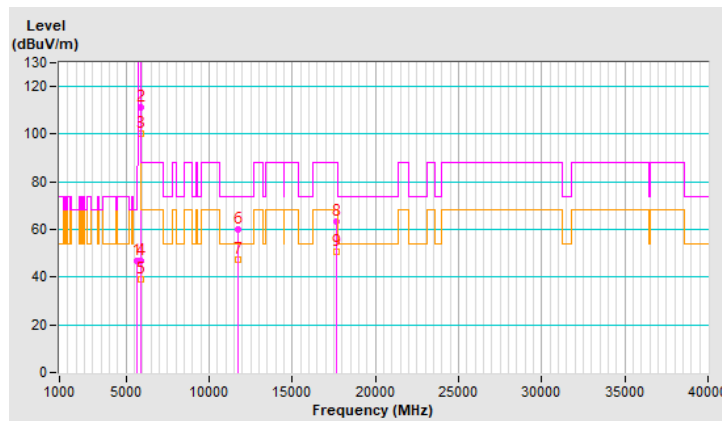

RF Mode	802.11ax (HE20) 26-tone RU	Channel	CH 177 : 5885 MHz
Frequency Range	1 GHz ~ 40 GHz	Detector Function & Bandwidth	(PK) RB = 1 MHz, VB = 3 MHz (AV) RB = 1 MHz, VB = 10 Hz
Input Power (System)	120 Vac, 60 Hz	Environmental Conditions	22°C, 70% RH
Tested By	Louis Yang		

Antenna Polarity & Test Distance : Vertical at 3 m								
No	Frequency (MHz)	Emission Level (dBuV/m)	Limit (dBuV/m)	Margin (dB)	Antenna Height (m)	Table Angle (Degree)	Raw Value (dBuV)	Correction Factor (dB/m)
1	#5650.00	49.6 PK	68.2	-18.6	1.59 V	20	47.6	2.0
2	*5885.00	114.5 PK			1.59 V	20	112.1	2.4
3	*5885.00	104.2 AV			1.59 V	20	101.8	2.4
4	#5895.00	60.3 PK	110.2	-49.9	1.59 V	20	57.9	2.4
5	#5895.00	56.3 AV	90.2	-33.9	1.59 V	20	53.9	2.4
6	11770.00	64.6 PK	74.0	-9.4	1.61 V	7	52.4	12.2
7	11770.00	51.3 AV	54.0	-2.7	1.61 V	7	39.1	12.2
8	#17655.00	63.5 PK	88.2	-24.7	1.52 V	18	43.5	20.0
9	#17655.00	52.5 AV	68.2	-15.7	1.52 V	18	32.5	20.0

Remarks:

1. Emission Level(dBuV/m) = Raw Value(dBuV) + Correction Factor(dB/m)
2. Correction Factor(dB/m) = Antenna Factor(dB/m) + Cable Factor(dB) – Pre-Amplifier Factor(dB)
3. Margin value = Emission Level – Limit value
4. The other emission levels were very low against the limit.
5. " * " : Fundamental frequency, the limit was restricted at the RF Output Power.
6. " # " : The radiated frequency is out of the restricted band.

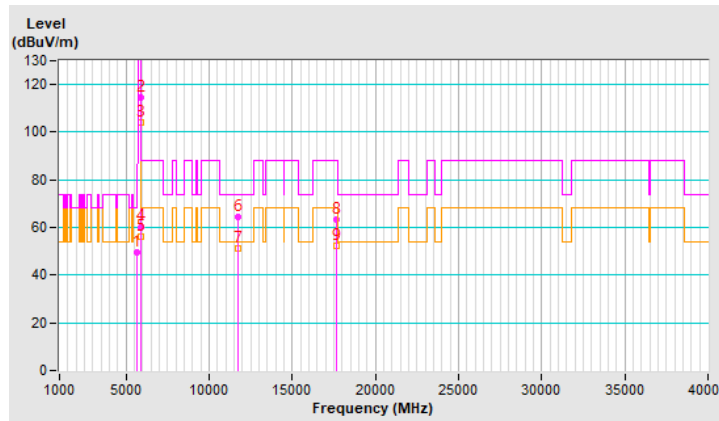

RF Mode	802.11ax (HE20) 52-tone RU	Channel	CH 169 : 5845 MHz
Frequency Range	1 GHz ~ 40 GHz	Detector Function & Bandwidth	(PK) RB = 1 MHz, VB = 3 MHz (AV) RB = 1 MHz, VB = 10 Hz
Input Power (System)	120 Vac, 60 Hz	Environmental Conditions	22°C, 70% RH
Tested By	Louis Yang		

Antenna Polarity & Test Distance : Horizontal at 3 m								
No	Frequency (MHz)	Emission Level (dBuV/m)	Limit (dBuV/m)	Margin (dB)	Antenna Height (m)	Table Angle (Degree)	Raw Value (dBuV)	Correction Factor (dB/m)
1	#5650.00	45.4 PK	68.2	-22.8	1.53 H	81	43.4	2.0
2	*5845.00	111.8 PK			1.60 H	88	109.5	2.3
3	*5845.00	100.5 AV			1.60 H	88	98.2	2.3
4	#5895.00	49.3 PK	110.2	-60.9	1.52 H	95	46.9	2.4
5	#5895.00	41.6 AV	90.2	-48.6	1.52 H	95	39.2	2.4
6	11690.00	60.3 PK	74.0	-13.7	2.09 H	16	47.9	12.4
7	11690.00	47.8 AV	54.0	-6.2	2.09 H	16	35.4	12.4
8	#17535.00	63.1 PK	88.2	-25.1	1.90 H	22	43.9	19.2
9	#17535.00	51.1 AV	68.2	-17.1	1.90 H	22	31.9	19.2

Remarks:

1. Emission Level(dBuV/m) = Raw Value(dBuV) + Correction Factor(dB/m)
2. Correction Factor(dB/m) = Antenna Factor(dB/m) + Cable Factor(dB) – Pre-Amplifier Factor(dB)
3. Margin value = Emission Level – Limit value
4. The other emission levels were very low against the limit.
5. " * " : Fundamental frequency, the limit was restricted at the RF Output Power.
6. " # " : The radiated frequency is out of the restricted band.

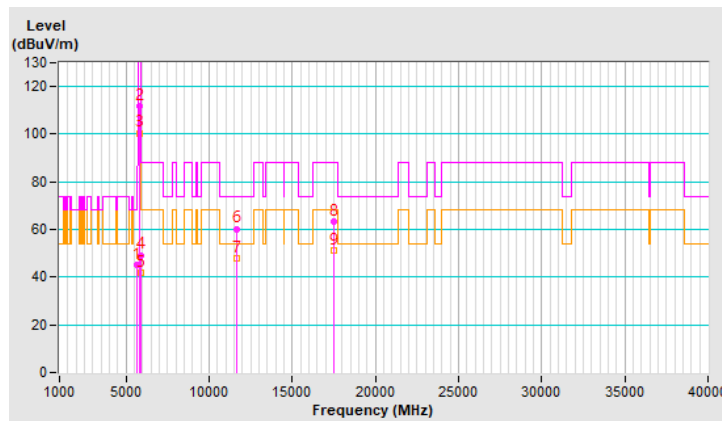

RF Mode	802.11ax (HE20) 52-tone RU	Channel	CH 169 : 5845 MHz
Frequency Range	1 GHz ~ 40 GHz	Detector Function & Bandwidth	(PK) RB = 1 MHz, VB = 3 MHz (AV) RB = 1 MHz, VB = 10 Hz
Input Power (System)	120 Vac, 60 Hz	Environmental Conditions	22°C, 70% RH
Tested By	Louis Yang		

Antenna Polarity & Test Distance : Vertical at 3 m								
No	Frequency (MHz)	Emission Level (dBuV/m)	Limit (dBuV/m)	Margin (dB)	Antenna Height (m)	Table Angle (Degree)	Raw Value (dBuV)	Correction Factor (dB/m)
1	#5650.00	38.9 PK	68.2	-29.3	1.74 V	9	36.9	2.0
2	*5845.00	114.0 PK			1.74 V	9	111.7	2.3
3	*5845.00	104.0 AV			1.74 V	9	101.7	2.3
4	#5895.00	40.7 PK	110.2	-69.5	1.74 V	9	38.3	2.4
5	#5895.00	31.5 AV	90.2	-58.7	1.74 V	9	29.1	2.4
6	11690.00	63.7 PK	74.0	-10.3	1.37 V	35	51.3	12.4
7	11690.00	51.4 AV	54.0	-2.6	1.37 V	35	39.0	12.4
8	#17535.00	63.8 PK	88.2	-24.4	1.64 V	38	44.6	19.2
9	#17535.00	52.3 AV	68.2	-15.9	1.64 V	38	33.1	19.2

Remarks:

1. Emission Level(dBuV/m) = Raw Value(dBuV) + Correction Factor(dB/m)
2. Correction Factor(dB/m) = Antenna Factor(dB/m) + Cable Factor(dB) – Pre-Amplifier Factor(dB)
3. Margin value = Emission Level – Limit value
4. The other emission levels were very low against the limit.
5. " * " : Fundamental frequency, the limit was restricted at the RF Output Power.
6. " # " : The radiated frequency is out of the restricted band.

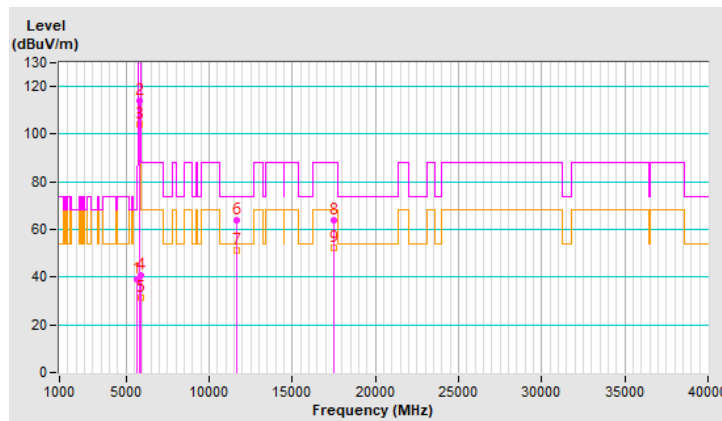

RF Mode	802.11ax (HE20) 52-tone RU	Channel	CH 173 : 5865 MHz
Frequency Range	1 GHz ~ 40 GHz	Detector Function & Bandwidth	(PK) RB = 1 MHz, VB = 3 MHz (AV) RB = 1 MHz, VB = 10 Hz
Input Power (System)	120 Vac, 60 Hz	Environmental Conditions	22°C, 70% RH
Tested By	Louis Yang		

Antenna Polarity & Test Distance : Horizontal at 3 m								
No	Frequency (MHz)	Emission Level (dBuV/m)	Limit (dBuV/m)	Margin (dB)	Antenna Height (m)	Table Angle (Degree)	Raw Value (dBuV)	Correction Factor (dB/m)
1	#5650.00	44.5 PK	68.2	-23.7	1.48 H	104	42.5	2.0
2	*5865.00	112.8 PK			1.48 H	104	110.5	2.3
3	*5865.00	100.7 AV			1.48 H	104	98.4	2.3
4	#5895.00	48.2 PK	110.2	-62.0	1.48 H	104	45.8	2.4
5	#5895.00	40.4 AV	90.2	-49.8	1.48 H	104	38.0	2.4
6	11730.00	60.7 PK	74.0	-13.3	2.14 H	12	48.5	12.2
7	11730.00	47.8 AV	54.0	-6.2	2.14 H	12	35.6	12.2
8	#17595.00	62.4 PK	88.2	-25.8	1.97 H	33	42.7	19.7
9	#17595.00	50.2 AV	68.2	-18.0	1.97 H	33	30.5	19.7

Remarks:

1. Emission Level(dBuV/m) = Raw Value(dBuV) + Correction Factor(dB/m)
2. Correction Factor(dB/m) = Antenna Factor(dB/m) + Cable Factor(dB) – Pre-Amplifier Factor(dB)
3. Margin value = Emission Level – Limit value
4. The other emission levels were very low against the limit.
5. " * " : Fundamental frequency, the limit was restricted at the RF Output Power.
6. " # " : The radiated frequency is out of the restricted band.

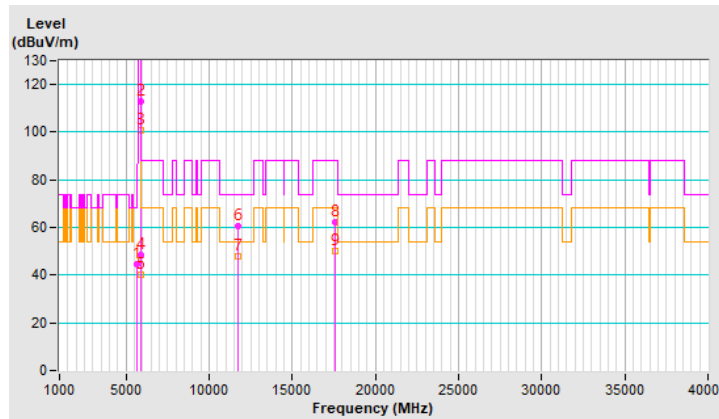

RF Mode	802.11ax (HE20) 52-tone RU	Channel	CH 173 : 5865 MHz
Frequency Range	1 GHz ~ 40 GHz	Detector Function & Bandwidth	(PK) RB = 1 MHz, VB = 3 MHz (AV) RB = 1 MHz, VB = 10 Hz
Input Power (System)	120 Vac, 60 Hz	Environmental Conditions	22°C, 70% RH
Tested By	Louis Yang		

Antenna Polarity & Test Distance : Vertical at 3 m								
No	Frequency (MHz)	Emission Level (dBuV/m)	Limit (dBuV/m)	Margin (dB)	Antenna Height (m)	Table Angle (Degree)	Raw Value (dBuV)	Correction Factor (dB/m)
1	#5650.00	48.5 PK	68.2	-19.7	1.68 V	7	46.5	2.0
2	*5865.00	114.4 PK			1.68 V	7	112.1	2.3
3	*5865.00	104.9 AV			1.68 V	7	102.6	2.3
4	#5895.00	54.9 PK	110.2	-55.3	1.68 V	7	52.5	2.4
5	#5895.00	45.7 AV	90.2	-44.5	1.68 V	7	43.3	2.4
6	11730.00	62.8 PK	74.0	-11.2	1.75 V	144	50.6	12.2
7	11730.00	51.2 AV	54.0	-2.8	1.75 V	144	39.0	12.2
8	#17595.00	63.9 PK	88.2	-24.3	1.50 V	44	44.2	19.7
9	#17595.00	53.0 AV	68.2	-15.2	1.50 V	44	33.3	19.7

Remarks:

1. Emission Level(dBuV/m) = Raw Value(dBuV) + Correction Factor(dB/m)
2. Correction Factor(dB/m) = Antenna Factor(dB/m) + Cable Factor(dB) – Pre-Amplifier Factor(dB)
3. Margin value = Emission Level – Limit value
4. The other emission levels were very low against the limit.
5. " * " : Fundamental frequency, the limit was restricted at the RF Output Power.
6. " # " : The radiated frequency is out of the restricted band.

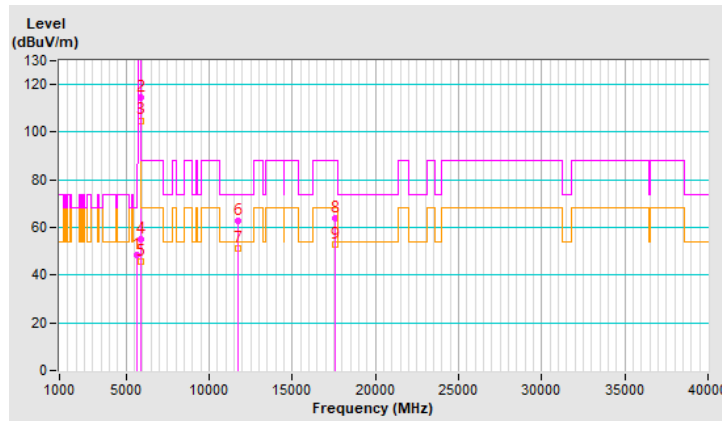

RF Mode	802.11ax (HE20) 52-tone RU	Channel	CH 177 : 5885 MHz
Frequency Range	1 GHz ~ 40 GHz	Detector Function & Bandwidth	(PK) RB = 1 MHz, VB = 3 MHz (AV) RB = 1 MHz, VB = 10 Hz
Input Power (System)	120 Vac, 60 Hz	Environmental Conditions	22°C, 70% RH
Tested By	Louis Yang		

Antenna Polarity & Test Distance : Horizontal at 3 m								
No	Frequency (MHz)	Emission Level (dBuV/m)	Limit (dBuV/m)	Margin (dB)	Antenna Height (m)	Table Angle (Degree)	Raw Value (dBuV)	Correction Factor (dB/m)
1	#5650.00	47.2 PK	68.2	-21.0	1.56 H	118	45.2	2.0
2	*5885.00	111.5 PK			1.56 H	118	109.1	2.4
3	*5885.00	100.7 AV			1.56 H	118	98.3	2.4
4	#5897.00	47.5 PK	108.7	-61.2	1.56 H	118	45.1	2.4
5	#5897.00	40.2 AV	88.7	-48.5	1.56 H	118	37.8	2.4
6	11770.00	59.9 PK	74.0	-14.1	2.14 H	6	47.7	12.2
7	11770.00	47.2 AV	54.0	-6.8	2.14 H	6	35.0	12.2
8	#17655.00	62.6 PK	88.2	-25.6	1.86 H	35	42.6	20.0
9	#17655.00	50.2 AV	68.2	-18.0	1.86 H	35	30.2	20.0

Remarks:

1. Emission Level(dBuV/m) = Raw Value(dBuV) + Correction Factor(dB/m)
2. Correction Factor(dB/m) = Antenna Factor(dB/m) + Cable Factor(dB) – Pre-Amplifier Factor(dB)
3. Margin value = Emission Level – Limit value
4. The other emission levels were very low against the limit.
5. " * " : Fundamental frequency, the limit was restricted at the RF Output Power.
6. " # " : The radiated frequency is out of the restricted band.

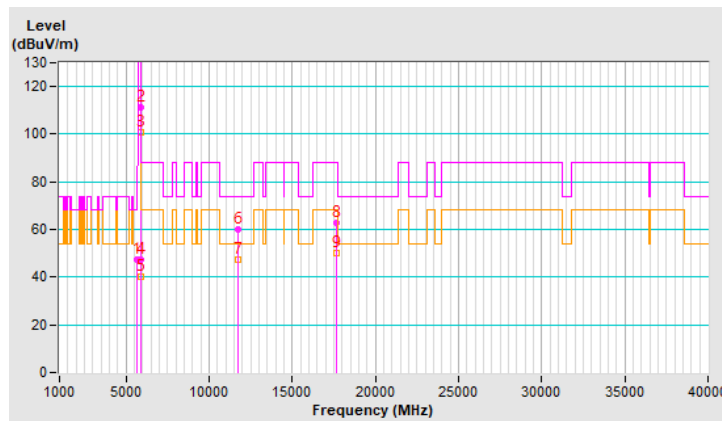

RF Mode	802.11ax (HE20) 52-tone RU	Channel	CH 177 : 5885 MHz
Frequency Range	1 GHz ~ 40 GHz	Detector Function & Bandwidth	(PK) RB = 1 MHz, VB = 3 MHz (AV) RB = 1 MHz, VB = 10 Hz
Input Power (System)	120 Vac, 60 Hz	Environmental Conditions	22°C, 70% RH
Tested By	Louis Yang		

Antenna Polarity & Test Distance : Vertical at 3 m								
No	Frequency (MHz)	Emission Level (dBuV/m)	Limit (dBuV/m)	Margin (dB)	Antenna Height (m)	Table Angle (Degree)	Raw Value (dBuV)	Correction Factor (dB/m)
1	#5650.00	49.0 PK	68.2	-19.2	1.67 V	25	47.0	2.0
2	*5885.00	115.8 PK			1.67 V	25	113.4	2.4
3	*5885.00	105.7 AV			1.67 V	25	103.3	2.4
4	#5895.00	70.2 PK	110.2	-40.0	1.67 V	25	67.8	2.4
5	#5895.00	64.8 AV	90.2	-25.4	1.67 V	25	62.4	2.4
6	11770.00	63.2 PK	74.0	-10.8	1.70 V	145	51.0	12.2
7	11770.00	50.5 AV	54.0	-3.5	1.70 V	145	38.3	12.2
8	#17655.00	63.6 PK	88.2	-24.6	1.55 V	11	43.6	20.0
9	#17655.00	52.7 AV	68.2	-15.5	1.55 V	11	32.7	20.0

Remarks:

1. Emission Level(dBuV/m) = Raw Value(dBuV) + Correction Factor(dB/m)
2. Correction Factor(dB/m) = Antenna Factor(dB/m) + Cable Factor(dB) – Pre-Amplifier Factor(dB)
3. Margin value = Emission Level – Limit value
4. The other emission levels were very low against the limit.
5. " * " : Fundamental frequency, the limit was restricted at the RF Output Power.
6. " # " : The radiated frequency is out of the restricted band.

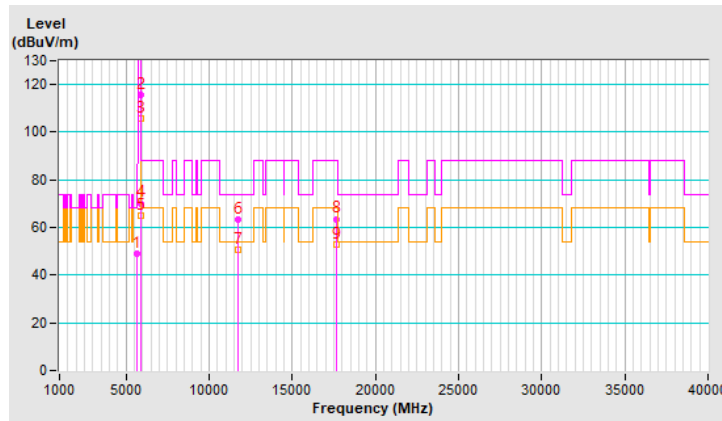

RF Mode	802.11ax (HE20) 106-tone RU	Channel	CH 169 : 5845 MHz
Frequency Range	1 GHz ~ 40 GHz	Detector Function & Bandwidth	(PK) RB = 1 MHz, VB = 3 MHz (AV) RB = 1 MHz, VB = 10 Hz
Input Power (System)	120 Vac, 60 Hz	Environmental Conditions	22°C, 70% RH
Tested By	Louis Yang		

Antenna Polarity & Test Distance : Horizontal at 3 m								
No	Frequency (MHz)	Emission Level (dBuV/m)	Limit (dBuV/m)	Margin (dB)	Antenna Height (m)	Table Angle (Degree)	Raw Value (dBuV)	Correction Factor (dB/m)
1	#5650.00	45.9 PK	68.2	-22.3	1.50 H	124	43.9	2.0
2	*5845.00	112.9 PK			1.50 H	124	110.6	2.3
3	*5845.00	100.8 AV			1.50 H	124	98.5	2.3
4	#5895.00	46.6 PK	110.2	-63.6	1.50 H	124	44.2	2.4
5	#5895.00	39.4 AV	90.2	-50.8	1.50 H	124	37.0	2.4
6	11690.00	60.4 PK	74.0	-13.6	2.18 H	35	48.0	12.4
7	11690.00	47.9 AV	54.0	-6.1	2.18 H	35	35.5	12.4
8	#17535.00	62.4 PK	88.2	-25.8	1.87 H	62	43.2	19.2
9	#17535.00	50.3 AV	68.2	-17.9	1.87 H	62	31.1	19.2

Remarks:

1. Emission Level(dBuV/m) = Raw Value(dBuV) + Correction Factor(dB/m)
2. Correction Factor(dB/m) = Antenna Factor(dB/m) + Cable Factor(dB) – Pre-Amplifier Factor(dB)
3. Margin value = Emission Level – Limit value
4. The other emission levels were very low against the limit.
5. " * " : Fundamental frequency, the limit was restricted at the RF Output Power.
6. " # " : The radiated frequency is out of the restricted band.

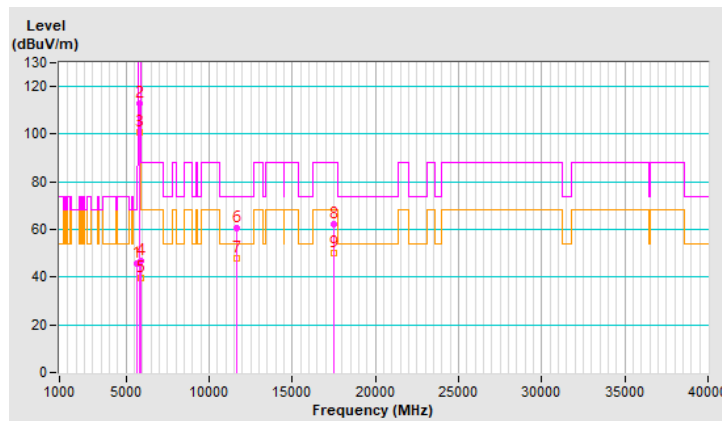

RF Mode	802.11ax (HE20) 106-tone RU	Channel	CH 169 : 5845 MHz
Frequency Range	1 GHz ~ 40 GHz	Detector Function & Bandwidth	(PK) RB = 1 MHz, VB = 3 MHz (AV) RB = 1 MHz, VB = 10 Hz
Input Power (System)	120 Vac, 60 Hz	Environmental Conditions	22°C, 70% RH
Tested By	Louis Yang		

Antenna Polarity & Test Distance : Vertical at 3 m								
No	Frequency (MHz)	Emission Level (dBuV/m)	Limit (dBuV/m)	Margin (dB)	Antenna Height (m)	Table Angle (Degree)	Raw Value (dBuV)	Correction Factor (dB/m)
1	#5650.00	52.2 PK	68.2	-16.0	1.66 V	58	50.2	2.0
2	*5845.00	115.0 PK			1.66 V	58	112.7	2.3
3	*5845.00	105.3 AV			1.66 V	58	103.0	2.3
4	#5895.00	53.0 PK	110.2	-57.2	1.66 V	58	50.6	2.4
5	#5895.00	48.3 AV	90.2	-41.9	1.66 V	58	45.9	2.4
6	11690.00	61.4 PK	74.0	-12.6	1.54 V	197	49.0	12.4
7	11690.00	49.7 AV	54.0	-4.3	1.54 V	197	37.3	12.4
8	#17535.00	63.5 PK	88.2	-24.7	1.49 V	122	44.3	19.2
9	#17535.00	52.2 AV	68.2	-16.0	1.49 V	122	33.0	19.2

Remarks:

1. Emission Level(dBuV/m) = Raw Value(dBuV) + Correction Factor(dB/m)
2. Correction Factor(dB/m) = Antenna Factor(dB/m) + Cable Factor(dB) – Pre-Amplifier Factor(dB)
3. Margin value = Emission Level – Limit value
4. The other emission levels were very low against the limit.
5. " * " : Fundamental frequency, the limit was restricted at the RF Output Power.
6. " # " : The radiated frequency is out of the restricted band.

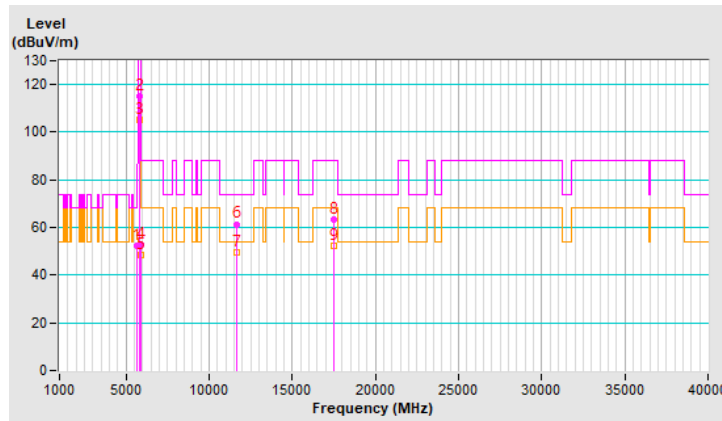

RF Mode	802.11ax (HE20) 106-tone RU	Channel	CH 173 : 5865 MHz
Frequency Range	1 GHz ~ 40 GHz	Detector Function & Bandwidth	(PK) RB = 1 MHz, VB = 3 MHz (AV) RB = 1 MHz, VB = 10 Hz
Input Power (System)	120 Vac, 60 Hz	Environmental Conditions	22°C, 70% RH
Tested By	Louis Yang		

Antenna Polarity & Test Distance : Horizontal at 3 m								
No	Frequency (MHz)	Emission Level (dBuV/m)	Limit (dBuV/m)	Margin (dB)	Antenna Height (m)	Table Angle (Degree)	Raw Value (dBuV)	Correction Factor (dB/m)
1	#5650.00	45.1 PK	68.2	-23.1	1.66 H	107	43.1	2.0
2	*5865.00	112.2 PK			1.66 H	107	109.9	2.3
3	*5865.00	101.2 AV			1.66 H	107	98.9	2.3
4	#5895.00	47.1 PK	110.2	-63.1	1.66 H	107	44.7	2.4
5	#5895.00	40.3 AV	90.2	-49.9	1.66 H	107	37.9	2.4
6	11730.00	60.7 PK	74.0	-13.3	2.18 H	15	48.5	12.2
7	11730.00	47.6 AV	54.0	-6.4	2.18 H	15	35.4	12.2
8	#17595.00	62.9 PK	88.2	-25.3	1.95 H	155	43.2	19.7
9	#17595.00	50.3 AV	68.2	-17.9	1.95 H	155	30.6	19.7

Remarks:

1. Emission Level(dBuV/m) = Raw Value(dBuV) + Correction Factor(dB/m)
2. Correction Factor(dB/m) = Antenna Factor(dB/m) + Cable Factor(dB) – Pre-Amplifier Factor(dB)
3. Margin value = Emission Level – Limit value
4. The other emission levels were very low against the limit.
5. " * " : Fundamental frequency, the limit was restricted at the RF Output Power.
6. " # " : The radiated frequency is out of the restricted band.

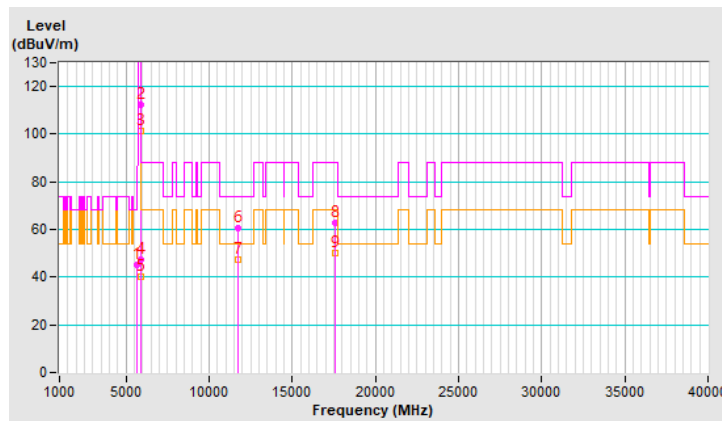

RF Mode	802.11ax (HE20) 106-tone RU	Channel	CH 173 : 5865 MHz
Frequency Range	1 GHz ~ 40 GHz	Detector Function & Bandwidth	(PK) RB = 1 MHz, VB = 3 MHz (AV) RB = 1 MHz, VB = 10 Hz
Input Power (System)	120 Vac, 60 Hz	Environmental Conditions	22°C, 70% RH
Tested By	Louis Yang		

Antenna Polarity & Test Distance : Vertical at 3 m								
No	Frequency (MHz)	Emission Level (dBuV/m)	Limit (dBuV/m)	Margin (dB)	Antenna Height (m)	Table Angle (Degree)	Raw Value (dBuV)	Correction Factor (dB/m)
1	#5650.00	52.4 PK	68.2	-15.8	1.62 V	55	50.4	2.0
2	*5865.00	117.4 PK			1.62 V	55	115.1	2.3
3	*5865.00	107.1 AV			1.62 V	55	104.8	2.3
4	#5895.00	54.2 PK	110.2	-56.0	1.62 V	55	51.8	2.4
5	#5895.00	49.8 AV	90.2	-40.4	1.62 V	55	47.4	2.4
6	11730.00	60.0 PK	74.0	-14.0	1.67 V	226	47.8	12.2
7	11730.00	48.9 AV	54.0	-5.1	1.67 V	226	36.7	12.2
8	#17595.00	64.0 PK	88.2	-24.2	1.65 V	149	44.3	19.7
9	#17595.00	52.9 AV	68.2	-15.3	1.65 V	149	33.2	19.7

Remarks:

1. Emission Level(dBuV/m) = Raw Value(dBuV) + Correction Factor(dB/m)
2. Correction Factor(dB/m) = Antenna Factor(dB/m) + Cable Factor(dB) – Pre-Amplifier Factor(dB)
3. Margin value = Emission Level – Limit value
4. The other emission levels were very low against the limit.
5. " * " : Fundamental frequency, the limit was restricted at the RF Output Power.
6. " # " : The radiated frequency is out of the restricted band.

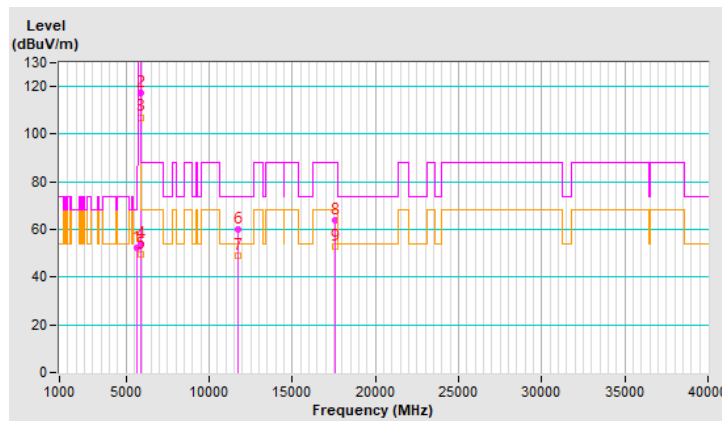

RF Mode	802.11ax (HE20) 106-tone RU	Channel	CH 177 : 5885 MHz
Frequency Range	1 GHz ~ 40 GHz	Detector Function & Bandwidth	(PK) RB = 1 MHz, VB = 3 MHz (AV) RB = 1 MHz, VB = 10 Hz
Input Power (System)	120 Vac, 60 Hz	Environmental Conditions	22°C, 70% RH
Tested By	Louis Yang		

Antenna Polarity & Test Distance : Horizontal at 3 m								
No	Frequency (MHz)	Emission Level (dBUV/m)	Limit (dBUV/m)	Margin (dB)	Antenna Height (m)	Table Angle (Degree)	Raw Value (dBUV)	Correction Factor (dB/m)
1	#5650.00	46.6 PK	68.2	-21.6	1.67 H	139	44.6	2.0
2	*5885.00	113.8 PK			1.67 H	139	111.4	2.4
3	*5885.00	101.9 AV			1.67 H	139	99.5	2.4
4	#5897.00	47.0 PK	108.7	-61.7	1.67 H	139	44.6	2.4
5	#5897.00	39.8 AV	88.7	-48.9	1.67 H	139	37.4	2.4
6	11770.00	60.2 PK	74.0	-13.8	2.16 H	17	48.0	12.2
7	11770.00	47.8 AV	54.0	-6.2	2.16 H	17	35.6	12.2
8	#17655.00	63.3 PK	88.2	-24.9	1.85 H	38	43.3	20.0
9	#17655.00	51.0 AV	68.2	-17.2	1.85 H	38	31.0	20.0

Remarks:

1. Emission Level(dBUV/m) = Raw Value(dBuV) + Correction Factor(dB/m)
2. Correction Factor(dB/m) = Antenna Factor(dB/m) + Cable Factor(dB) – Pre-Amplifier Factor(dB)
3. Margin value = Emission Level – Limit value
4. The other emission levels were very low against the limit.
5. " * " : Fundamental frequency, the limit was restricted at the RF Output Power.
6. " # " : The radiated frequency is out of the restricted band.

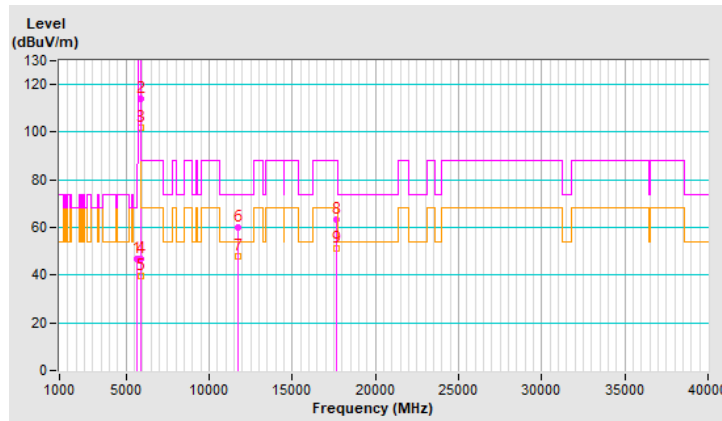

RF Mode	802.11ax (HE20) 106-tone RU	Channel	CH 177 : 5885 MHz
Frequency Range	1 GHz ~ 40 GHz	Detector Function & Bandwidth	(PK) RB = 1 MHz, VB = 3 MHz (AV) RB = 1 MHz, VB = 10 Hz
Input Power (System)	120 Vac, 60 Hz	Environmental Conditions	22°C, 70% RH
Tested By	Louis Yang		

Antenna Polarity & Test Distance : Vertical at 3 m								
No	Frequency (MHz)	Emission Level (dBuV/m)	Limit (dBuV/m)	Margin (dB)	Antenna Height (m)	Table Angle (Degree)	Raw Value (dBuV)	Correction Factor (dB/m)
1	#5650.00	51.9 PK	68.2	-16.3	1.70 V	76	49.9	2.0
2	*5885.00	115.9 PK			1.70 V	76	113.5	2.4
3	*5885.00	105.6 AV			1.70 V	76	103.2	2.4
4	#5895.00	86.6 PK	110.2	-23.6	1.70 V	76	84.2	2.4
5	#5895.00	72.5 AV	90.2	-17.7	1.70 V	76	70.1	2.4
6	11770.00	60.6 PK	74.0	-13.4	1.62 V	188	48.4	12.2
7	11770.00	48.8 AV	54.0	-5.2	1.62 V	188	36.6	12.2
8	#17655.00	63.5 PK	88.2	-24.7	1.63 V	138	43.5	20.0
9	#17655.00	52.4 AV	68.2	-15.8	1.63 V	138	32.4	20.0

Remarks:

1. Emission Level(dBuV/m) = Raw Value(dBuV) + Correction Factor(dB/m)
2. Correction Factor(dB/m) = Antenna Factor(dB/m) + Cable Factor(dB) – Pre-Amplifier Factor(dB)
3. Margin value = Emission Level – Limit value
4. The other emission levels were very low against the limit.
5. " * " : Fundamental frequency, the limit was restricted at the RF Output Power.
6. " # " : The radiated frequency is out of the restricted band.

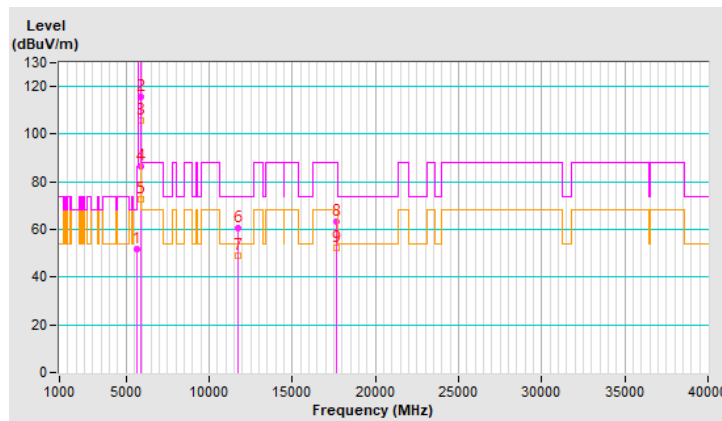

Mode C

RF Mode	802.11a	Channel	CH 169 : 5845 MHz
Frequency Range	1 GHz ~ 40 GHz	Detector Function & Bandwidth	(PK) RB = 1 MHz, VB = 3 MHz (AV) RB = 1 MHz, VB = 10 Hz
Input Power (System)	120 Vac, 60 Hz	Environmental Conditions	28°C, 75% RH
Tested By	Louis Yang		

Antenna Polarity & Test Distance : Horizontal at 3 m								
No	Frequency (MHz)	Emission Level (dBUV/m)	Limit (dBUV/m)	Margin (dB)	Antenna Height (m)	Table Angle (Degree)	Raw Value (dBUV)	Correction Factor (dB/m)
1	#5630.90	50.6 PK	68.2	-17.6	1.68 H	330	49.4	1.2
2	*5845.00	116.6 PK			1.68 H	330	114.8	1.8
3	*5845.00	107.1 AV			1.68 H	330	105.3	1.8
4	#5895.50	72.3 PK	109.8	-37.5	1.68 H	330	70.4	1.9
5	#5895.50	61.1 AV	89.8	-28.7	1.68 H	330	59.2	1.9
6	11690.00	61.1 PK	74.0	-12.9	2.56 H	287	49.4	11.7
7	11690.00	47.3 AV	54.0	-6.7	2.56 H	287	35.6	11.7
8	#17535.00	56.3 PK	88.2	-31.9	3.14 H	311	38.7	17.6
9	#17535.00	43.4 AV	68.2	-24.8	3.14 H	311	25.8	17.6

Remarks:

1. Emission Level(dBUV/m) = Raw Value(dBUV) + Correction Factor(dB/m)
2. Correction Factor(dB/m) = Antenna Factor(dB/m) + Cable Factor(dB) – Pre-Amplifier Factor(dB)
3. Margin value = Emission Level – Limit value
4. The other emission levels were very low against the limit.
5. " * " : Fundamental frequency, the limit was restricted at the RF Output Power.
6. " # " : The radiated frequency is out of the restricted band.

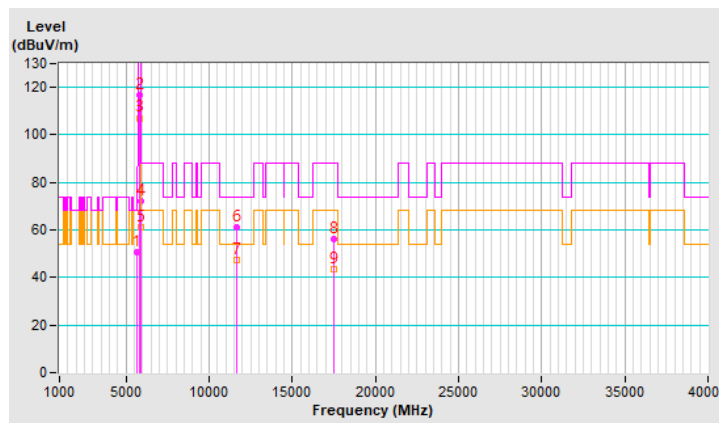

RF Mode	802.11a	Channel	CH 169 : 5845 MHz
Frequency Range	1 GHz ~ 40 GHz	Detector Function & Bandwidth	(PK) RB = 1 MHz, VB = 3 MHz (AV) RB = 1 MHz, VB = 10 Hz
Input Power (System)	120 Vac, 60 Hz	Environmental Conditions	28°C, 75% RH
Tested By	Louis Yang		

Antenna Polarity & Test Distance : Vertical at 3 m								
No	Frequency (MHz)	Emission Level (dBuV/m)	Limit (dBuV/m)	Margin (dB)	Antenna Height (m)	Table Angle (Degree)	Raw Value (dBuV)	Correction Factor (dB/m)
1	#5650.00	50.3 PK	68.2	-17.9	2.72 V	335	49.0	1.3
2	*5845.00	108.9 PK			2.72 V	335	107.1	1.8
3	*5845.00	98.6 AV			2.72 V	335	96.8	1.8
4	#5895.00	58.8 PK	110.2	-51.4	2.72 V	335	56.9	1.9
5	#5895.00	49.3 AV	90.2	-40.9	2.72 V	335	47.4	1.9
6	11690.00	62.8 PK	74.0	-11.2	1.51 V	136	51.1	11.7
7	11690.00	48.9 AV	54.0	-5.1	1.51 V	136	37.2	11.7
8	#17535.00	57.1 PK	88.2	-31.1	1.38 V	351	39.5	17.6
9	#17535.00	43.0 AV	68.2	-25.2	1.38 V	351	25.4	17.6

Remarks:

1. Emission Level(dBuV/m) = Raw Value(dBuV) + Correction Factor(dB/m)
2. Correction Factor(dB/m) = Antenna Factor(dB/m) + Cable Factor(dB) – Pre-Amplifier Factor(dB)
3. Margin value = Emission Level – Limit value
4. The other emission levels were very low against the limit.
5. " * " : Fundamental frequency, the limit was restricted at the RF Output Power.
6. " # " : The radiated frequency is out of the restricted band.

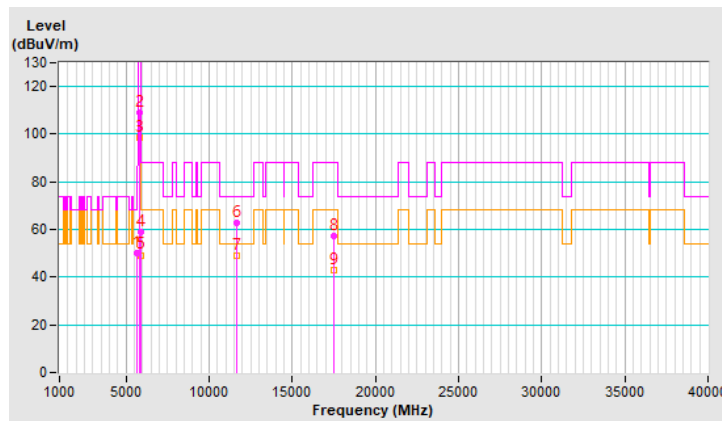

RF Mode	802.11a	Channel	CH 173 : 5865 MHz
Frequency Range	1 GHz ~ 40 GHz	Detector Function & Bandwidth	(PK) RB = 1 MHz, VB = 3 MHz (AV) RB = 1 MHz, VB = 10 Hz
Input Power (System)	120 Vac, 60 Hz	Environmental Conditions	28°C, 75% RH
Tested By	Louis Yang		

Antenna Polarity & Test Distance : Horizontal at 3 m								
No	Frequency (MHz)	Emission Level (dBuV/m)	Limit (dBuV/m)	Margin (dB)	Antenna Height (m)	Table Angle (Degree)	Raw Value (dBuV)	Correction Factor (dB/m)
1	#5633.40	50.8 PK	68.2	-17.4	1.75 H	332	49.6	1.2
2	*5865.00	117.8 PK			1.75 H	332	116.0	1.8
3	*5865.00	107.9 AV			1.75 H	332	106.1	1.8
4	#5896.60	84.0 PK	109.0	-25.0	1.75 H	332	82.1	1.9
5	#5896.60	62.2 AV	89.0	-26.8	1.75 H	332	60.3	1.9
6	11730.00	61.3 PK	74.0	-12.7	2.26 H	319	49.8	11.5
7	11730.00	47.4 AV	54.0	-6.6	2.26 H	319	35.9	11.5
8	#17595.00	55.5 PK	88.2	-32.7	3.13 H	333	37.6	17.9
9	#17595.00	42.2 AV	68.2	-26.0	3.13 H	333	24.3	17.9

Remarks:

1. Emission Level(dBuV/m) = Raw Value(dBuV) + Correction Factor(dB/m)
2. Correction Factor(dB/m) = Antenna Factor(dB/m) + Cable Factor(dB) – Pre-Amplifier Factor(dB)
3. Margin value = Emission Level – Limit value
4. The other emission levels were very low against the limit.
5. " * " : Fundamental frequency, the limit was restricted at the RF Output Power.
6. " # " : The radiated frequency is out of the restricted band.

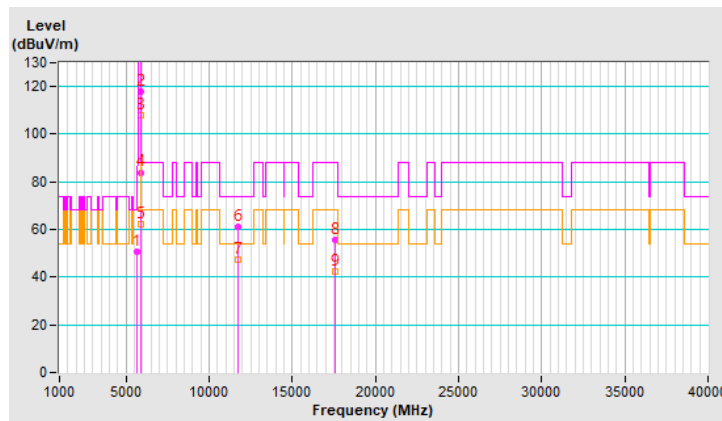

RF Mode	802.11a	Channel	CH 173 : 5865 MHz
Frequency Range	1 GHz ~ 40 GHz	Detector Function & Bandwidth	(PK) RB = 1 MHz, VB = 3 MHz (AV) RB = 1 MHz, VB = 10 Hz
Input Power (System)	120 Vac, 60 Hz	Environmental Conditions	28°C, 75% RH
Tested By	Louis Yang		

Antenna Polarity & Test Distance : Vertical at 3 m								
No	Frequency (MHz)	Emission Level (dBuV/m)	Limit (dBuV/m)	Margin (dB)	Antenna Height (m)	Table Angle (Degree)	Raw Value (dBuV)	Correction Factor (dB/m)
1	#5650.00	50.3 PK	68.2	-17.9	2.34 V	305	49.0	1.3
2	*5865.00	107.6 PK			2.34 V	305	105.8	1.8
3	*5865.00	98.6 AV			2.34 V	305	96.8	1.8
4	#5895.00	74.6 PK	110.2	-35.6	2.34 V	305	72.7	1.9
5	#5895.00	63.4 AV	90.2	-26.8	2.34 V	305	61.5	1.9
6	11730.00	62.4 PK	74.0	-11.6	1.52 V	135	50.9	11.5
7	11730.00	48.3 AV	54.0	-5.7	1.52 V	135	36.8	11.5
8	#17595.00	55.9 PK	88.2	-32.3	1.43 V	305	38.0	17.9
9	#17595.00	42.0 AV	68.2	-26.2	1.43 V	305	24.1	17.9

Remarks:

1. Emission Level(dBuV/m) = Raw Value(dBuV) + Correction Factor(dB/m)
2. Correction Factor(dB/m) = Antenna Factor(dB/m) + Cable Factor(dB) – Pre-Amplifier Factor(dB)
3. Margin value = Emission Level – Limit value
4. The other emission levels were very low against the limit.
5. " * " : Fundamental frequency, the limit was restricted at the RF Output Power.
6. " # " : The radiated frequency is out of the restricted band.

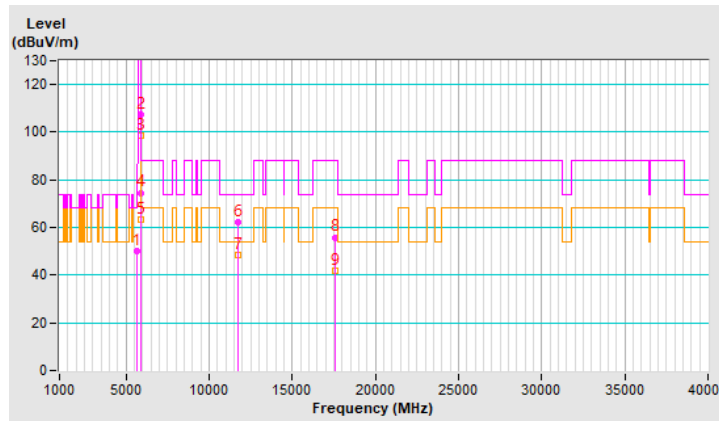

RF Mode	802.11a	Channel	CH 177 : 5885 MHz
Frequency Range	1 GHz ~ 40 GHz	Detector Function & Bandwidth	(PK) RB = 1 MHz, VB = 3 MHz (AV) RB = 1 MHz, VB = 10 Hz
Input Power (System)	120 Vac, 60 Hz	Environmental Conditions	28°C, 75% RH
Tested By	Louis Yang		

Antenna Polarity & Test Distance : Horizontal at 3 m								
No	Frequency (MHz)	Emission Level (dBuV/m)	Limit (dBuV/m)	Margin (dB)	Antenna Height (m)	Table Angle (Degree)	Raw Value (dBuV)	Correction Factor (dB/m)
1	#5647.70	53.3 PK	68.2	-14.9	1.62 H	360	52.0	1.3
2	*5885.00	114.0 PK			1.62 H	360	112.1	1.9
3	*5885.00	104.6 AV			1.62 H	360	102.7	1.9
4	#5895.10	74.7 PK	110.1	-35.4	1.62 H	360	72.8	1.9
5	#5895.10	63.3 AV	90.1	-26.8	1.62 H	360	61.4	1.9
6	11770.00	61.2 PK	74.0	-12.8	2.53 H	295	49.8	11.4
7	11770.00	46.7 AV	54.0	-7.3	2.53 H	295	35.3	11.4
8	#17655.00	56.7 PK	88.2	-31.5	3.01 H	332	38.6	18.1
9	#17655.00	43.4 AV	68.2	-24.8	3.01 H	332	25.3	18.1

Remarks:

1. Emission Level(dBuV/m) = Raw Value(dBuV) + Correction Factor(dB/m)
2. Correction Factor(dB/m) = Antenna Factor(dB/m) + Cable Factor(dB) – Pre-Amplifier Factor(dB)
3. Margin value = Emission Level – Limit value
4. The other emission levels were very low against the limit.
5. " * " : Fundamental frequency, the limit was restricted at the RF Output Power.
6. " # " : The radiated frequency is out of the restricted band.

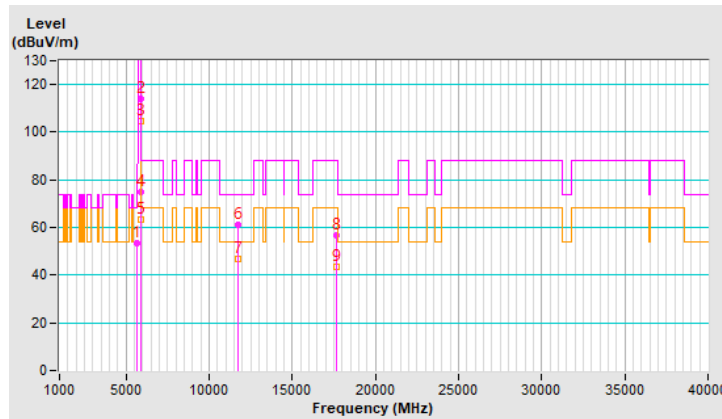

RF Mode	802.11a	Channel	CH 177 : 5885 MHz
Frequency Range	1 GHz ~ 40 GHz	Detector Function & Bandwidth	(PK) RB = 1 MHz, VB = 3 MHz (AV) RB = 1 MHz, VB = 10 Hz
Input Power (System)	120 Vac, 60 Hz	Environmental Conditions	28°C, 75% RH
Tested By	Louis Yang		

Antenna Polarity & Test Distance : Vertical at 3 m								
No	Frequency (MHz)	Emission Level (dBuV/m)	Limit (dBuV/m)	Margin (dB)	Antenna Height (m)	Table Angle (Degree)	Raw Value (dBuV)	Correction Factor (dB/m)
1	#5650.00	49.8 PK	68.2	-18.4	3.01 V	357	48.5	1.3
2	*5885.00	108.1 PK			3.01 V	357	106.2	1.9
3	*5885.00	99.0 AV			3.01 V	357	97.1	1.9
4	#5895.00	74.9 PK	110.2	-35.3	3.01 V	357	73.0	1.9
5	#5895.00	63.7 AV	90.2	-26.5	3.01 V	357	61.8	1.9
6	11770.00	63.2 PK	74.0	-10.8	1.43 V	179	51.8	11.4
7	11770.00	49.4 AV	54.0	-4.6	1.43 V	179	38.0	11.4
8	#17655.00	57.3 PK	88.2	-30.9	1.45 V	326	39.2	18.1
9	#17655.00	42.9 AV	68.2	-25.3	1.45 V	326	24.8	18.1

Remarks:

1. Emission Level(dBuV/m) = Raw Value(dBuV) + Correction Factor(dB/m)
2. Correction Factor(dB/m) = Antenna Factor(dB/m) + Cable Factor(dB) – Pre-Amplifier Factor(dB)
3. Margin value = Emission Level – Limit value
4. The other emission levels were very low against the limit.
5. " * " : Fundamental frequency, the limit was restricted at the RF Output Power.
6. " # " : The radiated frequency is out of the restricted band.

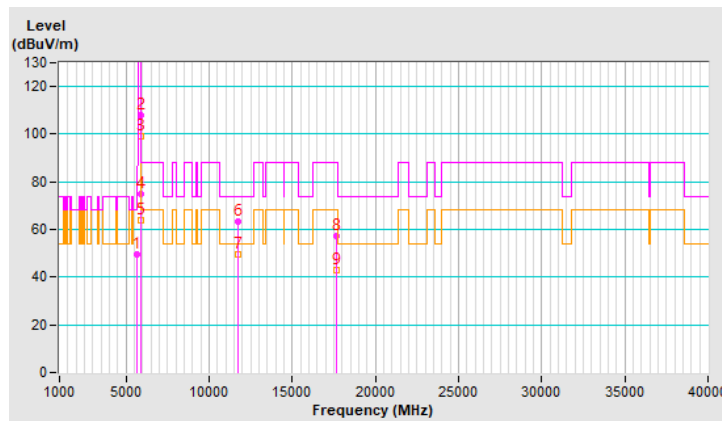

RF Mode	802.11ax (HE20)	Channel	CH 169 : 5845 MHz
Frequency Range	1 GHz ~ 40 GHz	Detector Function & Bandwidth	(PK) RB = 1 MHz, VB = 3 MHz (AV) RB = 1 MHz, VB = 10 Hz
Input Power (System)	120 Vac, 60 Hz	Environmental Conditions	28°C, 75% RH
Tested By	Louis Yang		

Antenna Polarity & Test Distance : Horizontal at 3 m								
No	Frequency (MHz)	Emission Level (dBuV/m)	Limit (dBuV/m)	Margin (dB)	Antenna Height (m)	Table Angle (Degree)	Raw Value (dBuV)	Correction Factor (dB/m)
1	#5559.08	49.7 PK	68.2	-18.5	1.72 H	336	48.6	1.1
2	*5845.00	116.8 PK			1.72 H	336	115.0	1.8
3	*5845.00	107.2 AV			1.72 H	336	105.4	1.8
4	#6017.63	71.8 PK	88.2	-16.4	1.72 H	336	69.7	2.1
5	#6017.63	61.4 AV	68.2	-6.8	1.72 H	336	59.3	2.1
6	11690.00	61.2 PK	74.0	-12.8	2.42 H	317	49.5	11.7
7	11690.00	47.2 AV	54.0	-6.8	2.42 H	317	35.5	11.7
8	#17535.00	56.7 PK	88.2	-31.5	3.01 H	284	39.1	17.6
9	#17535.00	43.4 AV	68.2	-24.8	3.01 H	284	25.8	17.6

Remarks:

1. Emission Level(dBuV/m) = Raw Value(dBuV) + Correction Factor(dB/m)
2. Correction Factor(dB/m) = Antenna Factor(dB/m) + Cable Factor(dB) – Pre-Amplifier Factor(dB)
3. Margin value = Emission Level – Limit value
4. The other emission levels were very low against the limit.
5. " * " : Fundamental frequency, the limit was restricted at the RF Output Power.
6. " # " : The radiated frequency is out of the restricted band.

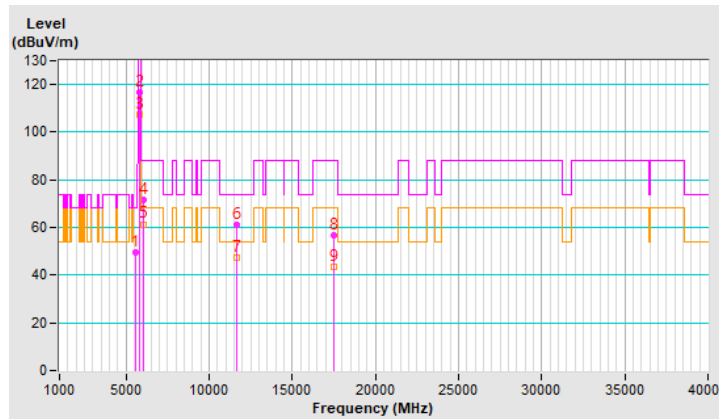

RF Mode	802.11ax (HE20)	Channel	CH 169 : 5845 MHz
Frequency Range	1 GHz ~ 40 GHz	Detector Function & Bandwidth	(PK) RB = 1 MHz, VB = 3 MHz (AV) RB = 1 MHz, VB = 10 Hz
Input Power (System)	120 Vac, 60 Hz	Environmental Conditions	28°C, 75% RH
Tested By	Louis Yang		

Antenna Polarity & Test Distance : Vertical at 3 m								
No	Frequency (MHz)	Emission Level (dBuV/m)	Limit (dBuV/m)	Margin (dB)	Antenna Height (m)	Table Angle (Degree)	Raw Value (dBuV)	Correction Factor (dB/m)
1	#5650.00	48.6 PK	68.2	-19.6	3.55 V	349	47.3	1.3
2	*5845.00	110.3 PK			3.55 V	349	108.5	1.8
3	*5845.00	100.8 AV			3.55 V	349	99.0	1.8
4	#5895.00	61.1 PK	110.2	-49.1	3.55 V	349	59.2	1.9
5	#5895.00	50.9 AV	90.2	-39.3	3.55 V	349	49.0	1.9
6	11690.00	61.9 PK	74.0	-12.1	1.45 V	171	50.2	11.7
7	11690.00	47.8 AV	54.0	-6.2	1.45 V	171	36.1	11.7
8	#17535.00	56.6 PK	88.2	-31.6	1.37 V	341	39.0	17.6
9	#17535.00	41.5 AV	68.2	-26.7	1.37 V	341	23.9	17.6

Remarks:

1. Emission Level(dBuV/m) = Raw Value(dBuV) + Correction Factor(dB/m)
2. Correction Factor(dB/m) = Antenna Factor(dB/m) + Cable Factor(dB) – Pre-Amplifier Factor(dB)
3. Margin value = Emission Level – Limit value
4. The other emission levels were very low against the limit.
5. " * " : Fundamental frequency, the limit was restricted at the RF Output Power.
6. " # " : The radiated frequency is out of the restricted band.

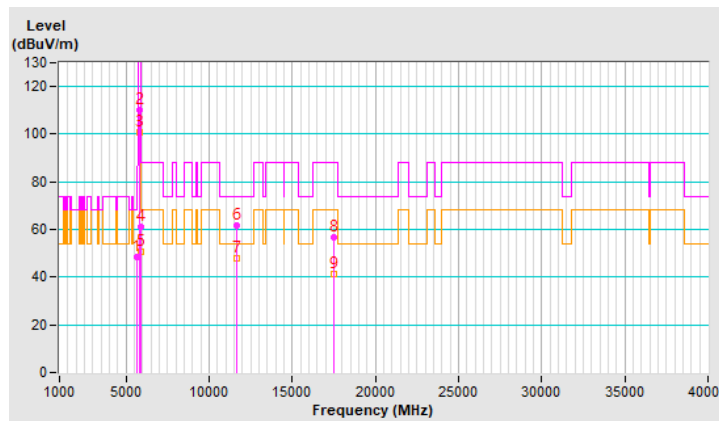

RF Mode	802.11ax (HE20)	Channel	CH 173 : 5865 MHz
Frequency Range	1 GHz ~ 40 GHz	Detector Function & Bandwidth	(PK) RB = 1 MHz, VB = 3 MHz (AV) RB = 1 MHz, VB = 10 Hz
Input Power (System)	120 Vac, 60 Hz	Environmental Conditions	28°C, 75% RH
Tested By	Louis Yang		

Antenna Polarity & Test Distance : Horizontal at 3 m								
No	Frequency (MHz)	Emission Level (dBuV/m)	Limit (dBuV/m)	Margin (dB)	Antenna Height (m)	Table Angle (Degree)	Raw Value (dBuV)	Correction Factor (dB/m)
1	#5648.80	50.9 PK	68.2	-17.3	1.66 H	305	49.6	1.3
2	*5865.00	116.6 PK			1.66 H	305	114.8	1.8
3	*5865.00	107.5 AV			1.66 H	305	105.7	1.8
4	#5893.90	79.2 PK	152.2	-73.0	1.66 H	305	77.3	1.9
5	#5893.90	72.5 AV	152.2	-79.7	1.66 H	305	70.6	1.9
6	11730.00	60.3 PK	74.0	-13.7	2.57 H	274	48.8	11.5
7	11730.00	46.1 AV	54.0	-7.9	2.57 H	274	34.6	11.5
8	#17595.00	57.3 PK	88.2	-30.9	3.04 H	323	39.4	17.9
9	#17595.00	43.6 AV	68.2	-24.6	3.04 H	323	25.7	17.9

Remarks:

1. Emission Level(dBuV/m) = Raw Value(dBuV) + Correction Factor(dB/m)
2. Correction Factor(dB/m) = Antenna Factor(dB/m) + Cable Factor(dB) – Pre-Amplifier Factor(dB)
3. Margin value = Emission Level – Limit value
4. The other emission levels were very low against the limit.
5. " * " : Fundamental frequency, the limit was restricted at the RF Output Power.
6. " # " : The radiated frequency is out of the restricted band.

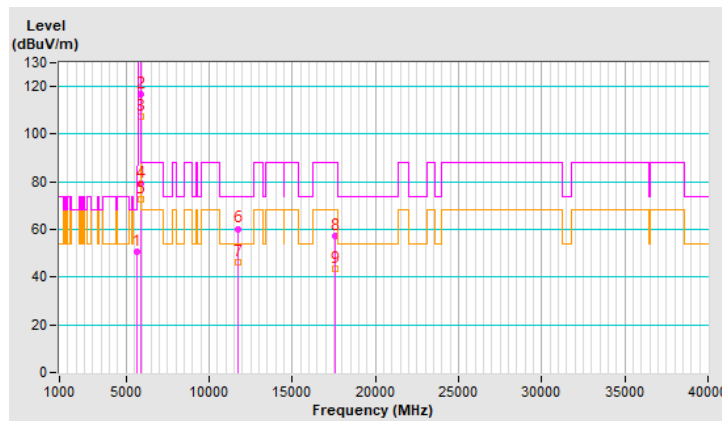

RF Mode	802.11ax (HE20)	Channel	CH 173 : 5865 MHz
Frequency Range	1 GHz ~ 40 GHz	Detector Function & Bandwidth	(PK) RB = 1 MHz, VB = 3 MHz (AV) RB = 1 MHz, VB = 10 Hz
Input Power (System)	120 Vac, 60 Hz	Environmental Conditions	28°C, 75% RH
Tested By	Louis Yang		

Antenna Polarity & Test Distance : Vertical at 3 m								
No	Frequency (MHz)	Emission Level (dBuV/m)	Limit (dBuV/m)	Margin (dB)	Antenna Height (m)	Table Angle (Degree)	Raw Value (dBuV)	Correction Factor (dB/m)
1	#5650.00	49.8 PK	68.2	-18.4	3.50 V	275	48.5	1.3
2	*5865.00	108.7 PK			3.50 V	275	106.9	1.8
3	*5865.00	99.8 AV			3.50 V	275	98.0	1.8
4	#5895.00	71.0 PK	110.2	-39.2	3.50 V	275	69.1	1.9
5	#5895.00	62.8 AV	90.2	-27.4	3.50 V	275	60.9	1.9
6	11730.00	63.0 PK	74.0	-11.0	1.54 V	175	51.5	11.5
7	11730.00	48.9 AV	54.0	-5.1	1.54 V	175	37.4	11.5
8	#17595.00	56.1 PK	88.2	-32.1	1.45 V	326	38.2	17.9
9	#17595.00	41.3 AV	68.2	-26.9	1.45 V	326	23.4	17.9

Remarks:

1. Emission Level(dBuV/m) = Raw Value(dBuV) + Correction Factor(dB/m)
2. Correction Factor(dB/m) = Antenna Factor(dB/m) + Cable Factor(dB) – Pre-Amplifier Factor(dB)
3. Margin value = Emission Level – Limit value
4. The other emission levels were very low against the limit.
5. " * " : Fundamental frequency, the limit was restricted at the RF Output Power.
6. " # " : The radiated frequency is out of the restricted band.

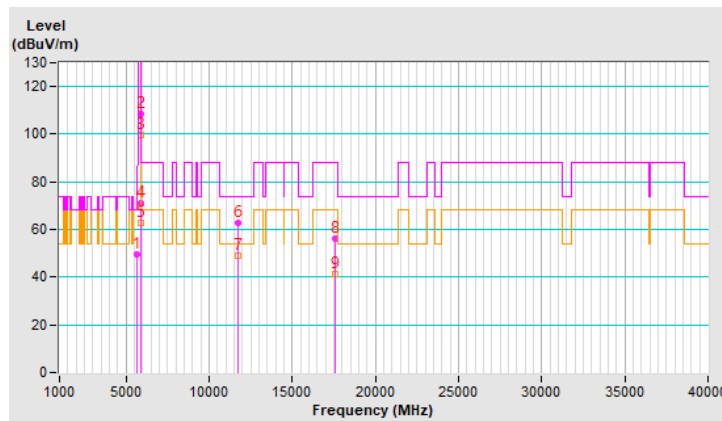

RF Mode	802.11ax (HE20)	Channel	CH 177 : 5885 MHz
Frequency Range	1 GHz ~ 40 GHz	Detector Function & Bandwidth	(PK) RB = 1 MHz, VB = 3 MHz (AV) RB = 1 MHz, VB = 10 Hz
Input Power (System)	120 Vac, 60 Hz	Environmental Conditions	28°C, 75% RH
Tested By	Louis Yang		

Antenna Polarity & Test Distance : Horizontal at 3 m								
No	Frequency (MHz)	Emission Level (dBuV/m)	Limit (dBuV/m)	Margin (dB)	Antenna Height (m)	Table Angle (Degree)	Raw Value (dBuV)	Correction Factor (dB/m)
1	#5578.70	49.8 PK	68.2	-18.4	1.72 H	335	48.7	1.1
2	*5885.00	115.4 PK			1.72 H	335	113.5	1.9
3	*5885.00	106.0 AV			1.72 H	335	104.1	1.9
4	#5895.94	75.5 PK	109.5	-34.0	1.72 H	335	73.6	1.9
5	#5895.94	64.2 AV	89.5	-25.3	1.72 H	335	62.3	1.9
6	11770.00	61.3 PK	74.0	-12.7	2.46 H	331	49.9	11.4
7	11770.00	47.2 AV	54.0	-6.8	2.46 H	331	35.8	11.4
8	#17655.00	55.4 PK	88.2	-32.8	2.99 H	311	37.3	18.1
9	#17655.00	41.5 AV	68.2	-26.7	2.99 H	311	23.4	18.1

Remarks:

1. Emission Level(dBuV/m) = Raw Value(dBuV) + Correction Factor(dB/m)
2. Correction Factor(dB/m) = Antenna Factor(dB/m) + Cable Factor(dB) – Pre-Amplifier Factor(dB)
3. Margin value = Emission Level – Limit value
4. The other emission levels were very low against the limit.
5. " * " : Fundamental frequency, the limit was restricted at the RF Output Power.
6. " # " : The radiated frequency is out of the restricted band.

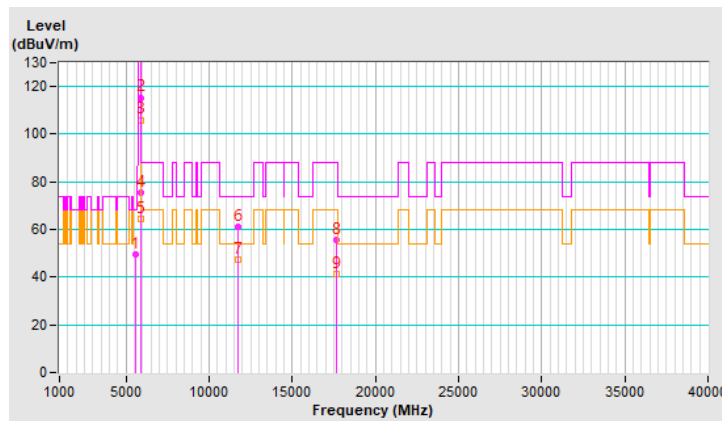

RF Mode	802.11ax (HE20)	Channel	CH 177 : 5885 MHz
Frequency Range	1 GHz ~ 40 GHz	Detector Function & Bandwidth	(PK) RB = 1 MHz, VB = 3 MHz (AV) RB = 1 MHz, VB = 10 Hz
Input Power (System)	120 Vac, 60 Hz	Environmental Conditions	28°C, 75% RH
Tested By	Louis Yang		

Antenna Polarity & Test Distance : Vertical at 3 m								
No	Frequency (MHz)	Emission Level (dBuV/m)	Limit (dBuV/m)	Margin (dB)	Antenna Height (m)	Table Angle (Degree)	Raw Value (dBuV)	Correction Factor (dB/m)
1	#5650.00	51.4 PK	68.2	-16.8	3.58 V	341	50.1	1.3
2	*5885.00	109.8 PK			3.58 V	341	107.9	1.9
3	*5885.00	99.8 AV			3.58 V	341	97.9	1.9
4	#5895.00	75.2 PK	110.2	-35.0	3.58 V	341	73.3	1.9
5	#5895.00	63.8 AV	90.2	-26.4	3.58 V	341	61.9	1.9
6	11770.00	61.9 PK	74.0	-12.1	1.52 V	171	50.5	11.4
7	11770.00	48.3 AV	54.0	-5.7	1.52 V	171	36.9	11.4
8	#17655.00	58.4 PK	88.2	-29.8	1.41 V	327	40.3	18.1
9	#17655.00	43.2 AV	68.2	-25.0	1.41 V	327	25.1	18.1

Remarks:

1. Emission Level(dBuV/m) = Raw Value(dBuV) + Correction Factor(dB/m)
2. Correction Factor(dB/m) = Antenna Factor(dB/m) + Cable Factor(dB) – Pre-Amplifier Factor(dB)
3. Margin value = Emission Level – Limit value
4. The other emission levels were very low against the limit.
5. " * " : Fundamental frequency, the limit was restricted at the RF Output Power.
6. " # " : The radiated frequency is out of the restricted band.

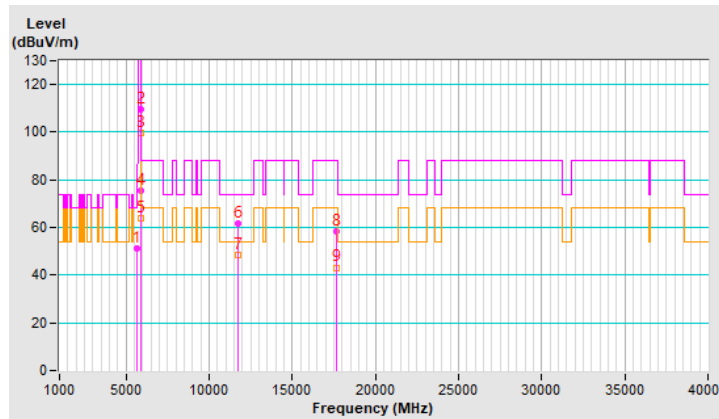

RF Mode	802.11ax (HE40)	Channel	CH 167 : 5835 MHz
Frequency Range	1 GHz ~ 40 GHz	Detector Function & Bandwidth	(PK) RB = 1 MHz, VB = 3 MHz (AV) RB = 1 MHz, VB = 10 Hz
Input Power (System)	120 Vac, 60 Hz	Environmental Conditions	28°C, 75% RH
Tested By	Louis Yang		

Antenna Polarity & Test Distance : Horizontal at 3 m								
No	Frequency (MHz)	Emission Level (dBuV/m)	Limit (dBuV/m)	Margin (dB)	Antenna Height (m)	Table Angle (Degree)	Raw Value (dBuV)	Correction Factor (dB/m)
1	#5650.00	49.1 PK	68.2	-19.1	1.80 H	323	47.8	1.3
2	*5835.00	114.1 PK			1.80 H	323	112.3	1.8
3	*5835.00	103.2 AV			1.80 H	323	101.4	1.8
4	#5895.00	75.1 PK	110.2	-35.1	1.80 H	323	73.2	1.9
5	#5895.00	63.7 AV	90.2	-26.5	1.80 H	323	61.8	1.9
6	11670.00	61.2 PK	74.0	-12.8	2.58 H	276	49.6	11.6
7	11670.00	47.0 AV	54.0	-7.0	2.58 H	276	35.4	11.6
8	#17505.00	57.0 PK	88.2	-31.2	3.04 H	349	39.5	17.5
9	#17505.00	43.5 AV	68.2	-24.7	3.04 H	349	26.0	17.5

Remarks:

1. Emission Level(dBuV/m) = Raw Value(dBuV) + Correction Factor(dB/m)
2. Correction Factor(dB/m) = Antenna Factor(dB/m) + Cable Factor(dB) – Pre-Amplifier Factor(dB)
3. Margin value = Emission Level – Limit value
4. The other emission levels were very low against the limit.
5. " * " : Fundamental frequency, the limit was restricted at the RF Output Power.
6. " # " : The radiated frequency is out of the restricted band.

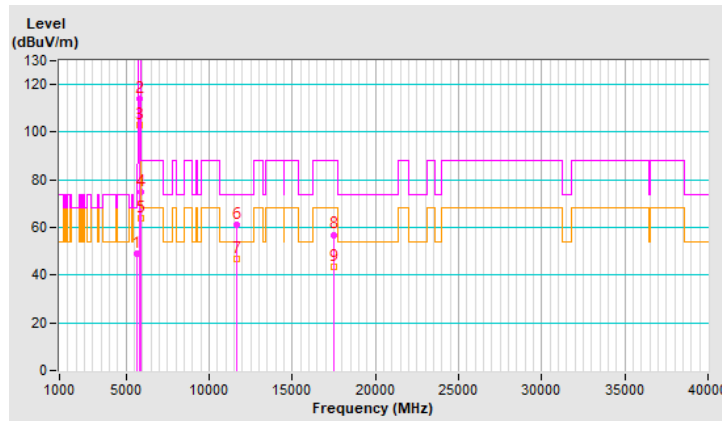

RF Mode	802.11ax (HE40)	Channel	CH 167 : 5835 MHz
Frequency Range	1 GHz ~ 40 GHz	Detector Function & Bandwidth	(PK) RB = 1 MHz, VB = 3 MHz (AV) RB = 1 MHz, VB = 10 Hz
Input Power (System)	120 Vac, 60 Hz	Environmental Conditions	28°C, 75% RH
Tested By	Louis Yang		

Antenna Polarity & Test Distance : Vertical at 3 m								
No	Frequency (MHz)	Emission Level (dBuV/m)	Limit (dBuV/m)	Margin (dB)	Antenna Height (m)	Table Angle (Degree)	Raw Value (dBuV)	Correction Factor (dB/m)
1	#5650.00	52.2 PK	68.2	-16.0	3.82 V	337	50.9	1.3
2	*5835.00	106.1 PK			3.82 V	337	104.3	1.8
3	*5835.00	96.5 AV			3.82 V	337	94.7	1.8
4	#5895.00	74.8 PK	110.2	-35.4	3.82 V	337	72.9	1.9
5	#5895.00	63.5 AV	90.2	-26.7	3.82 V	337	61.6	1.9
6	11670.00	63.3 PK	74.0	-10.7	1.55 V	184	51.7	11.6
7	11670.00	49.0 AV	54.0	-5.0	1.55 V	184	37.4	11.6
8	#17505.00	57.2 PK	88.2	-31.0	1.39 V	343	39.7	17.5
9	#17505.00	42.0 AV	68.2	-26.2	1.39 V	343	24.5	17.5

Remarks:

1. Emission Level(dBuV/m) = Raw Value(dBuV) + Correction Factor(dB/m)
2. Correction Factor(dB/m) = Antenna Factor(dB/m) + Cable Factor(dB) – Pre-Amplifier Factor(dB)
3. Margin value = Emission Level – Limit value
4. The other emission levels were very low against the limit.
5. " * " : Fundamental frequency, the limit was restricted at the RF Output Power.
6. " # " : The radiated frequency is out of the restricted band.

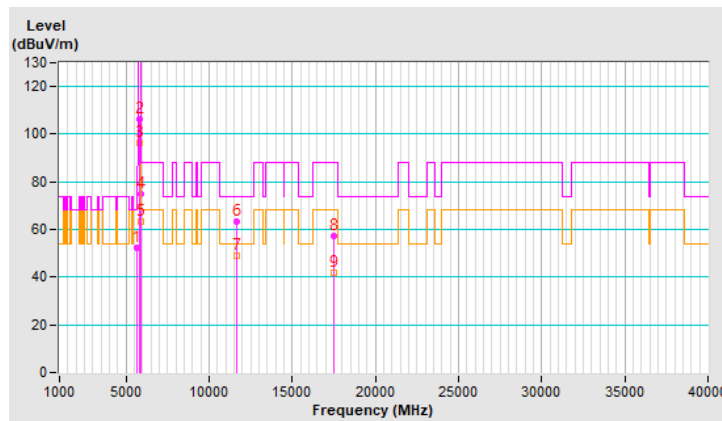

RF Mode	802.11ax (HE40)	Channel	CH 175 : 5875 MHz
Frequency Range	1 GHz ~ 40 GHz	Detector Function & Bandwidth	(PK) RB = 1 MHz, VB = 3 MHz (AV) RB = 1 MHz, VB = 10 Hz
Input Power (System)	120 Vac, 60 Hz	Environmental Conditions	28°C, 75% RH
Tested By	Louis Yang		

Antenna Polarity & Test Distance : Horizontal at 3 m								
No	Frequency (MHz)	Emission Level (dBuV/m)	Limit (dBuV/m)	Margin (dB)	Antenna Height (m)	Table Angle (Degree)	Raw Value (dBuV)	Correction Factor (dB/m)
1	#5650.00	51.6 PK	68.2	-16.6	1.54 H	360	50.3	1.3
2	*5875.00	110.7 PK			1.54 H	360	108.9	1.8
3	*5875.00	100.8 AV			1.54 H	360	99.0	1.8
4	#5908.03	75.5 PK	100.6	-25.1	1.54 H	360	73.6	1.9
5	#5908.03	63.9 AV	80.6	-16.7	1.54 H	360	62.0	1.9
6	11750.00	59.5 PK	74.0	-14.5	2.65 H	318	47.9	11.6
7	11750.00	45.7 AV	54.0	-8.3	2.65 H	318	34.1	11.6
8	#17625.00	55.5 PK	88.2	-32.7	3.19 H	285	37.5	18.0
9	#17625.00	42.1 AV	68.2	-26.1	3.19 H	285	24.1	18.0

Remarks:

1. Emission Level(dBuV/m) = Raw Value(dBuV) + Correction Factor(dB/m)
2. Correction Factor(dB/m) = Antenna Factor(dB/m) + Cable Factor(dB) – Pre-Amplifier Factor(dB)
3. Margin value = Emission Level – Limit value
4. The other emission levels were very low against the limit.
5. " * " : Fundamental frequency, the limit was restricted at the RF Output Power.
6. " # " : The radiated frequency is out of the restricted band.

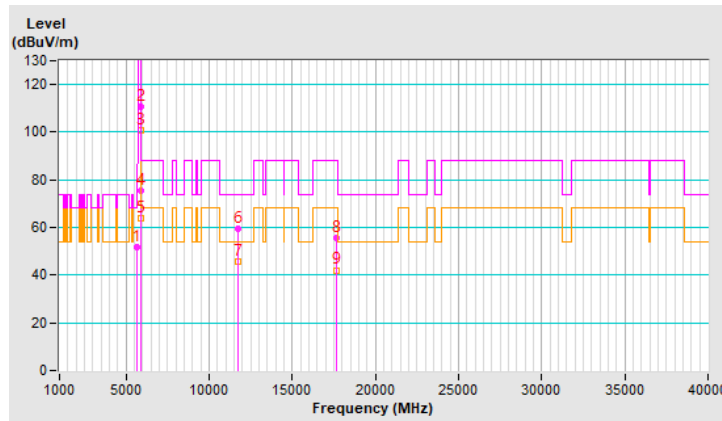

RF Mode	802.11ax (HE40)	Channel	CH 175 : 5875 MHz
Frequency Range	1 GHz ~ 40 GHz	Detector Function & Bandwidth	(PK) RB = 1 MHz, VB = 3 MHz (AV) RB = 1 MHz, VB = 10 Hz
Input Power (System)	120 Vac, 60 Hz	Environmental Conditions	28°C, 75% RH
Tested By	Louis Yang		

Antenna Polarity & Test Distance : Vertical at 3 m								
No	Frequency (MHz)	Emission Level (dBuV/m)	Limit (dBuV/m)	Margin (dB)	Antenna Height (m)	Table Angle (Degree)	Raw Value (dBuV)	Correction Factor (dB/m)
1	#5650.00	49.2 PK	68.2	-19.0	2.19 V	340	47.9	1.3
2	*5875.00	105.5 PK			2.19 V	340	103.7	1.8
3	*5875.00	95.4 AV			2.19 V	340	93.6	1.8
4	#5895.00	75.7 PK	110.2	-34.5	2.19 V	340	73.8	1.9
5	#5895.00	64.1 AV	90.2	-26.1	2.19 V	340	62.2	1.9
6	11750.00	61.9 PK	74.0	-12.1	1.50 V	180	50.3	11.6
7	11750.00	48.3 AV	54.0	-5.7	1.50 V	180	36.7	11.6
8	#17625.00	56.1 PK	88.2	-32.1	1.39 V	360	38.1	18.0
9	#17625.00	42.4 AV	68.2	-25.8	1.39 V	360	24.4	18.0

Remarks:

1. Emission Level(dBuV/m) = Raw Value(dBuV) + Correction Factor(dB/m)
2. Correction Factor(dB/m) = Antenna Factor(dB/m) + Cable Factor(dB) – Pre-Amplifier Factor(dB)
3. Margin value = Emission Level – Limit value
4. The other emission levels were very low against the limit.
5. " * " : Fundamental frequency, the limit was restricted at the RF Output Power.
6. " # " : The radiated frequency is out of the restricted band.

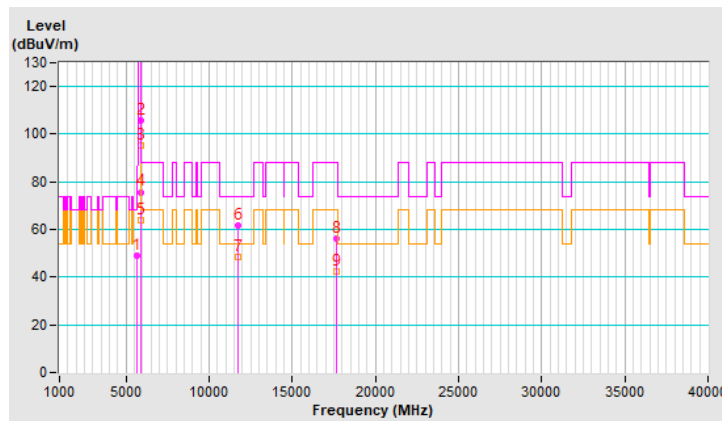

RF Mode	802.11ax (HE80)	Channel	CH 171 : 5855 MHz
Frequency Range	1 GHz ~ 40 GHz	Detector Function & Bandwidth	(PK) RB = 1 MHz, VB = 3 MHz (AV) RB = 1 MHz, VB = 5.1 kHz
Input Power (System)	120 Vac, 60 Hz	Environmental Conditions	28°C, 75% RH
Tested By	Louis Yang		

Antenna Polarity & Test Distance : Horizontal at 3 m								
No	Frequency (MHz)	Emission Level (dBuV/m)	Limit (dBuV/m)	Margin (dB)	Antenna Height (m)	Table Angle (Degree)	Raw Value (dBuV)	Correction Factor (dB/m)
1	#5650.00	49.6 PK	68.2	-18.6	1.50 H	360	48.3	1.3
2	*5855.00	105.3 PK			1.50 H	360	103.5	1.8
3	*5855.00	95.4 AV			1.50 H	360	93.6	1.8
4	#5927.20	75.8 PK	88.2	-12.4	1.50 H	360	73.8	2.0
5	#5927.20	66.6 AV	68.2	-1.6	1.50 H	360	64.6	2.0
6	11710.00	60.5 PK	74.0	-13.5	2.48 H	304	48.9	11.6
7	11710.00	46.8 AV	54.0	-7.2	2.48 H	304	35.2	11.6
8	#17565.00	55.7 PK	88.2	-32.5	3.20 H	305	38.0	17.7
9	#17565.00	42.4 AV	68.2	-25.8	3.20 H	305	24.7	17.7

Remarks:

1. Emission Level(dBuV/m) = Raw Value(dBuV) + Correction Factor(dB/m)
2. Correction Factor(dB/m) = Antenna Factor(dB/m) + Cable Factor(dB) – Pre-Amplifier Factor(dB)
3. Margin value = Emission Level – Limit value
4. The other emission levels were very low against the limit.
5. " * " : Fundamental frequency, the limit was restricted at the RF Output Power.
6. " # " : The radiated frequency is out of the restricted band.

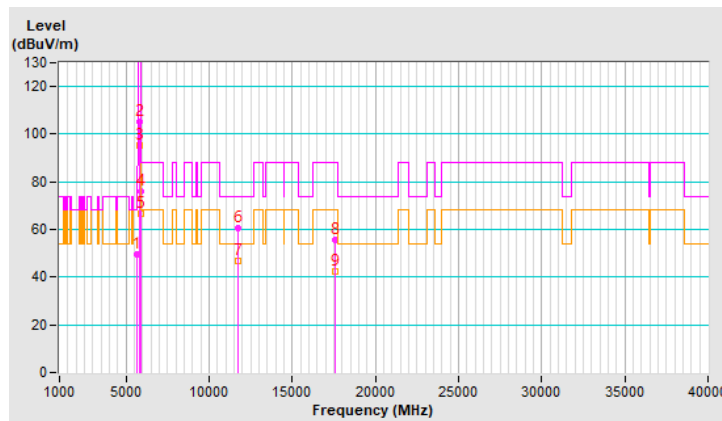

RF Mode	802.11ax (HE80)	Channel	CH 171 : 5855 MHz
Frequency Range	1 GHz ~ 40 GHz	Detector Function & Bandwidth	(PK) RB = 1 MHz, VB = 3 MHz (AV) RB = 1 MHz, VB = 5.1 kHz
Input Power (System)	120 Vac, 60 Hz	Environmental Conditions	28°C, 75% RH
Tested By	Louis Yang		

Antenna Polarity & Test Distance : Vertical at 3 m								
No	Frequency (MHz)	Emission Level (dBuV/m)	Limit (dBuV/m)	Margin (dB)	Antenna Height (m)	Table Angle (Degree)	Raw Value (dBuV)	Correction Factor (dB/m)
1	#5650.00	48.7 PK	68.2	-19.5	2.37 V	328	47.4	1.3
2	*5855.00	100.9 PK			2.37 V	328	99.1	1.8
3	*5855.00	90.7 AV			2.37 V	328	88.9	1.8
4	#5895.00	80.0 PK	110.2	-30.2	2.37 V	328	78.1	1.9
5	#5895.00	66.0 AV	90.2	-24.2	2.37 V	328	64.1	1.9
6	11710.00	62.1 PK	74.0	-11.9	1.65 V	158	50.5	11.6
7	11710.00	48.3 AV	54.0	-5.7	1.65 V	158	36.7	11.6
8	#17565.00	56.8 PK	88.2	-31.4	1.49 V	337	39.1	17.7
9	#17565.00	42.3 AV	68.2	-25.9	1.49 V	337	24.6	17.7

Remarks:

1. Emission Level(dBuV/m) = Raw Value(dBuV) + Correction Factor(dB/m)
2. Correction Factor(dB/m) = Antenna Factor(dB/m) + Cable Factor(dB) – Pre-Amplifier Factor(dB)
3. Margin value = Emission Level – Limit value
4. The other emission levels were very low against the limit.
5. " * " : Fundamental frequency, the limit was restricted at the RF Output Power.
6. " # " : The radiated frequency is out of the restricted band.

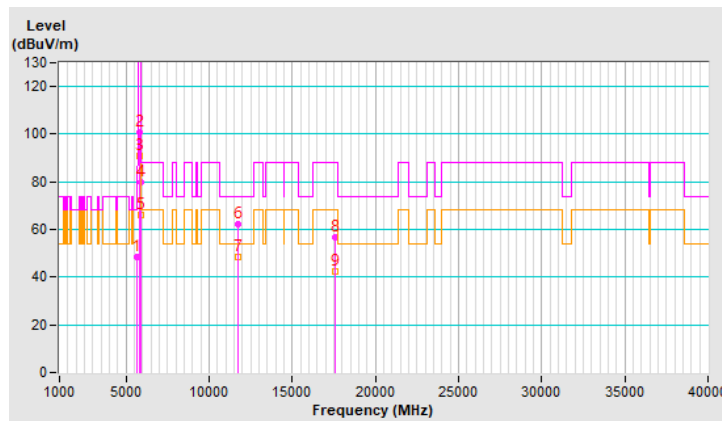

RF Mode	802.11ax (HE20) 26-tone RU	Channel	CH 169 : 5845 MHz
Frequency Range	1 GHz ~ 40 GHz	Detector Function & Bandwidth	(PK) RB = 1 MHz, VB = 3 MHz (AV) RB = 1 MHz, VB = 10 Hz
Input Power (System)	120 Vac, 60 Hz	Environmental Conditions	22°C, 70% RH
Tested By	Louis Yang		

Antenna Polarity & Test Distance : Horizontal at 3 m								
No	Frequency (MHz)	Emission Level (dBuV/m)	Limit (dBuV/m)	Margin (dB)	Antenna Height (m)	Table Angle (Degree)	Raw Value (dBuV)	Correction Factor (dB/m)
1	#5650.00	50.9 PK	68.2	-17.3	1.48 H	168	48.9	2.0
2	*5845.00	116.1 PK			1.48 H	168	113.8	2.3
3	*5845.00	106.8 AV			1.48 H	168	104.5	2.3
4	#5895.00	52.4 PK	110.2	-57.8	1.48 H	168	50.0	2.4
5	#5895.00	34.4 AV	90.2	-55.8	1.48 H	168	32.0	2.4
6	11690.00	58.6 PK	74.0	-15.4	1.60 H	129	46.2	12.4
7	11690.00	45.5 AV	54.0	-8.5	1.60 H	129	33.1	12.4
8	#17535.00	65.6 PK	88.2	-22.6	1.59 H	190	46.4	19.2
9	#17535.00	42.0 AV	68.2	-26.2	1.59 H	190	22.8	19.2

Remarks:

1. Emission Level(dBuV/m) = Raw Value(dBuV) + Correction Factor(dB/m)
2. Correction Factor(dB/m) = Antenna Factor(dB/m) + Cable Factor(dB) – Pre-Amplifier Factor(dB)
3. Margin value = Emission Level – Limit value
4. The other emission levels were very low against the limit.
5. " * " : Fundamental frequency, the limit was restricted at the RF Output Power.
6. " # " : The radiated frequency is out of the restricted band.

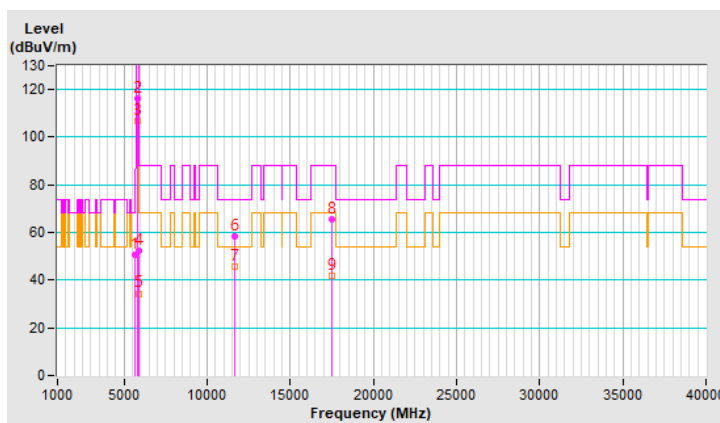

RF Mode	802.11ax (HE20) 26-tone RU	Channel	CH 169 : 5845 MHz
Frequency Range	1 GHz ~ 40 GHz	Detector Function & Bandwidth	(PK) RB = 1 MHz, VB = 3 MHz (AV) RB = 1 MHz, VB = 10 Hz
Input Power (System)	120 Vac, 60 Hz	Environmental Conditions	22°C, 70% RH
Tested By	Louis Yang		

Antenna Polarity & Test Distance : Vertical at 3 m								
No	Frequency (MHz)	Emission Level (dBuV/m)	Limit (dBuV/m)	Margin (dB)	Antenna Height (m)	Table Angle (Degree)	Raw Value (dBuV)	Correction Factor (dB/m)
1	#5650.00	48.1 PK	68.2	-20.1	2.64 V	98	46.1	2.0
2	*5845.00	112.1 PK			2.64 V	98	109.8	2.3
3	*5845.00	100.0 AV			2.64 V	98	97.7	2.3
4	#5895.00	47.5 PK	110.2	-62.7	2.64 V	98	45.1	2.4
5	#5895.00	32.0 AV	90.2	-58.2	2.64 V	98	29.6	2.4
6	11690.00	55.0 PK	74.0	-19.0	1.98 V	201	42.6	12.4
7	11690.00	41.7 AV	54.0	-12.3	1.98 V	201	29.3	12.4
8	#17535.00	64.6 PK	88.2	-23.6	2.58 V	158	45.4	19.2
9	#17535.00	42.1 AV	68.2	-26.1	2.58 V	158	22.9	19.2

Remarks:

1. Emission Level(dBuV/m) = Raw Value(dBuV) + Correction Factor(dB/m)
2. Correction Factor(dB/m) = Antenna Factor(dB/m) + Cable Factor(dB) – Pre-Amplifier Factor(dB)
3. Margin value = Emission Level – Limit value
4. The other emission levels were very low against the limit.
5. " * " : Fundamental frequency, the limit was restricted at the RF Output Power.
6. " # " : The radiated frequency is out of the restricted band.

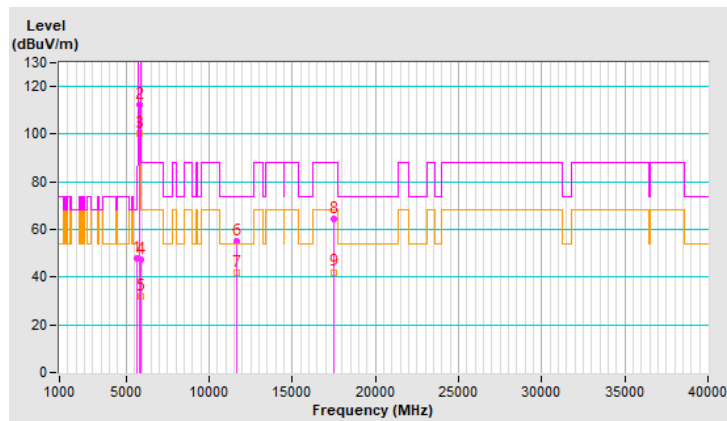

RF Mode	802.11ax (HE20) 26-tone RU	Channel	CH 173 : 5865 MHz
Frequency Range	1 GHz ~ 40 GHz	Detector Function & Bandwidth	(PK) RB = 1 MHz, VB = 3 MHz (AV) RB = 1 MHz, VB = 10 Hz
Input Power (System)	120 Vac, 60 Hz	Environmental Conditions	22°C, 70% RH
Tested By	Louis Yang		

Antenna Polarity & Test Distance : Horizontal at 3 m								
No	Frequency (MHz)	Emission Level (dBuV/m)	Limit (dBuV/m)	Margin (dB)	Antenna Height (m)	Table Angle (Degree)	Raw Value (dBuV)	Correction Factor (dB/m)
1	#5650.00	50.2 PK	68.2	-18.0	1.56 H	192	48.2	2.0
2	*5865.00	114.7 PK			1.56 H	192	112.4	2.3
3	*5865.00	105.1 AV			1.56 H	192	102.8	2.3
4	#5895.00	49.4 PK	110.2	-60.8	1.56 H	192	47.0	2.4
5	#5895.00	37.8 AV	90.2	-52.4	1.56 H	192	35.4	2.4
6	11730.00	63.5 PK	74.0	-10.5	1.44 H	170	51.3	12.2
7	11730.00	50.4 AV	54.0	-3.6	1.44 H	170	38.2	12.2
8	#17595.00	65.7 PK	88.2	-22.5	1.58 H	118	46.0	19.7
9	#17595.00	42.0 AV	68.2	-26.2	1.58 H	118	22.3	19.7

Remarks:

1. Emission Level(dBuV/m) = Raw Value(dBuV) + Correction Factor(dB/m)
2. Correction Factor(dB/m) = Antenna Factor(dB/m) + Cable Factor(dB) – Pre-Amplifier Factor(dB)
3. Margin value = Emission Level – Limit value
4. The other emission levels were very low against the limit.
5. " * " : Fundamental frequency, the limit was restricted at the RF Output Power.
6. " # " : The radiated frequency is out of the restricted band.

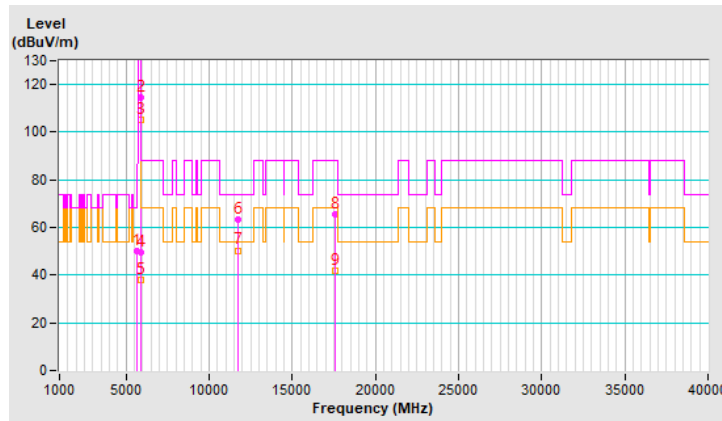

RF Mode	802.11ax (HE20) 26-tone RU	Channel	CH 173 : 5865 MHz
Frequency Range	1 GHz ~ 40 GHz	Detector Function & Bandwidth	(PK) RB = 1 MHz, VB = 3 MHz (AV) RB = 1 MHz, VB = 10 Hz
Input Power (System)	120 Vac, 60 Hz	Environmental Conditions	22°C, 70% RH
Tested By	Louis Yang		

Antenna Polarity & Test Distance : Vertical at 3 m								
No	Frequency (MHz)	Emission Level (dBuV/m)	Limit (dBuV/m)	Margin (dB)	Antenna Height (m)	Table Angle (Degree)	Raw Value (dBuV)	Correction Factor (dB/m)
1	#5650.00	48.5 PK	68.2	-19.7	2.71 V	67	46.5	2.0
2	*5865.00	112.7 PK			2.71 V	67	110.4	2.3
3	*5865.00	100.4 AV			2.71 V	67	98.1	2.3
4	#5895.00	47.7 PK	110.2	-62.5	2.71 V	67	45.3	2.4
5	#5895.00	32.2 AV	90.2	-58.0	2.71 V	67	29.8	2.4
6	11730.00	54.0 PK	74.0	-20.0	1.96 V	207	41.8	12.2
7	11730.00	41.2 AV	54.0	-12.8	1.96 V	207	29.0	12.2
8	#17595.00	64.5 PK	88.2	-23.7	2.48 V	184	44.8	19.7
9	#17595.00	42.1 AV	68.2	-26.1	2.48 V	184	22.4	19.7

Remarks:

1. Emission Level(dBuV/m) = Raw Value(dBuV) + Correction Factor(dB/m)
2. Correction Factor(dB/m) = Antenna Factor(dB/m) + Cable Factor(dB) – Pre-Amplifier Factor(dB)
3. Margin value = Emission Level – Limit value
4. The other emission levels were very low against the limit.
5. " * " : Fundamental frequency, the limit was restricted at the RF Output Power.
6. " # " : The radiated frequency is out of the restricted band.

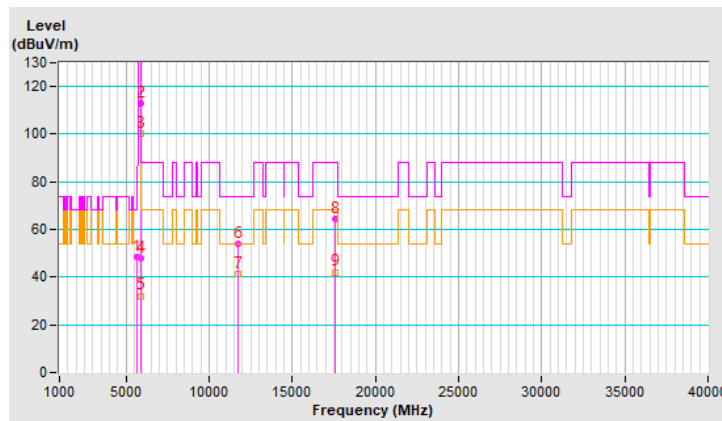

RF Mode	802.11ax (HE20) 26-tone RU	Channel	CH 177 : 5885 MHz
Frequency Range	1 GHz ~ 40 GHz	Detector Function & Bandwidth	(PK) RB = 1 MHz, VB = 3 MHz (AV) RB = 1 MHz, VB = 10 Hz
Input Power (System)	120 Vac, 60 Hz	Environmental Conditions	22°C, 70% RH
Tested By	Louis Yang		

Antenna Polarity & Test Distance : Horizontal at 3 m								
No	Frequency (MHz)	Emission Level (dBuV/m)	Limit (dBuV/m)	Margin (dB)	Antenna Height (m)	Table Angle (Degree)	Raw Value (dBuV)	Correction Factor (dB/m)
1	#5650.00	50.1 PK	68.2	-18.1	1.43 H	159	48.1	2.0
2	*5885.00	115.8 PK			1.43 H	159	113.4	2.4
3	*5885.00	105.6 AV			1.43 H	159	103.2	2.4
4	#5897.00	60.2 PK	108.7	-48.5	1.43 H	159	57.8	2.4
5	#5897.00	54.0 AV	88.7	-34.7	1.43 H	159	51.6	2.4
6	11770.00	64.9 PK	74.0	-9.1	1.37 H	153	52.7	12.2
7	11770.00	50.3 AV	54.0	-3.7	1.37 H	153	38.1	12.2
8	#17655.00	65.2 PK	88.2	-23.0	1.50 H	192	45.2	20.0
9	#17655.00	41.9 AV	68.2	-26.3	1.50 H	192	21.9	20.0

Remarks:

1. Emission Level(dBuV/m) = Raw Value(dBuV) + Correction Factor(dB/m)
2. Correction Factor(dB/m) = Antenna Factor(dB/m) + Cable Factor(dB) – Pre-Amplifier Factor(dB)
3. Margin value = Emission Level – Limit value
4. The other emission levels were very low against the limit.
5. " * " : Fundamental frequency, the limit was restricted at the RF Output Power.
6. " # " : The radiated frequency is out of the restricted band.

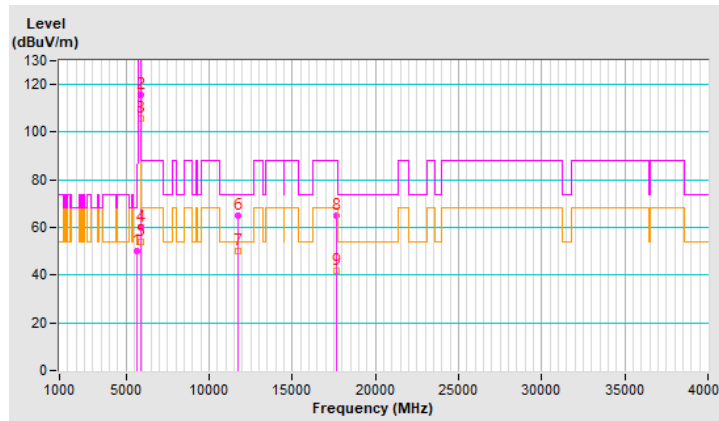

RF Mode	802.11ax (HE20) 26-tone RU	Channel	CH 177 : 5885 MHz
Frequency Range	1 GHz ~ 40 GHz	Detector Function & Bandwidth	(PK) RB = 1 MHz, VB = 3 MHz (AV) RB = 1 MHz, VB = 10 Hz
Input Power (System)	120 Vac, 60 Hz	Environmental Conditions	22°C, 70% RH
Tested By	Louis Yang		

Antenna Polarity & Test Distance : Vertical at 3 m								
No	Frequency (MHz)	Emission Level (dBuV/m)	Limit (dBuV/m)	Margin (dB)	Antenna Height (m)	Table Angle (Degree)	Raw Value (dBuV)	Correction Factor (dB/m)
1	#5650.00	48.6 PK	68.2	-19.6	2.68 V	112	46.6	2.0
2	*5885.00	112.1 PK			2.68 V	112	109.7	2.4
3	*5885.00	100.1 AV			2.68 V	112	97.7	2.4
4	#5895.00	47.8 PK	110.2	-62.4	2.68 V	112	45.4	2.4
5	#5895.00	31.3 AV	90.2	-58.9	2.68 V	112	28.9	2.4
6	11770.00	54.5 PK	74.0	-19.5	1.89 V	268	42.3	12.2
7	11770.00	41.5 AV	54.0	-12.5	1.89 V	268	29.3	12.2
8	#17655.00	64.6 PK	88.2	-23.6	2.63 V	161	44.6	20.0
9	#17655.00	42.5 AV	68.2	-25.7	2.63 V	161	22.5	20.0

Remarks:

1. Emission Level(dBuV/m) = Raw Value(dBuV) + Correction Factor(dB/m)
2. Correction Factor(dB/m) = Antenna Factor(dB/m) + Cable Factor(dB) – Pre-Amplifier Factor(dB)
3. Margin value = Emission Level – Limit value
4. The other emission levels were very low against the limit.
5. " * " : Fundamental frequency, the limit was restricted at the RF Output Power.
6. " # " : The radiated frequency is out of the restricted band.

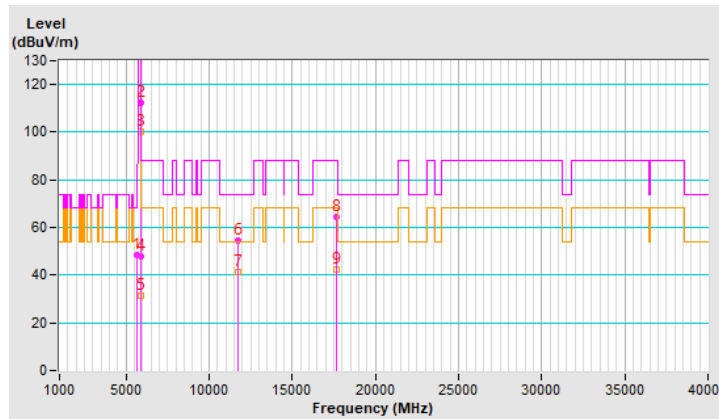

RF Mode	802.11ax (HE20) 52-tone RU	Channel	CH 169 : 5845 MHz
Frequency Range	1 GHz ~ 40 GHz	Detector Function & Bandwidth	(PK) RB = 1 MHz, VB = 3 MHz (AV) RB = 1 MHz, VB = 10 Hz
Input Power (System)	120 Vac, 60 Hz	Environmental Conditions	22°C, 70% RH
Tested By	Louis Yang		

Antenna Polarity & Test Distance : Horizontal at 3 m								
No	Frequency (MHz)	Emission Level (dBuV/m)	Limit (dBuV/m)	Margin (dB)	Antenna Height (m)	Table Angle (Degree)	Raw Value (dBuV)	Correction Factor (dB/m)
1	#5650.00	50.7 PK	68.2	-17.5	1.40 H	213	48.7	2.0
2	*5845.00	115.6 PK			1.40 H	213	113.3	2.3
3	*5845.00	105.1 AV			1.40 H	213	102.8	2.3
4	#5895.00	51.8 PK	110.2	-58.4	1.40 H	213	49.4	2.4
5	#5895.00	36.8 AV	90.2	-53.4	1.40 H	213	34.4	2.4
6	11690.00	60.6 PK	74.0	-13.4	1.63 H	153	48.2	12.4
7	11690.00	48.5 AV	54.0	-5.5	1.63 H	153	36.1	12.4
8	#17535.00	66.1 PK	88.2	-22.1	1.54 H	148	46.9	19.2
9	#17535.00	41.8 AV	68.2	-26.4	1.54 H	148	22.6	19.2

Remarks:

1. Emission Level(dBuV/m) = Raw Value(dBuV) + Correction Factor(dB/m)
2. Correction Factor(dB/m) = Antenna Factor(dB/m) + Cable Factor(dB) – Pre-Amplifier Factor(dB)
3. Margin value = Emission Level – Limit value
4. The other emission levels were very low against the limit.
5. " * " : Fundamental frequency, the limit was restricted at the RF Output Power.
6. " # " : The radiated frequency is out of the restricted band.

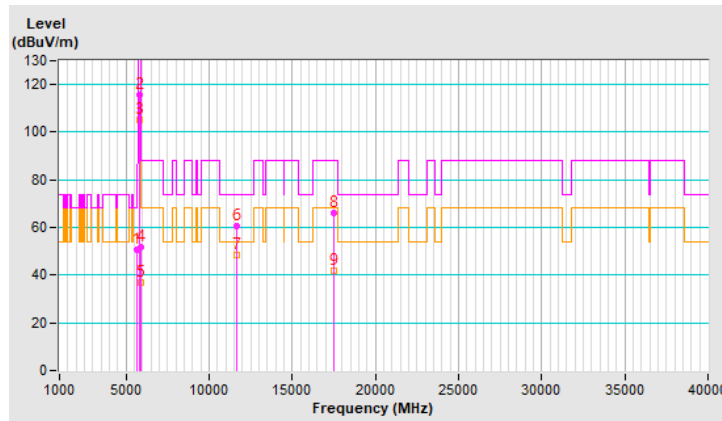

RF Mode	802.11ax (HE20) 52-tone RU	Channel	CH 169 : 5845 MHz
Frequency Range	1 GHz ~ 40 GHz	Detector Function & Bandwidth	(PK) RB = 1 MHz, VB = 3 MHz (AV) RB = 1 MHz, VB = 10 Hz
Input Power (System)	120 Vac, 60 Hz	Environmental Conditions	22°C, 70% RH
Tested By	Louis Yang		

Antenna Polarity & Test Distance : Vertical at 3 m								
No	Frequency (MHz)	Emission Level (dBuV/m)	Limit (dBuV/m)	Margin (dB)	Antenna Height (m)	Table Angle (Degree)	Raw Value (dBuV)	Correction Factor (dB/m)
1	#5650.00	48.5 PK	68.2	-19.7	2.85 V	104	46.5	2.0
2	*5845.00	111.6 PK			2.85 V	104	109.3	2.3
3	*5845.00	99.5 AV			2.85 V	104	97.2	2.3
4	#5895.00	47.7 PK	110.2	-62.5	2.85 V	104	45.3	2.4
5	#5895.00	31.9 AV	90.2	-58.3	2.85 V	104	29.5	2.4
6	11690.00	54.8 PK	74.0	-19.2	1.85 V	197	42.4	12.4
7	11690.00	42.3 AV	54.0	-11.7	1.85 V	197	29.9	12.4
8	#17535.00	65.4 PK	88.2	-22.8	2.48 V	180	46.2	19.2
9	#17535.00	42.0 AV	68.2	-26.2	2.48 V	180	22.8	19.2

Remarks:

1. Emission Level(dBuV/m) = Raw Value(dBuV) + Correction Factor(dB/m)
2. Correction Factor(dB/m) = Antenna Factor(dB/m) + Cable Factor(dB) – Pre-Amplifier Factor(dB)
3. Margin value = Emission Level – Limit value
4. The other emission levels were very low against the limit.
5. " * " : Fundamental frequency, the limit was restricted at the RF Output Power.
6. " # " : The radiated frequency is out of the restricted band.

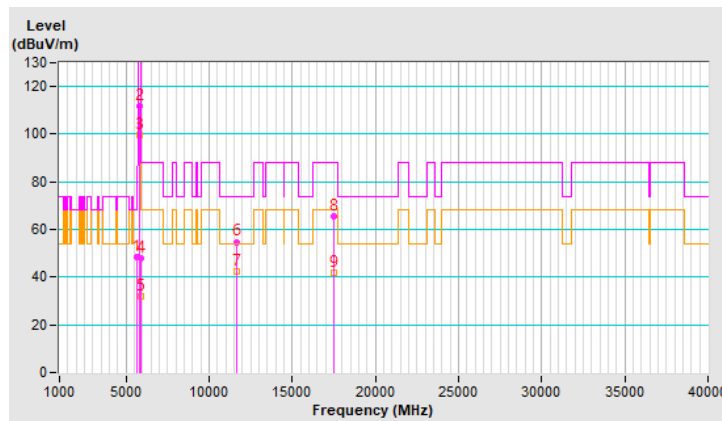

RF Mode	802.11ax (HE20) 52-tone RU	Channel	CH 173 : 5865 MHz
Frequency Range	1 GHz ~ 40 GHz	Detector Function & Bandwidth	(PK) RB = 1 MHz, VB = 3 MHz (AV) RB = 1 MHz, VB = 10 Hz
Input Power (System)	120 Vac, 60 Hz	Environmental Conditions	22°C, 70% RH
Tested By	Louis Yang		

Antenna Polarity & Test Distance : Horizontal at 3 m								
No	Frequency (MHz)	Emission Level (dBuV/m)	Limit (dBuV/m)	Margin (dB)	Antenna Height (m)	Table Angle (Degree)	Raw Value (dBuV)	Correction Factor (dB/m)
1	#5650.00	50.1 PK	68.2	-18.1	1.43 H	152	48.1	2.0
2	*5865.00	114.0 PK			1.43 H	152	111.7	2.3
3	*5865.00	103.6 AV			1.43 H	152	101.3	2.3
4	#5895.00	60.5 PK	110.2	-49.7	1.43 H	152	58.1	2.4
5	#5895.00	52.4 AV	90.2	-37.8	1.43 H	152	50.0	2.4
6	11730.00	61.2 PK	74.0	-12.8	1.54 H	186	49.0	12.2
7	11730.00	50.7 AV	54.0	-3.3	1.54 H	186	38.5	12.2
8	#17595.00	65.7 PK	88.2	-22.5	1.36 H	141	46.0	19.7
9	#17595.00	42.2 AV	68.2	-26.0	1.36 H	141	22.5	19.7

Remarks:

1. Emission Level(dBuV/m) = Raw Value(dBuV) + Correction Factor(dB/m)
2. Correction Factor(dB/m) = Antenna Factor(dB/m) + Cable Factor(dB) – Pre-Amplifier Factor(dB)
3. Margin value = Emission Level – Limit value
4. The other emission levels were very low against the limit.
5. " * " : Fundamental frequency, the limit was restricted at the RF Output Power.
6. " # " : The radiated frequency is out of the restricted band.

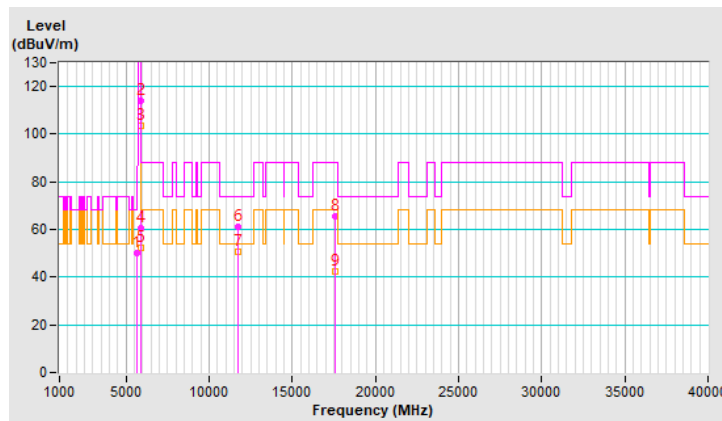

RF Mode	802.11ax (HE20) 52-tone RU	Channel	CH 173 : 5865 MHz
Frequency Range	1 GHz ~ 40 GHz	Detector Function & Bandwidth	(PK) RB = 1 MHz, VB = 3 MHz (AV) RB = 1 MHz, VB = 10 Hz
Input Power (System)	120 Vac, 60 Hz	Environmental Conditions	22°C, 70% RH
Tested By	Louis Yang		

Antenna Polarity & Test Distance : Vertical at 3 m								
No	Frequency (MHz)	Emission Level (dBuV/m)	Limit (dBuV/m)	Margin (dB)	Antenna Height (m)	Table Angle (Degree)	Raw Value (dBuV)	Correction Factor (dB/m)
1	#5650.00	49.0 PK	68.2	-19.2	2.71 V	95	47.0	2.0
2	*5865.00	112.2 PK			2.71 V	95	109.9	2.3
3	*5865.00	100.7 AV			2.71 V	95	98.4	2.3
4	#5895.00	46.6 PK	110.2	-63.6	2.71 V	95	44.2	2.4
5	#5895.00	30.8 AV	90.2	-59.4	2.71 V	95	28.4	2.4
6	11730.00	54.4 PK	74.0	-19.6	1.89 V	178	42.2	12.2
7	11730.00	41.2 AV	54.0	-12.8	1.89 V	178	29.0	12.2
8	#17595.00	64.3 PK	88.2	-23.9	2.40 V	188	44.6	19.7
9	#17595.00	42.1 AV	68.2	-26.1	2.40 V	188	22.4	19.7

Remarks:

1. Emission Level(dBuV/m) = Raw Value(dBuV) + Correction Factor(dB/m)
2. Correction Factor(dB/m) = Antenna Factor(dB/m) + Cable Factor(dB) – Pre-Amplifier Factor(dB)
3. Margin value = Emission Level – Limit value
4. The other emission levels were very low against the limit.
5. " * " : Fundamental frequency, the limit was restricted at the RF Output Power.
6. " # " : The radiated frequency is out of the restricted band.

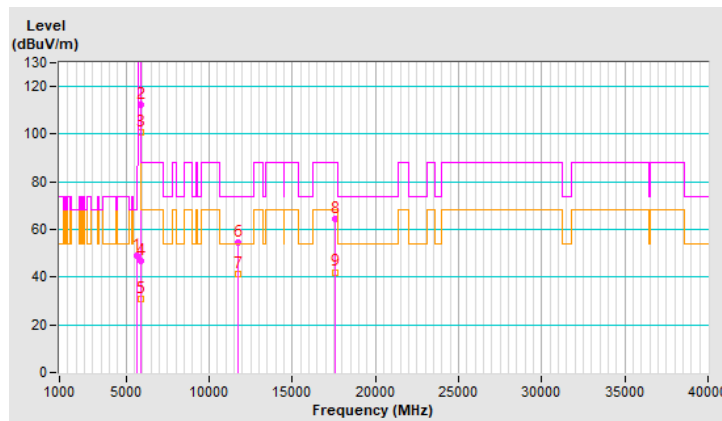

RF Mode	802.11ax (HE20) 52-tone RU	Channel	CH 177 : 5885 MHz
Frequency Range	1 GHz ~ 40 GHz	Detector Function & Bandwidth	(PK) RB = 1 MHz, VB = 3 MHz (AV) RB = 1 MHz, VB = 10 Hz
Input Power (System)	120 Vac, 60 Hz	Environmental Conditions	22°C, 70% RH
Tested By	Louis Yang		

Antenna Polarity & Test Distance : Horizontal at 3 m								
No	Frequency (MHz)	Emission Level (dBuV/m)	Limit (dBuV/m)	Margin (dB)	Antenna Height (m)	Table Angle (Degree)	Raw Value (dBuV)	Correction Factor (dB/m)
1	#5650.00	49.9 PK	68.2	-18.3	1.43 H	185	47.9	2.0
2	*5885.00	115.6 PK			1.43 H	185	113.2	2.4
3	*5885.00	104.9 AV			1.43 H	185	102.5	2.4
4	#5897.00	62.3 PK	108.7	-46.4	1.43 H	185	59.9	2.4
5	#5897.00	57.8 AV	88.7	-30.9	1.43 H	185	55.4	2.4
6	11770.00	62.8 PK	74.0	-11.2	1.31 H	123	50.6	12.2
7	11770.00	49.8 AV	54.0	-4.2	1.31 H	123	37.6	12.2
8	#17655.00	65.8 PK	88.2	-22.4	1.43 H	145	45.8	20.0
9	#17655.00	41.8 AV	68.2	-26.4	1.43 H	145	21.8	20.0

Remarks:

1. Emission Level(dBuV/m) = Raw Value(dBuV) + Correction Factor(dB/m)
2. Correction Factor(dB/m) = Antenna Factor(dB/m) + Cable Factor(dB) – Pre-Amplifier Factor(dB)
3. Margin value = Emission Level – Limit value
4. The other emission levels were very low against the limit.
5. " * " : Fundamental frequency, the limit was restricted at the RF Output Power.
6. " # " : The radiated frequency is out of the restricted band.

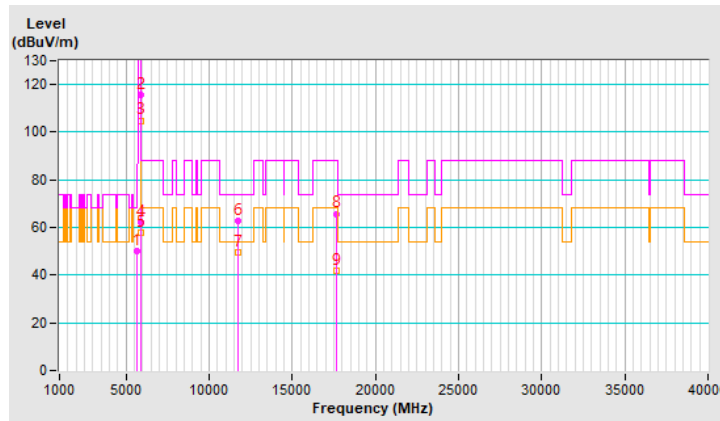

RF Mode	802.11ax (HE20) 52-tone RU	Channel	CH 177 : 5885 MHz
Frequency Range	1 GHz ~ 40 GHz	Detector Function & Bandwidth	(PK) RB = 1 MHz, VB = 3 MHz (AV) RB = 1 MHz, VB = 10 Hz
Input Power (System)	120 Vac, 60 Hz	Environmental Conditions	22°C, 70% RH
Tested By	Louis Yang		

Antenna Polarity & Test Distance : Vertical at 3 m								
No	Frequency (MHz)	Emission Level (dBuV/m)	Limit (dBuV/m)	Margin (dB)	Antenna Height (m)	Table Angle (Degree)	Raw Value (dBuV)	Correction Factor (dB/m)
1	#5650.00	47.9 PK	68.2	-20.3	2.78 V	121	45.9	2.0
2	*5885.00	111.7 PK			2.78 V	121	109.3	2.4
3	*5885.00	99.9 AV			2.78 V	121	97.5	2.4
4	#5895.00	48.2 PK	110.2	-62.0	2.78 V	121	45.8	2.4
5	#5895.00	32.0 AV	90.2	-58.2	2.78 V	121	29.6	2.4
6	11770.00	52.6 PK	74.0	-21.4	1.91 V	184	40.4	12.2
7	11770.00	40.7 AV	54.0	-13.3	1.91 V	184	28.5	12.2
8	#17655.00	64.1 PK	88.2	-24.1	2.62 V	198	44.1	20.0
9	#17655.00	42.3 AV	68.2	-25.9	2.62 V	198	22.3	20.0

Remarks:

1. Emission Level(dBuV/m) = Raw Value(dBuV) + Correction Factor(dB/m)
2. Correction Factor(dB/m) = Antenna Factor(dB/m) + Cable Factor(dB) – Pre-Amplifier Factor(dB)
3. Margin value = Emission Level – Limit value
4. The other emission levels were very low against the limit.
5. " * " : Fundamental frequency, the limit was restricted at the RF Output Power.
6. " # " : The radiated frequency is out of the restricted band.

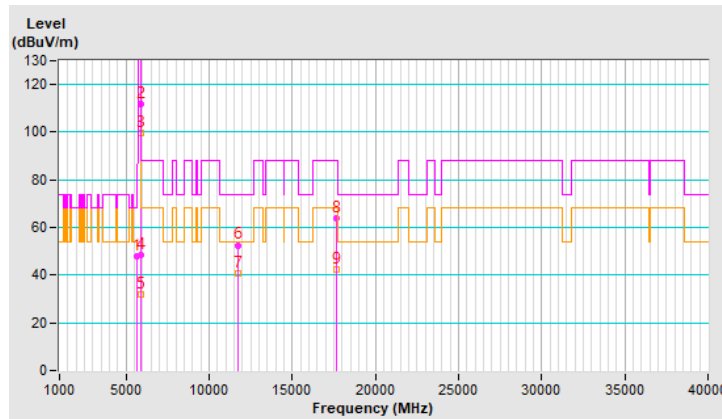

RF Mode	802.11ax (HE20) 106-tone RU	Channel	CH 169 : 5845 MHz
Frequency Range	1 GHz ~ 40 GHz	Detector Function & Bandwidth	(PK) RB = 1 MHz, VB = 3 MHz (AV) RB = 1 MHz, VB = 10 Hz
Input Power (System)	120 Vac, 60 Hz	Environmental Conditions	22°C, 70% RH
Tested By	Louis Yang		

Antenna Polarity & Test Distance : Horizontal at 3 m								
No	Frequency (MHz)	Emission Level (dBuV/m)	Limit (dBuV/m)	Margin (dB)	Antenna Height (m)	Table Angle (Degree)	Raw Value (dBuV)	Correction Factor (dB/m)
1	#5650.00	49.7 PK	68.2	-18.5	1.58 H	140	47.7	2.0
2	*5845.00	114.2 PK			1.58 H	140	111.9	2.3
3	*5845.00	103.6 AV			1.58 H	140	101.3	2.3
4	#5895.00	50.3 PK	110.2	-59.9	1.58 H	140	47.9	2.4
5	#5895.00	36.1 AV	90.2	-54.1	1.58 H	140	33.7	2.4
6	11690.00	56.9 PK	74.0	-17.1	1.67 H	173	44.5	12.4
7	11690.00	45.9 AV	54.0	-8.1	1.67 H	173	33.5	12.4
8	#17535.00	66.0 PK	88.2	-22.2	1.52 H	186	46.8	19.2
9	#17535.00	42.0 AV	68.2	-26.2	1.52 H	186	22.8	19.2

Remarks:

1. Emission Level(dBuV/m) = Raw Value(dBuV) + Correction Factor(dB/m)
2. Correction Factor(dB/m) = Antenna Factor(dB/m) + Cable Factor(dB) – Pre-Amplifier Factor(dB)
3. Margin value = Emission Level – Limit value
4. The other emission levels were very low against the limit.
5. " * " : Fundamental frequency, the limit was restricted at the RF Output Power.
6. " # " : The radiated frequency is out of the restricted band.

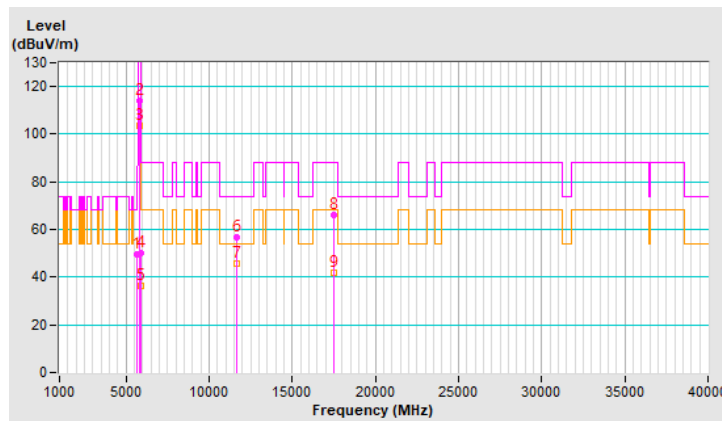

RF Mode	802.11ax (HE20) 106-tone RU	Channel	CH 169 : 5845 MHz
Frequency Range	1 GHz ~ 40 GHz	Detector Function & Bandwidth	(PK) RB = 1 MHz, VB = 3 MHz (AV) RB = 1 MHz, VB = 10 Hz
Input Power (System)	120 Vac, 60 Hz	Environmental Conditions	22°C, 70% RH
Tested By	Louis Yang		

Antenna Polarity & Test Distance : Vertical at 3 m								
No	Frequency (MHz)	Emission Level (dBuV/m)	Limit (dBuV/m)	Margin (dB)	Antenna Height (m)	Table Angle (Degree)	Raw Value (dBuV)	Correction Factor (dB/m)
1	#5650.00	48.0 PK	68.2	-20.2	2.66 V	43	46.0	2.0
2	*5845.00	114.2 PK			2.66 V	43	111.9	2.3
3	*5845.00	101.1 AV			2.66 V	43	98.8	2.3
4	#5895.00	48.9 PK	110.2	-61.3	2.66 V	43	46.5	2.4
5	#5895.00	33.2 AV	90.2	-57.0	2.66 V	43	30.8	2.4
6	11690.00	54.7 PK	74.0	-19.3	1.76 V	231	42.3	12.4
7	11690.00	41.9 AV	54.0	-12.1	1.76 V	231	29.5	12.4
8	#17535.00	64.2 PK	88.2	-24.0	2.38 V	176	45.0	19.2
9	#17535.00	42.4 AV	68.2	-25.8	2.38 V	176	23.2	19.2

Remarks:

1. Emission Level(dBuV/m) = Raw Value(dBuV) + Correction Factor(dB/m)
2. Correction Factor(dB/m) = Antenna Factor(dB/m) + Cable Factor(dB) – Pre-Amplifier Factor(dB)
3. Margin value = Emission Level – Limit value
4. The other emission levels were very low against the limit.
5. " * " : Fundamental frequency, the limit was restricted at the RF Output Power.
6. " # " : The radiated frequency is out of the restricted band.

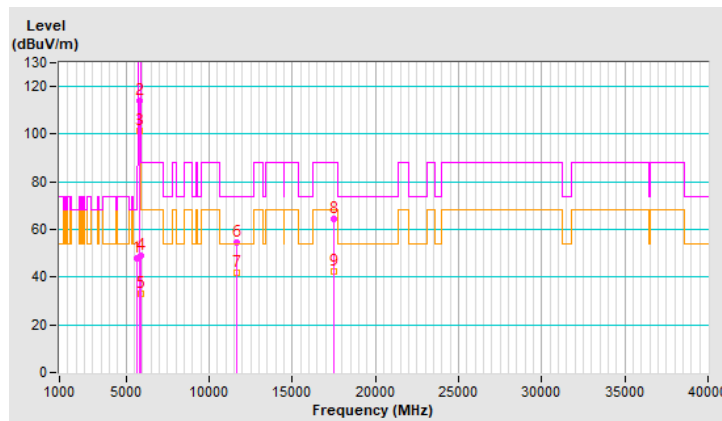

RF Mode	802.11ax (HE20) 106-tone RU	Channel	CH 173 : 5865 MHz
Frequency Range	1 GHz ~ 40 GHz	Detector Function & Bandwidth	(PK) RB = 1 MHz, VB = 3 MHz (AV) RB = 1 MHz, VB = 10 Hz
Input Power (System)	120 Vac, 60 Hz	Environmental Conditions	22°C, 70% RH
Tested By	Louis Yang		

Antenna Polarity & Test Distance : Horizontal at 3 m								
No	Frequency (MHz)	Emission Level (dBuV/m)	Limit (dBuV/m)	Margin (dB)	Antenna Height (m)	Table Angle (Degree)	Raw Value (dBuV)	Correction Factor (dB/m)
1	#5650.00	50.2 PK	68.2	-18.0	1.55 H	168	48.2	2.0
2	*5865.00	113.5 PK			1.55 H	168	111.2	2.3
3	*5865.00	103.8 AV			1.55 H	168	101.5	2.3
4	#5895.00	60.1 PK	110.2	-50.1	1.55 H	168	57.7	2.4
5	#5895.00	54.2 AV	90.2	-36.0	1.55 H	168	51.8	2.4
6	11730.00	58.5 PK	74.0	-15.5	1.61 H	190	46.3	12.2
7	11730.00	48.2 AV	54.0	-5.8	1.61 H	190	36.0	12.2
8	#17595.00	65.7 PK	88.2	-22.5	1.54 H	174	46.0	19.7
9	#17595.00	41.7 AV	68.2	-26.5	1.54 H	174	22.0	19.7

Remarks:

1. Emission Level(dBuV/m) = Raw Value(dBuV) + Correction Factor(dB/m)
2. Correction Factor(dB/m) = Antenna Factor(dB/m) + Cable Factor(dB) – Pre-Amplifier Factor(dB)
3. Margin value = Emission Level – Limit value
4. The other emission levels were very low against the limit.
5. " * " : Fundamental frequency, the limit was restricted at the RF Output Power.
6. " # " : The radiated frequency is out of the restricted band.

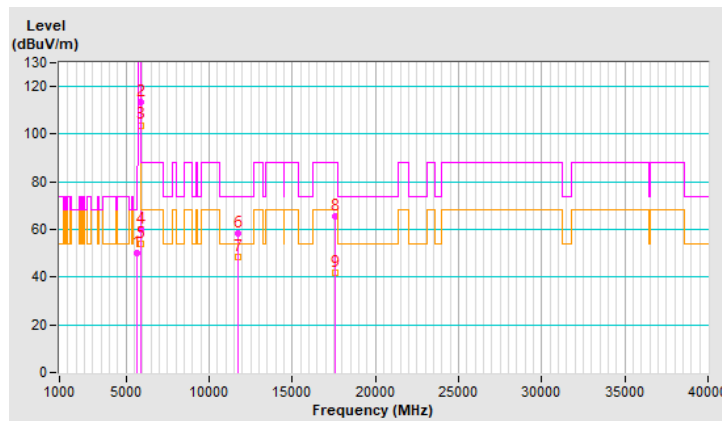



RF Mode	802.11ax (HE20) 106-tone RU	Channel	CH 173 : 5865 MHz
Frequency Range	1 GHz ~ 40 GHz	Detector Function & Bandwidth	(PK) RB = 1 MHz, VB = 3 MHz (AV) RB = 1 MHz, VB = 10 Hz
Input Power (System)	120 Vac, 60 Hz	Environmental Conditions	22°C, 70% RH
Tested By	Louis Yang		

Antenna Polarity & Test Distance : Vertical at 3 m								
No	Frequency (MHz)	Emission Level (dBuV/m)	Limit (dBuV/m)	Margin (dB)	Antenna Height (m)	Table Angle (Degree)	Raw Value (dBuV)	Correction Factor (dB/m)
1	#5650.00	48.4 PK	68.2	-19.8	2.72 V	73	46.4	2.0
2	*5865.00	110.4 PK			2.72 V	73	108.1	2.3
3	*5865.00	98.1 AV			2.72 V	73	95.8	2.3
4	#5895.00	48.9 PK	110.2	-61.3	2.72 V	73	46.5	2.4
5	#5895.00	32.3 AV	90.2	-57.9	2.72 V	73	29.9	2.4
6	11730.00	54.2 PK	74.0	-19.8	1.94 V	186	42.0	12.2
7	11730.00	41.6 AV	54.0	-12.4	1.94 V	186	29.4	12.2
8	#17595.00	64.0 PK	88.2	-24.2	2.55 V	193	44.3	19.7
9	#17595.00	42.3 AV	68.2	-25.9	2.55 V	193	22.6	19.7

Remarks:

1. Emission Level(dBuV/m) = Raw Value(dBuV) + Correction Factor(dB/m)
2. Correction Factor(dB/m) = Antenna Factor(dB/m) + Cable Factor(dB) – Pre-Amplifier Factor(dB)
3. Margin value = Emission Level – Limit value
4. The other emission levels were very low against the limit.
5. " * " : Fundamental frequency, the limit was restricted at the RF Output Power.
6. " # " : The radiated frequency is out of the restricted band.

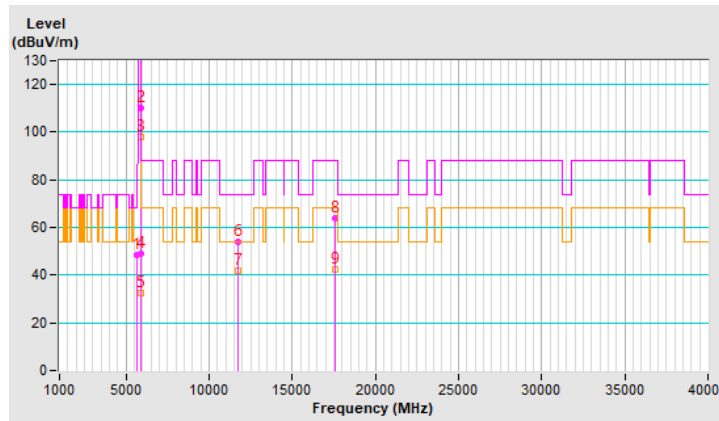

RF Mode	802.11ax (HE20) 106-tone RU	Channel	CH 177 : 5885 MHz
Frequency Range	1 GHz ~ 40 GHz	Detector Function & Bandwidth	(PK) RB = 1 MHz, VB = 3 MHz (AV) RB = 1 MHz, VB = 10 Hz
Input Power (System)	120 Vac, 60 Hz	Environmental Conditions	22°C, 70% RH
Tested By	Louis Yang		

Antenna Polarity & Test Distance : Horizontal at 3 m								
No	Frequency (MHz)	Emission Level (dBuV/m)	Limit (dBuV/m)	Margin (dB)	Antenna Height (m)	Table Angle (Degree)	Raw Value (dBuV)	Correction Factor (dB/m)
1	#5650.00	49.2 PK	68.2	-19.0	1.53 H	149	47.2	2.0
2	*5885.00	112.1 PK			1.53 H	149	109.7	2.4
3	*5885.00	102.8 AV			1.53 H	149	100.4	2.4
4	#5897.00	63.8 PK	108.7	-44.9	1.53 H	149	61.4	2.4
5	#5897.00	58.8 AV	88.7	-29.9	1.53 H	149	56.4	2.4
6	11770.00	61.8 PK	74.0	-12.2	1.28 H	152	49.6	12.2
7	11770.00	50.9 AV	54.0	-3.1	1.28 H	152	38.7	12.2
8	#17655.00	65.9 PK	88.2	-22.3	1.41 H	199	45.9	20.0
9	#17655.00	41.9 AV	68.2	-26.3	1.41 H	199	21.9	20.0

Remarks:

1. Emission Level(dBuV/m) = Raw Value(dBuV) + Correction Factor(dB/m)
2. Correction Factor(dB/m) = Antenna Factor(dB/m) + Cable Factor(dB) – Pre-Amplifier Factor(dB)
3. Margin value = Emission Level – Limit value
4. The other emission levels were very low against the limit.
5. " * " : Fundamental frequency, the limit was restricted at the RF Output Power.
6. " # " : The radiated frequency is out of the restricted band.

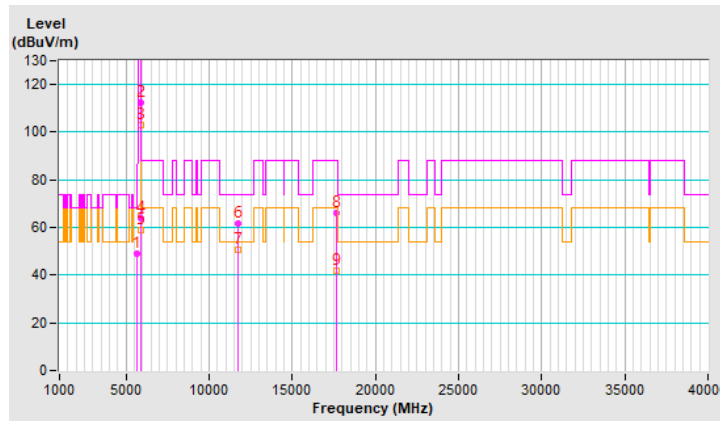

RF Mode	802.11ax (HE20) 106-tone RU	Channel	CH 177 : 5885 MHz
Frequency Range	1 GHz ~ 40 GHz	Detector Function & Bandwidth	(PK) RB = 1 MHz, VB = 3 MHz (AV) RB = 1 MHz, VB = 10 Hz
Input Power (System)	120 Vac, 60 Hz	Environmental Conditions	22°C, 70% RH
Tested By	Louis Yang		

Antenna Polarity & Test Distance : Vertical at 3 m								
No	Frequency (MHz)	Emission Level (dBuV/m)	Limit (dBuV/m)	Margin (dB)	Antenna Height (m)	Table Angle (Degree)	Raw Value (dBuV)	Correction Factor (dB/m)
1	#5650.00	47.3 PK	68.2	-20.9	2.78 V	118	45.3	2.0
2	*5885.00	112.8 PK			2.78 V	118	110.4	2.4
3	*5885.00	99.7 AV			2.78 V	118	97.3	2.4
4	#5895.00	46.8 PK	110.2	-63.4	2.78 V	118	44.4	2.4
5	#5895.00	31.3 AV	90.2	-58.9	2.78 V	118	28.9	2.4
6	11770.00	55.4 PK	74.0	-18.6	1.92 V	161	43.2	12.2
7	11770.00	42.0 AV	54.0	-12.0	1.92 V	161	29.8	12.2
8	#17655.00	63.9 PK	88.2	-24.3	2.67 V	199	43.9	20.0
9	#17655.00	42.2 AV	68.2	-26.0	2.67 V	199	22.2	20.0

Remarks:

1. Emission Level(dBuV/m) = Raw Value(dBuV) + Correction Factor(dB/m)
2. Correction Factor(dB/m) = Antenna Factor(dB/m) + Cable Factor(dB) – Pre-Amplifier Factor(dB)
3. Margin value = Emission Level – Limit value
4. The other emission levels were very low against the limit.
5. " * " : Fundamental frequency, the limit was restricted at the RF Output Power.
6. " # " : The radiated frequency is out of the restricted band.

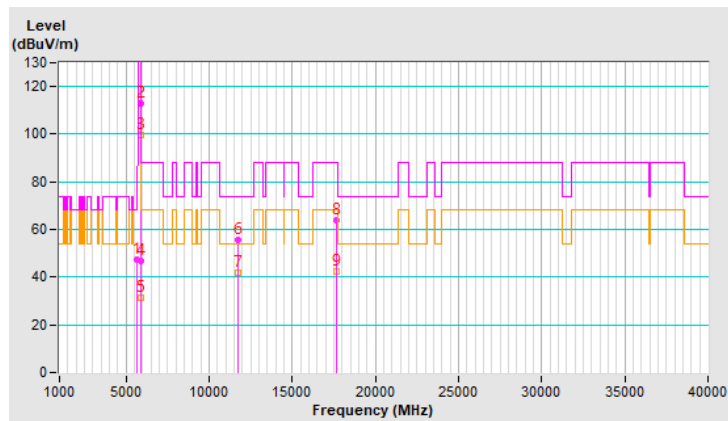

Plot of Band Edge Mode A

Frequency Range	5.55 GHz ~ 6.025 GHz	Detector Function & Bandwidth	(PK) RB = 1 MHz, VB = 3 MHz (RMS) RB = 1 MHz, VB = 3 MHz
------------------------	----------------------	--	---

802.11a Channel 169

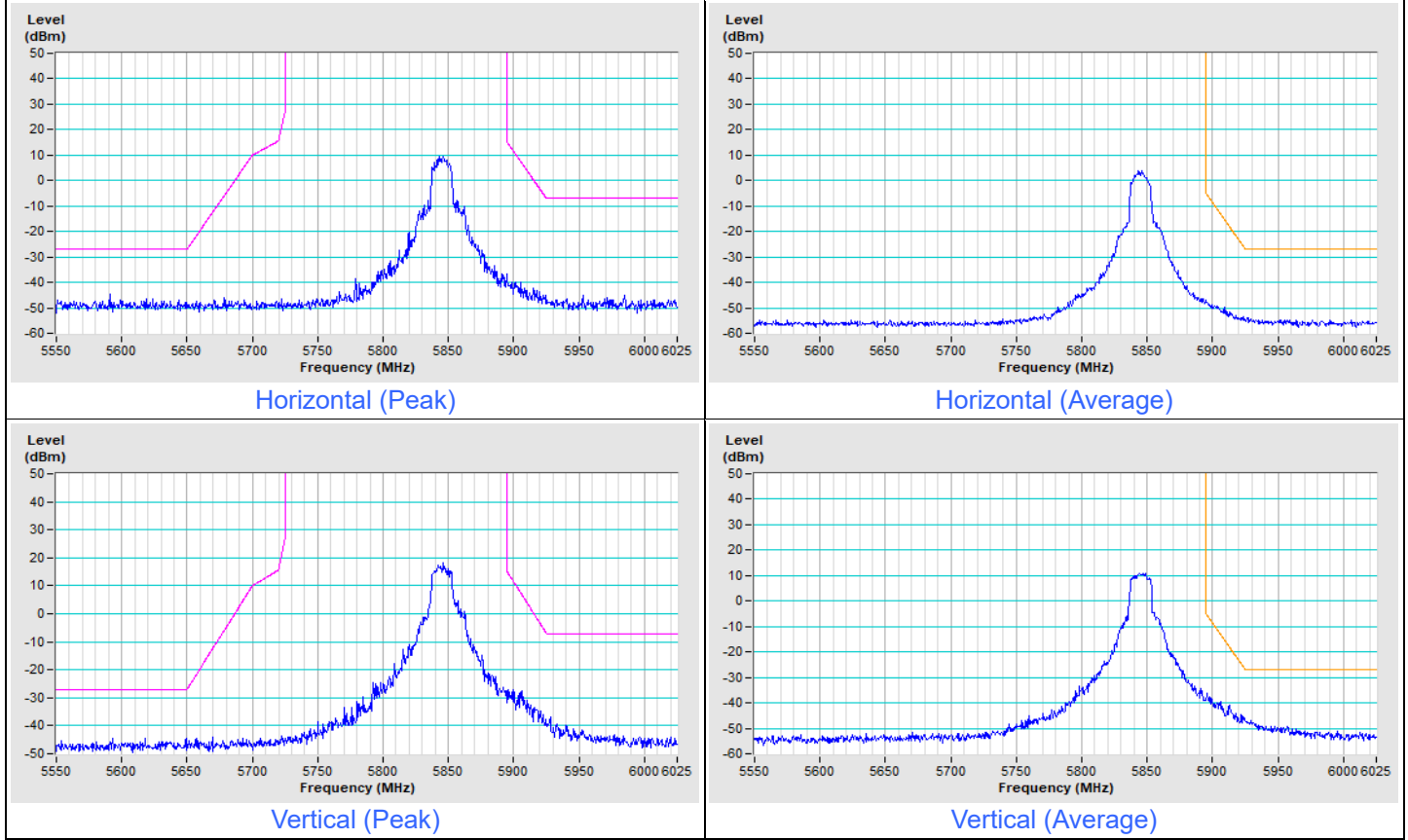

802.11a Channel 173

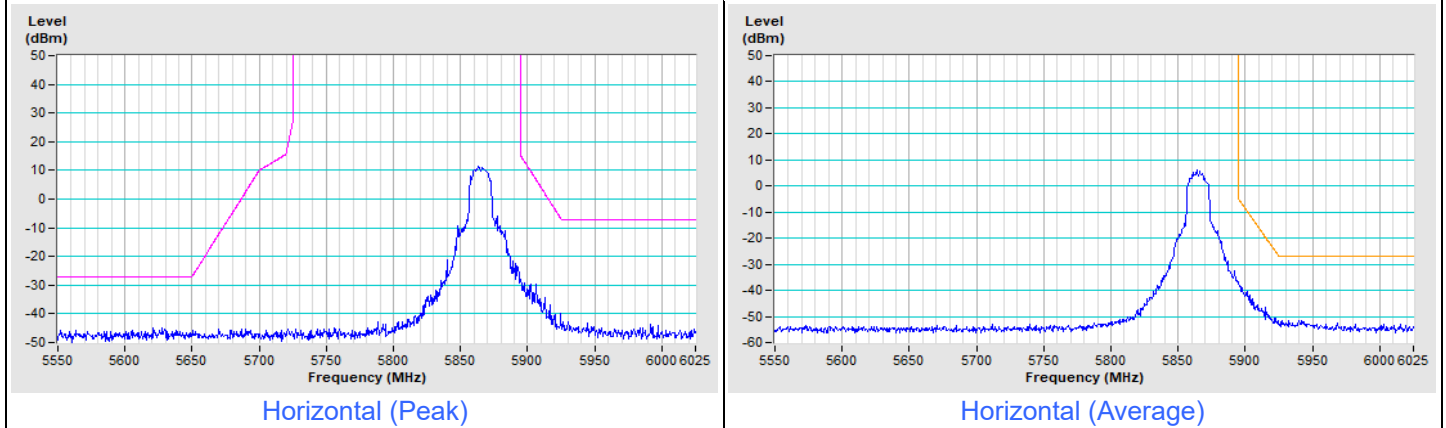

802.11a Channel 173

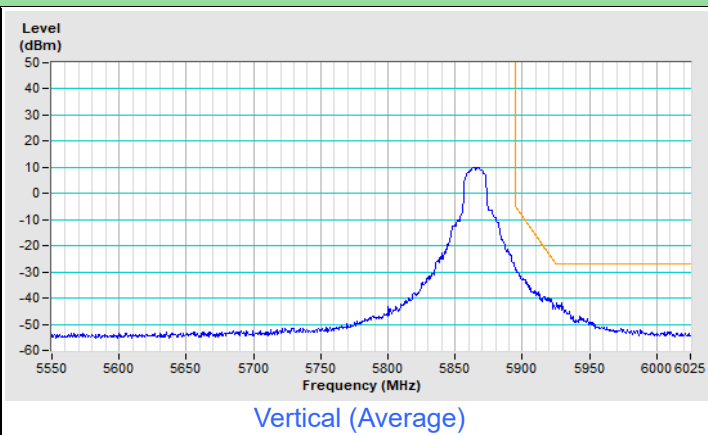
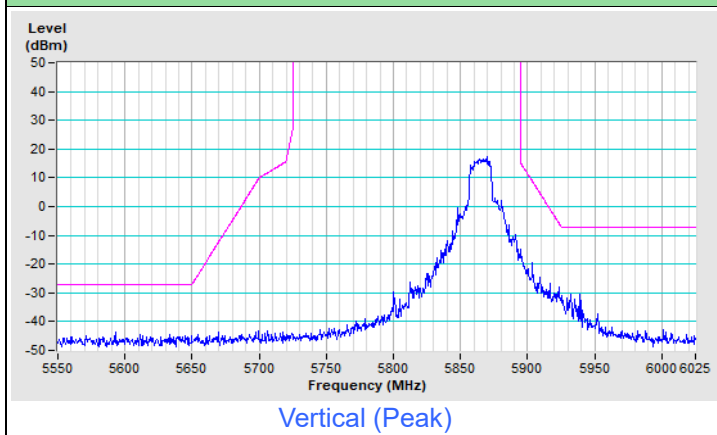

802.11a Channel 177

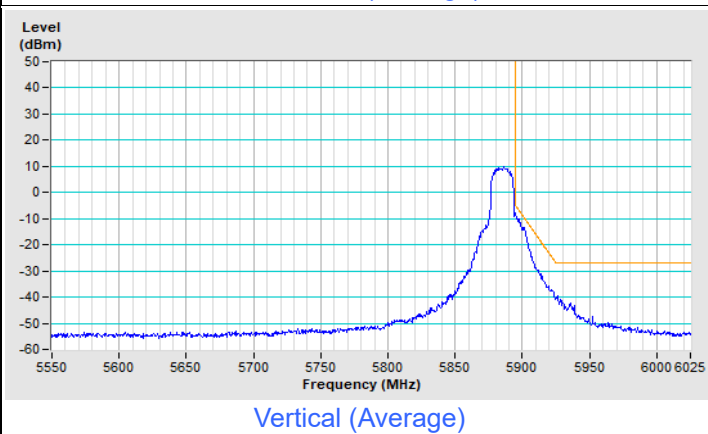
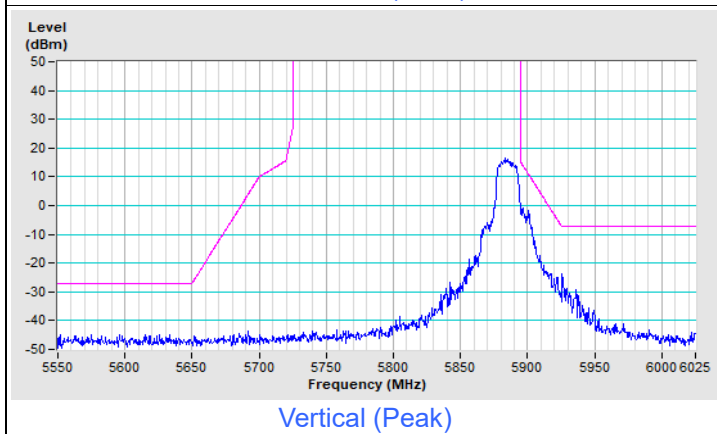
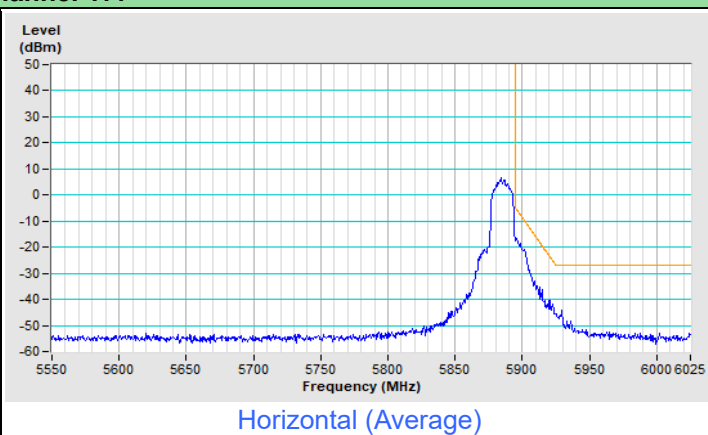
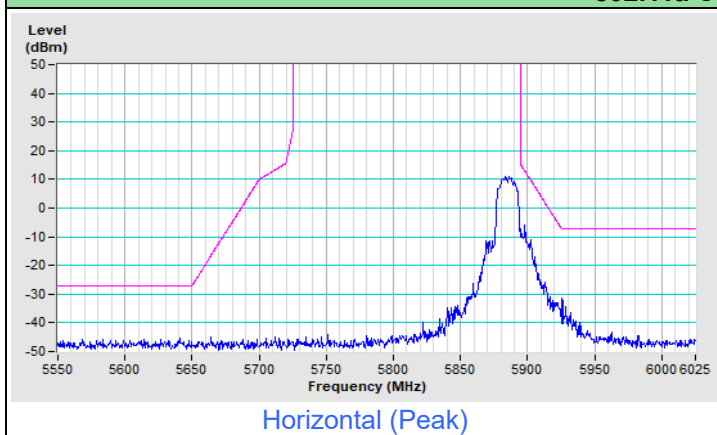



Frequency Range	5.55 GHz ~ 6.025 GHz	Detector Function & Bandwidth	(PK) RB = 1 MHz, VB = 3 MHz (RMS) RB = 1 MHz, VB = 3 MHz
------------------------	----------------------	--	---

802.11ax (HE20) Channel 169

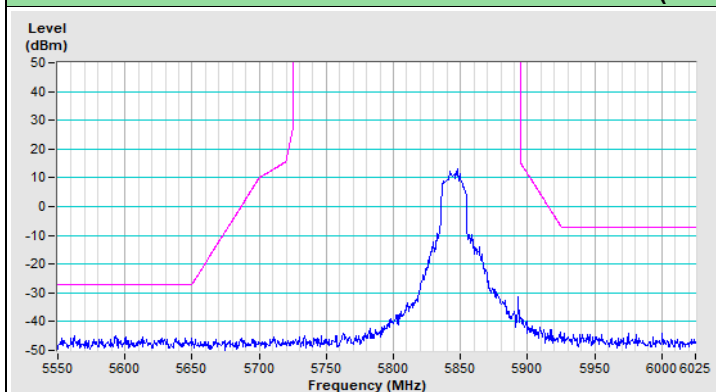

Horizontal (Peak)

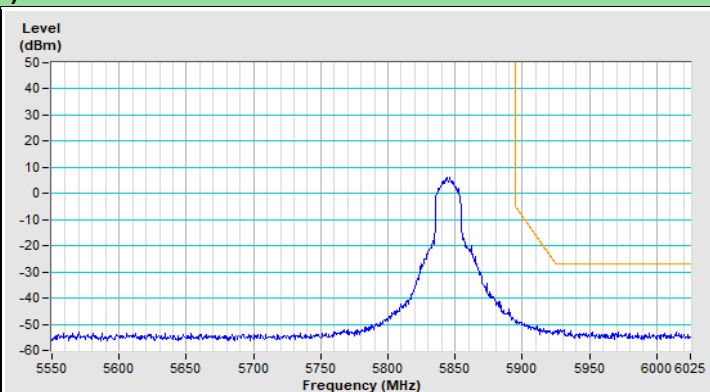

Horizontal (Average)

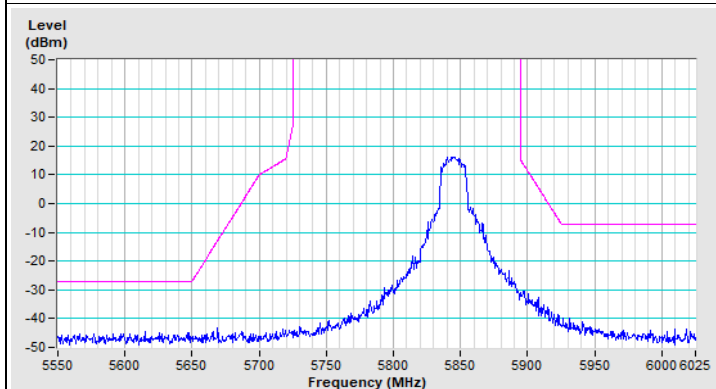

Vertical (Peak)

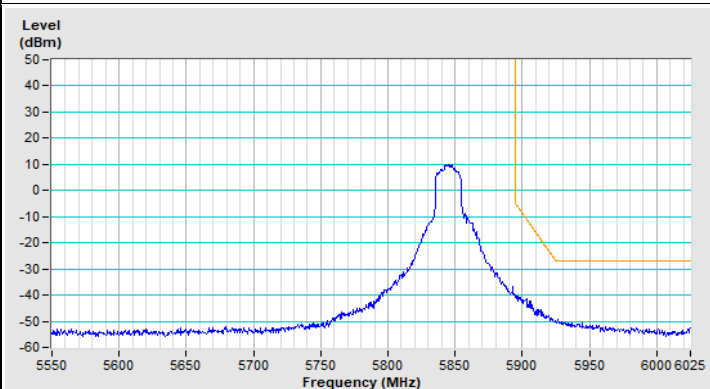

Vertical (Average)

802.11ax (HE20) Channel 173

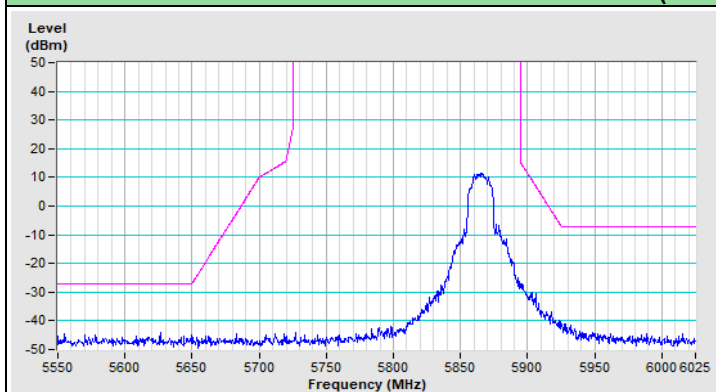

Horizontal (Peak)

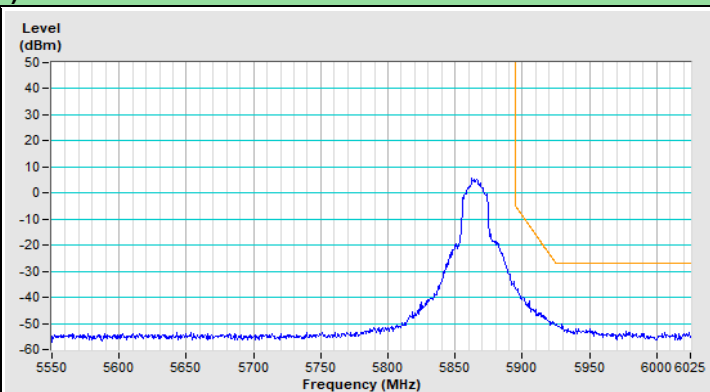

Horizontal (Average)

802.11ax (HE20) Channel 173

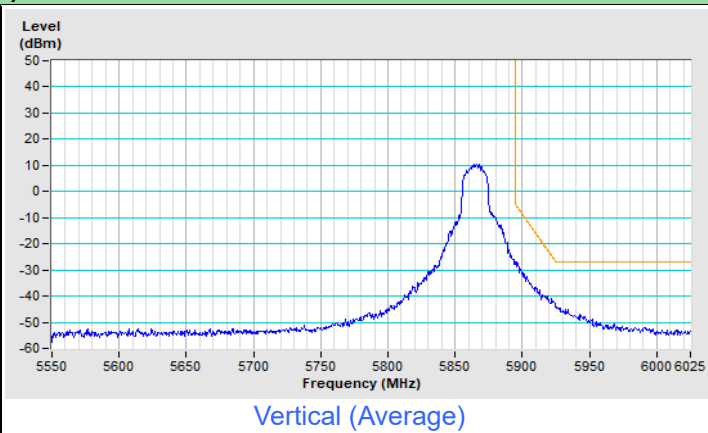
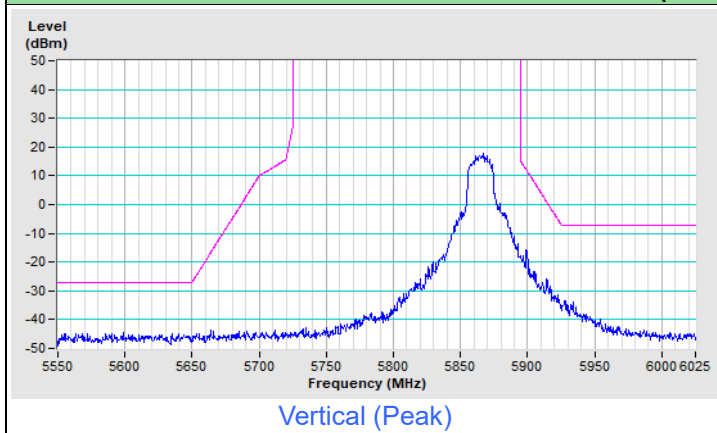

802.11ax (HE20) Channel 177

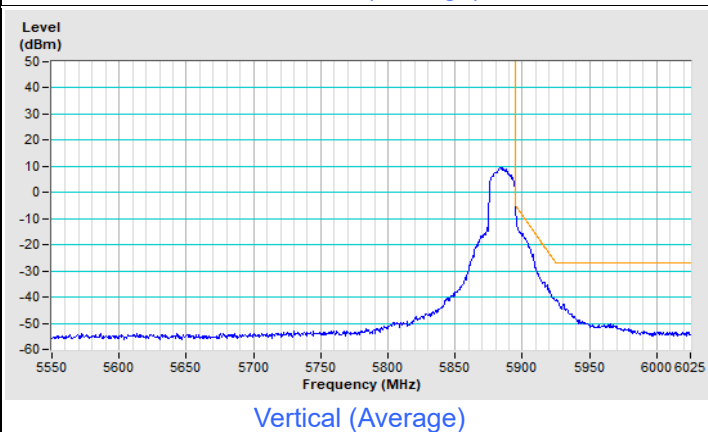
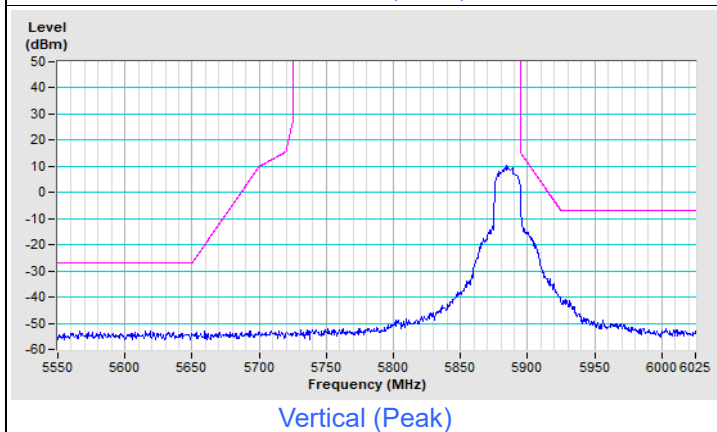
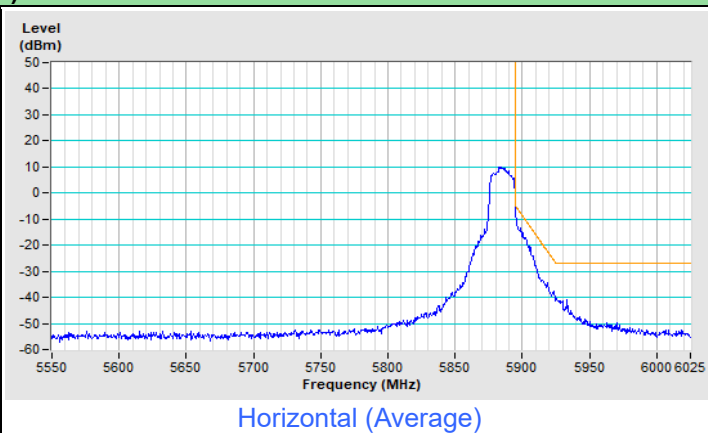
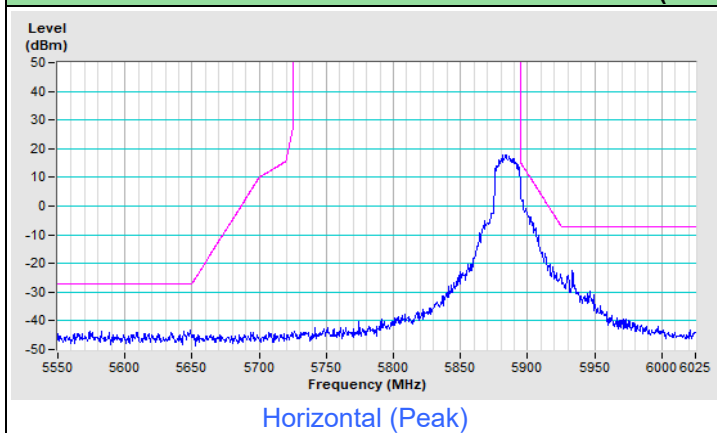



Frequency Range	5.55 GHz ~ 6.025 GHz	Detector Function & Bandwidth	(PK) RB = 1 MHz, VB = 3 MHz (RMS) RB = 1 MHz, VB = 3 MHz
------------------------	----------------------	--	---

802.11ax (HE40) Channel 167

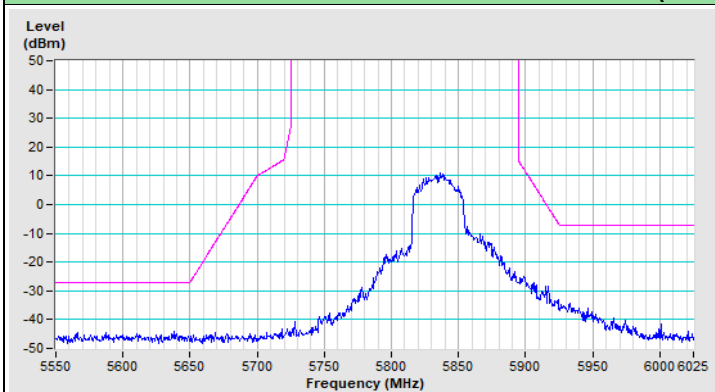

Horizontal (Peak)

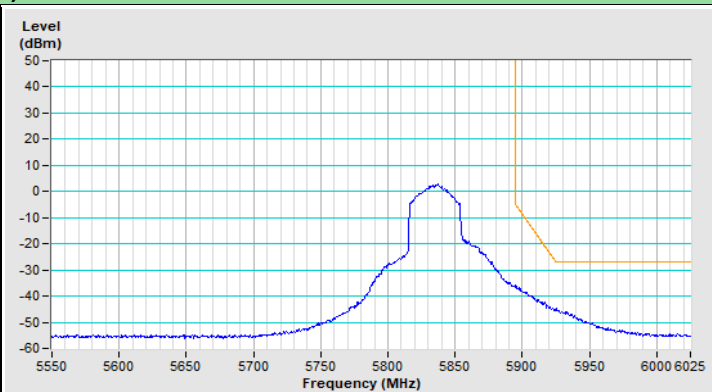

Horizontal (Average)

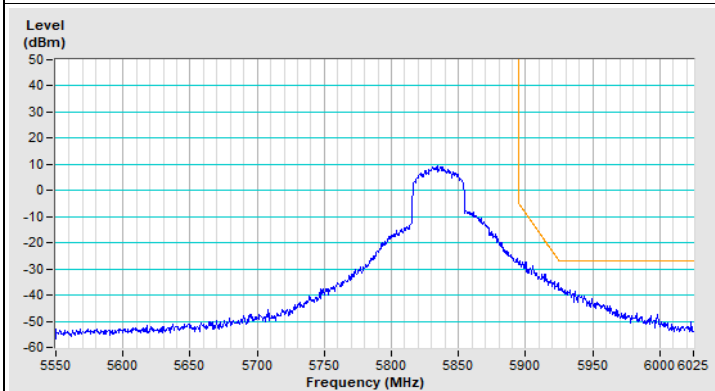

Vertical (Peak)

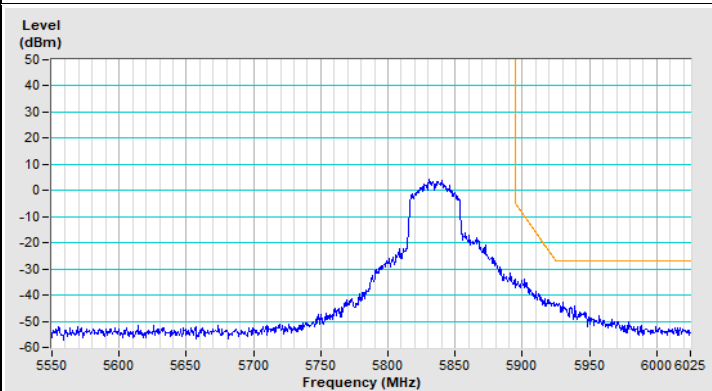

Vertical (Average)

802.11ax (HE40) Channel 175

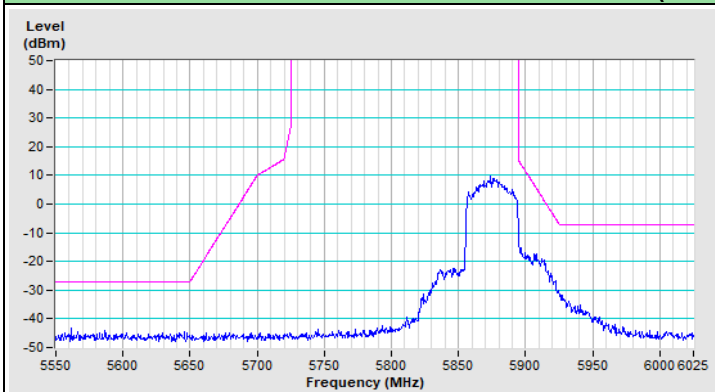

Horizontal (Peak)

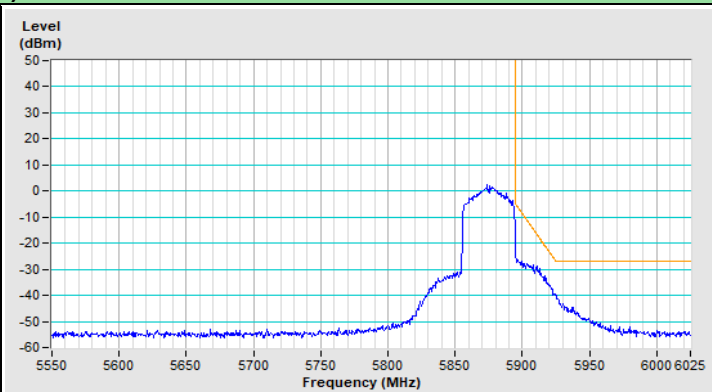

Horizontal (Average)

802.11ax (HE40) Channel 175

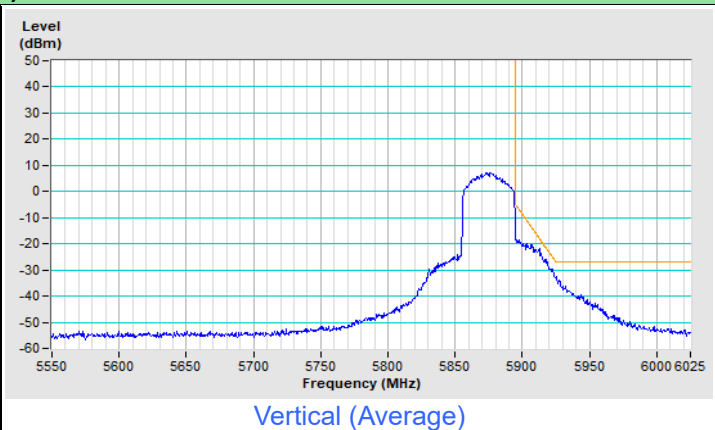
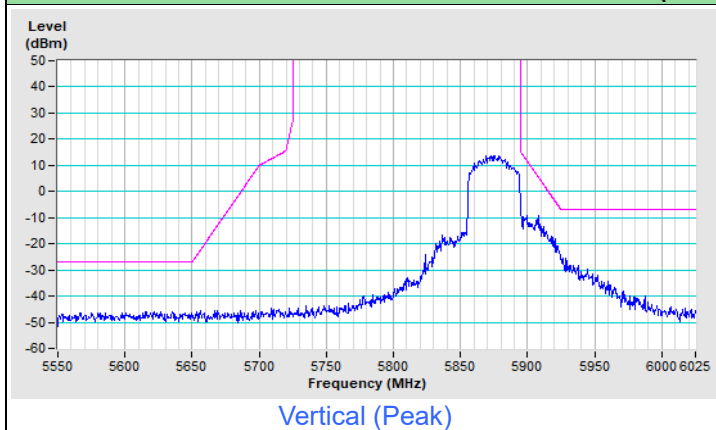

Frequency Range	5.55 GHz ~ 6.025 GHz	Detector Function & Bandwidth	(PK) RB = 1 MHz, VB = 3 MHz (RMS) RB = 1 MHz, VB = 3 MHz
------------------------	----------------------	--	---

802.11ax (HE80) Channel 171

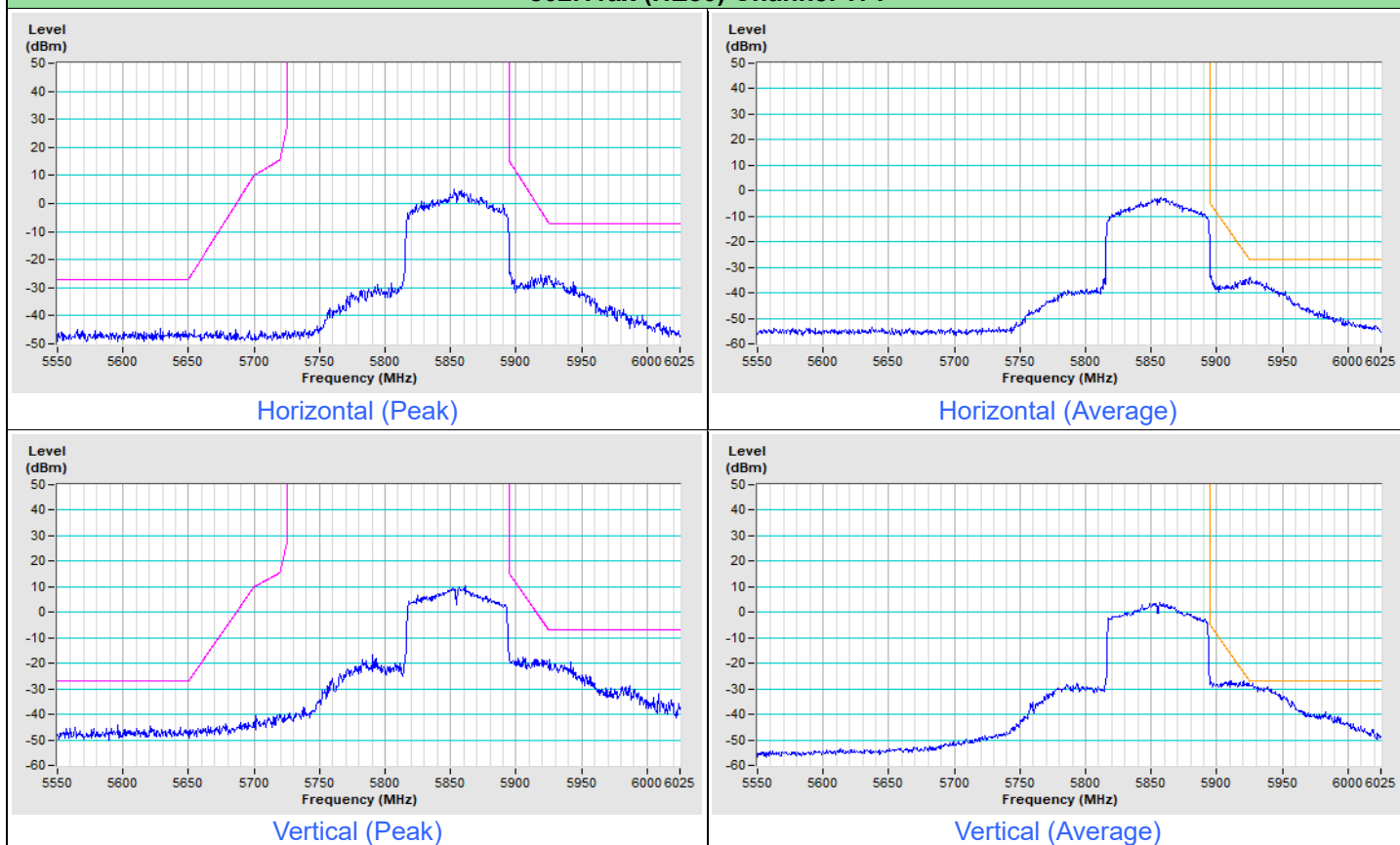

Frequency Range	5.55 GHz ~ 6.025 GHz	Detector Function & Bandwidth	(PK) RB = 1 MHz, VB = 3 MHz (RMS) RB = 1 MHz, VB = 3 MHz
------------------------	----------------------	--	---

802.11ax (HE20) 26-tone RU Channel 169

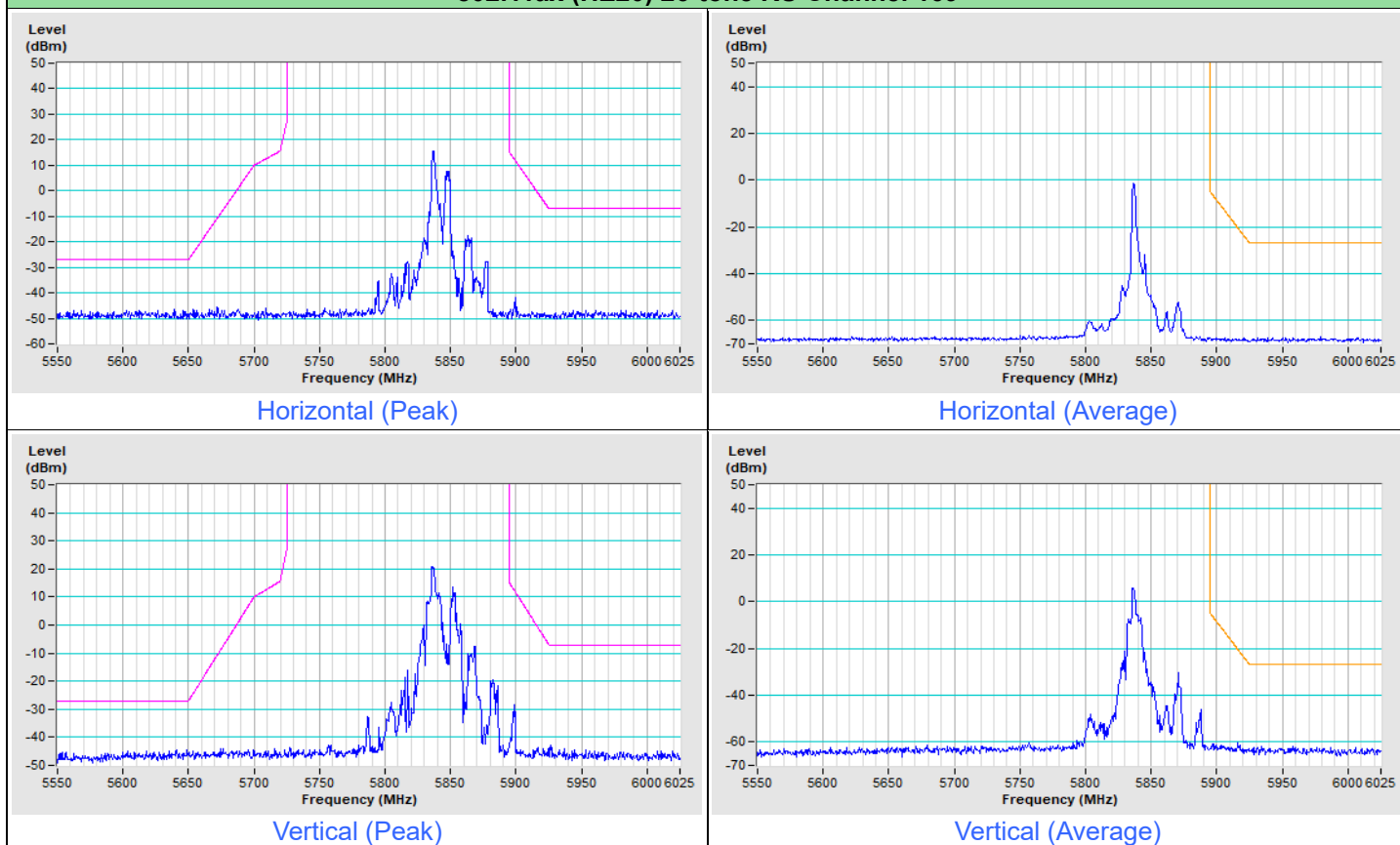

802.11ax (HE20) 26-tone RU Channel 173

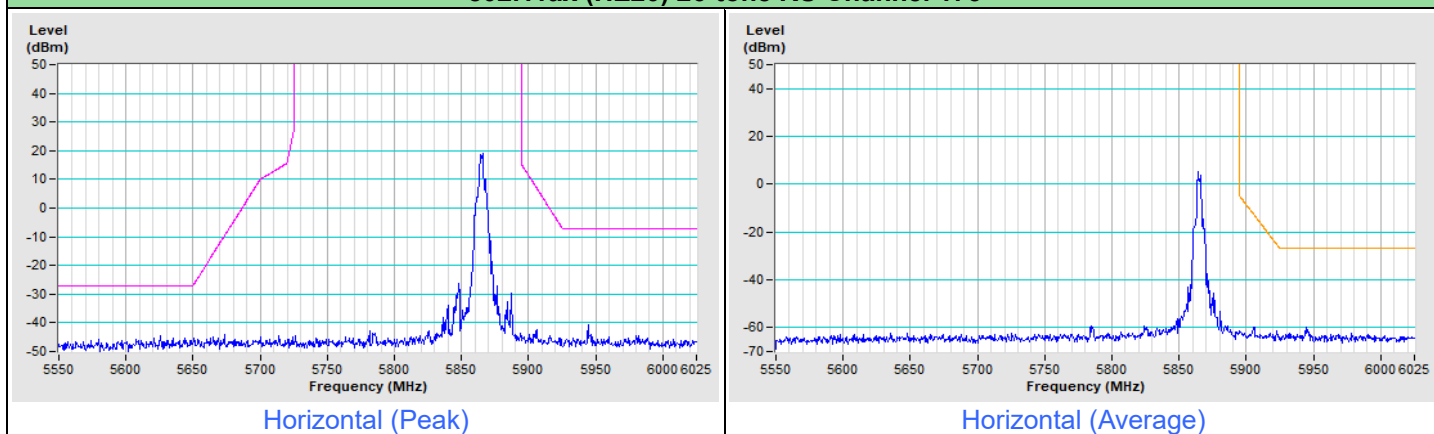

802.11ax (HE20) 26-tone RU Channel 173

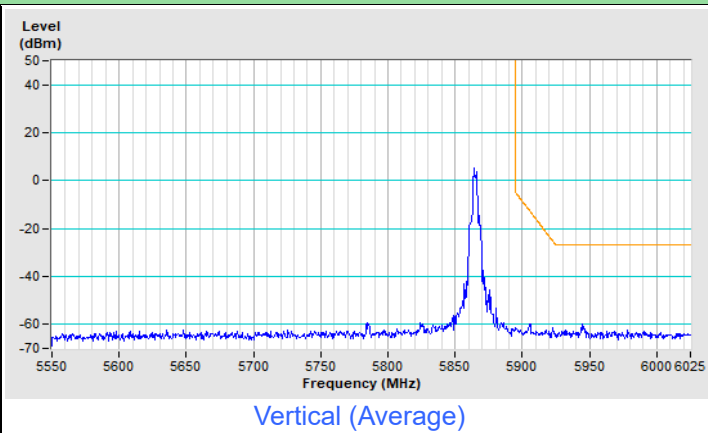
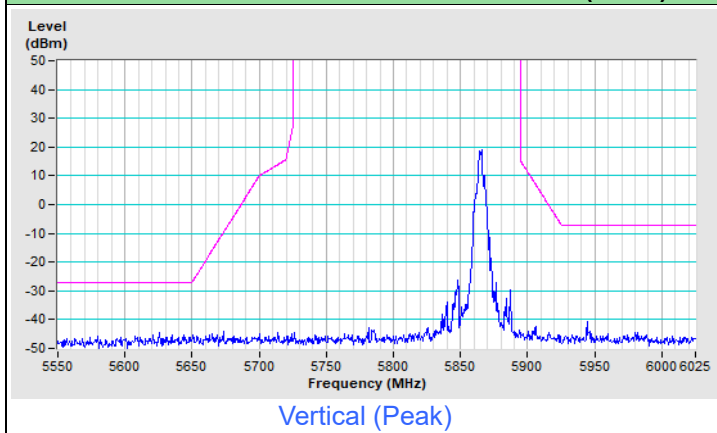

802.11ax (HE20) 26-tone RU Channel 177

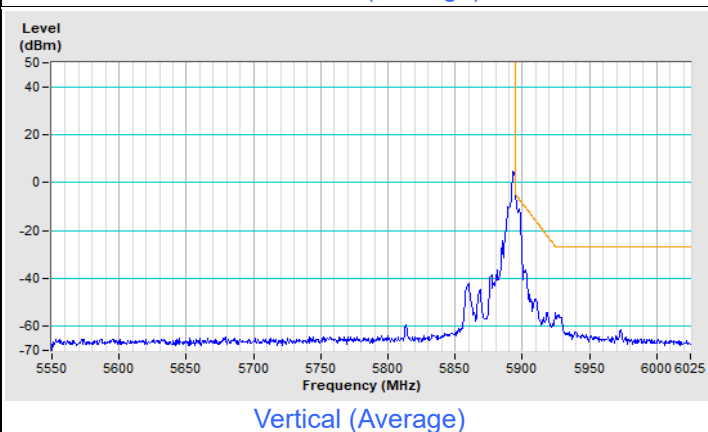
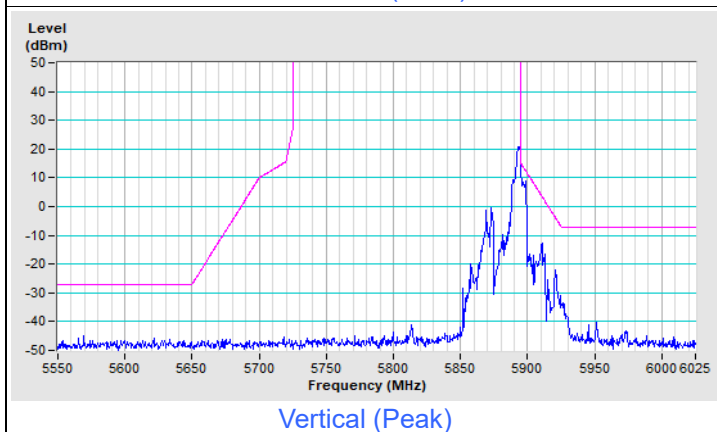
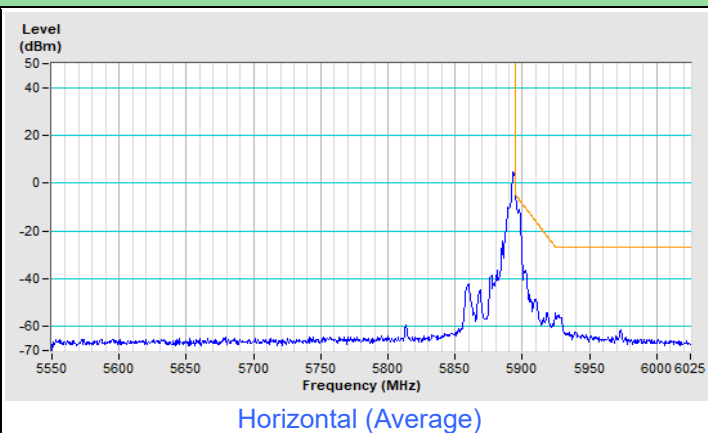
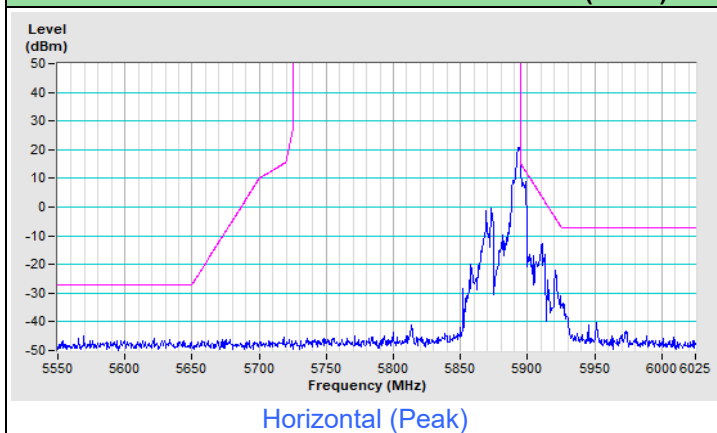

Frequency Range	5.55 GHz ~ 6.025 GHz	Detector Function & Bandwidth	(PK) RB = 1 MHz, VB = 3 MHz (RMS) RB = 1 MHz, VB = 3 MHz
------------------------	----------------------	--	---

802.11ax (HE20) 52-tone RU Channel 169

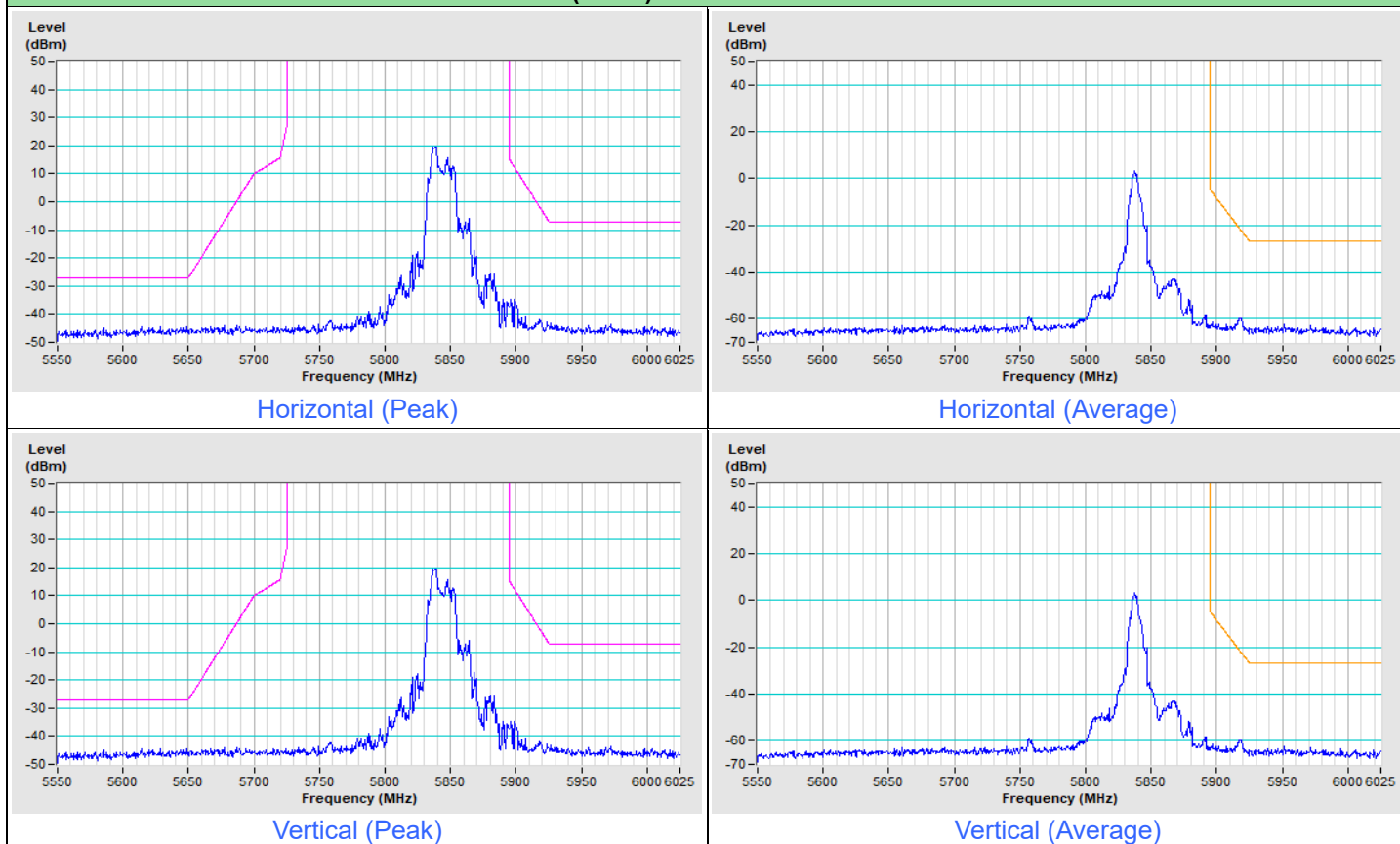

802.11ax (HE20) 52-tone RU Channel 173

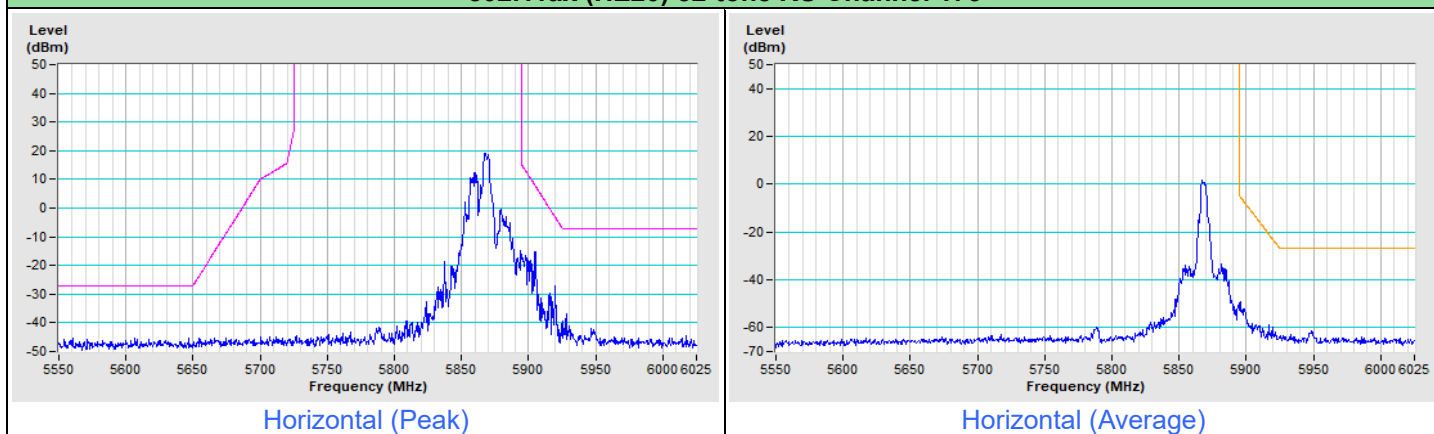

802.11ax (HE20) 52-tone RU Channel 173

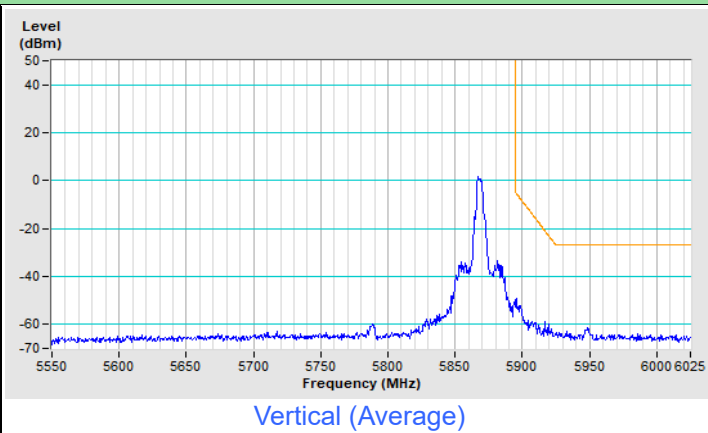
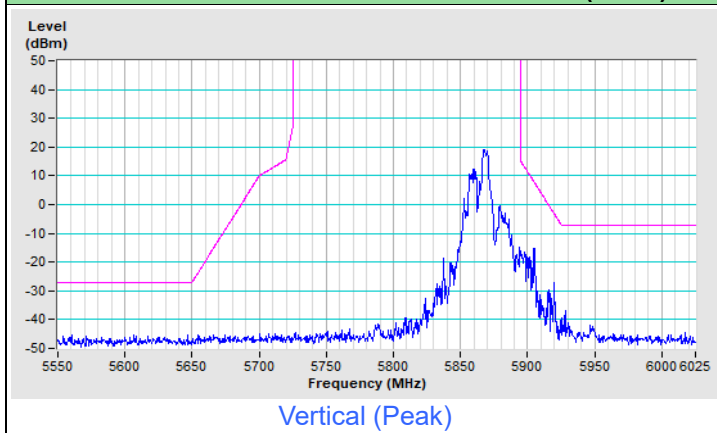

802.11ax (HE20) 52-tone RU Channel 177

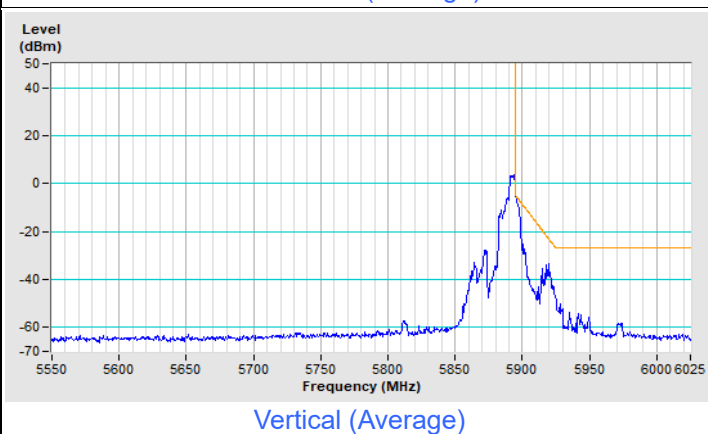
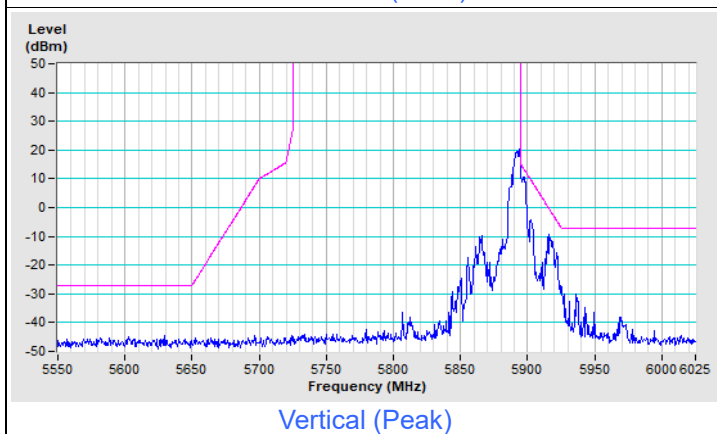
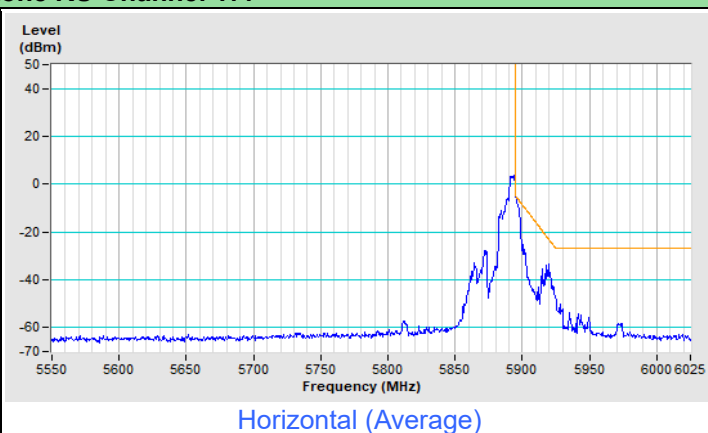
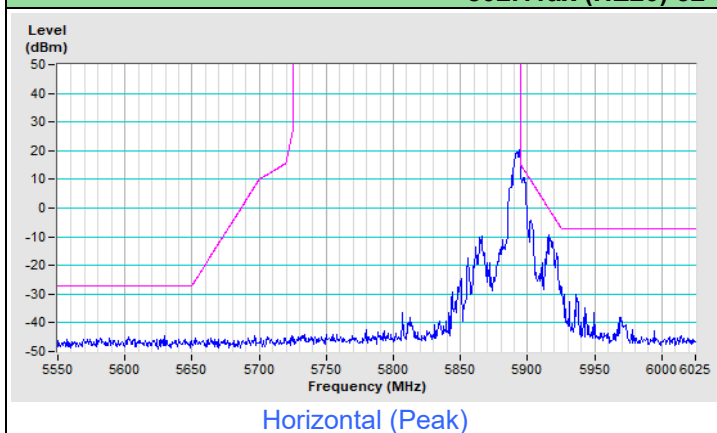



Frequency Range	5.55 GHz ~ 6.025 GHz	Detector Function & Bandwidth	(PK) RB = 1 MHz, VB = 3 MHz (RMS) RB = 1 MHz, VB = 3 MHz
------------------------	----------------------	--	---

802.11ax (HE20) 106-tone RU Channel 169

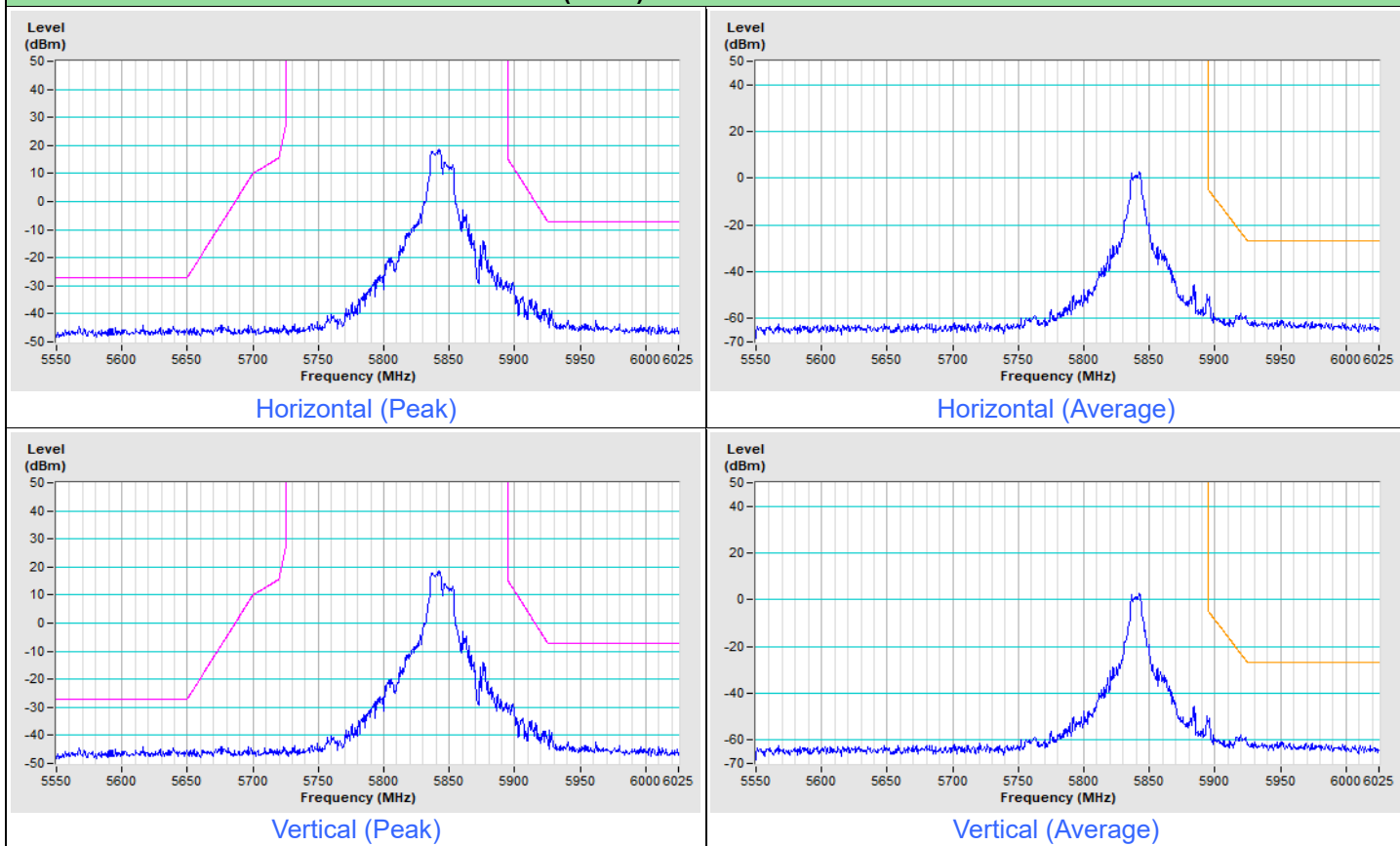

802.11ax (HE20) 106-tone RU Channel 173

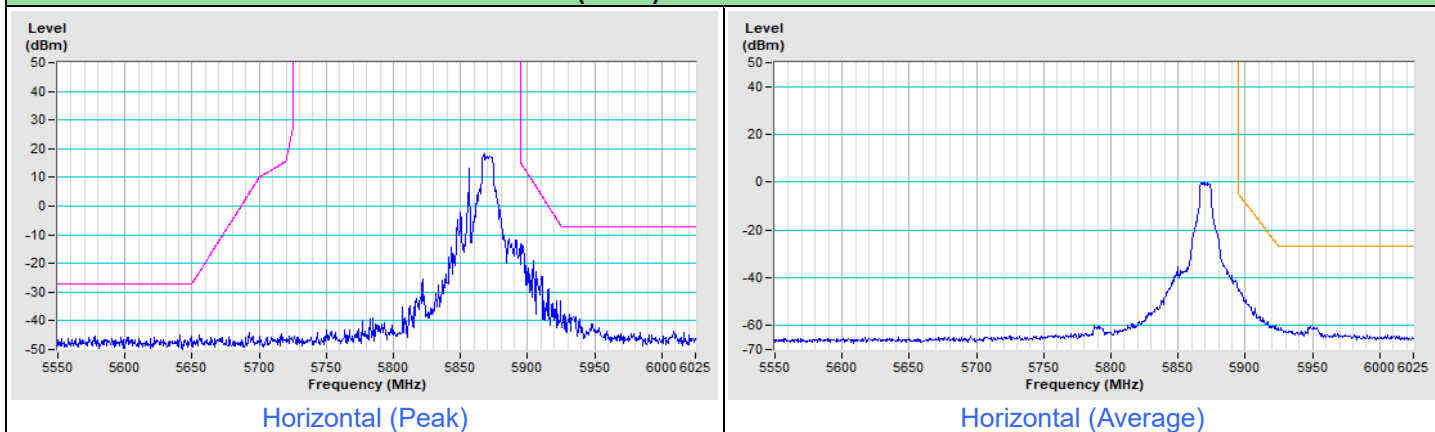

802.11ax (HE20) 106-tone RU Channel 173

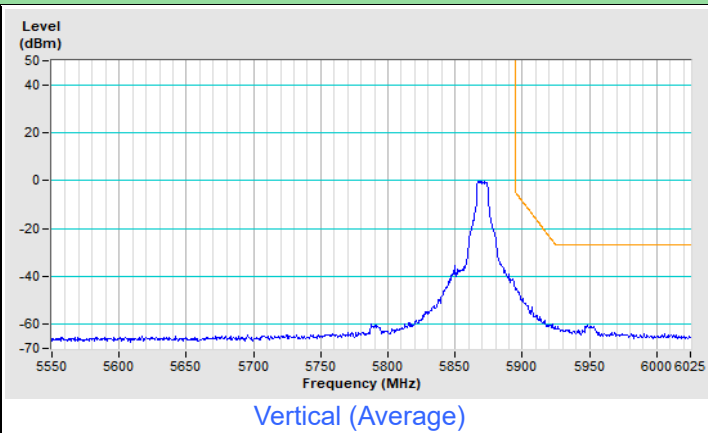
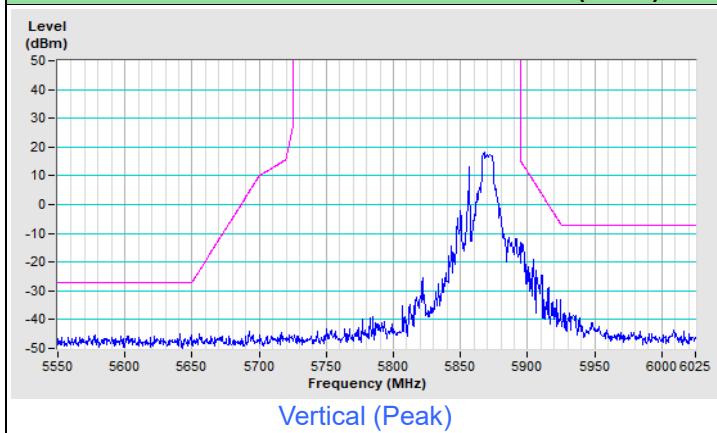

802.11ax (HE20) 106-tone RU Channel 177

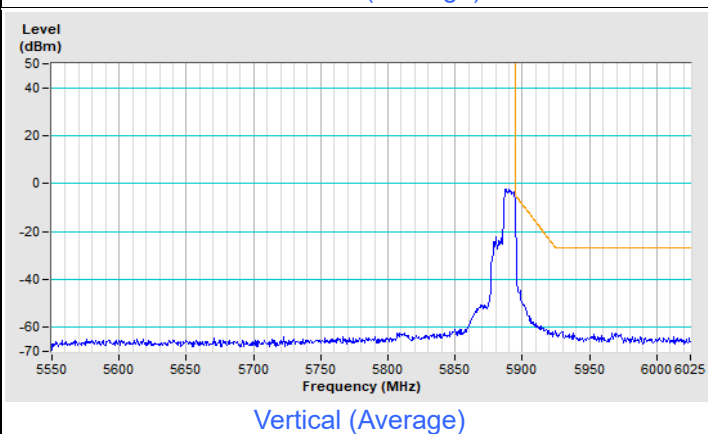
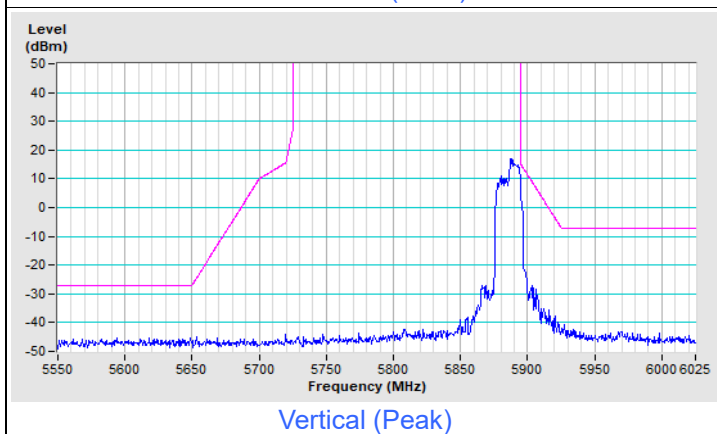
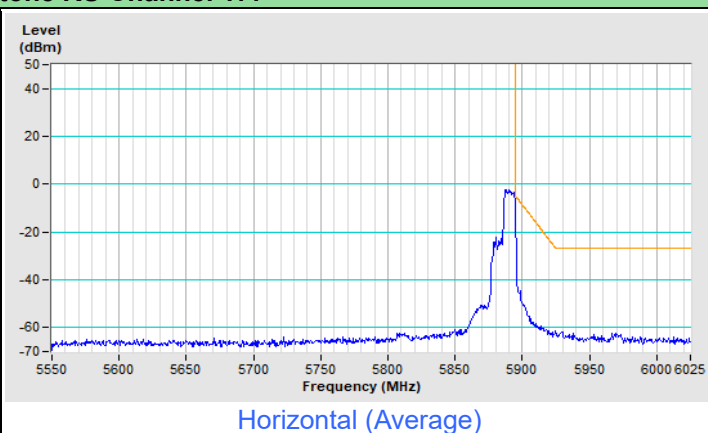
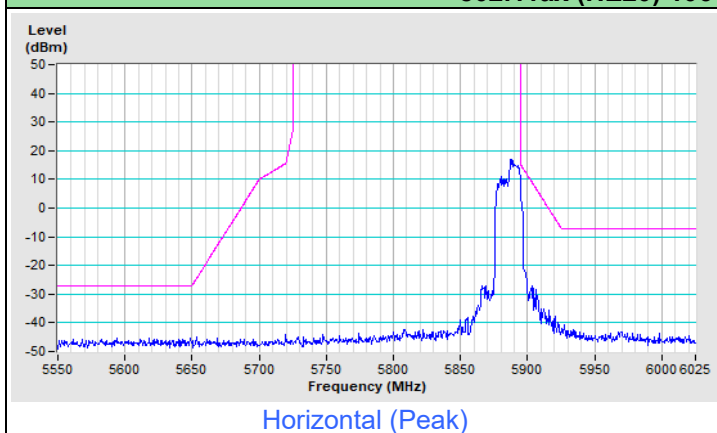

Plot of Band Edge Mode B

Frequency Range	5.55 GHz ~ 6.025 GHz	Detector Function & Bandwidth	(PK) RB = 1 MHz, VB = 3 MHz (RMS) RB = 1 MHz, VB = 3 MHz
------------------------	----------------------	--	---

802.11a Channel 169

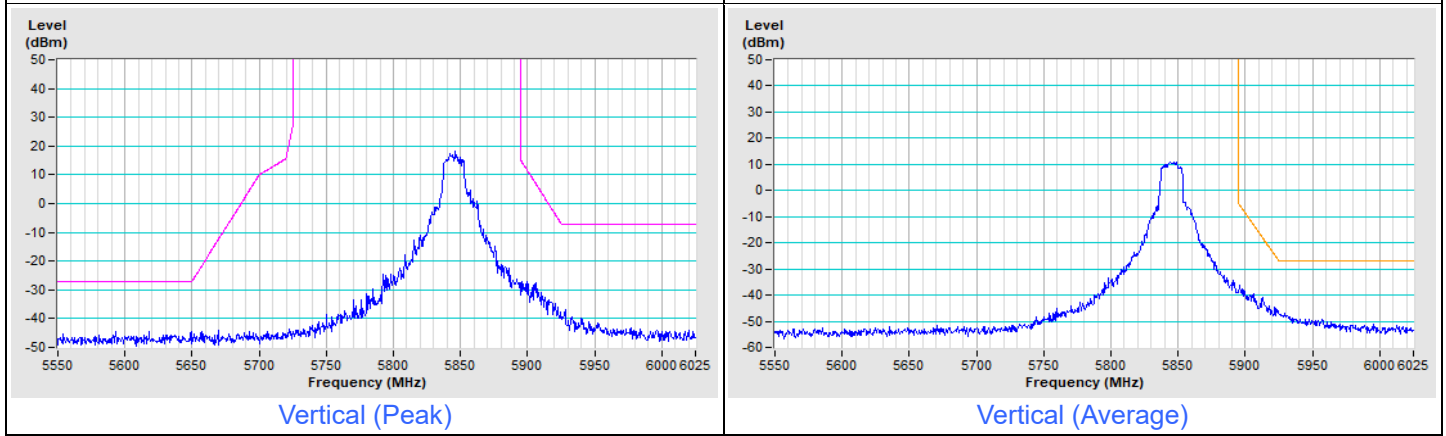
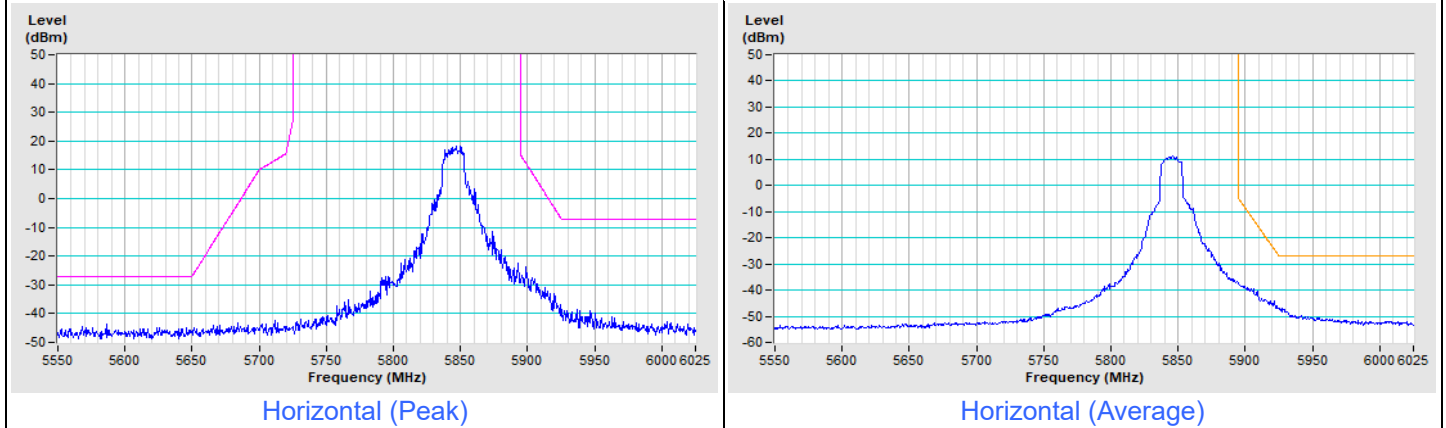

802.11a Channel 173

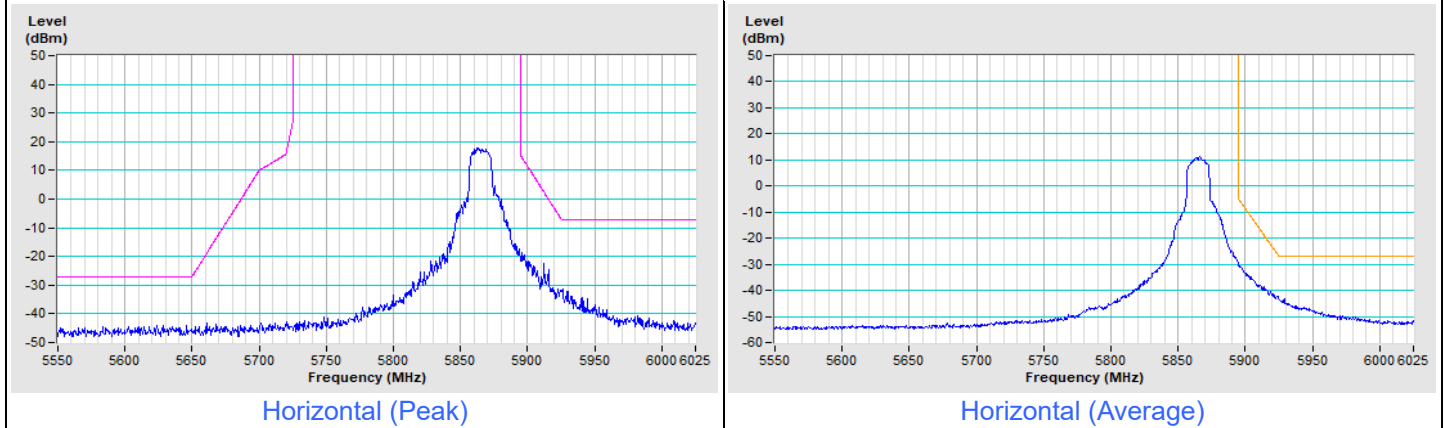

802.11a Channel 173

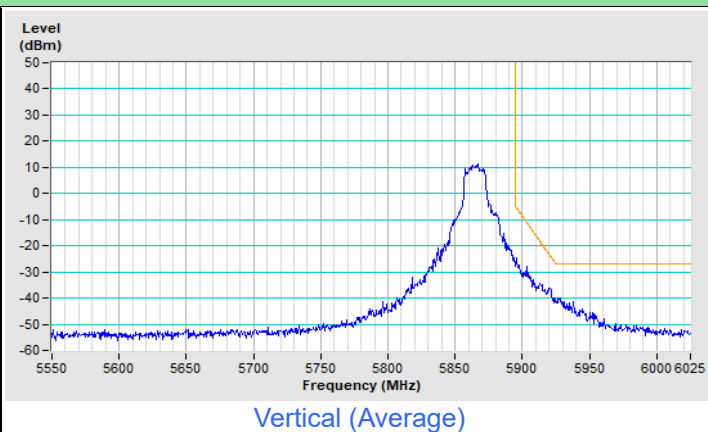
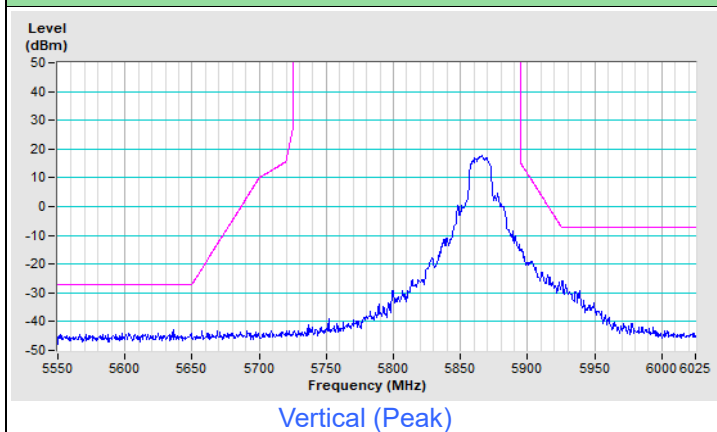

802.11a Channel 177

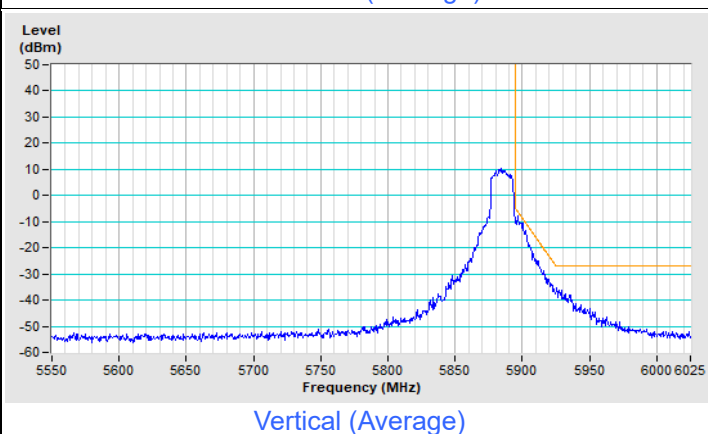
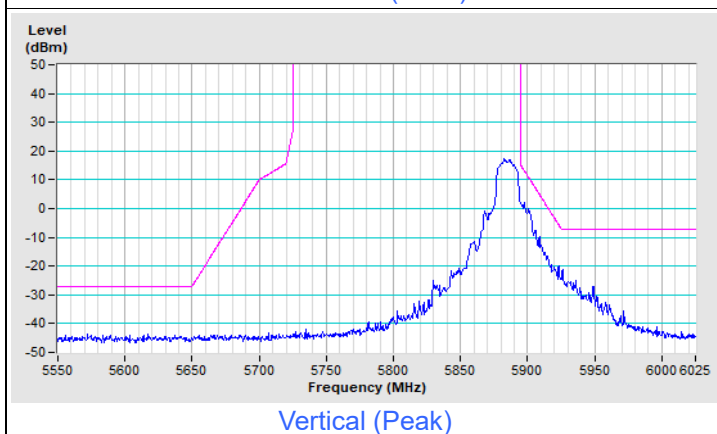
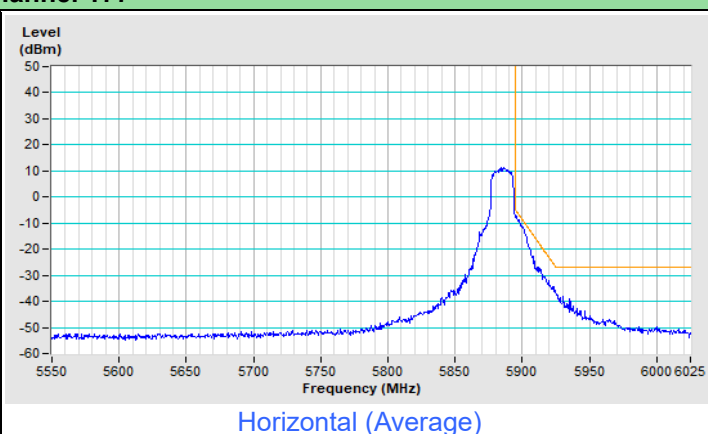
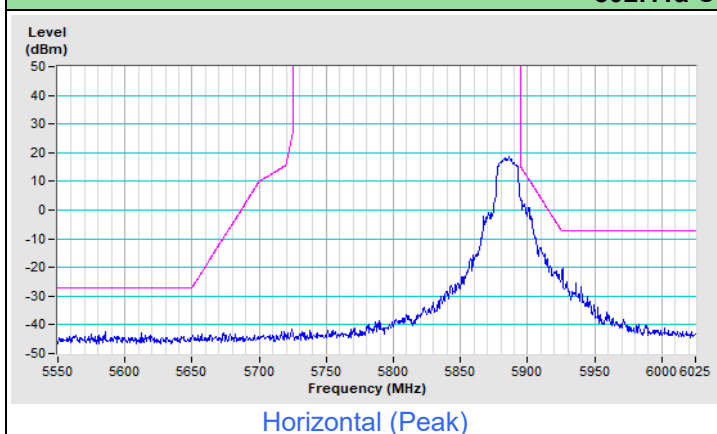



Frequency Range	5.55 GHz ~ 6.025 GHz	Detector Function & Bandwidth	(PK) RB = 1 MHz, VB = 3 MHz (RMS) RB = 1 MHz, VB = 3 MHz
------------------------	----------------------	--	---

802.11ax (HE20) Channel 169

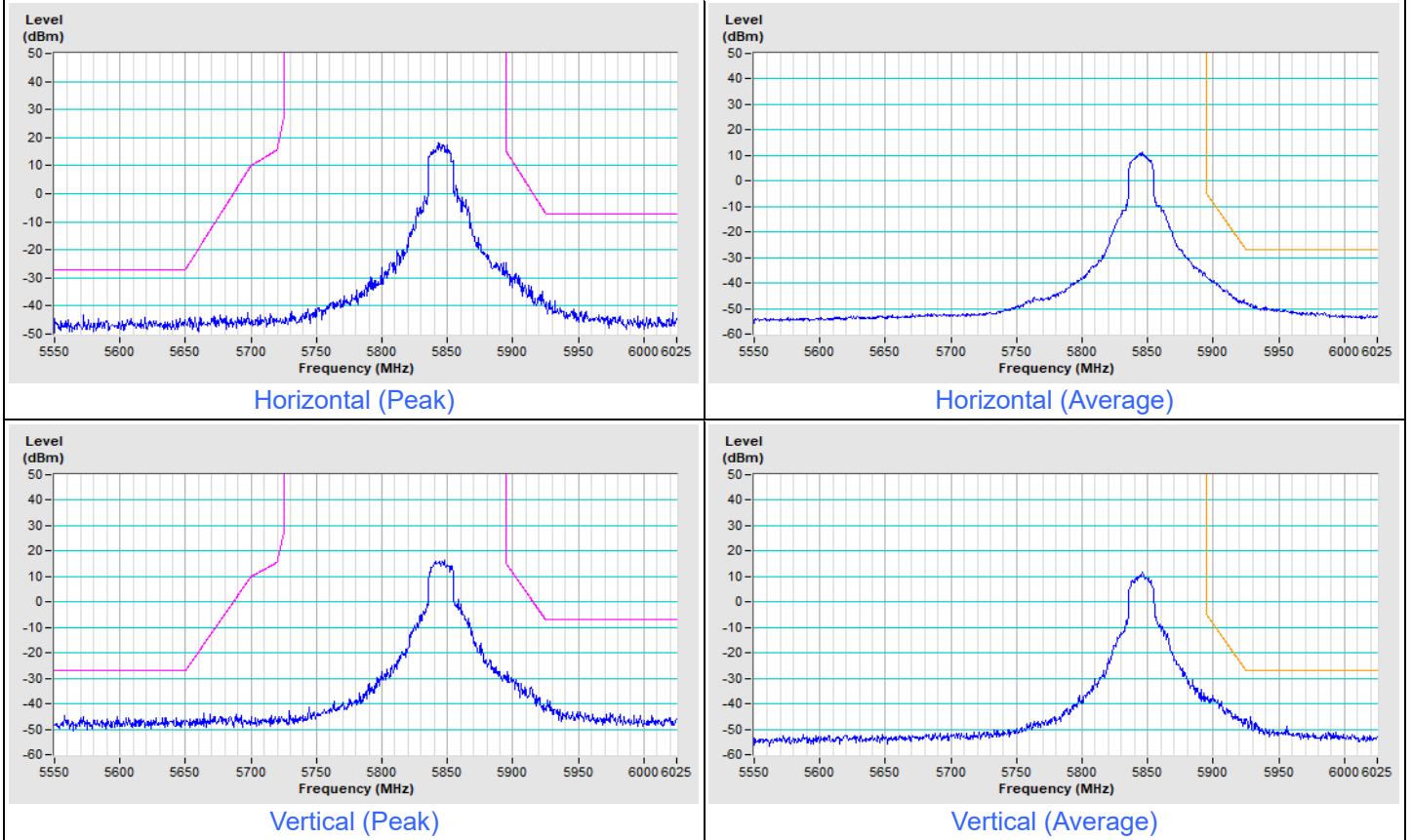

802.11ax (HE20) Channel 173

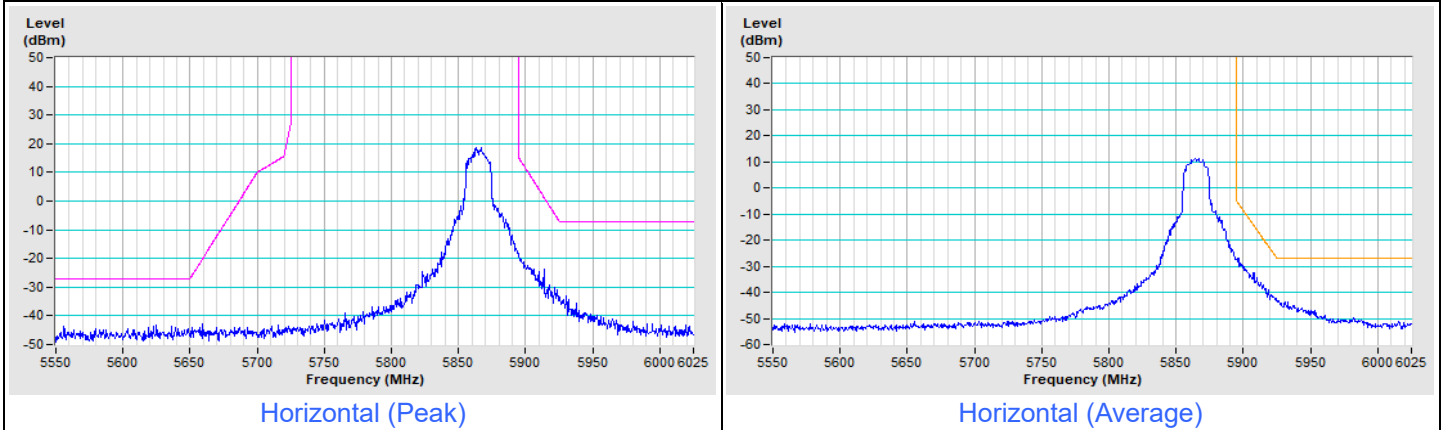

802.11ax (HE20) Channel 173

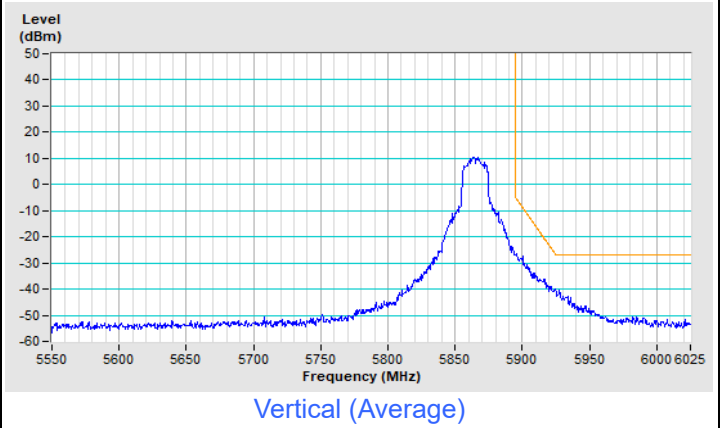
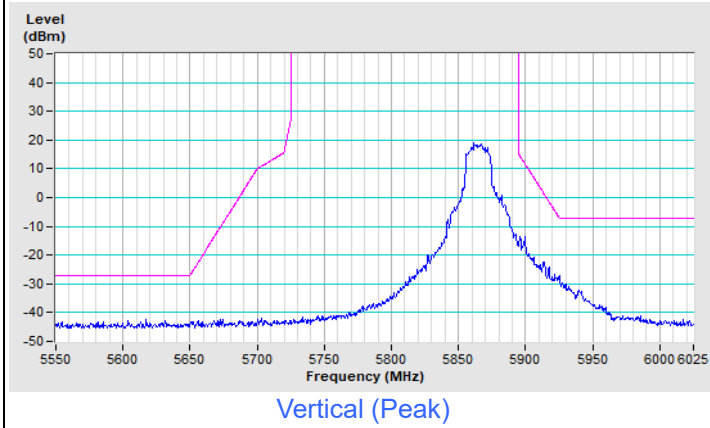

802.11ax (HE20) Channel 177

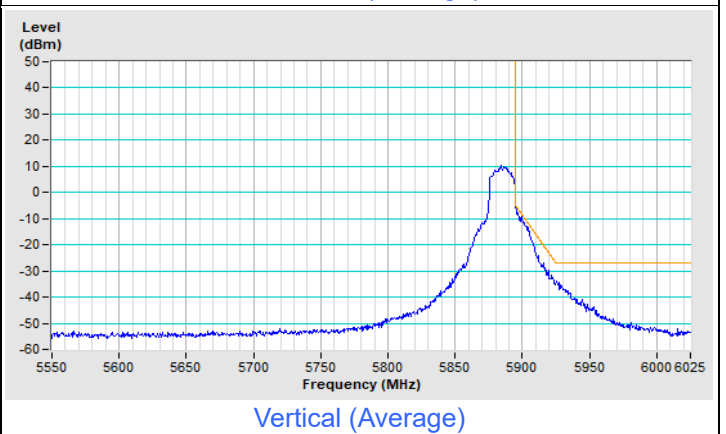
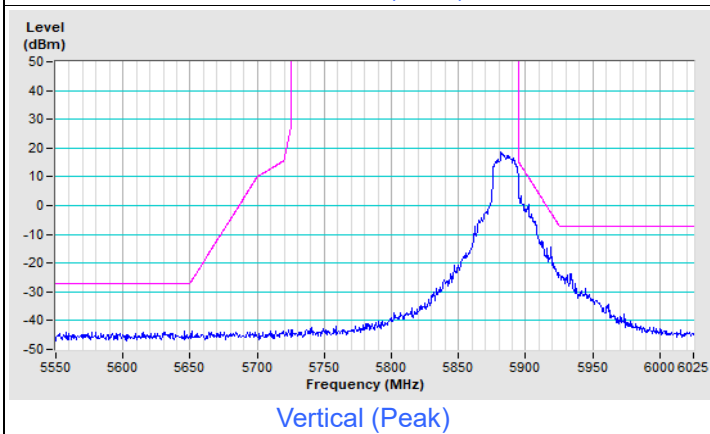
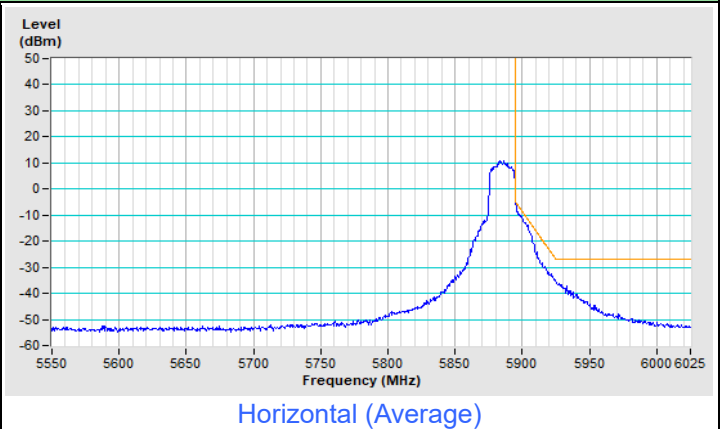
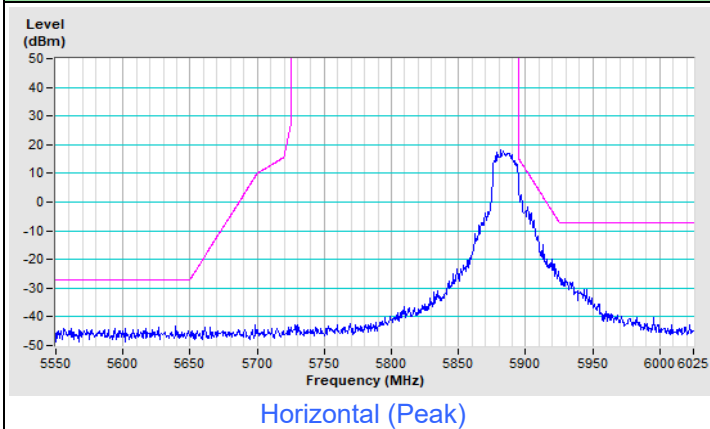



Frequency Range	5.55 GHz ~ 6.025 GHz	Detector Function & Bandwidth	(PK) RB = 1 MHz, VB = 3 MHz (RMS) RB = 1 MHz, VB = 3 MHz
------------------------	----------------------	--	---

802.11ax (HE40) Channel 167

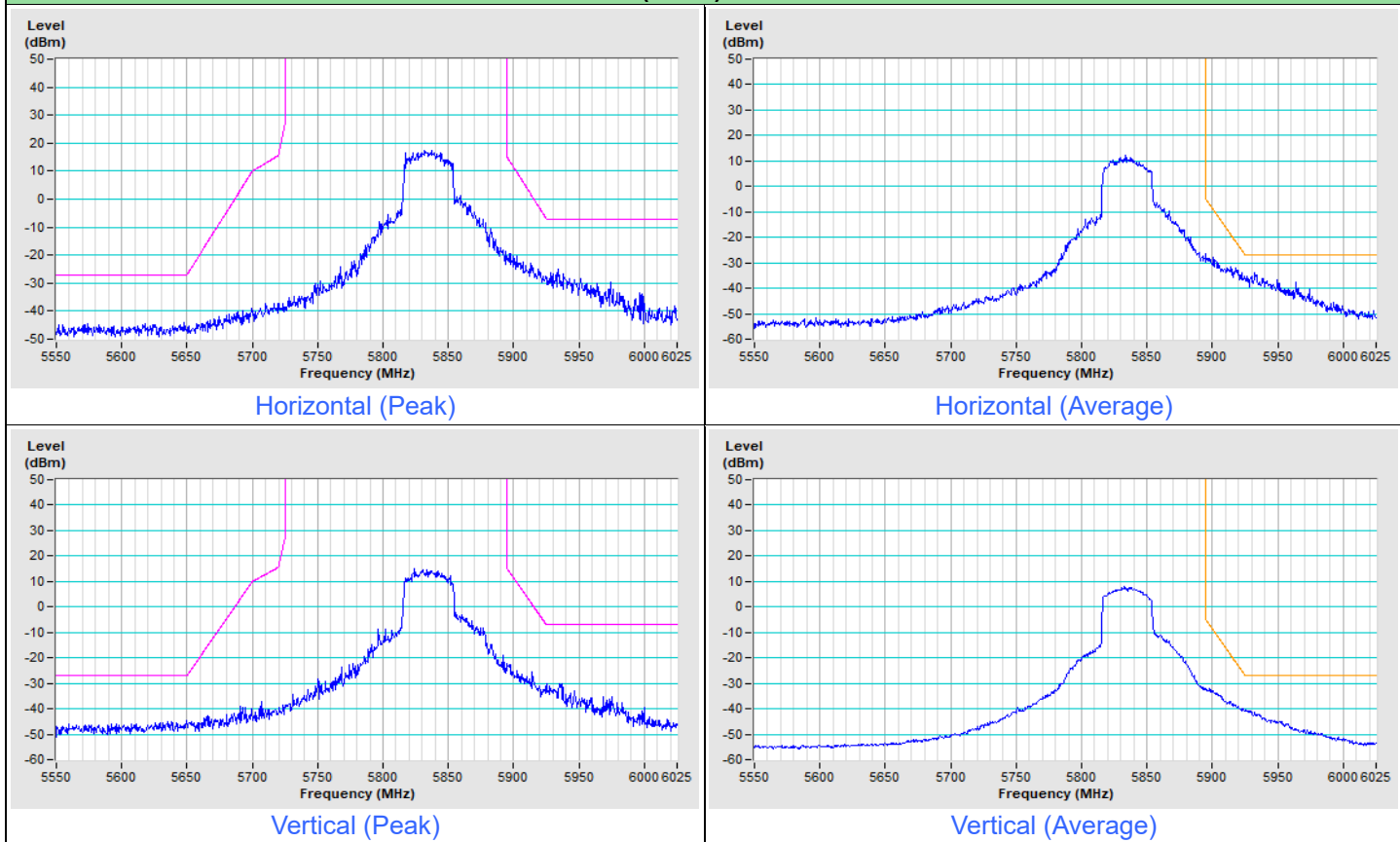

802.11ax (HE40) Channel 175

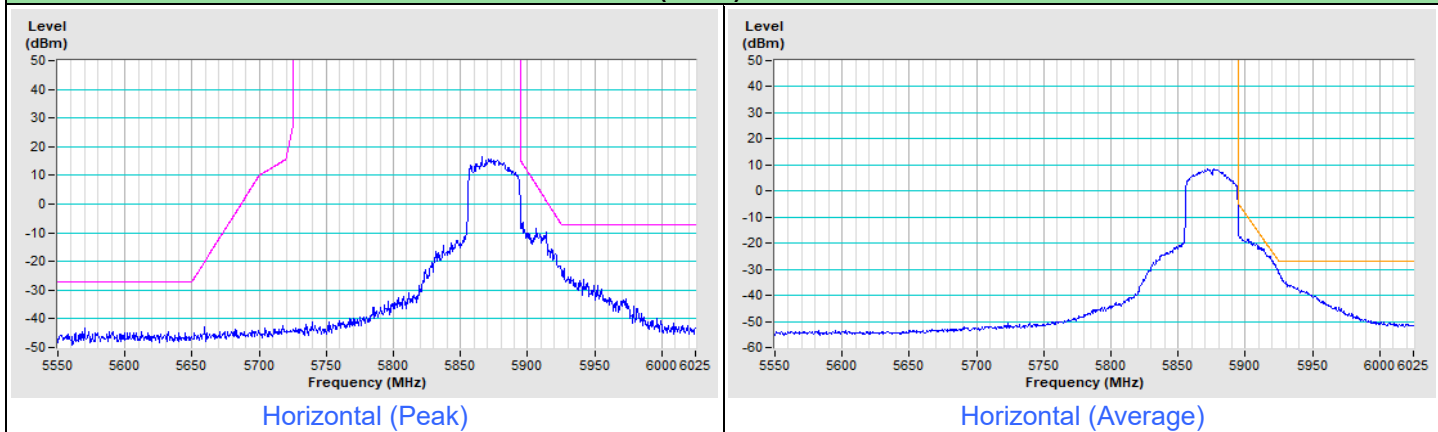

802.11ax (HE40) Channel 175

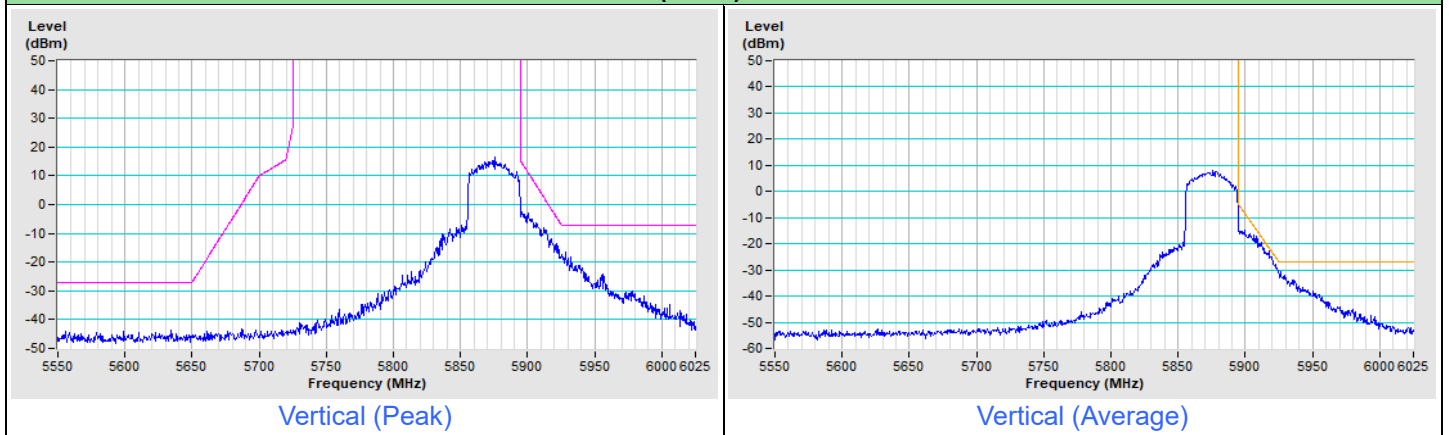



Frequency Range	5.55 GHz ~ 6.025 GHz	Detector Function & Bandwidth	(PK) RB = 1 MHz, VB = 3 MHz (RMS) RB = 1 MHz, VB = 3 MHz
------------------------	----------------------	--	---

802.11ax (HE80) Channel 171

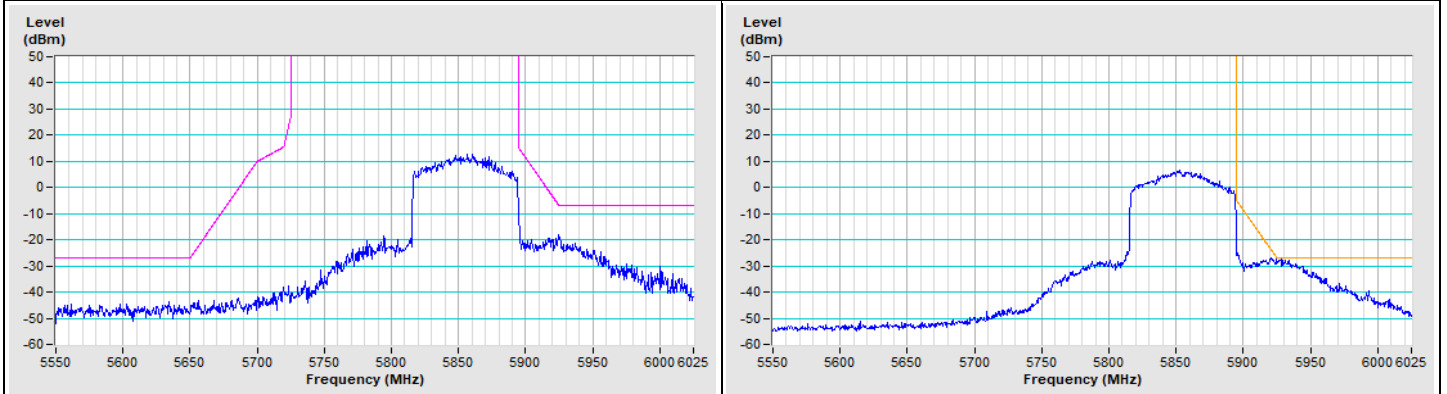

Horizontal (Peak)

Horizontal (Average)

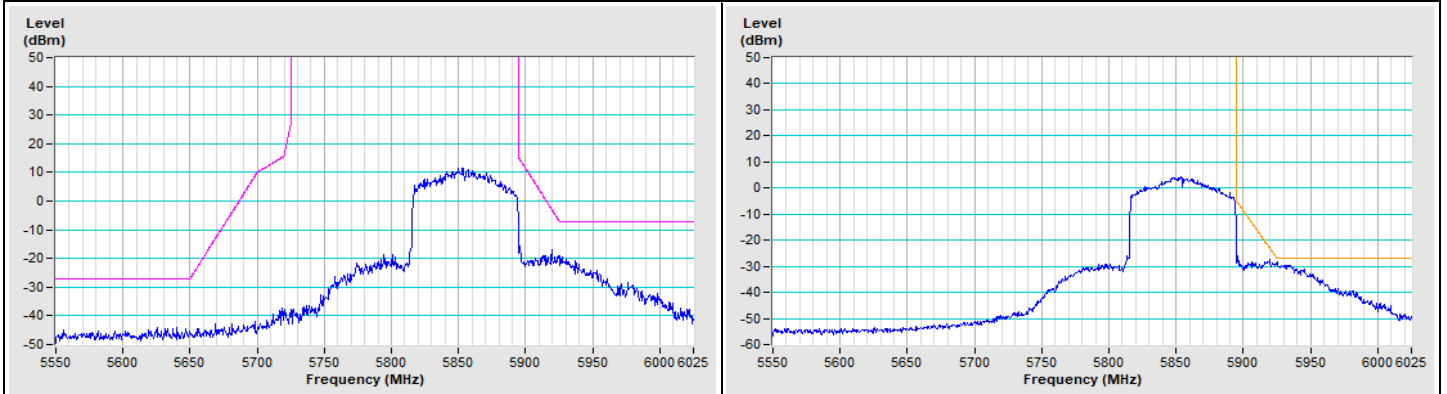

Vertical (Peak)

Vertical (Average)



Frequency Range	5.55 GHz ~ 6.025 GHz	Detector Function & Bandwidth	(PK) RB = 1 MHz, VB = 3 MHz (RMS) RB = 1 MHz, VB = 3 MHz
------------------------	----------------------	--	---

802.11ax (HE20) 26-tone RU Channel 169

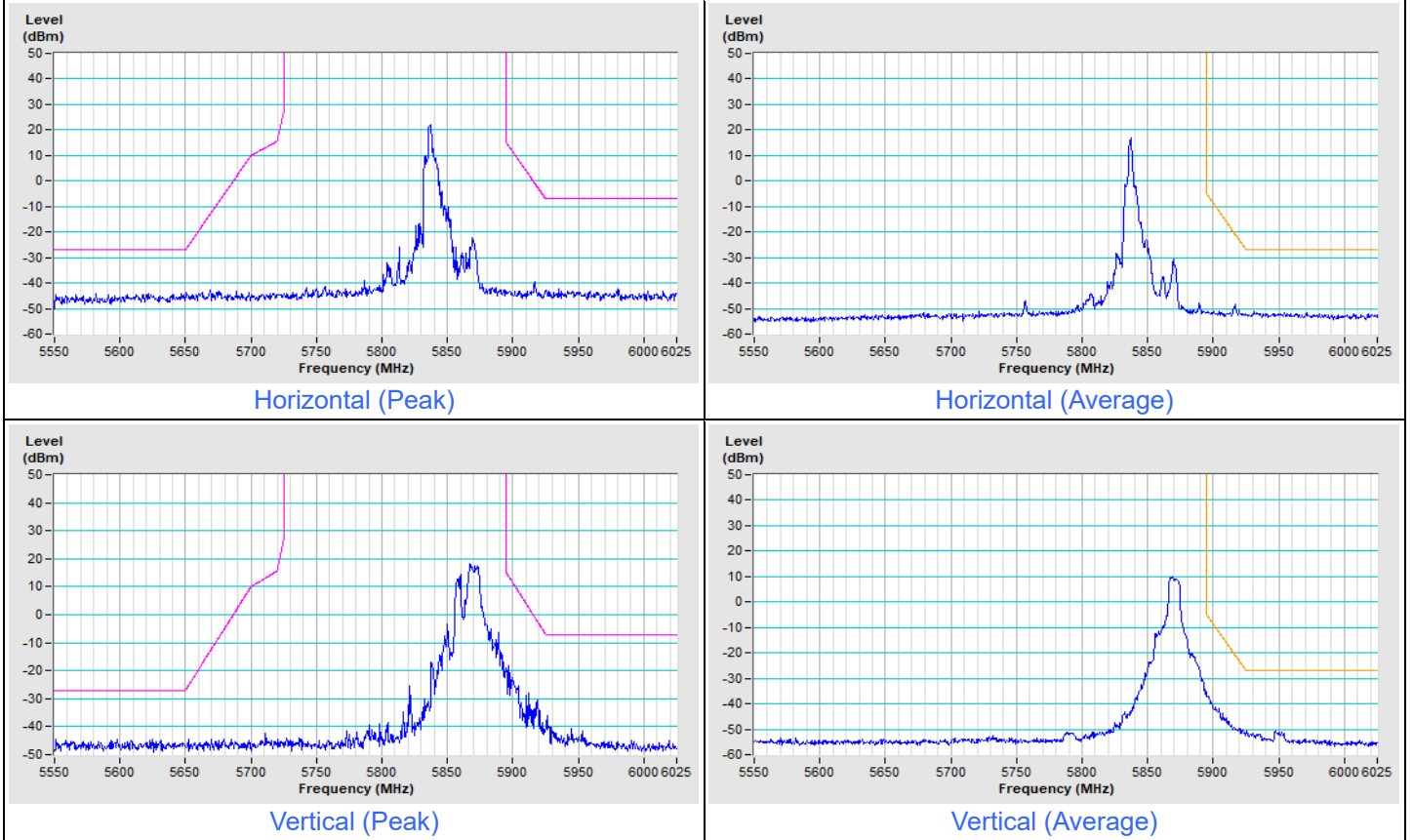

802.11ax (HE20) 26-tone RU Channel 173

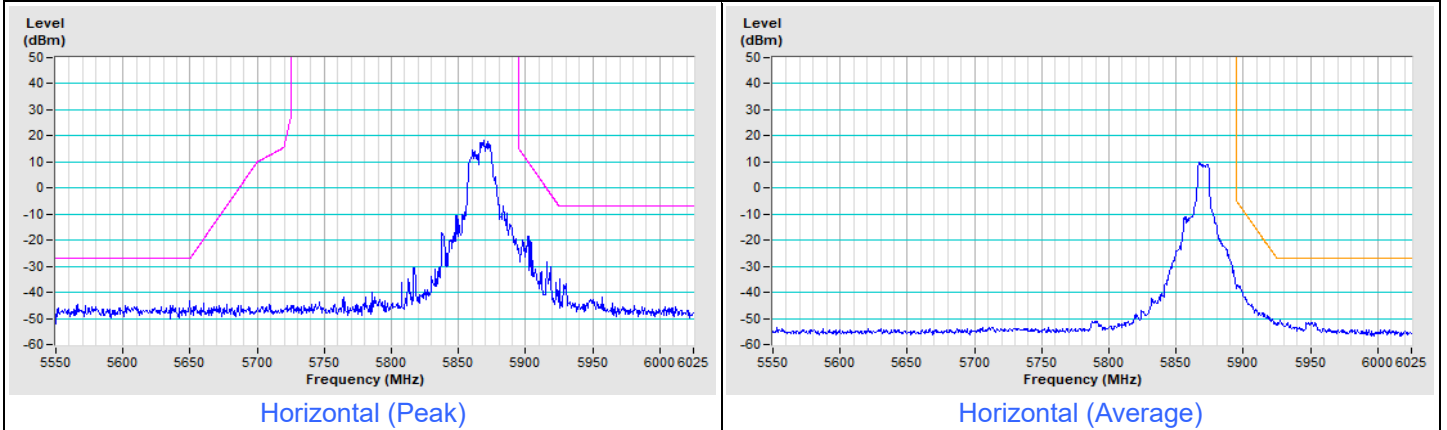

802.11ax (HE20) 26-tone RU Channel 173

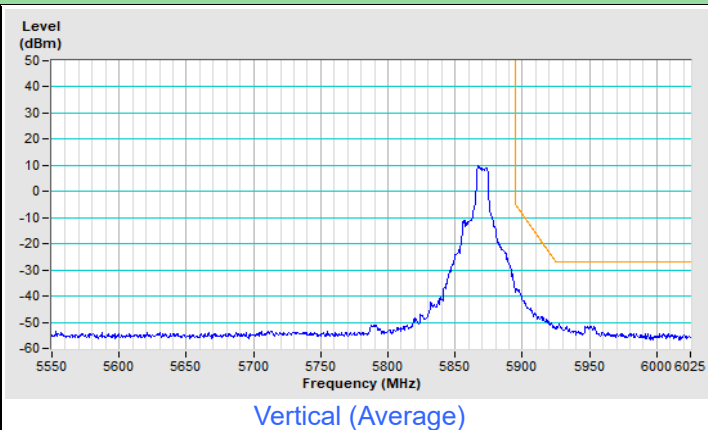
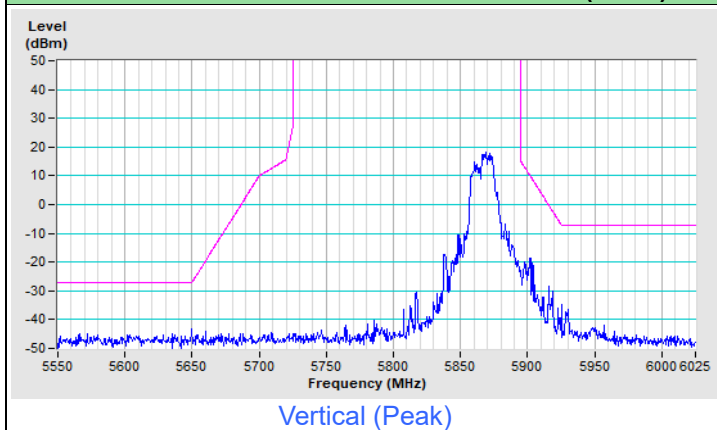

802.11ax (HE20) 26-tone RU Channel 177

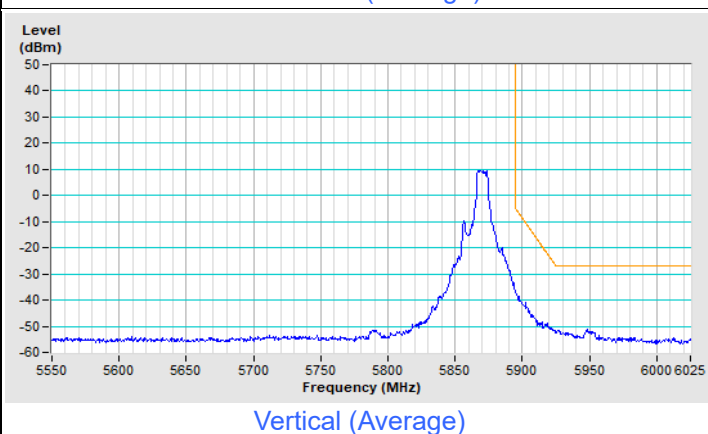
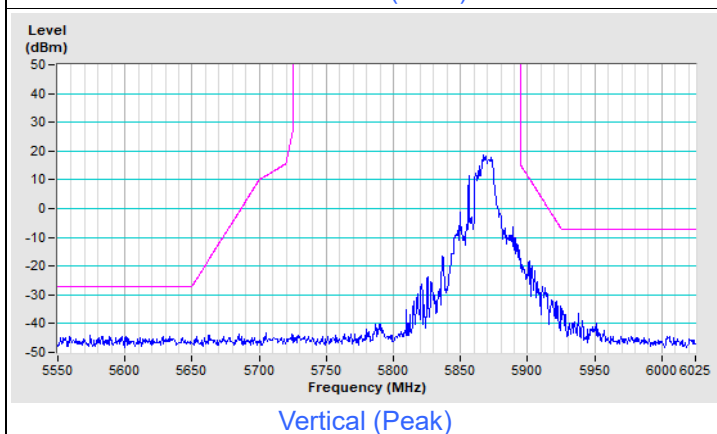
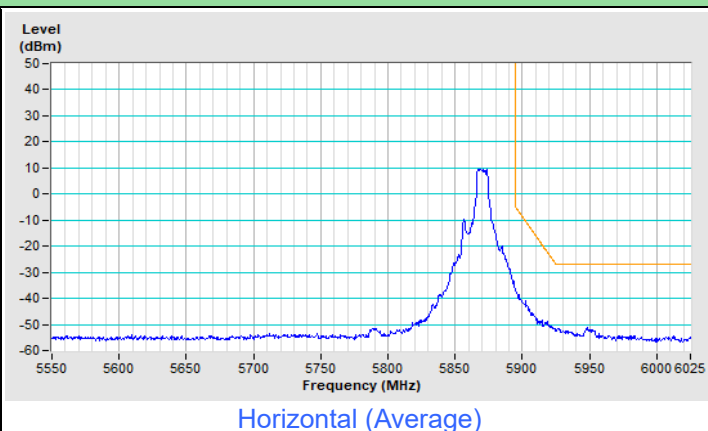
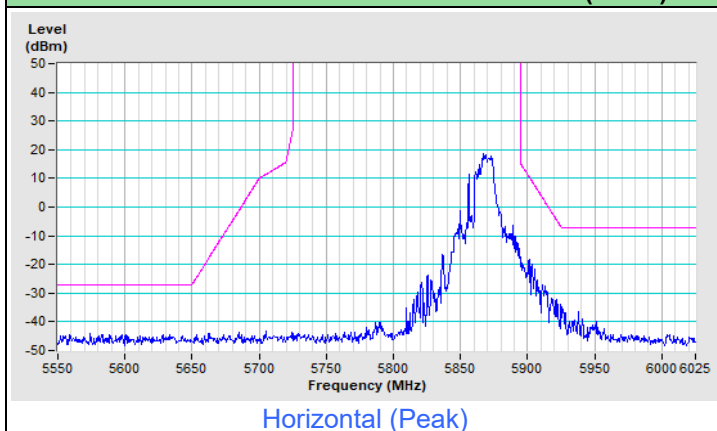



Frequency Range	5.55 GHz ~ 6.025 GHz	Detector Function & Bandwidth	(PK) RB = 1 MHz, VB = 3 MHz (RMS) RB = 1 MHz, VB = 3 MHz
------------------------	----------------------	--	---

802.11ax (HE20) 52-tone RU Channel 169

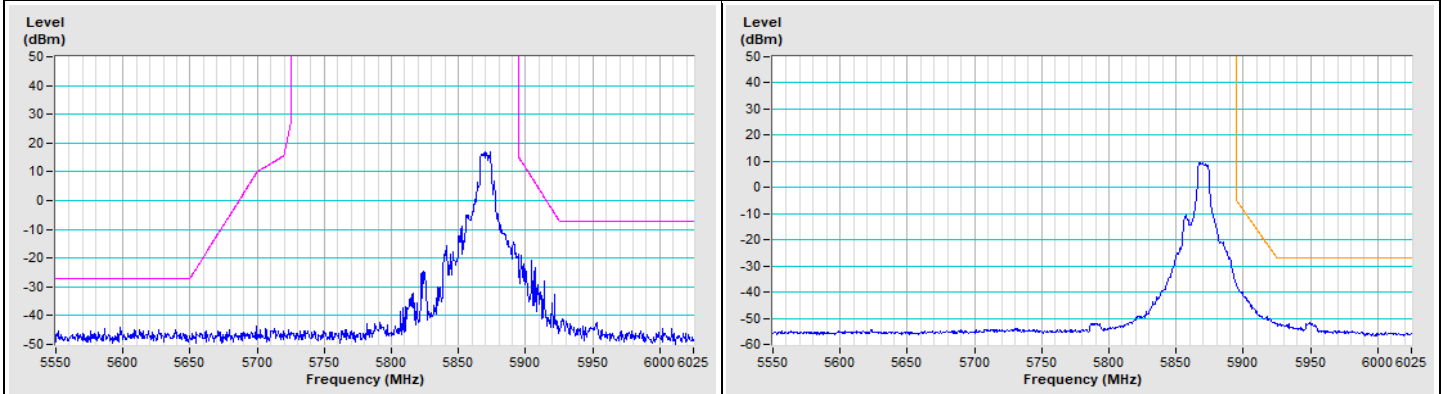

Horizontal (Peak)

Horizontal (Average)

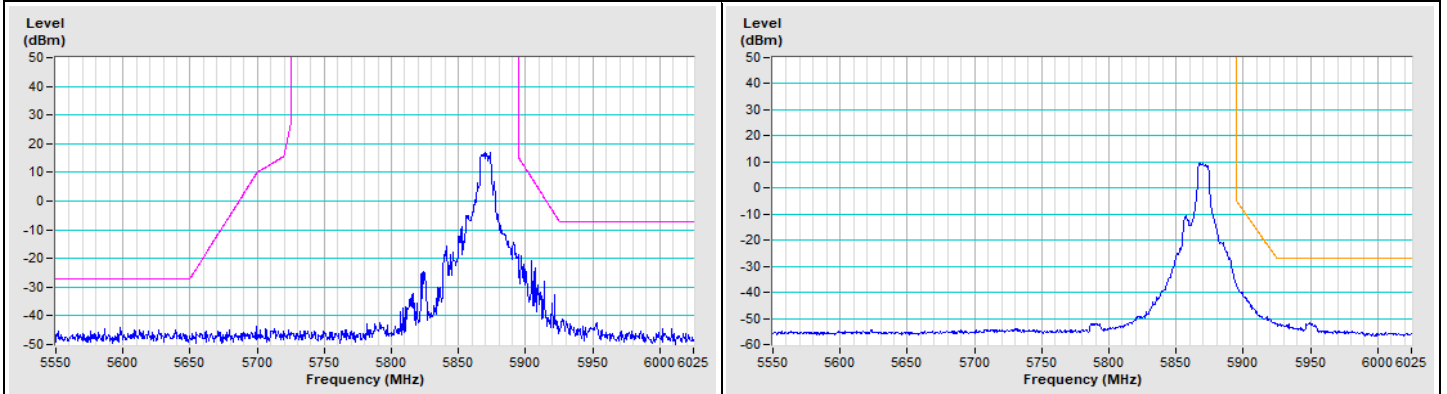

Vertical (Peak)

Vertical (Average)

802.11ax (HE20) 52-tone RU Channel 173

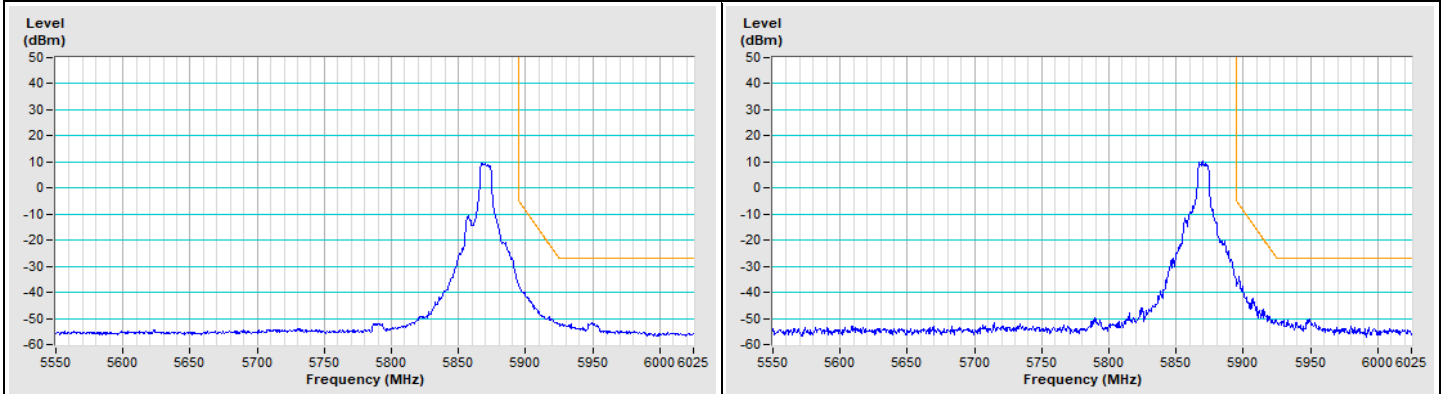

Horizontal (Peak)

Horizontal (Average)

802.11ax (HE20) 52-tone RU Channel 173

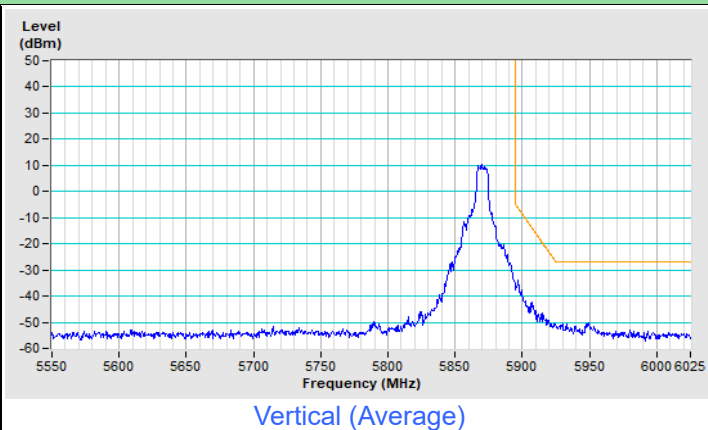
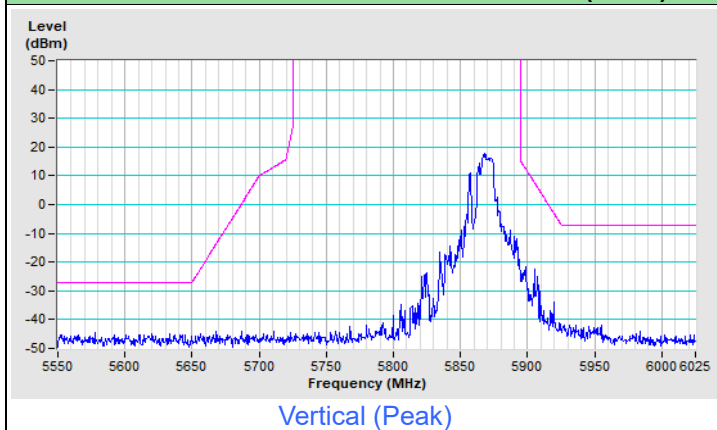

802.11ax (HE20) 52-tone RU Channel 177

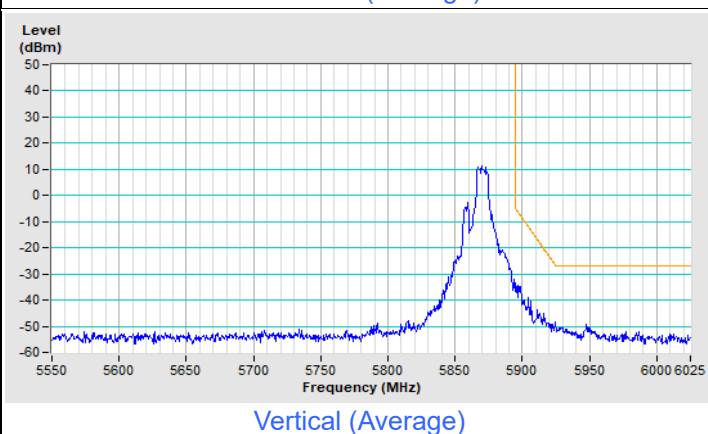
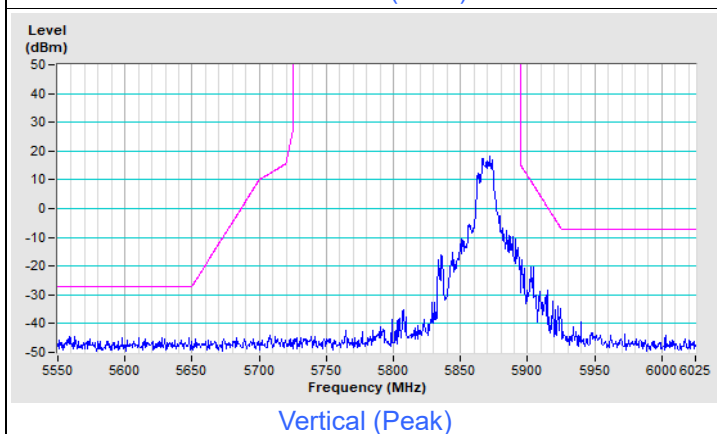
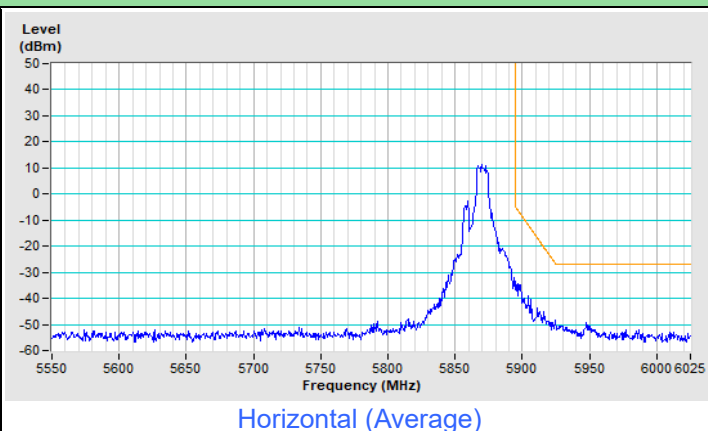
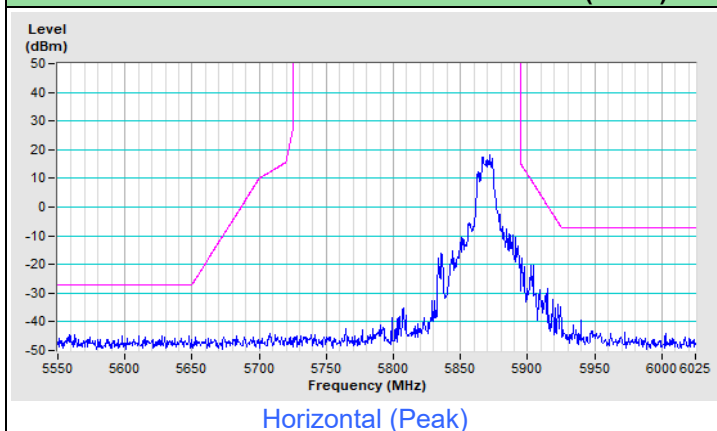

802.11ax (HE20) 106-tone RU Channel 173

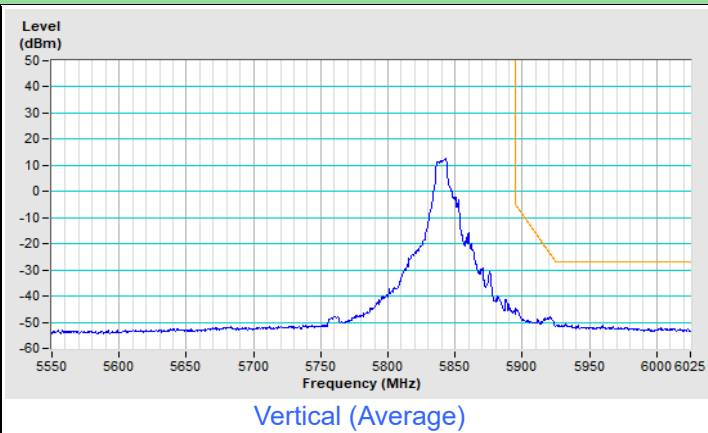
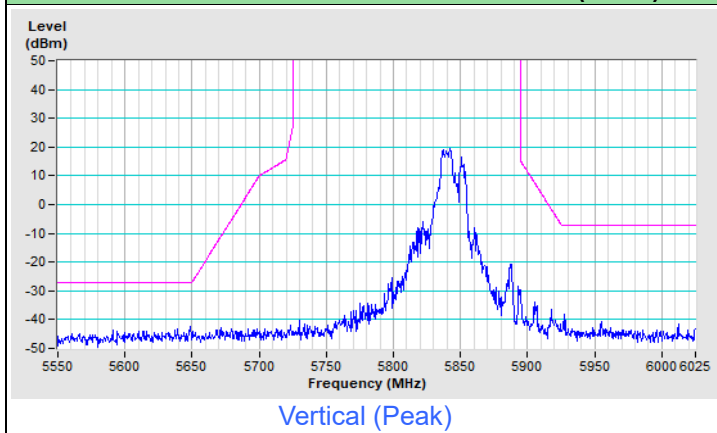

802.11ax (HE20) 106-tone RU Channel 177

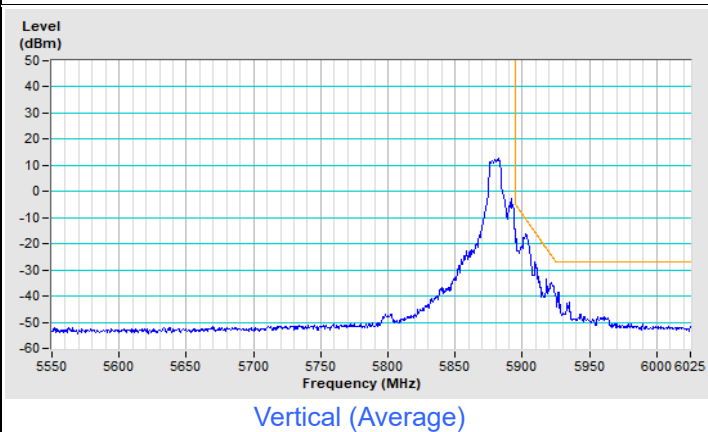
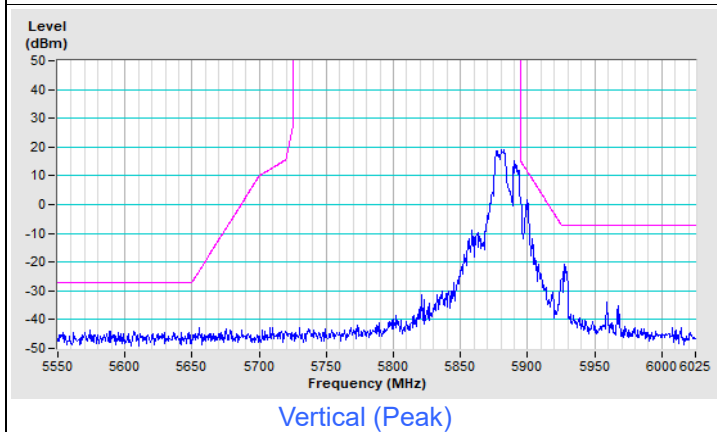
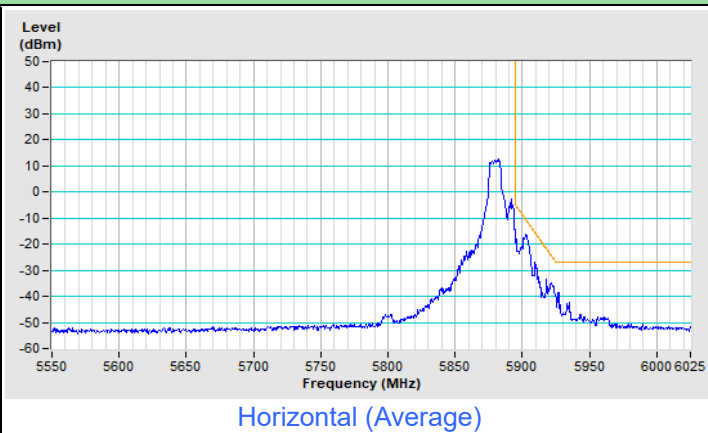
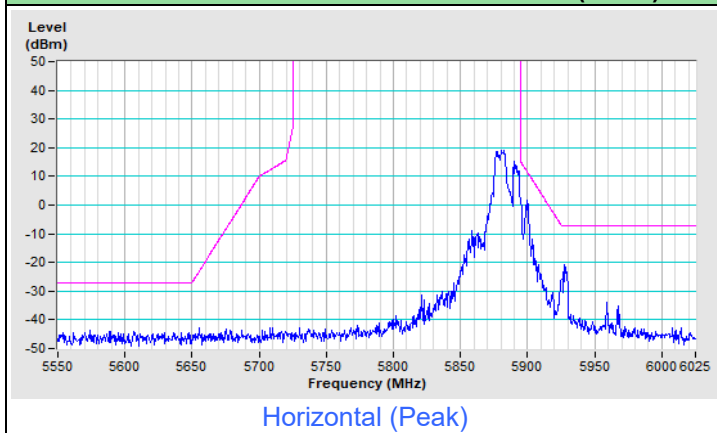

Plot of Band Edge Mode C

Frequency Range	5.55 GHz ~ 6.025 GHz	Detector Function & Bandwidth	(PK) RB = 1 MHz, VB = 3 MHz (RMS) RB = 1 MHz, VB = 3 MHz
------------------------	----------------------	--	---

802.11a Channel 169

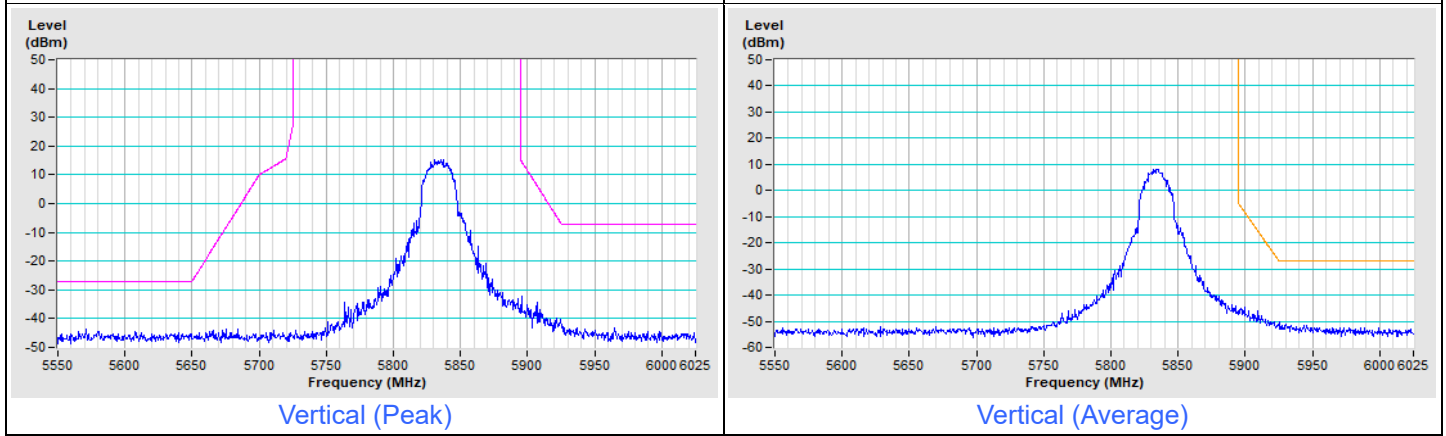
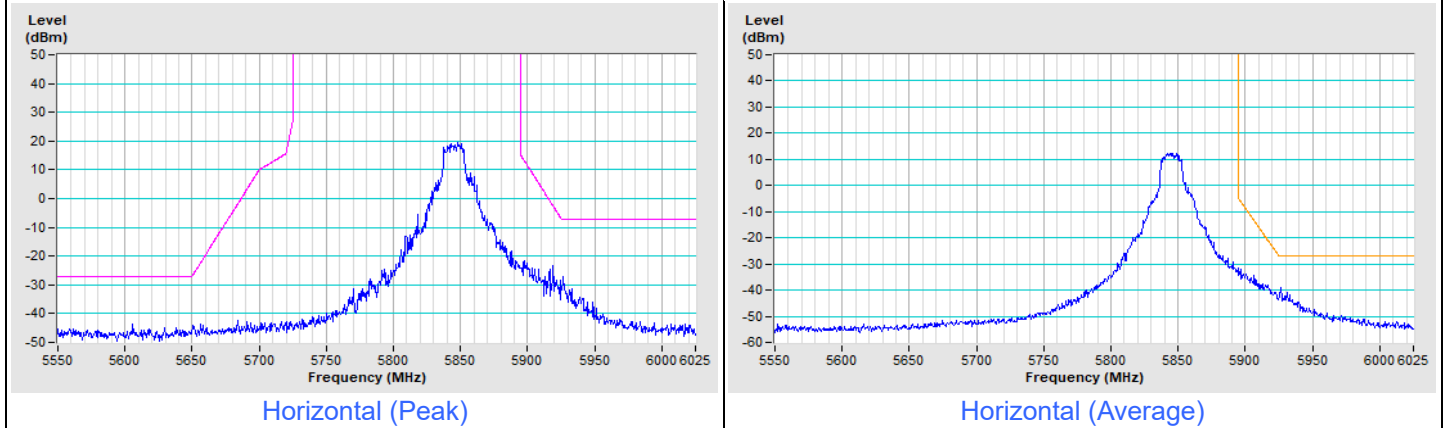

802.11a Channel 173

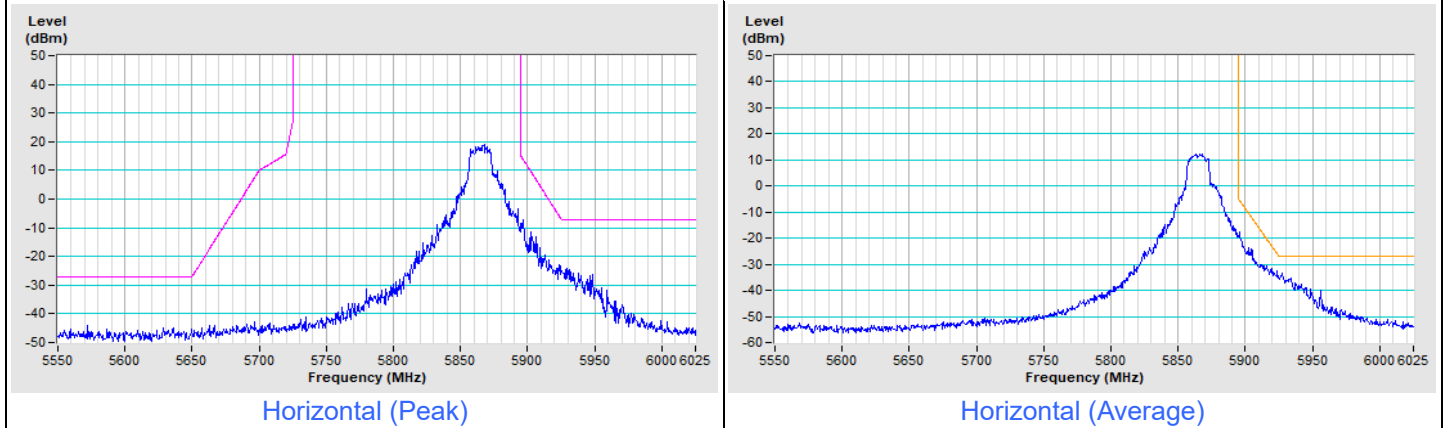

802.11a Channel 173

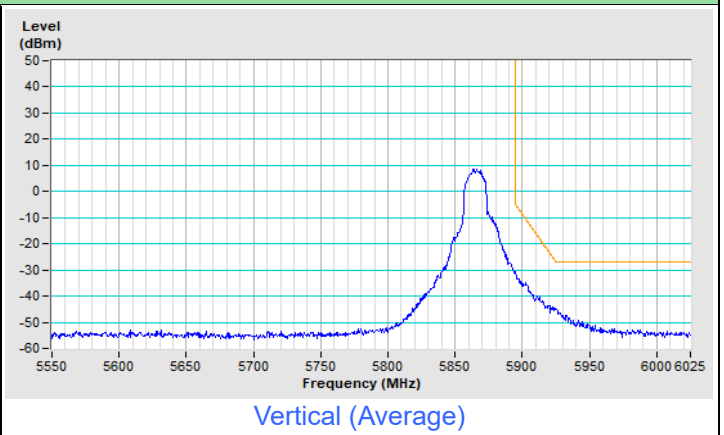
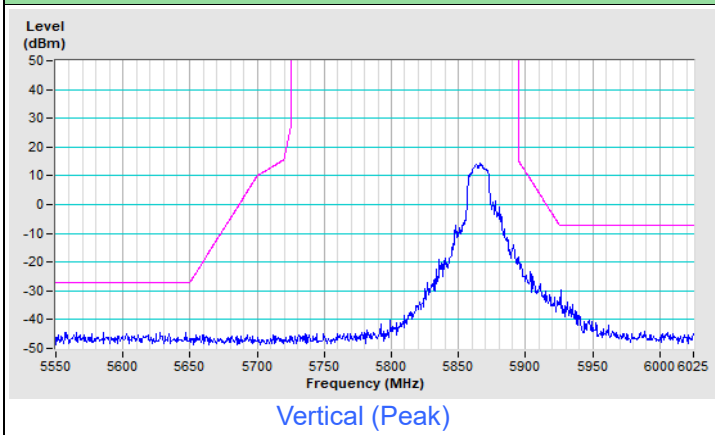

802.11a Channel 177

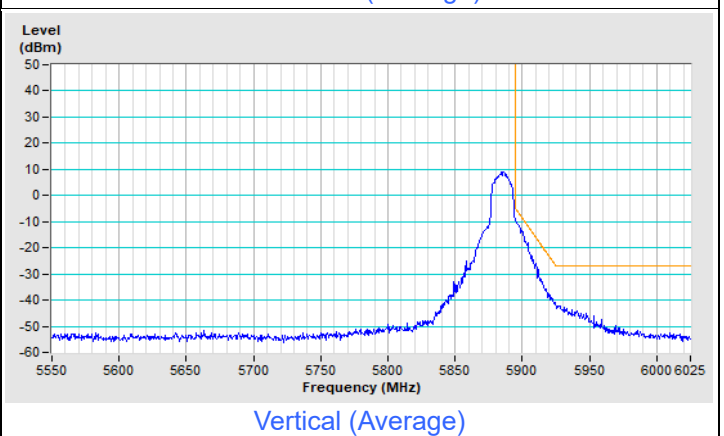
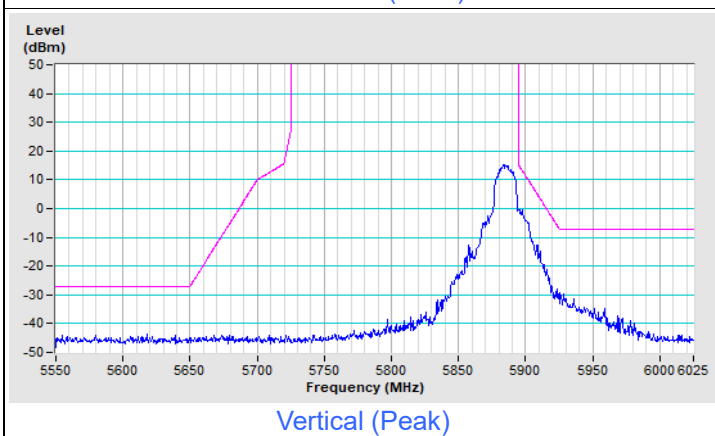
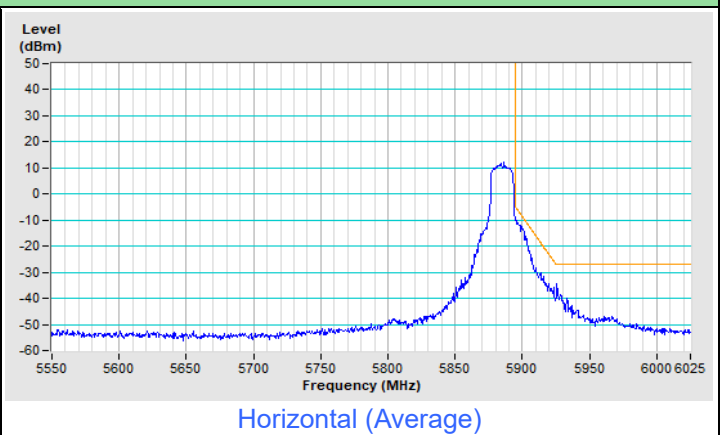
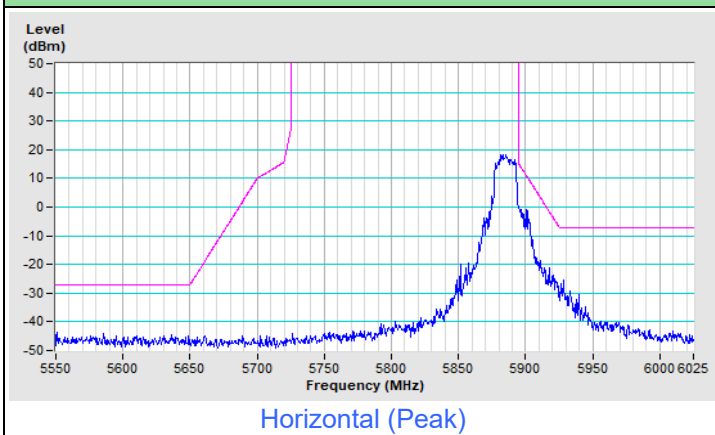



Frequency Range	5.55 GHz ~ 6.025 GHz	Detector Function & Bandwidth	(PK) RB = 1 MHz, VB = 3 MHz (RMS) RB = 1 MHz, VB = 3 MHz
------------------------	----------------------	--	---

802.11ax (HE20) Channel 169

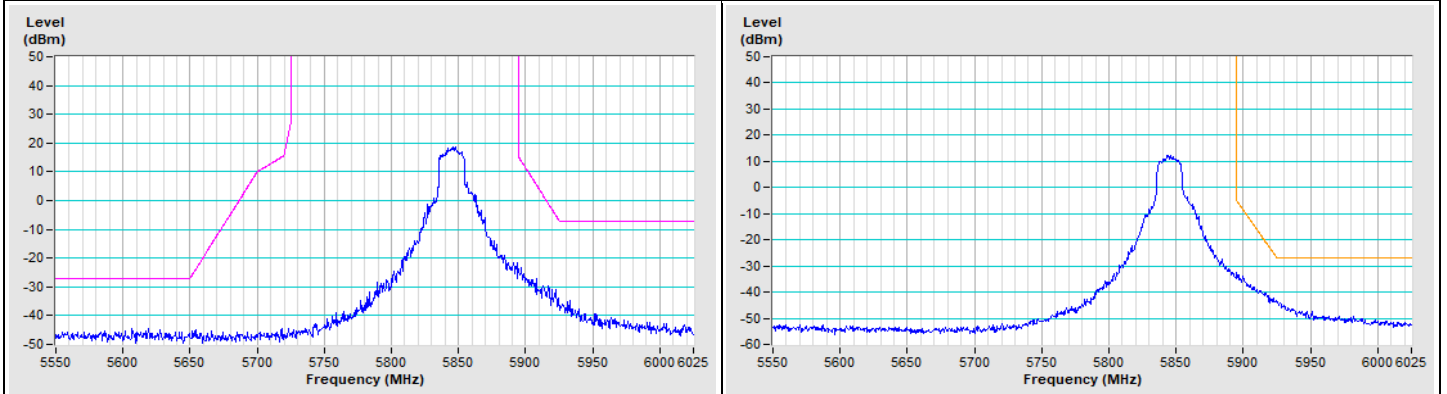

Horizontal (Peak)

Horizontal (Average)

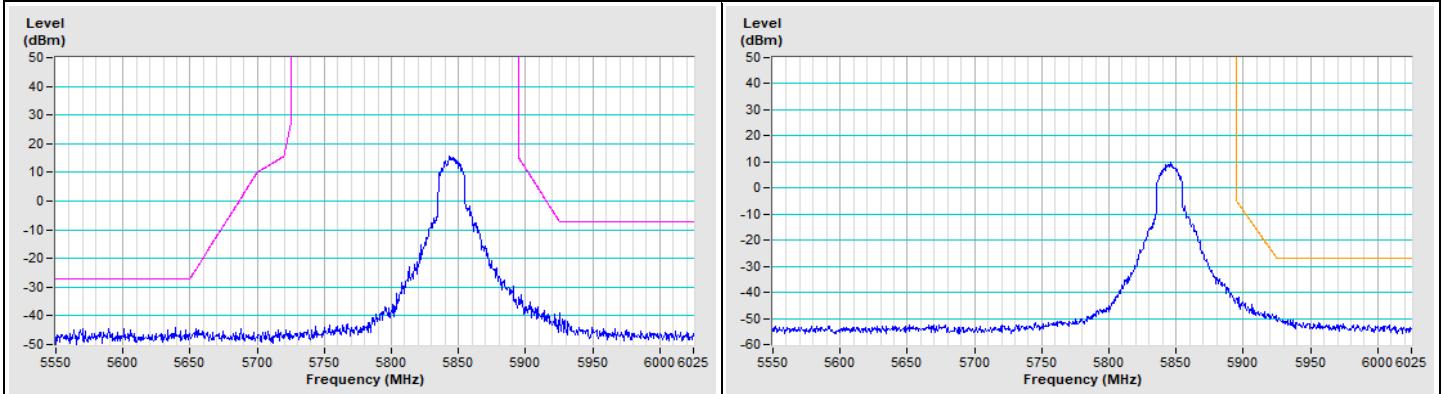

Vertical (Peak)

Vertical (Average)

802.11ax (HE20) Channel 173

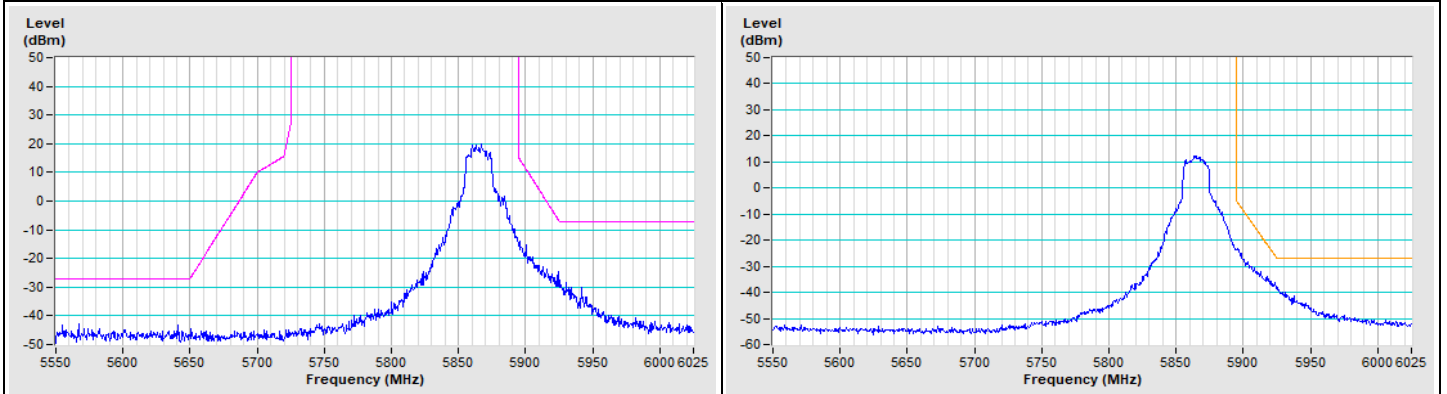

Horizontal (Peak)

Horizontal (Average)

802.11ax (HE20) Channel 173

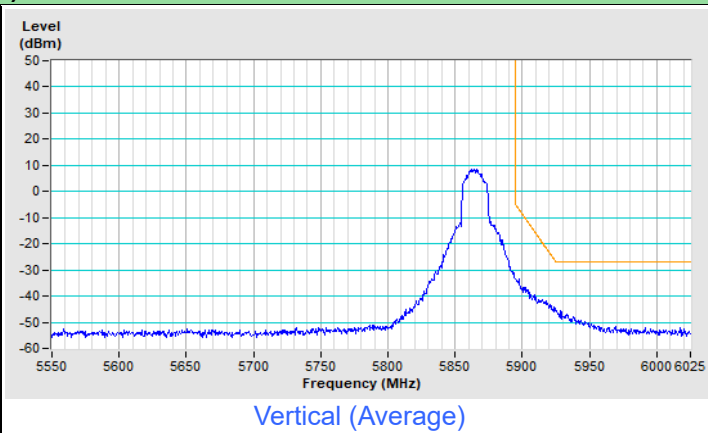
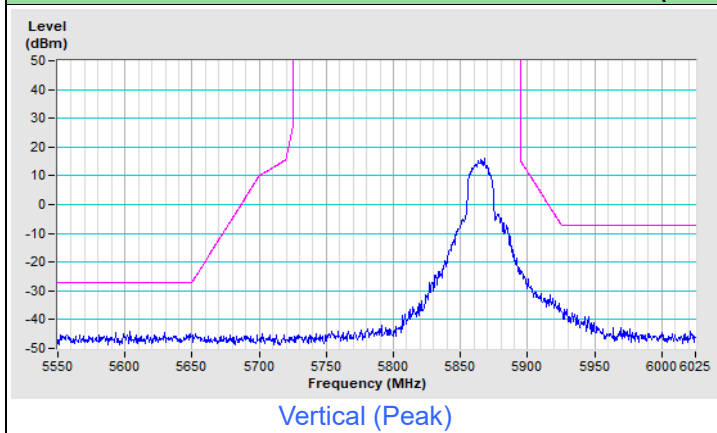

802.11ax (HE20) Channel 177

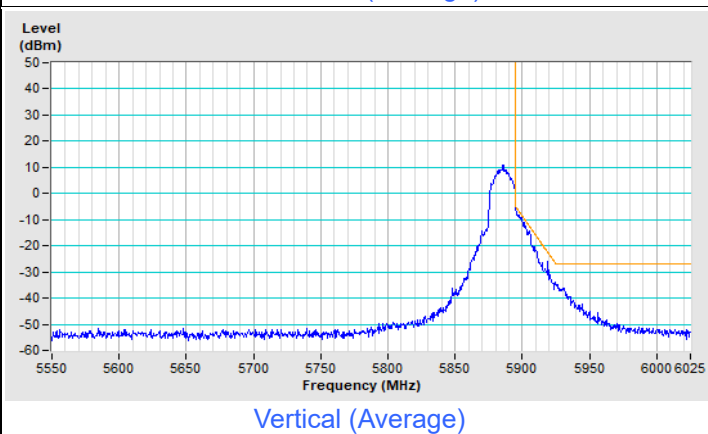
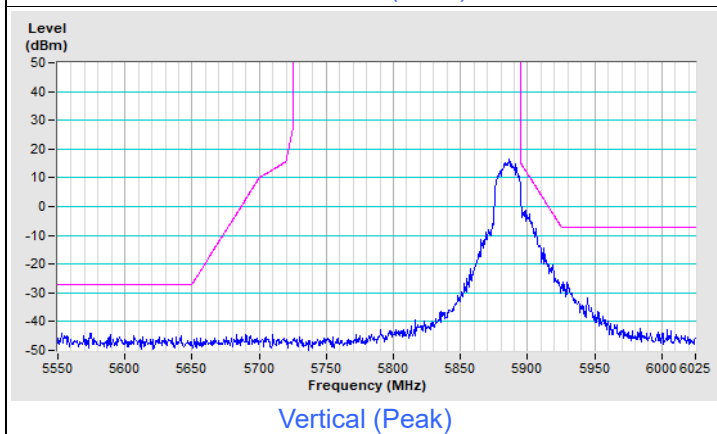
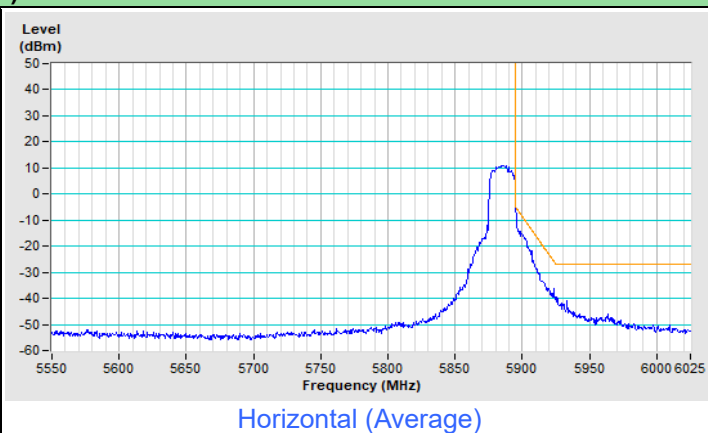
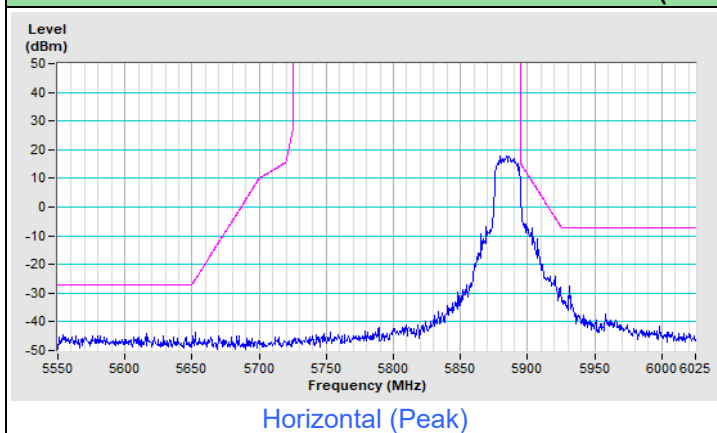

802.11ax (HE40) Channel 175

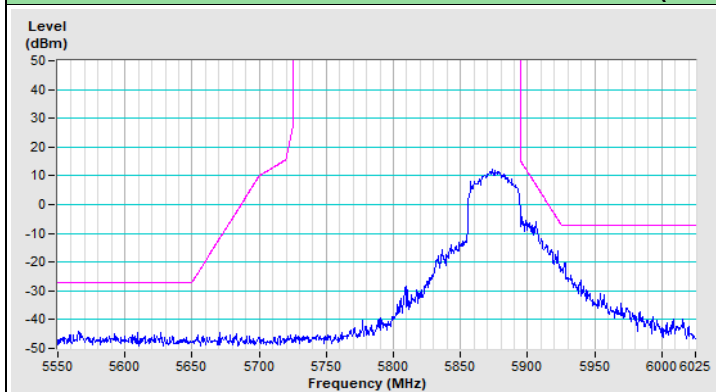

Vertical (Peak)

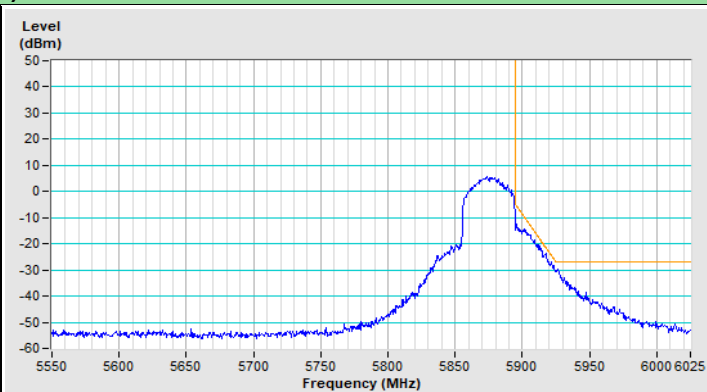

Vertical (Average)



Frequency Range	5.55 GHz ~ 6.025 GHz	Detector Function & Bandwidth	(PK) RB = 1 MHz, VB = 3 MHz (RMS) RB = 1 MHz, VB = 3 MHz
------------------------	----------------------	--	---

802.11ax (HE80) Channel 171

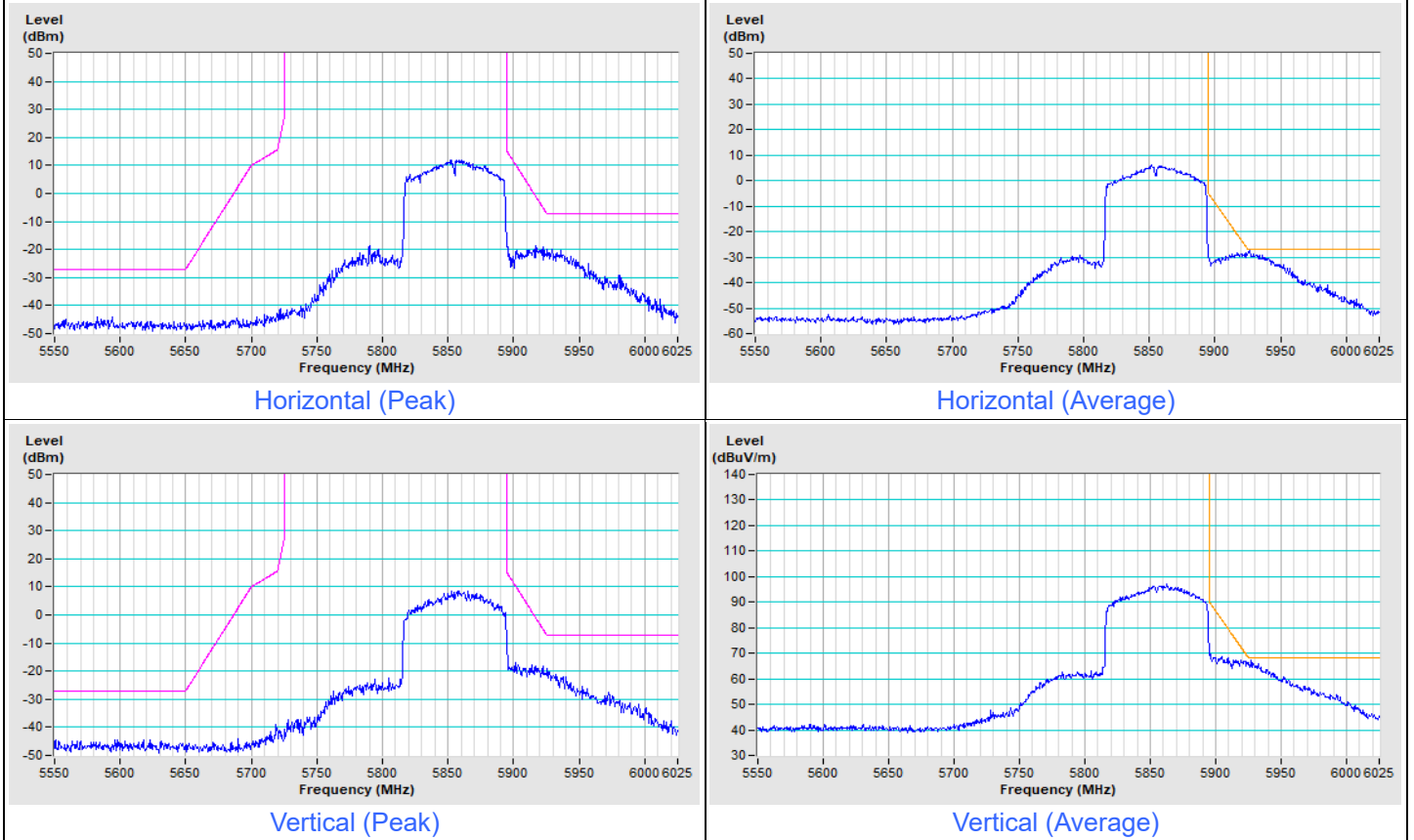



Frequency Range	5.55 GHz ~ 6.025 GHz	Detector Function & Bandwidth	(PK) RB = 1 MHz, VB = 3 MHz (RMS) RB = 1 MHz, VB = 3 MHz
------------------------	----------------------	--	---

802.11ax (HE20) 26-tone RU Channel 169

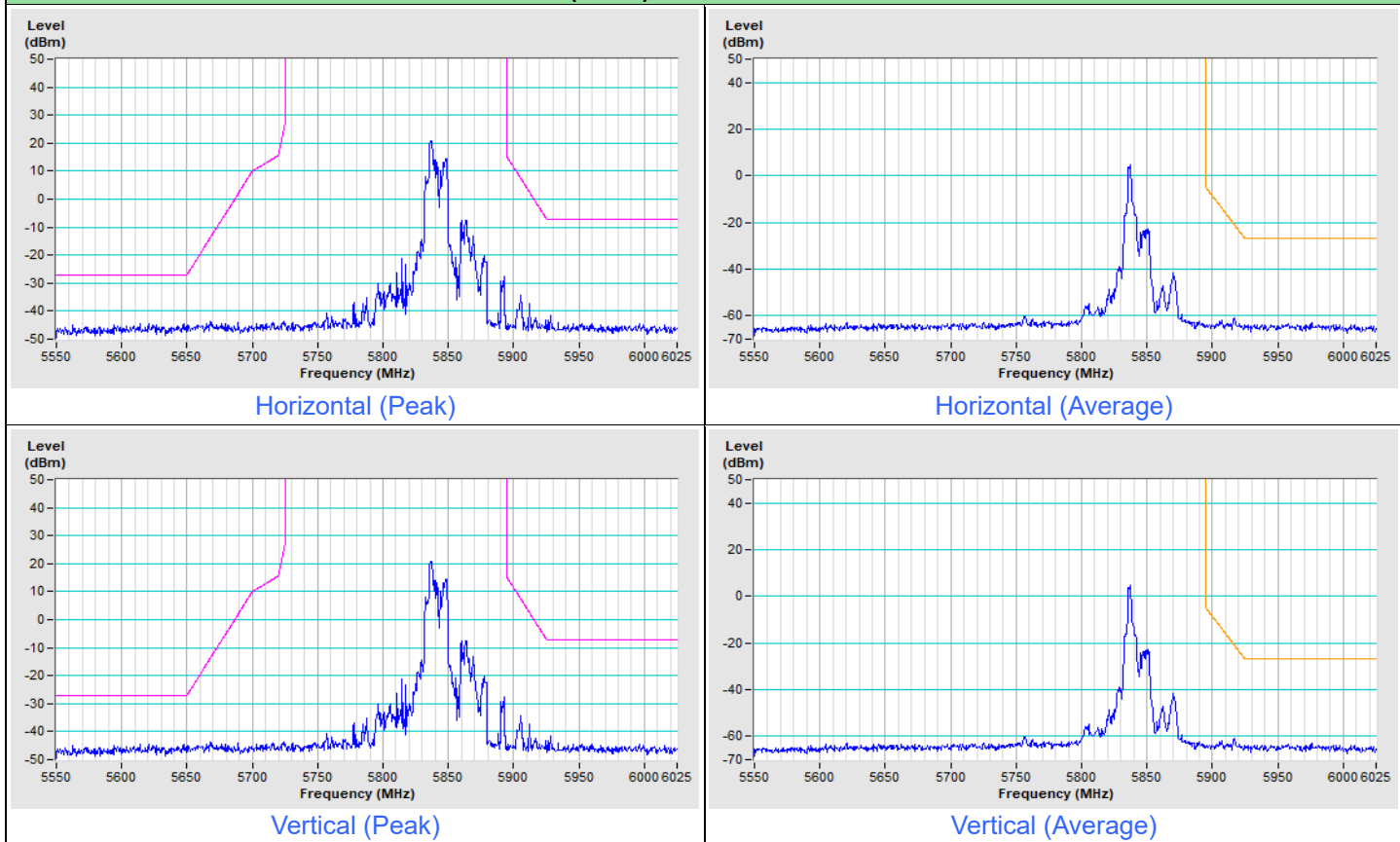

802.11ax (HE20) 26-tone RU Channel 173

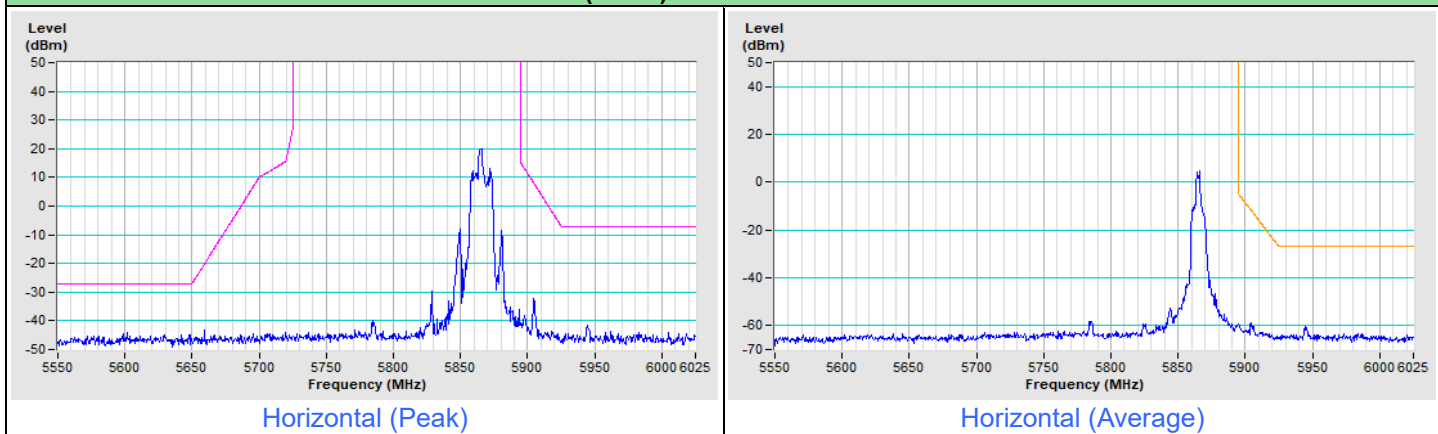

802.11ax (HE20) 26-tone RU Channel 173

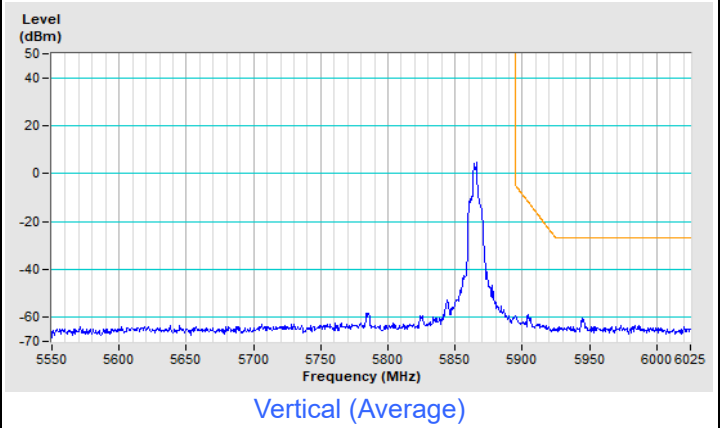
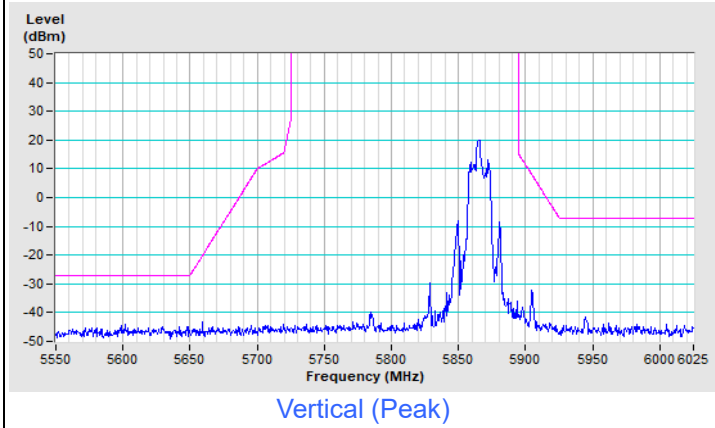

802.11ax (HE20) 26-tone RU Channel 177

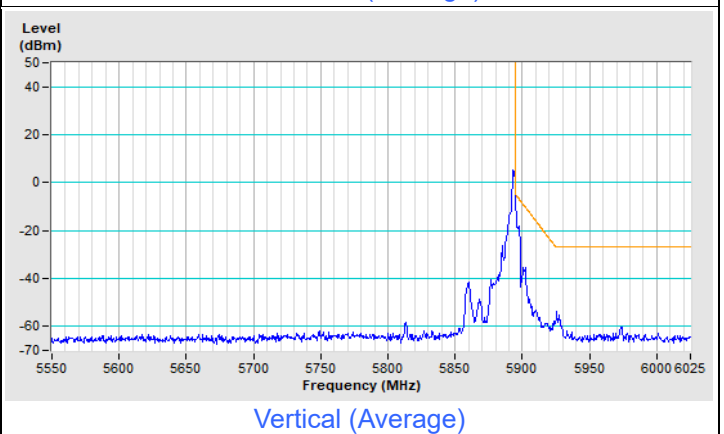
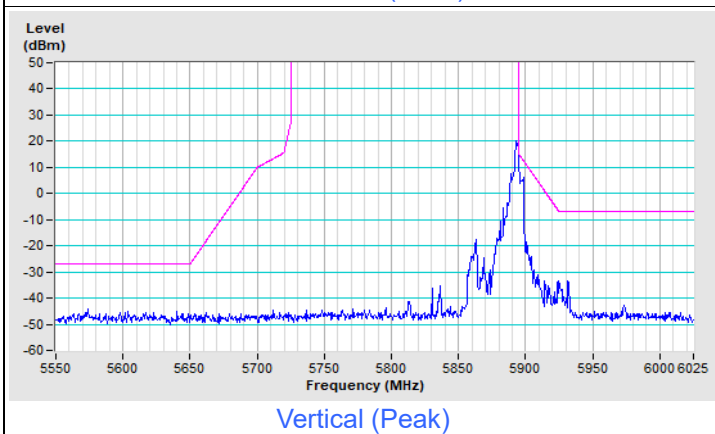
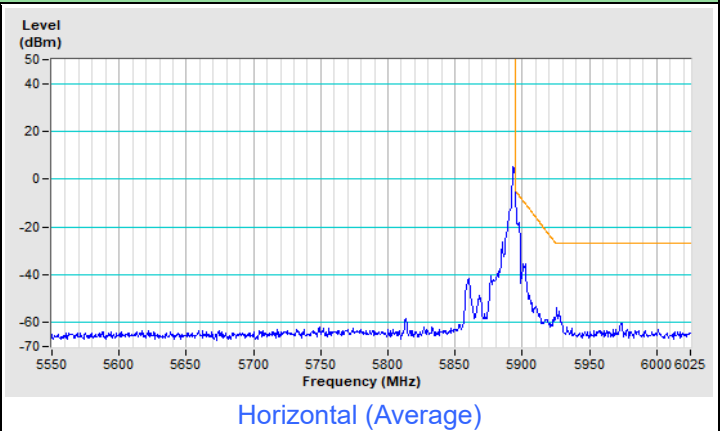
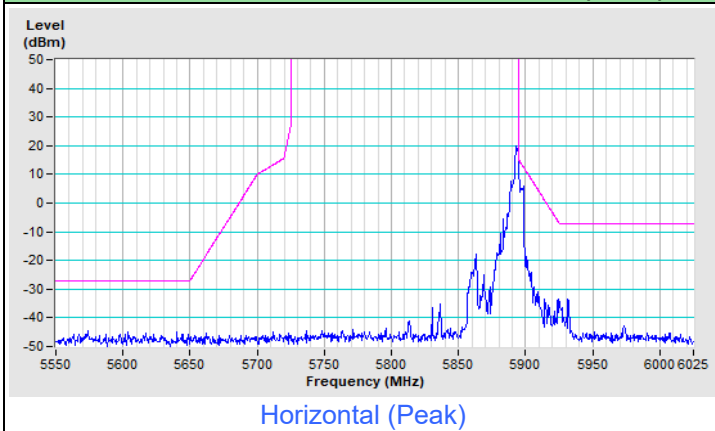



Frequency Range	5.55 GHz ~ 6.025 GHz	Detector Function & Bandwidth	(PK) RB = 1 MHz, VB = 3 MHz (RMS) RB = 1 MHz, VB = 3 MHz
------------------------	----------------------	--	---

802.11ax (HE20) 52-tone RU Channel 169

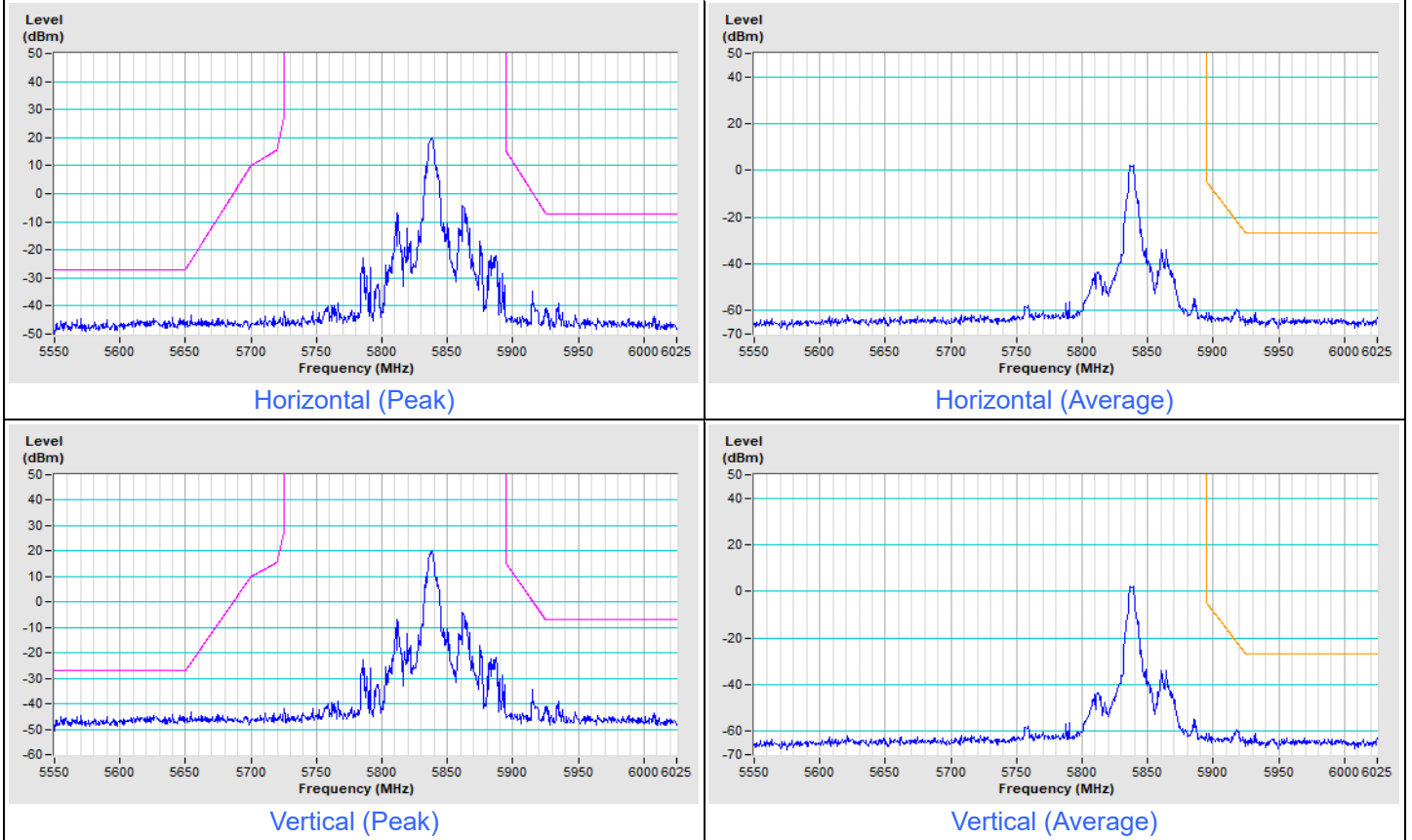

802.11ax (HE20) 52-tone RU Channel 173

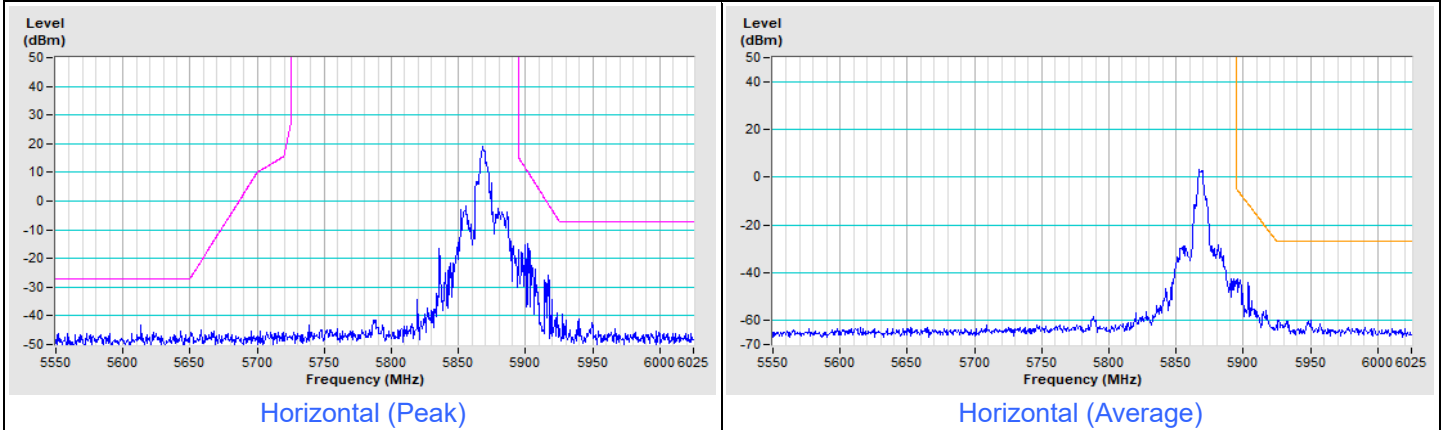

802.11ax (HE20) 52-tone RU Channel 173

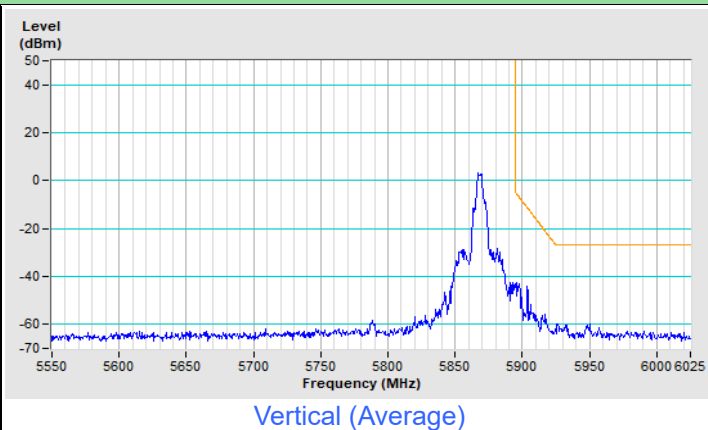
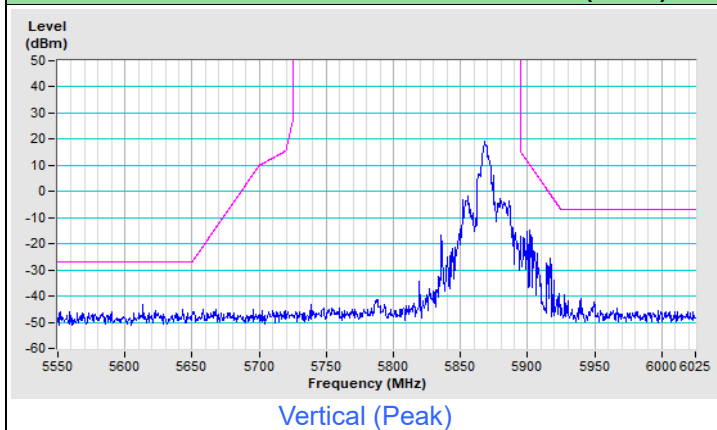

802.11ax (HE20) 52-tone RU Channel 177

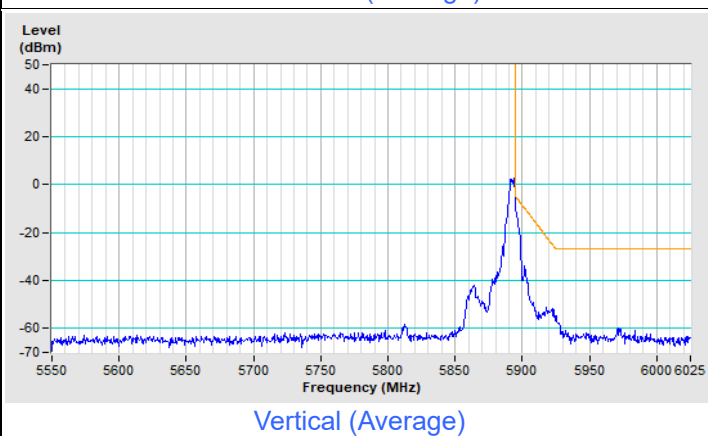
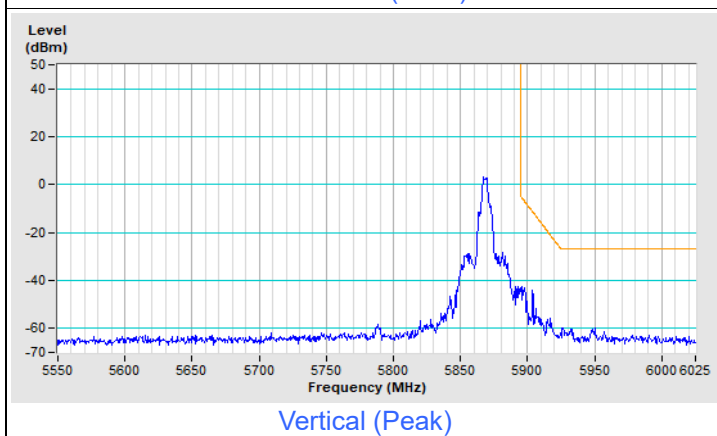
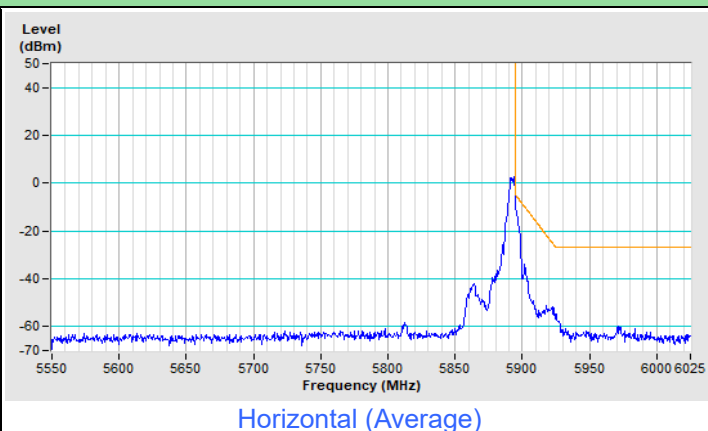
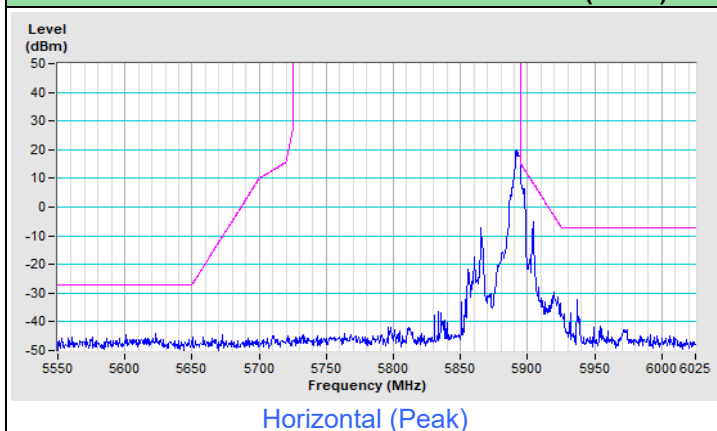



Frequency Range	5.55 GHz ~ 6.025 GHz	Detector Function & Bandwidth	(PK) RB = 1 MHz, VB = 3 MHz (RMS) RB = 1 MHz, VB = 3 MHz
------------------------	----------------------	--	---

802.11ax (HE20) 106-tone RU Channel 169

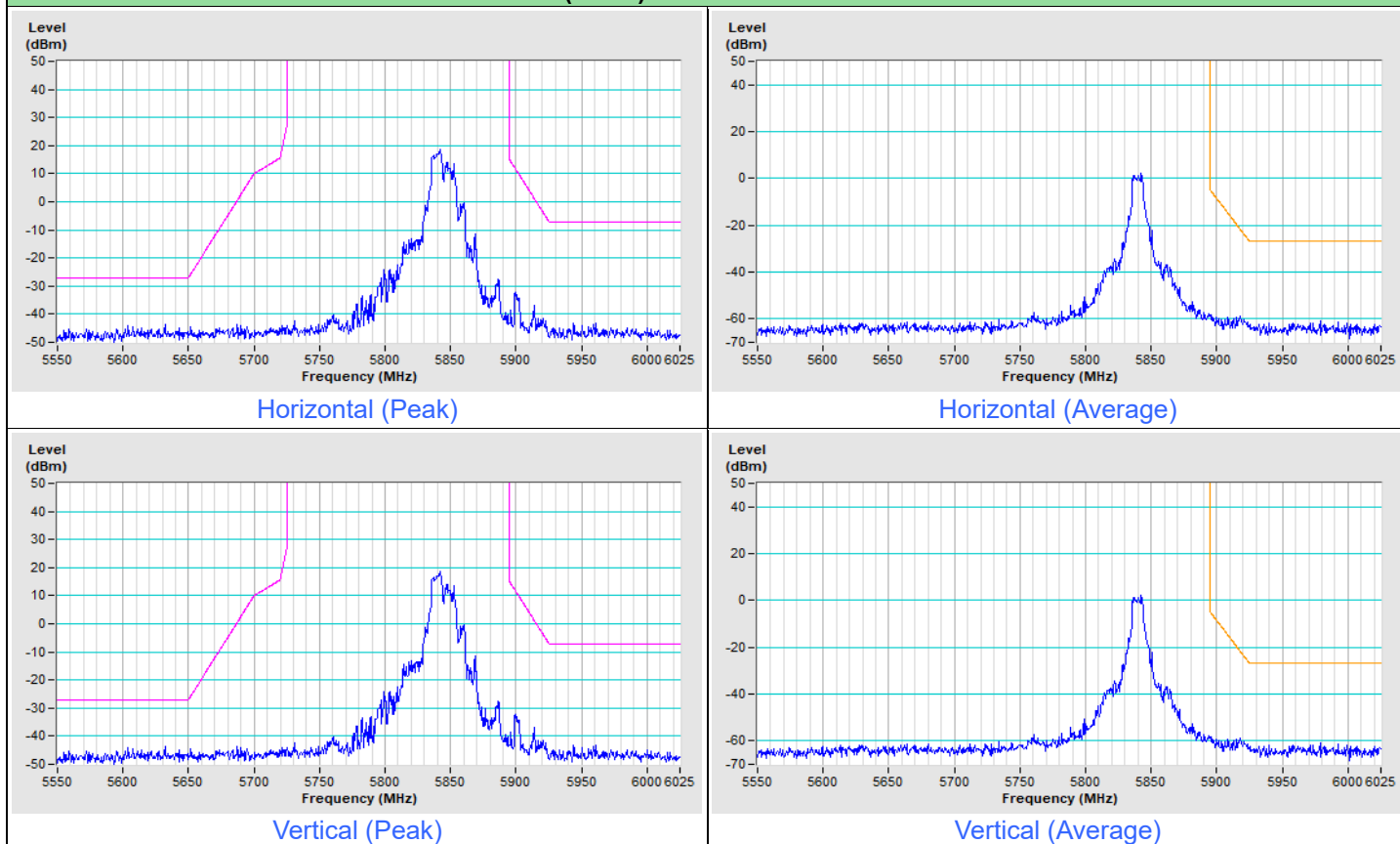

802.11ax (HE20) 106-tone RU Channel 173

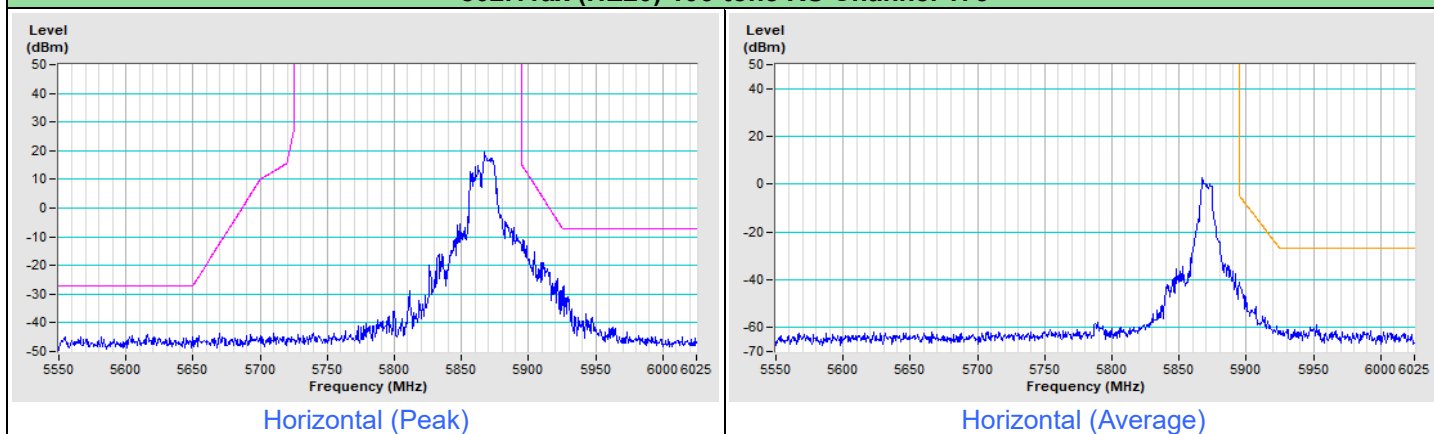

802.11ax (HE20) 106-tone RU Channel 173

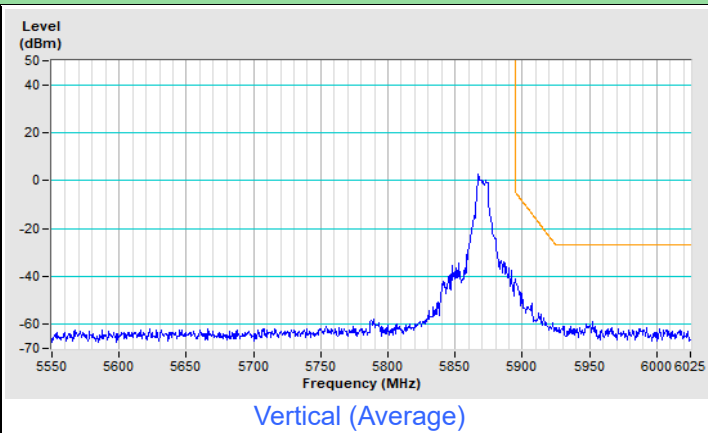
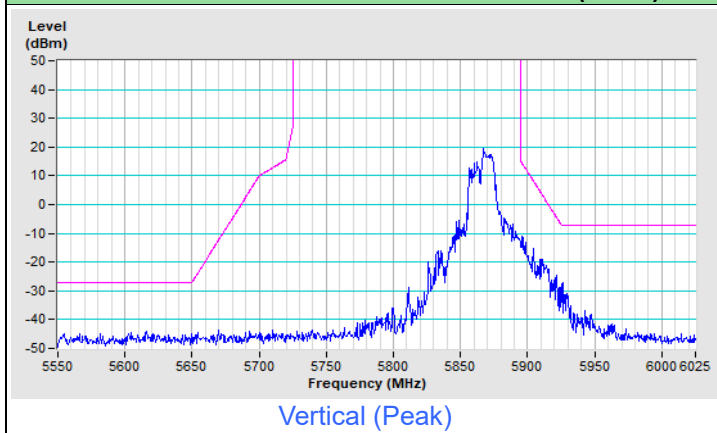

802.11ax (HE20) 106-tone RU Channel 177

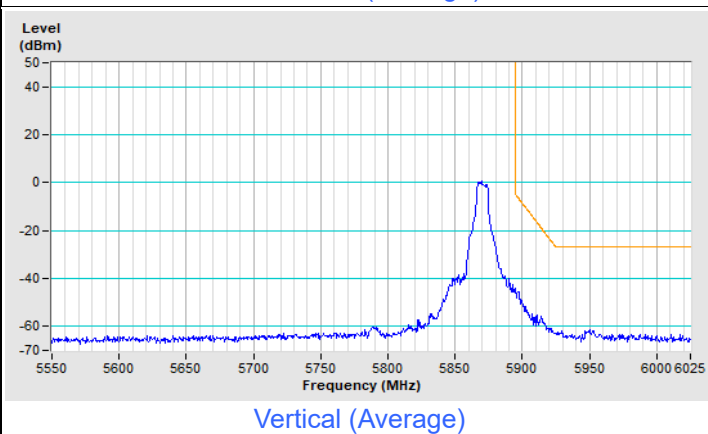
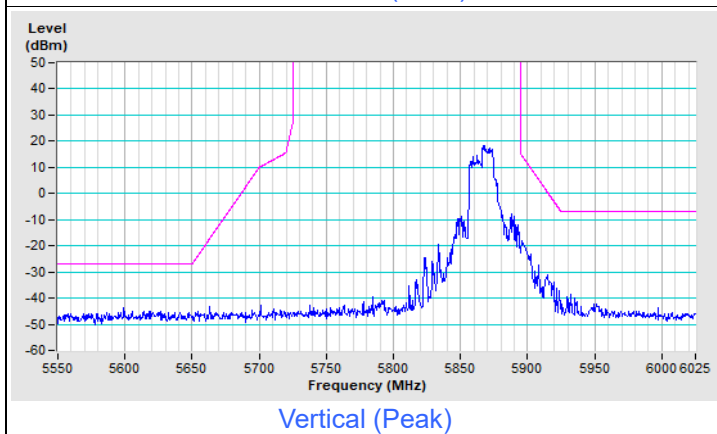
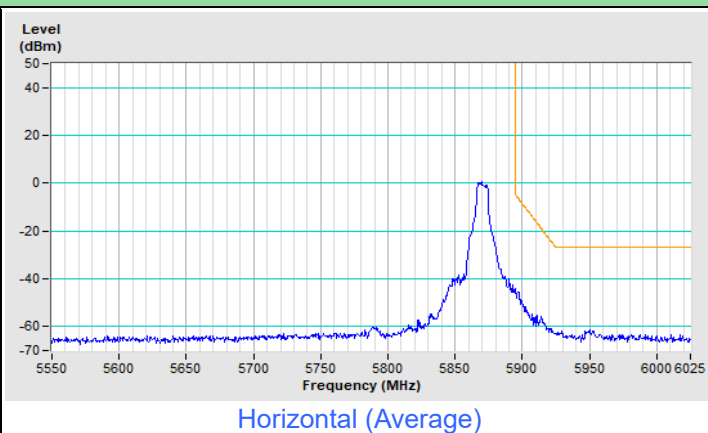
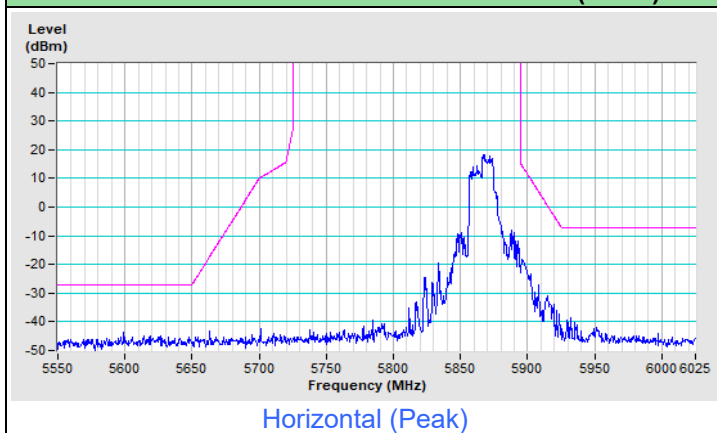

8 Operational Restrictions for 5.85-5.895GHz U-NII Devices

In the 5.850-5.895 GHz band, client devices must operate under the control of an indoor access point. In all cases, an exception exists for transmitting brief messages to an access point when attempting to join its network after detecting a signal that confirms that an access point is operating on a particular channel. Access points may connect to other access points. Client devices are prohibited from connecting directly to another client device.

Device is a Client device, all restrictions are meet the §15.407 requirements. Please refer to the Attestation letter exhibit supplied within this application.

9 Pictures of Test Arrangements

Please refer to the attached file (Test Setup Photo)

10 Information of the Testing Laboratories

We, Bureau Veritas Consumer Products Services (H.K.) Ltd., Taoyuan Branch, were founded in 1988 to provide our best service in EMC, Radio, Telecom and Safety consultation. Our laboratories are FCC recognized accredited test firms and accredited according to ISO/IEC 17025.

If you have any comments, please feel free to contact us at the following:

Lin Kou EMC/RF Lab

Tel: 886-2-26052180

Fax: 886-2-26051924

Hsin Chu EMC/RF/Telecom Lab

Tel: 886-3-6668565

Fax: 886-3-6668323

Hwa Ya EMC/RF/Safety Lab

Tel: 886-3-3183232

Fax: 886-3-3270892

Email: service.adt@bureauveritas.com

Web Site: <http://ee.bureauveritas.com.tw>

The address and road map of all our labs can be found in our web site also.

--- END ---